

January

25 Cents

POPULAR MECHANICS MAGAZINE

WRITTEN SO YOU CAN UNDERSTAND IT

REG'D. TRADE MARK. GREAT BRITAIN. No. 410426

REG. U. S. PAT. OFF.



SEE PAGE 19

It takes *only* 8 weeks to get a big job



O. H. Justus owns a big agency and repair shop at Parkersburg, W. Va. He says "that my schools give motor secrets that will put any man 'on easy street.'"

In the Auto and Tractor Business

Read what these men are doing—here is your big chance to get "on easy street." Come to these great shops on the biggest **FREE** offer ever made.

Big Firms Need Trained Men

The Auto and Tractor Business is on the boom. Thousands of trained men will be needed during the next few months. I get calls every day from Garages, Battery Stations, Auto Repair, Welding Shops and other successful concerns for Rahe men. When the big fellows need high grade men they know where to come for them. They want Rahe trained men.

My Training Unusual

Scientific tool training—that's the secret. You do things here according to the latest engineering standards. Thousands of dollars have been spent in modern tools and equipment. That's why my men are at home in the biggest shops in the country. If you want to succeed the way Beimer and Justus and the rest have—qualify by the same method in only eight weeks or stay as long as you like.



Emanuel Rushfeldt, Alberta, says: "Earning \$10 a day and only 20 years old."

I'll Pay Your Railroad Fare and Board You

In order to fill the openings that now exist, I am making an offer no one has ever made before—**Free Railroad Fare, Free Board for eight weeks.**

SAVE
\$50 to \$75

You Save Big Money by acting now. Pack your grip—get on a train—Come to school right now before it is too late—**OR WRITE TODAY.**



W. W. Pence gets \$250 a month and expenses operating a tractor in the oil fields.

Send for **FREE** Book

My big illustrated training book tells how others are succeeding. It tells many things you ought to know about Autos and Tractors. Write for it and my **short time** offer NOW. It soon expires.

Rahe *Auto & Tractor* Schools

CHICAGO
4445 Grand Blvd.

Dept. 899 CINCINNATI
Ninth and Walnut



Louis Beimer at 24 was made foreman over men many years older. That's not luck—it's Rahe training.



Rahe Auto & Tractor Schools,
Dept. 899, (address school nearest you)
4445 Grand Blvd., or Ninth & Walnut,
Chicago, Ill. Cincinnati, Ohio.

Without any obligation, send me your big free book, "The Evolution of Transportation." Also information regarding special temporary offer.

Name.....

Street.....

City.....State.....

Is this offer too good to be true?

Are we offering a value too great to be credible? Do people "shy" at the thought of receiving too much for their money?

WE recently mailed several thousand circulars to booklovers. We described and pictured these thirty volumes of the Little Leather Library honestly, sincerely, accurately. But we received relatively few orders.

Then we mailed several thousand additional circulars to booklovers, this time enclosing a sample cover of one of the volumes illustrated at right. Orders came in by the hundred! The reason, we believe, is that most people cannot believe we can really offer so great a value *unless they see a sample!*

In this advertisement, naturally, it is impossible for us to show you a sample volume. We must depend on your faith in the advertisements appearing in *Popular-Mechanics*; and we are hoping you will believe what we say, instead of thinking this offer is "too good to be true."

What this offer is

Here, then, is our offer. The illustration at right shows thirty of the world's greatest masterpieces of literature. These include the finest works of such immortal authors as Shakespeare, Kipling, Stevenson, Emerson, Poe, Coleridge, Burns, Omar Khayyam, Macaulay, Lincoln, Washington, Oscar Wilde, Gilbert, Longfellow, Drummond, Conan Doyle, Edward Everett Hale, Thoreau, Tennyson, Browning and others. These are books which no one cares to confess he has not read and reread; books which bear reading a score of times.

Each of these volumes is complete—this is not that abomination, a collection of extracts; the 30 volumes, pocket size contain over 3,000 pages; the paper is a high-grade white wove antique, equal to that used in books selling at \$1.50 to \$2.00; the type is clear and easy to read; the binding, while NOT leather, is a beautiful limp craft, tinted in antique copper and green, and so handsomely embossed as to give it the appearance of hand tooled leather; it is *five times more durable than leather!*

What about the price?

The price of this entire set of thirty volumes, exactly as described and illustrated, is \$2.98 plus postage; please bear in mind that there are NO installment payments—no further payments of any kind!

How can we do it? That is the question most often asked of us. Yet the answer is simple. *These books are produced in editions of a million at a time!* Quantity production—that is the secret.

Free—Four Volumes of Kipling

It is worth our while to give our customers something valuable if they will cooperate with us by sending in their orders at once. That is the reason, the only reason, we offer you, in addition to the regular set of 30 volumes, **FOUR VOLUMES OF RUDYARD KIPLING FREE, IN EXACTLY THE SAME BINDING AS THE REST OF THE SET**—if you will send in your order at once, instead of waiting. These four volumes include his best work. Among them are the following: *The Vampire, and Other Verses; The Man Who Was; The Phantom Rickshaw; A Conference of the Powers; The Recrudescence of Imray; At the End of the Passage; The Mutiny of the Mavericks; My Own True Ghost Story.*

This offer, as you can gather, is simply an experiment. It must not be taken as a precedent. If you want this set of books we urge you to obtain them *now*, instead of *LATER*, so that you can obtain not only the thirty volumes, but the four equally splendid volumes of Kipling. Do not send money. Simply mail the coupon or a letter.

LITTLE LEATHER LIBRARY CORPORATION
Dept. 821, 354 Fourth Ave., New York City



Send No Money

Name.....
Address.....
City..... State.....

Little
Leather
Library
Corporation
Dept. 821
354 Fourth Avenue
New York City

Please send me on approval the 30 volumes of the De Luxe edition of the Little Leather Library (and the four volumes of Kipling free). I will pay the postman \$2.98 plus the postage upon delivery. It is understood, however, that this is not to be considered a purchase. If the books do not in every way come up to expectations, I reserve the right to return them any time within thirty days, and you agree to return my money. It is understood that \$2.98 plus the postage is positively the only payment to be made on this set. (Outside U.S. \$3.50. Cash with order).

"PLANK WITH CYPRESS AND YOU PLANK BUT ONCE."



A Row Boat or a Cruiser

Plank her with non-rot, non-warp, genuine

Tide Water
Cypress
"The Wood Eternal"

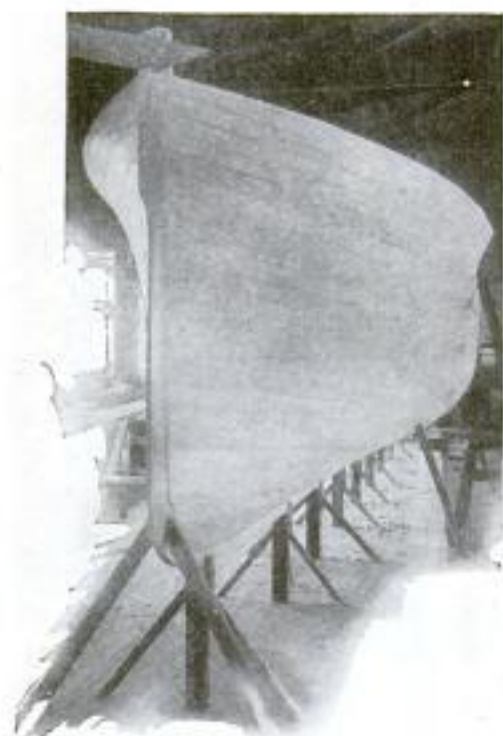

For all marine use SPECIFY "ALL-HEART" GRADE. It assures the boat owner satisfactory service in the highest degree.

He will be immune from the annoyance and expense of oft-recurring repair bills, which take the joy out of boating. "Plank with Cypress and you plank but once." Send for

FREE BOOK *Volume 19*, of the famous Cypress Pocket Library, and get *all the facts* about the good properties of Cypress, the best lumber for boats, big or little. Address:

Your local dealer will supply you. If he hasn't enough Cypress let us know at once.

SOUTHERN CYPRESS Manufacturer's Association

1219 Poydras Bldg., New Orleans, La., or
 1219 Graham Building., Jacksonville, Fla.

Insist on "tide water" Cypress—you can identify it by this mark:



Burching Bay - 43

Popular Mechanics Magazine

6 N. Michigan Avenue, Chicago, U. S. A.

H. H. WINDSOR, Editor

London: Hachette & Cie,
16-17, King William Street, Charing Cross, W. C. 2

Paris: Hachette & Cie,
111 Rue Reaumur

Melbourne, Australia,
The Australasian News Co.

ISSUED MONTHLY

SUBSCRIPTION:

SINGLE COPY, 25 CENTS

In United States and its possessions, also Canada, Cuba, and Mexico, per year, postpaid - \$3.00

To all other countries in the Postal Union 3.50

All subscriptions are discontinued at expiration. Please examine the date printed on your wrapper.

Entered as Second Class Matter Sept. 15, 1903, at the Post Office at Chicago, Illinois, under Act of March 3rd, 1879.
Entered as Second Class Matter at the Post Office Department, Canada.

Published monthly by POPULAR MECHANICS CO.

Copyright, 1922, by H. H. Windsor.

Copyright in Australia.

Vol. 39

Contents for January, 1923

No. 1

| | | | |
|--|-----|--|-----|
| Accident—Coupé Lands Bottom Up..... | 79 | Cribbage Board, Oblong, Has Metal "Pegs"..... | 116 |
| Air Compressor, Portable, of Unusual Design..... | 13 | Cutter, Binder Twine, Aids Grain Threshing..... | 6 |
| Airplane Engine, Self-Cooling, Has Complete Expansion..... | 91 | Date and Stamping Machine Has Signature of User.. | 94 |
| Airplane Fleet, Atlantic, of U. S. Navy..... | 15 | Desert Soil to be Treated with Sulphuric Acid..... | 109 |
| Airplanes, Magnetic Landing Brake for Stopping.... | 1 | Drawing Instruments Aid in Ruling and Lettering.. | 42 |
| Airplanes, Naval, Tested at Detroit Air Meet..... | 23 | Electricity—Electromagnetic Attraction, Duplication of, by H. A. Lane..... | 5 |
| Alarm Clock Lights Alcohol Lamp..... | 49 | Electricity, 1,000,000 Volts of, Photographed..... | 53 |
| Alum, New Process Reclaims, from Filtration Plants. | 119 | Enamels, Improved, Developed for Iron Ware..... | 90 |
| Arc Cutting Tool, Electric, for Rivets..... | 79 | Filing Cabinet Open on Both Sides..... | 91 |
| Automobile Engines, Method of Vapor Cooling..... | 64 | Filter, Self Cleaning, Cleans Cistern Water..... | 117 |
| Automobile Fuel Mixture, Electrically Regulated Air Feed for..... | 96 | Fire Alarm Box, New, Simple to Operate..... | 94 |
| Automobile, Light English, Has Many Merits..... | 69 | Fire Escape, City, Is Home of Bee Families..... | 66 |
| Automobile Pantry Box on Rear Luggage Carrier.... | 70 | Fire Extinguisher, Glass, Easily Handled..... | 124 |
| Automobile Parking System, New, Makes Cars Easily Removable..... | 39 | Fire Hose Shut Off Valve Has New Features..... | 50 |
| Automobile Radiator Fan with Blades Automatically Adjusted..... | 92 | Fish—Bass Caught with Live Mice and Toy Balloons | 58 |
| Automobile Rear Light Signals Safety and Danger... | 73 | Fish—Eels, Strenuous Life of..... | 14 |
| Automobile Rubber Step Mats Cleave to Running Board..... | 87 | Fishing, Strange Method of, in Hawaiian Islands.... | 108 |
| Automobile, Small, Leaps over 15 Foot House..... | 101 | Flanging Press, Hydraulic, Has Simple Control..... | 117 |
| Automobile Tourists, Traveling Homes for, Manufactured in Standard Models..... | 88 | Flax Pulling Machine Supersedes Hand Labor..... | 102 |
| Automobiles, Postal, Cross Alpine Passes..... | 2 | Floor Blocks, Cement, Serve as Measure in Store... 78 | |
| Automotive Course, Egyptian Officials Arrive for... | 52 | Floor Oiler, Hardwood, Sprays by Air Pressure.... | 96 |
| Banjos and Drums, Two Novelties for Use on..... | 90 | Flying Field, Largest, Planned for Dayton, Ohio.... | 120 |
| Bears, Mushing with in Alaska, by Stratford F. Corbett..... | 18 | Food, Digestibility of, Tested in Glass Container.... | 103 |
| Bedpost Apparatus Records Moves of Sleeper..... | 85 | Fountains, Rude, Built along California Road..... | 39 |
| Belting, Cotton Fabric, Made by Chemical Process. | 26 | Furnace Electrode, Electric, Is Self Baked and Renewable..... | 60 |
| Boat—Barge, Nonsinkable, Made of Balsa Wood.... | 28 | Fuse, Renewable, Plug Type, Has Indicating Lamp.. | 26 |
| Boat—Schooner, Canadian, Winner of Championship Trophy..... | 117 | Gas Burner, New, Protects Fixtures and Ceiling.... | 113 |
| Boats—Scows, Large Steel, for Use on Lakes of Maine | 49 | Gas Burner with Air Blast Gives High Temperature. | 42 |
| Bolt Heads, Small, Painting in Large Quantities... | 55 | Gas Danger, Added Odor Gives Warning of..... | 6 |
| Bottles Corked and Sealed by New Machine..... | 80 | Gas, Explosive, Mixture Reduces Hazards of..... | 118 |
| Bowling Game, Giant, Invented by U. S. Marines... | 69 | Golf Course Sand, Soil, and Humus Mixer Driven by Gas Engine..... | 90 |
| Bridge, American Bascule, for Tientsin, China..... | 4 | Golf Machine for Practicing Indoors or Out..... | 72 |
| Bridge, Runaway Logs Carry, down Canadian Stream | 85 | Golf School, Outdoor, in London Public Park..... | 65 |
| Bridges, Skew Arch, Measuring Strains and Stresses for..... | 77 | Grain Bins, Knockdown, of Wired Boards..... | 74 |
| Buffalo Stampede, Filming a..... | 37 | Grate Bars, Alloy Steel, Prove Economical..... | 80 |
| Building—Apartment House Project to Cost \$30,000,000..... | 61 | Gun, Four Barreled, Rifle and Shotgun Combined in Harbor Extensions, Several, at Auckland, New Zealand..... | 104 |
| Café Boards, Special, Serve Patrons in Autos..... | 71 | Highway, Dredging from Mobile Bay to Make..... | 36 |
| Camp Table and Chairs Carried in Neat Kit..... | 119 | Highways, Illinois, Safety Signs along, by R. Franklin Mundorf..... | 67 |
| Children's Picture Pages..... | 122 | Hoist, Charging, Effects Economy in Foundries.... | 58 |
| Chinaware, New Device for Painting Lines on..... | 94 | Hoist Hook, Safety, Cannot Unlock When Loaded.. | 119 |
| Chocolate Packing Box, Air Insulated, Protects from Heat..... | 39 | Hotel, Apartment, Balconies in Courtyard Beautify House, Concrete, cannot be Told from Wood..... | 45 |
| Church, Old Brick, Restored with Veneer of Concrete City Hall, Local, for Philadelphia Suburb..... | 54 | Household Devices..... | 114 |
| City, Plague Proof, in India, by J. H. Stephens.... | 7 | Hydrogliders, New Models of, by R. C. Folger.... | 56 |
| Civic Features..... | 110 | Ice House Condenser Built of Creosoted Lumber.... | 34 |
| Clamp, Efficient Grounding, for Electrical Work.... | 124 | Inclinometer of Unusual Accuracy..... | 70 |
| Clock, Tickless, Operates on New Principle..... | 34 | Insurance Policies, Daily, Sold by Slot Machines... | 94 |
| Coal Chutes, New Cast Iron, with Wire Glass Doors | 44 | Ironing Board Support, Convenient, Is Also Table.. | 64 |
| Collar Cloth, Linenlike, Is Easily Cleaned..... | 116 | Irrigation Dam, Semicircular Concrete..... | 86 |
| Coal Dust Ignition, Electric Arc Proven a Source of Comment and Review, by H. H. Windsor..... | 29 | Irrigation Project for Reclaiming Yuma Land, by Geo. F. Paul..... | 75 |
| Corn Lister Plants Four Rows at One Time..... | 33 | Jewels, Phosphorescent, for "Pearl" Dance..... | 35 |
| Corn Harvester, Homemade, Run by One Man..... | 36 | Ladders, Steel Tubular, Have Many Merits..... | 116 |
| Crane, Locomotive Type, Mounted on Motor Truck.. | 73 | Lamp Arms, Self-Adjusting, for Localized Lighting. | 60 |
| Crane, Navy, to Have World's Largest Luffing Screws | 108 | Lepers' Colony, Donation to, by Knights of Pythias.. | 113 |
| Crane, New Crawler Type, Operates in Swamp..... | 43 | Loader, Improved, Has Self-Contained Drive..... | 51 |
| | | Lock and Alarm Combined Has Bell and Light.... | 10 |
| | | Machinery Rapidly Removed and Instantly Installed Map, Aerial Mosaic, Shows Marvelous Detail, by Geo. F. Paul..... | 107 |
| | | Memorials, New..... | 40 |

[Continued on Page 4]

This One



G1E3-W7Z-WNQP

aterial

[Contents—Continued]

| | | | |
|---|-----|---|-----|
| Micrometer Case, Handy, Protects Instrument..... | 61 | Waterfall Slide for Sport in South Sea Isle..... | 64 |
| Micrometer Gauge, Inside, Is Self-Alining and Centering..... | 10 | Wheel, Novel, for Transporting Small Loads..... | 52 |
| Mine Car Stops on Grade if Rope Breaks, by Geo. F. Paul..... | 27 | Window Screen, Adjustable, Is Close Fitting..... | 124 |
| Miners, Entrapped, Hints to, by Bureau of Mines..... | 164 | Windows, Display, Woman Makes Home behind..... | 84 |
| Motion Picture Screen, New, Reduces Glare and Eye-strain..... | 95 | Wire Insulation, Burning of, Presents Odd Sight..... | 124 |
| Motion Pictures, Making at Summit of Mt. Hood..... | 24 | Wireless Caravan Advertises World's Fair..... | 112 |
| Motion Pictures, "Storm Machine" on Wheels for..... | 86 | Wireless, Field, Hand Cranked Generator Used in..... | 44 |
| Motor Bus, Drawing Room Incorporated in..... | 15 | Wireless Lightning Arrester Has Inclosed Gaps..... | 109 |
| Motor Bus Speaking Tube Is Aid to Driver..... | 64 | Wireless Meters, Tiny, Fit Panel Peepholes..... | 80 |
| Motor Truck Engines, Frame for, Facilitates Repairs..... | 59 | Wireless Outfit, Compact and Portable..... | 106 |
| Motor Trucks, Mired, Wheel Attachment Lifts..... | 106 | Wireless Service, New, to London and Germany..... | 96 |
| Motorboats, Speedy, Manned by Game Wardens..... | 51 | Wireless Set, "Reflex," Three Tubes Work as Six in..... | 22 |
| Motorcycle Guard Clamped under Engine..... | 38 | Wireless, Teaching Deaf and Dumb by, by H. H. Dunn..... | 81 |
| Mountain Road, 18 Mile One Way, to Mt. Mitchell..... | 121 | Wireless Vacuum Tubes, High Powered..... | 54 |
| Oil Tank, Huge, Set on Fire by Electric Drill..... | 20 | Wood, Hard Synthetic, Made from Cellulose..... | 66 |
| Paper Clasp, Pliable Steel, Useful in Office..... | 17 | Woods, Small, on Mountain Conserve Moisture..... | 113 |
| Pearls, Many American, Sold to Women of India..... | 109 | Wrench, Simple Pipe, Made in Three Parts..... | 116 |
| Pen, Ordinary Steel, Detachable Ink Fountain for..... | 119 | | |
| Phonograph Records, Playing Time Increased on..... | 20 | SHOP NOTES | |
| Photography, Exposure Meter Simplifies..... | 22 | Automobile Wheels, Device for Alining..... | 143 |
| Picture of Bear Realistically Embroidered by Artist..... | 70 | Automobile Wheels, Rear, How to Remove..... | 138 |
| Picture of Rural Life Made of Human Hair..... | 74 | Axle Housing, Cracked, Pressing Off..... | 138 |
| Pigs, Suckling, Collar for, Prevents Suffocation by Sow..... | 10 | Batteries, Hooks on Terminal Tonga Lift..... | 140 |
| Pipes, Welded Steel, Hydraulic Testing Machine for..... | 11 | Bench Shear for Small Shop..... | 139 |
| Piston Rings, Compressor for Insertion of..... | 124 | Brackets, Attaching to Irregular Surfaces..... | 136 |
| Piston Vise, Gas Engine, for Use in Garages..... | 34 | Business Cards, Gummed..... | 141 |
| Plow, Subsoiling Attachment for..... | 74 | Center Testers Made to Magnify Errors..... | 144 |
| Police, German, to Wear Bullet Proof Armor..... | 60 | Concrete, How to Color..... | 134 |
| Potato Digging and Loading Machine Combined..... | 11 | Crimping Tool for Tinner..... | 137 |
| Prize Offers..... | 163 | Draftsmen, Cross Section Paper Aids..... | 139 |
| Punch Press Operated by Foot or Power..... | 10 | Drip Can, Oil, for Use on Tapping Machine..... | 126 |
| Radiator, Legless, Supported by New Attachment..... | 112 | Driveways, Concrete Wheel Ways for, Serve as Gutters..... | 130 |
| Railroad—Locomotive, First Electric, for Britain's Main Line..... | 55 | Garbage Cans, Inclosure for..... | 129 |
| Railroad—Locomotives, New Passenger, Are Large and Powerful..... | 72 | Gate, Combination, for Farmyard..... | 128 |
| Reclamation Work, Bombay, India, Extended by..... | 21 | Gauge, Vacuum, Made from Pressure Gauge..... | 128 |
| Records, Burned, New Method of Deciphering..... | 50 | Gauges Made of Steel Tubing..... | 143 |
| Rescue Work, Novel, of Recovering Bodies from Well..... | 14 | Ice, Imitation, for Window Displays..... | 127 |
| Road, Automobile, Church Furnishes Stone for..... | 21 | Ladder Wedge Prevents Slipping..... | 130 |
| Road to "Big Tree" Country Difficult to Build..... | 48 | Lathe Chuck for Threaded Work..... | 140 |
| Road, \$7,000,000, to Relieve Traffic Jam, by Robert Morgan..... | 93 | Lathe Faceplate Work, Locating Arm for..... | 130 |
| Road-Building Equipment, Modern, Adapted by Siam..... | 33 | Logs, How to Handle Easily..... | 137 |
| Safes, Reinforced Concrete, Fireproof and Portable..... | 71 | Mail Box Post, Rural, Made of Concrete..... | 125 |
| Sawmill, Portable, Built on Old Motor Car..... | 102 | Maps, Base for Mounting..... | 130 |
| Screw and Nut Setting Tool, Motor Driven..... | 92 | Molds and Ladles, Ingot, Heating and Drying..... | 136 |
| Seaplane—Quadriplane, French, Has Original Features..... | 13 | Motion Pictures, Reflector for, Aids Pianist..... | 144 |
| Ship Driven against Wind by Wind-Driven Turbine..... | 101 | Nuts, Tool for Loosening..... | 137 |
| Ship "Majestic" Nosed to Pier by 18 Tugs..... | 16 | Oxygen Cylinders, Device for Rolling..... | 144 |
| Ship, Rebuilt, Is American Legion Clubhouse..... | 95 | Pipe, Setting in Concrete..... | 128 |
| Ship—Steamship, World's Largest, Drydocked at Boston..... | 17 | Plane Bits, Protection While Inserting..... | 138 |
| Ships, Wrecks of, in Widely Separated Localities..... | 62 | Plug Cocks, Grinder for..... | 141 |
| Shipyards, One Man, by L. R. Perry..... | 97 | Poultry Houses, Automatic Ventilator for..... | 127 |
| Shoe, Nonslipping Spiked, for Firemen..... | 6 | Pricker for Draftsmen..... | 129 |
| Sign, Attractive Electric, for Interior Display..... | 72 | Punch Presses, Stock Oiling Device for..... | 142 |
| Soot Blower Cleans Tubes with Sand Blast..... | 120 | Reamer, Bent, How to Straighten..... | 138 |
| Spark Plug, Carbon Proof, Has Radiating Pins..... | 96 | Rivets, Steel, Damage Brake Drums..... | 126 |
| Spark Plug Cleaner Also Used as Gauge..... | 109 | Sand, Method of Clearing from Loading Tracks..... | 127 |
| Spark Plug, New Separable, Easily Cleaned..... | 60 | Saws, Circular, Finger Guard for..... | 135 |
| Speed Indicator, Convenient, of Simple Design..... | 113 | Scale Holder for Lathe Use..... | 126 |
| Steam Valve Has No Packing and Renewable Parts..... | 104 | Signs, Reversing and Duplicating Tool for..... | 142 |
| Steel, Special, Identified by Thermoelectric Test..... | 120 | Sling, Safe, for Handling Heavy Bars..... | 141 |
| Stereoscopic Device Aids Motion Study..... | 52 | Soil, Crusted, Homemade Implement for Breaking..... | 135 |
| Stock Piles, High, Heavy Trucks Used to Build..... | 83 | Soldering Bit, Small, Easily Made..... | 140 |
| Stone, Peculiar, Resembles Human Workmanship..... | 59 | Soldering Vertical Seams..... | 136 |
| Street Car Rails 420 Feet Long, Laying..... | 26 | Spark Plug Tester Protects Ignition Coil..... | 129 |
| Subway Fare Boxes, Attachment on, Displays Bogus Coins..... | 121 | Stud Tool, Improved..... | 138 |
| Suction Pumps, Valveless, Novel Type..... | 44 | Tables, Attachable, for Serving Customers in Autos..... | 141 |
| Switch, Motor Operated Snap, Has Wide Application..... | 103 | Tools, Preventing from Rusting..... | 142 |
| Table, Correct Posture, Relieves Fatigue..... | 6 | Tracings, Worn, How to Mend..... | 137 |
| Tag Marker, Novel Metal, Saves Time..... | 78 | Tractor, Small Garden, How to Make..... | 131 |
| Tank, New Type Storage, Saves Oil..... | 84 | Vise for Holding Small Screws..... | 134 |
| Tennis Balls Carried on Racket by Spring..... | 112 | Vise, Tray under, Catches Small Pieces..... | 140 |
| Theater Stage-to-Dressing Room Call System Invented by Actor..... | 2 | Washers and Sleeves, How to Saw Slots in..... | 129 |
| Tire Inflator, Automatic, Handy for Autoist..... | 52 | Wireless Switches, Action of, Improved by Vaseline..... | 144 |
| Tobacco Pouch Has Pad to Moistens Contents..... | 101 | | |
| Turbines Made Noiseless by Means of Insulation..... | 80 | AMATEUR MECHANICS | |
| Turkeys, Large Flock of, Walked to Market..... | 44 | Ash Receiver, Small, Easily Made..... | 161 |
| Valve, Recessed Flexible, for Pneumatic Tubes..... | 120 | Automobile Headlamp Rims, Wrench for..... | 150 |
| Wallpaper Machine Trims and Pastes..... | 13 | Automobile Hood Holder..... | 155 |
| Watch, Scarf Pin, Smaller Than Dime..... | 92 | Automobile, "Jib" Curtains for..... | 162 |
| Water Engine, New, Utilizes Low Heads Efficiently..... | 118 | Boat, Small, Method of Towing..... | 155 |
| | | Bookmark, Simple, How to Make..... | 150 |
| | | Chicken Brooder, Inexpensive..... | 161 |
| | | Christmas Tree, Lighting Transformer for..... | 153 |
| | | Churn Made from Sirup Pail..... | 156 |
| | | Cider Press, Improvised..... | 146 |
| | | Creeper for Painters..... | 145 |

DRAKE'S PRACTICAL MECHANICAL BOOKS

THEY WILL RAISE YOUR PAY—

ORDER ON 5-DAY TRIAL

The books listed below will perfect you in your chosen trade — pave the way to the big positions. Written in non-technical language—easy to read and understand. *Every book covers its subject completely. An entire course of instruction condensed into one volume.* Your choice sent postpaid — you benefit 5 days — money refunded in full if not entirely satisfactory. Order direct from this page.

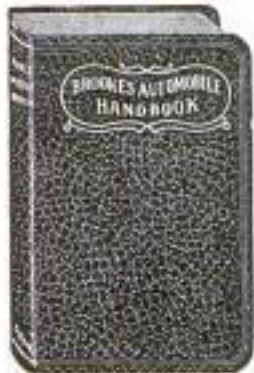

Automobile Books

- Automobile Ignition, by ManlyLeatherette \$2.00
 Automobile Starting and Lighting, by Manly.....Leatherette \$2.00
 Brookes' Automobile Handbook.....Leatherette \$2.00
 Ford Motor Car, Truck and Tractor, by Manly.....Cloth \$1.50
 Starting and Lighting Troubles, Remedies and Repairs, by ManlyLeatherette \$3.00
 Automobile Battery, Care and Repair, by Manly.....Leatherette \$2.00
 Automobile Catechism and Repair Manual.....Leatherette \$1.50
 Tires and Vulcanizing, by TurfordCloth \$2.00
 Gas and Oil Engine Handbook.....Cloth \$1.50
 Automobile Upkeep and Care, by Manly.....Cloth \$1.50
 Motorcycle Handbook, by Manly.....Cloth \$1.50

Shop Practice Books

- Sheet Metal Workers' Manual.....Leatherette \$2.00
 Oxy-Acetylene Welding and CuttingCloth \$1.25
 Slide Rule and Logarithmic TablesLeatherette \$2.00
 Handbook for Millwrights.....Cloth \$2.00
 Modern Blacksmithing.....Cloth \$1.25
 Machine Shop Practice.....Cloth \$2.00

- Mechanical Drawing and Machine DesignCloth \$2.00
 Pattern Making.....Cloth \$1.50

Carpentry Books

- Cloth Binding
 Modern Carpentry, 2 vols.....\$3.00
 The Steel Square, 2 vols.....\$3.00
 Wooden Boat and Shipbuilding.....\$1.50
 Modern Estimator\$1.50
 Timber Framing\$2.00
 Builder's Architectural Drawing.....\$2.00
 Concrete\$1.50
 Practical Bungalows\$1.00
 Low Cost Homes.....\$1.00
 Roof Framing, by Van Gasbeek.....\$1.50
 Stair Building and Hand Railing\$1.50

Electrical Books

- Practical Applied Electricity.....\$2.00
 Alternating Current\$1.50
 Electric Motor Control Systems.....\$1.50
 Wiring Diagrams and Descriptions\$1.50
 Electrical Tables and Data.....\$1.50
 Armature and Magnet Winding.....\$1.50
 Modern Electrical Construction.....\$1.50
 Modern Electric Illumination.....\$1.50
 Electricians' Operating and Testing\$1.50
 Motion Picture Operation.....\$1.50
 Drake's Electrical Dictionary.....\$1.50
 Electric Motors, D. & A.....\$1.50
 Electrical Measurements and Meter Testing\$1.50
 Drake's Telephone Handbook.....\$1.50
 Easy Experiments.....Cloth \$1.25
 Wireless Telegraph and Telephone Handbook.....Cloth \$1.25
 Telegraphy Self-Taught.....Cloth \$1.25

Steam Engineering

- Swingle's Handbook for Steam Engineers and Electricians.....Leatherette \$4.00
 Examination Questions and Answers for Marine and Stationary Engineers.....Leatherette \$2.00
 Steam Boilers.....Leatherette \$2.00
 Swingle's Catechism of Steam, Gas and Electrical EngineeringLeatherette \$1.50

Painting Books

- Scene Painting and Bulletin ArtCloth \$4.00
 A Show at Sho' Cards.....Cloth \$4.00
 Sign PaintingCloth \$4.00
 Strong's Book of Designs.....Leatherette \$4.00
 Strong's Art of Show Card WritingCloth \$4.00
 Signist's Alphabets.....Cloth \$1.50
 Modern Painter's Cyclopedia.....Cloth \$2.00
 Automobile Painting.....Cloth \$1.50
 Estimates, Costs and Profits, Painting and Decorating.....Cloth \$1.50
 New Hardwood Finishing.....Cloth \$1.50
 The Amateur Artist.....Cloth \$1.50
 New StencilsCloth \$1.25
 Chalk Talk and Crayon PresentationCloth \$1.25

Farm Books

- Farm Mechanics.....Cloth \$1.25
 Farm Buildings.....Cloth \$1.25
 Farm Engines.....Cloth \$1.25
 Traction Farming.....Cloth \$1.50

Business and Reference Books

- Better Business Letters.....Cloth \$1.00
 Better Business English.....Cloth \$1.00
 Better Advertising.....Cloth \$1.00
 Finger Prints Simplified.....Cloth \$2.00
 Practical Bricklaying.....Cloth \$1.25
 Practical Instruction for DetectivesCloth \$1.00
 Practical PlumbingCloth \$1.50
 Hot Water Heating.....Cloth \$1.50
 Elementary Chemistry.....Cloth \$1.50
 Courses in Civil Service.....Cloth \$1.50
 Cyclopedia of Recipes.....Cloth \$1.50
 American Star Speaker.....Cloth \$1.50

Modern Languages

- By Prof. P. S. Allen, U. of Chicago
 French without a Teacher.....Cloth \$1.25
 Spanish without a Teacher.....Cloth \$1.25
 German without a Teacher.....Cloth \$1.25
 Everyday French.....\$1.25
 Everyday Spanish.....\$1.25

ORDER DIRECT FROM THIS PAGE—ON OUR MONEY-BACK PLAN

The books listed above are only a few of the many in our catalogue, which you will receive promptly after filling out and mailing us the attached coupon. For quick action order direct from this page—cross name of each book wanted and send in with price quoted. We prepay postage and send the books on our money-back plan.

FREDERICK J. DRAKE & CO.

PUBLISHERS

1008 Michigan Ave., Chicago

Drake Books Are For Sale at All Book Stores

FREDERICK J. DRAKE & CO.
 1008 Michigan Avenue
 Chicago, Ill.

GENTLEMEN:—Please send me free, postage paid, your illustrated catalogue which lists and describes over 100 Practical Mechanical Books for Home Study.

My name is

and my address

Mail Coupon For Free Catalogue
 Your Guide to Home Study

Agents

**"Ye Gods,
—some seller!
I made \$215 to-day"**
—writes Bentley

The Oliver Oil-Gas Burner

does away with coal and wood. Burns 95% air—5% oil. Turns any range, furnace or stove into a gas stove. 16 different models. Burns kerosene (coal oil). Gives much or little heat by simply turning valve. Think of the appeal you can make in every community. Solves fuel problem. Cheaper than coal, wood or gas—absolutely safe. Does away with drudgery—no fires to make, no ashes, dirt, smoke, chopping, carrying coal and wood. Easy to install. Doesn't change stove. Protects health. Easy to demonstrate—slips in or out of stove in one minute. Show any woman what it will do right in her own home and sale is made. Big demand all year. Let the fuel shortage make you big money.

Big profit. Some Oliver agents earn as high as \$1000 per month. \$21 a day is easy.

Free Sample Case Offer
and book "New Kind of Heat"
Write for them now.

Oliver Oil-Gas Burner & Machine Co.
Oldest, largest Manufacturers Oil-Gas Burners in the world.
2014-M Oliver Building,
ST. LOUIS, MO.



Read what these Oliver agents say:

\$660 a month
"Have averaged \$660 profit a month for last six months."
A. M. Russell, Conn.

\$1000 in 4 weeks
"Am making \$1000 per month. I have made big money before, but did not expect so much. Your Burner is just the thing."
J. Carnegie, S. Dak.

Buy car with profit
"Have earned enough in one month to buy me a new auto."
S. W. Knappen, Col.

Sells like beer in a dry town
"Am sending today for seven Oliver's. This is one day's orders (\$85 profit). Selling like beer in a dry town."
W. H. Drew, Mich.

\$43 in one evening
I made \$43 last night.
N. B. Chelan, Wash.

[Contents—Continued from Page 4]

| | |
|--|-----|
| Door Spring Combined with Hinges..... | 156 |
| Electric Lamps, Repair for..... | 147 |
| Fenders, Loose Truck, Bolt for..... | 152 |
| File Board Facilitates Binding of Papers..... | 148 |
| Fishhook, Emergency..... | 155 |
| Flower Holder Made from Olive Bottle..... | 152 |
| Fluid, How to Pour in Small Receptacles..... | 150 |
| Furnace, Increasing Efficiency of..... | 146 |
| Games of Chance, Spinning Dial for..... | 152 |
| Gate Hinge, Practical, How to Make..... | 146 |
| Glass, How to Write on..... | 160 |
| Glue, Strong Waterproof, How to Make..... | 161 |
| Hinges, Detaching Quickly..... | 161 |
| Key Holder, Novel..... | 161 |
| Ladder Rungs, Non-slip..... | 151 |
| Lighting Fixture, Novel, for Porch..... | 148 |
| Magneto Magnets, Testing Strength of..... | 158 |
| Motor, Electric Fan, Utilizing..... | 158 |
| Pen, Shading, Draws Borders..... | 155 |
| Photograph Cabinet, Easily Made..... | 151 |
| Pistol, Preventing Corrosion of, in Holster..... | 162 |
| Roller Coaster for Skaters..... | 145 |
| Sadrons, Heating Quickly..... | 148 |
| Shelves, Drained, for Flowerpots..... | 147 |
| Sled, Novel Type, for Children..... | 155 |
| Stove Fire Boxes, How to Line..... | 152 |
| Table, Card, How to Re-Cover..... | 156 |
| Telephone Bell, How to Muffle Sound of..... | 156 |
| Tire Blow Out Patch Holder for Replacing on Rim.. | 147 |
| Toy—Push Car, How to Make..... | 159 |
| Toy—Tractor, How to Make..... | 157 |
| Toy—Waltzing Doll Wagon, How to Make..... | 160 |
| Wireless Antenna, House Lighting Circuit Used as.. | 162 |
| Wireless Wave Trap..... | 160 |
| Xylophone, How to Make..... | 149 |

LEARN TO GET DOLLARS OUT OF WATCHES.
WATCH-REPAIRING, ENGRAVING, JEWELRY REPAIRING.

WRITE NOW.

AMERICAN TRADE SCHOOL
830 W. MONUMENT SQUARE, RACINE, WIS.

COYNE

LEARN ELECTRICITY AT

SEE OUR AD ON BACK COVER

HOW TO PAINT Signs and Sho-Cards

MEN! Learn the Sign and Sho' Card business. Become independent. Easy to learn. Pays big money. Our remarkable book gives complete instructions.

STOREKEEPERS: This book will quickly teach you how to make your own signs.

CONTENTS: Alphabets, Colors, HOW TO MIX PAINTS, Show Cards, Window Signs, Banners, Board and Wall Signs, Ready Made Letters, Gliding, Commercial Art and Tricks of the Trade. Contains 100 alphabets and designs. Bound in flexible imitation leather, gold edges. \$2.00 postpaid or C. O. D.

OGLIVIE INSTITUTE
57 Ross St. Dept. 5 New York



Learn Autos and Tractors

Wonderful opportunities constantly offered trained men; we train you thoroughly to start your own business or make good money as motor expert, driver, shop foreman, etc.

7,000 Graduates making good. Catalog Free

Cleveland Automobile School, 1814 E. 24th St., Cleveland, O.

"BECOME A LIGHTNING TRICK CARTOONIST"

MAKE MONEY CHALK TALKING. SEND \$1.00 FOR SNAPPY PROGRAM OF TRICK DRAWINGS WITH INSTRUCTIONS BY A PROFESSIONAL CARTOONIST. SATISFACTION GUARANTEED. CIRCULAR FREE. BALDA ART SERVICE, QT. OSHKOSH WIS.

GOV'T JOBS OPEN

Railway Mail Clerks, City Carriers, Rural Carriers, City Postal Clerks, Clerks at Washington, D. C.

\$1400 to \$2300 a Year Steady, Short Hours, Long vacations with pay.

MEN - WOMEN OVER 17

Send coupon immediately for full list of positions now open to you. Don't delay.

FRANKLIN INSTITUTE Dept. L179 Rochester, N. Y.

FRANKLIN INSTITUTE, Dept. L179, Rochester, N. Y.

Gentlemen: Kindly send me, at once, and entirely without charge or any obligation on my part, list of U. S. Government big paid positions now open to me. Advise me also regarding the salaries, hours, work, vacation and date of the coming examination in my section, sending me also free sample examination questions.

Name.....
Address.....

ELECTRICAL WORKERS!

HAWKINS ELECTRICAL GUIDES

START YOU ON THE UP-GRADE

Invest spare time in study NOW! Draw out dividends in dollars LATER. The way to EARN more is to LEARN more. HAWKINS ELECTRICAL GUIDES lift you to the job higher up. Hundreds of Chief Electricians, Chief Engineers, Foremen and Managers write us that they owe their jobs to the GUIDES. Just your name and address on the coupon below! No money until you are satisfied. Get out your pencil or borrow one, Mr. Electrical Worker! Take this most important step of your career this minute!

Take the
FIRST
Step
NOW!

"I must compliment you on the thoroughness and the simplicity of the Guides"—Geo. M. Rowe. "They are so plain that one can practically learn the electrical game from the Guides alone"—L. R. Burton. "Worth \$10 down and \$10 a month"—James B.

Stewart. "They were the cause of a 100% increase in my salary"—A. W. Thompson. "They cover every possible subject in electrical engineering"—R. T. Van Dewoort. "Much better than a correspondence course I have been studying"—C. A. Harrington.

These books tell you all about—

Magnetism—Induction—Experiments—Dynamoes—Electric Machinery—Motors—Armatures—Armature Windings—Installing of Dynamoes—Electrical Instrument Testing—Practical Management of Dynamoes and Motors—Distribution Systems—Wiring—Wiring Diagrams—Sign Flashers—Storage Batteries—Principles of Alternating Currents and Alternators—Alternating Current Motors—Transformers—Converters—Rectifiers—Alternating Current Systems—Circuit Breakers—Measuring Instruments—Switch Boards—Wiring—Power Stations—Installing—Telephone—Telegraph—Wireless—Bells—Lighting—Railways. Also many Modern Practical Applications of Electricity and Ready Reference Index

FREE EXAMINATION

Not a cent to pay until you see the books. No obligation to buy unless you are satisfied. Send Coupon now—today—and get this great help library and see if it is not worth \$100 to you—pay \$1.00 a month for ten months or return it.



\$1 PER MO. ENTIRE SET \$10. COMPLETE

**Flexible Covers—Pocket Size
4700 PICTURES—3500 PAGES**



SEND ONLY THIS COUPON—LOOK THIS ENTIRE SET OVER FREE!

THEO. AUDEL & CO., 72 Fifth Ave., N. Y.

Please submit for examination **Hawkins Electrical Guides** (Price \$1.00 each). Ship at once, prepaid, the 10 numbers. If satisfactory, I agree to send you \$1 within seven days and to further mail you \$1 each month until paid.

Signature

Occupation

Employed by

Residence

Reference

PM-Jan. 23



A Big Raise in Salary!

Is Very Easy to Get, If You Go About It in the Right Way

You have often heard of others who have doubled and trebled their salaries in a year's time. You wondered how they did it. Was it a pull? Don't you think it. When a man is hired he gets paid for exactly what he does, there is no sentiment in business. It's preparing for the future and knowing what to do at the right time that doubles and trebles salaries.

Remember When You Were a Kid

and tried to ride a bike for the very first time? You thought that you would never learn and then—all of a sudden you knew how, and said in surprise: "Why it's a cinch if you know how." It's that way with most things, and getting a job with big money is no exception to the rule, if you know how.

We Will Show You How

Without loss to you of a single working hour we can show you a sure way to success and big pay. A large number of men in each of the positions listed are enjoying their salaries because of our help—we want to help you. Make check on the coupon against the job you want and we will help you to get it. Write or print your name on the coupon and send it in today.

American School

Dept. G. 174, Drexel Ave. and 58th St., Chicago

American School, Dept. G. 174, Drexel Ave., and 58th St., Chicago

Send me full information on the subject checked and how you will help me win success.

..... Architect
 Building Contractor
 Automobile Engineer
 Automobile Repairman
 Civil Engineer
 Structural Engineer
 Business Manager
 Cert. Public Accountant
 Accountant and Auditor
 Bookkeeper
 Draftsman and Designer

..... Electrical Engineer
 Electric Light and Power
 General Education
 Vocational Guidance
 Business Law
 Lawyer
 Machine Shop Practice
 Photoplay Writer
 Mechanical Engineer
 Shop Superintendent
 Employment Manager

..... Steam Engineer
 Foremanship
 Sanitary Engineer
 Surveyor (& Mapping)
 Telephone Engineer
 Telegraph Engineer
 High School Graduate
 Fire Insurance Expert
 Wireless Radio
 Undecided

Name..... Address.....



Stop Wondering How I Teach Piano; I'll Show You, FREE

YEAR after year you've seen my advertisement in all the leading publications, offering to teach you piano in *quarter* the usual time. Year after year my school has grown and grown until now I have far more students than were ever before taught by one man. In 1921 over a thousand students *graduated* from my Piano or Organ course and received their diplomas.

Yet when I first started giving piano and organ lessons by mail in 1891 my method was laughed at. Could any conservatory have grown as it has, obtained students in every state of the Union and in fact practically every civilized country of the world unless it produced very unusual and satisfying RESULTS for its students? See for yourself what it is that has brought my method so rapidly to the front. Write for free booklet and sample lessons.

Now, for the first time, you can obtain sample lessons without charge. In the past I have always been opposed to sending out free lessons, even to persons who were seriously interested in my course. But my friends have insisted that I give everybody a chance to see for themselves just how simple, interesting and DIFFERENT my lessons are, and I have consented to try the experiment *for a short time*. Simply mail the coupon below or write a postcard, and the 64-page booklet and sample lessons will go to you at once absolutely free and without obligation.

Within four lessons you will play an interesting piece on the piano or organ, not only in the original key, but in all other keys as well. Most students practice months before they acquire this ability. It is made possible by my patented invention the Colorotone. Another invention obtainable only from me is my hand-operated moving picture device, Quinn-dex. By means of Quinn-dex you actually see my fingers in motion on the piano, and can learn just how to train your own fingers.

When I say that I can teach you piano in *quarter* the usual time, do not think that this is too good to be true. Modern inventions and improved methods have accomplished just as great wonders in other branches of education. You at least owe it to yourself to *investigate*. Send coupon or postcard at once, before the offer of free sample lessons is withdrawn.

Quinn
Conservatory,
Studio PM 61,
598 Columbia Road,
Boston 25, Mass.

Please send me, without cost or obligation your free booklet, "How to Learn Piano or Organ," free sample lessons, and full particulars of your method.

Name.....

Address.....



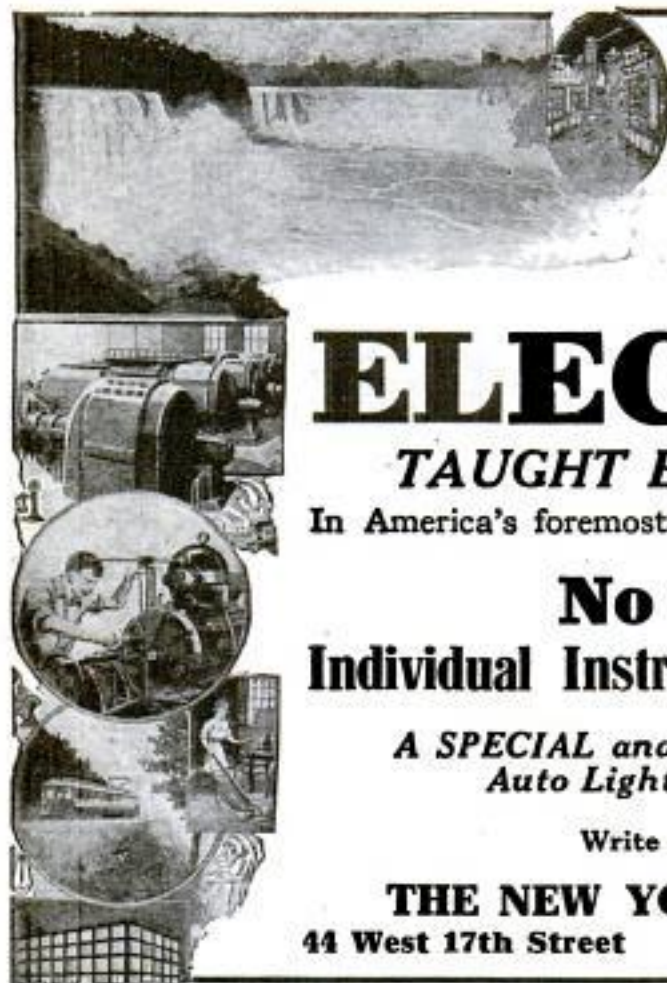

LEARN BY DOING

Every phase of all branches of

ELECTRICITY

TAUGHT BY ACTUAL PRACTICE

In America's foremost and oldest institution for trade training.

No Books Used
Individual Instruction **Start Any Day**

A SPECIAL and SEPARATE Course in Ignition,
 Auto Lighting and STARTER Systems.

Write for FREE 64-Page Catalog.

THE NEW YORK ELECTRICAL SCHOOL

44 West 17th Street

NEW YORK CITY

DRAW CARTOONS
 and **COMIC STRIPS** IT WILL
 Let a former staff cartoonist of the N. Y. World, N. Y. American, Life, and Judge, train you for success by **PAY YOU TO LEARN**
CORRESPONDENCE
 Send 6c stamps for illustrated BOOKLET, comic strip folder and particulars.

Box 358 The Carl Anderson School Madison, Wis.

LEARN WATCHMAKING

and become independent. Good-paying positions secured. Easy to learn. Send for FREE CATALOG.

ST. LOUIS WATCHMAKING SCHOOL, Dept. 5, ST. LOUIS, MO.

LAW High-Grade Instruction

By Correspondence
 Prepares You for the Bar—Est. 1892
 University Methods.

Standard Text-Books. Approved by Bench and Bar. Graduates practicing in every state. Send today for Free Catalog and Rules for Admission to the Bar.

Chicago School of Law
 520 Reaper Block Chicago, Ill.



LEARN MECHANICAL DENTISTRY

Earn \$35 to \$125 a week. Taught by actual practice—day or night. Three months' course. Modern laboratories. No previous training required. Established 30 years. For 16-page catalog, write Dept. 2.

BODEE DENTAL INSTITUTE
 NEW YORK 136 W. 52d St. PHILADELPHIA 15th & Walnut Sts. BUFFALO 1225 Main St. BROOKLYN 10 Flatbush Ave.

"THERE'S MONEY IN IT"
AT HOME LEARN TELEGRAPHY AT HOME
MORSE AND WIRELESS
TEACH YOURSELF in half usual time, at trifling cost, with the wonderful Automatic Transmitter **THE OMNIGRAPH**. Sends unlimited Morse or Continental messages, at any speed, just as an expert operator would. Adopted by U. S. Government, and leading Universities, Colleges and Telegraph Schools. 3 styles. Catalog free.
OMNIGRAPH MFG. CO. 16-22 Hudson St., NEW YORK

WANTED

Railway Mail Clerks
 \$1600 to \$2300 Year

MEN—BOYS OVER 16
SHOULD WRITE IMMEDIATELY

Steady work. No layoffs. Paid Vacations

Common education sufficient:
 Send coupon today—SURE

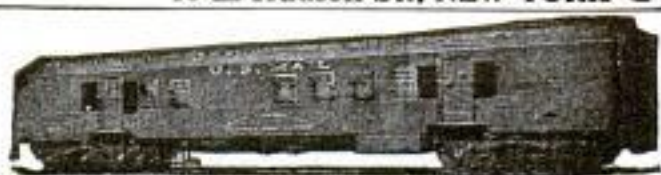

FRANKLIN INSTITUTE, Dept. L176, Rochester, N. Y.
 Sirs: Send me without charge, (1) Sample Railway Mail Clerk Examination questions; (2) Schedule showing places of all coming U. S. Government examinations; (3) list of many Government jobs now obtainable.

COUPON Name.....
 Address.....

How "Modest Jim" Won the \$50 Prize

By WILLIAM LAWRENCE
Author of "The Awakening"

"YES—I remember why they call the Big Boss 'Modest Jim,'" said the Old Timer. "It started way back twenty years ago.

"I was in my third apprentice year when Jim Hadley came to work here—a quiet, bashful boy. His father had died and he was forced to leave grammar school and go to work.

"He was never among the groups of boys dodging the boss or watching the clock nor mixed up in anything that wasn't strictly business. And he never fooled away his time with the bunch after hours, so we left him pretty much to himself. We called him 'Modest Jim.'

"One day Old Man Adams, who owned this outfit in those days, came out into the shop and tacked up a sign over the foreman's desk.

"It seemed that the Old Man and his designer had run into a stone wall or what was Greek to most of us kids those days, and was offering a prize of fifty dollars to anyone who solved the problem. He must have been up against it or he never would have asked our bunch for help.

"About two weeks later, after the rest of us had forgotten all about it, the Old Man rushed out to Jim and fairly pushed five crisp ten dollar bills into his hand. He had solved the problem.

"When the foreman asked him how he did it, he replied, 'Oh, it wasn't anything great. Only a fresh brain on a stale subject.' That's all he ever said about it. But do you know what that boy had been doing? He'd been studying with the International Correspondence Schools in his spare time. No wonder he got ahead!

"And he went right up, and up and up, until today he is the Big Boss. And the rest of us are just about where we started. He's still 'Modest Jim,' but he's earning five times as much as I am.

"Take my advice, lad, and follow along in Jim's footsteps. Don't wait until it's too late to get the special training that is so essential to success."

Employers everywhere are looking for men like "Modest Jim"—men who want to get ahead—who are willing to devote a part of their spare time to training for advancement.

How much longer are you going to wait before taking the step that is bound to bring you a better job and more money?



Isn't it better to make your start now than to wait a year or five years and then wish you had? It certainly is!

No matter where you live, the I. C. S. will come to you. No matter what your handicaps or how small your means, we have a plan to meet your circumstances. No matter how limited your previous education, the simply-written, wonderfully-illustrated I. C. S. lessons make it easy to learn. No matter what career you may choose, some one of the 300 I. C. S. courses will surely suit your needs.

This is all we ask: Without cost, without obligating yourself in any way, put it up to us to prove how we can help you. Just mark and mail this coupon.

----- TEAR OUT HERE -----
INTERNATIONAL CORRESPONDENCE SCHOOLS
Box 5692-C, Scranton, Penna.

Without cost or obligation, please tell me how I can qualify for the position or in the subject before which I have marked an X:

BUSINESS TRAINING DEPARTMENT

- | | |
|---|---|
| <input type="checkbox"/> Business Management | <input type="checkbox"/> Salesmanship |
| <input type="checkbox"/> Industrial Management | <input type="checkbox"/> Advertising |
| <input type="checkbox"/> Personnel Organization | <input type="checkbox"/> Better Letters |
| <input type="checkbox"/> Traffic Management | <input type="checkbox"/> Foreign Trade |
| <input type="checkbox"/> Business Law | <input type="checkbox"/> Stenography and Typing |
| <input type="checkbox"/> Banking and Banking Law | <input type="checkbox"/> Business English |
| <input type="checkbox"/> Accountancy (Including C.P.A.) | <input type="checkbox"/> Civil Service |
| <input type="checkbox"/> Nicholson Cost Accounting | <input type="checkbox"/> Railway Mail Clerk |
| <input type="checkbox"/> Bookkeeping | <input type="checkbox"/> Common School Subjects |
| <input type="checkbox"/> Private Secretary | <input type="checkbox"/> High School Subjects |
| <input type="checkbox"/> Business Spanish <input type="checkbox"/> French | <input type="checkbox"/> Illustrating <input type="checkbox"/> Cartooning |

TECHNICAL AND INDUSTRIAL DEPARTMENT

- | | |
|--|--|
| <input type="checkbox"/> Electrical Engineering | <input type="checkbox"/> Architect |
| <input type="checkbox"/> Electric Lighting | <input type="checkbox"/> Blue Print Reading |
| <input type="checkbox"/> Mechanical Engineer | <input type="checkbox"/> Contractor and Builder |
| <input type="checkbox"/> Mechanical Draftsman | <input type="checkbox"/> Architectural Drafter |
| <input type="checkbox"/> Machine Shop Practice | <input type="checkbox"/> Concrete Builder |
| <input type="checkbox"/> Railroad Positions | <input type="checkbox"/> Structural Engineer |
| <input type="checkbox"/> Gas Engine Operating | <input type="checkbox"/> Plumbing and Heating |
| <input type="checkbox"/> Civil Engineer | <input type="checkbox"/> Chemistry <input type="checkbox"/> Pharmacy |
| <input type="checkbox"/> Surveying and Mapping | <input type="checkbox"/> Automobile Work |
| <input type="checkbox"/> Metallurgy | <input type="checkbox"/> Navigation |
| <input type="checkbox"/> Steam Engineering | <input type="checkbox"/> Agriculture and Poultry |
| <input type="checkbox"/> Radio <input type="checkbox"/> Airplane Engines | <input type="checkbox"/> Mathematics |

Name.....
Street.....
Address.....

City..... State.....

Occupation.....

Persons residing in Canada should send this coupon to the International Correspondence Schools Canadian, Limited, Montreal, Canada.

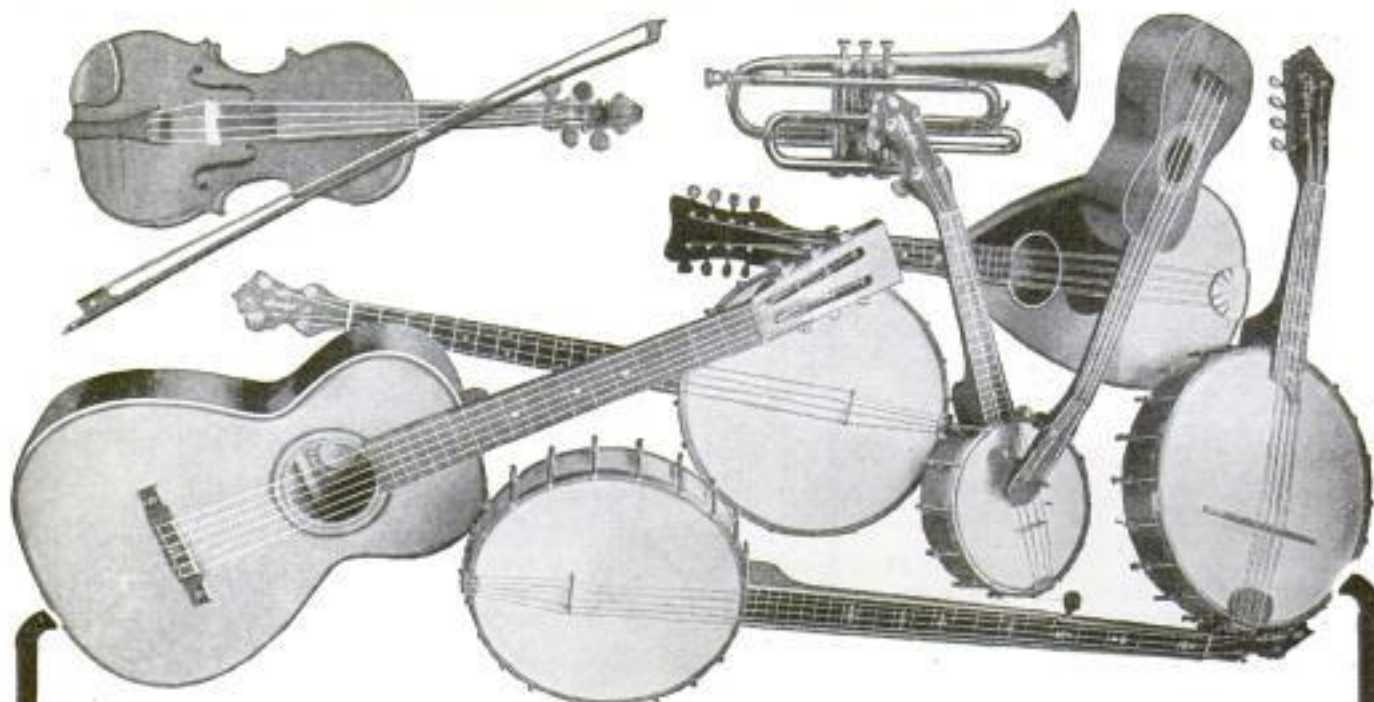

YOUR CHOICE \$
FREE 20 *Violin, Mandolin, Guitar, Ukulele, Hawaiian Guitar, Banjo, Banjo Mandolin, Tenor Banjo, Cornet or Banjo Ukulele.*

Actually given away, absolutely free, to pupils in each locality. Last year we gave away thousands of high-grade musical instruments on this sensational offer, now repeated for YOUR benefit.

We have the most wonderful new system of teaching NOTE music by mail. Take your choice of any of these magnificent instruments absolutely free and learn to play by this easy to learn method. Can have you playing standard note music in 4 lessons. A very small charge for lessons—just a few cents a week—your only expense. Your success guaranteed. Pay nothing if you fail to learn; you take no risk. Complete outfit free with every instrument. Don't wait a minute, but mail the coupon NOW.

To Advertise Our Copyrighted Course

Our plan is, \$2.00 monthly for lessons. No charge for instrument. Ukulele and banjo ukulele given free with 20 lessons at 50c a lesson. Tenor banjo, banjo and Hawaiian Guitar given free with 32 lessons at 50c a lesson; Violin, mandolin, guitar and banjo mandolin given free with 56 lessons, 43½c a lesson. Lessons are mailed one each week. Fill out the coupon and enclose \$2.00 or, we will send instrument and complete outfit subject to examination at express office C. O. D. \$2.00 for first month's lessons, and you will get an instrument you will be proud to own. At end of one week if you are not delighted with instrument and lessons, send outfit back and we will refund your money.

FREE INSTRUMENT COUPON

Slingerland's Correspondence School of Music
 Department 4, 1815 Orchard Street,
 Chicago, Illinois

Please send me one..... free.

- Plan No. 1. I am enclosing \$2.00 for first month's lessons.
- Plan No. 2. Send outfit and lesson C. O. D. \$2.00; but if I am not satisfied at end of one week's trial, I will return outfit and my \$2.00 is to be returned to me or, I will pay \$2.00 monthly until lessons are paid for.

Name.....

St..... R. F. D.....

City..... State.....

Do not delay, but mail the coupon today, before it is too late. Be sure to state whether you want a free Violin, Mandolin, Guitar, Ukulele, Hawaiian Guitar, Banjo, Banjo Mandolin, Tenor Banjo. We guarantee any one of these instruments positively worth \$20 or more. For cornet, piano, organ and further information, write for booklet.

SLINGERLAND'S CORRESPONDENCE SCHOOL OF MUSIC
 Dept. 4, 1815 Orchard St., Chicago, Illinois

What Do You Call an Opportunity?

IN my lifetime I have heard many men speak of opportunity. I have read some very fine definitions of this wonder-word. It has been the subject of many splendid speeches; authors have written abundantly about it in prose and poetry.

You have said, "I wish I had an opportunity."

But I am wondering what you call an opportunity.

Do you—as so many do—mistakenly associate it with "good fortune" or "good luck"?

Suppose tomorrow you heard of a \$10,000 position seeking a man. Could you fill it? If so, it would be an opportunity. If not, it would be no opportunity at all so far as you are concerned. It would be merely a bit of information from which you could not benefit.

Opportunity, I believe, is usually a recognition of worth.

The biggest opportunity that can ever come to you will never be any bigger than your preparation—your worth-whileness.

If you are not worth considering, Opportunity won't give you a thought.

The biggest job of all the big jobs open and

filled in the last twenty-four hours would have been an opportunity for you—

—if you had been prepared.

And I am not one who believes that Opportunity knocks but once.

The hundreds of opportunities which are here to-day will come again to-morrow—

—if you are prepared.

But you can be sure they will never be found on the door-steps of worthless prospects—men who are not ready.

Opportunity seeks and finds only those who have paid the price of preparation. She does not pick men as

you pick a number from a lottery; neither does she cover up what she has to offer. Her gifts are an open book—yours from which to choose.

Pick the thing you want, and get ready for it. Opportunities do not come except as you attract them. LaSalle training offers a sure way to increase your powers of attraction.

Just bear in mind that the biggest opportunity that can ever come to you will never be greater than your preparation.

J. Choplin
President LaSalle Extension University
of Chicago, Illinois

HOME-STUDY COURSES

THAT LEAD TO BUSINESS CAREERS

LaSalle Extension University

The Largest Business Training Institution in the World

INQUIRY COUPON

LA SALLE EXTENSION UNIVERSITY Dept. 164-R CHICAGO, ILLINOIS

Please send me catalog and full information regarding the course and service I have marked with an X below. Also a copy of your booklet, "Ten Years' Promotion in One," all without obligation to me.

- | | | |
|--|--|---|
| <input type="checkbox"/> Business Management: Training for Official, Managerial, Sales and Executive positions. | <input type="checkbox"/> Railway Accounting and Station Management: Training for Railway Auditors, Comptrollers, Accountants, Clerks, Station Agents, Members of Railway and Public Utilities Commissions, etc. | <input type="checkbox"/> Modern Foremanship and Production Methods: Training in the direction and handling of industrial forces—for Executives, Managers, Superintendents, Contractors, Foremen, Sub-foremen, etc. |
| <input type="checkbox"/> Modern Salesmanship: Training for Sales and Advertising Executives, Solicitors, Sales Promotion Managers, Salesmen, Manufacturers' Agents and all those engaged in retail, wholesale or specialty selling. | <input type="checkbox"/> Industrial Management Efficiency: For Executives, Managers, Office and Shop Employees and those desiring practical training in industrial management principles and practice. | <input type="checkbox"/> Personnel and Employment Management: Training for Employers, Employment Managers, Executives, Industrial Engineers. |
| <input type="checkbox"/> Higher Accountancy: Training for positions as Auditor, Comptroller, Certified Public Accountant, Cost Accountant, etc. | <input type="checkbox"/> Modern Business Correspondence and Practice: Training for Sales and Collection Correspondents; Sales Promotion Managers; Credit and Office Managers; Correspondence Supervisors, Secretaries, etc. | <input type="checkbox"/> C. P. A. Coaching for Advanced Accountants. |
| <input type="checkbox"/> Traffic Management—Foreign and Domestic: Training for positions as Railroad or Industrial Traffic Manager, etc. | <input type="checkbox"/> Banking and Finance. | <input type="checkbox"/> Commercial Law. |
| <input type="checkbox"/> Law: Training for Bar; LL. B. Degree. | | <input type="checkbox"/> Expert Bookkeeping. |
| | | <input type="checkbox"/> Business English. |
| | | <input type="checkbox"/> Commercial Spanish. |
| | | <input type="checkbox"/> Effective Speaking. |

Name..... Present Position..... Address.....

Are YOU in a Rut?



The way to get out

Put your shoulder to the wheel. Stop saying you have no chance, that luck is against you. You have your spare evening hours, seven o'clock to ten, which you can use in gaining technical or business knowledge. You have to possess this knowledge before employers will give you more responsibility. Experience is a fine teacher, but make use of the experience of other men. That kind of experience has been laid down plainly in the practical courses of the United Y. M. C. A. Schools.

More than 30,000 ambitious young men have enrolled for our unique form of instruction by mail, which "gives the most for the least money." It brings you man-to-man counsel and expert assistance on all of your problems.

Let us help you to get out of the rut and on the high road to the place in the world that is rightfully yours—if you work for it. Mark and mail the coupon below.

SOME OF OUR 300 CORRESPONDENCE COURSES

| | | |
|-----------------------|------------------------------------|-----------------------|
| Accountancy | Business Courses | Public Speaking |
| Advertising | Business Administration | Salesmanship |
| Banking | Business English | Secretarial |
| Better Letters | Business Finance | Show Card Writing |
| Bookkeeping | Business Law | Stenography |
| Business Arithmetic | Complete Letter-Writing | Traffic Management |
| | Office Management | |
| | Technical and Other Courses | |
| Agricultural Courses | Foreign Languages | Plan Reading |
| Applied Psychology | Foremanship | Plumbing |
| Architecture | Highway Engineering | Poultry Husbandry |
| Automobile Courses | High School Courses | Radio Engineering |
| Building Construction | Illustrating | Radio Telegraphy |
| Civil Engineering | Insurance Courses | Steam Engineering |
| Courses | Mathematical | Courses |
| Drafting Courses | Courses | Structural Drafting |
| Electrical Courses | Mechanical Engineering | Surveying |
| English Courses | Own-Your-Home | Use of the Slide Rule |
| Factory Management | Course | Vocational Guidance |

Are you an ex-service man?



Correspondence Instruction

347 Madison Avenue

Dept. 74-J New York City

Without obligating me, please advise regarding the course in

Name.....

Full Address.....

(Please write plainly.)

Learn to Write

I Teach by Mail

I CAN make a good penman of you at your home during spare time, no matter where you live or how poorly you now write. My simplified system has shown thousands of others the way to good penmanship during the past twenty years — it can and will do the same for YOU!

Beautifully Illustrated Book "How to Become a Good Penman" FREE!

It contains general information, with testimonials and beautiful specimens of penmanship showing what others have accomplished by the Tamblin System. (Your name elegantly written on a card if you enclose stamp for postage.) WRITE TODAY. Address

F. W. TAMBLIN

418 Ridge Bldg., Kansas City, Mo., U. S. A.

F. W. Tamblin

STAMMER

If you stammer attend no stammering school till you get my large FREE book entitled "STAMMERING, Its Origin and the Advanced Natural Method of Cure," bound in cloth and stamped in pure gold. Ask for special tuition rate and a FREE copy of "The Natural Speech Magazine." Largest, best equipped and most successful school in the world for the cure of stammering, stuttering, etc. No sing-song or time beat. Write today. The North-Western School, 2317 Grand Ave., Milwaukee, Wis.

Factory to Rider

Saves \$10 to \$25 on the Ranger Bicycle you select. You can have your choice of 44 Styles, colors and sizes. Delivered free on approval, express prepaid, for 30 DAYS' FREE TRIAL.

12 Months to Pay if desired. Possession and use of plan. Parents often advance first payment.

Tires best quality, at factory prices, express prepaid. Lamps, wheels and equipment, low prices. Send No Money, do business direct with makers.

Mead Cycle Company Dept. K108 Chicago

Write today for free Ranger Catalog, factory prices and marvelous easy payment terms



Play Cornet?

Trombone, Baritone, etc.? You can't afford to be without "Lip Science." Marvelous secret manual for brass players. Easy playing in the entire register. Highest notes without effort. Results guaranteed. Send postal — get free information. Act now!

W. E. HITCHCOCK, Publisher Dept. "M" 5337 Prairie Ave., Chicago

SHORTHAND IN ONE MONTH

Boyd—the Wonderful, New, Easy System. Writers hold World's record. 100 to 150 words a minute in 30 days guaranteed. New Principles—dictation first week. Best for Court Reporting and Secretaries. Also Typewriting, Bookkeeping and Commercial Law. Send today for Catalog and Money-Back Guarantee. CHICAGO HOME STUDY SCHOOLS, 892 Reaper Block, Chicago, Ill.

Copyrighted material

What Would You Give to Become A Really Good Dancer?

How much would it be worth to you to make yourself so popular through your ability to dance all of the very latest steps, that everyone would be anxious to have you attend their social affairs?



GOOD dancers always have the best time. The best dancers and the prettiest girls always want a good partner. From the business as well as the social standpoint, it is really time and money profitably spent to add dancing to your other accomplishments. Especially so, since it now costs so little—and a fine dancing ability can be mastered in only a few hours.



Arthur Murray
Dancing Instructor
to the Vanderbilts

Arthur Murray has perfected a method by which you can learn in the privacy of your own home, to dance any of the latest dances in a few minutes—and all of them in a short time. Instructions are so simple that even a child can quickly learn. In one evening you can master the steps of any single dance. Partner or music are not necessary. After learning you can dance with the best dancer in your town and not make a single misstep.

Learn Without Partner or Music

Arthur Murray's remarkable method is so clearly explained and lucidly written that you don't need anyone to explain the instructions. The diagrams show every movement—just how to make each step of every dance, and the written instructions are concise and easily remembered. After you have quickly learned the steps by yourself in your own room, you can dance perfectly with anyone. It will also be quite easy for you to dance in correct time on any floor to any orchestra or phonograph music.

Arthur Murray is recognized as America's foremost authority on social dancing. Such people as the Vanderbilts, Ex-Gov. Locke Craig of North Carolina and scores of other socially prominent people chose Mr. Murray as their dancing instructor. Dancing teachers the world over take lessons from him—and it is a fact that more than 60,000 people have learned to become popular dancers through his Learn-at-home methods.

Free Proof You Can Learn the Latest Steps in an Evening

Private instruction in Mr. Murray's studio would cost you \$10 per lesson. But through his new method of teaching dancing at home, you get the same high class instruction at a ridiculously low price. And if you aren't delighted, the instruction doesn't cost you one cent.

To prove that he can teach you, Mr. Murray will send you his full sixteen-lesson course for five days' free trial. Through these sixteen lessons you will learn, The Correct Dancing Position—How to Gain

Confidence—How to Follow Successfully—The Art of Making Your Feet Look

Attractive—The Correct Walk in the Fox Trot—The Basic Principles in Waltzing—How to Waltz Backward—The Secret of Leading—The Chasse in the Fox Trot—The Forward Waltz Step—How to Leave One Partner to Dance with Another—How to Learn and Also Teach Your Child to Dance—What the Advanced Dancer Should Know—How to Develop Your Sense of Rhythm—Etiquette of the Ballroom.

Send No Money—Not One Cent

Satisfy yourself that the new course can quickly teach you all of the new dances and latest steps. See for yourself how easily you can master all of the newest dances and be able to enjoy yourself at the very next affair to which you are invited. Just fill in and mail the coupon—or a postcard or letter will do—and the special course will be promptly sent to you. When your own postman hands it to you, simply deposit with him only \$1.00 plus the few cents postage, and the course is yours without any further payments of any kind. Keep the course for five full days—practice all the steps—learn everything the lessons teach, because that is the only way you can prove to your full satisfaction that Arthur Murray's method is the quickest, easiest and most delightful way to learn how to dance correctly and expertly. Then, within five days, if you desire to do so, you may return the course and your deposit will be promptly refunded without any question. But should you decide to keep the course, as you surely will, it becomes your property without further payments of any kind.

Your Satisfaction Guaranteed

Several times Arthur Murray has been asked how one can learn by mail to dance? The answer and the proof that you can learn is found in these special lessons. After reading them over and practicing the steps as shown in the diagrams, no one can help but feel fully convinced that Arthur Murray's course does teach everything promised. And so positive is Mr. Murray that he can teach you that he absolutely guarantees your complete satisfaction or your money will be fully refunded.

You have always wanted to learn to dance—you have always promised yourself that some day you would learn! Here is your best opportunity. And remember, you now receive the 16 lessons for only \$1.00.

ARTHUR MURRAY

Studio 552 801 Madison Ave. New York

Arthur Murray, Studio 552,
801 Madison Avenue, New York.

To prove that you can teach me to dance in one evening at home you may send the sixteen-lesson course in plain cover and when the postman hands it to me I will deposit with him \$1.00, plus a few cents postage in full payment. If, within 5 days, I decide to return the course I may do so and you will refund my money promptly and without question.

Name.....

Address.....

City..... State.....

If apt to be out when the postman calls, you may send the dollar now and we will pay postage. (Price outside U. S. \$1.10 cash with order.)

Here's What a Few Say

I practiced yesterday and learned the Fox Trot through the night. Tonight I danced a number of times with a good dancer to the music of a phonograph and had no trouble in leading or balance.

J. M. MEALY,
Flatwood, W. Va.

I am getting along very nicely with the instructions. I have so many pupils I have to have a larger place.

ALBERT J. DELANEY,
Bay City, Mich.

Before I got your lessons I couldn't dance a step, but now I go to dances and have a good time, like the rest of them. I'll always be thankful that I have taken your course.

BEGGI THORGERSON,
Ethridge, Mont.



BE A RAILWAY TRAFFIC INSPECTOR

The Most Pleasant Work I Know of

By L. P. Reifein



"I have been employed as a Railway Traffic Inspector for several months now and since the first day I began studying the course, an entire new field has been opened up to me. It is the most pleasant work that I have ever had the good fortune to be engaged in.

"I was employed as a passenger brakeman on one of the largest R. R. Companies, and when the Business Depression came into us in spring of 1921 I was suspended on account of

reduction in force. Whereas this position is permanent, and without the wonderful course prescribed, I would have never been able to be engaged in this line of work.

"This line here extends from the state line of N. H. to state line of R. I., being 15 divisions, and the ride of today will not be the one you make to-morrow. They cover the whole Eastern half of the state of Mass.

"Another great thing, you are practically your own boss, and deal only with best of men in this line of work.

"I owe a debt of thanks to the Standard Business Training Institute for the great opportunity derived from their course of study where advancements are unlimited."

Position Guaranteed

Earn Up to \$250 per Month Expenses Paid

Prepare in three months' spare-time study at home for this fascinating profession. Many opportunities for advancement; many men are needed. Steady, pleasant out-door work; travel or remain near home.

You Take No Risk

After completing course if we do not get you a position paying at least \$110.00 a month and expenses, we refund your entire enrollment fee. Cost is moderate.

Send coupon today for full details

Standard Business Training Institute
Buffalo, N. Y.



Standard Business Training Institute
Buffalo, N. Y.

Send me, entirely free, Booklet No. D-976 giving full particulars about course in Railway Traffic Inspection.

Name.....

Street.....

City.....

ELECTRICAL ENGINEERING men with training are in demand. For more than a quarter of a century this school has been training men of ambition and limited time, for the electrical industries. Condensed course in Electrical ENGINEERING enables graduates to secure good positions and promotions. Theoretical and practical Electricity, Mathematics, Steam and Gas Engines, Mechanical Drawing. Students construct dynamos, install wiring and test electrical machinery. Course with diploma, complete **IN ONE YEAR**



Thoroughly equipped fireproof dormitories, dining hall, laboratories, shops. Over 3000 men trained. Write for catalog. 30th year opened Sept. 27, 1922.

BLISS ELECTRICAL SCHOOL
404 TAKOMA AVENUE, WASHINGTON, D. C.



HOW TO BECOME A PROFESSIONAL PHOTOGRAPHER

Earning \$35 to \$125 a Week

An interesting illustrated booklet (free) on choosing a vocation, the exceptional opportunities Photography offers you and how to avail yourself of these advantages.

Motion Picture—Commercial—Portraiture

Three to six months' Practical course. Modern equipment. Day or evening classes. Easy terms. Call or write for Catalog No. 46.

N. Y. INSTITUTE OF PHOTOGRAPHY
NEW YORK CHICAGO BROOKLYN
141 W. 36th St. 630 So. Wabash Ave. 505 State St.



SAVE MAKE MONEY

Anyone can do their own ELECTRICAL WORK and work for others in their spare time. ELECTRICAL KINKS tells how to do wiring and repairing of bells, lighting, garages, vacuum cleaners, washing machines, table lamps, etc. The most complete book on everything electrical in the home. Electrify your home, and make a dollar an hour working for others. ONLY \$1.00, cash or pay postman. Satisfaction guaranteed. Special Offer. Ask how you can get this book FREE. Home Book Co., 188AC Arcade Bldg., Cleveland, Ohio

Can You Spell?

Then equip yourself by mail for a profession offering big pay and no lack of employment.

BECOME A PROOF-READER

Men and women of ambition should write today for the free descriptive booklet entitled "Read to Live."

THE MAWSON EDITORIAL SCHOOL, 12 Wadsworth St.
Cambridge, Massachusetts



Earn Money at Home In Your Spare Time

Our men are making as high as \$600 per month—all and part time. You can make and sell glass sign, name and number plates by new United method. No art training needed. Big demand for signs, everyone wants a United. Write today for full details about our complete, fascinating course in sign making and selling by our easy system.

UNITED LETTERING COMPANY, 1092 Jones Law Bldg., Pittsburgh, Pa.

FREE OUTDOOR MAGAZINE

Every person interested in Dogs, Hunting, Fishing and Outdoor Sports will be sent a copy of SPORTSMAN'S DIGEST Free. Send name and address to Sportsman's Digest, 505 D Butler Bldg., Cincinnati.



Learn Watchwork, Jewelrywork and Engraving.

A fine trade commanding a good salary, and your services are always in demand. Address HOBLOLOGICAL, Dept. P, Bradley Institute, Peoria, Ill., for our latest catalog.

WHY not spend Spring, Summer and Fall gathering butterflies, insects? I buy hundreds of kinds for collections. Some worth \$1 to \$7 each. Simple outdoor work with my instructions, pictures, price list. Get posted now. Send 10c (NOT STAMPS) for my Illustrated Prospectus. Mr. Sinclair, Dealer in Insects, Dept. G, Ocean Park, Calif.



It's a Crime to Slave for Low Pay — When It's So Easy To Earn Big Money

If You Are Making Small Pay, Then You Ought to Investigate This Simple Plan that Has Shown Thousands a Way to Magnificent Earnings

It is little short of an actual crime for a man to struggle along trying to make ends meet, when he can easily step into a position with better pay and unlimited opportunities for making money.

The sentence for a crime of this kind is "a lifetime of drudgery." Trying to make ends meet is a much harder task than making from three to ten times as much money as you are now making. For you can just as easily take advantage of the experience of countless others who, in one swift stroke, have jumped from small pay in blind-alley jobs to incomes of anywhere from \$5,000 to \$10,000 a year.

These Men Investigated and—

As an office worker in Detroit, Mr. B. H. Voss slaved away for \$125 a month. But he saw his one big opportunity—grasped it—and increased his pay to \$500 a month.

As a farmhand, George W. Kearns, of Oklahoma City, grasped the same opportunity. He writes, "Last week I cleared \$306, and this week \$218." And Mr. Kearns earned \$60 a month previously.

Mr. J. L. DeBonis, Chicago, now enjoying magnificent earnings. Before investigating, he was earning \$16 a week as a clerk.

When Charles Berry, of Winterset, Ia., decided that it was a crime to slave for low pay, he was earning \$18 a week. And then the very first month he earned \$1,000.

A whole book could be filled with stories equally amazing of men who have taken this new, quick road to big pay. Nor is there anything exceptional about these men. They were once in the same circumstances that you may be in now. They were discouraged, tired of working for small pay, and disgusted with their prospects. And then, as though by a touch of magic, they were earning salaries that they had never dared hope for.

For they have entered a new field—a field that they had never dreamed of as theirs—one that is not only the most interesting, but the best paying branch of all business—selling.

A Foolish Notion About Salesmen

The average man imagines that, in order to make good in selling, he must be a "born" salesman. Nothing could be further from the truth. There is no such thing as a



"born" salesman. Thousands of clerks, machinists, book-keepers, factory hands, firemen and farmhands, to-day, are making big money in the selling field through the simple plan you are invited to investigate.

Secrets that Make Master Salesmen

No matter what your earnings may be, you can quickly learn the secrets of selling that have put thousands into the big-pay class. For the past fifteen years the National Salesmen's Training Association has successfully trained thousands for the selling field—and through its Free Employment Service helped thousands to secure good selling positions.

And through the National Demonstration Method you gain actual experience in overcoming sales problems of all descriptions while studying in your spare time at home. Then, through the N. S. T. A. System of Electives, you get specific instructions in how to sell the line or lines you want to handle. In other words, the proved selling plans of master salesmen in all lines are laid before you.

Book on "Modern Salesmanship" Free

Without cost or obligation, we will gladly mail you a copy of a very interesting book, "Modern Salesmanship," in addition to many interesting facts about salesmanship, it will also give you full information as to how you can become a highly paid salesman. No matter what you may think now, this book will prove to you that it's a crime to slave for low pay when magnificent earnings are within easy reach. There is no obligation, so just fill in the coupon and mail it to-day.

National Salesmen's Training Association
Dept. 12-A
Chicago, Ill.

National Salesmen's Training Association,
Dept. 12-A, Chicago, Ill.

Send me FREE your book, "Modern Salesmanship," and proof that I can become a Master Salesman. Also send me list of lines with openings for salesmen.

Name.....

Address

Age Occupation

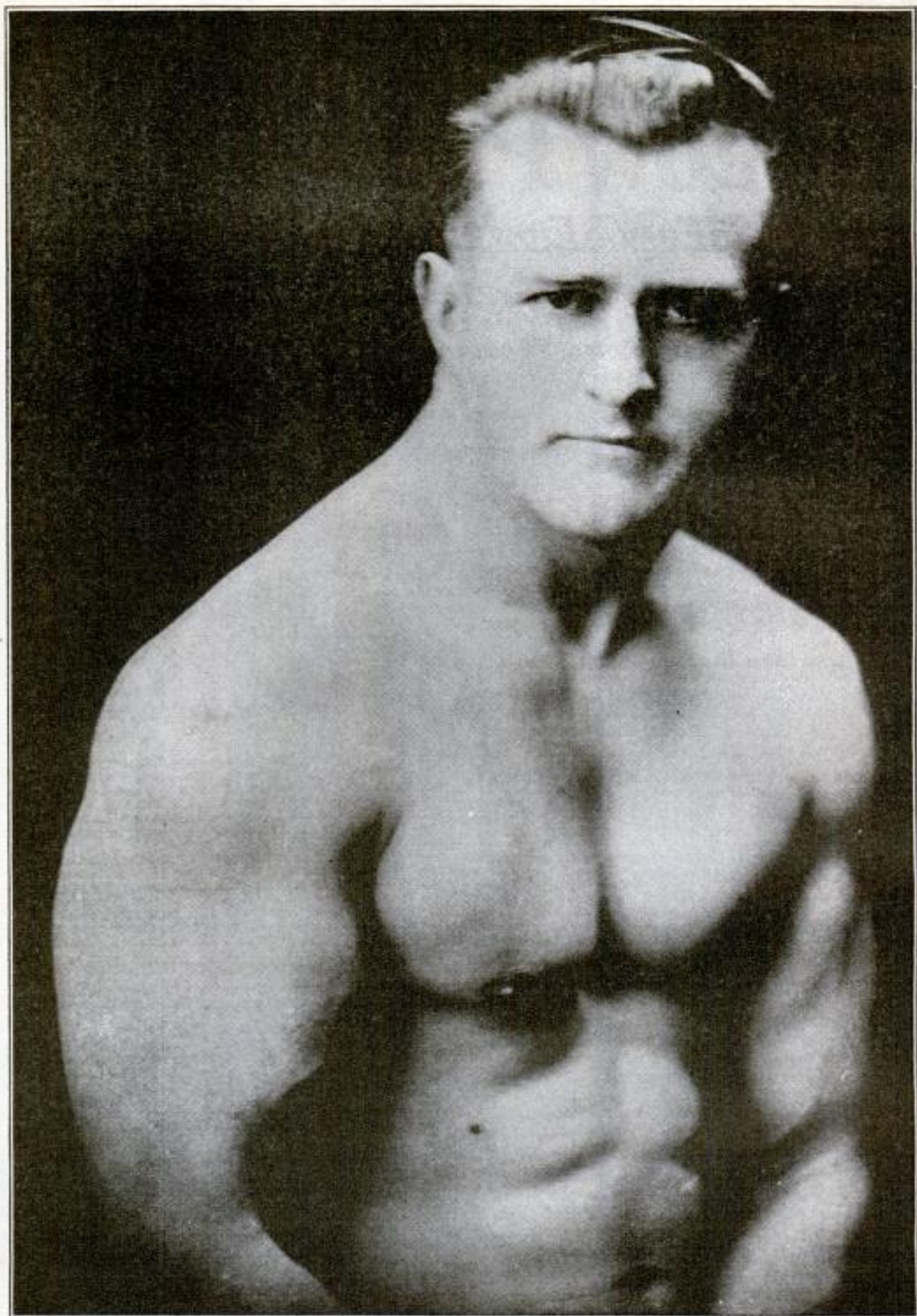

Earle E. Liederman
The Acme of Physical Perfection

Women Admire Men

for their strength

MAN was meant to be woman's protector. The better he can meet this qualification, the more will he be admired. Read back through the ages and you will find this has always been true. There was a time when men fought with each other to decide who would own a certain woman just as they would fight over a pot of gold. Civilization and culture soon overcame such savage conditions, but the man of strength and power has continued to have the advantage. *Ivanhoe* describes the knights entering into combat, after which the conqueror would kiss the hand or show respect in some manner to the lady he held in highest regard.

The Man of Today

What must womanhood think of the present-day man? Statistics show that over 95 per cent of us are suffering from some ailment. Our indulgence in worldly pleasures has made us a race of anaemic, flat-chested dyspeptics. It is no wonder that man's years on earth have been shortened. What can he expect when he wastes the very strength that God gave him?

I heard one girl say the other day: "Of course I admire a strong, healthy man, but the men I meet are so weak-kneed they can barely stand up straight." It is true. The strong man of today is the exception. And that is my task. To make the exceptional man.

Do You Seek Admiration?

Do you wish to be one of these weak-kneed dyspeptics? Or have you enough manhood left to say: "I will be strong?" I don't care what your present condition is. If you have a spark of will-power left, I can make you a man to be admired by all. Just think! I guarantee to put one full inch of muscle on your arms in 30 days. Yes, and two full inches on your chest in the same length of time. But that is only the start. From then on you will notice a complete change in your physical make-up. You not only develop big, brawny arms and a full chest, but a complete armor plate of muscle surrounding a body that has been rebuilt inwardly as well. You will have the flash to your eye and the spring to your step that shows you to be a human dynamo. You will be admired and sought after in both the business and social world. You will be a leader of men. All these things and more are awaiting you. It is now up to you to decide just what manner of man you will be. Come then, for time flies.



EARLE E. LIEDERMAN (left) and one of his pupils in an interesting statue pose. This is one of the many attractive illustrations appearing in Mr. Liederman's 64 page book

"MUSCULAR DEVELOPMENT"

EARLE E. LIEDERMAN,

Dept. 2001, 305 Broadway, New York City.

Dear Sir:—I enclose herewith 10 cents, for which you are to send me, without any obligation on my part whatever, a copy of your latest book, "Muscular Development."

Name

Address

City State

Send for My New 64 Page Book

"Muscular Development"

It contains dozens and dozens of full page photographs of myself and my numerous pupils; also full description of my wonderful offer to you. This book is bound to interest you and thrill you. It will be an impetus—an inspiration to every red-blooded man. All I ask you to cover is the price of wrapping and postage—10 cents. Remember this does not obligate you in any way. Don't delay one minute. This may be the turning-point in your life today. So tear off the coupon and mail at once while it is on your mind.

EARLE E. LIEDERMAN

Dept. 2001 305 Broadway, New York City

See page 131 in back part of magazine for further information of Earle E. Liederman.

Why haven't
you
clipped this
coupon

----- TEAR OUT HERE -----
INTERNATIONAL CORRESPONDENCE SCHOOLS
Box 5695-C, Scranton, Penna.

Without cost or obligation, please tell me how I can qualify for the position or in the subject before which I have marked an X:

BUSINESS TRAINING DEPARTMENT

- | | |
|---|---|
| <input type="checkbox"/> Business Management | <input type="checkbox"/> Salesmanship |
| <input type="checkbox"/> Industrial Management | <input type="checkbox"/> Advertising |
| <input type="checkbox"/> Personnel Organization | <input type="checkbox"/> Better Letters |
| <input type="checkbox"/> Traffic Management | <input type="checkbox"/> Foreign Trade |
| <input type="checkbox"/> Business Law | <input type="checkbox"/> Stenography and Typing |
| <input type="checkbox"/> Banking and Banking Law | <input type="checkbox"/> Business English |
| <input type="checkbox"/> Accountancy (including C.P.A.) | <input type="checkbox"/> Civil Service |
| <input type="checkbox"/> Nicholson Cost Accounting | <input type="checkbox"/> Railway Mail Clerk |
| <input type="checkbox"/> Bookkeeping | <input type="checkbox"/> Common School Subjects |
| <input type="checkbox"/> Private Secretary | <input type="checkbox"/> High School Subjects |
| <input type="checkbox"/> Business Spanish <input type="checkbox"/> French | <input type="checkbox"/> Illustrating <input type="checkbox"/> Cartooning |

TECHNICAL AND INDUSTRIAL DEPARTMENT

- | | |
|--|--|
| <input type="checkbox"/> Electrical Engineering | <input type="checkbox"/> Architect |
| <input type="checkbox"/> Electric Lighting | <input type="checkbox"/> Blue Print Reading |
| <input type="checkbox"/> Mechanical Engineer | <input type="checkbox"/> Contractor and Builder |
| <input type="checkbox"/> Mechanical Draftsman | <input type="checkbox"/> Architectural Draftsman |
| <input type="checkbox"/> Machine Shop Practice | <input type="checkbox"/> Concrete Builder |
| <input type="checkbox"/> Railroad Positions | <input type="checkbox"/> Structural Engineer |
| <input type="checkbox"/> Gas Engine Operating | <input type="checkbox"/> Plumbing and Heating |
| <input type="checkbox"/> Civil Engineer | <input type="checkbox"/> Chemistry <input type="checkbox"/> Pharmacy |
| <input type="checkbox"/> Surveying and Mapping | <input type="checkbox"/> Automobile Work |
| <input type="checkbox"/> Metallurgy | <input type="checkbox"/> Navigation |
| <input type="checkbox"/> Steam Engineering | <input type="checkbox"/> Agriculture and Poultry |
| <input type="checkbox"/> Radio <input type="checkbox"/> Airplane Engines | <input type="checkbox"/> Mathematics |

Name.....
Street.....
Address.....
City..... State.....

Occupation.....
Persons residing in Canada should send this coupon to the International Correspondence Schools Canadian, Limited, Montreal, Canada.

Please Mention Popular Mechanics

LIFE-LONG POSITIONS



\$133
a month

**Earn \$1600 to \$2300 Yearly
Free Yearly Railroad Pass**

Why work at uncertain jobs? You can pass Civil Service examinations with our help and be appointed Government Railway Mail Clerk. Expenses paid; vacations and sick-leave with full pay. No strikes or shut-downs. You are trained by men who have spent a life-time in the service. Their training enables you to pass examinations with top-notch ratings. Examinations held regularly in every state. Ages 18 to 35. Common school education is sufficient. Sample questions and full details FREE.

WRITE US TODAY

COLUMBUS INSTITUTE

Dept. O-13

COLUMBUS, OHIO

Keystone Institute
"The Service School"

A fully equipped school with expert instructors, organized to give intensive instruction in

2-Year Courses
Electrical Engineering
Mechanical Engineering
Accounting and Business Administration
16 weeks' course in Automotive Engineering

Day and Night Classes. Graduates are sought by large and small industrial establishments and are filling important positions in all sections of the country. Write for information on subject that interests you to Keystone Institute. Address The Vice President,
133 North 4th Street, Reading, Penna.

LEARN WATCH REPAIRING

Be a watchmaker—you can learn this profitable trade by correspondence in a few weeks in your own home by the DeSelms Chart System. After you complete the course you will know a watch from A to Z. You will know just what the matter is and how to repair one. When you graduate you will be a practical watchmaker and repairer and competent to fill any position. Positions for our graduates.

Ask for our Free Book. It explains our system and terms
THE DeSELMS WATCH SCHOOL
23 Perry Street ATTICA, INDIANA



DO YOU STAMMER?

Safe Methods based on many successful years' experience and scientific research, for the correction of all Speech Defects employed in the Speech Clinics at the Ithaca Conservatory of Music under the direction of

DR. FREDERICK MARTIN.

(himself once a confirmed stammerer)

Formerly Director of Speech Improvement, Board of Education, New York City. Lecturer, Post-graduate Medical Hospital, New York City. Normal Courses for Teachers of Speech Improvement. Dormitories and complete equipment.

MARTIN INSTITUTE FOR SPEECH CORRECTION
440 Dewitt Park, Ithaca, N. Y.



Wonderful; new device, guides your hand; corrects your writing in few days. Big improvement in three hours. No failures. Complete outline FREE. Write C. J. Ozment, D-34, St. Louis, Mo.

BE AN ARTIST

Comics, Cartoons, Commercial, Newspaper and Magazine Illustrating, Paste/Crayon Portraits and Fashion. Our simple method quickly develops your talent in spare time. By Mail or Local Classes. Write for terms and list of successful Students. ASSOCIATED ART STUDIOS 67-B Flatiron Building, NEW YORK

BE A PIANO TECHNICIAN



Our Tune-a-Phone Guides You to Success
Tuning, Voicing, Regulating, Finishing and General Care of Piano Taught in ONE Complete Course. 25 years of successful Correspondence Instruction makes our guarantee worth while. Knowledge of music NOT necessary. Write for FREE BOOKLET and the plan that saves you all risk in testing our method of teaching.
MILES BRYANT SCHOOL, 24 Bryant Bldg., Augusta, Mich.

Look Here!

Would you like to earn more money than you ever dreamed was possible? Do you want to get away from a life of low pay and long hours of weary drudgery? Would you like to get into a profession where the work is easy and pleasant; where big pay is offered? Then read this wonderful offer to ambitious men!



B. W. COOKE
President
Coyne Trade and
Engineering School

I Guarantee

to train you for the position of Expert Draftsman. There is a tremendous demand for trained draftsmen. Here is your chance. Take advantage of this money-making opportunity. **I positively guarantee to train you for the position of Expert Draftsman until you are earning at least**

\$250⁰⁰ a Month

Before a building can be put up—before a machine can be made—or before a bridge can be built, draftsmen must draw the plans. In machine shops—in manufacturing plants—in fact wherever there is industry trained draftsmen are needed.

Now is the time to start. Draftsmen get good pay from the beginning and can work up to \$500 a month

and more. Draftsmen are needed everywhere. Work in any part of the country you please. Coyne training makes everything easy for you. Coyne student, L. T. Dubendorf, writes: "Immediately after completing Coyne course I went to work for Armour & Co. Work was easy for me. Five months later I accepted a position in New York at a large increase in salary." Read this offer:



Free This Expert Draftsman's Complete Outfit → Gives You Practical Training

Outfit includes complete set of fine "professional" drawing instruments with double set of compasses and dividers all in velvet lined case. Drawing board, T square, two triangles, protractor, universal curve, triangular, standard scale, waterproof ink, pens, pencils and all accessories. **Coyne methods are practical.** This expert's superb complete outfit given free to every Coyne student. Coyne training makes you advance. Coyne Student Joseph

Jebany writes: "Your drafting school put me on the road to success. I am very thankful for the instructions received and I have recommended your school to my friends." Now then—

You can't make a mistake if you write for the Coyne free book. Coyne students say every minute of the course was enjoyable. Some students took good positions three months before their course was finished. Here is your opportunity.

FREE Book →

Mail this coupon for our interesting illustrated book, "Drafting, the Foundation of Industry," sent you free. It explains all about the Coyne home study method. It shows you how to become a draftsman in the quickest and easiest way. You want to know all about this great institution and its wonderful and practical training methods. Don't put off this opportunity. Send for this book now. Get the free drafting outfit offer. It's absolutely free, no obligation. The book contains the most valuable information you will ever get in your life. Send that coupon now.

B. W. Cooke, President

COYNE TRADE AND ENGINEERING SCHOOL

Recognized Producer of Successful Men

552-598 So. Throop St., Dept. 1771, Chicago, Ill.

COYNE TRADE AND ENGINEERING SCHOOL

Dept. 1771, 552-598 So. Throop St., Chicago, Ill.

Dear Sirs:—Please send me, absolutely free, without obligation, your book, "Drafting, the Foundation of Industry," also full information about the Course in Drafting and your **Special Free Outfit Offer**, and your \$250.00 a month guarantee.

Name

Address

City.....State.....

Play
Without
Notes

Be a Master of
JAZZ and RAGTIME



Anyone who can remember a tune can easily and quickly learn to play Jazz, Ragtime and Popular Songs by ear, at a very small cost. New Niagara Method makes piano playing wonderfully simple.

NO matter how little you know about music — even though you “have never touched a piano” — if you can just remember a tune, you can learn to **PLAY BY EAR**. I have perfected an entirely new system. It is so simple, so easy, and shows you so many little tricks of playing that it just comes natural to pick out on the piano any piece that is running through your mind. Even those who could not learn by the old-fashioned method grasp the NIAGARA idea readily, and follow through the entire course of twenty lessons quickly.

Play By Ear in 90 Days

No need to devote years to study, in order to learn piano nowadays. Neither is special talent necessary. Every lesson is so easy, so interesting and fascinating that you “can’t keep your hands off the piano.” Just devote a part of your spare time to it for ninety days and you will be playing and entertaining your friends almost before you realize how this wonderful new accomplishment has been acquired. No tiresome scales, no arpeggios to learn — no do-re-mi, no tiresome practice and meaningless exercises. You learn a bass accompaniment that applies to ANY SONG you play by ear. Once learned you have it for all time and become master of the piano. Experienced and talented musicians are amazed at the rapid progress of Niagara School students and say they cannot understand why this method was not thought of years ago. Yet it has never been used before and is not used by any other teacher or school today.

Be the Popular One in Your Crowd

One who can sit down any time without notes or music, reel off the latest jazz and ragtime song hits that entertain folks — always being the popular one in the crowd, the center of attraction, the life of the party, sought and invited everywhere.

As easily as hundreds of others have learned, so you, too, can learn and profit by it — not only through the pleasure it provides, but also by playing at dances, movies and other entertainments.

Decide to begin now. Just spend a little part of your time with my easy, fascinating lessons, and see how quickly you “catch on” and learn to play. You will be amazed, whether you are a beginner or an advanced student.

Write for my book, “The Niagara Method,” describing this wonderful new method of playing by ear. It is sent to you FREE.

RONALD G. WRIGHT, Director,
Niagara School of Music, Dept. 496
Niagara Falls, N. Y.

Clip This Coupon Now

NIAGARA SCHOOL OF MUSIC, Dept. 496, Niagara Falls, N. Y.

Please send me your Free Booklet
describing “The Niagara Method.”

Name.....
Street..... City.....
Age..... Ever taken piano lessons?..... For how long a time?.....



THIS BOOK
FREE



Which job can you fill?

All these jobs were advertised in a single issue of a Chicago newspaper under "Help Wanted." Which one can you fill?

There are good jobs like these with big pay everywhere for men capable of holding them. Why don't you get one? If you haven't the knowledge necessary to make you capable of holding down the best kind of a job, *make up your mind right now to get it.* There is a set of Home Study Books listed below that will quickly fit you to hold any job you want—spare time only is needed.

These books were written by some of the greatest experts in each line. Nothing but plain everyday English is used—thousands of pictures, diagrams and tables help to make everything as simple as A B C. You can't go wrong with these books before you—they explain everything you need to know. Pick out the set you want and see our *free* trial offer below.

Cut Prices on Practical Books

Carpentry and Contracting, 5 vols., 2138 pp., 1000 pict. Was \$37.50...Now \$19.80
Civil Engineering, 9 vols., 3000 pages, 3000 pictures. Was \$67.50...Now \$34.80
Electrical Engineering, 8 vols., 4100 pages, 3300 pictures. Was \$80.00...Now \$39.80
Automobile Engineering, 6 vols., 2600 pp., 3900 pictures. Was \$45.00...Now \$21.80
Machine Shop Practice, 6 vols., 2300 pp., 2500 pictures. Was \$45.00...Now \$21.80
Steam and Gas Engineering, 7 vols., 3300 pp., 2500 pict. Was \$52.50...Now \$24.80

Law and Practice (with reading course), 13 v., 6000 p., illus. Was \$97.50...Now \$49.80
Fire Prevention and Insurance, 4 vols., 1500 pp., 600 pict. Was \$30...Now \$14.80
Telephony and Telegraphy, 4 vols., 1728 pp., 2000 pict. Was \$39.00...Now \$14.80
Sanitation, Heating, Ventilation, 4 vols., 1454 pp., 1400 pict. Was \$30...Now \$14.80
Business Management, 8 vols., 2599 pp., Well illus. Was \$52.50...Now \$29.80
Drawing, 4 vols., 1578 pages, 1000 pictures, blueprints, etc. Was \$30.00...Now \$14.80

7 DAYS' FREE TRIAL

We'll gladly send you any set of these books you want for seven days' free examination. Don't send us a cent. Just pay the small shipping charges when the books arrive. Examine them carefully. Use them at your work for an entire week. If you feel that the books are not worth more than we ask for them, send them back at our expense. If you keep them, pay only the bargain price on the easy terms explained below.

75c a Week That's all you pay if you keep the books you select. Send \$2.80 within 7 days and the balance of the cut price at the rate of \$3.00 a month (75c a week). Did you ever hear of a more generous offer? Remember, you take no chances—you don't pay us anything if you don't keep the books. *Mail the coupon NOW—before you turn this page.*

AMERICAN TECHNICAL SOCIETY, Dept. X-191, Chicago

Wanted

Office Men

Auditors, Accountants, Office Managers, Credit Men, Cashiers, Bookkeepers and Cost Clerks—\$2,000 to \$7,500 a year.

Factory Men

Electrical and Mechanical Engineers, Factory Managers, Superintendents, Foremen, Designers and Draftsmen—\$2,000 to \$12,000 a year.

Construction Men

Civil and Structural Engineers, Transmitters, Construction Superintendents and Foremen, Estimators, Designers and Draftsmen—\$2,500 to \$10,000 a year.

Trades

Machinists and Toolmakers, Auto Repairers, Electricians, Stationary Engineers, Firemen, Plumbers, Carpenters, Pattern Makers and Telephone Men—\$2,000 to \$4,000 a year.

A Real Bargain

The price of these Pay Raising Books is cut in half

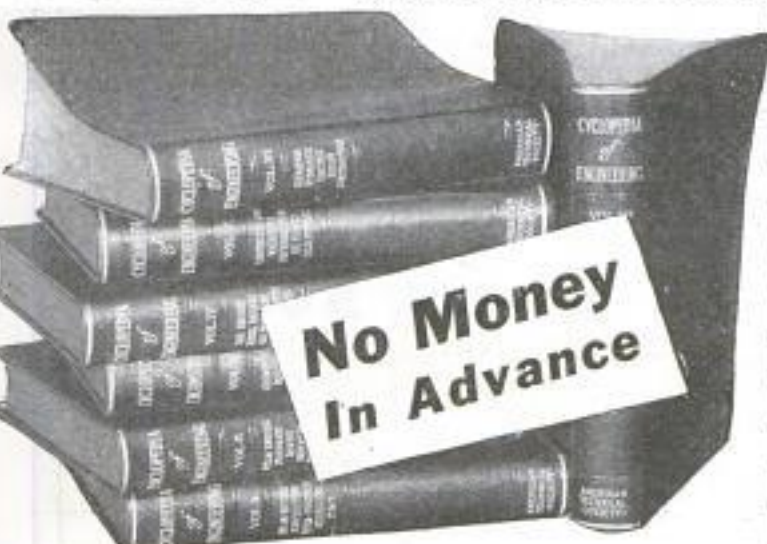

SPECIAL DISCOUNT COUPON

AMERICAN TECHNICAL SOCIETY
Dept. X-191, Chicago, U. S. A.

Please send me set of.....

for 7 DAYS' examination, shipping charges collect. I will examine the books thoroughly, and, if satisfied, will send \$2.80 within 7 days and \$3 each month until I have paid the special price of \$..... If I decide not to keep the books I will return them at your expense at the end of one week. Title not to pass to me until the set is fully paid for.

Name.....

Address.....

City..... State.....

Reference.....

Please fill out all lines

\$80 Drafting

To every student enrolling now I give an opportunity of getting an \$80 drafting course absolutely without cost to him. So send in your sketch today and learn all about this offer.

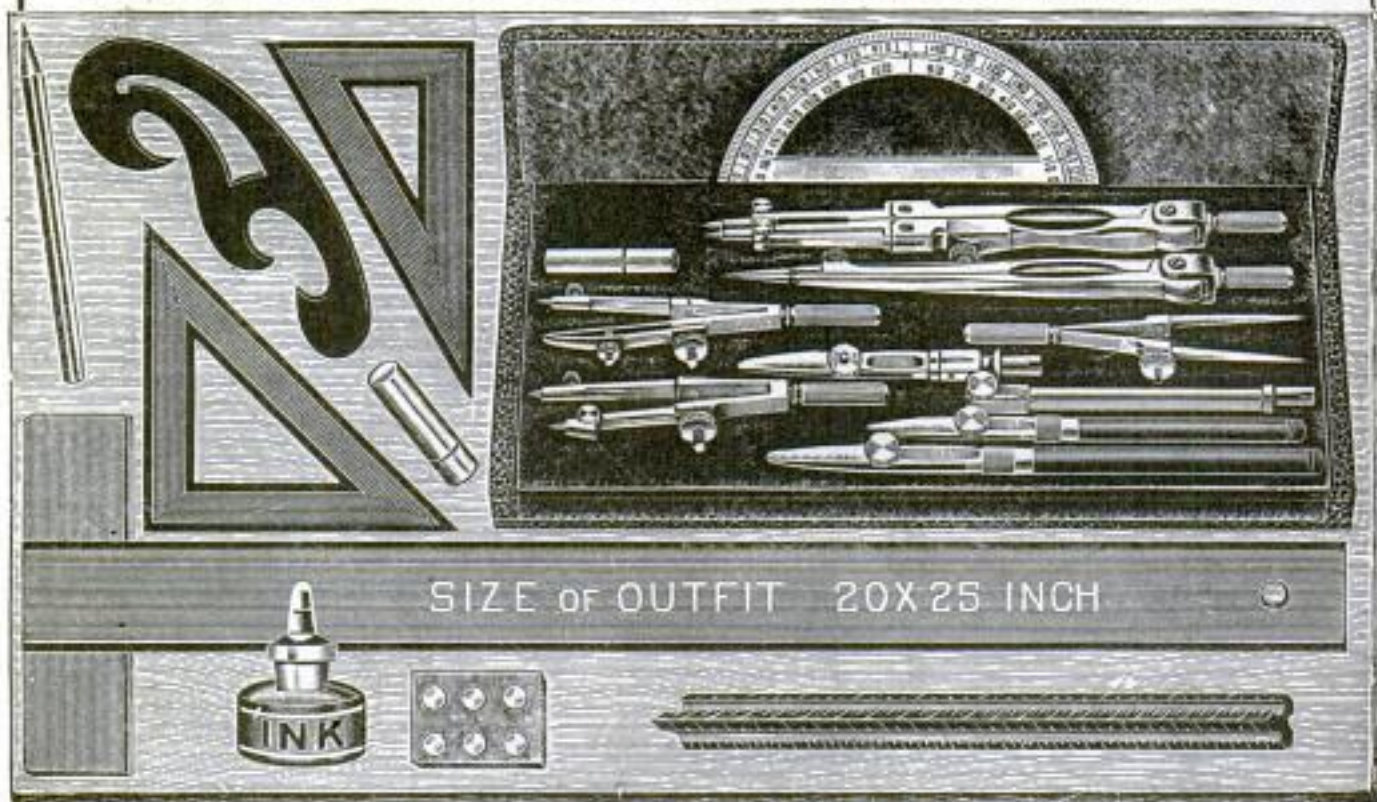

Drawing Outfit Free!

To every student enrolling now I give an opportunity also of getting a regulation draftsman's outfit made up of the very same instruments which I use myself. Every student gets this splendid set without cost. See illustration above.



Draftsman's Pocket Rule FREE! -To Everyone Sending the Sketch

To every man sending copy of sketch shown on next page I am going to mail free and prepaid the Draftsman's Ivory Pocket Rule shown here. This will come to you entirely with my compliments. With it I will send a 6x9 book on "Successful Draftsmanship." If you

are interested in becoming a draftsman, if you think you have or may attain drafting ability, sit down and copy the drawing on next page, mailing it to me today, writing your name and your address and your age plainly on the sheet of paper containing the drawing.

Read Next Page for Full Particulars 

Course FREE

Copy This Sketch

I AM anxious to find men with desire to become draftsmen. With business picking up everywhere many thousands of draftsmen will be needed at salaries ranging from \$3000 to \$3600 per year.

In asking you to copy this sketch I believe I will be able to tell from the sketch you send in what kind of an opportunity you will have in this great profession.

There are no conditions requiring you to buy anything. You are under no obligations in sending your sketch. What I want to know is how much you are interested in drawing and your sketch will tell me that.

Ambitious boys and men between the ages of 16 to 50 are wanted by big business concerns, and the man who is ready when opportunity calls him will get the best position and the highest pay.

Mail Your Drawing At Once
—and Get an Ivorine **FREE!**
Pocket Rule Absolutely

Ambitious men interested in drafting, hurry! Don't wait! This is your opportunity to get into this great profession. Accept the offer which I am making now. Send in your sketch or request for FREE book and FREE Ivorine Pocket Rule. Mail the coupon TODAY!



Copy this sketch

\$250 to \$300 per Month

I am Chief Draftsman of the Engineers' Equipment Co., and I know that there are thousands of ambitious men who would like to better themselves, make more money and secure faster advancement. Positions paying \$250 to \$300 per month, which ought to be filled by skilled draftsmen, are vacant everywhere. I want to find the men who with practical training and personal assistance will be qualified to fill these positions. No man can hope to share in the great coming prosperity in manufacturing and building unless he is properly trained and is able to do first class practical work.

I know that this is the time to get ready. This is why I am making the above offer. I can now take and train a limited number of students personally and I will give to those students a guarantee to give them by mail practical drawing room training until they are placed in a permanent position with a salary of \$250 to \$300 per month.

Send Coupon for Free Book

Send coupon for my free book, "Successful Draftsmanship". Also full information as to how you can get an \$80 Draftsman's Course Free. Even if you don't send in a sketch send the coupon for the free book.

Chief Draftsman, Engineers' Equipment Co.
1951 Lawrence Ave., Div. 1351, Chicago, Ill.

You should act promptly on this offer because it is my belief that even though you start now the great boom will be well on by the time you are ready to accept a position as a skilled draftsman. So write to me at once. Enclose sketch or not, as you choose, but find out about the opportunities ahead of you. Let me send you the book "Successful Draftsmanship" telling how you may take advantage of these opportunities by learning drafting at home.

I Guarantee

to train you until you are placed in a position paying \$250 to \$300 per month.

Chief Draftsman, Engineers' Equipment Co.
1951 Lawrence Ave., Div. 1351, Chicago, Ill.

Without any obligation to me please mail your book "Successful Draftsmanship" and full particulars of your liberal "Personal Direction" offer to a few students. Also full information as to how I can get an \$80 Drafting Course Free.

Name.....

Address.....

.....Age.....

No use looking for your ship to come in



unless you've sent one out

Men talk about "when my ship comes in" without reflecting that ships come in only when they have been sent out. The plain truth is that positions of responsibility, honor, leadership and good pay, come only to the men who have the foresight to prepare themselves for bigger opportunities.

Success is a conquest—not a bequest. It is won by pluck, not luck; by working, not wishing.

If you want a bigger opportunity to come to you in 1923, 1924 or 1925, have the foresight to begin preparing right now—not next month. Use your spare hours studying with the United Y. M. C. A. Schools. Every year you have 936 week-day spare hours between seven and ten o'clock. The United Y. M. C. A. Schools now offer more than 300 correspondence courses, and an instruction-by-mail service that gives you the most for the least money.

Get our friendly counsel on your problem. We will tell you how thousands of ambitious young men are, with our help, making their "ships come in." Mark and mail the coupon today.

SOME OF OUR 300 CORRESPONDENCE COURSES

| | | |
|---------------------------|------------------------------------|---------------------------|
| Accountancy | Business Courses | Office Management |
| Advertising | Business Administration | Public Speaking |
| Banking | Business English | Salesmanship |
| Better Letters | Business Finance | Secretarial |
| Bookkeeping | Business Law | Show Card Writing |
| Business Arithmetic | Complete Letter-Writing | Stenography |
| | | Traffic Management |
| | Technical and Other Courses | |
| Agricultural Courses | Factory Management | Own-Your-Home Course |
| Applied Psychology | Foreign Languages | Plan Reading |
| Architecture | Foremanship | Plumbing |
| Automobile Courses | Highway Engineering | Poultry Husbandry |
| Building Construction | High School Courses | Radio Engineering |
| Civil Engineering Courses | Illustrating | Radio Telegraphy |
| Drafting Courses | Insurance Courses | Steam Engineering Courses |
| Electrical Courses | Mathematical Courses | Structural Drafting |
| English Courses | Mechanical Engineering | Surveying |
| | | Use of the Slide Rule |
| | | Vocational Guidance |

Are you an ex-service man?



Correspondence Instruction

347 Madison Avenue
Dept. 2-J New York City

Without obligating me, please advise regarding the course in

Name.....

Full Address.....

(Please write plainly.)

WE TEACH COMMERCIAL ART

Meyer Both Company, the largest commercial art organization in the field, offers you a different and practical training. If you like to draw, develop your talent. Study this practical course—taught by this widely known institution, with twenty-two years success—which each year produces and sells to advertisers in the United States and Canada over ten thousand commercial drawings. Who else could give you so wide an experience? Commercial art is a business necessity—a highly paid, intensely interesting profession, equally open to men and women. Home study instruction.

Get Facts Before You Enroll in any School.

Ask the Advertising Manager of the leading newspaper in your section, anywhere in the United States, Canada, England or Australia—about the Meyer Both Company—let them tell you about us. Write for our illustrated book, "YOUR OPPORTUNITY"—for one-half the cost of mailing—four cents in stamps.

MEYER BOTH COMPANY

Department of Art Instruction
Michigan Ave. at 20th St., Dept. 16 CHICAGO, ILL.

NOTE—To Art and Engraving Firms:
Secure practical artists among our graduates. Write us.

LAW

IN YOUR SPARE TIME
Learn law with only institution giving same course by correspondence as was given for years at resident classes of this college. **DEGREE OF LL. B. CONFERRED.** One year business law course prepares you for success in business. Law trained business men in demand. Three year university course covers preparation for bar examination. Money back guaranteed if not satisfied. Low fee, easy terms, includes complete 1921 thirteen volume library, text material and all expenses. Write for **FREE BOOK.**
Hamilton College of Law 431 South Dearborn St. Dept. 61 Chicago

Ride A Ranger

The finest bicycle ever built. 44 Styles, colors, sizes; made in our new factory. **SAVE \$10 to \$25** by direct from the factory purchase.

Delivered free on approval, express prepaid, for 30 Days' Free Trial. 12 MONTHS to PAY, if desired.

Best quality at factory prices, express paid. Lamps, wheels, horns, equipment and repairs at unusually low prices. **Send No Money, do business direct with makers.**

Mead Cycle Company
Dept. K18 Chicago



Write today for free Ranger Catalog, factory prices and marvelous easy payment terms.

5,000 FORMULAS

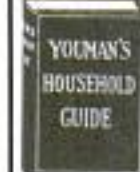

The 530 double-column pages in Youman's Household Guide contain nothing but formulas and processes for every phase of human effort. Many recipes hitherto unpublished. Any one of the five thousand easily worth more than the price you pay for ALL. To be without this book is costing you \$\$\$\$.

Prices, postpaid, Cloth \$2.00. Heavy paper..... **\$1.25**

WELLS & EDWARDS, BOOKSELLERS. Dept. A
852 George Street, CHICAGO

Send for free circular and 40 page Book Catalog

STAMMER NO MORE

Kill the fear of stammering. Re-education the key. The widely famed Hatfield Method fully outlined in an accurate, dependable, worthwhile book—"HOW TO STOP STAMMERING." It has inspired thousands. Free copy today.

THE HATFIELD INSTITUTE, 109 N. Dearborn, Chicago, Ill.

LEARN WATCH REPAIRING



You can learn by our modern and original system of instruction every part of the Watch Repairing Trade at home as good or better than at a shop. You can earn money while learning and secure a well paying position or start in business after completing our course of instruction. Good watch repairs are always in demand and earn from \$20 to \$70 per week. For particulars apply to the **WISCONSIN SCHOOL OF WATCH REPAIRING**
166 Mason St., MILWAUKEE, WIS.

FLEXIBLE
BINDINGPOCKET
SIZE

ENTIRE SET ONLY \$12

\$1
PER
MONTH

\$10,000. Master Set AUDEL'S ENGINEERS and MECHANICS GUIDES —

THE BOOKS YOU HAVE
BEEN WAITING FOR

4750 Pages—8754 Illustrations

Just completed—Audel's New Master Set for Engineers
and Mechanics!

Every Engineer, Mechanic and Electrical worker will
welcome this set as a sure source of advancement and higher
pay because of the complete up-to-date information that is
thoroughly and easily explained on every branch of Engineer-
ing and Electrical practice.

Why a \$10,000 Library? Because it would cost the reader
more than \$10,000 together with years of labor and experience
to collect, plan, arrange and prepare for his own study and
ready reference, the vast fund of knowledge printed in this
Master Set.

The entire set costs you only twelve dollars—knowledge
and instruction that has cost thousands of dollars and years
of time—yours for \$12.00—\$1.00 a month.

Study This Brief Table of Contents

Theory, Practice and Operation of
ALL Steam Engines, Valve Motions—
VALVE SETTING; complete in-
formation on ALL engines and pumps—
CORLESS ENGINES and the Theory,
Construction and Operation of all
Steam Engines, including UNIFLOW
and POPPET VALVE ENGINES,
and LOCOMOBILES—Locomotive-
Marine Engines; Turbines; Rotary
Engines—the Indicator—Lubrication
—PRACTICAL MANAGEMENT.
How to use Indicator—GAS, GAS-
OLINE, OIL, KEROSENE and FULL
DIESEL ENGINES—Accumulators and
Aviation—HOW TO SELECT AN
ENGINE, working instructions, draw-
ings on STEAM ENGINE DESIGN,
including rules and formulae, Theory
and Construction of ALL Steam
Boilers, Heat-Combinations; Fuel and
Flue Gas Analysis—CO₂ recorder—
Characteristics of Boilers—Materials

—Construction of all types of Boilers,
(THE LATEST PRACTICE)—Boiler
Construction—Mechanical Stokers—
Oil Burners—Setting—Chimneys—
Mechanical Drafts—HOW TO
SELECT A BOILER—Complete in-
structions and drawings on BOILER
DESIGN based on A. S. M. E. BOILER
CODE—OPERATION, including
installation, FIRING; care and repair
of Steam Boilers—Pipes, Fittings and
Pipe Fitting—Heating and Ventila-
tion—Refrigeration—Cooling Towers
—Condensers—Distilling Apparatus
—Elevators—Cranes and Hoisting
Machinery—Ropes and Cables—Splic-
ing—electric wiring in ALL branches;
compendium of practical electrical
engineering as an aid for engineers
and electricians in obtaining a license
—57 chapters—ready reference index,
covering entire field of Modern
Electricity.

*Helping Hand
Books that answer
Your Questions*

FREE
EXAM-
INATION



Send No Money—Send Only This Coupon

THEO. AUDEL & CO.,
72 Fifth Ave., New York City

Please submit me for free examination, AUDEL'S \$10,000
MASTER SET FOR ENGINEERS AND MECHANICS. Ship
at once prepaid, the 8 numbers, total cost \$12.00. If satisfactory,
I agree to send you \$1 within seven days and to further mail you
\$1 each month until paid.

Name.....

Occupation.....

Employed by.....

Home Address.....

Reference.....

PM JAN. 28



"A Dollar A Minute"

"That's what I figure my spare-time study with the I. C. S. was worth to me. It was the best investment I ever made. I'm now making \$160 a week—or almost twice as much in an hour as I used to make in a whole day!"

EVERY mail brings letters from some of the two million students of the International Correspondence Schools telling of promotions or increases in salary as the rewards of spare-time study.

What are you doing with the hours after supper? Can you afford to let them slip by unimproved when you can easily make them mean so much? One hour a day spent with the I. C. S. will prepare you for the position you want in the work you like best. Yes, it will! Put it up to us to prove it. Mark and mail this coupon now!

----- TEAR OUT HERE -----

INTERNATIONAL CORRESPONDENCE SCHOOLS
Box 5693-C, Scranton, Penna.

Without cost or obligation, please tell me how I can qualify for the position or in the subject before which I have marked an X:

BUSINESS TRAINING DEPARTMENT

- | | |
|---|---|
| <input type="checkbox"/> Business Management | <input type="checkbox"/> Salesmanship |
| <input type="checkbox"/> Industrial Management | <input type="checkbox"/> Advertising |
| <input type="checkbox"/> Personnel Organization | <input type="checkbox"/> Better Letters |
| <input type="checkbox"/> Traffic Management | <input type="checkbox"/> Foreign Trade |
| <input type="checkbox"/> Business Law | <input type="checkbox"/> Stenography and Typing |
| <input type="checkbox"/> Banking and Banking Law | <input type="checkbox"/> Business English |
| <input type="checkbox"/> Accountancy (including C.P.A.) | <input type="checkbox"/> Civil Service |
| <input type="checkbox"/> Nicholson Cost Accounting | <input type="checkbox"/> Railway Mail Clerk |
| <input type="checkbox"/> Bookkeeping | <input type="checkbox"/> Common School Subjects |
| <input type="checkbox"/> Private Secretary | <input type="checkbox"/> High School Subjects |
| <input type="checkbox"/> Business Spanish <input type="checkbox"/> French | <input type="checkbox"/> Illustrating <input type="checkbox"/> Cartooning |

TECHNICAL AND INDUSTRIAL DEPARTMENT

- | | |
|--|--|
| <input type="checkbox"/> Electrical Engineering | <input type="checkbox"/> Architect |
| <input type="checkbox"/> Electric Lighting | <input type="checkbox"/> Blue Print Reading |
| <input type="checkbox"/> Mechanical Engineer | <input type="checkbox"/> Contractor and Builder |
| <input type="checkbox"/> Mechanical Draftsman | <input type="checkbox"/> Architectural Draftsman |
| <input type="checkbox"/> Machine Shop Practice | <input type="checkbox"/> Concrete Builder |
| <input type="checkbox"/> Railroad Positions | <input type="checkbox"/> Structural Engineer |
| <input type="checkbox"/> Gas Engine Operating | <input type="checkbox"/> Plumbing and Heating |
| <input type="checkbox"/> Civil Engineer | <input type="checkbox"/> Chemistry <input type="checkbox"/> Pharmacy |
| <input type="checkbox"/> Surveying and Mapping | <input type="checkbox"/> Automobile Work |
| <input type="checkbox"/> Metallurgy | <input type="checkbox"/> Navigation |
| <input type="checkbox"/> Steam Engineering | <input type="checkbox"/> Agriculture and Poultry |
| <input type="checkbox"/> Radio <input type="checkbox"/> Airplane Engines | <input type="checkbox"/> Mathematics |

Name.....
Street..... 6-26-22
Address.....

City..... State.....

Occupation.....

Persons residing in Canada should send this coupon to the International Correspondence Schools Canadian, Limited, Montreal, Canada.

Please Mention Popular Mechanics

\$1,500 to \$6,000 a Year

Dental Laboratory

Be a mechanical dentist—a high class, agreeable occupation for men or women. Course is inexpensive. Takes only short time to complete. Experience or entrance requirements unnecessary. No license required. McCarrie graduates make big successes and are in great demand everywhere. Largest and best equipped school laboratory and clinic in America; individual practical instruction; modern up-to-date methods. Write for trial scholarship offer. Find out how easy it is to fit yourself for this highly paid and dignified profession. Learn the McCarrie way. It pays.

Write for Book No. 30

McCARRIE
SCHOOL OF MECHANICAL DENTISTRY
34 and 36 W. LAKE STREET, CHICAGO, ILL.

Music Lessons

UNDER MASTER TEACHERS

At Home

A Complete Conservatory Course By Mail

Wonderful home study music lessons under great American and European teachers. Endorsed by Paderewski. Master teachers guide and coach you. Lessons a marvel of simplicity and completeness.

Any Instrument Write telling us course you are interested in—Piano, Harmony, Voice, Public School Music, Violin, Cornet, Mandolin, Guitar, Banjo or Reed Organ—and we will send our FREE CATALOG with details of course you want. Send NOW.

University Extension Conservatory, 721 Siegel-Myers Bldg., Chicago, Ill.

"STAMMERING

Its Cause and Cure"

You can be quickly cured if you stammer. Send 10 cents, coin or stamps, for 288 page cloth bound book on Stammering and Stuttering. It tells how I cured myself after Stammering and Stuttering for 20 years. BENJAMIN N. BOGUE
745 Bogue Building, 1147 N. Ill. St. Indianapolis

BE AN EXPERT Penman

I TEACH BY MAIL. You can become an expert penman right in your own home by my method. Small Cost. All that is required is some of your Spare Time. Write for my book, "HOW TO BECOME AN EXPERT PENMAN." It contains specimens and tells how others became expert writers by the TEVIS METHOD. Your name written on a card if you enclose stamp. FREE BOOK. Write today. T. M. TEVIS. BOX 25K. CHILLICOTHE, MO.

LEARN SHOW CARD WRITING BY MAIL OR LOCAL DISPLAY ART CLASSES

Study under the direction of Arnold Binger, the leading expert in the line. Positions await competent students. Write for our beautiful illustrated Booklet and terms. BINGER SCHOOL OF SHOW CARD & DISPLAY ART
2116 Flatiron Building, Broadway & 23rd Street, NEW YORK CITY

ILLINOIS COLLEGE OF PHOTOGRAPHY

Established 1893. Photography or Photo-Engraving complete in six months. Salaries of \$35 to \$100 on graduating. College assists in locating positions. Tuition and living expense low. Address LE GRAND A. FLACK, Pres., Box 413, Effingham, Ill.

LEARN WATCHMAKING AND ENGRAVING

Earn while learning. Most practical watch school. Individual instructions. Graduates in great demand. Book free. Chicago School of Watchmaking, Dept. 20, 4840 Lincoln Ave., Chicago

Learn Wireless

At Home In Spare Time



Mail Coupon for FREE BOOK

Now Easy to Learn Through New Way

Why stay in a rut? Wireless is fascinating, offers you world-wide travel if you want it, brings you big money and fine opportunities. Through an amazing New Way you can easily qualify at home in spare time without any previous experience. Right from where you are now this wonderful automatic method takes you steadily, thoroughly and rapidly, step by step, to the fine wireless jobs.

MAIL Coupon Today for This Wonderful Book, "How to Learn Radio at Home"—Sent at Once to You Without Obligation or Cost. Let us tell you all about this splendid field that is clamoring for trained men. Wireless is one of the most fascinating fields in the world—and you can easily learn it at home in a short period of your spare time. Wireless offers you world-wide travel, interesting work, good pay (amounting to from \$2,400 to \$10,000 a year) and a fine future. Absolutely no knowledge of electricity or wireless necessary. Thousands have learned through this new, easy way. Mail coupon now for this complete illustrated book and our Offer.



Earn \$2,400 to \$10,000 a Year

WIRELESS is sweeping over the world like wildfire! You can easily learn it. You can qualify for the big opportunities open on land and sea—paying \$2,400 to \$10,000 a year. As you know, wireless is the fastest growing field in the world today. Its wonders are startling the whole earth. And it's only just started. Amazing openings are waiting for you. You have but to prepare—and you can easily do that at home in spare time through this new easy way. Wireless salaries amount to \$50 a week to start. And you can go from there to the bigger jobs paying \$10,000 a year. No knowledge of electricity or wireless necessary.

Anyone can learn quickly our new easy way.

Thousands Found It Easy

Thousands have rapidly learned this new easy way. Letters come in daily telling us the big jobs they hold in land stations in every part of the country. Others tell how they are visiting every nook and corner of the world. Our new way, patented and copyrighted by us (oldest and largest wireless school of its kind in America), quickly qualifies you. This New Way has special automatic features (furnished you as part of the course) which will teach you the code in half the usual time and take you step by step, right through our special copy-

righted shortest course. Through this amazing method you find yourself a complete and valuable wireless expert almost before you realize it.

A Recognized School

The National Radio Institute was the original and is today the oldest and largest wireless school in America teaching wireless by mail. This institute is officially recognized by the U. S. Department of Commerce, its diploma is given official credit.

Let us tell you about our amazing automatic method. Let us tell you how you can travel all over the world with easy work and good pay. Or, if you wish, you can accept one of the big wireless positions on land which are now urgently in need of your services.

FREE BOOK

It costs you nothing to get our interesting, illustrated booklet, "How to Learn Radio at Home." Just mail this coupon for it, and it will be sent by return mail. It will also tell you about the offer we are making for a limited time, giving you extra our new course in Wireless Telegraphy. No solicitor will call upon you and you will not be obligated in any way if you mail this coupon at once.

Don't miss this booklet. Fill out coupon now and mail it today.

NATIONAL RADIO INSTITUTE
Department 15A, Washington, D. C.

National Radio Institute
Dept. 15A, Washington, D. C.

Send me your FREE book, "How to Learn Radio at Home." Tell me about your Home Study Course in Wireless Telegraphy and Telephony and your offer.

Name.....Age.....
(Please Write Plainly.)

Address.....

City.....State.....

I am interested in a Sea position. I am interested in a Land position.



**One Year Ago Every One of These
You Are Reading Now — Today
mechanics, Many Owning Their Own**

STUDY THIS PICTURE Do you not want to join the crowd of keen, ambitious, energetic young men who are learning to be expert mechanics at this world-famous trade school? Take up the work you like. Every day you hesitate and delay is that much time lost. Learn Auto-Mechanics by the—

FREE RADIO COURSE

**START
THE
NEW YEAR
RIGHT**

Sweeney System of Practical Experience

The Great Million Dollar School, world famous, and the success of my thousands of graduates are due to the Sweeney System.

This is what you get here and can't get anywhere else. I have taught 50,000 men to be expert repairmen, chauffeurs, tractor engineers, etc. I am proud of the fact that I was selected by the U. S. Government to train 5,000 men for mechanical work in the service. I teach by using tools, not books. You learn as you do the real work with your hands.

LEARN A TRADE

Now is the time for you to learn a trade. I teach men to be successful auto mechanics. Can you make a tire? Can you weld a broken crank case? Can you build a battery? Can you repair an automobile? Can you go anywhere in the U. S. and get a job in a garage, repair shop, auto agency, tire shop, welding concern? Can you get a job as a driver or chauffeur?

LEARN A

Sweeney

**SCHOOL OF AUTO
1137 SWEENEY BLDG.**





Men Read an Advertisement Just as These Men Are Trained Auto Me-Independent Prosperous Business

Hundreds of Good Jobs paying \$50.00 a Week and More are open to Sweeney Trained Men. You need no previous experience. I train you in 8 weeks with tools, not books

I PAY YOUR RAILWAY FARE

I want you to come now—not to wait and postpone—I am making it easy for you—I will help you—the first step is to send for my free catalog.

I am now paying your Railroad fare to Kansas City and giving a free radio course. No extras. No books. You are sure of getting a job when you graduate. I can't tell it all here, but send for my big catalog. Investigate this real opportunity.

FREE

The first step is to send me the coupon or write a postcard for my 72-page illustrated catalog. It tells all about this

Million Dollar Trade School. How thousands of men just like you, without any special knowledge, but simply a liking for mechanics, MADE A LIFETIME SUCCESS as a result of this simple training.

I don't care how old you are. I don't care how small your education, for I teach with **TOOLS, NOT BOOKS**. I need 5000 salesmen and representatives to handle Sweeney batteries and radio supplies. I want managers for branch offices. I will hire you if you are in earnest and will qualify. And if you are willing to go to work, **I WILL PAY YOUR RAILWAY FARE** to Kansas City. Write me **NOW!** No colored students accepted.

You cannot get the **SWEENEY SYSTEM OF PRACTICAL EXPERIENCE** anywhere else—the system that trains men in eight weeks for big paying jobs.

E. J. SWEENEY,
President

TRADE

Sweeney

**TRACTOR-AVIATION
KANSAS CITY, MO**

**This FREE Book
Tells You
Every-
thing**

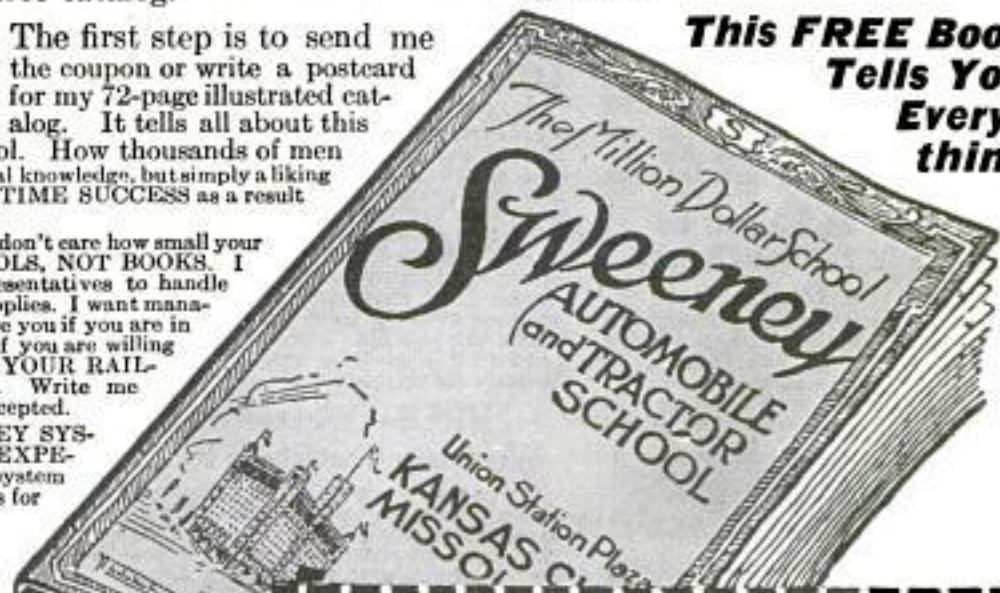

EMORY J. SWEENEY, President
1137 Sweeney Bldg., Kansas City, Mo.

Send me your offer of a guaranteed position, your big free catalog and full details of the Sweeney eight weeks' course leading to an immediate money-making opportunity.

Name

Address

ELECTRICITY

Lifts Men Out of Small Pay Jobs



Are You Satisfied With Your Job?
Have You Got all the Money You Want?
If Not Send for My Big New
FREE Book and Learn How to

Earn \$3,500 to \$10,000 a Year As an Electrical Expert

TRAINED "Electrical Experts" are in great demand at the highest salaries, and the opportunities for advancement and a big success in this line are the greatest ever known.

"Electrical Experts" earn \$70 to \$200 a week. Fit yourself for one of these big paying positions. Big jobs everywhere are waiting for trained men to fill them.

**Learn at Home to
Earn \$12.00 to \$30.00
a Day**

Today even the ordinary Electrician—the "screw driver" kind—is making money—big money. But it's the trained man—the man who knows the whys and wherefores of Electricity—the "Electrical Expert"—who is picked

out to "boss" ordinary Electricians—to boss Big Jobs—the jobs that pay. You, too, can learn to fill one of these jobs—spare time only is needed. Be an "Electrical Expert"—Earn \$70 to \$200 a week.

I Give You a Real Training

As Chief Engineer of the Chicago Engineering Works, I know exactly the kind of training a man needs to get the best positions at the highest salaries. Hundreds of my students are now earning \$3,500 to \$10,000 a year. Many are successful ELECTRICAL CONTRACTORS. Every branch of Electricity is open to you when you have finished my course. My experience as a practical engineer and my most unusual course makes this possible. I even have special lessons for those who want to go into business for themselves.

FREE—Electrical Working Outfit—FREE

I give each student Outfit of Electrical Tools, Materials and Measuring Instruments absolutely FREE. I also furnish them with all supplies, including examination paper, and many other things that other schools don't furnish. You do PRACTICAL work—AT HOME with this Outfit. You start right in after the first few lessons to WORK AT YOUR PROFESSION in a practical way.

Age or Lack of Experience No Drawback

You don't have to be a College Man;
you don't have to be a High School

graduate. If you can read and write English, my course will make you a big success. It is the most simple, thorough, and successful Electrical Course in existence, and offers every man, regardless of age, education, or previous experience, the chance to become, in a very short time, an "Electrical Expert," able to make from \$70 to \$200 a week.

Your Satisfaction Guaranteed

So sure am I that you can learn Electricity—so sure am I that after studying with me you, too, can get into the "big money" class in electrical work, that I will guarantee under bond to return every single penny paid me in tuition if, when you have finished my course, you are not satisfied it was the best investment you ever made.

Get Started Now—Mail Coupon

I want to send you the "Vital Facts" of the Electrical Industry, including my Electrical Book, Proof Lessons, and a sample of my guarantee bond all FREE. These cost you nothing and you'll enjoy them. Make the start today for a bright future in Electricity. Send in the coupon—NOW.

L. L. COOKE, Chief Engineer
Chicago Engineering Works
Dept. 11
2150 Lawrence Ave., Chicago, Ill.

USE THIS FREE OUTFIT COUPON

L. L. Cooke, Chief Engineer
Chicago Engineering Works,
Dept. 11
2150 Lawrence Ave., Chicago, Ill.

Dear Sir:—Send at once the "Vital Facts" containing Sample Lessons, your Big Book, and full particulars of your Free Outfit and Home Study Course—all fully prepaid, without obligation on my part.

Name.....

Address.....

The "Cooke" Trained Man is the "Big Pay" Man

CLASSIFIED ADVERTISEMENTS

WORLD'S BEST WANT AD MEDIUM

Advertisements in this section, 25 cents per word, each insertion, minimum 10 words, payable in advance. To be inserted under proper classification in February issue, copy should be in our office Dec. 25th.

AUTOMOBILE SUPPLIES

AUTOMOBILE parts for all makes and models of cars. We save you 10 to 90% and ship same day your order is received. We have gears, shafts, springs, pistons, pins and rings, cylinder head gaskets, bushings, clutch leathers, radiators, coils, magnets, Timken, Hyatt, New Departure and connecting rod bearings, crank cases, crank shafts, connecting rods, Atwater Kent, Connecticut, Delco and Remy ignition systems and parts. When you want auto-parts, write us, giving make, model and year of car and what parts are wanted. We will quote prices before making shipment, if you desire. We guarantee to please you or money refunded. Auto Tire & Parts Co., 501 Broadway, Cape Girardeau, Mo.

COMPRESSORS, twin cylinder automatic air electric driven, \$28 cash, balance easy terms. Buffers, battery chargers, same easy payments. Send postal to Hobart's, Troy, Ohio.

AUTOMOBILE parts, guaranteed new, for all cars. Save money; get our wholesale prices on gears, shafts and bearings. State make of car, model and parts wanted. Parts shipped immediately from stock. We refund your money, including transportation charges, if not satisfied. Mechanics Gear Co., 3708 No. Halsted St., Chicago.

AUTOMOBILE and radio batteries at a saving of 50%, direct from factory to you. Auto batteries, 6 volt, 11 plate, \$12.00; 6 volt, 13 plate, \$14.00; 12 volt, 7 plate, \$18.00. Radio 6 volt, 7 plate, \$10.00; 6 volt, 9 plate, \$12.00. Auto batteries guaranteed unconditionally for 18 months; Radio batteries, 2 years. Standard Auto Parts, 1221 Wabash Ave., Chicago, Ill.

KEEP Skid Chains Efficient. The Woodworth Chain Tool (patented) easily replaces broken cross chains without removing from the tire. Old off and new on in a minute. Practical, easy to operate, inexpensive, saving time and temper. Only \$1.10. Postage Prepaid. Order yours now! Manufactured and sold by C. S. Zeuner, 149 Lafayette Ave., Brooklyn, N. Y. Good Proposition for Jobbers!

CONSTANT potential 8-hour battery charging pays big profits. Eliminates competition. Comes on easy monthly payments, paid by profits. Send postal to Hobartson's, Troy, Ohio.

AUTO Owner Tire Agent wanted each locality to use and take orders for hand-made Mellinger extra ply and cord tires; guaranteed by bond for 8,000 and 10,000 miles (no seconds); shipped prepaid on approval; get your tires free; no capital or experience required; make \$100 to \$300 weekly. Write for wholesale prices and sample section. Mellinger Tire Co., 929-K Oak, Kansas City, Mo.

"SURESTART" Electric Hot Spot. Motorists install it. Start instantly coldest weather. Saves battery and trouble. Once used, you'll never do without. Fit any car. Satisfaction guaranteed. Ask garageman or write for details. Wiegand Co., 423 1st Avenue, Pittsburgh, Pa.

AUTOMOBILE Owners, garagemen, mechanics, send today for free copy of this month's issue. It contains helpful, instructive information on overhauling, ignition troubles, wiring, carburetors, storage batteries, etc. Over 120 pages, illustrated. Send for free copy today. Automobile Digest, 505 Butler Bldg., Cincinnati.

AIR Compressors—Genuine Brunner Compressors, new, on very attractive terms; send post card. Brunner Mfg. Co., Dept. A, Utica, N. Y.

AIR compressors, for garages, tire shops etc. Price \$25, new. Shaw Mfg. Co., Galesburg, Kans.

AUTOMOBILE, motorcycle magazines. List free! Toepff Magazine Agency, Middletown, N. Y.

LIBERTY Air Compressors, for garages, tire-shops, filling stations, also paint spraying equipment. Air Compressor & Equipment Co., 1437 Carroll Avenue, Chicago, Ill. Distributors wanted.

USED Parts for Dodge Brothers' cars, 50% off list. Harris Motor Car Company, Cape Girardeau, Mo.

RADY-O Plugs end all spark plug trouble. Satisfaction guaranteed or money refunded. Five Dollars per set of four. Address R. T. Mfg. Co., Green Bay, Wis.

OIL-LESS spark plugs, keep clean by Vacuum, dealers write for folder and prices. Dinger Spark Plug Co., Melvina, Wis.

AUTOMOBILES

AUTOMOBILE Repairman's Helper. In Two Vols. An excellent new work that gives every operation required to adjust or repair the troubles likely to be found in all standard cars. Vol. 1—Repairshop Practice—Passenger Cars—Trucks, 335 pp., 417 figs. Price \$2. Vol. 2—General Shop Practice Passenger Cars—Parts and Accessories, 528 pp., 428 figs. Price \$3. Popular Mechanics Book Dept., 6 N. Michigan Ave., Chicago.

PATENTS—Write today for Free Instruction Book and Evidence of Conception Blank. Send sketch or model for examination and opinion; strictly confidential. No delay in my offices; my reply special delivery. Reasonable terms. Personal attention. Clarence R. O'Brien, Registered Patent Lawyer, Southern Building, Washington, D. C.

REPAIRING Ford Cars, Trucks and Tractors in the most proper and efficient way is explained in a new 229-page book by the former Director of the Ford Motor Co. Service School. This information is otherwise unavailable outside of the Ford plant. Written more especially for the mechanic and repairman. Price \$2, postpaid. Popular Mechanics Book Dept., 6 N. Michigan Ave., Chicago.

PATENTS—Write for our free illustrated Guide Book and Evidence of Conception Blank. Send model or sketch and description of your invention and we will give our opinion of its patentable nature. Highest references. Prompt service. Reasonable terms. Victor J. Evans & Co., 185 Ninth, Washington, D. C.

AUTOMOBILE Owners, garagemen, mechanics, send today for free copy of this month's issue. It contains helpful, instructive information on overhauling, ignition troubles, wiring, carburetors, storage batteries, etc. Over 120 pages illustrated. Send for free copy today. Automobile Digest, 505 Butler Bldg., Cincinnati.

NON-ALCOHOLIC Anti-Freeze for Radiators; non-corrosive; non-explosive; freezeless above 32 below zero. Makes four gallons liquid. Low evaporation. \$3.25 postpaid. Burson Chemical Laboratory, Ottumwa, Iowa.

DYKE'S Automobile Encyclopedia, 13th edition, new, greater than ever, entirely rewritten and rearranged. Contains greatest array of auto facts ever published in one vol. Separate books containing same information cost \$21. Over 1200 pages and 4100 illus. Cloth \$8. Flex. Amer. Morocco \$7.50 postpaid. Popular Mechanics Book Dept., 6 N. Michigan Ave., Chicago.

FOR FORD OWNERS

FORD Owner Agents Wanted. Buy New Car with Gasoline Saved with Gas Nozzles and Hot Spots. Money-back guarantee. Postpaid \$2.50. F. C. Reed Co., Lock Box 77, Phillipsburg, N. J.

INSTANT Vaporizer for Fords; makes starting easy in coldest weather. Goes between carburetor and manifold. Easily attached. Price postpaid \$2.00. Ride in comfort during winter by using waste heat from exhaust. Complete heater easily attached. \$2.00 postpaid. Shaw Manufacturing Co., Galesburg, Kans.

FORD Car Repair Book Sent Free. This complete and well illustrated valuable book explains in a simple way how to overcome Ford car troubles; Repairing, Economical Winter Driving, Cold Weather Car Starting, Equipment for Fall and Winter, Caring Piston Ring Troubles, Carburetor Adjustments and Repairs, Connecting Rods, Timers, Transmission Troubles, and practically every phase of Ford car driving, repairing and equipment. Send 25c coin for three months' trial subscription and get the valuable repair book free. Ford Owner and Dealer Magazine, 525 Montgomery Bldg., Milwaukee, Wis.

AGENTS with Fords, \$30.00 a day selling Brass Water Circulating Pumps \$1.00, sells for \$10.00. Shock Absorbers and Snubbers \$3.50, sells for \$8.50. Nickel Byplex Bumper, F. or R., \$5.50, sells for \$12.00. Explosion Whistle, Brass, \$2.00, sells for \$4.50. All guaranteed first class. Enclose money order for any item. Will ship at once so you can start selling. Universal Mfg. Co., 1110 S. Michigan, Chicago.

FORDS run 34 miles on gallon gasoline. Other cars show proportionate saving. Wonderful new carburetor. Starts easy in coldest weather. Fits any car. Attach yourself. Money back guarantee. Sent on 30 days' trial. Agents wanted. Air Friction Carburetor Co., Dept. 3221, Dayton, Ohio.

100,000 MILES guaranteed service by using The Nelson Ball Bearing Timer on Ford Cars. Easy starting. Smooth running. Postpaid \$3.50 U. S. A. 620 East Water Street, Milwaukee, Wis.

FORD Owners—Equip your Ford with priming cups. Dealers jobbers wanted. Midset Cyclecar Co., Box 103 Highland Station, Springfield, Mass.

"BROWNE" Magneto Post. for Fords; new invention, can be taken out in a few seconds without removing screws. Better contact. Stronger current. \$1.90 postpaid. Agents wanted. Tom Brown Company, Wilkes-Barre, Pa.

CYCLE "Dynamic" hot-spot guarantees 25 to 35 miles per gallon. Greatest hill-climber known. Cycle Manifold Co., South High, Akron, Ohio.

CONVERT Ford into ton truck; complete attachments \$20. Unwin, 55 Broadway, N. Y.

FARM with your Ford. The Adapto Tractor makes your Ford a powerful tractor that will plow and do "any three horses' work. Includes Belt Power Attachment that buzzes wood, fills silo, etc. Guaranteed not to injure your Ford or money back. Dealers wanted. Tractor Co., Geneva, Ohio.

SPEEDSTER Fans. Don't fail to see "Red-I-Kut" ad. Page 132.

MAGNETESTER tells exact condition Ford. Fordson magneto, \$5.50. Recharge Fords in car from any light socket. Rechargers, \$5.00 up. 25 ton gear presses, \$12.50. List and low prices. Benner Mfg. Co., Webb City, Mo.

THERMO-PLATE for Fords; Forces heat out of crank case—reduces temperature. Wonderful Demonstrator. Agents wanted. Eaton Mfg. Co., Low Moon, Ia.

FORD Door opening Curtains, heavy material, curb side \$8.00, complete set \$11.00 postpaid. J. L. Stuller, Wooster, Ohio.

FORD water circulator prevents freezing and overheating. Easily attached. Satisfaction guaranteed. Pay postman only three seventy. Tractor Co., Geneva, Ohio.

FORD Owners, don't ruin your car by leaving it chattered. Correct same by installing Bredar's Ball Shim. Price \$1.10. Write for information. Nic Bredar's Son Mfg. Co., Rock Island, Ill.

MOTORCYCLES, BICYCLES AND SUPPLIES

WONDERFUL bargains in reconditioned motorcycles. Priced as low as \$35. Sidecars from \$25 up. Everyone expertly rebuilt and guaranteed in absolutely first-class condition. Don't delay. Send 2c for new big catalog showing 1923 bargains. Western Supplies Co., 539 Hayutin Bldg., Denver, Colo.

DON'T buy a Bicycle Motor Attachment until you get our new catalogue and prices. Also runs washers, pumps and shop machinery. Shaw Mfg. Co., Dept. 27, Galesburg, Kans.

'19 INDIAN 3 Speed \$85.00. '20 Indian 3 Speed \$100.00. '21 Indian 3 Speed \$150.00. Howard A. French Company, Baltimore, Md.; Washington, D. C.

USED parts for all motorcycles, cheap. State wants. Schuck Cycle Co., 1922 Westlake, Seattle, Wash.

SEND for our Bargain Bulletin and Money-Saving Message. It will save you money on Motorcycles, Side Cars, Motor Wheels, Repair Parts and Accessories. Some used parts at less than half. Cleveland and Henderson Motorcycles our specialty. See our ad on page 132. American Motor Cycle Co., 2043-5-7 W. Chicago Ave., Chicago.

NEW Rogers Side Cars \$49.50. Fit any Motorcycle. Rebuilt bargains—Motorcycles, Engines, Magnets, Parts, Bicycle Parts. Special repairs, Cylinder grinding, including Piston, Rings \$4.00. Scored Cylinders—refilled \$4.75. State your requirements. Enclose Stamp, America's Best Equipped Cycle Shop, Erickson, 438 W. 79th St., Chicago.

FOR Sale, 1920 Indian Motorcycle. Big Value, Electrically equipped, guaranteed, \$100. Reference, Farmers Nat'l Bank Address, C. Edw. Pulver, Hudson, N. Y.

USED Motorcycles. Best values in the country from \$25 up. Get our free lists. Seeber & Hofheins, Buffalo, New York.

U-BICYCLE-LOCK—new, patented device for locking bicycles; fits over tire and rim. Send \$1.00 before too late. U-Bicycle-Lock Company, Upper Montclair, New Jersey.

AVIATION

REAL aeronautical bargains, turnbuckles 20c, aero cloth 38c, shock absorber 5c, Gnome motors \$150.00, tubing 5c per foot, airplane sheet steel 5c per pound, tape 3c, sparkplugs 25c, high tension wires with terminals 20c, wheels 20x4 \$6.00; brass screws 40c per gross, plywood 20c, aircraft nuts 5c. Many other bargains. Sale sheet 2c. Heath Airplane Co., Chicago, Ill.

INVENTORS desiring patents should write for our Free Illustrated Guide Book and Evidence of Conception Blank. Send model or sketch for our opinion of its patentable nature. Highest references. Prompt service. Reasonable terms. Victor J. Evans & Co., 187 Ninth, Washington, D. C.

PATENTS—Send for our free book. Contains valuable information for inventors. Send sketch of your invention for Free Opinion of its patentable nature. Prompt service. (Twenty years' experience.) Talbert & Talbert, 472 Talbert Bldg., Washington, D. C.

MY "Baby Biplane" has made 36 successful flights, using Ford Engine, and she's still going beautifully. 5x7 photographs and specifications, \$1.50. C. C. Melton, 3547 E. 34th, Kansas City, Mo.

PILOTS trained: Complete course and position for competent graduates \$200. Ardie Miller, Benton, Ill.

PROPELLERS for aeroplane propulsion, 5-foot diameter \$12; 6 foot for Fords \$15; others in proportion. Motorcycle sleigh blueprints 15c. Ford size \$1.00. Pictures free. Crawford Motor and Aeroplane, Long Beach, California.

GOING to Learn to Fly? I can save you money on your course, no matter where you live. Write at once. Pilot J. DeForest Smith, St. Clair Hotel, Schenectady, N. Y.

A WONDERFUL opportunity to learn to fly by our new method, includes three hours' instruction in the air, and one month intensive shop course, complete at \$100.00. Special night flying instruction proposition to students enrolling prior to February. Heath Airplane Co., Chicago, Ill.

FOR Sale, Patent for all-metal Aero-plane, indestructible by fire, no nose-diver, etc. Eugene Wilder, Box 83, Boulder, Colo.

AIRPLANE Motor, new, \$50.00. Smith Machinery Company, Houston, Texas.

SPEEDY "Aerodrive" 8-cyl. Blueprint 50c. Lerbome motors \$1.00. Dope \$1.00. Turnbuckles 20c. List 2c. Oestgaard Aircraft, 4269 North Narragansett, Chicago.

AIRPLANE propellers, new, \$2.50 to \$10.00. Airplanes with motors, practically new, \$350.00. Curtis OX-5 motors, 8 cylinders, 90 h. p., \$150.00. Smith Machinery Co., 403 Grogan Building, Houston, Texas.

BIGGEST, best catalogue Model Aeroplanes, Parts and Supplies; 5c postpaid. Ideal Aeroplane Co., 67 1/2 West Houston, New York.

AVIATORS' Dandy leather winter helmets \$6.50; Resistal, unshatterable goggles \$5; airplanes, motors and supplies. Floyd Logan, 716 W. Superior, Cleveland.

MOTORCYCLE motors, propellers and equipment for Aeroplanes, snow and ice, low prices. Shaw Mfg. Co., Chicago, Ill.

SEND for our Glider literature; also literature on our latest Ford, or Motorcycle Motored Airplanes, 4c each. Heath Airplane Co., Chicago, Ill.

WELDING

WELDING Encyclopedia—A complete instruction book on all welding processes; oxy-acetylene, electric arc, electric resistance and thermit. Welding of all weldable metals fully discussed. 328 pp. 375 illus. The accumulated experience of the welding brains of America is yours for \$5. Money back if not satisfied. Popular Mechanics Book Dept., 6 N. Michigan Ave., Chicago.

BOOKS AND PERIODICALS

BIG money in writing photoplays, stories, poems, songs. Send today for free copy America's leading writer's magazine, full of helpful advice on writing and selling. Writer's Digest, 708 Butler Building, Cincinnati.

PLANS for Poultry Houses. All styles. 150 illustrations; secret of getting winter eggs, and copy of "The Full Egg Basket." Send 25 cents. Inland Poultry Journal, Dept. 74, Indianapolis, Ind.

BOOKS, Formulas, Secrets on all subjects. Prices of 1,000 Rare Substances, how and where they come from, 10c. Catalogs free. World Book Supply, D. 688 Milwaukee, Chicago.

BOYS' toy-maker book, 64 pages, illustrated, 10c. Amateur Electrician, 64 pages, illustrated, 10c. Radio Sets, how to build, illustrated, 25c. Western Puzzle Works, St. Paul, Minn.

INDUSTRIAL Alcohol. Wright's book everybody wants. Full directions for making with drawings of necessary apparatus. \$2.50 postpaid. Spon & Chamberlain, 120 P. M. Liberty Street, New York, N. Y.

YOU should have our New Illustrated List of Practical Books, Free. Spon & Chamberlain, 120 P. M. Liberty Street, New York, N. Y.

GREATEST "Master Key" 35 full course lessons, leather gold-leaved \$5.00. Lucky oriental ring \$2.00. Catalogs 2c. Sovereign Company, 40 Broadway, Buffalo.

MOCK Trials, 25c. Black Art 25c. Telepathy, 25c. 6th, 7th Book Moses, 50c. Smith's Novelties, 6735 South Elizabeth St., Chicago.

TOEPP'S Trade Magazine Service, Middletown, N. Y. List free! What's wanted?

STARTING a Magazine Subscription Agency. Copy, 10c. D. D. Green, Leslie, Michigan.

"ELECTRICAL Kinks" Most complete book on everything electrical in the home. See advertisement on page 14.

1,000,000 INDUSTRIAL Facts, Calculations, Receipts, Processes, and Trade Secrets for every business are contained in the 1016 page Book "Moore's Universal Assistant and Complete Mechanic." 500 Engravings. Cloth. Price \$2 postpaid. Popular Mechanics Book Dept., 6 N. Michigan Ave., Chicago.

HYPNOTISM. Astounds, controls others. Wants gratified. 25 Easy lessons \$1.00. "Mindreading" (any distance) Wonderful, 30c. Popular Institute, 11614 Belmont, Chicago.

FREE Book—"Elijah Coming Before Christ." Address, Megiddo Publishers, Rochester, N. Y.

BOOKS. Any kind. Lists. Higene's, A2441 Post Street, San Francisco, Cal.

STOP Guessing—The New Building Estimators' Handbook by Arthur enables the carpenter, contractor, builder to prepare with confidence estimates based on actual, present-day conditions. Over 1000 pages, 467 illus., 600 tables, flexible—\$6 postpaid. Popular Mechanics Book Dept., 6 N. Michigan Ave., Chicago.

"LAUGHING It Thru." Fun in winning. A tonic for the tired and frazzled. Guaranteed to cure any size grouch. 25c per copy. Mutual Supply Co., Bradford, Pa.

IMPROVE Your Handwriting. Chart and Lesson Course 50c postpaid. Business Methods, 302 Willoughby Building, Chicago.

OUR new catalogue listing over five hundred carefully selected practical books under eighty different subject groupings will be sent free upon request. Popular Mechanics Book Dept., 6 N. Michigan Ave., Chicago.

PICTURES AND POSTCARDS

JOIN Live Postcard Club; membership lists including catalog, 10c. Harvey Teeple, Decatur, Indiana.

50 MAIL-ORDER Magazines and Papers \$1.00. Address Hansen Company, Brookings, S. Dak.

POSTCARDS, Beautiful French girls; Samples, literature, 25c. None free. Movie Star Photographs; name your favorites; 13 for 25c. Smith's Novelties, 6735 South Elizabeth St., Chicago.

30 ACTUAL photographs of Washington, D. C., 35 cents, postpaid. Box 171 Penna. Ave. Sta., Washington, D. C.

EXCHANGE Postcards, letters, curlics with foreigners. Membership \$1 (bill). Delcavefer, 282-M d'Entraigues, Tours, France.

FOREIGN postcards, 25c dozen; 50 different \$1. Durso, 25 Mulberry, N. Y. City.

NOVELTIES, CURIOS, ETC.

DISAPPEARING Ink—Ink that vanishes and then becomes visible as required. Great fun when used at parties, etc. Fifty cents bottle. Puckram Advertising Agency, Brocton, N. Y.

SACRIFICE Sale. 37 Solid Gold-Mounted Elk's Tooth Charms. Bought at Sheriff Sale. Make offer for one or lot. Sent on approval. Ship express or parcel post. C. O. D. J. P. Dorion, Box 109, Lyndonville, Vermont.

BAMBOO Fountain Pens \$1.25; money refunded if not satisfied. P. Fozos, New Richmond, Wis.

GAMES AND ENTERTAINMENTS

MAH-JONGG—The ancient intriguing game of China now being introduced into this country. Very fascinating. Send for further details or mail us your order for the game in either one of two styles, number 103 at \$10, or number 105 at \$35, prepaid to your address. Popular Mechanics Book Dept., 6 N. Michigan Ave., Chicago.

SERPENT of India. Greatest trick in the world. Done anywhere. A common knot is tied in the body of this remarkable reptile. When held up by tail, snake slowly rises, head first and actually unties itself. Repeats at will. Silk snake, complete with special patter. Just send a dollar bill. Our big Magic Catalog Free with every order. Address Thayer Magic Co., 334 San Pedro St., Los Angeles, Calif.

67 TRICKS, 250 jokes, riddles, 73 toasts, 8 Fortune Telling secrets, 52 moneymaking secrets, 22 funny readings and big catalog 10c. Ideal Novelty Shop, 5501-T North Bobey, Chicago.

ENTERTAINING Books, Puzzles, Tricks. Catalog free. Andeo, 4049-TA, North Whipple, Chicago.

PLAYS, musical comedies and revues, minstrel music, blackface skits, vaudeville acts, monologs, dialog, recitations, entertainments, musical readings, stage handbooks, make-up goods. Big catalog free. T. S. Denison & Co., 625 So. Wabash, Dept. 11, Chicago.

VENTRILLOQUISM taught almost anyone at home. Small cost. Send 2c stamp today for particulars and proof. George W. Smith, Room M-294, 125 N. Jefferson Ave., Peoria, Illinois.

BOYS! Girls—Big package 20 new games. Enjoy long winter evenings. For 15c. Jax Company, Steger, Ill.

300 KINDS Iron, wood and wire puzzles. Leader and illustrated list 10c. Western Puzzle Works, St. Paul, Minn.

MAGICAL apparatus, plays, books, card tricks, mindreading, etc. Illustrated catalog free. Heaney Magic Co., Berlin, Wis.

SHIMMIE Dancer—Real stuff, Boys! 16c. Catalog free. Western Sales Co., St. Paul, Minn.

MAGIC TRICKS, BOOKS AND JOKERS' NOVELTIES

EXPOSED!—Astonishing, undetectable trick of making lighted cigarette disappear with sleeves rolled up and arms outstretched from body. Easy to perform anywhere. With sixty Master Mind tricks, one dollar. Address C. Murphy, R-1 Edgewood Road, Ashville, N. C.

MAGIC. Ventriloquial Punch Figures, Stage Money, Books, Magazines, Escapes, Secrets, Illusions, Flowers, Roll Paper, Catalogs, 10c. Address, Gilmaglio, Morgan Park, Ill.

BE a Magician. We supply the leading professionals and amateurs with magical apparatus, card tricks, crystal gazing supplies, mindreading, books, jokes, novelties, tricks, plays, etc. Large illustrated catalog free. Buy direct from manufacturers. Latest and best. Heaney Magic Co., Berlin, Wis.

14 CARD tricks; 40 magic tricks; 10c. Catalogs. Smith's Novelties, 6735 S. Elizabeth St., Chicago.

NEW "Mind Reading" stunt. Mystified everybody. Particulars, "Mack," Atascadero, California.

PAPER Magic—A new book by Houdini in which are described not only a large number of tricks with paper but also the amusing and puzzling articles which may be made of folded paper and tearing of paper. Paper puzzles are also included. 206 pages. Illus. Price \$2.50 postpaid. Popular Mechanics Co., 6 N. Michigan Ave., Chicago.

MAGIC—Tricks, Books and Supplies. For Amateurs as well as the great professionals. Anyone can learn through our instructions. Feature Acts in Mind Reading, Spiritualism, Rope Ties, etc. Large illustrated Professional Catalog, 10c. Chicago Magic Co., Dept. B, 149 S. Dearborn St., Chicago, Ill.

"33 TRICKS" 6c. New 48-Page Copyrighted Book. Explains 10 Pocket Tricks; 10 Card Tricks; 10 Parlor Tricks and 3 Mysterious Mind-reading Effects. Mailed for 6c stamps, including 1923 Catalog of Magic and Imported Novelties. Write now! Lyle Douglas, Station A, Dallas, Texas.

FUN, Jokers' goods, trick pencils, small bombs, sneeze powder, sooner dogs, pills, new puzzles, shooting cigars, cigarettes, books, 100 others. Send for illustrated catalogue today. Grandefeld, 1238 Theriot Ave., W. F., New York.

TRICKS, Puzzles, jokes, magical apparatus, plays, stage supplies, mind-reading, sensational escapes. 160-page illustrated professional catalog, 10c. Oaks Magical Co., Dept. 548, Oshkosh, Wis.

STAMP COLLECTING

BEST one-cent approvals in America. F. P. Hand, 1117 So. 66th St., Philadelphia, Pa.

FREE—Beautiful set of stamps to approval applicants. Postage 2c. Yonkers Exchange, Yonkers, N. Y.

50 PICTORIAL Stamps, many unused, for 20 cents. Harma, 1713 Waverly, Detroit, Mich.

BARGAIN: 1,000 Mixed Stamps, 20c; 11,000, \$2.00. Nielsen, 1923 Melrose, Chicago.

WONDER packet stamps, 10c. Approvals. Buckley, 712 Bowen, Dayton, Ohio.

100 DIFFERENT foreign stamps, 20 cts. M. Place, Harding, Mass.

LIKE Triangular Stamps? To introduce our Sudden Service Approvals we'll send triangular Plume, set China ships, large \$1.00 United States revenue, also packet 50 foreign, millimetre scale, perforation gauge, ruler and bargain lists for only 9c! Pennell Stamp Company, Dept. P, Fullerton Bldg., St. Louis, Mo.

\$1.00 CATALOG value, all diff. stamps, only 10c; approvals with each order; also free lists, book, gauge, etc. About \$3.00 Cat. value, 25c. \$5.00 for 75c. Hawkeye Stamp Co., Cedar Rapids, 39, Ia.

BOYS! 102 different from White Russia, Fiume (Triangle), etc.; perforation gauge, stamp wallet, free to approval applicants. Postage 6 cents. Pathe Stamp Co., 321 Woodward Ave., Atlanta, Ga.

FREE! 25 Different British Colonials to approval applicants sending 2c. 1000 Different Stamps, \$1.50; 600, \$1.00; 300, 40c; 200, 20c; 100, 10c. Nickles, 123 Florida, Washington, D. C.

FREE packet with 50% approvals. Reference, please. Stamps bought, exchanged, 150 different 10c. Russian 10,000 roubles 2501 20c. Lists free. Whelan, Box 174, Jersey City, N. J.

STAMPS—50 different Jamaica, Venezuela, etc., only 7c; 100 all diff., 10c; 1000 all diff., \$2.50; 100 diff., U. S., 25c; 1000 Hinges, 10c; 50 per cent approvals with every order. List free. I buy stamps. Write L. B. Dover, Dept. A, Longmont, Colo.

NYASSA set Free, for a request for my % 1 and 20 approvals, also the higher priced desirable stamps at 50% Disc't. Send reference and get extra premiums. Chas. T. Egner, 4455 Frankford Ave., Fr'd, Phila., Pa.

LARGE perforation gauge free to applicants for finest 50% approvals and U. S. post. Scott 1923 Catalog \$1.60 postpaid. Midwest Stamp Company, Kemper Building, Kansas City, Missouri.

FREE! Send 11c for 58c worth of stamps. Spend \$1 in one month. Get 11c back! We pay postage. W. F. Cannon, 1413 Carey, Davenport, Iowa.

PAPUA, Antigua, Samoa, Sarawak, Kinuchau, Seychelles, Caroline, Mariana, etc. Also airmail set, None common. Catalog value \$1.05. Only 30c. Porter, 2551 South Hoover, Los Angeles, Calif.

24 VARIETIES Cuban stamps, 10 cents. List of 8,000 low-priced stamps free. Address Chambers Stamp Co., 111P, Nassau St., New York City, N. Y.

158 GENUINE Foreign Stamps Mexico War Issues, Venezuela, Salvador and India Service, Guatemala, China, etc., only 10c. Finest approval sheets 50 to 60%. Agents Wanted. Big 72-p. Lists Free. We Buy Stamps. Estab. 29 yrs. Hussman Stamp Co., Dept. 54, St. Louis, Mo.

NYASSA 1901, 10 varieties 25c. Catalogued 69c. Fenway Packet 105 different, including Abyssinia, Turkey, White Russia, etc. 250 hinges, set Atlantes 12c; still going big. Thousands sold. Fenway net approvals with each order. Fenway Stamp Co., Fenway Station, Boston, Mass.

FREE! Sectional Loose Leaf Postage Stamp Album at the rate of 8 pages each month given with subscription to our monthly Journal. Send two-cent stamp for prospectus. United Stamp Co., 140 S. Dearborn St., Chicago, Ill.

STAMPS, 50 Varieties, Africa, Brazil, Peru, Cuba, Mexico, etc., 10c. 50 different U. S., 25c; 1,000 mixed, 40c; 1,000 hinges, 10c. List free. C. Stegman, 5948 Cote Brillante, St. Louis, Mo.

COLLECTIONS: 100 Different Stamps, 10 Cents, 200, 20 Cents, 500 One Dollar, Sonnee Company, Ivy Street, St. Paul, Minn.

PRICE List Free—Over Four Hundred Bargain Sets and Packets. A. D. Hardman, 7 Iowa Circle, Washington, D. C.

1500 DIFFERENT stamps \$5.00; 1000, \$2.50; 500, \$1.00; 325, 50c. Fred Onken, 630 79th Street, Brooklyn.

STAMPS on approval, $\frac{1}{4}$, $\frac{1}{2}$, $\frac{3}{4}$ cents and up. Free Premium. Herbert Kelgwin, Middletown, N. Y.

"ENCASED" Postage: valuable, interesting, rare. Sample, Lists and Premium 17c. Dunning, Brookline, 57, Mass.

U. S. 100 VAR., Cat. about \$2.00 for 15c. Jax Stamp Co., Steger, Ill.

STAMPS sent on approval at 70% discount. Reference required. Emory Renoll, Hanover, Pa.

PACKET 10c. Approvals. Foreigners write. Kenyon, Box 492, Nashville, Tenn.

PRECANCELLED Stamps, Single, Pairs, Strips, Blocks. Louis Beebe, Niantic, Conn.

LET me show you how you can increase your collection to at least 10,000 at a cost of only a few cents per stamp. Address Tubbs, 4021 First, San Diego, Calif.

PACKET of 23 stamps, no two countries alike. Packet hinges. Set of \$1 and \$2 U. S. Rev., all for 5c. Mention paper. Miami Stamp Co., Toledo, Ohio.

SUPERB packet containing Liberia Triangle, Epirus, Azerbaijan, Danzig, 5 airplane stamps, etc. Price 10c to approval applicants. Address Grossman Company, 1568 First Avenue, New York City.

NYASSA, Allenstein, Herzegovina, Holkar, Ukraina stamps, menagerie packet, 250 hinges, 10c. Liberty, 3974 Arsenal, St. Louis, Mo.

STAMPS, 20 unused, all different, free. Postage 2c. Mention paper. Quaker Stamp Co., Toledo, O.

SNAPS—150 different stamps, 18c; 60 different United States Stamps 12c. With each order we give free our price list of sets, packets, albums, etc., and our pamphlet which tells "how to make a collection properly." Queen City Stamp Company, Room 38, 694 Race, Cincinnati, Ohio.

16 VARIETIES Canadian War Tax, including \$2.00 rare, only \$1.25. Ralph Wilby, Weston, Ontario.

100 SELECTED different New Europe stamps 15c. Marston, City Hall, Box 1279, New York.

20 UNUSED stamps free. All different. Postage, 2c. Fisk Stamps, Toledo, Ohio.

FREE! Rare stamp to approval applicants. Albert Behnke, Davenport, Iowa.

100 DIFFERENT: Bargain Stamp Catalog, 5c. Elvin Stanton, Niantic, Conn.

200 DIFFERENT stamps ten cents to introduce our classy 50% approval selections. Address, Atlas Stamp Co., Kansas City, Mo.

WILL exchange 10 acres virgin Florida land, costing \$300.00, ideally located below frost line, for collection of U. S. Stamps. C. L. Huntley, 3302 Fulton, Chicago.

100 DIFFERENT Neurope free to serious applicants for our 50%, 60%, or net approvals. References required. Wilmar Edgar, Cherokee, Iowa.

20 DIFFERENT catalogue value \$1.00, 20; 60 value \$3.40, 60; 100 value \$5.00, \$1.00. F. Seebeck, 1957 Toronto, Regina, Canada.

TEDDY Roosevelt 5c blue unused, also Portuguese Colonials 50 different only 22c. Jacob Fischer, 1539 North Lawler, Chicago.

FRENCH Colonies Free—Beautiful Picture set, including Native Chiefs, Tigers, Pictorials, 2c Postage. Empire Stamp Company, Toronto, Canada.

FREE—25 different U. S. stamps with 60% approvals to reliable parties. 80 different U. S., 25c. C. Seldenberg, Merton, Wis.

105 CHINA, etc., stamp dictionary, list, 2c. Album (500 illustrations), 3c. Bullard, Sta. A, Boston.

COLE'S Approvals will Satisfy. Selection upon request. W. Jay Cole, 3019 Wallace St., Chicago.

FREE Bargain Lists—Stamps, Carlos—Emerson Shop, 635 Bower Street, Elkhart, Indiana.

UKRAINIA—14 var. .08. Heatherdale Co., 4940 Lyndale So., Minneapolis, Minn.

FREE China 12 var. with approvals. Henry B. Hunt, Compton, Calif.

\$100 PACKET Stamps for 5c. Hull, 12 West 101st, New York.

FOREIGN Stamp Collection Sent Free. Cornish Company, Schenectady, N. Y.

100 DIFFERENT Stamps and Perforation Gauge, 10 Cents. Sonnee Stamp Co., 675 Ivy Street, St. Paul, Minn.

35 DIFFERENT stamps free. Postage 2c. Michael, 5602 Prairie, Chicago.

NEWFOUNDLAND stamp bargains! Lists sent, Rev. Butler, St. Georges, Newfoundland.

WONDER packet 10c to approval applicants. Buckley, 712 Bowen, Dayton, Ohio.

100 DIFFERENT 8c. Co-operative Stamp Co., 710 Pelham, St. Paul, Minn.

FREE Set of Stamps to approval applicants sending 2c. Address, Richard P. Lamprecht, Valparaiso, Ind.

STAMPS Free—Ask for money-saving approvals. John P. Borresen, Cedar Falls, Ia.

FREE "Leader" Pkt. to approval applicants sending 2c stamp. Earl Stamp Co., 1811, 26th Ave., North, Minneapolis, Minn.

BIG Variety Packet Foreign Stamps free for 2c postage. Gray Stamp Co., Station E., Toronto, Canada.

STAMPS Free—War Stamps, Surcharged, Unused, Pictorials, British, French Colonials, 2c postage. Midland Stamp Co., Toronto, Canada.

4000 MIXED (Pound) 250-300 kinds, 60c. Lynes, Marlton, New Jersey.

RARE COINS

HOW'S this for ten cents? Mail 10c with your name and address, and you'll get a genuine old coin over 100 years old and a 56-page illustrated Coin Catalog. A "just-to-get-acquainted offer." Coin Collecting will prove pleasant and profitable to you. Start now. B. Max Mehl, Numismatist, Mehl Bldg., Dept. P, Fort Worth, Texas. Largest Rare Coin Establishment in the United States.

OLD coins wanted. Do you know that coin collectors pay up to \$100.00 for certain U. S. Cents, and high premiums for all rare coins? We buy all kinds. Send 4c for large Coin Circular. May mean much profit to you. Numismatic Bank, Dept. H., Ft. Worth, Texas.

\$2 To \$500 each paid for hundreds of Old Coins. Keep all old money. Send ten cents for Illustrated Coin Value Book, 48c. Guaranteed prices. Get posted. We pay cash. Clarke Coin Company, Avenue 2, Le Roy, N. Y.

CALIFORNIA gold, $\frac{3}{4}$ size, 27c. $\frac{3}{16}$ size, 53c. 3c piece and catalogue, 19c. Address Norman Shultz, Colorado Springs, Colo.

$\frac{1}{2}$ WASHINGTON \$1.00; 1787 cent 40c; Jackson cent 10c; Numismatic magazine 12c. A. Wylie, Wheaton, Illinois.

40 OLD Coins all Different \$1.00. Catalogue Free. Claud Denney, Box 315, Dallas, Tex.

OLD coins, large fall selling catalogue of coins for sale, free. Catalogue quoting prices paid for coins, ten cents. William Hesselin, 101B Tremont St., Boston, Mass.

OLD United States coins for sale; price list free. Ambrose Brown, Pearl St., Marblehead, Mass.

20 DIFFERENT Foreign Coins 50c, postpaid. Otto Oddehon, Dallas, Texas.

100,000 RUSSIAN Ruble 25c. 1,000,000 Ruble \$2.00. Start in a Business of your own. George Grigolett, Drawer 491, Chicago, Illinois.

50,000 COINS, medals, paper money, antique pistols, swords, curios; lists free. Collectors Exchange, 1336 Willington, Philadelphia.

FOR BOYS

BOYS build three foot model airplane at small cost. Write Aero Shop, 3050 Huribot Ave., Detroit, Mich.

MOUTH-ORGAN Instructor, 25c. Learn in one hour. Address G. Eisea, Bowling Green, Ohio.

MOVING Picture Machines, \$1.50 up. Radio Sets \$1.50. Punch & Judy theatre, very funny, 25c stamps. Nite Mail Order & Supply Co., 609 27th St., Denver, Colo.

BOYS, 25 cents shows you how to make several games and toys cheap. Fred Megow, Lancaster, Wis.

BOYS!—You who like gripping, thrilling stories of achievement will want to read "Victories of the Engineer," a book that tells in a way you can understand it how the great feats in railroad engineering, building great bridges, ships, dams, canals, harbors, tunnels, mining, etc., have been accomplished. By A. Williams, 487 pp., 250 ill. Price \$2.00 postpaid. Popular Mechanics Book Dept., 6 N. Michigan Ave., Chicago.

PERFORMING Battle Aeroplane 25c; wonderful toy for boys. Radio Plans free. McCormack Spec. Co., Guilford, Conn.

OUTDOOR Winter Sports—How to Make Devices for. Plain instructions and clear drawings for building motor-driven sleds, snow speedsters, air-propelled sleds and ice boats, ski sleds and gliders, skis and ski running, ice yachts, coasting toboggans, etc. Price 25c postpaid. Popular Mechanics Book Dept., 6 N. Michigan Ave., Chicago.

CAMERAS AND PHOTO SUPPLIES

HAVE You a Camera? Write for Free sample of our big magazine, showing how to make better pictures and earn money. American Photography, 790 Camera House, Boston, 17, Mass.

SPECIAL Trial Offer: Any size Kodak film developed for 5c; prints 2c each. Overnight service. Expert work. Roanoke Photo Finishing Co., 209 Bell Ave., Roanoke, Va.

MAKE Stereoscopic pictures with any ordinary Camera, using Pucha's Stereo Adapter. Price \$5.00. Agents wanted. Superior Manufacturing Co., Oakland, Calif.

KODAK Finishing—Special 5x8 Enlargement 25c, in colors 75c. Copying, one picture, also negative 50c. Kodafin, 387 Bellevue Place, Milwaukee, Wis.

SAMPLE enlargement, dime and negative (returned). Sample 6-exposure roll finished glossy, 25c silver. Brown Studio, Lake Elmo, Minn.

JUST Published—Our new complete 128-page catalog and bargain book of new and used cameras and supplies. Our goods are guaranteed finest quality obtainable. We have thousands of satisfied customers. Write at once for this bargain bulletin, just hot from the press. Address Central Camera Co., 124 S. Wabash Ave., Dept. E-64, Chicago, Ill.

ESTABLISH yourself at home—as an Expert Photographer and train with R. Vant, director International Studios, 3431—3691 Michigan Ave., Chicago.

MOTION PICTURES AND SUPPLIES

WILLIAMSON Moving Picture Camera will sell or trade for loud speaker radio. Bennett, 5508 St. John Ave., Kansas City, Missouri.

SEND \$3.00 for the Cinema Hand Book. Everything pertaining to motion-picture making, taking projecting studio laboratory work. 572-page book, pocket size, only \$3.00 postpaid. Also the new complete courses of the New York Institute of Photography, Motion Picture Photography, postpaid, \$6.00. Motion Picture Projection, postpaid, \$5.00. Motion Picture Directing, postpaid, \$3.00. Screen Acting, postpaid, \$3.00. Photoplay Writing, postpaid, \$3.00. The most elaborate works ever written on this subject. Bass Special Offer: The five books at \$17.50 postpaid. Free Cinema catalog. Bass Camera Company, Motion Picture Division, 109 N. Dearborn, Chicago.

FREE to Writers—A wonderful little book of money-making hints, suggestions, ideas; the A B C of successful story and play writing. Absolutely Free. Just address Authors Press, Dept. 12, Auburn, New York.

\$35.00 PROFIT nightly. Small capital starts you. No experience needed. Our machines are used and endorsed by government institutions. Catalog free. Atlas Moving Picture Company, 482 Morton Bldg., Chicago.

\$\$\$ FOR Ideas. Photoplay plots accepted any form; revised, criticized, copyrighted, marketed. Advice free. Universal Scenario Corporation, 917 Western Mutual Life Bldg., Los Angeles.

FILMS For Sale—\$2.50 per Reel up. Address Queen Feature Service, Birmingham, Ala.

AMERICA'S Greatest Fortunes have been made in the Moving Picture Business. Small investment needed. We furnish complete theatre equipment. Easy payments. Openings everywhere. Catalog free. Monarch Theatre Supply Co., Dept. F, 724 So. Wabash Ave., Chicago, Ill.

HOME Movie Projectors \$30—Suit Case Projector \$40—Films \$3 reel—100 feet films \$1. Movie Camera, fastest lens, \$60. Tripled, \$85. Address Ray, 326 Fifth Avenue, New York.

MAKE money writing photoplays; details free to beginners. No correspondence course. Producers League, 230 Wainswright, St. Louis.

MAKE \$50-\$100 Weekly writing motion-picture plays. Details Free. Rex Publishers, Hannibal, Mo.

MACHINES, Films, Supplies, Bargain lists. National Equipment Co., Duluth, Minn.

EDUCATIONAL AND INSTRUCTION

WORLD-ROMIC System—Masterkey to All Languages. Primers, 15 languages, \$1.94 each language; Arabic, Chinese, Danish, Dutch, English, French German, Italian, Japanese, Panjabi, Polish, Portuguese, Russian, Spanish, Swedish. Pronunciation Tables, 92 languages, 30c each language. Languages Publishing Company, 8 West 40th St., New York.

ARTIFICIAL Marble, sanitary flooring instructions, ornamental casting, concrete plaster, papier-mache decorations, garden furniture, statuary, Rubber-moulds, Electro-metallurgy, particulars and 200 illustrations free. Chris Mahler, Box 122, Huntington, N. Y.

SHOW-CARD, writing a pleasant, profitable profession easily and quickly learnt by our new, simple, graphic-block system. Artistic ability not necessary. We teach you how. Distance no object. Full particulars and booklet free. Wilson Methods, Limited, Dept. M, 64 East Richmond, Toronto, Canada.

DOUBLE Entry Bookkeeping mastered in 60 hours with 8 keys; guaranteed; diplomas. Our graduates lead in bookkeeping, auditing, accountancy, balance sheets, financial statements. International Bookkeeping Institute, Dept. 8, Springfield, Mo.

LINCOLN-JEFFERSON University. Home study in Academy, College, Theological, Law, Music, Pharmacy, Business and Graduate Schools, leading to degrees. Box W, 64 W. Randolph St., Chicago.

THEATRICAL Scene Painting taught by Mail. Only course of its kind. Send stamps for Illustrated Literature. Enkeboll Art Schools, Omaha, Neb.

SHORTHAND, the easiest, accurate, rapid, self-teaching book, \$1.50. Buy Business College, 13th and F, Washington, D. C.

CARTOON Course, \$1. Christman, 2925 Euclid Ave., Kansas City, Mo.

INVENTORS—Write for our Illustrated guide book and Evidence of Conception Blank. Send model or sketch and description for free opinion of its patentable nature. Highest references. Prompt attention. Reasonable terms. Victor J. Evans & Co., 167 Ninth, Washington, D. C.

BIG Money. Learn Short-Story Writing by mail from Dr. Burton, greatest authority. Free book. Laird Extension Institute, 9 Laird Bldg., Minneapolis.

FREE Folder—"Fortunes in Fur Farming," on small grounds. Learn by mail. Address American Farmers School, 8 Laird Bldg., Minneapolis.

WANTED: Information exchanged about commercial uses for air compressors. Address Engineering Dept., Brunner Mfg. Co., Utica, N. Y.

HARMONICA, Violin, Piano, Ukulele, or Mandolin instructors, 25c. Address G. Eisea, Bowling Green, Ohio.

BOOKKEEPING in a week; price \$2.00. Dukes, 1857-9 Walton Ave., New York.

HAVE a business of your own; the most fascinating, best paying business-profession in the World, a foot correctionist; easy terms for training you at home in a few weeks, a new protected system that has enabled men and women to rise in one step to greater earnings than they ever thought possible; no capital required or goods to buy, no agency or soliciting. Address, Stephenson Laboratories, 1 Back Bay, Boston, Mass.

BIG Money in writing photoplays, stories, poems, songs. Send today for Free copy America's leading writer's magazine, full of helpful advice on writing and selling. Writer's Digest, 603 Butler Building, Cincinnati.

LEARN Drafting at home by new method. Get into the big pay class. Send for particulars. The Locke System, 3113 Linden Ave., Philadelphia, Pa.

ENGINEERING and General Scientific information and papers prepared to order by experts. Estimates free. National Drafting Service, 5826 Ga. Ave., Washington, D. C.

WRITE articles, stories, news, in spare time for newspapers and magazines. Big pay. Copyright book free. Press Syndicate, 352, St. Louis, Mo.

DRAWING Instruments—Slide Rules. Highest quality—lowest prices. Direct from importer. Circular free. Automotive Engineering Co., Castle Hall, Indianapolis, Ind.

USED books, educational nature, sold, rented, bought, exchanged. Bargain list free. Lee Mountain, Dept. 66, Pisgah, Ala.

TRADE, vocational magazines. List free Toepf Magazine Agency, Middletown, N. Y.

LEARN Auto Painting in Detroit. Would it be of interest to you in knowing how some of our scholars with only a 4 day training are making as much as 10 to 12 dollars per day? Or would you with little capital like to start a business of your own? If so. For free particulars write Dept. Z, Detroit Auto Painting School, The Pioneer Auto Painting School of America, 426 Superior Street, Detroit, Michigan.

ROPP'S Calculator and Short-Cut Arithmetic shows the answer as quickly as a watch shows the time to all problems likely to occur in office, store, shop, bank, farm or factory. Price, pocket size, paper 35 cents, cloth 50 cents, leatherette \$1. Desk size, cloth \$1.50 postpaid. Popular Mechanics Book Dept., 6 N. Michigan Ave., Chicago.

MEN—Course in piece work—rate setting—stop watch methods quickly taught—Best—cheapest—catalog free. Citizens School, 412, 105 W. Monroe St., Chicago, Ill.

MATHEMATICS taught by mail. Arithmetic, Algebra, Geometry, Mensuration, Trigonometry, Logarithms, and Mechanics courses. Address, Harding School, 76 Brighton, Highland Park, Mich.

LEARN Expert Shorthand. Pitman training prepares successful writers; easy, practical home study. Business Methods, 304 Willoughby Building, Chicago.

CARTOONISTS—Improve your style by following the work of the greatest cartoonists found in the bound volumes of Cartoons magazine. Eight volumes, each covering six months, Jan.-June, 1917, to July-Dec., 1920, inclusive, 1,200 cartoons, 900 pages to a volume, 7 by 9½ in., 3 in. thick. New books; durable and attractive binding. Sold separately at \$2 per vol. postpaid. Supply very limited. Send at once. Popular Mechanics Book Dept., 6 N. Michigan Ave., Chicago.

PLAN reading, concrete design and arithmetic taught by mail. C. Beeman, 94 Brighton, Detroit, Mich.

KNOWLEDGE Counts if you take a mail course in Heating and Ventilating Engineering. Veteran and practical engineer instructors only. The Northern Institute, 1951-D East 57th Street, Cleveland, Ohio.

"WHAT to Invent for Profit" free. Patent News, N. Washington, D. C.

SCENERY TO RENT

SETTINGS for Opera, Plays, Minstrels. Plush Drogs, Address Amelia Grain, Philadelphia.

TELEGRAPHY

WANTED—Young men and women to learn Morse and Wireless Telegraphy. Railroads and Wireless Companies in great need of operators. We teach you quickly, and procure positions at big salaries. Great opportunities for advancement. All expenses low; can earn part. Write today for free catalog. School established 1874. Dodge's Telegraph Institute, "H" Street, Valparaiso, Ind.

TELEGRAPHY—Morse and Wireless—taught at home in half usual time and at trifling cost. Omnigraph Automatic Transmitter will send, on Sounder or Buzzer, unlimited messages, any speed, just as expert operator would. Adopted by U. S. Govt. and used by leading Universities, Colleges, Technical and Telegraph Schools throughout U. S. Catalog free. Omnigraph Mfg. Co., 18 Hudson St., New York.

WIRELESS

BUILD your own electrolytic storage battery Charger. Plates and complete instructions \$1.00. Descriptive circular free. Peerless Electrical Parts Co., 105 Harris, Rochester, N. Y.

RADIO OUTFITS AND SUPPLIES

LOUD Speaker for any Crystal Set. Hear music over entire house. Easily constructed by amateurs. Eliminates Storage Battery. Instructions complete 25c. Catalogue Free. Representatives wanted. Steintz Wireless Manufacturing Co., Eastend, Pittsburg, Pa.

GUARANTEED Radio Set, Mahogany Cabinet. Receives 50 miles. Complete with 3000-ohm Double Headset and necessary accessories, ready to install. Special \$18.00. Quality Radio Company, 831 West 16th, Chicago.

FIFTY complete hook-ups, from crystal set to latest Armstrong super-regenerative receiver, clearly illustrated with descriptions; 20c. Westboard Engineers, 399 Canal St., New York.

RADIO and Electrical Supplies. Send for free Monthly Bulletin. Lowest prices. Get on our mailing list for bargains. Holmes Electric Co., Libertyville, Ill.

VACUUM tube receiver, batteries, pair phones and aerial \$25. Prices reduced on Radio apparatus. Address, Ray, 326 5th Avenue, New York.

RADIO Sets; Guaranteed; \$6.25 and \$12.50; Radio Books, 25c. Supplies. Smith's Novelties, 6735 So. Elizabeth St., Chicago.

TOEPP'S Radio Magazine Service, Middletown, N. Y. What's wanted? List free!

RADIO Outfits \$15 and up. Send for circular. Radio & Electric Supply, Robinson, Ill.

VACUUM Tube Set, \$16. A beautiful high priced set for less money. We receive Los Angeles Times on these. Northern Radio Co., 238 N. Madison, Bay City, Mich.

RADIO Books—Send for our specially selected list of 20 leading volumes among the reliable radio publications and also our complete book catalog. They are sent free upon request. Popular Mechanics Book Dept., 6 N. Michigan Ave., Chicago.

TUNER, detector, two step amplifier, direct from Manufacturer, \$55.00. Elsewhere, \$85.00. Globe Radio, 492 East 148 St., New York.

BUSINESS OPPORTUNITIES

\$2,400 UPWARDS Yearly—\$500-\$1,000 Single Deal—without capital most anywhere. I've Made It—Others Have—So Can You the coming Months. Time is Ripe. Be Posted. Begin Now. Avoid Mistakes. Mail check today for Our New "Master Dealer Training Course." (Twenty Lessons—Six Easy Parts.) Learn How make Real Estate Easy—Safe—more Profitable. Based upon Quarter Century's Specializing Experience. Unequaled anywhere. Special Price this month \$6.85 on money back Guarantee. Master Dealer Forms and our \$5.00 Copyrighted Optioning System included Free. Send today. Enjoy real prosperity tomorrow. Catalog ten red stamps. Stephens Co-Operating Realtor Service, Desk M, Muncie, Ind.

DISTRICT Managers seeking an opportunity to develop along larger lines, we can offer a splendid position selling our high-grade guaranteed silk hosiery from mill to wearer—all colors, both plain and with clo's. If you know how to handle men, a hustler yourself with a record that will stand investigation, you can make good. Write us immediately with full details of your past connections. Dyx Hosiery Company, 508 Lyric Bldg., Cincinnati, O.

MAIL Order Business is your opportunity. Brenner's Famous Handbooks teach how to start small, grow big. Sell merchandise, service, ideas; enormous profits. Spare time to begin. Get complete set, 11 books, \$3.00, and be posted. Brenner, 325 Walnut, Philadelphia. Descriptive Catalog and big batch interesting mail order information, 25c. None free.

NEW! Most unique smokers' article on the market. Ash tray with patented cigarette extinguisher attachment. Puts out cigarette in 3 to 5 seconds. Stub is dropped into bowl of tray by slight pressure on release lever. Eliminates fire danger, fumes, stale odors, and messy fingers and tray. Handsomely nicked brass construction, with red, blue, or yellow glass sanitary bowl. Size 5x5x3½ inches. Prepaid, \$3.00. Ideal for mail-order or agents. Each tray packed in carton ready for mailing. R. West Co., 41 East 42nd St., New York City.

PATENTS Procured—Trade Marks Registered. A comprehensive, experienced, prompt service for the protection and development of your ideas. Preliminary advice gladly furnished without charge. Booklet of information and form for disclosing idea free on request. Richard B. Owen, 30 Owen Bldg., Washington, D. C., or 2278 R. Woolworth Bldg., New York, N. Y.

START 1923 Right! Manufacture The Biggest Selling Specialties from Miller's Guaranteed Manufacturer's Formulas and detailed simple instructions. Investment Small—No Machinery Required. 30-Minute Complexions Clay, Mexican Yucca Soap, Concentrated Vanilla, Magic Windshield Wipers, Kadalac Polishing Cloths, Amazon Self Vulcanizing Tire Repair, Bluing Paddies, Launderite Marvel Washing Compound, Toy Rubber Balloons, Coconut Creme Custard Powders, all latest Food Products. Stamp brings many lists. Don't compare these Formulas with the cheap junk advertised by Others. 27 years supplying the Best, Highest References, Miller Chemist Miller, Chemist, 809 De Leon, Tampa, Florida.

MEN—Look into our proposition of Wallpaper Cleaning. Take big cleaning contracts. Unlimited field. C. Swanson & Sons, Mankato, Minn.

HEY! Look! Millions Wanted! Big money selling Baby Chix, Schmidt made over \$18,000 one season. Send for your copy of "Millions Wanted." An expert's practical book of instructions, \$1.00 per copy postpaid. Novelty Supply Company, Route 3, Box 89, Vineland, N. J.

MARBLE mixing instructions, covering wood or cement flooring ¼ inch thick, fireproof, waterproof, low cost, sanitary, all colors. Particulars, 200 illustrations free. Chris Mahler, Box 122, Huntington, N. Y.

"SCHEMER Magazine," Alliance, Ohio, prints big profit schemes; one subscriber making \$25,000 from three; another \$10,000 from one. Try your luck. Year, only \$1.00; three months, 25c.

START a pressing, cleaning and dyeing shop, excellent field, splendid profits. We tell you how. Write for booklet. Ben-Vonde System, Dept. C, Charlotte, N. C.

TANNING, All kinds, simple way. Information booklet formula sample leather free. Tools, materials furnished. Representatives wanted. Custom Tanning Co., Carlton, Texas.

LEARN the collection business. Good income, quick results. Interesting booklet, "Skillful Collecting," free. National Collectors Assn., Long St., Newark, O.

SILVERING Mirrors! My exclusive French Tartaric method opens enormously profitable business. Booklet free. H. Barstow, 514 23d Street, Oakland, Calif.

MAKE Rubber Stamps. Easy to make, easy to sell, and profitable. Price \$1.00. Andrew Kulk, Epton, Penna.

\$3,000 TO \$8,000 Yearly. Want it? Others are making it. Send check or money order today for our invaluable books "How to Sell Real Estate," \$3.00—and "How to Conduct Real Estate and Insurance Business," \$1.50. Absolute satisfaction guaranteed. Free catalogs. Realty Book Co., Dept. 52, Cleveland, Ohio.

BECOME a Landscape Architect. Dignified exclusive profession not overrun with competition. Crowded with opportunities for money-making and big fees. \$5,000 to \$10,000 incomes attained by experts. Easy to master through our correspondence methods. Established 1916. Get information today. American Landscape School, 56-K, Newark, N. Y.

RAISE guinea pigs. Pay better than poultry or rabbits; easy to raise; little space required. We guarantee market. Particulars and booklet how to raise free. Cavies Distributing Co., 3102 Grand Ave., Kansas City, Mo.

GET into the specialty manufacturing business. Amazing profits. We will send you free book explaining our system. Write immediately. A wonderful opportunity awaits you. National Scientific Laboratories, 211 North Monroe, Richmond, Va.

BE your own Boss. Learn Shoe Repairing at Home. Be Independent. You cannot Fail with our Book of Instructions. Postpaid One Dollar. American Bench Shoemakers, Dept. 2, Aurora, Ill.

AMBITIOUS Men, write today for attractive proposition, selling subscriptions to America's most popular automobile and sportsman's magazine. Quick sales. Big profits. Pleasant work. Digest Pub. Co., 9505 Butler Bldg., Cincinnati, Ohio.

CAPITAL Furnished. Banking House will supply funds to manufacture and market something new in an invention or discovery. Describe briefly. Address, "Capital," Room 26, 244 Washington St., Boston.

MAKE Money at Home making toys. We show you how. Send \$1 for complete working drawings and designs. DeKalb Designing Co., Dept. 6, Decatur, Ga.

CAPITAL Seekers, put your project before 500 live brokers. Cost trifling under my system. Details Free. Leonard, 1410 First Nat'l Bank Bldg., Chicago.

START Profitable Plating, Automobile Painting Shop; Little Capital; Enormous profits. Interesting plans free. "Rorick," 427 Carroll St., Akron, Ohio.

CHEMICAL Expert will furnish Formulas and Trade Secrets. All lines. Lists Free. W. L. Cummings, Ph.D., 228 Gordon Ave., Syracuse, N. Y.

SHOE-SOLE-SAVER, your chance to make money; guaranteed formula. Write, O. Dieke, 2107 Grand, Milwaukee, Wis.

YOUR Opportunity. Resilver Mirrors. Complete Instructions, \$1.00. Helbach Products Co., 722 S. Walker, Oklahoma City, Okla.

MAKE money with your camera. Lancaster, Box 967, Los Angeles, Calif.

DOLLARS yearly in your backyard. No Mushroom dope. Particulars free. Metz, 313 East 89th, New York, N. Y.

START in business. Samples and stock 15c. Cochran, Grayville, Ohio.

ADVERTISE. Country town newspapers. List free. Pennell Company, Covington, Ky.

ENTER a new business. Earn \$2,000 to \$6,000 yearly in professional fees making and fitting a foot specialty, openings everywhere, with all the trade you can attend to; easily learned by anyone at home in a few weeks, at small expense; no further capital required, no goods to buy, job hunting, soliciting or agency. Address Stephenson Laboratories, 11 Back Bay, Boston, Mass.

PROSPEROUS Real Estate business of your own or position worth \$3,500? Our graduates have choice. Training at home prepares you in short time. We help you make good. Bulletin free. Penn Realty School, 1900 Ellsworth, Philadelphia.

START your own independent real-estate business co-operating with a national organization. Full details with list from which you may start selling at once on fair commission, a dime. American Real Estate, 116 East Sherman, Hutchinson, Kan.

IF you have about \$1,000 and capable of organizing sales force, to sell article needed by every merchant, wholesaler and retailer, which should net you \$10,000 profit first year, write Sales Director, 828 Reaper Block, Chicago.

EXCEPTIONAL Opportunity for Sales Manager capable of handling state distribution. Marvelous new Adding Machine. Retail \$15. Work equals \$350 machine. Tremendous possibilities. Unlimited profits. Write quick for details. Lightning Calculator Co., Dept. B, Grand Rapids, Mich.

WE Start You in Business, furnishing everything; men and women. \$30.00 to \$100.00 weekly operating our "New System Specialty Candy Factories" anywhere. Opportunity lifetime; booklet free. W. Hillyer Ragsdale, Drawer 4, East Orange, N. J.

RESPONSIBLE Corporation wants general sales manager to open branch office, manage salesmen. \$500 to \$5,000 necessary; expenses allowed to Baltimore if you qualify. Address Manager, 603 N. Eutaw St., Baltimore, Md.

NON-FREEZE for Auto radiators. Lasts entire season. Costs 12 cents; you get one to two dollars. Write for particulars. Richards, Chemist, Box 2402, Boston, Mass.

LEARN Automobile Painting, Top Repairing, Making Auto Specialties, Enormous Demand. Pays \$20.00 Daily at Home. We teach you How. Particulars Free. Auto-finishco, Sheboygan, Wisconsin.

ADVERTISERS: For quick returns, use our Sunday newspaper lists. Reasonable rates, prompt reliable service. Lists free. Sun Advertising Agency, 1501 Arcade Bldg., St. Louis, Mo.

ATTENTION! You can have a business of your own. Establish and operate New System Real Estate Business, brokerage and insurance agency in your community. Office at home. Earn \$5,000 year. Representatives wanted everywhere. Send stamp free booklet. Hayes Realty Association, Cincinnati, Ohio.

PATENTS—Write today for Free instruction book and Evidence of Conception blank. Send sketch or model for examination and opinion; strictly confidential. No delay in my offices; my reply special delivery. Reasonable terms. Personal attention. Clarence B. O'Brien, Registered Patent Lawyer, Southern Bldg., Washington, D. C.

START your own Business. Buy and sell Foreign Money like a Banker. Make 100-200% profit. One Million Russian Ruble \$2.00. Ten Million only \$11.00. Write for information, George Grigoletti, Drawer 491, Chicago, Illinois.

WANTED—Ambitious men to start profitable local or mail order business at home, quickly, inexpensively, without previous experience. Others made \$15 day. Write immediately. "Kraft," Box 896-PM, San Francisco, Calif.

500 FORMULAS. Resilvering Mirrors—Renewing Dry Batteries—10 Luminous Paints, 25c. Ideal Book Shop, 5501-ML North Robey, Chicago.

UNUSUAL opportunity for men and women with small investment to earn big income. Address E. G. Hadley Co., F. and M. Bank Bldg., Ft. Worth, Texas.

SEND 25c for paying Mail Order Plan that brings the Quarters in every mail. Bucknam, 63 Court St., Room 1, Boston, Mass.

"COAL Saver." Make and sell it. Cash in on "Big Coal Shortage." Particulars Free. Write today. Sims, Lake, New York.

BE a Safe Expert. Big pay. Quickly learned, easy fascinating work. Write J. Hartmann, 913 21st Street, Rock Island, Ill.

OPEN hat, clothes, fur cleaning establishment at home. Descriptive literature free. Byron, 27 Sta. L, New York, N. Y.

PREPARE—Sell Your Own Products. Formulas, trade secrets. Different, dependable. Catalog free. B. Thaxly Co., Washington, D. C.

MAKE \$6 to \$12 a day. A new, good-paying business. No goods to buy. Details free. Address Walk-Easy Company, Washington, D. C.

UNLIMITED Possibilities, making metal toys at home. No tools or experience required. Particulars free. New Specialty Co., 158 E. 31st St., New York.

EARN \$10 daily silvering mirrors, plating and refinishing metalware, autos, chandeliers, bedsteads, headlights. Outfits furnished. E. Decie Laboratories, 1133 Broadway, New York.

SIGNS, Cards, Banners, easily painted with letter patterns. Samples free. Address Outdoor Adv. Service, Lockport, N. Y.

START a cleaning, pressing, dyeing shop. Splendid field, big profits. Plans free. International System, Dept. 19, Excelsior Springs, Mo.

MANUFACTURE—5 Original Ideas. Particulars Free. F. Creed, 686 Hayes St., San Francisco, Calif.

JUMPING frogs; papier mache; Sample 10c; Gross \$2.00; Retail for \$14.40. V. C. Robinson, Maryville, Mo.

668 WAYS to make money—2,716 Formulas "Encyclopedia Business Opportunities," 3 volumes, \$1. Ideal Book Shop, 5501-VL North Robey, Chicago.

"WHAT to Invent for Profit" free. Patent News-C., Washington, D. C.

GOOD money easily earned at home spare time silvering mirrors; no capital. Free instructive book tells how. Patterson & Co., Brooksville, Ky.

I MADE \$30 a Week Home. French Breadmaking. 15 years' experience; Free Booklet tells. Ashbrook, 67, Marengo, O.

DISPLAY advertisement, page 148. Welch's Diamond Chip Company.

"HOW to Sell Patents" free. Patent News-H., Washington, D. C.

CHEMISTRY

STOP, Look, Listen: I solve any chemical or electrical problem for five dollars. Any trade secret five dollars. Write me. W. Stedman Richards, Consulting Chemist, Box 2402, Boston, Mass.

CHEMICAL Analysis honestly and correctly done by L. E. Tenney, Colton, N. Y.

FOR accurate chemical analysis, sample matching, and reliable formulas at reasonable rates, write Somers Laboratories, 160 N. Wells, Chicago, Illinois.

FORMULAS AND TRADE SECRETS

FASTEST money-making formula on earth. One Dollar. Write today! Address, Arthur Schwartz, 1439 American Ave., Milwaukee, Wis.

FORMULAS of the better sort. Write for our free catalog. National Scientific Laboratories, 211 North Monroe, Richmond, Va.

EXCELLENT Formulae: Face Cream, Hair Shampoo, Hair Tonic, \$2.00 each. All for \$5.00. Consulting Chemists. Address, Box 813, Providence, R. I.

SELL. Wholesalers, Retailers, Manufacturers, Consumers, Vanilla Flavoring, 500% profit. Steady Repeater. Tested Formulas \$1. Graham, Box 1872, Denver, Colo.

VALUABLE Free Information regarding Manufacturer's Guaranteed Reliable Formulas for all lines of Best Sellers. No Junk. Miller, Chemist, 807 DeLeon, Tampa, Florida.

FORMULA Catalog Free. Big Selling Specialties. Fast Money-makers. Allen's Enterprises, 1227 Milwaukee Ave., Chicago, Ill.

800 FORMULAS 25c; Luminous Paint—Resilvering Mirrors—Renewing Dry Batteries—Mechanics Soap—Gas Tonic—Carbon Remover—Puncture Plugger, 20c each. Entire collection 50c. Ideal Book Shop, 5501-FL North Robey, Chicago.

MY great book of 500 successful Money-Making Formulas, 50c postpaid. Rudolph Bjerregaard, Rollag, Minn.

1,000,000 FORMULAS, recipes, trade secrets—1016 pages, \$2.00. Hillside Laboratories, 7021-A So. Winchester, Chicago.

"COAL Saver." Particulars Free! Write Today! Simms' Lake, N. Y.

FORMULAS—Guaranteed. Catalog free. Bestovall Laboratories, 4049-FA, North Whipple, Chicago.

10,000 SELECTED scientific, chemical, technological and practical recipes and processes including hundreds of so called trade secrets for every business alphabetically arranged in one large volume of 800 pages. Price \$4 postpaid. Popular Mechanics Book Dept., 8 N. Michigan Ave., Chicago.

1,000,000 FORMULAS, 1016 pages, \$2. 500 Formulas Free if you order quick. Ideal Book Shop, 5501-ML North Robey, Chicago.

3,000 FORMULAS, Money-makers, 400 pages, \$1. Bestovall Laboratories, 4049-BA, North Whipple, Chicago.

AGENTS WANTED

WANTED—Tailoring Sales Agent—Make big money from very start—\$60.00 to \$75.00 weekly. Largest made-to-measure tailoring house, furnishing an equipment of five hundred woolsens, wants you to take orders. Satisfaction guaranteed. Biggest merchants in many towns started with our line. If you want to establish yourself permanently in business and make big money write for full particulars, giving your experience as salesman or tailor's sales agent. H. F. Foster, Sales Manager, Lock Box 483, Chicago.

AGENTS—Best seller: Jem Rubber Repair for tires and tubes; supersedes vulcanization at saving of over 800%; put it on cold, vulcanizes itself in two minutes, and is guaranteed to last the life of the tire or tube. Sells to every auto owner and accessory dealer. For particulars how to make big money and free sample, address Amazon Rubber Co., Amazon Bldg., Philadelphia, Pa., Dept. 505.

AGENTS—Sell our Artkraft felt rugs. Made of all new bright stock. Colors, red, green, blue, tan, etc. If you are looking for something to double your money on, send for our sample 28x33, \$1.50 prepaid, and we will show you how. E. Condon, 77 Bedford St., Boston, Mass.

AGENTS—6 Fuses in one Plug 25c. Market is enormous—profits large. Every home a live prospect; also factories, stores and others. Approved by Underwriters' laboratories. Send 25c for sample or \$1.00 for five and proposition to distributing agents. Moss-Schury Mfg. Co., 446 E. Woodbridge St., Detroit, Mich.

AGENTS! A sale in every home for our beautiful Dress Goods, Silks and General Yard Goods. Quick sales! Big profits! Large book of over 1000 handsome fabric samples furnished to agents. Write today. National Importing & Mfg. Co., Dept. 6X, 573 Broadway, New York.

LARGE Shirt Manufacturer wants Agents to sell complete line of shirts direct to wearer. Exclusive patterns. Big values. Free samples. Madison Mills, 503 Broadway, New York, N. Y.

300% PROFIT—Whirlwind Seller. Klean-Rite Magic Washing Compound. Washes Clothes Without Rubbing. Sells 25c. You can make 15c. "Distributing Samples Free." Premium Plan gets business. Exclusive territory. Write quick. Bestever Products Co., 1941-K1, Irving Park, Chicago.

AGENTS Wanted—\$4.00 to \$10.00 daily taking orders for "Super" and "Junior" Fyr-Fyter Extinguishers on our new Sales Plan. Commissions paid cash daily. Everyone who owns anything that will catch fire is a live prospect. Homes, farms, auto-owners, schools, churches, factories, all need them. Sell on sight. Sales limited only by calls you can make a day. Write today for exclusive territory and free booklet. "Building a Permanent Income as a Fyr-Fyter Representative." Fyr-Fyter Co., 1503 Fyr-Fyter Bldg., Dayton, Ohio.

MONEY—Money—Money! Make it selling Hanslick, the new and unbeatable hand-cleaner—the original powdered hand soap! Removes grease, grime, ink, paint, etc. without injuring skin. Spreads like wildfire. Cheaper than all others. Sells in cans (or bulk with dispensers) to garages, autoists, auto supply companies, mechanics, factory and office folks, to housewives, hardware stores. Huge quantities used weekly by mercantile houses. Big repeat business assured. Exclusive agencies, crews working for you, fast sales, splendid profits, permanent business for hustlers. Live ones can clean up \$500 a month. Send 10c (coin or stamps) for liberal sample can. Complete sales plan goes with it. Write quick to Solar Products Co., 124 W. Lake St., Chicago, Ill.

AGENTS—Send for sample "Fretnot"—the washday wonder. Be convinced you can do a whirlwind business. You can clear at least \$20 to \$100 weekly, according to spare or whole time. You don't have to talk; if she doesn't buy at sight, leave sample; she will be looking for you long before you are able to make the rounds again. Samples furnished free. Premiums for your customers. Exclusive territory guaranteed to agents who can produce. Credits given. Don't call. P. M. Motter & Sons, 20 E. Jackson Blvd., Chicago.

AGENTS—\$60 to \$200 a week. Free samples gold and silver sign letters for office windows, store fronts and glass signs of all kinds. Anyone can put them on. No experience necessary. Big demand everywhere. Over 500% profit. Fred Foley, Binghamton, N. Y., made \$485.00 first month. Albert Gibbons, Kansas City, made \$212.00 in ten days. Liberal offer to general agents. Write today for sample of our high-grade window letters. Address, Metallic Letter Co., 431-C North Clark St., Chicago, Ill.

A WONDERFUL Seller! Any man, woman, boy or girl can make big wages. Some agents make from \$8.00 to \$20.00 per day. Crimp Grip Clothes Line Fasteners are a simple, time-saving device for holding a rope—also used for many other purposes. It pays for itself quickly in time saved on wash days. No knots—it fastens and releases quickly. Every home a prospect. Every housewife who uses Crimp Grips—and there are thousands of them—is a booster. There is but one Crimp Grip. Write for particulars, or send 50c for one pair and a mounted sample, with full particulars to agents. Crimp Grip Company, Belvidere, Ill.

TAILORING Agents Wanted—Make \$50 to \$100 and more per week selling our wonderful virgin wool one-price line. Suits and overcoats sell for \$29.50. None higher. Retail stores ask at least \$50 for the same quality. You collect your profits in advance. We ship C. O. D. to customer for balance. We furnish beautiful 6x9 swatch outfit and powerful co-operation. Several hundred successful salesmen are now earning \$50 to \$100 a week and more. The low price and wonderful quality wins enthusiastic customers and repeat business. That's what counts. Hustlers write at once. Mention territory wanted. Sales Manager, J. B. Simpson, Inc., Dept. 333, 831-843 W. Adams St., Chicago, Ill.

\$8.00 TO \$20.00 per day. A wonderful seller. Any man, woman, boy or girl can make big wages selling Crimp Grip Clothes Line Fasteners. It is a perfect rope holder and can be used for many purposes. Crimp Grips are a simple, time-saving device. They last a life time and will not rust; it holds the line tight, and saves time on wash days. Every buyer is a booster. Send 50c for Mounted Sample and one pair of Crimp Grip Clothes Line Fasteners. Write for particulars. Crimp Grip Company, Belvidere, Ill.

AUTOMOBILE Free to Tailoring Agents: Make \$75.00 a week and up and get an automobile free taking orders for our fine tailored-to-measure suits. Big assortment of All-Wool Fabrics all at the one low price of \$29.75. Every order pays you big cash profit in advance. We supply finest selling outfit and give an automobile free to every man who qualifies. Write quick for starting offer. Dept. 506, Park Tailoring Company, Chicago.

AGENTS with Fords, \$20.00 a day selling Brass Water Circulating Pumps \$4.00, sells for \$10.00. Shock Absorbers and Souders \$3.50, sells for \$8.50. Nickel Bypass Bumper, F. or R., \$5.50, sells for \$12.00. Explosion Whistle, Brass, \$2.00, sells for \$4.50. All guaranteed first class. Enclose money order for any item; will ship at once so you can start selling. Universal Mfg. Co., 1110 S. Michigan, Chicago.

TAILORING Salesmen—Make \$75.00 a week selling our strictly all-wool made-to-measure suits at \$26.50. You collect profits in advance and keep them. We supply finest selling outfit in America. Many exclusive money-making features. Tailoring, raincoat and side line men, part or full time, write us immediately. Goodwear Chicago, Inc., 843 W. Adams, Dept. 293, Chicago, Ill.

EVERY Raincoat Agent should get our proposition at once. If you have never sold raincoats and waterproofed overcoats now is the time to start. Any man able to talk is able to sell raincoats. Write for our "profit sharing, collective buying, superior quality" offer. Associated Raincoat Agents, Inc., 448-A North Wells, Chicago.

100% PROFIT—Free Goods—No Investment. High grade guaranteed aluminum utensil specialties and cutlery. 10 to 15 dollars per day easily made. Perfection Aluminum Mfg. Co., Desk A, Lemont, Ill.

WE want an agent in every town to sell "Ruby" Furniture Polish. Twenty-five sales a day means \$36.00 per week. William J. Oberting Company, Indianapolis, Ind.

AGENTS—To sell Herith Auto Specialties. One hundred per cent profit. Agent should have Car and some selling ability. O. B. Herith Mfg. Co., Hartford, Conn.

NOT oil but pressure burner that transforms all kinds into Kerosene blue-gas stoves. Cheapest heat. Territory distributors wanted. Talbot Mfg. Co., 115, St. Louis, Mo.

WANTED—District Purchasing Agents. \$250 per month. Steady employment and exclusive territory. Write now. Experience unnecessary. National Instrument Company, 4704 North Hamilton, Chicago.

ELECTRIC Soldering Iron, extra tip for Radio Soldering. Guaranteed. Postpaid \$3.50. Agents wanted. Nat'l Specialties, 32m Union Sq., New York, N. Y.

FORTUNE Maker—Thread-Cutting Thimble. Live wires only. Sample, 15c. Automobile Mfg. Co., 3753 Monticello, Chicago.

GET the exclusive district selling rights for "FLASHONDASH," low gasoline signal for Ford cars. New invention. No competition. Write for details. Auto Gas Gauge Co., 536-D, Hackett Road, Toledo, Ohio.

AGENTS—Sell Latest Imported Pocket Pencil Sharpener; 100% profit. Sample mailed 25c. Voigt Novelty, West Frankfort, Ill.

AGENTS: Cost \$5.00, your profit \$39.50, transferring monograms on autos, trunks, bags, furniture, etc. No experience, no license. Write for free samples. Address Transfer Monogram Co., Inc., 10 Orchard St., Dept. 151, Newark, N. J.

AGENTS: Sell Boyer's Wonderful Beauty Creams, face powders, perfumes, etc. Big line. Exclusive agency. Make \$1 to \$3 every hour. Women wonderfully successful; we trust you. Write Boyer International Co., 944 N. Clark, Chicago.

\$5 TO \$15 Daily Easy—Introducing New Style Guaranteed Hosiery. Must wear or replaced free. No capital or experience required. Just show samples, write orders. Your pay in advance. We deliver and collect. Elegant outfit furnished all colors and grades, including silks—wool and heathers. Mac-O-Chee Mills Co., Desk 2561, Cincinnati, O.

MAN in each town to plate auto parts, reflectors, bathroom fixtures, refinish beds, mirrors, chandeliers; by new method. No capital or experience required. Simple plan of manufacturing at home starts you in big money-making business. Outfit furnished. Free particulars and proofs. Gunmetal Co., Ave. H, Decatur, Ill.

CENTRAL Indiana Manufacturers now marketing an entirely new auto accessory that makes night driving safe, eliminating glare from approaching headlights. Want general sales managers to open branch office, handle exclusive territory and manage salesmen. Some investment necessary. Profit possibilities practically unlimited. Ray Auto Filter Co., Marion, Ind.

AGENTS—\$15 a day—Easy, quick Sales—Free Auto—Big weekly Bonus—\$1.50 premium Free to every customer. Simply show our Beautiful 7 piece, Solid Aluminum Handle Cutlery Set. Appeals instantly. We deliver and collect, Pay daily. New Era Mfg. Co., 805 Madison St., Dept. 21-G, Chicago.

BIG Money-Makers. Large factory offers you big profits. Over 200 fast sellers. Toilet gift sets, flavoring extracts, remedies, soaps, bring you \$8.00 to \$25.00 daily. Howe of Illinois makes \$4.00 an hour. Sample outfit free to workers. Lincoln Chemical Works, Dept. 155, 2956 No. Leavitt, Chicago.

PORTRAIT agents earn big money selling our Photo medallions. Photo medallion clocks, Religious medallions, Photo pocket mirrors, Photo buttons, Photo jewelry, and Fraternal Photo medallions. Send for free catalogue. Satisfaction guaranteed. Four-day service. Address Gibson Photo Jewelry Co., Apartment 7, 698 Gravesend Ave., Brooklyn, N. Y.

\$75.00 WEEKLY Commissions. Coin money (65) newest household, automobile specialties—(Just out). Every home, garage, automobilist, accessory store instantly buys (1) to (100)—No money. No experience needed. Exclusive territory going fast. Write Quick for free samples. Factory (A), Box 494, Hartford, Conn.

WHY waste time on experiments? Needle Books always sell. We have the best flashiest and cheapest Needle Books on the market. Retail from 10c to a dollar. English make. Send for sample and illustrated catalogue. Lea Brothers, 145 East 23rd St., New York.

SELFOLITE—Agents, Streetmen—Selfolite lights any fire while user sleeps, or any time. Performs surprising stunts. Newly patented. Sample 25c, postpaid; money back. Particulars. Kaytwo Mfg. Co., C195 Station A, Boston, Mass.

\$75.00 A Week. "Whirlwind Sellers." Free Samples. (10 New Specialties.) Dollars roll into agents. "Surprises Them All." Every home, office, automobilist, garage buys 1 to 100. No money, no experience necessary. You get all "Reorders." Nulife (Factory A) Corp., Hartford, Conn.

AGENTS. Distributors. Energetic men every city, can earn \$50 to \$100 weekly selling new line household specialties. Start at once; large demand; sell on sight. Big Three Money-Maker sent free; selling instructions, folders furnished. The Fernald Company, North East, Pa.

LARGE manufacturer wants agents to sell guaranteed made to measure raincoats, Gabardines and Reversible top and raincoat combined. Make \$75 to \$100 weekly. Profit in advance. We deliver and collect. Outfit free. Standard Raincoat Co., 163 West 21st Street, New York, N. Y.

CAN you make money selling? Use your imagination. Don't you know every housewife wants a "dustless" and almost "waterless" window cleaner? Gem Polish will do the work. Spare or full time. Gem Polish Mfg. Co., 10 Ohio St., Indianapolis, Ind.

MAKE \$9 to \$42 a day showing New 300 candle power light in homes. Burns gasoline or kerosene. No stock investment. Demonstrations by appointment. Quick sales. Write today for free outfit offer. Akron Lamp Co., 21 Lamp Bldg., Akron, O.

PORTRAIT Agents: Our goods will make you big profits. Delivery guaranteed. Refunds credited. Prompt shipments. Send for latest catalog and prices. Adam J. Kroll & Co., 602 Blue Island Ave., Chicago, Ill.

AGENTS sell Laundry Tablets under your own name and brand. Free samples and circulars furnished with every order. Particulars free; sample, fifteen cents. Write today. Krebs & Products, College Point, N. Y.

MAN or Lady in every town to distribute our 7 Piece Aluminum Handled Cutlery Set. Whole or spare time. Experience not necessary. Sells on sight. High Quality Guaranteed. \$10.00 per day to right people. Perfection Aluminum Mfg. Co., Desk A, Lemont, Ill.

BIG Season now on. Make \$9 to \$42 daily taking orders for The "Diamond Light" Lamps and Lanterns. 300 Candle Power. Beats electricity. No capital required. Write today for catalog and free outfit offer. Akron Lamp Co., 32 Lamp Bldg., Akron, Ohio.

AGENTS, Distributors, Energetic men every city, can earn \$50 to \$100 weekly selling new line household specialties. Start at once; large demand; sell on sight. Big Three Money-Maker sent free; selling instructions, folders furnished. The Fernald Company, North East, Pa.

YOU can be your own boss with our Key Check outfit. Good for \$5 a day stamping names on pocket key checks, fobs, etc. Sample check with your name and address, 20 cents. Pease Die Works, Dept. M, Winchester, N. H.

AGENTS, \$85.00 weekly. Eradium (Luminous) Crucifix (it shines in the dark). Sell in every Catholic home for \$2.00, costs \$4c. No capital required. Free samples. We deliver and collect. Pioneer Corporation, 6301 Yale Ave., Chicago, Ill.

AGENTS—If you are making less than \$300 a month our proposition on Sentinel Burglar Alarms for windows and doors will interest you. Many agents earn \$20 daily. Brand new inventions. No wires, batteries or nails. Instantly attached to any door or window. Handsomely nickel plated. Sell on sight. No competition. Provides cheap burglar insurance. Big money makers. Write today for extremely liberal terms to agents. Sentinel Alarm Co., 140 S. Dearborn St., Chicago, Ill.

FORD Owners—Use Lincoln Brakes for Fords, a full wrap external contracting brake operating on regular Ford drum at rear wheels. A real brake that lessens the upkeep, prolongs the life and adds to the safety of operating Ford cars and trucks. An attractive proposition, \$5.00 profit in each sale; samples furnished at agent's price. Write for details. P. O. Box 282, Connersville, Indiana.

AGENTS—Earn \$25 to \$100 weekly introducing Ho-Ro-Co. toilet goods, extracts, and household necessities. Men or women wanted for full or spare time. Ho-Ro-Co. Tonic and Medicated Skin and Scalp Soap are great profit makers. Repeat orders easy and sure. Over 100 other fast sellers. Free sample case offer; free samples and advertising matter. Write today. Ho-Ro-Co. Mfg. Co., 188 Locust St., St. Louis, Mo.

AT Last—World's Greatest Adding Machine. Almost human. Retail \$15; work equals \$300 machine. \$500 monthly easily made, demonstrating to stores, offices, garages, factories. Simple, easy; adds, subtracts, multiplies, divides, automatically. Speedy, accurate, durable, handsome. Five year guarantee. Tremendous demand; amazing profits. Liberal trial offer. Protected territory. Write quick. Lightning Calculator Corp., Dept. F, Grand Rapids, Mich.

\$5 TO \$15 Daily Easy—Introducing New Style Guaranteed Hosiery. Must wear or replaced free. No capital or experience required. Just show samples, write orders. Your pay in advance. We deliver and collect. Elegant outfit furnished all colors and grades including silks—wool and heathers. Mac-O-Chee Mills Co., Desk 2581, Cincinnati, O.

AGENTS—Full or spare time, selling guaranteed all silk white pongee shirts, direct to consumer; splendid Christmas offering. Agent's price \$2.50 with collar; money back if dissatisfied. Free sample. Pongee Shirt Co., 438 4th Ave., New York, Dept. C.

\$50,000 PICTURE Man Friedman made taking orders. Beginners can make \$100.00 weekly with my canvassing spiel, experienced men make more. Free circular, "Profits in Portraits," explains. Samples free. Picture Man Friedman, Dept. 8, 673 Madison, Chicago.

AGENTS—\$85.00 weekly is a small income if you sell the Eradium (Luminous) Crucifix. Every Catholic will buy for \$2.00. Costs \$4c. Your profit 140%. Demonstrating Case free. All homes can use Luminous Switch Plates, Bulbs and House Numbers. Quick easy sales that bring big money. The Pioneer Corporation, 6301 Yale Ave., Chicago.

AGENTS, Salesmen: Sell complete Radio Receiving Sets, part or all time. Special introductory prices, 30 days' free trial, dealers or direct. Wonderful opportunity. Protected territory. Your outfit free. Home Radio Phone Co., 115 N. Desplaines, Chicago.

AGENTS make \$10 daily—Big line guaranteed extracts, food products, perfumes, toilet goods, household necessities. No capital or experience needed. Free sample case and instructions. Write for amazing offer. Perkins Products Co., Desk 6, Hastings, Neb.

YOU can make big money selling "Grime," the wonderful grease and dirt remover; every auto owner and mechanic becomes permanent customer on demonstration. Write for proposition. Grime Products Co., 24 Noble Ct. N. W., Cleveland, Ohio.

PORTRAITS, photo pillow tops, frames, sheet pictures, medallions, merchant's signs, waterproof and tea aprons, silk and wool hosiery, luminous crucifixes; catalog, 50 specialties free. 30 days' credit. Jas. C. Bailey Co., Desk J1, Chicago.

PORTRAIT Agents and Others. Get Big Profits. Sell Perry Photo Medallions. You charge \$2.98; make 400% profit. \$10 daily easy. Big, exclusive line. 4-day service. Perry Photo Novelty Corporation, Section 16, 360 Bowery, New York.

FOUR Articles, 300% profit, domestic and imported. Excellent mail order, beginners' or agents' proposition. All four samples, 25c, stamps or coin. Valuable information free. Nite Mail Order & Supply Co., 609 27th St., Denver, Colo.

WANTED—Men and women agents and crew managers. Brand new silk and wool hosiery proposition. Direct from mill. Absolutely new; no competition. Sells like hot cakes, pays big commission. Styls Hosiery Co., New Haven, Conn.

CLARKE made \$18 an hour selling vest-pocket windshield cleaner needed by every autoist, motorman, engineer; one rub keeps glass clear 24 hours; 60,000 sold; amazing proposition free. Security Mfg. Co., Dept. 627, Toledo, Ohio.

AGENTS—Stamping names on Pocket Key Protectors; sample check with your name and address, 25c. Stamping Outfits, Emblems Checks, Check Fobs, Name Plates. Hart Mfg. Co., Desk 2, 303 Degraw St., Brooklyn, N. Y.

SPECIALTY Salesmen making \$10.00 daily selling Ball Valve Non-Splash Water Filters on sight. Best canvassers' article ever put on market. Write for details. C. A. Shinn, Manufacturer, 73 Franklin, New York.

AGENTS—Genuine Gold Letters anyone can put on Store Windows. Guaranteed to not tarnish. Large profits. Enormous demand. Free samples. Write today. Genuine Gold Letter Co., 429-A North Clark, Chicago.

IF you need good live agents—fellows who can get the business—ask me how others are doing it. I'll gladly render the necessary assistance. J. Roy McClellan, Mgr. Classified Advertising, Popular Mechanics Magazine, Chicago.

OUR Agents make \$35 to \$50 daily and are getting it with New Marvelous Invention. Sells to everybody; low price—pocket outfit. Write Suren Co., 25 N. Dearborn St., Chicago.

AGENTS, Sell Wolverine Laundry Soap. A wonderful repeater and good profit-maker. Free automobile to hustlers. Wolverine Soap Co., Dept. B-3, Grand Rapids, Mich.

"AUTHENTIC Life of Henry Ford"—amazing, thrilling. Fastest selling Book. Be first. \$100 weekly easy. Free outfit. Hertel Co., 9 So. Clinton, Chicago.

AGENTS—Men, women, to sell Pure Silk Hosiery direct to wearer. Commissions paid daily. Full commission on all repeat orders. We deliver and collect. Write Norwalk Hosiery Mills, Norwalk, Conn.

AGENTS—Clever Invention! Inkspoon makes every pen a fountain pen. Fast office seller; big profit, demand increasing everywhere. Exclusive territory offered. Sample free. H. Marul Company, Tribune Bldg., New York, N. Y.

AGENTS—Crew men, novelty men, Gloop-Pen, a 50c mucilage fountain pen; everybody buys on demonstration. Write for big profit plan. Gloop-Pen Co., 56-FF Pine St., New York.

FORD owner agents—Cyclo "Dynamic" hot-spot guarantees 25 to 35 miles per gallon. Vacuum heat control makes wonderful hill-climber. Cyclo Manifold Co., High St., Akron, Ohio.

AGENTS—New patented curtain rod, necessity in every home; big profit; 4 to 10 sales at every house. Write for free sample. Home Curtain Rod Co., Providence, R. I.

SELL Necessities. Everybody needs and buys the "Business Guide." Bryant cleared \$800.00 in July. Send for sample. It's free. Nichols Co., Box 4-B, Naperville, Ill.

AGENTS—Drop your dead ones. The Universal Sanitary Milk Bottle Cover is the new home necessity. Converts bottle into pitcher. Cannot spill if tipped over. Sanitary and easily cleaned. Best 25c seller out. Sample 25c. Write now. E. Z. Art Needle Co., 513 N. Dearborn, Chicago, Ill.

PATENTS—Write today for Free instruction book and Evidence of Conception blank. Send sketch or model for examination and opinion; strictly confidential. No delay in my offices; my reply special delivery. Reasonable terms. Personal attention. Clarence B. O'Brien, Registered Patent Lawyer, Southern Bldg., Washington, D. C.

MAKE Big Money Selling the Famous Amberoid Unbreakable Combs. Kind you can hit with a hammer. Regular \$1.00 sample with terms to agents 25c. C. Bucknam, 63 Court St., Room 1, Boston, Mass.

LIVE Agents make \$10 Day selling Eureka Strainer and Splash Preventer for every water faucet. Takes on sight. Widely advertised and known. Get details today. A. B. Seed Filter Company, 73 Franklin, New York.

MAKE 600% Profit, Free Samples. Lowest priced Gold window letters for stores, offices. Anybody can do it. Large demand. Exclusive territory. Big future. Sideline. Acme Letter Co., 361-D, West Superior, Chicago.

\$200 WEEKLY. Free samples. Sell gold sign letters to stores, offices. No experience. Big future guaranteed. Can travel. Exclusive territory. Become our general agent. Acme Letter Co., 361D West Superior, Chicago.

MANUFACTURER offers exceptional opportunity to those capable of organizing sales force of women to handle a product universally in demand by women. Write American Rubber Products Co., Dept. 611, Pittsburgh, Pa.

AGENTS make a dollar an hour. Sell Mendots, a patent patch for instantly mending leaks in all utensils. Sample package free. Collette Mfg. Co., Dept. 404-B, Amsterdam, N. Y.

RADY-O Plugs end all spark plug trouble. Sold on money-back guarantee. Exclusive territory to agents. Write at once. R. T. Mfg. Company, Green Bay, Wis.

AGENTS for Wonderful Coal Saving Device. Saves half Coal. Guaranteed. All coal consumers buy. Profit \$100 weekly. A. Dalot, 294 N. Fifth St., Philadelphia, Pa.

AGENTS and Salesmen, here is your big opportunity. Sell Elite and high-class Pearl necklaces direct to consumer, at importer's prices. W. J. Trythall, Importer's Representative, Nashauk, Minn.

AGENTS—Big Profits, Selling Wumrub Polish, for Furniture, Woodwork, Automobiles, etc. Cleans and polishes. Write for Big Free offer. Fritch's Laboratories, 312 North Carpenter, Chicago.

WORLD'S fastest agent's seller. 300% Profit. Needed in every home and store. Establish Permanent business. Premier Mfg. Co., 813 E. Grand Blvd., Detroit, Mich.

AGENTS! A sale in every home for our beautiful dress goods, silks and general yard goods. Quick sales! Big profits! Large book of nearly 1000 handsome fabric samples furnished to agents. Write today. National Importing & Mfg. Co., Dept. 6X, 573 Broadway, New York, N. Y.

BIG Profits Selling New \$3.50 Automatic Adding Machine. Absolutely accurate. Fully guaranteed. Quick sales. Ten daily easy. No competition. Pocket size. Business people everywhere positive customers. Thousands being sold. Tremendous demand. Here's high-grade money-maker. Bassett Co., 1458-L, Hollywood Ave., Chicago.

AGENTS—New Invention. Harper's Ten-Use Brush Set and Fibre Broom. It sweeps, washes and dries upstairs windows, scrubs and mops floors and does five other things. Big profits; easy seller. Free trial offer. Harper Brush Works, Dept. 72, Fairfield, Iowa.

"\$10 A DAY and More," our new book, shows clearly how you may gain sure success and large profits selling Guaranteed Hosiery and Underwear, factory to family. It is Free. Write today. C. & D. Company, 41-E, Grand Rapids, Mich.

PATENTS—Write for our free illustrated guide book and Evidence of Conception Blank. Send sketch or model for our opinion of its patentable nature free. Highest references. Prompt attention. Reasonable terms. Victor J. Evans & Co., 163 Ninth, Washington, D. C.

MAKE \$25 to \$50 Week representing Clows' Famous Philadelphia Hosiery, direct from mill—for men, women, children. Every pair guaranteed. Prices that win. Free book "How to Start" tells the story. George Clows Company, Desk 31, Philadelphia, Pa.

WHY work for others? Make and sell your own goods. We show you how. Enormous profits. Write quick for free book explaining everything. National Scientific Laboratories, 211 North Monroe, Richmond, Va.

SELL the latest nationally approved cooking utensil, the Squire Broilet. Sells on sight. Convenient to carry and show. \$98 profit weekly easy for live agents. Get full details from A. A. Squire Mfg. Corp., 250 Madison Ave., New York.

BUILD a permanent business of your own with the high-grade, quick-selling "Nibco" specialties. Exclusive territory. \$10.00 to \$20.00 profits a day easy for earnest salespeople. Send for interesting folder. A. A. Silver-Chamberlin Co., Clayton, N. J.

BIG Money and Fast Sales. Every owner buys Gold Initials for his auto. You charge \$1.50; make \$1.35. Ten orders a day easy. Write for particulars and free samples. American Monogram Co., Dept. 40, East Orange, N. J.

AGENTS—Make big money the year round selling latest New York fashions, so smart-looking and low-priced no woman can resist buying. Strump & Co., Dept. 16, 29 West 34th St., New York.

100% PROFIT selling our felt rugs to homes, hotels, offices, etc. Everybody buys. We are manufacturers, not jobbers. Prices defy competition. \$75 week easy. Newark Felt Rug Company, 36-C Bergen Street, Newark, N. J.

ANY man handy with paint brush or light tools can start new mechanical business on nearly nothing; needed everywhere; nearly all profit; experience not required. John Braceland, 1457 So. Ninth, Philadelphia, Pa.

NEW and Novel—Vanilla Powders, just add water; Bluing Paddle; Radio Polishing Cloth. Immense profits. Sell families, stores; exclusive or side line. Investigate, you'll be glad. Shillings Chemical Works, Hamlet, Ind.

FACTORY representatives to sell the All Brass Auto Spark Plug. Commissions 20% and 10% on the dollar. Sample sent C. O. D. for 65c. Allen Specialty Co., 2751 West Lake St., Chicago.

WHY work for others? Make and sell your own goods. We show you how. Enormous profits. Write quick for free book explaining everything. National Scientific Laboratories, 211 North Monroe, Richmond, Va.

EARN big money fast applying gold initials to autos. Every owner buys—\$1.35 profit on \$1.50 sale—particulars and samples free. Write quick. Lithogram Co., Dept. 17, East Orange, N. J.

YOU can make \$10 to \$20 daily selling Rex India Fibre Brooms. Outlast three ordinary brooms. 100% Profit. Write Rex Fibre Products Company, 145-C New Jersey Ave., Brooklyn, N. Y.

EASY Money—Plenty of it—awaits those undertaking the sale of Phoenix Sanitary Brushes. Write at once for full particulars. Phoenix Brush Supply Company, Suite 610-C, 1270 Broadway, New York.

SELL "Amens" Shirts; best-looking, biggest value. Manufacturer to wearer. Every order nets profit \$1.50-\$2.25. Write for winning sales plan. Menzin Shirt Co., 3863-A, Third Ave., New York.

MEN'S Shirts. Easy to sell. Big demand everywhere. Make \$15.00 daily. Undersell stores. Complete line. Exclusive patterns. Free samples. Chicago Shirt Co., 9 So. Clinton, Factory 205, Chicago.

BIG Agent's and Mail Order Magazine of Opportunities and Information, including "Supply" Guide; three months, 25c. Harvey Teeple, Decatur, Indiana.

27,000 RECORDS guaranteed with one Everplay Phonograph Needle; new—different; cannot injure records; \$10.00 daily easy. Free sample to workers. Everplay, McClurg Bldg., Desk 16, Chicago.

AGENTS, Salesmen, energetic, anywhere, everywhere, on high-class spare time proposition, worth \$25 to \$100 weekly. No investment, everything furnished. Address, Box 1622, New Haven, Conn.

WILL pay 25 per cent of value of patent to agent who will sell it. Ask particulars. F. Hostetter, 8905 Third Ave., Brooklyn, N. Y.

AGENTS—Big profits, Gold Sign letters easily applied, samples free. Liberal offer to General Agents. Dept. C. Interstate Sign, 2620 No. Halsted St., Chicago.

AGENTS: Big profits. Genuine Gold Leaf Window Letters anyone can put up. Scripts and 57 varieties. Chicago Agency Co., 842 Altgeld St., Chicago.

GASOLINE self-blowing torches for Radio Men, Mechanics, etc. Agents' price \$1.00. Description free. Eureka Sp'y Wks. 457 W. Second, Elmira, N. Y.

EVERYBODY uses extracts. Sell Duo Double Strength Extracts. Complete line household necessities. Big repeaters. Write today. Duo Co., Dept. E1, Attica, N. Y.

GALLAGHER made \$336.00 in one week selling guaranteed Collection Systems, used by all business men. Sayers Mfg., 2815 Sheffield Ave., Chicago, Ill.

SPIRAL Curtain Rods, broom protectors, Ironing Sheet Clips, factory prices. Other fast sellers. Address Hunt Mfg. Co., Box 1652-P, Paterson, N. J.

AGENTS, control territory, Edjol Flavors, household necessities, perfumes, creams, toilet water, famous "Erding's Herb Tablets." Jet Pharmaceutical Co., Allentown, Pa.

AGENTS: Big Money Monogramming by Transfer Method. Catalog Showing Over 50 Styles and Particulars Free. Motorists' Accessories Co., Mansfield, Ohio.

RUMMAGE sales make \$50.00 daily. We start you. Representatives wanted everywhere. Permanent business. "Crosby Co.," 609 Division St., Chicago.

EITHER Sex make \$50.00 weekly selling Bleachrite Washing Compound; big profit, enormous repeater. W. E. Garrett Co., Tulsa, Okla.

WE start You Without a Dollar. Soaps, Extracts, Perfumes, Toilet Goods. Experience unnecessary. Carnation Co., Dept. 201, St. Louis.

AGENTS to sell Kerosene Burners for all purposes. Big Profits. Economy Mfg. Co., 616 W. Monroe St., Chicago.

AGENTS: Big money selling great household necessities; exclusive rights. Webster Co., 2545 N. Clark St., Chicago, Ill.

AGENTS Make \$75 a week selling Hood and Radiator Covers to Ford owners only. Write today. A. & T. Sales Co., Tonawanda, N. Y.

\$20.00 DAILY easy. Big Wonder Line of New York. 31 fast sellers used by everybody. Samples free. Textile Products Company, 693 Broadway, New York.

WHY work for others? Make and sell your own goods. We show you how. Enormous profits. Write quick for free book explaining everything. National Scientific Laboratories, 211 North Monroe, Richmond, Va.

HOUSEHOLD and office necessity, endorsed by "Good Housekeeping." An article of daily use. Large profits. Everett & Barron Co., Providence, R. I.

WE pay \$200 monthly salary, furnish rig and expenses to introduce our guaranteed poultry and stock powders. Bigler Company, X368 Springfield, Illinois.

FASTEST Selling Ford Necessity just out. Seward's profit one day \$74.00. Territory going fast. Write quick. Super, 421 National, Milwaukee, Wis.

AGENTS—33c profit every 35c sale; greatest proposition ever; hundreds of dollars for you; sample free. Empire's Branch, Ventnor, N. J.

GOLD Leaf Sign Letters; make and sell; profits exceed 1,000%; immense demand; particulars free. Johnston Co., Quincy, Ill.

AGENTS—Try our Needle Cushions; Good sellers; Big profits. Sample 15c. Peters, Gardiner, Maine.

FORMULAS—Catalog of Money-makers Free. Clover Laboratories, 5501-CE, North Robey, Chicago.

AGENTS—30,000 Miles without a puncture with Insude Tyres. Wonderful invention. Just slip inside casing before replacing tube. No tools needed. Will not heat or pinch. Positively prevent punctures and blowouts. Guaranteed double tire mileage. Old worn out Casings give 3 to 5 thousand miles more service. Biggest thing on the market. Low priced, \$3 to \$20 a day. Write for territory. American Accessories Co., B-978, Cincinnati, Ohio.

GET posted for Spring. Good prices paid for butterflies, insects. See Sinclair display advertisement, page 15.

AGENTS—Enormous profits selling Genuine Gold Leaf sign letters. Guaranteed not to fade. Establish a permanent business or travel. Anybody can do it. Free samples. Guarantee Sign Service, A 361 West Superior, Chicago.

MUCILAGE Fountain Pen—Agents, big profits. Sells Home or Office. Lasts Lifetime. Never Dry. No Sticky Fingers. Fountain Pen Size. Sample 50c. Mucilage Fountain Pen Co., Steger, Ill.

"HOW to Sell Patents" free. Patent News-O, Washington, D. C.

SALES Agents. Men or women. \$200 a month. Year round position. No layoffs. Take orders for Jennings New Style Hosiery. Written guarantee of satisfaction or new hose free. Write for outfit. Jennings Mfg. Co., Dept. 288, Dayton, Ohio.

AGENTS. \$54 a week; travel by auto, install New Stove Converter in country homes. Wonderful invention. Cook and bake all year without coal or wood. No gas or electricity needed. We furnish the auto. Sample free. Thomas Mfg. Co., Cass 2562, Dayton, Ohio.

AGENTS \$7 a day. Take orders for Stove Transformer. Use common coal-oil for cooking, heating, baking. Cheaper than coal. Fits any stove. No capital needed. Write for outfit. Parker Mfg. Co., Burner 1178, Dayton, Ohio.

"COAL Saver." Agents make and sell. Free Particulars. Write Simms, Lake, New York.

SELL Household articles to the Hardware Merchant. Superior Manufacturing Company, Oakland, California.

AUTOMATIC Kuff Buttons—your cuffs open and close instantly when sleeves are raised or lowered. Great convenience, laundry reducer, Sensational seller. Master Jewelers, Sheboygan, Wisconsin.

350% AND more profit—\$2.38 on each Photo-Medallion you sell. Quick sales. Write for catalogue and prices. Medallion Novelty Company, 208-C Bowery, New York.

LIGHTNING, wonderful new electrolyte, guaranteed to charge discharged batteries instantly and permanently. Send \$3.50 for agent's proposition and sample to R. H. Julien, Copas, Minn.

WHY work for others? Make and sell your own goods. We show you how. Enormous profits. Write quick for free book explaining everything. National Scientific Laboratories, 211 North Monroe, Richmond, Va.

AMBITIOUS Men, write today for attractive proposition, selling subscriptions to America's most popular automobile and sportsman's magazine. Quick sales. Big profits. Pleasant work. Digest Pub. Co., 9505 Butler Bldg., Cincinnati, O.

AGENTS, Big Profits selling new Spark Plug attachments; fit any Plug. (Patent applied for.) Agent's sample 15c. Write. Hart Sparkyces, 2041 2nd Blvd., Detroit, Mich.

AGENTS make big money selling Electric Finger Rings, Wrist, Ankle Bands and Body Battery. Sample ring 20c; circular free. Star Metal Works, McKinney, Texas.

"AUTHENTIC Life of Henry Ford"—Amazing, thrilling, fastest selling book. Be first. \$100 weekly easy. Free outfit. Hertel Co., 9 So. Clinton, Chicago.

A BUSINESS of Your Own—Make sparkling glass name plates, numbers, checkboards, medallions, signs; big illustrated book free. E. Palmer, 511 Wooster, O.

EARN \$10 daily silvering mirrors, plating and refinishing metalware, autos, chandeliers, bedsteads, headlights. Outfits furnished. E. Decie Laboratories, 1183 Broadway, New York.

POLISHING Cloth—easy seller, big money. Hundred other tip-top specialties. Get this proposition. Address Newton & Co., 82 Main Street, Newark, N. Y.

AGENTS make 500% profit handling Auto Monograms, New Pictures, Window Letters, Transfer Flags, Novelty Signs. Catalog free. Write Hinton Co., Star City, Ind.

CALIFORNIA Rosebuds selling like hot cakes. Agents coining money; new stuff. Big profits. Catalog free. Mission, 2421-PM, Smith, Detroit.

MOST Wonderful Seller. 90c profit every dollar. No stock to carry. License unnecessary. Sample free. Mission, 2421-PM, Smith, Detroit.

AGENTS: Big Returns, fast office sellers; particulars and samples free. One Dip Pen Co., 2 Daily Record, Baltimore, Md.

GET Our Free Sample Case—Toilet articles, perfumes and specialties. Wonderfully profitable. La Derma Co., Dept. A, St. Louis, Mo.

FREE Book, Start little Mail Order business. Home employment evenings. Pier, Dept. 11A, 74 Cortlandt Street, New York.

WONDERFUL discovery. Charges batteries in ten minutes. Gallon free to Agents. Address, Radiolite Co., St. Paul, Minn.

FIFTY "Ideal" Sidelines for Mail Dealers and Agents. 500% profit. K. Home, 1957 Warren, Chicago.

YOUR picture on Pocket Mirror (colors), \$1.00. Photo returned unharmed. Black Studio, Los Angeles, Calif.

AGENTS—Our dish cloths sell at every house. Utility Manufacturing Co., Norwich, Conn.

AGENTS—\$4 an hour for your spare time. Write for Canvassers' Outfit containing 18 samples of guaranteed line of pure food flavors, perfumes, soaps, toilet preparations, etc. Sell in every home. Big repeaters. Steady income. Send for Sample Case today. Light weight. Beautiful appearance. American Products Company, 7907 American Bldg., Cincinnati, Ohio.

TEN Rapid Sellers—all profitable. Windshield Cleaners, spark plugs, transformers, visors, etc. No investment. Generous commissions. Jubilee Mfg. Co., 43, Sta. C, Omaha, Nebr.

EASY, pleasant work for Mechanics, Shop Men, Clerks, during spare hours; will add many dollars to their salaries. Also want persons who can give full time. Big wages assured. Novelty Cutlery Co., 67 Bar St., Canton, O.

AGENTS—C. T. A. prices reduced again. Suits \$18.00, made to order, any size or style. Orders easy to get. Big profits. Sample outfit free. Write Chicago Tailors Ass'n, World's largest tailors, Dept. 207, Station C, Chicago.

MILLION Dollar Business, nationally known, wants one man to take charge each county. 75 Different household necessities. "Sure-Shot" selling plan with Free Gift makes sales easy. Wizard Products Co., 1400 W. 37 St., Chicago.

AGENTS to sell Holland Sunburnt Kerosene Burners, for stoves and furnaces. Big money to be made. Write for our proposition. You want the best. Holland Brass Works, Inc., 620 West Monroe St., Chicago.

DON'T Risk One Penny for Anyone's Formulas for Information to "Make and Sell your own Goods" till I've sent you my Valuable Literature and Many Formula Lists of Guaranteed Reliable Formulas for Manufacturing Biggest Selling Specialties in all lines. Highest References. Twenty-six years supplying the Best. Miller Chemist, 805 De Leon, Tampa, Florida.

HIGH-GRADE SALESMEN WANTED

WERE you ever offered a grocery store? You can handle Sugar, Flour, Canned Goods, Dried Fruit, Coffee and entire line of groceries, as well as Paints, Roofing, Toilet Articles and Automobile Oils, with no rent to pay; no money invested. Take large orders from samples. Goods are guaranteed and proven quality. Selling experience not necessary. Steady, profitable work for "workers." Address Hitchcock-Hill Co., Dept. 200, Chicago, Ill. Reference: Any Bank or Express Co.

SALESMEN wanted for C. E. Z. automatic headlight. Takes danger out of night driving. Safe, sane and lawful. Better than spotlight. Easy to sell. Retail \$5.00; 30-day money back guarantee helps you. Installed in 30 minutes by anyone. No holes to bore, no special tools required. Liberal commission. Write for salesman's proposition at once. Admiral Welding Machine Co., 1619 Locust St., Kansas City, Mo.

BEST Seller: Jen Rubber Repair for tires and tubes; supersedes vulcanization at saving of over 800%; put it on cold, vulcanizes itself in two minutes, guaranteed to last life of tire or tube; sells to every auto owner and accessory dealer. Get particulars how to make big money and free sample. Amazon Rubber Co., Philadelphia, Pa., Dept. 510.

EVERETT salesmen earn largest commissions paid by any Woodenware Manufacturer. Sell High-Grade Household Woodenware to Hardware and Furniture dealers. Big demand. Salesmen wanted in both United States and Canada. You can build up a big business with dealers in your territory. Some of our salesmen average a \$1,000 a month. Write today. Everett Mfg. Co., Dept. Eight, Sault Ste. Marie, Canada.

SALESMEN, sell low range, low price radio receiving sets \$10.00 monthly payments. No investment, we finance responsible district representatives. Ten sales monthly assures you \$350.00 steady monthly income. Every home a prospect. Our plan is sweeping the country. Don't wait to write; telegraph, giving references. Ozarka Radio, 6368 North Clark Street, Chicago.

\$125 TO \$300 a week. Salesmen with slight knowledge of motors who can reach car owners, can earn \$300 weekly without making a single sale. If they can also make sales, profits may reach \$25,000 yearly. Phillips, 228 W. 29th St., New York.

SALESMEN Given Protected territory to sell Doublewear Shoes direct from factory to wearer. Our new measure board insure perfect fitting. Write for particulars and list of open counties. Doublewear Sho Co., Manufacturers, Minneapolis, Minn.

SALESMEN: \$100 earned by Dahlen first day. Taylor averages \$1,000 monthly selling our vending machines. Write quick The Hot P-Nut Machine Co., 123 S. Jefferson St., Chicago, Ill.

SALESMEN—Main or Sideline—Sell Merchants Vending Machines—Make big money quick—Free goods deals—Other attractive items. Write quick. United Specialty Company, 277 E. Long St., Columbus, Ohio.

OIL or Coal? "The Burning Question," interesting booklet, discusses high efficient residence oil burners. Copy free. Write to E. L. Miller, author, 40 West Third Street, Kansas City, Mo.

GOOD Side Line, selling Christmas Seal to trade. Commission. H. T. Patrick, 521 Penhurst St., Rochester, N. Y.

SALESMEN: Nelson's Loose Leaf Encyclopaedia. Exclusive territory, highest commissions. Dalton Riggs, Crilly Bldg. Chicago.

SALESMEN—AMMC Salve, Piles, Infections, etc.; sample 10c. Dept. 6, AMMC Peotone, Ill.

SALESMEN Wanted—Local or traveling part or full time, to sell calendars, fans, fly swatters, brushes, rulers, etc. Over two hundred stock designs of paraffin signs, ice cards, etc., for all merchants. Fin side line, liberal commission. The Harrison Co., Union City, Ind.

TRAVELING Salesmen calling on retail stores wanted by large manufacturer to sell wonderful line of business-boosting articles. Year round, fast selling, main or side line. If not earning \$150.00 weekly address Elbasser Works, 222 Charles St., Boonville, N. Y.

SALESMEN—Become Independent. Own your business; experience unnecessary; selling our \$7,500 Accidental Death, \$50 Accident, \$25 Sick Weekly Benefits; \$12.50 yearly; other amounts proportionate. Guaranteed steady income from renewals \$250,000 deposited Insurance Department Registration Dept. A, Newark, N. J.

\$4.00 PROFIT on every \$5.00 sale "Free sample," new specialty (money getter). Every storekeeper, doctor buy quickly. Connors made \$20.00 first hour Dacey made \$38.00 first day. Experience unnecessary. All territories now open. Drawer 596, Hartford, Conn.

SALESMEN Can make \$5.00 a day selling our Calendars, Pencils, Signs, Advertising Novelties, Yardsticks, Whistles, etc. Liberal terms. Sells entire year. Fin side line. Local and traveling agencies. Model Calendar Co., Dept. 226, South Bend Ind.

TAILORING Salesmen: You can earn \$50.00 to \$150.00 a week selling our virgin wool line of tailored to order suits and overcoats retailing at \$29.50. None higher. All one price. Regular \$50.00 values. We have a large assortment of rich, dependable fabrics. Beautiful patterns and weaves. Satisfaction guaranteed. You collect your profits in advance. We ship C. O. D. to customer for balance. No investment required. We furnish 6x9 swatch line complete with agency supplies. Protected territory for hustlers. Substantial income derived from repeat business after first season. Experience not essential. Write before your territory has been spoken for. Address J. B. Simpson, Inc., Dept. 354 831 W. Adams Street, Chicago, Ill.

THE Lure of the Motion Picture Screen tied in with a sure-shot sales proposition—combining fascinating work with big earning possibilities. That's the combination offered you—selling motion picture publicity service to fifty different lines of business. Our pace-maker has just duplicated his first year's earnings of \$23,251.17 in his second year, over the same territory. Drop a postal card, or wire, for complete details to the largest film publicity company in the country. Alexander Film Company, 1151 Main, Spokane, Wash.

MAKE \$5,000 every year—\$2,000 in spare time. You share profits besides. Show "Weather Monarch" Raincoats and Waterproof Overcoats. Ask about "Duo Coat" (No. 999). Get sample raincoat free. Associated Raincoat Agents, Inc., 446-A North Wells, Chicago.

AMBITIOUS Men, write today for attractive proposition, selling subscriptions to America's most popular Automobile and sportsman's magazine. Quick sales. Big profits. Pleasant work. Digest Pub. Co., 9505 Butler Bldg., Cincinnati, O.

AGENTS—Sell Patented Cigar Lighters and Cigar-Case Moisteners. Big Profits. Start making money at once. Write for circulars, cuts and sales plan. Drake Mfg. Co., Dept. M, Milwaukee, Wis.

SELL something original! Something every merchant needs—"Zim's Peerless Collection System." Exclusive collecting features has collected for 1% cost. Sells \$7.50. Creditors' Association, E-312 McKnight Bldg., Minneapolis, Minn.

SOMETHING New, a Necessity. All business and professional men need it. Sells \$7.50, costs you \$2.50. Big repeater. Write for sample. Merchants Ass'n, Minneapolis, Minn.

MINUTES pay dollars demonstrating world's greatest specialty. Wonderful new three-pound Adding Machine. Retail \$15. Work equals \$300.00 machine. Adds, subtracts, multiplies, divides, automatically. Speedy, accurate, durable, handsome. Five-year Guarantee. Tremendous demand everywhere. Amazing profits, main or sideline. Experience unnecessary. Write quick for liberal trial offer and protected territory. Lightning Calculator Co., Dept. G, Grand Rapids, Mich.

EASY to sell Groceries, Paints, Automobile Oils, Roofing, Stock Food to consumers from samples, no capital or experience necessary; steady, profitable work. Commissions advanced. Satisfaction guaranteed. 50 years in business. Write for full particulars. Leverin & Browne Co., Wholesale Grocers, 1775 S. State Street, Chicago, Ill.

BIG profits—\$250.00 to \$300.00 a month—selling high grade Leather Fan Belts and Belting to Auto Accessory Dealers and Garages. Full time only. Write Monarch Belting Co., 1270 Ontario St., Cleveland, Ohio.

AGENTS—\$40-\$200 a week. Free samples. Gold sign letters anyone can put on store windows. Liberal offer to general agents. Metallic Letter Co., 431-E N. Clark St., Chicago.

STEADY income representing attractive line of toilet necessities. A display of art and quality. Additional bonus. De Pottier Cosmetics, 862 Title Insurance Bldg., Los Angeles, Calif.

CALIFORNIA Rosebuds selling like hot cakes. Agents coming money. Absolutely new. Big profits. Catalog free. Mission, 2421-SP, Smith, Detroit.

SALESMEN, local or traveling, to sell new electric fixture to stores. Small capital required. Radio & Electric Supply, Robinson, Ill.

57 MILES per gallon made with new patented gasoline Vaporizer. Write for particulars. Vaporizer Co., Pukwana, S. Dak.

SALESMEN wanted. Good propositions. Sorel Lock Limited, Sorel, Que., Canada.

TEN Rapid Sellers—all profitable. Windshield Cleaners, spark plugs, transformers, visors, etc. No investment. Generous commissions. Jubilee Mfg. Co., 42, 8th St., Omaha, Neb.

BIG Profits—\$300.00 to \$400.00 a month—selling Leather Belting and Pulley Covering to Factories, Mill Supply and Hardware Jobbers. See our advertisement December issue "Belting." Side line or full time. Write Monarch Belting Co., Ontario Bldg., Cleveland, Ohio.

SALESMAN—Create profitable business by becoming exclusive distributor of device that saves high-priced coal. Sells readily. Other distributors making good. Advertising furnished. Profits sure and steady. Write. Crown, Richmond, Ind.

HELP WANTED

WHAT is it worth to you? Distributor—District Manager—Salesman or Agent—to have the agency for the best line of Rubber Specialties on the market? Hot Water Bottles, Bathing Caps, Combination Shopping Bags, Pure Rubber and Rubberized Aprons, Rubber Gloves, and forty other fast selling articles needed in every home. Profits range from 100 to 150 per cent. Write B. & G. Rubber Mfg. Co., 615 Penn Ave., Pittsburgh, Pa., Dept. 214.

DISTRICT Managers. Big Profits. Men capable of organizing and managing crews of lady solicitors can easily clear \$50 to \$100 per week with the B. & G. Protector, the original and best protector on the market. Every woman between fifteen and fifty needs and buys it. B. & G. Rubber Co., 618 Penn Ave., Pittsburgh, Pa., Dept. 213.

HOTELS Need Trained Men. Nationwide demand for high-salaried men; past experience unnecessary. We train you by mail and put you in touch with big opportunities. Big pay, fine living, interesting work, quick advancement; permanent. Write for Free Book, "Your Big Opportunity," Lewis Hotel Training Schools, Room 351, Washington, D. C.

EARN \$110 to \$250 monthly, expenses paid, as Railway Traffic Inspector. Position guaranteed after 3 months' spare time study or money refunded. Excellent opportunities. Write for Free Booklet CM-46, Standard Business Training Inst., Buffalo, N. Y.

\$100 MADE in one week by young man in small town without capital or experience in local advertising business. Why can't you do likewise? Free book tells how. S. Meyer, 211 Seventh St., Louisville, Ky.

YOUNG Men, Women, age 18 and over, wanted for U. S. Railway Mail, Post-office and other Government positions. Good salary. Full particulars free. Write today to Columbia School Civil Service, 411 Pope Bldg., Washington, D. C.

FIREMEN, Brakemen, Baggage-men. Sleeping car, train porters (colored). \$140-\$200. Experience unnecessary. 810 Railway Bureau, East St. Louis, Ill.

WE want a few more men to take orders for our one-price line of tailoring offering All-Wool Made-to-Measure Suits guaranteed \$50.00 values at only \$29.75. Every order you take pays you a good profit, in advance. Experience not necessary. Hustlers can clean up big. Write today. Park Tailoring Company, Dept. 507, Chicago, Ill.

AMBITIOUS Men, write today for attractive proposition, selling subscriptions to America's most popular Automobile and sportsman's magazine. Quick Sales. Big profits. Pleasant work. Digest Pub. Co., 9505 Butler Bldg., Cincinnati, O.

BE a Finger Print Expert. Demand increasing. Write for special free offer. American Finger Print System, 1966 Broadway, N. Y.

MEN wanted to qualify for Firemen, Brakemen. Transportation furnished. Write W. Boggs, St. Louis.

MAKE money writing Photo-plays; details free to beginners. No correspondence course. Producers' League, 250 Wainwright, St. Louis.

BE a Finger Print Expert—Opportunities opening everywhere. Write National System, 186 East 79th, New York.

EARN \$15-\$50 weekly writing show cards. No canvassing. Experience unnecessary. We train you. Particulars, terms free. Sho-Rite Sign System, Inc., 2346, Detroit, Mich.

SALESMEN, Independence awaits the Live Wires who grasp this opportunity. Warehouses, terminals, steamship companies, factories, hotels, cafes, etc., desperately need our scientific, positive, but simple method of extermination of rats and mice; grateful clients and long contracts await you; best exclusive territories going fast. Commission only. Write today. The Ratlin Laboratory, Inc., 115 Broad St., New York.

\$5 TO \$15 Daily Easy—Introducing New Style Guaranteed Hosiery. Must wear or replaced free. No capital or experience required. Just show samples, write orders. Your pay in advance. We deliver and collect. Elegant outfit furnished all colors and grades including silks—wool and heathers. Mac-O-Chee Mills Co. Desk 2601, Cincinnati, O.

INVENTORIES desiring to secure patents should write for our book. "How to Get Your Patent," tells our terms and methods. Send sketch for our opinion of its patentable nature. Randolph & Co., Patent Attorneys, 629 F. Washington, D. C.

SIGN Letter Agents and Painters; 500% Profit. Gold and Silver Sign Letters for Stores and Office Windows. Anyone can put on. Big demand. Free samples. Metallic Letter Co., 431D N. Clark St., Chicago.

MAN in every county to sell land from our lists at fair commission. Sample list from which you may start selling immediately, a dime. American Real Estate, 116 East Sherman, Hutchinson, Kan.

DISTRICT Managers, general agents, with ability to organize force of producers wanted. Old established firm. Big-paying proposition. Write for details to Fitzcharles Dry Goods Company, 615 Fitzcharles Building, Trenton, N. J.

ELECTRICIANS' Examination books of questions and answers with diagrams, symbols, tables, notes, and formulas, for preparation for license \$1.25. Aaron Shapiro, 296 Broadway, New York.

ALL men, women, boys, girls, 17 to 60, willing to accept Government Positions, \$117-\$190, traveling or stationary. Write Mr. Ozment, 101 St. Louis, immediately.

STORIES, poems, plays, etc., are wanted for publication. Good ideas bring big money. Submit manuscripts or write Literary Bureau, 522, Hannibal, Mo.

OUR genuine gold window sign letters are an excellent money-making proposition for handy men. Slann Sign System, Bethune Ave. E., Detroit, Mich.

EARN \$10 daily silvering mirrors, plating and refinishing metalware, autos, chandeliers, bedsteads, headlights. Outfits furnished. E. Decle Laboratories, 1133 Broadway, New York, N. Y.

WANTED: Railway Mail Clerks—\$1,600 to \$2,300. Exams everywhere. Write today for full information. Patterson, Civil Service Expert, Box 4025, Rochester, N. Y.

WRITE articles, stories, news, in spare time for newspapers and magazines. Big pay. Copyright book free. Press Syndicate, 533, St. Louis, Mo.

FREE Book. Start little mail order business. Home employment evenings. Pier, Dept. 12A, 74 Cortlandt Street, New York.

SILVERING Mirrors, French plate. Easily learned, immense profits. Plans free. Wear Mirror Works, Dept. 25, Excelsior Springs, Mo.

FREE Plans. Stop Daily Grind. Silver mirrors, headlights, tableware, etc. Clarence Sprinkle, Dept. 28, Marion, Ind.

FIREMEN and Brakemen, beginners \$150, later \$250 monthly; railroads everywhere (which position?). Railway Association, Desk M-1, Brooklyn, N. Y.

GOVERNMENT Railway Mail Clerks, \$135-\$195 Month. List positions open—free. Write immediately. Franklin Institute, Dept. M21, Rochester, N. Y.

WE pay big money for painting pillow tops. Simple, easy, quick. Experience unnecessary. Nileart Company, 2241 Ft. Wayne, Ind.

GET posted for Spring—good prices paid for butterflies, insects. See Sinclair display advertisement, page 16.

MEN Wanted. Railway Mail Clerks, \$133 Month. List positions free. Franklin Institute, Dept. M21, Rochester, N. Y.

WANTED Immediately. Several hundred Men-women over 17 to prepare for U. S. Government Positions. Railway Mail Clerks, City Mail Carriers Clerks at Washington, D. C. \$100 to \$185 Month. Pleasant work. Short hours. Long vacation with pay. Common education sufficient. Complete list positions free. Write Franklin Institute, Dept. M3, Rochester, N. Y.

WANTED—Man of good standing in his community to take orders for trees, shrubs, roses, vines, bulbs, old fashioned flowers. Permanent. High commissions paid weekly. No delivering or collecting. Write today. First National Nurseries, Rochester, N. Y.

RAILWAY Mail Clerks, Postoffice and other help wanted by Government. \$1400 to \$2300. Examinations everywhere soon. Write today for full information. Chicago Civil Service College, A-41 Kesner Building, Chicago.

U. S. GOVERNMENT wants Help. Railway Mail Clerks—Clerks at Washington. Men-women over 17. \$100-\$195 Month. List positions free. Franklin Institute, Dept. M21, Rochester, N. Y.

YOU are wanted. U. S. Government jobs. \$100-\$195 Month. Many openings. List free. Write immediately. Franklin Institute, Dept. M21, Rochester, N. Y.

FOR ADVERTISERS

INTERNATIONALIZE your business!!! Sell!—Trade!—Buy! Everything!—Everywhere!!! 1c word; \$1.00 inch; one-half, 6"x9" page, only \$8.00; page \$10.00. World-wide circulation! International Opportunity, 2279 First Ave., New York.

ADVERTISE in 24 Big Sunday Newspapers, 25 words \$15.00. Catalog listing 1,000 leading Dailies, Weeklies, Magazines, 4c stamps. Union Advertising, Baltimore Bldg., Chicago.

ADVERTISE your ad in 100 magazines for 4c per word. Sample copy 10c. Harry Seell, 1621 State Ave., Cincinnati, Ohio.

INCH Display Advertisement 141 Magazines Thrice \$15. Year \$50. Page \$100. Wood's Popular Services, Atlantic City, N. J.

IF it's advertising write Jacobus Advertising Service, Irvington, New Jersey.

FLYER—25 words in combined list 75 Sunday and weekly newspapers \$5. Cope Agency, 233, Champaign, Ill.

COMMERCIAL Engraving and Printing—the most practical and complete book on engraving, printing and allied subjects ever published. Over 800 pages and 1500 illustrations presenting over 3500 distinct ideas on 35 separate subjects. Cloth. Price \$15.00 prepaid. We highly recommend this book. Popular Mechanics Book Dept., 6 N. Michigan Ave., Chicago.

BLOTTERS will advertise your business or product. Samples for stamp. Labarre Company, Pittston, Pa.

ITEMIZED latest advertising rates every large daily, complete. 10c. Kline, Kline Bldg., Kent, Ohio.

ART AND ADVERTISING

PORTRAITS in oil. Your portrait, 12 by 15 inches, painted on canvas in permanent oils for \$10. Genuine oil portraits; not tinted enlargements. Send clear photograph, stating color hair, eyes, complexion. Or write for particulars and sample of work. Satisfaction guaranteed. Cleeland Studios, Redmond, Wash.

CARTOONS, Comics, Caricatures made. You can suggest own ideas. Art Service, 80 No. Third St., Meriden, Conn.

HAND OIL Painted Portrait in Life Colors, from your photo. Agents wanted. Frank Cadle, Augusta, Ga.

INFORMATION

RELIABLE information furnished on any subject or money refunded, 75c. Co-operative Service, Times Plaza, Box 364, Brooklyn, N. Y.

BUSINESS SERVICE

INCORPORATE. Our lawyers do the work, saving you time, annoyance and money in incorporating under the most liberal laws of Arizona. Laws and forms free. Southwestern Securities & Investment Co., Box D488, Phoenix, Ariz.

PURCHASES made, business commissions reliably executed in New York City and vicinity for non-resident firms, families or individuals. Edward Boyte, 309 Fifth Ave., New York.

GET a position by mail. Eight winning letters of application. \$5. Floyd V. Studer, Canadian, Texas.

MAILING LISTS

75,000 UP to date names. Any list for your requirements. 2,500 for \$5.50 typewritten. We mail your circulars, direct, 2½c. C. H. Davis & Son, News & Merchandise, 614 W. Jefferson, Greenfield, Ohio.

HOUSEWIVES, \$1.00 thousand. Any list procured. Walter Miller, Berwick, Pa.

PROSPEROUS middle west; Rural and small town buyers; Either sex; 100, 10c; 1000, 98c; 4000, \$3.00. Guaranteed. V. C. Robinson, Maryville, Mo.

TYPEWRITERS AND SUPPLIES

TYPEWRITERS. All Makes. Save one-half. Thoroughly Rebuilt in our factory by the famous "Young Process." Fully guaranteed. Free trial. We handle all standard makes. Cash or sold on easy terms. Write for Catalog. Young Typewriter Co., Dept. 502, Chicago, Ill.

ALL makes rebuilt, refinished, guaranteed five years; thirty days' free trial allowed. Oliviers, Underwoods, Monarchs, Remingtons; others \$15.00 up. Send for our lists and agents' proposition. Typewriter Exchange, 2316 University Ave., New York City, N. Y.

UNDERWOOD Typewriters at far less than manufacturers' price; rebuilt, all worn parts replaced, guaranteed good as new. Cash, installment payments. Write for Catalog 1511. Shigman-Ward Mfg. Co., estab. 1892, Montrose and Ravenswood Ave., Chicago, Ill.

SIMPLEX Typewriters; Guaranteed; 2 sizes: \$1.75 and \$3.25, prepaid. Smith's Novelties, 6735 S. Elizabeth St., Chicago.

DUPLICATORS AND DEVICES

"MODERN" Duplicators save Time, Labor, and Money. Gets Business, Reproduces Typewritten or Penned Letters, Drawings, Lessons, Music, Menus, Bids, Notices, Specifications, Maps or anything in one or more colors. Prints Two per minute. Special Sale On. 30 Days Free Trial. \$2.25 up. Booklet Free. J. E. Durkin-Reeves Co., Pittsburgh, Pa.

YOU can make 50 to 100 copies of a letter, notice, etc., at a cost of three cents on a Hoyer Quality Duplicator. Write for free trial offer. The Hoyer Duplicator Co., 162 N. Wells St., Chicago, Ill.

ADDING MACHINES

NEW \$3.50 Automatic Adding Machine. Adds, Subtracts, Multiplies. Absolutely accurate. Capacity \$999,999.99. Fully guaranteed. 75,000 pleased users. Makes adding easy, positive, quick. Eliminates Mistakes. Saves Time. Postpaid, \$3.50. Bassett Co., 1458-K, Hollywood Ave., Chicago.

FREE Trial. Marvelous new Adding Machine. Adds, Subtracts, Multiplies, Divides, automatically. Work equals \$350.00 machine. Price only \$15.00. Speedy, durable, handsome. Five-year guarantee. Used by largest corporations. Write today for catalog and free trial offer. Lightning Calculator Co., Dept. E, Grand Rapids, Mich.

PRINTING, ENGRAVING AND MULTIGRAPHING

1,000 LETTERHEADS or Envelopes. \$3.00, sent prepaid. Samples Free. Mat-tax's Print Shop, Tremont, La.

ALL Printing Prices Smashed. 5,000 Letterheads or Envelopes \$13.85. Samples. Quality Printshop, Marietta, Ohio.

REDUCED prices for better printing. 1,000 Bond letter-heads, \$5.00; 1,000 good envelopes, \$4.25; 1,000 four-page folders, 3½x6¼ inches, \$12.00. Catalogues, circulars, booklets our specialty. All printing at reduced prices. Samples free. Fantus, 525 S. Dearborn St., Chicago.

PLATELESS Engraved and Embossed Stationery; Samples Free. Agents wanted. "Dad" Walter, 363 Jay Street, Brooklyn, N. Y.

GOLD lettered advertising pencils for you; buy direct, save entire middleman's profit. Samples free (no agents). Address, S. Musial & Co., 422 Walnut St., Yonkers, N. Y.

250 LETTERHEADS, 250 white envelopes printed and mailed, \$3.00. Samples printing free. Sunco, Mohawk, N. Y.

PRINTING Outfits—Presses, type supplies, type novelties. Send stamp for catalogue. Model Press, York, Penna.

1,000 20-lb. BOND Letterheads, \$3.50; 5,000, \$15.00. Samples. Annville Printing Company, Annville, Pa.

225 BOND Letterheads, Envelopes, Bill-heads, Cards, \$1.25 each; Combination, \$4.00. Economic Press, Leonia, N. J.

PRE-USED Printing Presses. Type and supplies. List for stamp. Popular Bargains, Richland, Pa.

TRY our attractive two-color letterheads on 20-lb. watermarked bond, 2,000, \$9.50; 5,000, \$19.50. E. Fowler, Clintonville, Conn.

LETTER and Bill Heads, statements, cards, envelopes per thousand, \$3.00; samples free. Export Paper Products Co., New Orleans, La.

INTRODUCTION Offer—250 Business cards, Letterheads, Envelopes, all for \$4. Reliance Print Shop, Box 192, Elyria, Ohio.

100 CALLING cards 50c. Card case free. Rubber stamps—name and address 50c. Wm. Sirdevan, Ravenna, Ohio.

BOOKLET, catalogue and commercial printing, reasonable prices. Printery, Bremen, Ohio.

5000 5½x8½ CIRCULARS \$8.50; Typewriter Letters, Stationery, Low Prices. Bargain List, Samples. Good's Printery, Harrisonburg, Va.

1,000 HAMMERMILL letterheads, envelopes, \$3.25; 250, \$1.25. Samples free. Troib Press, 98 Providence, Worcester, Mass.

500 GUMMED Stickers 25c. each. Printed with Name and Address. LeBeuf, Fairview Station, Detroit.

1,000 LETTERHEADS or Envelopes, \$3.00. Sent Prepaid. Samples Free. Monitor Press, Morrisville, Pa.

500 PRINTED Envelopes, postpaid, \$2.25. Quantity prices, everything. Quality Printery, Robinson, Ill.

IMITATION typewritten letters, Multigraphing, Mimeographing, Printing, Cal System, Fairview Station, Detroit.

GOOD Printing—Promptly. Samples free. 1,000 Envelopes \$2.75. Printshop, Rockland, Wisconsin.

EMBOSS business, personal stationery. Samples, stamp. Daniels Company, Pittston, Pa.

1000 HAMMERMILL bond letter-heads or envelopes, \$3.45. Multigraphing at low prices. Samples on request. Address C. B. Hatfield, Box 353, Owego, N. Y.

FOR MEN

ARE You Old at Forty? See our advertisement on page 148 of this issue. The Electro Thermal Company, Steubenville, Ohio.

FOR SMOKERS

SMOKE Real tobacco. Sample 10c. Folder free. Direct to smoker. Hast Mailing Co., Paducah, Ky.

HOMESPUN Smoking Tobacco, Mild and Mellow—10 lbs. \$1.50; 20 lbs. \$2.75; delivery guaranteed. We furnish free recipe for preparing. Smoking Tobacco Exchange, Sedalia, Ky.

MADE in Germany. "Columbia." New patent shagpipe. Smokes perfectly dry. No waste of tobacco. Biggest nicotine absorber. Easy cleaned. 75 cents postpaid. (Send Postal Money Order.) Dealers special price. Ben Gamm, Importer, 673 North Dearborn Street, Chicago, Ill.

GUNS, SPORTING GOODS, ETC.

LET us tan your furs for coats, robes, sets, caps, etc. Big thirty-two page catalog, gives full information. Write today. H. Willard, Son & Company, Station A. Marshalltown, Iowa.

ANTIQUES AND WAR RELICS

FOR Dens—Relics collected from Europe's battlefields. Fully illustrated catalogue and sample War Photographs 25c. Lieut. Walsh, 2117 Regent Place, Brooklyn, N. Y.

EUROPEAN War Money, 150 different for \$1.00. Grutzmacher, Mukwonago, Wis.

INDIAN Baskets, Blankets, Wampum, Mats. Wholesale. Catalogue. Gilham, Kelseyville, Calif.

BOATS AND LAUNCHES

"HOW to make your boat leakproof." Send for booklet. L. W. Ferdinand & Co., 152 Kneeland St., Boston, Mass.

12' FOLDING Rowboat. Construction blueprint 30c. Weeshe-Uco, West Market, Detroit, Mich.

RAZORS AND BLADES

"BETTER Shaving" Blades Resharpener. Any make. Guaranteed Service. Standard Safety Razor Corporation, Pittsburgh, Pa.

BLADES, resharpened, one edge 2c; double edge New York Edge Co., Glen Cove, N. Y.

PHONOGRAPHS AND RECORDS

BUILD Your Own Phonograph. Big saving. Pleasant, instructive work. Complete instructions, blue-prints, etc., absolutely free. Write today. Associated Phonograph Co., Dept. AP-10, Cincinnati, Ohio.

BUILD Your Phonograph. Quality phonoparts. Quality Serecator motor and motors of other types. Electric Motors, tonearms, reproducers, amplifiers, case material, accessories. Free blueprints and building instructions. Big saving. Wonderful results. Prompt delivery. Catalog mailed for ten cents. Hoosier Manufacturing & Supply Co., 313 Baldwin Block, Indianapolis, Ind.

BUILD a genuine Choraleon phonograph and save over half. Big profit building and selling. We furnish motors, tone-arms, full instructions and all necessary parts. Send for catalog and free blueprint offer. Choraleon Phonograph and Radio Co., 123 11th St., Elkhart, Ind.

BUILD Phonographs. New Tone-Arm just out. Enclosed Motors at Lowest prices. Write for Big Bargain circular illustrating Complete Phonographs at \$49.00. American Phonograph Company, 3513 North Crawford, Chicago.

FOR quality, service and economy, use Superior phonograph builders' equipment. Catalogue. Superior Phonoparts Co., Erie, Pa.

MUSIC AND MUSICAL INSTRUMENTS

SONG Writers—Have you poems? I have real proposition. Ray Hibbeler, D110, 4040 Dickens Av., Chicago.

WRITE Songs. Big money and reputation. Write for information. J. Gordon Pub. Co., 201 N. Hoyne Ave., Chicago.

CORNETISTS — Trombonists — Saxophonists — Clarinetists. Send for "Free Pointers No. 2." Name instrument. Virtuoso School, Buffalo, New York.

MUSICIANS: Learn harmony in 12 easy lessons—new—write Delamater System, 5337 So. Prairie Ave., Chgo.

YOUR Song Printed, 25 copies, \$3.00. Sample song, etc., for silver dime. Tully Murphy, 406 E. 20th, Baltimore, Md.

"MUSIC Composed" to words. Bauer Bros. (formerly of Sousa's Band), Oshkosh, Wis.

I WANT song poems. Casper Nathan, Garrick Theatre Building, Chicago.

JOIN our Sheet Music Club and receive latest popular music of all publishers, \$1.00 Year Plan. Write today for details. Sheet Music Club, Suite 703, 1545 Broadway, New York.

PLAY band instruments without study. No lessons required. Send today for Free booklet. Gives full particulars about these wonderful instruments. Sonophone Co., 548 PA, Wythe Ave., Brooklyn, N. Y.

VIOLINS—Deep, Mellow, Soulful—on credit. Easy terms for wonderful instrument. Get details today. Gustav F. Henning, 2424 Gaylord St., Denver, Colo.

OPTICAL GOODS

THE Invisible World Revealed! Microscopes, magnifying 500 times, by mail 75c. George Mayerle, Expert Optical Service, 909 Market St., San Francisco, Calif.

DIAMONDS, WATCHES AND JEWELRY

FREE — "Horseshoe-Nail-Ring," sterling silver, gold top, genuine garnet center. Write Cognito, Elizabeth, N. J.

CHRISTMAS or New Year's presents? Every woman and girl wants a pearl necklace. Never before have pearls been so popular. You can fool a man on pearls but women know good ones! That's why you'll make a real hit by giving our genuine imported indestructible Japanese pearls, absolutely guaranteed. The color is rich—exactly like fabulously priced Oriental pearls. They cannot be properly described—you should see them to appreciate their beauty. 14, 18 and 24 inch strands, graduated, with gold clasps, \$12.50. Very small pearls, graduated, same lengths, \$19.50. "De Luxe" opera length (70 inches) large, gorgeously colored, perfectly matched pearls, \$30.00. All in nice gift cases. Send money order or cashier's check and pearls will be sent immediately by insured parcel post. J. Bennett, 1060 Lawrence Ave., Chicago.

FOR THE HOME

SAVE Coal. Make a Kerosene burner for less than \$4.00. Guaranteed Plans \$1.00. McCormack Spec. Co., Guilford, Conn.

FURS

YOUR raw furs made up into beautiful garments. Catalog free. Arthur Felber Fur Co., 25 N. Dearborn St., Dept. P.M.3, Chicago, Ill.

FOOD PRODUCTS

PECANS: Texas New Crop, delivered you, five pounds and up, 55c pound. Nectar Nut Co., Granbury, Texas.

FOR SALE—New crop extra large paper shell pecans, any quantity, 75c lb., delivered. Edwards & Wilson Pecan Co., 302 Grand Bldg., Macon, Ga.

PATENT ATTORNEYS

BEFORE or after filing application for patent on your invention it will pay you to read over my "Inventor's Advisor No. 3," free for asking. M. Lahner, Registered Patent Attorney, 3 Park Row, New York.

PATENTS Procured and Trade-Marks Registered. Advice and terms upon request. Robb, Robb & Hill, 1348 Hanna Building, Cleveland, Ohio; 811 McLaughlin Bldg., Washington, D. C.

PATENTS—Before disclosing an invention, the inventor should write for our blank form "Record of Invention." This should be signed, witnessed and returned to us together with model or sketch and description of the invention and we will give our opinion as to its patentable nature free. Our Three Books mailed free to inventors. Our illustrated Guide Book, "How to Obtain a Patent," contains full instructions regarding Patents, Trademarks, Foreign Patents, Our Methods, Terms, and 100 Mechanical Movements illustrated and described. Articles on Patent Practice and Procedure and Law points for inventors. Our Trademark Book shows the value and necessity of trademark protection and gives information regarding unfair competition. We have direct agencies in all the principal foreign countries and secure foreign patents in the shortest possible time and at the lowest cost. Write for our illustrated guide book on Foreign Patents, sent free to any address. "List of Patent Buyers" sent free, containing unsolicited letters from manufacturers and others who are constantly writing us regarding the purchase or leasing of meritorious patents. We endeavor to assist our clients in the commercial development of their inventions. Owing to the growth of our business we have established for the benefit of our clients Branch Offices in New York City at 1607 Woolworth Bldg., Philadelphia at 714 Liberty Bldg., Pittsburgh, Pa., at 514 Empire Bldg., Chicago, Ill., at 1114 Tacoma Bldg., and San Francisco, Calif., at 1010 Hobart Bldg., Victor J. Evans & Co. Main Office, 181 Ninth, Washington, D. C.

PATENTS. Booklet free. Highest references. Best results. Promptness assured. Send model or drawing for preliminary examination. Watson E. Coleman, Patent Lawyer, 624 F Street, Washington, D. C.

"INVENTORS' Guide," free on request; gives very valuable information and advice. Write Frank Ledermann, 15-P Park Row, New York.

PATENTS—"How to Obtain a Patent" is the name of a book which every inventor should have. It will be sent free upon request, and will tell you what you want to know about patents. It contains the whole story. It describes the different parts of the application and explains in simple language the prosecution before the Patent Office. It tells about joint applications, reissues, agreements, assignments, licenses, interferences, infringements, process patents, design patents, trade-marks, and prints and labels. If you are interested in patents either as an inventor, manufacturer or owner of a patent you will enjoy reading this book which was written by a lawyer who has had twenty-five years' experience in patent matters. If you have an invention and will send us a sketch, model or photograph of it we will promptly make a search of the Patent Office records and advise you whether or not, in our opinion, your invention is patentable. Our charge for the service being \$5.00. We feel that our experience of twenty-five years has fitted us to render prompt and efficient service which will merit your confidence. Write today. Talbert & Talbert, 443 Talbert Building, Washington, D. C.

HERBERT JENNER, Patent Attorney and Mechanical Expert, 624 F St., Washington, D. C. I report if patent obtainable and exact cost. Send for circular.

PATENTS promptly procured. Personal, careful and efficient service. Highest references. Moderate fees. Send sketch for model or actual search and advice. George P. Kimmel, Master of Patent Law, 54 D. Loan and Trust Bldg., Washington, D. C.

PATENTS! Send sketch or model for search of pertinent U. S. patents and Report, including copies of patents nearest to your idea. These earlier patents may offer valuable suggestions for improving or perfecting your invention. No charge for preliminary information or advice. O'Connell & O'Connell, 314 Jenifer Bldg., Washington, D. C.

PATENTS Secured. Prompt service. Avoid dangerous delays. Send for our "Record of Invention" form and Free Book telling how to obtain a Patent. Send sketch or model for examination. Preliminary advice without charge. Highest references. Write today. J. L. Jackson & Co., 244 Ourray Bldg., Washington, D. C.

INVENTORS: Send sketch or model of invention for opinion concerning patentable nature and exact cost of patent. Book, "How to Obtain a Patent," sent free. Tells what every inventor should know. Established twenty-eight years. Highest references, prompt service, reasonable charges. Address Chandlee & Chandlee, 438 Seventh, Washington, D. C.

PATENTS Procured—Trade Marks Registered—A comprehensive, experienced, prompt service for the protection and development of your ideas. Preliminary advice gladly furnished without charge. Booklet of information and form for disclosing idea free on request. Richard B. Owen, 30 Owen Building, Washington, D. C., or 2276 R Woolworth Bldg., New York.

MILLIONS spent annually for ideas! Hundreds now wanted! Patent yours and profit! Write today for free books—tell how to protect yourself, how to invent, ideas wanted, how we help you sell, etc., 540 Patent Dept., American Industries, Inc., Washington, D. C.

PATENTS—Write today for Free Instruction book and Evidence of Conception blank. Send sketch or model for examination and opinion; strictly confidential. No delay in my offices; my reply special delivery. Reasonable terms. Personal attention. Clarence B. O'Brien, Registered Patent Lawyer, Southern Building, Washington, D. C.

PATENTS—Trademarks. Thirty-five years' experience. Send model or sketch for opinion as to patentability. Free "Inventors Guide." Highest references and personal attention assure best results. Franklin H. Hough, 522 Washington, Loan & Trust Bldg., Washington, D. C.

PATENTS—Prompt, personal, efficient service by an attorney-at-law skilled in all branches of Patent Practice. Over 18 years' actual experience; full information upon request. B. P. Fishburne, 331 McGill Bldg., Washington, D. C.

INVENTORS! Write to U. S. Patent Office for free copy of "Information Concerning Patents," then engage a competent Patent Lawyer to protect your ideas. Ralph Burch, Patent Lawyer, Jenifer Bldg., Washington.

PATENTS and Trade-marks obtained. Prompt service. Write for our new book on patents. Established in 1889. D. Swift & Co., 309 7th St., Washington, D. C.

PATENT application filed on partial payment plan. Trade-marks, copyrights, etc., Milo E. Stevens & Co., 635 F St., Washington. 352 Monadnock Bldg., Chicago. Estab. 1864.

INVENTORS—Send for form "Evidence of Conception" to be signed and witnessed. Form, fee schedule information free. Lancaster and Allwine, 221 Ouray Bldg., Washington, D. C.

INVENTIONS Patented; Trade-marks Registered; reasonable charges; prompt service; plain advice; request detailed information. Jaynes & Jaynes, 700 Kellogg, Wash., D. C.

MONROE MILLER, Ouray Building, Washington, D. C., patent attorney, mechanical and electrical expert. Best quality of work and results. Moderate charges.

BOOKLET, "Particulars": Sterling Buck, Near Patent Office, Washington, D. C.

FOR INVENTORS

INVENTORS and Manufacturers: Have your invention designed for commercial use; we make Drawings to Scale, Blue Prints, Models, Dies, Tools, Fixtures and Automatic Machinery for economical Manufacturing, Automatic Coin-Controlled Dispensing Machines, designed and constructed. John Frick, Mechanical Engineer, 1105 Arch St., Philadelphia, Pa.

PATENTS. Write for free illustrated guide book. Send model or sketch and description for free opinion of its patentable nature. Highest references. Prompt attention. Reasonable terms. Victor J. Evans & Co., 157 Ninth, Washington, D. C.

GET your own patents. Application blanks, complete instructions \$1. Cutting Boss, Campbell, Cal.

"INVENTOR'S Guide," free on request; gives very valuable information and advice. Write Frank Ledermann, 15-F Park Row, New York.

THE value of invention lays in the mechanics drawing. I make them. Address Fosco, New Richmond, Wis.

PATENTS—"How to Obtain a Patent" is the name of a book which every inventor should have. It will be sent free upon request, and will tell you what you want to know about patents. It contains the whole story. It describes the different parts of the application and explains in simple language the prosecution before the Patent Office. It tells about joint applications, reissues, agreements, assignments, licenses, interferences, infringements, process patents, design patents, trade-marks, and prints and labels. If you are interested in patents either as an inventor, manufacturer or owner of a patent you will enjoy reading this book which was written by a lawyer who has had twenty-five years' experience in patent matters. If you have an invention and will send us a sketch, model or photograph of it we will promptly make a search of the Patent Office records and advise you whether or not, in our opinion, your invention is patentable, our charge for the service being \$5.00. We feel that our experience of twenty-five years has fitted us to render prompt and efficient service which will merit your confidence. Write today. Talbert & Talbert, 464 Talbert Building, Washington, D. C.

PATENTS. If you have an invention which you wish to patent you can write fully and freely to Munn & Co. for advice in regard to the best way of obtaining protection. Please send sketches or a model of your invention and a description of the device, explaining its operation. All communications are strictly confidential. Our vast practice, extending over a period of seventy-seven years, enables us in many cases to advise in regard to patentability without expense to the client. Our Handbook on Patents is sent free on request. This explains our methods, terms, etc., in regard to Patents, Trade Marks, Foreign Patents, etc. "Scientific American" contains Patent Office Notes. Decisions of interest to inventors, and particulars of recently patented inventions. Munn & Co., Solicitors of Patents, 623 Woolworth Bldg., New York; Scientific American Bldg., Washington, D. C.; 801 A Tower Bldg., Chicago, Ill.; 611 Hanna Bldg., Cleveland, Ohio; Hobart Bldg., San Francisco, Calif.

HAVE you a Patent to sell? June 14th, 1922. Note: I have just sold at \$4500.00 the United States Patent covering an Aluminum House Number and Frame. Owned, invented and patented by Mr. W. H. Heisel of 522 So. Clinton Street, Syracuse, N. Y. This is The Hamilton Metal Products Company of Hamilton, Ohio. Charles A. Scott, "I Sell Patents," 773 Garson Ave., Rochester, N. Y.

PATENTS Secured. Prompt service. Avoid dangerous delays. Send for our "Record of Invention" form and Free Book telling how to obtain a Patent. Send sketch or model for examination. Preliminary advice without charge. Highest references. Write today. J. L. Jackson & Co., 242, Ouray Bldg., Washington, D. C.

HAVE You an Invention? If so, write for our free book. "How to Get Your Patent," tells our terms and methods. Send model or sketch for our opinion of its patentable nature. Randolph & Co., Dept. 144, Washington, D. C.

MANUFACTURERS and other addresses, every known line. Lowest rates. Capital Advertising Agency, Washington, D. C.

INVENTOR'S Educator. 900 Mechanical Movements. 50 Perpetual Motions. How to procure and sell patents. Mechanical Movements greatly assist inventors, suggest new ideas. Explains how to select an attorney and avoid Patent Sharks. Price \$1.50. Postage free. Fred G. Dieterich & Co., 621 Ouray Building, Washington, D. C.

WILL purchase Patents on Sheet Metal tools, Automobile accessories or Hardware specialties. F. V. Bogart, 715 Park Ave., Rockford, Ill.

MODEL Making and experimental work; Modern Shop; expert workmen. Manufacturing. Lamson Model and Experimental Works, 625 W. Jackson, Chicago.

PATENTS Procured—Trade Marks Registered. A comprehensive, experienced, prompt service for the protection and development of your ideas. Preliminary advice gladly furnished without charge. Booklet of information and form for disclosing idea free on request. Richard B. Owen, 30 Owen Bldg., Washington, D. C., or 2276 R Woolworth Bldg., New York, N. Y.

UNPATENTED Ideas can be sold. I tell you how and help you make the sale. Particulars free. Write W. T. Greene, 106 The Atlantic, Washington, D. C.

PATENTS—Write today for Free Instruction book and Evidence of Conception blank. Send sketch or model for examination and opinion, strictly confidential. No delay in my offices; my reply special delivery. Reasonable terms. Personal attention. Clarence B. O'Brien, Registered Patent Lawyer, Southern Bldg., Washington, D. C.

INVENTIONS developed, special machinery, tools, etc., designed, drawing and models furnished. S. W. Phelps, 514 Cedar St., Chattanooga, Tenn.

PATENTS FOR SALE

ROYALTY or cash. U. S. and Canadian patented Intermediate Auxiliary Transmission for Ford cars and trucks. Improvement patent applied for. Tested six months. Million dollar a year proposition for right party. Descriptive or detail shop prints sent to responsible parties. Address Jesse C. Snyder, Frostburg, Md.

BEVERAGE Dispenser—13616-1; Rotary Brush—12220-1; Car Journal Bearing & Lubricating Means Therefor—12220-2; Automobile Curtain Case—13872-1; Fountain Pen—13160-1. Talbert & Talbert, Talbert Bldg., Washington, D. C.

EUROPEAN process converting cheap, low-grade steel into best high-grade steel. Will sell or go in partnership. Write E. Seifert, 1126 163rd Street, Woodhaven, Long Island, N. Y.

WANT organized sales distributors for much needed article for Grocers. Big money made. Will sell patent for cash and royalty. Myers, 455 Lumber Ex. Bldg., Minneapolis, Minn.

FOR Sale—Patent for Comb-Cleaning device; \$1,000 cash or royalty terms. Write for further information to Louis Spak, Bryant, Wis., R. No. 2, Box 34.

WANTED to sell or develop patent No. 1,391,193. Automatic Gearshift Limit of simplicity. For further particulars address John Kirkeby, 1143 Sycamore St., San Luis Obispo, Calif.

HOOK and Eye—To be attached to garments like safety pins. Patented and for sale by M. D. Forrest, Melbourne, Fla.

FOR royalty only. I hold patent on end-loss clothes line. Address, James Miller, R. F. D. No. 3, Fort Edward, N. Y.

FOR Sale—Patent on a new improved screw-driver. Best offer takes. M. Flodin, 28 Havre St., E. Boston, Mass.

FOR Sale—Patent, Dustless Ash Sifter; can sieve ashes in house. R. Mason, 10 Cowen St., Saratoga Springs, N. Y.

FOR Sale—Patent No. 1,385,756, piston valve; outright or royalty. Robert Briggs, 2115 So. Law Ave., Wichita, Kans.

FOR Sale—Automatic antiseptic valve patent. H. Curtis, Colebrook, Conn.

FOR Sale outright or royalty. Automatic Auto Pump. Keeps tires properly inflated at all times. E. C. Hanson, 567 Elliott St., Buffalo, N. Y.

AUTOMOBILE Direction Flashing Signal can be seen from all directions. Just patented. Cash or royalty. L. D. Gaddis, General Delivery, Terre Haute, Ind.

CANADIAN Patent Rights for Sale—United States applied for. Distinctive Soot Range Cleaner. Address A. Cameron, 1219 Pandora, Victoria, B. C.

YOU have a worth-while patent, haven't you? Why don't you tell our two million readers about it? Most of them are specially interested in patents and new inventions. Ask me to tell you how other inventors successfully sold their patents. J. Roy McClellan, Manager, Classified Advertising, Popular Mechanics Magazine, Chicago, Ill.

FOR Sale—United States or Canadian Patent, "Dickens Anti-Window Battler," illustrated in October Popular Mechanics, page 543. B. F. Dickens, 1004 Standard Bank, Vancouver, British Columbia.

MILKING Machine. The Ford of its class. Outright or guarantee and royalty. Best offer gets it. Address Albert Close, 22 Netherwood Ave., Plainfield, N. J.

NATIONALLY Advertisd, extensively used metal desk instrument. Exceptional premium. Patent and dies for sale. Deskaid, 105 West 40th, New York.

MUST sell patent on new, pretty checker game. Sample on request. Michael Di Luchio, P. O. Box 187, Wilmington, Del.

KITCHEN necessity, doughnut cutter, ejects centers. Particulars from Alfred Johnson, 2155 Clarence Ave., Racine, Wis.

PLUMBING patents by old plumber of 30 years' experience. Inlet and Waste valves outside of tank. Washer replacements in 15 seconds, no tools necessary. Positively noiseless. A. P. Richardson, 246 South Sierra Vista Drive, Eagle Rock City, California.

LACEY Patent Sense. See page 142.

U. S. PATENT No. 1,267,694, and Canadian, No. 192,732, on metallic clothes-pin. Price \$50,000 for both. Arthur W. Balston, Huron, S. Dak., Box 510.

PRACTICAL Pinless Clothes Line, holds anything, manufactured cheaply. Sells outright. For details write Wm. F. Cushing, 932 Court Circle, Los Angeles, Calif.

PATENTS. My fees in installments. Advice book free. Frank Fuller, Washington, D. C.

BEST offer takes fine Patent, Reb. Allen, Ra, Pensacola, Fla.

PATENTS For Sale: To sell, buy or obtain patents write Patent News—P, Washington, D. C.

SURVEYING INSTRUMENTS

NEW and used surveying instruments direct from factory. Satisfaction guaranteed or money refunded. Wissler, 619 Broadway, St. Louis.

MODELS AND MODEL SUPPLIES

MODEL Steam Engines, Boilers, Boats, Model Ship and Naval Fittings, Model Makers' supplies. Send 20c for new, enlarged illustrated catalogue and handbook. Bathe Mfg. Co., Dept. D, 5214 Woodland Ave., Philadelphia, Pa.

MODELS, We have fully equipped model shop and carry full line of model supplies. Modern Machine & Pattern Co., Terre Haute, Ind.

INVENTORS—Write for our free illustrated guide book and Evidence of Conception Blank. Highest references. Prompt attention. Reasonable Terms. Victor J. Evans & Co., 165 Ninth, Washington, D. C.

MODELS and special machines built. Punch press work, tool and die making wanted. Raffel Model & Machine Works, 4532 Palmer St., Chicago, Ill.

PUNCH press and screw-machine work, tool and die making, model and special machine work wanted. Have doubled our manufacturing space and added machinery. Let our factory be your factory. Quality Hardware and Machine Co., Dept. A, 6150-56 N. Clark St., Chicago.

MODEL Making and experimental work; Modern Shop expert workmen. Manufacturing. Lamson Model and Experimental Works, 625 W. Jackson, Chicago.

WE make working models for inventors and do experimental work and carry a complete stock of brass gears and model supplies. Send for catalogue. The Pierce Model Works, Tinley Park, Ill.

MODEL ships and large model electric railways made to order by the Famous Good Bros., 42 N. El Molino, Pasadena, Calif.

PATENTS—Write today for Free instruction book and Evidence of Conception blank. Send sketch or model for examination and opinion; strictly confidential. No delay in my offices; my reply special delivery. Reasonable terms. Personal attention. Clarence B. O'Brien, Registered Patent Lawyer, Southern Bldg., Washington, D. C.

PRACTICAL model steam engines, boilers, blow-lamps, pumps, fittings. Send 10c in stamps for new catalogue. Model Machine Shop Co., 415-17 East 71st St., New York City.

FOR MANUFACTURERS

MANUFACTURERS! Do you want to manufacture on royalty basis an economically manufactured article that will save retailers about \$1.00 per 5 gallons of ice cream? It is a device for scraping ice-cream dippers; enables to serve uniform portions; saves time and money. Patent applied for. For particulars, write Wm. M. Malloy, Stony Point, N. Y.

WANTED—Connection with Factory to manufacture a quick-selling automobile accessory. Preferably royalty basis. Address Accessory, 502 S. Hull St., Montgomery, Ala.

WANTED—Metal Stamping and Model work taken on contract basis. We are ideally located and equipped to develop patents. Meyers Company, Box 263, Bedford, Ind.

MANUFACTURING

WE are equipped to manufacture all kinds of wire and light metal goods. Stampings, Dies and Tools. Punch press work. Patented articles wanted. Safety Wire Gas Globe Company, Columbus, Ohio.

LONG established manufacturer of auto accessories which are daily sold by practically all wholesale and retail accessory houses, will consider manufacturing and distributing new products capable of equally wide sale through same channels. Patented articles preferred. Address "Accessory Manufacturer," 1400 North American Building, Chicago, Ill.

SPRINGS Made to order. Spring wire of all kinds. Wright Bros. Spring and Wire Works, 5616 Huron St., Chicago, Ill.

PATTERNS, wood and metal. Models, tools and dies. Brass, bronze, aluminum and iron castings. Screw machine work, production work of all kinds. Write Modern Machine & Pattern Co., Terre Haute, Ind.

WIRE Goods, all kinds, made to order. Cooley Mfg. Co., 524-530 N. Western Ave., Chicago.

WE manufacture metal specialties of every description, including tools, dies, etc. Let us develop your patent or model for large and economical production. Send sketch or model for prices. Superior Tool Works, 12 South Clinton Street, Chicago, Ill.

GEARS, tools and metal specialties. Send for price list. Weldon Machine Works, 2940 Herndon St., Chicago.

IF you want dies and metal stampings, write us. Lyons Machine Works, Lyons, Ia.

WE specialize on Dies, Stamping, Light Manufacturing by E. W. Miner, 5 Alden ball St., Danville, Ill.

MANUFACTURER with sales force covering United States and Canada wants household or auto accessory invention on royalty or purchase basis. Peoples Mfg., 564 W. Randolph, Chicago.

FOR reasonable prices on models, dies, stampings, manufacturing and experimenting. Reinforced Switch & Mfg. Co., 409 E. North Ave., Pittsburgh, Pa.

SCREWS, nuts, screw machine products, all metals. Autosecrew Co., 355 West Broadway, New York City.

MACHINERY, TOOLS AND SUPPLIES

WANTED: Information about new air compressors. Write for free manual. Engineers Dept., Brunner Mfg. Co., Utica, N. Y.

DIES, Tool and General Manufacturing Model and manufacturing New Invention, our specialty. Logan Mach. Co., 222 S. Clinton St., Chicago, Ill.

THE Bulldog Drift Bolt Puller, patented May 27, 1919. An especially designed tool for withdrawing driftbolts, large spikes and rods from heavy wood timbers; to be operated with a common crowbar; goes between timbers; can be carried in the workman's pocket. Useful in bridge building, car repairing, wharf and dock work, logging chutes, etc. Price \$1.00 each or \$10.00 per dozen. Order direct from Electric Steel Foundry, Portland, Ore., Fred Engstrom, Mullian, Idaho.

LIGHT Power Transmission Machinery, Bearings, Hangers, Pulleys, Reducing Gears. Send for Catalog. Windfield H. Smith, Buffalo, N. Y.

TOOLMAKERS—Machinists, investigate the Miner Patented Spring Toolholder. Manufactured by E. W. Miner, 5 Alden St., Hartford, Conn.

ELECTRICAL

BLUEPRINTS, Electrical Connecting Diagrams. Particulars free. Samples 20c. Address Charles Chittenden, M3624 Matthews, Kansas City, Mo.

ELECTRICITY For 10c Per Hour. Metasco Auto Generator. Operates on any make automobile. Produces electricity for Moving Picture Machines, Theatres, Schools, Churches, Homes, Etc. Write for free particulars. Monarch Theatre Supply Co., Dept. AG 724 South Wabash Ave., Chicago.

ELECTRIC motors and supplies, including sockets, wire conduit, cleats, loom, rosettes, switches. New revised wholesale prices. Illustrated Catalog free. Hyro Electric Co., 633-GH, South Dearborn St., Chicago.

ARE You Old at Forty? See our advertisement on page 148 of this issue. The Electro Thermal Company, Steubenville, Ohio.

ELECTRICAL Experimenters—Here is the book you have been waiting for—"How to Make Things Electrical," 256 articles, 427 pages, 353 illustrations. Size 4 1/2 x 7, cloth binding. Price \$2.50 postpaid. Popular Mechanics Book Dept., 6 N. Michigan Ave., Chicago.

ENGINES, MOTORS AND DYNAMOS

ALTERNATING and direct current motor bargains. New and rebuilt. All guaranteed for one year. Special prices. Get our price list before buying. Motors exchanged and repaired. Hyro Electric Co., 633-RM South Dearborn St., Chicago.

SMALL Gasoline, Steam Engine, Dynamos, Motors, Storage Batteries, etc., new and secondhand. Bargain Bulletin 133 free. Dynamic Manufacturing Co., First National Bank Bldg., Chicago.

AUTOMOBILE Owners, garagemen, mechanics, send today for free copy of this month's issue. It contains helpful, instructive information on overhauling, ignition troubles, wiring, carburetors, storage batteries, etc. Over 120 pages illustrated. Send for free copy today. Automobile Digest, 507 Butler Bldg., Cincinnati.

FOR THE SHOP

WILCO Gas Torch—A hand torch of Bunsen type. No adjustments, nothing to wear out. Does work of expensive shop outfits. Indispensable in general shop work, experimenters, battery and radio work, or any work requiring intense blue flame. Usable wherever illuminating gas is available. Made of brass in 3 sizes—Large \$1.25, Medium \$1.00, Small 75c, including 6 feet rubber tubing. Set of 3 sizes \$2.50 postpaid. Money refunded if not thoroughly satisfied. Address: The Paramount National Supply Co., 611 Arlington Ave., Redwood City, Calif.

THE "Universal" Machine Shop Rule. Indispensable to mechanics, machinists, foremen, draftsmen, rule setters, etc. Price with instruction circular, \$1.50. Your money back if not satisfied. H. Pollakoff, 709 Sixth Avenue, New York City, N. Y.

JUST Published—Popular Mechanics Shop Notes for 1923—Vol. XIX. 544 articles, 436 illustrations, 224 pages. Price 50 cents, postpaid. Popular Mechanics Book Dept., 6 N. Michigan Ave., Chicago.

BLACKSMITHS

BLACKSMITHS. Listen: Any Handy man can make more money doing hard jobs easy. Forging and welding solid, with Toy's Modern Methods of Blacksmithing. Hardening and tempering to a standard with colored tempering charts. All for one dollar. Samples Free. W. M. Toy, Sidney, O.

FOR MECHANICS

PATENTS—Write for our free illustrated guide book and Evidence of Conception Blank. Send model for sketch and description of the invention for our opinion of its patentable nature free. Highest references. Prompt attention. Reasonable terms. Victor J. Evans & Co., 184 Ninth, Washington, D. C.

PATENTS—Write today for Free instruction book and Evidence of Conception blank. Send sketch or model for examination and opinion; strictly confidential. No delay in my office; by reply special delivery. Reasonable terms. Personal attention. Clarence B. O'Brien, Registered Patent Lawyer, Southern Bldg., Washington, D. C.

SHOP Notes Volume 17 contains 762 practical articles such as Half-ton Traveling Crane, Boring Machine, Toggle Press, Gas-Fired Forge, Oil-Gas Generator, Movable Table for Drill Press, etc., 224 pp. 496 Ills. 50 cents postpaid. Popular Mechanics Book Dept., 6 N. Michigan Ave., Chicago.

FOR SALE—MISCELLANEOUS

ADDRESSOGRAPHS. Letter Folders, Multigraphs, Envelope Sealers, Duplicators, less than half price. Guaranteed. Pruitt Co., 112-B N. La Salle, Chicago.

FOR Sale, new \$20 Mechanical drawing outfit, \$5.75. National Instrument Co., 4704 N. Hamilton, Chicago.

MOTOR Ice sled. Complete. 4 cylinder motor. 7 foot propeller. Bargain. C. A. Briar, Monona, Iowa.

TWO Dollar Mimeograph—Sent on approval. Primos Specialty Co., Primos, Pa.

GASOLINE Lamps and Lanterns. Catalog Free. Little Wonder Light Co., Terre Haute, Ind.

BUY—Exchange—Sell! Many of our readers have for sale or exchange the article you are looking for—and lots of them are looking for the very items you want to turn into cash. Get together! Let our two million readers know your wishes—they'll help you! Send your ad today to J. Roy McClellan, Manager Classified Advertising, Popular Mechanics Magazine, Chicago.

WANTED—MISCELLANEOUS

CASH for Gold, Platinum, Silver, Diamonds, Liberty Bonds, War Thrift, Unused Postage Stamps, False Teeth, Magneto Points, Jobs, any valuables. Mail in today. Cash sent, return mail. Goods returned in ten days if you're not satisfied. Ohio Smelting Co., 306 Hippodrome Bldg., Cleveland, Ohio.

MAIL us your discarded jewelry, Gold Crowns and Bridges, Watches, Diamonds, Silver, Platinum, War Savings Stamps and Old False Teeth. Money sent at once. Goods Ret. if offer is refused. United States Smelting Works, (Old Reliable) Dept. 71, Chicago.

DISPLAY advertisement, Page 148. Welch's Diamond Chip Company.

REAL ESTATE AND FARM LANDS

FREE Book of Florida Facts. Own your own orange grove in beautiful Fruitland Park. A few cents a day you now waste will buy it for you. A few dollars a month may provide you with a life income. Schnitzler sold his twenty acre grove here for \$40,000—two thousand an acre. He saw the same opportunity that's offered you and planted a grove. Result—he reaped a small fortune. You have the same chance but you must act now. Write today for Free Book of Actual Photographs, Florida Facts and the interesting story of a Fruitland Park Farm. Learn of crops that help you buy it. Address today, Lake County Land Owners' Association, 93 Sunset Way, Fruitland Park, Fla.

FARMS Wanted by cash buyers, spring delivery. Describe, state lowest price. R. A. McNown, 312 Wilkinson Bldg., Omaha, Neb.

FOR Sale—Three full sections in McKenzie County and two sections in Billings County, North Dakota. Each section contains land suitable for crops, balance for cattle. Each section has valuable deposits of lignite which some day will alone be worth many times the present value of the land. This part of the state is developing very rapidly, with good schools within easy access. As owner cannot use this land himself will sell one or more sections at a price which almost anyone can afford to pay. Address: W. care Popular Mechanics, 6 N. Michigan Ave., Chicago.

PROPERTY Owners—Get cash for your real estate, business or other property. To quickly sell, exchange or buy property any kind anywhere, write Western Security Co., 104, Hannibal, Mo.

SELL your property quickly for cash, no matter where located. Don't pay big commissions. Particulars free. Real Estate Salesmen Co., Desk B., Lincoln, Neb.

\$10 TO \$50 Down Starts you on 20, 40 or 80 acres, near hustling city in lower Michigan; balance long time. Learn how to get a farm home. Write for free illustrated booklet giving full information, Swigart Land Company, P-1259 First National Bank Building, Chicago.

\$5 DOWN, \$5 monthly; 10 acres unimproved poultry, fruit, stock, woodland; \$100; Ozarks. Fishing, hunting, trapping. Alfred Zimmerman, 1800 N. Fifth, Kansas City, Kansas.

ATTENTION! "Get Acquainted." Cash for your property. Farm, Hotel or Retail Store, no matter where located; confidential service. Hayes' Business Agency, Cincinnati, Ohio.

OKLAHOMA farms write for free agricultural booklet. Board of Commerce, Shawnee, Oklahoma.

DOGS, BIRDS, POULTRY, PETS

GREAT Dane Pups—For Danes that have size and intelligence write Collins Kennels, Box 169, Beedsburg, Wis.

LARGE Black Newfoundlands. The child's dog supreme. Estolized in poetry and story. Registered puppies from America's leading kennel; males \$49, females \$25 delivered. Sent C. O. D. to reliable parties. Bert Carmony, Shelbyville, Ind.

BREED Squabs. Book free. E. Rice, Melrose Highlands, 77 Massachusetts.

SILVERBLACK foxes, skunks, muskrats, Animal bait, traps, Booklet dime. Arthur Schumacher, Lockland, O.

FERRETS \$4.50, Imported Canaries \$5.00, Parrots, Pigeons, Puppies, Kittens. Breeders Exchange, Minneapolis, Minn.

AIREDALES and Wirehaired Fox Terriers. W. W. Lichty, Woodstock, Illinois.

THE American's Policies cover dogs against death from all causes including theft and disappearance. Agents Wanted. American Mutual Live Stock Insurance Company, Springfield, Illinois.

POULTRY

BABY Chicks, Eggs—Five Leading Varieties. Catalog describing 73-Acre Poultry Farm free. Goshen Poultry Farms, Route 29, Goshen, Ind.

SEEDS, PLANTS, TREES, ETC.

WANTED—Everyone interested in gardening to write for free copy of our beautiful Seed and Plant Guide. Our new specialties will interest you. H. W. Buckbee, Rockford Seed Farms, Dept. 901, Rockford, Ill.

PERSONAL

HOROSCOPE—Most modern and correct interpretations only. We send no circulars. Astrology advantageously used. Send 25c and birthdate. Receive constructive reading, tables of your important days, and other useful data. Individual service. Money returned if dissatisfied. Cosmologic Company, Dept. PM, Box 5, Fordham Station, New York City, N. Y.

YOUR Horoscope covering full year 50c. Includes extensive reading, valuable daily guide, large pictorial chart, and special forecasts for each month. Scientific, complete. Try it. Money back if dissatisfied. Give birthdate. Address H. Daniels, Flatbush Station, Box 32, Brooklyn, N. Y.

YOUR emotional nature is your dynamo. Is it working for or against you? Explanatory literature free. Address Robert Knox, Box 728, San Francisco, Calif.

ASTROLOGY. Dependable. Practical Service is what really counts. Send 25c. Birth date, general reading. Hamick, Box 578, Oakland, Calif.

FORMULAS: Alcohol Perfumery, Trade secrets, etc., 50c each. Expert chemist. No stamps. J. Lester, 467 St. Hubert, Montreal, Canada.

CHOOSE The Right Vocation. Free Self-Analysis Chart. Vocational Service Bureau, 20 E. Jackson, Chicago.

STUDY Your Type—Do More—Be More—Have More. Self-Revealing Chart and Personal Development Guide for 10c. Write Thomson-Heywood, Dept. 985, Chronicle Bldg., San Francisco, Cal.

FREE—Stop using tobacco. We will give free information how to conquer habit easily and permanently. Results guaranteed. Anti-Tobacco League, Box K, Omaha, Neb.

SOLVE Your Problems. Know your Personality. True Success Principles and Self-Revealing Chart for 10c. Thomson-Heywood, Dept. G, Chronicle Bldg., San Francisco, Calif.

ARE You Old at Forty? See our advertisement on page 148 of this issue. The Electro Thermal Company, Steubenville, Ohio.

TOBACCO Kills Manly Vigor. Quit easily. Cigarettes, chewing, smoking, snuff conquered or no charge. Small sum if satisfactory. Stops craving; harmless. Full treatment on trial. Perkins Co., 34-A, Hastings, Neb.

Additional Classified Ads Page 50



Big Jobs Ready

For men who will train as Building Experts

Not in years has there been such a boom in building as we see sweeping across the country today. Homes, factories, warehouses, office buildings, stores—all kinds of buildings—are being planned and constructed by thousands in every community.

This means an immediate and pressing need for men who can **plan, estimate and superintend** the work, and to such men greater opportunities are open for making money than the building business has ever offered before.

Are you a workman ambitious to become a foreman or a superintendent? Are you a foreman or superintendent who wants to start in the contracting business? Are you an apprentice looking forward to becoming one of the big men in your calling? Are you a small contractor who would like to take on big jobs? No matter where you are today, you can get into the big pay class if you get more knowledge of the higher branches of your trade. It is knowledge like this which has enabled the men ahead of you to reach paying positions or to make more money in businesses of their own. All you need is training to step ahead of the crowd and to earn an expert's income.

Train at Home in Spare Time Under the Chicago "Tech" Experts

The way to get an expert's training is to go to experts for it. Make their experience yours. That is the quick and sure way to advance. You will learn more in a month from them than you can learn in a year from picking up a fact here and a method there as you go along at your daily work.

You don't have to quit your job or take an hour from it to get the instruction given by the practical men at Chicago Technical College. They will teach you by mail. In your spare time you get the results of the experience which it has taken the best men in your trade years to gain. Step by step you are taken through the whole subject—every point made clear in **Plan Reading, Estimating, Construction, Superintendence**. You are trained to do the executive work in

building, which means the top-notch income.

No need to argue with any man who sees things as they are—no need to tell him that the big money goes, not to the man who handles the saw or trowel, who strings wires or wipes joints—it goes to the man who can plan, figure and direct the work—getting it out right and on time.

If you are ambitious to make the most out of any building trade, at least find out how the Chicago "Tech" way helps men like you to get ahead. Read our free book and blue print offer—and then act. Don't put off—get the coupon into the mail today.

FREE Book and Blueprints

Send coupon for our Free Book "How to Read Blue Prints." Just out. It contains a Trial Lesson in Plan Reading and with it we send blue prints, drawings, etc. Test yourself and see how quickly you can learn by our method. Other schools ask you to pay first; we send you this lesson first—it does not cost you one penny. Tell every man in the building lines about this great free offer.

Send the Coupon Get this free book and see how Chicago Tech. training will put you ahead. Just sign your name on the coupon and put "X" opposite course which interests you. Get ready now for bigger pay. Mail the coupon.



Learn Draftsmanship At Home



No experience necessary; no special school training required to take up Drafting. Learn to draw plans and get in the big salary class. Architectural, Structural Steel, Mechanical, Electrical and other industries are calling for trained draftsmen.

Drafting is at the foundation of all industry. Clean, pleasant, interesting and highly paid work. Easy to learn by the Chicago Tech. Plan.

Drawing Outfit Free We send you a complete drawing outfit—Instruments, T-Square, Drawing Board, etc., if you enroll as a student in Drafting.

Free Trial Lesson Mark "X" in the coupon opposite "Drafting" and get this Free Trial Lesson and instructive matter showing the splendid opportunities for you as a Chicago Tech. trained draftsman.

SEND THE COUPON TODAY

Chicago Technical College

130 Chicago Tech. Bldg., Chicago, Ill.

Without cost or obligation on me, please send instructive information on subject marked below.

- Builders' Course**
Plan Reading, Estimating, Superintending, etc.
- Drafting**
Mechanical, Electrical, Architectural, etc.
- Surveying**
and Topographic Drafting.
- Plan Reading of Machinery**
for Shop Men, Machinists, etc.
- Aeronautical Engineering**
Aeroplane Construction and Design.
- Automobile Course**
Gas Engines, Ignition, Starting, Lighting, etc.

Name.....

Address.....

City.....State.....

Continued from Page 48

LIFE revelation with large pictorial chart showing talents, suitable occupation, life partner, etc. Send 10c. birthdate to St. Germain Society, Sharpsburg, Pa.

TOBACCO or Snuff Habit cured or no pay. \$1.00 if cured. Remedy sent on trial. Superba Co., TP., Baltimore, Md.

TOBACCO Destroys Vital Power. Ni-Ko makes quitting pleasure. Ni-Ko System, Wichita, Kan.

MISCELLANEOUS

STARTING a Company? Save expenses and taxes by organizing on the popular, Common Law plan under a pure Declaration of Trust. No experience required to fill in Demaree Standard Forms. Issue shares and begin doing business at once. Genuine Demaree Forms are nationally known, approved by attorneys and utilized by successful concerns throughout the United States. Send for large, free pamphlet (C-53) containing valuable information that you may need. C. S. Demaree, legal blank publisher, 708 Walnut, Kansas City, Mo.

WHERE buy any manufactured article, book, or service. Guaranteed addresses 5c each; minimum 10c. Address General Information, Ann Arbor, Mich.

CUTS anybody can make. Simple, cheap process, \$1. Specimens, particulars, 2c stamp. M. Day, Windfall, Ind.

ARIZONA Incorporation completed day papers are filed, without nominal or par value shares. Least cost. Greatest advantages. Operate anywhere. Forms Free. Stoddard Incorporating Company, 8-R, Phoenix, Ariz.

ENGRAVE all metals with "Metal Engraving Fluid X" easy as write. Bottle 50 cts. Money order. J. Redondo, Box 799, Schenectady, N. Y.

WATERPROOF and harden your new concrete work. Martinek Paint Company, 112 Humphrey Street, Corona, N. Y.

CUTS anybody can make. Simple, cheap process, \$1. Specimens, particulars, 2c stamp. M. Day, Windfall, Ind.

MUSIC rubber stamps, stencils, burning brands, photo type, rubber type catalogue 25c. School chart outfits. Sign marker catalogue 25c. W. Karstaedt, Dayton, Ohio.

INCORPORATE your company in Colorado. Low cost. No stockholders' liability. Do business anywhere. Nothing need be paid in. Stock may be issued for patents and services. Booklet free. Continental Corporations Co., 509 Engineers Bldg., Denver, Colorado.

INFORMATION: Positively any question answered. 10c each. Satisfaction guaranteed. Address General Information, Ann Arbor, Mich.

CHRISTMAS is coming! Importer by extra fortunate purchase offers genuine Japanese indestructible pearl necklaces at greatly reduced prices. 18 inch and 24 inch graduated small pearls, rich and lustrous, \$19.50; standard size, \$12.50. "Opera length" (70 inches) "De Luxe" necklaces, composed of large, perfectly matched, richly colored pearls, \$30.00—cannot be duplicated for twice this price. All in handsome gift boxes, sent by insured parcel post immediately on receipt of your order. Send draft, certified, or cashier's check, postoffice or express money order—other remittances not accepted. Order now while supply is good and prices low. Address J. Bennett, 1060 Lawrence Ave., Chicago.

5 MASTER Keys. Work like magic in emergencies or prove whether your home is burglar-proof. Test and open thousands of locks. Send \$1 today. Novel key chain free. Master Key Co., 3M Manhattan Block, Milwaukee, Wis.

ART Metal Workers—You will find our book "Metal Work and Etching" a complete manual on making book ends, desk sets, pad corners, paper knives, letter openers, stationery racks, rocking blotters, desk calendars, arts and crafts jewelry, etc., 96 pp. illus. Price 50 cents postpaid. Popular Mechanics Book Dept., 6 N. Michigan Ave., Chicago.

DO you want quick money? Then send us anything of value, including furs, fur coats, diamonds, jewelry—anything worth while. Highest prices paid immediately. Complete satisfaction guaranteed or goods returned. Try us. Markowitz Company, 407 Chamber of Commerce, Los Angeles, California.

BE Business-like. No. 6 envelopes typed with your address. 35c per 100. Also guides and souvenir booklets of scenic places for sale. Inquire Luther Reed, Orwigburg, Pa.

STOP! that repair bill—lower your cost of operation and be familiar with your auto by having in your vest pocket for emergency reference a copy of a new, compact little book entitled "Causes and Remedies for Ills and Ails of an Automobile." Price \$1 postpaid. Popular Mechanics Book Dept., 6 N. Michigan Ave., Chicago.

MAKE big money opening safes and setting combinations, Wayne Strong, Box 1430, Los Angeles, Cal.

PUBLISH your own Magazine. Sample and instructions for quarter. LeBeuf, Fairview Station, Detroit, Mich.

ARE You Old at Forty? See our advertisement on page 148 of this issue. The Electro Thermal Company, Steubenville, Ohio.

GET posted for Spring—Good prices paid for butterflies, insects. See Sinclair display advertisement, page 16.

I Want 235 Salesmen

Who Want to Earn at Least \$5000 a Year



B. M. OLIVER

KNOWING that this magazine is read by the progressive type of salesmen I take this means to "tell the world" that I want to get in touch with some live-wire salesmen. I am not looking for supermen—just fellows who have confidence in themselves—and particularly the fellow who wants to make real money, say about \$5,000 a year or more.

I want to show you the way to big money. Many of my sales representatives are averaging \$500 a month; others exceed that amount. Right on my desk here I've got a letter from F. W. Bentley of Philadelphia telling how he made \$215 in one day—and one from A. M. Russell of Hartford, Conn., who made \$660 in one month. I have scores of other similar letters in my files—from R. Berger of Ontario, who makes \$250 a week, from J. Carnegay of South Dakota telling how he is making \$1,000 a month; from W. Drew of Michigan who makes \$85 a day. There is no reason under the sun why you should not make a minimum of \$100 a week right from the start.

Oliver Oil-Gas Burner & Machine Co.,
2048-M Oliver Bldg., St. Louis, Mo.

Please send me full facts about how I can make big money representing you in my territory. Also your plan, if I wish to make big money in my spare time.

Name

Address

City State

I want you to be the representative of the famous OLIVER OIL-GAS BURNER—an invention that instantly turns any stove or furnace into an oil-gas stove, making an even oil-gas fire in any stove or furnace at the turn of a valve, with three times the heat of coal and wood and none of the bother or dirt.

Every Home Wants This New Invention

The Oliver Oil-Gas Burner does away with coal and wood. Banishes all worry about strikes, scarcity and high prices. Turns any range, furnace or stove into an oil-gas stove. 16 different models. Burns 5% kerosene (coal oil) and 95% air. Think of the appeal you can make in every community! Cheaper than coal, wood or gas—absolutely safe.

Does away with drudgery—no fires to make, no ashes, dirt, smoke, chopping, carrying coal and wood. Easy to install. Doesn't change stove. Protects health from exposure and uneven heat. Easy to demonstrate—slips in or out of stove in one minute. Show any woman what it will do right in her own home and the sale is made. Big demand all year—does away with that housewife's dreaded hot summer kitchen.

Write Me At Once

Now, if you are ambitious and really want to connect with a live proposition then just mail coupon today and I will promptly forward you full details with absolute proof that you can make a minimum of \$5,000 a year as an Oliver Salesman. Address:

B. M. Oliver, President.

OLIVER OIL-GAS BURNER & MACHINE CO.

Oldest and Largest Manufacturers
of Oil-Gas Burners in the World.

2048-M Oliver Bldg.

St. Louis, Mo.

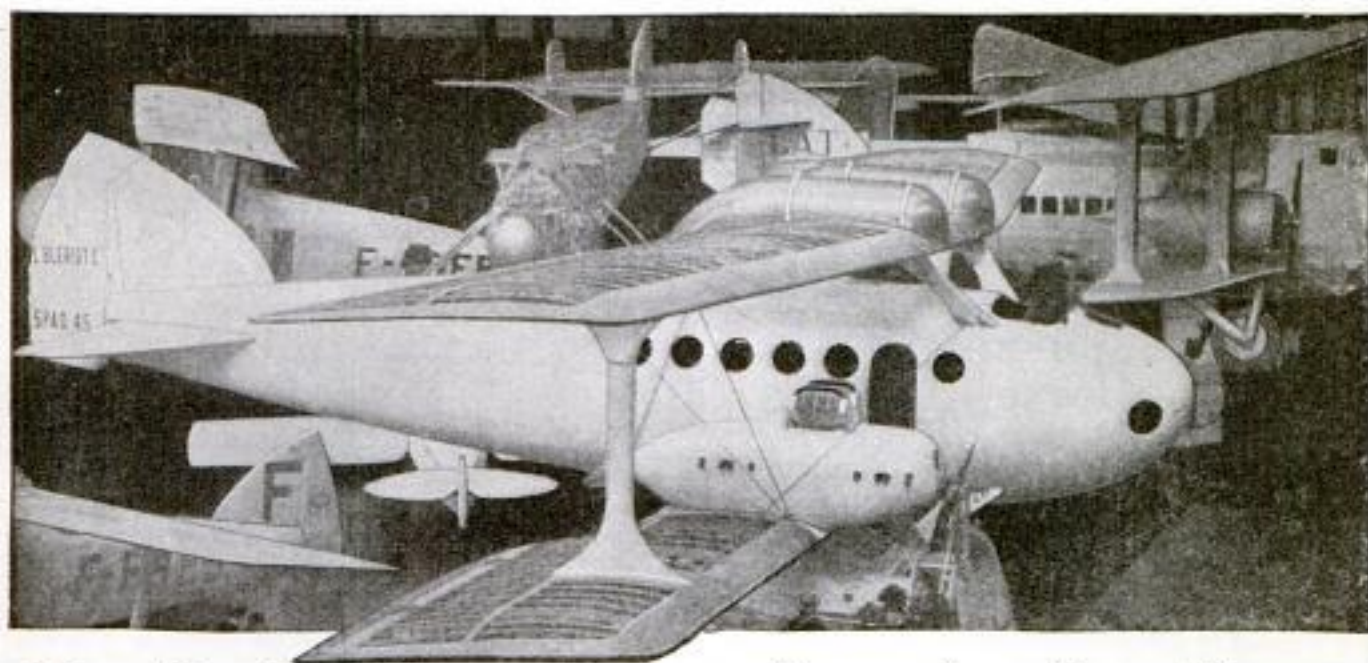

Quick Success in Aviation Fascinating—Daring—Big Paying

To young men of daring, no other field of work offers such a fascination, such high pay, nor such opportunities for quick success as the field of Aviation. As yet, aviation is practically in its infancy. NOW is the time to get in.

Amazing Opportunities in Airplane Industries

In the automobile industry and in the moving picture business hundreds of men got rich by getting in at the start. They made their success before others woke up. Today, these lines offer no greater opportunities than a hundred and one others. BUT AVIATION IS NEW. Get in while the opportunity and pay are big. All over the country there is a clamor for trained men. It is not a question of pay but of getting capable men.

Here Are Real Positions, \$50 to \$150 Per Week

Aeronautical Instructor, Aeronautical Engineer, Aeronautical Contractor, Airplane Repairman, Airplane Mechanician, Airplane Inspector, Airplane Salesman, Airplane Assembler, Airplane Builder.



View in an Airplane Factory

A Sure and Easy Way to Learn Aviation—at Home



A New Job—The Aerial Postman

The study of aviation is almost as fascinating as the actual work. Every lesson is full of interest. That is why it is easy to learn aviation. You do not have to make yourself study—it is like reading an in-

teresting book that tells you things you have always wanted to know. Only one hour each evening will give you the basic training in a surprisingly short time. You need only a common school education.

One of my students, James Powers, Pa., says, "I am indeed surprised that such a valuable Course can be had from such practical men for so little cost."



A New Seven-Passenger Airplane

Personal Instruction by Experienced Men

Men who have had actual experience give you personal attention. They select the lessons, lectures, blueprints and bulletins. They tell you things that are essential in everyday practice. Each lesson is easy to read and understand.

BIG BOOK FREE of Opportunities

Send coupon below for New Book, just out, "Opportunities in the Airplane Industry." It is interesting and instructive. It will show you many things you never knew before about aviation. Due to shortage of paper we could get only a limited supply of these books—send the coupon before they are all gone.

AMERICAN SCHOOL OF AVIATION
3601 Michigan Ave., Dept. 1191, Chicago, Ill.

AMERICAN SCHOOL OF AVIATION
3601 Michigan Ave., Dept. 1191, Chicago, Ill.

Without any obligation, send me your Free Book, "Opportunities in the Airplane Industry," also information about your Course in Practical Aeronautics.

Name.....

Street.....

City..... State.....

The AUTOMOBILE BUSINESS is THE Business to Get Into

Twelve Million
Automobiles
Need Service

Twelve Million Cars, sixty million tires, millions of batteries and electrical systems to over-haul, repair and replace to keep in running order. Get that picture well fixed in your mind, then you can begin to appreciate WHY the AUTOMOBILE Business is THE Business to get into.

Think of the opportunities in the repair and re-sale end of the business alone! There are only about 50,000 garages and service stations in the United States. Thousands of additional garages, thousands of battery repair shops, tire shops and welding shops, are needed to help care for these millions of cars.

Try to picture in your mind what TWELVE MILLION AUTOMOBILES mean—a line that would reach one and one-third times around the

world! Think what that means as a business opportunity!! Can you think of a better field for ambitious, wide-awake men who have been specially trained for that kind of work?

Remember, this branch of the business continues regardless of whether or not the factories turn out another car. These millions of cars must have service the whole year 'round—a fact which means much for the success of M. S. A. S. Trained Men.

Earn \$2,000 to \$10,000 Yearly



Both the manufacture and up-keep repair of all these machines require skilled men—trained men—men who KNOW! The automobile industry employs millions of men, and additional men are needed all the time. Factories, garages and service stations are continually asking us for M. S. A. S. Trained Men who can fill responsible jobs with good pay. The M. S. A. S. Trained Man doesn't have to worry—and wonder. He KNOWS—and that means SUCCESS!

What We Teach—and Why

The Automobile Industry must have Trained Men. The average mechanic or "handy man" won't do. Automobiles are too expensive to let an untrained man experiment with them. Even though sturdily built, an automobile engine is a delicate piece of machinery. They must be accurately adjusted in every particular—pistons, connecting rods, crank shaft, valves, timing gears, etc. Then the starting, lighting and ignition system, and the power transmission through gears, etc. All these points and many others, must be thoroughly understood to successfully solve the many problems connected with automobile construction and operation.

Our Course covers every one of these subjects completely. When you have finished our Course you will be able to handle any problem connected with the construction, upkeep, repair and operation of autos, trucks, tractors, gas engines and farm lighting plants. That is why M. S. A. S. Graduates are always in demand. They are thoroughly trained—they KNOW!

Read What the Manufacturers Say

These letters written by Factory Executives speak for themselves. The M. S. A. S. is the only factory endorsed school. Many of the manufacturers helped us outline our Courses because they appreciated the work we were doing and were glad to co-operate with us. Do you think it pays to get the benefit of experience such as these men offer? It certainly does!

Auto Industry—the Automobile Center of the World. Practically 79% of the automobiles are made in the Detroit district. This is a big advantage for M. S. A. S. Students. They get the benefit of hearty co-operation from the big factories. They meet the factory executives and service men; they learn factory methods first handed; they listen to lectures and talks by factory men; they learn about cars in a manner impossible away from the factories. That is why M. S. A. S. Trained Men are in demand with big factories and service stations.



Michigan State
301 Auto Bldg. Detroit, Mich.

Endorsed by Big Factories Read These Letters



Detroit, Mich., U.S.A.

Do not believe you would make any mistake in attending this school if you wish to become thoroughly experienced in the automobile business.

HUDSON MOTOR CAR COMPANY

DETROIT, MICH., U. S. A.

This school is thought very highly of by the automobile men of Detroit. You will make no mistake by entering for a course.



BUICK MOTOR COMPANY

We believe the Michigan State Auto School located at Detroit would best meet your requirements, as its course in technical training is most thorough and complete in every detail.

THE STUDEBAKER CORPORATION OF AMERICA

We do not know a better automobile school that we could recommend to you than the Michigan State.

Learn in Detroit— It's a Big Advantage

When you think of automobiles you think of Detroit, the Auto Center, and it is only natural to think of the M. S. A. S. in the Auto Center when you think of Automobile training. This is the Heart of the

This Man Made \$8,000. Last Year



in a little
shop of
his own

If you are one of those fellows who wonders if there are any opportunities left, read what this man Epps has to say in his letter quoted on this page. And when you read it, remember this one fact: Epps was not an exceptional fellow, neither has his experience been exceptional. He is just an average man—only one of thousands of M. S. A. S. Graduates who have "Made Good" because they were THOROUGHLY TRAINED!

The real secret of Epps' success was that he wanted to "get somewhere" and had the gumption to START! He knew that all the good jobs were not held by the "white collar" boys and he started out to prove it. His letter tells a pretty complete story—and we have lots more like it in our files—wonderful letters which tell how boys from 17 to 65 have been helped upward and onward toward Success by M. S. A. S. Training.



Endorsed by Graduates

Read Mr. Epps' Letter

SQUARE DEAL GARAGE
E. H. EPPS & SON
VARNA, ONTARIO

FORD SERVICE STATION

M. S. A. S.,
Detroit, Michigan.

Dear Friends:

Just a line to let you know how I am getting along since I graduated in 1917 and started in business. Last year our net profits ran about \$8,000 on used cars, repairing, and tire repairing. I have one of the largest Tire Repair depots in Western Ontario. I returned to the M. S. A. S. for advanced electricity, battery, and radiator work, all of which I am now adding to my business.

Speaking of recommendations, last summer I had a party stop at the garage and ask for Mr. Epps. When I went to see him he told me that a friend of his in Denver, Colo., had told him if he was in Western Ontario to be sure and go to Epps' Square Deal Garage to get his work done.

Wishing you all success,

Your graduate,

LORNE K. EPPS.

The Kind of Men Who Make Good

A lot of folks get the idea that a man must be a "natural mechanic" to make good in the automobile business. Maybe he does have to "like machinery" but he doesn't need to be a mechanic. One of the best graduates we ever turned out was a \$13.50 per week "pencil pusher" who hardly knew what a wheel base was. We changed him into a \$42.50 per week automobile electrician, and he is still climbing.

Another man quit an office job to take our Course—and pushed himself into a \$10,000 per year garage business. Another came here as a High School graduate at 17, and about a year after finishing our Course was making nearly \$5,000 per year in a business of his own. Another real fellow who through hard luck was unable to support his family, borrowed the money to take our Course, and today has a successful business in Minnesota.

All these fellows had Gumption—they had Ambition—they wanted to Get Somewhere!—and they were willing to do the necessary plugging to get there. Mere wishing won't do it—neither will waiting. You must get Action! If you are willing to do that, Our Course will help you Get There!



A. G. Zeller
Pres.

Good Positions
Await Our
Graduates

Factories, garages and service stations continually call for M. S. A. S. trained men. These positions pay good salaries and offer excellent opportunity for advancement or to build a business of your own. There are more opportunities for trained men in Detroit and elsewhere than we can fill. Let the M. S. A. S. fit you for the wonderful future of the Automobile business.—A. G. Zeller, Pres.

Read This Guarantee

We guarantee that a graduate of our Automobile and Tractor Course will be qualified to fill a position as assembler, demonstrator, tester, repair man, auto electrician, chauffeur, tractor operator or farm lighting expert, or we will refund his tuition fee.



This Is Your Opportunity

Don't say you never had a chance. A Big One faces you right now! Get Busy! Don't wait for some one to push you along. Send for our free literature. Learn what other fellows have done, then show the World what YOU can do. Be a Winner. Get Started! Fill out and mail the Coupon NOW—TO-DAY!

SEND THIS COUPON TODAY!

Michigan State Automobile School
301 Auto Bldg., Detroit, Mich.

Gentlemen: Send me your FREE Catalog telling all about the opportunities in the Auto Business.

Name.....

Street or R. F. D.....

City..... State.....

Automobile School
3729 Woodward Ave. Detroit, Mich.



"I'm as Good a Man as Jim!"

"They made him manager today, at a fine increase in salary. He's the fourth man in the office to be promoted since January. And all were picked for the same reason—they had studied in spare time with the International Correspondence Schools and learned to do some one thing better than the rest of us.

"I've thought it all out, Grace. I'm as good a man as any one of them. All I need is special training—and I'm going to get it. If the I. C. S. can raise other men's salaries it can raise mine. If it can bring a better home with more comforts to Jim and his family it can do it for us. See this coupon? It means my start toward a better job and I'm going to mail it to Scranton tonight!"

Thousands of men now know the joy of happy, prosperous homes because they let the International Correspondence Schools prepare them in spare hours for bigger work and better pay. You will find them in offices, shops, stores, mills, mines, factories, on railroads—everywhere.

Why don't you study some one thing and get ready for a real job, at a salary that will give your wife and children the things you would like them to have?

You can do it! Pick the position you want in the work you like best and the I. C. S. will prepare you for it right in your own home, in your spare time—you need not lose a day or a dollar from your present occupation.

Yes, you can do it! More than two million have done it in the last thirty years. More than 150,000 are doing it right now. Join them without another day's delay. Mark and mail this coupon!

----- TEAR OUT HERE -----

INTERNATIONAL CORRESPONDENCE SCHOOLS
Box 9110-C, Scranton, Penna.

Without cost or obligation, please tell me how I can qualify for the position or in the subject before which I have marked an X:

BUSINESS TRAINING DEPARTMENT

- | | |
|---|---|
| <input type="checkbox"/> Business Management | <input type="checkbox"/> Salesmanship |
| <input type="checkbox"/> Industrial Management | <input type="checkbox"/> Advertising |
| <input type="checkbox"/> Personnel Organization | <input type="checkbox"/> Better Letters |
| <input type="checkbox"/> Traffic Management | <input type="checkbox"/> Foreign Trade |
| <input type="checkbox"/> Business Law | <input type="checkbox"/> Stenography and Typing |
| <input type="checkbox"/> Banking and Banking Law | <input type="checkbox"/> Business English |
| <input type="checkbox"/> Accountancy (including C.P.A.) | <input type="checkbox"/> Civil Service |
| <input type="checkbox"/> Nicholson Cost Accounting | <input type="checkbox"/> Railway Mail Clerk |
| <input type="checkbox"/> Bookkeeping | <input type="checkbox"/> Common School Subjects |
| <input type="checkbox"/> Private Secretary | <input type="checkbox"/> High School Subjects |
| <input type="checkbox"/> Business Spanish | <input type="checkbox"/> Illustrating |
| <input type="checkbox"/> French | <input type="checkbox"/> Cartooning |

TECHNICAL AND INDUSTRIAL DEPARTMENT

- | | |
|---|--|
| <input type="checkbox"/> Electrical Engineering | <input type="checkbox"/> Architect |
| <input type="checkbox"/> Electric Lighting | <input type="checkbox"/> Blue Print Reading |
| <input type="checkbox"/> Mechanical Engineer | <input type="checkbox"/> Contractor and Builder |
| <input type="checkbox"/> Mechanical Draftsman | <input type="checkbox"/> Architectural Draftsman |
| <input type="checkbox"/> Machine Shop Practice | <input type="checkbox"/> Concrete Builder |
| <input type="checkbox"/> Railroad Positions | <input type="checkbox"/> Structural Engineer |
| <input type="checkbox"/> Gas Engine Operating | <input type="checkbox"/> Plumbing and Heating |
| <input type="checkbox"/> Civil Engineer | <input type="checkbox"/> Chemistry |
| <input type="checkbox"/> Surveying and Mapping | <input type="checkbox"/> Automobile Work |
| <input type="checkbox"/> Metallurgy | <input type="checkbox"/> Navigation |
| <input type="checkbox"/> Steam Engineering | <input type="checkbox"/> Agriculture and Poultry |
| <input type="checkbox"/> Radio | <input type="checkbox"/> Mathematics |
| <input type="checkbox"/> Airplane Engines | |

Name.....
Street.....
Address.....

City..... State.....

Occupation.....

Persons residing in Canada should send this coupon to the International Correspondence Schools Canadian, Limited, Montreal, Canada.

Please Mention Popular Mechanics



MUSICAL INSTRUCTION BOOKS

These books are illustrated and gotten up to make the method of self-teaching so simple that any one without any knowledge of music could learn to play any of the following:

| | |
|---------------------------|-----|
| ACCORDEON MADE EASY | 25c |
| BANJO MADE EASY | 25c |
| GUITAR MADE EASY | 25c |
| MANDOLIN MADE EASY | 25c |
| PIANO MADE EASY | 25c |
| UKULELE MADE EASY | 25c |
| VIOLIN MADE EASY | 25c |

The above prices are postpaid. Any 5 titles \$1.00, postpaid.
J. C. DORN, 725 So. Dearborn Street, Dept. 17, Chicago

ARTIST'S OUTFIT FREE

Write quick for our remarkable offer. Learn NOW at home, in spare time, by our new instruction method. Commercial Art, Cartooning, Illustrating, Designing. Delightful fascinating work in big demand. \$50.00 paid for one drawing. Handsome book free expires everliving.

SEND FOR IT TODAY

WASHINGTON SCHOOL OF ART, Inc.
1955 Marden Bldg. Washington, D. C.

STAMMERERS

For 55 years we have successfully corrected stammering by our simple and natural course of individual lessons. Attend no school until you have read our free booklet, "How To Stop Stammering."

SAMUEL A. ROBBINS, Director,
Boston Stammerers' Institute
246 Huntington Ave. Boston 17, Mass.

Electrical Course

In Book Form

Here is the quickest, easiest, cheapest way to learn electricity. Think of it! A complete electrical course in book form. No tiresome lessons with a lot of mathematics. Just plain everyday electrical facts—the very things and the only things you need know to hold down a good paying job. Written and simplified by 27 of the biggest men in the electrical field. 8 big books—4100 pages and 3300 pictures.

Electricity Means Success

—Good Pay and a Good Job. You can succeed in electricity. It's one of the best paying fields open to young men who know.

You do not have to give up your present position, just a few pleasant hours spent in the evenings on this subject, and success is yours.

FREE TRIAL!
Just mail the coupon—don't send a cent. We send books for a week's free use. Look them over yourself, and see how thoroughly and completely everything about electricity is explained in them.

American Technical Society
58th St. & Drexel Ave. Dept. E-191

American Technical Society, Dept. E-191, Chicago

Send me your 8 volume set of Electrical Books for a week's free use. I will either return the books in 7 days or remit \$2.80 and pay you \$5.90 each month until a total of \$28.80 is paid.

Name.....

Address.....

Employed by.....

Copy this coupon on larger sheet if more convenient

Learn to Mount Specimens like These

Write for
**FREE
Taxidermy
Book!**

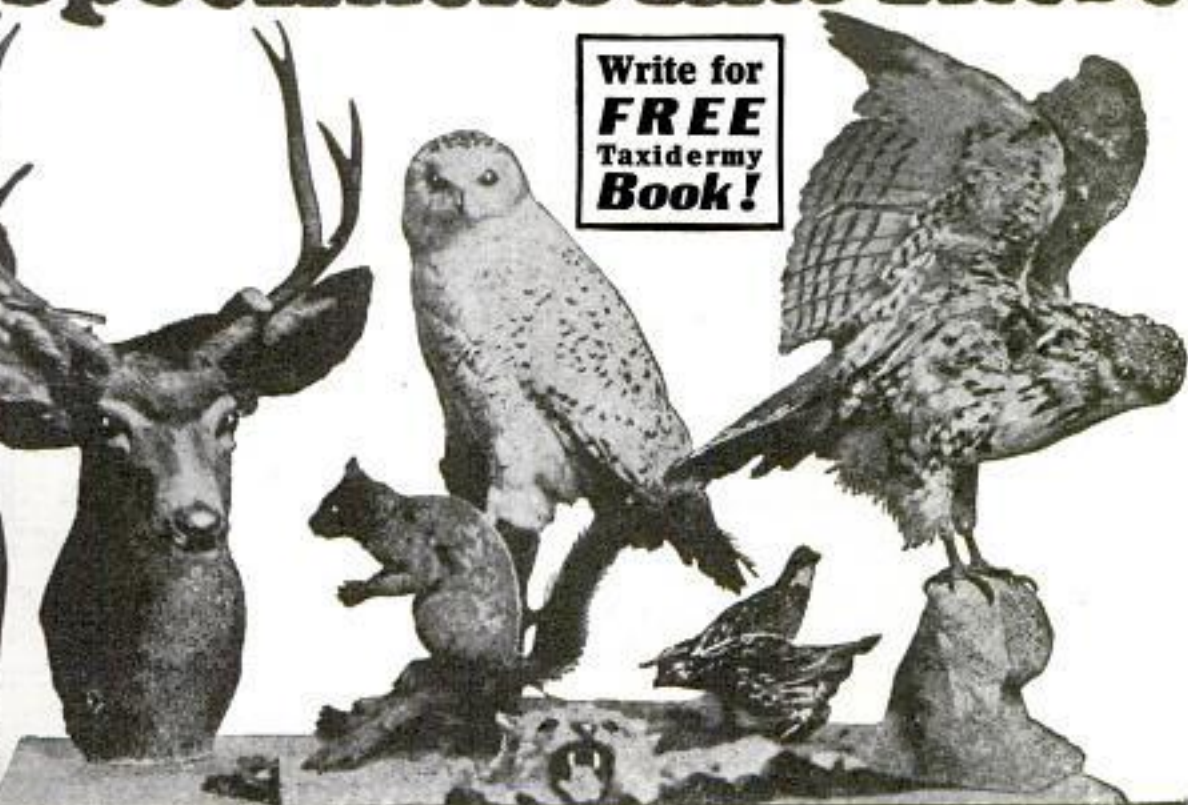

Mount Birds, Animals and Fish *Be a Taxidermist. Learn by Mail*

You can now learn quickly, easily and thoroughly right in your own home by mail. Mount all kinds of game—birds, animals, game heads, fish, also taxskins and furs and make fine robes and rugs. Our wonderful course of 40 lessons teaches you all about taxidermy. The most interesting art you ever studied or can study. Here is the opportunity you have long wanted. Write for free book today. Men, women and boys—all love this wonderful art and all learn quickly. Of untold value to hunters and trappers. Business men, farmers and clerks, all take our lessons and are completely fascinated with this beautiful and easily learned art. If you do nothing else today, send for the free book and investigate.

Make Big Money!

Sell your mounted specimens (if you wish). Big demand and big prices. Mount for your sportsmen friends. The news soon travels that you are a taxidermist and the work pours in. Our students earn big extra money in spare time for guns, traps, books, radio, vacations, etc. One writes "have made over \$500.00 from taxidermy, in spare time, since I joined the school". The most profitable "side line" business in the world.

Learn Field Taxidermy Sportsmen and fishermen, you must know "field taxidermy" to properly care for specimens when you take them, if they are to be correctly mounted later. This is of great importance to all who take hunting and fishing trips. Completely taught in our lessons.

Be a Taxidermy Artist

We now reveal all secrets of taxidermy. We teach latest methods. You become a true artist. You can decorate your home, office or den with nature's finest art—actual game specimens, preserved exactly like life—not mere pictures, but the beautiful game itself. You can become a true taxidermy artist, using spare time only.

NORTHWESTERN SCHOOL OF TAXIDERMISTRY
1771 Elwood Bldg. Omaha, Neb.

Sportsmen—Fishermen

If you do not save your finest trophies you miss and lose more than half the pleasure and all the profit. Save your hard-earned elk, deer, wild cat, grouse, duck, bass or trout. All real sportsmen now insist on knowing taxidermy. We can teach you. Our school teaches taxidermy—nothing else. 20 years in business. 75000 graduates in every civilized country. Now is the time to start.

Write for FREE Book

Our beautifully illustrated Taxidermy Book tells you how to learn the art. Send the coupon at once and receive copy by return mail extremely interesting, and shows dozens of photos of mounted game specimens.

FREE This book is absolutely free. No obligation on your part whatever. If you hunt, fish or trap, you need this book. You cannot imagine how interesting and valuable it will be to you, so send right now. Don't delay or you may forget it. Clip the coupon this minute.

Free Book Coupon

Northwestern School of Taxidermy
1771 Elwood Bldg., Omaha, Neb.
Send me absolutely free your illustrated book, "How to Learn Taxidermy." No obligation.

Name

Address



NAVIGATION



**Taught
in Your
Home
or on
Board
Ship**

**Salaries to \$315.00
Per Month and Expenses**

Sail the Seven Seas as a ship's officer. See the world and get an education which can be secured in no other way. Earn more money than you can on land.

Join America's Mighty Merchant Fleet

America's great, modern passenger and freight vessels now sail to all parts of the world—India, Africa, Asia, China, Japan, Europe, South America, Australia, New Zealand, etc.

Course Adopted by U. S. Navy Education System

The U. S. Navy officials, in search for the simplest, most thorough, best course, on Navigation for the use of enlisted men, have officially adopted the Sheppard Course on Ocean and Coast Navigation. It is the only course of its kind in the world. It enables you to completely master the most fascinating subject in existence in six months or less, during your spare time.

First Lesson Free

First lesson of 52 pages and 36-page illustrated prospectus will be sent free without obligation, upon receipt of coupon below.

Lose no time. You can begin actual training in navigation upon receipt of this free lesson.

"Shove Off"—Join America's Mighty Merchant Fleet—Return This Free Coupon Today

**WORLD TECHNICAL INSTITUTE,
Fuller Building, Jersey City, N. J.**

Send by return mail free booklet, entitled, "Your Future Is on the Seven Seas," which gives every particular about Captain Warren Sheppard's Course on Ocean and Coast Navigation, also Lesson No. 1 of the Course.

Signature

Address

Present Position

PM 1-23



Think of it! \$175 paid to F. L. Bennett, Amsterdam, N. Y., for one mechanical drawing.

Any young man can easily duplicate Bennett's success by practicing at home like he did. You, too, can become an expert draftsman if you are ambitious.

A new, simple method of drafting puts the big jobs within your reach. Master Draftsman Bitting will show you how. You begin to DRAW at once. No long and tedious study. Bitting has made draftsmen in 100 hours.

**Drawing Outfit
FREE!**

To those who act at once we offer a complete drawing outfit FREE. This is a special offer to beginners who want a well paid profession—not merely an ordinary job!

Blue Print Reading There's big money in blue print reading, and you can perfect yourself in this important and profitable work without learning to draw.

Costs Nothing to Find Out

Write today for our free offer on professional draftsman's outfit. Find out how you, too, can get \$175 for a single drawing or become a blue print expert. Send for FREE book "Language of the Engineer." Address,

**Master Draftsman Bitting
Dept. 232, 15th and Wallace Sts., Philadelphia, Pa.**



\$30 to \$60 a Week

for spare time work alone. Professional drummers are in demand everywhere and make big money. You can quickly and easily learn to play band, orchestra and dance music through my home study course of 20 interesting lessons. Write for particulars of easy payment plan.

**The Herman H. Rinne Correspondence
School of Modern Drumming
3154 Park Ave. Indianapolis**



BECOME A RAILWAY MAIL CLERK

Examinations soon. \$1600 to \$2300 a year.
No strikes or lockouts. Common education

sufficient. No "pull" necessary. Mail coupon for catalog.

**Patterson Civil Service School
Dept. 81, Rochester, N. Y.**

Sirs:—Send me without charge your Catalog, describing this and other fine U. S. Government positions.

Name

Address

Repair Any Auto OR Auto Truck

Examine These NEW/AUTO BOOKS FREE

Be an expert auto repair man. You can have the skill that makes every complicated trouble as easy to fix as taking out a spark plug. Learn every detail of all makes of cars and trucks. Know exactly how to find what's wrong and how to make all repairs quickly. These great new Auto Books show you how.

Make Money Repairing Autos

Over 9 million cars are in operation and thousands of men are needed to keep them in good going condition. There are more jobs open than there are good men to fill them. Never before have expert auto repair men been in such great demand and made so much money. Now is your great money-earning opportunity in the auto repair business. Every mechanic, every chauffeur, every car owner needs this great New Library of Automobile Engineering.

Tells About

Explosion Motors, Welding, Motor Construction and Repair, Carburetors and Settings, Valves, Cooling, Lubrication, Fly-Wheels, Clutch Transmission, Final Drive, Steering Frames, Tires, Vulcanizing, Ignition, Starting and Lighting Systems, Shop Kinks, Public Garage Design, Equipment and Operation, Electrics, Storage Batteries—Care and Repair, Steam Cars, Motorcycles, Commercial Trucks, Glossary, More than 100 blue prints Wir'g Diagrams.

75c a Week If You Decide to Buy

Let us send you the complete six-volume set of Automobile Engineering for one week's examination. Read the simple directions for repairing every automobile trouble. Six thick volumes 5½ x 8¾ inches, flexibly bound and stamped in gold, 2,650 pages, 2,100 illustrations, wiring diagrams, etc. Everything in plain, every-day language simple to understand. If you decide to keep them, send only \$2.80 in seven days, and \$3 a month thereafter until the special introductory price of \$21.80 has been paid. The regular price is \$45.00, so you save \$23.20 by acting at once.

Send No Money

Don't send a penny! Your name and address in the coupon brings the six books to you at once for seven days' trial.

Mail Coupon NOW

American Technical Society

Dept. A-191 Chicago, U. S. A.



Starting and
Lighting



Welding



Transmission

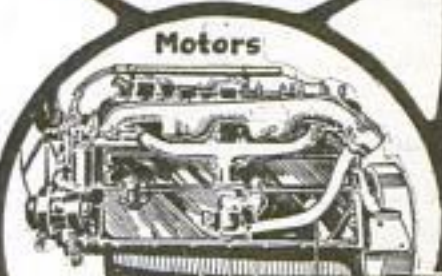

Motors

AMERICAN TECHNICAL SOCIETY

Dept. A-191, Chicago, U. S. A.

Please send me the six-volume set of Automobile Engineering for seven days' examination, shipping charges collect. If I decide to buy, I will send \$2.80 within seven days and balance at \$3.00 a month until \$21.80 has been paid. Then you will send me a receipt showing that the set of books are mine and fully paid for. If I think I can get along without the books, I will return them, after 7 days, at your expense.

Name.....

Address.....

Employed by.....

\$1,000 REWARD

Was offered for the capture of the person who stole bonds and jewelry from the De-Wade country estate. And it looked as though the \$1,000 would go begging until a finger print expert started work on the case. In less than five hours he located a clue in the shape of a finger print, identified the criminal and made the capture.

Be a Finger Print Expert Learn at Home in Your Spare Time

Reap the big rewards that fall to trained men in this fascinating profession. With the development of the science of finger-prints and its fast increasing use in banks, large industries, hospitals and government institutions, the demand for experts is rapidly growing. Mastery of this profession will open up a brilliant career to you.

POSITIONS GUARANTEED

We absolutely guarantee positions in connection with finger print bureaus to our graduates.

Secret Service Course FREE

A valuable course in Secret Service Intelligence is given, FREE of charge, to students of our course. This information in itself is worth more than the cost of the complete course.

With our course of study you are given a complete set of working tools, FREE of charge. Detailed instructions accompany them so that you can easily become expert in their use.

WRITE FOR FREE REPORTS

telling about the uses of finger prints in business and for purposes of identification. Find out how you can become a finger print expert in a very short time at home. Special limited offer. Write NOW while it lasts.

U. S. SCHOOL OF FINGER PRINTS

Room 1351 7003 No. Clark St. Chicago, Illinois

Please send me FREE Reports on Finger Print and Secret Service Investigation work with full information about your course of study.

Name

Address

Age..... Occupation.....

Please Mention Popular Mechanics

BE AN ARTIST

We can teach you **DRAWING** in your own home during your spare time.

Our 18 years of successful teaching prove our ability. 10 Courses in Commercial and Illustrative Drawing. Teachers Normal and Applied Art. Endorsed by high art authorities. Students trained by members of our Faculty are filling high-salaried positions. Artist's Outfit FREE to Enrolled Students. Write today for Art Year Book.

OUR HANDSOME ART YEAR BOOK "FREE" to you!

SCHOOL OF APPLIED ART

ADDED ART BLDG. NO. 2 BATTLE CREEK MICH.

"Forging Ahead in Business"

This 116-page book which we will send you tells of the wonderful help which the Modern Business Course and Service is to 200,000 business men; tells how it helps; tells who are back of this great institution, who are enrolled, and what they say about it.

Send for this book today

ALEXANDER HAMILTON INSTITUTE
679 Astor Place, New York



MUSIC LESSONS FREE

IN YOUR OWN HOME

You can read Music like this quickly

Piano, Organ, Violin, Mandolin, Guitar, Banjo, etc. Beginners or advanced players. One lesson weekly. Illustrations make everything plain. Only expense about 2c per day to cover cost of postage and music used. Write for FREE booklet which contains everything in full.

AMERICAN SCHOOL OF MUSIC, 51 Lakeside Building, CHICAGO

FREE "Linene" COLLAR

For trial, a sample of our style Rubens; if you send 2 cents in U. S. stamps for postage and state size wanted

Reversible Collar Co., Dept. U Boston, Mass.

MEN WANTED

Prepare as Firemen, Brakemen, Electric Motormen, and colored Train Porters. Hundreds put to work—\$150 to \$200 a month. No experience necessary. 500 more wanted. Enclose stamp for application blank. Name position you want.

L RAILWAY C. I. Dept. 40 INDIANAPOLIS, IND.

TELEGRAPHY

(Morse and Wireless) and RAILWAY ACCOUNTING taught thoroughly. Big salaries; great opportunities. Oldest, largest school. Endorsed by Telegraph, Railway, Radio, and Government officials. Expenses or—opportunities to earn large portions. Catalog free.

DODGE'S INSTITUTE, Dyke Street, Valparaiso, Ind.

Clear-Tone FOR PIMPLES

Your skin can be quickly cleared of Pimples, Blackheads, Acne Eruptions on the face or body, Enlarged Pores, Oily or Shiny Skin. \$1,000.00 Gold Cash says I can clear your skin of the above blemishes. WRITE TODAY for my FREE Booklet—"A Clear-Tone Skin"—telling how I cured myself after being afflicted for fifteen years.

FREE

E.S.GIVENS, 121 Chemical Bldg., Kansas City, Mo.

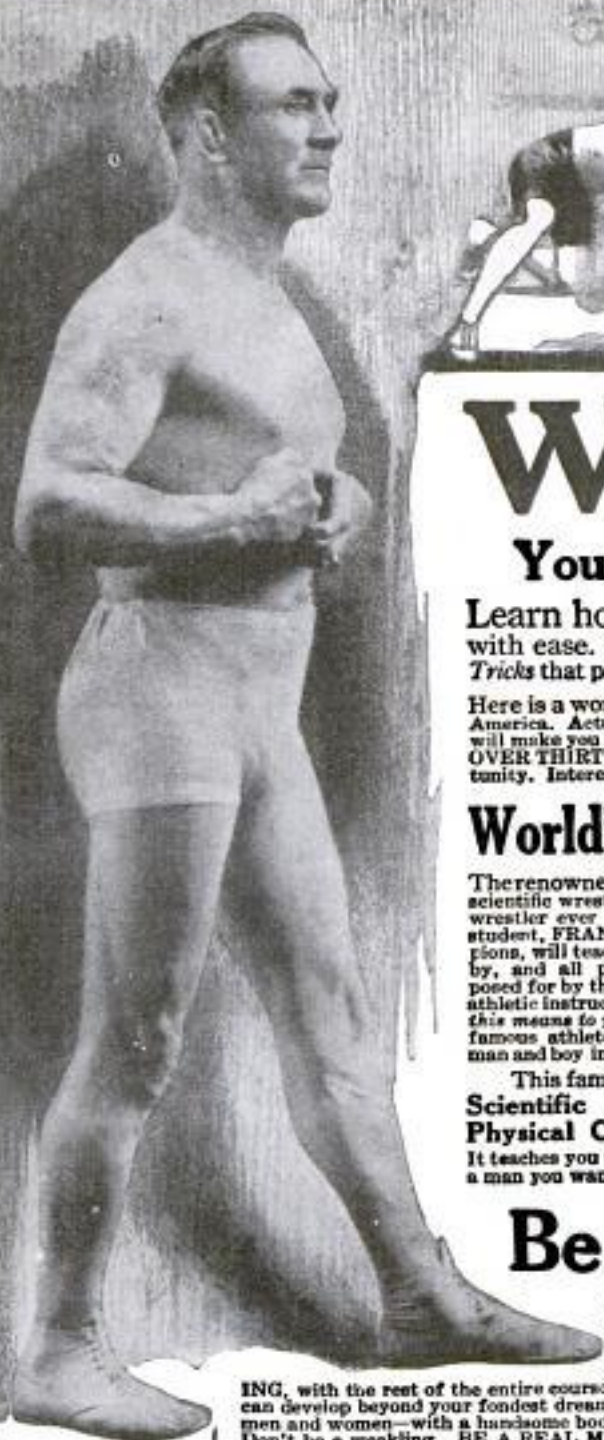

Wrestling

You Can Now Learn at Home

Learn how to throw and handle large strong men with ease. Learn the marvelous *Holds, Blocks, Breaks and Tricks* that positively enable you *To Win* against mere size and strength.

Here is a wonderful opportunity long waited for by the men and boys of America. Actual *World's Champions* now offer you the secret inside training that will make you an **EXPERT**. The fame of this school has swept the entire continent. **OVER THIRTY THOUSAND STUDENTS NOW ENROLLED.** Grasp this opportunity. Interest yourself **NOW** and write today for our amazing **FREE BOOK**.

World's Champions Will Teach You

The renowned "Farmer Burns," father of scientific wrestling and the greatest scientific wrestler ever known, and his world-known student, **FRANK GOTCH**, champion of champions, will teach you. Every lesson written by, and all photos illustrating the lessons posed for by these two greatest wrestlers and athletic instructors of all time. Think of what this means to you. To be a student of these famous athletes has been the dream of every man and boy interested in sports.

This famous course teaches you **Scientific Wrestling, Jiu Jitsu, Physical Culture, Self-Defense**. It teaches you to become exactly the kind of a man you want to be.

Free Book

Send no money. Merely ask for the **FREE BOOK**. It will prove of great value to you. It tells all about scientific wrestling, and how to become a magnificent man and athlete. Farmer Burns wants every **AMBITIOUS** man and boy to have a copy. **GET YOURS TODAY.**

Be a Great Athlete

The wrestling lessons are marvelous. You quickly learn to handle, throw and control men and boys much bigger and stronger than yourself. Think of the satisfaction, the fun, the value of being a **REAL EXPERT**. The lessons in self defense enable you to protect yourself and others under all conditions. The **PHYSICAL TRAINING**, with the rest of the entire course develops you into a fine strong, healthy, competent athlete. You can develop beyond your fondest dreams. You can have a body and personality that make you a leader of men and women—with a handsome body, vibrant with strength and energy that all will admire and envy. Don't be a weakling. **BE A REAL MAN.**

WIN all games and physical contests. It will open to you the road to success in everything you undertake. You **OWE** it to yourself to **INVESTIGATE**. May we send the **FREE BOOK**? Ask today.

Farmer Burns

The world's greatest wrestler and athletic instructor. His school is a real sensation. His students are tremendously enthusiastic and secure results beyond their fondest dreams. You can become the student of this famous man and of the peerless **FRANK GOTCH**. If you are a man or boy with red blood, and ambitious to become a **real man** and to **SUCCEED**, then by all means do not lay this magazine aside until you have written the school for full particulars.

WIN

A weak, undeveloped body means failure. A splendid athletic physique spells **SUCCESS IN EVERYTHING**. You can win in games, in contests, in business, in social affairs if you have the wonderful personality and popularity that an upright handsome athletic body brings to you. If you are already strong we can still help you immensely. If you are a weakling **THIS IS YOUR REAL OPPORTUNITY.**

Write Today!

Get our new **FREE BOOK**, brimful of interest and fascination. It tells you how to learn right in your own home in spare time to be a **SKILLED EXPERT WRESTLER**, wonderful at self defense, and how to **WIN** all games and physical contests. It will open to you the road to success in everything you undertake. You **OWE** it to yourself to **INVESTIGATE**. May we send the **FREE BOOK**? Ask today.

Farmer Burns School
1771 Railway Exchange, Omaha, Neb.

FREE Book Coupon

FARMER BURNS SCHOOL
1771 Railway Exchange, Omaha, Neb.

Please send at once without obligation on my part, your **FREE BOOK** on Scientific Wrestling, Physical Culture, Self-Defense and How to Win.

Name.....

Address.....

Age.....

PLAY MUSIC ON A SAW

FREE

A special tempered Musical Saw, Saw Bow, Soft Hammer are furnished free with Course of Instruction. This Course is short, simple and easy. Only three lessons, one each week—no monotonous finger exercises or months of tedious practice.

C. J. MUSSEHL

332 Mack Bldg. Fort Atkinson, Wis.

YOU can produce wonderful, soft, sweet music from a common carpenter's saw with a violin bow or soft hammer, if you know how. No musical ability required—you need not know one note from another.

Easy to Learn I absolutely guarantee to teach you to play popular and classical music within 3 weeks' time. I will give you my secrets and tricks that I have learned in my ten years' success as a saw musician, secrets which I guarded carefully until I introduced "The Musical Saw." I have successfully instructed thousands and have organized hundreds of "Sawing Trios & Quartettes" for Lodges, Clubs and Legion Posts. No charge whatsoever if I fail. **MAKE BIG MONEY** and amaze your friends playing for dances, Club, Lodge and Church Entertainments. Write today for complete information "How to Play a Saw"—sent free.



NO MORE BALD HEADS



WHEN our VACUUM CAP is used a few minutes daily. We accept no pay until you have tried the Cap 60 days and are satisfied. The Vacuum Cap is an appliance that draws the blood to the Hair Roots and starts a new healthy crop of hair. It stops Dandruff, stops the hair from falling out.

Bought by Doctors and men who know that it is the only reasonable HAIR GROWER known to science. No Drugs Used. Write for application blank, testimonials, and booklet on "HAIR," sent sealed in plain envelope. FREE.

THE MODERN VACUUM CAP CO.

F 559 BARCLAY, DENVER, COLO.

Don't Wear a Truss



MR. C. E. BROOKS

BE COMFORTABLE—Wear the Brooks Appliance, the modern scientific invention which gives rupture sufferers immediate relief. It has no obnoxious springs or pads. Automatic Air Cushions bind and draw together the broken parts. No salves or plasters. Durable. Cheap. Sent on trial to prove its worth. Never on sale in stores as every Appliance is made to order, the proper size and shape of Air Cushion depending on the nature of each case. Beware of imitations. Look for trade-mark bearing portrait and signature of C. E. Brooks which appears on every Appliance. None other genuine. Full information and booklet sent free in plain, sealed envelope.

BROOKS APPLIANCE CO.,

126-H State St., Marshall, Mich.

Complete

High School at Home

New, easy method teaches you complete High School Course in spare time. Prepares you for college, C. P. A., and the professions. Makes for more pay and a better job. Experienced

Industrial Correspondence University,

Dept. 231,

15th and Wallace Sts., Philadelphia, Pa.

teachers guarantee success. Send for FREE booklet. Costs nothing to find out. A letter may be worth hundreds of dollars to you. Write us today.

A BETTER JOB NOW!

Learn good trade in a few weeks. 10 million autos, trucks and tractors need service. Repairmen needed. FREE 188 page catalog gives full particulars. Write today Michigan State Automobile School, 21 Auto Bldg., Detroit, Mich.

MINSTRELS

Musical Comedies and Revues, with full instructions for staging. You can stage your own show with our books. Full line of plays, music, cross-fire, monologues, afterpieces, vaudeville acts and make-up. CATALOGUE FREE. T. S. DENISON & CO., 623 So. Wabash, Dept. 19, Chicago



WANTED! Get \$1600 to \$2300 a Year

U.S. RAILWAY
MAIL
CLERKS

MEN--BOYS OVER 16 SHOULD MAIL COUPON IMMEDIATELY

Franklin Institute, Dept. L178, Rochester, N. Y.

Sirs: Send me, without charge, (1) sample Railway Mail Clerk Examination questions; (2) schedules showing places of coming U. S. Government examinations; (3) list of many Government jobs obtainable.

**STEADY WORK NO LAYOFFS
PAID VACATIONS**

Common Education Sufficient
Send Coupon Today—SURE

Name.....
Address.....

Learn an Auto Trade

**Big
Pay
Jobs
Open**
in
California



Auto Experts Needed Everywhere

California Offers Greatest Opportunities. Learn Right at National Automotive—Los Angeles—Many Unusual Advantages—No Extra Cost

RIGHT now is the greatest opportunity in years for you to get into the fastest money-making business in the world today. Auto industry is making fortunes for thousands. Men are rich who were penniless five years ago. Big concrete garages stand today where small repair shops started some man to success. Get into auto business now. Auto experts are needed and needed badly. Garage owners want men who KNOW AUTOS. Men who have trained at National Automotive.

A Million Autos in California No Winter Weather to Stop Business

Sooner or later you will want to come to sunny California—to Los Angeles—why not now? Words cannot tell you of this wonderful country where the ocean, the mountains, the city and the country are closely connected by miles and miles of wonderful paved highways; where sunshine warms the winter winds and ocean breezes cool the summer sun. And it's new—big opportunities for everyone, for YOU.

No Age Limit—No Education Required

YOU can become an auto mechanic, electrician, ignition expert, garage foreman, salesman-demonstrator, or used car appraiser after a few short weeks' training at National Automotive. No previous education necessary; no age limit. YOU CAN FILL A BIG PAY JOB.

A New and Finer National Assures Success

Tremendous demand for National trained experts made necessary—a bigger, finer and greater National Automotive. Many new and wonderful advantages for you. Thousands and

thousands of dollars worth of modern equipment. Practical shop practice trains you right. Actual construction work on all types of motors—Packards, Cadillacs, Fords, etc. Ignition, battery and lathe work; driving, vulcanizing and salesmanship. Special advanced electrical course FREE. Expert mechanic instructors to train you. You KNOW autos when you finish NATIONAL training. NOW, 30-day 19th anniversary reduced tuition offer. Mail coupon for full information.

Like college life at new National Automotive—right across the street from 130-acre Exposition Park. Ball grounds, gymnasium, swimming pool, world's largest stadium, amusements, everything FREE to you. Right in the heart of a big city—Los Angeles. **No other city in America like Los Angeles; no other school like NATIONAL.**

Earn Room and Board

Jobs guaranteed to earn your room and board while learning. Think of it. You can become a big-pay auto expert at practically no expense, except small tuition cost; no extras; no tools to buy, no books used. Unlimited FREE employment service.

And then your reward—big pay, steady work, a good job for life. Hurry! Get into the auto business at once.

Send for FREE Auto Book

Mail coupon for big free illustrated auto book. Explains everything. 72 pages of auto facts. Scores of photo illustrations of auto construction. Tells why any man of any age can learn at NATIONAL. How National Special Employment Service finds your job for YOU. Send for this wonderful FREE book today—now. Read about Paul Briggs, 6th & Madison St., Portland, Ore., who is making \$4000 a year in auto work. How National has placed hundreds of men just like you in big pay jobs. There's a job at big-pay waiting for YOU NOW. Mail coupon at once. Hurry

NATIONAL AUTOMOTIVE SCHOOL
Dept. 25 Los Angeles, Cal.

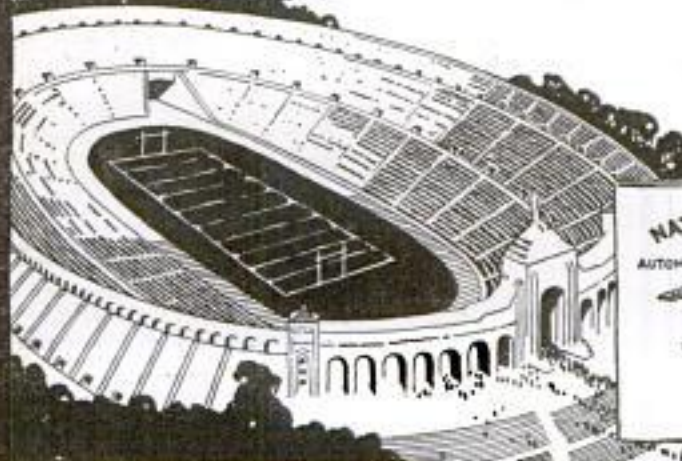

NATIONAL
AUTOMOTIVE SCHOOL



Mail the Coupon for **Free Auto Book**

NATIONAL AUTOMOTIVE SCHOOL,
Dept. 25, 511 S. Figueroa St.,
Los Angeles, Cal.

Please send me your 72-page illustrated auto book, absolutely FREE.

Name

Street No.

City State



"\$60 More a Month!"

LAST night I came home with great news—a \$60 increase in salary! I took the money out of my pocket and asked Mary to count it. You should have seen her face light up when she found the extra \$60. I think she was even happier than I was, for it was the third increase in a year.

"Today I am manager of my department—earning more money than I ever thought it would be possible for me to make. I owe it all to the training I received from the International Correspondence Schools. That little coupon was the means of changing my whole life."

HOW much longer are you going to wait before taking the step that is bound to bring you more money? Isn't it better to start now than to wait for years and then realize what the delay has cost you?

One hour after supper each night spent with the I. C. S. in your own home will prepare you for the position you want in the work you like best.

Don't let another priceless hour go to waste! Without cost or obligation, let us prove that we can help you. Mark and mail this coupon.

----- TEAR OUT HERE -----
INTERNATIONAL CORRESPONDENCE SCHOOLS
Box 5694-C, Scranton, Penna.

Without cost or obligation, please tell me how I can qualify for the position or in the subject before which I have marked an X:

BUSINESS TRAINING DEPARTMENT

- | | |
|---|---|
| <input type="checkbox"/> Business Management | <input type="checkbox"/> Salesmanship |
| <input type="checkbox"/> Industrial Management | <input type="checkbox"/> Advertising |
| <input type="checkbox"/> Personnel Organization | <input type="checkbox"/> Better Letters |
| <input type="checkbox"/> Traffic Management | <input type="checkbox"/> Foreign Trade |
| <input type="checkbox"/> Business Law | <input type="checkbox"/> Stenography and Typing |
| <input type="checkbox"/> Banking and Banking Law | <input type="checkbox"/> Business English |
| <input type="checkbox"/> Accountancy (including C.P.A.) | <input type="checkbox"/> Civil Service |
| <input type="checkbox"/> Nicholson Cost Accounting | <input type="checkbox"/> Railway Mail Clerk |
| <input type="checkbox"/> Bookkeeping | <input type="checkbox"/> Common School Subjects |
| <input type="checkbox"/> Private Secretary | <input type="checkbox"/> High School Subjects |
| <input type="checkbox"/> Business Spanish <input type="checkbox"/> French | <input type="checkbox"/> Illustrating <input type="checkbox"/> Cartooning |

TECHNICAL AND INDUSTRIAL DEPARTMENT

- | | |
|--|--|
| <input type="checkbox"/> Electrical Engineering | <input type="checkbox"/> Architect |
| <input type="checkbox"/> Electric Lighting | <input type="checkbox"/> Blue Print Reading |
| <input type="checkbox"/> Mechanical Engineer | <input type="checkbox"/> Contractor and Builder |
| <input type="checkbox"/> Mechanical Draftsman | <input type="checkbox"/> Architectural Draftsman |
| <input type="checkbox"/> Machine Shop Practice | <input type="checkbox"/> Concrete Builder |
| <input type="checkbox"/> Railroad Positions | <input type="checkbox"/> Structural Engineer |
| <input type="checkbox"/> Gas Engine Operating | <input type="checkbox"/> Plumbing and Heating |
| <input type="checkbox"/> Civil Engineer | <input type="checkbox"/> Chemistry <input type="checkbox"/> Pharmacy |
| <input type="checkbox"/> Surveying and Mapping | <input type="checkbox"/> Automobile Work |
| <input type="checkbox"/> Metallurgy | <input type="checkbox"/> Navigation |
| <input type="checkbox"/> Steam Engineering | <input type="checkbox"/> Agriculture and Poultry |
| <input type="checkbox"/> Radio <input type="checkbox"/> Airplane Engines | <input type="checkbox"/> Mathematics |

Name.....
Street.....
Address..... 6.26.22

City..... State.....

Occupation.....

Persons residing in Canada should send this coupon to the International Correspondence Schools Canadian, Limited, Montreal, Canada.

Please Mention Popular Mechanics

RAISE POULTRY FOR PROFIT

We teach you how. Easily learned at home. Our guaranteed methods make success certain—indorsed by leading Agricultural Colleges. Send TODAY for FREE BOOK—"How To Raise Poultry For Profit."



National Poultry Institute
Dept. 312 Washington, D. C.

SCHOOL BOX

GIVEN with Fountain Pen, Pencils, Knife, Pen Holder, Eraser, for selling 30 packages Chewing Gum at 5c a pkg. Write today.



BLUINE MFG. CO., 720 MILL ST., CONCORD JUNCTION, MASS



Big Money

Made by agents selling our wonderful Facial Soap, Perfumes, Toilet Articles, Spices, Extracts, etc. Free cake of soap and agents' terms mailed to any address.

LACASSIAN CO., Dept. 455 ST. LOUIS, MO.

Stop Snuffling



Get rid of nasty Catarrh. Stop sneezing, hawking, spitting, and coughing. You weren't born with that disgusting disease. You acquired it because your Lungs, Liver, Bowels, Kidneys and all other organs designed to eliminate waste matter, are not functioning properly. Now your vitality is falling, your tongue is coated, your breath is foul and your Nose, Throat, Lungs and every part of your body, are loaded with Catarrh poisons. Don't waste your time and money on dope and drugs, sprays and washes, pills and powders. These can never remove the cause of your trouble. The only way to gain relief is to drive out the waste matter and build up your body—all of it—through Nature's Laws.

STRONGFORTISM—The Modern Science of Health Promotion. will aid Nature in forever banishing Catarrh and all other ailments. I guarantee it.

Mark the subjects on the free consultation coupon on which you want special confidential information (write additional ailments on extra line) and send with 10c (one dime) for postage, etc. on my "Practical Talk on Catarrh" and my free book, "Promotion and Conservation of Health, Strength and Mental Energy". Send for them Right Now TODAY.

LIONEL STRONGFORT

Strongfort
The Perfect Man

Physical and Health Specialist
Founded 1895

Dept. 47

Newark, New Jersey

Cut out and Mail this Coupon

FREE CONSULTATION COUPON

Mr. LIONEL STRONGFORT, Dept. 47, Newark, N. J.—Please send me your book, "PROMOTION AND CONSERVATION OF HEALTH, STRENGTH AND MENTAL ENERGY," for postage on which I enclose a 10c piece (one dime). I have marked (X) before the subjects in which I am interested. Also on those I may write on extra line below.

- | | | |
|---|---|---|
| <input type="checkbox"/> Colds | <input type="checkbox"/> Increased | <input type="checkbox"/> Poor Memory |
| <input type="checkbox"/> Catarrh | <input type="checkbox"/> Height | <input type="checkbox"/> Rheumatism |
| <input type="checkbox"/> Asthma | <input type="checkbox"/> Pimples | <input type="checkbox"/> Falling Hair |
| <input type="checkbox"/> Hay Fever | <input type="checkbox"/> Diabetes | <input type="checkbox"/> Neurasthenia |
| <input type="checkbox"/> Obesity | <input type="checkbox"/> Blackheads | <input type="checkbox"/> Weak Eyes |
| <input type="checkbox"/> Headache | <input type="checkbox"/> Insomnia | <input type="checkbox"/> Gastritis |
| <input type="checkbox"/> Thinness | <input type="checkbox"/> Short Wind | <input type="checkbox"/> Heart Weakness |
| <input type="checkbox"/> Rupture | <input type="checkbox"/> Flat Feet | <input type="checkbox"/> Poor Circulation |
| <input type="checkbox"/> Lumbago | <input type="checkbox"/> Stomach | <input type="checkbox"/> Skin Disorders |
| <input type="checkbox"/> Neuritis | <input type="checkbox"/> Disorders | <input type="checkbox"/> Despondency |
| <input type="checkbox"/> Neuralgia | <input type="checkbox"/> Constipation | <input type="checkbox"/> Round Shoulders |
| <input type="checkbox"/> Debility | <input type="checkbox"/> Biliousness | <input type="checkbox"/> Lung Troubles |
| <input type="checkbox"/> Flat Chest | <input type="checkbox"/> Torpid Liver | <input type="checkbox"/> Stoop Shoulders |
| <input type="checkbox"/> Fear | <input type="checkbox"/> Indigestion | <input type="checkbox"/> Muscular |
| <input type="checkbox"/> Deformity (Describe) | <input type="checkbox"/> Nervousness | <input type="checkbox"/> Development |
| | <input type="checkbox"/> Weakness (Specify) | <input type="checkbox"/> Great Strength |

Mention other ailments here

Name

Age Occupation

Street

City..... State.....

"I'm A Man."

I Want Man's Pay!"



That is what Albert Foster wrote us eighteen months ago, and he goes on: "I'm tired of being bossed for \$25 a week. I want a He-Man job with real pay. I want to get into the \$100 a week class. Tell me how to do it." We showed him how. Today he has a He-Man job and He-Man pay. We tell of his experience because it's typical.

WHAT ARE YOU? A man who is up and doing, getting real money, or are you simply marking time on \$25 or \$30 a week? \$100 jobs don't go begging. If you want one you've got to go after it. Are you satisfied with your present condition in life? If you are, we have nothing to offer you, but if you want one of these real jobs with big pay, then we can help you and help you in a hurry.

A REAL MAN with a real man's pay is what you want to be, and we will show you how. Without loss to you of a single working hour, we will show you a sure way to success and big pay. A large number of men in each of the positions listed are enjoying their salaries because of our help—we want to help you.

Make a check on the coupon against the job you want and we will help you get it. Write or print your name on the coupon and send it in today. You will be under no obligation.

AMERICAN SCHOOL

Dept. G-174a; Drexel Ave. and 58th St. CHICAGO



ARCHITECT
\$5000 TO \$15000



ELECTRICAL ENGINEER
\$4000 TO \$10,000



ACCOUNTANT
\$7000 TO \$15000



BUSINESS MANAGER
\$5000 TO \$15000



AUTOMOBILE ENGINEER
\$4000 TO \$10,000



CIVIL ENGINEER
\$5000 TO \$15,000

American School

Dept. G-174a Drexel Ave. and 58th St. Chicago

Send me full information on the subject checked and how you will help me win success.

- | | |
|------------------------------|----------------------------|
|Architect |Lawyer |
|Building Contractor |Machine Shop Practice |
|Automobile Engineer |Photoplay Writer |
|Automobile Repairman |Mechanical Engineer |
|Civil Engineer |Shop Superintendent |
|Structural Engineer |Employment Manager |
|Business Manager |Steam Engineer |
|Cert. Public Accountant |Foremanship |
|Accountant and Auditor |Sanitary Engineer |
|Bookkeeper |Surveyor (& Mapping) |
|Draftsman and Designer |Telephone Engineer |
|Electrical Engineer |Telegraph Engineer |
|Electric Light & Power |High School Graduate |
|General Education |Fire Insurance Expert |
|Vocational Guidance |Wireless Radio |
|Business Law |Undecided |

Name

Address

LEARN TO DRAW AND MAKE MONEY

By Following Cartoonist EVANS' "EASY TO LEARN" METHOD

Here is a SIMPLE WAY To Draw a Comic Face **TRY IT**



Take your pencil and draw lightly a square (any size). Then add to it with pencil as shown in the small squares above. Erase all pencil guide lines after the drawing is completed. You can draw any kind of comic face by simply changing the shape of the nose, forehead, chin, etc.

Send in your drawing and let us see what you can do. You may have more natural ability than you think. Some of the **cleverest cartoonists** are former students. They had no experience before enrolling, but worked at the lessons during their spare time, and found Cartoonist EVANS' METHOD "easy to learn" and are now making good money. It is not hard to learn to draw originals when you are shown in a practical way. The method above is only one of many simple methods explained in the course.

We don't offer any "grand prizes," or "free materials" to encourage enrollments. The school is endorsed by well known cartoonists because they know the students are handled right.

Write today for Portfolio of EVANS Cartoons and full information about the school, and learn how to draw pictures which you can sell. The Course Is Not Expensive.



THE W. L. EVANS SCHOOL OF CARTOONING

"The School That Has the Long Established Reputation"

821 Leader Bldg.

CLEVELAND, OHIO

10,000 Trained Men Wanted in the Electrical Industry

Salaries \$72 to \$200 Per Week



Wayne C. Robinette,
President
WORLD TECHNICAL INST.

Never before in the history of electricity have salaries been so high. Never has there been such an insistent demand for trained men. Nearly one billion dollars per year are being spent in the electrical field, and yet the nation's demand has not been met.

YOU! Young man and old—are you seeking independence? Are you helping yourself?

This is your opportunity. Waste no more valuable time in thinking and talking about what your life work is going to be. In electricity your success is assured.

Technical educators are amazed

"I am amazed at the manner in which the World Technical Institute instructs students in the most difficult problems in electricity without the use of higher mathematics," says one of the principal vocational educators of America.

Ten years ahead of all similar courses

Endorsed by the Vocational Training Center of the U.S. Army, the Chicago Board of Education, the Charleston Board of Education, the Southern California Edison Company and more than a score of other large educational bodies.

Correspondence instruction at last standardized

A dependable, exact and thorough course of training, whose educational value equals those of college or university. And you become a seasoned, trained expert in six to ten months, using only your spare time.

Free Instruments and Material, Free Employment Service, Diploma and Money-Back Guarantee Bond.

Free—56-page book. Merely return the coupon below

FREE COUPON

**WORLD TECHNICAL INSTITUTE,
Fuller Bldg., Jersey City, N. J.**

Gentlemen:—Send to me postpaid and without obligation, your valuable illustrated book entitled, "Electricity Taught by a Master Teacher," also full particulars in regard to your course and the remarkable offers you are making to students.

Name.....
Address.....
..... PM 1-23

You Can Play the Hawaiian Guitar

Just Like the Hawaiians!**Because Our Native Hawaiian Instructors Will Help You****OUR STUDENTS SAY**

Koster School,
214 So. Franklin St.,
Chicago, Ill.

First Hawaiian Conservatory of
Music, Inc.

I shall certainly be very glad to recommend your course whenever the chance is mine to do so. Mr. W. H. Johnson has not phoned me yet, and if he does not please in a day or so, will write him. Am sending a letter to Miss Helen Sivik today which I think may help to secure her enrollment, and I shall be glad at any time to write a personal letter to anyone whom you may suggest.

Your former student,
W. L. Walker.

San Quentin, Calif.

First Hawaiian Conservatory of Music,
908 Woolworth Building, N. Y. City.

Dear Sirs—

Lessons 18 and 19 came last evening and I was pleased to see that they are beginning to get hard, or at least a little bit more to learn in them. I have a great deal of spare time to put in on the guitar and I enjoy it. Your course is the simplest and most interesting I have ever tried to learn. I am getting along fine and can play every lesson up to the last one and I can readily see that when I have finished with all of the lessons I will be able to play most anything and play it good. I am in appreciation.

Yours truly, J. E. FERGUSON.

P. S. If at any time you wish to see my name as a reference for your course you may do so, as I think that any one who takes it up will derive a great benefit from it and never regret it.

Our improved method of teaching is so simple, plain and easy that you begin on a piece with your first lesson. In half an hour you can play it. Thousands of successful students prove this to be true.

ONLY 4 MOTIONS We have reduced the necessary motions you learn to only four, and you acquire these in a very few minutes. Then it is only a matter of a little practice to acquire the weird, fascinating, tremolos, staccatos, slurs and other effects that make this instrument so delightful. **The Hawaiian Guitar plays any kind of music, both the melody and the accompaniment.**

FREE Just think of it. 52 lessons on this wonderful guitar. You get a beautiful large sized **Genuine Hawaiian Guitar absolutely free as soon as you enroll for the lessons.** All the necessary picks, the steel playing bar and 52 pieces of music are included **without cost to you.**

Special Arrangements for Lessons if You Have Your Own Guitar
This Makes A Splendid Christmas Gift

Play Any Music

In half an hour after you get the free Hawaiian Guitar and the first lesson you can play Hawaiian Melodies.

In a very short time after a little practice you can play any kind of music as well as Hawaiian, both the melody and accompaniment.

[TEAR OUT COUPON]

Your favorite instrument given away **FREE** with first lesson. **SPECIAL COURSES UNDER FAMOUS TEACHERS.** Learn to play VIOLIN, TENOR BANJO or UKULELE.

First Hawaiian Conservatory of Music, Inc.
233 Broadway (Woolworth Bldg.), New York City

Please send me full information about your 52 easy lessons and **FREE GUITAR OFFER.**

NAME.....

ADDRESS.....

TOWN.....STATE.....P.M.1

Print name and address clearly.

ELECTRICITY LEARN AT HOME

Send for catalog which tells how Burgess Home Training enables men and boys to get good jobs and keep them.
Burgess Electrical School, Dept. P-1, 744 E. 42nd St., Chicago

**New Way to learn Violin, Mandolin, Mandolin Banjo.**

Marvelous new way to be a Musician. I give you my instructions on PHONOGRAPH RECORDS. Nothing ever like it. First lesson will convince you that you will be able to play music. Play real pieces in a few days. In 60 days play as professional and make big money. Any phonograph will do. My records and instructions do the work!

INSTRUMENT GIVEN ABSOLUTELY FREE

Let me give you a free Violin, Mandolin or Mandolin Banjo **FREE.** Write today for my special offer and full description of my wonderful new method of teaching these instruments. A post-card will do. No obligation. My name known to whole music world of America and Europe. Write me today.

F. M. SCHNEIDER, Director, Schneider School of Music
238 Vermont St., Blue Island, Ill. (A suburb of Chicago)

LEARN AT HOME in your spare time!**AUTOMOTIVE MASTER MECHANICS**

wanted at big pay, \$3,000 to \$8,000 a year.
CHICAGO AUTOMOTIVE INSTITUTE, J. R. Bayston, Pres.
Dept. 202, 608 S. Dearborn St., Chicago, Ill.

ROPP'S CALCULATOR SHOWS THE ANSWER

as quickly as a watch shows the time to all problems likely to occur in the office, store, shop, bank, farm or factory.
Pocket size, paper, 35c. Cloth, 50c. Leatherette, \$1.
Popular Mechanics Book Dept., 6 N. Michigan Ave., Chicago.

BE A NEWSPAPER ARTIST!

Win fortune and fame. **MANUEL ROSENBERG COURSE IN NEWSPAPER ART** tells you how. 71 Lessons and 150 illustrations. Drawing made easy. Complete instruction in layouts, lettering, illustration, cartooning and sketching. Ten years' experience as staff artist of important American dailies. Price only \$5. Order TODAY. Your money refunded if you do not agree that this is the greatest art course value ever offered.
MANUEL ROSENBERG, Butler Bldg., Cincinnati, O.

**HISTORY of the WORLD AT A BARGAIN**

We will name our **Bargain Price** and easy terms of payment only in **direct letters** to **Popular Mechanics** readers. A **coupon** for your convenience is printed at the bottom of this advertisement. **Tear off the coupon,** write name and address plainly and mail now before you forget it. **Sample pages free.**

\$1 Only
Brings Books
\$1 Weekly
Pays for Them



FREE
We will mail free a beautiful 32-page booklet of sample pages to all who mail us the coupon.

Six Thousand Years of History

NOW as never before you should know the progress of mankind. Reading this work will increase your fund of knowledge, improve your mental powers, and increase your earning capacity in any business or occupation. The man or woman who knows history has infinitely better chances of success than the unformed. "Show me a family of readers," said Napoleon, "and I will show you the people who rule the world." Mail the coupon.

FREE COUPON

WESTERN NEWSPAPER ASSOCIATION (1-23)
140 So. Dearborn St., Chicago, Ill.

Please mail your 32-page free sample booklet of *The History of the World*, containing sample pages and photographs of great characters in history, and write me full particulars of your special offer to **Popular Mechanics** readers.

NAME.....

ADDRESS.....

Please Mention Popular Mechanics

Copyrighted material



THE SECRET OF DRAWING

WE'LL tell you the secret of drawing, right here! It is learning of correct principles, observation, practice, and perseverance.

No marvelous "secret" of drawing exists that will make you a success overnight. In any line of endeavor where the hand and the eye must be skilled, practice is essential. But there is a vast difference between haphazard "practice" and the scientific practice given by the Federal Course, that develops your talent on a sure foundation by the *quickest possible method*, and makes the work truly a pleasure. Learn at home in spare time. No previous training or experience needed. The Federal Course clearly explains each step, and gives you *individual personal criticisms* on all lessons.

Get This Free Book "YOUR FUTURE"

Send for this book to-day if you are 16 years old or more and in earnest about your future. It is beautifully illustrated, tells every detail you need to know about the Federal Course, and shows work of Federal Students. Fill out and mail the coupon NOW, kindly stating your age.



COUPON

Federal School of Commercial Designing,
685 Federal Schools Bldg., Minneapolis, Minn.
Please send me "YOUR FUTURE" without charge or obligation.

Name

Age.....Occupation.....

Write your address plainly in margin

\$1.00 DELIVERS to Your Home

Complete Outfit

Violet Ray

ONLY \$1.00 brings this complete, scientific Violet Rays outfit to you. Treat yourself and family at home, save delay, costly doctors and medicines. Thousands use Violet Rays at home to relieve pain and sickness. The identical outfits doctors have bought from us for years and with which they successfully treat many ailments, including those listed below.

QUICK RESULTS—No Medicine

Violet Rays work quickly, it's scientific, goes after the cause. That's why results are quick, permanent. Dr. Duncan, Kewanee, Ill., writes, "Violet Rays is the finest thing I ever used . . . to relieve pain, treatments are so pleasant all my patients like it." Use it yourself at home, you save Doctor's bills.

BEAUTY AID

Brings natural, magnetic beauty of health, no dieting, exercise or drugs. FREE book tells in detail how high priced beauty specialists use it to improve scalp and skin.

EARN CASH

Men, women, without experience earn liberal profits in spare time showing Violet Rays to neighbors. Proves results first demonstration. Sells on sight. Get attractive offer and wholesale prices now.

SEND FOR FREE BOOK

Explains how Nikola Tesla discovered Violet Rays, how it works, why it heals. Tells what doctors and plain folks accomplish in conquering pain, disease and nervous trouble with Violet Rays.

Reveals Marvelous Scientific Discovery Shows charts of human body, explains where pains start, how to banish them. Offered FREE for a limited time only, to introduce Violet Rays. Send for FREE copy.

Check Your Ailment Below for Free Advice Here is a partial list of ailments successfully treated with Violet Ray:

| | | | |
|--------------|--------------|-------------|----------------|
| Catarrh | Eye Diseases | Lumbago | Skin Diseases |
| Chilblains | Falling Hair | Nervousness | Sore Throat |
| Colds | Hay Fever | Neuritis | Sprains |
| Constipation | Headache | Paralysis | Tonsillitis |
| Earaches | Goitre | Piles | Whooping Cough |
| Eczema | Insomnia | Rheumatism | Asthma |

Mail Coupon—Send No Money

VI-REX ELECTRIC COMPANY
326 West Madison St., Dept. 21, Chicago

Please send me without cost or obligation your free book describing your VI-REX Violet Ray outfits, and details of your \$1.00 offer.

Name

Address

City

State

LEARN Modern Barbering the Short Way

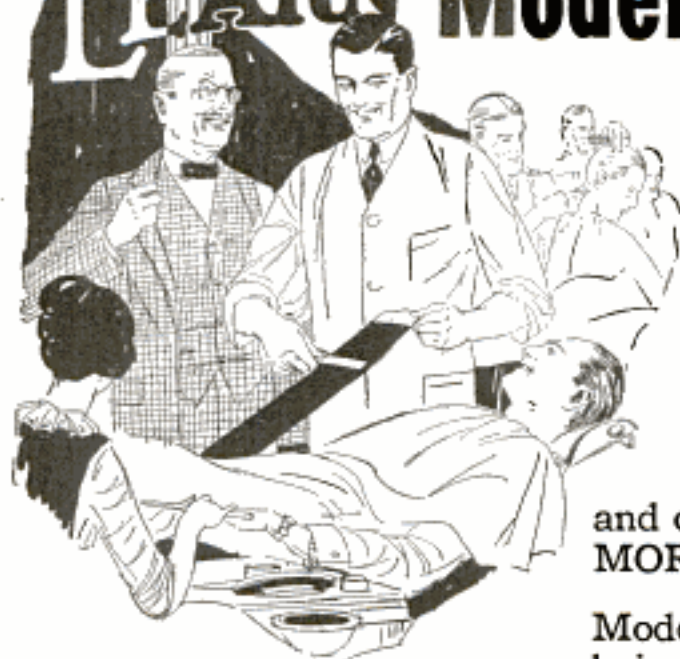

A Clean, Carefree, Good Paying Business

that you can acquire easily. A trade that enables you to TRAVEL AND SEE THE WORLD, one that pays in tips and commission in addition to salaries, MORE THAN MOST MEN EARN.

Modern barbering includes the electric hair cutter, the mechanical massage and scientific treatments. It also affords a study—if one desires—on hair and skin, and makes the barber of today a MAN AMONG MEN.

TO BE YOUR OWN BOSS is a worthy ambition. You can own your shop with small capital, and be independent. We equip your place on easy terms.

OUR SHORT PRACTICAL COURSE has more than doubled the earning power for thousands. We can do this for you. The average annual income exceeds most tradesmen because it is steady work the year around.

Our catalog, that we mail free, tells how we enable you to EARN WHILE LEARNING, how we put you into the BEST CITY JOBS, how we equip your shop on EASY PAYMENTS; in fact, how we take you just as you are, make your life work easier, better paying and more independent.

We have 33 branch schools in leading cities. We have one near you.

*Write any one of the following addresses
for our booklet B. Do it today.*

THE MOLER SYSTEM OF COLLEGES

157 Third Ave.
105 S. Wells St.
810 N. 6th St.
544 Main St.
341 W. 5th St.
215 Huron Rd.
1045 Cass Ave.
1229 17th St.
110 S. 14th St.
513 E. Water St.
1005 Canal St.
192 Marrietta St.
80 N. 2nd St.
910 Main St.
712 Franklin Ave.
727 W. Commerce St.
198 Queen St., E.

New York, N. Y.
Chicago, Ill.
St. Louis, Mo.
Kansas City, Mo.
Cincinnati, Ohio
Cleveland, Ohio
Detroit, Mich.
Denver, Colo.
Omaha, Nebr.
Milwaukee, Wis.
New Orleans, La.
Atlanta, Ga.
Memphis, Tenn.
Dallas, Texas
Houston, Texas
San Antonio, Texas
Toronto, Ont., Can.

Moler System of Colleges

Address Nearest Branch

Please send me without obligation on my part your booklet B.

Name

Address



"There's One Man We're Going to Keep"

"Ed Wilson, there, is one of the most ambitious men in the plant. I notice that he never fools away his spare time. He studies his International Correspondence Schools Course every chance he gets.

"It's been the making of him, too. He hasn't been here nearly so long as Tom Downey, who was laid off yesterday, but he knows ten times as much about this business.

"I'm going to give him Tom's job at a raise in salary. He's the kind of man we want around here."

HOW do you stand in your shop or office? Are you an Ed Wilson or a Tom Downey? Are you going up? Or down? No matter where you live, the International Correspondence Schools will come to you. No matter what your handicaps or how small your means, we have a plan to meet your circumstances. No matter how limited your previous education, the simply-written, wonderfully-illustrated I. C. S. textbooks makes it easy to learn.

This is all we ask: Without cost, without obligating yourself in any way, put it up to us to prove how we can help you. Just mark and mail this coupon.

----- TEAR OUT HERE -----

INTERNATIONAL CORRESPONDENCE SCHOOLS
Box 5697-C, Scranton, Penna.

Without cost or obligation, please tell me how I can qualify for the position or in the subject before which I have marked an X:

BUSINESS TRAINING DEPARTMENT

- | | |
|---|---|
| <input type="checkbox"/> Business Management | <input type="checkbox"/> Salesmanship |
| <input type="checkbox"/> Industrial Management | <input type="checkbox"/> Advertising |
| <input type="checkbox"/> Personnel Organization | <input type="checkbox"/> Better Letters |
| <input type="checkbox"/> Traffic Management | <input type="checkbox"/> Foreign Trade |
| <input type="checkbox"/> Business Law | <input type="checkbox"/> Stenography and Typing |
| <input type="checkbox"/> Banking and Banking Law | <input type="checkbox"/> Business English |
| <input type="checkbox"/> Accountancy (including C.P.A.) | <input type="checkbox"/> Civil Service |
| <input type="checkbox"/> Nicholson Cost Accounting | <input type="checkbox"/> Railway Mail Clerk |
| <input type="checkbox"/> Bookkeeping | <input type="checkbox"/> Common School Subjects |
| <input type="checkbox"/> Private Secretary | <input type="checkbox"/> High School Subjects |
| <input type="checkbox"/> Business Spanish <input type="checkbox"/> French | <input type="checkbox"/> Illustrating <input type="checkbox"/> Cartooning |

TECHNICAL AND INDUSTRIAL DEPARTMENT

- | | |
|--|--|
| <input type="checkbox"/> Electrical Engineering | <input type="checkbox"/> Architect |
| <input type="checkbox"/> Electric Lighting | <input type="checkbox"/> Blue Print Reading |
| <input type="checkbox"/> Mechanical Engineer | <input type="checkbox"/> Contractor and Builder |
| <input type="checkbox"/> Mechanical Draftsman | <input type="checkbox"/> Architectural Draftsman |
| <input type="checkbox"/> Machine Shop Practice | <input type="checkbox"/> Concrete Builder |
| <input type="checkbox"/> Railroad Positions | <input type="checkbox"/> Structural Engineer |
| <input type="checkbox"/> Gas Engine Operating | <input type="checkbox"/> Plumbing and Heating |
| <input type="checkbox"/> Civil Engineer | <input type="checkbox"/> Chemistry <input type="checkbox"/> Pharmacy |
| <input type="checkbox"/> Surveying and Mapping | <input type="checkbox"/> Automobile Work |
| <input type="checkbox"/> Metallurgy | <input type="checkbox"/> Navigation |
| <input type="checkbox"/> Steam Engineering | <input type="checkbox"/> Agriculture and Poultry |
| <input type="checkbox"/> Radio <input type="checkbox"/> Airplane Engines | <input type="checkbox"/> Mathematics |

Name.....
Street..... 6-26-22
Address.....

City..... State.....

Occupation.....

Persons residing in Canada should send this coupon to the International Correspondence Schools Canadian, Limited, Montreal, Canada.



SHOP WORK with a

CARNES ARTIFICIAL ARM

FOR nearly ten years a Carnes Artificial Arm has kept Mr. Pahbe Yazze of Lawrence, Kan., on the payroll as a draftsman and machinist at a good salary. Thousands of other mechanics, artisans, office workers, farmers and laborers owe their independence to this improved arm.

Life-Like in Action and Appearance

The Carnes Arm cannot be detected from the natural except by close inspection. Its user can dress himself, use knife, fork, pen, pencil and keys; pick up large or small objects, carry grips—in fact, do virtually everything that was possible before. He can bend the elbow of the Carnes Arm, bend and turn the wrist and open and close the fingers at will, even if the amputation is at the shoulder.

192-Page Book FREE. A book of 192 pages, profusely illustrated with photographs showing what can be done with this remarkable invention, will be sent free to any person interested. Send for it now.

CARNES ARTIFICIAL LIMB CO.,
208 Carnes Bldg., Kansas City, Mo.

STOP USING A TRUSS

Do Away With Steel And Rubber Bands

FREE TRIAL



FREE to 5,000 Truss Sufferers

To the extent of 5,000 sufferers who may apply I will send, ABSOLUTELY FREE, a sufficient quantity of the Plapao to positively convince them that this is the only logical, common-sense way of treating rupture. Plapao is a highly astringent medication placed within the Plapao-Pad and being absorbed through the skin, creates a wonderful feeling of relief and at the same time tends to strengthen the weakened muscles and thus permanently close the rupture opening. The process of recovery is natural, so you'll have no use for a truss—you can throw it away forever! Old and young have testified under oath that the Plapao-Pads cured their rupture—many of them long-standing, aggravated cases—without delay from work. Patent allowed in U. S. and foreign countries. Awarded Gold Medal at Rome and Grand Prix at Paris.

Send No Money—for a sufficient quantity of the Plapao is sent without charge to enable you to give it a thorough test; you pay nothing for this trial now or ever. Write for it and full information today. Address Plapao Laboratories, Block 1427 St. Louis, Mo.



If He Had Passed It Up

He Would Still be a Laborer at \$2 a Day. No Money, Nothing Ahead but Hard Work, Longer Hours—and Regrets. But He Didn't Pass It Up

He decided to learn Mechanical Drawing. He buckled down to work with the Columbia School of Drafting. When he had a quiet half hour to spend he spent it—as a wise man spends money—to get full returns.

MADE \$275 EXTRA IN 3 DAYS. He recently received \$275 for one drawing that only took him three days to draw.

NOW HOW ABOUT YOU? Are you working up hill or down? Count the money in your pay envelope next pay day. You'll find the answer there.

MAKE \$35 TO \$100.00 A WEEK. We will train you to be an expert Draftsman in your spare time at home by mail. There's lots of room for you if you act now.

PROMOTION IS QUICK. WE'LL QUALIFY YOU for a high-salaried position in the drafting field and keep you in touch with openings for Draftsmen in the big machine shops, industrial plants and United States Government departments. Men who start as

Draftsmen are often advanced to Chief Draftsmen, Chief Engineers, Production Managers and so on.

GET THE RIGHT TRAINING. Mr. Claffin, the founder and director, stands personally in back of the Columbia School of Drafting. You spend no time in long-winded theories—useless and expensive to you. You start on actual drawing work the day you receive your first lesson.

YOU NEED NO PREVIOUS TRAINING. The course is easy to understand and easy to follow. Many students are qualified even before they complete the course.

SUCCESS CALLS MEN OF ACTION ONLY. If you are a man of action clip the coupon now and show that you are a man of action. Keep right on top of this opportunity to make real money. Don't go looking for a pair of scissors. Tear the coupon off and mail it right now. We have a special offer for those who reply promptly. Get started now.

What We Give You

PRACTICAL PROBLEMS. You are carefully coached in practical Drafting work.

WE HELP YOU GET A JOB. We help you get a position as a practical Draftsman as soon as you are qualified.

PERSONAL INSTRUCTION AND SUPERVISION THROUGHOUT THE COURSE. You receive the personal instruction and help of Roy C. Claffin, president of the Columbia School of Drafting and a practical Draftsman of many years' experience.

DRAFTSMAN'S EQUIPMENT. We furnish you with a full set of Drawing Equipment and Drafting Instruments as shown in the picture below when you enroll. You keep both sets on completing the course.

CONSULTATION PRIVILEGES. You are free to write us at any time for advice and suggestions regarding your success.

DIPLOMA. The diploma we give you on completing the course attests to your proficiency as a Draftsman. It is an "earning wedge" to success.

FREE SUBSCRIPTION TO DRAFTSMAN'S PUBLICATION "THE COMPASS." You are given free a subscription to our helpful, inspiring publication, "The Compass."

U. S. Civil Service Commission Needs DRAFTSMEN

The following are a few of the many positions open in Government Departments from time to time. The salaries are starting salaries, subject to increase. Practically all of them carry a bonus of \$240 a year additional.

Architectural Designer..... \$4,000
Chief Draftsman (Aeronautical) Naval Aircraft Factory, per day... 15.04
Aeronautical Draftsman—Field Service of Navy Department, \$5.20 per day to \$12 per day.

FREE BOOK

Send in this coupon today. Immediately on receipt of it we will send you our book, "Your Future in Drafting," which tells you all about our new method of teaching Mechanical Drawing and gives full details of our special offer to those who reply promptly.

THE COLUMBIA SCHOOL OF DRAFTING

Roy C. Claffin, President

Dept. 1892, 14th and T Sts., N. W., Washington, D. C.

Free Book Coupon

COLUMBIA SCHOOL OF DRAFTING,
 Dept. 1892, 14th and T Sts., N. W., Washington, D. C.

Enter my name for a free subscription to "The Compass" and also send me without charge your illustrated book on Drafting, telling me how I can secure your complete Home Study Course and your help in securing a position as Draftsman.

Name.....

Address.....

City..... State.....

Drafting Outfit Free



FREE We give you free with our course this professional Drafting outfit. It is yours to keep when you complete the course.

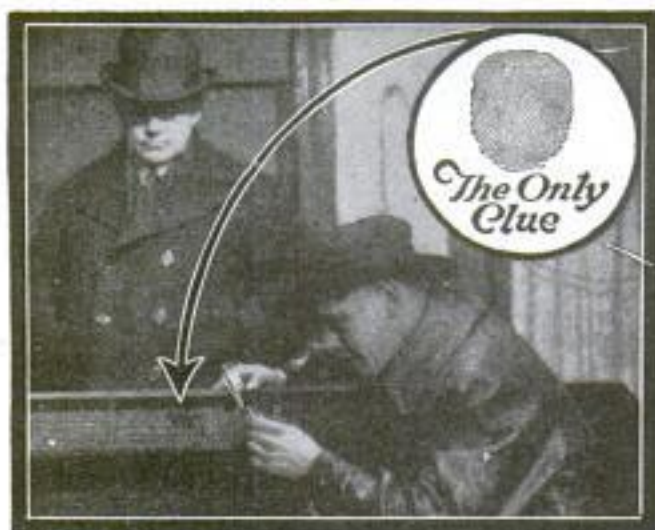

\$500 REWARD for TWO HOURS WORK

It was in answer to a request from the Chief of Police that Warren Biglow, the Finger Print Expert, arrived at the scene of the daring robbery of the T—O—Company offices. The job was undoubtedly the work of skilled cracksmen and robbers of uncommon nerve. \$6,500 in currency—the company payroll—was gone. Not a single apparent clue had been found by the police. Almost immediately after his arrival Biglow turned his attention to a heavy table which had been tipped up on its side. Examination of the glossy mahogany showed an excellent set of finger prints. The thief might just as well have left his calling card. To make a long story short, his prints were photographed and taken to Central Office, where they were matched with those of "Big Joe" Moran, a safe blower well known to the police. Moran was subsequently caught and convicted on Biglow's testimony and finger-print proof. Most of the money was recovered. In the meantime the T—O—Company had offered a \$500 reward, which was given to Biglow—his pay for two hour's work.

Be a Finger Print Expert—Learn at Home in Spare Time

Could you imagine more fascinating work than this? Often life and death depend upon the decisions of finger-print evidence—and big rewards go to the EXPERT. Thousands of trained men are now needed in this great field. The finger-print work of governments, corporations, police departments, detective agencies and individuals has created a new profession. Many experts regularly earn from \$3000 to \$10,000 a year in this fascinating game. And now you can easily learn the secrets of this new science in your spare time—at home. Any man with common school education and average ability can become a Finger Print Expert in a surprisingly short time.

FREE Finger-Print Outfit and Large Illustrated Book!

For a limited time we are making a special offer of a complete Professional Finger Print outfit, absolutely free and also a Free Course in Secret Service Intelligence. Mastery of these two kindred professions will open a brilliant career for you. Write quickly for fully illustrated free book on Finger Prints which explains this wonderful training in detail. Don't wait until this offer has expired—mail the coupon now. You may never see this announcement again! Address

University of Applied Science

Dept. 1351, 1920 Sunnyside Ave., Chicago

University of Applied Science, Dept. 1351, 1920 Sunnyside Ave., Chicago

Gentlemen: Without any obligation whatever send me your new, fully illustrated, FREE book on Finger Prints and your offer of a free course in Secret Service Intelligence.

Name.....Age.....

Address.....

Town.....State.....

Please Mention Popular Mechanics

COMMERCIAL ART

Taught By Improved Methods

Many art school advertisements tell about the great and ever increasing demand for commercial artists—big pay—equal opportunity for both men and women, etc. Very good! This is all quite true, but you must first be properly taught. Understand? Properly taught! Few top notch artists are good instructors. Very few. By searching through many studios we have found them.

A Master Course Is Offered

Endorsed as the official training school for leading Commercial Art houses, employing hundreds of artists. Correct educational methods applied. A practical educator and a corps of top notch commercial artists, offer students the benefit of 20 to 30 years of high grade experience. Only the best instruction is good enough for you. Students finishing half of this unusual course can secure and hold desirable positions. Course can be made to pay for itself many times while studying. Either class room or home study instruction. Same course. Same credits. If you like to draw, let's talk it over.

Ask for our book telling all about Commercial Art and the opportunities it presents AS WE TEACH IT. Send 6 cents in stamps for postage.

NATIONAL ACADEMY OF COMMERCIAL ART

230 EAST OHIO ST.
DEPT. CHICAGO,
ILL.

NORTHWESTERN

$\frac{1}{4}$ H.P. 110 Volt \$13.50
A. C. Motor . .



Same Motor equipped as \$25.00
buffer and grinder

(Send cash with order.)

We guarantee to satisfy you or return
your money.

Write for free descriptive bulletin covering
these and other sizes

NORTHWESTERN ELECTRIC COMPANY
408 So. Hoyne Ave., Chicago.



High School Course in Two Years!

Lack of High School Training has kept thousands of men and women from attaining business and social position. Without this training you are absolutely barred from a successful business career, from leading professions, from well-paid civil service jobs, from teaching and college entrance. In fact, all preferred positions are closed to you without this vital training. You can't stand this heavy handicap nor do you have to. The American School can give you the valuable training you missed.

Put Your Idle Hours to Work You can complete our simplified High School Course within two years by spare-time study. Then you will be mentally equipped to handle a worthwhile position. This course, prepared by some of America's leading professors, will broaden your mind, give you a wider outlook and make you keen, alert and capable.

Remove Your Handicap

Whether you need High School Training or specialized instruction in your chosen line — NOW is the time to remove your handicap. You must know the short cuts and efficiency methods. You must know the HOW and WHY. Over 50,000 students owe their success to training received from the practical, money-making Courses in the coupon below. Let us tell you about this training — about the Course you are interested in. Check and mail the coupon.

American School

Dept. H174, Drexel Ave. and 58th St., Chicago

American School

Dept. H174, Drexel Ave. and 58th St., Chicago

Send me full information on the subject checked and how you will help me win success.

- | | |
|------------------------------|----------------------------|
|Architect |Lawyer |
|Building Contractor |Machine Shop Practice |
|Automobile Engineer |Photoplay Writer |
|Automobile Repairman |Mechanical Engineer |
|Civil Engineer |Shop Superintendent |
|Structural Engineer |Employment Manager |
|Business Manager |Steam Engineer |
|Cert. Public Accountant |Foremanship |
|Accountant and Auditor |Sanitary Engineer |
|Bookkeeper |Surveyor (& Mapping) |
|Draftsman and Designer |Telephone Engineer |
|Electrical Engineer |Telegraph Engineer |
|Electric Light & Power |High School Graduate* |
|General Education |Fire Insurance Expert |
|Vocational Guidance |Wireless Radio |
|Business Law |Undecided |

Name.....

Address.....

Please Mention Popular Mechanics

His New Invention Finds and Corrects Your Mistakes in English

As a result of thousands of tests, Sherwin Cody found that the average person is only 61% efficient in the vital points of English. In a five-minute conversation, or in an average one-page letter, from five to fifty errors will appear. It is surprising how many experienced stenographers fall in spelling such common words as "business," "abbreviate," etc. It is astonishing how many business men say "between you and I," instead of "between you and me," and use "who" for "whom," and mispronounce the simplest words. Few people know whether to use one or two "c's" or "m's" or "r's," whether to spell words with "ie" or "ei," and when to use commas in order to make their meaning absolutely clear.



SHERWIN CODY

A Remarkable Discovery

Mr. Cody has specialized in English for the past 20 years. But instead of going along in the old way he has applied scientific principles to teaching the correct use of our language. He made tens of thousands of tests of his various devices before inventing his present method. In all his tests he found that the trouble with old methods is that points learned do not stick in the mind. In school you were asked to remember rules, and if you forgot the rules you never could tell what was right and what was wrong. For five years Mr. Cody worked almost day and night to find a way to reduce bad habits in writing and speech with good ones. And as a result of his experience he evolved his wonderful new

Self-Correcting Method

Mr. Cody was granted a patent on his unique device, and now he places it at your disposal. This invention is simple, fascinating, time-saving, and incomparably efficient. You do the lesson given on any page, then you see exactly how Mr. Cody himself would correct it. You mark your errors and check them in the first blank column. Next week you try that page again, on the second unmarked sheet, correct your errors, and check them in the second column. You see at a glance what you have learned and what you have failed to remember, until you have reached the 100% point in spelling, punctuation, grammar, and expression.

Only 15 Minutes a Day

A remarkable advantage of Mr. Cody's course is the speed with which these habit-forming practice drills can be carried out. You can write the answers to fifty questions in 15 minutes and correct your work in five minutes more. You waste no time in going over the things you already know. Your efforts are automatically concentrated on the mistakes you are in the habit of making, and through constantly being shown the right way, you soon acquire the correct habit in place of the incorrect habit. There are no rules to remember. There is no tedious copying. There is no heart-breaking drudgery.

NEW BOOK FREE

Every time you talk, every time you write, you show what you are. Your English reveals you as nothing else can. When you use the wrong word, when you mispronounce a word, when you misspell a word, when you punctuate incorrectly, when you use flat, ordinary words, you handicap yourself. If you feel your lack of language power, if you are ever embarrassed by mistakes, if you cannot command the exact words to express your ideas, our new booklet "How to Speak and Write Masterly English" will prove a revelation to you. Merely mail the coupon, and it will be sent by return mail. Learn how Sherwin Cody's new invention makes command of language easy to gain in 15 minutes a day.

Mail this coupon or a postal AT ONCE

Sherwin Cody School of English
51 Searle Building Rochester, N. Y.

SHERWIN CODY SCHOOL OF ENGLISH
51 Searle Building, Rochester, New York.

Please send me at once your Free Book, "How to Speak and Write Masterly English."

Name.....

Address.....

City..... State.....

EARN up to **\$400** per Mo.
LIVING EXPENSES PAID

Big Opportunities for You in Hotel Work

More Positions Open Than We Can Fill

80,000 men and women wanted by leading hotels. Opportunities unlimited—need not half supplied. New hotels, now building, asking us for graduates.

A big profession—new, uncrowded. Good pay, good quarters, rapid advancement. A chance to live in luxury among people worth while.

How to Prepare Yourself

You can qualify for a good-paying position by devoting spare time at home to a series of easily understood, inexpensive lessons, known as the Hotel Operation and Management Course, covering every phase of the hotel business. Compiled by nationally known hotel experts; our method of training, endorsed by leading hotel executives such as Roy Carruthers, Managing Director, The Waldorf-Astoria, New York; Senator Van Orman, of the Van Orman hotels of the Middle West, and others.

A Position Is Waiting for YOU

More applications received daily for our graduates than we can supply. One new 750 room hotel has placed order with us to fill every position with our graduates. Positions ready to be filled in all parts of America, large and small hotels. Will you qualify? Mail this coupon today for booklet and latest Employment Bulletin listing many positions open.

STANDARD BUSINESS TRAINING INST.
 1005 Carlton Court, Buffalo, N. Y.

Standard Business Training Inst.
 1005 Carlton Court, Buffalo, N. Y.

Send me free booklet No. 1005 giving full information about Hotel Operation and Management Course; also Employment Bulletin.

Name

Street

City

WANTED

Standard Business Training Institute graduates are wanted for Following Positions open:

(Partial List)

2 Ass't Managers. Salary \$300-\$400 Mo. Apartment and Meals.

4 Room Clerks. Salary \$225-\$250 Mo. Meals.

2 Mail Clerks. Salary \$150 Mo. Meals.

1 Steward. Salary \$375-\$425 Mo. Meals.

1 Housekeeper. Salary \$175 Mo. Apartment and Meals.

12 Floor Clerks. Salary \$100-\$125 Mo. Meals.

6 Food Checkers. Salary \$90 Mo. Room and Meals.

More Positions Open Than We Can Fill



FREE!

Guaranteed radio frequency hook-ups, giving perfect reception of voice and music through loud speaker over range of 1,500 miles, will be sent on request, with full directions for installing. Write for them today.

Electrical Research Laboratories
 Dept. J, 2515 Michigan Ave., Chicago

Direct comparative tests establish the superiority of Erla radio frequency transformers for long distance receiving. Ask your dealer or write us. Price \$4.00

Erla bezels improve 100% the appearance of any receiving set. Telescoping rim fits 1 1/4 in. hole in any 3/4 in. to 1 in. panel. Ask your dealer or write us. Price 20c



FREE LIGHTING FIXTURE CATALOGUE



Our prices are 50% LOWER than elsewhere in the United States. We manufacture our own electric fixtures and eliminate the dealer's profits by selling DIRECT FROM OUR FACTORY to you. Special 8-room sets complete ready to hang as low as \$24.50. Write at once for latest catalog.

UNITED LIGHTING FIXTURE CO.
 280 Bowery Dept. 152 New York City

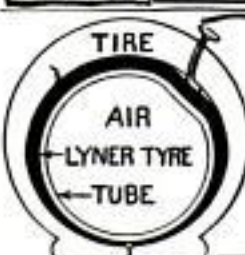

AGENTS!!!

One wanted in every county to introduce **LYNER TYRES**. Prevents 90% of punctures. Guarantee against blow-outs. Doubles tire mileage. No tools needed. Easy to sell, repeat orders, large commission. Protected territory. Write for proposition. Full or spare time.

PELLETIER TYRE COMPANY
 115 S. Dearborn Chicago

"BAM-BEE-NO" Real Baseball on any table

Just out. New game. Interest all. Miniature base ball. Including 16P-Book of all plays known. Excitement, Fun, Thrills Galore! Send \$1.50 for complete set. Play 3 games; if not all we say return game and money will be refunded. A free Xmas gift for any ball fan. Folder and testimonials free.

Dept. 613 **THE BAMBEENO SALES CO.** Toledo, Ohio

A LATHER THAT SOOTHES

Palmolive Shaving Cream gives a full, creamy lather that makes the beard wax-like. The razor moves smoothly. Palmolive is also a lotion. Contains both Palm and Olive oils. Write for free trial tube. Large size tube at drugstore 35c.

THE PALMOLIVE COMPANY, Milwaukee, U.S.A.
PALMOLIVE SHAVING CREAM



"BOW LEGS and KNOCK-KNEES" UNSIGHTLY

SEND FOR BOOKLET SHOWING PHOTOS OF MEN WITH AND WITHOUT THE PERFECT LEG FORMS

PERFECT SALES CO.
 140 N. Mayfield Ave., Dept. 5, Chicago, Ill.

DEAFNESS IS MISERY

I know because I was Deaf and had **Head Noises** for over 30 years. My invisible Antiseptic Ear Drums restored my hearing and stopped Head Noises, and will do it for you. They are Tiny Megaphones. Cannot be seen when worn. Effective when Deafness is caused by Catarrh or by Perforated, Partially or Wholly Destroyed Natural Drums. Easy to put in, easy to take out. Are "Unseen comforts." Inexpensive. Write for Booklet and my sworn statement of how I recovered my hearing.

A. O. LEONARD, Suite 226, 70 5th Avenue, New York City

5 Magic Keys

Work like magic in emergencies or prove whether your door or padlocks are burglar-proof. Open and test thousands of different locks. Recommended by users in ten different nations. Most wonderful and only keys of their kind. Send \$1 today. Novel key chain FREE with set. **MASTER KEY CO., 25M Manhattan Block, Milwaukee, Wis.**



Now I Make \$100.00 a Week



George Glick

For eight years I was tied to a job in a retail store; when I finally broke loose, I increased my earnings 150%

George Glick

For eight years I worked in a retail store, and as far as salaries go for that kind of work, I was doing pretty well. I got my \$40.00 every Saturday, and I suppose I should have been happy, but somehow or other, that \$40.00 a week wouldn't buy me everything I wanted. Expenses piled up something awful. Baby had to have new shoes mighty often; Florence had to have her music lessons; my savings account didn't grow; I didn't carry enough insurance; I felt I wasn't getting anywhere.

Then one day, Mort Lyons, who had worked with me for years, dropped into the store and after the usual greetings, he told me what he was doing. I was surprised when he told me that he was averaging better than \$80.00 a week. Now Mort is a pretty good salesman, but I knew I could outsell him. I had always been a hard worker, and was rated a better salesman. It set me thinking, if Mort can earn \$80.00 a week, why can't I?

Mort told me of his connection with J. B. Simpson, and of the wonderful clothes they make to retail at \$29.50. From what he said of the firm I knew they must be first class, and Mort wouldn't be identified with anyone that wasn't. And when he showed me his samples, my eyes nearly popped out. There were the same fabrics for \$29.50 that we were selling at \$50.00 and even \$65.00. "But, Mort," I said, "how can they do it?" "That's a wonderful story in itself," said Mort, "which I'll tell you later."

I thought it over for the next few days, but I just didn't have the nerve to make the plunge. Separating myself from \$40.00 a week sure and certain, rain or shine, seemed to me a very risky proposition. I talked it over with my wife and as usual, she had a good suggestion. She said, "George, take your vacation now. It's January. Business is dull in your store, and they will be glad to have you go now."

Well, the next week I started out and by the following Saturday, I had earned \$36.00. The next week I made \$52.00 and had enough prospects lined up to bring me \$50.00 more. I went back to the store and quit my job. They laughed at me when I told them what I was going to do. "You'll be back in a month," they said, "begging for your job," but believe me, they couldn't give me enough money to even get me back into that old hole in the wall.

I have been at it now for a year and last month I made \$520.00; the month before, I made \$538.00; my earnings for the first year in this

business will be about \$4,850.00 and next year I will increase that by at least one or two thousand dollars.

I am sitting pretty now. I've got a connection with the finest outfit you could possibly imagine, honest and honorable people, offering values that positively cannot be duplicated by anyone else. How they can do it is the wonder of everybody.

One day I made a trip through their tailor shops and believe me, it opened my eyes. I found them cutting trimmings without any waste by a process exclusively their own. I saw methods used by them that I had never heard of before, and I thought I knew something about making clothes as well as selling them. I found them buying woolens and paying less than half of what we used to pay in our little store. I found them applying the principle of many sales and small profits and the highest efficiency in every department throughout their entire establishment.

Believe me, it was a lucky day for me when I heard of J. B. SIMPSON.

If you are looking for a way to get into the big money class and would like to take up a proposition that will pay any diligent worker \$50.00 to \$150.00 a week, write J. B. Simpson, Inc., Chicago, Illinois.

The quality of their all wool tailored to order suits will amaze you. Their values are so extraordinary, and they've got it so far over any other tailoring that you have ever seen at this price, that you will hardly believe your own eyes. Write them today. They will send you full information. Experience in this line is not essential. They will teach you. One of their most successful men formerly sold stock and bonds. Another used to be a grocery clerk. A third sold pianos. They will teach you—if you are willing to learn. Mail the coupon.

Free Information Coupon

J. B. Simpson, Inc., Dept. 385,
Chicago, Ill.

I have read the story of George Glick and would be glad to have you tell me more about the wonderful opportunity you have for salesmen.

Name.....

Street.....

City..... State.....

Territory Wanted.....

LEARN CARTOONING the Right Way

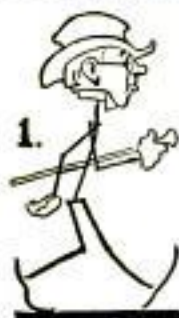

1.

Have your ability trained by the school that has developed many famous cartoonists.

If you like to draw—if you find pleasure in picking up a pencil and paper and trying to make sketches or cartoons, don't regard it merely as a hobby. Have your ability developed and earn a good income as a cartoonist.



2.

Hundreds of nationally known cartoonists, such as Branner of the Chicago Tribune; Blosser, who draws "Freckles and His Friends"; Gene Byrnes, creator of "Reg'lar Fellers"; Thiele of the Sioux City Tribune; Fung, of the Seattle Times and others equally well known, took the Landon Course at home, in their spare time, and fitted themselves for their present positions at salaries ranging from \$50 to \$200 and more per week.



3.

Have YOUR talent developed by the same method

What the above mentioned boys did you can do, with the same training. The Landon method of teaching makes cartooning easy to learn. By means of an extensive series of Big picture charts all the necessary details of ORIGINAL drawing are explained step by step, in a clear and simple manner.



4.

FACTS that determine the superiority of the Landon School:

1. Landon School Students are securing the best cartooning positions which open up everywhere.
2. The picture chart method of instruction was originated and is used exclusively by the Landon School.
3. From the very beginning, the Landon Course teaches ORIGINAL drawing. No copy work.
4. Individual attention and criticism of student's work. Personal coaching whenever necessary.
5. Specialized instruction on how to originate cartoon ideas. This is an exclusive feature of the Landon Course.
6. Practical assistance in securing positions for students and help in marketing their work.
7. The price is within reach of everyone who is ambitious to succeed. Easy payments can be arranged.



5.

Write today for full information about the Landon Course, and sample chart by means of which you can test your own ability. Find out what the possibilities are for YOU in this interesting profession. Please state your age.

The Landon School

338 National Bldg.

Cleveland, Ohio

Please Mention Popular Mechanics



THIRTY-FIVE EASY LESSONS IN RADIO 50c

A systematic course of elementary principles written in a simple and concise lesson course, easily understood. Thousands have taken up Radio for entertainment and are operating their own amateur sets.

This book embodies all the principles and application of everyday radio for the home and in business. Paper cover.

Price postpaid 50c

SHREWSBURY PUBLISHING CO.
5525 West Lake Street Chicago, Ill.

EJECTOR CIGARETTE CASE "Just Press the Button!" \$1.50

and up it comes! Latest in "smoke" cases. Keeps cigarettes perfect, prevents crushing. Works every time, smoothly, noiselessly. Every smoker wants one. Mailed to you for \$1.50, if not at your dealer's.



DEALERS! If you want to handle a good live number, write for special Assortment Offer of cases in Nickel, Silver and Gold plate, and Sterling Silver and Gold Filled, retailing from \$1.50 to \$20.00

THE LYONS MFG. CO.

342-MP YORK ST.,

New Haven, Conn.

BLANK CARTRIDGE PISTOL

Protection against Burglars, Tramps, & Dogs

PRICES
50c.
\$1.00



Well made and effective. Modelled on latest type of Revolver; appearance alone is enough to scare a burglar. When loaded it may be as effective as a real revolver without danger to life. It takes standard .38 Cal. Blank Cartridges obtainable everywhere. Price 50c., Superior quality \$1.00 postpaid. Blank Cartridges, by express, 50c per 100.

Johnson Smith & Co., 1218 Washington Ave., Dept. 942, Racine, Wis.

How to Get Rid of Moles



A simple, safe home treatment—15 years' success in my practice. Moles (Also BIG Growths) Dry Up.

Ask for Free Booklet of Full Particulars

WM. DAVIS, M. D.

124-5 Grove Ave., Woodbridge, N. J.

STOP TOBACCO

If you cannot stop it, do you know why? Do you know its effect on efficiency? This subject discussed in common-sense manner in booklet written by one who conducted anti-cigarette clinic for L. A. Police Dept. for over a year. Treated thousands—all forms. Booklet free as long as they last. Write Dr. T. H. Trinwith, Black Bldg., Los Angeles, Calif.

Auto Mechanic Makes \$5200 Net Profit 1st Year



Unlimited Opportunities for Auto Mechanics

Here's an opportunity to go into business for yourself. Greer men are making good money—they get the pick of waiting positions and are successful. You have the same chance to succeed. Greer training will fit you in a few short weeks to take a position or start a business of your own, paying good money right from the start.

Greer training most complete. Greer College of Automotive Engineering is a residence trade school, **not** a correspondence school. Thorough, successful training by actual practice. Master Mechanic instructions insure personal, individual training. Practical shop work on autos, trucks, tractors, all types of motors, ignition and starting systems.

HERE IS THE COMPLETE COURSE:

Truck, Tractor and Automobile Repairing and Overhauling, Roadside Repairs, Primary Ignition, Vulcanizing and Tire Repairing, Electric Lighting and Starting Systems, Machine Shop Practice, Acetylene Welding and Cutting, Storage Batteries, Salesmanship.

Be a certified Automotive Engineer. The Greer Diploma insures your success

Start now—No need to delay. No matter what you are doing now or planning to do in the future, if you have Greer training you are sure of good pay and steady employment.

WRITE AT ONCE Get the facts, the success of thousands of Greer satisfied graduates proves the superiority of the Greer practical training method. No previous experience necessary. We specialize in quick and thorough training for men of all ages.

FREE BOOK Newest and most interesting—"How to Succeed in the Automobile Business," is a book you'll find a real guide to a better job at bigger pay. Fill out the coupon and mail today.

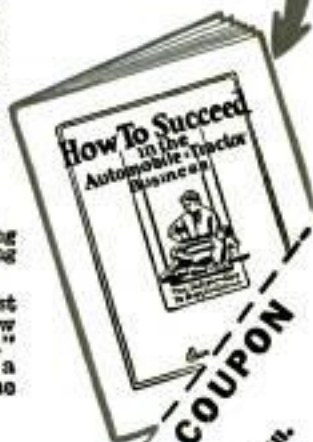

MAIL THIS FREE BOOK COUPON

Greer College of Automotive Engineering, Chicago, Ill.
 Send me your Free Book, "How to Succeed in the Automobile Business" and Special Tuition Offer.

Name.....
 Address.....

GREER COLLEGE

of Automotive Engineering

2071 South Wabash Avenue, Chicago, U. S. A.



BIG PRICES PAID TO ARTISTS

YOU are indeed fortunate if you like to draw! Develop your talent—become a commercial artist! Thousands of business firms pay millions of dollars yearly for good advertising drawings and designs. Well-trained artists command \$50, \$75, \$100, \$150 a week—sometimes even more. "Top-notch" designers receive \$250, \$500, \$1000 and up for single drawings.

Learn Quickly at Home in Your Spare Time

Get into this fascinating profession which has a future as big as modern advertising and modern business. The Federal "Master Course" teaches you the methods and ideas that make your drawings worth real money. It gives you individual personal criticisms on your lessons. No previous training or experience needed. And best of all—Leading successful artists are authors of exclusive lessons in the Federal Course. They will give you the benefit of their experience and advice, only in this Course.

Get This Free Book "YOUR FUTURE"

Investigate now—by all means send for this book. It's free to anyone 16 years old or more who is in earnest about his or her future. Beautifully illustrated in colors, it gives facts about the field of commercial art, names of the famous artists who are Federal Authors, and every detail you will want to know about the Course. It is a proven result-getter. Mark and mail the coupon right now—kindly stating your age and occupation.

COUPON

Federal School of Commercial Designing
684 Federal Schools Building
Minneapolis, Minn.

Please send me "YOUR FUTURE", without charge or obligation.

Age.....Occupation.....

Name.....

(Write your address
plainly in
margin.)

A FILE
NOT A FILE

Stop Forgetting

Make Your Mind an index from which you select facts, figures, names, faces. Develop concentration, self-control, overcome hesitations, forgetfulness.

Write today for FREE memory and concentration test and illustrated booklet, "How to Remember."

PROF. HENRY DICKSON
Dept. 705-A Evanston, Ill.

Learn Auto and Tractor Business

Earn \$150 to \$400 a Month
Greater opportunities than ever for
Rahé Trained Motor Mechanics.
Learn here in Six to Eight Weeks.

Write today and let me "SHOW YOU HOW."
RAHE AUTO AND SCHOOL 1075 Locust St.
RAHE TRACTOR SCHOOL Kansas City, Mo.
*(The Original and Only School Under the Personal Supervision
of HENRY J. RAHE. Established 1907.)*

LEARN ENGINEERING

Course, 3 months to 2 years practical-technical training under experts. Not a Trade School, but a practical-technical college teaching electricity, steam, gas, auto-electric, sensory wiring, drafting. Extensive laboratory and shop equipment. Degrees awarded. Day and night sessions. Enroll any time.

FINLAY ENGINEERING COLLEGE
1001 Indiana Avenue Kansas City, Mo.

"HOW I BEAT THE GAME"

The inspiring Story of how one poorly paid garage mechanic won success, his own business and a big income. Tells how you can increase your salary from 100 to 500%. Send for it today FREE.

Ambu Engineering Institute
Dept. 11 2632 Prairie Ave., Chicago, Ill.

Play "JAZZ" on the Saxophone

Become a musician so quickly as to astound everyone. Learn by playing real music—instead of tiresome "exercises." You'll soon become the most popular person in your "set."

New Easy Method

is a revelation. Nothing else like it for thoroughness and rapidity. So simple that young and old find it easy to play with amazing skill. No "trick music"—but actual notes, learned quickly right in your own home.

LEARN TO PLAY ANY INSTRUMENT

| | |
|------------------|---------------|
| Piano | Mandolin |
| Organ | Drums and |
| Violin | Traps |
| Banjo | Harmony and |
| Clarinet | Composition |
| Flute | Sight Singing |
| Harp | Ukulele |
| Cornet | Piccolo |
| Cello | Trombone |
| Guitar | Saxophone |
| Voice and Speech | Culture |
| Automatic Finger | Control |

Free Book

offers this wonderful musical opportunity. Send for it today before copies are exhausted. You'll be astounded, thrilled, fascinated, at this easy, rapid way to become a veritable master of your favorite instrument. Name below the instrument you are particularly interested in.

U. S. SCHOOL OF MUSIC, 71 Brunswick Bldg., New York City
Send me your amazing free book "Music Lessons in Your Own Home." This does not put me under any obligation. (Please Write Plainly.)

NAME.....
ADDRESS.....
INSTRUMENT.....

How to Read Blueprints and Plans.

How to Use the Steel Square Successfully.

What You Should Know About Carpentry and Building.

How to Build a Frame or a Brick Structure.

What You Should Know About Sheet Metal Work.

How to Be a Successful Building Superintendent.

What You Should Know About Heating and Ventilating.

How to Write and Read Building Specifications.

What You Should Know About Water Supply and Drainage.

How to Estimate the Cost of a Building.

What You Should Know About Plastering and Painting.

How to Know Material and Select the Best.

How to Build of Concrete and Steel.

How to Care for Tools.

A Thousand Things You Ought to Know

EVERY day in your work you get up against new problems—sometimes it is only some old "sticker" coming in a new way. Just the same, though, it takes a lot of time to figure them out. **Don't do it.** Here's everything worked out for you. Every problem, big or little, that you will meet in a day's work. Hundreds of new ideas and better ways of doing things. Hundreds of ways the other fellows are making money. Hundreds of ways **you** can make more out of the same work you are doing now.

CARPENTRY AND CONTRACTING

Five great big volumes flexibly bound in genuine American Morocco with 2,138 pages and more than 1,000 blueprints, plans, pictures and diagrams. It is the newest, most complete, most practical work of its kind ever published. Twenty-five well-known experts prepared these great books, gathering the material from hundreds of different sources. Every man in the shop and on the job should have them. Written in such plain language that anyone can understand them.

7 Days' FREE Examination

Send the coupon for these great Carpentry and Contracting books TODAY. You can't afford to be without them and you don't take any risk at all. The coupon brings the whole set by express collect for a week's free examination. Use the books a week and notify us to get them back if they don't please you. If you like them, send us only \$2.80 and \$3.00 each month thereafter until \$19.80 is paid. If you prefer to pay cash with order, send only \$17.80. The return privilege holds good just the same. Send the coupon NOW. Remember—sending for the books does not obligate you to buy.

AMERICAN TECHNICAL SOCIETY, Dept. G-191, Chicago



**American Technical Society,
Dept. G-191, Chicago**

Please send me the five-volume Cyclopedia of Carpentry and Contracting, shipping charges collect. I will send you \$2.80 in seven days and \$3.00 each month thereafter until \$19.80 has been paid, or return the books at your expense.

Name

Street and No.

City and State

Reference

(Please fill in all lines.)

Men Wanted

\$150 to \$400 a Month

is actually being made by good mechanics—not just in a few cases but as a general rule. Hundreds of letters from our former students prove that "Iowa State" trained men are getting the big-paying jobs or making a success of their own business. The whole United States is a field of opportunity for you, once you learn motor mechanics **right**. Trained men are wanted everywhere.

Be a trained man—learn a trade—get out of the low-wage class and earn real money. We extend a real helping hand—we help you get ahead thru your own efforts—that's the greatest assistance that can be offered to any man—to help him **help himself**—that's the one big reason for this school's existence.

If you could read all the inspiring letters we get from former students—how quickly they spot trouble, how successfully they perform all kinds of repair jobs, what big money they're making—you'd be confident of your own chances for success. For instance, read this letter from Burke Grieme:—

"My \$23,000 garage and equipment is the result of my course in the Iowa State Auto & Tractor School. I had no gas engine experience, but I had the ambition to get ahead, so I took a seven weeks' course in the Iowa State Auto & Tractor School and went into business for myself. Today I own and conduct a big business."

Master Big Shop Standard Methods in 7 Weeks

Here you get a **thorough, standard, practical training** in the care, repair and operation of autos, trucks, tractors, stationary gas engines and aeroplane mechanics, all in one course—all for one small price. You work with tools and modern equipment—not books. Our test and trouble work alone is worth the price of the entire course. No education or experience required. No age limit. Life scholarships. **Y. M. C. A. Membership** and a night Business Course included—no extra charge.

Big free book—Tells all about the big opportunities of motor mechanics and our practical big shop standards of instruction. Write for it.

F. D. HENNESSY, President and Manager
IOWA STATE AUTO, TRACTOR & ELECTRICAL SCHOOL

739 Nebraska Street,
Sioux City,
Iowa

"The
Quality
School"



F. D. HENNESSY
739 Nebraska St.
Sioux City, Iowa

**Fill Out
and Mail
TODAY**

Name.....
Address.....

Send your **FREE** Book.

Please Mention Popular Mechanics



How to Box 40c

By Terry McGovern,
James J. Corbett,
J. Gardner Smith, M. D., Arthur P.
Keeley and Gus. E. Keeley.

How to Box to Win. How to Build Muscle. How to Punch the Bag and How to Stand, Walk or Run. This interesting book written by experts is known also as "The Book of Health and Strength." It will greatly assist everyone in keeping fit, in putting them in condition to master a strenuous undertaking either physical or mental.

Illustrations. Size 4 1/2 x 7 1/4 in. Paper cover. 135 pages
SHREWBURY PUBLISHING CO.
5525 West Lake Street, Chicago, Ill.

FREE THIS TENSOR BANJO



Become Popular—Play all the Hits
Surprise your friends

No musical
knowledge necessary.
Rush your name and we
will tell you HOW you can get
this Tensor Banjo or any other in-
strument and learn to play at once.

C. Ortol, 15 Park Row, New York

EVERYBODY CAN PLAY

Learn Photography at HOME

Make \$75.00 a Week on the Side

Establish yourself as a Photographic Expert quickly—during your spare time—under a leading photographer. I'll show you how to start your own business—or command a large salary. Send for my unusual offer—It's only temporary. Act at once. A postal will do. **H. H. VANT.**
INTERNATIONAL STUDIOS, Inc.
Dept. 1391, 3601 Mich. Ave., Chicago, U. S. A.



High School Course in Two Years

This simplified, complete High School Course—specially prepared for home study by leading professors—meets all requirements for entrance to college and the leading professions.

30 Other Courses Whether you need High School training or specialized instruction in any trade or profession the American School can help you. Check and mail coupon for Free Bulletin.

American School
Drexel Ave. and 58th Street
Dept. H174A,
Chicago

American School, Dept. H174A, Drexel Ave. and 58th St., Chicago
Send me full information on the subject checked and how you will help me win success.

- | | |
|-------------------------------|------------------------------|
| Architect | Lawyer |
| Building Contractor | Machine Shop Practice |
| Automobile Engineer | Photoplay Writer |
| Automobile Repairman | Mechanical Engineer |
| Civil Engineer | Shop Superintendent |
| Structural Engineer | Employment Manager |
| Business Manager | Steam Engineer |
| Cert. Public Accountant | Foremanship |
| Accountant and Auditor | Sanitary Engineer |
| Bookkeeper | Surveyor (and Mapping) |
| Draftsman and Designer | Telephone Engineer |
| Electrical Engineer | Telegraph Engineer |
| Electric Light & Power | High School Graduate |
| General Education | Fire Insurance Expert |
| Vocational Guidance | Wireless Radio |
| Business Law | Undecided |

Name.....
Address.....

Copyrighted material

Stylish Moleskin Cloth Coat

50¢ Down

\$20.00 Value
Special Price
\$13⁸⁵

Send only 50c with coupon for this coat. Guaranteed rain proof, and is also suitable for stylish top coat. Made from moleskin cloth, a smooth, soft-finished material resembling chamios leather. Warm and comfortable in the coldest weather. Double-breasted belted style with stylish plaited pockets. Strap on sleeve. Yoke back with inverted plait, giving the coat plenty of fullness. Collar can be converted into military style, buttoning close up to neck or worn as shown in illustration. Backed with fancy plaid fast colored woven lining. All seams sewed, strapped and cemented. 45 inches long. Sizes 34 to 46. Rich Leather Brown Shade.

Order by No. F-19. Terms, 50c with coupon. \$2.25 monthly, Total price, \$13.85.

6 Months to Pay

Buy the Elmer Richards way. You can always be well dressed and pay in small monthly sums, so small you will never miss the expense. Money back if not satisfied. No charge for credit. Don't miss this bargain. Supply limited at this special bargain price.

Elmer Richards Co.

Dept. 1771, West 35th Street, Chicago, Ill.

I enclose 50c. Send Moleskin
Cloth Coat No. F-19. Size.....

If I am not satisfied when I receive the coat I can return it and get my payment back with charges. Otherwise, I will pay advertised terms, 50c with coupon, \$2.25 monthly. Total price, \$13.85.

Name.....

Address.....

P. O.....State.....



**Rain
Proof**

—
**Plaid
Backed**

**Mail
This
Coupon
Today**

Write for our
Monthly Bulletin of men's,
women's and
children's
clothing and
shoes. All
your needs
supplied on
small month-
ly payments.

**No C. O. D.
Charges to Pay**

1

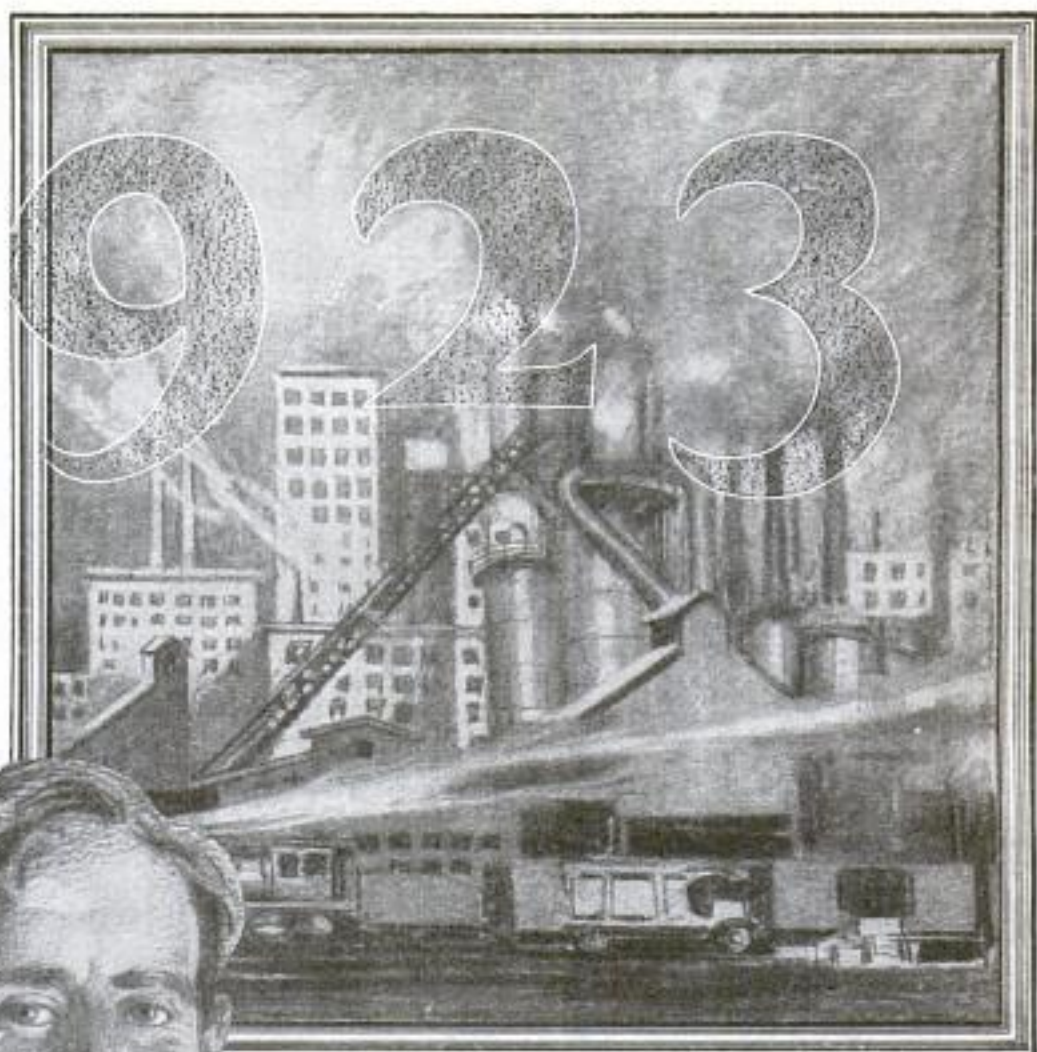

"smiling through"

HARD work and a steadfast faith in the future will fulfill the promise of prosperity to American industry in the year to come, just as surely as they defeated the threat of calamity in the year that has passed.



THE L. S. STARRETT COMPANY
 The World's Greatest Toolmakers—Manufacturers of Hacksaws Unexcelled
 ATHOL, MASSACHUSETTS

408

Popular Mechanics Magazine

REGISTERED IN U. S. PATENT OFFICE

WRITTEN SO YOU CAN UNDERSTAND IT

Vol. 39

763

JANUARY, 1923

No. 1

Magnetic Brake Designed to Stop Airplanes

A MAGNETIC braking device has recently been designed, that has for its object the stopping of airplanes landing on the deck of a ship, the roof of a building, or other limited area. Two somewhat similar schemes are proposed, both of which involve the use of an iron landing platform. In one, electromagnets are

located at various points throughout the iron platform and are energized by turning on the current from an electric generator, in such a manner that adjacent sections are of opposite polarity. Iron-shod skids on the plane are attracted to the platform with a force that can be regulated, and in this manner the

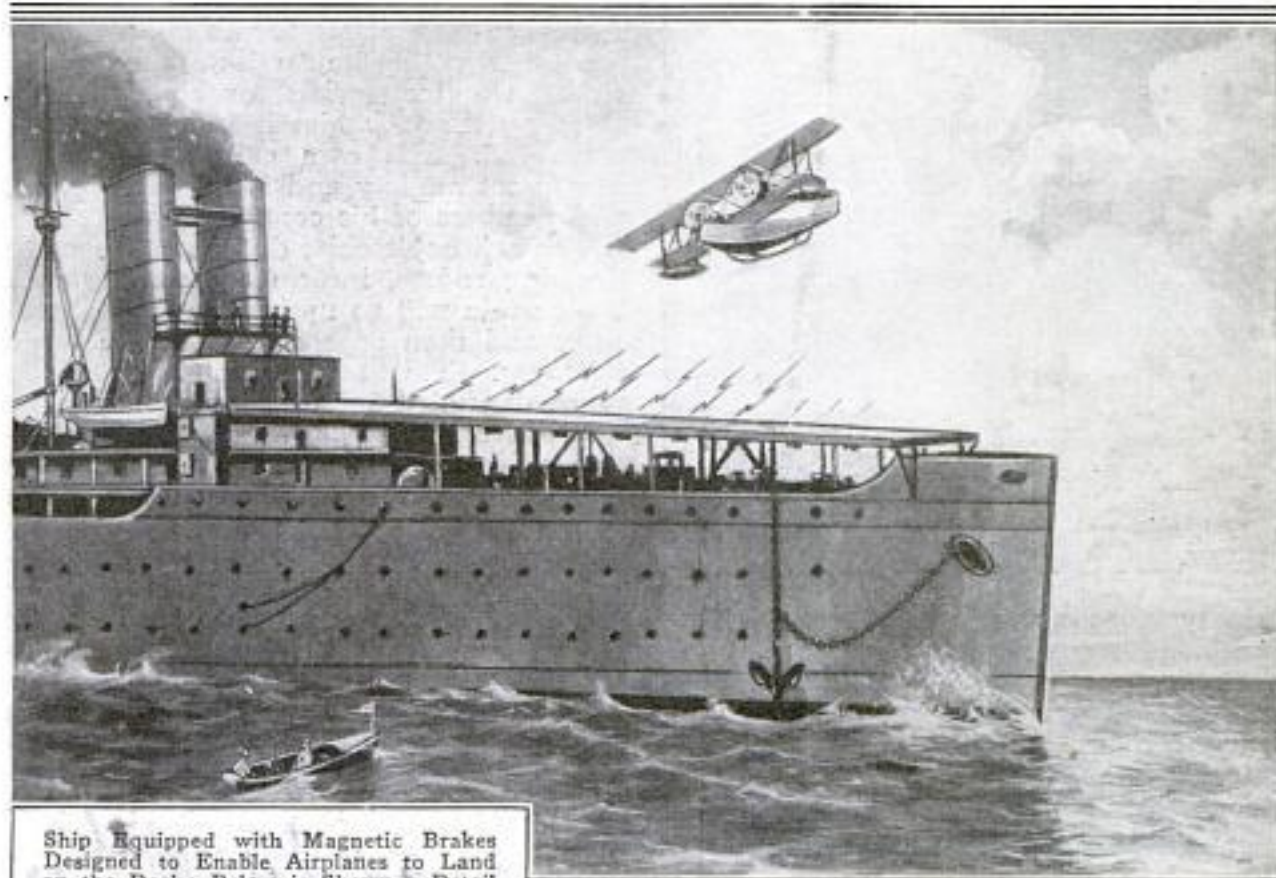

Ship Equipped with Magnetic Brakes Designed to Enable Airplanes to Land on the Deck: Below is Shown a Detail of the Magnetized Landing Platform Which Consists of Adjacent Sections of Opposite Polarity

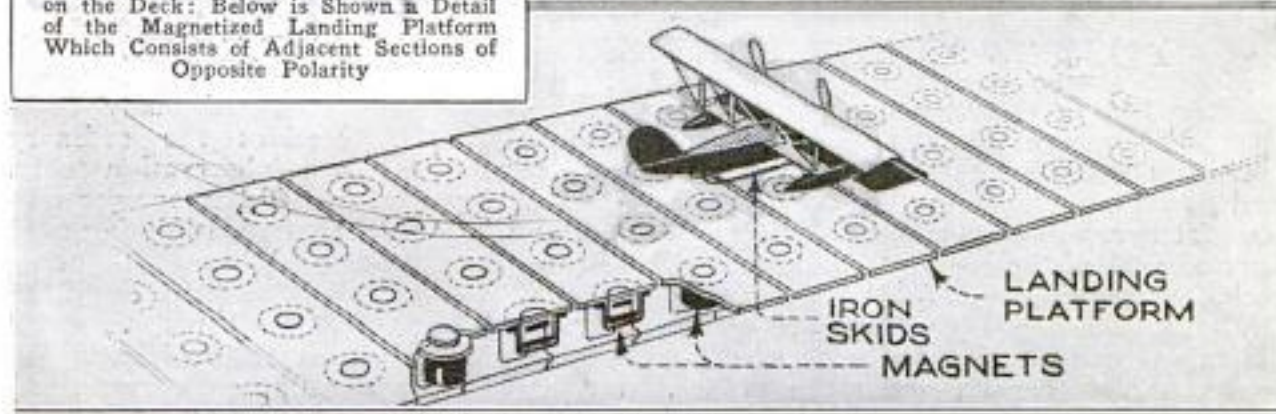

Mr. F. E. Scholfield, Waterford, Conn.

landing of the plane is controlled and checked to within a short distance, depending upon the strength of the magnets. The other scheme contemplates the

use of electromagnets directly attached to the landing shoes, and an electric generator and control system installed in the airplane.

789

RIFLE AND SHOTGUN COMBINED IN FOUR-BARRELED GUN

Four-barreled guns are the latest thing in the American hunting world. Guns of

rifle barrels are placed one above and one below the two shotgun barrels. This type of gun is of particular advantage for hunting in a territory where a wide variety of game abounds. The weight of the guns is about 8½ pounds.

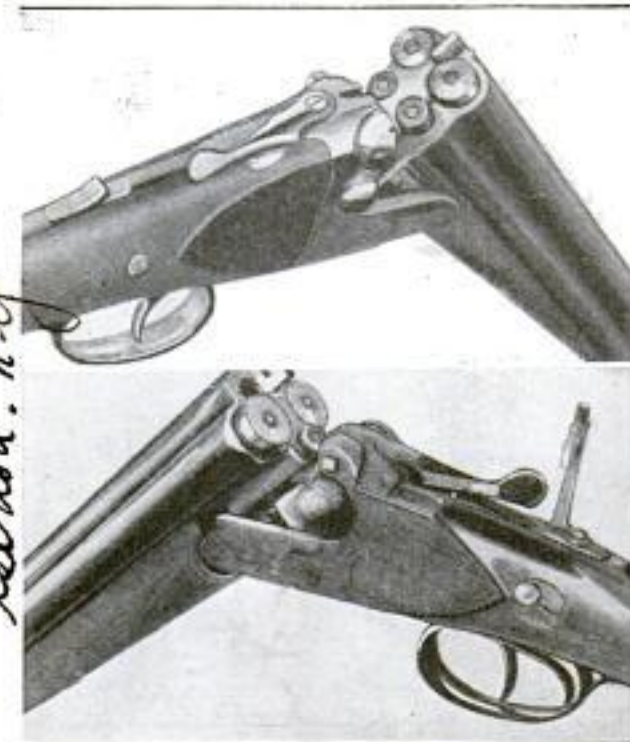

Above: Gun with Two Shotgun Barrels above Two Rifle Barrels. Below: Two 12-Gauge Barrels with a Rifle Barrel Above and Below

this type, as made by an eastern gunsmith, generally have two rifle and two shotgun barrels, although the arrangement is occasionally varied. Two shotgun barrels of the same gauge are usually placed on top, while below them are two rifle barrels, one of high caliber and the other of low caliber. In some designs the

STAGE-TO-DRESSING-ROOM CALL SYSTEM INVENTED BY ACTOR

The call boy, a position that has meant for many actors the first stepping stone on the road to theatrical fame, may be eliminated as a result of an electrical arrangement developed by an actor. This man is so fond of mechanics in an experimental way, that he carries a special tray of tools and materials for his tinkering insisting that for him it is more than a mere fad. His own call system saves him great anxiety and is a benefit to all the members of his company.

The call boy's chief duty is to hurry to dressing rooms, inform the players that the curtain will go up in one or two minutes, and then report back to the stage manager. This actor thought that too much depended upon the reliability of the boy, so he worked out an electric call system using microphones. From his own dressing room he is able to listen in on every word uttered on the stage. Two receivers have been placed in the foot-light trough, one on each side of the stage, and these are wired to his dressing room. Similar connections are made to the rooms of the other leading members of the cast. As the show proceeds from one city to another this equipment is installed, and it is thought that some theaters may make it part of the house equipment.

Stensen Hunter - with movie

POSTAL MOTOR CARS CROSS ALPINE PASSES

After having, some time ago, established a service of automobiles over mountain roads in Switzerland, the federal postal administration has now gone a step farther, and started a similar service over several of the highest Alpine passes, including the Klausen, 6,404 feet, and St. Gothard, 6,936 feet high. In spite of the difficulties to be contended with, such as sharp, narrow curves, and steep grades, these motor cars have been entirely suc-

cessful, and have attracted many additional tourists. Besides the ordinary roadsters, there are observation cars, each equipped with a 40-horsepower motor, and having accommodation for over a dozen passengers, all seated facing forward with an unobstructed view of the scenery. The car has three powerful brakes, and by means of special steering apparatus, takes the sharpest curves without the necessity of backing up.

*Adm. + mfr. Fred Adolphson
Lenora. N.Y.*

645

*New York
Court Theatre
address care of the*

647 Cmt. Marie Widmer
337 Allaire Ave Leonia, N.J.



New Swiss Postal Motor Car on the Furka Road: The Rhône Glacier is Seen in the Background. The Sketch Below Shows Grimzel Pass, an Alpine Road of a Century Ago

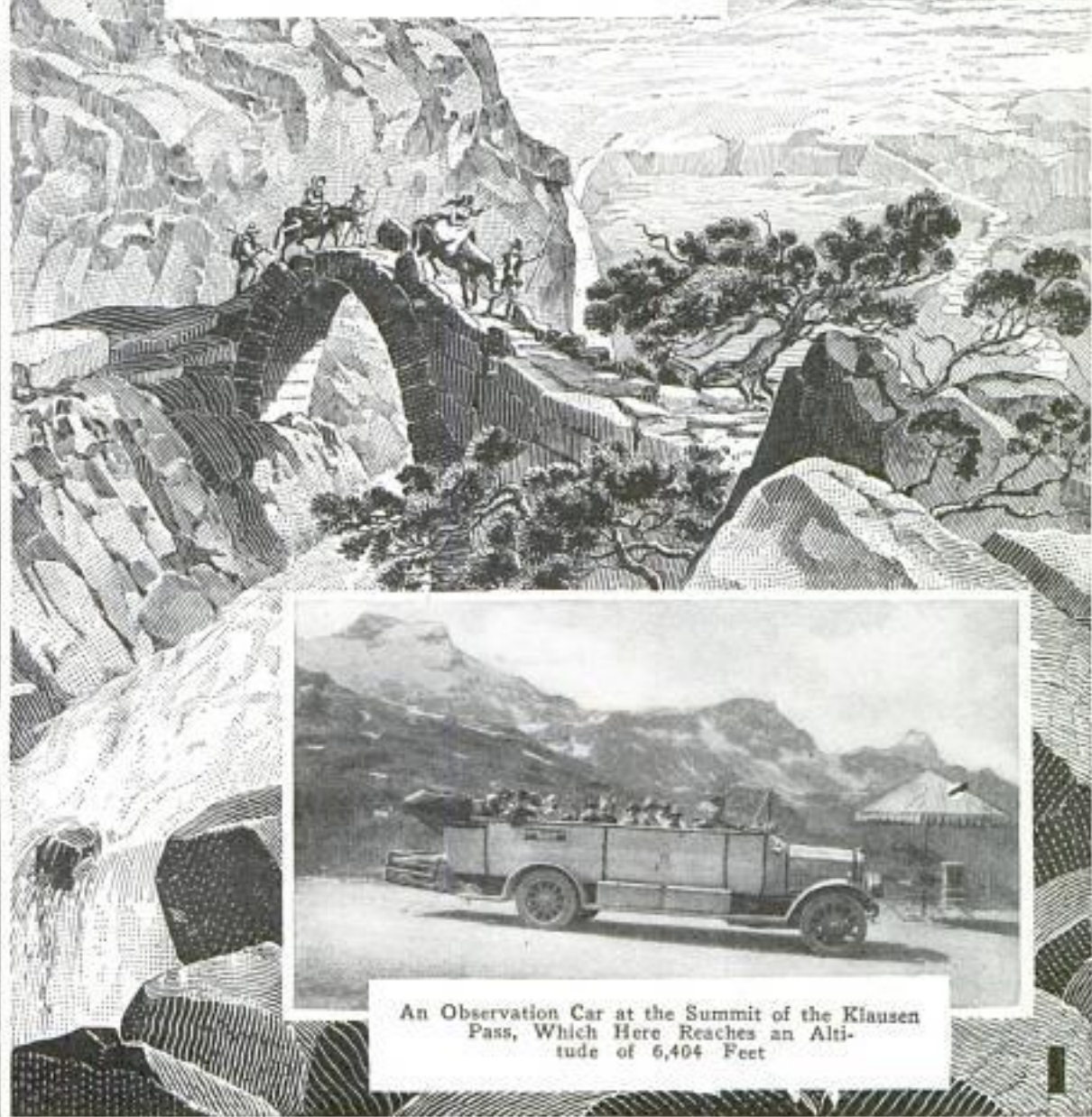

An Observation Car at the Summit of the Klausen Pass, Which Here Reaches an Altitude of 6,404 Feet

6804
Strauss Bascul Bridge Co.
225 N. Michigan Ave.
POPULAR MECHANICS
Chicago

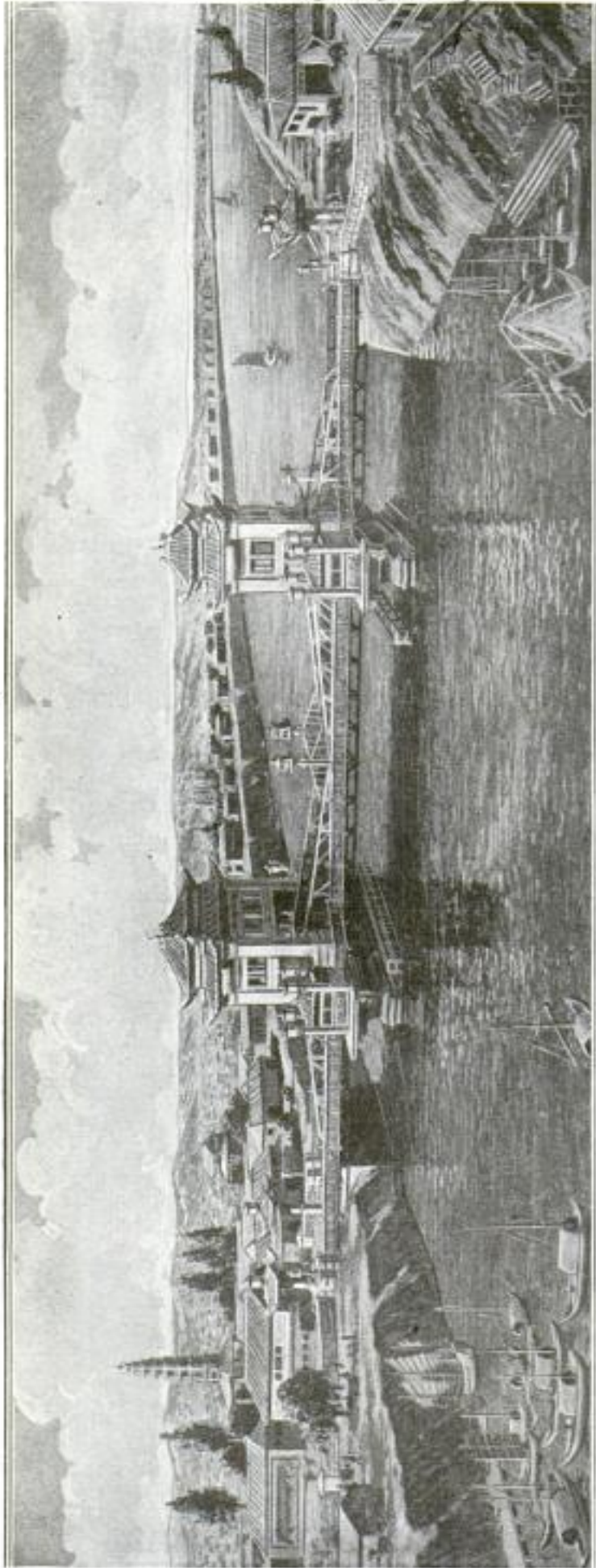

Copyright, The Strauss Bascul Bridge Co.
Modern American Bascul Bridge Adorned with Towers and Ornaments of an Ancient Chinese Style of Architecture, Now being Erected over the Pei River, at Tientsin: The Towers Inclose the Overhead Counterweights That Are Characteristic of This Type of Bascul

AMERICAN BASCULE BRIDGE FOR TIEN- TSIN, CHINA

Now being erected over the Pei River, at Tientsin, China, an entirely modern bridge of the latest American bascule type, adorned with pagoda-like towers and Chinese ornaments, will, when completed, be an interesting combination of the very old with the very new. The bridge will have a total length of 280 feet between abutments, and will consist of a vertical overhead-counterweight double-leaf span in the center, 130 feet long between trunnions, flanked on each side by 75-foot fixed spans. The overhead concrete-counterweight type was adopted because the extreme high-water level is only a few feet below the roadway level. It also furnished an opportunity for suitable Chinese architectural treatment, as the counterweights could be conveniently inclosed in the two pagoda-like towers. The bridge will have a clear roadway, 35 feet wide, and two 7-foot side-walks on the bascule span. A double-track electric railway will be carried in the center of the roadway. Each pier consists of two reinforced-concrete cylinders, 10 feet in diameter, joined at the top by two reinforced-concrete beams with brackets, 21 feet 9 inches long. The operating machinery, which consists of a pinion engaging a curved rack on the bottom chord of the tail end of each truss, is arranged in four units, one at the end of each pier below the bridge floor. Each pinion is driven by a 15-horsepower motor, through a train of reduction gears, and will open the bridge in $1\frac{1}{2}$ minutes. Above the machinery are four operators' houses, from which the bridge can be operated by hand. Normally, both leaves are controlled from one of these houses.

*Genl. Harold F. Blanchard
Tuckahoe, N.Y.*

DUPLICATION OF ELECTROMAGNETIC ATTRACTION

473

BY H. A. LANE

A DUPLICATION of electromagnetic attraction without using the customary coils of wire has been produced and utilized in a practical manner by two Danish engineers, Knut Rahbeck and Alfred Johnsen. Instead of coils, plates are used. One of these plates must be a metallic electrical conductor—iron, copper, brass, or like substance being satisfactory—while the other must be but a partial conductor, such as agate, and covered on the bottom with tinfoil. Apparatus of this description constituted their experimental outfit.

Using this equipment, the engineers connect one wire of an electrical circuit to the tinfoil on the lower side of the agate plate, and the other wire to the metallic plate. When the current is switched on, the plates are attracted to each other. The switching off of the current, however, immediately deenergizes the plates, causing them to assume their natural state. While this instantaneous attraction, or sticking together of

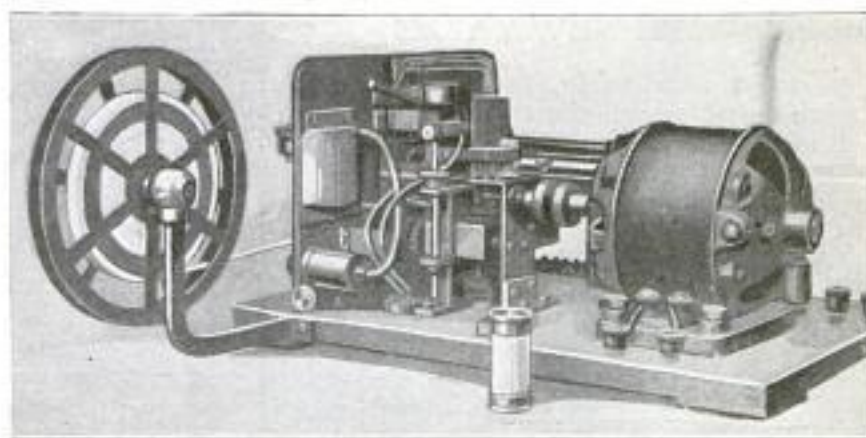

Rapid-Telegraphing Machine Which Prints from 400 to 2,000 Letters a Minute and Which is Based on the Phenomenon of Attraction between a Metal Disk and a Tinfoil-Covered Agate Plate

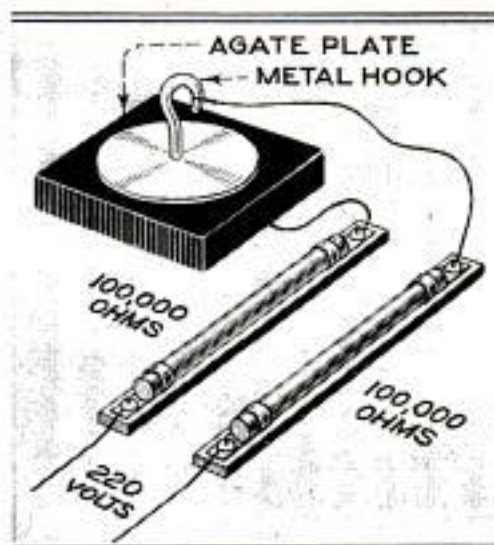

Crude Apparatus Which Constituted the Experimental Working Outfit: A Very Small Current Suffices to Produce the Nonmagnetic Attraction

the two bodies, is not a discovery nor an unfamiliar phenomenon, the adaptations to which this principle has been put by the two men are interesting.

One of the adaptations of this property has resulted in the production of a rapid-telegraphing machine, with which it is possible to attain a speed of 400 to 2,000 letters a minute. Another use is that of amplifying telephone messages. Wireless is also included in the list of possibilities which the utilization of this attraction has aided. Although development of the idea has progressed but little past the experimental stage at present, work is constantly being carried on with this principle as its basis.

□ To eliminate the unsightly appearance of black lines resulting from the use of the common bituminous fillers for cracks and joints in concrete pavements, a substitute concrete-colored filler has been developed by the U. S. Bureau of Public Roads. The filler consists of a mixture of resin, crude rubber, and sufficient barium sulphate to give the desired color.



Two Views of an Adaptation of the Attraction Principle, in Which the Sound Box of a Mandolin, with Other Equipment, is Used for the Transmission of Musical Tones

Acquired by Mr. Enck F. North St. Petersburg, Conn.

772
6
I no. F. B. Isilbreth.
68 Eagle Rock Way,
Montclair N.J.
POPULAR MECHANICS

W. F. Mangelsdorf
State Chemist
Little Rock
Ark.

CORRECT POSTURE POSSIBLE WITH NEW TABLE

785

With a new table, for the design of which a noted efficiency engineer is responsible, it is possible to assume a sci-



This Convenient Reading or Writing Table can be Tilted at the Proper Angle for Fatigue Elimination and for Comfort

entifically correct posture. It forms part of a deep, comfortable rocking-chair, and is intended to be tilted to a convenient angle so as to relieve the strain upon the muscles and eyes usually following upon the constant shifting of position when writing or reading at the ordinary table.

BINDER-TWINE CUTTER AIDS GRAIN THRESHING

785

A novel device for cutting the twine with which bundles of grain are bound, is intended to be worn on the worker's left hand. It consists of a leather sheath to which is attached a copper support for a detachable and highly tempered steel



Above: Close-Up of Twine-Cutting Device Worn on the Left Hand. Left: Twine-Cutter, Showing How the Worker Use Both Hands to Tie the Bundles

blade having a saw-tooth edge so shaped that the twine is cut with little effort. The worker thus has both hands free, and is not so likely to cut himself as with the ordinary loose knife.

ADDED ODOR GIVES WARNING OF GAS DANGER

In order to render the escape of natural gas readily detectable, experiments have recently been made at Little Rock, Ark., for the purpose of finding a suitable substance to give the gas a distinct odor. A formula has finally been worked out, and the substance prepared from it is reported to be odoriferous, harmless, and with no effect upon the gas except as a mark of identification.

NONSLIPPING SPIKED SHOE

726 NOW WORN BY FIREMEN

All of the \$5,000,000 worth of army buildings at the Presidio, San Francisco, have steep shingle roofs, and to enable army firemen to climb these roofs with



Safety Sandal for Slipping over the Shoes of Firemen: The Sharp Metal Spikes Prevent Slipping

out danger of falling, the fire chief has designed a safety sandal that can be strapped over the shoes in five seconds while on the way to a fire. The sandal is provided with a thick leather sole that covers all but the heel of the shoe to which it is strapped. In this sole are a number of sharp metal spikes that penetrate the wooden shingles, and prevent any possibility of slippage.

Scientists have developed a process for extracting from wheat the vitamins and mineral salts that constitute its most valuable food elements. The vitamin extract can be used for increasing the food value of any article of diet, but is primarily intended for making whole-wheat bread of pure-white color.

Chemists from Ward Baking Co. New York, and various Universities.

Paul Avond 7, Rue de la Prairie,
Champigny-sur-Marne,
Seine France

Dr. Charles Sherman, U.S. Army,
Presidio, San Francisco, Calif.

A PLAGUE-PROOF CITY IN INDIA

*By J. H. Stephens 12 Cubbin
Road, Bangalore, South India*

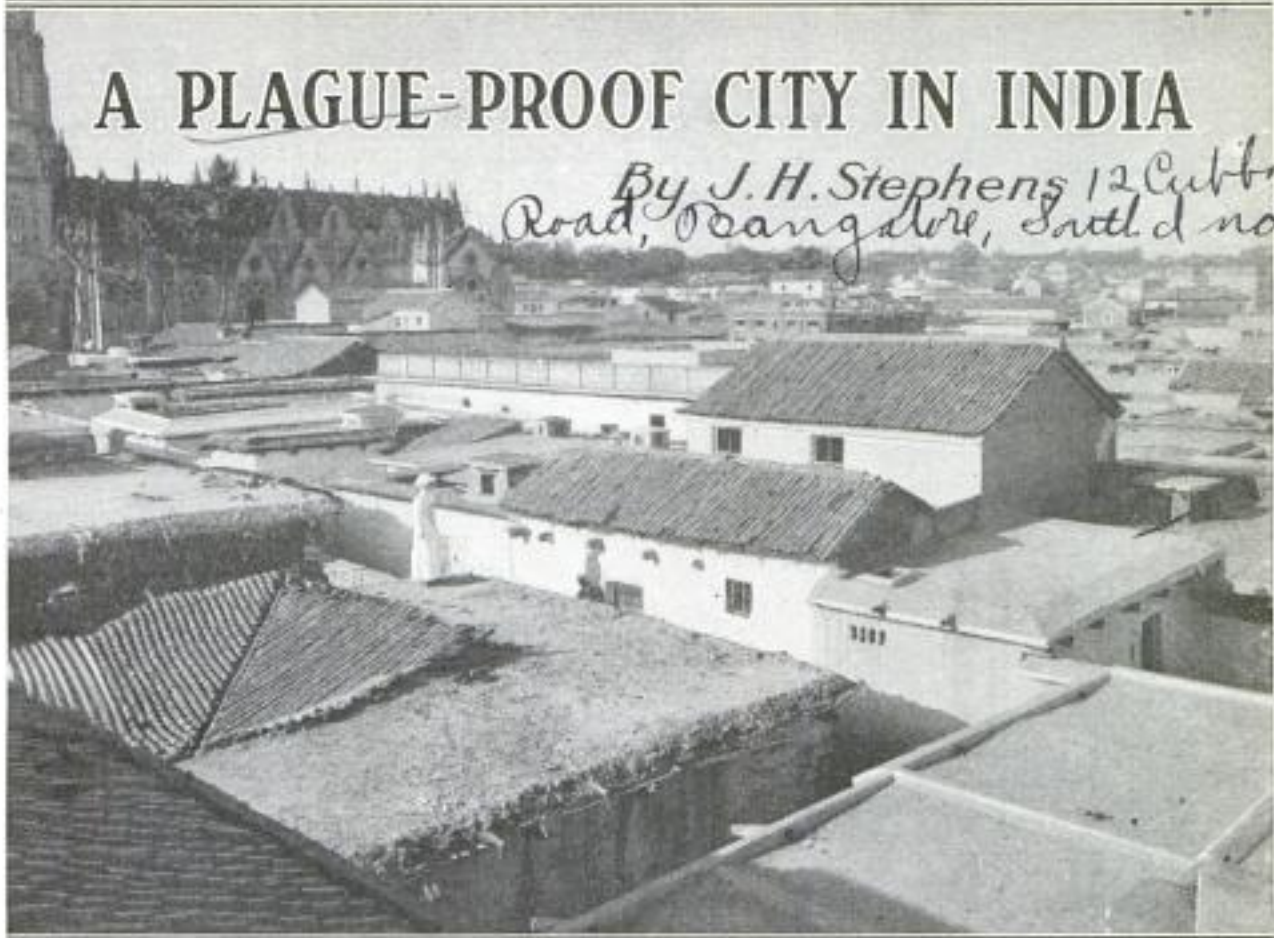

Part of the Native Indian City of Bangalore, Showing the Congestion of the Low, Mud-Roofed Houses: This Is One of the Sections of the City Where Plague Is Most Prevalent, Resulting from the Absence of Fresh Air and Sunlight. The Streets Are Narrow and the Houses Are Overcrowded

The author of this article—Mr. J. H. Stephens, of Bangalore, S. India—was engineer to the plague department from 1898 to 1912, and consequently had special facilities for studying plague in all its phases.—Editor.

ALTHOUGH Europe had suffered from many visitations of plague before and during the Middle Ages, it was not until the nineteenth century that plague came to India.

This was due to the prevalence in India of the ancient caste system of the Brahmins, which resulted in separation and segregation. The higher castes lived apart from the lower castes, and between each of such segregations open spaces were left which allowed the circulation of fresh air, and provided



An Indian Female Deity being Carried in Procession, Accompanied by Tom-Toms, and Whose Aid is Invoked during Visitations of Epidemics

for expansion without congestion. Thus, unwittingly, the caste system adopted one of the most effective measures for preventing the spreading of disease.

Under British administration, caste rules were less strictly observed, and the different castes tended to converge, whilst congestion increased, resulting in the first appearance of plague in the city of Bangalore, capital of the native state of Mysore, South India. It broke out first in the most congested quarter, where sunlight and air were

827



Part of the Plague-Proof Settlement, Showing a Number of Small Detached Houses, Some Finished and Some Still under Construction: This Part of the Settlement Is for Occupation by Poor Natives, and Is as Uncongested as the Richer Quarters. Each House Stands on a Site One-Twentieth of an Acre in Extent, and of This Area Only One-Third is Occupied by the Building

excluded or polluted. The natives were used to cholera and smallpox, but this new disease appalled them, and they appealed to their trusted friend, the British government, for help.

Then rational and preventive means of stamping out the disease were sought for. It was found that plague often appeared and reappeared in the same house. Upon carefully examining such houses it was observed that their locations were damper than those of more immune houses. It had already been found in Bangalore that moisture is one of the contributing causes of plague. In dry weather the disease will almost entirely disappear, reappearing immediately in wet periods, when it is at its worst. In other parts of India the disease acts differently, but in Bangalore it was found that while deficient sunlight and air were causes of the plague, the nature of the soil has also a great deal to do with its mitigation or the reverse.

In seeking a permanent preventive of plague it was found that the disease had a peculiar affinity for rodents, and the house rat, being the commonest rodent, becomes its first victim. The fleas from the dead rat carry it to human beings. The rats, however, although they were the first victims of the disease, were not its first cause. This was found to be the absence of light and air that resulted from congestion. The first remedy to be adopted, therefore, was to find a place where neither of these conditions would exist.

As a first step in this direction, about 50 acres of agricultural land, with open ground all around it, was acquired on the outskirts of Bangalore, and this was laid out as a new plague-proof settlement. The roads and streets were made very wide for India, and were sunk about 18 inches below the ground level. Thus the building sites between the roads and streets were in the form of elevated platforms, which kept the houses high and dry and free from dampness and moisture during the wettest season. Small detached houses for the poor were erected with open yards around each house. The site of each building was one-twentieth of an acre, and was di-



A Congested Part of the City of Bangalore Which has been Greatly Improved by the Removal of Some of the Small Overcrowded Houses, Thus Allowing the Admittance of Fresh Air and Sunlight to the Remaining Houses: This Was a First Means of Plague Prevention

vided into three parts, only one of which could be built on, the other two parts being left as an open yard. This made the new town not only plague-proof, but also a particularly healthy and agreeable place to live in. The town has become very popular, and is financially a great success, spreading rapidly in every direction. The little houses are all built on raised foundations with basements $1\frac{1}{2}$ feet high and with hard floors and roofs to make them proof against invasions by rats and aid in keeping the houses dry. This measure was first met with opposition on the part of the natives, who considered a raised house destructive of the privacy they de-

mand for their women, but this gradually subsided. This town has been under careful supervision for several years and it has been found to be quite plague-proof.

Bangalore has now learned that plague is a preventable disease, and that its bitter experiences of the past could have been avoided if overcrowding had been checked and kept under proper control.

Younger cities may learn valuable lessons from these experiences. Cities are going to expand more rapidly in the future than in the past, and if nature's laws are strictly observed, a healthier race of city population will come into being.



The Indian Method of Disposal of the Dead: At the Left is Shown the Manner of Carrying the Corpse to the Hindu Cemetery. Upon Its Arrival There, It is Laid on the Funeral Pyre. To the Right, the Pile of Wood has been Set on Fire

**PUNCH PRESS OPERATIVE
 BY FOOT OR POWER**

791

A small punch press that, by changing the position of a bolt with a screwdriver,

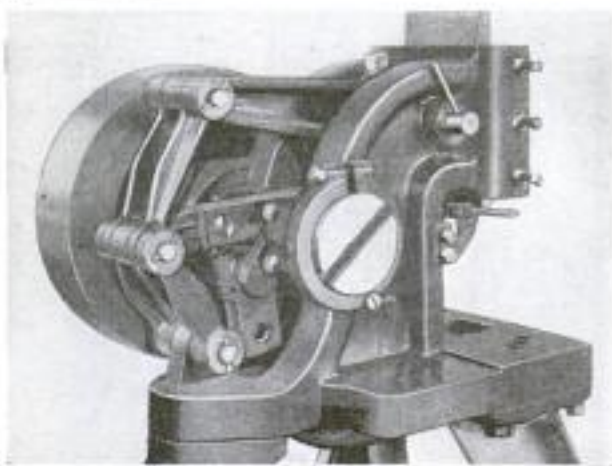

Combination Punch Press: By Changing the Position of the Bolt with the Slotted Head, the Press can be Operated Either by Foot or by Power

can be converted into either a foot or power press, has recently been placed on the market. It has an actuating mechanism of the pendulum type, and when operated as a foot press, the bolt is positioned so as to put this in connection with a swinging foot lever. By changing the position of the bolt, the pendulum is put into operating connection with the belt-driven flywheel, which is 12 inches in diameter. The stroke of the press is 1 inch, and the ram can be vertically adjusted.

**SELF-ALINING AND CENTERING
 INSIDE MICROMETER GAUGE**

799

Specially designed for gauging automobile cylinders quickly and accurately, a

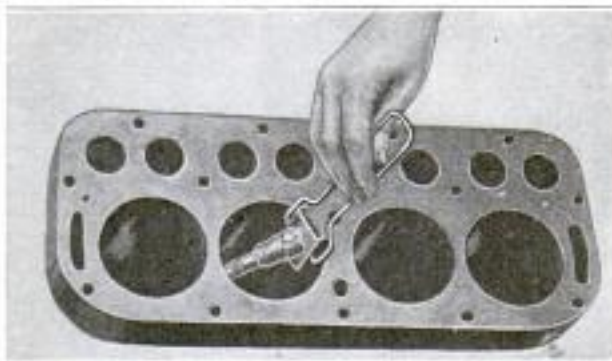

Self-Alining and Centering Inside Micrometer Gauge being Used to Measure the Bore of a Cylinder: The Small Setscrew Is for Locking It before Removal

self-alining and centering micrometer and height gauge consists of a micrometer body that has a sliding fit in the bushing

*L. D. Beard Tool Co.,
 Lancaster, Pa.*

of an alining base. This base is so constructed that it can be moved along the cylinder wall by means of a wire handle, and a downward pressure on this accurately centers the tool. The spindle of the micrometer is then screwed out until it touches the opposite wall of the cylinder, giving the exact diameter on the thimble, which is graduated in thousandths of an inch.

**700 COMBINED LOCK AND ALARM
 HAS BELL AND LIGHT**

Protection against burglars or other prowlers is provided by a combined lock and alarm in which are incorporated wiring connections for an electric bell and light. The lamp and gong may be mounted a considerable distance from the lock, and the wires extended to them. When anyone inserts a key into the lock or otherwise tampers with the bolt after the alarm has been set, current supplied from

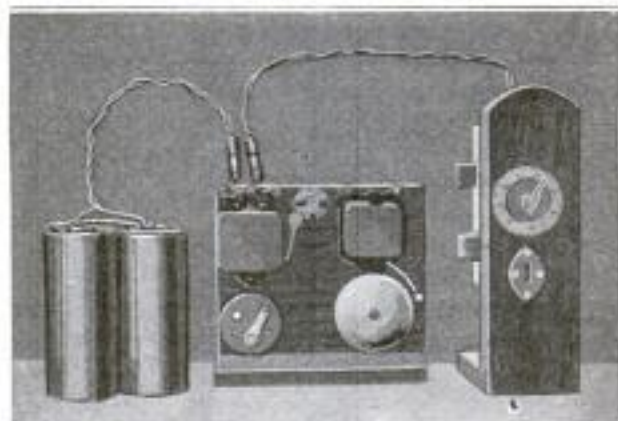

Combined Lock and Alarm, Showing the Batteries on the Left, the Alarms with Selective Switch in the Center, and Lock at the Right

a bank of batteries immediately causes the bell to ring or the lamp to light.

**736 COLLAR SAVES SUCKLING PIGS
 FROM SUFFOCATION BY SOW**

A collar, in connection with a body band studded with pointed steel bosses, has been devised for strapping onto the body of a suckling pig to prevent it from being smothered by the sow. The points prick the sow if she lies on the young pig, causing her to release it.



*d.w. Lyman Arkfeldt,
 A. F. W., Norfolk, Neb.*

759

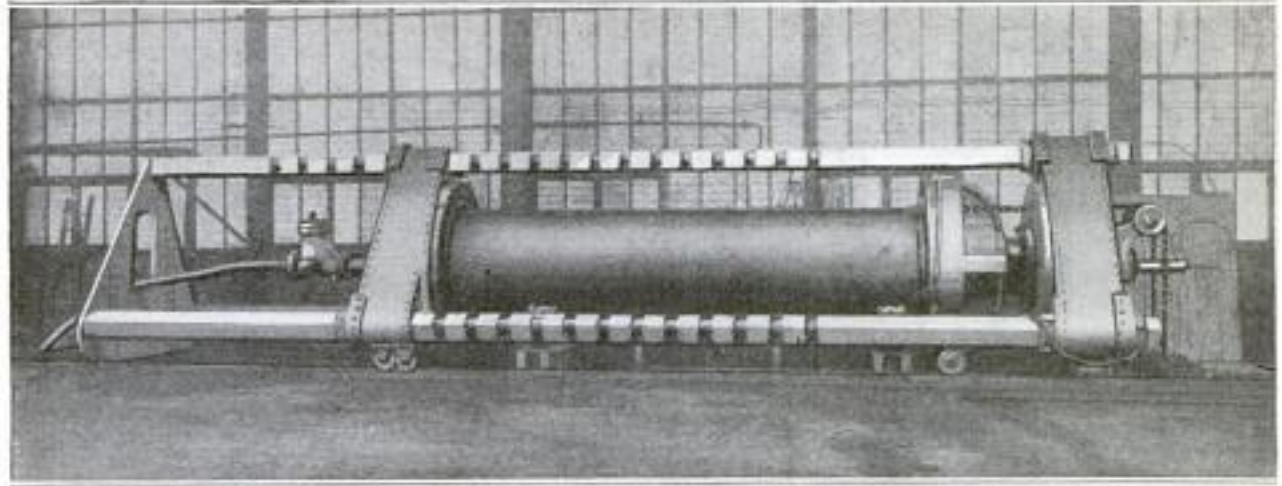

Hydraulic Testing Machine for Large Welded-Steel Pipes, Built in England, Where These Pipes Are in Extensive Use in Water Mains: The Pipe Shown under Test Is 16 Feet 6 Inches Long, 48 Inches in Diameter, 1/2 Inch Thick, and is being Tested at a Pressure of 260 Pounds per Square Inch

759

HYDRAULIC TESTING MACHINE FOR WELDED-STEEL PIPES

As welded-steel water mains are coming into extended use in England, a hydraulic machine has been specially designed there for testing the pipes of which such mains are composed. The pipe sections are of exceptionally large diameter and length, and the testing machine will admit a pipe up to 6 feet in diameter with a length of 25 feet, and will apply a pressure on the pipe up to 300 pounds per square inch. The machine is composed of two large triangular heads built of riveted plates, and stiffened so that they are exceedingly strong. The heads are tied together by three large square bars that have recesses along their entire lengths for holding stop blocks by which the machines can be adjusted for various lengths

of pipe. The pressure is applied hydraulically, sometimes subjecting the heads to a thrust of nearly 400 tons.

796

COMBINING POTATO DIGGING AND LOADING IMPLEMENTS

In potato harvesting, by connecting a loader to the rear of a digger, both being hauled by a tractor, the potatoes can be dug and loaded simultaneously into a horse-drawn wagon moving alongside the combination. One of the two potato elevators of the loader is arranged to dump the potatoes into the wagon. These elevators are constructed with separated steel slats so that any dirt left on the potatoes will fall to the ground. The elevators are driven by a system of sprockets and chains in connection with the wheels of the loader.



Combined Potato Digger and Loader Drawn by a Tractor and So Arranged That the Potatoes can be Dug and Loaded Simultaneously into an Accompanying Wagon: This Combination, Moving at a Speed of Three Miles an Hour, can Dig and Load Approximately 800 Bushels in a 10-Hour Day

Loader - Holt Mfg. Co. 417 Washington Ave. N.
Minneapolis, Minn.

Digger - Eureka Mower Co., Ittica, N.Y.

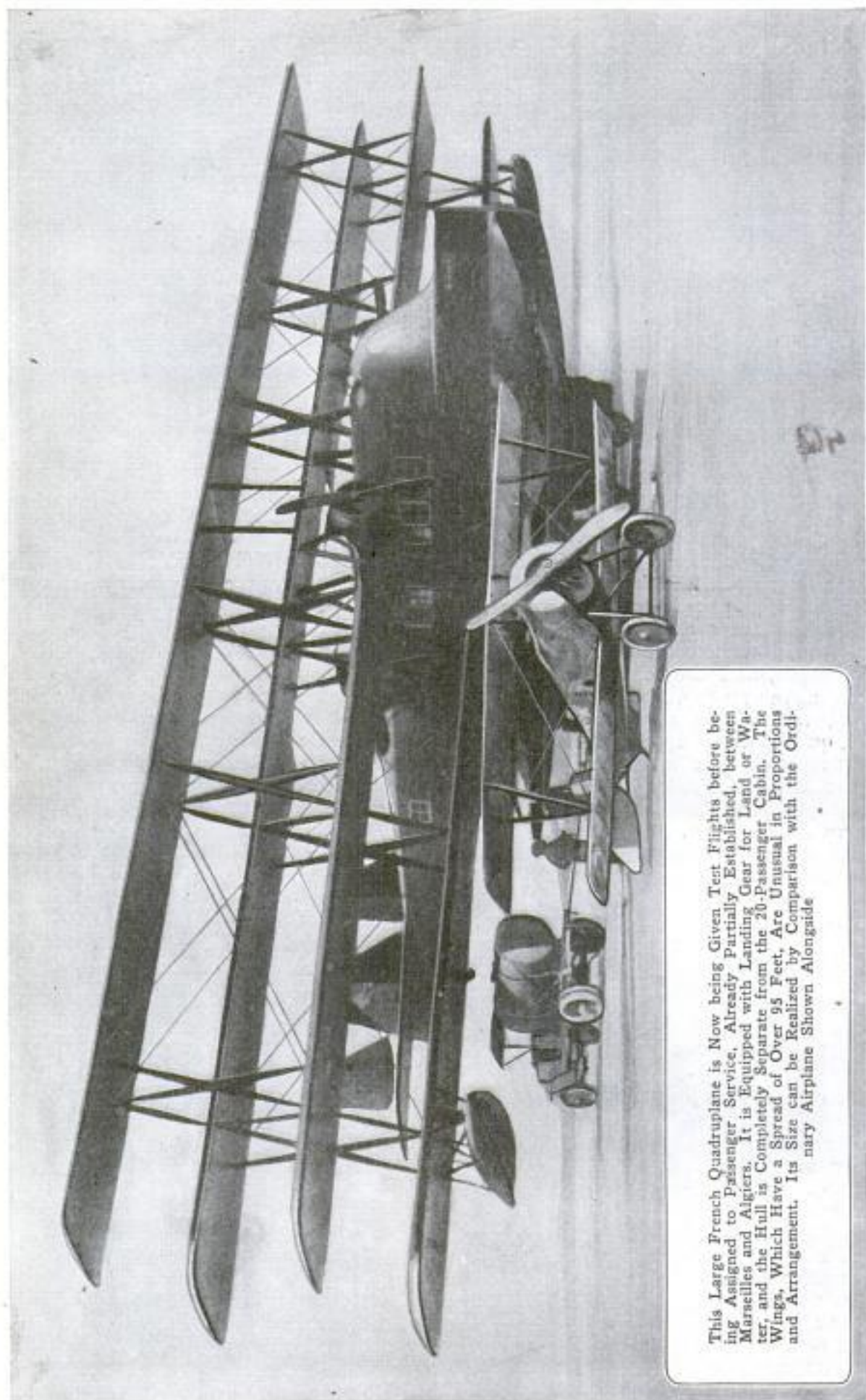

This Large French Quadruplane is Now being Given Test Flights before being Assigned to Passenger Service. Already Partially Established, between Marseilles and Algiers. It is Equipped with Landing Gear for Land or Water, and the Hull is Completely Separate from the 20-Passenger Cabin. The Wings, Which Have a Spread of Over 95 Feet, Are Unusual in Proportions and Arrangement. Its Size can be Realized by Comparison with the Ordinary Airplane Shown Alongside

870

Marcel Besson
Saint Raphael France
POPULAR MECHANICS

13
1913

FRENCH QUADRUPLANE HAS ORIGINAL FEATURES

A new type of giant flying boat, now under test in France, preliminary to its use in an already partly established passenger service over the Mediterranean, embodies many radical features of design. The V-bottomed hull is designed for rough seas and is completely separate from the cabin which seats 20 passengers. The four alternately staggered wings, each fitted with ailerons and having a width of only 6 feet 10 inches to a span

652

of 69 feet, are also unusual. The double seat for the pilots, located in the forward end of the fuselage, is accessible from the cabin and is provided with twin controls. There is also a signaling system to the engine room, similar to that on board steamships. The total weight of the airship is slightly over 10 tons and it is powered with four 250-horsepower engines arranged in two groups, connected to the two propellers.

Mr. Hope, U.S.A.

MACHINE TRIMS AND PASTES WALLPAPER

A new machine is said to have a capacity of trimming and pasting a roll of wallpaper in three minutes. A roll of paper is mounted underneath the table and near one end of the machine, and the paper which is fed from it passes under a guide roller to the top side of a paste roller. It is then led around another and larger roller, where the surplus paste is wiped off by a brush, and the selvage trimmed off by a revolving cutter. The paper is finally drawn back over the table and cut.

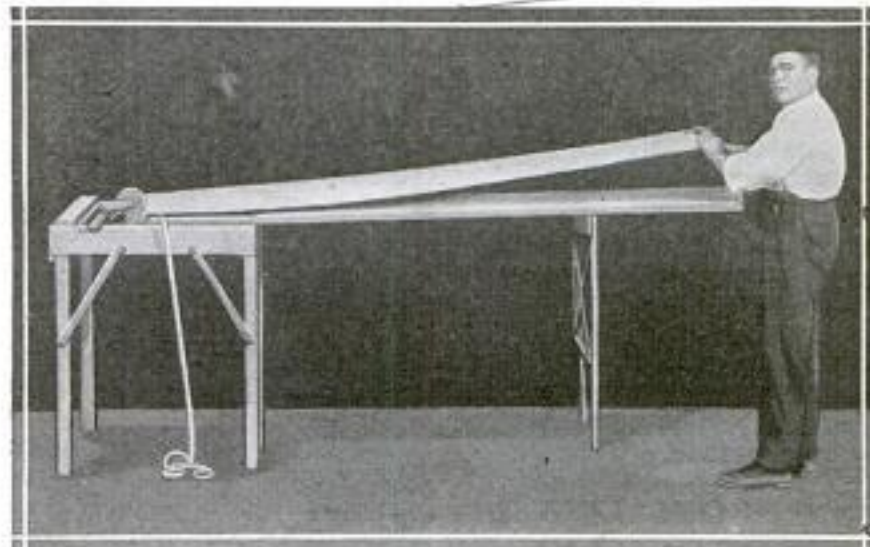

New Machine Which Trims the Selvage with a Revolving Cutter, Applies the Paste, and Wipes the Surplus from the Wallpaper as the Sheet is Pulled through the Rollers: It is Said to Have a Capacity of One Roll of Wallpaper in Three Minutes

Dr. E. Kelly

454



Portable Air-Compressor Unit Driven by a Gasoline Engine, Arranged to Give a Power Impulse to Each Compression Stroke of the Compressor

PORTABLE COMPRESSOR OF UNUSUAL DESIGN

A portable air compressor that is of different design from the ordinary units for similar service, provides two gas-engine cylinders direct-connected to each compressor cylinder, arranged to give a power impulse to each compression stroke of the compressor. The crank arrangement enables the maximum mean effective pressure of the engine to be applied against the heaviest part of the air-compression stroke, and the absence of gears or other transmission devices reduces frictional losses to a minimum. These units are supplied in three sizes, suitable for different capacities.

Domestic Engine & Pump Co.
Shippenburg, Pa.

Copyrighted material

NOVEL MEANS USED TO RECOVER BODIES FROM WELL

676

A fine example of resourcefulness was given in the recovery of the bodies of two men asphyxiated at the bottom of a 60-foot well, which accidentally filled with gas while being sunk. One of the men was overcome, and dropped from a rope into the well when he went to investigate the disappearance of the other. A threshing-machine blower with an automobile engine as motive power, was then rigged up to clear the well of gas, after which ropes were lowered and the bodies were brought to the surface.

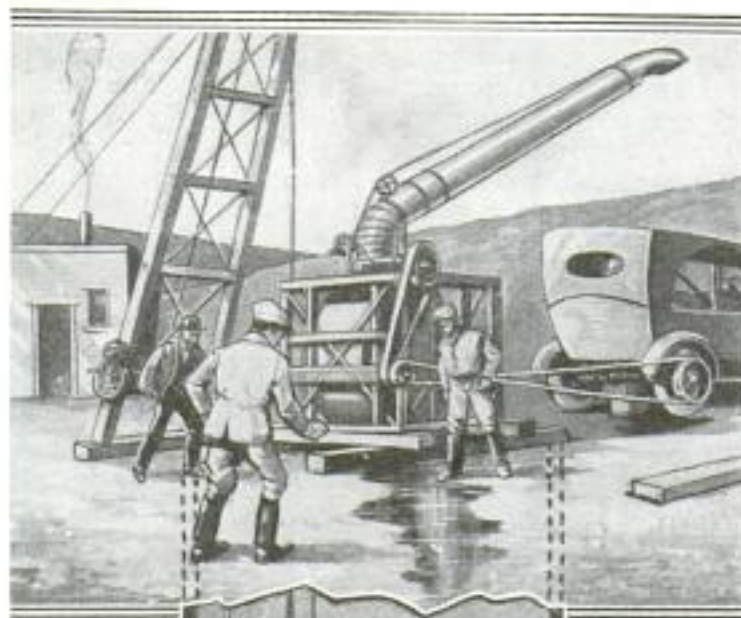

This Illustrates How a Threshing-Machine Blower, Driven by an Automobile Engine, was Used to Purge a Gas-Filled Well from Which It was Desired to Remove the Bodies of Two Men Asphyxiated There

tively toward the American and European coasts. The American larvæ reach their destination in one year, whereas it takes the European species three years to complete their migration. In each case, the

larvæ require about 10 months to develop into young eels, or "elvers," and to prepare to make their way, as they do at the end of that time, up the rivers to the most remote inland pools. An extraordinary feature about these migrations is that, though the larvæ of the two species breed on the

same spot, and are actually sometimes taken in the same net, no American larva ever starts for Europe, and no European for America. The American species completes its larval stage, when it must get into fresh water, in about one year, and if it started for Europe it would still be in the middle of the Atlantic when this condition is reached. If the European species went to America it would have to float about the coast for two years. By some marvelous instinct each species unerringly goes in the right direction. In both cases, after their arrival in inland fresh water, they remain there until they become mature, at about the age of six years, when they return seaward in winter, traveling about 10 miles nightly, until they reach their old breeding grounds, where, in their turn, they propagate new larvæ, and where they remain for the rest of their lives. These curious facts have been ascertained by Dr. Johannes Schmidt, a Danish zoölogist, after years of investigation.

STRENUOUS LIFE OF THE EEL IS AN INTERESTING STORY

751

There is a slight difference between American and European eels, but the interesting story of their curious lives seems to be about the same. These apparently sluggish creatures go through the most strenuous experiences imaginable, at least in their youth. The larvæ of both the American and the European eel are born in the spring at the bottom of the Atlantic, at a depth of about 1,000 feet, on a limited tract about 500 miles northeast of the Leeward Islands, approximately 2,500 miles southwest of England and, of course, very much nearer to any part of the American coast. During the first summer of their lives, the larvæ move up toward the surface, and in their second summer they start to migrate respec-

Manchester Guardian
10/6/22

522

Owned by Dredging Service Dept. of Army, U.S.

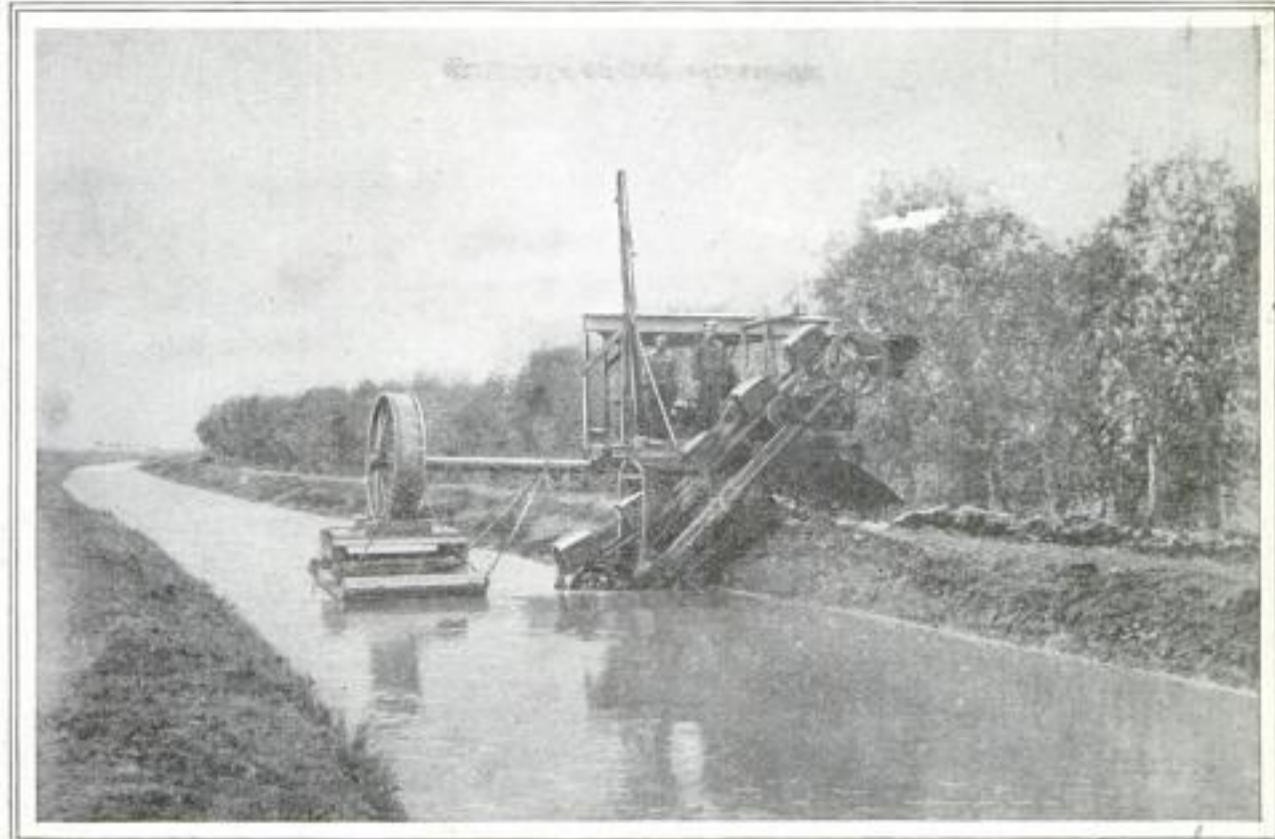

TRAVELING DREDGE OPERATES FROM BANKS OF CANALS

Machinery

THE most recent development in methods of keeping irrigation ditches and canals clear of the silt, is the use of a type of dredge that operates from the banks of the canals. A pair of endless chains with dredging buckets, such as are used on excavators, is mounted on a saddlelike support that hangs over the canal bank and reaches below the surface of the water. In connection with this, on the bank side, are two wheels, one in front for steering, and another in the rear which is the traction wheel. A third wheel is on the end of a heavy axle that reaches the opposite bank in narrow canals, or is supported on a barge in wider ones.

569

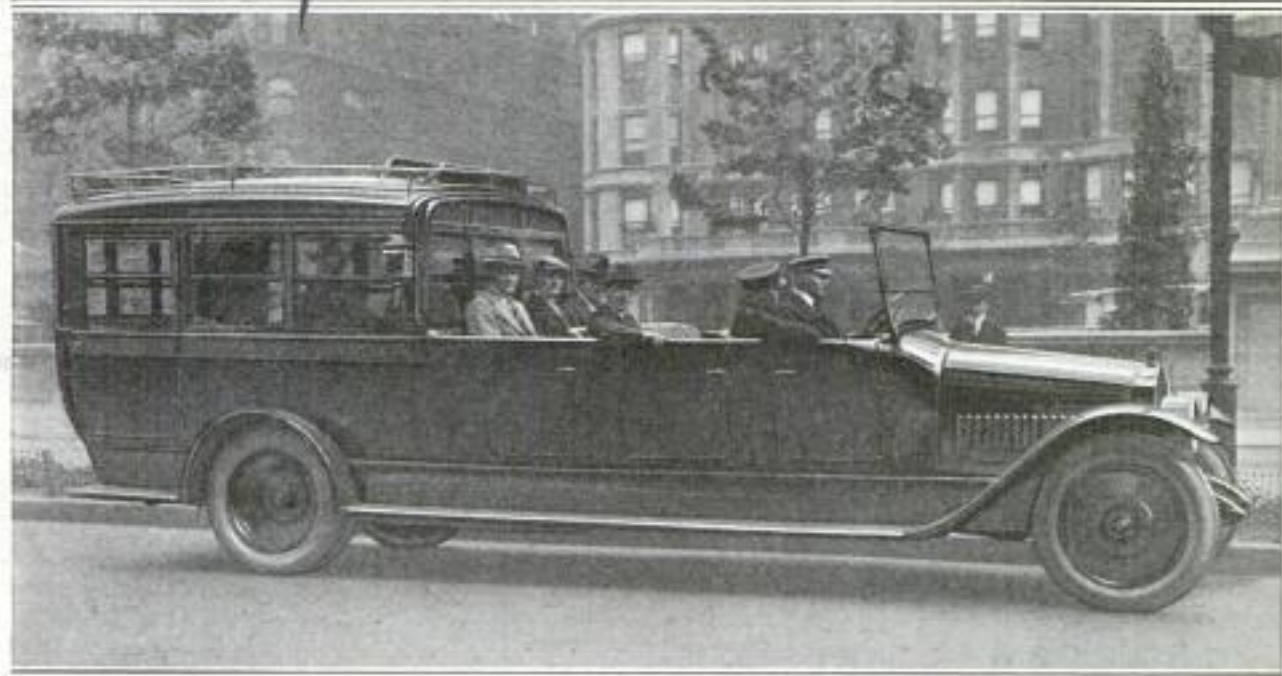

DRAWING ROOM INCORPORATED IN MOTOR BUS

DRAWING ROOM seats are a feature of one of the latest motor busses to be placed in service in Chicago as shown in the accompanying picture. The passenger capacity of the vehicle is 25 persons, of which 13 may ride out in the open air at the front, the remaining 12 occupying the richly upholstered drawing room at the rear. The front seats extend across the car, facing forward, while the seats in the closed compartment are arranged so that the occupants face each other. Around the edge of the drawing-room roof is a guard rail which provides a convenient place to carry the passengers' baggage.

White Motor Co., Cleveland, Ohio. Copyright material

"MAJESTIC" NOSED TO A PIER BY EIGHTEEN TUGS

ON a recent occasion, because of exceptionally high wind and tide, 18 tugs were required to nose the "Majestic," the largest ship afloat, into its berth on the North River, in New York City. Nine tugs were lined up on each side of the huge vessel. With large fenders on their bows, they gradually brought the "Majestic" alongside the pier.

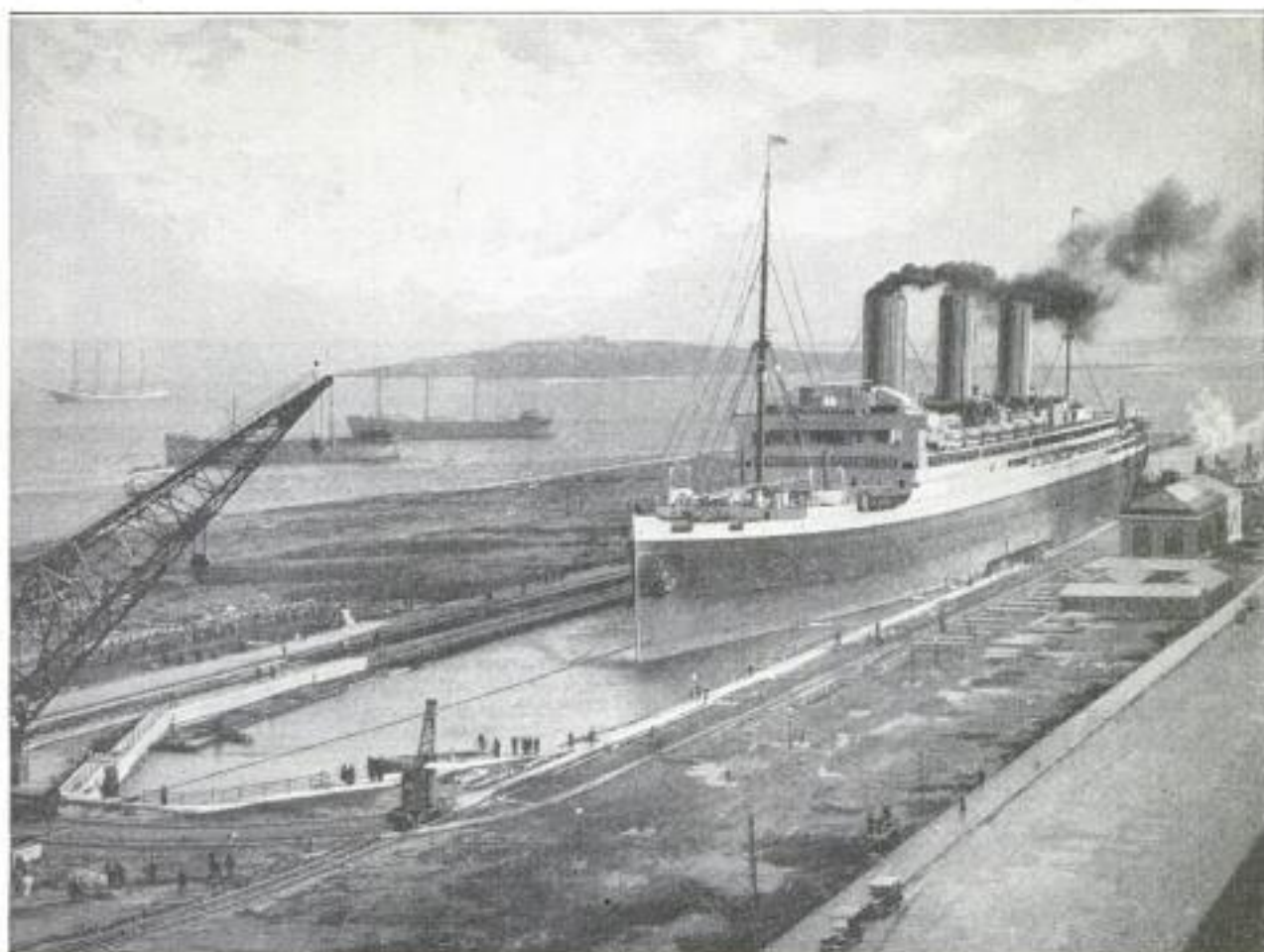

The World's Largest Steamship, the "Majestic," Shown Entering the World's Largest Drydock at Boston, Massachusetts: The Vessel Remained in the Dock for a Few Days Undergoing Repairs. The Dock Is 244 Feet Longer and 49 Feet Wider than the Largest Ship Afloat

890
**WORLD'S LARGEST STEAMSHIP
 DRYDOCKED AT BOSTON**

The White Star liner "Majestic," the world's largest steamship, was recently placed for repairs in the world's largest drydock, at Boston, Mass. This dock, which is 1,200 feet long, 149 feet wide, and 45 feet deep, and is one of a number of water-front improvements that has added greatly to Boston's shipping facilities, was completed during the war, and sold to the government in 1919. At the time the "Majestic" was docked in it, it was supposed to be the only drydock in the world large enough to accommodate this vessel. This aroused some controversy in England, and the Mersey Docks and Harbor Board pointed out the fact that they had a dock, known as the Gladstone Graving Dock, which is 1,050 feet long, 155 feet wide, and 46 feet deep, being, therefore, quite capable of accommodating vessels even larger than the "Majestic." There is in this country also another dock, at Portsmouth, N. H., which could accommodate the "Majestic," being 1,022 feet long, and proportionately wide and deep.

PLIABLE-STEEL PAPER CLASP
 955 IS USEFUL IN OFFICES

Made of thin flexible steel, a narrow band clasp, $6\frac{1}{2}$ inches long, holds a file of correspondence of from 2 to 100 sheets for handy reference, keeps the contents of a brief case separate, is useful for holding papers on desk pads, or on the paper holders of computing machines, and is convenient in many other ways. It

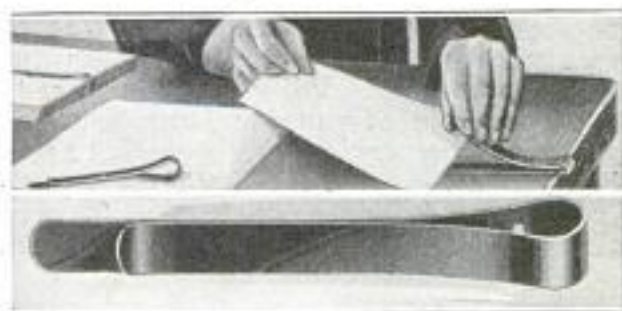

Flexible-Steel Paper Clasp, $6\frac{1}{2}$ Inches Long, That will Hold a File of Correspondence of from 2 to 100 Sheets, When Slipped In as Shown Above

takes the place of rubber bands and paper weights, and can be easily slipped over any bundle of papers up to 1 inch in thickness.

*The A. Tricker Co.,
 Cleveland, Ohio.
 1011 Park Ave*

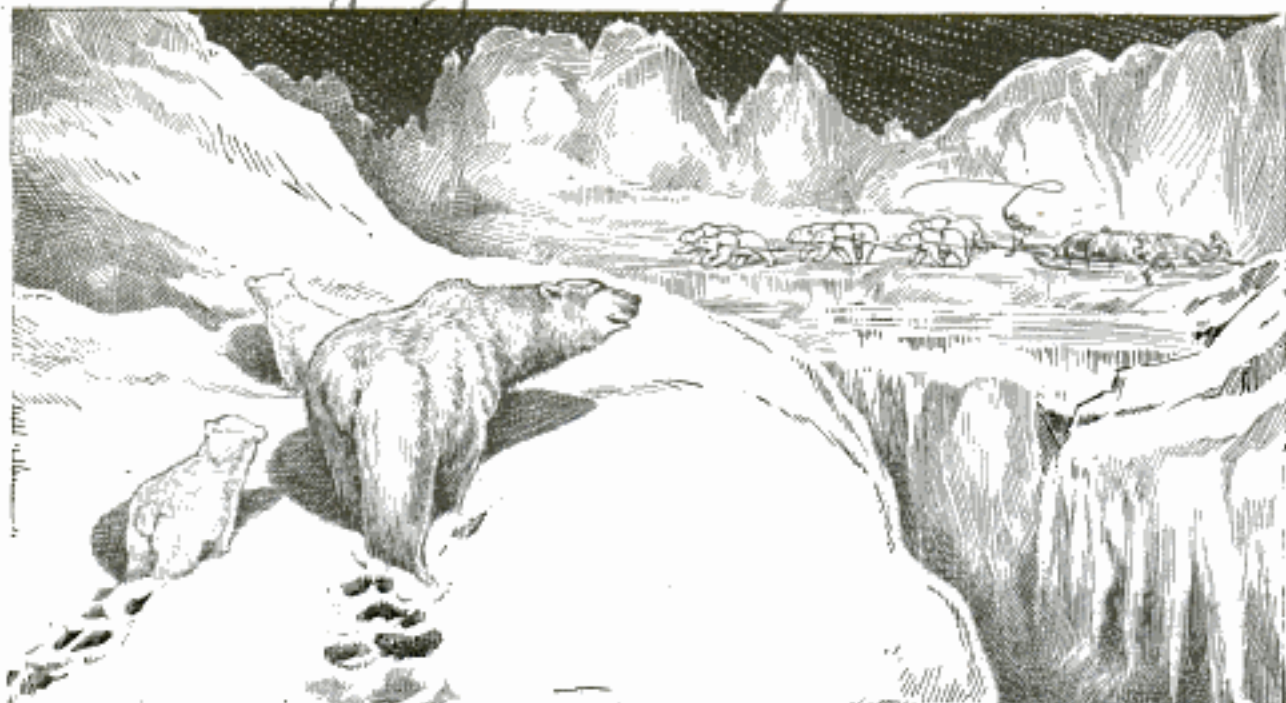

MUSHING WITH BEARS IN ALASKA

By STRATFORD F. CORBETT

IN Alaska they are talking of what may materialize into one of the most interesting experiments ever attempted in the north country: The Alaskan fur trader would train the polar bear to pull his sledge!

It was the representative of a large fur company who first conceived the scheme. Mushing along the northernmost rim of the continent in search of furs, he was surprised to come upon an Eskimo boy with a small sledge pulled by two polar cubs. Both bears had been in harness for some time, were fairly well broken, and showed no signs of viciousness or stubbornness.

While the Eskimo is, by necessity, too busy with hunting and fishing to attempt training the bear in a serious way, the manager of the fur company referred to sees actual possibilities in the idea for his kind of work. Polar bears—naturally swift, capable of running long distances without tiring, and strong enough to pull heavy loads—would make the most powerful sledge teams in the Arctic. Two of the species might easily pull a load that dogs could not budge, and, with six of them in harness, furs or other commodities could be transported in loads now unthinkable.

In selecting the team care would have to be exercised in eliminating animals showing predisposition to temper. It is conceded by zoölogists that there is as much difference in the dispositions and

tendencies of animals of the same species as there is between humans of the same race. For example, two bears may be captured together, may be members of the same family, yet one will show signs of friendliness, a willingness to adapt itself to its new surroundings, while the other will be unruly, unmanageable, and, therefore, entirely unsuitable for training. It would be folly, of course, to waste time on an animal of bad character.

There should be little trouble with a team, well-trained—and there is much to be gained, not only in heavier loads but in speed. While the Eskimo dog usually averages anywhere from 20 to 40 miles per day the bear under the same conditions is capable of doing 100 miles or more. Even Perry, who, if anyone, knew how to get the best from his dogs, never expected to make more than 50 miles a day consistently. The polar bear can travel twice that distance and do it day in and day out.

On the march, large quantities of food, seal, fish, and birds, would have to be carried for the team—a much larger quantity than the dogs would consume, but even allowing for this extra weight, the bear would be a far better transport animal than the best of dogs.

This one fact is a great advantage, and it may be that what is now a sport in a small section of Alaska will in time become a common practice all through the Arctic.

...at first ... and ...

... 18632 ...

32

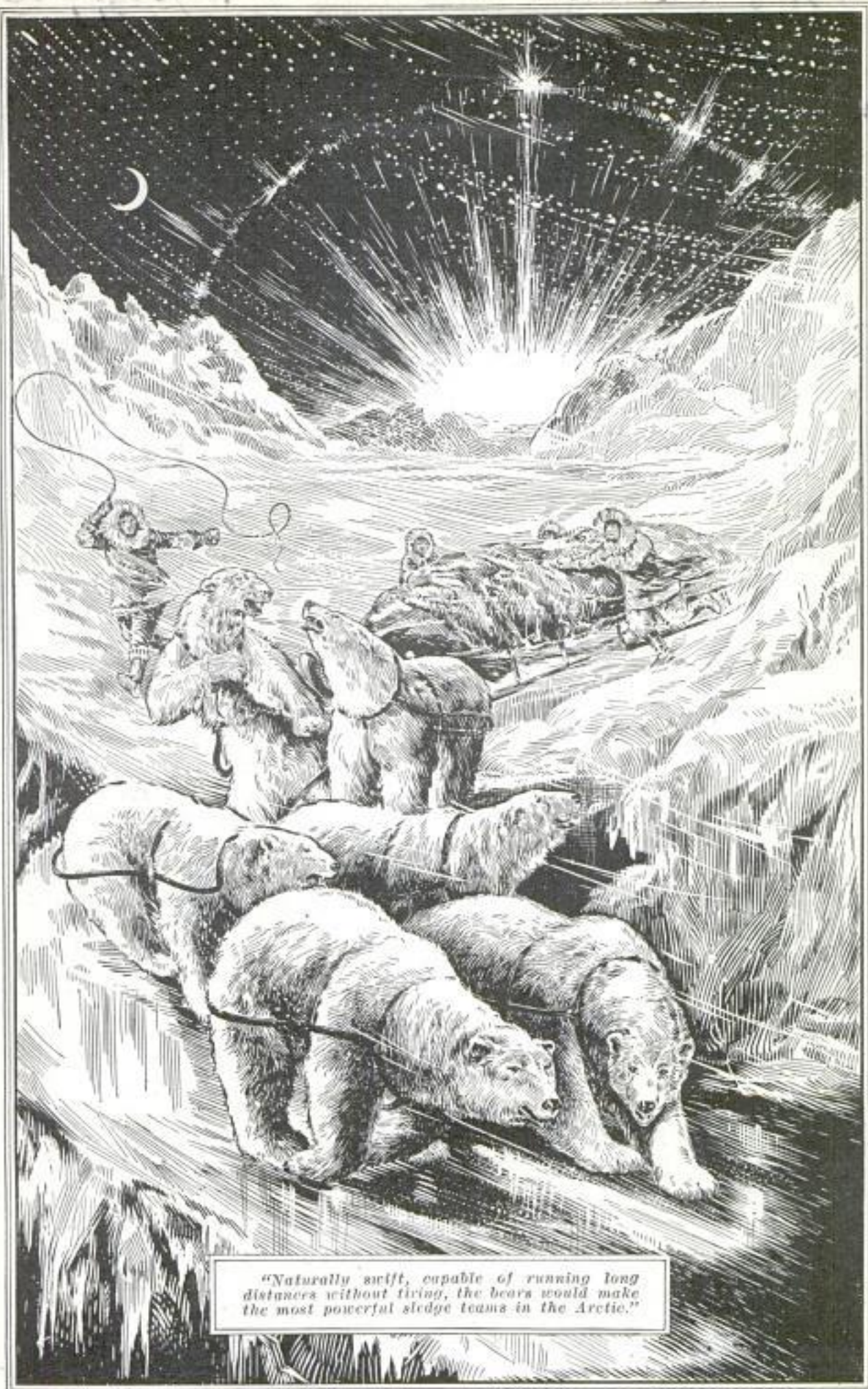

"Naturally swift, capable of running long distances without tiring, the bears would make the most powerful sledge teams in the Arctic."

... of ...

Encl. C. F. Brooks
521 E. Canella St
20

POPULAR MECHANICS
Whittier, Calif.
HUGE OIL TANK SET ON FIRE
BY ELECTRIC DRILL

836

A burning oil tank of 50,000-barrel capacity, near Whittier, Calif., recently attracted a curious throng of onlookers. The oil was ignited by sparks from an electric drill which workmen were operating near the top of the tank for the purpose of installing a gauge. Flames and dense black smoke immediately rose into the still air for a distance of 600 feet, in a huge column, and then spread out like a mammoth fan over the heads of the spectators. Efforts to quench the fierce blaze proved unavailing, and the picturesque fire continued until the contents of the tank, estimated to be worth \$100,000, were destroyed.

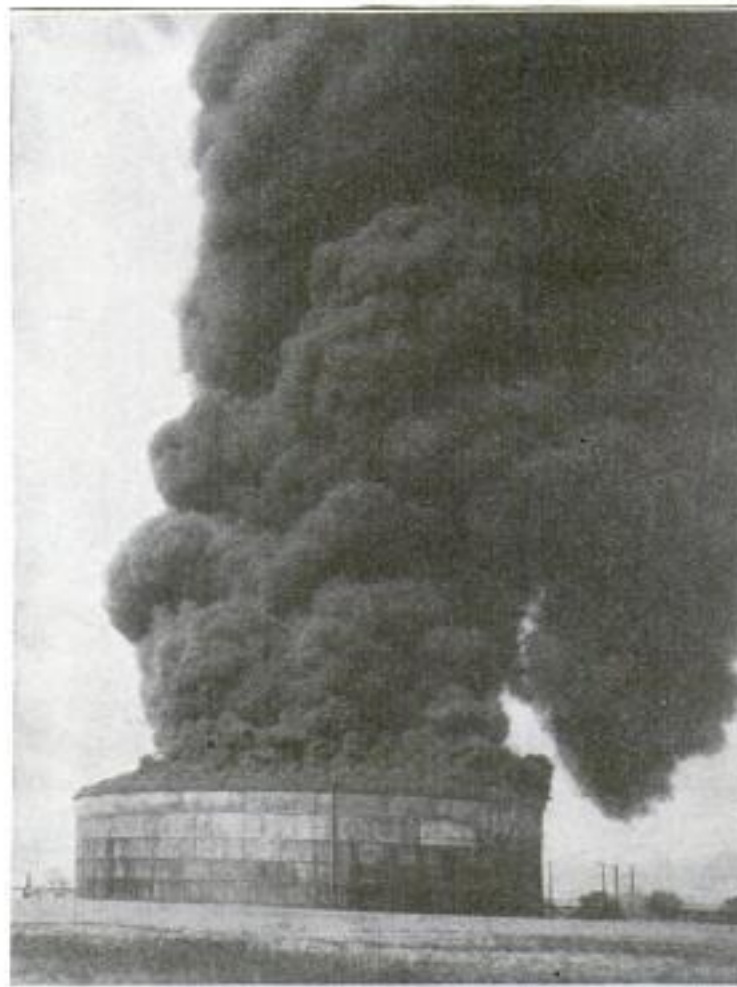

Huge Oil Tank Which was Set on Fire by Sparks from an Electric Drill, Showing How the Dense Clouds of Black Smoke Rose in a Column over the Heads of the Spectators before Spreading Out in the Shape of a Large Fan

☐ A new marine life belt, resembling the old form of body belt, but with buoyancy sufficient to support five or six persons clinging to life lines attached to it, has been demonstrated in France.

RESULTS OF EXPLORATIONS
MADE IN COLORADO

In Mesa Verde National Park, Colorado, explorers from the Smithsonian Institution recently unearthed a new prehistoric ruin, to which the name of "Pipe Shrine House" was given because over a dozen clay tobacco pipes were found in the shrine, where they had been thrown down centuries ago during ceremonial rites. The pipes were in a circular pit, 20 feet deep and about the same in diam-

4 no Pemberton
Patting, of World
857 Record Ltd.
PLAYING TIME IS INCREASED
ON PHONOGRAPH RECORDS

By controlling the speed of a revolving phonograph record, an English inventor gets 20 minutes of music on one side of a 12-inch record, instead of the usual four minutes or thereabouts. When the record

disk revolves at a uniform angular speed, as at present, the outer groove of the record moves more swiftly than any other groove that is nearer to the center. Thus, although the outer groove is about four times as long as the inner one, it can contain no more music, making necessary a variation in the recording speed. In the new method, the recording speed is made constant, and by correspondingly controlling the speed of the record, the impression upon it of a very much greater number of sound vibrations

is made possible. When being played, the record revolves slowly at the start, and then gradually speeds up.

eter, that was in the middle of a rectangular building, about 75 feet square and one story high, with a circular tower 15 to 20 feet high. In a cemetery near this house one of the skeletons was left without moving a single bone, and an inclosure was built around it on which a waterproof covering was placed, through which a visitor can observe the skeleton, with the food bowls and other relics, just as they were left over 500 years ago. This is the first time, it is said, a relic has been so preserved.

o. P. Pemberton
Patting, of World
857 Record Ltd.

W. H. James 4/22/22
903

Naperville, Ill.
POPULAR MECHANICS #14/22
CHURCH FURNISHES STONE
FOR AUTOMOBILE ROAD

899
EXTENDING BOMBAY, INDIA,
BY RECLAMATION WORK

uses for all
 The complaint is often heard nowadays that churches and automobiles are matters of conflicting interest. But such a complaint cannot be made at Naperville, Ill., for the Church of Saints Peter and Paul has actually furnished part of the stone ballast for the concrete automobile road between Aurora and Chicago. This was, however, not a spontaneous gift on the part of the church, but was due to a fire which gutted the church a short time ago, and left

Extensive reclamation work is being carried out at Bombay, India. By means of a great inclosing sea wall, four miles long, 1,145 acres of Back Bay

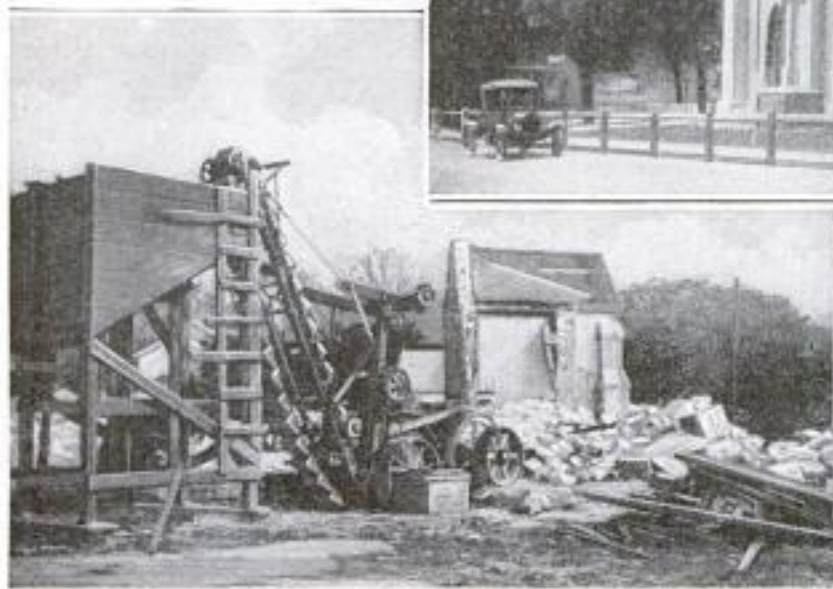
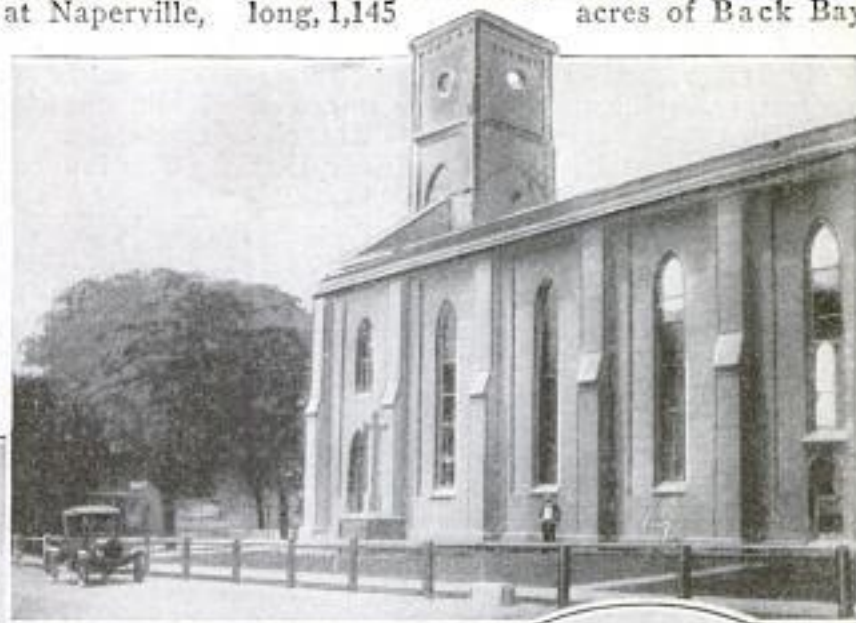

Top: Church at Naperville, Illinois, the Fire-Gutted Walls of Which Furnished Ballast for an Automobile Road. Above: Crusher Breaking Up the Stone Walls of the Church. Right: Temporary Belfry Where Chimes are Hung Until New Church is Completed

only the walls and part of the belfry standing.

As the church was built of limestone with a facing of concrete, it was bought by the contractors for the ballast it would make. Limestone often bursts with explosive violence, as is well known by campers, who avoid using it in or near a camp fire, and the walls of the church were badly cracked, though not showing from the outside. During the fire the bursting limestone could be heard quite a distance. The church will be rebuilt as soon as possible, and in the meantime the chimes have been hung in a temporary belfry near by, where they ring out a reminder of the hours of worship.

will be reclaimed. The estimated quantities of material required for this wall in cubic feet are: rubble, 9,223,280; heavy pitching stone, 3,465,500, and concrete, 3,694,690. An additional work of smaller importance is another reclamation of some 132 acres. The estimated total cost of these enterprises, less interest during the six years required for completion, is £583,333. The reclamation will have a system of wide roads and a well-planned street-railway service, all laid out so as to provide for a future subway system, which will eventually be necessary. Along the sea front will be a promenade at least 40 feet wide. At the southern end of the reclamation, there will be a military reservation of about 265 acres.

The Forest Radio Tele. Co. Jersey City, N.J.
 23
 990 THREE TUBES WORK AS SIX
 IN "REFLEX" RADIO SET

MECHANICS

Three vacuum tubes do the work formerly allotted to six, in a compact radio-receiving set displayed by an eastern manufacturer of wireless apparatus at the recent Boston radio show.

The set provides three stages of radio-frequency amplification and two stages of audio-frequency amplification. The circuit is arranged in such a manner that after the radio frequency of the incoming wireless waves has been amplified three times by the vacuum tubes, the waves are passed back through two of the tubes for further amplification at audio frequency.

The circuit used in passing back the waves through the same tubes is termed a "reflex circuit," and the set a reflex receiving set. The manufacturer of the set claims that it is even more efficient than a set providing six tubes, each one used for a separate amplification, while the user of the set saves the cost of additional tubes and the space that would be needed for the amplifying unit containing the tubes.

The entire set, with the exception of

batteries and the antenna, is housed in a box approximately 8 by 8 by 6 inches, and weighs only 8 pounds. It is stated that it has a reception range of 1,000 miles with its tiny indoor loop antenna. The range can be enlarged through the use of an outdoor antenna, connections for which are provided on the face of the box. The set is controlled by a single tuning knob, allowing the novice to operate it efficiently.

The indoor loop antenna used with the set is collapsible and very simple in construction. Sixteen strands of fine wire form the loop, and when set up it is only 2 feet high and 2 feet wide. Its base rests in a socket in the receiving set and the operator can swing it around easily with one hand. The four arms of the antenna, when in use, are held rigidly in extended position by means of a square metal plate at the crossing point of the arms, to which it is fastened by thumbscrews. When it is desired to take down the antenna, these screws can be quickly removed with the fingers and the antenna arms closed up, in much the same manner as an umbrella, into a compact bundle.

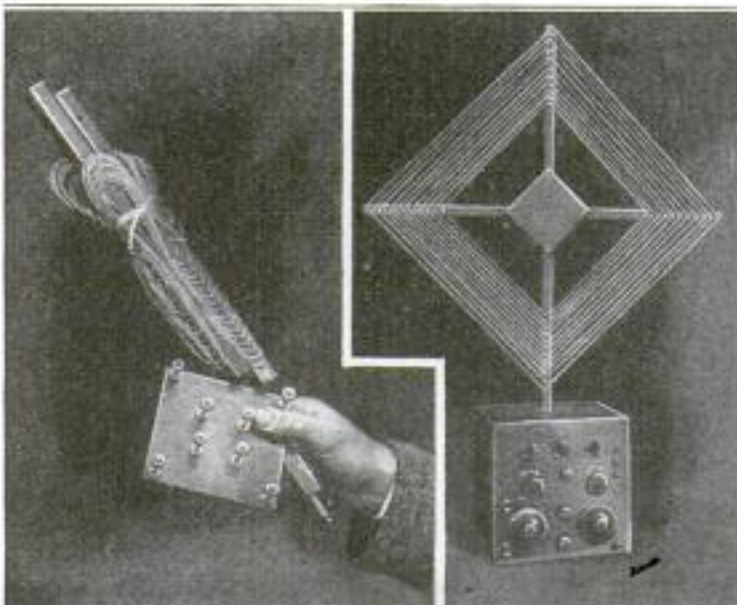

Left: Collapsed Loop Antenna of the "Reflex" Radio-Receiving Set, Together with the Metal Plate Which is Used to Hold the Loop Rigid When It is Opened. Right: Set Shown Erected in Readiness for the Reception of Broadcasting

*Direct to exposure meter Co
 Dan Franke
 402 meter
 622
 71 hood
 Bldg*



Above: Exposure Meter for Setting Camera to Different Lighting Conditions and Shutter Opening. Left: Exposure Meter in Use

EXPOSURE METER SIMPLIFIES PHOTOGRAPHY

A handy exposure meter has just been brought out that shows the operator how to set his camera to obtain properly exposed pictures under the existing light conditions. It consists of a metallic scale with a slide and five circular windows of graduated degrees of transparency. The object to be photographed is first viewed from the most transparent window, and then the slide is moved to the other windows until the one is reached through which the object is just dimly visible. The correct shutter speed and diaphragm opening will be indicated on the chart.

NAVAL AIRPLANES TESTED AT DETROIT AIR MEET

The Curtiss marine flying trophy race at the recent air derby held at Detroit, offered a welcome opportunity to try out a number of small airplanes designed by the Bureau of Aeronautics of the U. S. Navy and intended to be carried on board ships from which they would operate.

The object was to develop a small and compact plane, easily taken down and assembled aboard ship, that would have efficient flying characteristics. To that end all wires and turnbuckles in the wind bracing were eliminated, and the fuel tank was located in the lower wing, so that it could be dropped overboard by a quick release in case of fire by an incendiary bullet. Another feature was the provision of interchangeable landing gear for either land or water, according to the service required. Aside from these points common to all, the planes also were all made with a wing spread of 25 feet and a length of 24 feet 7 inches, but the TR-type differed from the TS-type in that planes of that designation were fitted with special racing wings.

In order to obtain information on

the same rating. The race was won by the "TR-1," piloted by Lieut. A. W. Gorton, U. S. N., at an average speed of



Small Compact Biplane Recently Developed by the United States Navy: It is Adapted for Alighting on Water, or Fitted with Landing Gear

112.65 miles an hour over the total distance of 160 miles, which consisted of eight laps around a closed circuit of 20 miles. Out of a field of eight that started, only one other contestant finished, owing to a series of unfortunate accidents.

While all of the engines mentioned were developed at the request of the Navy Department to meet the requirements of this particular type of air craft, it is exceptionally gratifying to our aeronautical engineers that the winner carried a power plant representing the first successful American air-cooled airplane engine. A satisfactory engine of this type is particularly important in naval planes because of the reduced weight and the absence of the radiator which is so vulnerable to machine-gun fire.



New Shipboard Type of Airplane Equipped with Pontoons for Water Service: Power is Furnished by an American Radial Air-Cooled Motor

planes of the same type with different engines, two were equipped with radial air-cooled 220-horsepower engines, and two with water-cooled engines of about

purposes. On the 40-foot crossarms are 15-unit insulators, hung so that they may be moved freely without taking down the cables.

816 Fred H. Kiser, 773 Milwaukee St
Portland Ore.

MAKING MOTION PICTURES AT THE SUMMIT
OF MOUNT HOOD

816 Scribner BY MEL WHARTON, 135 E. 12th St.
Portland Oregon.

THE difficulties of mountain scaling in the Pacific Northwest are stupendous under any conditions, but filming dramatic action on the slopes of ice-crevassed, wind-torn, and snow-swept peaks for the purpose of educating the world to the mountain climbs and snow sports in our own United States, presents obstacles which only those stanch of heart and firm of muscle dare undertake.

A complete troupe of actors and technical men, 15 in all, after 14 hours of fatiguing toil, recently reached the summit of Mt. Hood—a hazardous ascent without the impediment of motion-picture cameras and equipment. The expedition was the first in history to film dramatic action on the summit of a major snow-capped mountain. One woman, Miss Irene Marvin, leading lady, made the ascent. She is the first of her sex to defy the northeast slope of Mt. Hood, stay all night on top, and descend the opposite side.

The party arose at midnight, and at one o'clock, with flashlights and lanterns flickering against the foliage of the timber line, started upon the perilous climb. Before the first shafts of light illuminated the crest of Old Hood, they had reached the edge of the ice field which marks the beginning of the actual climb. After a short wait to rest pack-tired shoulders, the members slid into the loops of a life line and started the ascent.

Stops were made to take movies of the troupe in action on the mountainside. Miss Marvin was thrown down a crevasse, for a "thriller"—into the waiting meshes of a life net, to be sure, but nevertheless a nerve-trying ordeal because the ice is never to be trusted, and an insecure net means a catastrophe. The theater-going public feeds upon excitement, and the weaving of America's scenery into a story with red-blooded plot "puts over" the idea to be conveyed.

Early in the afternoon the expedition arrived at the end of the ice field, in which more than 5,000 steps were cut to insure footing for the heavily loaded movie caravan. Ice picks and alpenstocks were discarded because they are useless on the last thousand feet of sheer climb known as the "final ascent." The angle of inclination here is 80 degrees—so abrupt that, in places, strips of rope were hung over the edge of rocks to afford handholds. The warm sun, which melted supporting layers of ice under overhanging

rocks, sent thousands of powders of varying sizes—from a thumb to a bungalow—down the slope at awful speed. By crouching under overhanging ledges, death was cheated numerous times while thundering masses of rock poured overhead like black waterfalls.

To increase the difficulties of the climb, a snow and sleet storm raged as the expedition reached the top at three o'clock in the afternoon. Every person was fatigued and famished. Food packs had been left at the foot of the ice field, it being thought certain the descent could be made without difficulty. Within a few minutes after the top was reached, the summit and slopes of Mt. Hood were incased in a thick ice blanket, rendering return out of the question.

Through a blizzard that lasted the entire night, and a windstorm that attained a velocity of 50 miles an hour, the party of 15 huddled together, watching shafts of lightning play hide and seek overhead. A tedious and wearying night at last shaded into a lighter though violent dawn. That the climb to the summit might not be for naught, the actors performed their rôles in the raging tempest and recorded a film which is unusual.

A consultation and investigation of the northeast slope revealed the impracticability of descent that way, and it was determined to go down the easier south side. Fatigued and weak from hunger, the troupe marched into the teeth of the storm down the mountain, and in the middle of the afternoon reached a government camp, where food and shelter were obtained. The record of the trip in pictures was perfect, and the hardships of the journey were requited by the fact that a true message had been registered to inform the world that in America are to be found year-round snow and mountain sports the equal of any.

WIDEN OLD HIGHWAY BRIDGES
IN PENNSYLVANIA

914 The widening of over 1,800 old highway bridges, that are less than 16 feet wide, is to be begun next season by the State Highway Department of Pennsylvania. Most of these bridges, some of which are 100 years old, are too narrow to allow the passing of two trucks 90 inches wide, that are permitted to operate under the state law. The new bridges will be at least 24 feet wide.

Eng. News Record.
11/23/22 Copyright material

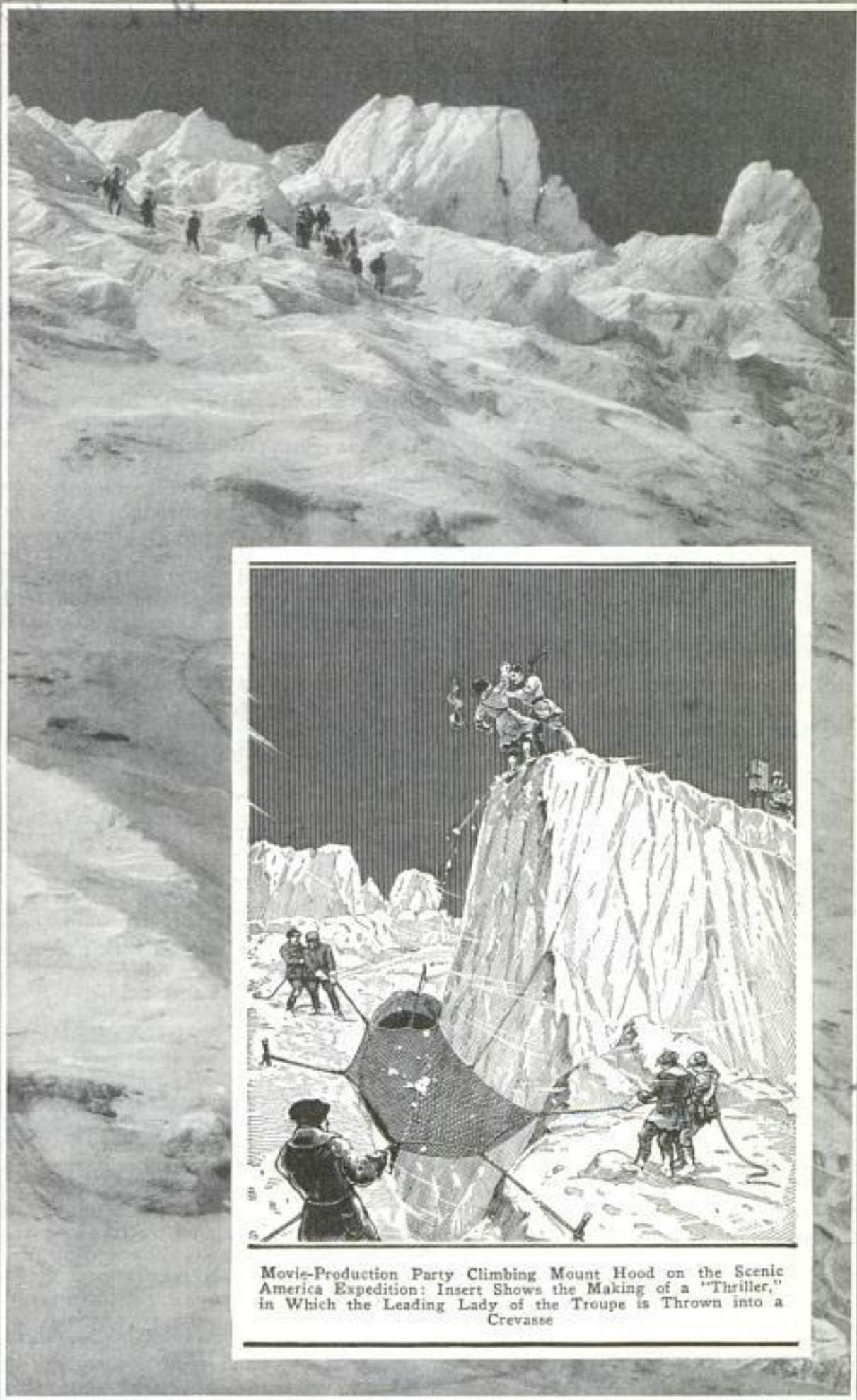

Movie-Production Party Climbing Mount Hood on the Scenic America Expedition: Insert Shows the Making of a "Thriller," in Which the Leading Lady of the Troupe is Thrown into a Crevasse

859
26

750

**LAYING STREET-CAR RAILS
420 FEET LONG**

Rails, 420 feet long, were recently laid on one of the street-railway lines at Washington, D. C. This unusual length

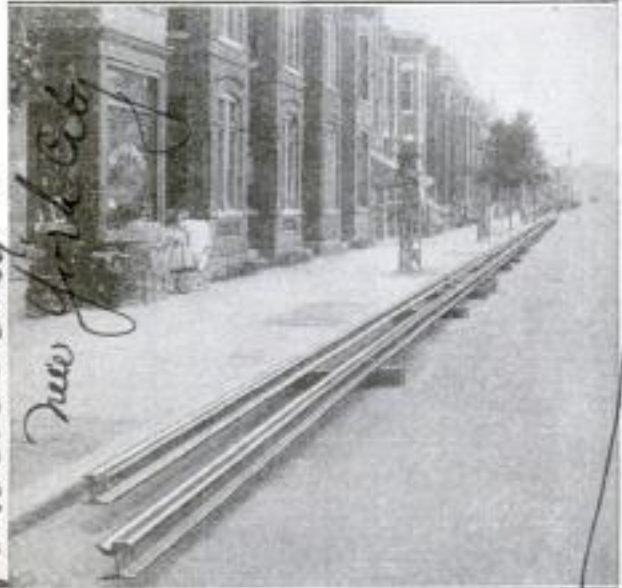

Rails, 420 Feet Long, Made by Welding Together Standard Lengths: They were Laid as Units

of rail was put down during a time when the car tracks were being relaid and, in order to avoid interruption to traffic, several standard rail lengths were welded together during the day. In the dull hours of the early morning the track gang replaced the old rails with the new units.

**PLUG-TYPE RENEWABLE FUSE
HAS INDICATING LAMP**

Plug-type renewable fuses, having indicating or pilot lamps, are a protection against annoying delays when using electric irons, washing machines, ranges,

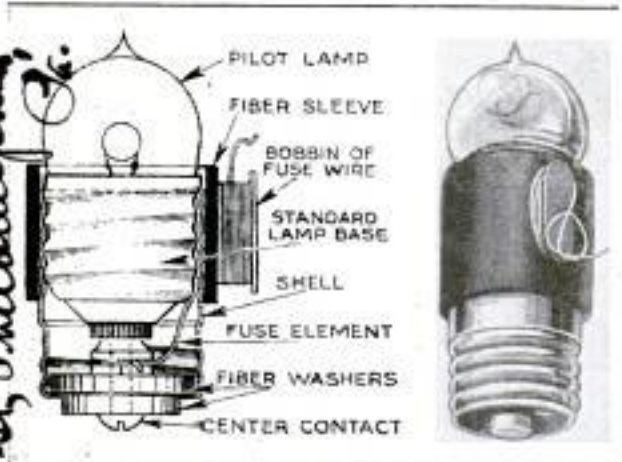

At the Left Is a Sectional View of the Plug-Type Renewable Fuse Which Contains an Indicating Lamp. Right: General View of Fuse

vacuum cleaners, and similar household appliances. The fuse is designed to fit in any standard distribution panel or fuse block. When a fuse "blows," its lamp lights, showing instantly just where the trouble lies. Any novice may then unscrew the pilot lamp, insert a new fuse wire, of which a supply is wrapped on a bobbin at the side of each fuse, replace the lamp, and thus quickly restore the interrupted power.

740 COTTON-FABRIC BELTING MADE BY CHEMICAL PROCESS

By means of a new chemical treatment cotton fabric is made suitable material for the manufacture of such products as belting, conveyors, trunks, and shoes. According to this method as many sheets of cotton cloth as are desired to be formed together, are passed through highly concentrated sulphuric acid, at such a rate that the cotton is kept in the acid only a predetermined length of time. This causes the surface of the cotton to become partly jellified, and while in this



Piece of Six-Ply Material Made from Chemically Treated Cotton Fabric, That Is Suitable for Shoes, Trunks, Belting, and the Like

state, the sheets are squeezed together between heavy rolls which also wring out the acid. The fabric is next passed through a water bath to which neutralizing agents have been added to stop the action of any remaining acid.

1859 MACHINERY RAPIDLY REMOVED AND INSTANTLY INSTALLED

A remarkable instance of what can be done by systematic preparation occurred recently in moving machinery from one automobile plant to another several miles away. A group of cylinder-block machines were kept running in their old location until the truck backed up to move them. Then the machinists checked out, and took street cars to the new location. The car lines were somewhat tortuous but, even so, the men were surprised when they reached their destination to find their machines already installed, with everything ready for setting up a piece of work and starting operations.

Thermite Corp
Broadway
New York City
204
C. F. P. Carver 3913
Locust St, Philadelphia, Pa.

8/2 *8/2* *Safety Appliance Co. Huntington W. Va.*
MINE CAR STOPS ON GRADE IF HOIST ROPE BREAKS

BY GEORGE F. PAUL, *201 Ellsworth Bldg Chicago*

A NEW type of safety mine car has been designed that operates on inclined planes. Tests have shown that, when loaded with from 2,000 to 6,000 pounds of timber and turned over an incline without the hoisting rope, it will stop after running about 30 feet, and

either direction, but the moment this limit is passed, whether through the breaking of the hoisting cable, failure of the hoisting machinery, lack of attention on the part of the engineer controlling the hoist, or any other cause, the car will be brought to rest.

The sheave wheel is a steel casting, which, for the sake of greater safety, is

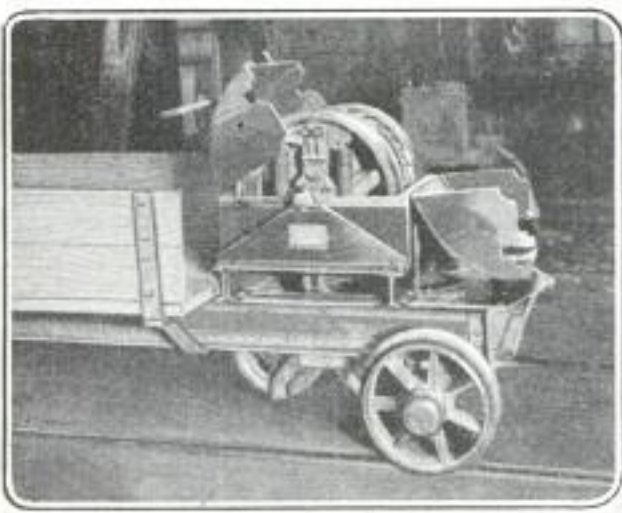

Above: Safety Car near the Top of Incline, Stopped Automatically after Running 25 Feet with the Hoisting Rope Cut. Upper Left: Side View of Car with Hood Open, Showing Details of Safety Device. Right: Car on Grade with Hoisting Rope Disconnected

also that, if the rope is cut while the car is proceeding up an incline, the car will not recede or back down more than 3 inches.

The car is brought to rest by the application of brakes to sheaves that are so arranged as to take an effective hold on cables placed within the tracks. The operation of the brakes is governed by the speed of the car. So long as the speed does not exceed that for which the governor is set, the car is free to move in

equipped with a pawl and ratchet in addition to the brake. The brake band is automatically actuated through a governor of the fly-ball type.

As typical of what the new car will do in use, may be cited the tests made with one of these cars on the plane of the Amherst Coal Co., at Amherstdale, W. Va. The incline of this mine is 850 feet in length and of considerable steepness, varying from 25 degrees at the bottom to 38 degrees at the top.

The report of one of the state mine inspectors on these tests included the following statements:

"First a short rope hitching was made from the hoisting cable to the car. This was provided so that the rope could be readily severed. The car was hoisted about two-thirds of the way up the plane, at which point the rope was cut. The car traveled back down the hill not more than 3 inches. It contained two occupants, one of whom cut the line. It did not seem to make any appreciable movement when the rope was severed.

"As a second test, men were stationed on the incline at approximately 100-foot intervals. The car was hoisted to the top of the plane, the hoisting rope was disconnected, and with one man operating the hand brake the car descended the hill,

stopped at the different points and picked up the entire party, bringing them to the bottom of the plane.

"The next demonstration was conducted entirely at the top of the hill. Two thousand three hundred pounds of dead weight was loaded onto the car; then it was turned loose over the knuckle. This was accomplished in the following manner: A short rope hitching was made as before, this being severed with a knife as the car came onto the steep grade. The car with its load started down the hill, but stopped automatically 25 ft. 7 in. from the top, at a point where the pitch was 35 degrees."

After these tests it was considered perfectly safe to give the coal company permission to carry as many men in a car as it will accommodate.

354

NONSINKABLE BARGE MADE OF BALSA WOOD

A San Francisco man has constructed a barge of balsa wood which is considerably lighter than cork although it has much greater structural strength than the latter. The balsa wood was ob-



to drive the barge and to operate the winches. Additional buoyancy is provided by 38 air tanks placed at various points throughout the barge. In the center of the deck a large hole is pro-

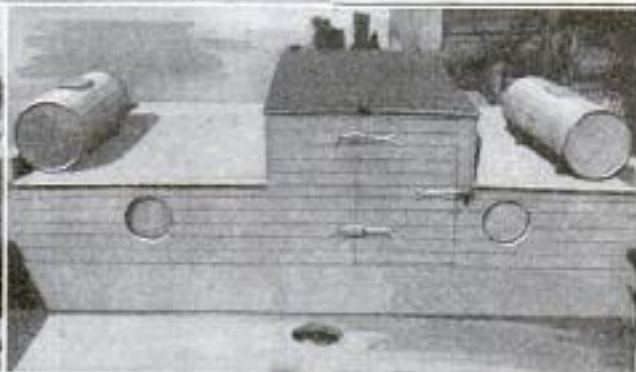

Top: Nonsinkable Barge Made of Balsa Wood Obtained from Life Preservers, Shown High and Dry on Land. Above: A View of the Completed Barge in the Water

tained from life preservers which were fastened together and the seams filled in with pitch. The barge, which is used mainly for salvage work, is 30 feet long, 14 feet wide, and draws 15 inches of water. Two 30-horsepower gasoline engines are used



Above: Close-Up of the Deckhouse in the Center of Which the Two Engines are Located. Left: Hole in Deck through Which Grappling Chains are Operated

vided for a winch-operated grappling chain and irons, used in raising sunken objects.

Three smaller holes in the deck act as self-bailers for the barge. Individual gasoline tanks for the engines are placed on the roof of the deckhouse.

Owner.

Capt. Thomas Whitelaw,
San Francisco, Calif.

COMMENT AND REVIEW

[These pages were printed November 27, 1922.]

LIKE a prodigal son at the apex of his luxurious living, our legislators, city, county, state, and national, are appropriating billions of dollars yearly, some of it with apparent disregard as to the necessity of the appropriation, or at least its absolute necessity at the present time.

It is easy for the army of reformers and advocates of the almost countless improvements—both moral and physical—to offer endless and convincing argument why this thing, and that, is fundamentally good. Few or none of them, in their competition to get legislation favorable to their own pet idea, stop to consider where the money is coming from or how the already overburdened taxpayer is to provide the funds. Many of these objects are admittedly good in themselves, just as a favorite daughter may insist on fur coats and automobiles of a quality and quantity exceeding father's ability to afford. The coats and cars are good in themselves beyond question, but how about father?

The Menace of Taxation

Do our governments, city, state, and national, exist to serve the people, or do the people exist to serve the governments? If you have been so busy paying taxes you have failed to realize the giant growing up in our midst, it is worth while to ponder these figures:

In fiscal year 1913-14 taxes were 6.4 per cent of all we earned.

In fiscal year 1920-21 taxes were 13 per cent of all we earned.

In calendar year 1921 taxes were *one-sixth* of our entire national income; and are still going strong. It is too early to determine the figures for 1922, but regardless of this appalling increase in so few years, congressmen are lugging in bills by the armsful for all sorts of excuses to spend millions upon millions on their favorite hobbies.

We are not yet through scrapping war material; we have pensions of the Civil War, Spanish-American War, and the recent war. There is the (at this writing) proposed bonus to soldiers who were uninjured; we have a big war debt and a billion yearly interest on it, all in addition to endless accumulated appropriations of previous congresses to be renewed yearly, and the fast increasing expenses of the necessary departments of the government. At home our state legislators are building stadia and other structures at state universities; there is the natural increase in new buildings to care for the increasing number of blind and insane, the wayward, and all the other state asylums.

It would surely seem that we have reached the point where daughter should be content for a time with what she now has, and not add more furs and cars to father's already crushing burden.

The overbalance of centralized power, even centuries ago, caused the downfall of great and once powerful governments. Federal Judge James H. Wilkerson declared in a recent address that national encroachment on state rights presents a problem to this country as serious as was the issue of the Civil War. The Federal Government should not do for the people of a state what the state can and should do for itself.

The steady and rapid invasion of the Government of those operations which properly belong to the states, and which, with perhaps a few unimportant exceptions, are being sufficiently well done by the states, is simply appalling. Especially is this true in the so-called welfare activities of Federal aid to states. During the past 50 years the Federal payroll has grown until it now exceeds 500,000 officials and employes, or ten times what it was in 1870, while the population in the same period has increased to less than three times what it was then.

The Roman Empire was wonderful and the most wealthy in the world at its height, but Spencer, in reviewing conditions during its decline, says, "So numerous were the receivers in comparison with the payers, and so enormous the weight of taxation, that the laborer broke down, the plains became deserts, and woods grew where the plow had been. It was impossible to number the officials who were rained upon every province and town, who each raised the valuation—as a proof of service done; and so the imposts went on increasing."

Judge E. H. Gary says: "Legislation represents the effort of human beings to promote moral, physical, and property rights and to promote general prosperity. There are two kinds of legislation, prohibitive and constructive. There is the third foolish kind: overlegislation, destructive and interfering. As to overlegislation, so

brilliantly discussed by Herbert Spencer, it has been the curse of nations, the cause of their downfall; it has interfered with liberty and human progress for as many years as we have records."

The greatest fallacy in this country today is that the taxes which come directly out of the "rich" only, are not in fact shared by every other man, woman, and child earning a living, or living without earning, in the entire country, regardless of how small that income may be. The more men the Government employs, the fewer there are left in a productive capacity. The less the production of any necessity, the greater its cost to the consumer.

We do not think to fear the avalanche because it has never yet crushed us, nor the earthquake and cyclone which have never leveled our homes, nor the threat of ultimate taxation beyond endurance; for we have not quite reached the breaking point. The picture seems impossible, but, doubtless, the Romans in their day of prosperity also thought likewise.



THE outspoken position taken by the investment bankers of the country during their recent national convention in regard to Government becoming its own manufacturer of supplies should receive a hearty response from the public. There are some things which require Federal administration. The Post Office Department is one which all governments assume to themselves, but any business man who has studied the proposition knows well enough that a corporation organized to handle, transport, and deliver the mails, would do so more efficiently in many ways, at less cost to the public, and still pay better salaries. Incidentally it would save the yearly appropriation of millions to make up the deficit in that department.

*Government
in
Business*

The present proposal to establish government factories for the manufacture of supplies for the Army and Navy, is decidedly a step in the wrong direction, as viewed from all standpoints.

Manufacturing firms and corporations as they exist, have in the past, and unquestionably will in future—if undisturbed—by reason of their active competition, guarantee a larger, better, and more efficient production of government supplies, and at a vastly less cost to the taxpayers than can possibly occur in Federal factories.

Railroads are not suspected of paying any more than they can help for their supplies, yet how few of the thousands of articles they buy are made by any railroad. Car wheels furnish a ready example; the roads and car builders consume practically all the car wheels made, yet less than one per cent of all these wheels are manufactured by the users.

The almost tragic demonstration of what the Government did, and particularly did not do, when it undertook to manage the railroad systems of the country, should suffice as an object lesson for at least a century. "The railroads," to quote the opinion of one of the highest operating officials of a well-known major road, "will not recover their previous morale and state of trained efficiency in a quarter of a century."

During the course of each year there actually are few, if any, articles which are bought to use in stores, factories, and homes, either for ordinary or extraordinary requirements, which do not appear upon the vouchers of every good-sized railroad. The roads however realize they cannot make these things as cheaply, for the same quality, as the manufacturers who specialize in these multitudinous articles. It is only the Government which can afford (!) this waste, with a nation of taxpayers to stand the inevitable loss. Not only is the effort of the Government to go into the manufacturing business a vicious one, but it kills competition and equipment and organization to produce, so that when the emergency comes and vast supplies are wanted on the instant, the Government would find itself limited for a time to what its own factories could turn out.

A few years ago, a successful business man offered to give whatever bonds the Government required to insure perfect performance; to save the annual appropriation to cover the deficiency; and to pay the Government the sum of \$5,000,000 each year for the concession of handling the mails; and to do all this without increasing the rate of postage on any class of mail.

Does anyone doubt that an organization of bankers could and would collect the income taxes at vastly less cost than the revenue department does now? If

all the banks spent as much time as the Government takes to collect an equal number of millions, they would either have to give up collections or increase the charge several times.

Examples can be multiplied until all the pages of this magazine would scarcely contain the first chapter. One easily and quickly grasped is a comparison of the telephone in this country and abroad. Here we have 12.4 phones for every 100 people and these are managed by a big corporation, which provides the best telephone service in the world; and voluntarily improves it constantly.

The average in Europe is only 1.2 phones to every 100 people. France, where the telephones belong to the government and are operated by its post-office department, has for two years imposed a penalty charge of 700 francs for each application for a new phone to be put in, for the express, and admitted, purpose of restricting the number of users—government inability to manage what had become—for it—an unwieldy function.

Our Government, undoubtedly, would not do quite as badly, but even in the earliest days of telephone exchanges here, it was never necessary for the little companies which were organized at the start, to impose such penalties, or even any at all, in order to hold back service and progress.

In 1850, Herbert Spencer wrote: "A function to each organ, and each organ to its own function, is the law of all organization. To do its work well, an apparatus must possess special fitness for that work; and this implies unfitness for any other work;" also, "In assuming any office besides its essential one, the state [Federal government] begins to lose the power of fulfilling its essential one."

Just now a lot of congressmen entirely without personal experience in the management of any large operation, or even a small one, seem obsessed with the idea of committing the Government to managing all sorts of things which are being satisfactorily managed by the states. While this opens doors to thousands of political appointments, it would crush the public as direct or indirect taxpayers.

As a matter of economy and efficiency it would be better and cheaper to even subsidize private concerns—which of course is absolutely unnecessary—than to undertake to do such work itself.

With the exception of some secret process which it must guard, there is so very little in favor of the Government making supplies which private firms and corporations can produce, that any step in that direction should be met with a storm of disapproval from one end of the country to the other.



DURING the year 1921, it cost the railroads of this country \$1,250,000 for accidents where automobiles and trains collided. In only a comparatively few cases were the railroads unquestionably to blame. The overwhelming majority

The Tide Turns

were due to inexcusable carelessness on the part of the drivers of the automobiles. Railroad trains are large and noisy, they can be seen and heard usually a considerable distance away. In most states, certainly in all the densely settled ones, in addition to the regulation danger sign maintained by the railroads, there are similar signs usually set several hundred feet from the crossing

warning autoists to exercise caution in approaching the track. At other points are gatemen; flashing red lights; warning bells. The engineer seldom fails to sound his whistle warning at a safe distance, and the locomotive bell rings. In spite of all these precautions grade-crossing accidents are multiplying rapidly, and the loss of life is appalling.

People seem regardless of danger, or become so occupied in conversation they are unconscious of it. The chief of the accident-claim department of a very large road, told me of one such, which occurred recently.

A long freight train was nearing a country highway, at not over 18 miles an hour, over a level track. It was a bright sunny day. The locomotive and several cars had already passed over the highway, when the conductor and one brakeman looking out the cupola window, saw an open car approaching at rapid speed and fully a half mile away. The highway was also level and there was nothing whatever to obstruct the view from either automobile or train. The auto approached without in the least slackening its speed, and struck the second freight car from the rear end of the train. The auto was a complete wreck, but its four male occupants escaped permanent injuries. Their explanation was they underestimated the length

and speed of the freight train and didn't think it was worth while to slacken speed, much less stop, as they expected to shoot across just behind the caboose.

The railroads have borne without much complaint the burden of such accidents all these years, but the tremendous increase in the number of cars, and apparently, in the carelessness of their drivers, has reached a point where they may be expected to react. In other words, the worm is beginning to turn.

We have evidence of this in a recent court decision, where a driver sued the Pennsylvania Railroad for damages to his car, which plainly resulted from his having carelessly run into a fast passenger train. The railroad sued the man for damage to its gates, which were proved to be down, and through which the car crashed because its driver failed to reduce his speed.

The case is interesting as the first of its kind, and as the prospect is that other roads will likely follow the same course, it evidently behooves the driver of an auto to stop, look, and listen, and have his car under control before he decides to run down the cannon-ball flier or even a way freight.

H. H. WINDSOR

ANCIENT POTTERY METHODS STILL IN USE

BY D. C. RETSLOFF,

*130 W. Walnut St.
San Diego, Calif.*

LONG before white men peopled America the Cliff Dwellers, in what is now known as New Mexico and Arizona,

sizes are being made today in southern California, and the manufacturing process is largely the old-fashioned one. Both men and women do the work and display with pride the articles they create.

"Ollas," as most of the vessels are called, are used as receptacles to hold water, food, or grain, although it is not uncommon to see some highly decorated ones set aside as purely ornamental. Many of the common ollas have the favorite ovolo molding at both base and lip. Others are broad at the base and taper to a slender neck. If a colored design is put on an olla, the work must be executed with great rapidity. The clay absorbs the colors very quickly and if a line is interrupted, the joining is quite perceptible.

The material is cheap, but the good workmanship of the artist makes the olla handsome and in some instances expensive as well. Frequently the clay is kneaded by barefooted workmen. After it has been properly worked up, the olla is shaped by hand. The final smoothing of both outside and inside is done with a piece of chamois wrapped around the workman's index finger. A mortar, cast at the base of the olla, is used to shape the lower half, the upper part being built without any support whatsoever. Small ollas, however, are molded without any casts and are turned out in great numbers by expert potters.

After the molding is done, the vessels are left to dry in the sun for several days, and then baked in a kiln like common brick.



Earthen Vessel in the Process of Manufacture, Showing How the Base is Moldered Inside of a Mortar and the Top Shaped by Hand

made pottery vessels from clay. Their art, by lessons and by word of mouth, has been handed down from generation to generation, and among the Mexicans and Indians of the southwestern part of the United States are found many expert pottery artists. Earthen vessels of all

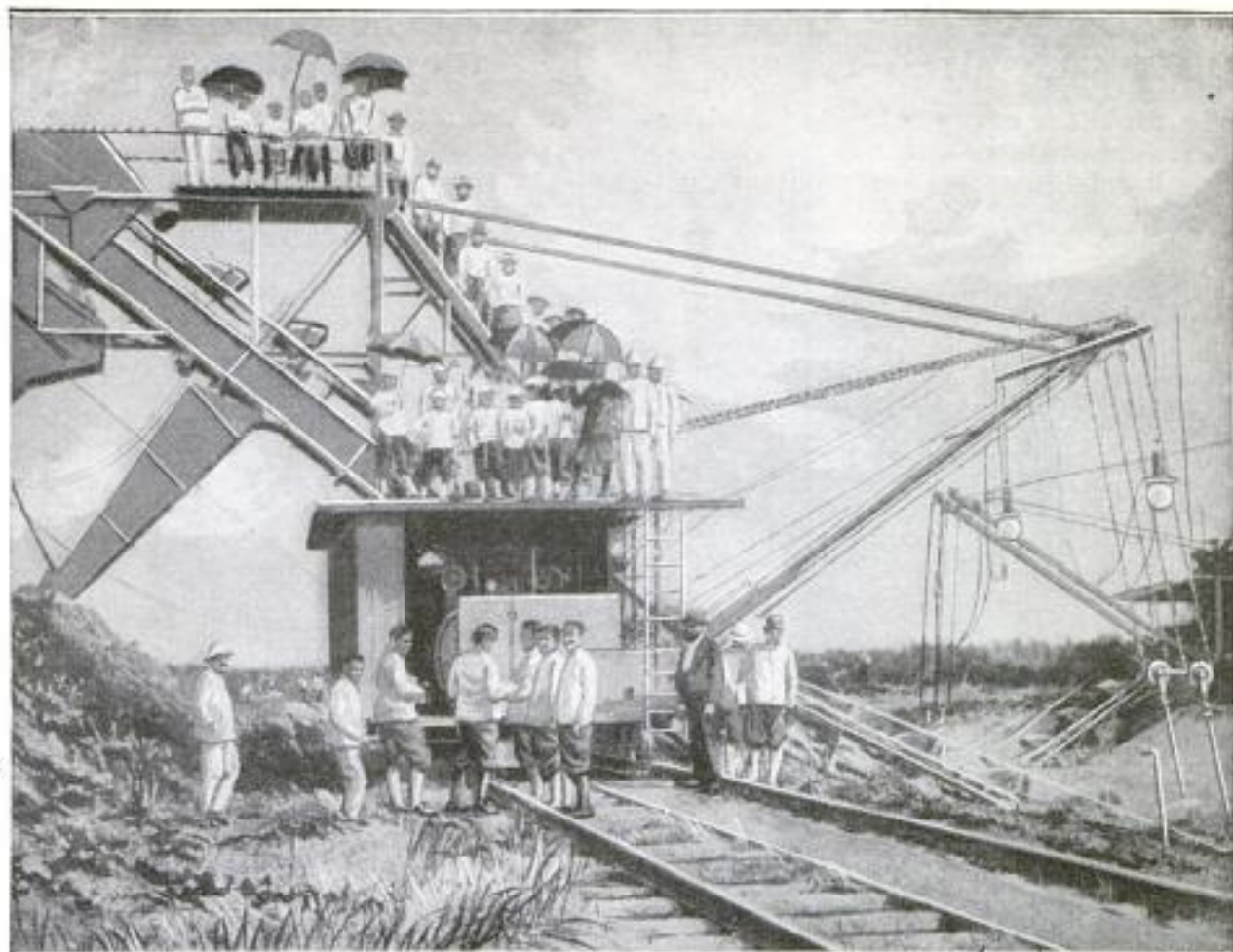

MODERN ROAD-BUILDING EQUIPMENT ADOPTED BY SIAM *International*

MODERN road-building equipment has been adopted by the government of Siam as a consequence of a recently conducted campaign for the betterment of that country's highways. The accompanying picture shows one of the mammoth dry dredgers which have been put in operation lately. The King of Siam and members of his official family attended the elaborate dedication ceremonies. This dredging outfit will remove approximately 250 cubic yards of earth in an hour and is operated by a gasoline engine.

413

CORN LISTER PLANTS FOUR ROWS AT ONE TIME

Planting, or listing, four rows of corn at one time, is achieved by a Kansas farmer who has thus practically doubled his efficiency during the planting season. His machine is a combination of two corn planters. Taking the drivewheels from a pair of these implements, the farmer attached them to a hitch crossbar behind a small tractor. When the grain is placed in the ground, it is not crosschecked, so that the speed of the outfit may be greatly increased over that attained by the customary corn planter. The arrangement is so simple, and so cheaply contrived, that other interested farmers could easily try it.

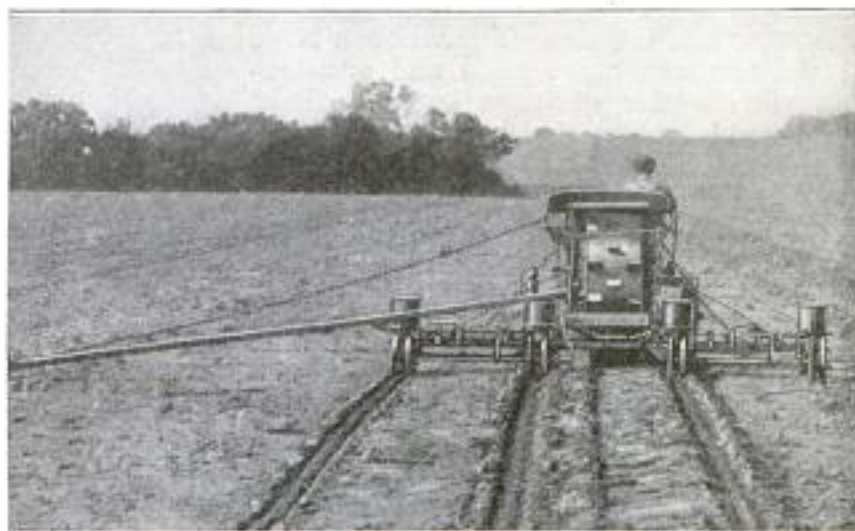

Corn Lister Which Plants Four Rows at One Time: The Speed of This Machine, When Crosschecking is Eliminated, may be Greatly Increased over That Obtained When Using an Ordinary Planter

*Kansas City Hay Press + Tractor Co
Kansas City, Mo.*

34

POPULAR MECHANICS

Laboratorium für Schwingungs-
TICKLESS CLOCK OPERATES
ON NEW PRINCIPLE

ICE-HOUSE CONDENSER BUILT OF CREOSOTED TIMBER

835

To avoid the costly upkeep of steel ice-house condensers, a New Jersey company has built a condenser out of creosoted timber.

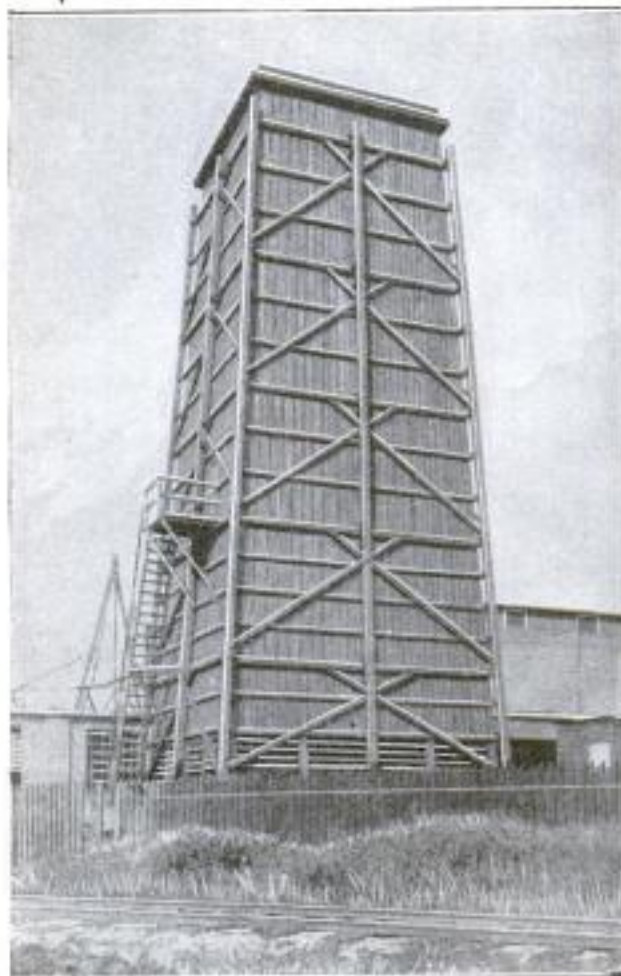

Ice-House Condenser Built of Creosoted Timber: It Is 32 Feet Square at the Open Lattices of the Base, 78 Feet High, and 27 Feet Square at the Top

soted timber. The structure is 32 feet square at the base, 78 feet high, and 27 feet square at the top. The wooden sides of the condenser are solid and substantial, with a tier of open latticework at the bottom, and an opening at the top, so that a current of fresh air rises continuously through the condenser, helping to cool the water that flows from top to bottom of it, and is then forced to the ammonia condenser on the top floor of the ice house by a pump with a capacity of 1,000 gallons a minute.

Nungesser, French flying ace in the late war, is reported to be building a large egg-shaped airplane, which experts declare will make 250 miles an hour. It will be a 700-horsepower monoplane with wings forming a forward-opening "V" with an angle of 120 degrees.

88

A clock that is tickless, because it operates without the usual lever, was one of the specimens recently exhibited by a German scientist in demonstrating, before a group of scientists and other interested persons, a new form of energy transformation. By this principle, which he discovered while studying the manner in which oscillating radio currents transmit energy to one another, energy of motion in one direction is converted directly into energy of motion in another direction, and the waste energy such as occurs in reciprocating machinery is eliminated. It is said to promise many important results when applied to high-speed engines, airplanes, the propulsion of ships, and other energy-utilizing devices.

138

GAS-ENGINE PISTON VISE FOR USE IN GARAGES

Intended specially for use in garages and repair shops, a gas-engine piston vise has been devised that can be adjusted to hold pistons of different sizes rigidly and in any position. The vise is of the circular type, and is clamped to the piston by means of an annular interior spring with an equal pressure on all parts of the piston. This spring is closed up by turning with its handle a shaft that operates in a U-shaped lateral extension of the clamp. Flanged to one end of the clamp is a square plate that is drilled for bolting to a workbench or any other support. The

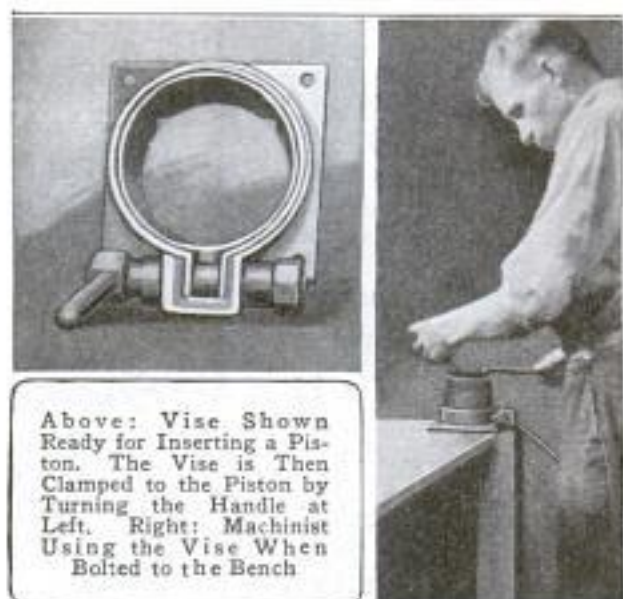

Above: Vise Shown Ready for Inserting a Piston. The Vise is Then Clamped to the Piston by Turning the Handle at Left. Right: Machinist Using the Vise When Bolted to the Bench

clamp can be used on small pistons by inserting a smaller spring bushing in the clamping spring.

J.A. Anderson,
Kasson, Minnesota



Prima Donna and Members of the Pearl Ballet Shown at Their Respective Stations on the Stage Just Before the Lights are Extinguished: Note the Black Costumes of the Ballet, and behind the Performers, the Black Stage Hangings, Both of Which Bring the Pearl Trimming Out in Clear Relief

PHOSPHORESCENT JEWELS FOR PEARL DANCE

By H. A. LANE

ONE of the most remarkable sights ever presented to a theater audience is the display of luminous pearls on the gowns worn by a prima donna and 10 ballet girls of a musical comedy. The pearls are used in a scene as a climax to a "pearl song" rendered by the prima donna. For this scene, the stage hangings are black and the costumes of the ballet are also of a black material. As the singer completes her number and retires into the wings of the stage, the ballet girls appear in their pearl-be-decked gowns. The prima donna then reappears for an encore, and the lights



Beautiful "Pages" of the Pearl Ballet, Who Carry the Prima Donna's Train: Although These Girls Wear Fewer Pearls than Any of the Others, the Silhouette of Their Glowing Jewels Is Just as Startling, as may be Seen in the Picture at the Bottom of the Page

are suddenly extinguished.

The audience is amazed as it sees nothing in the blackness except the designs and figures on the costumes, the pearls standing out in clear relief with a greenish-white glow. Neither the faces nor the arms of the performers are visible as they stand in the darkness, moving slightly to and fro to heighten the effect. When the encore is finished, the lights are switched on and the scene assumes its natural aspect, nothing strange being seen in the costumes as the curtain shuts them from view.

A glimpse behind

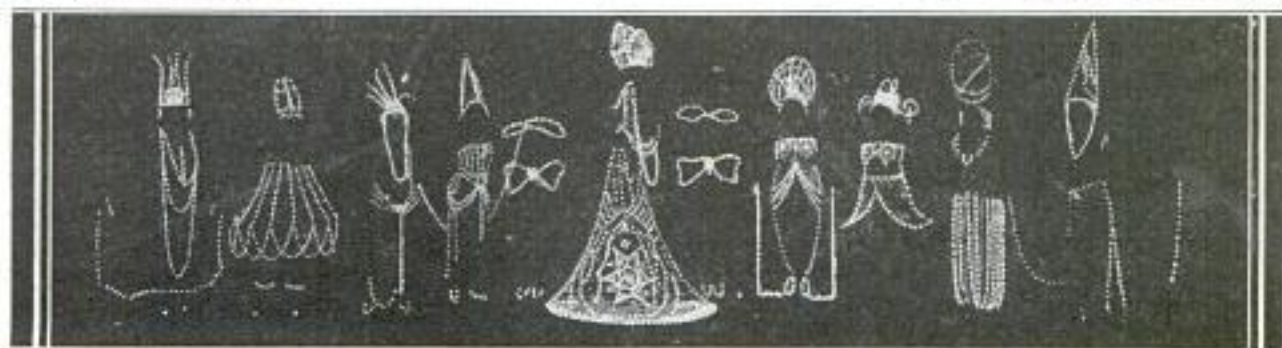

Amazing Silhouette Picture Produced When the Lights are Extinguished, Leaving Only the Glowing Pearls Outlined against the Blackness of the Costumes and Stage Hangings: To Heighten the Effect, the Ballet Members Sway Slowly To and Fro, Causing the Phosphorescent Jewels to Undulate in the Darkness

the scenes some 45 minutes before this "pearl" number is put on, however, reveals the caretaker of these costumes gingerly removing them from a specially designed trunk. The trunk is thickly padded with cotton to prevent damage to the pearl-trimmed dresses, which contain 250,000 pearls of various sizes and are insured for \$100,000. After the gowns are removed from the trunk they are hung on the wall of the dressing room, and a battery of powerful arc lamps is trained upon them. For 20 minutes they are subjected to the dazzling glare of the lamps, while the attendant painstakingly arranges and turns them so that each part will receive a full share of the illumination.

At the end of this period, the ballet girls appear and don the costumes. Then, with their eyes protected by black goggles, they, too, stand in the brilliant light, slowly turning round and round before the lamps, awaiting their cue to enter the stage.

In the meantime, the pearls on the gown of the prima donna must also be bathed in

light, and this is accomplished by throwing spotlights upon her as she renders the song number. Thus, while the audience is listening to the song, it does not realize that the spotlights are, during those few minutes, being used for a double purpose.

The bathing of the pearls in an intense light serves to revivify or invigorate a peculiar pastelike preparation with which they are filled, so that they will radiate a glow for approximately 15 minutes after being removed from the light. The paste, which is a combination of calcium sulphide, calcium fluoride, barium sulphide, and other ingredients, is the product of a French inventor. The quarter million of paste-filled pearls were delivered in bulk to the producers of the show in this country, who employed garment manufacturers to string them upon linen cords, similar to fishline, and trim the costumes. While this phosphorescent product is not a discovery, the adaptation of it in this particular instance is a departure from ordinary uses, the presentation as a whole being a thing of charm and beauty.

77ⁿ HOMEMADE CORN HARVESTER RUN BY ONE MAN

A combination corn picker and tractor, that harvests and loads 10 wagons with corn in 10 hours, has been made by an ingenious farmer of the middle West, who built the machine from parts of automobiles and other equipment purchased from secondhand dealers. The harvester is surmounted by a large box into which the corn is hoisted from the

wagon conveniently located and the contents emptied. The machine is of simple construction and is said to work smoothly and economically. One man can without difficulty operate the tractor and manipulate the corn-harvester equipment.

694 DREDGINGS FROM MOBILE BAY TO MAKE MOTOR HIGHWAY

Dredgings from the navigating channel of Mobile Bay, in Alabama, are being deposited along its eastward side, with the intention of ultimately using the thus formed new land as the foundation for an automobile drive. The proposed highway will extend from Mobile to Fort Morgan, situated at the mouth of the bay, and will have a length of 30 miles. An enormous amount of sand and mud is washed down from the Alabama river system every year. This is dredged out by the government, to maintain the necessary 30-foot depth in the channel, in such quantities that sufficient material will soon be on hand to permit the beginning of the roadway.



This Homemade Combination Corn Picker and Tractor Harvests and Loads 10 Wagonloads of Corn in 10 Hours, and is Operated by One Man. It is Built from Parts of Automobiles and Various Other Equipment

pickers by an elevator. When the box is filled, the machine is moved over to a

Archie Richardson
Becatur, Ala.

Built by John Peterson, Martin
Tombach, McLean Co., Ill.

FILMING A BUFFALO STAMPEDE

BY FRED. A. HERR,

333 Locust Ave.
Long Beach, Calif.

A HEAVY redwood barricade, filled with sand and earth to offer greater resistance to the onrushing horde of buffaloes, was the means employed recently by a company of film folk to cause and portray a wild-buffalo stampede. Entrenched behind it, with the cameras

is the last of the large herds surviving in America. This island, also known as Buffalo Island, was leased by the motion-picture company for the filming of the picture. Many of the stunts were in the nature of the common events of a motion-picture star's life. But even the most

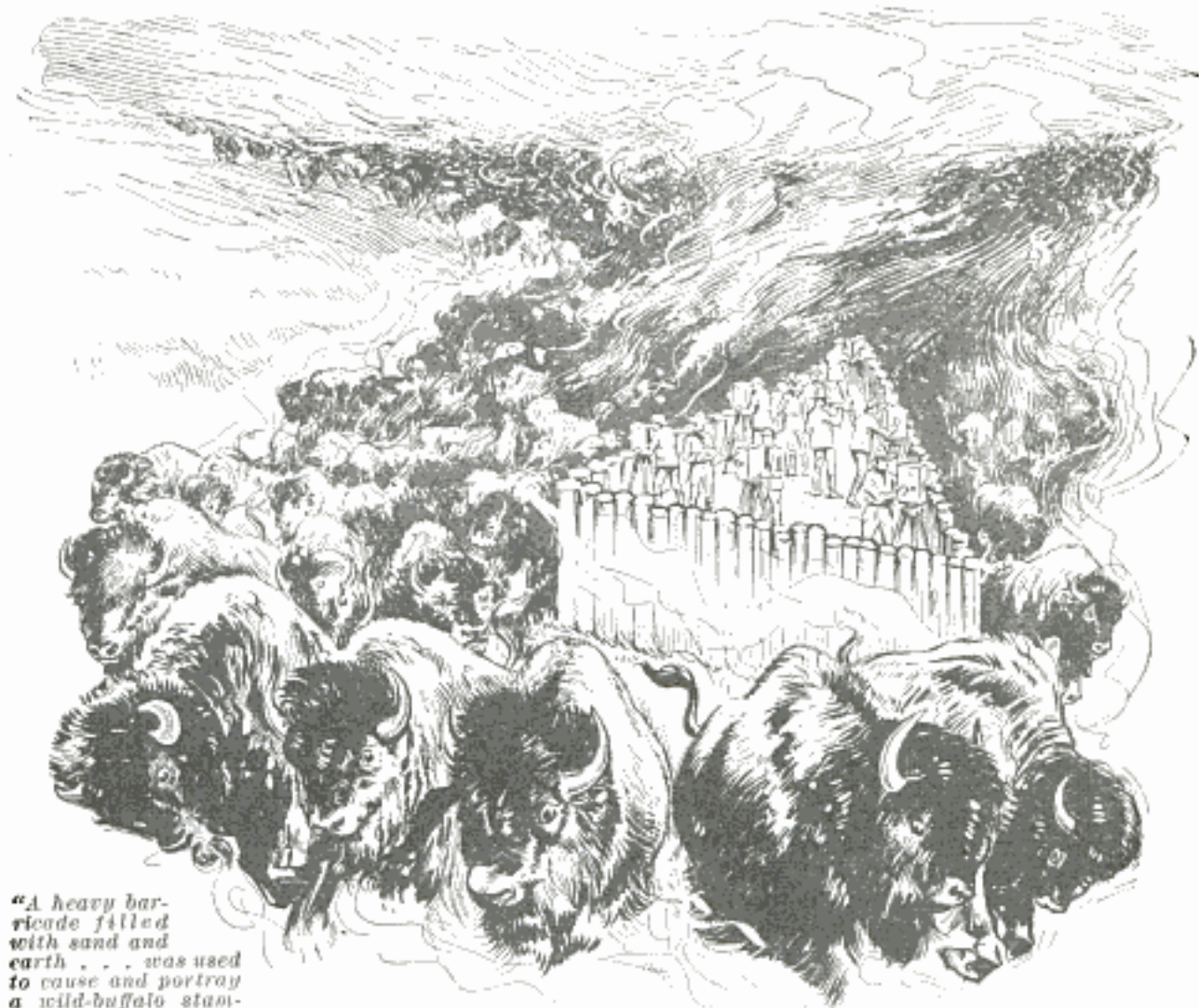

"A heavy barricade filled with sand and earth . . . was used to cause and portray a wild-buffalo stampede. . . . Even the

most blasé performers scratched with open-mouthed awe, as the herd of buffaloes thundered by the stockade. It recalled to their memories how the sturdy pioneers had encountered these maddened beasts when the red man and the monarchs of the plains roamed the western land."

gleaming over the top of the breastworks like the batteries on the banks of the little Somme River in France, the motion-picture troupe witnessed one of the most spectacular scenes ever staged for the industry.

A wild-eyed, bellowing, charging mass of buffaloes, enraged by a many miles' journey over rough country roads, to be used in the filming of episodes from Emerson Hough's story "The Covered Wagon," were stampeded past a battery of four cameras on Antelope Island, near Salt Lake City, Utah. The herd comprised approximately 10,000 animals and

blasé performers watched with open-mouthed awe, as the herd of buffaloes thundered by the stockade. It recalled to their memories how the sturdy pioneers had encountered these maddened beasts when the red man and the monarchs of the plains roamed the western land.

The barricade was 8 feet high, built in the form of a triangle, with the apex facing the direction from which the picture was to be taken. California redwood timbers, 10 inches thick, were driven into the ground in the manner of the old-time stockade. The interior was filled with sand and earth, to solidify the structure

and lend more resistance should the animals charge the stand. The rear was painted to resemble rocks. Atop was placed all the material used in the scene. A dozen actors, the directors, and the camera men likewise occupied seats on top of the barrier.

From this were first filmed individual scenes. Small herds were driven up, and into them plunged the actors afoot or on horseback. To film the grand finale, all the animals on the island were rounded up and driven to a point several miles east of the platform. A small hill intervened, so that the stampeding herd could be filmed as it mounted the horizon with

manes flying, and charged full tilt down the hillside toward the stockade.

Sitting in their assigned positions, the camera men and directors were eating lunch when the advance guard of the herd appeared on the hill to the east. The leaders of the herd swept over the top and charged in a surging mass straight for the stockade. From the barricade the cameras were in action, shooting the maddened herd as it tore onward, leaping and rearing. Charging forward, the herd seemed to make straight for the platform. A short distance beyond the stockade it veered to the left and disappeared over the brow of the distant hills.

**NEW GUARD FOR MOTORCYCLES
CLAMPED UNDER ENGINE**

A metal plate for motorcycles, which acts as a guard against pebbles picked up from the road by the front wheel and

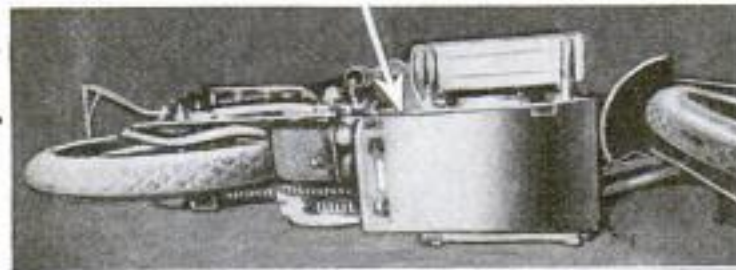
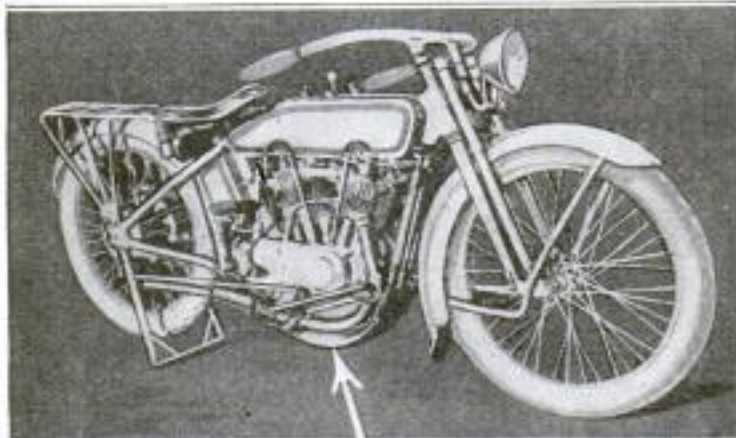

Above is Shown How the Metal Plate Curves under the Engine, Protecting It from Loose Pebbles. Below is a Bottom View of the Guard, Showing Its Ample Width

thrown backward, is one of the latest improvements in this field. The device consists of a broad arch-shaped plate extending beneath the motorcycle frame from the front footrest bar to the muffler. Clamped close to the frame, it protects engine and rider from stones, serves as a means of gliding over obstructions on the road surface, and with the added weight tending to lower the center of gravity, makes balancing less difficult.

**CAVALRY BOARD DEVELOPING
PACK COOKING OUTFIT**

The U. S. Army Cavalry Board has been experimenting for several years to develop a suitable pack cooking outfit for troopers, an article recommended as necessary by practically every officer who witnessed the disadvantages of individual cooking, when in the Mexican campaign the men were separated from their field ranges.

Of a number of designs submitted, all have been dropped for one reason or another, after test except the one receiving consideration at present. It consists of two side loads for a packhorse, each load containing a number of boilers, bake pans, and kitchen utensils, nested in two fire frames which can be hooked together to form a container for them.

The outfit is simple and, except for the fire frames, contains only articles already issued by the quartermaster corps. The weight will not exceed 200 pounds, including pack saddle or aparejo, to which the outfit can be lashed. It is now undergoing a field test,

upon conclusion of which, if the report is favorable, it is proposed to develop suitable hangers to avoid the necessity of using lashings, which are an inconvenient form of fastening.

Ⓢ A simple compound is reported to have been perfected that counteracts the effectiveness of poison gas, and the French government has provided funds for the manufacture of 35,000 pounds of the chemical.

584
Dr. W. Roy Stendel, Stendel Electrical Works, Magdalena, N.M.

908
Dr. W. A. Cooper, B. Cooper, M.C. + morph. Dept. W. H. Miller, Fred Riley, Kans.

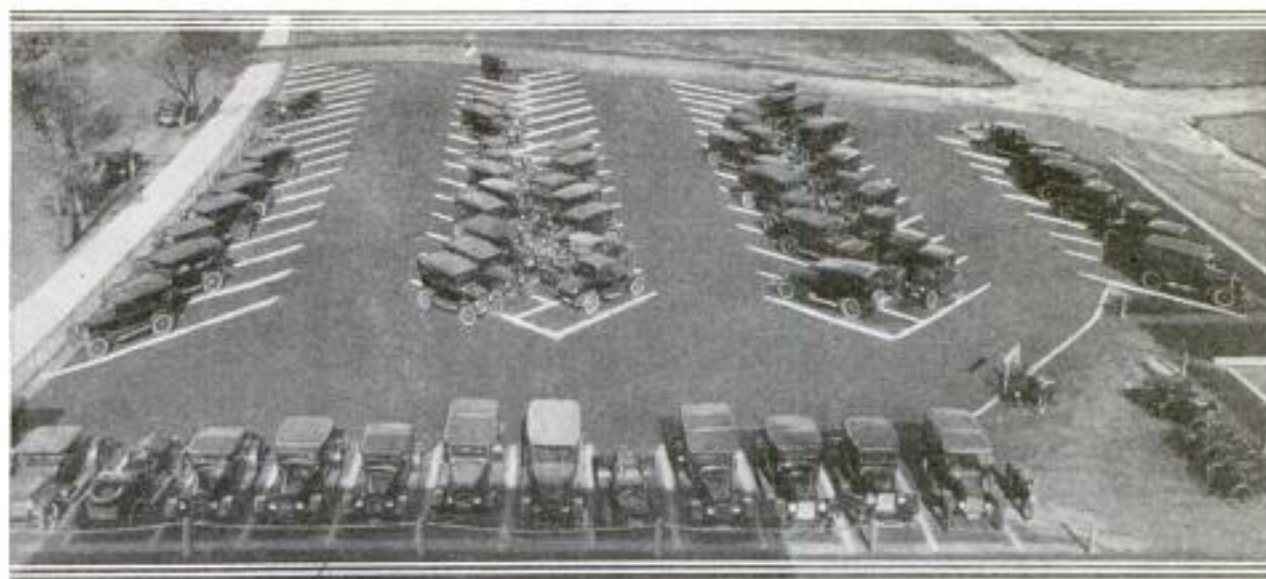

System of Parking Automobiles at the Massachusetts Institute of Technology: Any Car can be Backed Out Readily from the Spaces Outlined in White for Them upon the Gravel of the Parking Yard. To the Right Is the Space Specially Reserved for Motorcycles with Their Sidecars

828 ANY CAR EASILY REMOVABLE IN NEW PARKING SYSTEM

At the Massachusetts Institute of Technology, at Cambridge, many of the students have automobiles, and a system of parking them has been evolved by which any car can be driven away quickly at any time of the day. For each car a space is outlined in white upon the gravel of the yard reserved for parking. These lines are laid out at an angle so that a car can be backed out readily from its berth into the ample space that is left between the rows of cars. A separate space is reserved for motorcycles.

8178 CHOCOLATE SAVED FROM HEAT BY AIR-INSULATED BOX

For the purpose of packing chocolate so that it will resist high temperatures during shipment to tropical countries, a container has been devised on the principle of the vacuum bottle. Although ordinarily chocolate will melt, or at least

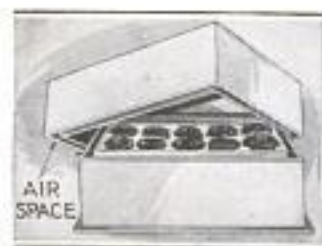

become soft, at a temperature of 90° F., in these boxes it remains hard at as high as 120°. The boxes are rectangular and telescopic, similar in construction to the baggage carriers once so universally known as "telescopes." Inside the outer box is a similar one in both halves of the telescope, these smaller ones fitting to-

gether in the same manner as the larger ones, and leaving a space, about 3/4 inch wide, between the two on all sides. Air is a poor conductor of heat, and this air space all around the container forms a good enough insulation to keep the heat from reaching the chocolate.

398 SIMPLE "FOUNTAINS" BUILT ALONG CALIFORNIA ROAD

Motorists over the recently completed Gaviota Pass road in California are delighted to find that the road builders paused for a moment at each natural spring they encountered along the road, took a few shovelfuls of concrete from the mixture they were laying for the road foundation, and fashioned a rude basin for the water from the spring. The water is cool and refreshing, and also furnishes a convenient source of supply when it is desired to refill the radiator.



One of the Crude Basins Built around Natural Springs along Gaviota Pass Road in California

Cont Frank B. Howe. 472 Mason Refers Home Calif Bldg. Los Angeles

W. W. L. Wheelock
40 Robert F. Salade
47 41 N. 15 St. P. Hita.

842

MONUMENTS IN VARIOUS PARTS OF THE WORLD



Monument to John Howard Payne, Author of the Words of the Song "Home Sweet Home," Erected by the Old Guard of Atlanta, upon the Site of the House of Chief Van, of the Cherokee Nation: Here Payne was Imprisoned on Suspicion of having Incited the Indians to Revolt. He was Found Not Guilty



Memorial to James Orton, the American Explorer, on Esteves Island in Lake Titicaca



Memorial to First Settlers of Blooming Grove, Illinois, Erected on Site of Its First Log Cabin



Memorial to Eugene Field, Poet Beloved by Countless Children, Erected in Lincoln Park, Chicago: The Front Group Illustrates His Most Famous Character, "Little Boy Blue," in the Land of Nod

COPYRIGHT, UNDERWOOD & UNDERWOOD

TO HEROES IN MILITARY AND CIVILIAN LIFE



Plaster Cast of a Heroic Statue of a Canadian Soldier, Designed by a Noted Canadian Sculptor, and Sent to a Seattle Foundry to be Cast in Bronze: The Statue will be Erected in Vancouver, British Columbia, in Honor of the Soldier Dead of the Dominion



COPYRIGHT, UNDERWOOD & UNDERWOOD

Monument to Missouri's Victims of the War, Erected at Cheppy, France: The Figure, Cast in Bronze, is the Work of Nancy C. Hahn, of St. Louis, and is Placed on a 10-Foot Granite Pedestal, Bearing the State's Coat of Arms as Its Only Inscription



Statue of Pasteur, the Great Bacteriologist, Mounted upon the Beautiful Monument That was Erected in Paris for the Celebration of the Centennial of the Great Scientist's Birth, December 27, 1922: The Monument was Paid For by Public Subscription

Edgar Bourquin
1353 main st.
Waltham, Mass

POPULAR MECHANICS

769
42

**INSTRUMENT SETS THAT HELP
 IN RULING AND LETTERING**

Neatly packed in a small case, a combination of drawing instruments adapted to facilitate fine lettering, is now on the market. For drawing inked lines

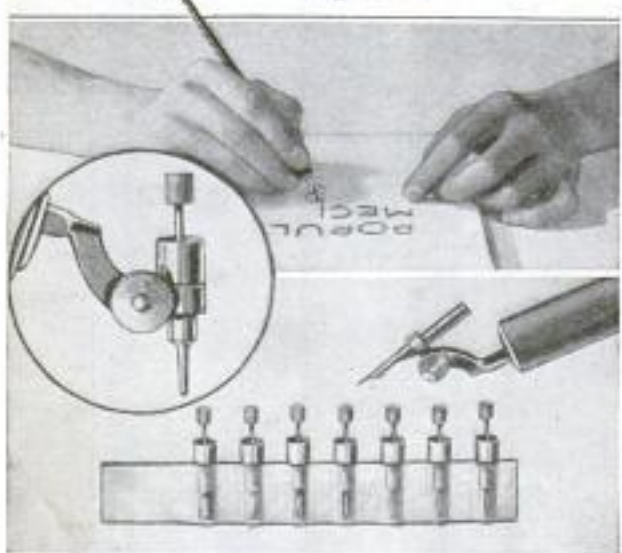

Seven Ruling Pen Points and, in Inset, One in Socket Ready for Use: To Right and Above, the Socket is Shown in Use with Ordinary Pen Point

and lettering of different thicknesses, eight pen points are provided, each of which consists of a small pointed tube of white metal for holding a supply of ink. Into this tube is inserted an ink feeder that can be extracted from the tube for cleansing purposes. The pen point fits into a socket that can be attached to any ordinary penholder. This socket can also be used with any small pen point. Included with each set is a line-ruling instrument for use with a straightedge or a T-square.

**GAS BURNER WITH AIR BLAST
 GIVES HIGH TEMPERATURE**

A new gas burner has been designed to overcome the necessity of using oxygen in working "high-melting" glasses and metals. It is said to maintain easily a flame temperature of over 3,000° F.,



New Gas Blast Burner, Designed to Eliminate the Use of Oxygen in Working "High-Melting" Point Glasses and Metals

with either natural or artificial gas under a pressure of 2 to 4 inches of water, or with an air blast of 3 to 5 pounds pressure per square inch. The burner will operate efficiently in any position, and by manipulating the control valves, a wide range of flame temperatures is possible, as is also an oxidizing or a reducing flame. Another feature is the change in the width of flame made possible by a sliding sleeve on the barrel tube.

**SCRAPPING IRON AND STEEL
 WITH EXPLOSIVES**

In scrapping iron castings or steel plates by means of explosives, such as dynamite, various methods are being used in England. The cartridges are made by covering with compressed clay a charge of the explosive. In the case of cast iron, which is most easily fractured by shock, a number of these cartridges are placed together at the strongest part of the casting. In the case of a steel plate, which is most easily fractured by a cutting or shearing process, the cartridges are placed end to end in a line across the plate. In heavy cast-iron blocks, a hole, about an inch in diameter, is drilled to the center of the strongest part of the casting, is then chambered out, and filled with the cartridges. This method has been applied to the scrapping of ships and the demolishing of wrecks.

**NEW DEVICE EASILY LOCKS
 TIRE TO CARRIER RIM**

The spare auto tire may be easily locked to the rear carrier rim with a hinged steel clamp now being sold. The device is shaped to fit the tire rim and tire, and has a small opening for the regular threaded stud. To install it, the front part is slipped over the stud from which the original nut and rim wedge have been removed, the nut is replaced and tightened, the hinged band swung into place, and finally, a padlock hooked through both ends of the clamp and a small bracket mounted on the carrier rim.



removed, the nut is replaced and tightened, the hinged band swung into place, and finally, a padlock hooked through both ends of the clamp and a small bracket mounted on the carrier rim.

Designed by Eugene R. Giegler, Research Lab.

The Will Corporation
Rochester, N.Y.

Hercules Mfg Co.
Chicago, Ill.

Chicago
NEW CRAWLER-TYPE CRANE OPERATES IN SWAMP

A crawler type of crane, recently placed on the market, has distinctive features in its design that apparently account for its performance in constructing a new road through a swamp. In this instance it operated from large wooden floats which were moved ahead as it advanced, although ordinarily it will run wherever the ground will sustain a weight of 10 pounds to the square inch. The rear axle is built around a hollow steel

casting, as in automobile practice, and the front axle is also a steel casting. It is operated by one man and regularly

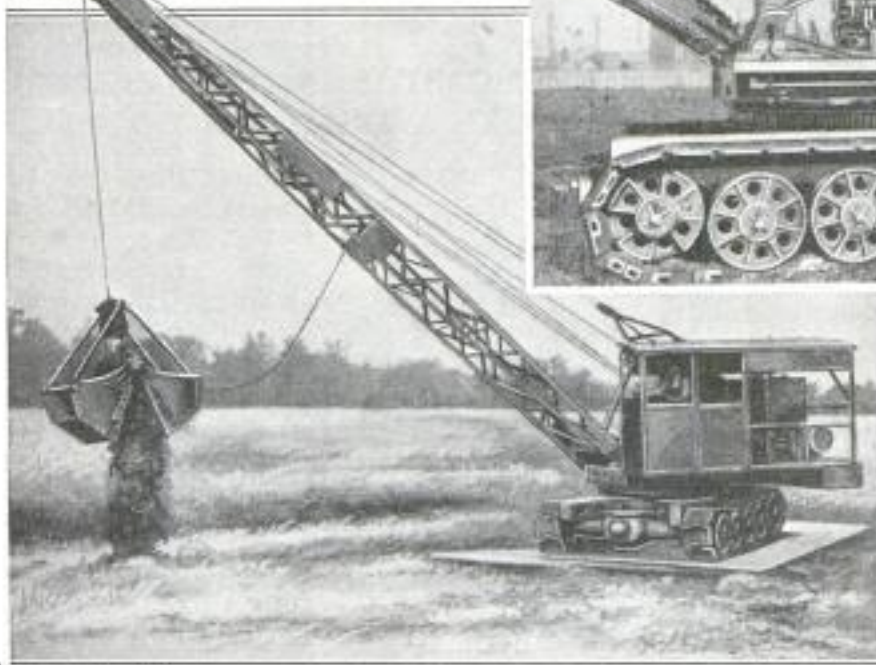
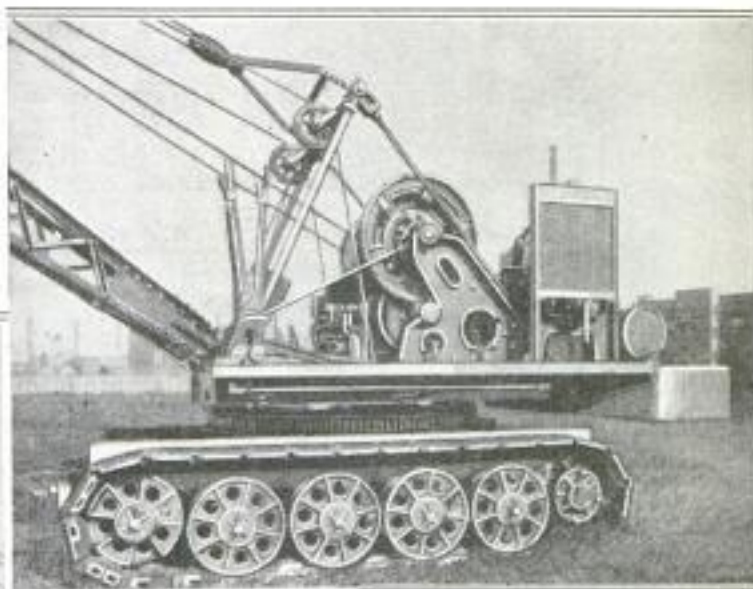

Above: New Crawler-Type Crane That Has a Capacity of 10 Tons at a 12-Foot Radius and 3 Tons at 30-Foot Radius. Left: Crane Mounted on Wooden Floats, Building a Swamp Road

equipped with a gasoline-engine driving unit, that uses kerosene equally well, but electric-motor or steam-engine drive is furnished when desired.

818
NOISELESS PUNCHING BAG FOR APARTMENTS

For a long time a serious problem has confronted apartment dwellers who desired to take their physical culture via the punching bag. In the general type of such an outfit, noise and vibration would bring protest—and often worse—from other tenants, while defacing of walls or woodwork necessary to securing it in place, is out of the question.

The problem has been solved with an "apartment" punching-bag platform free from vibration and noise. Its construction is such that it fits any doorway of standard dimensions, being held firmly in place without screws, bolts, or nuts, and padded with felt where it touches any woodwork. It is adjustable to any height for use by a child or grown-

up, and can be put into place and rigidly secured in less than one minute, and removed as easily.

The platform has a spring shock-absorbing equipment and all the practical

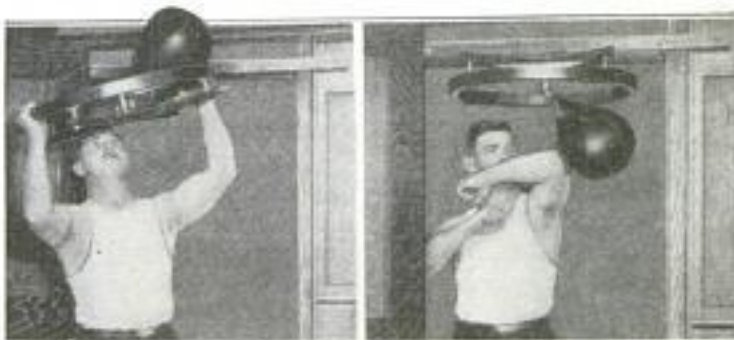

Left: Noiseless Punching-Bag Platform That Fits in Doorway without Marring Woodwork and is Quickly Put Up and Removed. Right: Punching-Bag Holder in Use

features required by the bag puncher. It is neat in appearance, made of seasoned stock in fumed-oak finish, and all metal parts are nicked.

Chas. H. Bergmann, Coloma, Mich.

Signal Corps

44

800

U. S. Army

**HAND-CRANKED GENERATOR
USED IN FIELD RADIO**

A hand-cranked electric generator has been developed for field service in connection with radio - pack sets of the Signal Corps of the U. S. Army. It is a self-contained unit, rated at 250 watts, and, at a speed of 3,333 revolutions a minute, will generate a 500-cycle current. The crankshaft, which is intended to be turned by a pair of cranks at a speed of 33 to 50 revolutions a minute, is back-g geared 100:1 to the armature shaft, which carries a flywheel for smooth running. It is arranged to be mounted on a collapsible four-legged stand.



The crankshaft, which is intended to be turned by a pair of cranks at a speed of 33 to 50 revolutions a minute, is back-g geared 100:1 to the armature shaft, which carries a flywheel for smooth running. It is arranged to be mounted on a collapsible four-legged stand.

**VALVELESS SUCTION PUMPS
OF NOVEL TYPE**

For air, gas, water, and viscous fluids, a type of reciprocating pump that is entirely valveless, and that is claimed to possess the highest possible cylinder efficiency, is now being manufactured in England. The body of the pump is in the form of a cylindrical casing, which has a fixed pistonlike head at each end, with an annular clearance between its outer rim and the inside wall of the casing. On the upper head is a stuffing box through which passes a rod that operates the reciprocating plunger. This is in the form of a

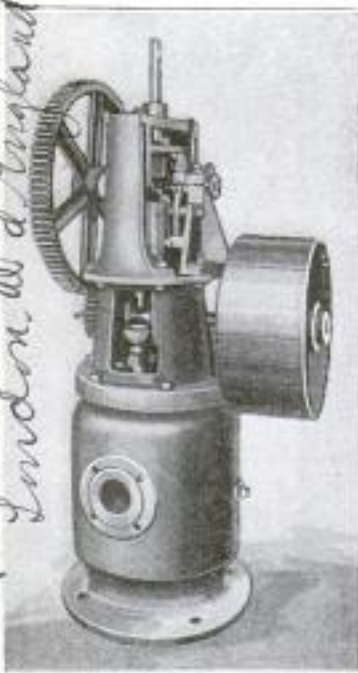

On the upper head is a stuffing box through which passes a rod that operates the reciprocating plunger. This is in the form of a

On the upper head is a stuffing box through which passes a rod that operates the reciprocating plunger. This is in the form of a

cylinder, open at both ends and divided into equal compartments by a diaphragm at its center, to which the plunger rod is connected. The reciprocation is done by means of a crankshaft mounted above the casing, and in connection with which are means for rotating the plunger at the end of each stroke. The purpose of this rotation is to close the inlet and discharge ports in the plunger that register with corresponding ports in the casing, these being open respectively during the up and downstrokes. The skirts of the plunger pass between the wall of the casing and its fixed heads during the reciprocation.

**NEW CAST-IRON COAL CHUTES
WITH WIRE-GLASS DOORS**

Coal chutes for building into foundation walls are now being made of cast iron instead of steel, and it is said that the former do not rust out as soon as the latter, and will last as long as the building itself. These cast-iron coal chutes are also being made with wire-glass doors, for the purpose of making them more visible, located, as they usually are, in the darkest part of the cellar wall. The chutes are equipped with an automatic latch on the inside of the door.

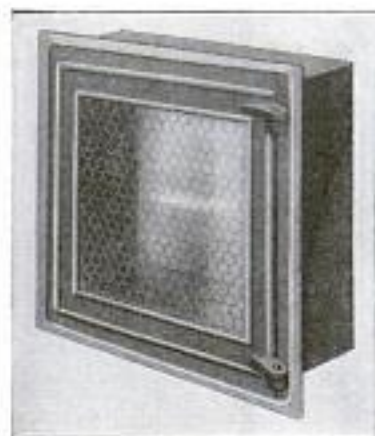

These cast-iron coal chutes are also being made with wire-glass doors, for the purpose of making them more visible, located, as they usually are, in the darkest part of the cellar wall. The chutes are equipped with an automatic latch on the inside of the door.

The chutes are equipped with an automatic latch on the inside of the door.

LARGE FLOCK OF TURKEYS

WALKED TO MARKET

A flock of more than 1,700 turkeys went on a cross-country hike in Walla Walla County, Washington, recently, when two farmers, living near Waitsburg, decided to drive their feathered charges to the market at the city of Walla Walla. The going was over fairly rough ground, and the 18-mile trip between the two towns consumed over a week.

Grasshoppers, ants, seeds, acorns, and other bits furnished natural food along the way, and this diet was supplemented by coarse meal mixed with cracked corn each night, to keep the birds in marketable condition.

W. W. World
11/19/22

802

Mr. W. H. Booniger 25 Great
Titchfield St. Oxford Circus,
London W. 1, England

849 Hardware & Lighting Fixtures:
Edw. Gray, Bangor

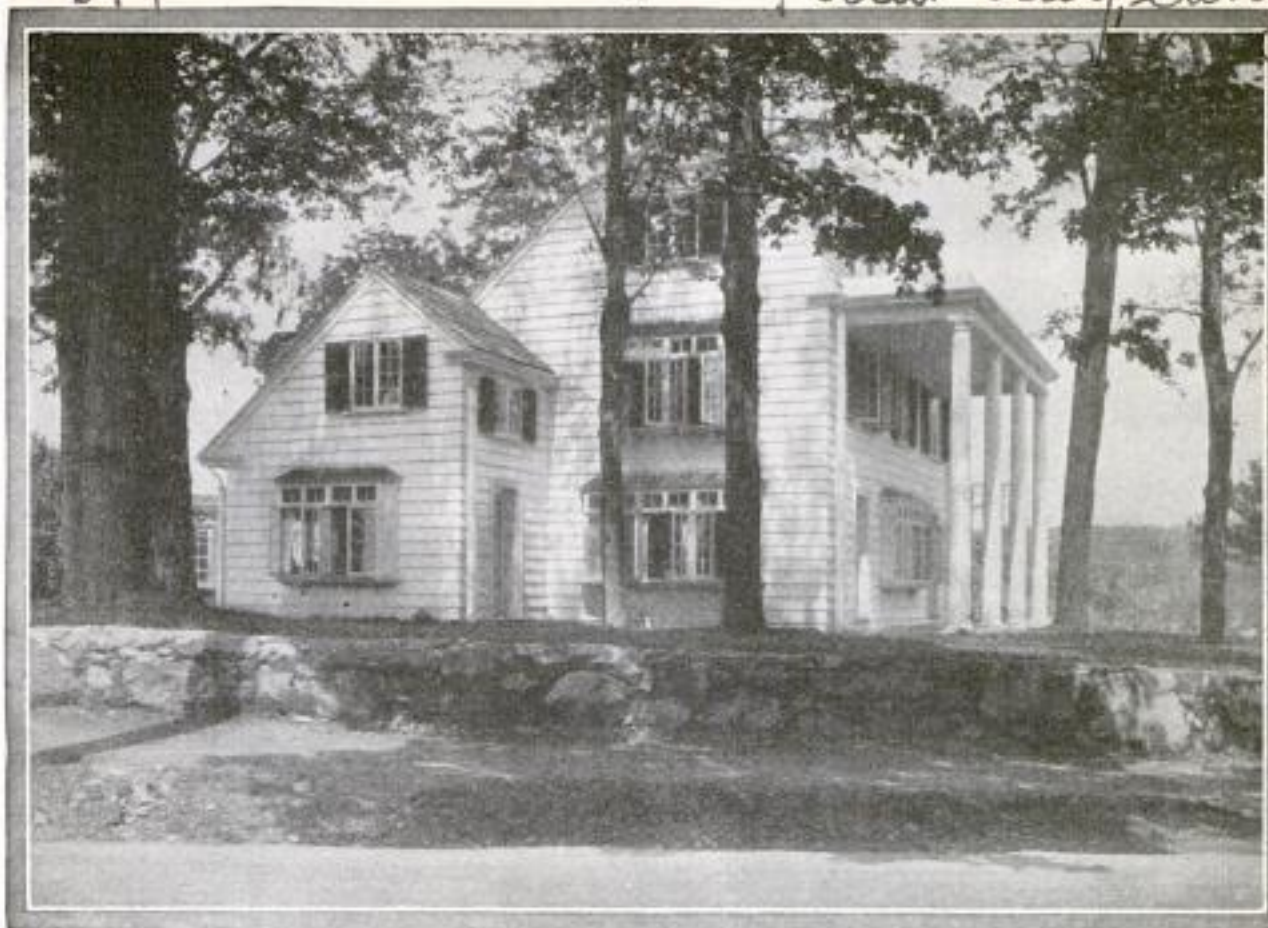

New England House of Concrete Which is So Cleverly Designed and Constructed That It cannot be Distinguished from a Wooden Dwelling Even Though the Observer Stands But a Few Feet Away: It has Been the Subject of Much Interesting Discussion among Noted Architects

mass
Architects -
New Bates + Whippleworth
Boston, Mass

849

A NEW ENGLAND HOUSE OF CONCRETE THAT CANNOT BE TOLD FROM WOOD

BY A. J. R. CURTIS

111 - W. Washington St.
Chicago

RESIDENCE architects — particularly in the vicinity of staid old Boston — find themselves in a quandary over a very unusual concrete house recently designed and built by a distinguished member of the profession. It is a concrete house that looks like a wooden house — so much so, that one may approach within a few feet of it without discovering the difference. Yet walls, floors, roofs, stairs, and steps, within and without, as well as such details as moldings, gutters, cornices, and columns, are entirely of reinforced concrete so placed that it is all one monolithic mass.

"Is it proper to use one material to imitate another?" and "Is an architect within the bounds of good ethics when he so ingeniously uses one material that it cannot be told from another?" are the questions that are being discussed. The building which has offered the reason for the argument is unquestionably not only an architectural classic, but it is

generally mistaken in the community for an example of white-enameled wooden surfaces so common in the better districts of New England.

The architect explains that the old New England farmhouse design, from which this house was created, is good for its own sake, regardless of the materials of which it is constructed; that the simple lines and proportions, not the material, make the architecture. In the acceptance of new materials of construction he does not see why good architecture of the past has to be abandoned, when it can be used to enrich, and really deserves preservation in permanent materials of more recent adaptation.

A study of the design and of the method of construction shows how skillfully form marks have been concealed, and the attention drawn from minor surface flaws by the expedient of building the forms in simple plank panels in the reverse of drop siding. All work is thus



Above is a Rear View of the Concrete House Displaying Some of Its Harmonious Structural Lines. Below at the Left is Seen the Side Entrance of the Dwelling. The Topmost Plan Shows the Second-Floor Room Arrangement, and That Below the Third Floor

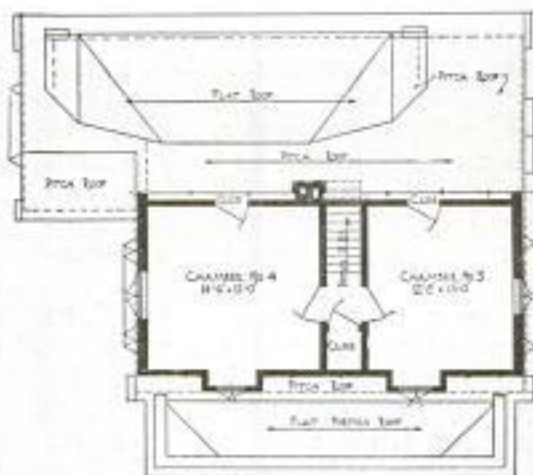
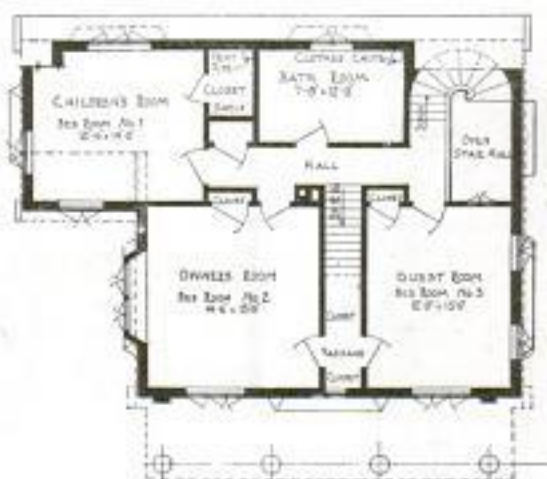

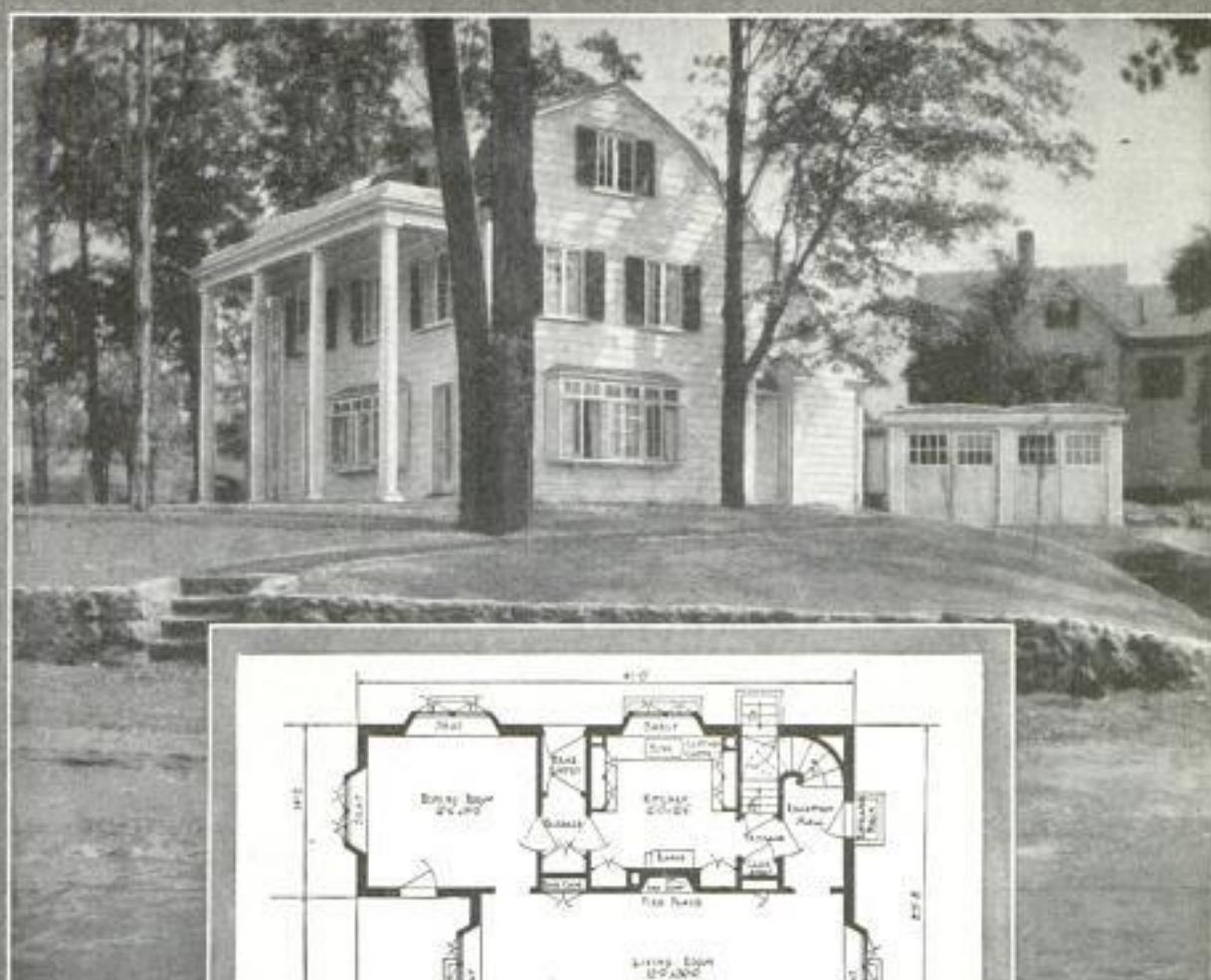

At the Top of the Page Is Another View of the Concrete House, Showing a Garage of the Same Material Erected at the Rear. The Plan Shown in the Center Gives the First or Ground-Floor Room Arrangement. At the Bottom is Seen the Interior of the Spacious and Tastily Furnished Living Room



started and stopped at these definite horizontal lines, doing away largely with possible blemishes and irregularities at the juncture of one day's work with the next. The ridges corresponding to drop siding make it possible to use a very small section of form, as the joints between form settings are well concealed. This saves a great deal of expense in construction.

The interesting house is located at 217 Common Street, Belmont, a suburb of Boston. It has eight large rooms and spacious hallways. The old-fashioned hard-

ware fittings, including door latches and lighting fixtures, were all made by hand by a smith whose work alone makes the house worth a visit. The structure is 30 feet by 44 feet in greatest dimensions, and has walls 10 inches in thickness, which include two 4-inch concrete walls with a 2-inch air space between. The reinforcing consists of $\frac{3}{4}$ -inch deformed steel bars, placed 8 inches apart in each direction. Thus insulated, the plastering was safely applied directly to the inner surface of the concrete.

782

ROAD TO "BIG-TREE" COUNTRY DIFFICULT TO BUILD

The recently completed highway connecting Santa Cruz, Calif., with the "Big-Tree" country, is of interest because of the unusual scenery along the route and the problems confronting the road builders. The straightest route that was

feasible to adopt, was found to lie along the cañons followed by the Southern Pacific Railroad, and it required great care in the handling of materials to keep any from dropping down and interfering with traffic, as in many places the highway was built on a steep slope over 100 feet above the tracks. Four sidehill culverts and 16 concrete retaining walls were constructed in order to provide for the roadbed in such places, and in a number of them the outside edges were supported by bents, 20 feet high, the inner edge being buried in the bank. To prevent undermining of the supports by the seepage of water from the hillside, a 14-inch layer of granite waste, available from a near-by quarry, was packed into the bank for several feet beyond the edge of the pavement. The longest of these viaducts is 160 feet long and is provided with an expansion joint about midway. Similar joints, consisting of a tar filler between the rail ends and the post, were put in at 40-foot intervals on the railings. The pavement is 16 feet wide except at sharp curves, where the width is 18 feet.



Left: One of the Concrete Viaducts, Built along Cañon Wall 100 Feet above Railroad Tracks, on Highway to "Big-Tree" Country. In Places, the Outer Edge of the Viaducts were Supported by Bents 20 Feet High. Right: One of the Curves of the Big-Tree Highway

Supervised by Lloyd Bowman, C. S. Santa Cruz County, Calif.

*Build in my case
Berwick N. H. for their
ammunition.*



First Steel Scow to be Used on the Lakes of Maine in Connection with the Lumber Industry: This Scow Has a Load Capacity of 30 Tons, and is Pushed through the Water by the Powerful Motorboat at a Speed of Six Miles an Hour in Calm Weather

757
**LARGE STEEL SCOWS FOR USE
ON THE LAKES OF MAINE**

As the endless-tread tractor has supplanted horses for long-distance hauling in the lumber woods of Maine, so has the steel scow of from 20 to 40 tons' capacity, propelled by a gasoline motorboat, taken the place of the small wooden craft, whose load capacity did not exceed three or four tons, and which was driven through the waters by rowboats in taking fall supplies across the lakes to camps.

The first of these scows has just been put into operation on Mooselookmeguntic Lake, in the Rangeley region. It is 38 feet long, 15 feet wide, and has a load capacity of 30 tons. It is pushed through the water by a powerful motorboat astern. The bow of this motorboat rests against a specially constructed steel bumper, while heavy poles, for all the world like a pair of buggy shafts, extend from the end of the scow along the sides of the motorboat to which they are lashed. In calm weather the motor craft will drive the loaded steel scow at the rate of six miles an hour.

As the result of several months of investigation, and of the testimony of an expert hydraulic engineer, the Massachusetts Department of Public Utilities has stopped the sale of securities in connection with a tide-motor project.

ALARM CLOCK LIGHTS

9417 **ALCOHOL LAMP**

A Frenchman has made a novel use of an alarm clock in adapting it to light, at a predetermined time, an alcohol burner used for heating water or for simple cooking purposes. At the time the alarm sounds, the spring releases a lever which removes the cap from the burner wick. Then a flint-and-steel device strikes a spark that ignites the burner, over which the cooking vessel has previously been placed.

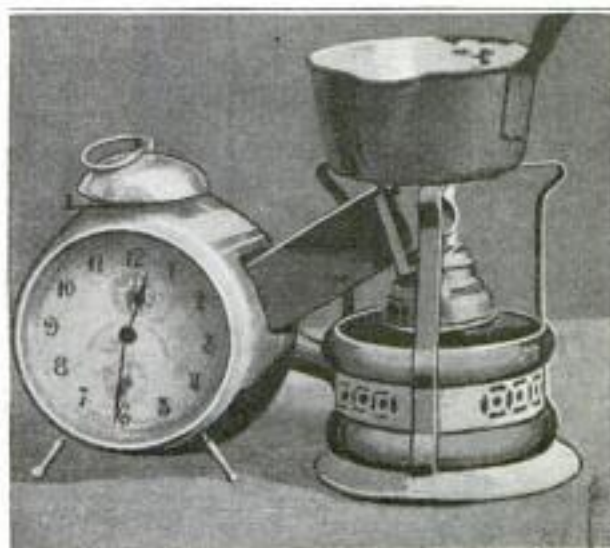

Alcohol Lamp and Alarm-Clock Device Which Lights the Lamp for Those Who Prepare Their Own Light Breakfast

*M. Swimbail, Horloger & Castelton,
(Auburn) 71 Range*

NEW METHOD OF DECIPHERING BURNED RECORDS

748

Acting upon requests to decipher illegible documents and papers, particularly those that have passed through fire with-



Charred Paper, the Writing on Which was Made Legible on Photographic Plates after Two Weeks' Contact in the Dark

out being burned to ashes, the Bureau of Standards has worked out a method that is very effective and comparatively simple. It is based on the principle that a photographic plate or film, besides being sensitive to light, is also sensitive to certain gases or vapors. Some of these have the property of fogging or rendering developable such portions of the plate as are exposed to their action, while others partially or completely desensitize the plate. The specimen under investigation is placed between two photographic plates and kept in intimate contact with the sensitized coating in the dark, for a period of two weeks in the case of fast plates. On



Appearance of Developed Negative after Two Weeks' Contact with Charred Paper: Writing on Both Sides of the Paper Is Visible

development in the usual manner, a perfect copy of the writing and printing is obtained; from which it is evident that the charred paper gives off gases that fog the plate, and that, where ink is present, there is little or no effect, the ink apparently acting like a screen and preventing the emanation of gas. It is interesting to note that the writing on both sides of the charred paper appears, that on the back being fainter than that on the face, indicating that the ink penetrates the paper to such a depth that its residue reduces the amount of gas escaping from beneath the ink.

747
FIRE-HOSE SHUT-OFF VALVE HAS NEW FEATURES

A new quick shut-off fire-hose valve has been developed that combines simplicity of construction with assured water-tightness. The valve, the body of which is integral with the fire-hose nozzle, is somewhat like a shut-off cock, but instead of being solid, the plug is cast in two parts. The larger part has an opening for the passage of water and also carries the stem



Fire-Hose Shut-Off Valve Which Combines Simplicity of Construction with Assured Water-Tightness

by which the plug is turned. Two small holes drilled through the valve allow the water pressure to force the smaller part of the plug against the valve seat. No packing is required, and the single washer used is held tight against the ground joint of the cap.

806
PROVE ELECTRIC ARC A SOURCE OF COAL-DUST IGNITION

That coal dust suspended in the air, under conditions likely to occur in pulverized-coal plants or in coal mines, can be exploded by an electric arc, has been proved by recent tests made by the Bureau of Mines. These tests indicate that in such places, all electrical equipment and devices should be housed in compartments that will prevent contact with the dusty atmosphere.

*San Francisco Fire Dept.
 Mr. McLaughlin, San Francisco Fire Dept.*

IMPROVED LOADER HAS SELF-CONTAINED DRIVE

For handling economically such materials as sand, gravel, coal, or coke, a new type of portable loader is an improvement in many respects upon other machines of this kind.



Elevator in Position for Transporting the Self-Propelling Loader, Which is Driven by the Same Motor as the Elevator

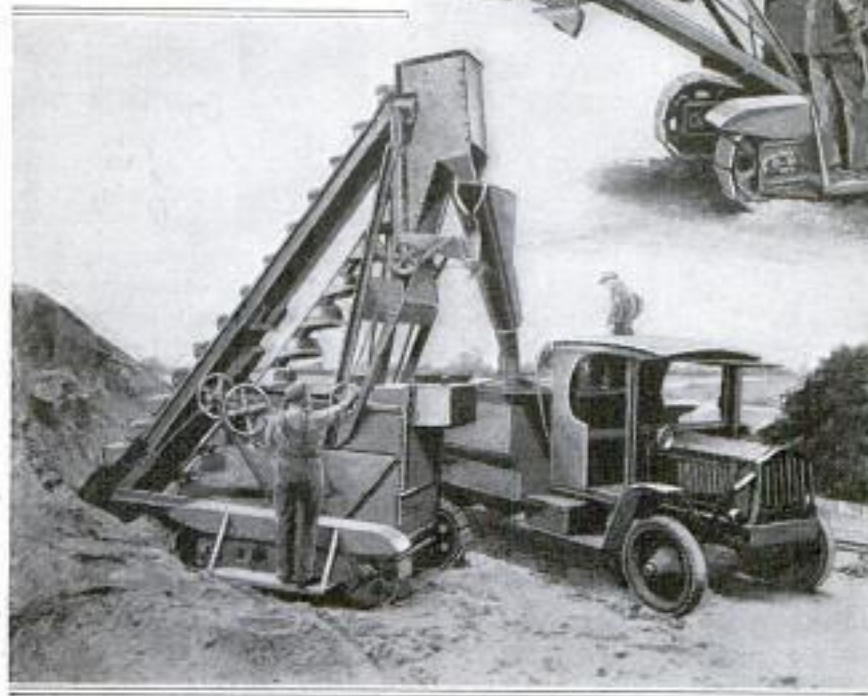

Portable Loader Shown Digging into a Pile of Material and Loading It from a Height of 9 Feet 6 Inches into a Motor Truck

The machine is mounted with three-point suspension on the portable frame in connection with two pairs of wheels that travel on the endless-tread principle. The machine is self-propelling, either gas or electrically driven, and has two speeds, one for moving from place to place and

The loader is composed of an endless link belt with digging buckets connected to it that have renewable steel cutting edges.

a slower speed for digging into the pile of material. The loader will discharge at a height of 9 feet 6 inches.

706

SPEEDY MOTORBOATS MANNED BY GAME WARDENS

The state of Illinois has purchased a fleet of eight high-powered motorboats for the water police service, in order to avoid the necessity, that has existed in the past, of having to commandeer private launches when patrol duty was necessary. It is hoped that with the help of these new motorboats violations of the game and fish laws will be suppressed. Manned by game wardens, these boats will patrol the rivers of the state, and the efficiency of the department should be increased.

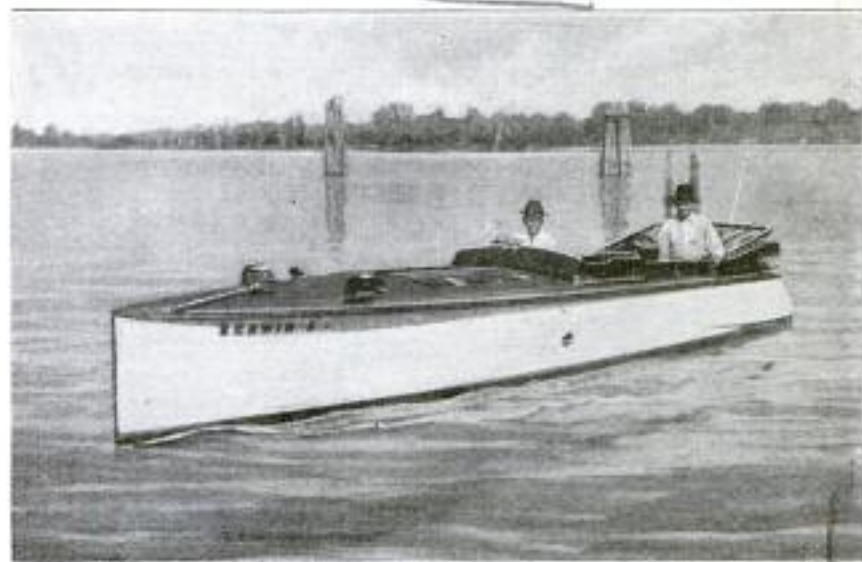

One of the Fleet of Eight Patrol Boats Bought by the State of Illinois to Help the Game Wardens Round Up Violators of the Game and Fish Laws

Carl E. Pierson, Bloomington, Ill.

Dr. Frank B. Sulbreth
 Engineer, Montclair N.J.
 52 Eagle Rock Way,
 68 Eagle Rock Way,
 715

Tire Inflator Co
 1323 Arch St.
 Philadelphia Pa.

POPULAR MECHANICS

STEREOSCOPIC DEVICE AIDS MOTION STUDY

By means of a simple device, the invention of an expert motion-study engineer,

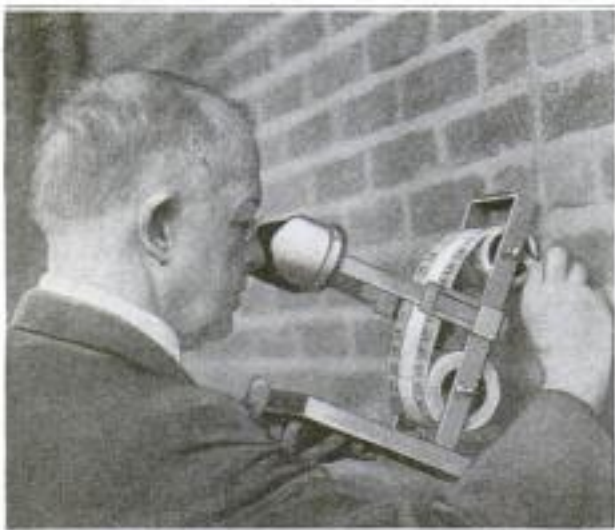

Simple Device That Aids Motion Study of Workers and Machines, Photographed by a Stereoscopic Moving-Picture Camera

apprentices and students can study the movements of a proficient worker who has been photographed with a stereoscopic motion-picture machine. The device consists of an ordinary set of stereoscopic lenses suitably mounted on a frame carrying two rolls, from which the film is wound and unwound.

NOVEL MEANS OF TRANSPORT FOR SMALL LOADS

A new device used in Germany for transporting small loads, consists of a metal plate encircled by a rubber tire, similar to a motorcycle wheel, and fas-



Above: Transport Device Taken Apart, Showing Receptacle for Various Articles. Right: Device Assembled and Ready for Use

tened to a bent handle, through which it passes. A piece of pan-shaped metal forms, with the wheel to which it is attached, a receptacle for liquids, books, or other material. A load of 100 pounds can easily be pushed a long distance by hand, or the carrier can be used as a trailer for cycles. Larger machines are being built.

AUTOMATIC TIRE INFLATER HANDY FOR THE AUTOIST

An extremely handy device for inflating a tire is in the form of a small, strong drum that is filled with a gas, harmless to rubber, and sufficient in quantity to inflate a tire to 65 pounds' pressure, without jacking, in a few seconds. In the cap of the drum is a threaded hole into which is screwed the tire-valve stem. The drum is turned until it is apparently tight on the stem, and then the cap is held with one hand while the drum is

Price \$1.50

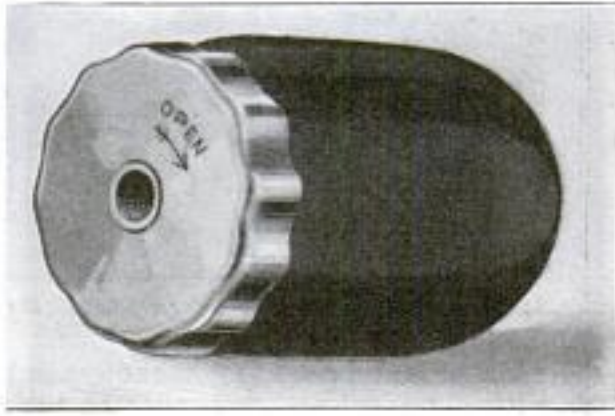

Novel Tire Inflator That is Screwed onto the Valve Stem and Inflates the Tire to 65 Pounds' Pressure in a Few Seconds

turned with the other in the same direction, causing the gas to flow into the tire. A reverse motion stops the flow of the gas. 821

EGYPTIAN OFFICIALS ARRIVE FOR AUTOMOTIVE COURSE

Six representatives of the Egyptian ministry of transport and communication recently arrived in this country for the purpose of taking a course in automotive engineering. Their entire expenses are being paid by that country. While the exact curriculum for these men has not been definitely decided upon for the length of time they will be here, the first year, at least, will be spent at a Michigan school. Here they will be taught tractor mechanics, tire and battery repairing, oxyacetylene welding, automotive electricity, and general machine shop work.

No data on maker

could not supply name

Michigan State Auto School Detroit Mich

General Electric Co. Schenectady N.Y.

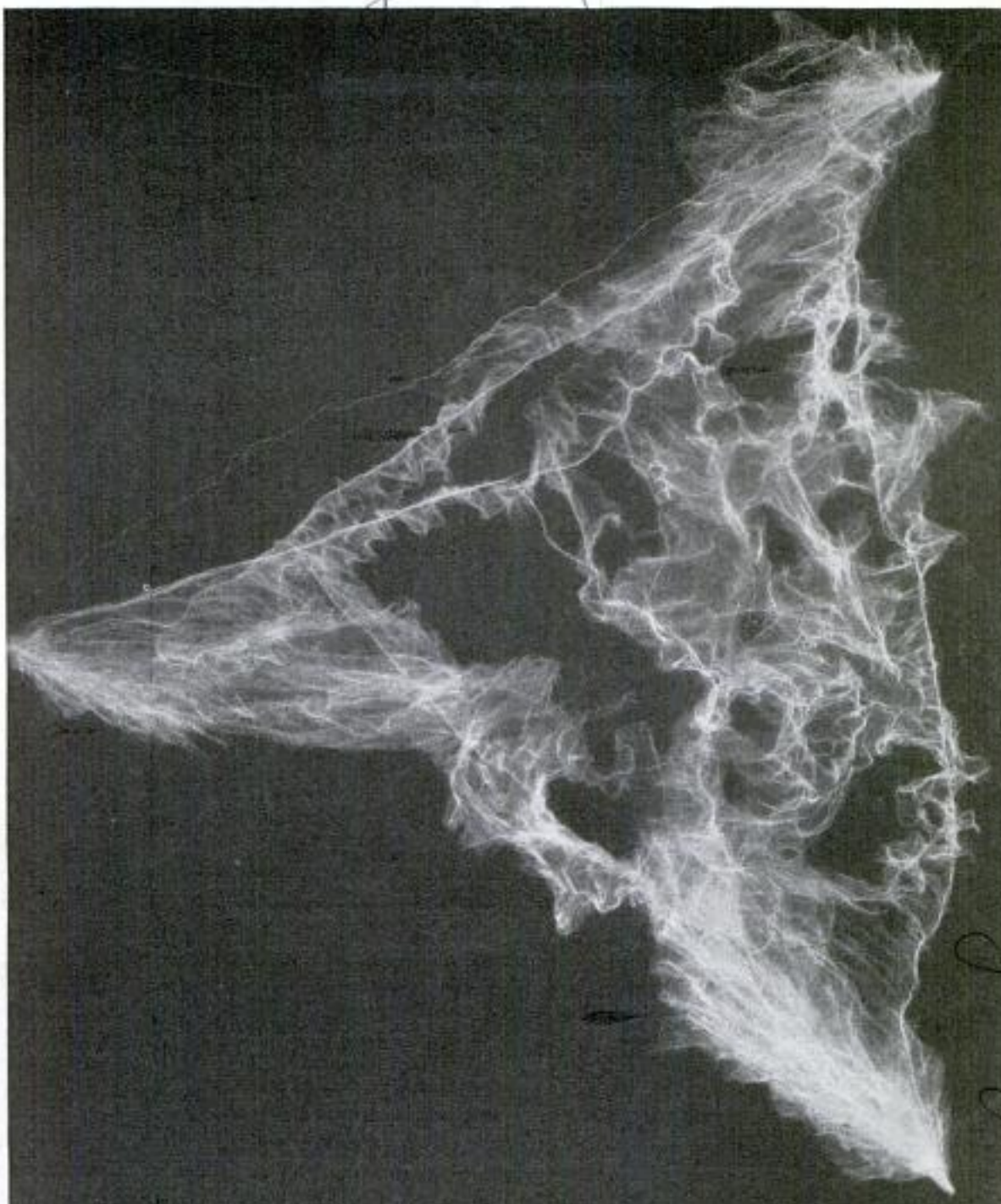

MAN-MADE MILLION-VOLT LIGHTNING

IN the days of Benjamin Franklin, of whom it was said that he wrung the lightning from the gods and gave it to man for his service, little was known of its nature, and the familiar zigzag line long remained its only graphic representation. Now, with the high-speed photographic lens taking the place of the human eye, and the discharge of enormous electric pressures, built up in the laboratory, supplanting nature's display, the violent bolt resolves itself into a maze of filmy threads of wonderful beauty and orderly formation.

The picture herewith was taken in the General Electric Company's laboratories, when a charge of 1,000,000 volts broke through the gaps between three electrodes, forming a 9-foot equilateral triangle.



731

Western Electric Co
110 Williams St
New York City

54

POPULAR MECHANICS

HIGH-POWERED VACUUM TUBES FOR RADIO WORK

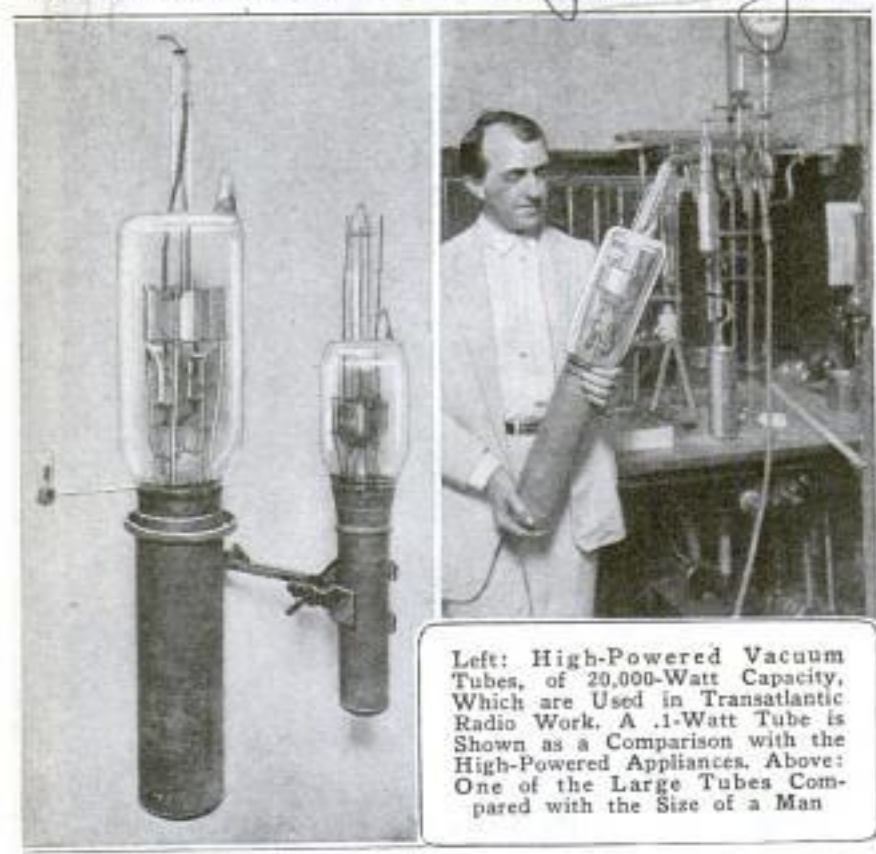

Left: High-Powered Vacuum Tubes, of 20,000-Watt Capacity, Which are Used in Transatlantic Radio Work. A .1-Watt Tube is Shown as a Comparison with the High-Powered Appliances. Above: One of the Large Tubes Compared with the Size of a Man

High-powered vacuum tubes have recently been successfully used in transatlantic radio work, signals having been transmitted and received between Nauen, Germany, and Rocky Point, L. I. The tubes were of 20-kilowatt capacity. Development of these vacuum tubes has proceeded steadily from a beginning of .1 or .2 watt, up to the point where they now handle 20,000 watts. Tubes even larger than this are now under construction. One of them, designed for a capacity of 100,000 watts, promises to be fully as successful as those now in use, in addition to possessing a higher efficiency, because it will have such an enormous amount of power.

12 LOCAL CITY HALL FOR PHILADELPHIA SUBURB

In Germantown, which is a section of Philadelphia, about six miles distant from its city hall, a local city hall is to be erected at a cost of \$450,000, which will contain offices for the transaction of every kind of city business excepting that which might require the attention of a court of record. The new sectional city hall is to be located on the site of what is known as Town Hall, a building almost a century old. The design of the new building is of the Colonial period, and it will be faced

with white marble. It will be of fireproof construction throughout, and will have a large front portico with Ionic columns, 24 feet in height. Beneath a tower, capped with a dome, 122 feet above ground level, will be a rotunda, 33 feet in diameter and 37 feet high, in which will be housed a collection of World War memorials. In the tower will be placed the clock and bell from the old town hall. Later on, similar buildings may be located in other sections of the city.

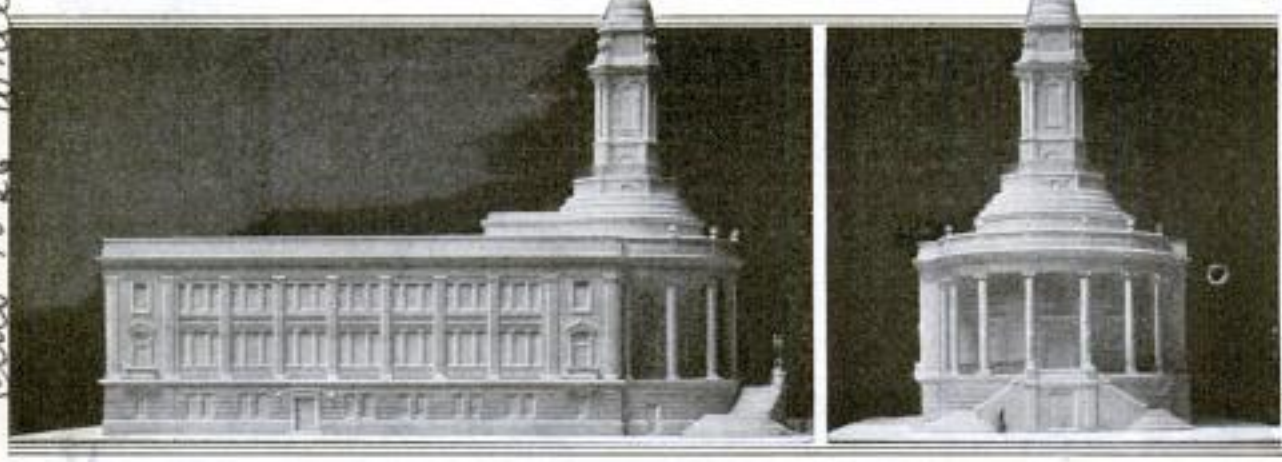

Left: Side Elevation of a Model of a Sectional City Hall That is About to be Erected in Germantown, a Suburb of Philadelphia, Pennsylvania. Right: Another View of the Building, Showing Its Portico with Ionic Columns, 24 Feet in Height, and Its Tower with a Dome, 122 Feet above Ground Level

Mrs. H. H. Clappren 49 Penn + Baycil
 Club 7026 Walnut Philadelphia

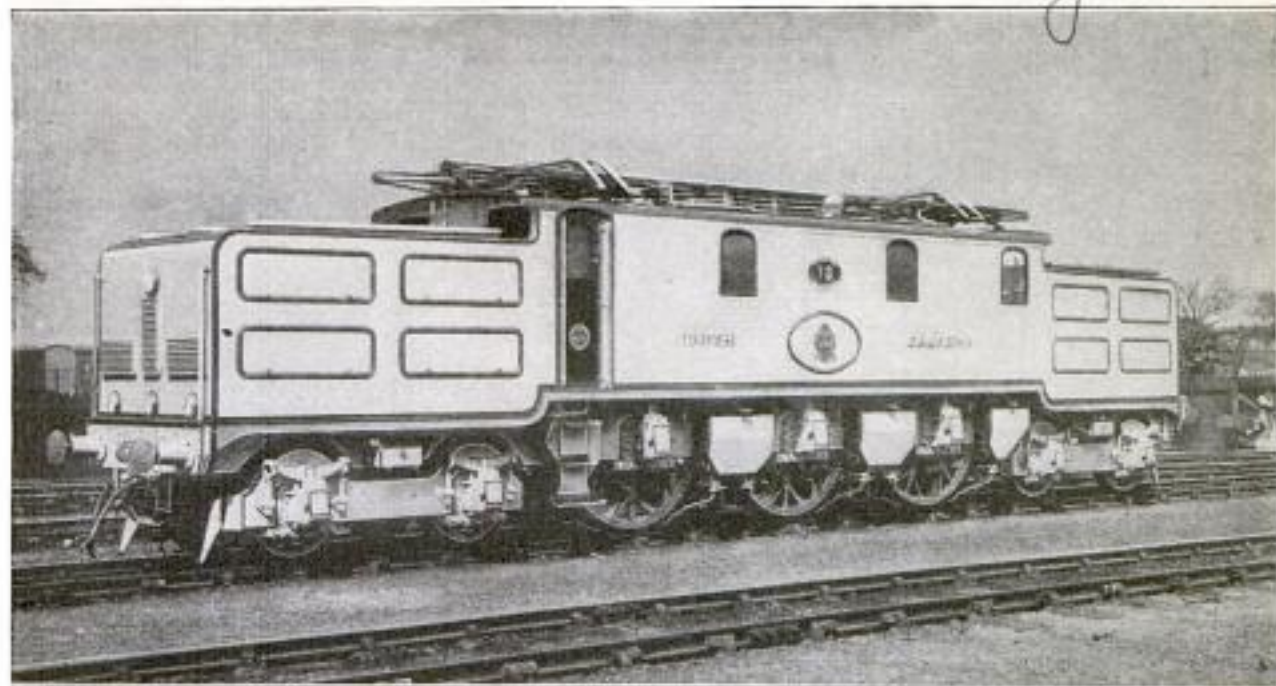

First Main-Line Electric Locomotive to Appear in Britain: It was Constructed for Use between York and Newcastle, One of the Most Important of the English Railways, but was First Given a Trial over the Short Run between York and Darlington

728
**BRITAIN'S FIRST MAIN-LINE
ELECTRIC LOCOMOTIVE**

Electric locomotives for suburban and interurban traffic have been used in Britain, as in America, for a number of years, but owing to various difficulties, principally of a financial nature, Britain, unlike America, has been slow in developing this type of engine for main-line work, and it is only now that its first high-speed electric-railway engine has appeared.

It is designed to travel at a safe maximum speed of 90 miles an hour, and will maintain an average of over a mile a minute on a long-distance journey. Built for one of the most important English railways, it was first tried on the short York and Darlington run—a distance of $44\frac{1}{4}$ miles—which is at present covered in 43 minutes by steam locomotives, or at a speed of 61.7 miles an hour. This is claimed to be the fastest run in the country. This engine is now used to pull the London and Scotch express over the east-coast route between York and Newcastle. Of 1,800 horsepower, it is capable of performing the above-mentioned high speed hauling a load of about 500 tons. It is fitted with a small electrically heated boiler for producing steam for heating the passenger coaches.

☐ A bank building under construction in Oak Park, Ill., will have a room suitably fitted to handle the business of juvenile patrons exclusively.

**PAINTING SMALL BOLT HEADS
IN LARGE QUANTITIES**

Very small bolt heads are painted rapidly, and in large numbers, by inserting them into perforations in a plate large enough to hold hundreds, or even thousands, of them. When the bolts are thus



Perforated Plate in Which Small Bolts are Inserted for Painting Their Heads: This Plate Holds 1,800 Bolts, and It Takes 45 Minutes to Insert Them

inserted, with their heads in rows, and all flush, a few strokes of the brush is all that is required to paint them.

*all. Steel Equipment Co.
Aurora, Ill.*

384

Mfr. Farman Co. Paris, France
Sold by: Wallace Kellett Philadelphia, Pa.

Build by W. J. Savage.
Ayer, Mass.

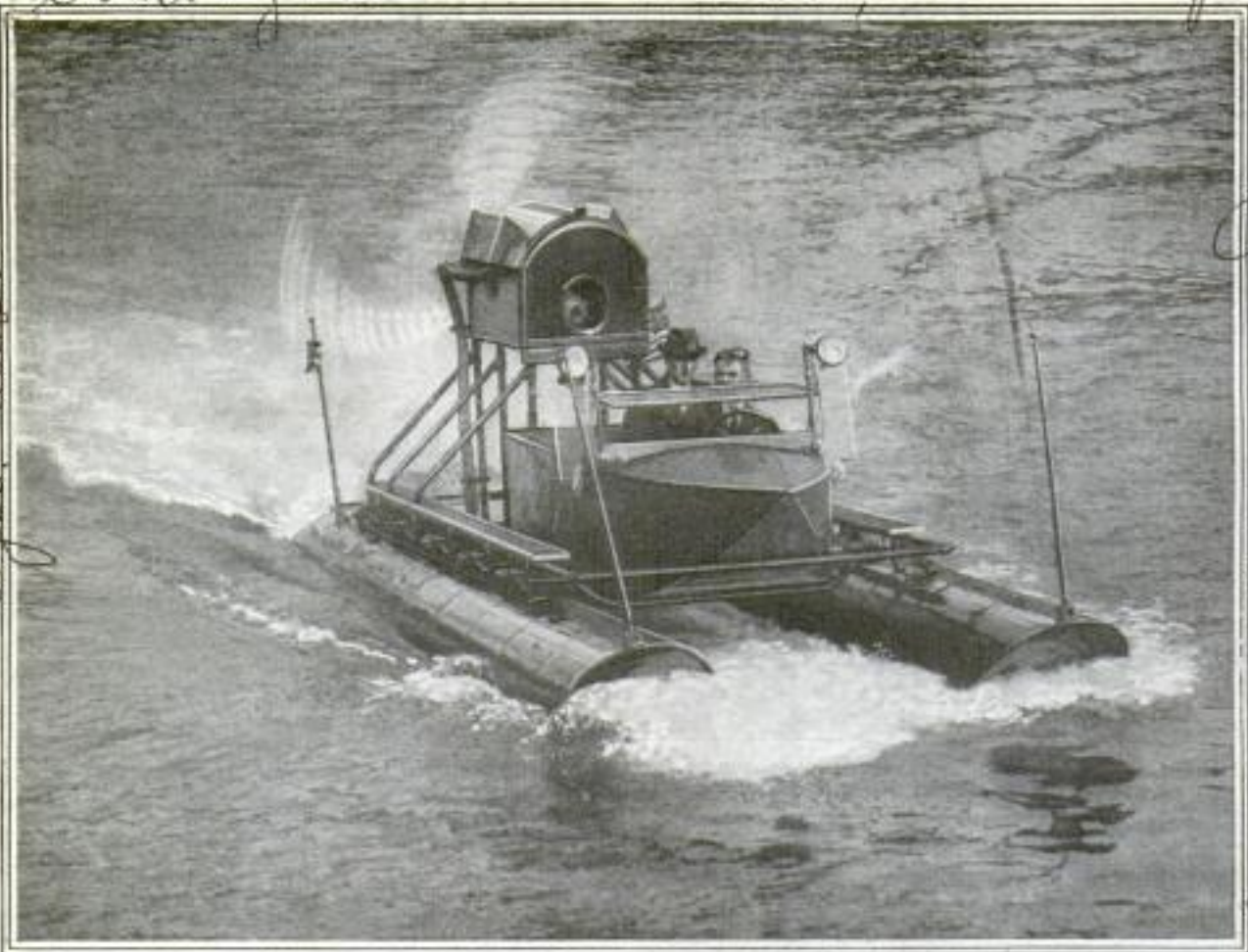

810
atta
d

January 1924-35

This Hydroglider, Built by an American Youth, Draws Only 1½ Inches of Water at a Speed of 45 Miles an Hour, and is Equipped with a Six-Passenger Automobile Body

384

SOME NEW HYDROGLIDERS

By R. C. FOLGER

RECENT designs of hydrogliders indicate the development of a type of water craft that is of interest to speed enthusiasts and may well be adapted to more useful purposes. The hydroglider, which combines some of the features of the hydroplane and the flying boat, is characterized by its light draft and air propeller. One of the latest of these is a cabin hydroglider now being built by a French concern. This craft carries 10 passengers, attains a speed of 45 to 50 miles an hour, draws 8 inches of water, and is propelled by a 190-horsepower engine and air propeller. A smaller glider, which is made by the same firm, and is said to be quite popular abroad, weighs only 350 pounds, draws 3 inches of water, and is driven by a 10-12-horsepower motor and air propeller that gives it a speed of 15 miles an hour.

Another French glider that has been developed as the result of recent experiments, features a new idea in the form of a water propeller that lifts the boat from underneath and enables an engine and air

propeller, of relatively low power, to drive the boat at great speed. One of the most interesting, which is the product of an American youth, draws 6 inches of water at a standstill and only 1½ inches at a speed of 45 miles an hour. It is non-sinkable and noncapsizable, for it has two pontoons, each with nine water-tight compartments. The regular six-passenger automobile body, placed on a 10-point suspension spring between the pontoons, is equipped with self-starter, windshield, lights, and one-man top and side curtains, making it serviceable in all weathers. It is said that on account of the method of suspending the body, practically no wave vibration is felt, even in a fairly rough sea.

ⓂA trio of 11-passenger flying boats have maintained a four-trip daily service between Detroit and Cleveland, without a single accident or fatality among the 2,521 passengers carried during the present season. The traveler makes the 90-minute trip in a luxurious cabin that excludes noise and wind.

Aeromarine Airways, Inc.
Cleveland, Ohio.

also articles - June 1922 - 907
December 1922 - 837

Alvise
1922-837



Small Hydroglider Which Weighs 350 Pounds, Draws 3 to 4 Inches of Water, and Makes 15 Miles an Hour with a 10-12-Horsepower Motor

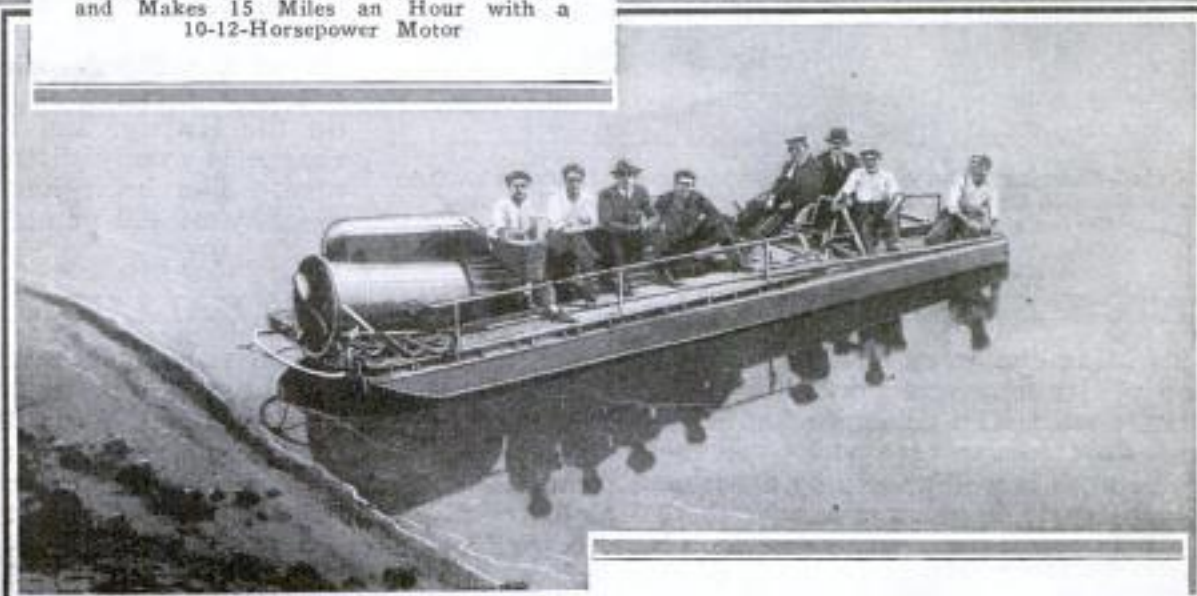

Above: Glider with Lifter Propeller, That Enables a High Speed to be Attained with Light Draft and Small Motor. Below: Ten-Passenger Cabin Glider of French Design, That Draws 8 Inches of Water and Has a Speed of About 50 Miles an Hour

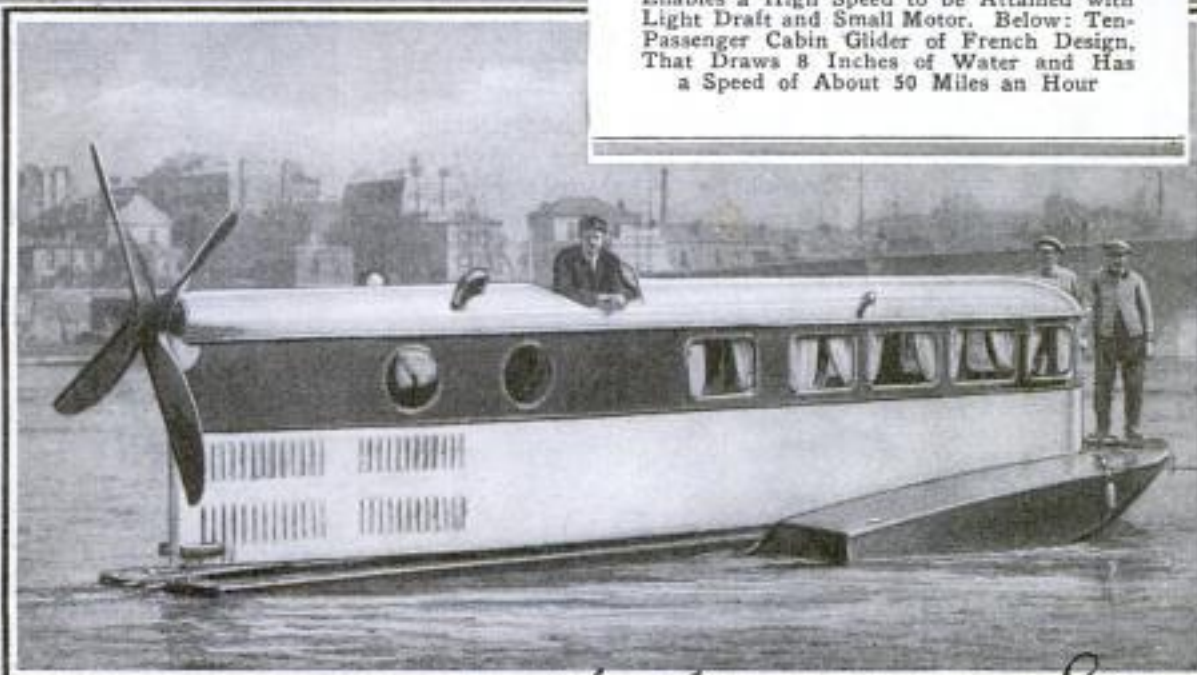

This one made by the Parmian Co.
Paris, France.
Agent - Wallace Kellett, 820 Atlantic Ave.
Philadelphia

58
 76

CHARGING HOIST EFFECTS ECONOMY IN FOUNDRIES

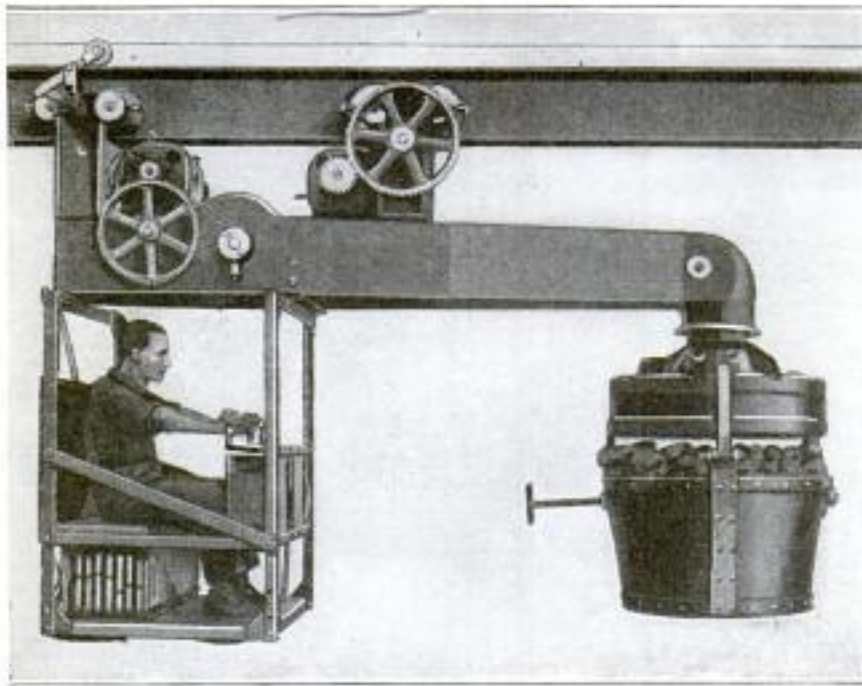

New Cupola-Charging Hoist with a Drop-Bottom Bucket Loaded with Coke: The Hoist is Operated Electrically, and the Charging Arm Also Carries a Magnet for Handling Pig Iron and Scrap

A hoist, recently developed, for charging materials into foundry cupolas, reduces the labor of this work and promises other savings in the maintenance of the cupola linings. The hoist, which travels on an I-beam, consists of a cast-iron cantilever arm from which is suspended, by cables, a magnet for handling pig iron and scrap, or a bottom-dump bucket in the case of coke. With this method, all the charged materials are deposited in the center of the cupola without any abrasive action on the lining, and the charge is evenly distributed. The hoist has a capacity of 400 pounds.

CATCH BASS WITH LIVE MICE AND TOY BALLOONS

Outwitting the wary bass by a combination of live mice and toy balloons, was the latest successful scheme of an angler in an effort to secure a string of these fish. Bass, as is well known by fishermen, are particularly fond of mice. With this

fact as the basis, a sportsman, after procuring several live mice in traps, fastened one of these, just ahead of the hooks, on his line. One or two balloons were then at-

tached to the line in such a manner that the mouse was kept afloat and was free to paddle around in the water. With this odd tackle, a number of large bass were caught in a lake known to be well supplied with fish, which, however, were the despair of anglers who had tried to catch them with bait of the ordinary variety. According to the fisherman, his catch was only limited by the supply of mice and balloons.



Above: Attaching Live Mouse to the Line.



Right: Rod and Line with Balloons Attached



Above: Catch of Bass Which was Only Limited by Supply of Mice and Balloons

Ent. Hogg + Floyd. 4/16 Hyman League Bldg. Los Angeles, Calif. 50



Two Views of Specially Designed Frame for Handling Heavy Truck Engines: The Frame can be Turned by Hand or Power

FRAME FOR TRUCK ENGINES 602 FACILITATES REPAIRS

The repairing of extremely heavy motor-truck engines has been facilitated by the introduction of a frame on which the engine, after it has been removed from the chassis, may be securely bolted. The frame is about waist-high, and has a ratchet and gear attachment with which it may be tilted to any desired angle. The mechanic is thus enabled to place the outfit in various positions, may sit down or stand up as he wishes, and always has convenient access to any of the parts. This frame was designed by the shop superintendent of a large truck company and has proved a successful means of reducing the overhauling costs of its many engines.

455 —

PECULIAR STONE RESEMBLES HUMAN WORKMANSHIP

A queer-looking stone found a short time ago in the mountains near Chattanooga, Tenn., at first appeared to be a relic of the workmanship of an ancient people, but a more careful examination showed it to be an odd geological specimen. The stone is an approximate cube of sandstone, 3 feet on a side, on the top of which appear more than 150 pigeon-holelike openings, the partitions of these being of iron. Many of these spaces are filled to the top with sand, which under the action of the sun and elements has become baked and hardened into a solid; others are open and fully 2 inches deep.

So much do the holes resemble the work of human hands it is difficult to believe the stone was not in use by prehistoric man. However, geologists are inclined to



Odd-Looking Geological Specimen Which Has the Appearance of Pigeonholes Made by Prehistoric Man

believe that the particles of iron have in bygone ages become associated in the partitions that now form the holes. Seams between the partitions make the resemblance to human workmanship the more striking.

Capt. Robert Sparks Walker.
 Chattanooga, Tenn

GERMAN POLICE WILL WEAR BULLET-PROOF ARMOR

Members of the German criminal-police force are to be shielded in the future with armor in the form of a coat of mail for the body, and a bullet-proof helmet for the head that will afford almost complete protection for the eyes. This armor has been proved by test to be capable of withstanding the fire of high-powered automatic pistols. The throat and neck are also protected with a bullet-proof collar above the coat of mail.



COPYRIGHT, UNDERWOOD & UNDERWOOD

The throat and neck are also protected with a bullet-proof collar above the coat of mail.

SELF-BAKED RENEWABLE TYPE OF FURNACE ELECTRODE

An electric-furnace electrode that is claimed to be everlasting, is built, baked, and renewed in its actual location in the furnace of which it is a part. Once installed, it will last at least as long as the furnace. Into a casing made of thin sheet iron, that serves as a mold, ordinary electrode mixture is tamped. The lower part of the electrode protrudes from this casing, and is placed in the smelting furnace, where it is baked by the heat from the crater, and also by that developed by the current in the electrode. Thus it consists of a lower internal baked part, and an upper

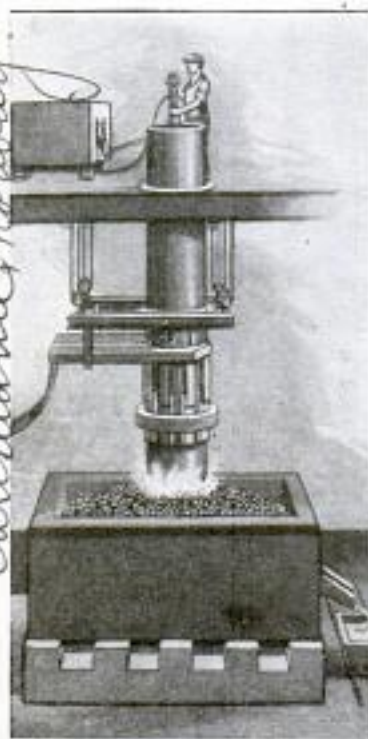

and also by that developed by the current in the electrode. Thus it consists of a lower internal baked part, and an upper

external unbaked part. It is suspended in the furnace by means of an adjustable clasp holder. The electrode is very long, and around its upper part is a platform where the casing can be lengthened by welding on a new section. The electrode is then lengthened by tamping in new electrode mixture.

NEW SEPARABLE SPARK PLUG THAT IS EASILY CLEANED

Without disturbing the porcelain or the packing, a recently patented spark plug can be thoroughly and readily cleaned. It is a modification of the separable type of spark plug, and is constructed so that part of the iron shell that screws into the cylinder can be unscrewed from the rest of the plug, making it easy to clean both the electrodes and the porcelain insulation, without having to remove any gland nut, or to interfere with the gaskets, as in separable plugs. The facility with which it is taken apart eliminates danger of breakage.



SELF-ADJUSTING LAMP ARMS FOR LOCALIZED LIGHTING

A type of self-adjusting arm with elbow, wrist, and telescopic action, is a fixture for local electric lighting, by means of which the light can be moved in a direct line from one point to another. In connection with the arm, each of the flexible joints consists of two dished cast-iron disks held together by a screw that passes loosely through the center of one disk, and is screwed rigidly into the center of the other.

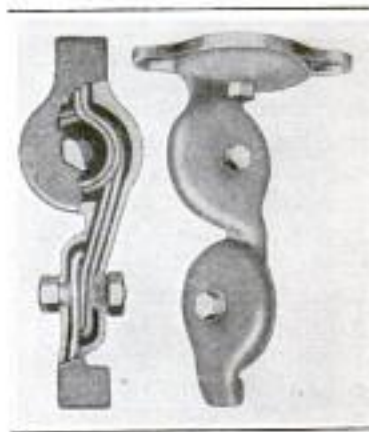

Localized Lighting Corp
540 W 58th St
New York

C.W. Soderberg + M. Senn, Slet norske aktieselskab for Elektroteknisk Industri Christiania, Norway

Peninsular Corp
Penobscot Bldg. 1.00
Detroit, Mich

481

454

Patented

Localized Lighting Corp
540 W 58th St
New York

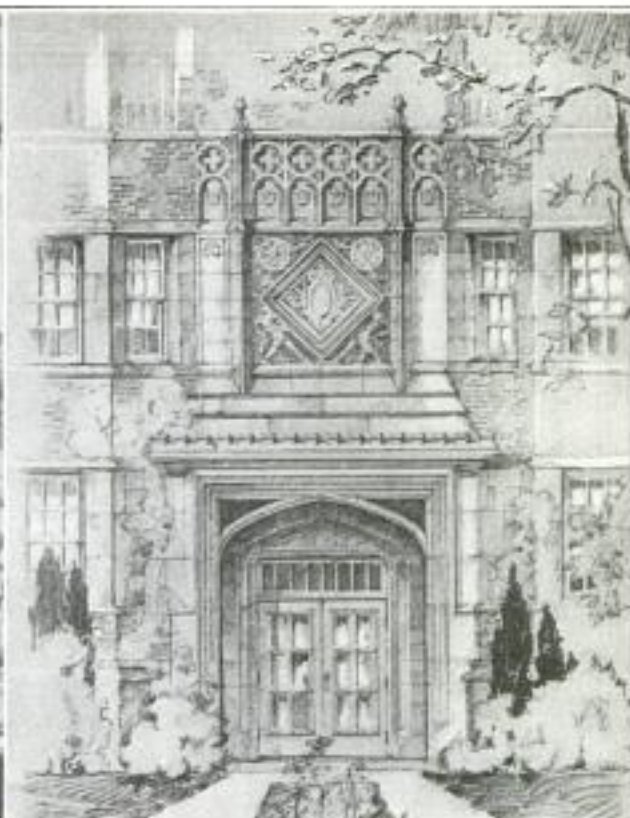

At the Left Is a General View of One of the Six Units of Moreland Courts, the \$30,000,000 Apartment-House Development Now under Way in Shaker Heights, an Exclusive Residential Section of Cleveland, Ohio. At the Right is Seen One of the Many Beautiful Entrances in the Group of Buildings

APARTMENT-HOUSE PROJECT
308 TO COST \$30,000,000

One of the largest building projects ever attempted in this country is now under way in Cleveland, Ohio, where ground has been broken for the beginning of a \$30,000,000 apartment-house development. The project consists of six structures which will accommodate 1,000 families. In addition to the vast number of apartments, there will also be included stores, markets, an English inn, and a motion-picture theater. The structures will typify the history of English architecture. Types of Georgian, Jacobean, Elizabethan, and Tudor architecture, will be arranged so as to blend harmoniously, and yet retain all the distinctive characteristics of these different periods. The site is located in Shaker Heights, an exclusive residential district. The finished apartments will vary in size from 4 up to 12-room suites, all possessing the latest improvements in heating, lighting, refrigeration, and garbage incineration, and it is thought that they will relieve, to a great extent, the general lack of apartment dwellings in that city.

At the present time over \$15,000,000,000 is invested in public utilities in this country.

HANDY POCKET CASE PROTECTS
72 MICROMETERS

A new pocket case made by a tool manufacturer provides a convenient place in which to keep micrometer calipers, besides affording protection against dirt and injury. Made of metal, leather-covered and plush-lined, it is shaped to fit into the pocket without causing much of a bulge, while the inside is properly formed to hold the instrument tightly. There are several styles for different types.

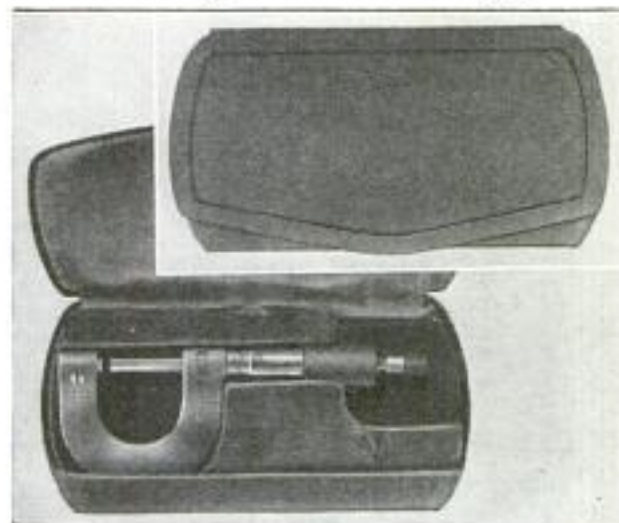

Above: Convenient Pocket Case for Micrometers Shown Closed. Below: Case Open, Showing How It is Constructed to Fit the Micrometer

Argonne & Sharpe Mfg. Co.
 Providence, R. I.

R. Melrose, 92 Waterloo St.
St. John, N. B., Canada

511

PERILS OF THE SEA STRIKINGLY ILLUSTRATED

International Sewer Corp. 226 William St. New York
J. E. Bayford Star Bldg Cincinnati, Ohio

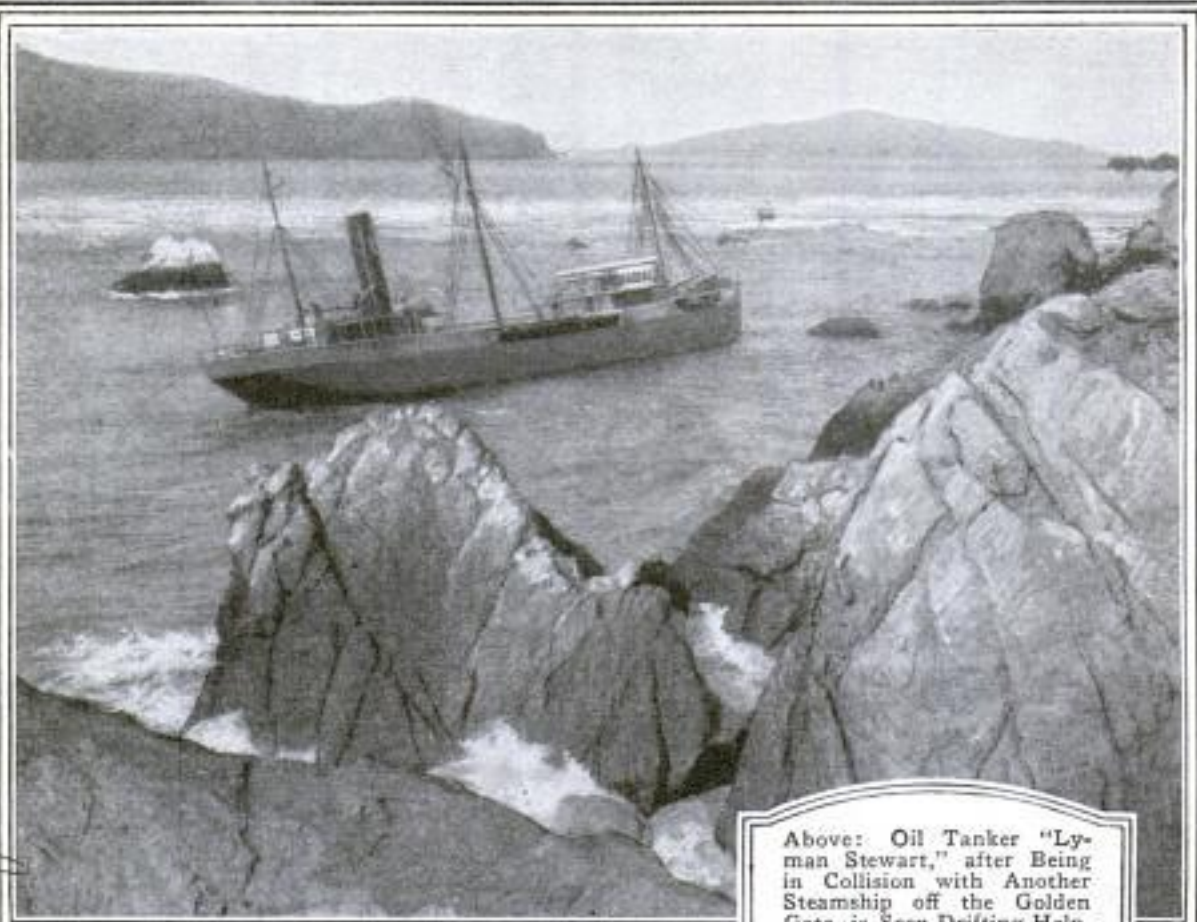

Above: Oil Tanker "Lyman Stewart," after Being in Collision with Another Steamship off the Golden Gate, is Seen Drifting Helplessly onto a Reef beside the Cliffs of Land's End. Below: Canadian Steamboat on the Rocks at Black Point, About Four Miles from the City of St. John, New Brunswick, as the Result of Getting off Its Course in a Dense Fog



511
Ship

BY WRECKS IN WIDELY SEPARATED LOCALITIES



Above: Biggest Fire in Cincinnati Harbor for 50 Years. Four Steamers, One of Which, the "Island Queen," is Seen in the Foreground, were Destroyed, as Well as the Two Wharves Seen Burning to the Right. Below: Steam Yacht "Taro," Which, While Bound from Newport to New York, Went Ashore near Westerly, Long Island



**SLIDE WATERFALL FOR SPORT
 IN SOUTH SEA ISLE**

**METHOD OF VAPOR-COOLING
 AUTOMOBILE ENGINES**

What appears to be a unique sport, combining the thrills of tobogganing,

In a vapor-cooling system for automobile engines, recently developed, the vapor



Above: A Native Girl Shooting the Falls at Papa-Seea, in the Samoa Islands. The Picture to the Right Gives a Good Idea of the Beauty of the Surroundings

skiing, and diving, is indulged in at Papa-Seea, near the town of Apia, in the Samoan Island group. At Papa-Seea, amid picturesque tropical surroundings, nature has fashioned an almost perfect water glide with a drop of about 60 feet. The action of the water has worn the rock smooth, the stream is large enough to give the human slider plenty of momentum, and the deep pool at the bottom is so small that even a poor swimmer can make shore. The sport is in great favor with native girls, who make a pretty picture as they shoot down.

or steam from the cylinder jacket, wherein the water is constantly boiling, goes to the bottom tank of the radiator instead of, as usual, to the top. Consequently, there is never any water in the radiator, and therefore the working surface can be kept at a very high temperature. With this system, the working surface is never cooler than 210° F., which means that, with the air as high as 80°, there is a difference of 130°. Thus there is a very high heat transfer and a correspondingly high radiator efficiency. Moreover, when alcohol is added to the water in winter it will be condensed automatically, and since the system is closed, there will be no loss by evaporation. Another most important feature is that the high average temperature allows the size of the radiator to be greatly reduced, at a consequent economy in first cost and in weight. This system may have a water filler at the bottom of the tank, or the customary top cap may be used.

CONVENIENT IRONING-BOARD

66 SUPPORT ALSO A TABLE

A combination breakfast table and ironing-board support, which folds into a narrow closet, is one of the latest kitchen novelties. When ready to iron, a lower door hinged to the bottom of the closet is pulled outward to serve as a brace. The table in its folded position is then put in place as a support for the ironing

**80 MOTOR-BUS SPEAKING TUBE
 IS AID TO DRIVER**

One of the recent models of motor busses has, along with numerous other conveniences, a speaking tube which extends from the outside rear of the machine to a point inside, at the front near the driver, who is thus enabled to hear the signals of cars approaching from behind that desire to pass. It is expected that this feature will be of great service to drivers of these busses in aiding them to allow the speedier machines to pass readily and without danger of accidents, which might be caused by crowding and consequent skidding off the roadway.



Left to Right: Support and Ironing Board Concealed in Wall; Support Let Down as Table, and Ironing Board Ready for Use

board, also kept in the closet. Unfolded, the support makes a small breakfast table.

Bulfin Furniture Co.
1911 San Pablo Ave
Berkeley, Calif

Commerce Motor Car Co.
Detroit Mich.

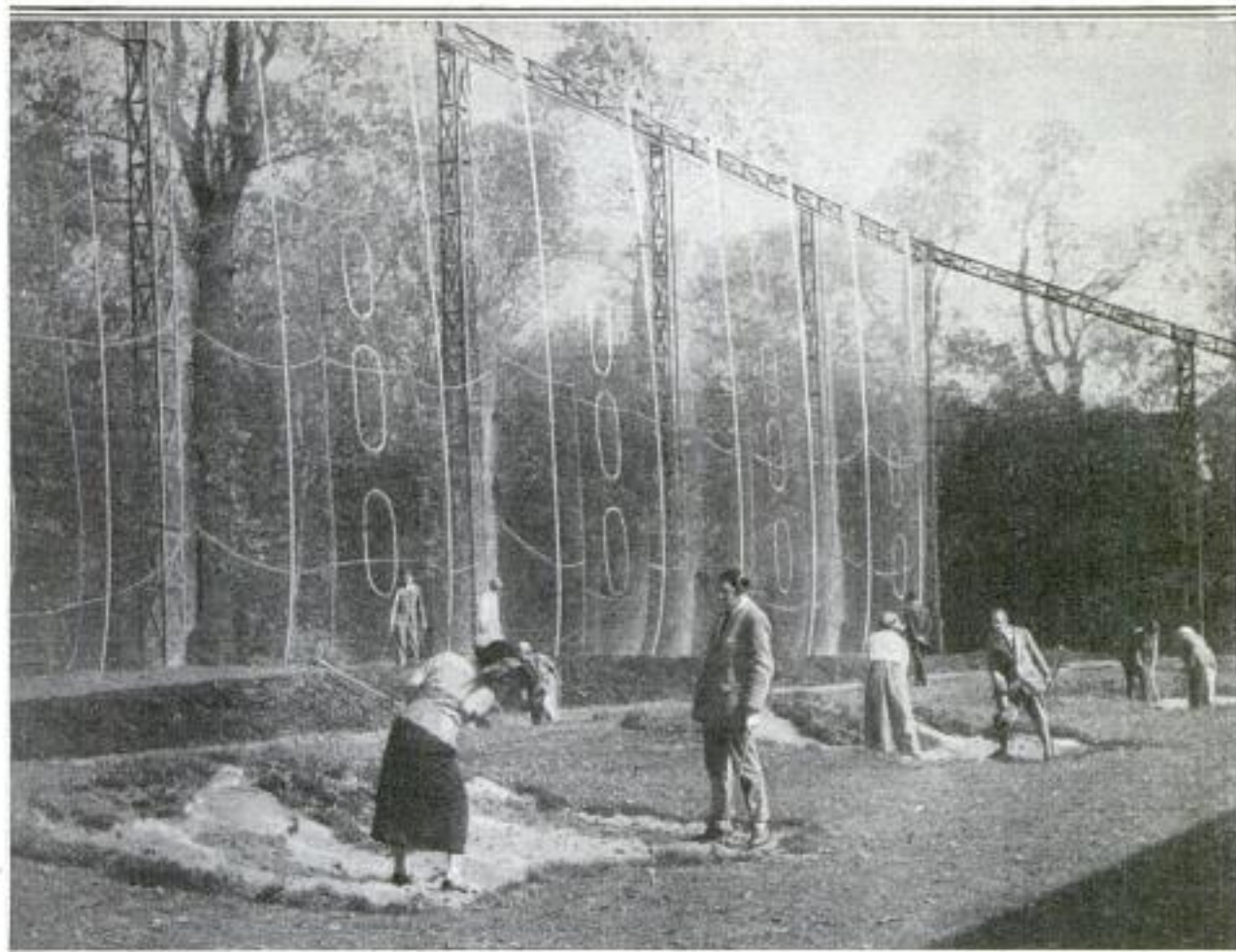

That English Women Are Fond of Golf Seems Evident from This Picture Which Shows the Bunkers before the "Target Net" at the Outdoor Golf School at the Kensington Gardens, London

595 OUTDOOR GOLF SCHOOL IN LONDON PUBLIC PARK

An outdoor golf school, with a shed for driving in wet weather, bunkers, and a large "target net" is arranged at the Kensington Gardens in London. There are several unusual advantages to be found in connection with this school, not the least of which is the fact that, although located in the open, it is not far removed from the main business and theatrical districts. By means of specially built bunkers and a great target net painted with white circles, it is possible to practice any kind of shot. The results of the drives in each case can be accurately determined by watching the section of the net to which the ball is hit. Many women in London are taking up the sport, and it is not unusual to find the school bunkers

almost entirely occupied by them. It seems to be a habit with some to break away from housework for an hour or so

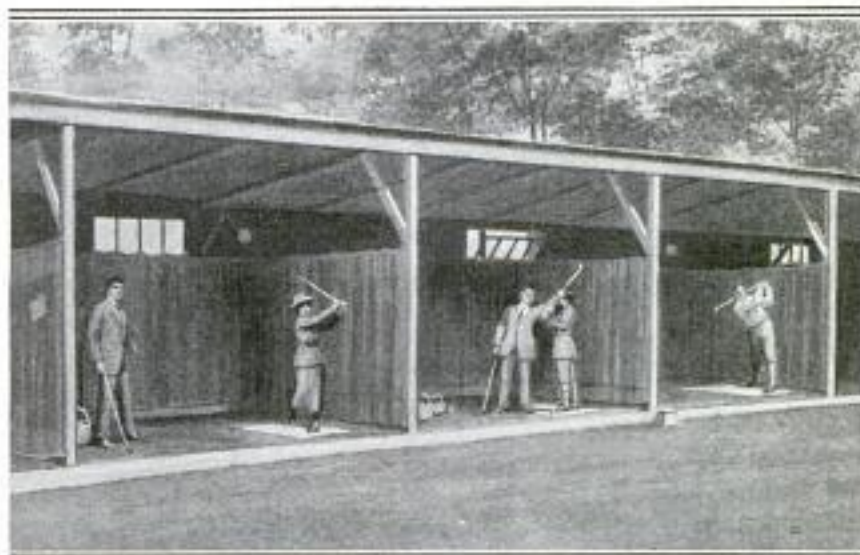

Each Stall in This Shed is Fitted with a Teeing Ground So That Long Drives may be Practiced. The Protection Afforded Permits Playing in Disagreeable Weather

each day. During the noon hour, business men, also, come for a short period.

Owned by H. H. Jepsen Boston,

POPULAR MECHANICS *Mass.*

66

414

CITY FIRE ESCAPE IS HOME OF BEE FAMILIES



The Beehives Arranged on This Fire Escape in a Congested District of Boston, House More than 40,000 Bees; This in Spite of the Fact That the Bees must Fly Several Miles Before Flowers are Reached

High on the fire escape of a building in a congested section of Boston live several colonies of honeybees. There are between 40,000 and 60,000 of them, according to the owner, who makes a hobby of keeping the insects. In order to obtain nectar to live on, and pollen to feed their young, the bees are forced to fly from 2 to 5 miles to the flowers in public parks and playgrounds. They never bother the hundreds of people working in near by buildings.

474

HARD SYNTHETIC WOOD MADE FROM CELLULOSE

Cellulose, a compound of carbon, hydrogen, and oxygen that forms the fundamental cell structure of all plants, is a main constituent of a vast number of textiles, in the manufacture of which it does not have to be hardened. In the past it has been hardened sufficiently to produce substances used in many industries, and now, in Germany, a textile expert has discovered a process by which it can be hardened sufficiently to produce synthetic woods that will serve as substitutes for oak, mahogany, walnut, indeed for any hard wood—even, it is said, for ebony. Moreover, the material can be dyed homogeneously in any color from bright yellow to deep black, and can then be polished and made to look exactly like natural wood.

This synthetic product will be much cheaper than real wood because it is made from vegetation available in large quantities, much of which is of otherwise little or no value, such as straws of all kinds, banana and other leaves, and any kind of grass. In all its characteristics it resembles hard wood, not being brittle like many other cellulose products, and being easily cut and machined. Moreover, it can be molded into any shape, such as boards, slabs, and parts of any inlaid pattern, thus saving a large amount of labor. It has other advantages, for it is not so inflammable as wood, and it has wonderful insulating qualities against both electricity and high or low temperatures.

Dr. Carl Leydt, Germany

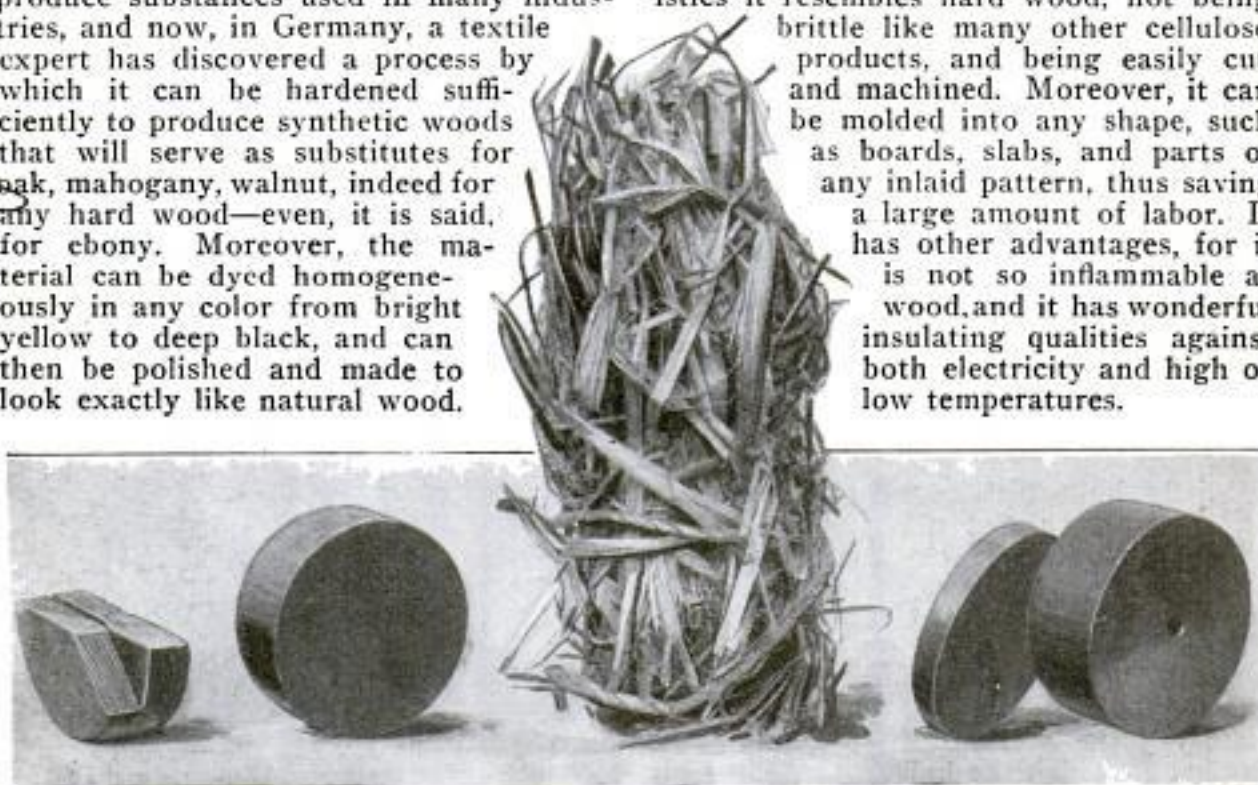

Bundle of Grass with Samples of the Synthetic Wood Made from This Cellulose Material: The Broken Sample Shows How It is Formed of Layers of Cellulose Pressed Together. It can be Moulded into Any Shape, and is as Hard as Oak, or Even Ebony

Carl Harold F. Blanchard,
Tuchahoe, N.Y.

Copyrighted material

ILLINOIS MAKES ITS HIGHWAYS SAFE

BY R. FRANKLIN MUNDORFF

1108 Ashwood Ave.
Kansas City, Mo.

THE state of Illinois, in taking up the marking of state highways, did not follow any system practiced by other states, but devised a plan of its own. This plan was designed to serve a twofold purpose: First, to make the highways as safe as possible under present-day traffic conditions; and second, to give as complete directory information to the traveling public as would be practicable.

To accomplish the first purpose, wood signs, 42 inches wide and 24 inches high, with black letters on a white background, were erected along the completed highways.



This Sign Has "Danger" Lettered in Red on a White Background, While the Words "State Road" Are in Smaller Black Letters

These signs, which are located 400 feet each way from every point of potential danger, are carried on 4 by 4-inch wooden posts, set 15 feet from the center of the pavement on the right-hand side; the bottom edge of the sign being 4 feet above the pavement.

On all side and crossroads connecting with the state roads, the signs read: "Danger—State Road"; the word "Danger" being painted red on a white background, and the letters 7 inches high and 4¾ inches wide. The words "State Road" are in black letters, 5 inches high and 2½ inches wide.



Left: Signs Indicating Caution over a Certain Distance Have Black Letters on a White Field with Diagonal Black and White Border. Center: Sign Denoting the Reason for Caution. Right: This Black-and-White Sign Indicates Slowing Down, and Degree of Care Necessary

On paved roads the signs read: "Look," "Caution," or "Danger," depending upon the location; the first being used where the driver need not slacken speed but should be on his guard; the second, where some speed reduction and care are necessary, and the last-mentioned where there is imminent danger.

The letters in the words "Look" and "Caution" are 7 inches high and are black on a white background, and in the word "Danger" of the same height, but are red on a white background. Beneath these words, the nature of the danger is indicated.

Where continuous care for a certain distance is necessary, caution zones have been established. These are marked at each end with a board lettered "Caution Zone." These signs have a border of diagonal black and white stripes approximately 2 inches wide. Throughout the zone all poles, bridge rails, and other stationary objects, and where necessary, special posts near the points of potential danger, are painted with diagonal black and white stripes, in order to avoid a great number of confusing separate signs.

Before the final adoption of this system of warning signs, a 60-mile stretch of road was marked in this manner and studied for a period of several months. This study resulted in a number of modifications, which, however, did not essentially alter the system. As finally placed, the signboards are set normal to the center line of the road. At this angle, the signs are quite conspicuous at 1,000 feet or more, and can be read at night at distances of 50 to 100 feet.

To accomplish the second purpose—that of furnishing directory information to the traveling public—signs are used in the following manner:

At the corporate limit of each city and village, a signboard of the same size as those carrying the warning signs is erected. The name of the city and the words "City Limit" appear on that side of the sign faced by the traveler when approaching the city. Here also is found, on the right-hand side of the road as the traveler leaves the city, a sign on which are

lettered the name of the next town and the distance to it, as well as the name of the next principal objective point on the route and the distance thereto.

All state routes are numbered. The back of each warning sign carries this number. On that side the borders of the state are outlined in black, and within this outline the route number appears in black numerals 5 $\frac{3}{8}$ inches high. Above or below the outline the distance along the route from its northerly or easterly terminus is noted in red numerals.

At crossroads and side roads leading to near-by cities and villages, an aluminum plate appears just below the signboard. On this the state borders are outlined, as before described, with the route number in raised black numerals and the mileage in raised red numerals.

The final scheme is the showing, on a complete road map of the state, not only the route numbers but the mileage numbers of each important intersecting road, which is marked by an aluminum sign. This enables the traveler at any intersecting road to check his exact location by

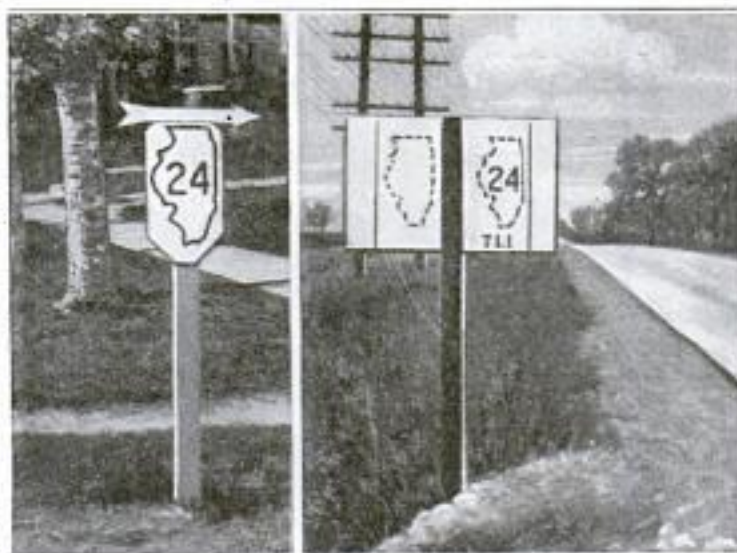

Left: Aluminum Route Marker Denoting Curve or Turn at a Street Intersection. Right: Back of Warning Sign at Crossroad, Bearing Outline of State Border and Giving Route and Mileage Numbers



Sign That Bears the Name of the City, and Warns the Autoist That the City Limit has been Reached

comparing both the route number and the mileage number of the intersection with those indicated on the map.

Within cities, three different signs are used, all of which have in common a double-faced flat plate, showing the state outline in black and the route number in raised black numerals. At turns, an arrow

pointing in the proper direction appears above the standard plate. At even miles the mileage number, in raised red figures, appears at the top of the plate. At other intersections the plate embodies no special features. These signs are located on the far side of the intersecting street, or to the right of the driver.

698

LIGHT CAR OF ENGLISH MAKE HAS MANY MERITS

Another development in the automobile world has appeared in the shape of an inexpensive light car manufactured in England and possessing many of the merits usually found only in the larger and more costly models. The little vehicle weighs less than 800 pounds. It has a 7-horsepower 4-cylinder water-cooled engine, three-speed gear box with reversible gear, shaft transmission, and brakes on all four of the detachable wire wheels. Its length is only 8 feet 8 inches, and width, 3 feet 10 inches. The tiny car seats two persons, has a collapsible top, windshield, side curtains, electric lighting, and during a recent track trial, a speed of 52 miles an hour was attained. It is

stated that this car has traveled 78 miles on but one gallon of gasoline.

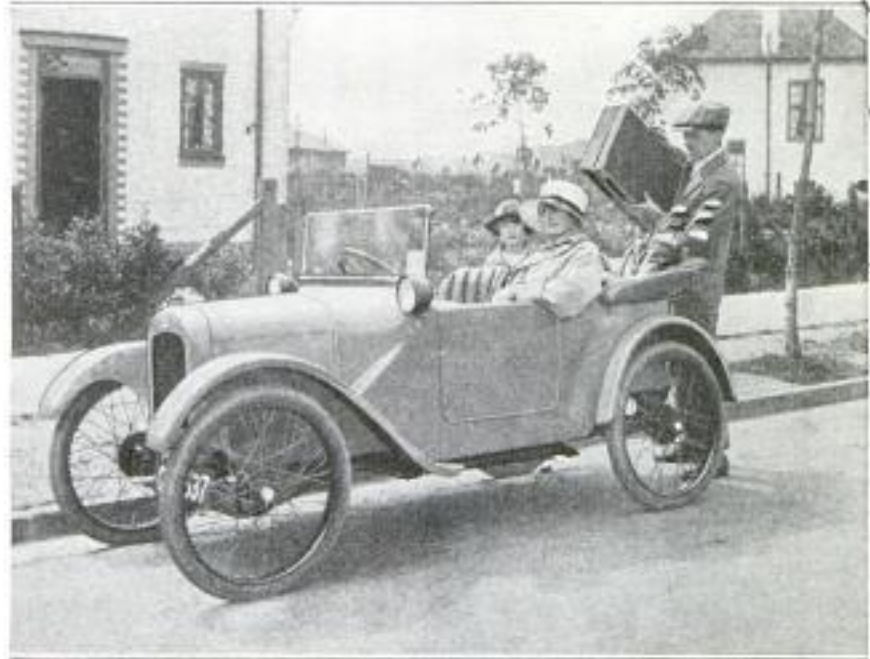

Light Car, Built in England, Which Has Many of the Merits Usually Found Only in the Larger and More Costly Models: Note the Ample Space at the Rear for Baggage

1718

GIANT BOWLING GAME INVENTED BY U. S. MARINES

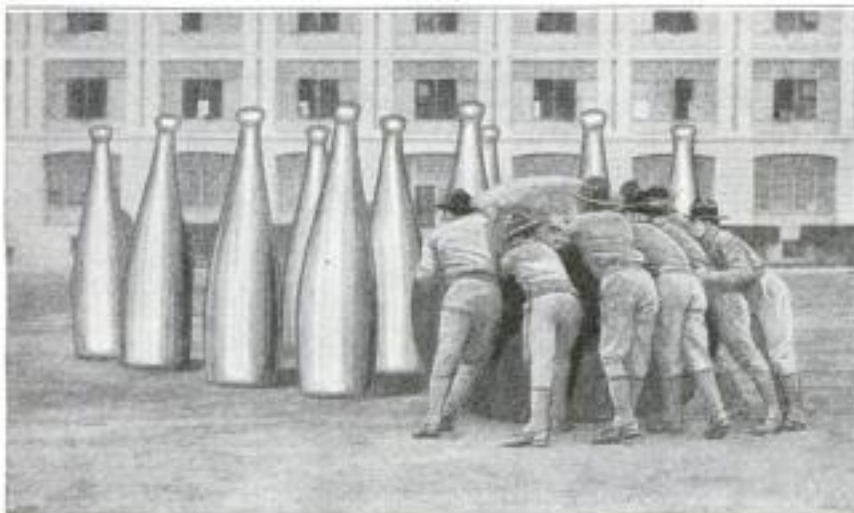

The Team of Eight Men in the Photograph Are About Ready to Send the Pushball at the Giant Bowling Pins in Such a Way as to Knock Down the Greatest Number

Feeling the regular form of bowling to be too mild a sport, marines stationed at Mare Island on San Pablo Bay, have devised a new outdoor adaptation of the game. Pins, 10 feet high, are set up in the usual order on a field, and a large-sized pushball is used by a team of eight men. The team, taking a running start, rolls the ball for the pins, and makes an attempt to hit them in such a way as to knock down the greatest number.

International

*Austin Motor Co. Ltd., Northfield
Longbridge Works, Birmingham, England*

543



REALISTIC PICTURE OF BEAR EMBROIDERED BY ARTIST

Making stitches so fine that they are scarcely discernible, a Japanese artist has embroidered a picture of a polar bear which is remarkable for its realism. The figure is done in silk on a gray-silk background. All the shading and coloring was finished by means of different-colored silk threads, with no part subjected to retouching after the needlework had been completed. The general perspective has been carefully carried out without sacrificing an accurate representation of details. The picture is on exhibition at the Art Institute, Chicago.

COPYRIGHT, INTERNATIONAL NEWSREEL CORP. This Realistic Reproduction of a Polar Bear Is the Needlework of a Japanese Artist. It Is Now on Exhibition at the Art Institute, Chicago

INCLINOMETER OF UNUSUAL ACCURACY

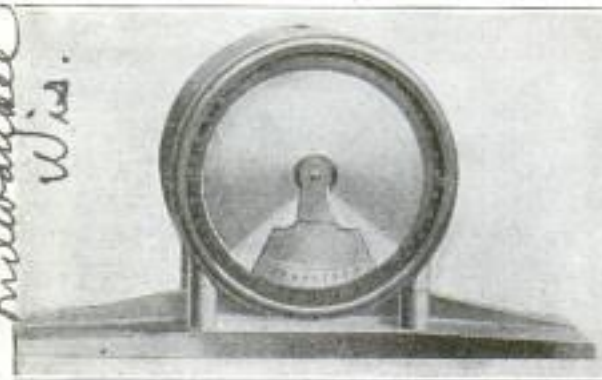

An instrument for rapidly determining the correct inclination of surfaces, in degrees and minutes, consists of a circular scale numbered from zero to 90 in four series, so that the circumference of a circle, 360 degrees, is represented. On the inside of the scaled circle is a free-swinging pendulum which has a scale in minutes, from zero to 12. When the instrument is placed on any surface, the position of the pendulum, which always hangs perpendicularly, automatically indicates whether the surface is level, or gives the degree of its inclination to the horizontal.

Inclinometer Which Gives Readings in Degrees and Minutes, Showing the Pendulum That Automatically Indicates the Angle of a Surface

AUTO PANTRY BOX ON REAR LUGGAGE CARRIER

Intended as a convenient means of carrying food and provisions on auto trips, a pantry box has been made which is fastened on the rear luggage carrier. The box, a foot deep at the base and 28 inches high, has a curved felt-padded back which fits snugly to the back of the car. The front of the closet is equipped with a hinged brace and drops down, forming a table for four. Of the 13 compartments for supplies and kitchen utensils, four have specially in-

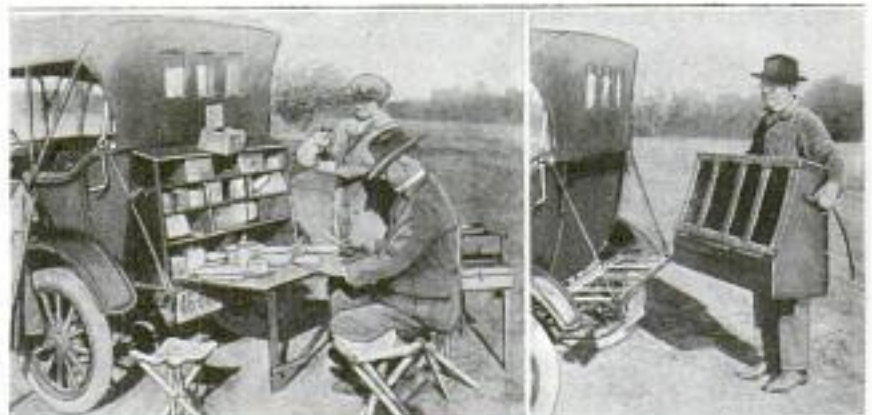

In the Illustration to the Left, the Pantry Box is Shown Open for Luncheon. On the Right, the Box is being Taken Off at the End of a Trip. Note the Padded Back

435
Stevens-Prentice Mfg. Co. 588
877 National Ave
Milwaukee Wis.
d.no. J. H. Johnson, The Johnson Auto
Kitchenette Co. 302 1/2 Charlotte St.
Kansas City, Mo

405

Write for information Beatm und
Eisen, 4 Duminikaner Bastei,
POPULAR MECHANICS

71

Wien, Austria

*Inv. + ingber
C. W. Thonig, Engineer
Wien*

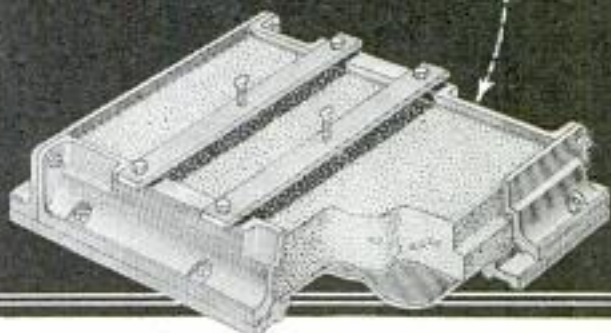
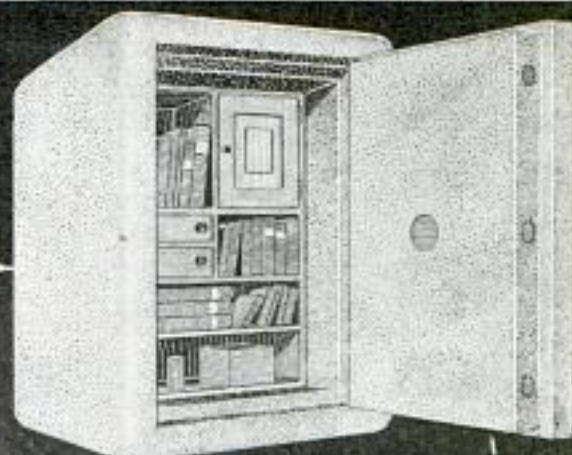
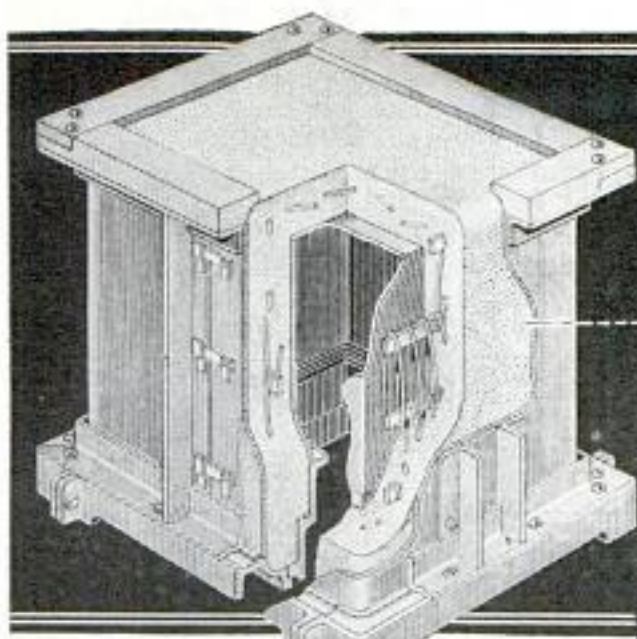

Partly Assembled Fireproof Portable Safe with Its Outside Layer of Concrete Stripped Off and One Corner in Section, to Show Details of Construction and the Reinforcement

The Door of the Safe with Parts Cut Away to Show Its Construction: As Indicated by the Arrow, the Finished Door is Shown Immediately Above It, in the View of the Completed Safe

REINFORCED-CONCRETE SAFES FIREPROOF AND PORTABLE

Portable safes made of concrete without any iron or steel outside casing, are now in use in Germany, and are also being exported. These small safes are said to possess all the advantages in respect to their fireproof and insulating qualities that are possessed by large concrete vaults. Securely connected to an iron base are four upright corner pieces formed of rectangular iron plates stiffened with angle irons. These meet at the center of each side of the safe, and form continuous walls. Inside these walls similar corner pieces, secured to the base, form the interior lining of the safe. The space between these two iron walls is filled with reinforcing rods of various kinds. For the strongest type of safe these are made of spirals hanging on horizontal rods. In lighter types, the spirals are omitted, and crisscrossed rods are used. Onto this construction, and inclosing it, concrete is poured so as to form a monolithic structure with outside concrete walls, giving the safe better protection against fire than is afforded by iron or steel casing that expands greatly, or even melts, at high temperatures.

SPECIAL BOARDS ENABLE CAFE TO SERVE PATRONS IN AUTO

For motorists who prefer eating lunch in their cars, a roadside café near Los Angeles, Calif., has adopted specially constructed boards so that its auto patrons

may be served without leaving their seats. The boards are of two types, the one designed for the front seat being fashioned at the end to fit under the steering wheel, while the second, intended for the rear

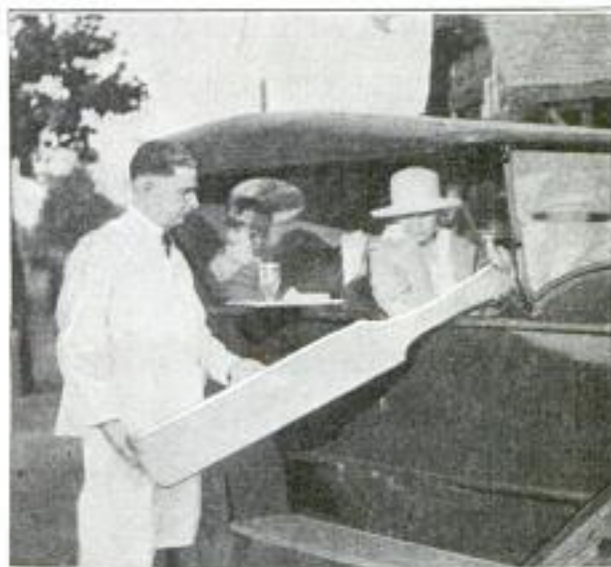

Waiter About to Put in Place the Specially Constructed Board for Serving the Auto Patrons of a Roadside Café

seat, is of even width throughout. Three-ply maple is the wood used, and the boards are left unpainted so that they may be easily cleaned.

not painted

Flexlume Corp
 74 Rail St
 Buffalo, N.Y.
 POPULAR
 ATTRACTIVE ELECTRIC SIGN
 FOR INTERIOR DISPLAY

An attractive electric sign for interior display has been produced and should

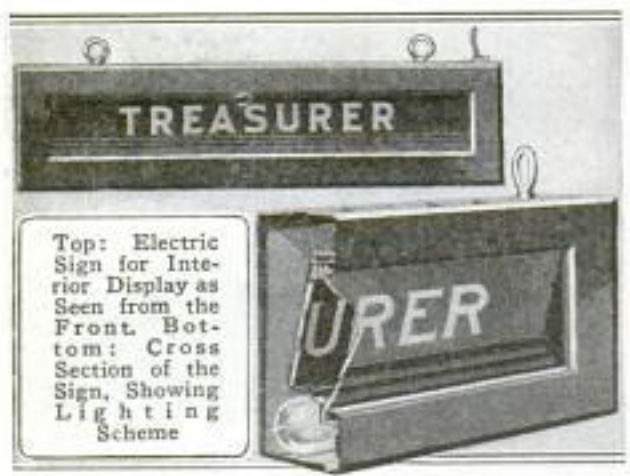

Top: Electric Sign for Interior Display as Seen from the Front. Bottom: Cross Section of the Sign, Showing Lighting Scheme

prove efficient for stores, hotels, banks, or wherever it is desired to designate different departments for the aid of the public. The sign possesses a two-way lighting feature. This is accomplished by flooding the face of the letters with light from an aperture below them, just over the lamps, and by a reflector at their rear, which causes the light to shine through them. Due to this double illumination of the white-glass letters, they stand out in unusually clear relief against the black background.

NEW PASSENGER LOCOMOTIVES ARE LARGE AND POWERFUL

A number of locomotives which are the largest and most powerful, of the simple engine type, ever built for passenger service have recently been delivered to a western railroad. The wheelbase of the engine and tender combined is 82 feet 2 3/4 inches and the total weight of engine and tender

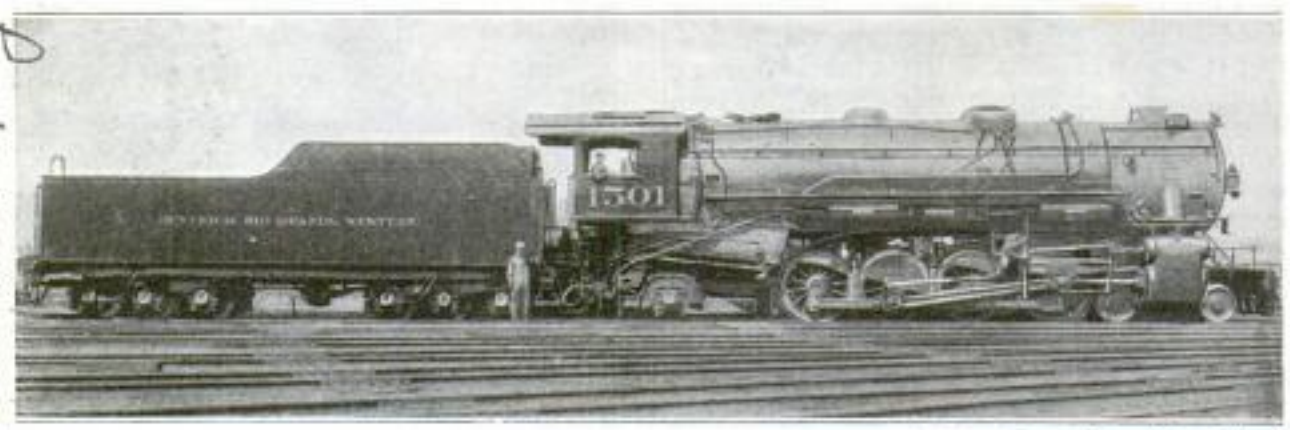

This is One of a Number of Similar Locomotives Which are the Largest and Most Powerful, of the Simple Engine Type, Ever Built for Passenger Service. It has a Drawbar Pull of 66,600 Pounds, and is Equipped with Automatic Stokers for Burning Soft Coal

*American Locomotive Co
 Scranton, N.Y.*

*List. James A. Reid,
 411 Grand Bldg,
 Los Angeles, Calif.*

MECHANICS
 is 644,600 pounds. The steam cylinders are 28 inches in diameter and have a 30-inch stroke. The maximum tractive power is 66,600 pounds when operating at 210 pounds per square inch boiler pressure. The furnace is equipped with automatic stokers for burning soft coal, of which the tender can carry a 20-ton supply. The capacity of the water tank is 14,000 gallons.

MEANS FOR PRACTICING GOLF AT HOME, INDOORS OR OUT

To satisfy the demand for a simple golf exerciser, a machine has been devised for practicing golf strokes at home, either indoors or out. It consists of a square steel base into which is screwed a steel post. Held in place at the top of the post is a small revolving plate to which are connected two highly tempered coil springs, which are fastened at their opposite ends to a clevis. Swiveled to this is a piece of airplane wire, which at its other end is attached securely to a golf ball. The ball, when struck from the ground or a tee,

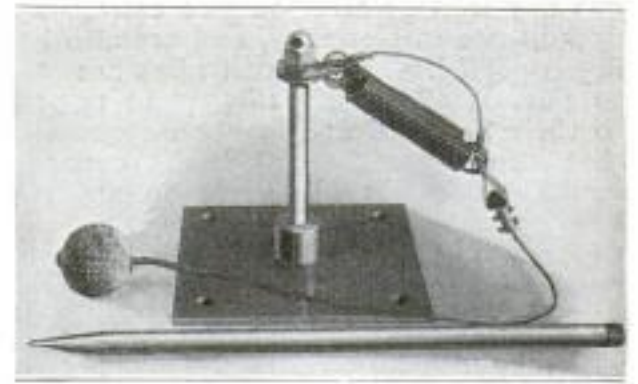

Machine for Practicing Golf Strokes at Home: Indoors, It is Screwed to the Floor; Outdoors, the Spike beside It is Attached and Pushed into the Ground

swings around the base for a length of time that varies with the nature of the stroke.

509 The Byers Machine Co. 300 Sycamore St.
 POPULAR MECHANICS
 Xenia, Ohio.



This Locomotive-Type Crane can be Mounted on Any Five-Ton Motor Truck Measuring at Least Nine Feet from the Back of the Driver's Seat to the Center of the Rear Axle. Nearly Worn-Out Trucks can be Used for This Service

509
LOCOMOTIVE-TYPE CRANE IS MOUNTED ON MOTOR TRUCK

Any five-ton motor truck, measuring approximately 9 feet from the rear of the driver's seat to the center of the rear axle, can be converted into a locomotive-type crane for service on many construction jobs, by means of equipment now available. The new attachment is built mostly of steel and has a four-cylinder gasoline engine, developing 30 horsepower, for swinging and raising the boom and for operating a hoisting hook, or any standard half-cubic-yard grab bucket weighing not over 200 pounds. The crane, unmounted, weighs six tons, and outriggers with jacks insure its stability when handling loads. Many motor trucks, too badly worn for most purposes, can be utilized to render satisfactory service with this additional piece of equipment.

Wire wigs for women, constructed of the finest wire and tinted to any desired color, are said to be the latest fashion in Paris.

AUTOMOBILE LIGHT SIGNALS BOTH SAFETY AND DANGER

Among the numerous modifications of automobile rear safety signals, one recently designed has the special feature of displaying continuously, under normal running conditions, a green safety light. As soon as an emergency requires the release of the clutch, or the application of the brake, the green light is automatically displaced by a red one, indicating danger. Besides the light, there are arrows on the signal lamp that flash red to show whether the car is about to turn to the right or left. When the car is at a standstill, the red light serves as a parking lamp.



Stover Engineering Co.
 Racine, Wis.

Owned by Mrs. E. O. Woodbury,
 Topsfield, Mass
 POPULAR MECHANICS

74
 605



The Picture Shown Here was Made Almost Entirely from Human Hair Contributed by 40 Individuals, All Members of the Same Family. The Fence in the Foreground and a Few Other Details were Made with Bits of Wood

**PICTURE OF RURAL LIFE
 MADE OF HUMAN HAIR**

Hairs of various shades and textures, taken from the heads of more than 40 individuals, were the principal elements used in the making of an interesting picture now more than a century old. The scene is that of a small lake showing, in the left foreground, a country homestead, and, opposite, across a crude bridge, a village. In the background is seen a range of mountains apparently done with an impressionistic touch. Except for the sky, water, a few fence sticks, and other details, the entire picture was made with human hair, all contributed by members of the same family.

413 **SUBSOILING ATTACHMENTS
 FOR ANY KIND OF PLOW**

Attachments for breaking up the subsoil, which can be connected to any standard right or left-hand, wood or steel-beam walking plow, as well as to sulky plows, are now on the market. For connection to a steel-beam plow two U-bolts, and for the wood plows, two clamps, are provided. For sulky plows only two bolts are required. The subsoiling is done with two steel blades, which can be detached to be resharpened. The attachment is adjustable so that the subsoiling can be done to any desired depth.

Price \$5.50.

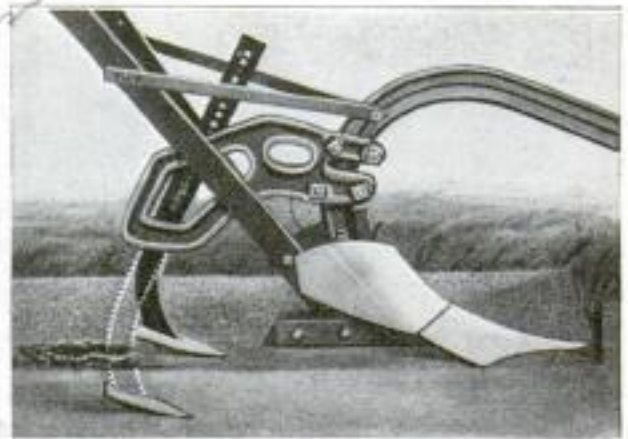

Subsoiling Attachment Connected to a Steel-Beam Plow: Dotted Lines Show How It can be Adjusted

611

**KNOCKDOWN GRAIN BINS
 OF WIRED BOARDS**

Demountable wooden bins have been introduced as a successful and economical substitute for the light galvanized-iron containers commonly used by the grain growers of the Northwest. The new bin is made up of 1 by 8-inch boards, from 6 to 8 feet in length, which are placed side by side and fastened together by wires, which are stapled to each unit. By using a greater or less number of boards, bins of any capacity may be built. The finished product may then be readily set up in any desired location for the reception of grain.

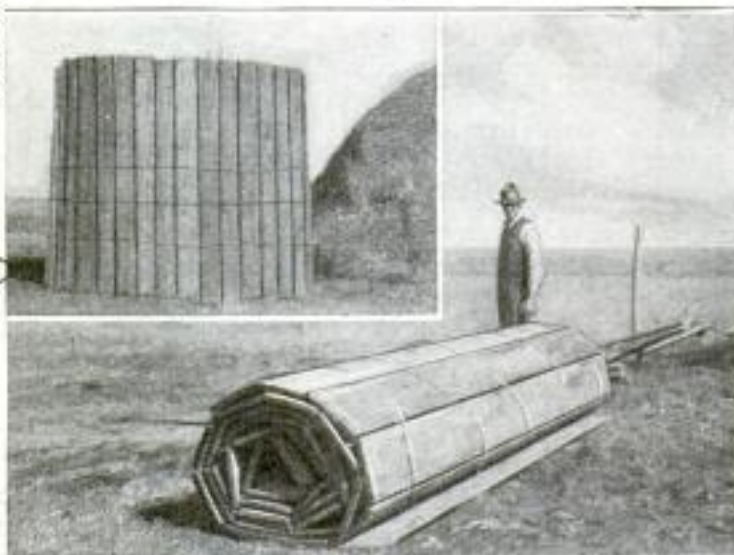

Demountable Grain Bin after being Emptied, Taken Down, and Rolled Up in Readiness to be Transported to the Storehouse: Insert Shows the Bin Set Up Ready for Use

Emt. C. E. Bacon, 137 E. Third
 St. Los Angeles, Calif.

Wm. F. Hartig Plow Co.,
 Evansville Ind.

Copyrighted material

RECLAIMING YUMA LAND

By George F. Paul, 900
Irregalen
Wellsworth Bldg. Chicago

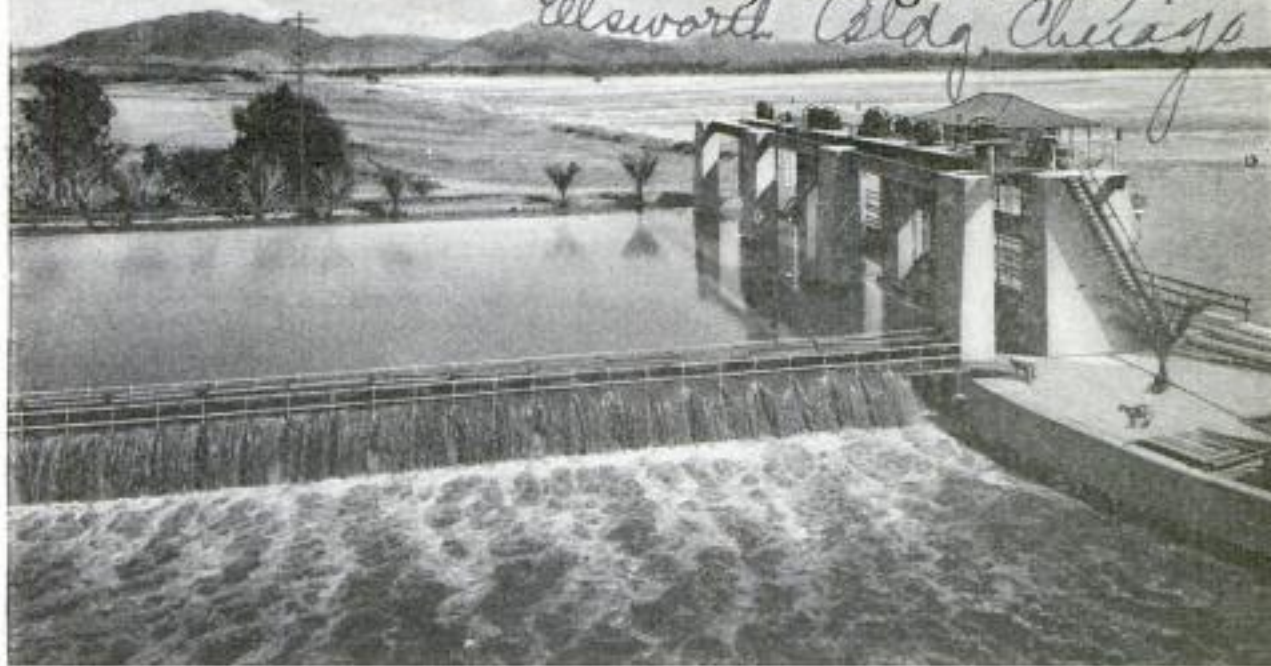

Laguna Dam, Sluiceway, Canal, and Control Gates on the Yuma Land Irrigation Project in the Arid Section of Southern California, Now being Pushed to Completion by the United States Reclamation Service

IN reclaiming the great Yuma Mesa—generally conceded to be the hottest part of the United States—more than 20 miles of concrete pipe, from 15 to 45 inches in diameter, is being used. This is merely for the first unit, or 6,000 acres, of a total area of 40,000 acres that will be irrigated. This unit of 6,000 acres is divided into 150 orchard tracts of 40 acres

each. Before the orchards are planted, there will be required for each tract about one mile of 15-inch pipe, or 150 miles for the entire unit; this is in addition to the 20 miles comprising the main system.

The mesa has a year-round growing season and a productive soil that is particularly adapted for growing citrus fruits. The fruit



Laying 18-Inch Concrete Pipe with a Dragline Excavator on the Mesa of the Yuma Land Project: In This Manner One-Quarter of a Mile of Pipe was Laid and the Joints Sealed Every Day

matures several weeks ahead of that grown in other sections of the Pacific-coast region. The irrigable area is from 80 to 215 feet above sea level and has a

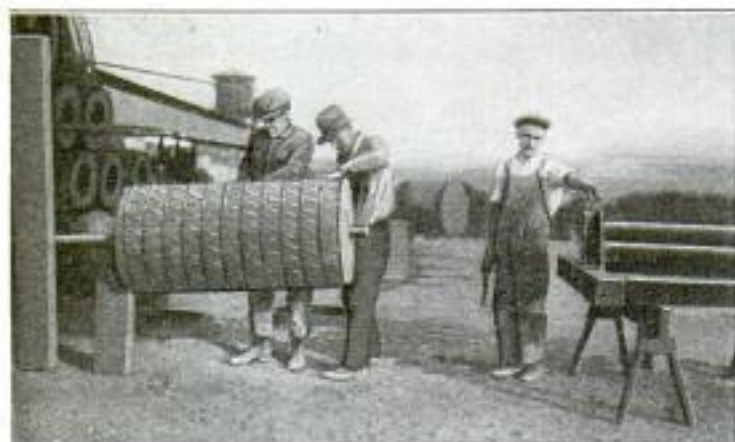

Fabricating the Reinforcing Mesh for a Section of Concrete Pipe Used on the Yuma Land Project: Raw Materials for Concrete Are Plentiful in This Region

temperature range of 22° to 118° F. The soil of the valleys is a rich alluvium, and of the mesa, gravelly sand. The annual rainfall does not amount to much, averaging about 2.5 inches. A real rain is a genuine treat; hence, irrigation is the



A Citrus Orchard in the Planting on the Mesa of the Yuma Irrigation Project, in Southern California

only method of producing crops on this arid soil that is baked for months under the summer sun. However, with abundant water coming, there is a wondrous transformation and the land commands big prices.

The work of manufacturing these miles of con-

crete pipe is under the direction of the U. S. Reclamation Service. Raw materials are plentiful in the region, and the main plant has been laid out so as to handle them readily. Bucket conveyors carry them to the screening tower, where they are graded by a rotary screen. Conical buckets, operating on gantry cranes, distribute the concrete to the molds. Chain hoists make it an easy matter to pour the concrete and handle the molds. When the pipe units are ready, they are loaded onto trailers. An endless-tread tractor pulls a string of eight trailers several miles over the sandy roads to the point where the work of pipe laying is in progress. A dragline excavator is used for laying the pipe. With this arrangement, good progress is made, more than a quarter of a mile of pipe being laid and the joints sealed every day. For handling the pipe a special clasp of the "clothespin" type is used, which greatly reduces breakage.

What irrigation is doing for the development of the Yuma district can readily be seen from the fact that in 1900 there were 100 bank depositors; today there are more than 10,000, and the number is steadily growing, thanks to the fact that water is turning the desert into a highly productive garden.



Six-Year-Old Orange Grove on the Yuma Mesa: A Total of 40,000 Acres has been Laid Out in 6,000-Acre Units, Which are Subdivided into 40-Acre Orchards

MEASURING SKEW-ARCH STRAINS AND STRESSES

There has always been considerable uncertainty as to the distribution of stresses, and especially as to the thrust at the abutments in a skew-arch bridge; that is to say, an arch which crosses a roadway diagonally, and thus has its abutments not directly opposite each other.

a vertical 2-inch pipe that bears against a solid overhead I-beam structure. By means of an adjusting screw at the end of the pipe, the load applied to any one spring can be ad-

In order to determine the nature and

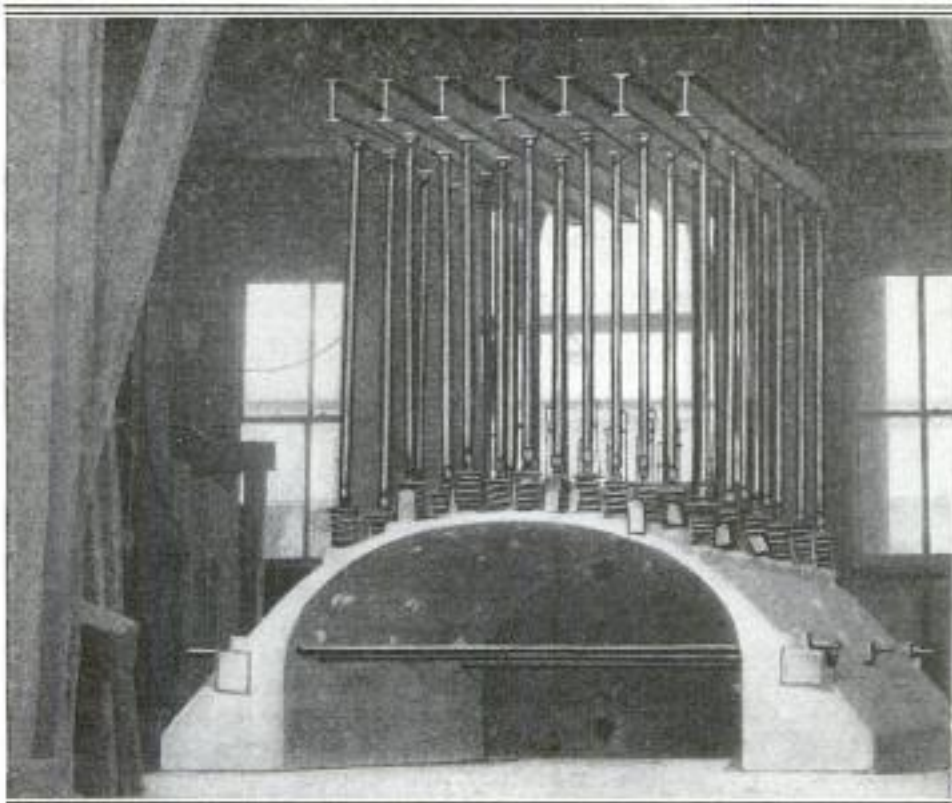

Method of Testing a Skew-Arch Bridge: Any Uniform Load is Applied by Means of the 42 Springs under the Pipes That Bear against the Overhead I-Beams. To the Right, One of These Springs is Shown Enlarged; the Tie-Rods between Abutments Are for Measuring the Thrust

the amount of these stresses positively, the Bureau of Public Roads, at its Arlington Experiment Station, near Washington, has under way a series of experimental tests to be made upon a model of a skew-arch bridge, one-quarter the size of an actual structure, and having an arch 7 feet in span, 4½ feet in width from face to face, with a height of 4 feet above the base of the abutments. The crown of the arch is 2 inches in thickness, and the arch barrel is reinforced with ¼-inch bars. At the springing line of the arch, the abutments are tied together with a number of parallel rods, and two diagonal ones that resist distortion of the arch in any direction.

justed as desired. The strains and the distribution of the stresses resulting from a gradual increase of the loading, will be measured with great precision by an instrument known as a strain gauge. From the results of a series of these tests, it is believed that enough information will be obtained to enable the engineer to formulate rules for the economical design of skew arches. By observing the stresses in the tie-rods, the thrust on the abutment will also be measured. In addition, observations will be made of any deflection or distortion of the arch. In this manner the arch will be tested to destruction.

For determining the effects upon the arch of a known dead load, 42 spiral springs are uniformly distributed over the top of the arch, each capable of carrying a load of 1,500 pounds, resting upon a flat concrete boss, and carrying above it

¶An international chain of weather stations along the arctic circle is being proposed by the United States Government. Experts say that the stations would increase the range of reliable forecasting to two weeks, practically doubling the efficiency of the service.

Contractor - H.C. Shute
Indianapolis, Ind.

Cont. Mrs. Helen
Combes, 6816 S Vermont
Ave. Los Angeles
Calif.

POPULAR MECHANICS

675⁷⁸

OLD BRICK CHURCH RESTORED
WITH VENEER OF CONCRETE

Converting an old red-brick church, in
Detroit, Mich., into a new white concrete



Red-Brick Church in Detroit, Michigan, 50 Years Old,
That has been Veneered with Cement and Made
to Look like a Church Built of Concrete Blocks

one, in appearance at least, has been ingeniously done in preparation for the fiftieth anniversary of the completion of the church. Scaffolding was erected around the old building; all the exterior dirt, paint, and defective brickwork were chipped away, leaving a rough, clean surface upon which a layer of cement was spread, and then, when dry, tooled to look like concrete blocks. Passers-by who do not know of this ingenious renovation, are at a loss to reconcile the date—1872—on the cornerstone with the extremely new-appearing concrete exterior. Even to the oldest residents, this complete change is somewhat bewildering.

CEMENT FLOOR BLOCKS SERVE
AS MEASURE IN STORE

A most convenient measure, 32 feet long and 2 feet wide, is available at a hardware store in Los Angeles, as a result of a contractor's foresight in laying the floor. Realizing that great lengths could not easily be measured on the counter, he laid the cement floor with blocks exactly 2 feet square. An aisle immediately in front of the counter is now always kept clear, and wire netting, rope, clothesline, chicken wire, and other bulky things sold by the foot or yard, are simply laid on the floor and measured by the squares. The government inspector of measurements for the district has officially approved the method.

NOVEL METAL-TAG MARKER

674 IS A TIMESAVER

A new device for stamping embossed figures on metal tags used in many factories, produces the entire number in one operation, insuring positive alinement of figures and saving considerable time. The figures to be embossed are set by means of four levers, in the same manner as a cash register is operated, and, as selected, appear in a window at the front of the machine. This feature of visibility minimizes the possibility of errors. The embossing is done quickly in one operation by simply pressing down a fifth lever, located at the bottom of the machine.

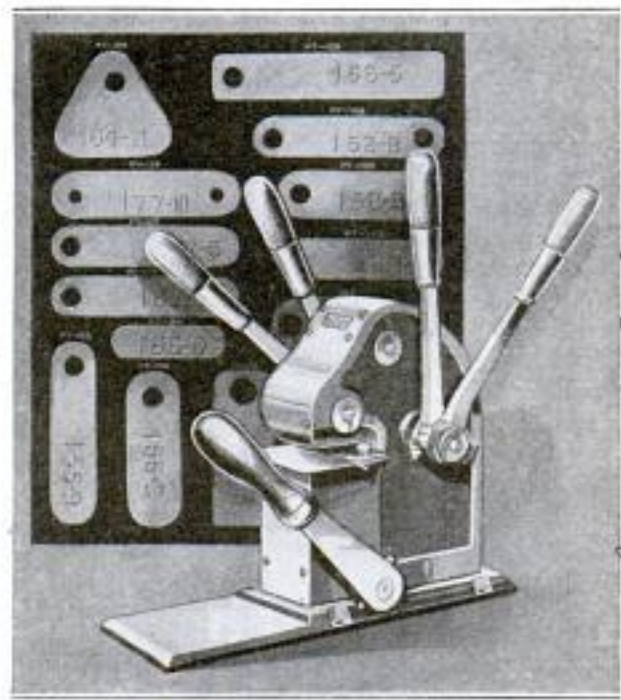

This Metal-Tag Marker Embosses the Entire Number
at One Operation, Resulting in a Better Job, as
Well as in Saving of Time and Labor

Panner Bros Stamp
207 Sandusky St. Pittsburgh

Located in Vermont Square

576 Electric Arc Cutting & Welding Co
 152 Jelliff Ave. Newark N.J. 79
 POPULAR MECHANICS

ELECTRIC-ARC CUTTING TOOL FOR RIVETS

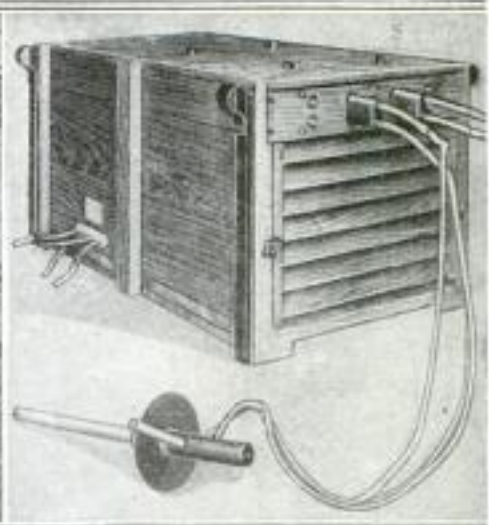
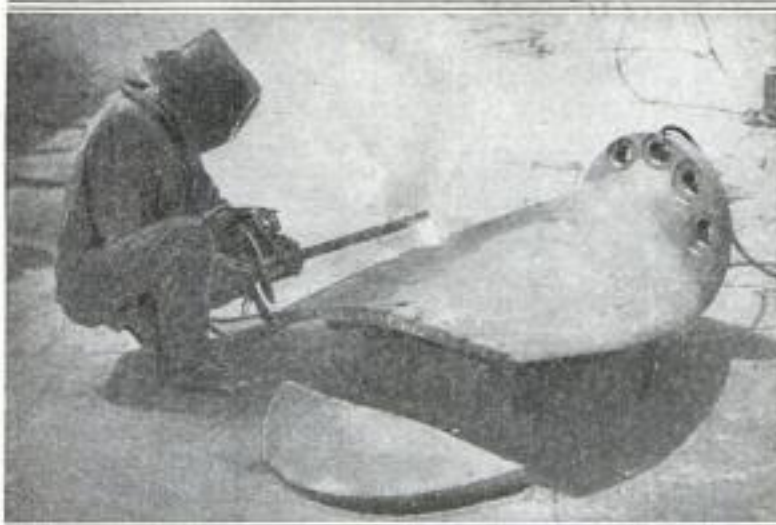

Tool in Use, Cutting Up a Propeller Blade: One Cut Is Completed and the Second Is under Way

For cutting any metal, and particularly for rivet cutting, there is now in use a specially designed electric-arc cutting machine. It is used for cutting up scrap, such as sections of cars, boilers, or tanks, to chargeable sizes, and will economically cut through any thickness under 6 inches. It will cut out more than 100 rivets per hour, at a very low cost per rivet. The tool is provided with a



The Arc Cutting Tool being Used in Cutting Out Rivets by Melting Off Their Heads

Welding and Cutting Transformer Shown in Connection with the Handle, Which can be Operated with One Hand

handle constructed to protect the operator in the holding of an electrode that will carry a current up to 1,000 amperes. The current is controlled by a special transformer which is portable, and may be placed indoors or out. In any location, it is proof against an atmosphere of dust or dirt. It is provided with ducts through which air is driven by means of a special bucket-type ball-bearing blower.

668 auto

COUPÉ LANDS BOTTOM UP IN ODD ACCIDENT

Shooting along a California highway at a good rate of speed recently, the front wheel of a coupé caught in an obstruction at a turn in the road. A moment later the car was standing, bottom side up, balanced on a small mound of earth to one side of the roadway. There were four passengers in the car at the time of the accident, but none of them sustained injuries. Neither was the body of the car seriously damaged. Recovering from the shock, the occupants righted the auto without mechanical aid.



The Coupé Above Landed in This Queer Position after Hitting an Obstruction in the Road. It had been Traveling at a High Rate of Speed. No One was Injured

Emb. Louis F. Bangle, 8570 E. 7th St. Los Angeles Calif.

Muesenberg Straight Eight

American Glass Bottle Seal Corp., 30 Church St.

Westinghouse Elec. & Mfg. Co

80

POPULAR MECHANICS

East Pittsburgh Pa

BOTTLES CORKED AND SEALED BY NEW MACHINE

MAKING TURBINES NOISELESS BY MEANS OF INSULATION

352

Corking and sealing bottles as these come from the automatic filler at the rate of 5,000 an hour, is possible with the

In spite of great precautions in connection with the cushioning with cork and sand of the concrete-block foundations, it

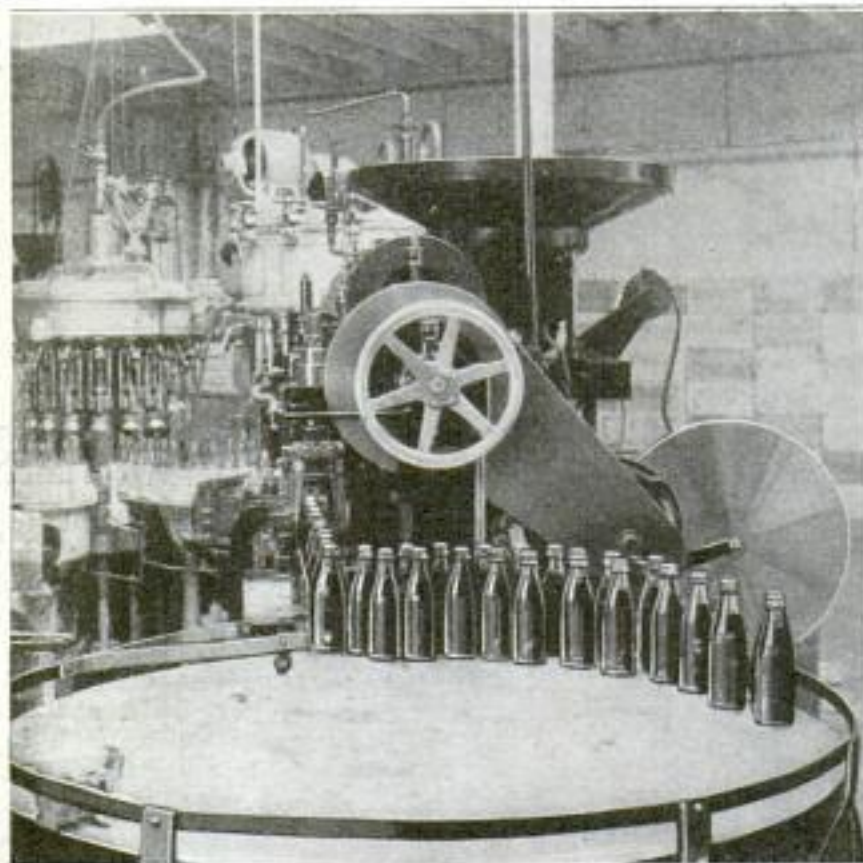

Automatic Bottle-Sealing Machine, Showing the Strip of Aluminum being Fed from the Coil at the Rear, While, at the Top of the Outfit, may be Seen the Large Hopper for the Cork or Paper Disks

was at first found impossible to prevent high-speed turbines from transmitting vibrations to the superstructure of a large hotel where the hum of the turbine could be heard in many rooms. Upon investigation, it was found that in pouring the concrete blocks, the cement had leaked into the cork and sand, thus destroying their insulating qualities. These defective foundations were torn out; and on the leveled surface of the bedrock a four-sided inclosure was built with 8-inch waterproofed brick walls. Alternate 2-inch layers of hair felt and compressed cork were placed on top of the bedrock, and were formed as a complete lining to the inside faces of the brick walls. After this was waterproofed with felt and pitch, the concrete was carefully poured into

use of a recently produced machine. Large hoppers on the outfit are filled with thin disks of cork or paraffined paper, and a strip of aluminum is fed from a coil. In operation, the machine places the cork or paper disk on the bottle, after which the aluminum seal is fastened on the containers, everything being done automatically.

the inclosure. The result was that not a sound from the turbines could be heard even in the room directly above them.

709 TINY METERS FOR RADIO SET FIT PANEL PEEPHOLES

Tiny ammeters and voltmeters, which fit any radio-panel peepholes, from 2 1/2 inch in size and up, are now available. They may be used with either alternating or direct current, and two types now on the market have ranges of 0 to .8 ampere with 0 to 6 volts, and 0 to 1.2 amperes with 0 to 10 volts. The meters are attached by long bolts to the rear of the panel and give added protection for costly vacuum tubes.

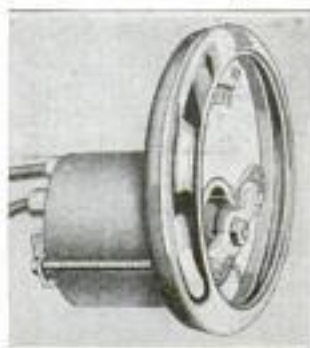

76 ALLOY-STEEL GRATE BARS PROVE ECONOMICAL

Heat-resisting steel castings are reported to have been developed that indicate substantial savings as a substitute for the conventional cast-iron grate bars. The higher cost of the alloy steel is largely offset by the fact that the grate bars can be made 25 to 40 per cent lighter than those of cast iron. They are said to last much longer than the iron bars, and are not subject to change of shape as is the case with cast iron. An American vessel has tried the bars with success.

drm age 10/19/22
239 W. 39th St.
New York

Burton Rogers Co
755 Boylston
Boston 17, Mass.

W.C. England.
London, W.C.
10/28/22
33 Norfolk St., London, W.C.

J. S. McCullough, Supt. California
State School for Deaf, Dumb
& Blind, Berkeley, Calif.

604

George Farrar,
12 Years of Age,
Who Learned to
Speak by Radio



Making the Deaf Hear and the Dumb Speak by Radio

BY H. H. DUNN, 2722 Prince St.
Berkeley, Calif.

WHILE some of the greatest scientists of the world are devoting their earnest attention to the perfecting of radio for the use of those who possess all their faculties, out on the Pacific coast a little group of men have been adapting it to the betterment of the conditions of those who are deprived of the ability to hear or to speak. Under the direction of J. S. McCullough, superintendent of the California State School for the Deaf, Dumb, and Blind, at Berkeley, this work has been brought to such a stage that young men and women who never have spoken a word in their lives are beginning to talk. Miniature amplifiers and more refined and delicate diaphragms in the earpieces on the receiving sets have enabled boys and girls, born deaf, to hear and enjoy radio concerts, lectures, and even to have explanations of their lessons given to them through the medium of the wireless.

This remarkable work has been carried on with homemade apparatus, a large part of it constructed and adapted by Carol Land, a young graduate of the school. Land, though born deaf and dumb, has learned to speak fluently and in a well-modulated voice, through "listening" in, with his deaf ears, on radio, and is now one of the heads of the school's department for the deaf.

According to Mr. McCullough, the secret of the aid given the deaf by radio is

that it sends out more accentuated vibrations than the human voice. While many deaf persons receive and perceive sound through their fingers, especially by placing them on the lips of speakers, just as blind persons have been trained to use their more sensitive fingers in place of their eyes, the radio carries a stronger vibration to the ear in which the drum is not entirely wanting, and impels the dormant nerves of hearing to transmit these augmented sound waves to the brain. In cases in which the eardrum is present, but "dead," this can be done, and is being done every day at the California school, but when the eardrum is absent, the radio, of course, has no effect.

The reason that many deaf persons also are mute, is that their so-called dead eardrums cannot pick up the vibrations of noises and translate them into understandable sounds. Their eardrums, however, can "feel" the more powerful vibrations and waves of the radio receiver, and, gradually, the nerves resume their functions, and the brain begins to translate the sounds received. Then, as the deaf begin to receive the sensations of sounds and to connect them with letters and words which they know through reading them with the eyes, they begin to try to imitate them with their unused vocal cords. Sometimes it is a slow process, but almost always they succeed. At first, their voices are uncontrolled,



State School for the Deaf, Dumb, and Blind, at Berkeley, California, Where Many Remarkable Results have been Obtained by the Use of Radio: The Insert Shows Carol Land, a Graduate of the School, Who has been Taught to Speak by Means of Radio, and Who Now Is an Instructor in the Department for the Deaf

their tones variable, and their pronunciation uneven, but eventually they learn to speak. They cannot hear their own voices, unless they hear them as spoken into the radio sender and then taken up by them at the receiving end, but a number of the boys and girls who were both deaf and mute a few months ago, are now speaking in good voices, and have had a new world opened to them.

The apparatus used is simple, in fact, all of it was made at the school, with the exception of the extra-loud amplifiers, which are hooked in between the coils and the earpieces, and of the unusually thin diaphragms in those earpieces, so that the vibrations sent against the dead eardrums may be as strong as they can be made. There is no new invention in the work, and Mr. McCullough believes that a very great majority of the deaf throughout the world could have a new field of enjoyment, education, and opportunity opened to them by this means. He also believes that all those mutes who have not totally lost their eardrums, and whose vocal cords have not become atrophied, could be taught to speak by the use of an ordinary radio outfit.

One of the most interesting examples of the pupils of the school who have learned to speak through use of the wireless, is George Farrar. This boy, 12 years

of age, had been deaf and mute from birth. When Mr. McCullough, at the beginning of his experiments, asked him to listen in on the radio, he began the work earnestly. For nearly two weeks there was no result. Then, suddenly, one afternoon, the long-continued and heavy vibrations of the radio waves began to do their work, and the boy heard the first "noise" he ever had heard in his life. He did not know what the noise meant, but he continued listening in, and as he kept up this work, hours at a time, he heard other sounds, and began to distinguish between different sounds, often repeated, though he did not know what they meant.

Mr. McCullough does his own broadcasting, locally, from a sending plant in his own office. In a loud, clear voice, he repeats the same word, time after time, until the children become familiar with it. Each day he writes out for them the words he is to give them, in the order in which they will be broadcast. As they come to recognize these sounds, they check them off their lists, and new words are given, with regular radio examinations and tests every few days on the sounds they already have had. The alphabet is handled in the same way.

One day little George Farrar looked up from his lists and saw an animal running across the campus of the state

school. He leaped up and shouted "dog," the first word he ever had spoken in his 12 years of life. His tone was loud and rather strident, but he was soon taught to modulate that. Since that day he has acquired a considerable vocabulary — of sounds, for he knew words before. Today he can carry on an extensive conversation about school matters, his lessons, and some outside subjects, in a nearly normal voice.

Few of those who have learned to receive and register impressions of sounds from the radio have failed, eventually, to learn to speak. Some have difficulty in controlling their voices; some are slow

to form words, even after they have heard them many times, but with the patience which is being used, and the tremendous improvement in their fellow boys and girls, the efforts of these little men and women of tomorrow are carrying them to greater fields of opportunity through improved hearing and the ability to speak. What was once an experiment at the school is no longer an experiment, but an established part of the school work, the results of which are carefully recorded and studied so that these records may form the basis of other and more advanced work, as the knowledge of radio and its utilization develops.

429
**HEAVY TRUCKS USED TO BUILD
 HIGH STOCK PILES**

Stock piles of bulk materials can be built up with heavy trucks, according to the method used by a highway-construction superintendent who provided runways in 10-foot units made interchangeable and of such weight that two men could easily handle one unit. A unit is built up of two 4 by 4-inch timbers laid parallel on 12-inch centers, on top of which are spiked 2 by 12 by 16-inch planks, so that the ends of the planks come flush with the 4 by 4-inch timbers, and a 4 by 4-inch timber bolted to the top of the planks, at the outside edge, forms a guide for the truck wheels. The units are fastened

together with $\frac{3}{4}$ -inch hooks and eyes, the lateral hooks being of a length to give the proper gauge to the track.



Above: View Showing the Runways Which are Built in Interchangeable Units, 10 Feet Long, and Laid Down for the Truck Used in Building the Stock Pile. Below: Side View of the Stock Pile, Showing Truck Dumping a Load of Crushed Stone

d no. H. B. Jay, Supt. of Construction
 323 W. W. Albert St., Carbondale, Ill.

536

Mr. Southern Steel Co., Attention
 San Antonio, Texas S. E. Beckells
 POPULAR MECHANICS

84

SAVE OIL WITH NEW TYPE OF STORAGE TANK

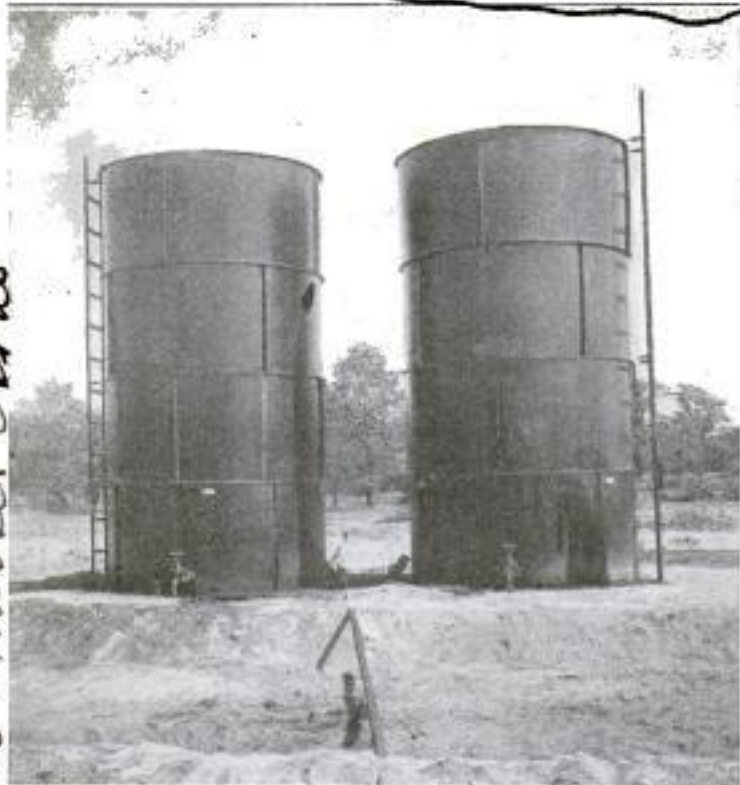

These Storage Tanks are Built with a Smaller Diameter and Greater Height than Usual, So That Surface Evaporation is Greatly Eliminated

Storage tanks with a smaller diameter and greater height are an important factor in decreasing evaporation, according to a Texas oil company, now busy installing the newer design. The smaller surface of the tank, it is claimed, overcomes to a large extent the usual loss from this cause. Another special feature in the construction is the arrangement of 16 incoming pipe lines, which are run down the inside to within a few inches of the bottom. This method serves to lessen the evaporation which would otherwise occur with the surface being constantly disturbed by the flowing in of oil at the top. The tanks are 19 feet high, have a diameter of 10 feet, and hold about 10,000 gallons. The old construction, it is estimated, resulted in a loss of about 20 per cent of the contents.

541

WOMAN MAKES HOME BEHIND DISPLAY WINDOWS



Entertaining Callers in Her Home behind Store Windows: Onlookers Seem to Be Much Interested

equipped with whatever home furnishings the store wishes to advertise, and the young woman has no other duty than to make herself at home. She has her meals, reads, receives callers, plays the piano, sings, and passes the day much as an ordinary housewife would.



Here the Young Woman is Seen with Her Hairdresser, While to the Right may be Noted a Portion of the Large Crowd Gathered Outside to Watch Her Activities

Erected by Frank C. Sampson & Co. Portland, Ore.
 Mrs. Edna Sampson, c/o Frank C. Sampson & Co. Portland, Ore.



At the Railroad Trestle near the St. John River in New Brunswick, Canada, Where the Runaway Logs and the Bridge were Finally Stopped: The Force of the Jam Was So Great at This Point That the Steel Bridge was Bent over the Trestle, While the Trestle Itself was Pushed Four Feet Out of Alinement

**MOVES OF SLEEPER RECORDED
 BY BEDPOST APPARATUS**

Recording continuously the slightest movements of a patient in bed and thereby determining the hours of complete and untroubled rest he has had, is an idea introduced by a German physician. This result is obtained by first placing a sheet of rubber beneath one of the bedposts and attaching special apparatus to the post. The apparatus consists, briefly, of a lever, one end of which is fastened to the bedpost, the other having a recording pen affixed to it. Underneath the pen is located a clockwork drum containing a chart divided into 24 hours, so that a continuous curve of the sleeper's movements is kept and may be consulted if it is desired to ascertain how he has rested, or to convince a patient that he has underrated his hours of rest.

**RUNAWAY LOGS CARRY BRIDGE
 DOWN CANADIAN STREAM**

Thousands of logs broke loose and carried a large steel road bridge down the Becaguimac River, near Hartland, N. B., recently after a continuous deluge of rain had swelled the stream 25 feet above its summer level. The logs were being held

in a dam when the waters rose. Breaking booms, stone piers, and dam, they swept downstream to a steel bridge which, after a short halt, was literally lifted off its foundations and carried along. The jam was finally stopped by



The Great Power behind the Thousands of Logs Piled Up in the Stream is Clearly Demonstrated by This Picture, Which Shows How the Heavy Steel Bridge was Bent over the Trestle

the Canadian Pacific Railroad trestle near the St. John River. Here the force of the impact was so great that the upper structure of the road bridge was bent over the trestle, while the trestle itself was pushed four feet out of alinement.

Those wishing further information on anything described in the editorial pages can obtain it by addressing Bureau of Information, Popular Mechanics Magazine, Chicago.

The Lancet 10/14/02

573 310-01-1

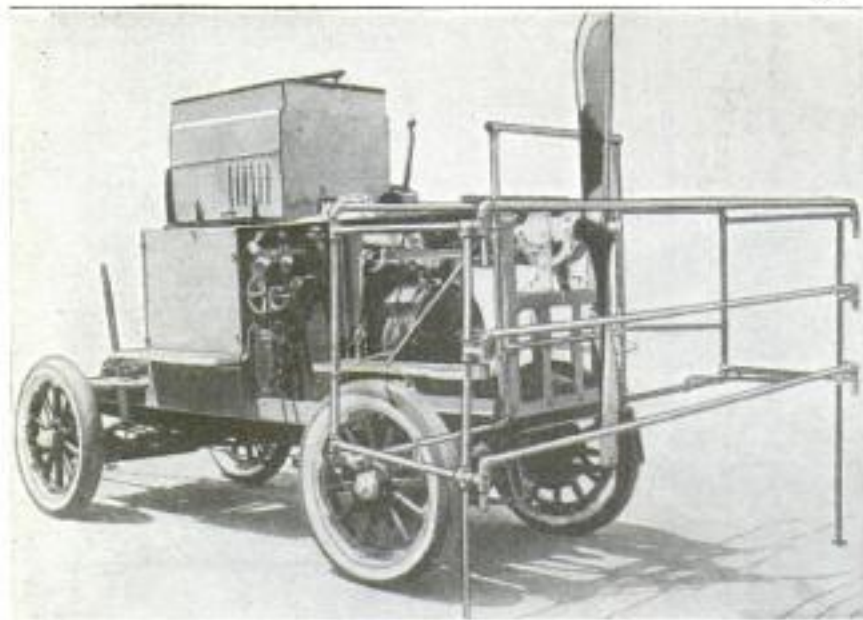

**"STORM MACHINE"
 ON WHEELS
 FOR MOVIES**

"Storm machines" are considered a necessity by the producers of motion pictures, one of these companies possessing an efficient and easily handled outfit which is mounted on the chassis of a motor truck. The truck engine drives a generator that furnishes current for the eight large arc lamps which produce the "lightning," while a propeller of the airplane type, also driven by the engine, provides the "cyclone" effects.

"Storm Machine," Showing the Box Containing the Arc Lights on Top, the Switchboard below This, While in Front are Seen the Generator and Propeller, with a Guard Rail around the Latter

9915

SEMICIRCULAR CONCRETE IRRIGATION DAM

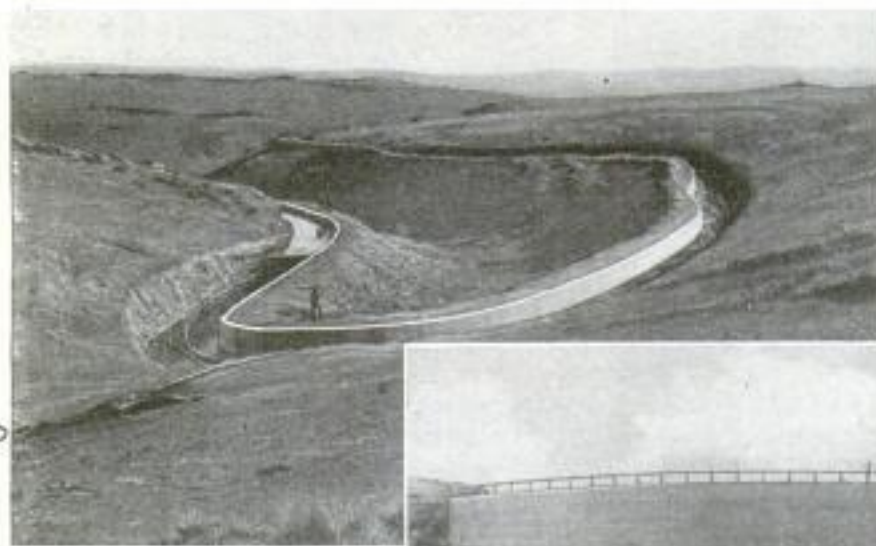

Bird's-Eye View of Concrete Irrigation Dam, Showing Its Outline, Curved with a Radius of 185 Feet, and 450 Feet Long, or Nearly a Complete Semicircle

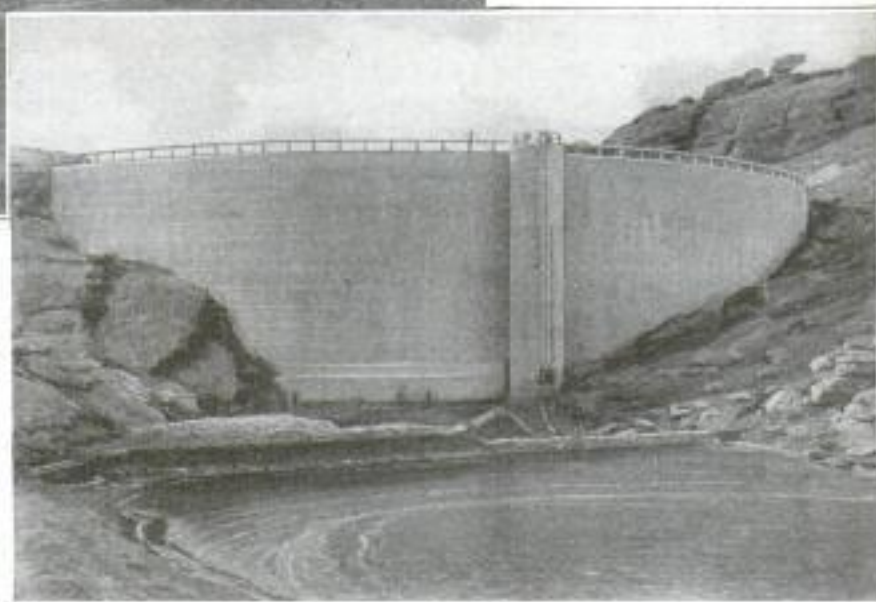

Front Elevation of Semicircular Concrete Dam, 90 Feet High above Ground and 23 Feet Deep below It: At the Ground Level It Is 25 Feet Thick

ground level it is 25 feet thick, tapering to only 4 feet 6 inches at the top. The dam is for storing water to be carried by a raceway to the head of a valley which it will irrigate, and was designed by the public-works department, so as

A concrete irrigation dam that is made very strong in proportion to its thickness because it is semicircular in form, has been built on one of the rivers in the province of Otago, New Zealand. The dam is 450 feet long, curved with a radius of 185 feet. It is 90 feet above the river bed, to have a storage capacity of approximately 10,000,000,000 gallons of water. At foundations 23 feet below.

Public Works Dept. New Zealand.
 Otago

O. Johnson, King Victoria St
 Pahiata, New Zealand

620 Builder - Chas. S. Ewing Co
Miami, Fla.

Arch. Hampton & Beemer

POPULAR MECHANICS

87



A Departure from Conventional Lines of Architecture is Seen in This Beautiful Apartment Building Which has been Erected at Miami Beach, Florida. The Walls are Treated with Waterproofed Stucco of a Two-Tone Mottled Design. Red Tile Cover the Court and Floors of the Gallery

620
**BALCONIES SET IN COURTYARD
BEAUTIFY APARTMENT HOTEL**

With the rapid development of Miami Beach, Fla., as a winter resort, there has sprung up a demand for apartment hotels of original design. One of the buildings planned to meet this demand is a splendid example of a combined Spanish and Moorish style of architecture. It has just enough ornamentation in the way of old handmade Spanish tile, wrought-iron grills, loggias, and balconies to enliven its quiet dignity.

The building is of reinforced-concrete pilaster and girder construction, with hollow-tile curtain walls. The latter are treated with two coats of waterproofed stucco of a two-tone mottled design. Stairways and gallery are of solid concrete, the floors of the gallery, as well as the walks in the court surrounding the fountain and giving access to the first-floor apartments, being covered with 6 by 6-inch red tile. Handmade Spanish tile support the gallery balustrade. Every room in the building faces either the street, the court, or a golf course, while shrubs, flowers, and tinted walls combine to give a touch of Old Mexico.

670
**RUBBER STEP MATS CLEAVE
TO AUTO RUNNING BOARD**

Rubber step mats for automobiles are now being made with raw-gum backs so that they may be easily stuck in place on the running board. The chief advantages claimed for this method are the simplicity of installation, and the fact that dirt and water cannot enter under the mat. It is also claimed bulging or buckling in the center is effectively eliminated. The usual method is to screw or rivet the mats in place.

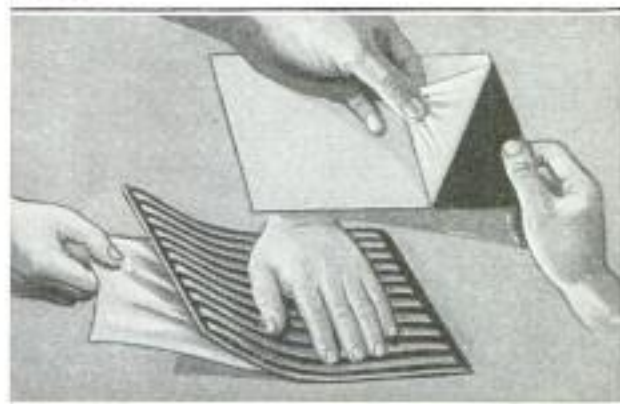

After the Paper Covering is Taken from the Raw-Gum Back of This Step Mat, the Mat is Stuck in Place

The Federal Rubber Co
Cudahy, Wis.
Copyrighted material

689 Pico Motor Car Company of
 California, 1730 Van Ness Ave. *Traveling
 Homes*
 TRAVELING HOMES FOR AUTOMOBILE TOURISTS
 San Francisco, Calif.

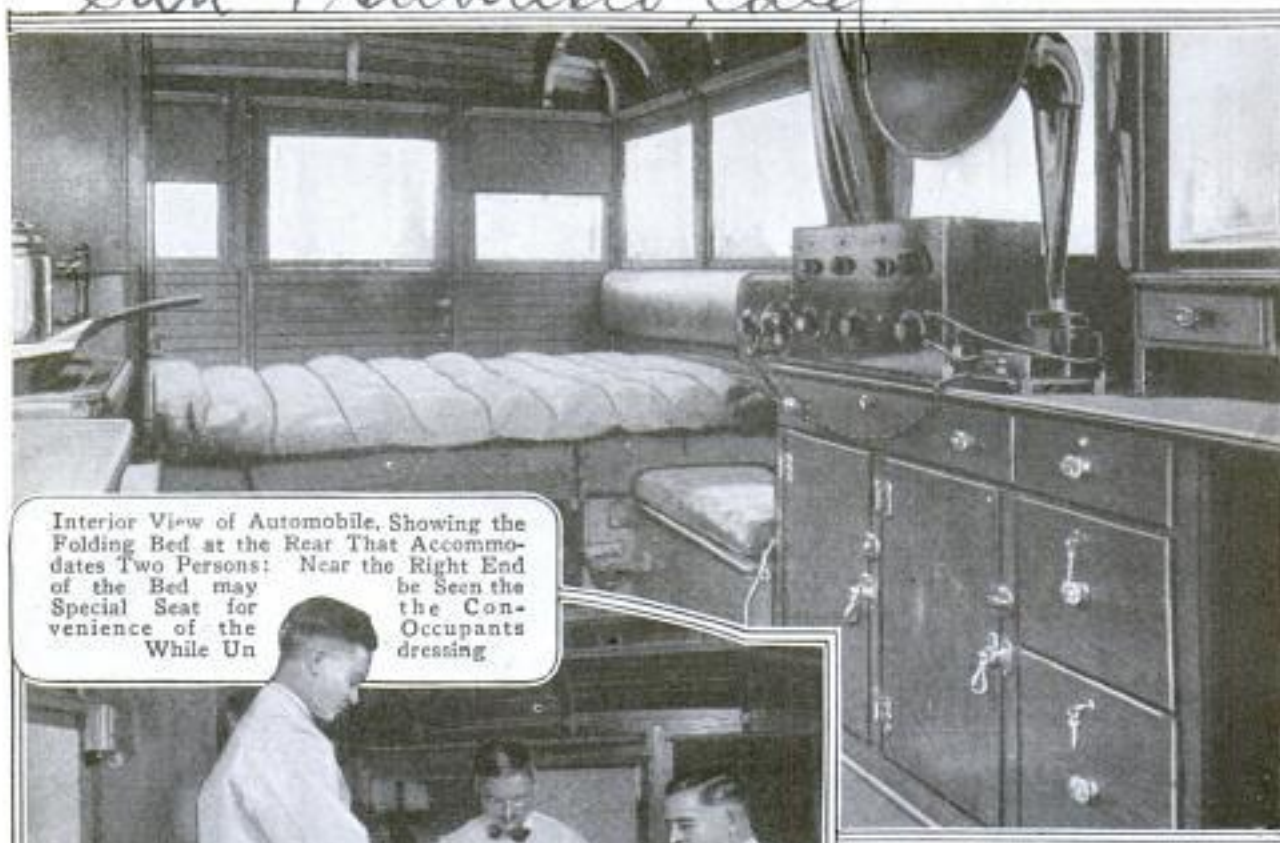

Interior View of Automobile, Showing the Folding Bed at the Rear That Accommodates Two Persons: Near the Right End of the Bed may be Seen the Special Seat for Convenience of the Occupants While Un-



TRAVELING homes for automobile tourists are now being manufactured in standard models by a western motor-car company. The machines consist of a stock chassis on which are mounted special bodies. These bodies are each equipped with a gasoline stove, collapsible table, lockers for cooking utensils, combination buffet and ice box, white-enameled sink, hot and cold circulating water, writing desk, clothes closet, dome electric lights, and fire extinguishers. Also, two revolving leather chairs may be moved about the interior, these fitting into socket holes in

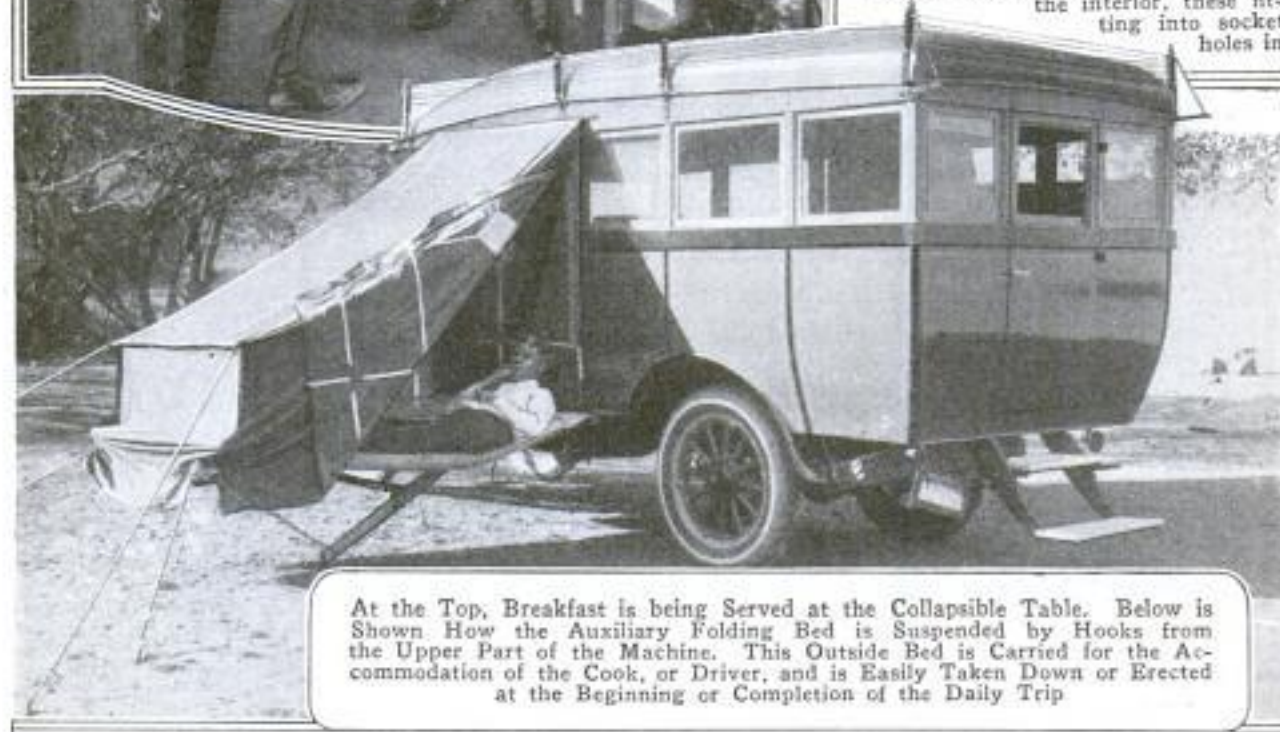

At the Top, Breakfast is being Served at the Collapsible Table. Below is Shown How the Auxiliary Folding Bed is Suspended by Hooks from the Upper Part of the Machine. This Outside Bed is Carried for the Accommodation of the Cook, or Driver, and is Easily Taken Down or Erected at the Beginning or Completion of the Daily Trip.

Made for Red Speedwagon
689 Chassis.

BEING MANUFACTURED IN STANDARD MODELS



Elaborately Equipped Motor Car, Showing the Radio Antenna on the Top, and the Auxiliary Folding Bed

the floor. A folding bed for two persons, and similar to those on a railway sleeper, is incorporated in the vehicle; while an auxiliary bed, or tent, which may be erected or hung by hooks from the top of the car on the outside, is carried on the running board. Radio equipment, with a loud speaker, is also one of the features. The engine is provided with a pump so that water may be obtained from a stream or lake, through the medium of a long hose.



The Man on the Left is Holding the Auxiliary Folding Bed Which is Carried on the Running Board, While Just behind Him may be Seen the Loops of the Long Hose Used for Obtaining Water from Streams or Lakes

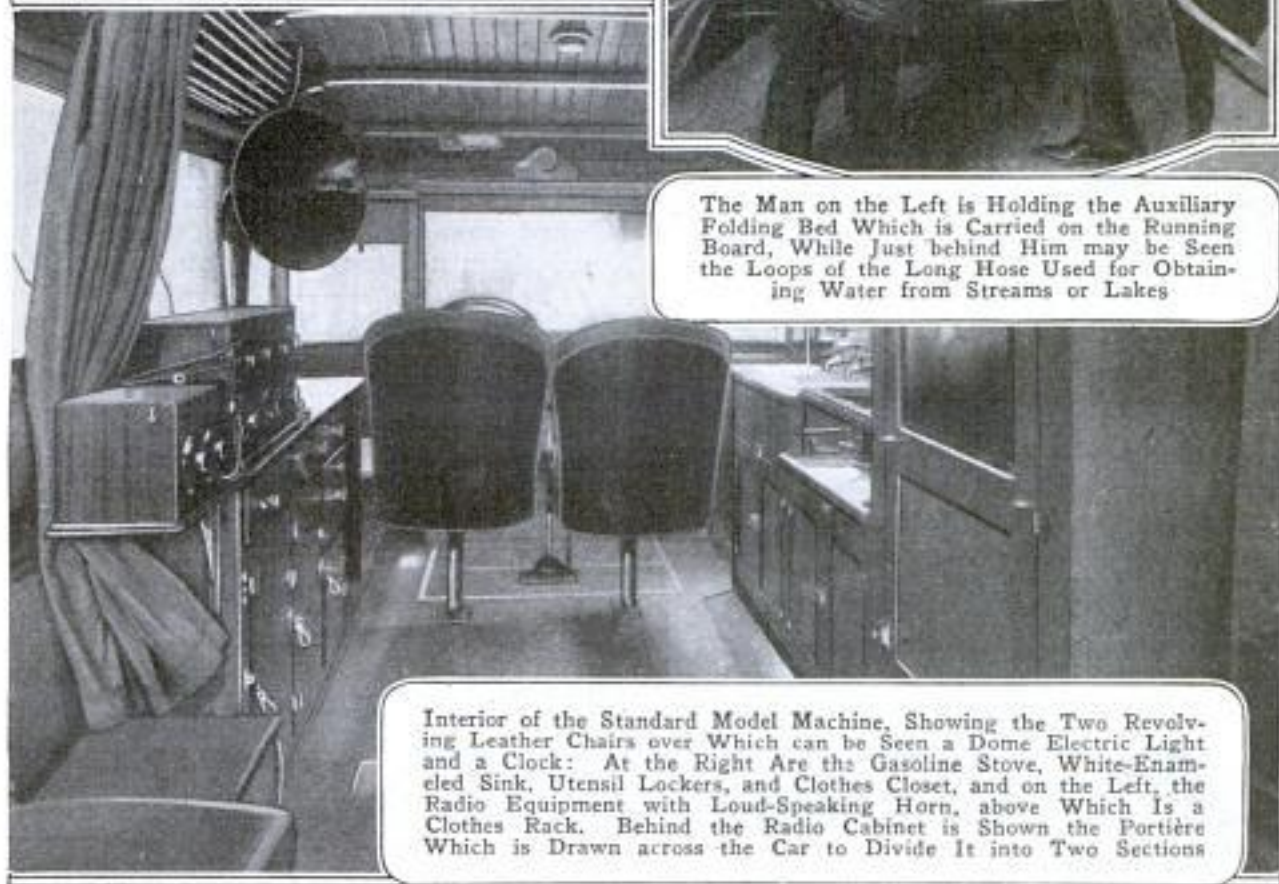

Interior of the Standard Model Machine, Showing the Two Revolving Leather Chairs over Which can be Seen a Dome Electric Light and a Clock: At the Right Are the Gasoline Stove, White-Enamelled Sink, Utensil Lockers, and Clothes Closet, and on the Left, the Radio Equipment with Loud-Speaking Horn, above Which is a Clothes Rack. Behind the Radio Cabinet is Shown the Portière Which is Drawn across the Car to Divide It into Two Sections

665 d no. Lester H. Martin
 Unity Bldg.
 POPULAR MECHANICS
 Bloomington, Ill.

Maplewood Club
 Bloomington, Ill.



Sand, Soil, and Humus Mixer: In the Foreground Is the Gasoline Engine, Belted to the Shaft That Drives the Inclined Conveyor over the Screen. The Fine Particles of the Mixed Ingredients are Seen underneath the Screen, While the Lumps and Foreign Matter are Shown below the Raised End

281

TWO NOVELTIES FOR USE ON BANJOS AND DRUMS

Two novelties for use with banjos are a head tightener that is said to increase the volume of the tone, and a combined screwdriver and multiple wrench that fits all bracket nuts on any banjo or drum. In the tightener, two ring sections are placed under the head of the banjo so that they can be forced against it by turning two thumbscrews connected with a bar attached to the banjo head on a center line. The multiple wrench is built like a small, thin pocketknife handle, with a screwdriver blade inside it, that slides out of the handle when in use, and into it for carrying in the pocket.

A. H. Hoover, Long Island City, New York

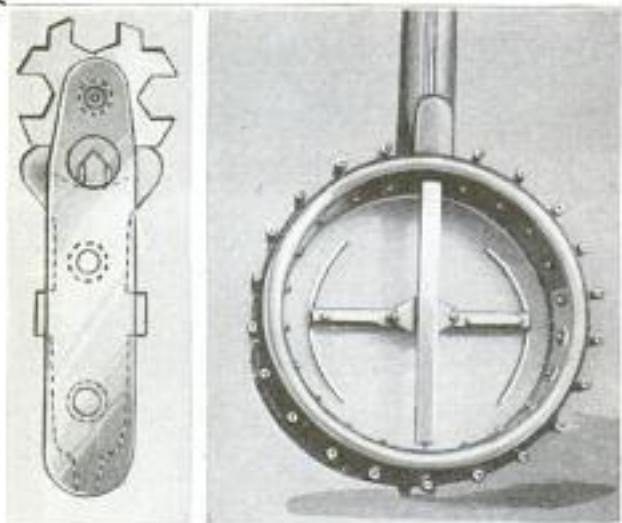

Left: Combined Screwdriver and Multiple Wrench. Right: Banjo Shown Fitted with the Head Tightener

SAND, SOIL, AND HUMUS MIXER 665 DRIVEN BY GAS ENGINE

The mixing of sand, soil, and humus to obtain a preparation to promote the growth of grass on golf-course greens, may now be accomplished with a gasoline-engine outfit. A small one-cylinder motor and a screen equipped with an endless conveyor, to the shaft of which the motor is belted, constitute the equipment. The ingredients are shoveled into the conveyor, which carries them along the screen, the fine particles falling through, while the lumps are dumped at the upper end. The country-club officials who developed this outfit, declare that it has saved them a large sum annually.

IMPROVED ENAMELS FOR IRON WARE DEVELOPED

The cracking of enameled ware has been found to be due to the fact that the enamel does not "fit" the iron over which it is placed, according to recent investigations at the Bureau of Standards. All substances expand when heated, and contract when cooled, and so if the rate of expansion were the same for the iron as for the enamel, they would stay together throughout any amount of heating and cooling, instead of the enamel cracking as it does when cold water is poured into a heated utensil. As a result of the investigations, the bureau has evolved formulas for enamels that will fit the iron better.

Dept. of Commerce, Washington, D.C.

470 A. Esross, 31, Rue Rouget de L'Isle,
Issy-les-Moulineaux
POPULAR MECHANICS 91
Seine, France

**SELF-COOLING AERO ENGINES
WITH COMPLETE EXPANSION**

A new French airplane engine that is attracting much attention, has a novel and very simple means of completing the expansion of the charge, after combustion, to little more than atmospheric pressure. This is done by making the stroke very long in proportion to the bore, and by having in each cylinder head only one small automatic inlet valve, with a comparatively strong spring, so that during the suction stroke the charge is drawn in through such a restricted opening that in volume, at normal pressure, it would be equivalent to only about half a cylinderful. The volume of the combustion chamber is so reduced by the long stroke of the piston that the compression of the charge, in spite of its reduced initial pressure, is as high as in any other engine, with proportionately high combustion pressures. Around the single small inlet valve in the cylinder head are a number of mechanically operated exhaust valves which eliminate all back pressure and maintain the low temperature of the fully expanded

gases. The result is that the engine can be cooled without water jacketing, or even radiating fins. Besides the elimination of back pressure and the great reduction of temperature, there are two other notable results from this construc-

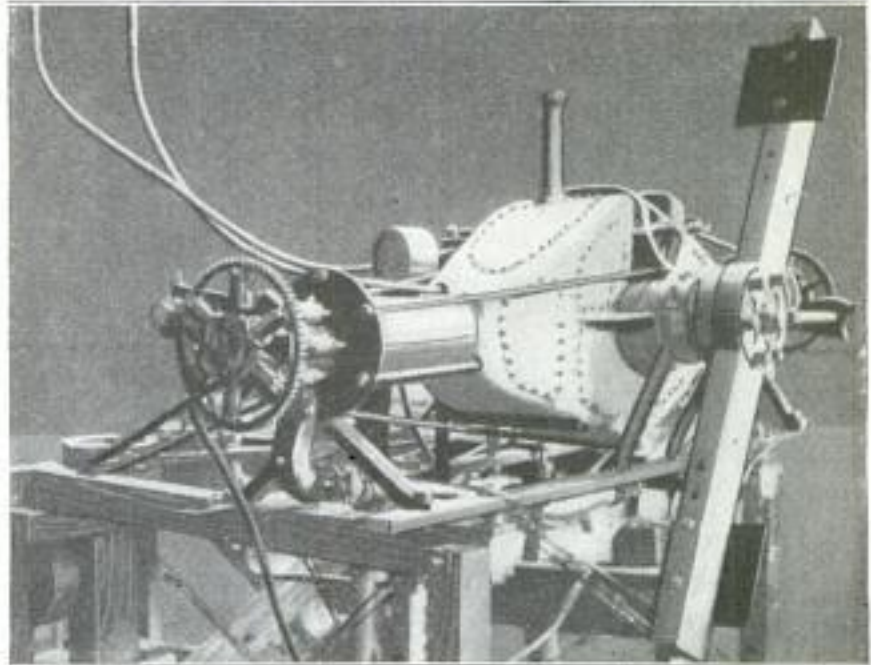

Novel French Airplane Engine, under Test, Which, after Combustion, Completes the Expansion of the Charge to Little More than Atmospheric Pressure: It Is Self-Cooled and Weighs About Two Pounds per Horsepower

tion: The exhaust is practically noiseless, and there is the added work done by the completion of the expansion. The model in which the principle was tested out, has two horizontal, opposed cylinders, and is so light that, though developing 25 horsepower, it weighs only about 50 pounds.

426



Efficient Filing Cabinet Which Aids Office Work, Showing How It may be Placed between Two Desks, Thus Enabling Both Employees to Use the Cards Freely

**FILING CABINET OPEN
ON TWO SIDES**

Efficient filing cabinets for use in connection with correspondence files and the like, in offices where several persons simultaneously use the same collection of cards, are now available. In use, the appliance is located midway between two desks, or tables. Being open at both sides, the file may be reached by the employe at either desk without having to rise from their seats. The cards are mounted on steel panels, each of which has a capacity of 100 names and addresses. Owing to the manner in which the cards are attached to the panels, it is impossible to spill or disarrange them while handling.

W. L. Allison 2506 Windsor Ave. Mrs. Allsworth C. Ede, Shuburg, Ill. dawa.

dw. Ferdinand J. Haschka,
 % Tiffany & Co; Fifth Ave - 37th
 92 POPULAR MECHANICS

613 WATCH USED AS SCARF PIN
 IS SMALLER THAN DIME

Almost a half less in diameter than a dime is the face of a new watch designed to be worn as a scarf pin. The Arabic



BY COURTESY OF THE JEWELERS' CIRCULAR

hour numerals are quite distinct so that it is not particularly difficult to make out the time. While the face leads one to believe that the movement is also exceedingly small, this is partly an illusion, for the works, concealed in the folds of the scarf, are really slightly larger. The small face and stem are neatly proportioned.

434 SCREW AND NUT-SETTING TOOL
 IS MOTOR-DRIVEN

A new tool for setting up screws and nuts is made in portable and stationary types and is driven by a self-contained electric motor. The portable type can be operated from an electric-light socket, and so can the stationary one if the line

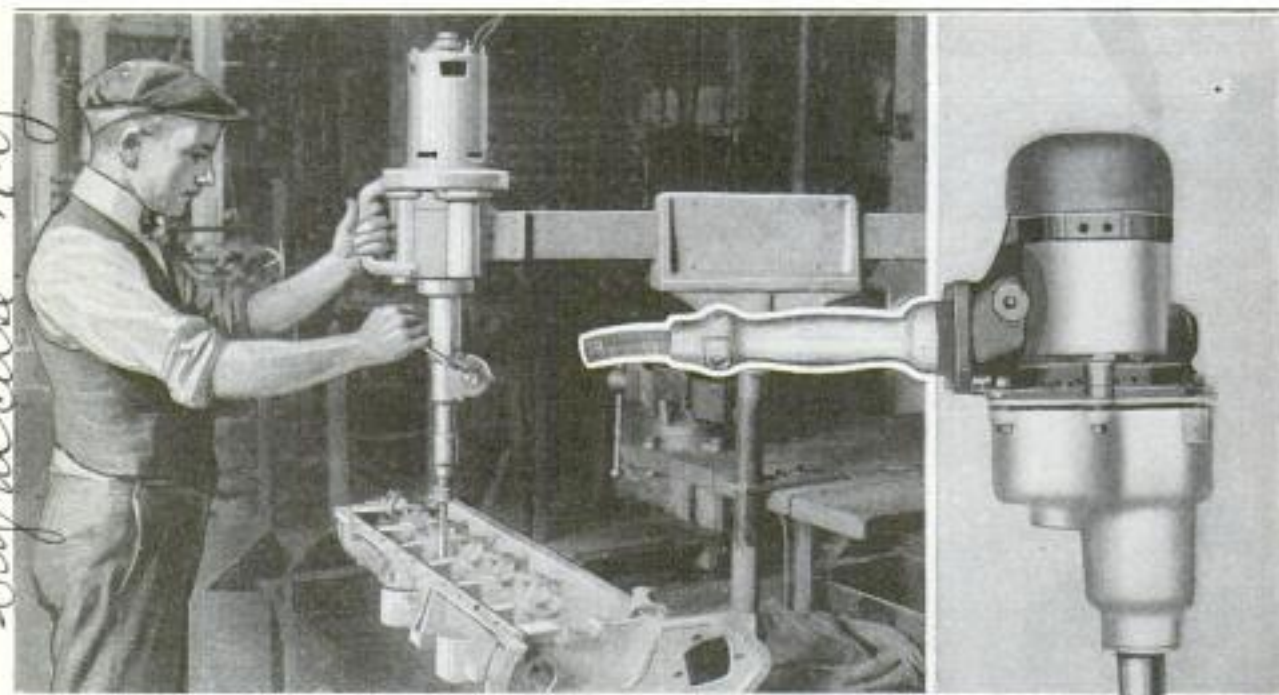

Left: Stationary Type of Screw and Nut-Setting Machine Which Handles Nuts and Screws from 1/2 to 1 Inch in Diameter, Right: Portable Screw and Nut-Setting Tool, Which will Drive and Set Nuts and Screws from 1/4 to 3/8 Inch in Diameter

has the necessary capacity. The driving mechanism consists of a multiple-disk clutch, adjustable to different setting requirements, and a positive clutch which automatically "kicks out" when the disk clutch is released, permitting the removal and replacement of tools while the motor is running. The tools are furnished with recessed and tapered wrenches, in which nuts and screws can be picked up and held while the spindle is at full speed.

RADIATOR FAN WITH BLADES
 AUTOMATICALLY ADJUSTED

The cooling effect of an improved radiator fan is automatically controlled by a thermostat installed in the upper radiator-hose connection. When hot, this expands and adjusts the movable fan blades so that they draw the outside air through the front of the radiator. When cold, the thermostat contracts, reversing the adjustment of the blades so as to blow the hot air from the engine onto the radiator. At intermediate temperatures the fan blades are adjusted accordingly.



not in market

Electrize Mfg Co. d. no.
 Syracuse N.Y.

General necessities Co. Milwaukee Wis

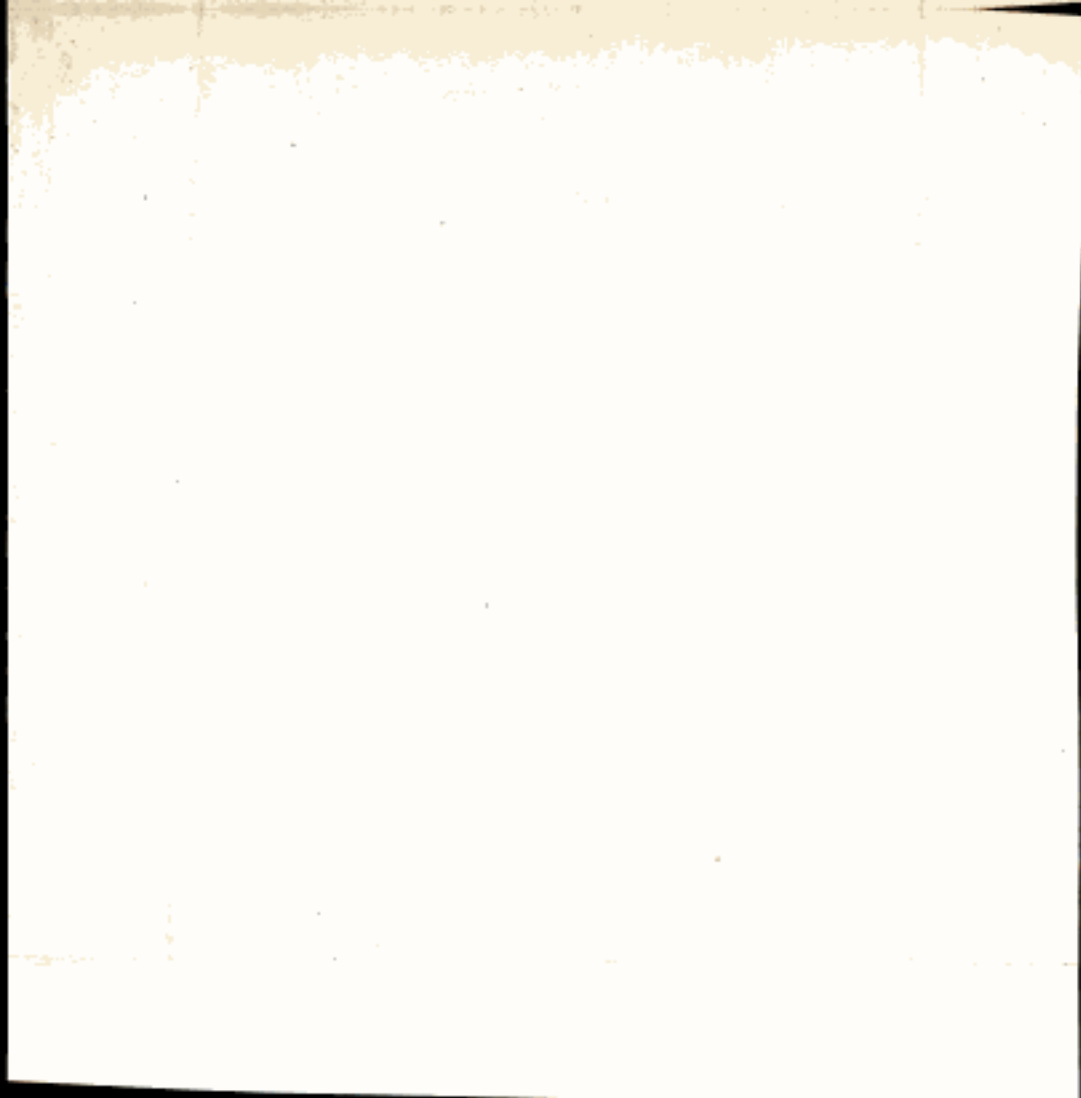

MERRILL & CO.
FIFTH AVENUE & 37TH STREET
NEW YORK

February 9th 1923

The Popular Mechanics Magazine
Chicago
Illinois

Mr. W. F. Unbarger
Bureau of Information

Dear Sir

In reply to your letter of recent date, we
only say that Mr. Hsachka made but one of the scarf
watches for his personal interest

It is not manufactured and is not likely
placed on the market

492 Cont. H. A. Plann.
2722 Prince St. Berkeley, Calif.



The Heavy Broken Line on This Map Indicates the \$7,000,000 Highway to Connect San Francisco with the San Joaquin Valley Roads. The Unbroken Line Shows the Only Present Outlet Southward from San Francisco, and the Proposed Skyline Boulevard Appears in the Foreground

SEVEN-MILLION ROAD TO RELIEVE TRAFFIC JAM

By ROBERT MORGAN

TO afford relief from the congestion which accompanies the passage of thousands of automotive vehicles daily into and out of San Francisco on the southern side, San Francisco County, assisted by the county of San Mateo, is preparing to construct a paved highway, 100 feet wide, and approximately 35 miles long, at a cost, including the necessary bridge over the southern end of San Francisco Bay, of \$7,000,000. The two counties have appropriated \$225,000 for the purchase of rights of way and for detailed surveys of the proposed line of the road.

There is only one paved highway, and that a narrow one, leading southward from San Francisco along the peninsula of which that city forms the northern end. This highway, in order to get into San Francisco, passes through the range of hills that borders San Francisco on the south. Through these hills, and through the industrial section of lower or southern San Francisco, traffic had to move very slowly. As a consequence, while traffic on the highway south of these hills moved in continuous streams at 30 to 35 miles an hour, when it entered San Francisco it was automatically reduced to 15 miles an hour or less. This condition literally "piled up" traffic into San Francisco at the city's southern boundary, and the proposal of a new 100-foot highway is the result.

Estimates made by engineers place the cost of the highway as far as Redwood City, and thence eastward to the edge of the bay, at \$4,300,000, and the cost of the bridge across the narrow bay, either at Ravenswood Point or at Dumbarton, at \$2,300,000. The eastward turn from Redwood City, and the bridge across the bay, are almost as important as the relief from congestion at the entrance to San Francisco, since the eastward-bound highway will connect, at Niles, with the main paved highways to and from the great and productive San Joaquin Valley, thus putting this valley in direct connection with San Francisco, and giving its producers motor-truck and auto-stage transportation to that city and its markets.

As soon as the rights of way have been obtained and the survey completed, the interested parties will go before the state government and ask for state aid. The state, in turn, will ask for Federal aid, inasmuch as this is to be a part of the state-highway system.

Surveys and the work of obtaining the rights of way are now going on, and no time will be lost in pressing the work of construction. The highway will run, still 100 feet wide, directly to the heart of the San Francisco business district. It will be so divided by pavement markers that six lines of traffic, three each way, may pass simultaneously upon it, and San Francisco commercial and industrial

areas will be greatly increased by its construction, while north-and-south traffic will be released from the present narrow road to a space four times as great. Traffic over this road today is six times as great as it was in 1914, when the road was

barely adequate for the traffic, so that from this some idea may be gained of the necessity which has impelled San Francisco to construct one of the widest paved highways in the world out of her back door into the heart of California.

DAILY INSURANCE POLICIES SOLD BY SLOT MACHINE

Daily insurance policies may now be taken out by prospective and apprehensive travelers who need only to insert a five-cent piece in a slot machine which also contains a scale for weighing. For death by train wreck, the nearest kin or other beneficiary receives \$1,000; for death on a train from sickness, the payment is \$500. Disability caused by any injury received while traveling on trains, yields



COPYRIGHT, UNDERWOOD & UNDERWOOD

\$5 per week for a term of 26 weeks, according to the provisions of these policies.

DATE AND STAMPING MACHINE HAS SIGNATURE OF USER

The responsibility for mistakes made in the dating or stamping of bills, receipts, or other documents of any kind, may be



welcome appliance. When thousands of papers are handled daily, errors invari-

ably occur, and with the names of the persons responsible for them appearing on the documents, these mistakes may be quickly traced to their respective sources.

PAINTING LINES ON CHINAWARE EASIER WITH NEW DEVICE

Lining chinaware is made easy by means of a new metal device. The arrangement consists of a small slide, the two hooked arms of which clasp the edge of the plate or bowl, and a movable crossbar with a screw adjustment. The crossbar is

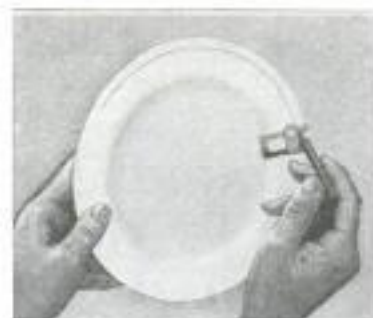

fixed at the desired distance from the edge, the pencil inserted, and the entire device drawn around the plate, leaving as it goes a clear, steady line.

NEW FIRE-ALARM BOX IS SIMPLE TO OPERATE

An improvement in fire-alarm boxes for the use of the public does away with the necessity of opening the outside door before pulling the alarm.



With the new box only two operations are required: A pull of the handle opens the door and a pull of the hook turns in the alarm. A substitute for glass in the key guard eliminates the danger of cutting the hands, and pressed-steel cases, heavily enameled with porcelain, afford protection against high-voltage electricity and lightning.

The Jewell Fire Alarm Tel. Co. Newton Upper Falls, Mass.

National Casualty Insurance Co. Washington, D.C. Detroit, Mich. 201 Mrs. Thorpe R. Post 108 7-7500 Wilmington, N.C.

D. M. Compagna Art Co. Chicago 016 & Wabach.



A Wooden Vessel Purchased by the American Legion Post, at Kirkland, Washington, and Converted, at Small Cost, into a Clubhouse

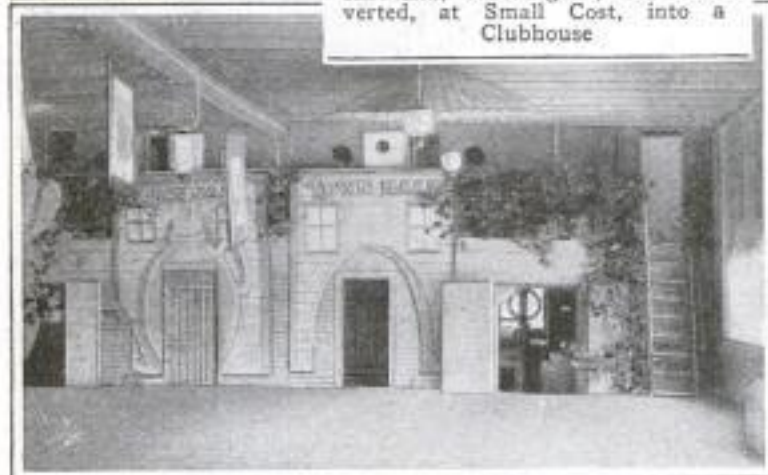

Left: A Corner of the Spacious Dance Hall Which was Formed by Inclosing the Cargo Deck of the Converted Ship. Right: The "Town Jail" or "Jug," Which Is an Accessory Built for Initiation Purposes and Other Uses on Special Occasions

664

REBUILT SHIP IS AMERICAN LEGION CLUBHOUSE

The Warren O. Grimm Post No. 83, American Legion, of Kirkland, Wash., has provided itself, at comparatively small cost, with an unusual clubhouse. Several months ago the legionnaires purchased for \$3,500 a 3,500-ton wooden steamer hull from the Emergency Fleet Corporation, and recently completed remodeling it into a clubhouse, at an expense of approximately \$2,000 for materials.

The hull was moored with its keel resting in shallow water on the east side of Lake Washington, and an inclined walk was built to it from the shore, with an admittance gate about halfway.

The cargo deck of the big steamer was resurfaced and inclosed, making a spacious ballroom. The whole ship was wired for electricity, and the cabin decks were converted into clubrooms; committee, men's smoking, and ladies' rooms, dining, and other rooms.

Opening night was marked by a huge celebration participated in by the various American Legion posts in the Puget Sound district.

NEW MOVIE SCREEN REDUCES GLARE AND EYESTRAIN

626

An improved movie screen is said to practically eliminate eyestrain and render the projected picture as clearly visible from a position at one side of the house as from a seat directly in front of the screen. It is made of a fabric to which is given a pure-white surface embossed with a multitude of small squares, resembling the surface of a miniature waffle iron.



The perfect diffusion and uniform illumination claimed for the light reflected from this curtain, depend upon the accuracy of the design and construction of the checkered surfaces.

Eureka Cinema Corp.
 193 Trumbull St. Ford Conn.

Masury-Young Co.
60 Roland St.

96 **POPULAR MECHANICS**
Charlestown Dist. Boston, Mass.

623 **OILER FOR HARDWOOD FLOORS**
SPRAYS BY AIR PRESSURE

An oiler for hardwood floors has been developed for use any place where it is desirable to lay the dust and preserve the wood. The appliance is operated by air pressure. It has a cylindrical tank in which an air pump is incorporated, and a spring-tension attachment that controls a tiny sprayer. In use, a gallon of oil is placed in the outfit, a few pounds pressure pumped into the tank, after which the operator is enabled to



spray any floor rapidly and in an efficient manner without waste of oil.

AIR FEED FOR FUEL MIXTURE REGULATED ELECTRICALLY

For regulating the supply of air mixed with the fuel in an automobile engine, and thus giving the greatest possible efficiency for varying speeds, an automatic electrical device is now on the market. It

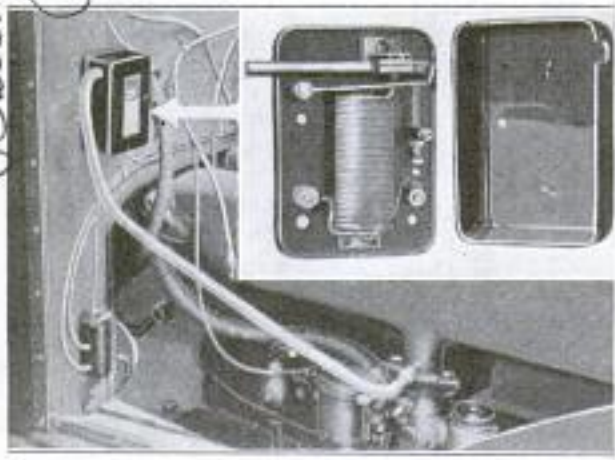

Air-Feed Regulator Shown Installed on the Dash of an Automobile: Enlarged Inset View Shows It Opened Up, Exposing Its Low-Resistance Coil

consists of a small low-resistance coil with a metal core, and an armature to the end of which is attached a valve that opens or closes an air-inlet pipe leading to the intake manifold, to which it is connected just above the carburetor. The coil is connected in series in the positive wire leading from the generator. At low speed, when a richer mixture is required, the magnetic force is not sufficient to attract the armature, and it closes the air inlet. As the speed increases, the armature opens the valve proportionately, until at high speed, when the armature is in contact with the coil, the valve is wide open, and the consequent air supply furnishes an economic fuel mixture. By means of a spring attached to the armature, it can be adjusted to suit any speed conditions.

760 CARBON-PROOF SPARK PLUG WITH RADIATING FINS

A new carbon-proof porcelain spark plug has been specially designed for winter driving by utilization of the principle of radiation.

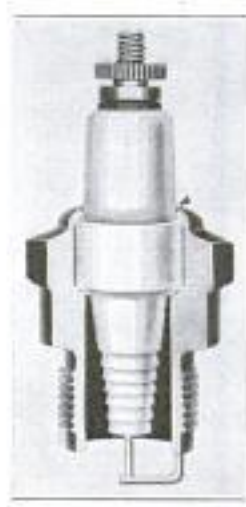

Around the inner end of the porcelain insulator are molded a series of saw-tooth girdles, so sharp-edged that they instantly attain a temperature high enough to burn off the oily soot that coats the smooth surface of ordinary porcelain insulators, and that may cause a short circuit. The plugs are made to suit all types of engines, and can be easily taken apart for cleaning.

778 PROVIDE NEW RADIO SERVICE TO LONDON AND GERMANY

Radio service from America to London and Germany is now available at a rate that will make it attractive to those who want to send messages to those places, according to a recent announcement. The rate is six cents a word, including the address and signature, with no minimum requirement. While a registered code address is acceptable, the text of the message is restricted to plain language. For the present the service is confined to London and Germany.

Radio Corp. of America
1901/22

Auto Electric Air Feed Inc.
1241 S Michigan Ave.
Chicago

A.C. Spark Plug Co. Auto & Acc.
Flint Mich

Misses

Copyrighted material

345 Cmt. L. R. Perry, 2165 Center St
Berkeley, Calif.



A View of the Lower End of the Bagley One-Man Shipyard, Looking toward the Water: The Marine Railway, on Which Vessels are Hauled High and Dry on the Land, and Its Largest Cradle Appear in the Center of the Picture, Which was Taken from the Roof of the Main Building

A ONE-MAN SHIPYARD

By L. R. PERRY

HERE is a tale of small things accomplishing big ones; of dimes performing the feats of dollars; of ambition developing inventive genius. It is an interesting testimonial to the fact that ambition backed by industry can make dreams come true.

The whole thing "in a nutshell" might be called a one-man shipyard, for that virtually is what it is, a shipyard and marine railway that one man can operate from beginning to end. It is a little industry that handles big jobs; an enterprise founded on empty pockets that now has an annual turnover which is providing amply for several families.

As the stranger comes upon this unique

plant on the shore of Oakland estuary, California, the first impression is one of

apparent dilapidation and disintegration. Buildings seem half torn down; things seem strangely scattered about. But the more a discerning eye investigates, the more the quite opposite is apparent—that the yard is alive and quite a novel one.

When, in my rambles with the camera, I happened onto this queer plant without its protecting fence, which no night watchman guards, I immediately sensed a story, and was not disappointed.

There are three personalities who mainly figure in this unique enterprise: J. W. Bagley, the father, and Percy and



An Old Tank Taken from a Dismantled Launch, Which has been Fitted with a Glass Level-Indicating Tube and is Now Used as the Gasoline Reservoir for the Engines

J. W. Bagley & Sons, Oakland Estuary, Calif.

J. W. Bagley
Owner

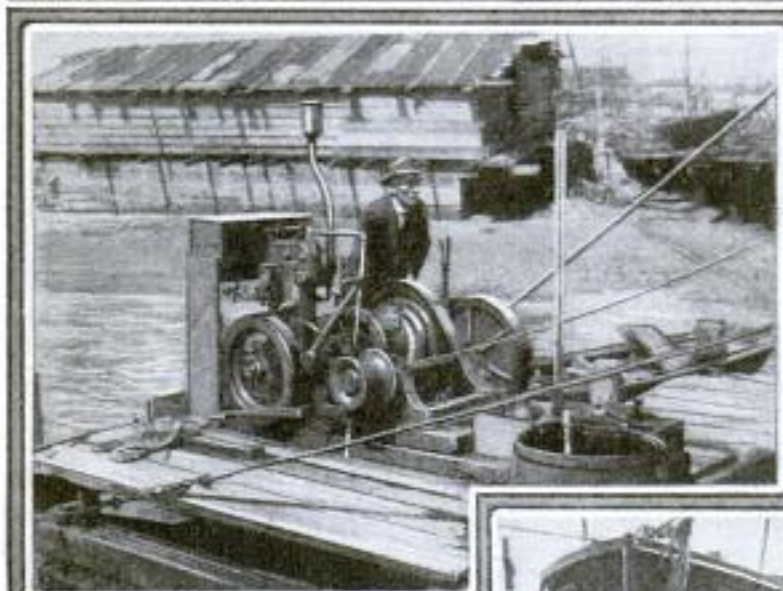
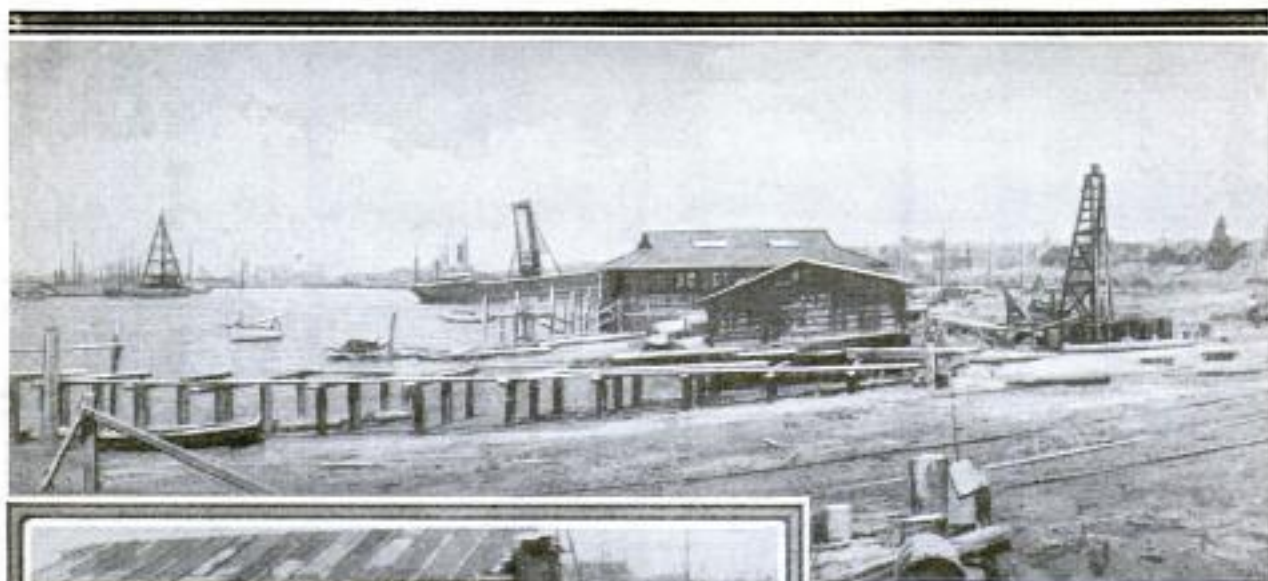

Above: A Partial View of the Bagley One-Man Shipyard from the Water's Edge, Showing the Pier, the Small Floating Pile Driver, and Several of the Portable Buildings of the Plant. In the Foreground a Portion of the Tracks of the Marine Railway can be Seen. The Shipyard Represents the Industry of a Father and Two Sons

Above, J. W. Bagley, Father of the Ingenious Sons, is Operating the Hoist of the Small Floating Pile Driver, Which was Constructed from an Old Pontoon and Equipment Accumulated from Various Sources. It is Used for Contract Work as Well as around the Yard



Above: The Bilge Blocks of the Cradles of the Marine Railway are Easily Slid into Position and Automatically Lock in Place under Water. Clamps Hold Them to the Cross Rails of the Cradle and They are Quickly Unlatched by a Jerk on a Cord. Left: Large Iron Sheave Made from Elevator Scraps and Used on the Head of One of the Smaller Cradles. It is Only One of the Many Evidences of Resourcefulness

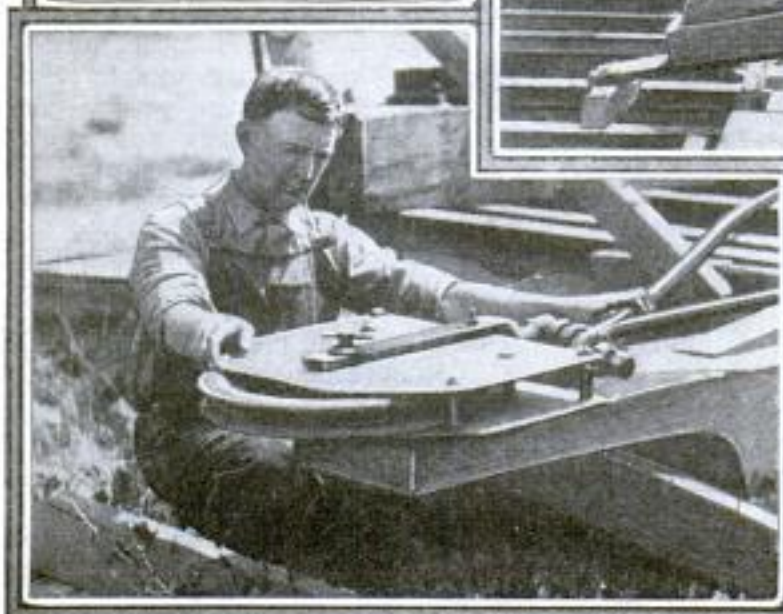



Above: A Continuation of the Bagley One-Man Shipyard from the Same Viewpoint, Showing Two Vessels Hauled High and Dry on the Marine Railway. Right: A Wood-Turning Lathe, Which Holds Anything from Dowels Up to Flagpoles and Rudder Posts, is Assembled on a Wooden Form, from Odd Parts of Machinery Picked Up Here and There

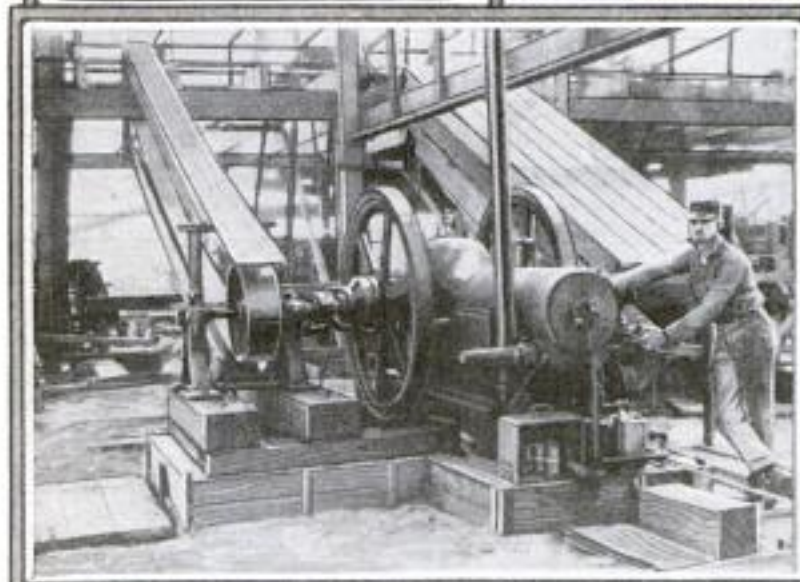
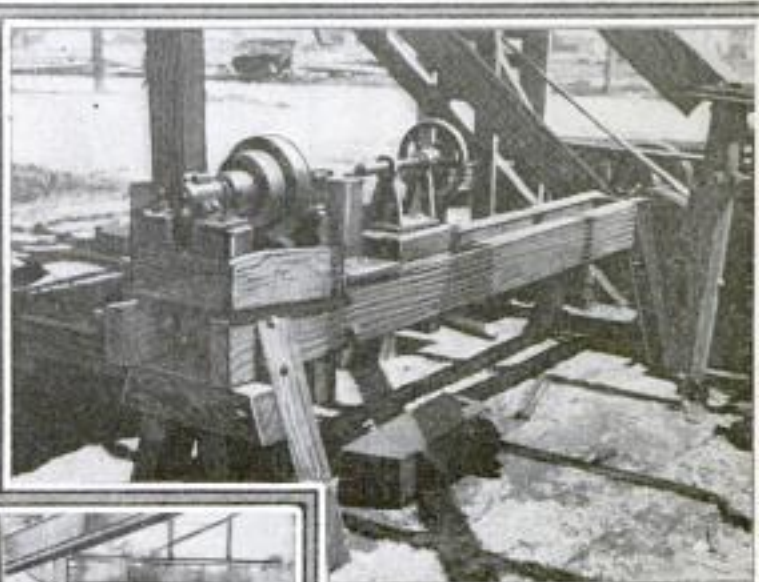

Left: Nelson Bagley and a View of the Engine Room, Showing a 25-Horsepower Gas Engine, Which Is One of Two Engines, Either of Which is Capable of Running the Machinery in the Plant, Alone or in Combination with the Other

Right: A Safety Device in the Form of a Hinged Door That Serves as a Guard in Front of the Engine Flywheel. In Most Places in This Plant, Belting is Protected with a Housing of Boards, but in Some Instances It is Allowed to Run Exposed to All Sorts of Weather. The View Shows a 17-Horsepower Gas Engine, Which can be Used Alone to Run the Plant, or Run in Combination with the Other Engine

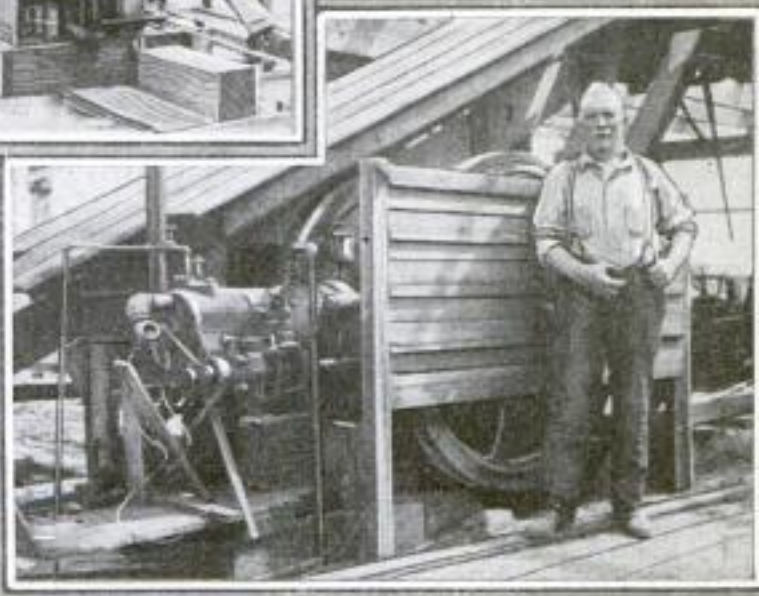

Nelson Bagley, the two sons. The business is today largely conducted by the father, architect by profession.

It is a striking feature of the conduct and expansion of this enterprise, to find

ble collections of machinery on skids, house and all; and in such manner as to readily become part of future units or combinations? All the smaller buildings of the plant are on skids, and have been moved several times so as best to facilitate jobs in hand.

The big marine railway and cradle is an interesting mechanical contrivance in itself. Essentially it is quite different from the average marine railway in that its 90-foot cradle is under-slung. The big wooden beams constituting the sides rest on axles. Fastened to the beams underneath with large U-bolts, and spaced about two feet apart, are the crossties of inverted 70-pound railroad rails. Keeled vessels rest on these and the steadying bilge blocks on the side beams, but flat-bottomed barges rest on the side beams, while the cradle is in transit. When ashore, the biggest barges are blocked up on the ground. This under-slung type of marine railway takes up less room, draws less water, and permits a simple record of forms of hulls to be kept in repeated dockings.

It is surprising what large jobs this small yard can handle. The photos show numerous men at work; but one man can alone haul out large craft, work it, and return it.

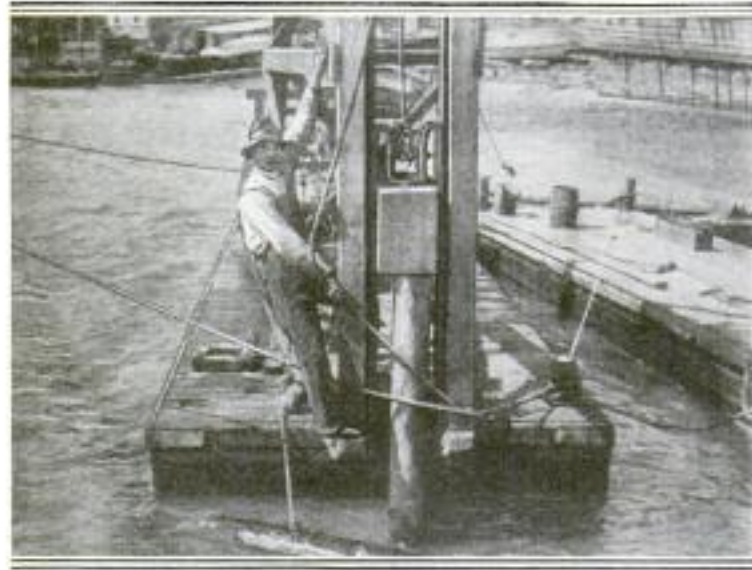

The Small Floating Pile Driver Operated by Percy Bagley: The Hammer Was Once the Counterweight of an Elevator. This 700-Pound Weight Now Easily Sinks a 10-Inch Pile

its main building under steady use without roof and walls, and even parts of floors still missing. Yet, if the plant must "pay for itself as it goes along," why not put any surplus resources to other use? And, if various jobs call for extensive shifting of equipment, and bigger schemes are held in view, why not assem-



Left: Simple Emergency Pump Made of Four Strips of Wood, Four Inches Wide, Nailed Together to Form a Long Box. A Square Piece of Flexible Leather Bolted to the Handle Acts as a Check Valve. Right: A Four-Inch Iron Pipe Serving as an Improved Steam Box, Used in Bending Ribs for a Quick Repair Job on the Launch in the Background

Authentic World

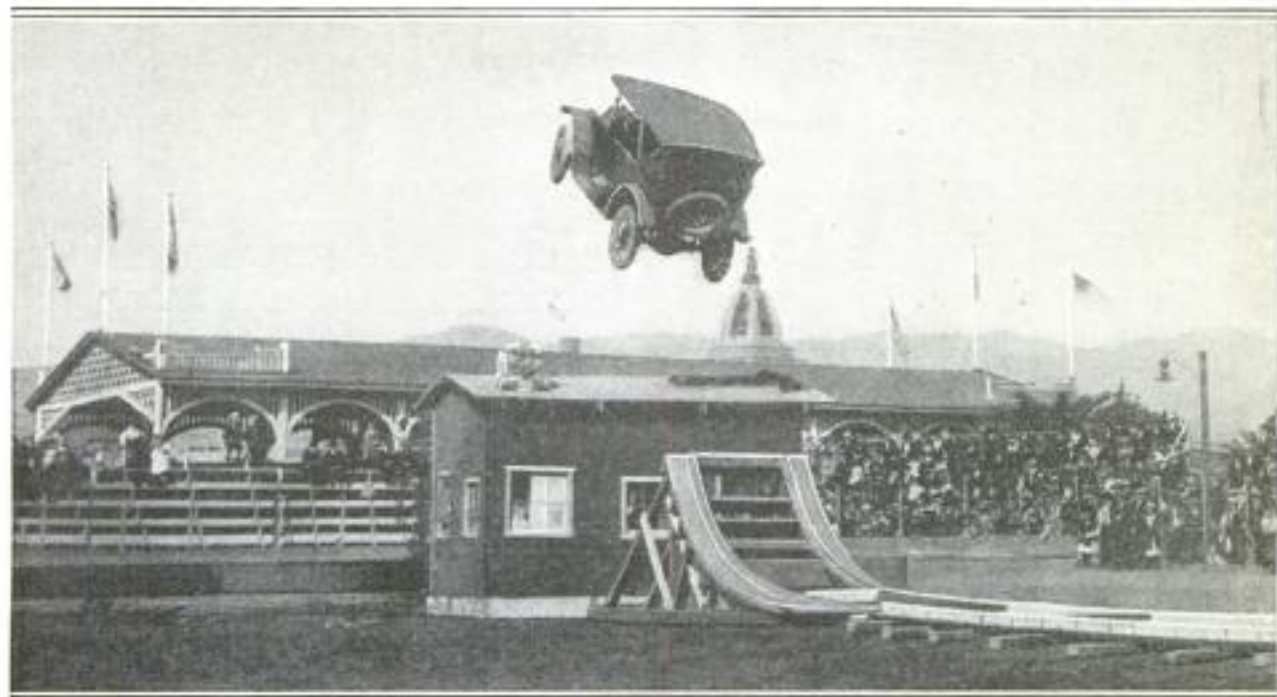

COPYRIGHT, UNDERWOOD & UNDERWOOD

Small Touring Car Shown in the Act of Leaping over the 15-Foot House: In the Foreground is Seen Part of the Long Track Having the Sharp Incline at the End. The Grand Stand, in the Background, is Well Filled with Interested Spectators

643
**SMALL TOURING CAR LEAPS
OVER 15-FOOT HOUSE**

Leaping over a house 15 feet in height, was the performance of a small touring car, recently, when this feat was exhibited as an amusement-park "thriller." A track, having a sharp incline at the end, was laid so that it led up to the house. Then the car was started along the track under its own power. Gathering great momentum by the time the abrupt upward turn at the end was reached, the machine leaped high in the air, easily clearing the structure.

809
**SHIP DRIVEN AGAINST WIND
BY WIND-DRIVEN TURBINE**

A ship that can be propelled dead against the wind by means of an exclusively wind-driven turbine, thus making the wind an aid instead of an obstacle, has been developed by three engineers in France, and was described recently before the Academy of Sciences. The turbine has been tested on a light boat, equipped with a screw propeller. The turbine is driven by the velocity of the wind, and there is such a perfect system of power transmission to the propeller that it drives the boat into the eye of the wind from which the turbine derives its motive power.

H. G. Jones Oct 24 / 22 P. 10
Recently an English explorer of Tibet was surprised to find that the Dalai Lama owns and operates a motorcycle.

671 **PAD IN TOBACCO POUCH
MOISTENS CONTENTS**

A rubber-lined tobacco pouch which contains a moistening pad, for keeping the contents in good condition, is the latest innovation for pipe smokers. The pouch is of convenient pocket size and



Above: Tobacco Pouch in Which is Incorporated an Oval Moistening Pad to Keep the Contents in Good Condition. Right: Pouch Closed, Showing the Side "Spout" through Which the Tobacco is Poured

has two snap fasteners that hold the top tightly closed after the tobacco has been placed within. To fill a pipe, it is not necessary to open the pouch, as a small outlet is incorporated in it, through which the tobacco may be poured.

are New York.
A. J. Rogers Co. 100 Fifth

Owned by Benj. Liverpool,
South Hanson,
Mass.

486 PORTABLE SAWMILL BUILT ON OLD MOTOR CAR

Riding to and from the scene of his labor on a portable sawmill, with which he daily cuts 10 cords of wood, is the

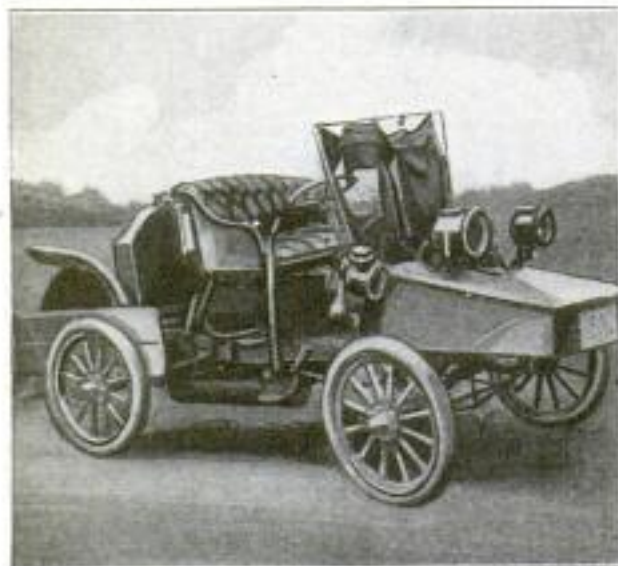

Portable Sawmill Built on an Old Motor Car, Showing the Circular-Saw Attachment at the Rear of the Strange-Appearing Outfit

occupation of a Massachusetts man. His homemade "mill" consists of a small motor car, 1906 model, on which a circular saw has been ingeniously rigged. With this odd outfit, the man tours over considerable territory, contracting to saw wood. Although the mill, or machine, is not impressive in appearance, the owner

finds it a remunerative investment, for the cost of operation is very small, and he usually picks up enough work to make every trip pay. The engine was originally air-cooled, but the owner rigged it up for water cooling.

475

MACHINES FOR FLAX-PULLING TO SUPERSEDE-HAND LABOR

One of the most costly and tedious of the processes in connection with the manufacture of linen is the pulling of the flax, which hitherto has had to be done by hand. New attempts are now being made in Europe to do this mechanically, and several tests have recently been made of different flax-pulling machines. The most successful seems to be one that is now running in Ireland. This machine, like others tried in England, France, Russia, and Canada, fundamentally consists of a comblike arrangement that grasps the flax stems, and by the resistance of the seed capsules of the fiber plucks them from the ground. All weeds growing among the flax slide through the puller and are not plucked. After being pulled, the flax is thrown onto a binding arrangement similar to that used in grain harvesters. It is then bound and shocked, also like sheaves of grain. The flax puller is hauled by horse or tractor, and only a driver and an operator on the puller are needed to operate the machine, which will harvest about 10 acres a day.

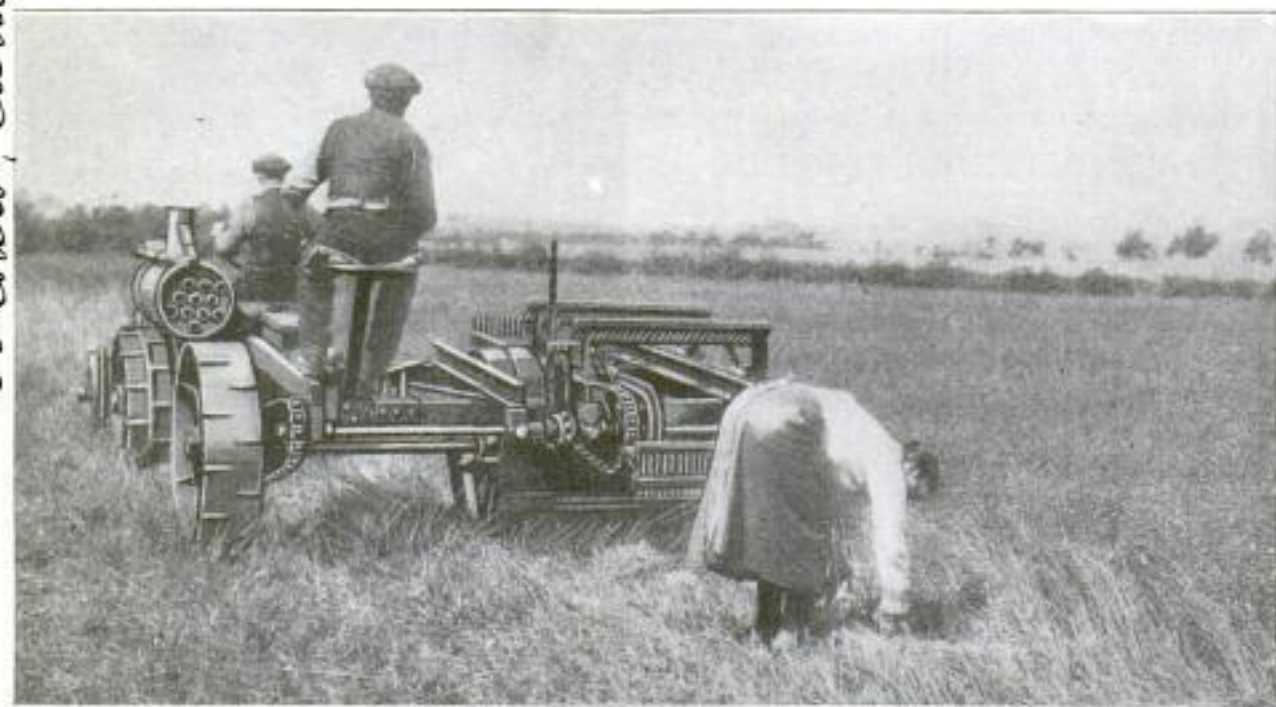

Flax-Pulling Machine That Harvests Flax Much in the Same Manner as a Binder Harvests Grain, Excepting That It Pulls the Flax Stems Out by the Roots Instead of Cutting Them: This is Done by the Comblike Device Driven by the Endless Chain

Imp. Canadian Vessot-Pulling Machine Co. Toronto, Canada.

Bennett-Crawford, Belfast, Ireland, Inv
Marshall, Sons & Co. Ltd., Leamington, Eng

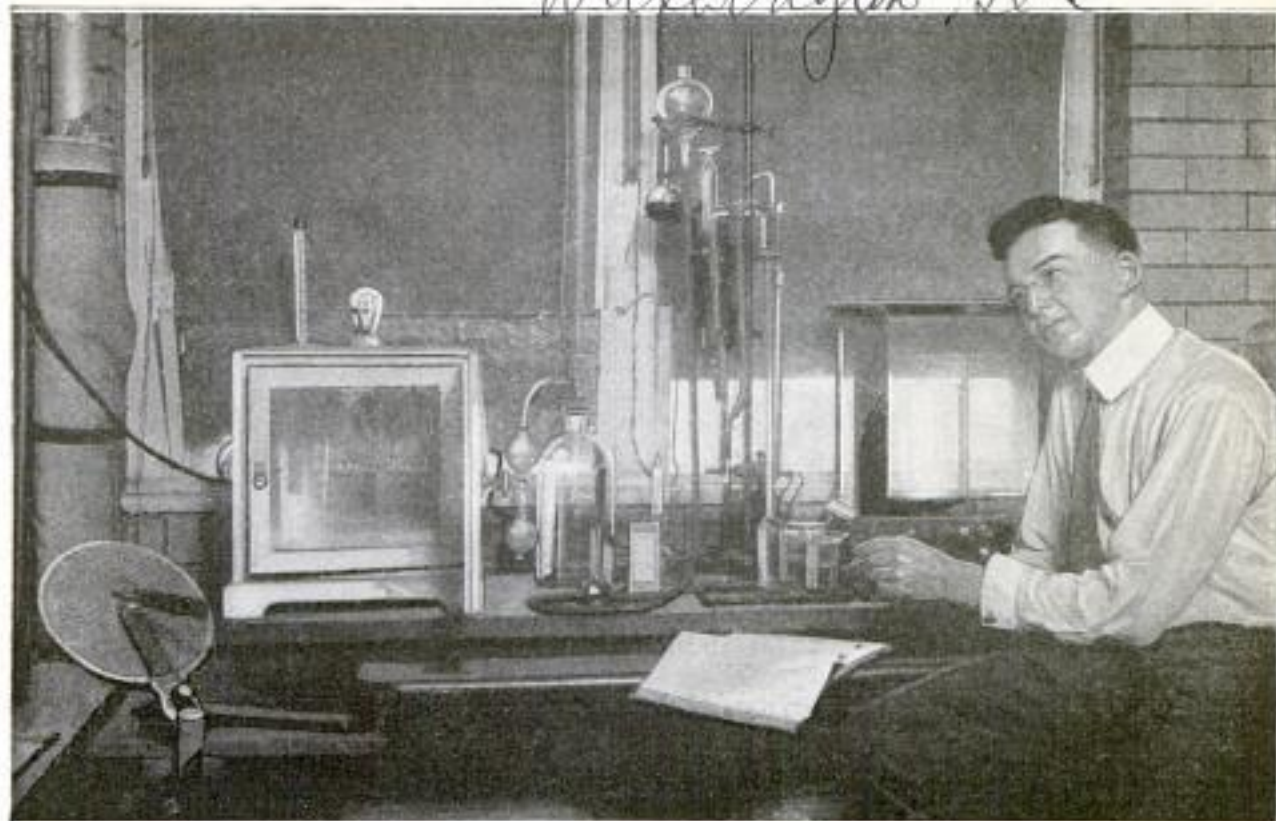

COPYRIGHT, HARRIS & EWING

Apparatus Used in Determining the Digestibility of Foods at the Bureau of Chemistry, Department of Agriculture, Where Formerly the Action of Certain Foods on White Rats and Guinea Pigs was Studied for the Same Purpose

453 TEST DIGESTIBILITY OF FOOD IN GLASS CONTAINER

The digestibility of certain foods is now being determined in suitable laboratory apparatus in preference to the method of studying their action on white rats and guinea pigs, at the Bureau of Chemistry, Department of Agriculture. For example, beans are placed in a glass container with a dilute solution of hydrochloric acid, similar to that found in the human stomach, a quantity of pepsin is added, and the mixture is placed in an incubator having a temperature of about 98° F., or the same as exists in the stomach. At the end of a given time, the contents are analyzed, and then treated with chemicals approximating the juices found in the lower digestive tract. 673

MOTOR-OPERATED SNAP SWITCH HAS WIDE APPLICATION

A new motor-operated snap switch that can be used on direct or alternating current, with little power consumption, and is applicable wherever automatic control of electrical devices is desired, has recently been produced. The switch is ruggedly built and mounted on a porcelain block, secured to the bottom of the cast-iron switch box, and a specially de-

signed motor is also fastened to the bottom of the box and geared to the switch, from which it is separated by an insulat-

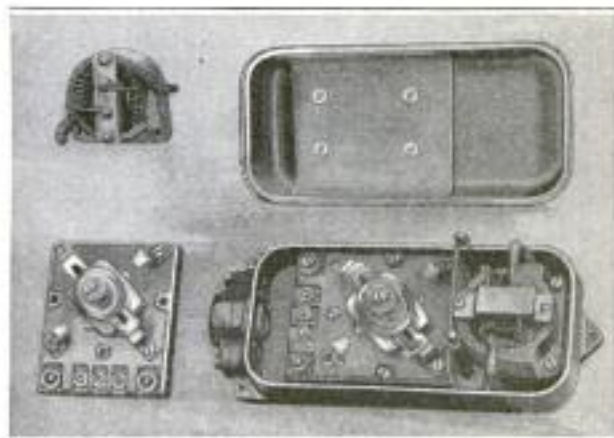

This Motor-Operated Snap Switch Is Adaptable Wherever Automatic Control of Electrical Devices is Desired, and Consumes Little Power

ing barrier. The motor is connected to the auxiliary control circuit and only operates intermittently. The bearings are of a special self-lubricating material.

Ⓞ The discovery of an alloy termed "or-eum," said to have the brightness, durability, and inoxidability of gold, has recently been announced by a French chemist, who also claims that these qualities will permit its substitution for gold in jewelry and other similar manufactures.

Butler + Son, Borough
 Brass & Iron Works

104

POPULAR MECHANICS

Blunfield, Manchester Eng.

NO PACKING IN STEAM VALVE
 WITH RENEWABLE PARTS

SEVERAL HARBOR EXTENSIONS
 AT AUCKLAND, NEW ZEALAND

9599

547

Steam valves, especially those used on superheated systems, require considerable attention to the packing in order to prevent leakage.

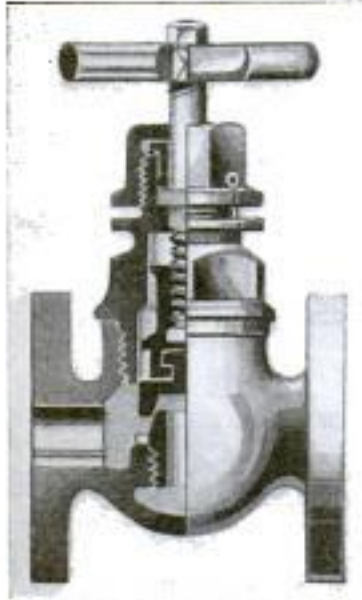

To overcome this nuisance, an English firm is manufacturing a packless valve which will operate satisfactorily on superheated as well as saturated-steam installations. In addition to being without packing, the four wearing parts, namely, the seat, clack valve,

nut, and spindle, are all renewable and tend to lower the maintenance costs.

A comprehensive system of harbor improvement is in progress at Auckland, New Zealand. Included therein are reinforced-concrete wharves, 240 to 280 feet wide, with deep-water berths, and steel cargo sheds, 320 feet long and 60 to 80 feet wide, equipped with modern loading and conveying machinery. All the wharves have a roadway 60 feet wide along their centers, and will eventually be provided with railroad connections from each berth. Refrigeration plants and lumber mills will be erected close to the berths. There are already sixteen 3 and 5-ton electric cranes, besides electric capstans, and others will be provided as the work progresses. Also, a large self-propelling floating crane, capable of lifting up to 80 tons, is now in operation. A great deal of reclamation work has already been done, hundreds of thousands of cubic yards of filling having been deposited in the last two years. At one point the reclamation is banked with a solid stone wall, of which 740 feet are already in place. Gas and electric lamps provide illumination.

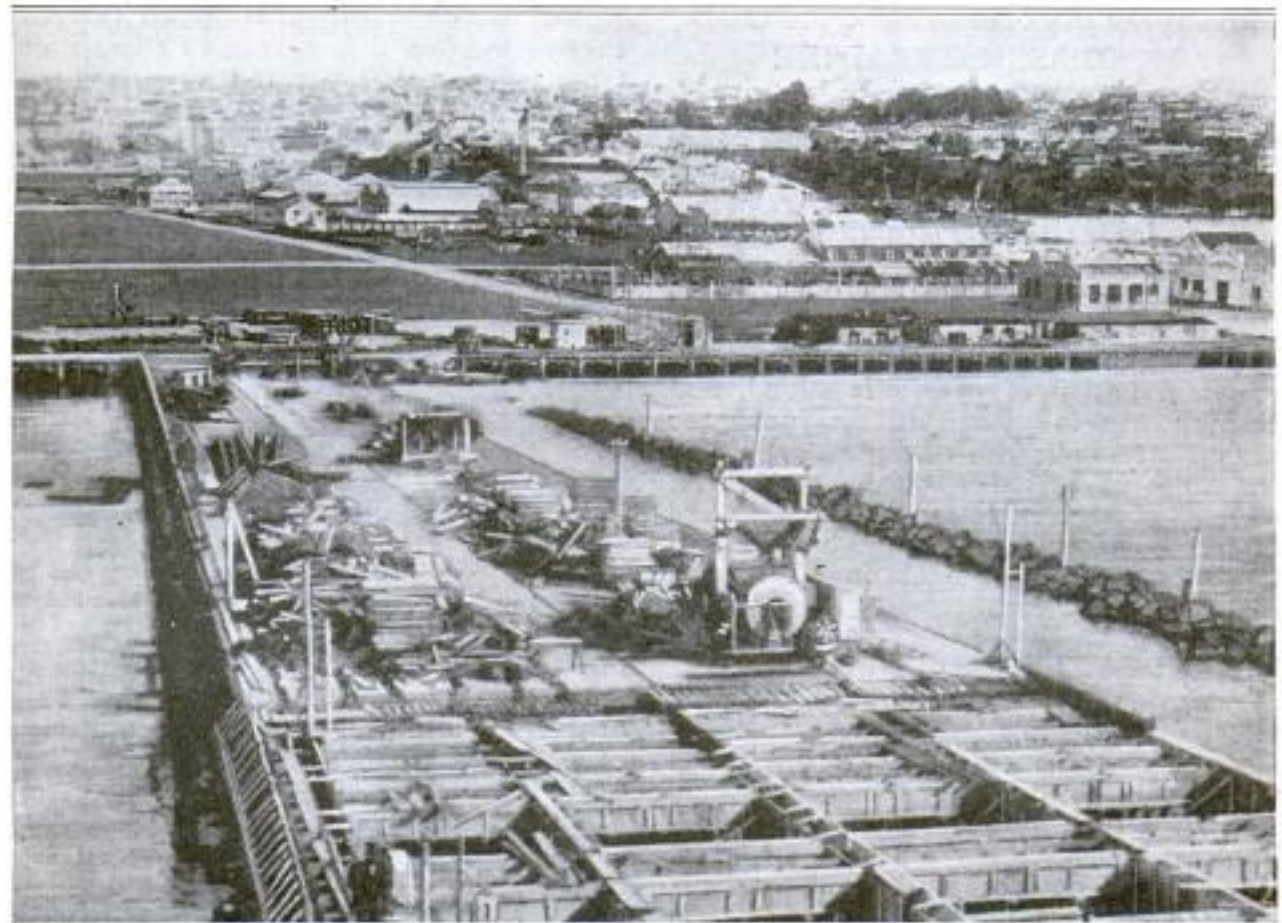

One of the New Reinforced-Concrete Wharves under Construction, That will Form Part of the Harbor Extensions at Auckland, New Zealand: These New Wharves Are 240 to 280 Feet Wide; along the Shore can be Seen Part of the Stone Wall Erected in Connection with the New Embankment

Cmd. O. Johnson, King & Victoria Sts.
 Pahiataua, New Zealand.

Copyrighted material

547

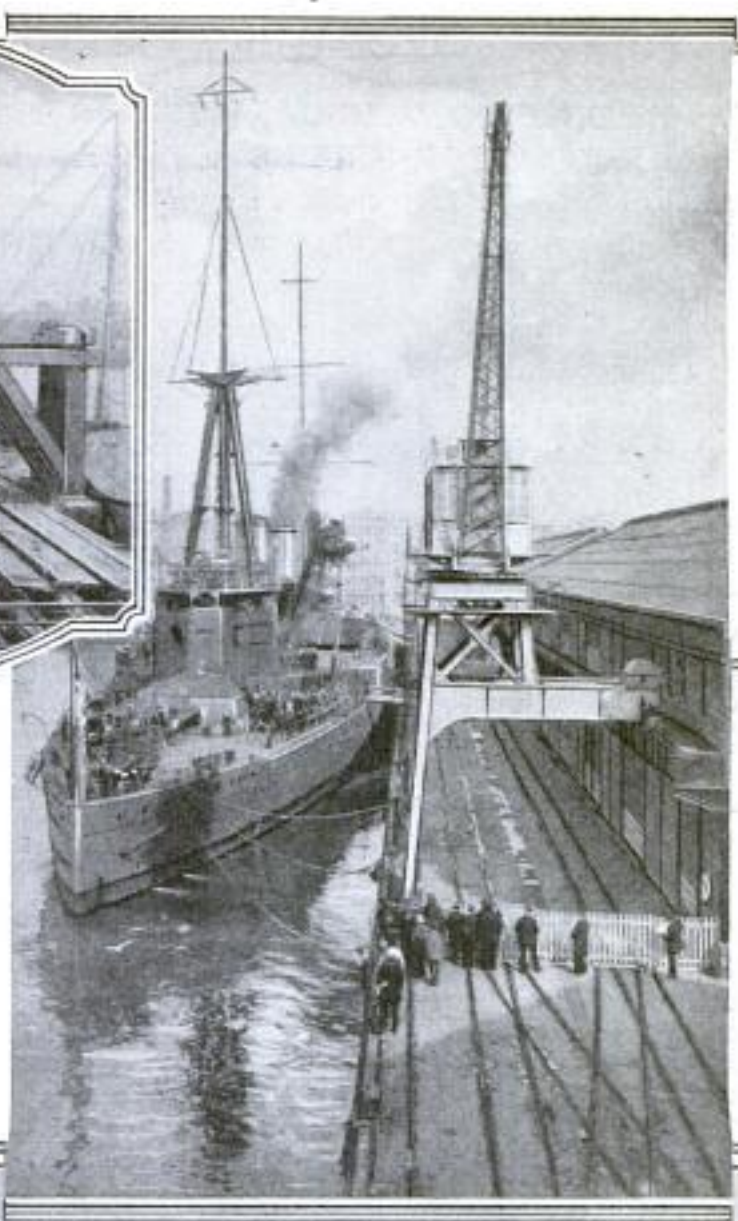
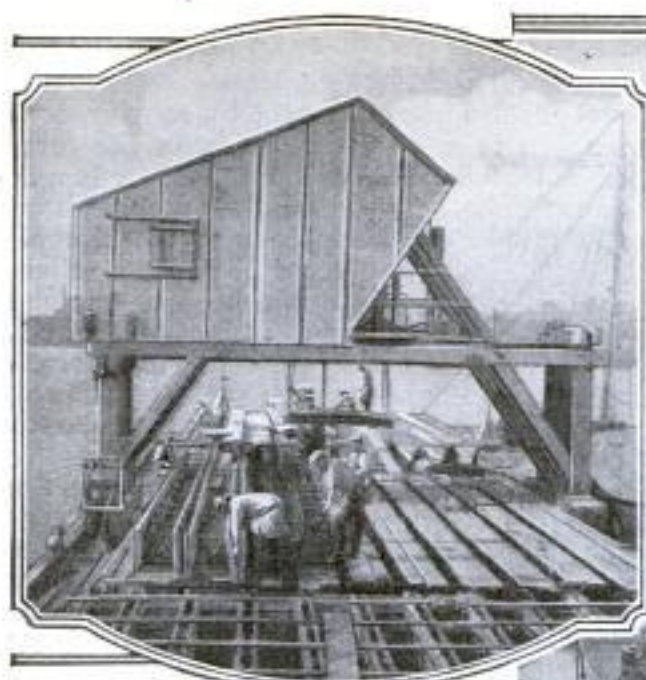

Above: Traveling Concrete Mixer at Work on One of the New Wharves in Connection with the Harbor Extensions at Auckland, New Zealand. It is Used for Making the Concrete Piles for the Wharf. Right: Part of One of the Reinforced-Concrete Wharves, Showing the Quay Side, with Its Railway Lines, and One of the Large Electric Traveling Cranes. Beside the Quay is Seen Part of One of the Two-Story Steel Cargo Sheds Which Are 320 Feet Long and 60 to 80 Feet Wide. Below: Concrete Pier Built to Act as a Tide Deflector in Connection with the New Harbor Extensions

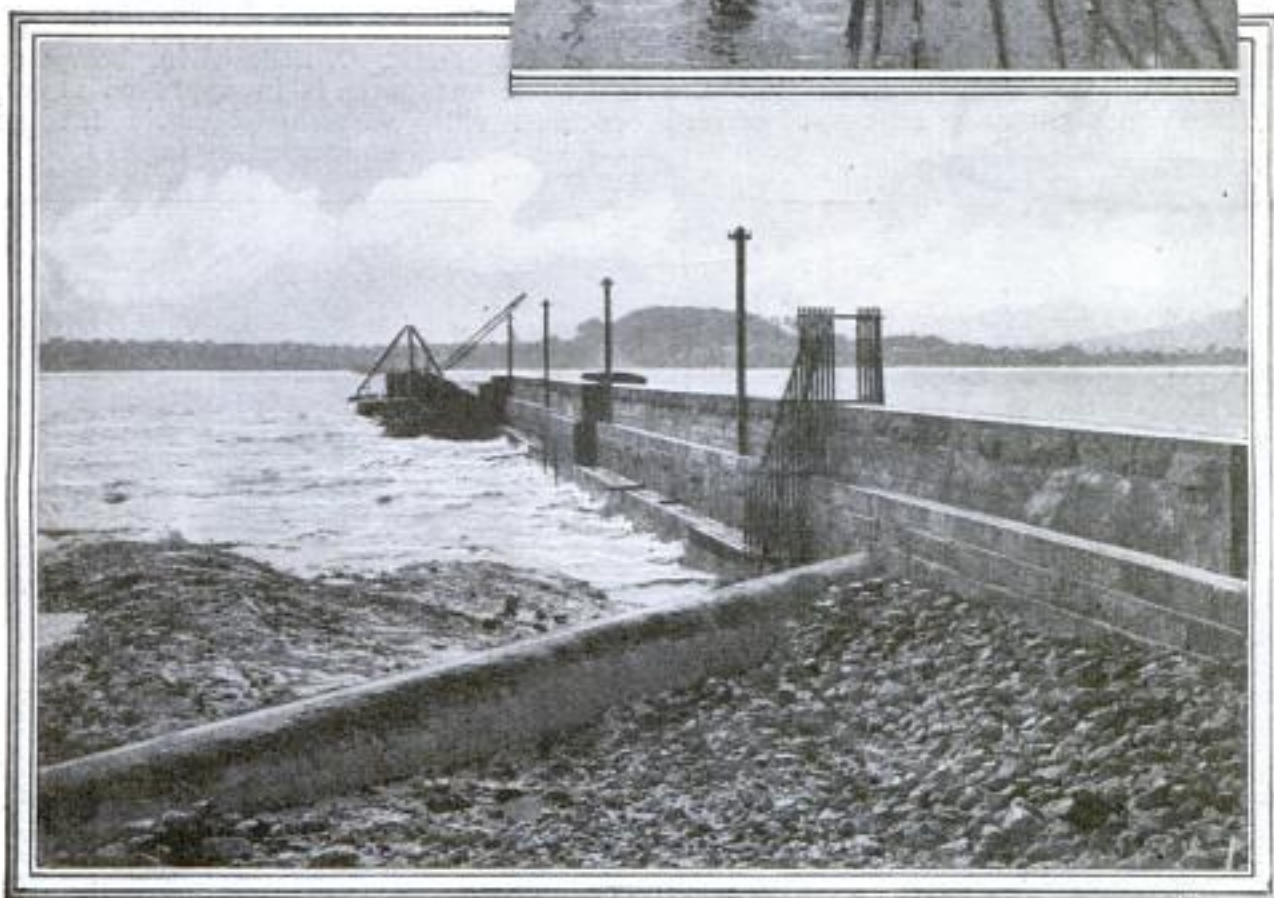

Chas. H. J. Strauss of The Strauss Lifting Co. Stratford, Conn.
POPULAR MECHANICS

65¹⁰⁶

ATTACHMENT TO WHEEL LIFTS MIRED MOTOR TRUCKS

For lifting motor trucks out of mud, sand, or snow, in which they may be

stranded, a portable attachment for connection to a mired wheel is in the form of a wooden four-sided block, in length about half the width of the truck. About the middle of this block is an eyebolt through which a chain having a hook at one end is passed. This chain is long enough to encircle the rim of the wheel, against which it is made tight by slipping the hook into a link of the chain. A tubular extension at the end of the block is so made that, when two blocks are placed on opposite wheels, they will telescope together. The truck is lifted by the blocks when the wheels are rotated.

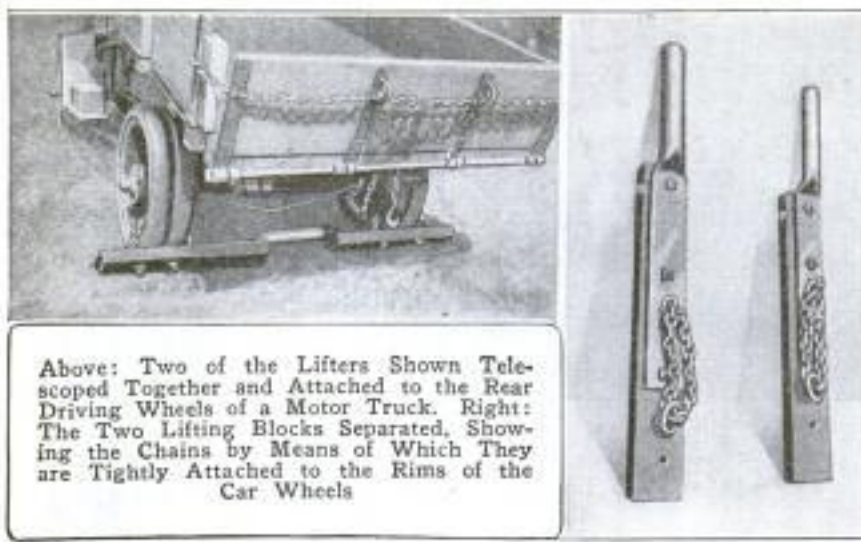

Above: Two of the Lifters Shown Telescoped Together and Attached to the Rear Driving Wheels of a Motor Truck. Right: The Two Lifting Blocks Separated, Showing the Chains by Means of Which They are Tightly Attached to the Rims of the Car Wheels

476

RADIO OUTFIT COMPACT AND PORTABLE

Nontechnical radio enthusiasts now have available to them a portable regenerative, or receiving, outfit which is not costly and is simple to control. The set is compactly constructed. Inclosed in a box, 7 by 9 by 11 inches in size, the equipment, consisting of A and B-batteries, head phones, vacuum tube, tuning coils, etc., and also enough wire for the ground and antenna, is easily carried

from place to place. It has a normal receiving range of 500 miles. During recent tests in Galveston, Tex., concerts from Georgia, Tennessee, Kansas, and Missouri were regularly received, while stations even more distant than these were also clearly heard despite the usually troublesome Gulf static. All the wiring between the different parts is in approved style, covered with varnished-cambic tubing and connected by lugs.

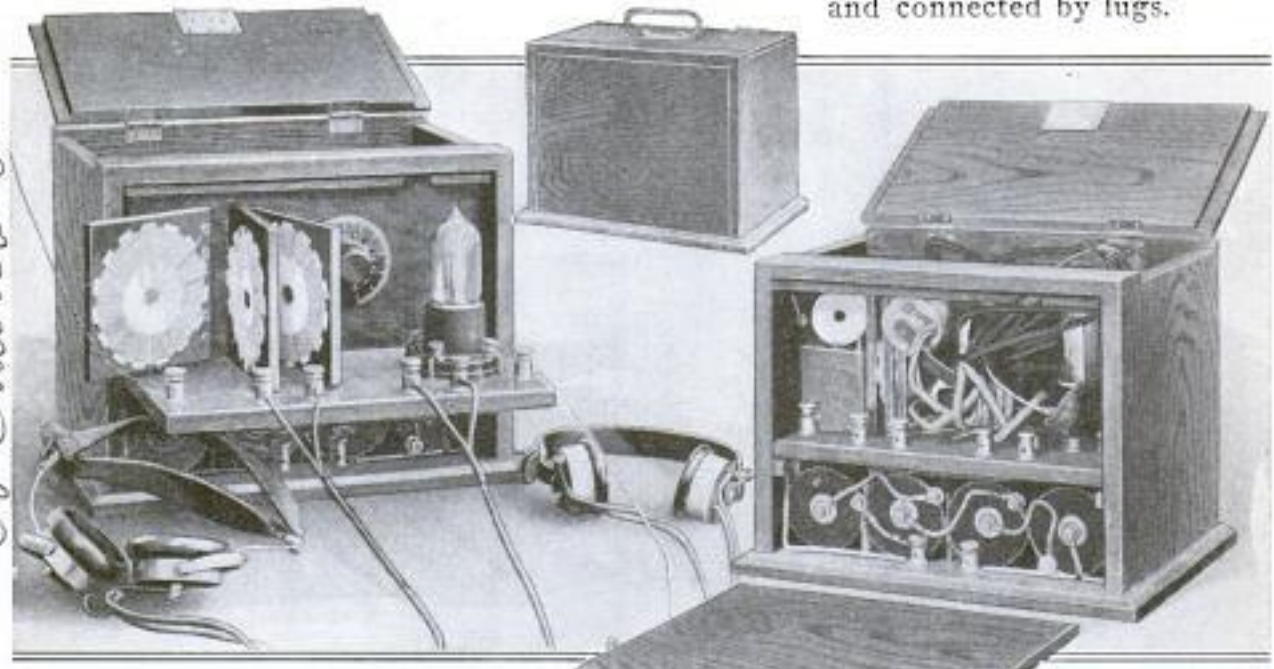

Left: Radio-Receiving Set Opened Up Ready for Use and Display. Upper Center: Reduced View of the Box Closed, Showing Carrying Handle. Right: Top and Side of the Box Opened, Illustrating the Compact Manner in Which the Outfit may be Packed for Carrying

*Arthur Paulson & Co. New York
 30 Church St. New York*

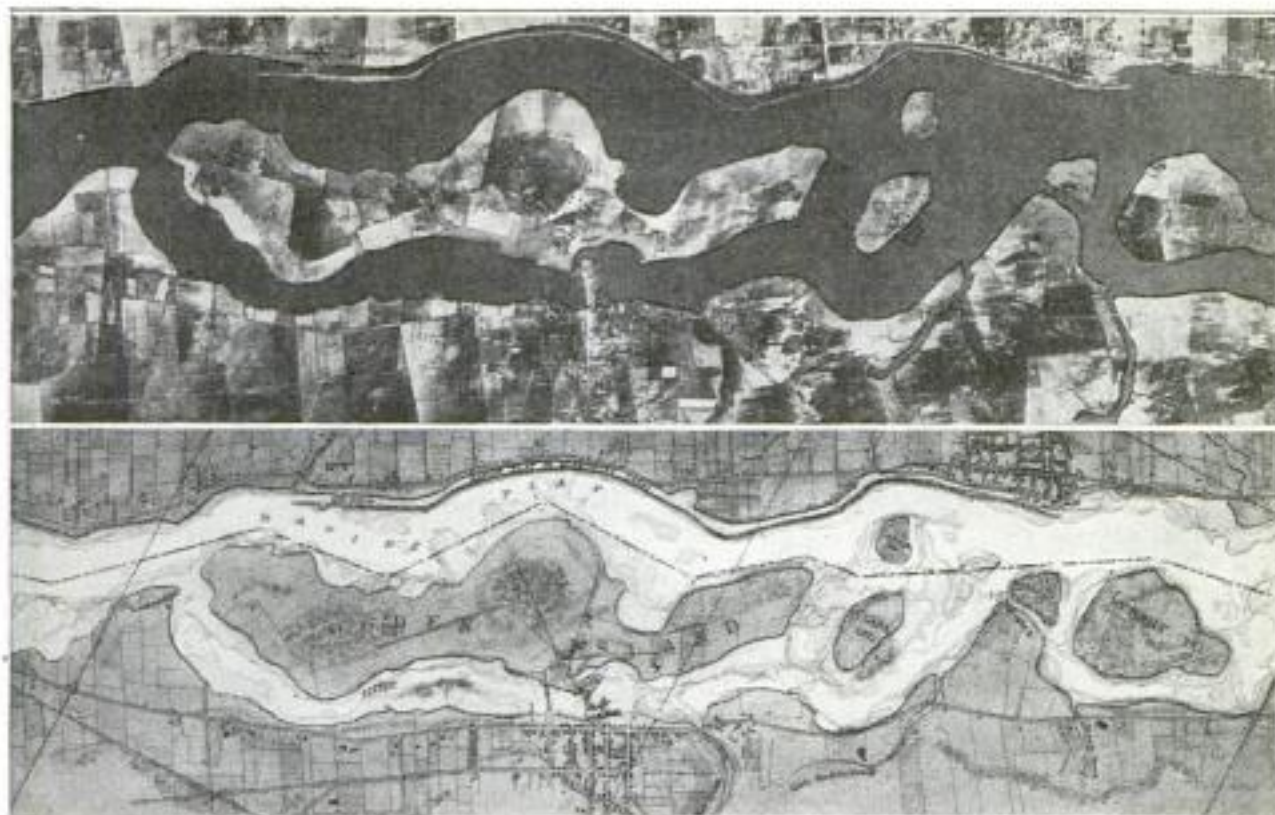

Top: Mosaic Map Made Up of 150 Photographs Taken from an Airplane. Below: A Hydrographic Chart or Standard Map, of the Same Area, Drawn to Approximately the Same Scale. Note the Accuracy of Detail in the Aerial Mosaic

AERIAL MOSAIC MAP SHOWS MARVELOUS DETAIL

BY GEORGE F. PAUL,

*900 Elsworth Bldg
Chicago*

THE possibilities of aerial photography in mapping water routes have been strikingly demonstrated in mosaics prepared by the Canadian Air Board, showing stretches along the St. Lawrence River. These mosaics were made for the Canadian section of the International Joint Commission for use in connection with its report on the St. Lawrence waterway project. The marvelous detail of these mosaics is brought out by comparison with charts made by the Corps of Engineers of the United States Army and issued by the United States Lake Survey Office. Probably no more accurate mapping and finer reproduction could be chosen for comparison purposes.

The pictures were taken from a DH-4 aeroplane, at an altitude of 8,000 feet, flown from Ottawa Air Station by Lieut. H. L. Holland. The flying conditions were excellent, and so closely did the prints from the original negatives match, that no rectification of the individual negatives was found necessary. This shows that under good flying conditions and with careful and skilled piloting remarkably accurate results can be obtained.

Owing to constant changes in light and shade on the water surfaces, due to ripples caused by the varying winds, passing water craft, and other natural conditions,

it was found impossible to obtain even matching in texture of the pictures forming the mosaic over such areas. To overcome the patchy appearance due to this, the water areas were brushed over so as to give a uniform texture. With this exception the mosaic was made direct from prints off the original negatives.

The possibilities of time and labor saving in map making can readily be seen from the comparison. Aerial surveying by photographic methods is being rapidly developed, and scientists in many countries are working on the development of maps, accurate to scale and elevation, from oblique and vertical aerial photographs. Mosaics such as here shown do not pretend to absolute accuracy, and cannot at present take the place of maps made from ground surveys. They are rather supplementary to them, giving an actual reproduction of the terrain as it exists, and showing it in much greater detail than the most carefully made map.

Provided a series of points, recognizable from the air, were fixed on the ground along a stretch of country of which a map was required, the whole of the detail of the map could be transferred from vertical aerial photographs taken, and the laborious process of traversing the whole could be dispensed with.

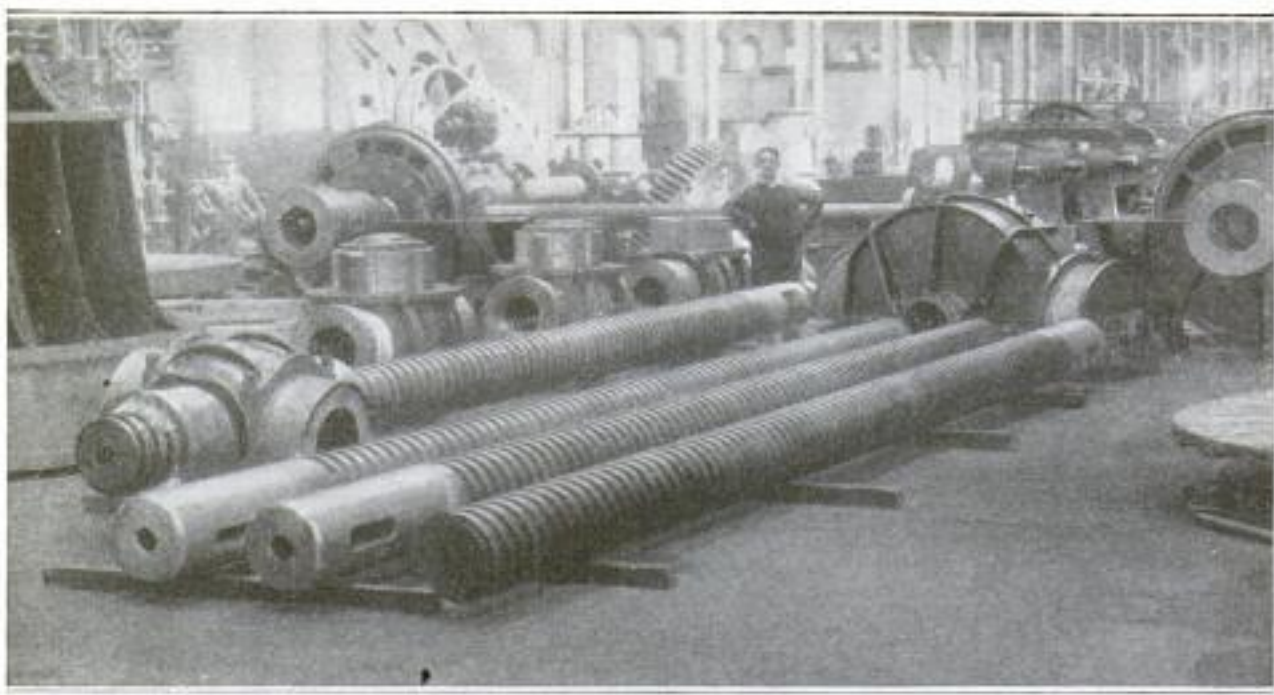

The Above are Reported to Be the Largest Luffing Screws Ever Made. Each Screw Is 15 Inches in Diameter, 28 Feet Long, and is Designed to Carry a Maximum Load of 1,000,000 Pounds; the Nut in Which It Turns, Weighs 5,000 Pounds

526

NAVY CRANE TO HAVE WORLD'S LARGEST LUFFING SCREWS

What are reported to be the largest luffing screws have been installed to move the boom of the 250-ton crane recently mounted on the old battleship "Kearsarge." Each screw is 15 inches in diameter, 28 feet long, and has a 2-inch square thread designed to run through a manganese-bronze nut, 5 feet long, that weighs 5,000 pounds. The screws are made of chrome-nickel steel, having an

ultimate tensile strength of 120,000 pounds per square inch, and are designed for a maximum load of 1,000,000 pounds each.

563

STRANGE METHOD OF FISHING IN HAWAIIAN ISLANDS

Natives of the Hawaiian Islands are fond of a small mudfish which they catch in an interesting manner. The spawn of the fish is regularly carried downstream to the sea by freshets, and, after hatching,

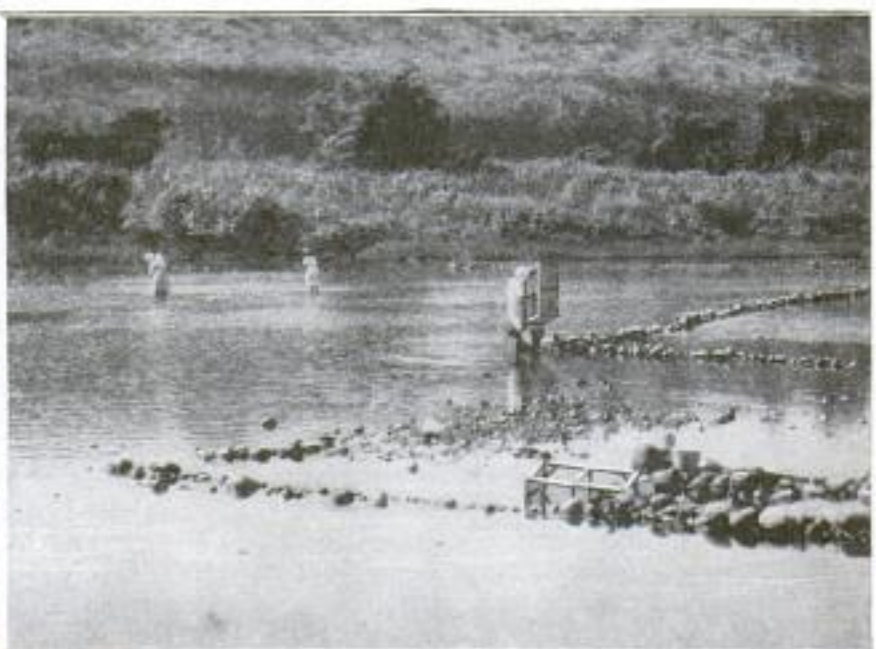

To the Left is Shown a Native Carrying the Type of Fish Trap Which Is in Common Use in the Hawaiian Islands. On the Right in the Foreground the Trap Is in Place at the Narrow Opening between Two Converging Dams. The Native in the Background is Emptying His Catch into a Small Pail

Chas. A. S. Clutterbuck, Waimea, Kauai, S. H.

American Pearls
Bunde & Upmeyer, 65 Nassau, New York.
A. J. Grinberg & Sons, 527 Fifth Ave.,
New York City.

If you've already sent in your renewal, please pay no attention to this notice.

POPULAR MECHANICS MAGAZINE
6 N. Michigan Ave., CHICAGO

Enclosed find \$_____

the "hinana," as it is named, begins swimming upstream. On the way it is led by converging dams, built with rocks gathered from the surrounding country, into boxlike traps, covered on all but the downstream side with fine wire gauze. By this means the fish are caught in large quantities.

plentiful in the river that buyers sometimes accumulate them by the peck. India, where the Hindu women covet the slug to use in embroidering gowns, mak-

L. D. Brach Supply Co., 129 S. West
Newark, N. J.

775
DESERT SOIL TO BE TREATED WITH SULPHURIC ACID

A donation of 100 tons of sulphuric acid to be used for experimental treatment of alkali soils in Arizona, has been made by a western mining company. The application of the acid and the subsequent care of the test crops will be conducted under the supervision of chemists and soil experts, some of whom believe that not only will worthless land be reclaimed but crop betterment result on large areas now under cultivation.

10/4/22

Eng. + Mining Journal Press.
RADIO LIGHTNING ARRESTER HAS INCLOSED GAPS

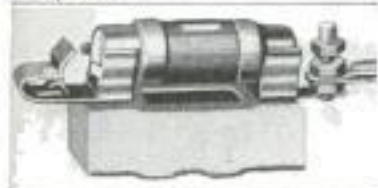

Lightning arresters are now a necessity of radio equipment and have been made the subject of a special ruling by the National Board of Underwriters. Each installation must be provided with an arrester that will operate at a potential of 500 volts or less. An arrester in which the gaps are widely separated and protected by a glass container has been produced, and is obviously superior to the ordinary air-gap type. The latter is frequently clogged with flying particles of dirt or other foreign matter, which entirely destroys its protective value.

692

9/2
MANY AMERICAN PEARLS SOLD TO WOMEN OF INDIA

It may surprise many American people to know that pearls of beautiful luster, perfect in shape, some weighing many grains and worth several hundred dollars, are regularly gathered from the Mississippi River. Pearls known as baroques, chunks of rough surface and imperfect shape but of many colors, are among the less expensive types collected. Then there are small dull bits known in the hunters' parlance as "slugs." These are so



Here are Shown Mississippi Pearls of All Kinds, Some Perfect Ones in the Hands beside Baroques, a Hatful of the Latter, and a Peck of "Slugs"

ing necklaces and other ornaments, is the principal market for this class of pearl.

686
CLEANER FOR SPARK PLUGS ALSO USED AS GAUGE

Spark plugs may be easily and rapidly cleaned by the use of a simple and inexpensive appliance which is manufactured in several sizes and can be used for most kinds of open-end plugs. The article is made of tempered steel in one neatly finished piece. The thickness of the metal provides a gauge for adjusting the spark terminals, which may also be scraped with a tiny file that is incorporated in the contrivance.



Top: Cleaner Shown Inserted in an Open-End Spark Plug. Bottom: Cleaner, Illustrating Its Simple Construction

Putnam Plays Conn
Larremich
Mr. Frederick Wambach,

Carl Florence Clark
McGregor, Iowa.

CIVIC FEATURES THAT PROMOTE THE COMFORT

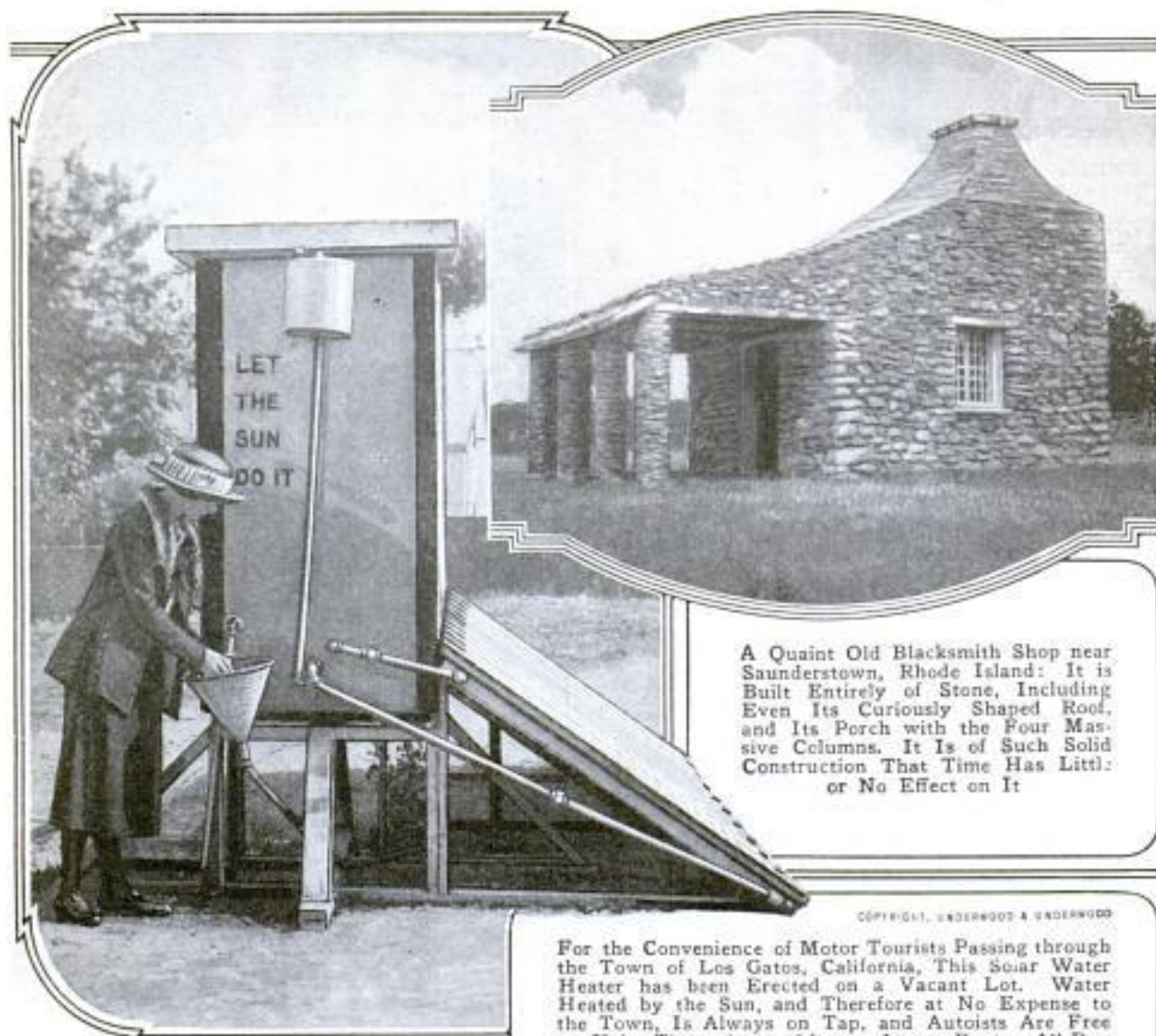

A Quaint Old Blacksmith Shop near Saunderstown, Rhode Island: It is Built Entirely of Stone, Including Even Its Curiously Shaped Roof, and Its Porch with the Four Massive Columns. It Is of Such Solid Construction That Time Has Little or No Effect on It

COPYRIGHT, UNDERWOOD & UNDERWOOD

For the Convenience of Motor Tourists Passing through the Town of Los Gatos, California, This Solar Water Heater has been Erected on a Vacant Lot. Water Heated by the Sun, and Therefore at No Expense to the Town, Is Always on Tap, and Autoists Are Free to Help Themselves. After a Long, Dusty, All-Day Ride, This Convenience Is Very Welcome

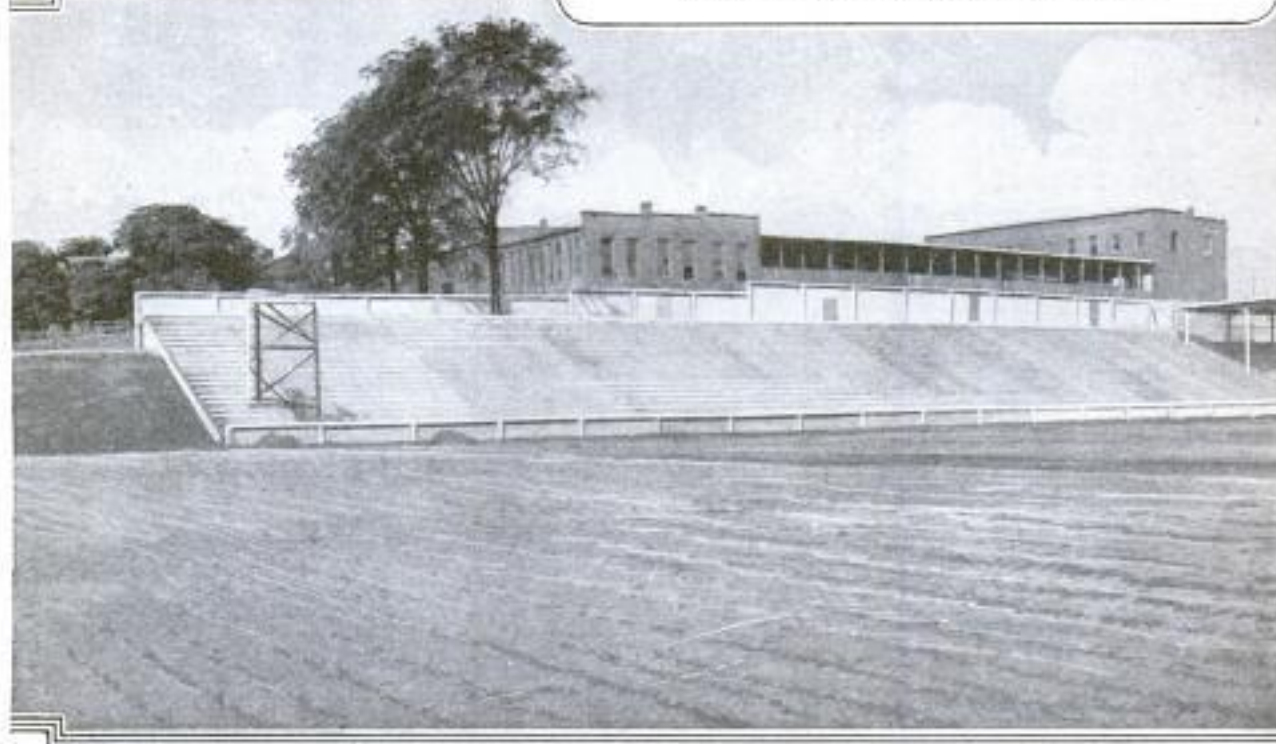

AND ENJOYMENT OF VISITORS AND RESIDENTS



During the "Safety-Week" Campaign at Atlanta, Georgia, This Monument was Erected at the City's Most Dangerous Street Corner as a Reminder of the Necessity of Care. The Monument Is 12 Feet High, and is Made of Wood Painted to Resemble Marble



Picturesque Concrete Stairway That Climbs a Rocky Hillside on North Main Street in Dubuque, Iowa: At the Top of the Hill Is a Public Park, and the City Authorities Decided to Replace an Old Sloping Walk with This Concrete Stairway, Thus Affording a Better Means of Reaching the Hilltop, and of Viewing the Scenery on the Way Up

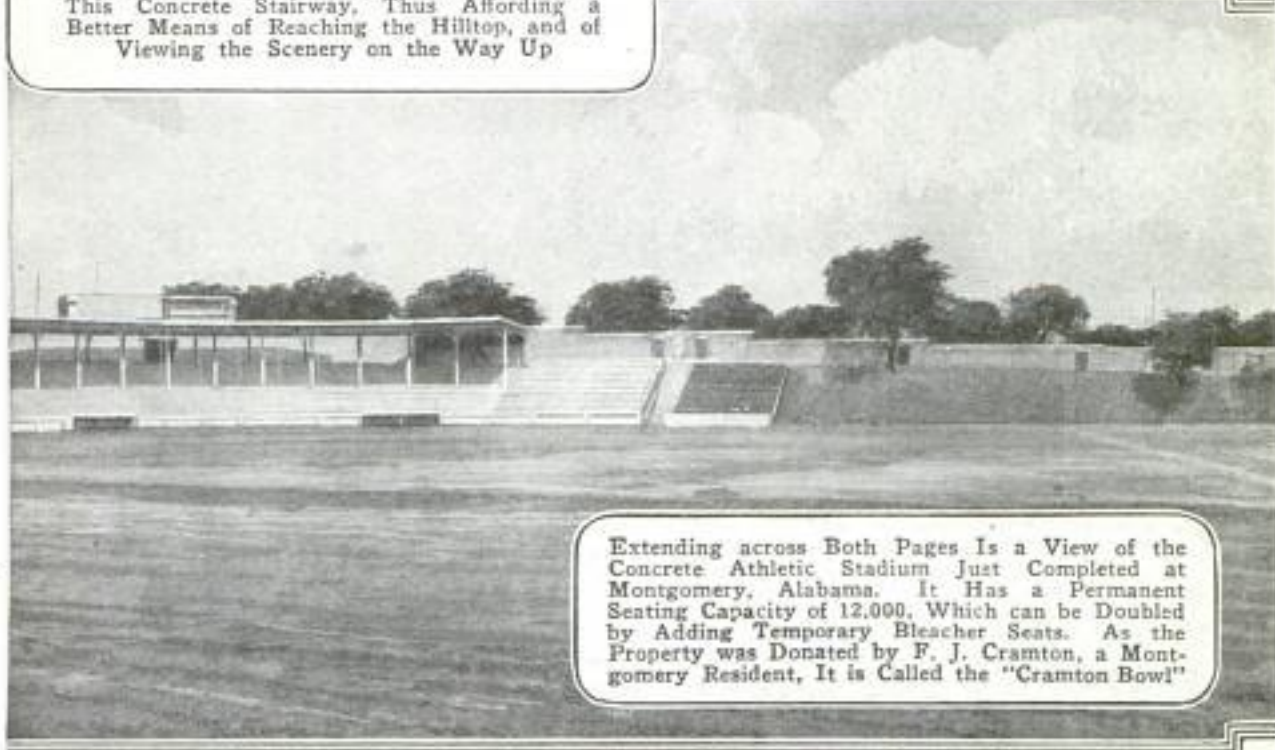

Extending across Both Pages Is a View of the Concrete Athletic Stadium Just Completed at Montgomery, Alabama. It Has a Permanent Seating Capacity of 12,000, Which can be Doubled by Adding Temporary Bleacher Seats. As the Property was Donated by F. J. Cramton, a Montgomery Resident, It is Called the "Cramton Bowl"

**LEGLESS RADIATOR SUPPORTED
625 BY NEW ATTACHMENT**

By means of a new device the bothersome legs of radiators, from around which dirt is removed with difficulty, are



In Connection with the Floor Supports, a Wall Bracket Prevents the Legless Radiator from Tipping. One of the End Supports and the Center Rest are Shown in the Foreground.

done away with and the radiator supported from the pipe connections at the floor. Inconspicuous wall braces prevent the radiator from tipping, and adjustable center rests are provided for long radiators. The attachments are made to suit the sizes of pipe commonly used for radiator connections, and they are adaptable to any size or make of radiator.

**WORLD'S FAIR ADVERTISED
BY RADIO CARAVAN**

Advertising a world's fair by radio, was the method employed by Oregonians during a recent campaign to interest the people of that state in the Atlantic-Pacific Highways and Electrical Exposition to be

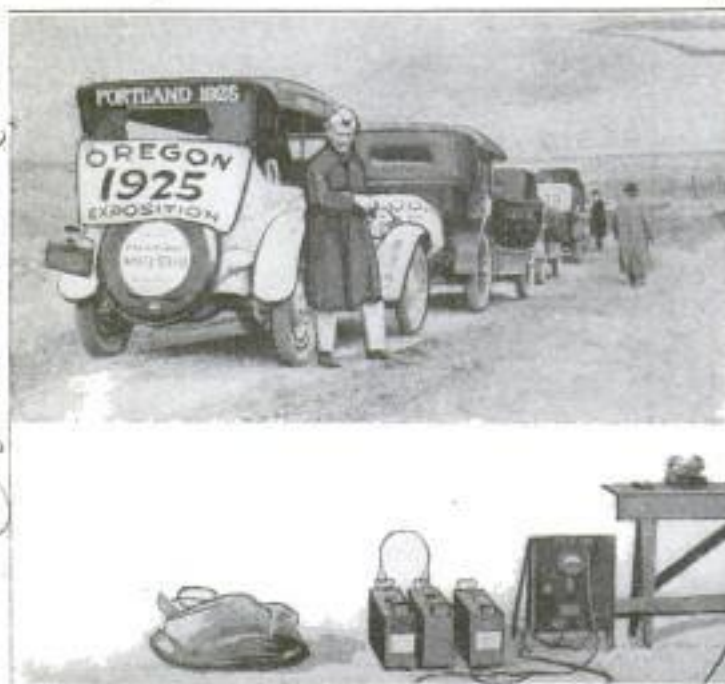

One of the Regulation United States Army Radio Sets Used during the Trip of the Caravan That Toured Eastern Oregon to Advertise a Coming Exposition: Insert Shows Poster-Decorated Cars of the Outfit

held at Portland, in 1925. A tour of eastern Oregon was made by 85 persons in 25 automobiles. Three army radio operators accompanied the caravan and demonstrated their apparatus. Thousands of country folk and ranchers, many of whom had never seen radio equipment nor listened to broadcasting, thronged about the cars containing the wireless outfits.

**685
TENNIS BALLS ARE CARRIED
ON RACKET BY SPRING**

Tennis players will appreciate an appliance introduced for the purpose of carrying that extra set of balls to and from the courts during the summer months when pocket space is usually limited. The contrivance consists of a spiral spring of brass wire, wound in such a manner that

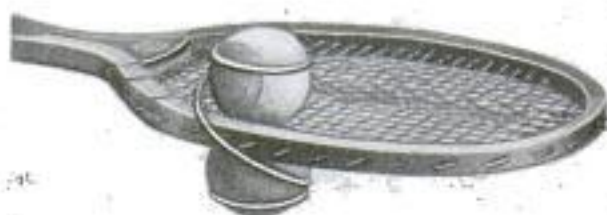

Spiral Spring for Carrying Tennis Balls, Showing the Two Ball-Holding Loops Held on the Racket by the Connecting Spring

it may be fastened to the side of a racket by its own tension, and containing two ball holding loops. During the game, the spring may be hung on the net.

*End. Mel Wharton, 135 E. 12th St
Portland Ore*

*615 S. Park Ave,
Independence, Mo.*

*Ant. Archie Richardson
Decatur, Ga.*

693

**SMALL WOODS ON MOUNTAINS
CONSERVE THE MOISTURE**

In central Tennessee, where drought more or less prevails, a simple method of conserving the moisture has been adopted. Throughout the district are many cone-shaped wooded mountains, and when these are cleared for cultivation a clump of trees is always left at the top, usually covering from 5 to 20 acres. It has been found that the moisture-conserving and distributing effect of these standing trees increases the crops of wheat on the cultivated hillsides so that the yield is more than could have been obtained by also cropping the area thus reserved, and, of course, at less cost of cultivation. The hillsides are so steep that it is impossible to cultivate them with modern machinery, and this is done with antiquated mule-drawn plows, while the crops are harvested with the scythe and cradle.

587
**CONVENIENT SPEED INDICATOR
IS OF SIMPLE DESIGN**

A speed indicator now being placed on the market accurately determines the revolutions of engines, motors, shaftings, and the like. A small inside dial registers every 100 revolutions up to 5,000 revolutions, although higher speeds can be easily determined, and figures showing through windows on an outer dial indicate every five revolutions. Two arrows

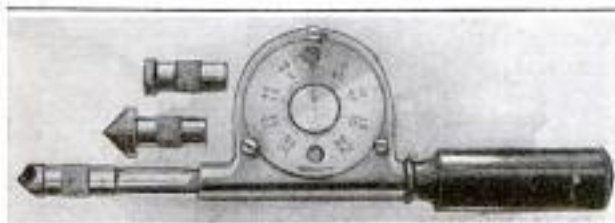

This New Speed Indicator of Simple Design Has, among Other Features, a Fiber Handle That Is an Insulation against Electricity

indicate the figures to use according to the direction of rotation, and the dial is quickly reset to zero.

*Brown & Sharp Mfg Co
Providence, R.I.*

580
**NEW GAS BURNER PROTECTS
FIXTURE AND CEILING**

The use of the ordinary mantle gas lights is invariably accompanied by the

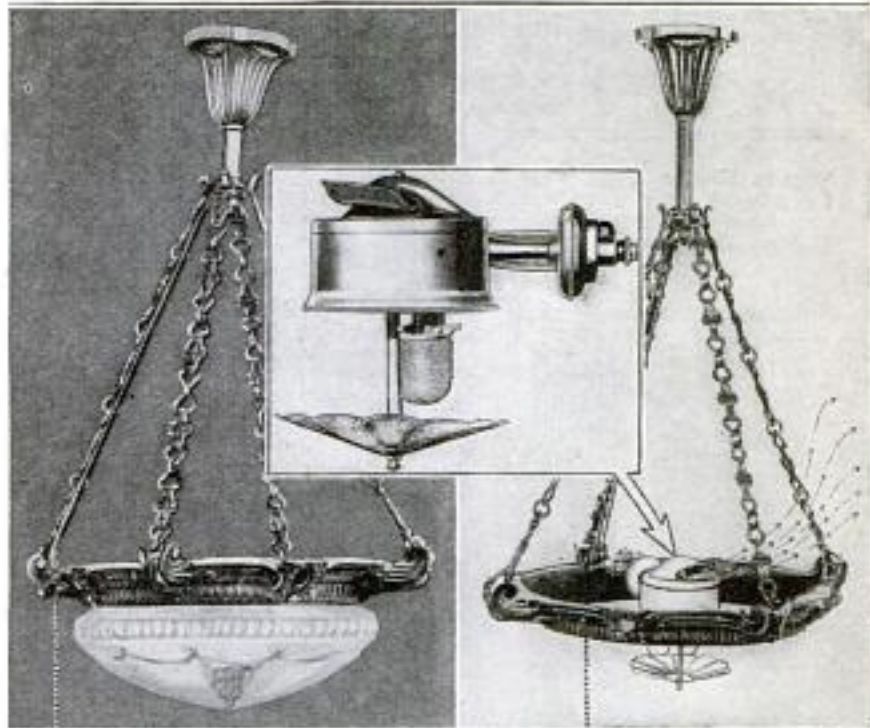

Left: Gas Fixture Completely Assembled. Right: Fixture with Bowl Removed, Showing the Heat-Deflecting Burner. Insert: Close-Up of Heat-Deflecting Burner, Mantle, and Saucerlike Mica Container

nuisance of dust collections on the fixture above the flame and on the ceiling. A remedy for this annoyance has been produced. This remedy consists of a specially designed burner which deflects the heat from the gas flame, so that it is projected at an angle, outward from the fixture. By this method, the heat, with the accompanying dust particles, does not come in contact with the fixture and cools considerably before reaching the ceiling. An added feature of the burner is a small mica baffle, or saucerlike container, suspended so as to catch the mantle when it, from age or any other reason, falls from its holder.

721
**DONATION TO LEPERS' COLONY
BY KNIGHTS OF PYTHIAS**

The Supreme Lodge, Knights of Pythias, has donated \$1,000,000 to the colony of lepers on Culion Island, in the Philippines. The money is to be used for building living quarters for the white lepers, to be known as "Stevens Memorial Hall"; for the establishment of an experimental laboratory for trying to find a leprosy cure, and to provide an endowment fund of approximately 900,000 dollars.

*Science
10 27/12*

The Walbach Co. Gloucester, N.Y.

SOME NOVEL AND LITTLE-KNOWN ACCESSORIES



Watch Holder That may be Slipped over the End of Any Ordinary Belt, Making It Handy for Sport Uses



Small, Compact Sewing Kit, Containing a Thimble, Needles, and a Number of Small Thread Spools



This Holder for Two Ice Picks and Coupon Book is Made of Tinfoil, Enameled White



Silk Wig, Pale Pink in Color and Having a Wreath of Small Blue Flowers: These Wigs, Also Made in Various Other Delicate Tints, Are in Vogue at Evening Affairs in London, England



Wastepaper Basket with a Flat Side So That It will Fit Closely against a Desk or Wall, Out of the Way

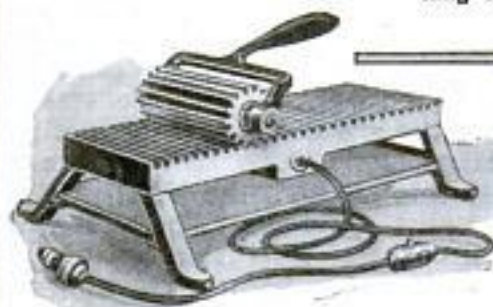

An Electric Fluting Iron with Which Curtains, Collars, Cuffs, Blouses, and the Like, may be Crimped

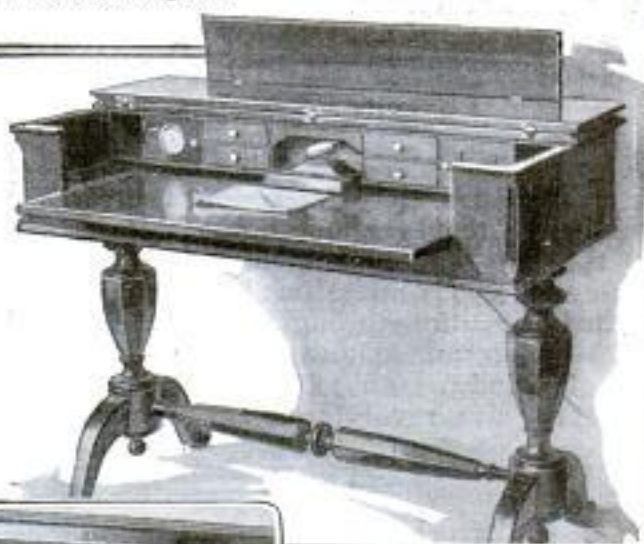

Writing Desk That Contains All the Usual Accessories Found in This Type of Furniture, and Also Has a Miniature Electric Light and a Small Built-In Clock: At the Left is a Close-Up, Showing Part of the Desk, and Clearly Illustrating the Built-In Clock and Electric-Light Bulb



Decorative Pendant Designed as an Owl, and Containing Luminous Paint for Finding Articles at Night



WATCH TENDED FOR THE HOME AND ITS MEMBERS

72

SEWIN

AN

SILK

19.

HOLDFE

C.

Des

WASTE

Eri

ELECT

Det

DECOR

Nati

WRIT

Chi

WRIST

Pi

Curt

St.

TATTI

Flu

SAVING

Co.

OPEN

Mi

DOOR

Jea

FOLDING

Bel

WASHIN

Ald

New



Convenient
Wristlet Made of Leather
or Silk Ribbon. That
Buckles On and is Used
for Carrying a Fancy
Handkerchief

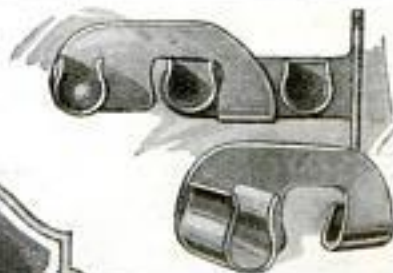

Curtain-Rod Brackets
with Which the Capacity
for Hanging Curtains
or Drapes may be Doubled
or Trebled



Attachment for Threading
the Shuttle of a Tasting Outfit, Which may
be Fitted to the Flywheel of a Sewing
Machine: Two Movable Clasps Hold the Shuttle,
Which is Filled in a Few Seconds



Saving Arrangement for
the Housewife, That
Aids Her in Placing a
Small Amount Aside
Each Week for the
Systematic Paying of
Accounts

Open-Fire Broiler with
Which the Camper or
Picnicker may Prepare
the Food without Having
to Bend over a
Smoky Fire



Door Silencer That
Fits over the Knobs
of Any Door and
Eliminates the Noise
from Slamming

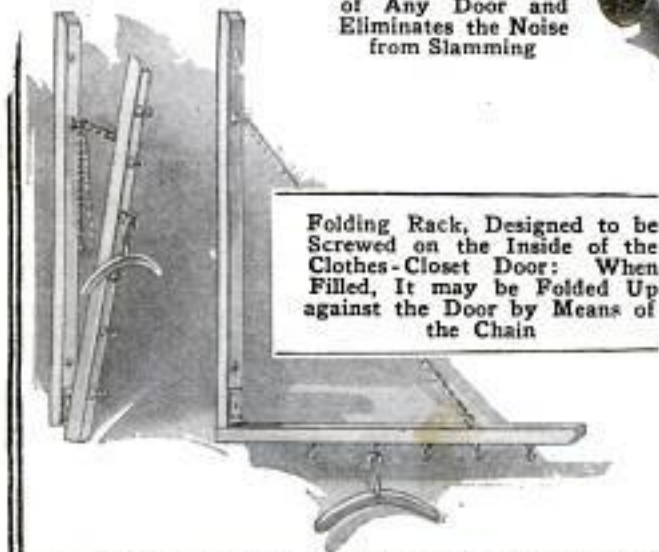

Folding Rack, Designed to be
Screwed on the Inside of the
Clothes-Closet Door: When
Filled, It may be Folded Up
against the Door by Means of
the Chain

This Washing Machine
Produces a Gas-Heated Spray
That Percolates and
Cleanses the Clothes
without Agitating Them



John W. Braun,
San Diego, Calif.

L. H. Sulmer Co.
Lancaster, Pa.

116

9819

POPULAR MECHANICS
4454-30th St.
OBLONG CRIBBAGE BOARD
HAS METAL "PEGS"

Baby, in a playful mood, may sweep the board to the floor, or the players may

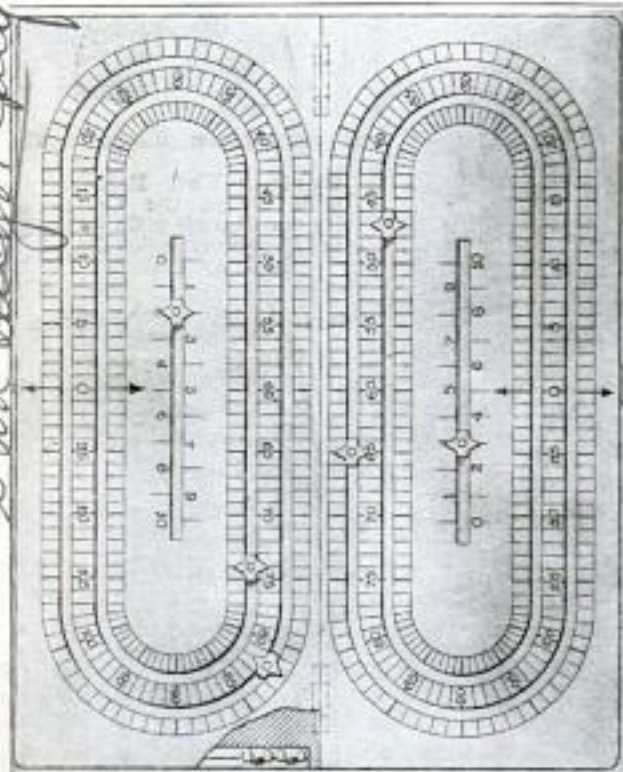

The Metal "Pegs" of This Cribbage Board Slide along a Marked Runway and cannot Fall Off. Extra Pegs are Kept in the Center

bring about a similar mishap, but the "pegs" of a new cribbage board will remain in place until deliberately moved. The board is oblong and has a marked runway for metal pointers which grip tightly. Extra pointers are kept in a socket in the center. If desired, the board can be folded and carried in an inside or outside coat pocket.

SIMPLE PIPE WRENCH MADE WITH ONLY THREE PARTS

A new form of pipe wrench, recently produced, is very simple in construction, for it has only three parts—a handle, a movable jaw, and a knurled nut for adjusting it. At the end of the handle, form-



One of the Larger-Sized Wrenches, with Four Sets of Teeth for Using the Wrench in Four Different Ways by Adjustment of the Movable Jaw

8 1/2" - \$2.25 24" - \$7.25

ing one jaw of the wrench, are two sets of teeth on the smaller sizes, and four on the larger. The movable jaw slides through the handle at this point, and is threaded to fit the adjusting nut operating in an opening in the handlebar. The movable jaw can be placed on either side of the handle, pointing upward for ordinary work, or downward for allowing the wrench to hang upon a pipe while the operator is engaged on other work. The duplicate sets of teeth double the life of the wrench.

LINENLIKE COLLAR CLOTH
602 IS EASILY CLEANED

Linenlike collar cloth, every thread of which is permanently insulated against stains and dirt so that these do not penetrate but affect the surface only, is a new development. When made up, the product appears to have all the desirable characteristics of the linen and semistiff tailored collars. Sample batches of this linenized cloth have been thoroughly tested in various steam laundries, with the result that stains, of the kinds ordinarily the most troublesome to be removed, have been taken out without difficulty or injury to the material.

STEEL TUBULAR LADDERS ARE LIGHT, STRONG, AND RIGID

Steel tubular ladders that are as light as wooden ones, and much stronger and more durable, are now being manufactured. The tubular rungs are inserted in holes in the oval-shaped hollow side members, to which they are bolted with long tie-rods, extending clear across the ladder and threaded at each end for nuts that are screwed tightly against the outside. The ladders are made of specially tempered steel, making them very strong and rigid in proportion to their light weight.

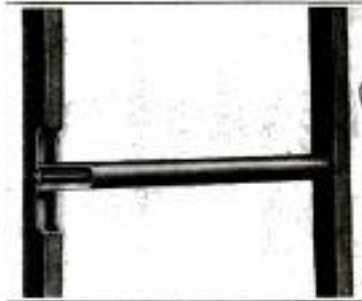

According to a recent decree, French airships must have a certificate from the Bureau Veritas, which is the French equivalent of Lloyds, stating that they are fit for service.

Address 90 Elizabeth Seymour,
503 Union Bell,
San Diego, Calif.
Greenfield Tap & Die Co.,
Greenfield, Mass.
589

The Sub Products Co. 2699 Leavitt St.
Detroit, Mich.

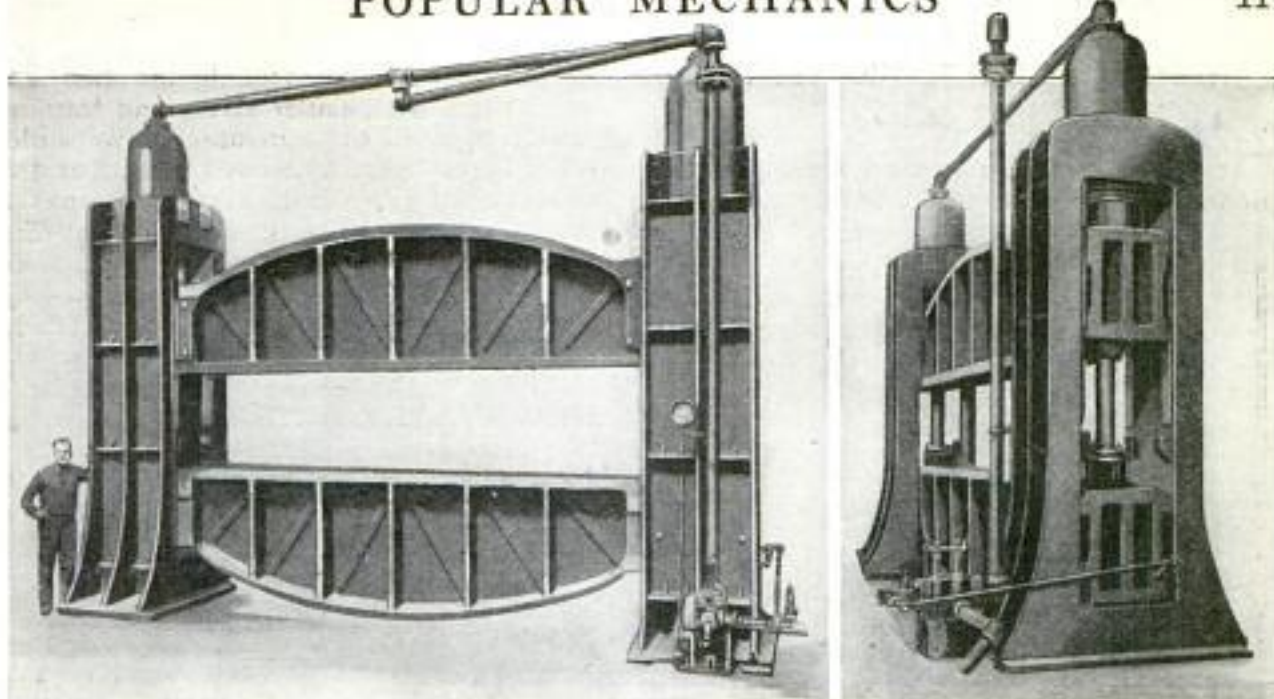

Left: Hydraulic Flanging Press from the Front, Its Immense Size Illustrated by Comparison with a Man's Height. The Controlling Hand Lever may be Seen under the Gauge. Right: End View of the Press, Showing the Huge Cylinders at the Top, with the Smaller Ones and the Poppet Valve Below

HYDRAULIC FLANGING PRESS
 585 HAS SIMPLE CONTROL

A hydraulic inverted flanging press, which exerts a pressure of 1,500 pounds per square inch, has recently been placed in service. The huge machine was designed for flanging steel plates for car ends, and is constructed of open-hearth steel castings. A pressure aggregating 435 tons is obtained from the inverted hydraulic cylinders which operate the platen, or upper part, while two smaller auxiliary cylinders restore this to the starting position. The press is open and accessible at both sides. The operation of the gigantic outfit is controlled through a three-way poppet, or lift, valve by means of a single hand lever.

CANADIAN SCHOONER WINNER
OF CHAMPIONSHIP TROPHY

As the result of the final race sailed off the port of Gloucester, Mass., October 26, when the "Bluenose," of Lunenburg, defeated the Gloucester schooner "Henry Ford," the trophy emblematic of the fishing-schooner championship of the north Atlantic goes to Canada. Besides the trophy, the Canadian winner gets a purse of \$3,000, while the loser receives \$2,000. The "Bluenose" was the winner last year, having defeated the Gloucester schooner "Elsie," off Halifax, N. S. The first contest for the trophy was sailed in 1920, and was won by the Gloucester schooner "Esperanto," which later foundered off Sable Island.

NY Times 10/27/22

SELF-CLEANING FILTER MAKES
CISTERN WATER CLEAN

In a new cistern filter, water entering at the top from a downspout flows over a slanting screen, which allows leaves and coarse material to be washed out through an outlet near the top. The water with fine dirt passes down into a chamber at the bottom, and, as the rain increases, rises through an inner charcoal chamber and reaches the cistern through an interior pipe. When the rain ceases, the clear water in the charcoal chamber backwashes the sediment through a small hole at the bottom of the filter, which is constantly draining sediment at a loss of about 10 per cent of water.

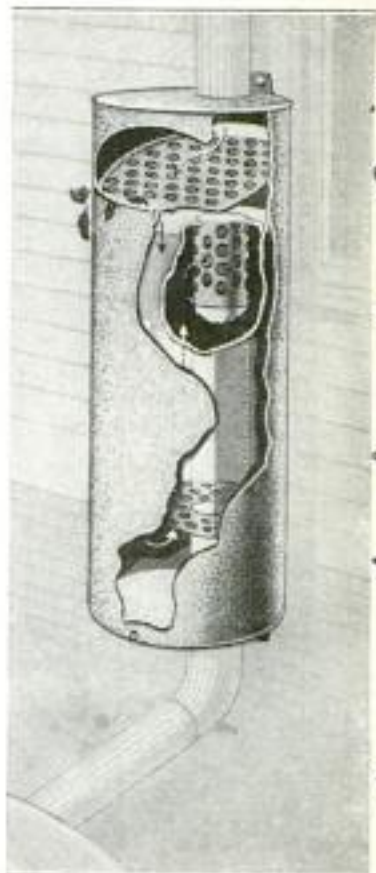

*Bennett System Cistern Sanitation Peoria, Ill.
 14 Schradysky Bldg.*

HAZARDS OF EXPLOSIVE GAS MIXTURES REDUCED

524

It is believed the use of a simple device, recently invented, will practically eliminate the dangers from accidental ex-

pllosion in mixtures of air and gas frequently found in mines, sewers, tunnels, and other inclosed spaces where gas is present from natural causes or results from trade wastes or industrial processes. This method is based on the idea of continuously removing the explosive mixture itself, more rapidly than it can accumulate, by burning it up at a temperature safely below the explosion point. The device has an ordinary electric-lamp base for connection to a 110-volt circuit for the purpose of heating the coil filament, which is either inclosed by a solid porous cylinder or sheathed in porous tubes, and the whole surrounded by wire gauze. The essential feature of this device is the application to the porous surface, of a catalyst which makes possible the oxidation, at a temperature below the normal ignition point, of the combustible elements in the gas, and the control of the resistance of the whole system so that it takes on a safe and effective operating temperature. The temperature found to be most satisfactory, when using platinum as a catalyzing agent, lies between 1,100 and 1,450° Fahrenheit.

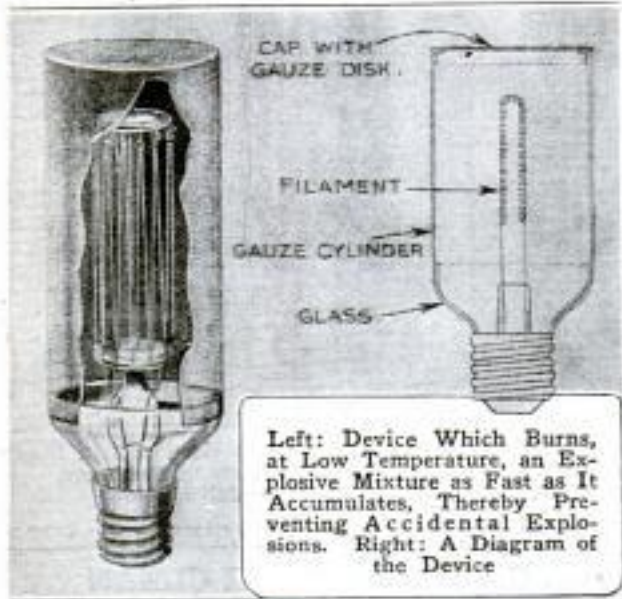

pllosion in mixtures of air and gas frequently found in mines, sewers, tunnels, and other inclosed spaces where gas is present from natural causes or results from trade wastes or industrial processes. This method is based on the idea of continuously removing the explosive mixture itself, more rapidly than it can accumulate, by burning it up at a temperature safely below the explosion point. The device has an ordinary electric-lamp base for connection to a 110-volt circuit for the purpose of heating the coil filament, which is either inclosed by a solid porous cylinder or sheathed in porous tubes, and the whole surrounded by wire gauze. The essential feature of this device is the application to the porous surface, of a

NEW WATER ENGINE UTILIZES LOW HEADS EFFICIENTLY

42

Water-power development has been limited, until recent years, to using considerable differences in water level, because no water motors were available for efficient utilization of low water heads. Gradual progress has been made in this direction, and now a German has designed a water engine for transforming the potential energy of low and varying heads, such as exist in small streams and at the tides, efficiently into useful work.

The engine is placed in a pit, which forms part of a dam construction to maintain the difference in water levels. The pit is directly connected to the higher level, and to the lower level by means of an ascending canal. In the pit is fixed a vertical pipe, which is either in communication with the pit or the discharge canal, according to the position of a swinging valve. Sliding up and down this pipe is a drum, the weight of which is nearly balanced by an air chamber in its lower end, but when the level of the water inside the drum is the same as that in the pit, there is still enough unbalanced weight in the drum to cause it to sink to the end of its travel. Then the valve is turned so that the water in the drum will run out of the pipe to the lower level, when the pressure of the water at the

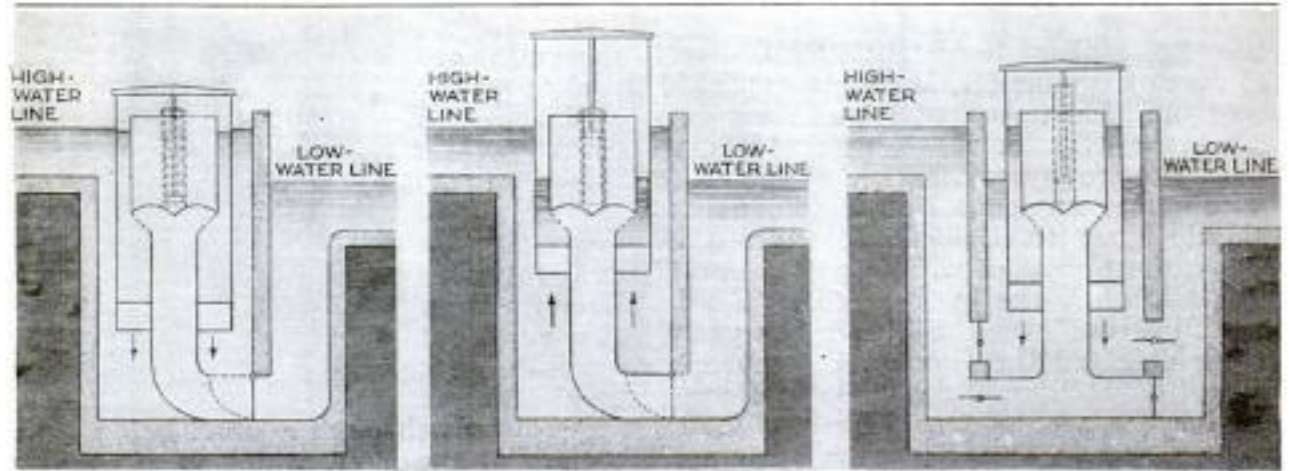

Left: New Low-Head Single-Acting Water Engine on the Down or Working Stroke. Center: Same Engine on the Upstroke. Right: Similar Engine of the Double-acting Type

Dr. W. Brauer Abraham, Berlin, W. S. Unter den Linden, 12/13
Willy Salge Co.
 Copyrighted material

Industrial Materials
Co. New York City
132 Nassau St.

TABLE AND FOUR CHAIRS
CARRIED IN NEAT KIT

A five-piece "dining-room set" which can be folded into a small flat case is the



Camp Table That Folds So as to Make a Neat Case, 27 Inches Long, 7 Inches Wide, and 2 Inches Thick: Chairs are Carried Inside

latest innovation in camp equipment. Simplicity is secured by having the table in only two parts; the chairs in one. The table is the height of an ordinary dining table and so constructed that the legs are out of the way. Canvas is used for the seat of the chairs. Both table and chairs are heavily enameled to protect them against rust.

DETACHABLE INK FOUNTAIN
FOR ORDINARY STEEL PEN

From 500 to 800 words, it is claimed, can be written without refilling with the

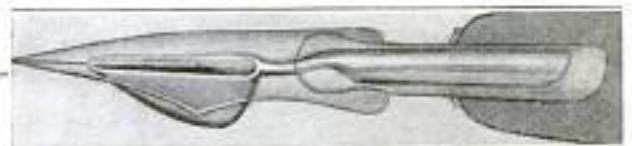

With the Little Cup Placed under the Regular Pen as Shown, 500 to 800 Words can be Written with One Filling

aid of a small spoonlike fountain, the handle of which fastens into the penholder directly under the pen. The fountain part touches the pen near its point.

Write our Bureau of Information, if you wish to know who makes or sells any article described in this magazine. Send no postage; the service is free.

higher level in the pit, acting on the outside under surface of the drum, forces the drum up, completing the stroke. The stroke of the engine is independent of the difference in water level, being limited by the depth of the pit and dimensions of the engine. A double-acting engine can be made by placing it in a pit connected by two canals and with a slightly more complicated valve arrangement. The engine can be attached to a pump for supplying water directly, or to pump water at high pressure into a storage reservoir, from which the water can be used to drive water wheels, which in turn may drive electric generators or other machines. The efficiency of this water engine is said to be between 70 and 80 per cent, and even as high as 90 per cent where the expense of installing large slow-running engines is warranted.

SAFETY HOIST HOOK CANNOT
UNLOCK WHEN LOADED

For safeguarding the operator, a hoist hook that cannot unlock when under tension, is now on the market. The sling chain carrying the load cannot be placed in the hook unless it is securely locked. The body parts of the hook are drop forgings of steel of a very high tensile strength, and the pivot pins are made



of noncorrosive metal with great resistance to shearing stress.

NEW PROCESS RECLAIMS ALUM
FROM FILTRATION PLANTS

A process by means of which practically all the alum used in the filtration of water can be recovered and reused, has recently been developed and adopted by the waterworks department of Atlanta, Ga. This process, the discovery of which was purely accidental, consists in treating the sludge from the settling tanks with sulphuric acid. A by-product obtained in the form of a finely divided pure-white clay, highly prized in the ceramic arts, is claimed to pay for the sulphuric acid and the labor of recovering the alum.

Mr. Frank W. Trumbold, New York
30 Church St., New York
Mr. Archie Richardson
Slocater, Ill.

W. W. Marvin & Co. 154 Nassau St. New York City

The All Metal Valve Co
 406 Kreson Bldg
 Detroit Mich

27' Cone
 8 ash sh
 Flushing, N.Y.

120

POPULAR MECHANICS

RECESSED FLEXIBLE VALVE FOR PNEUMATIC TUBES

925

Automatic in its action, a new all-metal valve for the pneumatic tubes of automobile tires is so constructed that it will positively retain any desired air pressure, independently of back pressure from within the tube.

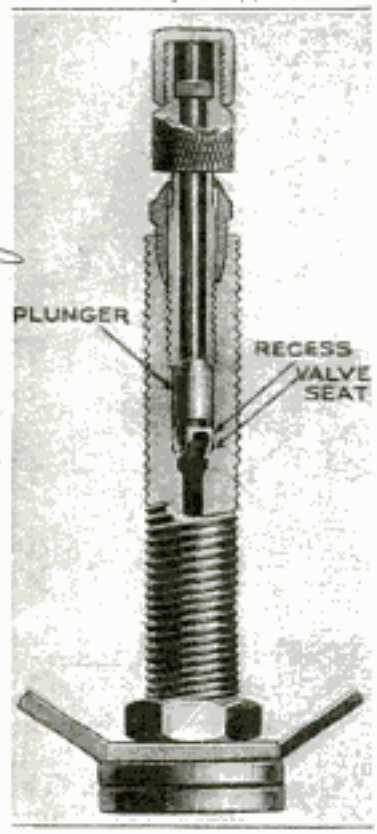

At the end of a plunger is a novel kind of valve that is recessed so that it is flexible, making it sufficiently elastic to form a perfect seal without being ground into the valve seat. The valve is opened, or positively held closed, by turning a threaded

sleeve with a knurled head on it. At the upper end of the valve plunger is a second seat that acts as a check, preventing the escape of air while the tire is being inflated.

Patent

SOOT BLOWER CLEANS TUBES WITH SAND BLAST

503

A device has recently been invented for removing soot from boiler tubes by means of a steam and sand-blast action. A whistle valve for admitting steam into the blower pipe, is operated by the same lever that controls the gate under the

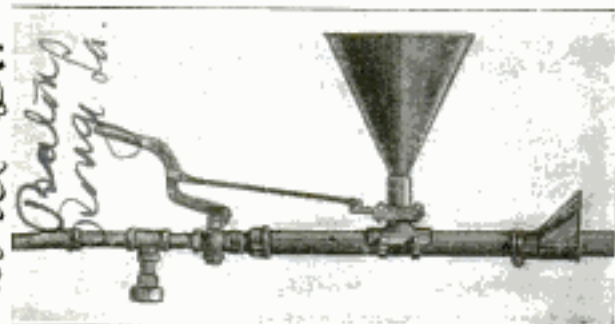

This Simple and Effective Soot Blower can be Operated as a Plain Air or Steam Blower, or with a Sand-Blast Action

Storrey Soot Blower Co
 1121 North St.

sand hopper. The device is of very simple construction and can be quickly converted into a straight steam or air blower by removing the sand hopper. With its use, hand scrapers and brushes can be eliminated, as the sand blast is said to remove effectively all soot and incrustation from the surface of the tubes, if used once a week.

TO IDENTIFY SPECIAL STEELS BY THERMOELECTRIC TEST

Because hardness tests do not serve completely to identify special steels, experiments have been performed in search of a test method that would make such identification complete and positive.

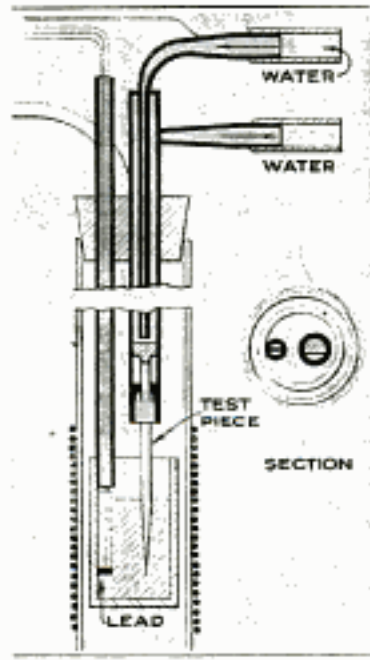

The method adopted depends on the amount of thermoelectric force generated when one end of the test piece is heated while the other end is kept cool. A bath of mercury is employed for heating one end of the test piece and for making connection to the voltmeter. The other connection is made to a water-cooled metallic clamp attached to the other end of the piece. This test has shown very promising results.

443

PLAN LARGEST FLYING FIELD AT DAYTON, OHIO

Announcement has been made that the largest flying field in the United States is to be established on a recently purchased large tract of land east of Dayton, Ohio. It is planned to move McCook Field, now the center of experimental work for the United States Air Service, to the new site and to include the famous Wilbur Wright Field. There has also been some indication that an air academy may be established at the McCook post. A number of citizens of Dayton bought the site and offered it to the government.

Washington Post
 10/26/22

EIGHTEEN-MILE ONE-WAY ROAD TO MT. MITCHELL

One-way traffic on an 18-mile stretch of road is the innovation which has apparently solved the safety problem on a much-traveled mountain thoroughfare, near Asheville, N. C. Too narrow for vehicles to pass, and abounding in sharp curves, the road would present many elements of danger if traffic were permitted to move in both directions at one time.

A solution was found by restricting the travel to ascending traffic during the morning hours and to descending during the afternoon. That this plan was good was clearly demonstrated by the absence of auto accidents on the road during the tourist season of 1922.

The road on which this traffic problem has been so well solved leads to a point near the summit of Mt. Mitchell, one of the highest peaks east of the Rocky Mountains, 6,711 feet above sea level. In its length of 18 miles the road climbs almost 4,400 feet, giving an average grade of $3\frac{1}{2}$ per cent. To build such a highway for tourists and sight-seeing traffic ordinarily would have involved a prohibitive outlay for construction work.

The roadbed, however, was originally made for a steam railroad used in lumber

operations. After the railroad had served its purpose, rails and ties were removed and the roadbed converted into a cinder-surfaced driveway of easy grade, and with stout bridges where needed. It makes a beautiful mountain ride. At four different places the road crosses the Blue Ridge Mountains, the divide for waters flowing to the Atlantic and the Mississippi.

For ascending travel the road is open during the summer season from 8:00 a. m. to 1:00 p. m., while for descending motorists the hours are 3:30 to 5:30 p. m. The downward journey may not be undertaken until the gate at the summit is thrown open. As a further safeguard against mishap, a traffic officer starts from the lower gate at one o'clock and travels to the top in a car known as "the trailer," to make sure that descending motorists will encounter no cars which may have been crippled during the upward journey.

If "cripples" are found, the crew of the trailer immediately renders first aid by fixing the engine, or if necessary, by towing the car in. When the trailer arrives and reports the way clear, the gate is

opened for descending travel, but never before.

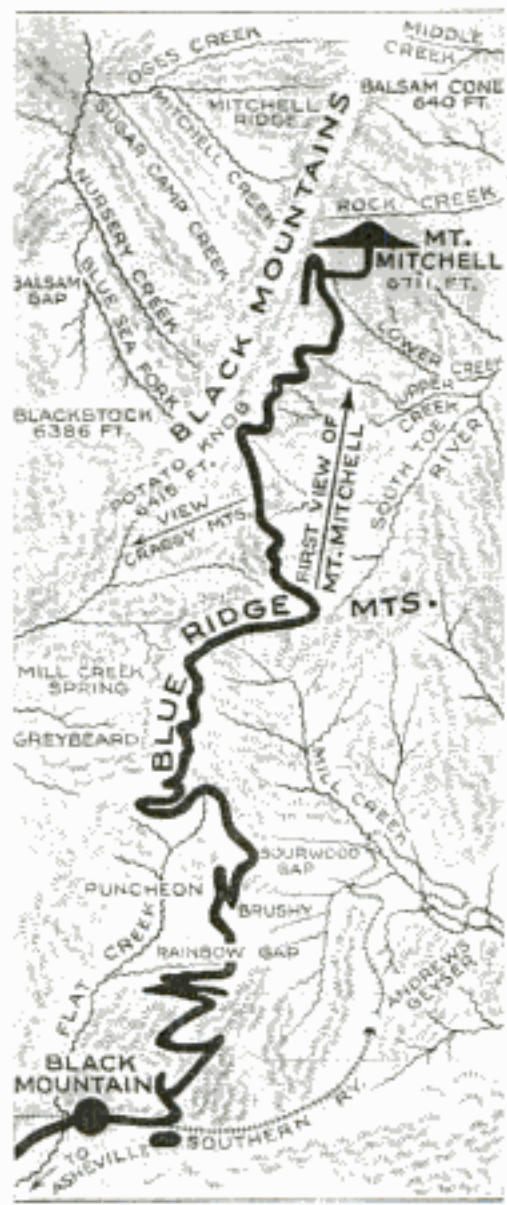

The Mountain Road, Shown Here, Runs to the Summit of Mount Mitchell, near Asheville, North Carolina, Climbing More than 4,000 Feet in 18 Miles. Only One-Way Traffic is Permitted

ATTACHMENT ON FARE BOXES DISPLAYS BOGUS COINS

Thousands of bogus coins in the shape of iron slugs, brass hat checks, etc., have been dropped into the fare boxes of the New York subway lines. These frauds are now, in some measure, safeguarded against. The remedy consists in the installation on the turnstile of an electric light equipped with a bull's-eye lens and

so located that a greatly magnified image of the article deposited is pictured on the glass front of the coin box. Inspectors stationed a few feet from the boxes may thus readily detect any counterfeits. To protect innocent persons who, from hurry or absent-mindedness, drop in a penny or a dime, the equipment contains an automatic appliance which rejects coins that are larger or smaller than the required nickel.

*Interborough Rapid Transit Co
 New York City*

Indianapolis Portrait Dolls

301 Castle Hall,
Indianapolis,
Ind.

CHILDREN'S PICTURE-STORY DEPARTMENT

655



One of the Latest Innovations in the Industry Is This Doll Made as an Exact Reproduction, on a Reduced Scale, of Its Little Owner. A Photographic Likeness of the Child's Face is Printed upon the Blank Face of the Doll, Whose Hair and Clothes are Made as Similar as Possible to Those of the Child



Above Is a Portrait of an 11-Year-Old English Boy Who has Performed the Remarkable Feat of Walking from Manchester to Southport, a Distance of More than 39 Miles, in 8 Hours 33 Minutes 35 Seconds, Being an Average of About $4\frac{1}{2}$ Miles an Hour—a Remarkable Record for a Boy



This Is the Novel, Realistic Method of Teaching History at a Public School in Sydney, Australia. Historical Incidents are Enacted by the Students, as Shown Above, Where a Band of Boys, Made Up as Natives and Brandishing Their Spears, are Attacking a Party of Explorers Armed with Pop-guns and Other Weapons

OF MODERN ACTIVITIES AND INTERESTS



In a Campaign against Vivisection in California, Where a Law was Proposed to Prohibit This Practice on All Animals under All Circumstances, the Children of the State Actively Took the Part of Their Pets, Asking Their Elders to Vote for the Law. Pictured to the Right Are Two Examples of Their Campaign Methods, in Which, Whenever Possible, Dogs and Puppies Took Part

This Young Lady is Wearing a Fancy Ball Dress That Symbolizes the Radio. She Wears Head Phones with the Antenna Supported above Them, and on Her Dress Are a Tuning Switch and Other Radio Devices



Fire Drill of a Very Realistic Nature at the Lane Technical High School, Chicago, Illinois: Fire was Imitated by the Use of Smoke Pots, Placed on the Window Sills, Which Discharged a Black Pall of Smoke, Illumined by Flashes of Flame. The Picture Shows the Fire Department at Work after the Orderly Escape of the 4,500 Students in Less than Three Minutes

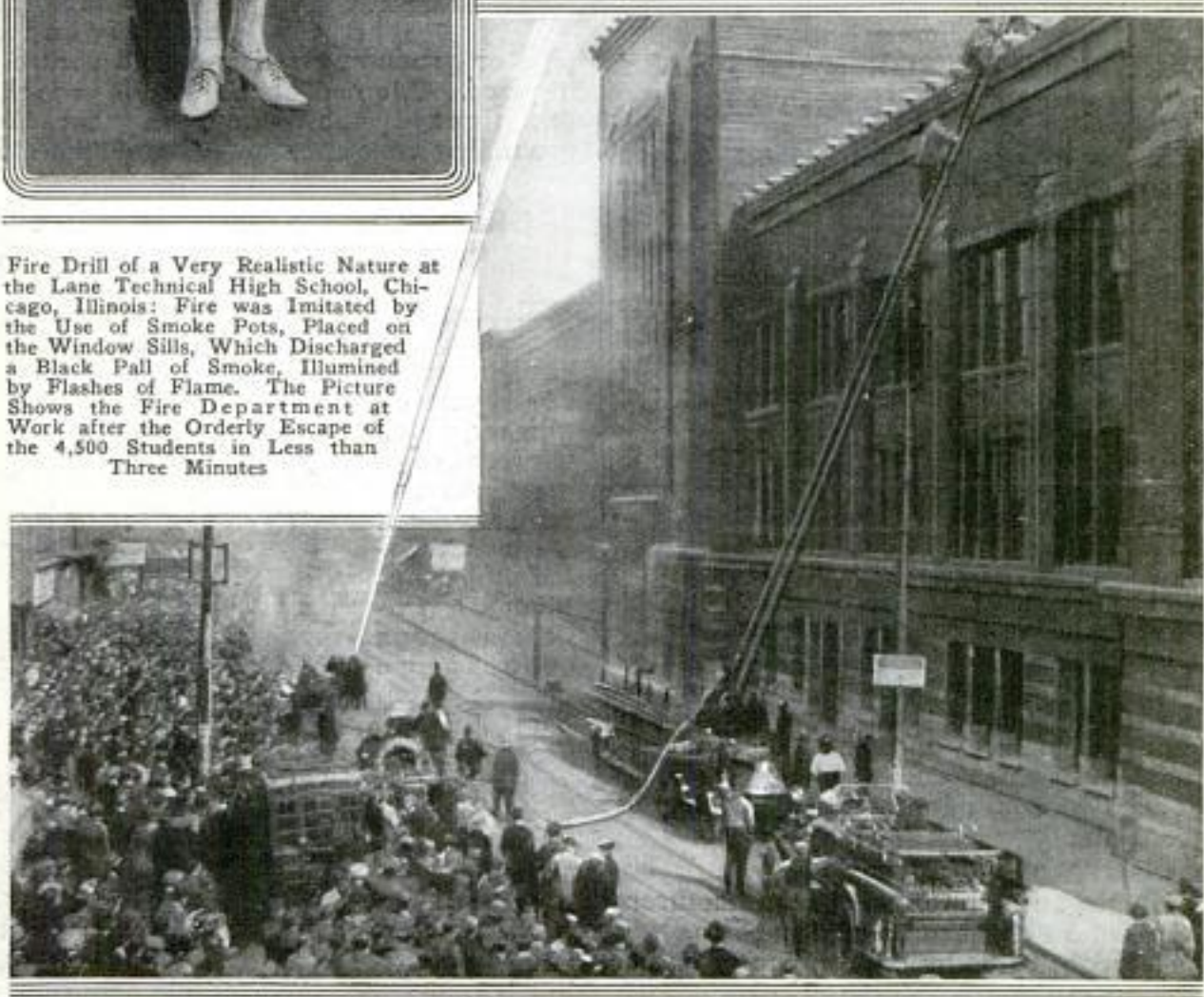

The Foster Screen Co., Inc.
 391 Mulberry St.
 Newark, N.J.

Blow Sanders
 3722 S. Park Ave
 Los Angeles, Calif.

124

POPULAR MECHANICS

**ADJUSTABLE WINDOW SCREEN
 VERY CLOSE-FITTING**

25

An adjustable screen for window casements has its metal frame so constructed that, when the window is pulled down onto it, the pressure expands the screen sideways, making such a perfect fit all around the screen that it is not possible for flies or mosquitoes to enter. To remove it, two cross rods that connect the four corners of the frame are

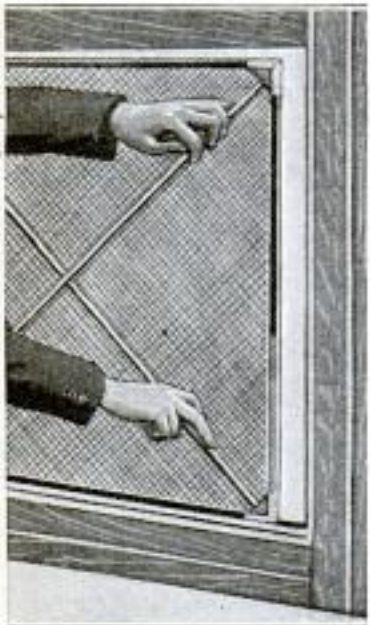

pulled sideways, causing the screen to expand upward.

**RING COMPRESSOR MAKES EASY
 INSERTION OF PISTONS**

532

A new device, which operates on the contracting-band idea, can be used for installing pistons in gasoline engines, either from the top of the cylinder or through the crankcase. The band that grips the piston rings is made of phosphor bronze in corrugated



form, and has a range that enables it to grip pistons up to 5 inches in diameter. A universal-jointed shaft operates the steel spool to which one end of the band is locked, and the free end of the band, which encircles the piston, is hooked to a pin in the steel housing of the spool.

Names and addresses of manufacturers of articles described in this magazine will be furnished free by our Bureau of Information.

**BURNING WIRE INSULATION
 PRESENTS ODD SIGHT**

724

An odd sight was presented to the interested onlookers at a recent fire, when the insulation burned from a number of electric wires in front of a blazing building in Pueblo, Colo. The covering flickered and smoldered with a peculiar reddish glow intermixed with a thick gray smoke, the insulation dripping to the sidewalk and the wires ultimately burning bare for a distance of two blocks.

**EFFICIENT GROUNDING CLAMP
 FOR ELECTRICAL WORK**

An efficient clamp, made of malleable iron and in two parts, which may be fastened together by a pair of bolts, is an improvement produced for the necessary "grounding" of electrical installations. By its use, seven full turns of wire may be placed around a



pipe or grounding rod and held securely in place. One end of the wire is brought out through the clamp, so that the grounding wire may be soldered thereto.

**GLASS FIRE EXTINGUISHER
 EASILY HANDLED**

Blazing oils, wood, or even an electric arc, may be effectually "put out" by an easily handled fire extinguisher, which consists of a glass container partly filled with chemicals. The appliance is similar in shape to a large electric-lamp bulb. The glass container is made in three sizes, suitable for the home, business, or motor car, and is provided with a simple mounting bracket.



Red Cup Lubricator Co.
 1603 S. Michigan Ave
 Chicago

Thomson. Friedlob, Myg. Co.
 Peoria, Ill.

Tringht Myg Co. Peoria, Ill.

f. c. c. c.

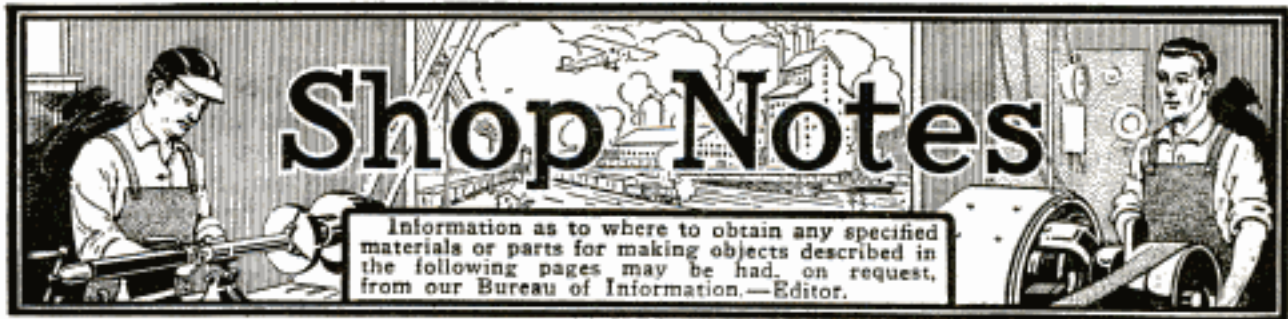

A Rural Mail-Box Post of Concrete

By A. J. R. CURTIS

PROGRESSIVE farmers and villagers all over the country are discarding the old makeshift wooden mail-box post, and substituting for it the modern concrete post, which is attractive in appearance, and is neither affected by frost, attacked by rot, nor likely to be destroyed by fire.

Any farmer with a little time to spare can make the post described in this article at home. It is so simple in construction that it is suggested as an excellent manual-training exercise for rural-school students.

The accompanying drawings show how the post is constructed. The form is built up on a floor having a level and regular surface, or on a pallet or mat of boards, 8 ft. long and at least 30 in. wide. If a floor is used, a strip of building, or other heavy, paper should be used as a covering. The form consists simply of a few wooden strips (dressed on all surfaces to be touched by the concrete), held in position by cleats lightly nailed to the floor or pallet. The post is cast on its side. Prepare first two pieces of 1-in. board, 7 ft. 4 in. long, 6 in. wide at one end, and tapering to a width of 4 in. at the other. Finish and sandpaper the opposite faces of each. One of these strips serves as a form for the straight, plain side of the post. The other serves as a form for the opposite side of the post, being cut as required, and joined to smaller pieces, of similar material, to make the entire outline of the bracket and shelf. The form for the interior triangle is best made from a block with a small

amount of taper, so that it can be withdrawn upward. This piece in particular must be well greased and sandpapered, and screweyes should be inserted in the top to make its removal easier.

The longitudinal strips are held apart by square blocks inserted between them at the lower and upper ends. Triangular blocks, inserted at the upper end, form the upper corners of the post, as shown.

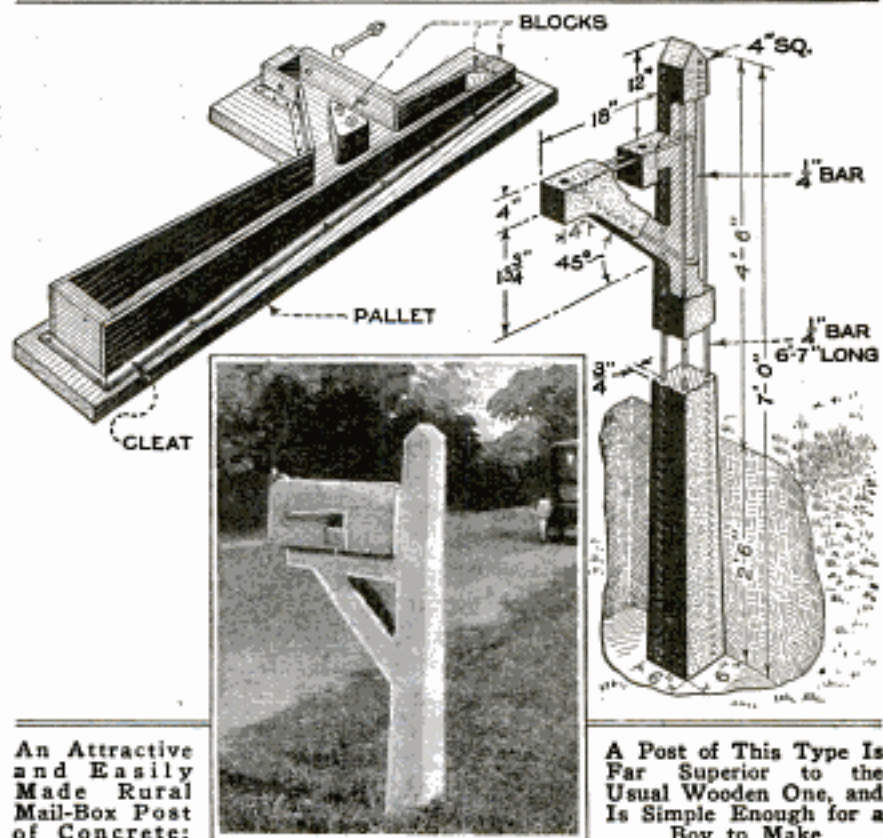

An Attractive and Easily Made Rural Mail-Box Post of Concrete:

A Post of This Type Is Far Superior to the Usual Wooden One, and Is Simple Enough for a Boy to Make

The reinforcing in the post consists of four $\frac{1}{4}$ -in. round bars, 6 ft. 9 in. long, placed symmetrically at the four corners of the post, $\frac{3}{4}$ in. in from the surfaces. The bracket and shelf are reinforced with two triangles made of $\frac{1}{4}$ -in. bars, bent as shown, and inserted in the mold one above the other, 1 in. away from all outer surfaces. The bolts to which the mail box is attached are placed through the molds before the concrete is deposited.

The concrete for the post is mixed in the proportions of 1 part Portland cement to 3 parts well-graded sand, under $\frac{1}{4}$ in. in size, or 1 part Portland cement to $2\frac{1}{2}$ parts sand and 1 to 2 parts of crushed stone, or pebbles, from $\frac{1}{4}$ in. to $\frac{1}{2}$ in. in size. The mixture must be made just wet enough to flow freely to all parts of the mold. The mold is well greased before the concrete is poured.

In moderate weather, allow the post to remain at least three days before attempting to raise or remove it. In cool

weather, wait four or five days. At the end of that time move it only with great care, as posts that later become very strong and hard are easily injured by careless handling while "green."

As soon as the mold is removed, brush and scrape off fins and other blemishes, and fill up holes and hollows with the same mixture as used in the post. Then paint the surfaces with a creamy mixture of cement and water, and store the post where it will not be exposed to sun, wind, or frost, or subject to strain.

A Simple Drip Can

The drip can shown in the illustration has been used for a considerable time for

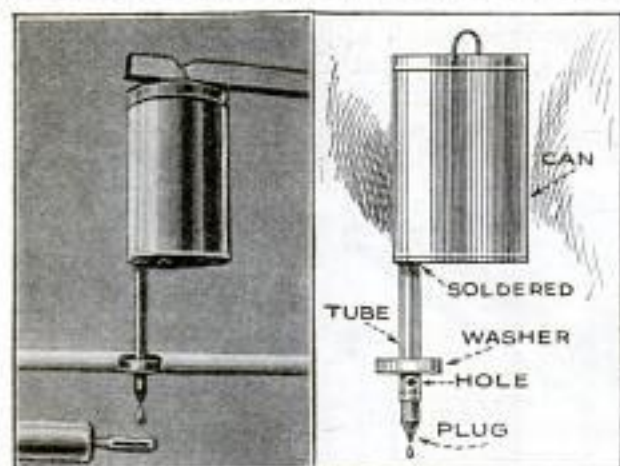

Simple Drip Can for Supplying Oil and Cutting Compounds to Taps in a Tapping Machine, Using Improved Supply-Regulating Valve

supplying oil and cutting compounds to taps used in a tapping machine, and has been found to give as much satisfaction as any device on the market.

It is made by piercing a hole in the bottom of a tin can and soldering a short length of copper tubing into this hole. A wooden plug, pointed at one end, is driven securely into the lower end of the tube, and a small hole is drilled in the tube just above the plug. The amount of liquid flowing out of this hole is controlled by covering the hole more or less with a leather or rubber washer that slides snugly on the tube.

Steel Rivets Damage Brake Drums

It is a very poor policy to substitute common steel rivets for copper and brass ones where the latter are used for a special reason, as, for instance, in relining brake and transmission bands. Here such substitution will entail considerable unforeseen expense. This was the case

when, in making repairs on a light car, it was found that the brake, slow-speed, and reverse drums were deeply grooved by the steel rivets used in lining the bands, making it necessary to remove the motor in order to replace these parts. Copper or brass rivets should be used under all circumstances when relining bands, and one should make sure that they are not copper-coated steel rivets by cutting one in two. Before substituting one material for another, in repair work of any kind, it should be ascertained that the substitution will not be harmful.

Scale Holder for Lathe Use

Much lathe work requires to be turned with a shoulder a definite distance from the end. When facing a shoulder to length, it is necessary to stop the lathe repeatedly in order to measure the distance, as while the machine is in motion, the scale cannot be applied with any degree of accuracy, apart from the danger involved due to the tendency of the scale to catch the work. With the holder

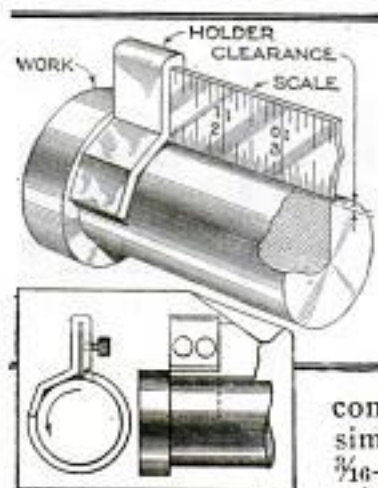

shown, however, the user can measure the work without stopping the lathe at all, saving a good deal of time and trouble where much work of this kind is done. The construction is very simple; a piece of $\frac{3}{16}$ -in. stock, 1 in. wide, is bent to form a "V," and then doubled over, as shown, to fit the scale. The side of the holder that bears against the shoulder is finished square with the V and the scale

slot. Two knurled screws are used to hold the scale in place. When attaching the holder to the scale, it should be laid on the work, close to the shoulder, whereupon the scale, with its bottom just clear of the work, is pushed in to touch the shoulder lightly, and the two screws are tightened. Any number of pieces can then be turned and measured with the lathe in motion, the scale being held exactly in line with the work, insuring accurate results. The holder, of course, should be casehardened.

Clearing Sand from Loading Tracks to Prevent Derailment

Derailment of cars, due to an excessive amount of sand and gravel on the loading tracks at material yards, is not an uncommon occurrence. An inexpensive method of keeping the tracks clean was

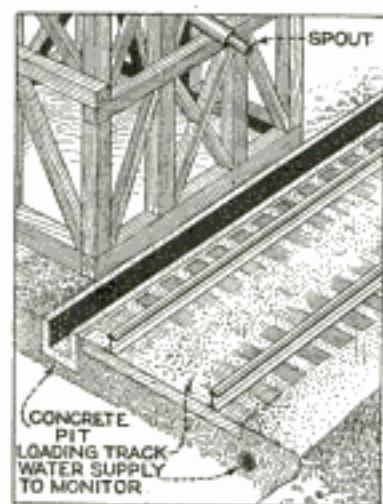

devised by a large building-material concern, and is shown in the drawing. A narrow concrete pit or trough was built on one side of the tracks; this drained into a waste basin. After a car had been loaded, the tracks were

Imitation Ice for Window Displays

flushed by means of a stream of water, directed from a monitor nozzle set on the outer side of the track. The water and sand run into the concrete trough and to the waste basin.

Imitation ice adds to the effect of window displays that advertise skates and other outdoor winter goods. It is usually made with pieces of plate glass, to which a "frosty" effect is given by sprinkling fine flakes of mica on the glass, after it has been painted with a thin solution of glue and water.

In order to make this imitation ice look as real as possible, the plate glass should be given a bluish hue by mounting it on light-blue crêpe paper, stretched tightly under the glass to eliminate the wrinkles.—H. Webster, Winnipeg, Can.

Automatic Ventilator for Poultry Houses

Most poultrymen today acknowledge the value of good ventilation in the win-

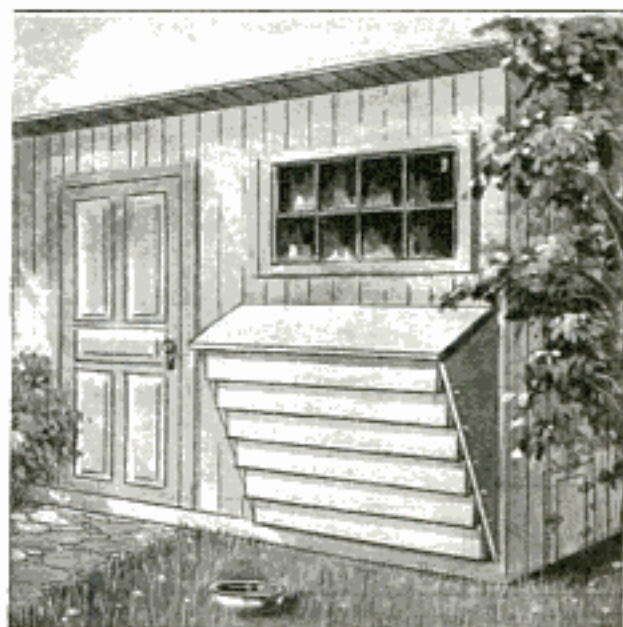

A Shutter for the Poultry House That, While Providing Ample Ventilation, Eliminates Draft, as It Closes Automatically in a Wind

ter laying pens. But ventilation without objectionable drafts is often hard to accomplish, especially where snowstorms and blizzards are of frequent occurrence. The open-air type of henhouse, which is in general use, is not entirely satisfactory because snow and rain can enter. Even if a muslin curtain is provided to prevent this, it is necessary to adjust this curtain according to weather conditions, and this is very often neglected. To overcome these difficulties, and to make the ventilation entirely automatic, a Wisconsin poultryman devised the shutter arrangement shown in the illustration.

It consists of a frame projecting from the side of the poultry house as shown, about 6 ft. long and 4 ft. high, roofed over with tar paper. Seven 6-in. boards are suspended within this frame, with enough space between them to insure proper ventilation at all times, and arranged in such a manner that they swing easily upon pivot nails driven through the frame at each end.

In fair weather the shutters hang vertically, but when gusts of wind, with rain or snow, beat against them, they close automatically. To prevent the fowls from scratching litter into the openings, which would interfere with the movement of the shutters, sparrow netting is tacked across the frame, on the inside of the house.—G. E. Hendrickson, Argyle, Wis.

Combination Farmyard Gate

A farmyard gate that answers a twofold purpose is shown in the illustration. One

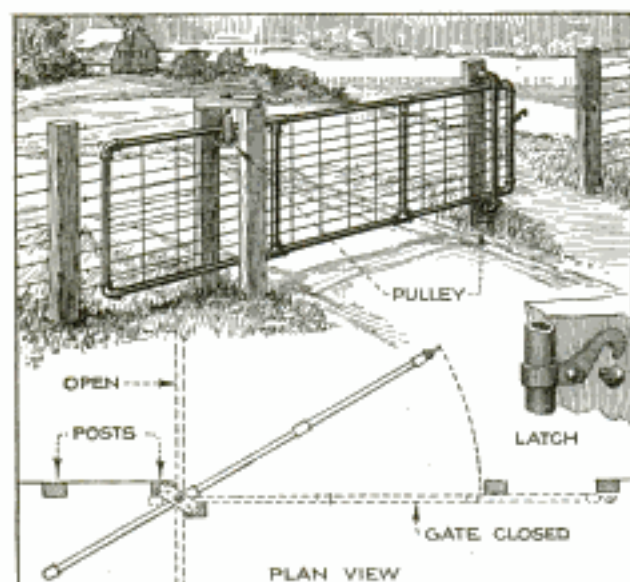

Sliding and Swinging Farmyard Gate That Serves Both Pedestrians and Cattle, or Vehicles

part is designed for pedestrians, and the other for cattle and farm vehicles.

To allow persons to pass through the gate, the latch is released and the gate pushed open; it is set on an incline so that it will close of its own weight. When it is desired to open the entire gate to permit cattle to pass through, it is pushed off the bottom pulley and swung around, which can be done very easily, as the other end of the gate is suspended from a swivel pulley, hung between two posts.

Vacuum Gauge Made from Pressure Gauge

While experimenting with a small ice machine, it was desired to know whether the compressor reduced the pressure sufficiently on the suction side. Two pressure gauges were available, but no vacuum gauge, and accordingly it was decided to try to convert one of these to register the amount of vacuum, if the

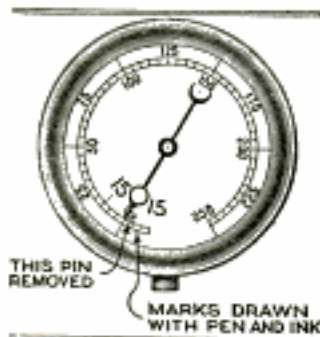

curved rack that engaged the gear on the indicator pinion was long enough. By removing the glass, indicator hand, and dial, it was easily ascertained that this was so. Satisfied on that point, the pin opposite the zero mark

on the dial was removed. Then, as the marking was regular from zero to 250, the dividers were set to indicate 5-lb. pressures and the graduations continued to 15 below zero. The dial was replaced, and, with the outlet open to the atmosphere, the pointer on the spindle was forced to stand at the zero mark. After this the glass cover was put back. On connecting the converted pressure gauge to the suction side of the compressor, the hand barely left the zero mark. The valves were then taken out of the machine and reground, after which everything operated as it should. The marking in this instance was made 15, because it was close enough for the purpose, as the machine functioned perfectly at the 5 mark.

Setting Pipe in Concrete

In the construction of a reinforced-concrete and steel factory building, it was specified that, wherever conduit or other pipe was to pass through a floor, a short piece of pipe having an internal diameter large enough to accommodate the conduit or pipe, should be set. The short pieces of pipe were to be flush with the ceiling on the underside and project about 2 in. beyond the floor

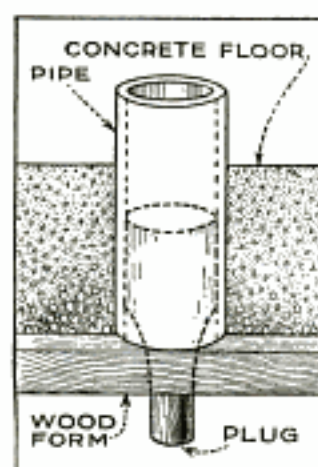

above. In most locations, it was difficult to secure these short lengths of pipe so that they would stay exactly where they were placed, and in the majority of cases, it was found that, after the concrete had set, and the forms had been removed, the sleeves had shifted

a little, or had risen enough to allow the semiliquid concrete to enter and partly fill the pipe. After a number of faults of this kind had been discovered, the method illustrated was devised and used with excellent results. A block of wood was neatly rounded to slip inside one of the pipes, the other end of the plug being whittled down to fit into an auger hole drilled through the wooden form. A hammer and smaller piece of pipe were used to drive the plug into the hole tightly. It was found that the pipes set in this manner stayed in the exact position in which they were placed.—Leon D. Quick, Milesburg, Pa.

Pricker for Draftsmen

The pricker that is usually included in a set of drawing instruments is rather clumsy to handle, and does not prove very satisfactory to those who find it necessary to use this instrument frequently, as is the case with structural and topographical draftsmen. An extremely handy and serviceable pricker can be made very easily by purchasing a medium-size crochet hook at a dry-goods store, and grinding off the hook, to make a fine, round point. It should be finished on an oil-stone to make a good job. This form of pricker will not tire or cramp the hand.—E. D. Hay, Des Moines, Ia.

An Inclosure for the Garbage Cans

It is always desirable to place the garbage cans, and the rubbish that accumulates about the yard, in a part of the yard entirely out of sight from the house. As this was impossible, in one case, because



A Small Inclosure, Used for Garbage Cans and Rubbish, Keeps the Back Yard Neat and Clean

the back yard was so small, an inclosure, 4 ft. by 7 ft., was formed, as shown, inside of the fence that separated the back yard from the alley. The garbage collector need not enter the yard, and as the gate can be kept latched or locked, stray dogs, cats, and other undesirable visitors are kept out.

An inclosure of this type can also be used as a temporary storage place for wood or coal, in cities where it is not permissible to dump material of this kind in the alley.

Sawing Slots in Sleeves and Washers

It is very inconvenient to saw internal slots in washers, or sleeves, by means of a common hacksaw, as the blade must be removed from the frame, inserted through the hole, and again be fastened to the frame. A good holder, that makes this unnecessary, can be made from a short

piece of broom handle, about 4 in. longer than the saw blade.

A groove is cut lengthwise in the holder, so that the blade can be inserted to

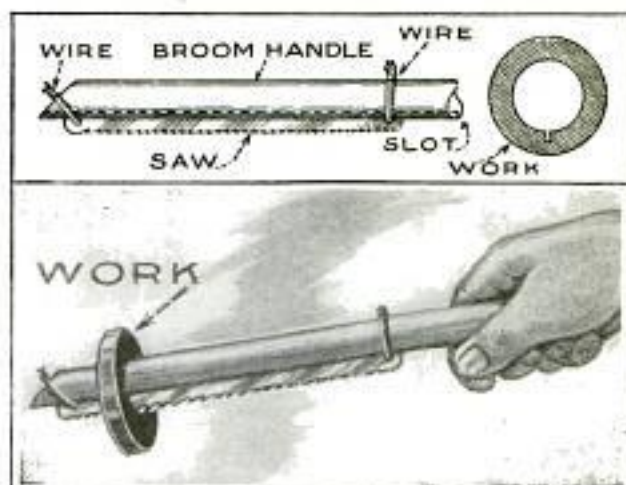

A Simple Tool for Sawing Internal Slots in Washers or Sleeves, Made from a Piece of Broomstick

about one-third of its depth. Soft wire is passed through the holes at each end of the blade and is twisted around the holder. The end of the holder is cut at an angle so that the wire, when twisted around this end, will pull the blade taut.

Spark-Plug Tester Protects Ignition Coil

Ignition coils are often injured while testing spark plugs. A plug with defective insulation will often spark under atmospheric pressure but fail to do so when under compression in the cylinder. Therefore, while testing it, a piece of mica is often placed between the points to increase the resistance and cause the spark to jump a gap of $\frac{1}{4}$ in. or more. Although this is an excellent method of testing spark plugs, the ignition coil is likely to be injured when the spark is caused to jump too far.

By using the simple arrangement shown in the illustration, the danger of coil breakdown is eliminated. The spark plug is placed across two brass brackets, which are mounted on an insulating base, and are fitted with points having a $\frac{1}{4}$ -in. air gap between them. The spark will jump this gap as soon as the gap in the plug is over $\frac{1}{4}$ inch.

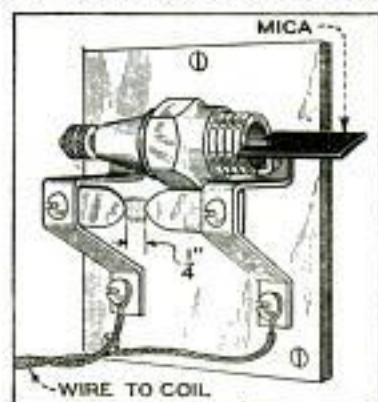

Concrete Wheel Ways Serve as Gutters

A plain dirt driveway, cut through a bank, was frequently ruined by washouts. As it was not desired to go to the ex-

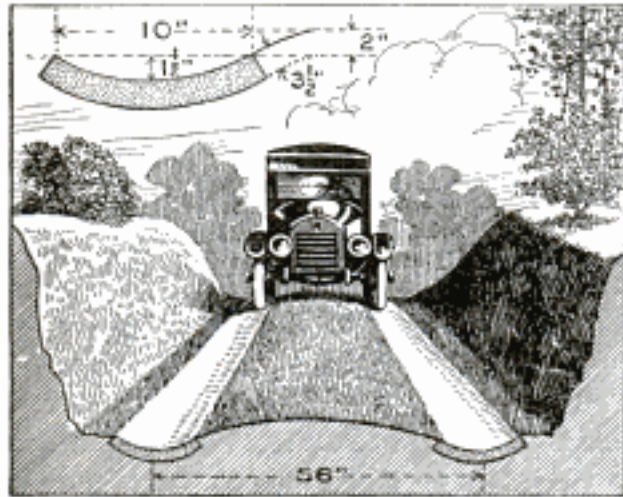

Concave Wheel Ways, That Also Serve as Gutters, Which were Built to Prevent Frequent Washouts That Ruined the Dirt Driveway

pense of building an entire cement driveway, two concave wheel ways, designed also to serve as gutters, were built, and no more trouble from washouts was experienced. These ways were 10 in. wide and about $3\frac{1}{2}$ in. thick, and made of a circular-arc section, with the center about $1\frac{1}{2}$ in. below the edges. The distance between the centers was 56 inches. The ground between the ways was crowned, so that all the water would be shed into them.—O. H. Hampsch, Nashville, Tenn.

Locating Arm for Faceplate Work

Sometimes it is a very difficult matter to bolt a job on the faceplate of a lathe while the former is on the spindle, and

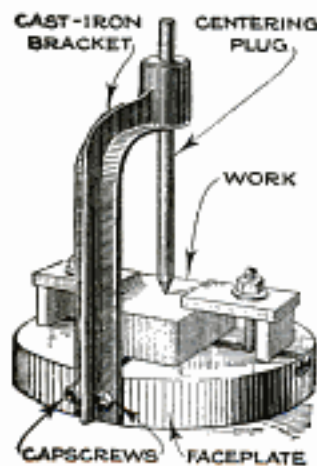

it often happens that it would be more convenient to lay the faceplate flat on a bench and bolt the work to it. When this is done, it generally requires much time and measuring to set the job near the right position. If much of this kind of work is done, a locating arm similar to the one shown in the drawing will soon pay for itself. The fixture consists of a cast-iron arm, screwed to the outer rim of the faceplate. The hole in the hub

part is bored out while the arm is in this position, and a centering plug is fitted. The faceplate, after the hub is bored out, can be removed and the job bolted to it. After the work is properly located by the centering plug, the locating arm is taken off and put away. It can be accurately replaced at any time by bolting it to the same position on the faceplate.

Rough work is usually held to the faceplate by the tailstock center, but this device is better when it is desired to preserve the punch mark on work that has been laid out accurately, and when the plate is put back on the lathe and the center mark tested, it will be necessary to move the job only slightly in order to bring the center-punch mark dead true.—Chas. Home-wood, Ontario, Calif.

Ladder Wedge Prevents Slipping

It is often necessary to place a ladder at such an angle to the wall that it has a tendency to slip. In such cases an assistant is usually required to hold the ladder firmly on the ground, which naturally increases the cost of the work. For this reason a builder improvised an excellent means of steadying the ladder so that it would not slip on the smoothest surfaces.

Three lengths of 1-in. board, slightly less in width than the distance between the ladder rungs, are screwed together to form a U-shaped frame. The simple arrangement is slipped between the two lowest rungs, as shown, and prevents all danger of slipping.—Harry Moore, Montreal, Can.

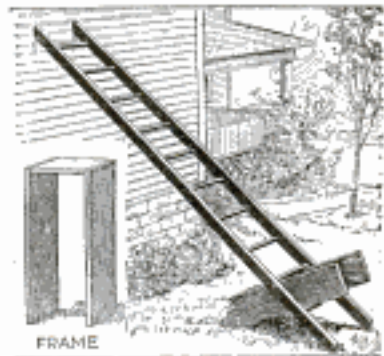

Base for Mounting Maps

When maps are used with the colored push-pin system, as for sales purposes, a substantial base should be provided to prevent the walls or desks on which the maps are kept from being marred. A good base is made by mounting the map on two or three thicknesses of blotting paper pasted together, enough sheets being used to insure that the pins will not penetrate to the surface below.—C. I. Reid, Millersburg, Pa.

Box 181, Route # 6,
 Allentown, Pa.
 Lead.

MAKING SMALL GARDEN TRACTORS

By J. V. Romig



THE owners of large truck gardens will find that much trouble and hard manual labor can be saved by the use of a small garden tractor. Tractors of this type will run from four to eight hours on a gallon of gasoline, depending on the work, and will do all that can be done with a horse, or even more. Anyone with a little mechanical experience can build the tractors herein described.

The frame of the larger tractor is made of two 3-in. channel irons, 38½ in. long, with rear cross members of ½ by 3-in. iron or steel plate. The front frame members are made of ½ by 4-in. plate, cut out as shown. Either rivets or bolts may be used in assembling, bolts being perhaps the easier, and just as satisfactory, if used with lock washers. Two bolts should be used on each cross member. All the steel need-

ed for the frame and other parts can be purchased for a few cents a pound from any structural-steel house, which will also do the necessary drilling and cutting, if desired, at a cost of a few dollars.

The axle, of 1¼-in. cold-rolled steel, is fastened to the frame by U-bolts. The wheels can be obtained from any farm-implement dealer, and should be of the

ribbed-tread type shown. The drive gear should, of course, be cast on the wheel; it should not be less than 6-pitch, to insure its being strong enough for the work. Both wheels run free on the axle, and are held in place with cotter pins and washers, as indicated. They should be provided with grease or oil cups, and must be kept well lubricated. The drive-pinion shaft is journaled in two small pillow

blocks, placed forward of the axle; its exact position is governed by the gearing. A little play should be allowed between pinion and gear, when assembling.

The speed of small garden tractors should be about 2½ miles per hour; this is attained, in the present instance, with an engine speed of 1,200 r.p.m. by using a speed reduction of 21 to 1, and 24-in. drive-wheels. About half of the speed reduction should be made

in the gearing, and the remainder in the belt drive from engine to pinion shaft. Pinions of three to six teeth are now available, that function as well as those with 12 or more, and that enable a large reduction to be obtained at one step.

The mounting of the engine is the most important part of the assembly. It is fastened to the cross member nearest

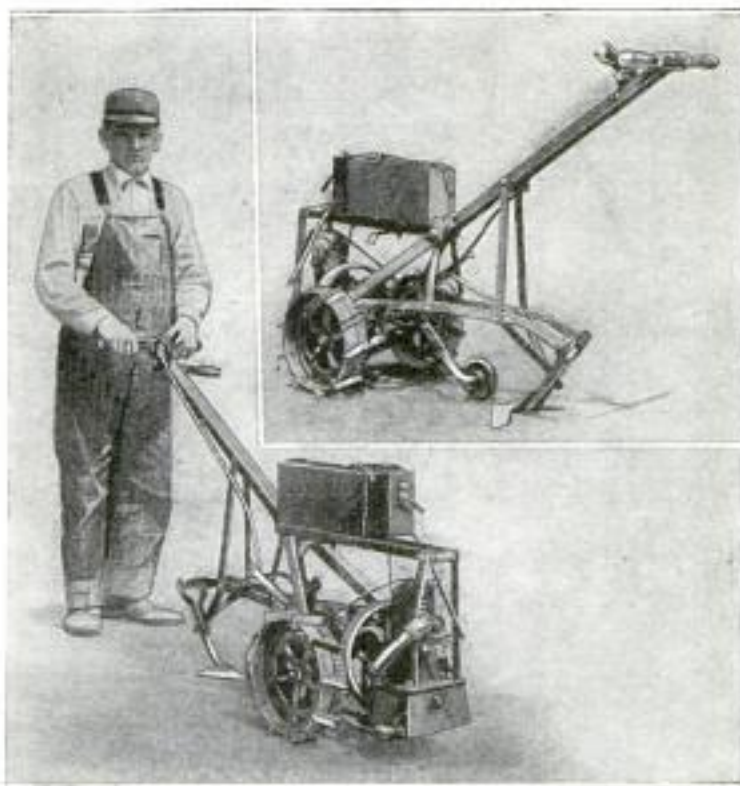

Front and Rear Views of Small Garden Tractor: This Is a Compact Little Machine That Is Capable of Hard Work

Flagged Motors Co. Boothell + 107th
 Oakland, Calif.

Engine - Centaur Tractor Co., Wrentham, Ohio.

City
 New York
 Park Row
 21
 38th St
 7th Ave
 Manhattan, N.Y.

They are braced by two $\frac{1}{4}$ by 2-in. straps, as shown. Two $\frac{1}{2}$ by 4-in. steel plates are bent to fit around the bolts, to form the drawbar brackets, and when the drawbar is bolted on, the whole assembly is free to move on the bolts. Short, heavy springs are placed between the upper nuts and the brackets, as shown, and make for easy action on rough or stony ground. The height of the drawbar from the ground is from 5 to 8 in., depending on the tools most used and on the choice of the maker.

The gasoline tank must be mounted high enough to provide a gravity feed to the carburetor; the brackets that hold it may be made of $\frac{3}{8}$ by $1\frac{1}{4}$ -in. steel. A box, set under the tank, contains the battery and ignition coil, and may also be used to carry tools, if desired.

Another type of small tractor is shown in the smaller illustrations. The basis of construction, in this case, is a large-sized lawnmower. Extension rims and cleats are riveted to the mower wheels, as shown, to provide traction, and the mower handle, raised to clear the gearing, etc., is used for steering. Power is furnished by a $\frac{1}{2}$ -hp. washing-machine engine, and the drive, shown in outline in the insert, is made up of gears taken from a grain binder. The ignition current is furnished by a dry battery, which was originally mounted on a bracket slung under the handle, the ignition coil being carried on another bracket at the bottom of the

handle. This was later changed, as shown, and the battery and coils carried on one bracket, mounted above the gearing. A lever, mounted on the end of the handle, controls the operation of the clutch. The method of attaching the tools is shown quite clearly in the various photographs.

Implements for small tractors can be purchased from any dealer or made up, as desired. Old automobile springs, bent to shape, sharpened, and drilled, make excellent spring-tooth cultivators; they should be made in various lengths of shank, so that they can be "staggered" on the drawbar. Shovels, hoes, hillers, etc., can, however, be bought much cheaper than it is possible to make them. Light and shallow plowing can be done in open soil, but in plowing, too much should not be expected of the tractor. The larger tractor weighs from 250 to 300 lb.; if extra weight is desired, boards may be laid on the lower webs of the frame, and the frame filled in with cement. A caster wheel may be fitted to the drawbar, to relieve the arms of weight when running the tractor to and from the garden.

Remember always to use a good grade of oil in the engine, one especially adapted for air-cooled engines, if possible.

Dust, which is the greatest enemy of farm and garden machinery, can be excluded largely by covering the engine and gearing with a sheet-metal hood.

Vise for Holding Small Screws

The illustration shows a practical method of holding small headless screws while slotting or pointing them.

A machine-saw blade is bent to the shape shown, forming a sort of miniature

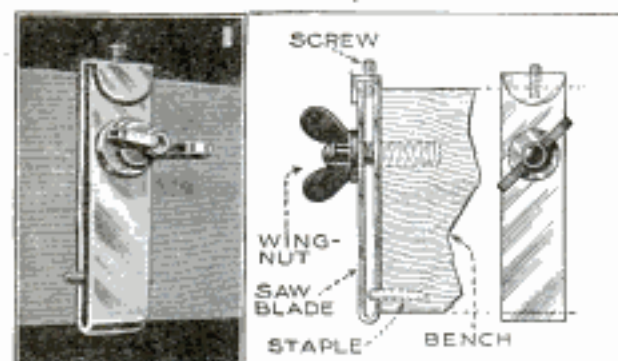

A Miniature Vise, Made from a Machine-Hacksaw Blade, for Holding Small Screws

vise, the space between the jaws being slightly larger than the diameter of the screw. A small hole is drilled and tapped

in the top of the rear jaw to receive the screw. Another hole is drilled through the sides of the jaws to admit a stud that is driven into the bench; a thumbscrew is run on this stud. The lower end of the vise is fastened to the bench by means of a staple. After the screw is inserted in the hole the thumbscrew is turned so that the vise grips the screw tightly.

Coloring Concrete

Mineral colors only should be used for coloring concrete. Other colors are affected by the cement and are therefore not permanent. The coloring matter should be incorporated in the top layer and distributed uniformly throughout the mass. In most cases this is best accomplished by mixing the color with the dry cement, and not with the sand, as the latter is usually wet and causes the coloring matter to lump. The color may also be dissolved in the water before it is added.

In order to determine the proportion

of color to use in producing a certain shade, a few sample batches should be mixed, with a different amount of color in each batch. These batches should then be allowed to dry thoroughly, as the color of concrete is very different when entirely dry and when just hardened. When the batch having the proper shade of color is found, the proportions used in mixing it must be accurately duplicated every time a quantity is made, so that the work will not appear spotty when finished. No more than 10 lb. of coloring should be used to each bag of cement.

Under no circumstances should dry color be sprinkled on fresh concrete and be troweled down in finishing, as this gives only a thin and uneven film of color, and at the same time makes the surface weak, and likely to dust. Color thus applied soon wears off, and the concrete will present a very spotty appearance.

Finger Guard for Circular Saws

To eliminate the danger of injuring the fingers, when working on a circular saw, a simple guard can be made of $\frac{5}{8}$ -in.

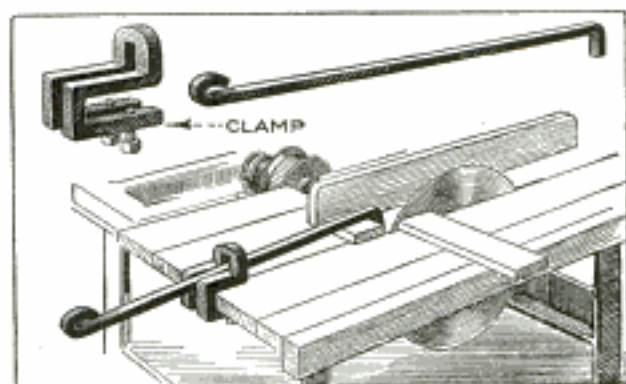

A Simple Safety Device for Protecting the Fingers of the Workman While Using a Circular Saw

square iron or steel. It consists of two pieces: a long bent arm and a clamp or guide. The latter is made so that it can be fastened on the edge of the table.

In operation, the regular work guide, on the top of the table, is set the required distance from the saw, and the clamp holding the arm is attached in a position centrally between the saw and regular work guide. The bent end of the long arm is then dropped over the work so that it will travel along as the piece is being cut. With the fingers of the left hand pressed against the work, between the arm and the guide, there is no possibility of a slip against the saw teeth. The long arm can also be used to draw back the cut stock, left between the guide and saw.

Homemade Implement Breaks Crusted Soil

Heavy rains often leave the surface of the soil so crusted that small grain has



A Homemade Device for Breaking the Surface of Crusted Soil, to Permit Small Plants to Come Up More Easily

difficulty in breaking through. The illustrations show a homemade implement that has been found very effective in breaking up crusted soil over small grain, or grass seed, without any danger of injuring the tiny plants, or of leaving a wide strip of unbroken ground.

The implement is constructed by fastening six pitchforks to a wooden cross-piece, 2 in. by 8 in. by 6 ft. in dimensions. The shanks of the forks are inserted into holes drilled 12 in. apart, and staples are used to hold them securely in position. The device can be attached to a cultivator, or other machine, by means of U-bolts.

The farmer who devised this had a tract of alfalfa, in an irrigated country, that was so crusted at the time the plants were ready to come through, that there seemed no way of saving the crop. By using this simple device, however, the ground was loosened up enough to permit

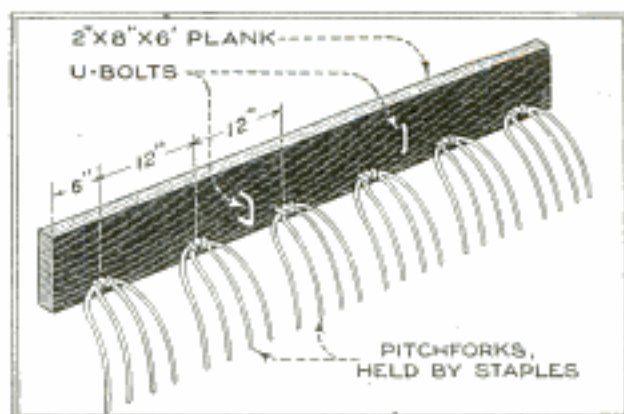

Details of the Soil Crusher: The Device can be Made in Half an Hour

the crop to come through and mature.—Mrs. R. D. Shultis, Grand Junction, Colo.

Heating and Drying Ingot Molds and Ladles

A handy and inexpensive way of drying out the lining of ladles and ingot

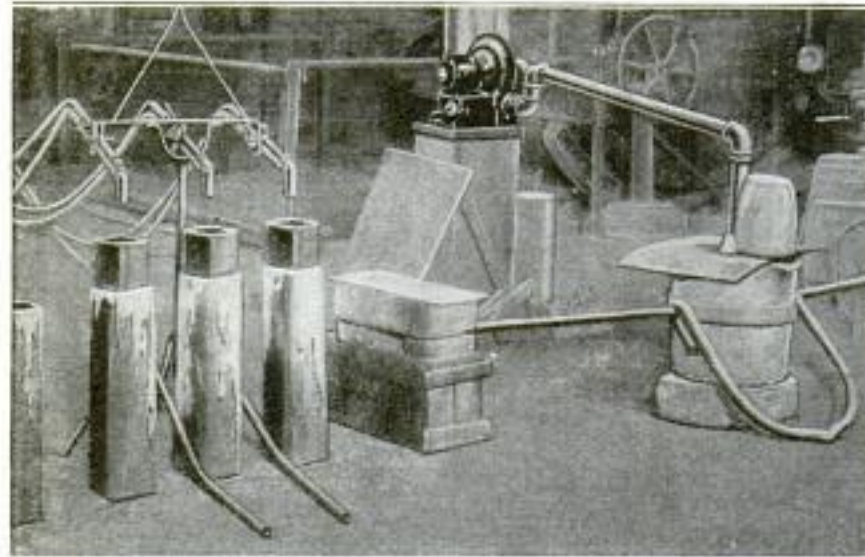

Left: Arrangement of Heaters for Ingot Molds to Reduce Amount of Scrap Cut Off. Right: Air-Gas Blower Used to Dry the Ingot Molds and Ladles

molds, in which use is made of a $\frac{1}{2}$ -hp. motor directly connected to a blower, is shown at the right in the illustration. The air and gas are mixed by the blower, which delivers a blast of flame to the bottom of the molds or ladle. A sheet of metal, with a hole in the top, confines the heat while the fire-clay lining is baking.

The "pipe" in ingots was greatly re-

duced in the shop using a device, shown at the left, to heat the metal as it cooled. Previously it had been necessary to crop off about one-third of each ingot as scrap. This reduction in the amount of

pipe was accomplished by using the hot top rings shown, and heating the outside and inside of the mold before and after pouring. These top rings are iron castings, 8 in. square and 8 in. long, lined with about 2 in. of molding sand, and baked on top of the electric furnace in which the metal is melted.

The gas burners are arranged in a rack, as shown, so that a blast of flame is directed to the bottom of the molds, until they are as hot as they can be made. At the same time, another set, not shown, is throwing flames against the outside. While the molds are being heated, the ladle is filled and the dross skimmed off. When everything is ready, the upper burners are extinguished, turned out of the way, and the ingots poured. The other burners continue to play against the outside of the molds until the ingots have become comparatively cold, so that the metal will not cool too quickly.

Soldering Vertical Seams

It is difficult and tedious work to solder vertical seams such as found in refrigerator interiors, tank linings, and in roofing work, because the solder has a tendency to run down from the underside of the soldering iron. To overcome this trouble, heat an iron to a dull red, draw

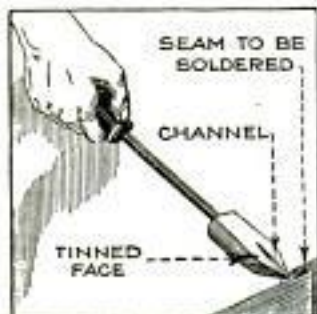

it out to the shape shown, and cut a small groove, about $\frac{1}{16}$ in. deep, in the upper face. This face only is filed and tinned. Starting at the top of the seam to be soldered, move the iron up and down, applying

the solder, which will run through the groove to the point of the iron and into the seam, but not down the untinned sides.

Attaching Brackets to Irregular Surfaces

A machinist in a small shop desired to put an automatic feed on a drill press. In doing so he met with the problem of attaching a bearing bracket firmly to the curved surface of the post, and it was therefore necessary to make a metal base that would fit this surface.

Four holes were drilled in the post, and tapped for studs, which were then screwed in. The bracket was put on the studs and the shaft was put in place so as to bring the bearing into accurate alignment. A clay mold was built around the space between bracket and post and filled with melted babbitt. When cool, this babbitt base was as solid and firm as could be desired.

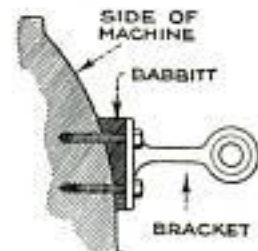

Mending Tracings

To mend a badly worn tracing, so that the adhesive tape will not come off when the tracing is handled, make a few small holes on each edge of the tear and apply the gummed mending tape on each side. The holes permit the opposite strips of gummed tape to stick together, and as there is more adhesion between the strips of tape than there is between the tape and the tracing, the tape will not come off so easily.—Frank Harazim, New York City.

Handling Logs Easily

In building a log stable on a homestead in Manitoba, Can., a simple method was employed that made it possible for one man to raise the heavy pine logs into place. Two skid logs were set against each wall, the upper ends being flattened to prevent them from rolling. Holes were



Placing the Logs, Used in Constructing a Stable, by Means of Skid Poles, Enabled One Man to Do the Job Alone

bored in these skids, about 18 in. apart, to fit strong wooden pegs. It was then possible to raise the logs, one end at a time, and to keep them in position on the skids by means of the pegs. After a log had been raised to such a height that a man standing on the ground could no longer handle it, another set of pegs were used as footrests in climbing the skids.

Tool for Loosening Nuts

It is a very common practice, and a poor one, to use a hammer and chisel for removing nuts in positions where it is impossible to reach them with a wrench, or impossible to swing a wrench even if it can be placed on the nut. The chisel

cuts and mars the edges so that they are very often unfit for further use. By using the simple tool shown in the photograph,

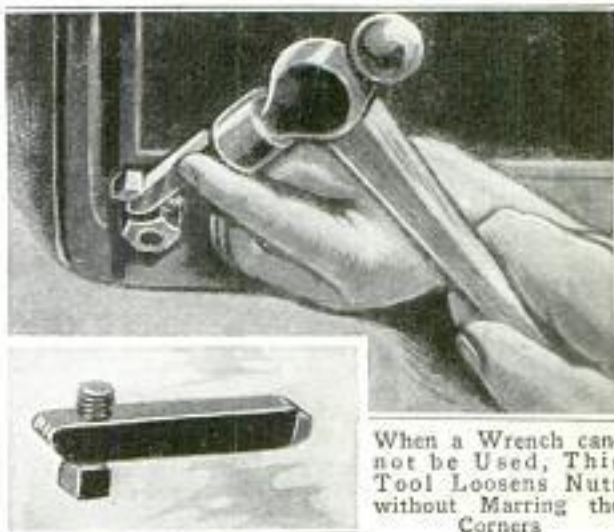

When a Wrench cannot be Used, This Tool Loosens Nuts without Marring the Corners

however, it is possible to remove the nuts without injuring them.

A piece of square stock, of suitable length, is rounded and checkered on one end with a file, and the other end is chamfered. About $\frac{1}{2}$ in. from the checkered end, a hole is drilled and tapped for a setscrew, and the point of the tool is then hardened and tempered. In using it, the checkered edge grips the nut securely, and the setscrew acts as a stop, preventing the tool from slipping. Only a slight mark will be left on the nut as evidence of the use of the tool.

Crimping Tool for Tanners

An excellent crimping tool for tanners can be made from an old pair of tongs, as shown in the illustration. The blocks that crimp the tin are best welded to the tong jaws. The upper lugs serve to give the tin the first bend, then the tin is inserted farther into the jaws, and the second bend given it by the two-pronged lug.



Pressing Off a Cracked Axle Housing

The drawing shows how a cracked axle housing was pressed out of the brake as-

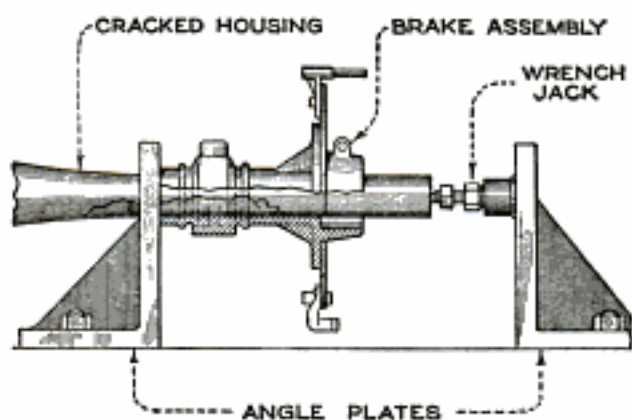

A Small Wrench Jack and Two Angle Plates Used to Force a Cracked Axle Housing from the Brake Assembly

sembly by means of a small wrench jack. The shoulder of the brake assembly was placed against the face of the left-hand angle plate, which had a V-slot cut in it. The jack was set against the other angle plate, and a piece of shafting placed between the jack and the end of the housing. This made it possible to exert a pressure of about 2,500 lb. on the housing, so that one man could do the job easily.—Daniel F. Smith, Jr., Pittsburg, Kan.

Improved Stud Tool

The two most common methods of setting studs are to use a stud tool that has a continuous thread through it, of the same size and hand as the stud, and to use locked nuts. Both of these methods require the use of two wrenches in releasing the tool from the stud, one wrench holding the tool or lower nut, while the other is used to loosen the upper nut or setscrew. An improved stud

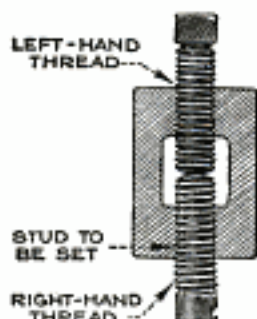

tool, that saves much time, is made as shown in the illustration. It is recessed in the center; one end is threaded to fit the stud, and a thread of the opposite hand is tapped in the other end, in which a setscrew is fitted. Simply turning the tool down on the stud, with the setscrew in place, locks the tool on the stud. By turning the upper setscrew in the same direction as the stud, the tool is unlocked. Only one wrench is required to lock or unlock it.

Simply turning the tool down on the stud, with the setscrew in place, locks the tool on the stud. By turning the upper setscrew in the same direction as the stud, the tool is unlocked. Only one wrench is required to lock or unlock it.

Removing Rear Wheels from Light Car

Rear wheels, that are forced on tapered axles, are often found so tight that a wheel puller will not remove them. It is, however, an easy matter to remove them by raising both rear wheels by means of a jack and starting the motor. When the wheels are revolving at a good speed, the clutch is released and the brake applied. By repeating this a few times the wheel will soon become so loose that it can easily be pulled from the axle.—Albert Chenicek, Chicago, Ill.

Straightening a Bent Reamer

A bent drill or reamer can be straightened easily without danger of breaking by placing it between the centers of a lathe, as shown. Reverse the regular toolholder and clamp it in the toolpost with the butt

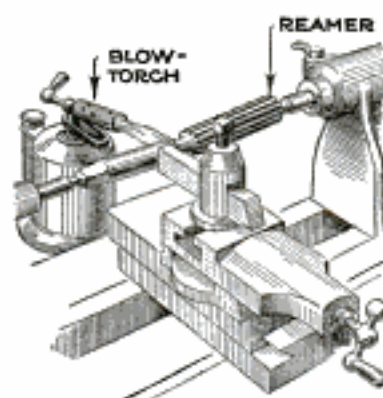

toward the tool being straightened. Play the flame of an ordinary blowtorch on the side of the shank opposite the toolholder. When the part is fairly hot, but not anything like red-hot,

proceed to squeeze the butt end of the toolholder against the shank by means of the crossfeed screw. Occasionally the tool being straightened is tested to determine when it is straight.

Protecting Plane Bit

After a plane bit is ground and honed, the edge is very often ruined while reinserting it in the plane, if the bit catches on the iron bottom instead of entering in the slot. By fastening a small wooden block between the sides of the plane, as indicated in the illustration, the bit will be properly guided into the slot. The block will not injure the edge should it be struck by the latter. The block is fastened by means of shellac.—M. E. Duggan, Kenosha, Wis.

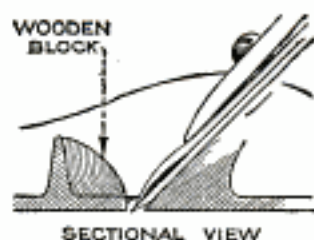

A Bench Shear for the Small Shop

BY CLIFFORD A. BUTTERWORTH

THE bench shear described in this article can be made very easily, and will cut much heavier metal than can be cut with a pair of hand shears. It is designed to give a leverage of 30 to 1 on short cuts, and 10 to 1 at the end of a full stroke. As the blade is 6 in. long, and there is a clearance of 6 in. behind it, it is possible to cut metal that is 24 in. wide, by cutting from both sides.

The base is made of 2-in. stock, to the dimensions shown in the drawing. Two blocks, 2 by 3 in., are bolted to it, and the holes drilled for the bolts are counter-

ing for the stud, which is a tight fit in the shear lever.

The hand lever and its supports are made of $\frac{7}{8}$ -in. ash. The lever works on a $\frac{1}{2}$ -in. bolt, and is also fitted with a bushing. One of the supports is fastened to the 2-in. ash block, while the other is screwed to the base. The links connecting the levers are made of $\frac{1}{4}$ -in. iron or steel. Both the hand lever and the shear lever are fitted with bushings for the link bolts, which are made of $\frac{3}{8}$ -in. steel.

The shear blades are made of $\frac{3}{8}$ -in. tool steel, hardened, and the edges ground.

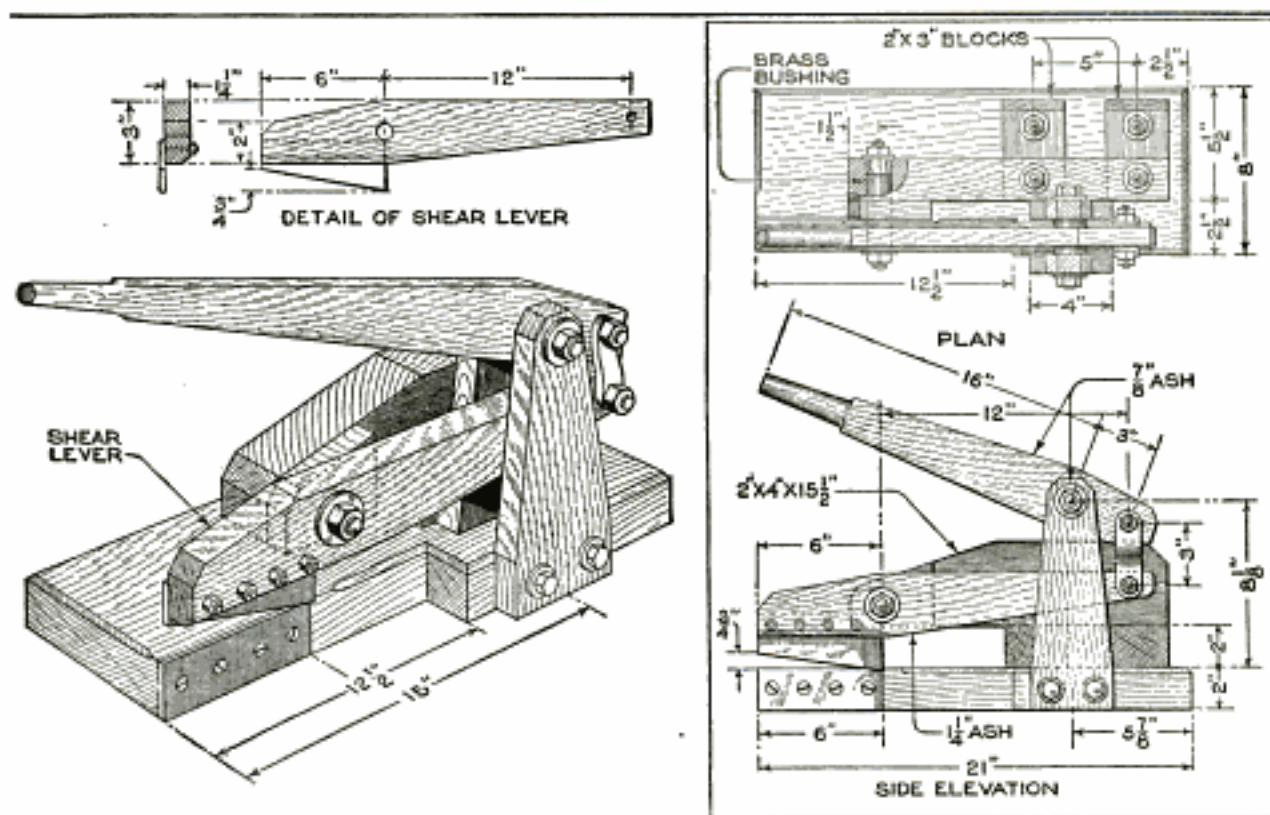

A Bench Shear That will Prove to Be a Very Serviceable Addition to the Equipment of Any Tin Shop: Due to Its Leverage, Much Thicker Metal can be Cut with It than with Any Ordinary Pair of Hand Shears. It is Made of Hardwood, with the Exception of the Links, Bolts, and Blades

bored on the underside of the base so that the heads of the bolts will be flush with the surface. Bolted on top of these blocks is a piece of ash, 2 by 4 by 15 1/2 in., and a short piece of 3/4-in. hardwood is attached to one end of this block with flat-head wood screws. This 3/4-in. piece is faced on the outside with a 1/8-in. steel plate, in which the screw holes are countersunk, so that the screw heads will be flush. The shear lever is attached by means of a 3/4-in. steel stud passing through these pieces, and it is also faced with a 1/8-in. steel plate where the surface comes in contact with the plate on the 3/4-in. block. A brass bushing is pressed into the blocks to serve as a bear-

The upper blade is 2 in. wide at the front, and 2 7/8 in. at the back; it is held to the shear lever by means of bolts, while the lower blade is fastened to the base by flat-head screws, countersunk flush.

Cross-Section Paper Aids in Making Diagrams

Considerable time is wasted by draftsmen in repeatedly picking up and laying aside the scale or dividers, when making wiring diagrams. This can be avoided by placing a sheet of cross-section paper under the tracing on which the diagram is to be drawn, and then scaling the diagram by means of the small squares.

Hooks on Terminal Tongs Lift Battery

The construction of many battery boxes, especially homemade ones, is such that the handles of the battery come below the edges of the box, and so close to the sides that it is almost impossible to remove the battery, without a special tool. A pair of terminal tongs, with the handle ends bent as shown in the illustration, will prove of considerable assistance. The hooks on the ends of the handles make it easy to lift heavy batteries from deep boxes.

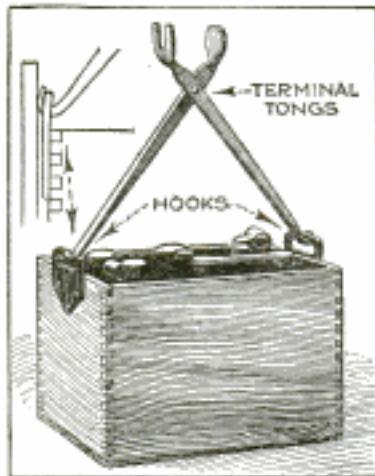

Chuck for Threaded Work

The drawing shows a handy type of lathe chuck to be used when working on threaded parts. It is often necessary to use a threaded chuck, but if the work is held in a chuck of the usual type, it is very difficult to release the work. The application of a pipe wrench may mar the surface, and perhaps spoil the job if a good finish is desired. The chuck illustrated is threaded to suit the work, and the tapping size of the hole continued for about the same distance as the threads. A plunger is turned to a sliding fit in this hole, after which a hole is drilled through the center of the plunger, a drive fit for a pin. The body of the chuck has a slot cut through it as shown, and is threaded outside to fit a knurled ring, which has four "tommy" holes drilled in it. The chuck is operated as follows: The work is screwed in with the fingers, until it is a safe distance in the chuck, when the

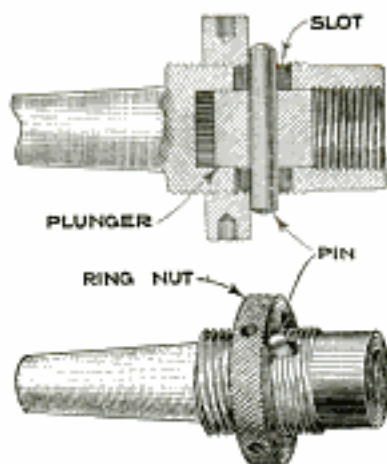

knurled ring is screwed up; this, bearing on the pin, pushes the plunger up tight against the face of the work. When removing the work, the ring is turned to the left, releasing the pressure of the plunger, so that the work can be unscrewed with the fingers. For light work, the chuck can be made with a taper shank to fit into the lathe spindle, but for heavy work it is best to thread the chuck to fit the spindle nose.

Tray under Vise Catches Small Pieces

When a vise is used for holding small pieces, it frequently happens that the work becomes loose, or slips through the fingers while being removed, and falls to the floor, where it is often lost in a crack.

This can be prevented very easily by fitting a tray to the bench so that it extends under the vise, as shown in the drawing. The tray consists of a piece of sheet tin, bent at right angles, and with the sides turned up and fastened at the corners with small screws. A hole cut in the front fits over the vise screw, and the bottom of the tray slides underneath the bench between two lagscrews fitted with washers.

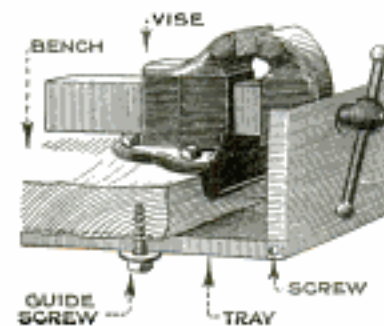

Small Soldering Bit Easily Made

A small soldering bit of the type illustrated can be made in a few minutes from a short length of $\frac{3}{8}$ -in. iron rod, some No. 6 copper wire, two small rivets, and a wooden file handle. The copper wire is doubled, sharpened to form the bit nose, and attached to the iron rod with the rivets; the rod is then driven into the handle. This bit has proved to be especially handy in soldering open circuits on small coils and rheostats.—G. C. Madison, West Haven, Conn.

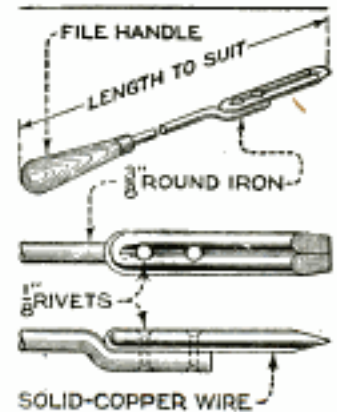

Gummed Business Cards

Business cards of machine repairmen are very often mislaid or lost, and this means that one must go to considerable trouble if the services of the same man are again desired. For this reason, the repairman will find it an excellent idea to use gummed small stickers, on which his name and address are printed, together with other advertising or recording data, as he may wish.

These stickers are made of a thin grade of tough paper, well covered with strong adhesive, so that they will stick for a long time. They should be pasted in a conspicuous place on the machine or fitting, where they may be accessible for constant reference, and at the same time present a neat appearance.

Grinder for Plug Cocks

The lever shown in the drawing makes the work of repairing leaky gas, water, or air cocks of the plug type a comparatively simple matter, and, as the tool will fit any valve handle of average size, is worth

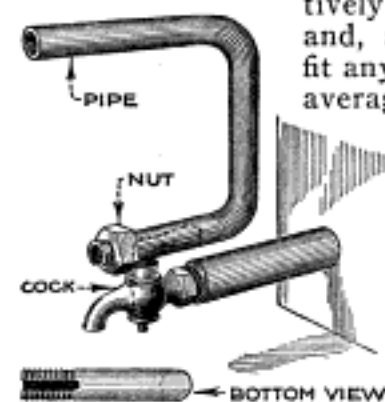

making where jobs of this kind must be done from time to time. The lever is made of a piece of pipe, bent to the shape shown,

although, if preferred, it can be built up of nipples and elbows. In any case, the bottom end is threaded and a slot cut in it, so that, when the lever is slipped over the handle, it will be held upright; a nut screwed onto the threaded end prevents the tool from sliding off in use.

The correct way to repair a defective cock of this type is to apply a little grinding compound, at first only where the bearing marks or rings show and not over the whole length of the plug as is often done. The plug is rotated in semicircles by a back-and-forth movement of the handle. Using the lever shown, a good purchase is obtained and greater pressure applied to the plug than by using the valve handle alone, as the more pressure that can be applied, the quicker the plug can be made tight. When the bearing marks begin to show over the whole surface of the cock, the paste may be applied to the entire length.

Safe Sling for Heavy Bars

When handling heavy and slippery round bars with a crane, it is customary to pass the end of the sling around the bar once and then through the loop at the other end. This method is not a safe one, and it occasionally happens that an unbalanced bar slips out of the hitch. The illustration shows the front and rear views of a hitch that is safe, and at the same time self-tightening. The end of the sling is passed twice around the bar, instead of once, before being passed through the loop.—A. J. Denner, Brooklyn, N. Y.

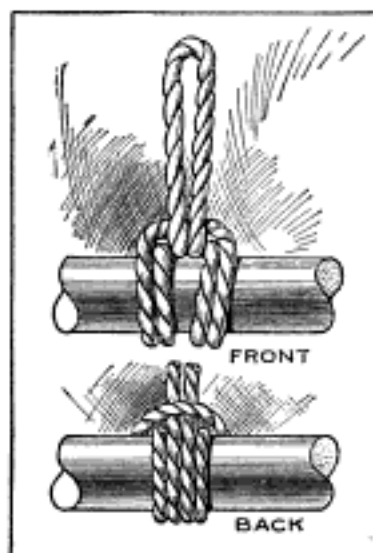

Auto Tables Please Store Patrons

Stores catering to the trade of automobile parties can add greatly to the convenience of their customers by using small serving tables of the type illustrated, which can be made at very little expense.

The tables slip over the edges of the automobile doors, and can be put in place instantly. Each one is fitted with an adjustable brace consisting of two pieces. One piece is securely fastened to the underside of the table and has a slot cut lengthwise in it. The other piece has a hole drilled near the end. The pieces slide one upon the other, and are clamped together by a bolt and a wingnut. A strip of wood is attached to the end of the brace, and another strip nailed to the edge of the table, as shown. Felt, glued to the wood as indicated, is used to prevent the table from scratching the varnished surface of the car doors.—Tom Freeman, Beaumont, Tex.

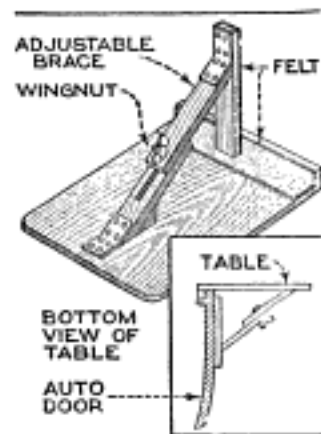

Reversing or Duplicating Tool

The interesting tool shown in the drawing was discovered in the shop of a sign

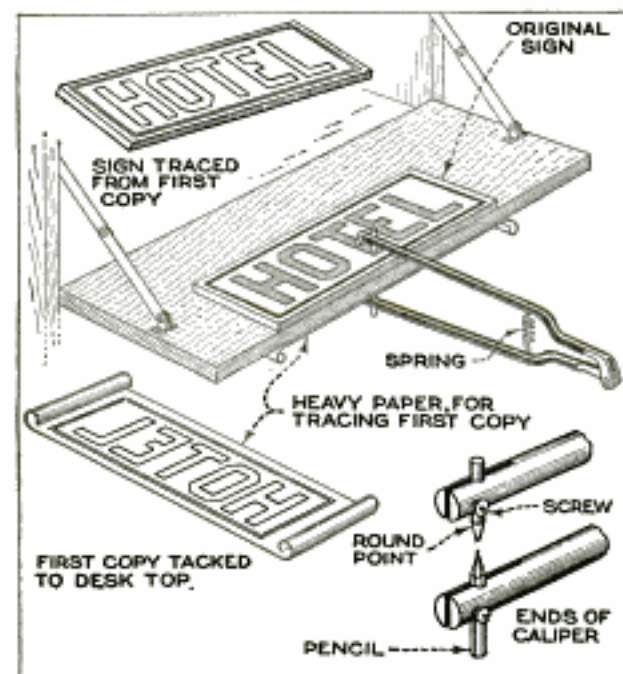

A Simple Tool That will Prove of Value to Sign Painters for Reversing or Duplicating Designs

painter, where it was used for making duplicate posters. Its uses are many; it will copy a picture, or transfer a drawing or design to the opposite "hand" without requiring any skill on the part of the person using it, so that a boy can do some work that ordinarily would require the time of a highly paid sign artist.

The tool consists simply of two rods, jointed as shown, drilled and slotted for a pencil and tracing point, and fitted with a spring. A buggy-top hinge would make a good tool of this kind.

As shown in the drawing, the original design is tacked to the top of a shelf, and a sheet of heavy tracing cloth, or paper, underneath. The design is then traced with the rounded point, producing a reversed copy on the paper underneath. If a duplicate of the original is required, the reverse is used, in the same manner, on top of the shelf.

The tracing point and the pencil should be exactly opposite each other, and be clamped tightly, as indicated, by means of round-head screws.

Preventing Tools from Rusting

Tools of all kinds soon become rusty when exposed continually to a damp atmosphere, or when used only occasionally. To prevent this, keep the tools in a box filled with oil-soaked sawdust. Oil

that is drained from the crankcase of an automobile, and that is to be thrown away, will serve very well for this purpose. Sand may be substituted for the sawdust, in a box where shovels, spades, and similar large tools are kept. The sand will also serve as a scouring agent that will prove of great help in removing the rust already on the tools.

Stock-Oiling Device for Punch Presses

The drawing shows a method of oiling tin, or other metal, in sheet form, that is being formed or drawn on the punch press. An oil tank, similar to those used on milling machines, is supported on a bracket attached to one side of the punch-press frame. A steel ring is fastened to the side of the ram by a bracket, and a felt ring, a little larger in diameter on the outside than the blanking size of the die, or the diameter of the cup to be

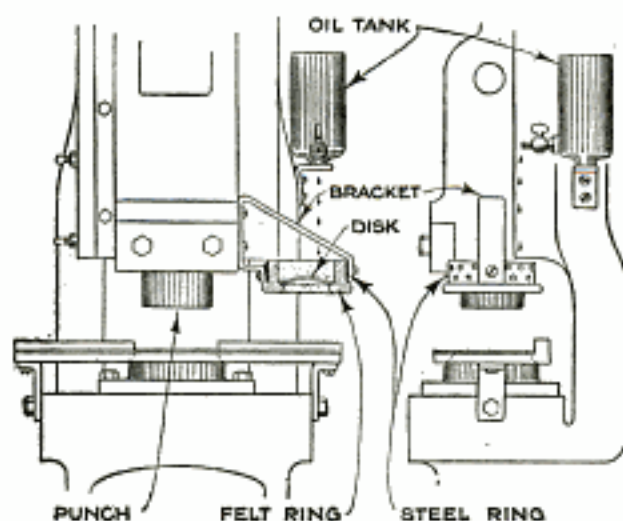

An Oiling Device for the Punching and Drawing Press, That Automatically Applies a Thin Film of Lubricant to the Face of the Stock at Each Downward Movement of the Ram

drawn, is forced into this ring, as shown. The felt ring is so located in relation to the punch that when the ram is in a "down" position, the pad will oil the stock as it rests on the platen, just where the punch will come on a later stroke. The oil drip is so arranged that the oil drops on a spring disk inside the felt pad, and the oil flow is regulated so that only a very light film of oil is left on the tin where it is needed in the drawing or blanking operation. This method, besides being economical in the amount of oil used, does away with the necessity of oiling as a separate operation, and on lithographed work, on which the lithographing tends to soften and scratch when left with a heavy coating of oil for a few hours, it is especially advantageous.

Alining Automobile Wheels

Alining the front wheels of an automobile alone is quite a job, and where work of this character is of frequent occurrence, as in the one-man garage, the alining device shown in the drawing will speedily prove its value.

Two pieces of $\frac{3}{4}$ -in. lumber, 3 in. wide and 8 or 9 ft. long, are planed true and fitted with ribs, glued and screwed to one side. The ribs are cut off and beveled, as shown, at the front ends of the "parallels," and cut off short about 1 ft. from the rear end. Two $\frac{3}{4}$ -in. pieces are then bolted to each rib and screwed to the parallel at the rear end, as shown. This forms a $\frac{3}{4}$ -in. slot, which is also cut through the bottom pieces, for the rear hook bolt. The front hook is inserted through a hole drilled a little forward of the center of the parallel, the rib being strengthened at this point. The bolts are made of $\frac{3}{8}$ -in. iron or steel rod, threaded on the upper end for wingnuts.

To use the device, the hooks are placed over the tire and rim on each wheel in such a manner that the straight edges are horizontal, then tightened. Then, by sighting over the projecting portions, they are made parallel. After making sure that both wheels are pointing straight ahead, the distance between the parallels is measured, close to the tires, as shown, then at the outer end of the parallels, and the two measurements are

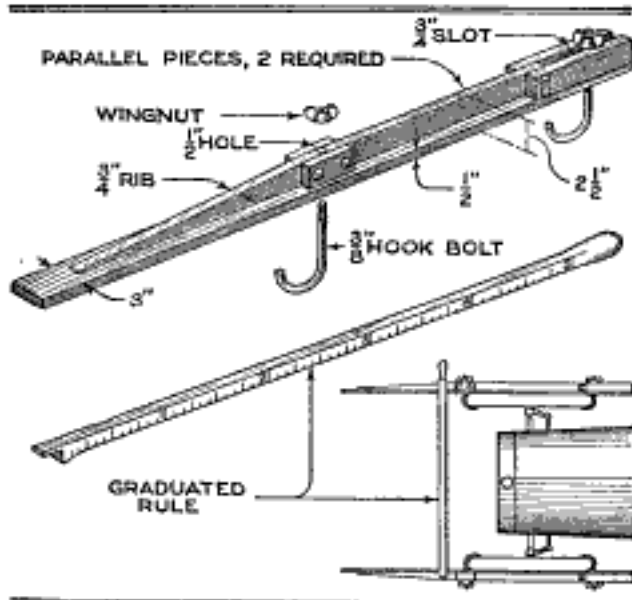

Truing Up the Front Wheels of an Automobile Is Not Usually a One-Man Job, but the Device Illustrated Above Makes It So

compared. The front wheels should "toe in" slightly, not less than $\frac{1}{4}$ in. nor more than $\frac{3}{8}$ inch.

Making Gouges of Steel Tubing

Gouges are tools that all woodworkers must use at times, but usually not often enough to necessitate the purchase of a

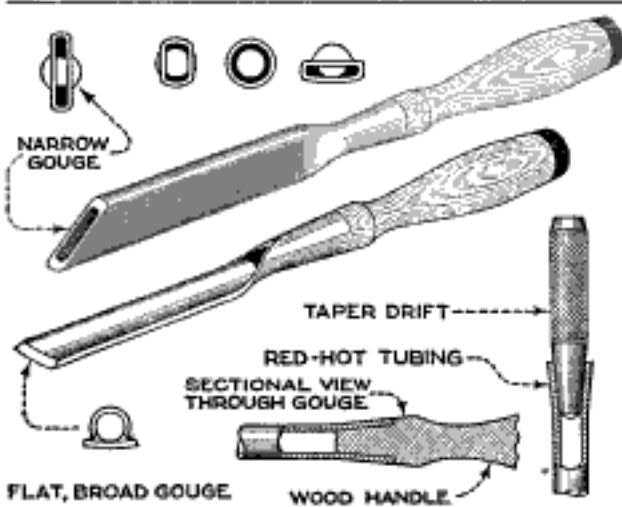

Steel Tubing, Used to Make Woodworkers' Gouges of Various Shapes and Sizes, and of Excellent Quality

complete set. Gouges made of seamless steel tubing, however, will answer excellently for the occasional user.

They are made from pieces of fairly heavy-gauge tubing, flared open at one end to receive a wooden handle. This is done by heating the tube until red and then driving a taper drift into it to expand it. For narrow gouges, the tubing is flattened as indicated, and beveled on the end to form the cutting edge. A medium-flat gouge can be made by flattening out the tubing a little less. By slitting the tube and spreading it open and almost flat, a broad gouge is formed.

To make the steel hold an edge, it is well to caseharden it slightly, which is done by dipping the red-hot steel in powdered cyanide of potassium and quenching in cold water. As these tools are always ground on their forward faces, the casehardening will not be ground away from the lower part of the cutting edge. In some cases it will be found that, if the tools are tempered after hardening, a better and longer-lasting edge will result. To those unaccustomed to using cyanide, a word of warning is necessary. Do not inhale the fumes, as cyanide of potassium is an active poison.

When scraping carbon from automobile pistons, and from the face of the cylinder block, use short headless set-screws to keep the particles of carbon out of the cylinder-head bolt holes. This method is easy and quick.

Reflector Aids Motion-Picture Pianist

It is often a great strain for the organist or pianist in a moving-picture theater to glance up continually at the picture

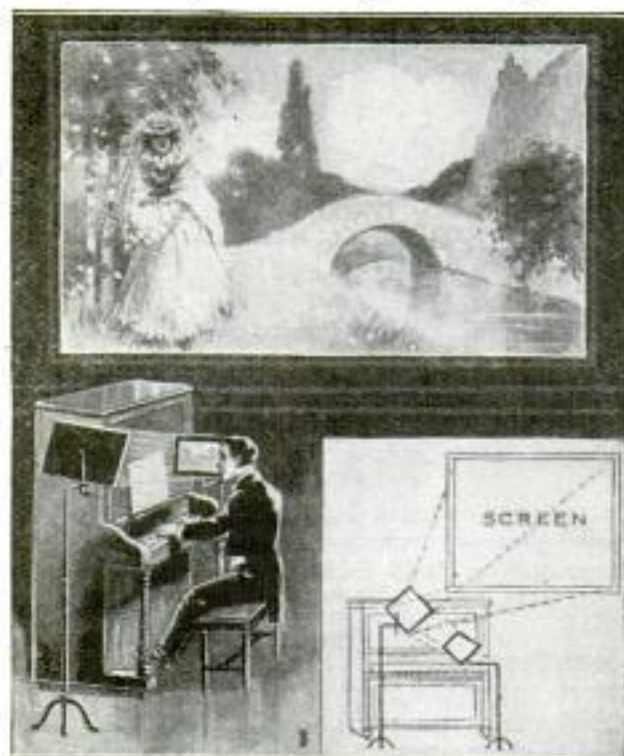

This Arrangement of Two Adjustable Mirrors Enables the Moving-Picture Theater Pianist to Follow the Picture without Turning His Head

while playing, in order to make the music correspond to the action.

This trouble can be overcome very easily by using two adjustable mirrors, mounted on portable stands, as shown in the photograph. One of these mirrors is set at such an angle as to catch the picture on the screen and reflect it into the second mirror, which is placed close to the music rack, and in front of the musician.—H. F. Hess, Des Moines, Ia.

Action of Radio Switches Improved by Vaseline

While in a laboratory where radio-resistance measurements of great importance were being conducted, a visitor was much surprised to see one of the assistants apply a generous amount of vaseline to the points and blades of a rotary, or dial, switch. The action was slightly squeaky, and the lubricant was applied to overcome the scratchy effect and make the instrument operate smoothly and with good electrical contact. It was explained, that, paradoxical as it may seem, the use of vaseline on such switches had been found to improve not only the mechanical action but the constancy of the

contact as well. This was discovered in an investigation where it was necessary to have a commutator operated with extraordinary definiteness and efficiency. Everything had failed until the worker drenched the part with oil. Much to his surprise, the experimenter found that this produced exactly the effect he sought. Since that time vaseline has been found to be equally effective, and cleaner and easier to apply than oil.

Making Center Testers Magnify Errors

A simple method of greatly magnifying the slightest movement at the point of a center-tester needle is to use a strong feather quill, about 1 ft. long, pressed on the end of the needle. The quill is very light and will not cause the needle to vibrate, which would be the case if an additional length of steel or even aluminum were used.—L. M. Steffen, Dayton, Ohio.

Rolling Oxygen Cylinders

Heavy oxygen cylinders are generally moved for short distances by tipping them slightly and rolling them on the edge in the same way as barrels. But owing to the small diameter, the height, and the weight of these cylinders, it is not an easy matter to roll them in this way. For this reason, the device shown in the drawing was made. It consists of a hardwood wheel, 6 or 7 in. larger in

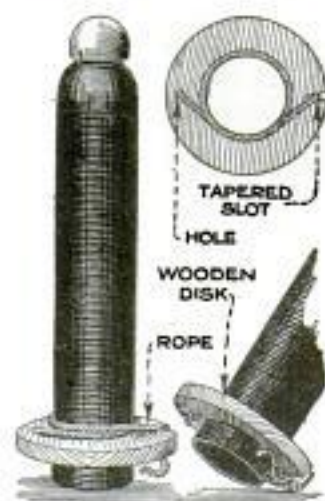

diameter than the cylinder, and fitting nicely over the bottom of the latter. A rope, knotted at the end, is passed through a hole drilled about halfway between the inner and outer edges of the wheel. After the rope is wound once or twice around the cylinder, it is caught in a tapered slot cut opposite the hole. By rolling the cylinder on the wheel in the direction opposite to that in which the rope is wound, the latter is tightened instantly. It can again be loosened by giving the wheel a slight twist in the same direction as the rope is wound.

By rolling the cylinder on the wheel in the direction opposite to that in which the rope is wound, the latter is tightened instantly. It can again be loosened by giving the wheel a slight twist in the same direction as the rope is wound.



A Roller Coaster for Skaters

BY DALE R. VAN HORN

THE ice coaster shown in the illustration will provide much exhilarating sport for skaters. Erected on smooth ice, it awaits the speeding skater, who shoots into one end, grasps the axle of the "car" and, after sweeping over the curves of the track, alights at the other end and speeds on.

The main frame of any coaster of this type consists of two

available, and upon whether adults or youngsters are to use the device. The drawing is intended only to serve as a general guide. The track should not end at the bottom of an incline but should run parallel to the ice—or nearly so—for some distance, so that the skater may balance himself on the ice, and let go the car before it strikes the bumper.

The car itself is nothing more than

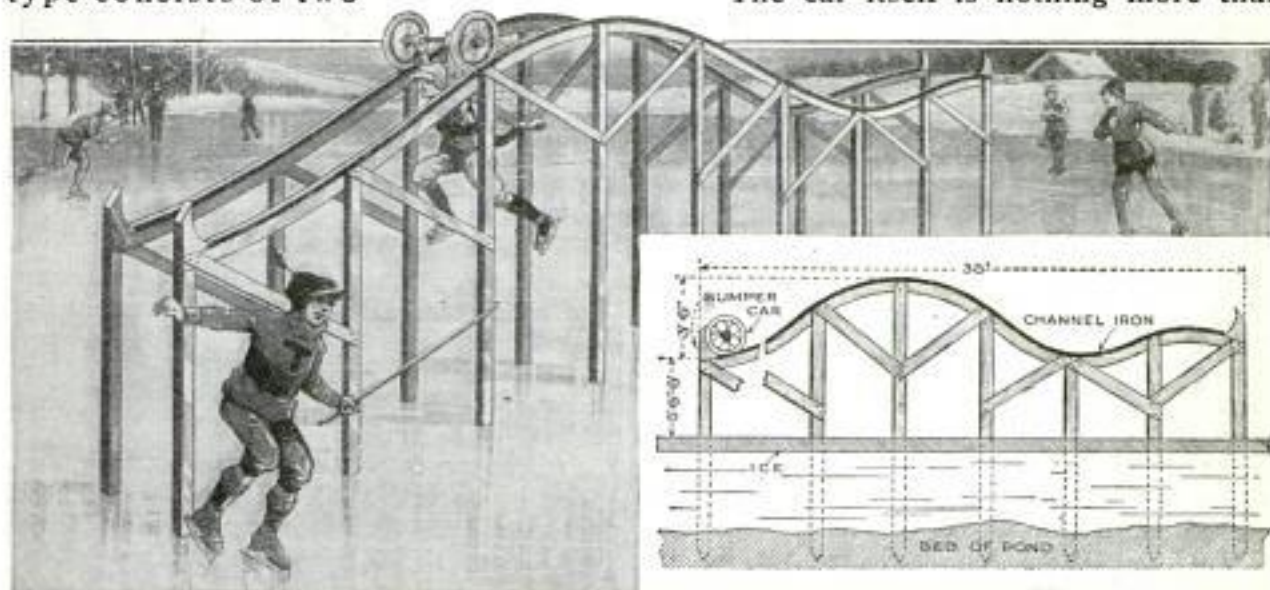

A Simple Coaster, Made of a Few Pieces of Lumber and Some Channel Iron, and Provided with a "Car" Made of a Tricycle or Buggy Axle, Furnishes Exhilarating Sport for the Skating Pond. The Drawing Serves Only as a Guide, the Dimensions Being Altered to Suit the Location or the Users' Convenience

rows of 4 by 4-in. posts, driven into the bottom of the pond or river through holes cut in the ice. When the ice again forms around the posts, they are quite rigid; they are set 6 ft. apart, and the track is 3 ft. wide. The pattern of the track curves is laid out on cardboard, in sections, and used to cut the 2 by 6-in. track timbers to shape. These timbers are nailed to the inside of the posts, and the posts are braced as shown. The track proper is made of light channel iron, bent to fit the 2 by 6-in. timbers, and spiked to them.

The dimensions of the coaster, as shown in the illustration, need not be rigidly adhered to. The height, length, etc., will depend entirely on the space

the axle and wheels of a tricycle, or baby buggy, preferably a ball-bearing one for easy running.

Creeper for Painters

When painting or varnishing floors and baseboards, I find a creeper of considerable assistance. It is made from a strong wooden box, about 1 ft. square and 15 in. high. A ball-bearing caster is mounted at each corner. This box is used as a seat and makes the work much easier. While working on doors and windows, the box can be placed on one side, and the paint or varnish set on it, so as to save one from stooping constantly to fill the brush.—C. O. Soots, North Salem, Ind.

Improved Cider Press

A simple but quite effective cider press was improvised from common equipment available about the house. It consisted

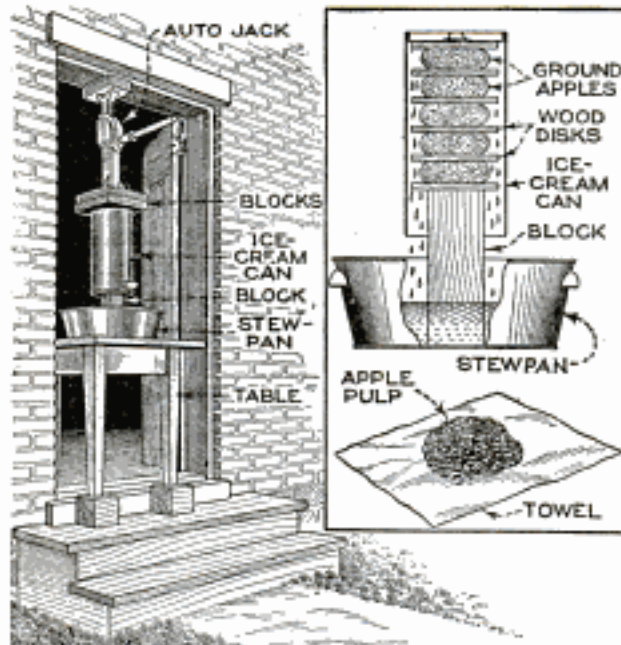

A Simple Cider Press That can be Improvised from Materials Found around the Average Household, or Easily Obtainable

of a stewpan, an ice-cream can, an auto jack, and a few pieces of wood and toweling, arranged as shown in the drawing.

The apples were first quartered, and, after the bad spots were removed, ground with a small food chopper, using the coarsest plate. The pressing of the juice was then accomplished by wrapping the apple mash in pieces of old towels, a quart of mash being placed in each piece of towel. These sacks of mash were placed in the ice-cream can to within $\frac{3}{4}$ in. of the top, and were separated from each other by wooden disks, a little smaller in diameter than the inside of the can. The can, with its contents, was then inverted and placed over a wooden block about 5 in. in diameter and 12 in. high, and the whole assembly set in a stewpan. By placing this arrangement on a small kitchen table in a doorway, and using an auto jack, as shown, to apply the pressure, the cider was squeezed out of the mash in a very short time.

In using this method, it might be thought that time and trouble could be saved by placing the mash in one large sack. This is not so, however; the cider cannot be squeezed out of such a bulk. By placing the batches between wooden disks as described, nearly all of the juice will be extracted. This method has proved to be quite practical.

Increasing Furnace Efficiency

The owner of a newly installed furnace experienced great difficulty in keeping the temperature at a point where the occupants of the house would be comfortable. After exhausting all other means, it was suggested that a blower be placed in the cold-air duct. This was done and no further trouble has been experienced.

A damper was placed in the cold-air duct to regulate the amount of cold air entering the furnace from outside, most of the cold air in moderate weather, and all of it in severe weather, being drawn through the cold-air register on the first floor. The cold-air duct is, of course, made so that the air can be drawn either from the outside of the house or from the register inside. The fan or blower was placed inside the duct about 2 ft. away from the furnace, and controlled by a switch upstairs. As a result of this change, the house is always maintained at a comfortable temperature, and many dollars have been saved in coal.—A. J. Spengler, Chicago, Ill.

A Practical Gate Hinge

Considerable difficulty is often experienced in attaching a gate to steel posts, in a manner that is rigid and substantial. A simple hinge was devised on our farm that has been found entirely satisfactory, and that has several advantages over hinges on the market.

To construct a hinge of this type, two $\frac{1}{2}$ -in. holes are drilled through the steel post, one about 6 in. from the top, the

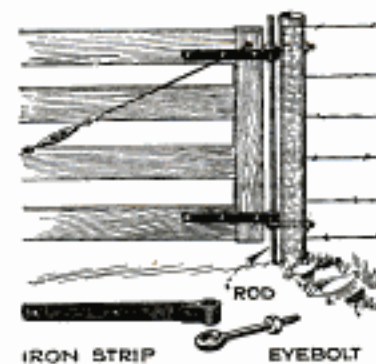

other 8 in. from the bottom. Eyebolts, with eyes $\frac{3}{4}$ in. in diameter, are fastened through these holes. Two pieces of flat iron, about $\frac{3}{8}$ in. thick, are bent as shown, and

three holes drilled in each for small bolts. These strips are then bolted to the gate so that after the gate has been raised in position, they will fit between the two eyebolts, as shown. A $\frac{3}{4}$ -in. pipe or rod is used for a hinge pin, and the gate will then swing freely either way.

This arrangement holds the gate firmly above the ground, while making it impossible for hogs to raise it off the hinge pin,

due to the position of the upper eyebolt. In winter months, the gate can be raised a few inches to clear the snow, by putting the upper hinge on top of the eyebolt.—J. R. Kuntz, Bremen, Ind.

Repairing Electric Lamps

It was found, in one garage, that a greater percentage of electric lamps was lost due to the loosening of the brass screw cap from the glass, than to the breaking of the glass or the burning out of the filament. When the cap became loose, the bulb would twist around, and this might cause the terminal wires to cross and blow out a fuse.

It was found possible to repair a number of these bulbs in the following way: Take two pieces of No. 20 bare copper wire, about 3 in. long, and solder these to the lamp terminals, to facilitate assembling, as shown. Push a piece of cotton wadding into the glass stem to prevent the wires from coming in contact

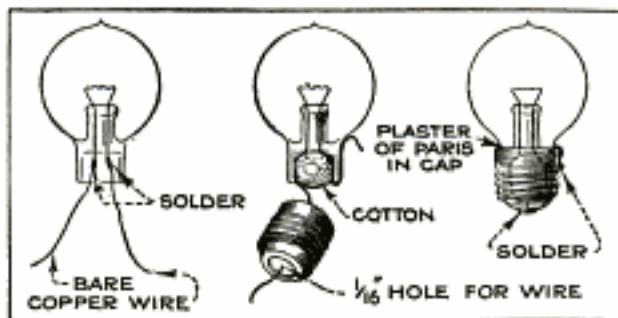

A Simple Method of Repairing Electric Lamps When the Brass Screw Caps Are Loose

with each other. Drill a $\frac{1}{16}$ -in. hole in the brass cap and draw one of the wires through this hole. Bend the other wire over the edge of the glass. Fill the cap with plaster of Paris and press the bulb in place, taking care to keep the wires taut. Then solder the ends of the wires to the cap, to assure a perfect connection. Globes repaired in this way will last just as long as new ones.—E. J. Bachman, Fullerton, Pa.

Drained Shelves for Flowerpots

Drained shelves, as shown in the illustration, are very practical for use with common flowerpots. A groove is cut in each shelf, the groove being made to slope toward a hole drilled in one end, and the shelf itself tilted a little in the same direction. Cemented into this hole is a rubber tube, leading to a groove cut in the shelf below, or to a receptacle. If two shelves are used, as shown, the re-

ceptacle is placed under the lower shelf. Each flowerpot is placed on the shelf so that the small drain hole in the bottom

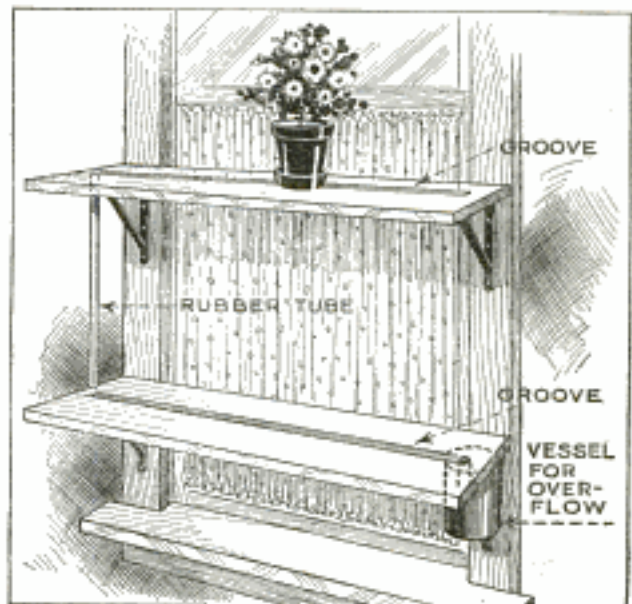

Flowerpot Shelves Provided with Drains, Make It Unnecessary to Remove the Pots When Watering, or to Have Dishes for the Pots

of the pot will be exactly over the groove. By using shelves of this kind, it is possible to prevent the troublesome overflow that ruins the varnished surface of the window sill and casings, and spatters the curtain and window. The shelves, of course, should be painted or shellacked, to prevent the water from soaking into them.—T. R. Hart, Ashtabula, Ohio.

Holding Blow-Out Patch While Replacing the Tire

The difficulty of keeping the edges of a blow-out patch outside the casing while a tire is being replaced on its rim is avoided when the holder shown in the drawing is used. This little device consists of a band, $\frac{1}{2}$ in. wide, cut from an old tube, and fitted with two sharp-pointed wire hooks. After inserting the patch, the hooks on the holder are pushed through its protruding edges, and the rubber band prevents the ends from catching under the rim while the tire is being applied.—G. A. Luers, Washington, District of Columbia.

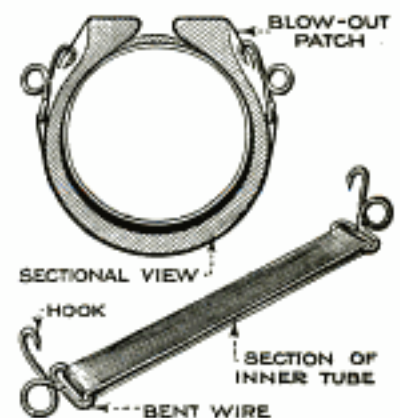

Novel Lighting Fixture for Porch

As a porch lighting fixture of the common ceiling type proved unsatisfactory,

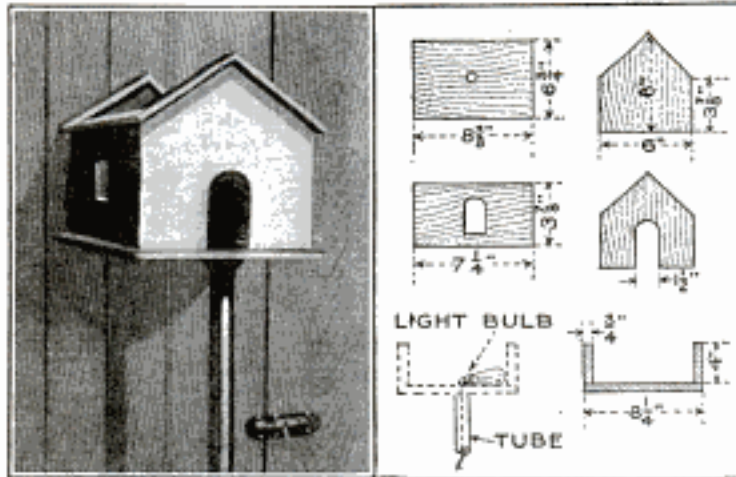

Two of These "Bird Houses" were Used as Indirect-Lighting Fixtures on a Porch, to Provide a Soft Light

because it gave a glaring light, two fixtures of the indirect type were made by a householder, and placed on each side of the porch, so as to provide a balanced illumination.

Each of these was made of $\frac{3}{4}$ -in. wood, and constructed, as shown in the illus-

tration, to resemble a bird house. A window was cut in each side and a door in front; orange-colored glass was inserted behind these openings and held in place with putty. The standards used as supports for the "bird houses" were made from lengths of tin piping, and the wires run through them. The lower end of each standard was firmly tamped into the soil in a large flowerpot, as a heavy base was necessary to keep the fixture from being overturned easily. When completed, the whole was given three coats of enamel, inside and outside. Various colors were used on the outside; a bright red on the roof edge, white on the ends and sides, and bright green on the base edge and on the edges of the door and windows. A 10-watt frosted lamp was used in each fixture.

When making a fixture of this type, it may be impossible to obtain colored glass for the doors and windows. In that case colored tissue paper can be used; it is pasted on the inside and shellacked. A strip of asbestos should be glued under the bulb to avoid charring the enamel.

File Board Facilitates Binding of Papers

A simple board, used for filing letters, bills, and similar matter, can easily be arranged so as to assist in binding this material after the file has been filled.

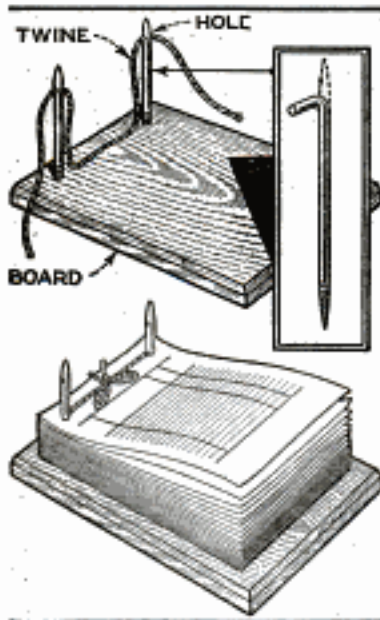

to assist in binding this material after the file has been filled. A hardwood board of the required size is fitted with two steel prongs. These are made from screw-hooks, straightened and ground to a point at the ends, as shown, and with small

holes drilled near these ends. A piece of twine is passed through the holes, enough slack being provided between the prongs to permit the papers to be pushed down firmly upon the board. When the

file is full, the ends of the string are pulled out of the prongs and tied. The papers can then be lifted off. This method of binding the papers while they are held in place on the file board does away with the slow and tedious work of stringing them singly.

Heating Sadirons Quickly

Considerable trouble was experienced in making sadirons sufficiently hot on an oilstove. After experimenting with several methods, none of which proved successful, a large stewpan was placed over two irons while they were being heated. Most of the heat was now confined about the irons, and consequently, they soon became hot. Food can be prepared much more quickly by applying the same idea, which

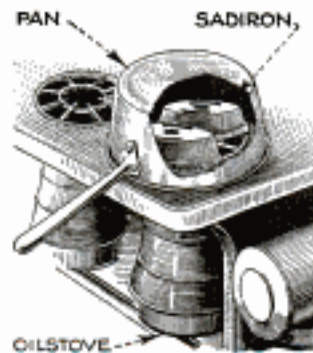

means a considerable saving in fuel.—Mrs. J. V. Romig, Allentown, Pa.

Felt and mallets from J. C. Heagan Inc., Rosewood + Bertland Ave A Homemade Xylophone Chicago.

BY VERNON W. PALEN

AN excellent xylophone can be made at home, by anyone who can handle simple tools. The volume of tone is not so great as in commercial instruments, as the homemade one is not equipped with resonators, but the quality of the tone is excellent, and, as the commercial one costs about \$50, and the homemade one about \$6.50, one can dispense with volume.

Oak is used throughout in the construction of the instrument, and it is best to purchase this from a planing mill, dressed to size. The bars, bar frames, and braces of the main stand are of $\frac{1}{2}$ by $1\frac{1}{8}$ -in. stock, and the endpieces of the stand are $\frac{3}{4}$ by 4 in. in dimensions, one piece being 8 in., and the other 29 in. long.

The first step is to construct the two triangular bar frames, the sides of which are 52 in. long; one endpiece is 14 in. and the other $3\frac{1}{2}$ in. long. The joints should be dovetailed, or half-lapped, glued, and screwed. The upper edges are faced with xylophone felt, glued on; this can be obtained at any large music store.

The bars cover $3\frac{1}{2}$ octaves, and are cut to the lengths given in the appended table. Most of the work in constructing the xylophone lies in the tuning of the bars, for, even though they are cut exactly to the lengths specified, they will, in most cases, be out of tune, as some parts of the wood are denser than others, and the bars must therefore be tuned separately.

Two methods may be used in tuning the bars. The middle-C bar may be tuned to the corresponding note on a piano, and the remainder of the bars tuned from it, or each bar may be tuned to its corresponding piano note. I used the first method, as I did not wish to litter up the room with sawdust and shavings; this method, however, demands a good ear.

To lower the pitch of a bar, it is hollowed out on the underside with a draw-shave, while held in a vise. To raise the pitch, a little is sawed off the end of the bar. Experiment will teach the constructor just about how much to remove in either case. The bars should be laid

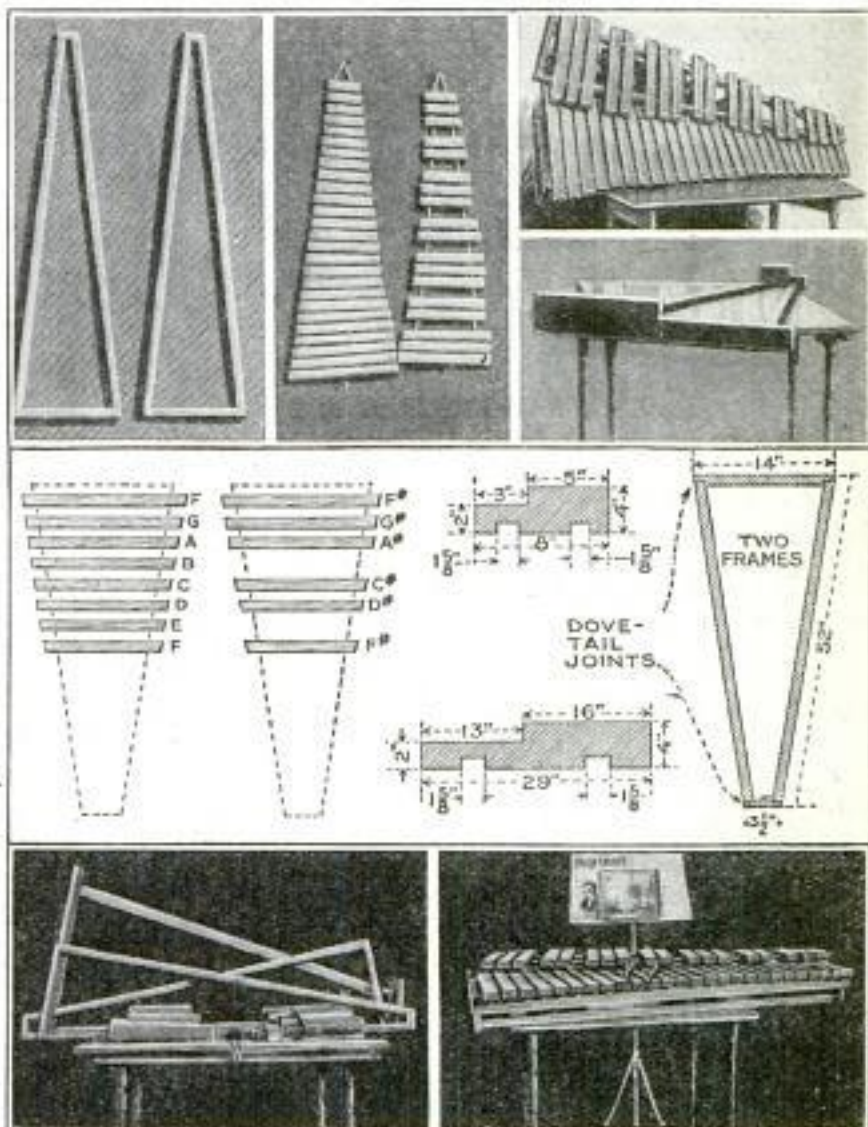

Upper Left: Triangular Bar Frames. Upper Center: The Finished Bars. Upper Right: Bars and Stand. Center: Details of Construction. Lower Left: Instrument Knocked Down. Lower Right: Xylophone Complete

in the approximately correct position on the frame, and struck with the mallet, to sound the note for tuning.

After tuning, the bars are drilled, about 2 in. from each end, for a heavy cord, and then sandpapered to a fine finish, stained, and varnished.

All the natural bars are strung together, on one pair of cords, a $\frac{1}{4}$ -in. piece of rubber tubing being slipped over the cord between adjacent bars. The sharp and flat bars are strung on their cords in groups of two and three, pieces of tubing $\frac{5}{8}$ in. long being used between bars, and

pieces 2 in. long between groups. The bars are then laid on the frame, and the cords fastened tightly to screweyes in the ends of the frame.

The instrument proper is now finished, but in order to raise the sharps and flats above the naturals, a stand is made, using

the pieces of 4-in. stock and two lengths of the 1 $\frac{5}{8}$ -in. stuff. The endpieces of the stand are stepped, and the braces set into grooves cut in the underside.

If xylophone felt, which is $\frac{1}{4}$ in. thick, cannot be obtained readily, a soft $\frac{1}{4}$ -in. rope can be used on the frames instead.

LENGTHS OF BARS IN INCHES

| | | | | | |
|---------|------------------|---------|------------------|---------|-----------------|
| F | 18 $\frac{3}{4}$ | G | 13 $\frac{3}{4}$ | A | 9 $\frac{1}{2}$ |
| F sharp | 17 $\frac{3}{4}$ | G sharp | 13 $\frac{5}{8}$ | A sharp | 9 $\frac{3}{4}$ |
| G | 17 $\frac{5}{8}$ | A | 13 | B | 9 |
| G sharp | 17 $\frac{1}{4}$ | A sharp | 12 $\frac{3}{4}$ | C | 8 $\frac{1}{2}$ |
| A | 17 | B | 12 $\frac{1}{2}$ | C sharp | 8 $\frac{5}{8}$ |
| A sharp | 16 $\frac{3}{4}$ | C | 12 | D | 8 |
| B | 16 $\frac{3}{8}$ | C sharp | 11 $\frac{3}{4}$ | D sharp | 7 $\frac{3}{4}$ |
| C | 15 $\frac{3}{4}$ | D | 11 $\frac{1}{2}$ | E | 7 $\frac{1}{2}$ |
| C sharp | 15 $\frac{1}{2}$ | D sharp | 11 $\frac{1}{8}$ | F | 7 $\frac{1}{8}$ |
| D | 15 $\frac{1}{4}$ | E | 11 | F sharp | 7 |
| D sharp | 15 | F | 10 $\frac{1}{2}$ | G | 6 $\frac{3}{4}$ |
| E | 14 $\frac{3}{4}$ | F sharp | 10 $\frac{1}{4}$ | G sharp | 6 $\frac{5}{8}$ |
| F | 14 | G | 10 | A | 6 $\frac{3}{8}$ |
| F sharp | 13 $\frac{3}{4}$ | G sharp | 9 $\frac{3}{4}$ | A sharp | 6 $\frac{1}{8}$ |
| | B | | 5 $\frac{3}{4}$ | C | 5 $\frac{1}{4}$ |

Radio-Wave Trap

In large cities, when different stations are broadcasting at the same time, much interference is caused in the reception of

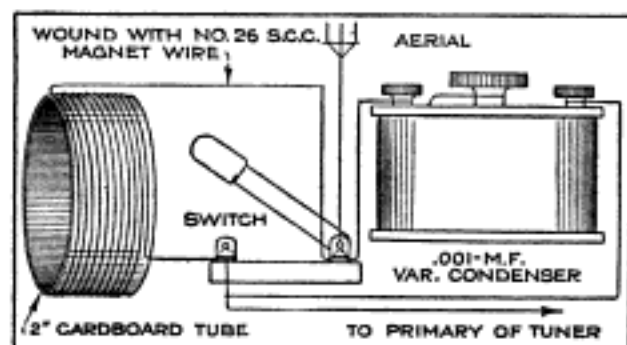

A Simple Radio-Wave Trap That will Eliminate Much Interference When Tuning the Radio-Receiving Set

the waves. This can be prevented, to some extent, by a wave trap. This consists of a large variable condenser, a coil of wire, and a small switch, connected as shown in the diagram. A 43-plate variable condenser with a capacity of .001 mf. is suitable.

The number of turns of wire wound on the cardboard tube depends on the length of the wave to be eliminated; for instance, if it is desired to eliminate a 200-meter wave in tuning to 360 meters, from 30 to 40 turns are necessary, and more turns, in proportion, for greater wave lengths. It is a good idea to use a common adjustable tuning coil for this purpose. Honeycomb coils can also be used if desired. To eliminate interference, the condenser is adjusted until the undesired wave is no longer heard, and the receiving set can then be tuned to maximum signal strength.

A Simple Bookmark

The corners of a sealed envelope, cut off in the shape of triangles, serve excellently as bookmarks. They will fit over the corners of the pages, and are free from an objectionable feature of most bookmarks, as they do not cover up any of the printed matter.—A. W. Michener, New York City.

Wrench for Headlamp Rims

Considerable force is required to turn the rim of an automobile headlight when it has become

rusted, and by force improperly applied or with improper tools, considerable damage may be done to the lamp. The drawing shows a convenient homemade tool that will remove any sticking headlamp rim without damage. A strip of brake lining is attached to one end of the two-piece handle, the separate parts of which are hinged together in the manner indicated, leaving an opening just a trifle larger than the thickness of the brake lining which passes through it. The binding action between the two parts of the handle holds the free end of the brake lining tightly and prevents it from slipping when the handle is pressed downward.

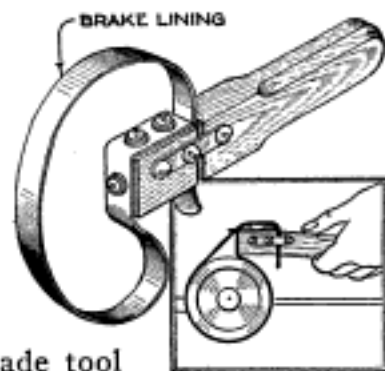

An Easily Made Photo Cabinet

The cabinet shown in the illustration, constructed like a sectional filing case, was made from discarded boxes, and proved of considerable value in filing photograph prints, negatives, and other photographic material. The top section, made from a 12 by 15 by 24-in. box, contains three drawers. The upper one extends the full width of the box, and is used to store the camera, tripod, film, developing trays, and similar material. The two smaller drawers below this have an inside width of $5\frac{1}{8}$ and $6\frac{5}{8}$ in. The narrow one contains a bibliography on photography, and a card index, on 3 by 5-in. cards, of the mounted photographs and the negatives. The wider drawer contains film and plate negatives; these are kept in $6\frac{1}{2}$ by $3\frac{5}{8}$ -in. plain manila envelopes, numbered in consecutive order, so that it is possible to find a particular negative quickly by referring to the subject index in the narrow drawer, to ascertain what the filing number is. The lower section contains one large drawer, in which are kept the photographs, mounted on 12 by $10\frac{1}{2}$ -in. pieces of cardboard. This size will hold five postcard-size photographs, three arranged vertically and two horizontally, or vice versa, as the card is held. Photos on related subjects are mounted on the same card and on adjacent cards. Each photo bears the same number as the corresponding negative and is listed in the subject index. Then if any group of photographs is wanted, it can be found and returned without any trouble. The lower drawer may also contain descriptive matter relative to the photographs, as well as books and catalogs on photography.

This method of filing photograph negatives is particularly useful in connection with photographs of a commercial character, as for instance, construction details or machining operations, where it is generally necessary to file some descrip-

tive matter with the prints, and where frequent reference is made to them.

The large drawer is very heavy when full, and to insure easy sliding, a roller should be made for it. For this purpose

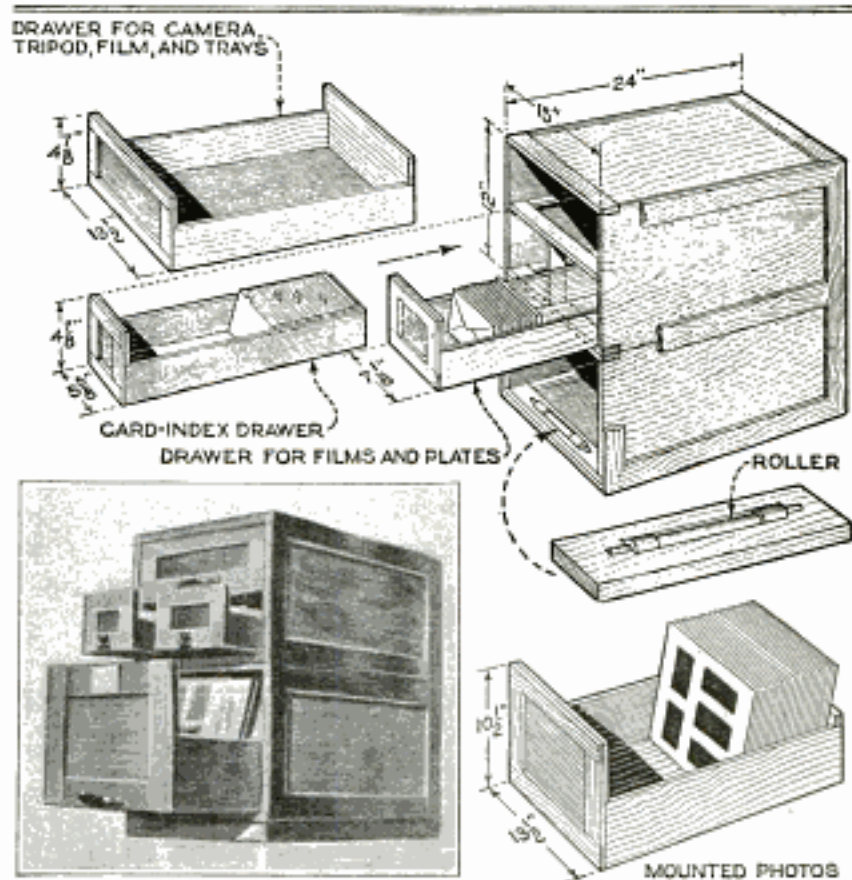

An Excellent Cabinet for Filing Prints, Negatives, and Other Photographic Matter: It Has a Subject Index, Referring to the Numbered Photographs and Negatives, and Space for the Camera, Tripod, and Developing Trays

a porcelain telephone fuse will serve excellently. The end nuts are removed, and short lengths of hollow curtain pole are slipped over the threaded ends, to serve as journals. A slot is cut in the front lower crosspiece of the box, and the roller laid in it, as shown in the drawing.

The method of construction is indicated in the drawing as well as the general dimensions. The panel strips are nailed on last, and give a very neat appearance to the cabinet.—C. N. Schuette, San Francisco, Calif.

Nonslip Ladder Rungs

When a bicycle tire is worn out, do not scrap it, but tack sections of it to the steps or rungs of ladders, thereby making them nonslipping. The inner side of the tire is slit the full length with a sharp knife, and the tire is then cut into pieces of the proper length, which are tacked to the rungs.—H. A. Gustafson, Chicago, Illinois.

A Spinning Dial for Games of Chance

The spinning dial shown in the illustration is an improvement over the usual

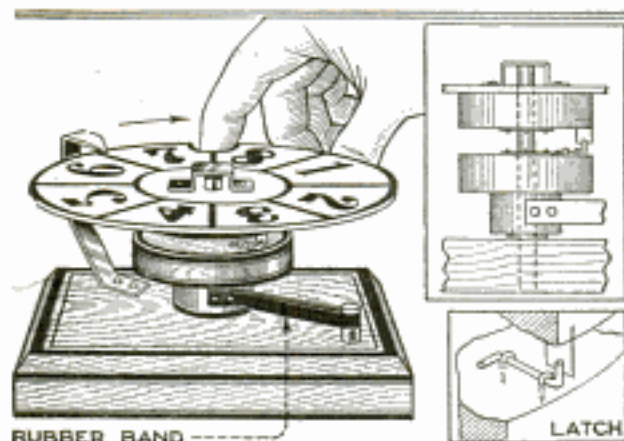

A Simple Spinning Dial for Games of Chance That is Spun by Pulling It Around a Quarter Turn with the Finger, and Then Releasing It

type, spun by snapping an index hand with the bent forefinger.

The wooden wheels can be cut from old spools, and the vertical axle used should be selected to fit easily in the spool holes. It is a short length of iron or brass rod, driven into a hole bored in the base block. The lower wheel is made up of a large and a small disk, glued together, and dropped over the axle, with a small washer between it and the block. A strong rubber band is tacked to the smaller disk, and stretched over a peg glued in a hole in the base, as shown. The upper wheel carries a dial made of heavy white Bristol board, with the numbers painted on it, and is supported on the axle by a small stirrup, made of sheet brass or tin and tacked to the wheel. Pointing the end of the axle, and making a centerpunch mark in the underside of the stirrup, in which the pointed end may fit, will make an easier-running dial, if found necessary. A wire latch, formed as shown and attached by staples to the lower wheel, engages with a short piece of sheet metal driven into the underside of the upper one. A sheet-metal index or pointer completes the device.

To spin the dial, it is pulled in the direction indicated by means of the finger, placed in a notch cut in the dial, about a quarter turn, then let go. The upper wheel pulls the lower one, by means of the latch, when turned clockwise, and, when the dial is released, the tension of the rubber band drives both wheels back. The upper one, carrying the dial, then spins freely, as the latch engages only in one direction.

Lining Stove Fire Boxes

Fire boxes, whether made of wrought or of cast iron, usually become burnt and brittle, due to the intense heat, and, as a consequence, they soon deteriorate. To prevent this, stove manufacturers provide a fire-clay lining inside of the fire box. This lining, however, also disintegrates in time, and exposes the iron.

A mixture for lining fire boxes, that has been found to be extremely durable, is made of 6 parts potter's clay, 2 parts plaster of Paris or cement, 1 part wood ashes, and 3 parts carborundum in powder form. All of these ingredients are mixed well while dry. Water is then added to make a stiff paste, and this is applied to the parts requiring repair, or to the whole fire box. The carborundum in the mixture enables it to withstand the heat. After the stove is lined with this mixture, it should be allowed to dry for a few days. When starting the fire for the first time, it should be brought to the point of maximum heat gradually.

Bolt for Loose Truck Fenders

The illustration shows a simple method of tightening loose fenders on a light truck.

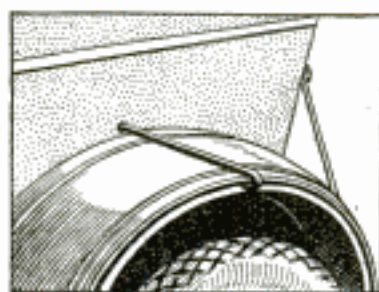

A $\frac{1}{4}$ -in. hole is drilled in the side of the body, just above the highest part of the fender. A long bolt, with the head cut off and the end bent over to form a hook, is hooked over the edge of the fender, and the threaded part is pushed through the hole in the truck side. By turning the nut on the inside, the fender can be tightened as much as necessary.

Flower Holder Made from Olive Bottle

Attractive flower holders for the porch and summer home are easily made from the tall, cylindrical bottles in which olives and pickles are packed. A piece of cretonne is sewed around the bottle just below the neck. The lower edge is gathered and drawn together under the bottle, and a tassel attached. A piece of colored ribbon or cord is sewed to the upper edge, so that the holder can be hung on a nail or hook in the wall.

Unable to secure any information concerning punchings used - suggest transformer in August

A CHRISTMAS-TREE LIGHTING TRANSFORMER

By E. E. SCOTT

MANY who have admired a Christmas tree in a store window, ablaze with varicolored electric lights, have doubtless continued to use the dangerous wax candle for their own tree, after inquiring the price of a lighting outfit. Most of these outfits are expensive because it is necessary to furnish a small transformer for stepping down the voltage of the house-lighting circuit to the 6 or 12 volts required by the small decorative lamps.

It is not a difficult job to make a small transformer, however, and this article describes how the author made his own, from magneto punchings. The punchings used by the author were obtained from an automobile-junk dealer; if any difficulty is experienced in obtaining punchings of similar size and shape, ordinary shuttle-armature magneto punchings, which are common, can be used, by winding the wire on a 3-in. stack, without a form, and adding about one-tenth more wire to the low-voltage coil, to make up for magnetic losses, which are due to the fact that there is not a complete magnetic circuit.

The construction of the coil proceeds as follows: First, a wooden form is made, as thick as the center leg of the punching, or core; 3 in. wide, and long enough to be held conveniently in the hand. One end is beveled, as shown, and a triangular piece, of the same material, tacked in place of the piece cut off. This permits the winding to be easily removed, when complete. To provide sufficient clearance for the core to slip easily into the coil, some tin guides are cut and bent, as shown, and fastened to the form by a strip or two of adhesive tape; the ears on the guides keep the wire within the necessary limits, and aid in forming the coil properly. The width of the guides, between the ears, will depend upon the

inside dimensions of the openings in the core. Having completed the form, wrap two layers of bond paper around it, and shellac them in place. Starting at either end, wind on 21 turns of No. 16 silk or cotton-covered magnet wire. At the 21st turn, scrape the wire bare, solder a thin strip of copper to it, tape the joint and strip, and continue winding. Between the layers of wire put a layer of bond paper, shellacked on. When 21 turns more have been wound on, bring out all three leads, that is, both ends of the wire and the copper strip, to one end of the coil, and shellac two layers of bond paper over the coil.

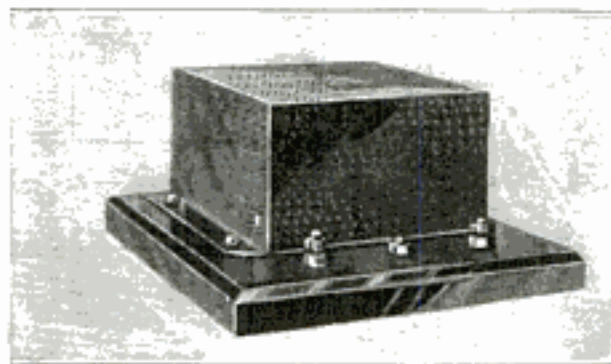

A Small Homemade Transformer for Lighting 6 or 12-Volt Christmas-Tree Lamps

Wind over this secondary coil a coil of 364 turns of No. 22 silk or cotton-covered wire (making no attempt to form layers, but taking care to prevent the wire from "bunching") and round the outer turns to conform to the shape of the inner diameter of the core. The ends of the coil should be bound down with tape, to prevent the wire from breaking, as it is quite fine. Remove the form and the tin guides, and proceed to wedge as many of the punchings as possible into and around the core. The punchings are cut, at the points marked A, so that they can be spread at these points, and the center leg pushed through the coil center. The length of the core, when wedged as tightly as possible, should be 3 in. When completely assembled, slide some heavy paper between the outside of the coil and the inside of the core, as shown in the drawing. The completed core and coil should be soaked in shellac overnight, and baked in a slow oven for about 24 hours, when a hard, solid unit will be formed.

The next step is to solder pieces of bell wire, about 4 in. long, to the three leads of the low-voltage coil, and a long piece

of twin lamp cord to the leads on the high-voltage coil. A wooden base, of the dimensions shown, is then made, of $\frac{1}{2}$ -in. hardwood, and holes are drilled in it for

shown complete in the drawing; they should be about $\frac{3}{16}$ in. in diameter, spaced $\frac{1}{2}$ in. apart, on both top and sides of the cover. The cover and base may now be

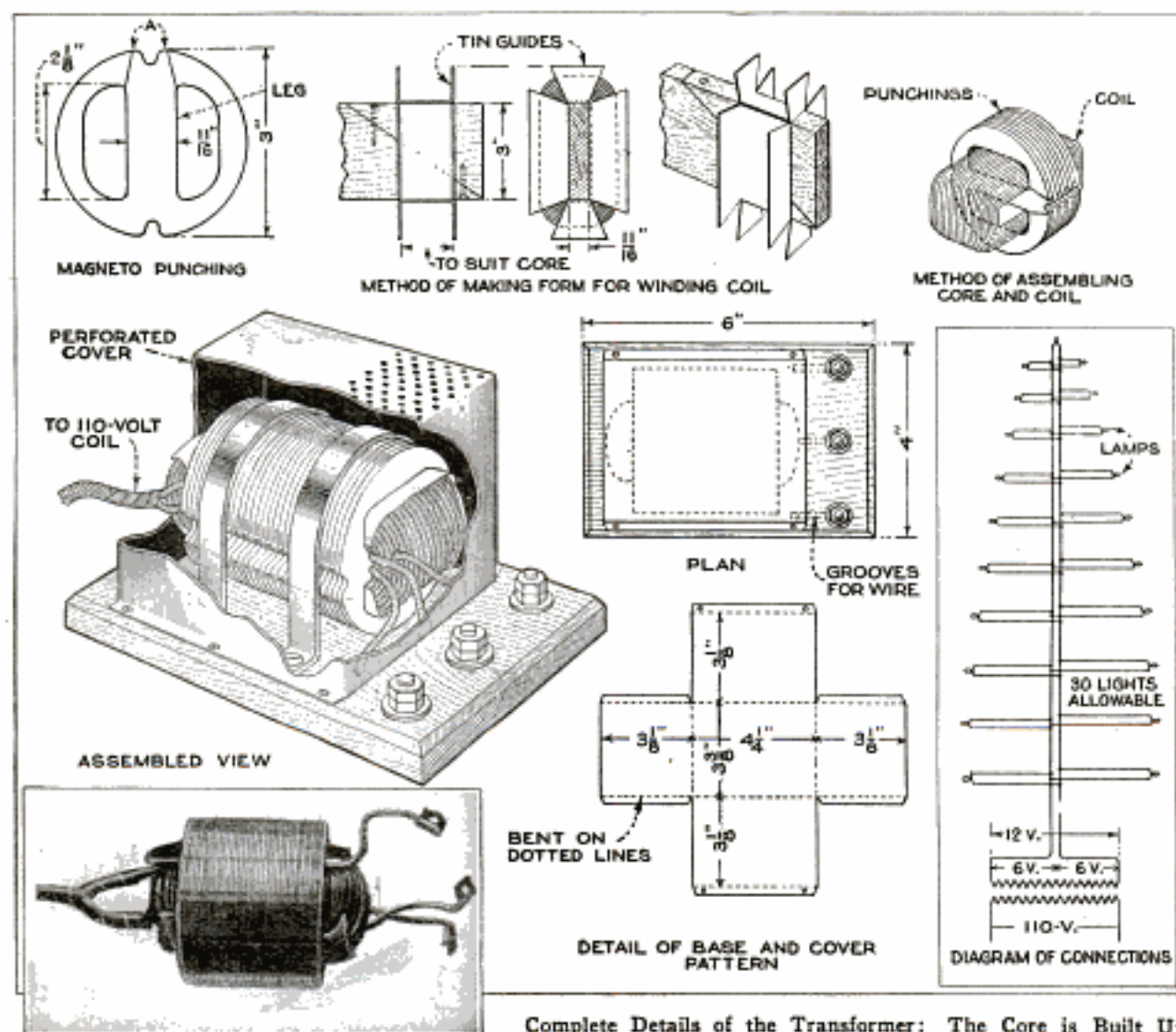

Complete Details of the Transformer: The Core is Built Up from the Discarded Magneto-Armature Punchings Shown at the Upper Left. The Insert at the Lower Left Shows the Completed Core and Coil, Ready for Mounting. A Wiring Diagram for the Lamp Cable is Given at the Right.

three terminals and the three bell-wire leads; grooves are also cut in the underside of the base, as indicated, for the leads.

The coil is placed in position, and the low-voltage leads passed through the holes; then lugs are soldered to their ends, so as to make good contact with the terminal screws. When the latter are put in place, the low-voltage side is complete. The coil may now be fastened to the base, as shown, using strips of tin or brass, $\frac{3}{8}$ in. wide.

A case of perforated metal should be made as shown in the drawing. A developed pattern for this is given, so the cutting and folding will be easy. The lapped edges should be soldered, to make the cover rigid. The perforations are not

enameled green, to harmonize with the tree.

The remainder of the apparatus consists of a main cable, about 12 ft. long, at the end of which is attached the socket for the lamp for the tree top. The other lamps are connected by branch cords, as shown in the wiring diagram.

This transformer is suitable for a 110 or 115-volt, 60-cycle circuit, and will serve thirty 6 or 12-volt, 3-watt lamps. If one end of the cord is connected to either of the outer terminals, and the other end to the center terminal, the potential will be 6 volts. If the ends are connected to the outer terminals, the potential is 12 volts.

The lamp cord on the 110-volt side can be made as long as desired, and fitted with a plug to fit a lamp socket.

Towing the Dinghy

There are numerous little pitfalls that lie in wait for one who attempts to run a large boat single-handed, and these may cause much annoyance, besides entailing considerable expense. One of these accidents, commonly called the "dinghy nuisance," is to have the painter of the dinghy wind around the propeller. This may not result in serious damage, but at least means a job of disentangling the rope in the water, which is a very unpleasant task, especially in cold weather.

To avoid this trouble, one owner, running a motor cruiser on the Lake of the Woods, Manitoba, employed a novel method of keeping the painter out of the propeller. This he did by stringing the rope with fishing-net floats, spaced about 1 ft. apart, which kept it from sinking. With a bow fender on the dinghy to prevent possible injuries resulting from collisions, it was possible to navigate in crowded water without being annoyed by the painter.—H. Webster, Winnipeg, Can.

Shading Pen Draws Borders

An ordinary No. 4 shading or marking pen, with a notch cut in the center, as shown, to make two points, makes an excellent bordering pen. Only one side is filled with ink, the other being pressed against the T-square or triangle. A pen of this kind will draw border lines that are always the same width.—C. R. Jones, Chicago, Ill.

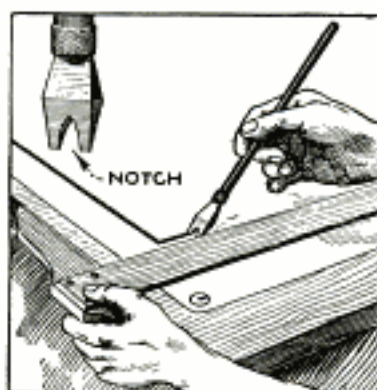

An Emergency Fishhook

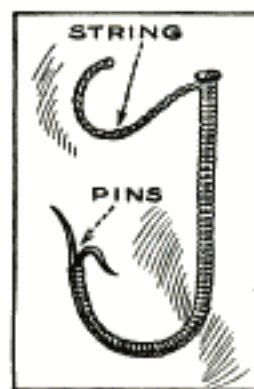

When out of hooks on a fishing trip, it is a simple matter to make some from pins. Fine string or thread is wound around two pins so that only the points protrude. These are bent over and the line is tied below the heads.—Louis Teuteberg, Hann.-Münden, Germany.

Novel Type of Sled for the Kiddies

A novel sled, designed on the order of the three-wheeled leg-power cars so popular during the summer, will meet with

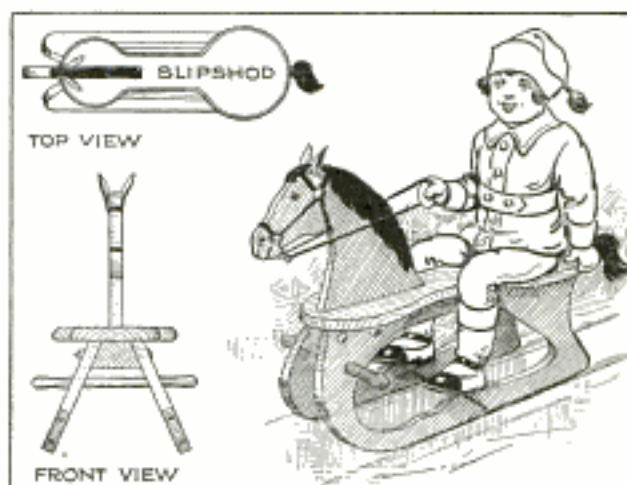

An Attractive and Sturdy Sled That Proves Very Popular among the Youngsters during the Winter

particular favor among the youngsters in the winter. Aside from the fact that it is solid and strong, it is higher than the ordinary sled, and thus prevents the child's clothes from dragging through snow and slush.

In constructing this sled, it is designed to suit the size of the child for whom it is intended. Lengths of flat or half-round iron are used to shoe the runners. When completed, the sled is painted to make it resemble a horse as nearly as possible.—F. J. Rosenberg, Redondo Beach, Calif.

Automobile-Hood Holder

When one side of an automobile-engine hood is lifted, in most cases, it must be held or rested on the cowl, invariably marring the finish.

A holder, such as the one illustrated, will prevent all possibility of marring the finish as well as any tendency of the hood to fall down and hit the repairman's hands or neck. A piece of stiff steel wire is bent to form the hook shown, which is fastened on the engine side of the dash with a large screw or small bolt. By experimenting a little, a position where the hood is well balanced can be found.

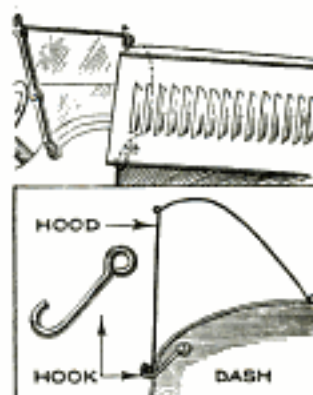

Door Spring Combined with Hinges

A very practical, neat, and inexpensive spring arrangement for closing doors is shown in the illustration. Although this

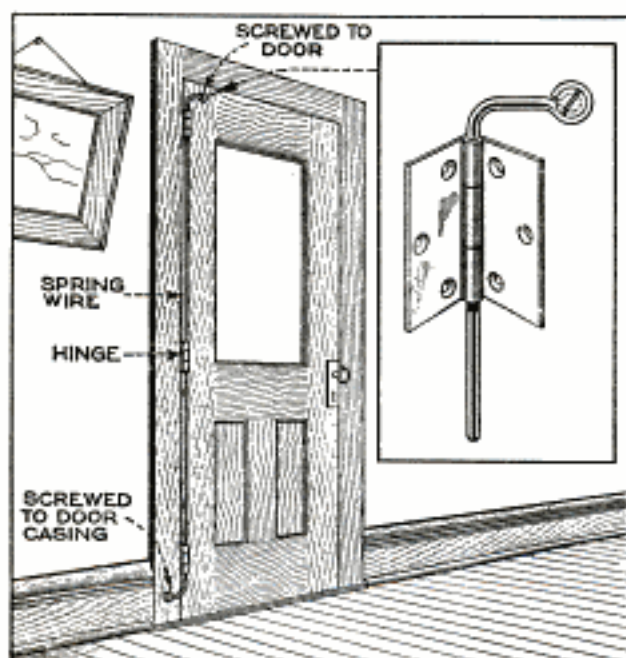

A Practical Spring That Is Neat in Appearance, and can Easily be Attached to Any Door

method was applied to a kitchen door, it is applicable to the doors of closets, cupboards, tool boxes, or any door that it is desired to close automatically.

After the pins were removed from the three butt hinges of the door, a length of steel wire, of the same thickness as the pins, was inserted through the hinges. Eyes were formed on the ends, which were then bent over and attached to the door and casing as shown, by means of woodscrews.

Muffling Sound of Telephone Bell

During sickness, it is often necessary to muffle the telephone bell so that its ringing will not annoy the patient, but

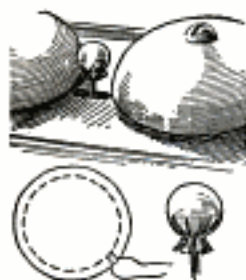

may still be heard by others. This can be done very effectively by cutting out a circular piece of cloth, 1 in. in diameter, and running a length of string through cuts made around the edge, so that the cloth can be drawn tightly over the hammer and tied. When the bell is rung, the result will be a buzz rather than a ring. The cloth can be turned around when it wears through on the sides that make contact with the bells.

Re-Covering a Card Table

When the covering of a card table needs renewing, do not remove the old covering unless badly torn. Place two thicknesses of cotton wadding over the surface, and draw one thickness of strong cotton cloth over it tightly. Cover this with dark-green holland. This surface is soft and smooth, and enables one to pick up a card without drawing it to the edge of the table. It is also noiseless and easily dusted. The table top itself should be made of 3 or 5-layer plywood, so that it will not warp, and cause the cloth to wrinkle.—J. A. Beebe, Rochester, N. Y.

Churn Made from Sirup Pail

A simple churn, that will produce butter in a short time without much effort on the part of the operator, can be made at very small cost.

The material used to construct it can be easily obtained; it consists of a sirup pail, a small wooden disk, into which some long spikes are driven, a clamp to hold the pail, two small screen-door springs, two shelf brackets, and a

wooden upright, about 6 ft. long. The wooden disk is attached to the can cover, by means of small wood screws, in such a way that the spikes project downward into the pail when the cover is in place. A small hole is drilled through the cover and disk and fitted with a cork. The pail is held in the clamp and is suspended between the screen-door springs; these are attached to the brackets on each end of the upright. The upright is screwed to a convenient wall.

After the pail has been filled to within 2 in. of the top with sour cream, it is pulled down as far as possible and released. It will then move up and down very rapidly for some time, due to the alternate stretching and recoiling of the springs. By pulling the pail down and releasing it at intervals, the butter will be churned in a short time.—L. E. Owen, College View, Neb.

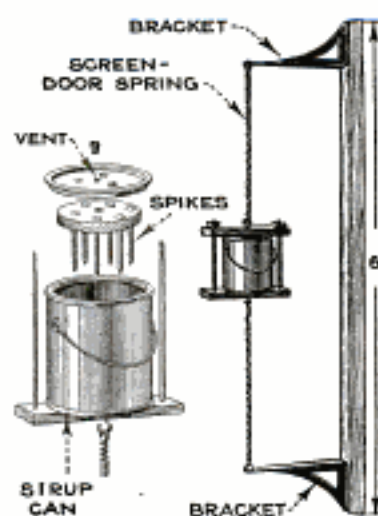

How to Make a Toy Tractor

By JOHN A. PRIOR

HAMMER, saw, and tin snips, or a pair of old shears, are the only tools required for making the toy tractor shown in the drawings. Driven by a form of rubber-band motor, it will run

wheel axle by a thread, wrapped around the axle and tied to the nail head. The front wheels are turned to the left by the thread, and the tension of a rubber band, tacked to one side of the axle, and to the

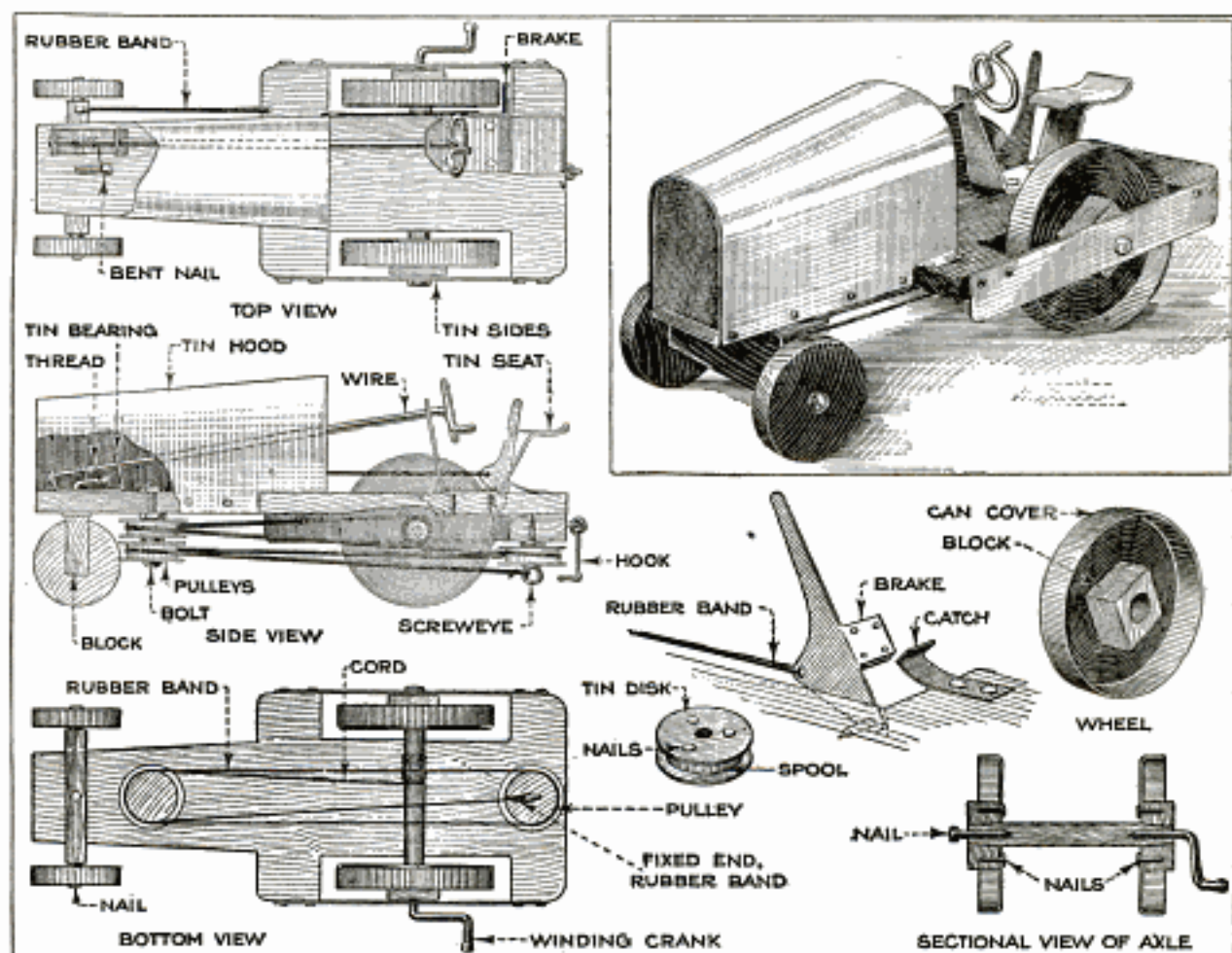

A Simple Rubber-Band Driven Toy Tractor That will Provide Much Amusement for the Little Folks: It can be Made Quite Realistic in Appearance, will Run 15 to 20 Feet on One Winding, and, If a Strong Band is Used, will Draw Small Trailers

15 or 20 ft. on one winding over a smooth surface, and, if a sufficiently strong band is used, the tractor will haul toy trailers. As the size of the floorboard, or frame, depends somewhat upon the size of the wheels, dimensions are purposely omitted. A good length is at least three times the diameter of the large driving wheels, and the board should not be more than $\frac{1}{2}$ or $\frac{5}{8}$ in. thick, to keep the weight at a minimum.

The driving wheels are made from can covers, from 4 to 6 in. in diameter. The manner of fitting them to the axle is shown so clearly in the drawing as to require no explanation. The axle bearings are simply holes punched or drilled in tin strips tacked to the frame. The front wheels are pivoted to the body by a bent nail, which is connected to the steering-

frame, as shown, pulls them around to the right when the steering wheel is turned in the opposite direction. The tin hood, seat, steering wheel, and brake, while not actually necessary, add to the finished appearance of the toy.

The most important feature of the tractor, of course, is the rubber-band motor, which is different from the usual twisted-band form, to meet the demand for slow speed and greater power. The tension of the rubber band acts through a cord wound onto the driving-wheel axle. To make the band long enough, it is passed around three pulleys, which are simply cut-down spools, mounted on nails for shafts. It is not essential that they be very free-running; in fact, a little friction at these points will help to hold down the speed of the tractor when the motor

is tightly wound. The pulleys are provided with flanges, made from tin disks, to prevent the band from slipping off. The rubber band is fixed to the rear-pulley axle, and passed around the pulleys in the manner indicated, the free end being attached to the driving cord fastened to the rear axle. The rubber band used should be a "live" one, and can be cut from an old inner tube. The driving cord should be small, but stout and smooth; fishline is best. The unstretched length of the rubber band should not be much greater than the distance between the front and rear pulleys. The motor is wound either by means of a nail, bent

into the form of a crank, and driven into one end of the rear axle, or by turning the wheels. The size of the axle depends upon the strength of the rubber bands; $1\frac{1}{2}$ to 2 in. is a good size to try. If there seems to be plenty of power, the tractor can be made to travel farther by cutting down the axle, but, of course, this will reduce the "drawbar pull."

When the motor is tightly wound, the wheels are likely to slip, but this may be overcome in several ways, either by reducing the diameter of the axle, adding weight over the rear wheels, or roughening the rims of the wheels by notching or punching holes in them with a nail.

Utilizing an Old Electric-Fan Motor

A fan motor has been found to be very useful for running a small foot lathe,

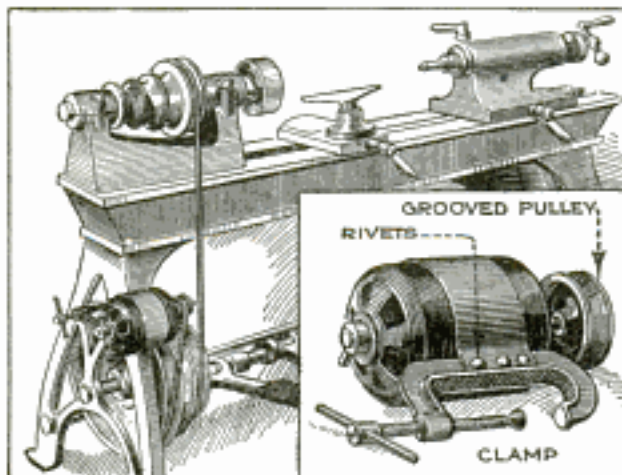

An Old Electric-Fan Motor, Attached to a C-Clamp, can be Used for Driving Any Light Machine

sewing machine, grinding wheel, or practically any other machine not requiring much power, and which is provided with a pulley.

To adapt a fan motor for such purposes, remove the stand, fan, and guard. Fit a steel band around the body of the motor, and rivet the band to a machinist's C-clamp, as shown in the illustration. To use the motor on a small foot lathe, clamp the motor to one of the supporting legs, and drive as shown. Provide the motor with a long lamp cord and a plug, so that it can be used at a distance from a socket.

A motor of this kind can also be attached to a carpet sweeper to revolve the brush at a high rate of speed, which is much more effective than when the brush is driven by the sweeper roller wheels. A heavy rubber band is used as a belt, and a pulley fastened to the brush shaft.

Testing Strength of Magneto Magnets

The magneto of a common car is incorporated with the flywheel, and consists of 16 permanent magnets that revolve in front of a stationary plate, to which a number of coils are attached. These magnets gradually lose their strength, and it is then necessary to re-magnetize them. In doing so, it is desirable to provide some means of determining the relative strength of each magnet, in comparison with that of a new one, and for this purpose the testing device shown in the drawing is of considerable value.

It consists of a spring balance attached to a vertical brass plate, the bottom edge of which is bent at right angles to form a stop. The plate is screwed to a wall. An iron rod, bent to triangular shape, as shown, is attached to the scale hook so that there will be a space of $\frac{1}{2}$ in. between the lower edge of this rod and the brass plate. The magnet to be tested is brought against the brass plate directly under the triangular iron rod, so that it will exert a pull upon the rod. The strength of this pull will then be registered accurately by the indicator of the scale. Two pins may be driven into the wall, to support the magnet, as shown, although these are not essential.

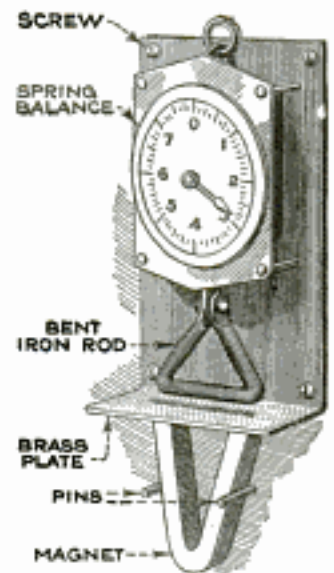

A Novel Push Car

The push car shown in the illustration can be made from scrap lumber, and when properly painted, will make a splendid toy for a growing child. The illustration really does not do justice to the solemn doglike effect produced by the novel method of mak-

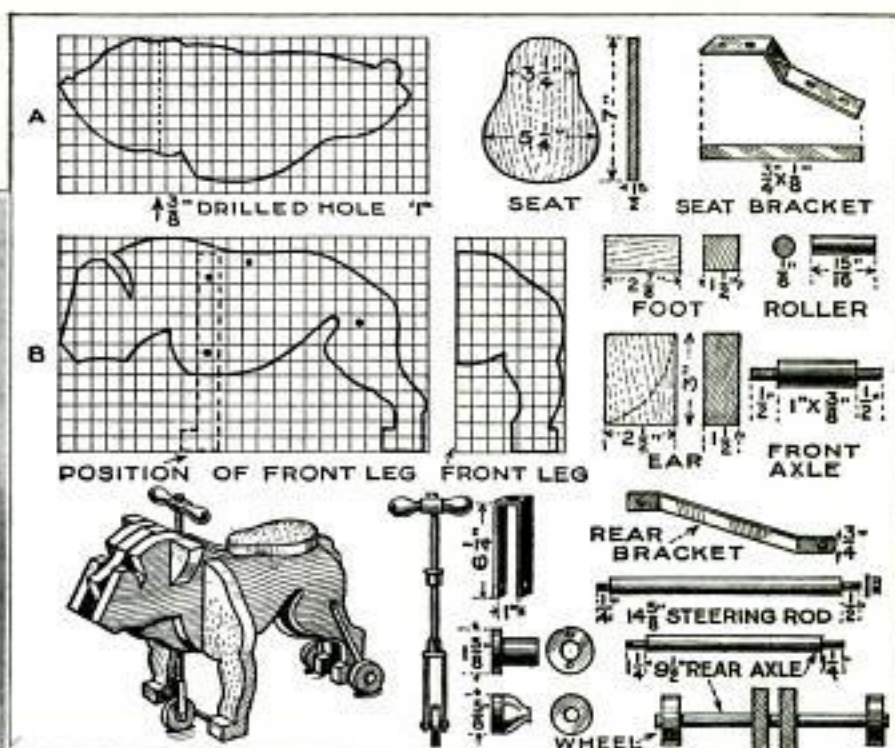

A Novel Push Car, Constructed and Painted to Resemble a Bulldog: It can be Made at Slight Expense, and will Provide an Endless Amount of Enjoyment for the Small Boy. The Body is Laid Out by Means of the Patterns Given

ing the head; it is sufficiently realistic to please any small boy.

The first step is to lay out the design of the body and leg pieces. These may either first be laid out on cardboard, or directly on the wood. By ruling the surface of the wood or cardboard into 1-in. squares, it is a very simple matter to copy the design. The stock used for the body is $\frac{3}{4}$ -in. pine. One piece is cut to pattern A, and two to pattern B; two ears and two forelegs and feet are then cut to the dimensions shown.

A $\frac{3}{8}$ -in. hole is drilled vertically through piece A, at the point indicated, for the steering shaft. This hole is counterbored top and bottom for metal bearings.

The forelegs are attached to the sides by long flat-head screws, put through holes bored in the legs, and countersunk. The feet are screwed and glued to the legs, and a $\frac{1}{2}$ -in. rod inserted through holes drilled in the legs to serve as a foot-rest. The three body sections are also fastened together by flat-head screws.

The steering shaft and the flat-steel front-wheel bracket, or housing, are welded together. The remainder of the fittings, and the manner of assembly, are made quite clear in the drawing.

Wood may be used for the wheels, but steel wheels, with a $\frac{5}{8}$ -in. hole, are preferable. Rollers, $\frac{1}{8}$ by $\frac{19}{16}$ in. in size, are used as bearings for the wheel, and are kept in position by nuts and washers.

When complete, give the "dog" two coats of flat white paint, then one coat of enamel. The head, tail, seat, and metal parts are enameled black, the eye slots and body white, and the tongue red.—E. W. Hosens, Cincinnati, Ohio.

Pouring Fluid into Small Receptacles without Spilling

To fill receptacles with fluid from larger containers, without spilling, is quite difficult. By holding a moistened match, or toothpick, firmly across the mouth of the bottle, as shown in the photograph, the job becomes easy, provided care is taken to prevent the liquid from "gulping."



Making a Waltzing-Doll Wagon

A little device that will please the small "mother" immensely is shown in the drawing. It is a wagon with a revolving platform, upon which a doll is fastened so that as the wagon is drawn over the floor, the doll waltzes around.

The wheels and platform are cut out of $\frac{1}{4}$ -in. plywood, to the sizes shown. The drivewheel has a number of finishing nails, $1\frac{1}{4}$ in. long, driven into it, as shown in the detail. The ends of the nails should be cut off, and all rough edges smoothed. A $\frac{3}{8}$ -in. hole is drilled in the center, for the end of the axle. The other wheel is like the drivewheel, but without the nails.

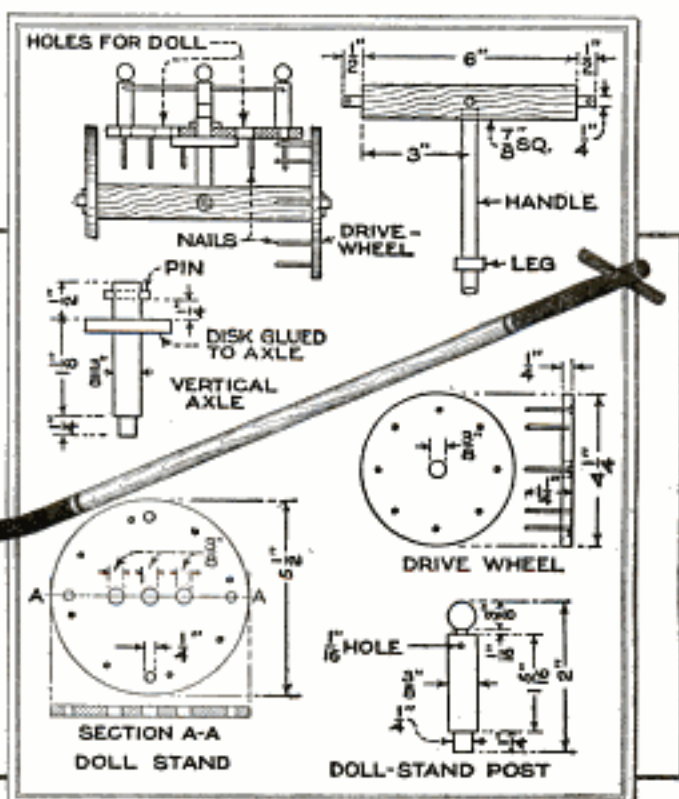
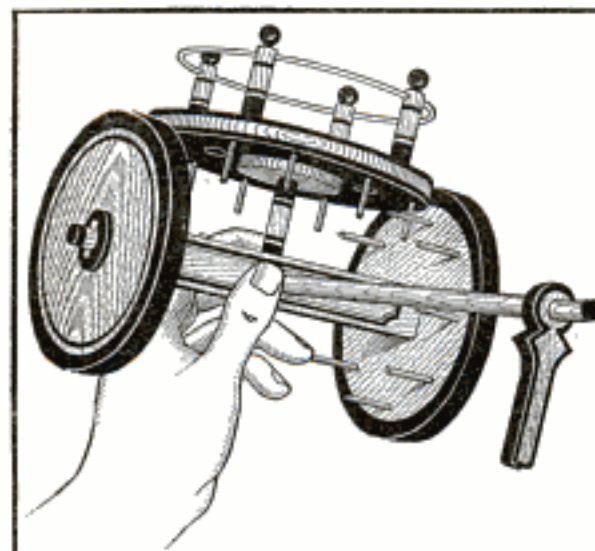

A Simple Homemade Toy for the Little Ones:

A Doll, on the Platform, will Waltz in a Manner Entirely Satisfactory to Them When the Toy is Drawn along the Floor. The Making of a Toy of This Kind would Provide a Fine Exercise for Junior Manual-Training Students

The platform has three $\frac{3}{8}$ -in. holes bored in it, as shown; the center hole is for the vertical axle, while the other two are for the feet of the doll. Four $\frac{1}{4}$ -in. holes are bored in the platform as indicated; these are for the wire-railling posts. These posts are made of $\frac{3}{8}$ -in. round wood, and plain round ones will do very well, if one has no means of turning the ends as shown. Nails are also driven into the platform, at such a radius that they will engage with those in the drivewheel, when the wagon is assembled. A better construction than the foregoing would be to use $\frac{1}{4}$ -in. pegs for the teeth of the "gears." The ends of the pegs should be turned or cut down, and glued into $\frac{3}{16}$ -in. holes drilled in wheel and platform.

The horizontal axle is made of pine, $\frac{7}{8}$ in. square, as shown, and the vertical axle and handle from $\frac{3}{8}$ -in. round stock. The railing on the platform is of $\frac{1}{16}$ -in. brass

or iron wire. The remaining details are quite clear from the drawing.

All stationary parts should be glued in place, including the wooden pins (common matches) that hold the wheels and platform in place.

A toy of this kind provides a very good exercise for junior manual-training students, as it illustrates, in about the simplest manner possible, the principles of gearing. The toy will make a good Christ-

mas present for little sister.—E. K. Wehry, Cedar Rapids, Ia.

Writing on Glass

When writing or lettering on glass, as, for instance, on the slides that are used extensively in moving-picture theaters for advertising purposes, it is impossible to make a neat job unless some preparation is used for coating the glass to prevent the ink from spreading. A simple but very effective substance for this purpose is the white of an egg.

Clean the glass perfectly before applying the white of egg. After covering the whole surface, allow the surplus to run off by holding the glass vertically. When the film has dried thoroughly, the ink will not spread in the least, and the lines can be drawn just as fine as desired.—C. A. Clark, Miyazaki, Japan.

A Strong Waterproof Glue

A waterproof glue of excellent adhesive qualities can be prepared as follows: Soak ordinary glue in water until it swells but does not lose its shape, then drain off the water. Put the glue in a gluepot and add an equal quantity of linseed oil; cook this mixture slowly until the whole is a jellylike mass. It is then ready for use. It must be heated each time it is used.—W. S. Standiford, Youngstown, Ohio.

Making Small Ash Receivers

Capacious and inexpensive ash receivers can be made from the pressed-steel disks used to protect the ends of rolls of prepared roofing. The edges of the disks are rolled or hammered as shown, and mounted on octagonal or circular wooden bases by means of screws driven through the holes in their centers. A coat of enamel finishes the receivers, which are not easily upset.—A. C. Cole, Chicago, Ill.



Quickly Detachable Hinges

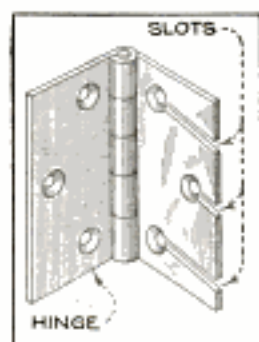

Ordinary butt hinges can be fitted to a light door so as to allow the door to be quickly removed, by cutting slots in the hinges at a slight angle, as shown. The slots must be wide enough to fit the screws used. The door can be removed by opening it, loosening the screws a few turns, and then sliding it off.

A Good Brooder

After experimenting a great deal with various kinds of chicken brooders, none of which proved to be entirely satisfactory, the brooder shown in the illustration was constructed, and gave excellent results.

It was built 3½ ft. square, and 30 in. high, with a floor 16 in. above the bottom of the frame, which was left open. A disk, 19 in. in diameter, was cut out of the center of the floor. A small opening,

6 in. square, was cut in one side of the upper section of the brooder, and fitted

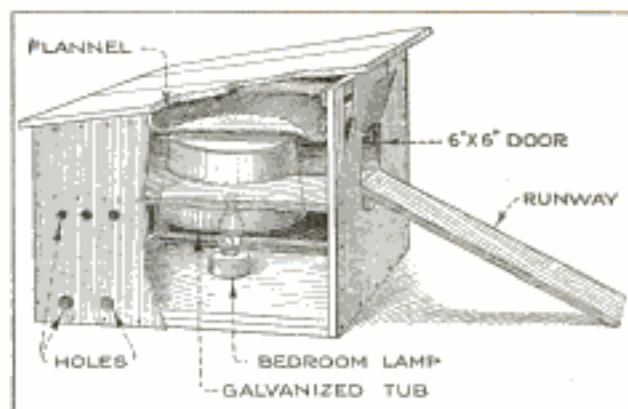

A Comfortable Brooder for Young Chicks: It can be Made in a Few Hours from Material at Hand on Any Farm

with a trapdoor and a 6-in. board, about 3 ft. long, to serve as a runway. A galvanized tub, 12 in. deep, 17 in. in diameter at the bottom, and 21 in. at the top, was fastened upside down in the circular hole in the floor, to form a radiator. A heavy-flannel cloth was nailed to the sides of the brooder, a little above the top of the pan, in order to retain the warmth. A door was then cut out in the lower section, large enough to allow a common bedroom lamp to be placed under the pan, and a few holes were bored in the side of this section to permit ventilation.—H. C. McKay, Eustis, Fla.

Novel Key Holder

Flat keys can be conveniently fastened together, as shown in the drawing, so that they do not take as much space, nor "jingle" as much, as they do when strung on a keyring.

A ¼-in. hole is drilled through each key, the holes in the outside keys being countersunk on one side. A piece of ¼-in. brass tubing is used to rivet the keys together, and as the outside keys are countersunk, the riveted ends of the tubing will be flush with the surfaces of the keys. The keys can then be opened and closed in the same way as the blades of a pocketknife.

If some keys in a set have larger holes than ¼ in., they should be placed in the center. By using tubing for riveting the keys together, they can be put on a keyring with other keys, if desired.

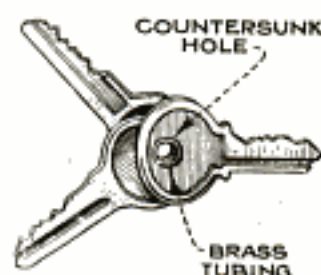

Using the House-Lighting Circuit as Antenna

As it is not always possible, especially in congested cities, to have an outdoor aerial, and as a loop antenna is not very

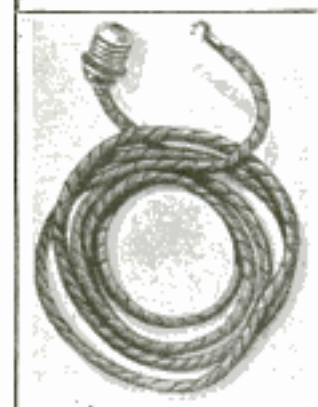

An Inexpensive but Satisfactory Attachment That Enables the Amateur to Use the Lighting Circuit as an Indoor Antenna

efficient unless used with several stages of radio and audio-frequency amplification, amateurs are often confronted with the problem

of providing a suitable antenna. It is possible, however, to hook up on the lighting circuit by means of the arrangement illustrated. This will give excellent results when used with a set that has one or two stages of amplification, providing there is not too much steel construction in the building.

Two pieces of common lamp cord, about 6 or 8 ft. long, are connected at one end to a plug. The other ends are well insulated by wrapping them, singly, with friction tape, so as to prevent them from coming in contact with each other and causing a short. Two other pieces of lamp cord of the same length are soldered at one end to a common terminal, or lug, while the other end of each is insulated as the first pair. The four cords are then assembled as shown in the drawing, with the plug at one end and the lug at the other, the whole arrangement forming a condenser. All four cords are then bound together into one cable by means of tape.

After assembling, the plug is screwed into a lighting socket, and the lug attached to the aerial post on the receiving set. By simply turning the socket key, as if to light a lamp, the device is brought in electrical connection with the network of wiring throughout the whole building. Surprising results can be obtained by this sort of antenna, although the signals will not be quite so loud as when obtained over a large outdoor aerial. With a two or three-step amplifier, it is usually loud enough.—F. L. Brittin, Chicago, Ill.

Preventing Corrosion of Firearm in Holster

Police officers, watchmen, and others whose work makes it necessary for them to carry a pistol, frequently find that it corrodes in the holster. This is due partly to the acids used in tanning the leather from which the holster was made, and partly to the moisture that the holster absorbs from the body and from the atmosphere. Flannel or chamois-skin linings are sometimes used to prevent this corrosion, but holsters provided with such linings are expensive.

An easy, inexpensive, and effective means of protecting the firearm against corrosion is to coat the inside of the holster with paraffin. To do this, the holster is warmed by holding it with the bare hand in an oven. Melted paraffin is then applied to the inside with a small brush. As the holster is warm, the paraffin will not harden on the surface as soon as it comes in contact with the leather, but will penetrate the pores. After it has cooled, and the superfluous paraffin is scraped off, the injurious acids of the leather, and the moisture of the body and atmosphere will not affect the pistol. Sportsmen will find this method also very practicable for preserving hunting arms carried in saddle scabbards.

"Jib" Curtains Increase Auto Comfort

The driver of an open roadster will find that the addition of the triangular "jib" curtains to his car will make driving in disagreeable weather considerably more comfortable without resorting to the both-

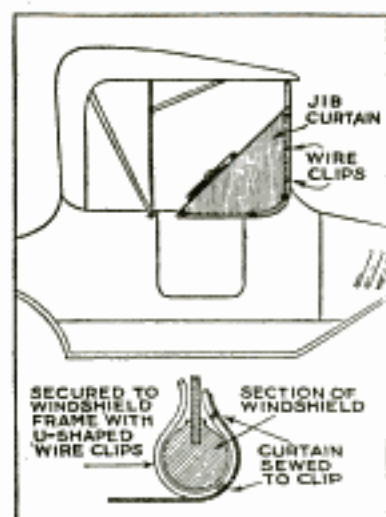

ersome side curtains. Curtains of the type shown can be left in place permanently and do not interfere with the car's accessibility.

The curtains can be made of any waterproof material, the front end being attached to the edge of the

windshield by means of U-shaped wire clips, while the lower edge is provided with eyelets for attaching to the regular curtain fasteners.

ca. Congp 102 Plab St. & W.
Washington D.C.

PRIZE OFFERS AND ANNOUNCEMENTS

359

POSITIVE ELECTRICITY FLOWS UPWARD FROM THE EARTH

The electrical and magnetic condition of the earth is yet somewhat of a mystery. All of the conditions found and things happening have not been accounted for, and the data obtained are often conflicting. One matter which is now puzzling investigators is the amount and character of the electric current flowing across the surface of the earth. It is possible to determine the current passing across an area of any character by determining the total magnetic force acting around the boundary. The scientific investigating ship, the "Carnegie" of the Carnegie Institute of Washington, has cruised over a large portion of the seas, and the data obtained permit the magnetic force around several loops or paths to be computed; and the resulting electrical currents flowing from the surface of the earth can be determined.

The results found for the north Atlantic Ocean indicate a positive current of electricity streaming upward from the surface of the sea having a strength of about one-twentieth of an ampere per square kilometer. This result compares favorably with those obtained from a path taken about the United States, which is around land, where a current of positive electricity was found to be flowing upward of about one-thirtieth of an ampere per square kilometer.

371
STANDARD STATE ZONING-ENABLING ACT ISSUED BY DEPARTMENT OF COMMERCE

Zoning ordinances for the regulation of the use, height, and area of buildings are being adopted by cities in almost every state in the Union, and in some states where there is no specific authority for zoning, these ordinances may be set aside by the courts. For this reason an enabling act, under which municipalities can adopt zoning regulations, is advisable. For the assistance of those responsible for the framing of state zoning-enabling acts, a standard model for such an act has been issued by the Department of Commerce. It is a 20-page mimeographed document with footnotes covering questions which might arise in the wording of various sections and provisions. The publication may be obtained free of charge from the Division of Building and Housing, Department of Commerce, Washington, D. C.

93
FIFTH BIENNIAL NATIONAL CONTEST FOR PROFESSIONAL MUSICIANS

The National Federation of Music Clubs announces the fifth biennial national contest for young professional musicians. These contests are arranged in sequence: state, district, and national. The first will be held in each state between Feb. 15 and March 30, 1923. The entire United States has been divided into 15 districts, and the contests will be held in these districts between April 15 and May 5. The national biennial contest between winners in the district contests will be held at Asheville, N. C., in June, 1923. Contestants in the voice department must be between the ages of 20 and 30 years; those in the violin and piano department must be between the ages of 16 and 30 years. The national chairman is Mrs. Charles A. McDonald, 205 Shorb Ave., Canton, Ohio.

324679
WORLD PRIZE CONTEST FOR THE BEST TREATISE REGARDING IMMORTALITY

For the best treatise on "The Christian Belief in Immortality in the Light of Modern Thought," a prize of \$1,000 will be awarded by The Churchman. An honorarium will be awarded to each of at least two essays of "marked excellence." The contest is open to the world, and writers are recommended not to exceed 25,000 words, though no limit is set. Essays written in foreign languages must be accompanied by an English translation. The characteristics most desirable are personal conviction, cogency of argument and accuracy of facts, and literary style. The contest closes Dec. 1, 1923. Address: Contest Editor, 2 West 47th Street, New York City, U. S. A.

681

MANY PRIZES ARE OFFERED FOR STORIES AND PICTURES OF NOTABLE BUILDINGS

For the best stories and pictures of buildings and landmarks in the United States or Canada, whether merely of local fame or a historical structure, 77 prizes of from \$250 to \$5 each, will be awarded by an association of concerns interested in paints and varnishes. Stories, not exceeding 200 words, without pictures will be eligible for any prize, but preference will be given to the combination. The picture may be in the form of a photograph, postcard, painting, or pen or pencil sketch. More than one picture may be submitted with a story, and any number of stories by the same person. The contest closes Feb. 1, 1923. Stories and pictures in one package should be mailed to: Prize Committee, Save the Surface Campaign, Box 50, The Bourse, Philadelphia, Pa.

BASS AND TROUT OF UNEQUALLED SIZE CAUGHT IN FISHING CONTEST

Two fish of record-breaking size were caught in the fishing contest of the Winchester Repeating Arms Company, announced in our issue of July, 1922. One was a bass, caught in Lake Serpentine, Fla., by O. C. Donehey, of Eustis. It weighed 18 pounds 8 ounces, and was 33 inches in length, with a girth of 28 inches. The other was a trout, caught by W. W. Reynolds, of Driggs, Ida., that weighed 10½ pounds, measured 28 inches in length, and had a girth of 17 inches. Both fishermen, of course, won prize rifles. The fish are said to be larger than any of their kind known to have been previously caught.

FOR BEST ESSAY ON MEDICAL RESEARCH, CASH PRIZE AND MEDAL ARE OFFERED

For the best dissertation on the results of original research in medicine, a prize of \$500 is offered by the Boylston Medical Committee. In case the winning essay shows special originality in the investigations detailed, the Boylston prize medal will be added to the money prize. The subject of the dissertation may be chosen by the writer. Essays entered for this prize must be in the hands of the secretary on or before Feb. 1, 1923. His address is: Reid Hunt, M. D., Harvard Medical School, Boston, Mass.

CONTEST FOR A PLAY SUITABLE FOR OUTDOOR PRESENTATION

For an original play suitable for presentation on the outdoor stage, the Forest Theater of Carmel, Calif., offers a prize of \$100. There is no limitation as to subject or scope, but the most desirable length will be a full evening play. Any play chosen will remain the property of its author, after three performances at the theater. Manuscripts, accompanied by return postage, must be in the hands of the secretary before Feb. 1, 1923. Address: Mrs. V. M. Porter, Secretary Forest Theater, Carmel, Calif.

TRADES AND AGRICULTURE TAUGHT TO DISABLED VETERANS

The opening of the first U. S. Veterans Bureau vocational school at Chillicothe, Ohio, under government supervision, inaugurates a new system in the rehabilitation of disabled veterans. All trades will be taught here, and the men who graduate from this school will be well worthy of employment by the business men of the nation, who are asked to cooperate in this manner in the movement.

WINNER OF THE PRIZE FOR BEST SLOGAN DESCRIBING DURHAM DUPLEX RAZOR

The judges have selected as the winner of the prize of \$500 for the best slogan describing the Durham Duplex Razor, offered in the contest announced in our January issue, 1922, Mr. L. P. Cherry, of Minneapolis, Minn. His winning slogan was "Fewer Strokes for Busy Folks."

900 2 outlandish
Hart World, 1923

When answering prize offers please mention Popular Mechanics Magazine

The Churchman Durham Duplex Razor Co
190 B Baldwin Ave.
Jersey City, N.J.

900. **MISSOURI WRITERS' GUILD CONTEST
FOR BEST SHORT STORY OR POEM**

Any person who has been a resident of Missouri for six months is eligible to compete in the Missouri Writers' Guild short-story and poetry contest, provided such person has not had more than two stories or poems published in magazines of national circulation. One prize of \$100 for the best short story, and one of \$25 for the best poem, will be given. The contest closes March 1, 1923. Address: Contest Secretary, Kansas City Chapter, Missouri Writers' Guild, Kansas City, Mo. *2802 E. 36th St. K.*

892. **U. S. CIVIL SERVICE EXAMINATIONS
TO FILL VARIOUS VACANCIES**

Applications from structural-steel draftsmen to fill vacancies at Pearl Harbor, Hawaii, at \$7.20 and \$7.60 per day, with an additional 96 cents per day while at the station; a vacancy at St. Thomas, Virgin Islands, at \$6.80 per day, and vacancies in the United States at higher, lower, or the same salaries, will be rated as received until Dec. 29, 1922.

Applications from instrument makers to fill various vacancies at salaries ranging from \$900 to \$1,800 a year, plus a bonus of \$20 a month, will be rated as received until Dec. 30, 1922.

Applicants for any of the above positions should write at once for Form 1312, stating the title of the examination desired. Address Civil Service Commission, Washington, D. C., or the Secretary of the U. S. Civil Service Board in the applicant's vicinity.

891. **SPECIAL CANADIAN INSTITUTE PRIZES
FOR ARTICLES ON CHEMISTRY**

To members and students of the Canadian Institute of Chemistry, resident in Canada, a first prize of \$50 and a second of \$25 are offered for the two best articles on the function of the modern chemist in industry, accepted for publication by any Canadian magazine, national in scope and of a business or literary nature. Articles must contain at least 3,000 words. The competition closes May 1, 1923. Address: Secretary, Canadian Institute of Chemistry, Toronto, Ontario.

898. **RECORD MOTORLESS AIRPLANE FLIGHTS
MADE IN A CONTEST IN ENGLAND**

The notable successes of French and German motorless flights raised the question in England whether they had fliers there who could rival the feats of their foreign colleagues, and to settle it a prize of £1,000

919. **HINTS TO ENTRAPPED MINERS BY THE BUREAU OF MINES**

From a recently issued bulletin of the United States Bureau of Mines, come the following hints to miners who may, when entrapped as the result of mine fires, shut themselves in crosscuts by erecting bulkheads:

1. When entrapped by gases, and forced back into a crosscut or drift in which is comparatively good air, keep in mind the thought of building a bulkhead, and collect tools, timber, water, and other necessities while on the way th.

2. Before constructing a bulkhead, make sure that there is no manway, or other connection, with another level, through which fumes could come. Also see that the drift is not in broken ground, or stoped through from a lower level, and back-filled with loose material through which gas could find its way. Even if a tight bulkhead be made, if these conditions are present, the inclosed area will soon fill with gas.

3. Under these conditions, with from 8 to 29 men employed, a bulkhead may be put up in from one to four hours' time.

4. When erected, test a bulkhead for leaks by means of a candle or carbide lamp.

was offered by the Daily Mail. The most notable achievement of the first day of the contest was a 37-minute glide by M. Fokker, the well-known Dutch airman, but this was afterward far surpassed by F. P. Raynham, a British aviator, who remained in the air in a motorless airplane for 1 hour and 53 minutes. On the last day of the contest two world records were established. In a Fokker biplane, J. R. Olley remained in the air with a passenger for 49 minutes, while the French airman, M. Maneyrol, in a tandem monoplane glider, won the Daily Mail prize by remaining in the air for 3 hours 22 minutes, thus beating by 12 minutes the previously established record in Germany by Hentzen.

CONTESTS PREVIOUSLY ANNOUNCED

Medals, Diplomas, and Money Awards: Announced August issue, 1921; awards offered by the Franklin Institute. The Franklin medal is for workers in technology; the Elliott-Cresson is for original research work and invention; the Howard N. Potts is for important development of previous discoveries and inventions. Each award consists of a gold medal with a diploma. There are also a silver medal, and a Certificate of Merit awarded for meritorious discoveries, and cash premiums for certain work in optics.

One Million Francs for Best Motor: Announced January issue, 1922; closes June 1, 1923; address, Aero Club of France, Paris.

Research Thesis by a Woman: Prize \$1,000; announced October issue, 1921; awarded annually; address, Dr. Lilian Welsh, Goucher College, Baltimore, Maryland.

Annual Commercial Airplane Contest for "Italy's Great Trophy": Announced July issue, 1922; address, Aero Club of Italy.

Best Novel by an American Author: Prize \$2,000; announced August issue, 1922; closes March 1, 1923; address, Harper & Brothers, New York City.

Competition for American Composers: Prizes from \$1,000 to \$100; announced October issue, 1922; closes Dec. 15, 1922; address, Mrs. Edwin B. Garigues, Room 201, Bellevue-Stratford, Philadelphia, Pa.

Best Symphonic Composition: Prize \$1,000; announced October issue, 1922; closes Jan. 1, 1923; address, Balaban & Katz, 175 N. State St., Chicago, Illinois.

For Many Kinds of Needlework: Three special prizes of \$100 each, and 162 class prizes from \$10 to \$1 each; announced December issue, 1922; closes Dec. 31, 1922; address, Star Needlework Journal, 260 West Broadway, New York City.

In accordance with the editorial policy of this magazine never to accept compensation in any form for what appears in our reading pages, and also to avoid all appearance of doing so, we are obliged to omit the name of the maker or the seller of any article described. This information, however, is kept on file and will be furnished free, by addressing Bureau of Information, Popular Mechanics Magazine, Chicago. [Editor.]

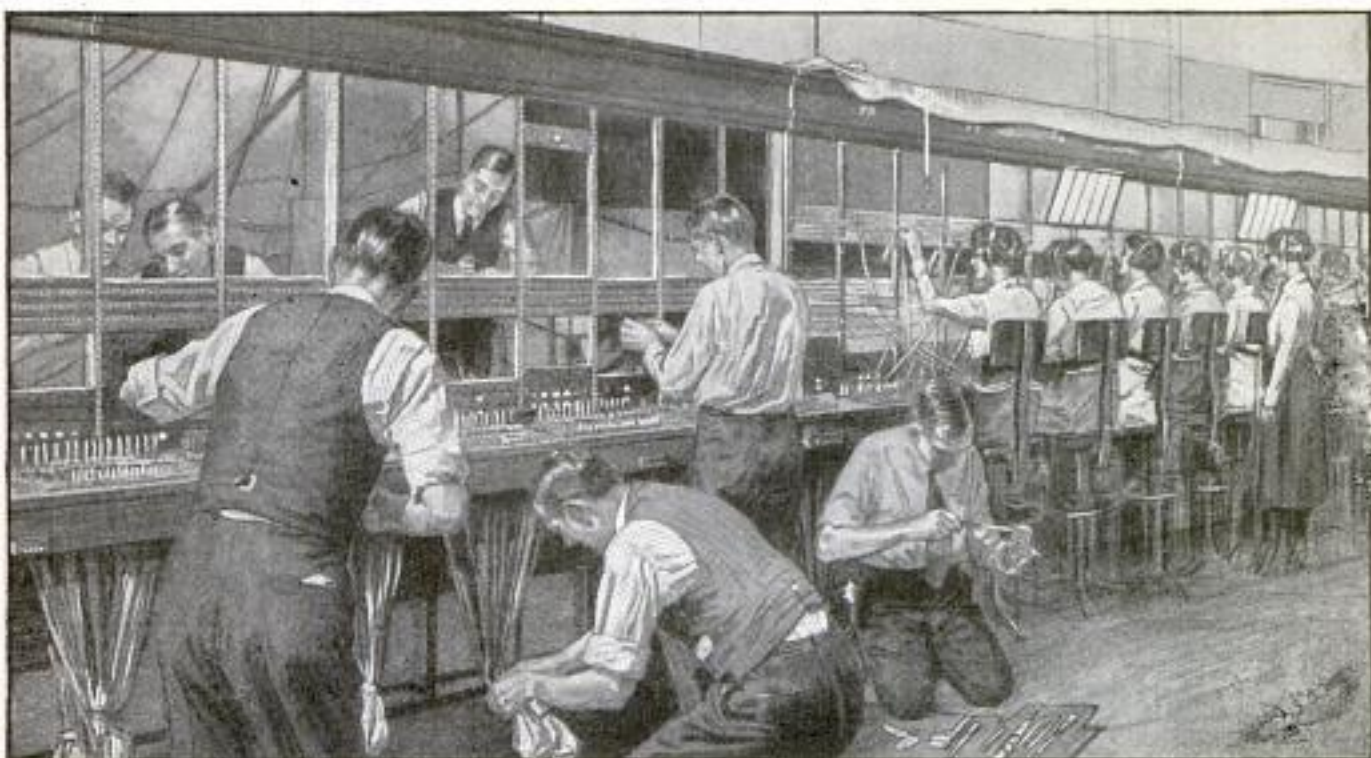

Expansion

A million new subscribers were linked to the Bell System during the past two years—putting into operation a million new routes of talk, and a corresponding increase in all intervening facilities such as switchboards, cable and long distance lines.

No other country is so well equipped as the United States for telephone communication. Yet, because of this—because the telephone is so useful—the demand for service keeps growing greater.

The growth of telephone de-

mand in the United States is greater than the growth of population. It is an intensive growth. An increasing percentage of the population is seeking telephone service.

The Bell System is providing for more investment, further technical achievement, more wires, switchboards and stations—and more subscribers. The American people require the best service. The best service means the most comprehensive service, not only for the necessities of to-day, but for the necessities of the future.

“BELL SYSTEM”

**AMERICAN TELEPHONE AND TELEGRAPH COMPANY
AND ASSOCIATED COMPANIES**

One Policy, One System, Universal Service, and all directed toward Better Service





Five New Ways To whiter, cleaner, safer teeth

Dental science has been seeking ways to better tooth protection.

All old methods proved inadequate. Tooth troubles were constantly increasing. Very few escaped them. Beautiful teeth were seen less often than now.

Dental research found the causes, then evolved five new ways to correct them.

The chief enemy

The chief tooth enemy was found to be film—that viscous film you feel. It clings to teeth, enters crevices and stays.

Food stains, etc., discolor it.

Then it forms dingy coats. Tartar is based on film. Most teeth are thus clouded more or less.

Film also holds food substance which ferments and forms acids. It holds the acids in contact with the teeth to cause decay. Germs breed by millions in it. They, with tartar, are the chief cause of pyorrhea.

Much left intact

Old ways of brushing left much of that film intact, to cloud the teeth and night and day threaten serious damage.

Two ways were found to

fight that film. One acts to curdle film, one to remove it, and without any harmful scouring. Able authorities proved those methods effective. They were embodied in a tooth paste called Pepsodent, and dentists the world over began to urge its use.

Other essentials

Other effects were found necessary, and ways were discovered to bring them. All are now embodied in Pepsodent.

Pepsodent stimulates the salivary flow—Nature's great tooth-protector.

It multiplies the alkalinity of the saliva. That is there to neutralize mouth acids, the cause of tooth decay.

It multiplies the starch digestant in the saliva. That is there to digest starch deposits on teeth which may otherwise ferment and form acids.

It polishes the teeth so film less easily adheres.

Prettier teeth came to millions

One result is prettier teeth. You see them everywhere—teeth you envy, maybe. But that is only a sign of cleaner, safer teeth. Film-coats, acids and deposits are effectively combated.

Send the coupon for a 10-Day Tube. Note how clean the teeth feel after using. Mark the absence of the viscous film. See how teeth whiten as the film-coats disappear.

Cut out the coupon now.

10-Day Tube Free

1054

THE PEPSODENT COMPANY,
Dept. 538, 1104 S. Wabash Ave., Chicago, Ill.

Mail 10-Day Tube of Pepsodent to

.....
.....

Only one tube to a family

PAT. OFF.
Pepsodent
REG. U.S.

The New-Day Dentifrice

A scientific film combatant, which whitens, cleans and protects the teeth without use of harmful grit. Now advised by leading dentists the world over.



Less labor in drilling when you use the right tools

"Impossible" drilling jobs become simple—all drilling jobs become easier with these ingenious "Yankee" drills. And the work is done quicker and better.

For doing away with hand feeding

"YANKEE" Chain Drill No. 1500

with automatic friction and ratchet feed

All you do is turn brace. Chain is tightened and drill quickly set to the work by "Yankee" Friction Feed; then automatically fed at exactly right pressure by "Yankee" Ratchet Feed. Saves drills. Three-jaw chuck for round shank drills up to $\frac{1}{2}$ in.



For awkward places where other drills won't work

"YANKEE" Ratchet Breast Drill No. 1555

"Yankee" DOUBLE Ratchet keeps drill cutting continuously in places where you can move crank handle only an inch in either direction. Five adjustments; plain drill, left-hand ratchet, right-hand ratchet, DOUBLE Ratchet, gears locked. Speed can be changed without removing drill from work. Length 17 in. Three-jaw chuck for round shank drills up to $\frac{1}{2}$ in.

For small holes in tight quarters

"YANKEE" Ratchet Hand Drill No. 1530

Only $10\frac{1}{2}$ in. long. Weighs only $1\frac{1}{4}$ pounds. Yet has all five adjustments of big "Yankee" Drills. Holds drills up to $\frac{3}{8}$ in.



Some other "Yankee" Tools

Quick-Return Spiral
Ratchet Screw-drivers
Ratchet Bench Drills
Automatic Push Drills
Ratchet Tap Wrenches

Tool Book FREE

Illustrates and describes all the "Yankee" Tools for saving time and labor.



Dealers everywhere sell "YANKEE" Tools

NORTH BROS. MFG. Co.

Philadelphia

"YANKEE" TOOLS

Make Better mechanics

BUY TODAY 10 MONTHS TO PAY



B11—Gent's Tooth Ring set with perfectly cut blue-white Diamond\$35



B12—Solitaire Cluster. 7 fine Diamonds set in Platinum in a fancy 18K White Gold mounting. \$65



B13—Artistic Platinum top Friendship Ring set with 5 blue-white Diamonds, White Gold Shank \$135



B14—Superior fine Diamond in beautiful hand-engraved Platinum ring. \$100



B15—Gent's hand-carved Belcher Ring set with fine blue-white Diamond. \$45



B16—Sweet's Engagement ring set with fine blue-white Diamond \$35



B17—"Sweetheart" Platinum ring set with superior fine Diamond\$150



B18—Unique Platinum top Green Gold ring set with 1 fine Diamond\$40



B20—Beautiful lavallo guine pearls, fine Diamond\$28



B19—Solitaire Cluster. 7 fine Diamonds set in Platinum \$85



B21—Four White Gold inverted hearts are set with 1 superior quality, sparkling Diamond.....\$75



B22—Ladies' Belcher ring set with 1 fine Diamond\$25



B23—Genuine Black Onyx set with fine Diamond in Platinum bezel \$33



B24—Solitaire Cluster. 7 fine Diamonds set in Platinum. 48.50



X38—14K. Solid White Gold case with sapphire jewel crown, 15 jewel, Rectangular adjusted movement. Fancy engraved Dial. Special Price\$32.50



B25—Sweet Engagement ring set with fine superior Blue Diamond\$55



B26—Beautiful hand-engraved White Gold mounting set with 1 fine superior Diamond \$50



B27—Sweet Engagement ring set with one superior fine Diamond\$65



B28—Sweet Engagement ring set with fine superior Blue Diamond\$99



B29—Superior Diamond set in 18K White Gold Cup\$50

Beautiful Xmas Gifts

On Credit—at Cash Prices

YOUR choice of any of these blue-white, perfectly cut Diamonds sent on APPROVAL. NO RISK, NO MONEY IN ADVANCE. If satisfied after examination, pay one-fifth the price and keep the article, sending us the balance of the money in ten equal monthly payments. Otherwise, if not pleased, simply return and examination will have cost nothing.

This complete stock is no further away than your nearest mail box

Beautiful Christmas Catalog FREE

98 pages in colors, crowded with thousands of wonderful bargains in Diamonds, Watches and Jewelry—gifts you will be proud to give. Ten months to pay on everything. Write now for your free copy.



Address Dept. G-F
L. W. SWEET, Inc.
New York City
Capital, \$1,000,000

L. W. SWEET INC. "THE HOUSE OF QUALITY"

1650-1660 BROADWAY, N.Y.



Harris Homes Beautiful

Permanent Built! —Now Within Your Reach

The combined efforts of these great departments in experimenting and testing materials and methods of construction have produced for you a **GUARANTEED** home, expert machine cut, bundled and marked—the last word in building economy.

Not One Penny in Advance

So sure are we of the super-excellence of our material and our **GUARANTEED** Ready-Cut System that we will ship you any **HARRIS HOME** without the payment of one cent down. Our plan Book explains our liberal terms fully.

BUILDING MATERIAL!

For over a quarter of a century, thrifty wise buyers have realized that here is the open door to real economy, whether it be a brand new home or material for improvements or repairs.

FREE BOOK OF PLANS!

The latest edition is waiting for you, contains our **FREE PLAN OFFER** and photographic reproductions, with floor plans and specifications of 100 beautiful homes. Mail coupon today.

Plumbing and Heating!!

Hot water and heating systems, warm air heating plants, pipeless furnaces and plumbing material of every kind—the product of America's leading makers. Our mammoth plumbing stock offers unlimited possibilities for you to save money. Our heating plants are guaranteed to heat your home in any weather with big fuel economy.



Bathroom Outfit Complete!

Consists of white porcelain enameled bathtub, 5 ft. long, complete with fittings, washdown closet outfit with white vitreous china earthenware bowl and tank fitted with mahogany seat and cover. Lavatory complete with indexed faucets, trap and supply pipes. Outfit \$67.50. Tub only, \$22.50. Closet outfit.....\$25.00. Tub with fittings, \$30.00. Lavatory...\$13.50.

MAIL THIS COUPON

HARRIS BROTHERS CO.

Dept. PG-7, Chicago

These books are **FREE** and sent postpaid. Mark an "X" in the squares to indicate which ones you wish.

- Harris Home Book of "Presto-up" Houses and Garages
- Book of Plans
- Building Material Catalog
- Plumbing and Heating Book

Name.....
Address.....



Expert Engineers Waiting to Help You

A rough sketch of your building showing number and size of rooms, doors, windows and height of ceiling is all we need to give you complete information and low prices.

At a small rental charge, we loan you the tools to do your own work in installing our plumbing and heating systems.



Free Book of Plans



5 Big Reasons why you'll like HANES

Read these over one by one. You'll be amazed to find such features in popular-priced underwear.

1 Hanes Staunch Elastic Shoulders are made with service-doubling lap seam. They fit right, with plenty of "give" for every motion.

2 Hanes Tailored Collarette won't gap or roll. Fits snugly around your neck always, and keeps the wind out.

3 Hanes Elastic Cuffs are made far stronger and better than the usual cuff. They fit the wrist firmly and won't flare or rip from the sleeve.

4 Hanes Closed Crotch is cut and stitched in a special way that really keeps it closed.

5 Hanes Elastic Ankles hold their shape through repeated washing. They never bunch over your shoes, but fit always.

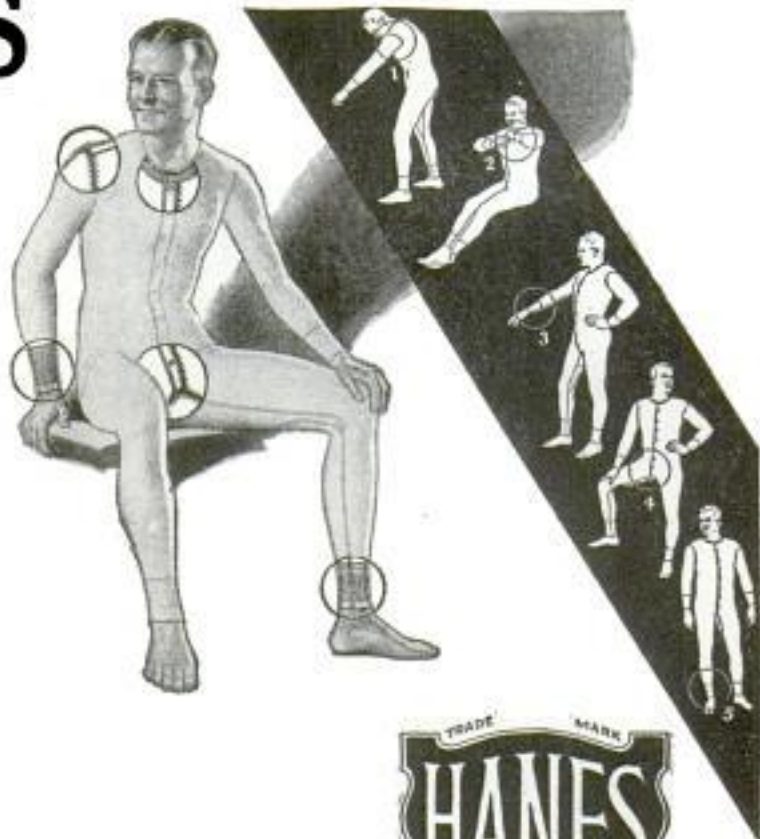

TRADE MARK
HANES
ELASTIC KNIT
UNDERWEAR

THEN consider that every strain-point is strongly reinforced and is guaranteed to hold fast. That the flat, non-irritating seams are guaranteed not to break. That the fine quality buttons are guaranteed to stay put. That the button-holes are guaranteed to keep their shape.

Bear in mind, too, that Hanes Winter Underwear is made of fine, fleecy cotton that keeps out cold. It's cut and tailored to fit. It snugs close, but without the slightest pulling or binding.

Tell your dealer you want Hanes. If he can't supply you, write us and we'll see that you get what you want. You can choose from heavy shirts and drawers and heavy union suits in two weights.

Boys can have Hanes—just the kind of winter underwear the youngsters like. Warm, snug-fitting, long-wearing. Two weights—heavy and extra heavy. Sizes 2 to 16 years. 2 to 4 year sizes with drop seat. Made also in knee length and short sleeves.

HANES GUARANTEE: We guarantee Hanes Underwear absolutely—every thread, stitch and button. We guarantee to return your money or give you a new garment if any seam breaks.

P. H. HANES KNITTING COMPANY

Winston-Salem, N. C.

ONLY
\$ **3**
DOWN
and you
keep this
typewriter



DIRECT
to you
from our
Factory

Big Saving
In Price

Yes, we will ship you this Genuine Underwood

Rebuilt in our own factory just like new for
ONLY \$3 down — NOT ONE CENT MORE
Until you have tried the machine 10 full days at our expense



Our Factory

EVERY MACHINE is fully guaranteed. New parts wherever needed. New enamel, new nickel, new lettering, new platen, new key rings—a complete, perfect typewriter. Impossible to tell it from a brand new Underwood either in appearance, durability or quality of finished work.

An up-to-date machine with two-color ribbon, back spacer, stencil device, automatic ribbon reverse, tabulator, etc. In addition we furnish **FREE** waterproof cover and special Touch Typewriter Instruction Book. You can learn to operate this Underwood in one day.

Big Book FREE

Our big handsomely illustrated catalog will be sent **free** on request. It tells you all about the advantages of owning a **STANDARD SIZE UNDERWOOD**; how and why this machine will last for years, saving many dollars not only in the purchase price but in its operation.

Send in the coupon and let us send you this beautifully illustrated book **FREE** without any obligation whatever.

Shipman-Ward Mfg. Co.
"Typewriter Emporium"
2121 Shipman Bldg.
Montrose and Ravenswood Aves., Chicago

Write Right Now
and learn how it is possible for us to ship you this Underwood Typewriter upon our **free trial** plan and our **direct-to-you money saving methods**. Get the full details now—just sign the coupon and mail **today**. Get all the facts—then decide.

No Obligation

—to buy. You don't have to order. Just sign the coupon, send it to us and we will mail you our **big catalog** absolutely free.

You will be amazed at the liberality of our offer, the beauty and all around excellence of our typewriters.

Send the
Coupon
Today

10 Days'
Free Trial

You have ten full days in which to try the typewriter before deciding whether you want to keep it. Give it every test—see for yourself—make the Underwood prove its worth to you. Don't take our word for it—put the Underwood before you and see if you don't think it the greatest typewriter bargain ever offered.

typewriter offer except to sign and send in the coupon. There is no obligation.

You

Big Saving to You

Our plan of selling to you **direct** makes possible enormous savings, which are all for your benefit. **Send in the coupon and we will send you prepaid** our big catalog, including "A Trip Through Our Factory." This shows how the Shipman-Ward Rebuilt Underwood is the best that can be produced at our **Special Price**.

don't have to do a thing to get our big **Free** catalog and complete details of our amazing

**FREE TRIAL
COUPON**

SHIPMAN-WARD MFG. CO.
2121 Shipman Bldg., Chicago

Please send me **FREE**, all charges fully prepaid, your **BIG NEW** catalog of **UNDERWOOD TYPEWRITERS** and complete details of your **FREE TRAIL Offer**.

It is understood that I am under no obligation whatever and that this is to be sent without one cent of cost to me.

Name.....
Street.....
City..... State.....

DON'T BLAME IT ON STATIC!

The Real Explanation of Much of the Trouble You Have with Your Radio Set

By J. C. Shaw

One of the things which the radio world is rapidly learning is that the term "static" has been very loosely used to cover a multitude of radio sins for which static is really in no way responsible.

It is discovering that many of the frying, crackling noises and much of the so-called interference laid at static's door are due to *the use of batteries of the wrong kind, or that leak an excessive amount of electricity.* Faulty batteries can undo the most careful work in construction of set and aeri-als.

Radio operators should remember particularly that "B" batteries are in series with the phones or amplifying horn and that any noises set up within the "B" batteries themselves will come in strong.

A growing understanding of these facts is leading to the use of high-grade storage batteries for both A and B work, since such storage batteries have just the characteristics needed for both efficiency and economy in radio service.

An interesting development in this connection is the new type of "B" battery and an all-rubber "A" battery put on the market by the Willard company. In these batteries, electrical leakage, which is present to such a great extent in the ordinary battery and which accounts for so much noise, is to a great extent overcome.

The "B" battery cells are cylindrical glass jars with hard-rubber, screwed-on covers. These are so spaced that the only contact between cells is through heavy, burned-on connectors. No sealing compound is used and the box is cut down so that the sides reach up only about half way to the tops of the jars.

These features and the use of threaded-rubber insulation, operators find, result in a battery which holds its voltage, is never sluggish and, with occasional recharging, lasts for years.

Inasmuch as this big improvement can be effected at an actual saving of money because of the long life of a really good storage battery, there is no question that this type of battery will rapidly be adopted for a great majority of sets. When this is done, the bugaboo of "static" will lose much of its terror.—(Advertisement)



\$5.00

No. 56
2000 OHMS

\$5.50

No. 56
3000 OHMS

You are taking no chances when you use a Murdock Headset with your Radio Receiving Set. Experts have used them for over 17 years.

And Murdock prices are so reasonable that every Radio enthusiast can afford them.

Get a pair from your dealer or send direct if he does not have them.

WM. J. MURDOCK CO.
349 Washington Ave. Chelsea, Mass.
1270 Broadway New York 509 Mission St. San Francisco

MURDOCK RADIO

STANDARD APPARATUS SINCE 1904

RADIO FREE—Entertainments, Concerts, Opera, Vaudeville, Market and Weather Reports, Sporting and Election Returns, Church Services, etc. **Hear Them All—Absolutely Free** with the wonderful Home Radio Phone—No special or electrical knowledge needed. Anyone can install and operate. Full Directions. **30 Days' Free Trial.** Satisfaction Guaranteed. Home Radio Outfits complete in every detail, delivered free on approval, express prepaid, at special introductory price. **User Agents Wanted**—Wonderful opportunity for big money. Radio Phone Parts and Supplies at lowest factory prices. **SEND NO MONEY**—Write at once for Big Special Offer.

HOME RADIO PHONE CO., Not Inc.
515 N. Dearborn St., Dept. 58-P CHICAGO

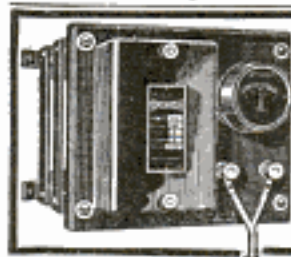

THE HOMCHARGER

Charges your AU-PRICE
TO or RADIO Battery
for a nickel **\$18.50**

Send for free bulletin

The Automatic Electrical Devices Co.
129 West Third St. Cincinnati, O.

DOUBLE HEAD
PHONES



**BOYS! A REAL
RADIO SET
ABSOLUTELY FREE**

RUSH your name and address and we will tell you HOW you can get this RADIO SET ABSOLUTELY FREE.

RADIO SET comes to you complete, with single slide tuning coil, crystal detector and phone condenser. **AND DOUBLE HEAD PHONES.** No batteries required; no experience.

Write Today for Free Radio Plan

HOME SUPPLY CO.
131 Duane St., Dept. 201
New York City

Radio

Catalogue

FREE

One copy of this complete Catalogue of Radio Outfits, parts, Dictionary of Radio Terms, Instruction Book, and Guide to Successful Radio Work—one copy is yours Free.

Simply write us a post card and we will mail the complete book to you Free, by return mail.

It quotes the lowest prices, amazingly low prices on everything for the expert and the amateur. Every improved part, the most up-to-date outfits, everything that is needed of the most modern type—at the lowest possible prices.

It gives a list of broadcasting stations, and gives much information about radio construction and operation. Every one interested in Radio needs this complete catalogue and book of instruction.

Why Pay Higher Prices?

Montgomery Ward & Co. has for fifty years dealt on a Money-Back basis, absolutely guaranteeing everything they sell. With quality absolutely assured, why pay higher prices elsewhere? Write today for this Free Radio Book and see for yourself the Saving it will bring you.

One copy is yours Free. You need only write us a post card.

Chicago Kansas City St. Paul
Fort Worth Portland, Ore.

Write to the house nearest you
ADDRESS DEPARTMENT 6-R

Montgomery Ward & Co.

— The Oldest Mail Order House is Today the Most Progressive —



No Money Down Sent on Approval

Our determination to this year double our sales of the world famous *Santa Fe Special* and *Bunn Special* Watches prompts this matchless offer.

While other watch dealers are raising their prices, asking you for larger monthly payments, and making payment terms harder for you to meet, we are offering you our new model *Santa Fe Special*, and the famous *Bunn Special*, no advance in price, no money down, easier terms and smaller monthly payments. We realize the war is over, and in order to double our business we **MUST** give you pre-war inducements, better prices, easier terms, and smaller payments.

LOOK! Santa Fe Special AND Bunn Special Watches

Without one penny of advance payment let us place in your hands to see, to examine, to inspect, to admire, to approve a real masterpiece in watch creation.

Page 12 of Our Watch Book Is of Special Interest to You!

Ask for our Watch Book free—then select the watch you would like to see, either the famous *Santa Fe Special* or the 6 position *Bunn Special*, and let us explain our easy payment plan and send the Watch, express prepaid, for you to examine. **No money down.**

REMEMBER No money down—easy payments buys a master timepiece—a 21 Jewel guaranteed for a lifetime at about half the price you pay for a similar watch of other makes. **No money down—a wonderful offer.**

Santa Fe Watch Co., 16 Thomas Bldg., Topeka, Kans.

Please send prepaid and without obligation your Watch Book free, explaining your "No Money Down" Offer on the *Santa Fe Special* Watch.

Name

Address

State

Santa Fe Watch Company
16 Thomas Bldg., Topeka, Kans.

Trade Mark Registered

WURLITZER

200 YEARS OF MUSICAL INSTRUMENT MAKING

Professional and Amateurs Praise Wurlitzer Instruments

"I am proud to be the owner of one of your new cornets. The tone, tune and valve action are positively superior to any I have experienced in all my years of cornet playing."

Harry L. Jacobs
(Soloist with Sousa's Band, Brooks's Marine Band, Chicago Grand Opera)

"If I could not get another like it, my Wurlitzer saxophone could not be bought from me for \$200.00."

J. Russel David, Rockford, Ind.

"Without your credit system it would have been impossible for me to own this beautiful instrument."

Arthur M. Samp, Madison Wis.



Try It in Your Own Home

WURLITZER will send you any instrument for a week's trial in your own home. No obligation to buy—no expense for the trial—you do not risk a penny. Wurlitzer instruments are known the world over for artistic quality and excellence of workmanship. Used by the greatest musicians, bands and orchestras. The House of Wurlitzer has made the finest musical instruments for over 200 years.

Easy Payments

Payments are conveniently arranged in small monthly sums—a few cents a day will pay. All instruments to you at lowest factory prices. Special combination offers on complete musical outfits—velvet lined case, all accessories, self-instructor, etc.—everything you need at practically the cost of the instrument alone.

Send for New Catalog!

The greatest musical catalog ever published! Over 3,000 articles—every known instrument described and illustrated—many of them shown in full colors.

Wurlitzer has stores in over 30 cities, but no matter where you live, Wurlitzer is no farther than your nearest mail box. Send coupon today.

The Rudolph Wurlitzer Co., Dept. 1771

117 E. 4th St., Cincinnati — 329 So. Wabash Ave., Chicago
120 W. 42nd St., New York — 250 Stockton St., San Francisco

Send me your new catalog with illustrations in color and full descriptions of every known musical instrument, also details of the Wurlitzer Free Trial Easy Payment Plan. No charge, no obligation.

Name

Address

(State musical instrument in which you are interested.)



Copyright 1922
The Rudolph Wurlitzer Co.

BUILD YOUR OWN RADIO

The Radio Specialty Company—RASCO for short—specializes in small orders; in fact, 50% of our orders are for less than one dollar. 24-hour service guaranteed.

This Company specializes in small parts for radio, selling only the highest class of materials. This Company is aware of the fact that very high prices prevail in radio now. By buying material from us you not only save anywhere from 50 to 75% on the cost of the instruments, but you have the fun and instruction of making them yourself.

Our quick, 24-hour service means satisfied customers. We have no Complaint Department. Hundreds of letters such as the following, unsolicited, are in our files:

41 Rodney St., W. St. John, N. B.
Dear Sirs:
Enclosed you will find one (1) dollar for which please send me 1 dozen binding posts No. 201 at \$1.00 per dozen and oblige,

George B. Ingraham.

P. S.—Rasco Service is sure all it is cracked up to be. I have received three different orders from Rasco and I am still waiting for an order from another Company which was sent in before the first Rasco order.

Yours truly,
G. B. I.

Quincy, Pa.
Gentlemen: I wish to inform you that your "Rasco" baby detector works as well as any high-priced detector, and is an absolute bargain. It's just what I was looking for and works to perfection on my set. I will constantly tell others about it.

Yours very truly,
T. Bayard Beatty, Jr.

Our prices are low and all goods are shipped prepaid. You deal with the oldest and only Company exclusively manufacturing the small parts in their own two big factories. Our big 64-page Catalog, No. 7, containing over 300 illustrations, will save you money. This catalog also contains

75 Diagrams of Vacuum Tube Hook-Ups

not to be found in any catalog, only found in expensive text books. This catalog sent only upon receipt of 15c. Once you have tried the RASCO service you are a customer for life. 85% of our customers always come back.



DETECTOR 50c

Radio Specialty Co.

98 E PARK PLAGE, NEW YORK CITY



Makes Your Radio Set Work Better

Perfect reception can be had only when wire connections are soldered. SOLDERALL and a match make perfect joints—guaranteed equal to wire or bar solder.

At leading Jobbers and Dealers or sent postpaid for 25c a tube.

SOLDERALL CO., Dept. P, Newark, N. J.

SOLDERALL
A Metal in Paste Form

FREE Radio Catalog



Our big stock of standard makes of radio sets, parts and supplies, fully illustrated. Play safe—buy standard equipment from a reliable house. We ship from stock.

Send \$6.50 for genuine Westinghouse WD-11 "peanut" tube—no storage battery needed. 60 cents extra for socket. Wonderful results.

JULIUS ANDRAE & SONS CO.

116 Michigan St. In business since 1860 Milwaukee, Wis.

BUILD YOUR RADIO



Save Money

Build Your Own At Home
Complete Standard Parts for Long Distance Radio Outfits. We do all machine work; you do the hand work; we tell you how. Immediate delivery. Also complete Radio Sets—all sizes at bargain prices. Write now for our big bargain catalog.

Colonial Radio Equipment Co., 4759 Calumet Avenue Dept. 10 Chicago, Ill.

Edeson Radio Phones

Adjustable Diaphragm Clearance

We guarantee satisfaction, or your money refunded. The adjustment feature places ear phones on a par with the world's greatest makes. Our sales plan eliminates dealer's profits and losses from bad accounts, brings the low price. Better phones cannot be made. Immediate delivery. Double 3000 Ohm set, \$1.99; 1500 Ohm single set, \$2.50. Circular free.



Edeson Phone Co., 6 Beach St. Dept. A-20 Boston Mass.

See your dealer for information about
RADISCO Radio Products
THE RADIO DISTRIBUTING CO.
Newark, N. J. U. S. A.

Duck Radio Pioneer Announces Startling Reductions

The Leading Line Since 1909 at Prices to You Less Than Dealers' Cost
FREE Illustrated pamphlet comprising sixty-two Duck radio instruments and sets, with reductions averaging 30%, mailed on request. Send postal today.

A Few of the Many Duck Products at Amazing Prices:
Moulded form rheostat, 70c; bakelite moulded socket, 70c; bakelite dial 55c; super-selective moulded variometer, \$4.65; 43 plate panel type variable condenser, pig tail connections, \$3.15; radio frequency receiving set, \$29.75. Duck's big 256 page radio catalog and text book mailed for 25c in coin or money order.
The William B. Duck Company, 223-227 Superior St., Toledo, Ohio

Please Mention Popular Mechanics



—Just the Case You and Your Micrometer Need

to protect the micrometer from dirt and injury. It fits the pocket nicely. Is not big and clumsy, and does not cause the pocket to bulge. Serviceable and handy.

Substantially made of metal—covered with imitation leather—plush lined—and with a strong spring cover.

Every Micrometer deserves one of these cases to help retain its accuracy. Get one from your dealer.

BROWN & SHARPE

POCKET MICROMETER CASE

2 Styles

No. 202. For regular 1" Micrometers

No. 203. For Rex 1" Micrometers

Price 60 cents

BROWN & SHARPE MFG. CO.
Providence, R. I., U. S. A.

Does Your Camera Shutter Work?

Seneca, Kodak, Premo, Anasco or Ingento Shutters repaired and adjusted. Any style or size. Expert work done and guaranteed. Prompt Service. Reasonable Prices. Send your shutter in today.

Address Shutter Division

SENECA CAMERA MFG. COMPANY
Rochester, N. Y.



Catch Fish,

Eels, Mink, Muskrats and many other fur-bearing animals, in large numbers, with our New, Folding, Galvanized Wire Mesh Traps. They catch them like a fly-trap catches flies. Made in all sizes. Very strong and durable. Write for Descriptive Price List, and our Free Booklet on best baits known for attracting fish and animals.

J. F. GREGORY, Dept. K-24, LEBANON, MO.

COYNE

LEARN ELECTRICITY AT

SEE
OUR AD
ON BACK
COVER

Going to Build Remodel or Repair?

DON'T think of planning a new home or repairing an old one without copies of our two free books.

Our Building Material Catalog shows latest ideas and most advanced styles for everything in building. We ship everywhere everything in the way of high grade lumber roofing, doors,

Catalog of 6000 Price Bargains

Beautifully Illustrated PLAN BOOK

CHICAGO MILLWORK SUPPLY CO., 1444 W. 37th St., Chicago, Ill.
PLEASE SEND ME YOUR FREE BOOKS.

Name _____

Town _____

State _____

Occupation _____

Let us develop plan from your rough sketches. Send your material bills for free estimate price.

Material Complete for Houses from \$500.00 Up

windows, porchwork, screens, builder's hardware, paints, wallboard, interior woodwork, plumbing, heating and water supply outfits -- all at money saving prices direct to you. Plan Book shows skillfully planned homes of all kinds, bungalows, city homes, suburban residences, country homes, barns. Tells you how to get building plans FREE. Write today. No obligation.

Books Are Free

THIS WONDERFUL INVENTION



converts any cook stove into a gas stove. Oxo-Gas made from kerosene and air is cheaper, cleaner and more efficient than coal. Send for catalog illustrating Oxo-Gas appliances for all purposes where coal is used. We have openings for General Sales Managers and distributors. Only those who can finance themselves considered.

GLORIA LIGHT COMPANY

111-119 N. MAY ST.

CHICAGO, ILL.



PLUMBING & HEATING

Buy Direct—Save 50%

\$66.95 Complete Bathroom Outfit \$66.95

Send NOW for our FREE Catalog "A" of Wholesale prices

Satisfaction Guaranteed

LAMPLOUGH BEAUMONT COMPANY
99 So. Portland Ave. Brooklyn, N. Y.

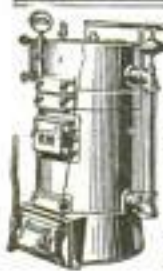

Imperial Sanitary Floor

Put on like Plaster
Wears like Iron
-waterproof
-fireproof
-resilient
-noiseless
-dustless

Base and Floor one solid piece

A composition material easily applied in plastic form over practically any kind of floor. Laid about 1/4 inch thick. Imperial floor does not crack, peel or come loose from foundation. A continuous, fine grained, smooth, non-slipping surface. No crevices to gather grease, dirt, dust, disease germs or moisture.

Ideal Floor for Kitchen, Pantry, Bath Room, Laundry, Porch, Garage, Restaurant, Theatre, Hotel, Factory, Office Building, Railroad Station, Hospital—wherever a beautiful, substantial floor is desired. Several practical colors. Full information and sample FLEX of your first and second choice of colors.

Imperial Floor Co., 110-112 Halstead St., Rochester, N. Y.

A Success for 15 Years



Stillwell PLAN BOOKS

—show Pictures, Floor Plans, Estimated Cost of Building and over 200 Selected Designs

CALIFORNIA STYLE HOMES
—for any climate

"Representative Calif. Homes"

50 Houses—7 to 10 Rooms—\$1

"The New Colonials"

60 Houses—6 to 10 Rooms—\$1

"West Coast Bungalows"

50 Houses—6 and 7 Rooms—\$1

"Little Bungalows"

75 Houses—3-4-5 Rooms—\$1

SPECIAL OFFER Send \$2.50 for any three of these books and get Garage Folder FREE
Money back if not satisfied

E. W. STILLWELL & CO., Architects, 972 Calif. Bldg., Los Angeles

Starting a Company?

Save expenses and taxes by organizing on the popular, COMMON LAW plan under a pure DECLARATION OF TRUST. No experience required to fill in DEMAREE STANDARD FORMS, issue shares and begin doing business at once. Genuine DEMAREE FORMS are nationally known, approved by attorneys, and utilized by successful concerns throughout the United States. Send for large, free pamphlet (D-53) containing valuable information that you may need. C. S. DEMAREE, legal blank publisher, 708 Walnut, Kansas City, Missouri.



"Lighting Fixtures"

READY TO HANG

(Direct from Manufacturers)

Completely wired, including glassware.

New designs. Send for catalogue No 24.

Send for DEALERS' proposition.

ERIE FIXTURE SUPPLY CO.

STA. A.

ERIE, PA.

Beautiful HOUSES \$900 and BUNGALOWS

CAN BE BUILT FOR AND UP
This and many others in my new book, Building Plans for Modern Homes, will save you hundreds of dollars. One of the most complete and comprehensive books of plans ever published by any architect. New edition just off the press. Nearly 500 floor plans and photographs of bungalows, Colonial houses, etc., costing from \$200 up; gives sizes and cost to build.
Sent postpaid for \$2.00



FREDERICK H. GOWING
ARCHITECT

101 Tremont St., BOSTON, MASS.

WHITE FLAME

BURNERS make your old kerosene lamps and lanterns give a brilliant, white light better than electricity or gas. Doubles your light. Saves oil. NO MANTLE TO BREAK. Guaranteed Safe and Reliable. Delights every user. Send now for complete sample postpaid 50 cents, stamps or coin. \$1.25. Money Back if Not Satisfactory.
Live Representatives Wanted. Exclusive Territory.
WHITE FLAME LIGHT CO., 68 Clark Bldg., Grand Rapids, Mich.



Different from all others—the NEW BENJAMIN

AIR RIFLE

Made on a different principle from all other Air-Rifles. The Benjamin is really a strong air-pump used to compress the air in the air chamber to any degree of power desired. From one to six strokes of the pump give all the force necessary. Each additional stroke gives increased power. The Benjamin works on the same principle as all air-drills and air-hammers—with this difference:

You control the shooting force as you desire. Look at this block of hardwood. It shows how Benjamin power is regulated as you wish.

You can't have accidents with a Benjamin. It's safe, always, because you control the power. The Benjamin never loses shooting force, and has no springs to get out of order or shake your aim. Write us for an interesting folder about this wonderful air-gun.

If your dealer does not handle same, send direct to factory—

**(PRICE \$5)
POSTPAID**

**BENJAMIN AIR-RIFLE & MFG.
CO., 415 N. Broadway, St. Louis, Mo.**

Ask your dealer for demonstration.

Pacific-Coast
Representatives
**TRAYER &
BOWER**
Los Angeles,
Calif., and
San Francisco,
Calif.



BIG PROFITS Charging Batteries

520 brings HB Battery Charger. Balance easy terms, \$150 to \$300 monthly profits. No repairs, no renewals, easy to operate. Sizes for 6, 10, 16 or 32 batteries. Let us recommend size for you. Free trial, money back guarantee. Write TODAY for information. **HOBBART BROS., CO.** Box M13 Troy, Ohio

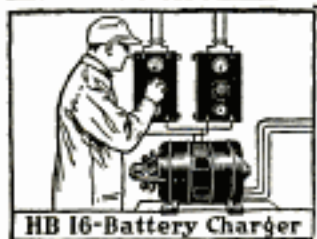

HB 16-Battery Charger

Cheapest Way to Go

to work or school and recreation is on a Ranger bicycle. You can have your choice of 44 styles, colors and sizes. **30 DAYS' FREE TRIAL.** Express prepaid. **Factory-to-Rider** Prices save you \$10 to \$25.

12 Months to Pay If desired. Saved time and expense easily meets the small payments. Parents often advance first payment.

Tires best quality, at factory prices, express prepaid. Lamps, wheels and equipment, low prices. Send **No Money**, do business direct with makers.

Mead Cycle Company Dept. K116 Chicago

Write today for free Ranger Catalog, factory prices and marvelous easy payment terms.



LINED LEATHER JERKINS

New U. S. Army standard jerkins with government inspection label. Made of fine quality tan leather, lined with olive drab wool cloth. Suitable for men or women for every outdoor activity. Sizes, 38 to 46. Shipping weight, 3 pounds.

Write for FREE, big catalogue No. 112 of Army, Navy, Camp and Sporting Goods.

RUSSELL'S INC.
245 W. 42nd St., New York



21 Jewel Burlington

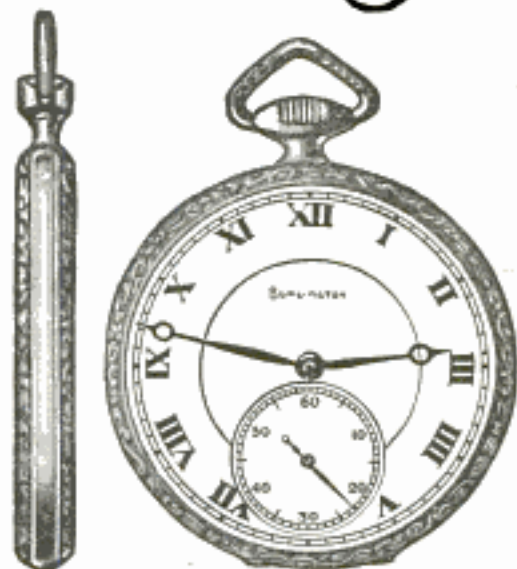

Adjusted to the Second 21 Ruby and Sapphire Jewels
Adjusted to Temperature 25 Year Gold Strata Case
Adjusted to Isochronism Your Choice of Dials
Adjusted to Positions (Including Montgomery B. R. Dial)
New Ideas in Thin Cases

Only \$1.00 Down

Only One Dollar Down will buy this masterpiece of watch manufacture. The balance you are allowed to pay in small, easy, monthly payments. The Burlington—a 21-Jewel Watch—is sold to you at a price much lower than that of other high-grade watches. Besides, you have the selection of the finest thin model designs and latest styles in watch cases. Don't delay! Write for the FREE Watch Book and our SPECIAL OFFER today.

Write While This Special Offer Lasts

Get the Burlington Watch Book by sending this coupon. Find out about this great special offer which is being made for only a limited time. You will know a great deal more about watch buying when you read this book. You will be able to "steer clear" of the over-priced watches which are no better. Remember, the Burlington is sent to you for only One Dollar down, balance in small monthly payments. Send the coupon for watch book and our special offer TODAY! Do not delay one minute!

Burlington Watch Company

Dept. 1351, 19th St. & Marshall Blvd., Chicago
Canadian Address: 62 Albert St., Winnipeg, Manitoba

Please send me (without obligations and prepaid) your free book on watches with full explanation of your \$1.00 down offer on the Burlington Watch.

Name _____

Address _____



A STOVE FOR A DIME A STERNO Canned Heat Folding Stove

that gives you heat in a few moments. Cook with it. Heat shaving water. Make coffee, tea. Hundreds of uses. Don't miss this opportunity to get this stove. Folds Flat and weighs only 8 ounces.

STERNO CANNED HEAT FOLDING STOVE will be sent to you on receipt of this ad and 10 cents by Sterno Corp., 9 East 37th Street, New York, Dept. P. M.

Only \$2 Down

Play Well in 4 Weeks

—Ten months to pay

Write for Free Catalog Folder telling all about the Masterbilt—the world's finest Saxophone outfit. Price now lowest ever quoted—5 days' trial—very easy monthly payments. No interest to pay—no extras. Outfit includes finest nickel trimmed and richly lined Case, Instruction Book, Album of Popular Saxophone Solos, Music Love, Carrying Strap, Mouthpiece and three fine Reeds.

"Masterbilt" Saxophones

Used by leading Bands and Orchestras. Highest quality, built in perfect tune, assembled and tested by experts. All latest key improvements, light, quick action and beautiful finish. Write today for FREE Catalog Folder fully describing these handsome Masterbilt outfits.

The Saxophone Shop, 429 S. Wabash Ave., Chicago
Largest Exclusive Dealers in Saxophone Supplies in the World

**WONDERFUL EVERLASTING
NEW ACID & RUST-PROOF KNIFE
IMMUNITY STEEL**

The beautiful lustre of the De Luxe designed, engraved handle made of Immunity Steel, is everlasting. This remarkable pocket knife resists attacks of all acids and cannot tarnish. Made entirely from Immunity Steel—two times stronger than the toughest tool steel. Extra sharp durable blades.

Splendid Gift that will last a lifetime for particular men and boys.

Price \$2.95 postpaid. Satisfaction guaranteed or money refunded. Rush your order as supply is limited. (State if wanted for watch chain, or plain.)

HUGO FRIEDMAN MANUFACTURING CO., 3654 Milwaukee Ave., Chicago
Makers of IMMUNITY STEEL PRODUCTS

NEW LIGHTNING CALCULATOR

ADD
SUBTRACTS
MULTIPLIES
DIVIDES

Only \$15.00

EQUALS WORK OF \$350.00 MODELS

No more brain-fag. No more costly errors. No more wasted hours from useless mental drudgery. USE AND ENJOY THIS WONDERFUL NEW \$15.00 ADDING MACHINE FREE ON TWO WEEKS' TRIAL

Observe how it automatically handles every calculation with speed, accuracy and efficiency. Note its every-day usefulness and life-long durability.—its unique features of handiness and portability. SEND NO MONEY.—just your business card or letterhead. The machine will reach you all charges prepaid. If it doesn't pay for itself within two weeks, send it back by parcel-post and you will owe us nothing. ACT TO-DAY IF YOU WANT PROMPT DELIVERY. Address, Dept. V.

LIGHTNING CALCULATOR CO., GRAND RAPIDS, MICH.

AGENTS: \$60 a Week
taking orders for New Kerosafe Burner—fits any stove. Burns kerosene (coal oil), cheapest fuel known. Quickly lighted; turns off by valve.

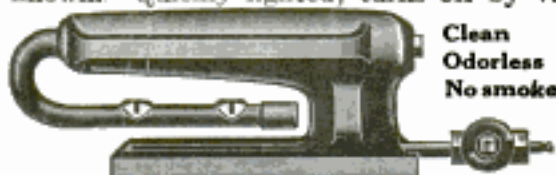

Clean
Odorless
No smoke

Easy to get orders on account of high price and scarcity of coal. Work spare time or full time. Write for sample.

Thomas Mfg. Co.

B-648

Dayton, Ohio

1000 SHOT ALL STEEL MAGAZINE AIR RIFLE

WE GIVE TO BOYS WITHOUT COST

HAMILTON 22 CAL. HUNTING RIFLE

Choice of six guns (on four easy plans) for selling our Magic Healing

Way-o-lens at 25c box. We Trust You! Order Seven Boxes Today On Postal Card—wepaid promptly, prepaid. Easy to sell—used in every home. Return money as instructed, choosing your gun according to one of the plans shown in our Big Premium List. Also 200 other Gifts or Big Cash Commission if you prefer. If you are prompt, a special Free Gift.

Waverly Co. 219 Tower Bldg, Monongahela, Pa.

CLASS PINS

FREE CATALOG GIVE NAME OF SCHOOL OR CLUB AND NUMBER IN CLASS

Either pin illustrated made with any 3 letters and 2 figures, one or two colors enamel. Silver plate, 20¢ ea., \$2.00 doz. Sterling silver, 40¢ ea., \$4.00 doz. Write for catalog of sterling and solid gold pins and rings.

249
Bastian Bros. Co. 458 Bastian Bldg., Rochester, N.Y.

SELF-FILLING INK PENCIL "INDEPENDENT"

Meets all requirements. Self-filling, non-leakable, safety cap. Attached clip. Smooth writing gold style point.

Guaranteed Improved Fountain Pen. Eliminates fatigue. Promotes efficiency. Writes uniform. A business necessity.

\$2 By Mail

Your Name in Gold—25 Cents Extra

AGENTS WANTED

J. C. ULLRICH & CO., 161 Washington St., New York

Moore Push-Pins
Glass Heads—Steel Points

Moore Push-less Hangers
To hang up things

Ask your dealer to show them

Sold Everywhere **10¢** per packet

Moore Push-Pin Co.
Wayne Junction Philadelphia

Start the New Year Right

Will 1923 Bring SUCCESS or FAILURE?

Right now is the time to decide. If you had started right one year ago you would be on the high road to success this very minute. Don't let another year pass you by. It is within your power to make yourself just what you will. Make this day the beginning of a new life and a better one.

I Will Give You Wealth—Health and Happiness

I will transform that body of yours and make you physically perfect. I will make a real HE man out of you. I will build out your chest so that every breath means increased life, purifying your blood and sending vim and vitality throughout your entire system. I will broaden your shoulders and give you the huge muscular arms and legs of an athlete. I will put pep in your old backbone and strengthen every vital organ within you. You will be just bubbling over with life, having the keen alert brain, the bright flashing eyes and the spring and step of youth. You will be admired and sought after in both the social and business world. You will be a leader of men, and the good things of life will naturally come your way.

I Challenge the World

If a man stood on the house-tops and shouted to the people that he was the strongest man on earth, it would avail him nothing. Someone would make him come down and prove it. But records speak for themselves. I will gladly show anyone personal letters from the leading strong men in the world today that my course is absolutely the best and the quickest to acquire physical perfection. Come on then and make me prove it—I like it. I have the means of making you a perfect physical specimen of manhood, of making you a successful leader of men. You will be a credit to your community. I have done this for thousands of others. What I have done for them I will do for you. I don't care what your present condition is. The weaker you are, the more noticeable the results. Come on then, start the New Year right.

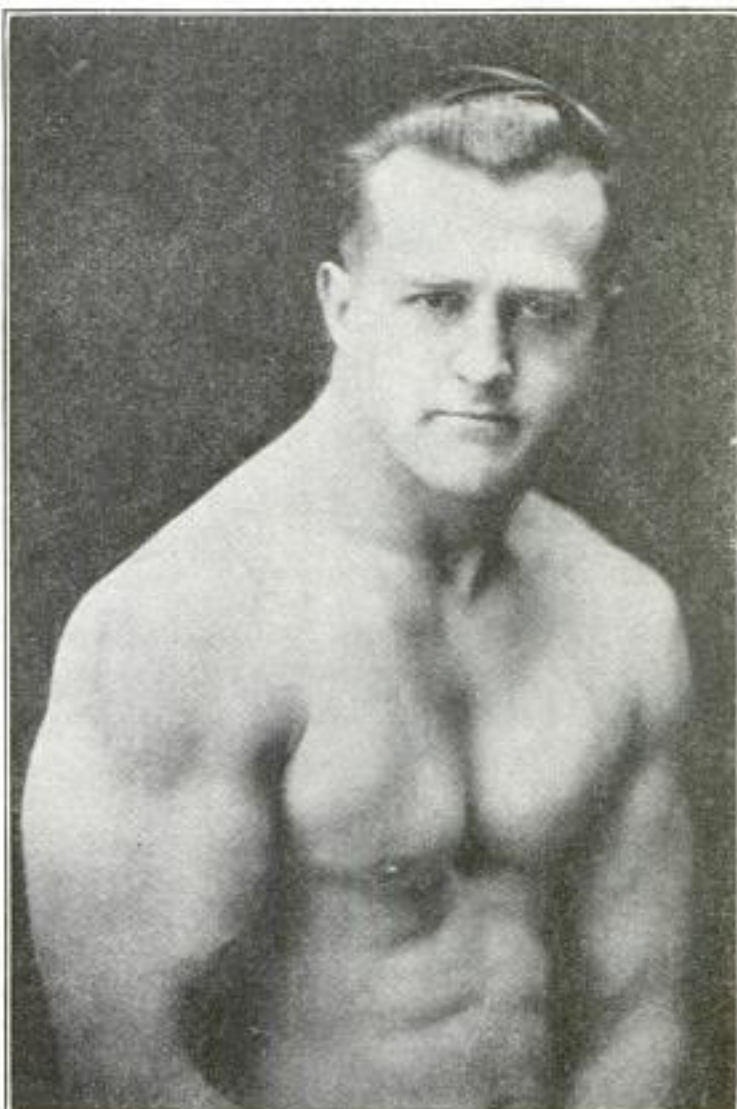

Earle E. Liederman as he is to-day

particulars of my splendid offer to you. This

Send for My New 64-page Book

“MUSCULAR DEVELOPMENT”

It Is FREE

It tells the secret. It contains dozens and dozens of full page photographs of myself and some of the world's best athletes whom I have trained. Also contains full particulars of my splendid offer to you. This book will be an impetus and inspiration to you. It will interest you from cover to cover. This valuable book and special offer will be sent on receipt of only 10c, stamps or coin, to cover cost of wrapping and mailing.

Don't miss this opportunity. Sit right down now and fill in the coupon. The sooner you get started on the road to health the easier it will be to reach perfect manhood. Don't drag along one day longer—mail the coupon today.

EARLE E. LIEDERMAN

Dept. 2001, 305 Broadway, New York City

(See pages number 18 and 19 in front of magazine)

EARLE E. LIEDERMAN

Dept. 2001, 305 Broadway, N. Y. City

Dear Sir: I enclose herewith 10c, for which you are to send me, without any obligation on my part whatever, a copy of your latest book, "Muscular Development." (Please write or print plainly.)

Name.....

Address.....

City.....State.....

The
Middleweight
Champion



Indian Scout

\$250
Electrically Equipped \$285

It's a Great Motorcycle
—at a Small Price

- 100 lbs. lighter than the average motorcycle
- lower and more easily handled
- plenty of power, with extremely low upkeep
- 75 miles to the gallon

It's a real pleasure to handle it. The Indian Scout will take you anywhere—and back. Quickly—Cheaply—Safely.

Your dealer will gladly demonstrate

Write Dept. 37
for booklet and nearest dealer's name.

Hendee
Manufacturing Co.

Largest Motorcycle
Manufacturer in the World

Springfield, Mass. U. S. A.

An Indian Sales Franchise is too good a proposition to be passed by a live dealer. Write for full particulars.

Please Mention Popular Mechanics

RADIO & AUTO Storage BATTERIES CHARGED

FROM A LAMP SOCKET At Home For a Few Cents. With An F-F BATTERY BOOSTER, a FULL WAVE AUTOMATIC MAGNETIC Rectifier for 105-125 Volt 60 Cycle A.C. Type A-B Charges 6 Volt "A" & Auto & Up to 120 Volts of "B" & Loud Speaker Storage Batteries In Series Indefinitely At Home Overnight. Disconnecting & Multiple Connections Unnecessary. No Grounds, Changing Circuits Separate. No Skill Required. **AMMETER** eliminates **GUESS WORK**. Infusible Electrodes Rectify Current. Will Charge A Dead Battery. Leave Battery Connected. Screw Plug In Lamp Socket, Snap Rectifier Clips On Terminals, Turn Switch & Battery Is Charged In Morning. **NOTHING LIKE IT MADE.** Is It Not Grand To Feel Your Radio Batteries Are Ready For All Radiophonic Music & News? Never Having To Tell Friends Your Batteries Are Dead? Fully Charged Batteries, By Starting Car Quick, Require Fewer Expensive Replacements. Do Not Think Your Battery Is Dead & Worn Out Because It Will Not Start Your Car. Buy A **BOOSTER**, Which Fills It With Life, Saves More Than Its Cost & Lasts A Lifetime. **7 TYPES BUILT BY A MASTER OF THE ART & POPULARLY PRICED.**



Charges Auto & Radio Batteries. The Larger Types are recommended for heavy Batteries, or where time is limited. Shipping Weights Complete with **AMMETER & BATTERY CLIPS** 11 to 15 pounds. Purchase from Your Dealer or Mail Check for Prompt Express Shipment. If for Parcel Post add Postage & Insurance Charges. Or **ORDER** us to forward **TYPE** desired. **C.O.D.** **ORDER** Now or **WRITE** Immediately for **FREE** Descriptive **BULLETIN 24 & 24A.** **THE FRANCE MFG. CO., CLEVELAND, OHIO, U. S. A.**

SMOOTH-ON REPAIR BOOK

MOTORISTS

SEND FOR THIS
FREE REPAIR BOOK

Tells how to make dozens of motor repairs such as leaky radiators, etc., easily, quickly and economically. Write for this FREE book and learn how

SMOOTH-ON IRON CEMENT NO. 1

can save you dollars on motor and household repairs. Sold by Hardware and General Stores in 6 oz., 1 lb. and 5 lb. tins. Also in larger sizes.

SMOOTH-ON MFG. CO.
Dept. 37-A Jersey City, N. J., U. S. A.

SMOOTH-ON IRON CEMENT



MAKE YOUR **FORD INTO THIS SPORT CAR** \$ ONLY **6.40**

Other types down to \$2.50. Famous sure fit, **Not-A-Fit** life-size patterns and simple picture instructions show how. You can easily convert your Ford into this fast, snappy Sport Car as hundreds have done with a few dollars worth of material from the hardware store. No need to lay up the car. The "PAL" with special disc wheel patterns, Pressed Metal Streamline Rear only \$6.40 delivered. Built low, rides wonderfully easy. Order NOW while we can make good delivery. Send for illustrated prospectus of Sport Radios "Ziffo" Toys and "Gosen" Windmills. Kuempel Co., 32 Kuempel Bldg., Guttenberg, Iowa



MOTORCYCLE BARGAINS

Save 25% to 65%

on Slightly used and Rebuilt Motorcycles, Side Cars, Johnson Motor Wheels, Evans Power Cycles, Bicycles. Send for Free Bargain Bulletin and Money Saving Message. Listing hundreds of Bargains in used, rebuilt and new machines, supplies, accessories, etc.

AMERICAN MOTOR CYCLE CO., CHICAGO
Dept. 114 2047 W. Chicago Avenue.

Prices Are Down

Choose from 1933 models, 44 styles, colors and sizes world famous Ranger and Pathfinder Bicycles. Shipped Free on approval for 30 days free trial. Protect yourself at these rock bottom prices.

12 Months to Pay if desired. Many boys and girls easily earn the small monthly payments. Parents often advance first payment. Best quality, at factory prices, express prepaid. Tires, Lamps, wheels and equipment, low prices. Send No Money, do business direct with makers.

Mead Cycle Company
Dept. K108 Chicago

Write today for free Ranger Catalog, factory prices and marvelous easy payment terms.

MOTORCYCLES

RELIABLE STANDARD MAKES that you can **DEPEND** on.

Enjoy the glorious experience of going wherever you like—whenever you like. The price is within your means—35% to 50% less than others. These machines are slightly used, thoroughly overhauled or rebuilt. Send for catalogue.



MYEROW BROS.,
258 Columbus Ave., Boston, Mass.

DEAF?

Here's
Free Proof
That You
Can Hear!

The wonderful, improved Acousticon has now enabled nearly 500,000 deaf people to hear. We are sure it will do the same for you; are so absolutely certain of it that we are eager to send you the



1923 ACOUSTICON
For 10 Days' FREE TRIAL
No Deposit—No Expense

There is nothing you will have to do but ask for your free trial. No money to pay, no red tape, no reservation to this offer. Our confidence in the present Acousticon is so complete that we will gladly take all the risk in proving, beyond any doubt, that the Joy of Hearing Can Be Yours Again!

The new Acousticon has improvements and patented features which cannot be duplicated, so no matter what you have ever tried, just ask for a free trial of the New Acousticon. You'll get it promptly, and if it doesn't make you hear, return it and you will owe us nothing—not one cent.

DICTOGRAPH PRODUCTS CORP.
1307 Candler Building, 229 W. 42d St., New York City

AGENTS: \$12 A DAY
New Kant-Klog Coal Oil Burner

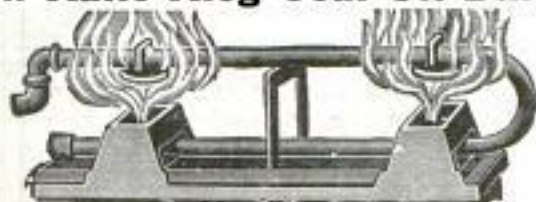

Most perfect burner ever invented. Can't clog up. Burns 85% air and 15% gas. Turns any coal or wood stove into a gas stove. Pays for itself in a short time. Cheaper than coal. Big seller. Popular price. Write for agency and territory.

PARKER MFG. CO., Burner 278, DAYTON, OHIO

\$3.00 per Month

A Whole Year to Pay

"Lady Lorraine"
Large solitaire, peridot blue white diamond, 14 kt. solid gold ring. Special \$47.75

Why wait longer when a few cents a day places this fiery brilliant, genuine blue white, perfect cut diamond on your finger. No risk, no delay. Satisfaction guaranteed. Regular \$60.00 value, our price, \$47.75.

REDUCED PRICES
Klein smashes prices on great million-dollar stock of diamonds, watches and jewelry—saves you one-third and trusts you for what you want.

WRITE FOR CATALOG

It tells the whole story—beautifully illustrates sensational bargains and explains credit plan that places them within easy reach. Why wait longer? Write for the catalog today—sure!

KLEIN & CO.
122 West Madison Street
Dept. B-713 Chicago, Ill.
Nearly One-Fourth Century Same Location

Great *New*



Invention for seekers of Health Power Beauty

Elco Health Generators at last are ready for you! If you want more health—greater power to enjoy the pleasures and delights about you, or if more beauty is your desire—write! Ask for the book on these inventions which has just been prepared. It will be sent to you without cost. It tells you how Elco Health Generators aid you in leaving the lethargy and hopelessness of bad health and weakness behind forever. Re-vitalize yourself. Bring back energy. Be wholly alive. Write today!

10 Days Free Trial—Write for Free Book!



These great new inventions generate Violet Ray, Vibration, Electricity and Ozone—combined or separate

Free Trial

They operate on the electric light in your home or on their own motive power at less than 50 cents per year. Elco Health Generators are positively the only instruments which can give you in one outfit Electricity, Violet Ray—Vibration and Ozone—the four greatest curative agents. Send the coupon below. Get the Free Book NOW!



For All These:

| | |
|--------------|---------------|
| Paralysis | Catarrh |
| Pimples | Insomnia |
| Falling Hair | Skin Diseases |
| Headache | Hay Fever |
| Lumbago | Neuralgia |
| Nervousness | Deafness |
| Rheumatism | Pain |
| Sore Throat | Development |
| Asthma | Neuritis |
| Black Heads | Obesity |

**Mail Coupon
for FREE Book!**

Do not put this paper down without sending the coupon. Don't go on as you are with pains and with almost no life and energy. You owe it to yourself to be a better man or woman. You were put here to enjoy life—not just to drag through it. So do not rest another day until you have put your name on the coupon here. That will bring the whole story of these great new inventions. Do it today—now.

Lindstrom & Company

442-448 N. Wells Street, Dept. 1351, Chicago, Ill.

Please send me your free book, "Health—Power—Beauty" and full information of your 10-day Free Trial Offer.

Name _____

Address _____

Please Mention Popular Mechanics

**LOOK AROUND!
EVERYBODY'S USING**

WHITING-ADAMS BRUSHES

A Merry-go-round of Brushes.
There are thousands of kinds and sizes of
WHITING-ADAMS BRUSHES
Your dealer sells them or will quickly get them for you.

Send for Illustrated Literature
JOHN L. WHITING - J. J. ADAMS CO., Boston, U. S. A.
Brush Makers for Over 113 Years and the Largest in the World.



Always on time

"The Fifth Avenue" Illinois 19 Jewel Watch

Give you everything you can demand of a timepiece—accuracy, dependability and beauty. A fully adjusted movement in a thin model, 55 year Green Gold filled Case and an unobtainable record of service. Unconditional guarantee against everything except loss and that our price of \$45.00 can not be duplicated.

\$5.00 DOWN — \$5.00 A MONTH
No Red Tape—No Delay—No Risk
FREE: *Deluxe catalog illustrating Diamonds, Watches and Jewelry of Quality.*
Write Dept. 155 Est. 33 years

AMERICAN WATCH & DIAMOND CO.
6 MAIDEN LANE NEW YORK

NEW SINGLE PHASE A. C. MOTORS

$\frac{3}{4}$ H. P.—110 volt, 60 cycle, 1725 speed, complete with cord, plug and grooved pulley.... \$13.00

General Electric

$\frac{1}{2}$ H. P., \$39.00
Includes pulley.



**ONE YEAR
GUARANTEE**

EMERSON

$\frac{3}{4}$ H. P., \$52.00
1 H. P., 62.00
 $1\frac{1}{2}$ H. P., 75.00
2 H. P., 89.00

Include Pulley and Base—All Motors, $\frac{1}{2}$ H. P. or larger, 110-220 Volt Rep. Ind. Type.

Satisfaction guaranteed or money refunded
Illustrated Catalog of Motors and Supplies FREE
HYRE ELECTRIC CO., 615-X So. Dearborn St., Chicago



It is the well known quality of **CRESCENT** machines that justifies you in selecting one of them each time you have need for wood work machinery. The **CRESCENT** line is better than ever and will always give you satisfaction in every particular. Ask today for catalog of hand saws, saw tables, jointers, shapers, planers, borers, routers and matchers, sewing saws, disk grinder, cut off table, hollow chisel mortiser, variety wood worker, Universal wood workers.

THE CRESCENT MACHINE CO., 93 Columbia Street, Leetonia, Ohio

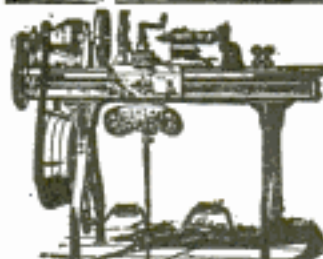

LATHES

9 to 18-inch Swing

List price \$165 and up according to size. When ready to buy send for Lathe Catalog and prices.

W. F. & John Barnes Co.
100 Ruby Street, ROCKFORD, ILL.

EVERY TOOTHBRUSH FAILS BETWEEN TEETH

50¢ AND \$1.00

This new Ivory device called "Saw" cleans the 30 danger spaces **BETWEEN TEETH** where 90% of all FATAL decay starts—Also prevents Bad Breath—Non-metallic—Safe—Avoid toothpicks—Price only 50¢ complete—Lasts a lifetime. New 4 months Refills 15¢. In Genuine Pyralin Ivory Finish with Leather Pocket case \$1.00—In gold case \$2.50. Special Agents Assortment only \$1.50. None Free. Nearly a million sold. Profits over 100%. Dents Book Free. **FLOSSY DENTAL CO., (Dept 20) Evanston, Ill.**

SEND 5 CENTS and get our 48 p. catalogue of **IDEAL Model Aeroplanes, Parts and Supplies.** Tells how to build Aeroplanes that fly like real ones. **IDEAL AEROPLANE & SUPPLY CO.** 159 Wooster St., cor. W. Houston New York City

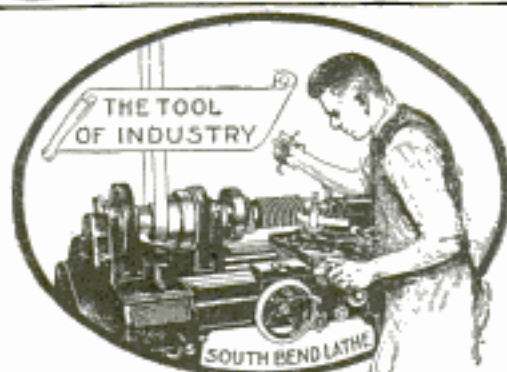

SOUTH BEND LATHES

Screw Cutting Engine Lathes

STANDARD CHANGE GEAR

| | |
|--------------------|-----------|
| 9'x 3' Lathe..... | \$ 176.00 |
| 11'x 4' Lathe..... | 228.00 |
| 13'x 5' Lathe..... | 304.00 |
| 15'x 6' Lathe..... | 376.00 |
| 16'x 8' Lathe..... | 452.00 |
| 18'x10' Lathe..... | 656.00 |
| 21'x12' Lathe..... | 933.00 |
| 24'x14' Lathe..... | 1254.00 |

QUICK CHANGE GEAR

| | |
|--------------------|-----------|
| 9'x 3' Lathe..... | \$ 216.00 |
| 11'x 4' Lathe..... | 273.00 |
| 13'x 5' Lathe..... | 354.00 |
| 15'x 6' Lathe..... | 431.00 |
| 16'x 8' Lathe..... | 512.00 |
| 18'x10' Lathe..... | 721.00 |
| 21'x12' Lathe..... | 1016.00 |
| 24'x14' Lathe..... | 1353.00 |

Catalog No. 77 sent free to any address

SOUTH BEND LATHE WORKS

625 E. Madison St.

SOUTH BEND, IND.

How to Run a Lathe:—New 80-page book, Revised Edition No. 24, for 10 cents postpaid, silver or stamps.

Copyrighted material

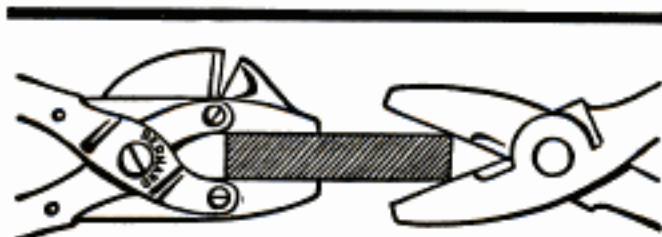

Bernard Pliers
(They Grip)

Old Style Pliers
(They Slip)

NUTS are square. Bernard Pliers have square jaws—meet exactly like a vise. Can't slip and bruise your knuckles like old-style pliers. Bull-dog grip and a quick, clean, sure cut. Talk to the hardware man about Bernards. Made in seven sizes.

Send for illustrated Plier Booklet M



BERNARD PLIERS
Wm. SCHOLLHORN CO.
NEW HAVEN, CONN.



The Midget "FIVE-IN-ONE" Slide Rule is a combination Mannheim, Log-Log, Add and Subtract, Polyphase and Binary Slide Rule. It will instantly add, subtract, multiply and divide any combination involving whole numbers, fractions, decimals and mixed numbers. Gives every possible root and power of every quantity. The graduations are printed on metal, coated with white celluloid and are green and waterproof. While it is the most versatile calculator ever invented, its operation is simple and easily understood. Diameter 4 inches. Price with 16-page Instruction Book, \$1.50. Leatherette carrying case 50c extra. Catalog free. Your money back if you are not satisfied.
GILSON SLIDE RULE CO., Niles, Mich.



BURN YOUR NAME ON TOOLS WITH ARKOGRAF

Protect your tools from theft. Write any name, engrave any design on metal with electricity like writing on paper with pen or pencil. Complete outfit \$3.66, prepaid anywhere. Interesting descriptive circular free. Write today. Agents Wanted. Arkograf Pen Company 1007 Yeon Building Portland, Oregon



Adjusts Instantly to Any Length
Just slide it out. Gives exact inside or outside diameter. No folding. Accurate, strong, brass trimmed. Any length 2 to 8 feet. If not at dealer's, sent postpaid.

Master Rule Mfg. Co., Inc. **Interlox**
841-43 East 136th Street
NEW YORK CITY **MASTER SLIDE RULE**



TOOL CHESTS
for Machinists & Toolmakers
Every tool arranged in order. No up-to-date mechanic should be without one. A Gerstner Case costs no more than some tools, and will last a lifetime. Catalog free.

Gerstner's
717 Columbia Street DAYTON, OHIO

ATKINS METAL CUTTING SAWS



Atkins AAA
"Non-Breakable"
Hack Saw
Blades

Cut Faster, Easier and Do Not Break

Atkins Hack Saw Blades save you time, labor and money on metal-cutting jobs. They are made of selected steel, hardened and tempered by a special gas-and-oil process which gives them a harder, keener edge and a tough, flexible, "non-breakable" back.

Prove for yourself that an Atkins Hack Saw Blade will cut faster and easier and last longer than other blades. Send ten cents for sample 8 or 10 inch blade, and tell us what metal you wish to cut.



No matter what saw you need—for wood- or metal-cutting—an Atkins will do the work quicker and better. KWIK-CUT Power Hack Saw Machines, circular saws, hand saws, band saws, cross-cut saws, pruning saws, etc. Write for booklets.

Get This New Book FREE!

A new edition of "Atkins Saws in the Shop" is ready. It gives helpful shop hints, tables and facts. Shows the right saw for every job. Tells how to get the best service from saws. It's brimful of time, money, and labor-saving suggestions. Write NOW.

E. C. ATKINS & CO., Inc.
Makers of "Silver Steel" Saws and Tools
Dept. P Indianapolis, Ind.

Please Mention Popular Mechanics

Copyrighted material



"Red Devil" Rapid Boring Auger Bits are 33 1/2% easier boring, have 10% greater clearance, and bore with or against the grain of any wood. Style 2400—10/16 in., shown here, 75c.

Red Devil Pliers

REG. U. S. PAT. OFF.

The handiest of
all-around
tools



THEY are sturdy—designed for hard work and long wear.

"Red Devil" Pliers make hard jobs easy.

They multiply the strength of your hand and wrist, and give you just the right hold at just the right place—a non-slip grip on that rusty nut, that screw eye you want to force into hard wood, that wire you want to bend.

Forged of steel for strength and backbone.

"Red Devil" Plier No. 999—6 1/2 inch, shown above, is a combination tool for all-around handiness. Price, 85c at dealers or us.

Mechanics' Tool Booklet Free.

"RED DEVIL" TOOLS—AMERICAN MADE
SMITH & HEMENWAY CO., Inc.

Manufacturers of "Red Devil" Tools
260 Broadway, New York, N. Y.

"Red Devil" Glass Cutters—the glaziers' standard tools of the world. "It's all in the wheel." Made in 40 styles. No. 024 shown here, 20c.



Please Mention Popular Mechanics

FOR HIS CHRISTMAS—\$2.70

will purchase one of our patented **Compound Lever VEST POCKET SNIPS**. They are 7 inches long and stamped from the same grade of crucible tool steel that our larger shears are made from. Guaranteed to cut 24 gauge metal. Highly polished and packed in individual boxes. Sent postpaid in U. S. or Canada upon receipt of price. If desired we can furnish in nickel-plated finish for 50 cents additional.



DROP-FORGED Compound Lever Snips \$4 to \$9.50 FOR HIS XMAS

Made for hardest service. Highly tempered crucible tool steel, drop forged. Cuts keen. Holds the edge. Cuts 18-gauge metal at point easily—rating power three times that of ordinary straight snip. For sale by dealers or sent postpaid in the United States at these prices:

| | |
|--------------|--------|
| 8-inch..... | \$4.00 |
| 10-inch..... | 6.00 |
| 12-inch..... | 8.00 |
| 14-inch..... | 9.50 |



FOLDER ON REQUEST
BARTLETT MFG. CO., 20 E. Lafayette Ave., Detroit, Mich.

The MONARCH Jr. Lathe

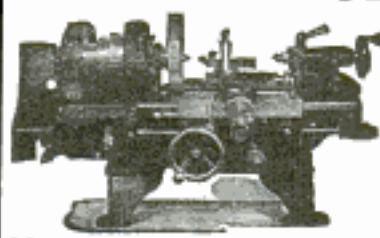

Inventors, experimenters, mechanics, and Auto Repairmen—here is an ideal, compact trouble-proof lathe—instantly ready to help you turn out the small parts you require. It works to an accuracy of 1/1000 of an inch. Can be installed on your workbench. Has semi-quick change gear and automatic safety device. Built with bed lengths to 5 feet, also with 11 inches swing at slightly higher price.

Monarch Jr. Engine Lathe \$225.
9-in. swing, 2 1/2 ft. bed

Write at once for your FREE copy of the MONARCH Lathe Catalog. MONARCH Lathes are built up to 30 inches swing.

THE MONARCH MACHINE TOOL CO.
400 Oak Street Sidney, Ohio

Small Cash Payment—Balance Easy Terms

\$20 Starts Battery Charging Business

Only \$20 cash brings an HB Battery Charger and starts a business that can make \$150 to \$300 clear monthly profit. Low cash terms on balance, easily paid by your profits. No Experience needed. Big demand for reliable battery charging. Write us TODAY for complete information. Do It NOW!
HOBART BROS. CO., Box M1, Troy, Ohio

HB Battery Charging Pays
\$1500 to \$3000 a Year

9 CORDS IN 10 HOURS



BY ONE MAN. It's KING OF THE WOODS. Saves money and backache. Send for FREE catalog No. B115 showing low price and latest improvements. First order gets agency. Folding Sawing Machine Co., 1005 East 75th St., Chicago, Ill.

Made by Good Mechanics for Good Mechanics

UNION TOOL CHESTS

They keep tools free from dirt, dust, theft or damage. Substantially made in a wide variety of patterns. Zinc or leatherette covered and quartered oak models. Ideal drawer arrangement.



Ask your hardware dealer, or write us for booklet describing more than 50 different sizes and patterns.

UNION TOOL CHEST CO.
22 Mill St. Rochester, N. Y.

SAVE YOUR BODY

Conserve Your Health and Efficiency First

"I Would Not Part with it for \$10,000"

So writes an enthusiastic, grateful customer. "Worth more than a farm," says another. In like manner testify over 100,000 people who have worn it.

The Natural Body Brace

Overcomes WEAKNESS and ORGANIC AILMENTS of WOMEN AND MEN. Develops erect, graceful figure.

Brings restful relief, comfort, ability to do things, health and strength.

Wear It 30 Days Free at Our Expense

Does away with the strain and pain of standing and walking; replaces and supports misplaced internal organs; reduces enlarged abdomen; straightens and strengthens the back; corrects stooping shoulders; develops lungs, chest and bust; relieves backache, curvatures, nervousness, ruptures, constipation, after effects of flu. Comfortable and easy to wear.

Keep Yourself Fit Write today for illustrated booklet, measurement blank, etc., and read our very liberal proposition.

HOWARD C. RASH, Pres. Natural Body Brace Co.
223 Rash Building SALINA, KANSAS



For Boys and Girls Also



KEYS DUPLICATED

2 FOR 25c

Any Type Key—Send Key with Order

Special rates to clubs and organizations

PHILADELPHIA KEY CO. 178 N. Broad St. PHILADELPHIA

MUSIC LESSONS FREE



IN YOUR OWN HOME

See how you can read music like this quickly
Piano, Organ, Violin, Mandolin, Guitar, Banjo, etc.
Beginners or advanced players. One lesson weekly. Illustrations make everything plain. Only expense about 2c per day to cover cost of postage and music. Write for **FREE** booklet which explains everything in full.

AMERICAN SCHOOL OF MUSIC, 50 Lakeside Building, CHICAGO

Agents

LARGE MANUFACTURER OF SHIRTS wants Agents to sell complete line of shirts direct to wearer. Exclusive patterns. Big values. No capital or experience required. Write for free samples.

MADISON SHIRT MILLS
807 Broadway New York, N. Y.

Clear-Tone FOR PIMPLES

Your skin can be quickly cleared of Pimples, Blackheads, Acne Eruptions on the face or body, Enlarged Pores, Oily or Shiny Skin. **\$1,000.00** Cold Cash says I can clear your skin of the above blemishes. **WRITE TODAY** for my **FREE** Booklet—"A Clear-Tone Skin"—telling how I cured myself after being afflicted for fifteen years.

E.S. GIVENS, 129 Chemical Bldg., Kansas City, Mo.



GREEN AUTOMATIC MACHINE



ADD TO YOUR INCOME

WITH LITTLE EFFORT A DAY MADE \$5 to \$10 EASY WITH

New Improved Green Automatic Machine

Sharpens, Honed and Strops all kinds of safety razor blades, in one operation, from four to six blades per minute. For both Quality and Quantity, this machine is in a class by itself. There is nothing like it on the market. Let us send you our descriptive literature explaining everything, including the **"AMERICAN" Key Cutter**—cuts square, angular or round slots

AMERICAN SHARPENING MACHINE CO. (Inc.), Dept. 1, 184 W. Washington St., CHICAGO



10 Buys 100

Engel "Art Corners"

Use them to mount all kodak pictures, post cards, clippings in albums

No Paste Needed

Made in Square, Round, Oval, Fancy and Heart of black, gray, sepia, and red gummed paper. Slip them on corners of pictures, then wet and stick. **QUICK-EASY-ARTISTIC.** No. 100, 10c. At photo supply, drug and station stores. Accept no substitutes; there is nothing as good. 10c brings full page, and samples from Engel Mfg. Co., Dept. 2N, 4711 N. Clark Street, Chicago

DIAMONDS WATCHES

LOFTIS

BROS. & CO. ESTD. 1858

Credit at Cash Prices

The Best Holiday Gift of All—a Genuine Diamond Ring

We import Diamonds direct from European markets and sell direct to you by mail. Our Diamonds are magnificent blue-white, perfect cut gems. Our immense BUYING POWER is a great saving to you. Why pay more than LOFTIS asks?

SEND FOR HOLIDAY CATALOG

Over 2,000 Illustrations of Diamond-set Jewelry, Watches, Wrist Watches, Pearls, Men's Bags, Silverware, etc.—gifts by which you will always be remembered. There is something appropriate for everyone. Select as many articles as you wish and have all charged in one account. Sent prepaid for your Free Examination. Easy Credit Terms. Catalog explains everything. Liberty Bonds Accepted.

LOFTIS THE OLD RELIABLE ORIGINAL CREDIT JEWELERS
DEPT. H-894
108 N. State Street, Chicago, Ill.
Stores in Leading Cities

New 300 Candle Power Lamp

Make \$60 to \$100 a Week

Introducing this wonderful new lamp. Gives soft, brilliant light; restful to eyes; ideal illumination.

Burns Kerosene or Gasoline

Clean, odorless, economical. Burns 96% air, 4% fuel. Absolutely safe. Lights with match. 100 times brighter than wick lamps. Patented. Greatest improvement of age. Table lamps, hanging lamps, lanterns. Work all or spare time. You simply take orders. We deliver by Parcel Post and do collecting. Commissions paid same day you take orders. No experience necessary. Get started at once. Big season now on. Write today for catalog and special agents' offer.

THE AKRON LAMP CO.
101 Lamp Bldg. Akron, Ohio

AGENTS Send for FREE Offer

BIG BARGAINS IN BAND INSTRUMENTS

Check the instrument in which you are interested, and send us your name and address. We will not only save you money, but give you the SERVICE that can be obtained only from EXPERIENCED BANDMEN.

THE DIXIE MUSIC HOUSE, 300 South Wabash Ave. CHICAGO

| | |
|---------------------|-----------------------------|
| Flutes and Piccolos | Alto and Soprano Saxophones |
| Oboes | Trumpets |
| Bassoons | Baritone |
| Clarinet | Saxo |
| Drum | Bells, Xylophone, Etc. |
| Contra and Trombone | |

Name _____
Town _____ State _____
Additional Address _____

THE AJAX EYELET FASTENER

BINDS AND INSERTS AJAX EYELETS IN PAPER, CARDBOARD, LEATHER OR CLOTH

It Saves Time by Punching the Hole, Feeding the Eyelet and Clinching It in One Operation.

Drop the eyelets into the magazine and go right ahead. Order from your stationer or direct.



PRICE WITH 1500 AJAX EYELETS, \$10.00 DELIVERED IN U.S.A.

Write for our catalogue of office tools
MACHINE APPLIANCE CORPORATION

351-353 Jay St. Spec. Dept. Brooklyn, N. Y.

KEITH'S \$2.50 OFFER



3 Plan Books, showing 100 designs and floor plans of artistic bungalows, cottages, or two-story houses—in frame, stucco and brick—and 8 months' subscription to Keith's Magazine—all for \$2.50.

Keith's Magazine for over 20 years an authority on planning, building and decorating homes—25¢ a copy on newsstands. With its help and Keith's Plans you can get the most distinctive, comfortable and satisfactory home with greatest economy.

Set of 8 plan books (260 plans) and Keith's for 12 months—\$4.50
Keith Corporation, 607 Abbey Bldg., Minneapolis, Minn.

\$1332.00 CASH AND AUTO GIVEN



This Offer Open to Men and Women!

A few choice places open for willing workers—men and women—as "Direct from the Factory" Representatives—to introduce our nationally advertised "Zanol" line of high class Food and Household Specialties. All or part time work. No experience and no capital needed. Workers making as high as \$80 to \$100 a week. Beginners \$5 to \$10 a day. Write for particulars and Ford Offer today.

American Products Co. 7226 American Bldg., Cincinnati, O.

AGENTS 500% PROFIT

\$60 - \$200 per week. Free samples **GOLD SIGN LETTERS** for store and office windows. Anyone can put them on. Big demand everywhere. Liberal offer to general agents.

METALLIC LETTER CO., 433B N. Clark, Chicago

MONEY IN MUSHROOMS

NOW TIME TO START

BIG DEMAND. HIGH PRICES BEING PAID

An uncrowded occupation. Exceptional opportunities for live men and women. Raised at home. Only small space needed. Small expenditure will start you in a practical money-making enterprise. Big profits. Booklet telling all free. Write Nat'l Spawn Co., Dept. 11, Waban, Mass.

Standard Typewriters

Save \$25 to \$60.

\$3.00 Down—Balance \$5.00 Monthly

Underwoods, Royals, Remingtons—all makes. Rebuilt in our factory; practically good as new. Every machine guaranteed. Prices now lower than ever! Write for Special Bargain List and particulars on 5-day Free Trial. Write today!

WYNN TYPEWRITER EXCHANGE
13 Reliance Bldg. Kansas City, Mo.

FREE TRIAL ~ Write Today!

Paralyzed For 10 Years

Hazel Bliss was deformed by Paralysis when a baby. She was 11 when she came to McLain Sanitarium. Photos and mother's letter below, tell what 5 months' treatment did:

When we arrived at the Sanitarium Hazel had a badly deformed foot and walked on her toes. When we left 5 months later, she had a nice straight foot and walked with her heel and bottom of her foot flat on the floor. I shall gladly recommend your Sanitarium to any crippled person.

MRS. EDITH BLISS,
Cooperstown, New York.

FOR CRIPPLED CHILDREN

The McLain Sanitarium is a thoroughly equipped private institution devoted exclusively to the treatment of Club Feet, Infantile Paralysis, Spinal Disease and Deformities, Wry Neck, Hip Disease, Diseases of the joints, especially as found in children and young adults. Our Book, "Deformities and Paralysis" and "Book of References" sent free.

The L. C. McLain Orthopedic Sanitarium
902 Aubert Avenue St. Louis, Mo.



MYSTERIOUS CHARM

\$1.00 each Gold-Plated

A very mysterious watch charm until revolved—then it produces a Square and Compass

Write for free catalogue of Masonic publications, Jewelry and paraphernalia.

REDDING & COMPANY

200 Fifth Avenue Dept. P New York City

TYPEWRITERS
We Save You 50 %
FREE TRIAL—EASY TERMS
Your choice of all STANDARD MAKES, UNDERWOOD, ROYAL, SILENT L. C. SMITH, Self-starting REMINGTON, etc. Rebuilt by the Famous "Young Process." Guaranteed good as new. Lowest cash prices. Free payments or rentals with special purchase privilege. Largest stock in U. S. Write for special prices and terms.
YOUNG TYPEWRITER CO., Dept. 492 CHICAGO

BURROWES

Home Billiard & Pool Tables

Magnificently made in all sizes, at all prices. Game exactly same as standard table. Become expert at home. Use in any room, on any house table or on its own folding stand. Quickly leveled. Put up or down in a minute. Small amount down, easy payments. Ask your dealer or WRITE TODAY for Catalog.
E. T. BURROWES CO., 53 Free St., Portland, Maine

A Home and Income For You in Sunny Florida



Be Independent—Own a Grapefruit and Orange Grove—A Truck or Poultry Farm. Increase Your Income

You Can Start a Grove Today Under Our New Plan

Develop a profit-earning fruit farm without leaving your present position—provide for your future. A small payment now and a few dollars invested each month.

A profit-producing fruit grove is a permanent investment and provides protection against old age.

THE RIGHT LAND IN THE RIGHT LOCATION AT THE RIGHT PRICE

We Have It—Any Size Farm

These splendid lands are suburban to Tampa, the metropolis of South Florida. Here you find the most healthful, the most delightful climate in North America. For ten years we have been right here helping develop Hillsboro—the banner agricultural County of Florida, and we are still here to serve you and to help you obtain the farm you want, on very easy payments extending over 2 or 3 years' time to suit.

Groves Developed for Non-Residents

If you want to remain in your present position for a few years we can develop a grapefruit and orange grove for you. When you are ready we will clear your land, furnish fruit trees, plant and care for your grove until you are ready to look after it.

We Raise Our Own Guaranteed Citrus Trees in Our Own Nurseries

This insures every purchaser the best fruit trees that can be grown. This also insures a successful grove. We can save you money on planting and caring for your grove.

\$300.00 to \$500.00 Per Acre Profit

This is not an unusual return for truck farmers in the Famous Tampa district. All kinds of vegetables can be grown. Big prices are paid for early potatoes, Winter cabbage, Bermuda onions, tomatoes, celery and dozens of other vegetables during the Winter and early Spring, when the north is covered with ice and snow. Strawberries, Melons, and other small fruits also yield large profits.

Write for Facts About Sunny Florida

IT COSTS YOU NOTHING TO LET US PROVE TO YOU that we have the land you want—in the location you want—at a price you can afford to pay and on the easiest terms you can imagine. Let us show you.

Fill out and mail us the coupon today and receive our large descriptive book FREE!

NORTH TAMPA LAND CO.

Suite 510 Monon Bldg. CHICAGO

Coupon for FREE Book on Florida

NORTH TAMPA LAND CO.
Suite 510 Monon Bldg., CHICAGO

Please send me your large illustrated Book, "The Call of the Southland," on choice Citrus Fruit and Truck Farms suburban to Tampa, Florida, and information on how I can have a grove developed on the monthly payment plan. P.M. 1-23.

Name.....
St. No.....
City.....
State.....

PATENTS TRADE-MARKS AND COPYRIGHTS

OUR OFFER—Free Opinion as to Patentable Nature

Before disclosing an invention, the inventor should write for our blank form "Record of Invention." This should be signed and witnessed and if returned to us together with model or sketch and description of the invention, we will give our opinion as to its patentable nature.

Our Three Books Mailed FREE to Inventors



OUR ILLUSTRATED GUIDE BOOK

HOW TO OBTAIN A PATENT

Contains full instructions regarding Patents, Trade-Marks, Foreign Patents, Our Methods, Terms, and 100 Mechanical Movements illustrated and described; Articles on Patent Practice and Procedure, and Law Points for inventors.

OUR TRADE MARK BOOK

Shows the value and necessity of trade-mark protection and gives information regarding unfair competition.

OUR FOREIGN PATENT BOOK

We have direct agencies in all the principal foreign countries and secure foreign patents in the shortest possible time and at the lowest cost. Write for our illustrated Guide Book on Foreign Patents, sent free to any address.

LIST OF PATENT BUYERS SENT FREE

Containing unsolicited letters from manufacturers and others who are constantly writing us regarding the purchase or leasing of meritorious patents. We endeavor to assist our clients in the commercial development of their inventions.

Specialization—Our Staff

The field of invention is so vast that it is impossible for any one man to become an expert in all the different classes of invention. For this reason Victor J. Evans & Co. employ a number of patent lawyers and mechanical experts who have been selected for their special knowledge and ability in certain lines of invention. Each case is placed in charge of experts in the classes to which the invention relates.

THE VALUE OF YOUR PATENT

will depend much upon the skill and care with which your case is prepared and prosecuted in the United States Patent Office. That every case entrusted to us receives our best efforts, and that our work is done consistently, skillfully, and thoroughly is evidenced by the many unsolicited letters of commendation that we receive constantly from our clients. We will furnish upon request lists of clients from any State in the Union for whom we have secured patents.

Our New York, Philadelphia, Pittsburgh, Chicago and San Francisco Offices

Owing to the growth of our business we have established for the benefit of our clients Branch Offices in New York City, Philadelphia, Pa., Pittsburgh, Pa., Chicago, Ill., and San Francisco, Cal. These branch offices being located in these large commercial cities together with our Main Office located near the U. S. Patent Office, in Washington, enables us to more promptly handle the business of our clients, particularly as the branch offices are in constant touch with the Main Office and fully equipped to handle patent business in all its branches.

Highest References—Prompt Attention—Reasonable Terms.

—FREE COUPON—

VICTOR J. EVANS & CO., Patent Attorneys

NEW YORK OFFICES
1007 Woolworth Building

CHICAGO OFFICES
1114 Tacoma Building

PHILADELPHIA OFFICES
714-715 Liberty Bldg.

PITTSBURGH OFFICES
514 Empire Building

SAN FRANCISCO OFFICES
Hobart Building

MAIN OFFICES: 765 9TH STREET, N.W., WASHINGTON, D. C.

Gentlemen: Please send me FREE OF CHARGE your books as described above.

Name Address

WANTED IDEAS



Inquiries from Manufacturers and Others Who Are Looking for Good Ideas

PROTECTED BY PATENTS

are constantly being received. Manufacturers are always interested in any new device for which there is a market, which fills a long felt need, which makes production possible at a lower cost, or which will do the work **BETTER**. There is undoubtedly a great demand today for really worth while inventions.

Your First Step

If you have an idea, send immediately for my blank form "TO RECORD YOUR INVENTION." You should serve your own best interests by filling out and signing this form before you disclose your invention TO ANY ONE. This document will help you determine and establish evidence of invention before filing an application in the U. S. Patent Office. A copy, with full instructions, will be gladly sent free on request.

NEW BOOK "SUCCESSFUL PATENTS" SENT FREE

Every man who has an invention, or ever hopes to have one, should send for a copy of my book "SUCCESSFUL PATENTS." It tells what everyone should know about patents, trademarks, copyrights, etc. It describes my methods, fees and terms, gives information relative to assignment or sale of rights, and instructions in detail. Mail coupon today for a free copy of this book or a post card request will do.

To the Man with an Idea

I offer a comprehensive, experienced, efficient service for his prompt, legal protection, and will endeavor to aid him in the commercial development of his proposition—my service is distinguished by over 12 years' successful practice, and by thousands of satisfied clients and by reasonable fees.

Send sketch, or model, and description, for advice as to cost, opinion as to its patentable nature, etc. Preliminary advice gladly furnished without charge.

----- COUPON -----

RICHARD B. OWEN, Patent Lawyer

*Main Office, 9-303 Owen Bldg., Washington, D. C.
Branch Office, 2276-E Woolworth Bldg., New York City.*

Please send me, without charge, or other obligation, a copy of your book, "SUCCESSFUL PATENTS," your form "TO RECORD YOUR INVENTION," and information concerning patents, etc.

Name.....Address {

PATENTS

IF YOU HAVE AN INVENTION which you wish to patent you can write fully and freely to Munn & Co., for advice in regard to the best way of obtaining protection. Please send sketches or a model of your invention and a description of the device, explaining its operation.

All communications are strictly confidential. Our vast practice, extending over a period of seventy-seven years, enables us in many cases to advise in regard to patentability without any expense to the client. Our Hand-Book on Patents is sent free on request. This explains our methods, terms, etc., in regard to **Patents, Trade Marks, Foreign Patents, etc.**

If you are a reader of the
**SCIENTIFIC
 AMERICAN**

you are probably aware of the fact that it has a special appeal to the inventor. Each issue contains a description of a large number of recently patented inventions. Pending patent legislation as well as the most recent rulings of the Patent Office and the courts are considered in its columns.

MUNN & CO.

SOLICITORS OF PATENTS

672 Woolworth Bldg., NEW YORK
 Scientific American Bldg., WASHINGTON, D. C.
 801 A Tower Bldg., - - CHICAGO, ILL.
 611 Hanna Bldg., - CLEVELAND, OHIO
 582 Market St. SAN FRANCISCO, CALIF.

Please Mention Popular Mechanics



PATENTS

Send us sketch or model for patentability opinion and exact cost of patent. Our book "How to Obtain a Patent," Sent Free on request. It tells how to apply for Patents, Trade Marks, Foreign Patents, Copyrights, etc.; gives information on Patent Procedure; tells what every inventor should know. Thousands of Inventors, who are our clients, are our references. **Chandlee & Chandlee, 25 Years Experience, 435 7th St. Washington, D. C.**

PATENTS

C. L. PARKER

Formerly Member Examining Corps, U. S. Patent Office

PATENT LAWYER

MCGILL BLDG.

WASHINGTON, D. C.

Patents, Trade Marks, Copyrights, Patent Litigation

Handbook for Inventors, "Protecting, Exploiting and Selling Inventions," sent free upon request.

PATENTS

TRADE-MARKS

COPYRIGHTS

Send for our free book of patent information.

Beale & Park 802 F St., Washington, D. C.
 16 S. Broad St., Philadelphia, Pa.

INVENTORS

who derive largest profits know and heed certain simple but vital facts before applying for

PATENTS

Our book *Patent Sense*, for Inventors and Manufacturers, gives those facts; free. Write Lacey & Lacey, 646 F St., Washington, D.C.

ESTABLISHED 1869

PATENTS Secured

Prompt service. Avoid dangerous delays. Send for our "Record of Invention" form and Free Book telling How to Obtain a Patent. Send sketch or model for examination. Preliminary advice without charge. Highest references. Write TODAY. J. L. Jackson & Co., 327 Ouray Bldg., Washington, D. C.



GEARS ALL KINDS SMALL

The most accurate made and prices reasonable. We carry a complete line of gears in stock for immediate shipment. Can also quote on special gears of all kinds. Send us your inquiries.

WRITE FOR CATALOGUE

CHICAGO STOCK GEAR WORKS
 105-109 S. Jefferson St., CHICAGO

The WONDERFUL

ERICKSON PATENT LEG

Will not chafe, overheat, nor draw end of stump.



ERICKSON ARTIFICIAL LIMB CO., 38 Wash. Av. N., Minneapolis, Minn.

TOBACCO

Habit Cured or No Pay

Any form, cigars, cigarettes, pipe, chewing or snuff Guaranteed. Harmless. Complete treatment sent on trial. Costs \$1.00 if it cures. Nothing if it fails. **SUPERBA CO. E-41 BALTIMORE, MD.**

INVENTORS

PROFIT FROM YOUR OWN IDEAS. We show you how. Thousands of men, and women, too, have ideas that would bring in fortunes if properly developed and protected.

HAVE YOU AN IDEA FOR THE IMPROVEMENT OF ANY THING? HAVE YOU AN IDEA OF SOMETHING ENTIRELY NEW? The smallest improvements, or new ideas, sometimes bring the biggest fortunes.

Can you think of a simple, practical idea that will fill one of the many requests we have on file for new inventions? Thousands of things are needed, NOW.

WE SHOW YOU HOW TO PROTECT YOUR IDEA; HOW TO GET THE MOST OUT OF IT.

SEND FOR THIS FREE BOOK

Tells you all you want to know about inventions, patents and trade marks. Valuable information. Patents advertised, for our clients, free, in "INVENTION and MANUFACTURING," a magazine for inventors, for the man with an idea. (One year's subscription 50c.)

A postal will do; but DO IT NOW; IT MAY MEAN THE STEPPING STONE TO FUTURE SUCCESS.

AMERICAN INDUSTRIES, Inc.
200 KRESGE BUILDING, WASHINGTON, D. C.



\$ DOLLARS IN HARES



Raise hares; quick easy profits. Small space; little capital necessary. Hares breed all year. 6 to 12 in litter, 4 to 8 litters year. Sell locally for meat and fur or ship to us. We guarantee you \$7 to \$25 cash a pair and pay express. Book free—write today.

STANDARD FOOD & FUR ASS'N
407B Broadway New York City

Our BUREAU OF INFORMATION will answer all questions regarding articles appearing in this magazine. Address Bureau of Information, Popular Mechanics Magazine, Chicago.

60% of Market Price

Will Buy Diamonds Here

This 1/4-1/18 Ct. perfectly cut diamond, a snapper, bluing solitaire, at \$42.65 among bargains in our lists. See the many big amazing values some as low as \$50 per Carat, other higher per Carat bargains. This 75 year oldest largest Diamond Banking Firm is all the world lends money on diamonds. Thousands of unpaid loans and other bargains. Most sell NOW.

Why Pay Full Prices

Costs Nothing To See. Any Diamond sent for absolutely free examination at our risk. No obligation. No cost to you. Latest Listings—Unpaid Loans. Sent Free. Describes Diamond Bargains in Detail, gives cash loan values guaranteed. Explains unlimited exchange privileges. Write Today. Postal card will do.

Jos. De Roy & Sons, 1994 De Roy Building Pittsburgh, Pa.
Only Opposite Post Office



This Ring \$42.65
3/4 - 1/16 Carat Perfectly Cut

PATENTS If You Have an Invention and Desire to Learn How to Secure a Patent

Send for our Guide Book, HOW TO GET A PATENT, sent Free on request. Tells our terms, methods, etc. Send model or sketch and description of your invention and we will give our opinion as to its patentable nature.

RANDOLPH & CO.
600 F St., N.W., Washington, D. C.

NAME.....
STREET.....
CITY..... STATE.....

U.S. PATENTS

PROTECT YOUR IDEAS

Avoid Delays. Profit From Your Invention. Write today for free book "How to Obtain a Patent." Send Sketch or Model of your idea for preliminary examination and my report. Your rights will be carefully safeguarded and held in strict confidence. Highest references. Prompt Personal Attention to each case.

CLARENCE A. O'BRIEN

Registered Patent Lawyer

798 SOUTHERN BUILDING, WASHINGTON, D. C.

FREE
WRITE
TODAY



INVENTORS!

Here is a chance for Invention and Industry to Meet. Reserve your SPACE now at the GRAND CENTRAL PALACE for the first

UNIVERSAL EXPOSITION of INVENTIONS and PATENTS

February 17-22, 1923.

For full information, write:

UNIVERSAL PATENT EXPOSITION CORP.
110 West 40th Street, New York City.

HAWAIIAN IM. DIAMONDS



No. 8010
Special price \$2.98

The Greatest Discovery the World Has Ever Known
Just to advertise these thirteen im. diamonds we will send you one of these 14K gold f. rings, postage paid. When it arrives pay postman \$2.98 C.O.D. charges to cover cost etc. Only 10,000 rings given away. Money refunded if you can tell it from a genuine diamond. Read size of finger.

KRAUTH & REED
Dept. C
Masonic Temple Chicago



No. 8011
Special price \$2.98

MOVIES OH BOY!!



Movies in Your Own Home
A great idea for the Holidays. Real moving picture machines in five models—as low as \$5.00. FILMS lowest prices in the country. Write now for free literature that explains everything.
PARAMOUNT MFG. COMPANY
Dept. M, Box 1371, Boston, Mass.

PATENTS

Booklet Free

Highest References

Promptness Assured

Best Results

Send drawing or model for preliminary examination

ALL BUSINESS GIVEN PROMPT AND PROPER ATTENTION

WATSON E. COLEMAN, Patent Lawyer, 624 F St., Washington, D. C.

U.S. PATENTS



SEND FOR THIS FORM

DON'T LOSE YOUR RIGHTS TO PATENT PROTECTION

Before disclosing your invention to anyone send for blank form "EVIDENCE OF CONCEPTION" to be signed and witnessed. A sample form together with printed instructions will show you just how to work up your evidence and establish the same before filing application for patent. As registered patent attorneys we represent hundreds of inventors all over the United States and Canada in the advancement of inventions. Our schedule of fees will be found reasonable. The form "Evidence of Conception," sample, instructions relating to obtaining of patents and schedule of fees sent upon request. Ask for them—a post card will do.

PATENTS AND TRADE MARKS

LANCASTER & ALLWINE

204 Ouray Bldg. Washington, D. C.
Originators of forms "Evidence of Conception."

Build Your Own PHONOGRAPH

IT'S EASY WITH OUR HELP

A few hours' interesting work saves over half and gives you a machine to suit your ideas. We furnish motors, tone arms, case material, blue prints and full instructions. Plays any record. Make fine profit building phonographs for your friends.

Write today for our FREE Blue print offer.

GET YOUR RADIO SUPPLIES FROM US

Choraleon Phonograph & Radio Co.
123 1st St., Elkhart, Ind.



SAVE OVER HALF

BURN Home Made GAS COAL STOVES

Change your coal or wood stove into a gas stove in 3 minutes. A Child can do it. Burn kerosene Vapor Gas—hotter than coal or wood and costs less. Safe and simple.

FREE TRIAL
Just turn a valve and get even heat instantly. No ashes, no dirt, no smoke, no wood to chop or carry. No fires to build and feed. No fuel wasted. Cooks and bakes better. No damage to stoves. Makes its own gas from common coal oil, cheapest, cleanest fuel. Guaranteed five years. Money back if not satisfied after 10 days trial.

Write for FREE folder with proof and SPECIAL OFFER
SIMPLEX UTILITIES MFG. CO.
110 Simplex Bldg. 2537 S. State St., Chicago



DEVELOP YOUR INVENTIVE ABILITY
Invention Is a Science

Let Great Inventors teach you how to invent, develop, patent and market your ideas; amazing new course teaches science of invention by mail.

Every man, woman, and child is born with *creative imagination*. Some develop this faculty to a greater degree than others, and those who develop it to the *greatest* extent are successful inventors. Invention is an orderly process of the mind, which combines two or more known facts to produce a new fact. Anyone who develops the right mental process can become an inventor. Every successful inventor has this type of mind, developed by constant experience over a period of perhaps



Raymond Francis Yates

author of the New Course in Inventive Science, in collaboration with 15 other inventors. Mr. Yates is known throughout the country as Editor of scientific magazines, writer of hundreds of articles and inventor of many practical devices and machines.

many years. Heretofore those who succeeded in the field of invention had to discover all the principles themselves. But, now, just as any student of medicine, law, or engineering can take full advantage of all the recorded experience in these fields of study, so can YOU take the same kind of short cut to the habits of thought, and the methods of work required of successful inventors.

Little Inventions Win Fortunes

Fortunes have been made by men who have thought of a "little" idea in a flash. The man who invented the bottle top, the man who invented the crimped hairpin, the man who invented the thin lead automatic pencil, the man who invented the snap fastener—all these men, perhaps, got their ideas in a flash, and founded their fortunes as a result of a single idea. But in every case their minds operated in accordance with the scientific laws of successful invention.

Edison says: "Invention should be taught as a profession." Every inventor realizes the hopelessness of groping in the dark for the habits of thought and methods of work required for successful invention. Trying to invent without knowing the fundamental requirements of invention is like trying to build a bridge without knowing engineering.

Don't Waste Ideas! Every man at some time or other has an idea for something he would like to invent, but his mind doesn't know how to work. He doesn't know what to do about it—doesn't know how to think along inventive lines—and soon someone whose mind is trained along inventive lines invents just the thing you may have thought of.

WRITE FREE BOOK FOR

A wonderful book explaining this wonderful new course in detail has been written and will be sent free to those genuinely interested. This book explains the course in detail, and proves that anyone can become an inventor who trains his mind!—it may be the beginning of a fortune for you. If you have ever had an idea for an invention, or if you would like to become a spare-time or professional inventor, and if you would like to know what to invent, send in your name at once on the coupon NOW! Only a limited number of these books are available, for free distribution.

BUREAU OF INVENTIVE SCIENCE
Dept. 31, Wisner Bldg.
Rochester, N. Y.

Please send me your free book "The Science of Invention."

Name.....

Address.....

City.....

State.....

Bureau of Inventive Science, 31 Wisner Bldg., Rochester, N. Y.



MAKE MORE MONEY

Add \$5.00 a Day to Your Profits With a Torit Acetylene Torch No. 13

For radiator repairing, general soldering, light brazing, heating, battery repairing, etc. Produces instant hot flame, works rapidly. Furnished with 4 different tips and soldering copper, enabling you to do a wider range of work.

USES ACETYLENE GAS ONLY

A splendid use for discarded auto acetylene tanks. Many owners make the Torch No. 13 pay for itself in a single day. Torch, with 4 different tips, soldering copper, 5 ft. tubing and connection for auto acetylene tank. \$7.50

ORDER TODAY FROM YOUR JOBBER, OR

ST. PAUL WELDING AND MFG. CO., 177 W. 3rd St., ST. PAUL, MINN.

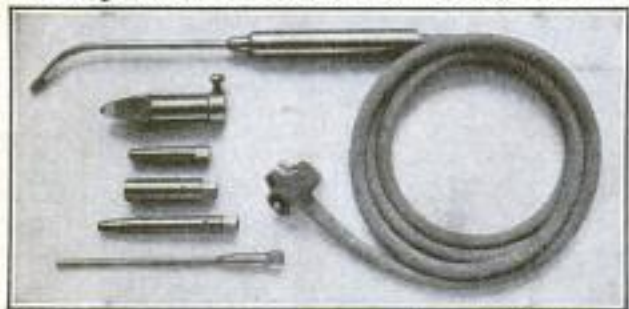

BE A SALESMAN

We teach you how—give you territory—furnish you a stock of Extracts, Spices, Remedies, Food Products, Toilet Articles and Stock Remedies on credit. You furnish auto or team and wagon—we do the rest.

Make \$200 to \$500 PER MONTH

Own your own business, be your own boss. Write for full particulars.

FURST & THOMAS, Freeport, Ill., Dept. 740



Little Giant Drill Press

Radio Panel just the thing for Shop and experimenting work. Mechanically right and well made. Weight 22 lbs. Price \$15.00.

Send for circular
SYPPER MANUFACTURING CO.
 Dept. "D" Toledo, Ohio

Better Work and More of It

—these are the results obtained to an amazing degree by hundreds of users of the

Boice Junior Bench Saw

A wonderfully practical, compact, all metal machine designed for accurate and speedy sawing, ripping, grooving, etc. Cuts 1 1/2" stock. Dadoes 3/8" deep and 3/4" wide. Driven by 1/4 or 1/2 h.p. motor. Special saws cut type-metal, bakelite, brass, etc. Portable. Attaches to lamp socket.

Write for descriptive literature on the Junior Bench Saw, 4" Jointer, 14" Bench Band Saw, Bench Drills, Motors, and larger Bench Saws.



W. B. & J. E. Boice, Dept. P. M. 1 114 23d St., Toledo, Ohio



This Misery

the dull pain of chronic headache, the sharp stab of neuralgia or the throb of quivering nerves need have no terrors for you.

Science has developed a modern treatment, Renulife Violet Ray, of high medicinal value. This high frequency electricity penetrates—soothing and quieting disturbed nerves, purifying the blood and stimulating the circulation. In practically every case immediate relief after the first treatment is followed by permanent, gratifying results.

Renulife VIOLET RAY can be used in your own home and in conjunction with any other treatment. Write your name and address on the margin of this page, mail to us and we will tell you just how much Renulife Violet Ray will help you. We have a Free Trial Plan—ask for it.

Renulife Electric Co.
 114 Newberry Bldg., Detroit
 (In Canada: Pitt St. East, Windsor, Ont.)



New Mint Vending Machine Makes You \$10 to \$20 a Day

Pays Rent for Store Owner

Install one in your store or any public place and get this easy profit. Requires no attention. Always works. Machine's profits pay the rent. Write us about rebuilt penny and nickel machines. Finished like new. In excellent running order. Pay their cost in 10 days.

Write or wire today for full particulars. \$25 down payment. Balance C. O. D. Mints \$15 per case—1,000 5 cent packages. Single boxes, 100 5 cent packages, \$2.50.

SILVER KING NOVELTY CO.
 400 Williams Bldg. Indianapolis, Ind.



Every boy loves boats and trains

Send 10 cents to The Ives Manufacturing Corporation, Bridgeport, Conn., for complete catalog of boats and trains.
IVES TOYS MAKE HAPPY BOYS



Max Fisher

Henry Halstead

Freddie Carter

Leading orchestra directors of Los Angeles, shown above use and endorse Conn instruments.

**Here's Your Chance
'For Extra Money**

There's a bigger demand than ever for players of saxophone, trumpet, trombone or tuba in dance and theatre orchestras. You can qualify for a well paying engagement, either whole or part time, through a short period of pleasurable practice with a Conn. Easiest playing instruments made. Used by leading symphony and jazz orchestras.

Free Trial! Easy Payments. Send for free book and details; mention instrument.

C. G. CONN, LTD.
131 Conn Bldg., Elkhart, Ind.



Get this Free Book



WORLD'S LARGEST MANUFACTURERS OF HIGH GRADE BAND AND ORCHESTRA INSTRUMENTS



Build This Phonograph Yourself

TREMENDOUS SAVING IN COST

Easy, fascinating work with our SIMPLIFIED PLANS. We furnish blue prints, diagrams, motor, cabinet pieces, ready-built horn, etc. You don't need to be a cabinet maker. A few hours assembling and you will have a fine instrument at one-quarter the regular retail price. **AGENTS MAKE MONEY** making and selling these instruments. Write today for full details and our FREE OFFER. Address: **MODERN PHONOGRAPH SUPPLY CO.** 213 N. Morgan St. Dept. 704 CHICAGO, ILL.

5 Master Keys

Work like magic in emergencies or prove whether your door or padlocks are burglar-proof. **Open and test thousands of different locks.** Recommended by users in ten different nations. Most wonderful and only keys of their kind. Send \$1 today. Novel key chain FREE with set. **MASTER KEY CO.**

2M MANHATTAN BLOCK Milwaukee, Wis.



BALBA bouquet perfume

Get Our Money-Making Agency Offer
Balba Sales Machines
Make \$200 to \$1000 Monthly

This new plan of selling high quality perfume has taken the country by storm. Men everywhere are jumping at the opportunity to get into this big money-making field.

Over 500 Cities Already Taken

Remember the first who qualify get the exclusive sales rights. We do the local newspaper and national advertising. Get full particulars NOW.

BALBA CORPORATION of AMERICA, Inc.
Dept. 44, Adams and Jackson Sts.
TOLEDO, OHIO, U. S. A.



Ladies' Ring
No. A4350

Genuine Diamond
Solid 14K Green Gold Ring
with White Gold Top.
Was \$50.00. Read new offer:
NOW \$38.75
A Year to Pay

Pay Nothing

An amazing new offer—wear this GENUINE DIAMOND for a week at our expense—absolutely no risk to you—deposit nothing—**READ EVERY WORD OF THIS OFFER:**

**Send No Money
Pay No C.O.D.**

Mail the Free Trial Coupon Below

Just send the coupon below—do not enclose a penny—and we will send you on approval at our expense your choice of these diamond rings. The ring illustrated above is the most beautiful hand engraved solid gold ladies' ring you ever saw, set with a fine, large, genuine blue-white diamond. **Pay nothing when it arrives.** Merely accept the ring and wear it for a week, at our expense. After a week decide. If you return the ring, that ends the matter. **You have risked nothing.** But if you keep the ring, send us only \$3.75 a month until you have paid the amazingly low price of \$38.75 for this regular \$50 value. The ring is an elaborate pierced model in solid 14K green gold with hand engraved white gold top. A striking new model. The diamond is a beauty—extra brilliant, blue white, perfectly cut—a remarkably big value.



Men's extra massive 14K solid gold fluted ring with 18K hand cut white gold top set with extra fine perfectly cut blue-white genuine diamond. **Extra Big Value. Now \$38.75 — \$3.75 a month. Send no money. Pay no C.O.D. A week's trial absolutely FREE. Mail coupon now.**

Just mail the Free Trial coupon below. Be sure to enclose finger size. **SEND NO MONEY—pay nothing on arrival.**

Harold Lachman Co., Dept. 1771, 204 S. Peoria St., Chicago

Send me absolutely free and prepaid, for a week's trial, the genuine diamond ring checked below. I am to pay nothing when it arrives. After one week I will either return the ring by registered mail and that ends the matter, or I will send you \$3.75 each month until \$38.75 has been paid. Title remains with you until fully paid. **I ENCLOSE MY FINGER SIZE.**

Ladies' Ring No. A4350

Men's Ring No. A4450

Name.....

Address.....

Age..... Occupation.....

Copyright 1922, Harold Lachman Co.



300 CANDLE POWER LIGHT

From Common KEROSENE or GASOLINE

A steady white light more brilliant than city gas or electricity at a fraction of the cost.

Equipped with Automatic Cleaning Needle. Makes and burns its own gas. Safe, simple and easy to operate.

Our Agents Make Big Money selling our complete line of lamps, lanterns, lighting systems, tanks and Doud Kerosene Oil Gas Burners for Cooking and Heating.

Write for full particulars and FREE TRIAL OFFER

DOUD LIGHTING CO.
1459-1461 Congress St., Chicago



Please Mention Popular Mechanics

Used by U. S. Gov't.

350 Saw Cuts a One Man Machine a Minute!

A Better, Faster Cutting Log Saw

Light Weight Easy to Move

Mechanically Operated Valves

F. O. B. \$91.50 12HP
Ottawa, Kansas

597.25 From Pittsburgh, Pa. 4 H-P at Proportionally Low Price

Learn about this World's Champion Log Saw and know how fast, easy and cheap you can saw logs, any size, fall trees, buzz up branches, and do other work.

OTTAWA LOG SAW The New Improved 1923 Model

is creating a sensation everywhere. Startling new improvements. A real money-getter for you. Saw and sell wood this winter; put money in the bank. Sold on 10-Year Guarantee; 30 Days' Trial; Cash or Easy Terms. Shipped quick from nearest to you of 9 Branch Houses.

Free Book! Send a postcard at once for your Free Copy of fine 36-page "Wood Sawing Encyclopedia"; also Big Special Offer. Write today.

OTTAWA MFG. CO.
1746-G Wood St., Ottawa, Kans.
Rm 1746-G Magee Bldg., Pittsburgh, Pa.

FREE WOOD SAWING ENCYCLO-PEDIA.

Do Your PRINTING

Cards, circulars, labels, tags, book, menus, paper, Press, \$12. Larger \$25. Job Press \$150 up. Save money. Print for others, BIG PROFITS. All easy, rules sent. Write factory TODAY for press catalog, TYPE, cards, paper. **THE PRESS CO., D-37, MERIDEN, CONN.**

LOOK EAT WELCH'S EAT LOOK

DIA M OND CHIPS

They're delicious

A DELICACY that surpasses anything on the market to-day

Manufacturing Rights now Open

WELCH'S DIAMOND CHIP CO. 408 Bank San Jose Bldg., San Jose, Calif.

Alfred's Ice King

A New Trade Name for Our Outfits

The Alfred Johnson Skate Co.

Dept. M 2812 W. North Ave., Chicago, Ill.

\$11.50 Complete



The Finest Tubular Skate and Shoe Made. Used by the World's Greatest Amateur and Professional Skaters. For Sale by All Good Dealers or Direct from Factory. Not Connected with Original Nestor Johnson Mfg. Co.

CHEMCRAFT Makes Any Boy an Amateur Chemist

Five Outfits: 75c to \$10.00 **SOLD BY ALL TOY STORES**

DIAMONDS

FOR A FEW CENTS A DAY

Don't send a single penny. Ten days Free Trial. When the ring comes examine it—if you are not convinced it is the Greatest Bargain in America, send it back at our expense. Only if pleased, send \$1.50 weekly—at the rate of a few cents a day. This Bargain Cluster Ring with 7 Blue-White Perfect Cut Diamonds can be yours. No red tape. No risk. Send for it today. It pictures thousands of bargains. Address Dept. 1771.

\$1.50 a Week

SEND NO MONEY

Looks like \$350 Solitaire NO. 91 only \$59.50

We Trust You

MONEY BACK GUARANTEE

Million Dollar Bargain Book

FREE

J.M. LYON & CO.
2-4 Maiden Lane N.Y.

Are YOU Old at 40?

A very common cause of early old age is the disturbed condition of an important gland. Even big strong men are not exempt from this serious irregularity. Our plainly written, interesting educational

FREE BOOK—Why Many Men Are Old at Forty

may bring a priceless message to you. It tells of a simple sensible way by which thousands have relieved this prostate gland condition. It tells how sciatica, backache, pains in toes and heels, interrupted sleep, mental depression, frequent micturation, etc., are so often due to this gland. Sold for over five years upon a money-back-if-not-satisfied plan. Do not confuse it with massage, medication, violet rays, etc. No obligation. Physician's inquiries especially invited.

Thermalaids

The Electro Thermal Co. 2117 Main Street, Steubenville, Ohio



Don't Take A Chance With Your FURS

GET wise, fellows—make those extra dollars yourself. We need your furs. You need the money. We are right in the heart of the New York Fur Manufacturing Industry. They are right at our door ready to take your furs as they come in and pay the right prices.

Your check goes back by return mail and you get one hundred cents on the dollar. We pay right because we sell right. This means we get all your shipments and do the business. Ask the trapper who knows. Once a Struck & Bossak shipper and you're always one. Our trappers have no poor years. They know in advance that we give a square deal and every shipment brings good money.

Send us your name and address. Get our Price Bulletins, Shipping Tags and full particulars. Do it right now. This means real dollars to you, so don't put it off. Write today.



Struck & Bossak, Inc.

155 West 28th Street
New York, N. Y.



Ship FURS to BIGGS

BIGGS at Kansas City offers hundreds of helps to shippers Free. Fur Market Reports and Price List! Most money—quickest! No commissions. Biggs pays highest Market Price for Furs, and then 5% more free to you in Biggs Cash Coupons.

Big Premium List and Trappers' Catalog sent FREE. Get traps, guns, baits, etc., without cost! Biggs' "Hold Separate" plan guarantees Full Market Price. Write for details. FREE subscription to "Trappers' Exchange," biggest illustrated trapper's magazine. Write NOW.

E. W. BIGGS & CO.,
717 Biggs Bldg., Kansas City, Mo.



A Year's Wear— or a New Pair Free

That's our guarantee of

Nu-Way
STRETCH
Suspenders

No rubber. Phosphor Bronze Springs give more, easier and lasting stretch and never rot. Always Comfortable. Suspenders, -75c; Garters, -50c; Hose Supporters, -25c. **ASK YOUR DEALER** if he hasn't them, send direct giving dealer's name. Look for Guarantee on every pair.

Nu-Way Stretch Suspender Co., Mfrs.
Dept. F 401 Adrian, Mich.



Send No Money

8-Window Pass Case, Card Case and Billfold

THE IDEAL XMAS GIFT

Be up to the minute. Carry all of your passes, lodge receipts, membership cards, loose change, bills, memos, etc., in the best-looking and most practical card case on the market.

A combination Card Case and Bill Fold made of **Genuine High Grade Leather** in a **Winston Grain**. It has eight windows for passes and membership cards, one full-size card pocket, two smaller pockets for stamps, car tickets, etc., one change pocket fastened with snap fastener, and one large pocket in back for bills. All pockets are lined. Turned edges hand tooled. Size closed, 3 1/4 x 5 1/2 in.



GOLD ENGRAVING FREE

We engrave your name, address (two lines) and Lodge Emblem in 23-carat gold, absolutely free. This work alone is worth \$1.50. The engraving gives the card case a very classy appearance and will be the means of identifying it if lost or stolen.

CHINESE LUCKY RING FREE

We want every one of our customers to have the best of luck and AS A SPECIAL HOLIDAY OFFER we will include with every card case sold one of these Chinese Good Luck Rings. A platinum ring with heavy black enamel top and embossed Chinese lettering in white, meaning "Good Luck." This ring is said to be almost uncanny in its power to bring "Good Luck," Health, Riches, and Happiness. Marvellous stories of good fortunes are told by its wearers. It's the last word in Novelty Rings. It sells for \$1.50, but we give it to you absolutely free of charge when you purchase a card case.



Eight window combination card case, value \$5.00
Gold stamping, name, town, state, and lodge emblem 1.50
Chinese Lucky Ring (FREE) 1.50

ALL FOR

ONLY - - \$2.90

SEND NO MONEY

Value \$8.00

If You Act at Once

You surely must have one of these card cases, and also the free Chinese ring. Remember, we do not ask for one penny in advance. Just fill out the coupon and pay the postman \$2.90 plus a few cents for postage when the package is delivered. We guarantee absolute satisfaction or your money refunded without question. You risk nothing. Send the coupon today.

P. P. REDINS MFG. CO., 6046 Superior Ave., Cleveland, Ohio

Send me the **Genuine Leather** combination card case shown above, with my name, town, state and lodge emblem in gold engraved absolutely free. Also include a Chinese Lucky Ring free. When the package arrives I will pay the postman \$2.90 plus a few cents for postage. If I am not fully satisfied, I will immediately return the case and the ring and you will refund my money.

Name

Street No.

City, State

Emblem Wanted

We do not send C. O. D. to Canada or Mexico

THE SHAW MOTOR ATTACHMENT Makes Your Bike a Motorcycle

A high grade 2 1/2 H. P. Motor attachment quickly clamped to any bike frame. Speed 4 to 40 miles an hour. 90 to 125 miles per gallon of gas.

Special Low Price Now! Write today for Complete Description and Special Low Prices on SHAW Motor Attachments and the Shaw Complete Motorbicycle.

SHAW MFG. CO., Dept. 37, GALESBURG, KANS.





Get This Wonderful Ring. If You Can Tell It From a Genuine Diamond Send It Back

These amazing, beautiful CORODITE diamonds positively match genuine diamonds in every way—same blazing flash and dazzling play of living rainbow fire. They, alone, stand the diamond tests, including terrific acid test of direct comparison. Lifetime experts need all their experience to see any difference. Prove this yourself.

Wear a Corodite Diamond 7 DAYS FREE

Make this test. You risk nothing. Wear a genuine Corodite and a diamond side by side on the same finger for 7 days. If you or your friends can tell the difference, send it back; you won't be out a single penny. That's a fair enough. If you keep the ring, price printed here is all you pay. No installments. Remember, Corodites alone have the same cutting as genuine stones.

- No. 1—Ladies' Tiffany Style 14K Gold S. Ring \$2.84
- No. 2—Gents' Heavy Belcher 14K Gold S. Ring \$3.48
- No. 3—Gents' Massive Hexagon Grapy Ring \$4.27
- No. 4—Ladies' Hand-Carved Basket Setting, platinum finish \$3.96
- No. 5—Ladies' Tiffany Orange Blossom Entwined \$3.94

Carat size gems. Beautiful mountings of most modern design. Choice of gold or latest white platinum finish. Unqualified 20-year guarantee. Handsome art leather case free with each ring.

SEND NO MONEY

Keep your money right at home. Just send name, address and number of ring wanted and size as shown by slip of paper, fitting end to end around finger joint. Your ring will come by return mail. When ring arrives deposit amount shown above with postman. If you decide not to keep ring after 7 days' wear, send it back and your money will be immediately returned. Send today.

E. RICHWINE CO.

333 S. Dearborn Street, Dept. 365, Chicago, Illinois

Sole Importers Genuine Corodite Diamonds

A Quality Hatcher at the Lowest Price "Successful" INCUBATORS & BROODERS

Mail a postal—Get our offer. Poultry lessons free to every buyer. Booklet, "How to Raise 48 Out of 50 Chicks," 10c. Catalog FREE. Make green, egg-making feed in "SUCCESSFUL" Grain Sprouters.



Des Moines Incubator Co.
689 Second St. Des Moines, Ia.

30 Years of Big Successes



World's Best Poultry Journal

You be the Judge!
6 Months' Trial 25c

ONE CENT U. S. STAMPS ACCEPTED

Tells how to keep poultry with greatest profit: 100 to 168 eggs monthly; 25th year. Best articles; expert advice; profusely illustrated. 1 yr., \$1.00; 5 yrs., \$2.00. Reliable Poultry Journal Pub. Co., Dept. 118 Dayton, Ohio

Detroit Incubator \$12⁴⁵

140-Egg Size—Guaranteed—has double walls, copper tank, full-size nursery, automatic regulation thermometer held so that chicks cannot break it when hatching. Detroit Brooders, too. Double walled, hot water heated. Write for special low price on both machines.



Detroit Incubator Co.
Dept. 32 Merritt St., Detroit, Mich.



American Poultry Journal
OLDEST, LARGEST and BEST
4 MONTHS' TRIAL 25 cents

1 Yr. 75c. 2 YEARS \$1 5 Yrs. \$2

Averages over 100 pages per issue—tells how to feed, house and breed; how to secure high egg production; how to hatch and rear poultry successfully. Established 1874. Only 25 cents for 4 months. Stamps accepted.
American Poultry Journal, 14-523 Plymouth Ct., Chicago

Free Book
Tells How to Get Big Egg Yield And Save Feed



1000 Amazing Money-Making Secrets
Never before has such a valuable, dependable poultry book been given free. Prof. Quisenberry explains his wonderful method of raising, breeding and feeding for heavy egg production, now in use by over 40,000 successful poultry raisers. Tells how Chas. Köttinger averaged \$11.27 net profit per hen! Mrs. Home made \$2000. Revised edition ready. Write quick. Simply send name today. Post card will do, for this 96-page free book "Dollars and Sense in the Poultry Business," outlining hundreds of poultry secrets and valuable information. No cost, no obligation.
AMERICAN POULTRY SCHOOL
Dept. 186 Kansas City, Mo.

FREE New Book on Home MEAT CURING



Tells how to produce fancy, high-priced sugar-cured meats and meat products quickly and easily. All about killing, dressing, curing and selling. Regular price \$1. FREE to farmers only. Write for it today—a post card will do.
E. H. WRIGHT CO., Ltd.,
826 Broadway, Kansas City, Mo.



Get My Reduced Prices on OLD TRUSTY

Find out how much I can save you on Old Trusty Incubators and Brooders. Nearly a million owners. Quick shipment from factory at Clay Center, Neb., or warehouse at St. Joseph, Mo. Mail a postal or letter today.
H. H. JOHNSON, "Incubator Man"
Clay Center, Neb.



Miller's Poultry Guide FREE

Tells how experts hatch, feed and raise poultry for profits. Also quotes low prices on baby chicks, pure bred poultry, eggs for hatching, incubators, Mammoth hatchers, poultry supplies, etc. Fully illustrated. Write today.
J. W. MILLER CO., Box 12, Rockford, Ill.



PLANS FOR POULTRY HOUSES!

All styles 150 Illustrations; secret of getting winter eggs, and copy of "The Full Egg Basket." Send 25 cents.
INLAND POULTRY JOURNAL, Dept. 74, Indianapolis, Ind.



WEBER'S Best laying, best paying chickens, ducks, geese & turkeys. Fine pure-bred quality. Fowls, Eggs, Incubators all at cut prices. 40 years poultry experience, and my 100 page Catalog and Breeders Guide Free.
W. A. Weber, Box 113, Mankato, Minn.

SQUAB BOOK FREE

Squabs are selling at the highest prices ever known. Breed them and make money. Write at once for free book, prices, etc.
Plymouth Rock Squab Co., 634 Howard St., Melrose Highlands, Mass



64 BREEDS Most Profitable chickens, ducks, turkeys and geese. Choice, pure-bred northern raised. Fowls, eggs, incubators at reduced prices. America's great poultry farm. 30th year. Valuable new 100-page book and catalog free.
R. F. NEUBERT Co., Box 91, Mankato, Minn.



GREIDER'S FINE CATALOG of fine bred poultry and incubators and brooders for 1923; choicest breeds illustrated and described; how to make hens lay, grow chicks—all facts. Low price on breeding stock and hatching eggs. 30 years in business. This book only 10c. **B. H. Greider, Box 19, Rheems, Pa.**



RAISE BELGIAN HARES
New Zealand Reds—Flemish Giants—American Blues. BIG PROFITS, WE PAY \$1.50 TO \$8 EACH. Also Cavies, Mink, Skunk, Fox, Muskrat, Etc. Easily raised anywhere. 32-page Catalog and Contract FREE!
Illustrated book "COMMON SENSE RABBIT RAISING," quarterly journal, and copy of America's leading small stock magazine, all for 10 cents. Address **Outdoor Enterprise Co., 1005 D. E. Bldg., KANSAS CITY, MO.**

Over 3,000,000 Users Endorse

New Kerosene Light

Beats Gas or Electricity



MAKE your home bright and cheerful, saving one-half on oil. Scientific tests prove this wonderful new Aladdin 5 times as efficient as the best round wick open-flame lamps. 60 candle power pure white light for 50 hours on a gallon of common kerosene. No odor, smoke, noise or pumping up. Won't explode. **Guaranteed.**

10 Days' Free Trial

Prove to yourself by free trial that Aladdin has no equal as a white light. If not satisfied return at our expense.

Get Yours Free We want one user in each locality to whom customers can be referred. In that way you may get your own without cost. Be the fortunate one to write first for 10 day free trial and learn how to get one free.

AGENTS WANTED To demonstrate the Aladdin in territory where oil lamps are used. Experience or capital unnecessary. Many agents average five lamps a day and make \$500 a month. Write quick for territory and samples.

\$1000.00 Will be given to **REWARD** anyone showing us an oil lamp equal to this Aladdin in every way. (Full details of this offer given in circular.)

THE MANTLE LAMP COMPANY OF AMERICA
304 Aladdin Bldg., 609 W. Lake Street, Chicago, U. S. A.

For the Tourist, Hunter, Motorist, Boy Scout, Farmer, etc.

POCKESCOPE POCKET TELESCOPE

finished in black, crystallized lacquer in gray suede leather case. Sent postpaid on receipt of \$2.00.
WATRY & HEIDKAMP, Dept. P 17 W. Randolph St., Chicago

FILMS - FILMS - FILMS

For the KEYSTONE

MOVIEGRAPH

Same as advertised in the Nov. and Dec. issues. This machine costs \$9.89 prepaid complete with three Non-Inflammable Reels, Charlie Chaplin in "Fun in the Bake Shop," Wm. S. Hart in "The New Sheriff," Tom Mix in "Battle on Hovesock." Machines guaranteed to give large clear pictures with ordinary electric bulb. Send \$9.89, get machine in time for Xmas.

Warren Mfg. Co., Box 240, Sta A, 115 E. Brookline St., Boston, Mass.

PROTECT YOUR HOME & FAMILY FROM BURGLARS

With Burglar Proof Key Attachment. IT Protects Life & Property From The Lawless Key Cannot Be Pushed Out. Prevents Burglars From Entering. Do You Feel Safe From Burglars? Do You Feel Secure At Night? Better Than Watch Dogs Or Watchmen. **ABSOLUTELY RELIABLE.** An Acceptable Gift. Great Money Maker For Agents. Does Not Mar The Finest Door. No Tools Or Screws Required. Snaps Quickly Into Place. Safeguard Your Home With Burglar Proof Key Attachments.

SAMPLE 25c.

Set Of 6 \$1 Postpaid. Do Not Put It Off. Write Your Name & Address On Margin Of This Page & Mail With Remittance To

KEY ATTACHMENT CO., MARSHALL BLDG., CLEVELAND, OHIO

"Will say I am highly pleased; find it does the work of \$100 machines. Have had several friends to see it; they were surprised that I got such a good machine for the money."

AMAZING VALUE

"I had an opportunity to investigate the other makes of typewriters and have come to the conclusion there is more real value in your machine at the price."

"I am well pleased with the typewriter and my friends have expressed surprise that a machine of such value could be turned out for the price. My son at the State Normal School says it is the smoothest running machine he ever tried and in many respects superior."

"Am pleased with typewriter; will take another five machines."

Brand-New:
From
Factory
To
You

**BIG SAVING - FREE TRIAL**

This beautiful machine is the only brand-new (unused), standard, full-size typewriter with a 4-row, 42-key, 84-character Universal keyboard that you can buy for less than \$100. It comes direct from factory to you at practically the wholesale price of other high-grade typewriters—a remarkable saving. Use Annell on your work at our expense, put it to the test for ten days; then if it doesn't satisfy you in every way, return it to us and we will refund even the express charges. You take no risk. Could anything be fairer?

Easy Terms

While you are enjoying the use of the machine, small monthly payments (much less than 20c per day) make it easy and convenient to own this full-size, brand-new (unused), 4-row, standard-keyboard typewriter.

Mechanical Marvel

Strength and simplicity are the outstanding qualities of this machine. Every essential operating convenience is possessed by Annell, including the 4-row, 42-key, 84-character Universal standard keyboard. This good Annell is made so well and lasts so long that the cost—if spread over the machine's lifetime—is less per day than the price of a postage stamp. And remember, the Annell is fully guaranteed.

Send Coupon Today

for complete information about the greatest of all typewriter offers. Don't miss it. Act now.

**NOT AN ORDER - MAIL TODAY**

ANNELL TYPEWRITER CO.
718 No. 230 East Ohio Street, Chicago.

Send me free catalog and complete information about your wonderful typewriter offer; this places me under no obligation.

Please Mention Popular Mechanics

DIAMONDS

ONLY \$2 DOWN AND 10 MONTHS TO PAY

Send only \$2.00 deposit as a guarantee of good faith and we will send your choice of the \$49.00 cluster diamond ring, or the \$50.00 beautiful solitaire diamond ring, or the \$12.00 wedding ring, or the \$25.00 wrist watch. Pay the balance in ten equal monthly payments. For the \$100.00 solitaire blue white diamond, send \$20.00 deposit. For the \$75.00 diamond, send \$15.00 deposit. Men's rings with same diamonds will be supplied at same price. Hundreds of similar bargains are described in our new catalog.

30 DAYS FREE TRIAL

Wear any article of your choice on trial for 30 days. If not satisfied send it back and we will return every cent you paid. Free examination at bank or express office before paying deposit. If desired Written guarantee that if any other jeweler in the U. S. can sell you equal merchandise for less money, you can get your money back. On this guarantee you cannot lose.

Write for our big catalog
\$1,000,000.00 and 43 yrs experience back of our guarantee

B. GUTTER & SONS
Wholesale Jewelers & Diamond Importers
172 NASSAU ST., DIV. 671, NEW YORK



5 SIZE HANDY TAP AND DIE SET, ONLY \$3.00 DIRECT FROM THE FACTORY TO YOU!

Our No. 11 Handy Set furnished in our highly finished chestnut box contains 5 each taps and dies (1-4, 5-10, 3-8, 7-10 & 1-2"), in the U. S. S. thread, 1 die stock, and one tap and reamer wrench.

Our No. 12 Set is the same as No. 11 except that the thread is B. A. E. instead of U. S. S. You are purchasing a splendid set at a very low figure. Send us your order at once and be one of our many satisfied customers.

Let us also send you one of our circulars illustrating our full line of Handy Tools.
Worcester Steel Products Co., Dep't. P 1, 25 Union St., Worcester, Mass. U. S. A.

Hand Forged
Razor Steel
Blades, No. 57



Direct at Factory Prices

This \$2 KNIFE \$1.18 Postpaid
Hand Forged Razor Steel Blades
Handy shaped Blade makes this knife best for mechanics, sportsmen and farmers; light but strong; re-sharpened easily. Stag handle. German silver finish; blades file tested, hand forged from razor steel and warranted.

Sample \$1.18 3 for \$3.00 Postpaid.

Send for our 100-page List and "HOW TO USE A RAZOR" **FREE**
MAHER & GROSH CO., 106 A St., Toledo, Ohio

There's money for you in making one ton of coal do the work of two tons

You can create an assured income for yourself by offering the public a means of saving high-priced coal. Become distributor for the Crown Fuel Saver—proved by use in thousands of homes.

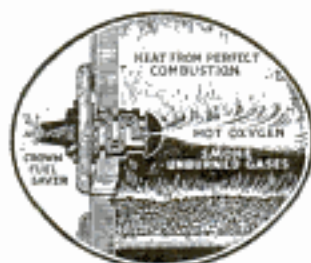

The CROWN will put you on a paying basis. It's easy to sell. Easy to install. Fits any furnace or boiler door. Users claim fuel-saving up to 50%; smoke reduction 50% to 75%.

Our exclusive distributorship opens the way to a permanent, profitable business. Advertising, selling helps and free training assure a worker success. Write or wire.

C. F. S. CO., 15 N. 10th St., Richmond, Ind.

COMPLETE HOME GYMNASIUM OUTFIT

Special Combination Offer, \$5 For 30 Days (\$10 Value) only

Made of best material and workmanship. Guaranteed to give perfect satisfaction. Three Distinctive Training Machines. Three Courses of Physical Exercises. Sent FREE with every outfit.



Spring Exerciser
For general all around muscle development



Grip Machine
Produce powerful arms and a vice-like grip



Chest Expander
Fast developer of arms, shoulders, back and lungs

Send for the 3 Outfits TODAY—Postpaid, only \$5
LIND-HENDRICKSON CO. (Makers) 63 Day Street, New York, Dept. PM

Put a CARTER OIL GAUGE

on your instrument board. Absolutely accurate in any kind of weather. Only \$4.95 for Ford, Dodge and Chevrolet. Only \$5.95 for Buick, Oakland and Chandler. You can attach one without special tools in 15 minutes. Satisfaction guaranteed or money back.
CARTER MOTOR ACCESSORIES, Inc., 390 Pearl St., Buffalo, N. Y.

34 MILES on Gallon of Gasoline



Wonderful carburetor. Reduces gasoline bills one-half to one-third. Increases power of motors 30% to 50%. Starts easy in coldest weather.

Sent on 30 DAYS' TRIAL

Fits any car. Attach yourself. Fords make as high as 34 miles to gallon. Other cars show proportionate saving. Send make of car. Special 30-day trial offer. Agents wanted.

AIR FRICTION CARBURETOR CO.

Dept. 3580

Dayton, Ohio.

Make your own Phonograph Records



On ANY Phonograph

Talk, whistle, sing, play any instrument. Use any phonograph, old or new. No special attachment needed. Simply use Pastime needles and blank records and you can reproduce anything, everything. So easy any child can do it. Pastime Metal Records are unbreakable, light, indestructible. Great entertainment for young and old. Make permanent records of loved ones voices, send messages on Pastime records anywhere.

COMPLETE OUTFIT \$1 POSTPAID

Send but \$1 for 3 blank double-faced Pastime metal records, a supply of recording needles and complete instructions.

Dept. 125-A.

A. J. ARCHIBALD Co., 1540 Broadway, N.Y.

Save \$10 to \$25 On Custom-made Re-covers

Easily attached; instructions sent. Top and back with 7x14 oblong beveled plate glass, tacks, welts, etc. \$10 and up. Fords \$5.20 and up. Special low prices on Dodges, Maxwells and Chevrolets. Ask for prices and samples—give name and year of car.

S-C PRODUCTS COMPANY, 1273 Nicholas Bldg., Toledo, Ohio

Use Insyde Tyres

Positively prevent punctures and blowouts. Give double tire mileage, any tire—old or new. Use over and over again. Old worn-out casings will give three to five thousand miles more service. Low priced. Special representatives wanted. Write today.

AMERICAN ACCESSORIES CO. B-1176 CINCINNATI, OHIO

TIRRO

THE IDEAL MENDING TAPE

At Drug Stores

BAUER & BLACK, 2500 DEARBORN ST., CHICAGO

OWN YOUR OWN BUSINESS ON A SMALL INVESTMENT Income \$600 and up Monthly

Duncan No. 10 or No. 3 Combination Shop Equipment is compact and complete in every way; will turn out quantity as well as quality work, guaranteed for mileage and wear.

Experience not necessary. We teach approved factory methods of tire repair. Big field open for progressive men to start in business for themselves on a small investment. EASY TIME PAYMENT PROPOSITION IF DESIRED. Old moulds taken in trade. While you hesitate someone is making big money. SPECIAL LOW PRICE OFFER on all orders received before Jan. 15, 1923. Write now for descriptive folders and prices of DUNCAN SECTIONAL MOULDS.

F. M. DUNCAN COMPANY

341-49 East Ohio Street, Department P, Chicago, U. S. A.



Duncan No. 10 or No. 3 will cure with sand bag as a pressure medium, equally as well as with air bags. Will cure twice as many tires per day as any other three cavity mould; will cure Two 2-1/4 or Three 4" or Two 4 1/2" either FABRIC OR CORD TIRES, perfect to size, form, width and contour.

BULLDOG Pipeless Furnace



Only

\$10

Puts the
BULLDOG
Pipeless
Furnace
in Your Home!

If you are even thinking of a furnace, write for our free catalog. The Bulldog is one furnace you must investigate. Heats without pipes! Comes completely erected. An extraordinary development in heating. Built on the foundation of common sense. Write for our catalog now before you forget.

Two Hours to Install

You do it yourself with nothing but a hammer and a saw. Rectangular shape (one of the common sense principles) allows passage through any door. The man desiring a warm, cheerful home at the very minimum of installation and fuel expense cannot afford to consider the purchase of any furnace until he finds out about the Bulldog.

Fits Any Floor Height

No matter what the depth of your basement or cellar may be—the Bulldog fits it. The adjustable casing (another common sense feature) takes care of this. When you read our catalog we think you will agree that this alone should be sufficient to influence you to choose the Bulldog. Mail this coupon TODAY!

Babson Bros.

19th and California Sts., Dept. 1351, Chicago

Without obligating me in any way, please send me your free catalog and \$10 down offer on the Bulldog Pipeless Furnace.

Name _____

Address _____

GET FACTORY PRICES ON GALVANIZED ROOFING



EDWARDS "REO" Metal Shingles

Absolutely rust-proof—edges as well as sides. Not the space of a pin point exposed to weather. Also fire and lightning proof. Reduces insurance. Outlast building. Need no repairs—and all roofing expense. Easy to lay—one man can do the work—hammer and nails only tools needed. Lay over old shingles if desired. Patent interlocking device makes water tight seams—all nail heads covered—no rust or leaks possible.

Exclusive "Tightcote" Process

Put all Edwards Galvanized Roofing in a class by itself. Bend, twist, strike it with a hammer as much as you like—you can't loosen or scale off the galvanizing—due to our "TIGHTCOTE" process which practically makes zinc covering a part of the metal sheet. No other galvanized roofing can withstand this test.

FREE Roofing Book Don't buy roofing until you get our big free book, describing Edwards famous "Tightcote"



Corrugated



Patent Slide Lock
No nail heads in sight or exposed to the weather



Brick Siding



Roofings, Sidings, and Ceilings, and our lowest factory prices. We sell you direct and save you in-between dealers' profits. Write for Roofing Book No. 150.

Low-Priced Garages

Lowest prices on Ready-Made Fire-Proof Steel Garages. Hot up any place. Send postal for Garage Book showing styles.



FREE Samples & Roofing Book

THE EDWARDS MFG. CO.
100-150 Pike St. CINCINNATI, O.



6 FUSES IN ONE PLUG 25c

"Turn To The Right—Back Comes Your Light" Approved by Underwriters' Laboratories. New Fuse Brought in Place by Turning Button. Ends Fuse Troubles Due to Use of Washers, Ironers, etc., as a new Fuse is Always ready.

DISTRIBUTING AGENTS WANTED

Repeater 6 is one of the finest agent's propositions on the market. Every home is a live prospect, also office buildings, stores, factories, etc. You can carry the sample in your pocket. Deliveries are easy, sales are quick, market enormous. Send 25c for sample and full particulars or send \$1.50 for five.

MOSS-SCHURY MANUFACTURING CO., Inc.
442 E. Woodbridge Street Detroit, Mich.

FORD OWNERS LOOK!!

JUST WHAT YOU WANTED A simple, never-fail, always ready engine driven tire pump. Fasten tube to tire, start engine, and ZIP—60 pounds air pressure in 90 seconds. A marvel; cheap; easy to attach; last a life time. Price, delivered \$7.50 East of Mississippi River, \$8.25 West; satisfaction guaranteed or money back in 10 days.

GEORGE CLAGETT MFG. CO.
631 Pa. Ave. Washington, D. C.



Good Profits for Demonstrator Agents

EVEN spare time earns big money! Never such a chance to turn sport into profit! You get a new demonstrator at factory price. All winter we send you prospects. Only one agent in a locality—so write today for reservation of territory. This is Ole Evinrude's fast 3 H P light twin cylinder outboard motor—sold only under name of "Elto"

Elto
3 H P Twin Outboard Motor
ELTO OUTBOARD MOTOR COMPANY
Dept. AA Manufacturers Home Building Milwaukee, Wisconsin

TIRE Agents Wanted

An auto owner in each locality to use and introduce Mellinger EXTRA-PLY and GORD Tires. Make big money part or full time. No capital or experience needed. Sample Sections furnished. **GUARANTEED 8,000 and 10,000 Miles** (No Second-Hands)

Hand made. Finest materials. Shipped prepaid on approval. **FREE Tires for Your Car** to one user in each locality for taking a few orders. Be first to write quick for Special Agents Offer and Low Wholesale Prices. **MELLINGER TIRE & RUBBER CO.**
910 North Oak Street Kansas City, Mo.



Auto Supplies
Knowing **HOW** to buy is merely knowing **WHERE**
This is Chicago's Great Wholesale House.
AUTO SUPPLIES AND MOTOR PARTS
WHOLESALE ONLY
Dealers send today for this big money-saving book
ACTELL AUTO ACCESSORIES COMPANY
3574 A South Michigan Avenue
CHICAGO

SEND for the INTERNATIONAL CATALOG
Factory to Consumer direct—
Our net price list of auto bodies and body supplies at Wholesale Prices.
Save big money by buying Direct from Factory
FOR FORD, CHEVROLET and DODGE.
PRICES FROM \$27.85 UP
International Body Works 914 W. Ohio Street, Chicago, Ill. Dept. 7

MAKE BIG PROFITS CHARGING BATTERIES \$20 Brings You an HB Charger
Long, easy terms on balances. No repairs or renewals—no experience needed to operate. **BIG MONTHLY PROFITS** will carry your shop overhead. Sizes for charging 8, 10, 16 or 32 batteries. Write for information. Money back guarantee.
HOBART BROS. CO.
Box M123, Troy, Ohio

Dependable
Champions
For Every Engine Everywhere
Ask your dealer to sell you a full set

You Can Save \$35.00
By recovering your old auto top frame yourself. Our recoverers are custom tailor made in our own factory to fit all makes and models of cars. Any person that can drive a car can put it on. We furnish instructions. Roof and quarters are sewed together with rear curtain, fasteners, welts and tacks complete. Give us the name, year and model number of your car and we will send you catalog with samples.
LIBERTY TOP & TIRE CO., Dept. E-7, Cincinnati, O.

MAKE OVER \$800.00 MONTHLY
Owning and operating an Anderson Vulcanizer which vulcanizes tires 3" to and including 5". You can vulcanize the smaller tires in all three molds. We guarantee no other vulcanizer will properly cure as many tires daily as the Anderson. It will do \$160 worth of work daily and will keep 8 men busy. You can run it ten hours daily, six days a week, for less than you can any other make, half a day. An Anderson School is near you.
ANDERSON STEAM VULCANIZER CO.
Popp-Williams Bldg. Indianapolis, Ind.

World Batteries for RADIO OR AUTOMOBILE SAVE YOU 50%

Buy direct from factory. Get highest quality—lowest prices and 100% battery service.

WRITTEN TWO-YEAR GUARANTEE

| AUTOMOBILE PRICES | |
|---|---------|
| 6 Volt, 11 Plate. | \$12.50 |
| Ford, Deaf, Chev. | |
| 6 Volt, 13 Plate. | 14.50 |
| Overland, Buick. | |
| 12 Volt, 7 Plate. | 18.00 |
| Marzell, Dodge. | |
| Same 50% Saving on all cars. Give make car. | |

Batteries shipped immediately express C.O.D. Thousands of satisfied users. Mail your order today!

| RADIO PRICES | |
|------------------|---------|
| 6 Volt, 40 Amps. | \$ 8.50 |
| 6 " 60 " " | 10.00 |
| 6 " 80 " " | 12.50 |
| 6 " 100 " " | 14.50 |

World Battery Company 1219 S. Wabash Ave., Dept. P
CHICAGO, ILL.

FORD CAR GOES 52 MILES ON ONE GALLON GAS

Walter Critchlow, 716 Madison Street, Suite 226, Chicago, Ill., inventor of a marvelous new water vapor and steam humidifier which uses 33½ per cent water in the engine, entirely doing away with carbon and giving ¼ to ½ more mileage, is offering one free to a user of each make of auto, in every locality, who will help him introduce it. Every car owner should write him for one at once. Give make of car.

Only \$45.00 For This Job Complete

Save exorbitant freight rates and one-half original cost by buying Ford Speedster bodies knocked-down. Simple, complete instructions furnished, all parts cut to exact fit. Any one can assemble this job. Complete with hood, radiator shell, instrument board, upholstery, metal parts, wood parts, bolts, screws, etc. Flat radiator shell furnished made up. Designed low with lack of wind resistance. Price set at \$90, further particulars on request.

The Central Auto Supply Co., Eng. Dep. 120, Louisville, Ky.

**AUTO SUPPLIES
WHOLESALE
3000 BARGAINS**

**SEND FOR THIS
CATALOG -
it's FREE!**

Everything you need
in Auto Supplies at
Amazingly LOW PRICES.

NEMCO BARGAIN SUPPLY HOUSE
1017 Jackson Boulevard - Chicago, Ill.

EVERY BOY WANTS THIS BOOK

Gilbert Boy Engineering for 1923
Wonderful articles on radio, sports and magic
10c postpaid

The A. C. Gilbert Company, 312 Blatchley Ave., New Haven, Conn.

\$2.63 **\$3.25**

SEND NO MONEY

If You Can Tell it from a GENUINE DIAMOND Send it back

To prove our blue-white MEXICAN DIAMOND cannot be told from a GENUINE DIAMOND and has same DAZZLING RAINBOW FIRE, we will send a selected 1 carat gem in ladies Solitaire Ring. (Cat. price \$5.25) for Half Price to introduce, \$2.63, or in Gentle Heavy Tooth Belcher Ring (Cat. Price \$6.50) for \$3.25. Our finest 12x Gold Filled mountings. GUARANTEED 20 YEARS. SEND NO MONEY. Just mail postcard or this ad, State Size. We will mail at once. When ring arrives deposit \$2.63 for Ladies ring or \$3.25 for Gentle with postman. If not pleased return in 2 days for money back less handling charges. Write for Free catalog. Agents Wanted.

MEXICAN DIAMOND IMPORTING CO., Dept. ET, Las Cruces, N. Mex.
(Exclusive controllers Mexican Diamonds)



\$70 to \$90 Daily

FLESSNER Brothers have hit their stride. Under date of Aug. 29, 1922, they say: "Did \$300 last week. Have averaged this amount during the past few weeks. Some days we take in \$70, \$80 and \$90." Others coining money too. Ira Shook's place regular magnet. On holidays receipts run high as \$375. My CRISPETTE machine does the trick! Makes those wonderfully delicious, toothsome confections that sell right and left.

Big Money in Crispettes

Money—lots of it—for those who start the CRISPETTE business. Gibbs writes: "Sold \$50 first night." Master's letter says; "Sold \$40 in one hour." Erwin's boy (going to school) makes \$35 every Saturday afternoon.

I Start You in Business

I furnish everything—secret formula, equipment, supplies, etc. Experience not necessary. It's a project you can handle. Amazing successes everywhere—cities, small towns, and so on. CRISPETTE habit grows and sticks wherever introduced.

\$1,000 Month Easily Possible

You are successful from the very start. No slow building-up process. **Business grows by leaps and bounds.** Some men wholesale to stores, others do direct retail business. All reap wonderful financial harvest. Raw materials plentiful and cheap. **Profits enormous.** Do not do another thing until you have clipped and mailed coupon.

LONG EAKINS CO.
128 HIGH STREET
SPRINGFIELD
OHIO



JUST MAIL THIS COUPON

LONG EAKINS CO.

128 High St., Springfield, Ohio

Please send me at once full details of the CRISPETTE business.

Name _____

Address _____

Please Mention Popular Mechanics

1/2 SAVED
BUY DIRECT
 GET BIG BOOK



DO YOUR OWN PLUMBING & HEATING AT LOW COST

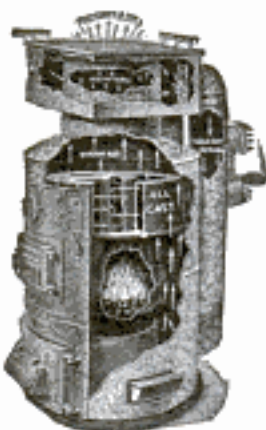

Pipeless Furnace

Send for our big instructive 256-page well-bound **HANDY-MAN** Book-Catalog. Every homeowner, contractor, farmer, mechanic, institution, etc., needs it. Shows over 10,000 fixtures and supplies in plumbing and heating at wholesale; how to save skilled labor, hard work and unnecessary material by our new

Cut-To-Fit Method

This wonderful encyclopedia on plumbing and heating helps you select and install the proper plumbing, water system, hot air, water or steam plant. Besides being our wholesale catalog, it has many practical plans, diagrams, sketches, elevations, handy hints, etc., showing how to do the work this newer easy way. Any handy man with a few tools can do his own installing with the aid of this

Big Handy Man Book

We have spared no effort, and have gone to a **GREAT EXPENSE** to compile this valuable book, and to keep from sending it to uninterested persons, we request 25c, which will be refunded on your first order, or send for our free bulletin.

Write today and save.

HARDIN-LAVIN CO.

50 Years at 4547-4557 Cottage Grove Avenue, CHICAGO

\$500,000 Plants Behind Our Guarantee



Hot Water Boiler

WESTINGHOUSE BATTERIES

A NEW WAY TO GET YOUR CLOTHES ABSOLUTELY FREE

and Make Big Money during your spare time—something different, better, bigger, more liberal than any offer ever made. Lower prices—better clothes—bigger cash profits—express or postage paid on everything.

DOUBLE PAY

Free Clothes and Cash Profits Besides. You can easily earn \$50.00 cash, extra, every week during your spare time, taking orders for our made-to-measure clothes. We don't ask you to use your cash profits for your own clothes. That's not our way of doing business. Ours is a new and better plan.

Witty-ize styles, real cloth samples—FREE colored fashion plates; inside wholesale prices—everything FREE. Just drop us a line today and we will send complete outfit FREE.

SPENCER MEAD CO., Dept. N-245 Chicago



WITTE "Power-Lite"

All the **POWER** You Need
 All the **LIGHT** You Want



Low Cost Ready to Attach to Your Wiring

IN our new "Power Lite" outfit we provide a specially built, Throttling Governor Electric Light Engine, connected to a 700-watt generator and 16-cell battery, making a practical Power and Light Outfit for farm and suburban homes. Besides running generator to charge battery, engine will operate cream separator, washing machine, churn, feed grinder, air compressor, pump, wood-saw or lineshaft.

SAVE \$50 TO \$100

You can operate engine on Kerosene, Distillate, Gasoline or Gas—run your machinery direct from engine—use battery for lights. Costs much less to install—more power. Plenty of light for house and barn—easy to operate. For particulars and prices, address,

WITTE ENGINE WORKS,
 174 Oakland Avenue, KANSAS CITY, MO.
 174 Empire Building, PITTSBURGH, PA.
 174 Fremont Street, SAN FRANCISCO, CAL.

TYPEWRITERS



\$50 buys a brand new Corona, the Personal Writing Machine. Fold it up, take it with you, typewrite anywhere! Write for free booklet No. 8.

Corona Typewriter Co., Inc.
 GROTON, N. Y.



AGENTS Make Big Money

Selling **D-REX-U** Safety Signal to automobile owners; complies with safety laws; guaranteed. Write today for wholesale price to agents and get territory quick. Big Winter Seller. Address Comstock-Bolton Co., Dept. K, 1925 E. 15th St., Kansas City, Mo.

GREAT 2 IN 1 LAMP

THE SECRET of QUICK SALES

Remove Shade for Outdoor Use
 300 Candle Power

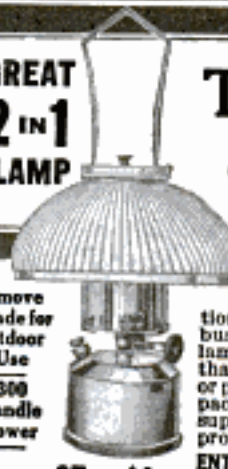

Burns 97% Air

There's a way that brings quick and certain sales of our brilliant Combination Handy-Lite. It's building profitable business for our agents—in spare time. This lamp meets the demand for a light brighter than gas or electricity but needing no wiring or piping. Lights with match. Smokeless, compact, handsomely nicked, durable. Write for supreme selling secret and attractive agency proposition.

ENTERPRISE TOOL AND METAL WORKS, Dept. 31
 126-8 So. Clinton St. Chicago, Ill.

Easy to Play Easy to Pay

Easiest of all wind instruments to play and one of the most beautiful—you will be astonished at the ease with which you can master a

BUESCHER

True-Tone Saxophone

You can learn the scale in an hour's practice and play popular music in a few weeks. Practice is a pleasure because you learn so quickly. You can take your place in a band within 90 days if you so desire. Three first lessons sent free. Unrivaled for home entertainment, church, lodge or school. In big demand for orchestra dance music.

Free Trial—Easy Payments

You may order any Buescher Saxophone, Cornet, Trumpet, Trombone or other Band or Orchestral Instrument without paying in advance, and try it six days in your own home, without obligation. If perfectly satisfied, pay for it on easy payments to suit your convenience. Mention the instrument interested in and a complete catalog will be mailed free. Send the coupon.



Dan Russo
Director Oricle
Terrace Orchestra
of Detroit.



Arnold Johnson
Director, Arnold
Johnson and His
Orchestra.



Gene Rodemich
Director of
Gene Rodemich's
Orchestra.

75%

of all popular phonograph records are played with Buescher Instruments. Ask for pictures of the Nation's Record Makers.

Saxophone Book Free

After nearly 300 years' supremacy, string instruments are almost entirely displaced by Saxophones in all nationally popular orchestras. Our Free Saxophone Book tells which Saxophone takes violin, cello and bass parts, and many other things you would like to know. Ask for your copy

BUESCHER BAND INSTRUMENT CO.
Makers of Everything in Band and Orchestra Instruments
2581 Buescher Block Elkhart, Indiana

Buescher Band Instrument Co.
2581 Buescher Block, Elkhart, Ind.
Gentlemen: I am interested in the instrument checked below:
...Saxophone...Cornet...Trombone...Trumpet.
(Mention any other instrument interested in)
Name.....
Street Address.....
Town.....State.....

Rings Bells Without Batteries

Avoid the annoyance of having bells out of order. At a nominal cost you can install this little device which will ring electric bells, buzzers, annunciators, electric heat regulators, door-openers, etc., from the same current that lights your home.

ONLY \$2.00
Canada \$3.00
Bell Ringer Transformer

Air-Way

Connects direct to lighting-current, and eliminates forever the use of troublesome dry batteries. Does not use enough current to register on meter. Buy it from any electrical dealer, or we will send it anywhere postpaid upon receipt of price. Your money back if you are not satisfied.

JOBBERS, DEALERS, AGENTS—Write for selling proposition.
AIR-WAY ELECTRIC APPLIANCE CORPORATION
Toledo, Ohio

NO MONEY DOWN

EASY TERMS **FREE TRIAL**

Save Big Money **Over a Year To Pay**

OLIVER Speedster

Here is the newest Oliver—the Speedster Model, handsomest, finest and most perfect standard typewriter we ever built. The triumph of 28 years of typewriter manufacturing. We don't ask you to buy it first. All we ask is that you send for it and try it FREE for five days. Note how easy and quiet is its action. Note the countless improvements and refinements that feature it. It is the fastest typewriter we ever built. No human hand can write fast enough to tax its speed. And we offer you this amazing new typewriter at the lowest price and the lowest term offered anywhere for a new standard machine.

TEST IT AT OUR RISK

Don't send a penny. We will ship you this wonderful typewriter for you to try out in your own home or office. Then if you are delighted with it you can pay for it on easy terms, a little each month. If not, return it at our expense. We take all the risk. You are under no obligation. Write for our amazing FREE TRIAL OFFER.

Deafness

Perfect hearing is now being restored in every condition of deafness or defective hearing from causes such as

Relaxed or Sunken Drums, Roaring or Hissing Sounds, Perforated, Partially Destroyed Drums, etc.

Wilson Common Sense Ear Drums

"Little Wireless Phones for the Ears"—require no medicine but effectively replace what is lacking or defective in the natural drums. They are simple devices, which the wearer easily fits into the ears where they are invisible. Soft, safe and comfortable to wear at all times.

Write today for our 168 page FREE book on DEAFNESS, giving you full particulars and plenty of testimonials.

WILSON EAR DRUM CO., Incorporated
508 Inter-Southern Building LOUISVILLE, KY.

NOW The Oliver Typewriter Company, 1091 Oliver Typewriter Building, Chicago.

Please send me, without obligation, your catalog, FREE TRIAL OFFER, easy payment terms and cash discount on the new OLIVER Speedster.

Name.....
Address.....
City.....

Save \$4 on the world's supreme Head Set

DICTOGRAPH Radio HEAD SET

Was \$12 Now \$8

NOW you can get the world-famous Dictograph Radio Head Set at a clear saving of \$4.00! The tremendous demand calling for quantity production makes possible the new price of only \$8.00. Never before has a radio Head Set of like quality been offered for so little money. This is exactly the same Dictograph Radio Head Set that has always sold for \$12.00—made by the makers of world

standard Dictograph products, including the marvelous "Acousticon" for the Deaf, the Detective Dictograph, the Dictograph System of Loud Speaking Telephones.

Take advantage of this saving now. Note the amazing improvement effected in your receiving set by the Dictograph principle of super-sensitive and accurate sound reception. 3000 ohms, for all crystal detector or vacuum tube receiving sets. Regularly furnished as Standard Equipment with leading radio receiving sets.

Note: Plans are now under way for the production of the new Dictograph SUPER-TONE Head Set, the most perfect instrument that can be made. Price \$12.00.

The Standard of the World

DICTOGRAPH PRODUCTS CORPORATION

220 West 42nd Street (Branches in all principal cities) New York City



DICTOGRAPH Radio LOUD SPEAKER

The perfect Loud Speaker for the home. A handsome instrument of superb quality and priced at only \$20 complete with 5 ft. flexible cord. Reproduces every sound in absolutely clear, natural tones, free from noise or distortion. Ask for a free demonstration at reliable radio shops.

\$20

complete with 5 ft. flexible silk cord. An overwhelming value at this low price.



FROST-FONES

*Super-inspected
Quality Fones and
Radio Parts*



FROST-FONES are built precisely as a delicate watch. Specially inspected to insure sensitivity and permanent strength. Frost-Fones excel for hearing local broadcasting stations or distance work.

Quantity production and efficient factory methods explain the low price of Frost Quality Fones.

America's leading jobbers and dealers sell Frost-Radio Equipment. Save money and insure satisfaction by insisting on Frost-Radio.

HERBERT H. FROST, Inc.
154 WEST LAKE STREET CHICAGO, ILLINOIS.



CATALOG No. 22 IS READY

Small Steam and Gasoline Engines, 1/4 H. P. up. Pumps, gears, model makers' supplies. Sent postpaid (2 dimes preferred) or 20c stamps.

Modern Engine & Supply Co.
334 Menard Bldg., Chicago



CROSLEY RADIO APPARATUS

BETTER—COSTS LESS

If interested in Radio, write for free copy of a Crosley Catalog. In it are helpful suggestions as to selection of right instrument or parts. If you wish to build your own outfit. Sold by dealers and jobbers everywhere.

CROSLEY MFG. CO.
Dept. P.M. Cincinnati

FREE CATALOG

I Need Branch Managers



LIGHTNING—WONDERFUL NEW ELECTROLYTE charges discharged batteries instantly. Eliminates old sulphuric acid method entirely. Eliminates sulphation. World has waited half a century for this invention. One gallon, retails \$19.98, free to agents. Lightning Battery Co., St. Paul, Minn.



**RADIO
HEAD SETS, JACKS, PLUGS,
MICROPHONES**
Manufacturers

**American Electric
COMPANY**

State and 64th Sts., Chicago, Ill.

Swear Off Tobacco

Tobacco Habit Banished Let Us Help You

Quick Results

Trying to quit the tobacco habit unaided is often a losing fight against heavy odds, and may mean a serious shock to your nervous system. So don't try it! Make the tobacco habit quit you. It will quit you if you will just take **Tobacco Redeemer** according to directions.

It doesn't make a particle of difference whether you've been a user of tobacco for a single month or 50 years, or how much you use, or in what form you use it. Whether you smoke cigars, cigarettes, pipe, chew plug or fine cut or use snuff—**Tobacco Redeemer** will positively remove all craving for tobacco in any form in a few days. Your tobacco craving will usually begin to decrease after the very first dose—there's no long waiting for results.

Tobacco Redeemer contains no habit-forming drugs of any kind and is marvelously quick, scientific and thoroughly reliable.

Not a Substitute

Tobacco Redeemer is in no sense a substitute for tobacco, but is a radical, efficient treatment. After finishing the treatment you have absolutely no desire to use tobacco again or to continue the use of the remedy. It helps to quiet the nerves, and will make you feel better in every way. If you really want to quit the tobacco habit—get rid of it so completely that when you see others using it, it will not awaken the slightest desire in you—you should at once begin a course of **Tobacco Redeemer** treatment for the habit.

Results Absolutely Guaranteed

A single trial will convince the most skeptical. Our legal, binding, money-back guarantee goes with each full treatment. If **Tobacco Redeemer** fails to banish the tobacco habit when taken according to the plain and easy directions, your money will be cheerfully refunded upon demand.

Let Us Send You Convincing Proof

If you are a slave of the tobacco habit and want to find a sure, quick way of quitting "for keeps" you owe it to yourself and to your family to mail the coupon below or send your name and address on a postal and receive our free booklet on the deadly effect of tobacco on the human system, and positive proof that **Tobacco Redeemer** will quickly free you from the habit.

Newell Pharmacal Company
Dept. 300 St. Louis, Mo.

Free Book Coupon

NEWELL PHARMACAL CO.,
Dept. 300 St. Louis, Mo.

Please send, without obligating me in any way, your free booklet regarding the tobacco habit and proof that **Tobacco Redeemer** will positively free me from the tobacco habit or my money will be refunded.

Name.....

Street and No.....

Town..... State.....



Tobacco Tells on
Nervous System



Tobacco Ruins
Digestion



Tobacco Stunts
Boy's Growth



Tobacco Robs
Man of Vitality



Tobacco Steals
from You the
Pleasures, Com-
forts, Luxuries
of Life





Representatives Wanted

Men or women can make \$5,000 or more yearly in exclusive territory.

Fun Every Minute with Your Gibson

Popular, "Jazz," or Classic—wherever you are and whatever music your taste or the occasion demands, is at your fingertips with your GIBSON. Learn at home in spare time. No previous musical knowledge required. No long drudgery or practice. FUN from the start—that's why

Gibson instruments

are "the Music Pals of the Nation." The modern standard of construction—guaranteed for life. Features such as Stradivarius arching (violin construction), tone of unexcelled quality and volume, superb finish, make Gibsons the preference of America's leading artists. And what a variety of instruments to choose from.

\$5.00 a Month Buys a Gibson

Mark your choice: [] Mandolin, [] Mandola, [] Mando-Cello, [] Mando-Bass, [] Guitar, [] Harp Guitar, [] Mandolin-Banjo, [] Guitar-Banjo, [] Tenor Banjo, [] Cello-Banjo. We supply handsome Carrying Case, Instruction Book, Pitch Pipe and Music Stand. Liberal allowances on old instruments.

Give name and address; we will send FREE Gibson Book, 112-page catalog, free trial offer and complete information about instrument you prefer. If you are a teacher mark here []; if you want agency, mark here []. Tear out and mail today—NOW.

Gibson Mandolin-Guitar Company

161 Parsons Street

Kalamazoo, Michigan

BIG BARGAIN LATEST CRAZE POLYCHROME TORCHERS

Handsome new kind of lamp. The latest craze in all the big cities. Regular price \$20 per set. Gives beautiful appearance to entire room when placed on the console table, buffet, dining table, or in entrance hall. Now found in most exclusive homes. Charming polychrome base and top, finished in fourteen carat hand-burnished gold and bright colors. Completely wired for any electric current.

SEND NO MONEY

Pay nothing until your pair of Torchers is in your home. And then—not \$20 the usual price—but only \$8.97 per pair on this amazing bargain offer. That is the entire cost to you. No further payments. You will be enchanted at the glowing transformation these exquisite lamps make in any room. Send no money. Pay postman when torchers are in your home. Money back in 10 days if returned in good condition and if not convinced that they would cost you \$20 per pair anywhere else.

PLASTIC MODELERS
Dept. 11, 554 W. Monroe St.
Chicago, Illinois.

Height 25 inches

AGENTS WANTED

This beautiful new lamp is sweeping the entire country. A big opportunity here for you to cash in on the popularity. Our special low price enables you to sell in big volume and at a splendid profit. If interested in a live proposition that has but to be seen in order to be admired and purchased write us at once.

Please Mention Popular Mechanics

\$10 A DAY FOR AGENTS MEN AND WOMEN

Full or spare time, introducing new hosiery from mill to consumer. Men's, women's, children's hosiery. Only mill in the country offering hosiery from 10c to \$1.50 pair. Latest styles. 33-1/3% Profit. Experience unnecessary. Regular income. Steady repeat orders. Year round position. No slack seasons. Sample line contains all styles including high grade silks. Write Today.

WACCO MILLS, Office
356 W. Van Buren St. Dept. K Chicago, Ill.

Send for Free Catalog of Money Saving Bargains



Bargains in firearms, shot guns, fishing tackle and other sporting items await those who send for this big, beautifully illustrated free catalog. Enjoy seasonally low prices. Write now for your free copy.
Paramount Trading Company
Dept. 243
34 West 25th St., New York.

Bargains
in
Sporting
Goods

AGENTS EARN BIG MONEY



USE YOUR SPARE TIME

selling the most complete line of guaranteed transparent handle Knives and Razors with Photo, Name and Lodge Emblem, also full line of cutlery. Write today for Catalog and Terms.
SOUTH BEND CUTLERY CO., 438 Hein Place, Chicago, Ill.

MOTORISTS



Do you know it's a pleasure to keep your car clean and restore its beauty with one of our **SELECT SPONGES** and **CHAMOIS OUTFITS**? Our sponges and chamois are of unsurpassed quality. **YET,**

Compare Our Prices

with your favorite mail order or bargain house. We send the **SELECT SPONGES** and **CHAMOIS OUTFIT** on approval, and welcome comparison of its quality with higher priced sponges and chamois.

SEND NO MONEY

Tear this ad out, write your name and full address plainly on the margin and place an (X) before the outfit desired. Then mail to us. Pay the postman only the amount of your selection.

We Pay All Parcel Post Charges

| Outfit | Chamois Size | Sponge Diam. | Price Complete |
|--------|--------------|--------------------------|--------------------------------|
| No. 10 | 15x20 in. | 6 to 6 $\frac{1}{2}$ in. | Florida Yellow \$1.35 per set |
| No. 11 | 17x23 in. | 6 $\frac{1}{4}$ to 7 in. | Cuba Sheepswool \$1.95 per set |
| No. 12 | 20x25 in. | 7 $\frac{1}{2}$ to 8 in. | Cuba Sheepswool \$2.45 per set |

If sponge or chamois only is needed the price is one-half of that particular set, plus 10 cents.

These genuine **CUBA SHEEPSWOOL** and **FLORIDA YELLOW SPONGES** are so called because they are sponges selected from those taken from the bed of the ocean off the Cuba and Florida coasts. Each chamois is selected, tanned and furnished in the natural (one-piece) form as taken from the animal.

Also ideal for household cleaning. Your order will be shipped promptly.
MOTOR CAR PRODUCTS CO., 549 W. Washington Bl., Chicago
Did You Mark the Outfit You Want?



ONLY THE BARGAIN OF THE SEASON

\$29.85 This is only one of the many exceptional offers in our catalogue just off the press. **SEND NOW**

For Body A full line of bodies and accessories to satisfy your season's need. Buy direct from the factory.

AUTO TIRE SALES CO., Dept. P4. Body Division
1346 S. Michigan Ave. Chicago

VITALIC Bicycle Tires

TRADE MARK REGISTERED
Tougher Than Elephant Hide

No More Acid-Burned Rugs, Clothing or Hands

The "Chaslyn" Sink-or-Swim Ball Battery Tester instantly shows condition of automobile or Radio "A" battery by the way the balls of different colors and gravities sink or swim in the acid.

Read without removing from battery cell.

Set also includes **Depth Gauge** and **Air-Controlled Stopper** for water bottle.

If your Dealer can't supply, send us **ONE DOLLAR**, and his name and address. Set will be sent postpaid.

The Chaslyn Company
4315 Kenmore Ave., Dept. 6
CHICAGO



"Look At Him Today!"

"Six years ago he started in here just as you are doing. Now he's General Manager and makes more in a day than he used to make in a week. The first week he was here he began to train for the job ahead by studying in spare time with the International Correspondence Schools. Inside of six months he got his first promotion. You've got the same chance he had, young man. Follow his example. Take up some I. C. S. course right away. What you are six years from now is entirely up to you."

This is the story of thousands of successful men. They did their work well, and in spare time, with I. C. S. help, trained themselves for advancement. That's the thing for you to do. Whatever your chosen work may be, there is an I. C. S. Course that will prepare you right at home for a better position with bigger pay.

More than 150,000 men are getting ready for promotion right now in the I. C. S. way. Let us tell you what we are doing for them and what we can do for you. The way to find out is easy. Just mark and mail this coupon.

----- TEAR OUT HERE -----
INTERNATIONAL CORRESPONDENCE SCHOOLS
Box 5696-C, Scranton, Penna.

Without cost or obligation, please tell me how I can qualify for the position or in the subject before which I have marked an X:

BUSINESS TRAINING DEPARTMENT

- | | |
|---|---|
| <input type="checkbox"/> Business Management | <input type="checkbox"/> Salesmanship |
| <input type="checkbox"/> Industrial Management | <input type="checkbox"/> Advertising |
| <input type="checkbox"/> Personnel Organization | <input type="checkbox"/> Better Letters |
| <input type="checkbox"/> Traffic Management | <input type="checkbox"/> Foreign Trade |
| <input type="checkbox"/> Business Law | <input type="checkbox"/> Stenography and Typing |
| <input type="checkbox"/> Banking and Banking Law | <input type="checkbox"/> Business English |
| <input type="checkbox"/> Accountancy (including C.P.A.) | <input type="checkbox"/> Civil Service |
| <input type="checkbox"/> Nicholson Cost Accounting | <input type="checkbox"/> Railway Mail Clerk |
| <input type="checkbox"/> Bookkeeping | <input type="checkbox"/> Common School Subjects |
| <input type="checkbox"/> Private Secretary | <input type="checkbox"/> High School Subjects |
| <input type="checkbox"/> Business Spanish | <input type="checkbox"/> Illustrating |
| <input type="checkbox"/> French | <input type="checkbox"/> Cartooning |

TECHNICAL AND INDUSTRIAL DEPARTMENT

- | | |
|---|--|
| <input type="checkbox"/> Electrical Engineering | <input type="checkbox"/> Architect |
| <input type="checkbox"/> Electric Lighting | <input type="checkbox"/> Blue Print Reading |
| <input type="checkbox"/> Mechanical Engineer | <input type="checkbox"/> Contractor and Builder |
| <input type="checkbox"/> Mechanical Draftsman | <input type="checkbox"/> Architectural Draftsman |
| <input type="checkbox"/> Machine Shop Practice | <input type="checkbox"/> Concrete Builder |
| <input type="checkbox"/> Railroad Positions | <input type="checkbox"/> Structural Engineer |
| <input type="checkbox"/> Gas Engine Operating | <input type="checkbox"/> Plumbing and Heating |
| <input type="checkbox"/> Civil Engineer | <input type="checkbox"/> Chemistry |
| <input type="checkbox"/> Surveying and Mapping | <input type="checkbox"/> Pharmacy |
| <input type="checkbox"/> Metallurgy | <input type="checkbox"/> Automobile Work |
| <input type="checkbox"/> Steam Engineering | <input type="checkbox"/> Navigation |
| <input type="checkbox"/> Radio | <input type="checkbox"/> Agriculture and Poultry |
| <input type="checkbox"/> Airplane Engines | <input type="checkbox"/> Mathematics |

Name.....
Street.....
Address.....

6-26-22

City..... State.....

Occupation.....

Persons residing in Canada should send this coupon to the International Correspondence Schools Canadian, Limited, Montreal, Canada.

Please Mention Popular Mechanics

Cycle Sledding—New!



A NEW winter sport for real red-bloods! You more daring ones may even "crack-the-whip", with several sleds hitched behind a speeding Harley-Davidson.

For sport or work, snow or shine, through drifts or slush, this sturdy mount takes you **anywhere**—swiftly, surely, comfortably. No cold weather troubles with a motorcycle. And best of all—there's the Harley-Davidson's wonderful economy—two cents a mile, including gas, oil, tires and all.

Harley-Davidson 1923 models, with 10 improvements, are the finest motorcycles ever built—**yet the prices are lower.**

See your dealer, or write for new literature and reduced prices.

HARLEY-DAVIDSON MOTOR CO.
MILWAUKEE WISCONSIN

Attractive dealer proposition for unassigned territories. Address Desk A-2.

Harley-Davidson
World's Champion Motorcycle

Please Mention Popular Mechanics

EASY FOR YOU TO OWN A FINE INSTRUMENT!

YEARS ago the famous King Brass Instruments were sold only for cash to famous musicians. But now due to our easy payment plan anyone can own one of these wonderful instruments.

SAVE MIDDLEMAN'S PROFITS

Simply order direct from the factory. You save middleman's profit—and you get a fine, new, sound-laboratory tested, acoustically perfect King Instrument. With it goes our guarantee plus free factory-service.

IT'S EASY TO OWN A KING

Rebuilt instruments, refinished to look like new, we sell for cash at low prices. New instruments on the easy payment plan. Thus it's "easy to own a King". Send for our latest complete catalog and list of special bargains.

THE H. N. WHITE COMPANY
5244 Superior Avenue Cleveland, Ohio



BATTERIES

Direct From FACTORY

AT WHOLESALE PRICES

Finest materials and workmanship. Long life—easy charging. **Guaranteed 24 mos.**

- 11 Pl. (6V.)—Ford, Chev., Mitchell, Hupp, Grant, Vels, Saxon - - - - - **\$12**
- 13 Pl. (6V.)—Buick, Cleve., Reo, Paige, Dort, Nash, Hudson, Stude. - - - - - **\$14**
- 7 Pl. (12V.)—Dodge, Franklin, Royal, Briscoe, Crow Elkhart - - - - - **\$17.50**

Send year and model of car.

Radio Batteries
80 amperes, \$12. 100 amperes, \$14.

Shipped express C. O. D. day order is received.

WESIDE BATTERY CO., Dept. 25
4445-47-49 W. Madison St. Chicago, Ill.



BABE RUTH DELIGHTS IN SPORT MOTORING, SO DO YOU

SPECIAL OFFER
Fastest Equip-ment. Tremendous Reductions

Ford Sport Bodies, Beautiful, High-Speed Models **\$37.50 up**



8-16 Overhead Valves
Selective Transmissions

Sport Fenders Underhung
Sport Fenders Standard
Crankshaft Counterbalances

| SPECIALS | | Price | Now |
|----------------------------|---------|--------|-----|
| Discs Flat (Set 8) Black | \$12.00 | \$5.00 | |
| Speed-Power Camshaft | 18.50 | 9.95 | |
| Disc Magneto, Brand New | 55.00 | 14.75 | |
| Underhung Fixtures | \$15.00 | \$9.95 | |
| 3:1. also 2 1/2 Gears | 17.50 | 7.75 | |
| Magneto Drive, Spiral Gear | 32.50 | 14.95 | |

S. P. FORD SPEED & POWER EQUIP. MFRS., 250 W. 54th St., New York City, N.Y.

W. L. DOUGLAS

\$5 \$6 \$7 & \$8 SHOES FOR MEN and WOMEN

W. L. Douglas shoes are actually demanded year after year by more people than any other shoe in the world

BECAUSE W. L. Douglas has been making surpassingly good shoes for forty-six years. This experience of nearly half a century in making shoes suitable for Men and Women in all walks of life should mean something to you when you need shoes and are looking for the best shoe values for your money.

W. L. DOUGLAS shoes in style, quality, material and workmanship are better than ever before; only by examining them can you appreciate their superior qualities.

No Matter Where You Live

shoe dealers can supply you with W. L. Douglas shoes. If not convenient to call at one of our 110 stores in the large cities, ask your shoe dealer for W. L. Douglas shoes. Protection against unreasonable profits is guaranteed by the name and price stamped on the sole of every pair before the shoes leave the factory. Refuse substitutes. The prices are the same everywhere.

If not for sale in your vicinity, write for catalog.

TO MERCHANTS: If no dealer in your town handles W. L. Douglas shoes, write today for exclusive rights to handle this quick selling, quick turn-over line.

W. L. Douglas
President
W. L. Douglas Shoe Co.
128 Spark St. Brockton, Mass.



BOYS SHOES

\$4.00 & \$4.50

Agents \$6 a Day



New cook stove burner for cooking, heating, baking. Burns (coal-oil) kerosene or distillate. Takes place of coal or wood. Fits any cooking stove or range. Easy to install. Absolutely safe.

FULLY GUARANTEED

Regulate by valve; burns just like gas. Steady, uniform heat. Simple, safe, clean. Nothing to get out of order. Our agents having wonderful success. Work spare time or full time. Big money each day. Write for agency. Jennings Mfg. Co., Burner 426, Dayton, Ohio

Ingersoll Watches
Models \$1.50 to \$9.00

"HOW I BEAT THE GAME"

The Inspiring Story of how one poorly paid garage mechanic won success, his own business and a big income. Tells how you can increase your salary from 100 to 500%. Send for it today FREE.

Ambu Engineering Institute

Dept. 11A 2632 Prairie Ave., Chicago, Ill.

Buchstein's Fibre Limb
is soothing to your stump—strong, cool, neat, light. Easy payments. Braces for all deformities.
D. BUCHSTEIN CO.
113 8th St. S., MINNEAPOLIS, MINN.

Send for Catalog Today



Guaranteed Six Months

Don't pay big prices for tires. Get these Standard adjusted tires at 1-3 the cost. And for a limited time, with each tire ordered we send another, same size for \$1. Among Bargains! These are Pisk, Goodrich, Goodyear, and other Standard cord and fabric tires slightly used. No sewed or double tread. Thousands of users get 10,000 and 12,000 miles. Remember we offer the extra tire for a short time only—just to introduce them. You will use nothing else when you have tried a pair. You are absolutely protected by our guarantee to replace, at 1-3 the original price any tire that does not wear 6 months. Order now. See these wonderful bargains for yourself. We can't hold this remarkable offer open long. **Send order—today!**

Note These Smashing Prices

| Size | 1 Tire | Size | 1 Tire | Size | 2 Tires | Size | 2 Tires |
|----------|---------|----------|---------|----------|---------|----------|---------|
| 30x3 | \$ 4.95 | 32x4 1/2 | \$ 9.50 | 30x3 1/2 | \$ 5.95 | 32x4 1/2 | \$10.50 |
| 30x3 1/2 | 5.95 | 32x4 1/2 | 9.75 | 30x3 1/2 | 6.95 | 32x4 1/2 | 10.75 |
| 32x4 1/2 | 6.75 | 34x4 1/2 | 10.00 | 32x3 1/2 | 7.75 | 34x4 1/2 | 11.00 |
| 31x4 | 7.75 | 35x4 1/2 | 11.00 | 31x4 | 8.75 | 35x4 1/2 | 12.00 |
| 32x4 | 8.25 | 36x4 1/2 | 12.25 | 32x4 | 9.25 | 36x4 1/2 | 13.25 |
| 33x4 | 8.75 | 35x5 | 12.25 | 33x4 | 9.75 | 35x5 | 13.25 |
| | | | | | 10.00 | 37x5 | 14.50 |

Deduct 10% from above prices if cash is sent with order.
\$1.00 DEPOSIT AS GOOD FAITH. Examine tires on arrival. Or send cash now and deduct 10% from above prices. In either case you can return tires if not satisfactory and your money will be promptly refunded. Simply state size of tire you want, whether straight side or clincher. Order now—while this amazing offer is open!

MOTORIST TIRE CO., 2611 S. Wabash Av., Chicago, Ill.

Whatever Your Question;—be it the pronunciation of Bolsheviki, the spelling of a puzzling word, the location of Murman Coast—the meaning of blighty, ace, tank, ukulele, etc., this Supreme Authority—

WEBSTER'S NEW INTERNATIONAL DICTIONARY

contains an accurate, final answer. 400,000 Words. 2700 Pages. 6000 Illustrations. Regular and India-Paper Editions. **G. & C. MERRIAM CO., Springfield, Mass.** Write for specimen pages, prices, etc. and FREE Pocket Maps per Popular Mechanics





Makes a Loudspeaker of Your Phonograph

Your phonograph instantly becomes the finest of loudspeakers when you attach Dulce-Tone Jr. Music fills the room—even to the farthest corners—with collo-like sweetness, for Dulce-Tone Jr. utilizes the wonderful soundbox, tone arm and needle that took science years to perfect.

Dulce-Tone Jr. is attached instantly. Complete—nothing else to buy. Simply place needle of phonograph on centre element of Dulce-Tone Jr., and attach wires to receiving outfit. Entertains whole roomful of guests without headphones. Various volumes produced by regulating field current. Current is supplied by "A" battery on receiving set, and never exceeds $\frac{1}{2}$ ampere. Exclusively made and guaranteed under KAEHNI circuit inventions and patent applications.

A \$50 Loudspeaker for \$15

No excessive profit—sold direct from factory to you. Order now. Get full value out of your radio and phonograph. Mail coupon now—attach a dollar and this wonderful instrument comes by return mail at \$14.50 C.O.D. Or send for literature. Mail the coupon today.

The Cleveland Radio Mfg. Co.
252 St. Clair Ave., N. E., Cleveland, Ohio

"Radio Simplified" \$1.00 BOOK FREE!

A new book by Frank and William Kaehni B.S.E.E. pioneers for 25 years. Radio fundamentals simply told, how to build and get best results—tricks in radio. Answers your questions. Formerly \$1.50. Worth \$2.50. Send seven two cent stamps to cover postage, etc. and names and addresses of three friends interested in radio and book comes prepaid. Only 5,000 copies. Use coupon.

The Cleveland Radio Mfg. Co. (Check items)
252 St. Clair Ave., N. E., Cleveland, Ohio. wanted
 Enclosed is \$1.00, send me a Dulce-Tone Jr. (balance C. O. D. \$14.50.)
 Send me your folder "Waves to You Through Your Phonograph." State name of your set and number of stages of amplification.

I enclose 7-20 stamps. Send me your book "Radio Simplified."

Name.....
Street and No.....
Town.....State.....

SAVE 25 to 40 Dollars Stoves—ranges—furnaces, etc. New designs, low prices, direct to you from factory. Write for money saving catalog No. 473.

A Kalamazoo
Direct to You

KALAMAZOO STOVE CO., Mfrs.
KALAMAZOO MICH.

WANTED

Railway Mail Clerks
\$1600 to \$2300 Year

MEN—BOYS OVER 16
SHOULD WRITE IMMEDIATELY

Steady work. No layoffs. Paid Vacations
Common education sufficient.

Send coupon today—SURE

MAKE YOUR RADIO LOUDER CLEARER

"UNITED" AUDIO-FREQUENCY TRANSFORMER amplifies the incoming signals—loud, clear; no howl or distortion. A fine piece of workmanship, magnetically shielded; fully mounted; as shown, postpaid \$4.50.

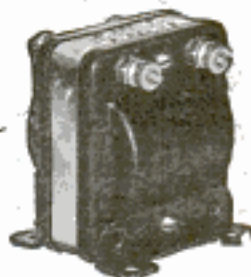

PAT. APPLIED FOR

"UNITED" VARIABLE CONDENSERS. Two types:

(1) With VERNIER ATTACHMENT. Plates are hard aluminum with Bakelite ends. Only Vernier with stop. Prices complete with dial and knob, postpaid:

46 Plate, \$6.50 26 Plate, \$5.50

(2) PLAIN (without Vernier, Dial or Knob):

43 Plate, \$4.50 5 Plate, \$2.75

23 Plate, 4.00 3 Plate, 2.25

11 Plate, 3.50 Postpaid.

"UNITED" devices have been adopted as standard equipment by leading manufacturers of sets. Back of them is a responsible House, with a half-million dollar plant.



Send remittance with order. Our money-back guarantee fully protects you

United Manufacturing & Distributing Co.
536 Lake Shore Drive
Chicago

Sargent Door Closers

Close all doors surely and silently and keep them shut.

SARGENT & COMPANY

Hdwe. Mfgs. 49 Water St., New Haven, Conn.

Home, Farm & Garage Necessity COMPLETE SAW MILL

Attach to Lighting Circuit to Operate.

Hundreds of Uses

Rips, Crosscuts, Bevels, Miters, Grooves, with accuracy and despatch.

3 1/2", 3" or 4" Saws may be used.



Adjustable to any angle. For all purposes.

CAPACITY OF SAWS:

| Saws | cuts | Thickness |
|--------|--------|-----------|
| 2 1/2" | 7-8" | |
| 3" | 1 1/2" | |
| 4" | 1 5/8" | |

Weight of complete equipment \$2 lbs.

All saws made by Henry Duxton & Sons Co. Sold with or without Motor.

SAW & SPECIALTY MFG. CO.

1029-31-H MELON STREET PHILADELPHIA, PA.

AGENTS, JOBBERS—EXCLUSIVE TERRITORIES OPEN

Saw Machine with 57" Saw, without Motor, \$14.50
With 1-6 H.P. Motor, Sliding Base \$45.00
Cord & Plug \$47.50
Mounted on Oak Base
All orders shipped F.O.B. Philadelphia.
State whether A.C. or D.C. Current is used.



FRANKLIN INSTITUTE, Dept. L177, Rochester, N. Y.

Sirs: Send me without charge, (1) sample Railway Mail Clerk Examination questions; (2) Schedule showing places of all coming U. S. Government examinations; (3) list of many Government jobs now obtainable.

Name.....

Address.....



(That's Wireless for "Attention!")

Listen in, everybody. This message is for *you*. Radio promises more than ever for the coming season. Are you going to get your share of the fun, the entertainment, the culture, and the many other advantages Radio now offers?

Then it's time to think of Radio equipment. When buying Radio parts or sets ask these questions:

Who Builds It? Who Uses It?

If it's SIGNAL equipment you'll find that it was produced by a plant and an organization whose experience in making small electrical goods goes back over a period of 35 years—that it grew up with "wireless."

And you'll find that it is used largely for commercial purposes, by the army and navy, by the professionals in Radio, as well as by the semi-professionals and the amateurs.

Buy SIGNAL Parts or Sets and you will buy Radio Service and Radio Satisfaction.

SIGNAL Electric Mfg. Co.

Factory and General Offices:

1910 BROADWAY, MENOMINEE, MICH.

Atlanta, Boston, Chicago, Cleveland, Minneapolis, Montreal,
Pittsburgh, San Francisco, St. Louis, Toronto.

You'll find our local address in your Telephone Directory



SIGNAL—Hulbert Battery Charger

Charge 2 batteries in your home at the same time for 5c—from any 110 volt A. C. lighting socket.

Send for our Booklet and Special Bulletins—use coupon below if you wish.

(2054B)

COUPON FOR GUIDE TO RADIO SATISFACTION

Signal Electric Mfg. Co.,
1910 Broadway, Menominee, Mich.

Please send, without obligation to me, your interesting book about SIGNAL Parts and Sets, to the name and address written on the margin of this page.



Ear Comfort, at Last, for Radio Fans

That's What the New Bates Ear Cushion Insures

What it is: A very light, soft, sound-proof cushion which fits over the radio receiver, excluding all outside noise, yet permitting the free transmission of every whisper of sound from the instrument in full volume and true tone. Its greatest advantage over the old style is the wonderful *comfort* it affords—can be held in place against the ear for hours without discomfort.

How Constructed: A smooth, soft, pure gum rubber cover enclosing a springy pad of cushioned rubber. Slips easily over any ordinary receiver and fits snugly into the crevices of the ear. Light as a feather—which adds greatly to the comfort of the user. An ample orifice permits the passage of tones from the radio in full volume.

Obtain these from your dealer if possible. If you cannot, mail attached coupon and \$1.50 and we will send postpaid "One Set Bates Ear Cushions" for the Radio.

Controlled and manufactured exclusively by

Bates & Company 1520 Montana Street
CHICAGO . ILL.

My Name is

Town

State.....R. F. D...

My dealer's name is

Town....State....R.F.D....

Air-Way Radio

A Wonderful New Source of Home Pleasure and Profit

"Listen-in" at home with an "AIR-WAY" to the latest news of the world, music of wonderful artists, church services, lectures by famous men and women, weather reports, market quotations on stocks, bonds, cattle, sheep, hogs, grains and crops. Give your children entertainment—college extension courses, over the easily-installed wireless telephone. All these priceless advantages are broadcasted daily without a penny of cost to you. It is all within your range, no matter where you live, if your home is equipped with "AIR-WAY" Radio.

Complete Sets or Easily-Assembled Parts of Guaranteed Quality



AIR-WAY Model "B" Complete Receiving Set, Long-distance vacuum tube outfit—detector and one-stage amplification.

"AIR-WAY" Green Seal Radio equipment represents the highest quality and latest in radio development—assures certain satisfaction in operation and reception of radio messages. With an "AIR-WAY" outfit you are capable of "tuning-in" to your choice of broadcasting stations. Pick up anywhere, any time, during day or evening, miracles in the air. Anyone can operate it. As simple to use as a telephone. Costs less than a good phonograph—more valuable to you and your family than an automobile.

FREE RADIO BOOK

Illustrates and completely describes "AIR-WAY" Green Seal Guaranteed Radio Equipment. Tells you best parts to use in building your own set or how to buy a complete long-range outfit at an amazingly low price. You need this book to intelligently select the most perfect operating equipment for Radio Receiving. Send name and address for it, today. It's FREE.

Air-Way Electric Appliance Corporation

Dept. 104 Toledo, Ohio

Look for this Guarantee Tag attached to every Radio Instrument you buy. The AIR-WAY Green Seal Guarantee Tag attached to a Radio Instrument is the symbol of quality that is known and preferred by experienced Radio Buyers.

**Air-Way
GREEN SEAL
GUARANTEE**

Please Mention Popular Mechanics

"Saws 25 Cords In 6 Hours"

That's what Ed. Davis, an Iowa wood sawyer says he did with a WITTE 6 H-P. Saw-Rig. Another claims 40 loads of pole wood in 8 hours and 20 minutes with a 6 H-P. Hundreds of WITTE Saw-Rig owners have made similar records and are coining money.

6 H-P.
Saw Rig

(Was \$305)



NOW
\$199.50 F.O.B. K.C.
F.O.B. Pkg. \$222.50

Any hustler can make big money with the WITTE. When not sawing you can operate other machinery. It's the one all-purpose outfit for farmers, and men who make sawing a regular business. When not sawing you can fill silos, grind feed, shell corn, thresh, or do other work. High Tension Ignition for quick starting. BOSCH Magneto for any size WITTE Engine or Saw Outfit on order. Lifetime Engine guarantee against defect as per catalog. Sent FREE. Write today for description and prices.

WITTE ENGINE WORKS

Kansas City, Mo.
1741 Oakland Ave.

Pittsburgh, Pa.
1741 Empire Bldg.

Let Us Develop and Manufacture Your Patent!

Our careful study often results in improvements of inventions. Highest type Engineering, Designing and Marketing Depts.; complete and economical service; 50 years' experience covering work for U. S. Gov't, Western Union Telegraph, Remington Typewriter, etc., etc. Send for Booklet J.

Fred'k Pearce Co., Inc., Est. 1872, 18-20 Rose St., N. Y.

Wonder Forge only \$6.85



Here it is—the WONDER FORGE! Bonanza for mechanics. Needed on every farm. Useful in garages and shops. Made entirely of steel. Handy. Always ready. Lasts lifetime. Takes up but little room. Portable. Highly geared—single turn of crank revolves blower twenty-one times. Delivers terrific blast through grate. Extra large blower. Easy running—child can operate. Produces white heat. Thousands in use. Gives universal satisfaction. Ideal for welding, shaping, bending, dressing and tempering tools. Comes complete ready to operate. Amazing value at \$6.85. Shipped direct to you on receipt of order. Guaranteed to be as represented or money refunded. You need this forge. Do your own blacksmithing and repair work. Saving on single job more than pays for forge. Send for catalog.

C. A. S. FORGE WORKS
BOX 400 SARANAC, MICH.

RADIO

\$15⁰⁰ DOWN
\$10 per Mo.

Complete Armstrong Regenerative Long- Distance Radio Receiving Set \$15⁰⁰ Down, \$10⁰⁰ per mo.

Licensed under the Armstrong U. S. Patent 1,113,149,
and pending letters of patent 807,388.

A limited number of the famous "SENSITONE" Regenerative Receiving Sets will be sold to responsible readers of Popular Mechanics at \$15.00 down and \$10.00 per month.

Set will be sent by express, immediately upon receipt of check or money order for \$15.00, accompanied by the signed coupon printed below. Some will see this ad in time to get the Set by Christmas, others will want to apply some of their "Christmas money" to its purchase.

It is **complete**, ready to set up and listen-in to any of the 500 broadcasting stations in the United States—everything you need: tuner detector, vacuum tube, batteries, headphone, aerial and wiring equipment, down to the smallest insulator or screw.

Price complete is \$95.00, giving you a set ordinarily sold at \$125.00 to \$150.00.

Send \$15.00 with order, followed by eight monthly remittances of \$10.00 each—enjoy it while you are paying for it.

We stand squarely back of every set sold. Look us up in Dun or Bradstreet, or ask any bank. Illustrated circular gives full particulars; but if you want the set to reach you by Christmas, don't wait for circular.

Fill out coupon, attach check or money order, mail today.

HAROLD R. WAKEM & CO.
835 W. Washington Blvd.
CHICAGO, ILL.

St. Pierre, S. D., Nov. 28, 1922.
Harold R. Wakem & Co., Chicago, Ill.

Gentlemen:—
Just received radio and am very much pleased with it, as it exceeded my expectations. So far have had no trouble in tuning in to most any station. The first night I got Pierre, Winnipeg, Canada, Minneapolis, Chicago, Dallas, Texas, Louisville, Ky., St. Louis, Los Angeles, Atlanta, Ga., and some stations in Oklahoma. The next night I added Kansas City, Davenport, Iowa, and a station in Washington to my string.

These all came in plainly in receiving, but I should like to use a loud speaker, as I am starting a sort of a radio club to help make my payments.

So I am enclosing \$10.00, first payment, for which please send me your two-step amplifier, subject to additional payments of \$5.00 each month until \$55.00 has been paid. I understand that the title remains in your possession until \$55.00 has been paid.

Please send this at once and be sure and address it Fort Pierre, S. D. The radio was addressed Meers, which is my post office, but not an express station, and it was shipped to Van Metre, which accounted for my delay in receiving it. Yours truly,

J. B. GILES.

P. S. I understand this is complete with bulbs.

Johnston City, Ill.
Harold R. Wakem & Co., Chicago, Ill.
Dear Sir:

Enclosed find \$10.00 money order, part payment for the Sensitone Receiver. Here are some of the stations I have already heard with the single detector: PWX-Havana, Cuba; KOA-Denver, Colo.; KIH-Los Angeles, Cal.; WGY-Schenectady, N. Y.; WBAP-Fort Worth, Texas.

Please send me the price of your two-step amplifier for the Sensitone. Yours truly,
CONRAD CWOZDZIK.

ORDER

Harold R. Wakem & Co.
835 W. Washington Blvd., Chicago, Ill.

Enclosed you will find \$15.00 as first payment, upon receipt of which you will send me your complete Sensitone Radio Receiving Set, as described above. After I have used the set for thirty days, I agree to send you \$10.00, and the same amount every thirty days thereafter, until the full purchase price is paid. This set is to remain the property of Harold R. Wakem & Co., until payments are completed.

Signed

Street address City

In the spaces below give the names of two references, banks or business houses preferred.

Name and Address

Name and Address

"Drilling days are never over"

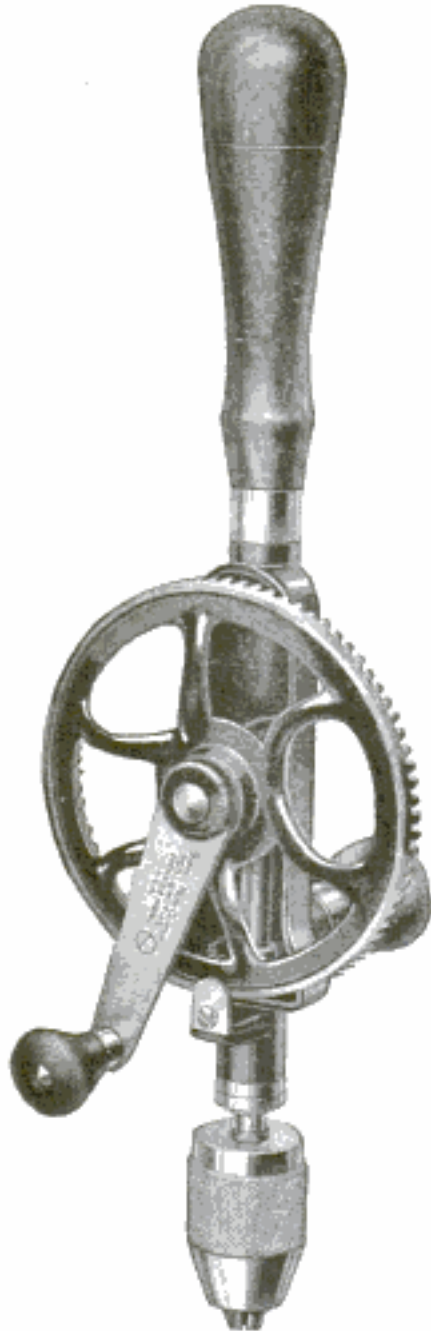

HAND DRILL
No. 1515 Price \$4.80
 This is a single speed drill. It has a screw cap containing 8 tool steel drills, 1/16 to 1/64 inch.

"Soldiers have a lot of drilling to do," observed Mr. Punch, "but so have carpenters and mechanics and any man who uses tools. For them every day is Drilling Day.

"I've found, however, that drilling a lot of holes has no terrors for the man who uses this Goodell-Pratt Hand Drill. It does its job so thoroughly that you'll consider it one of the best tool investments you ever made."

This Hand Drill has all the qualities that have made Goodell-Pratt tools famous. Its frame is aluminum, giving as great strength as iron but much lighter weight. The superior design and construction throughout will appeal to the most particular mechanic and general user of good tools.

From selection of raw material to final inspection before shipment no effort is spared in producing a hand drill of the highest grade, a drill that will give long and useful service.

Your hardware dealer has this hand drill or can get it for you. Meanwhile, write for our free illustrated catalog No. 14 showing all the Goodell-Pratt "1500 Good Tools." There are many that will interest every man who uses good tools.

GOODELL-PRATT COMPANY

Toolsmiths

Greenfield, Mass., U. S. A.

GOODELL-PRATT
1500 GOOD TOOLS

Direct To You

Water Cooled Head

Easy to start

Mechanically Operated Valves

Burns Kerosene

Throttling Governor

Automatic Air Venturi

EASY, NOW, TO OWN THIS

New and Improved 1923 Model

OTTAWA ENGINE

PERFECTED and ready—the 1923 Model OTTAWA—a wonderful engine, 5 years ahead! Built with startling improvements and refinements which make its introduction an event of great importance to farmers and shop-

men everywhere. It is the Master Engine of today—the result of years of experience in engine designing. Perfect workmanship and highest quality materials, together with its marvelous improvements, make the 1923 Model OTTAWA the greatest of all farm and shop engines.

Burns Kerosene—Saving in Fuel Soon Pays for Engine.

For a quarter of a century, any honest man has been able to get our engine under terms by which the engine paid for itself while he used it—because, OTTAWA Engines use less fuel, give more power from a gallon of kerosene than any gasoline engine gives from a gallon of gasoline. They are easy to start and operate by the man who has had little engine experience. In selecting the OTTAWA you are assured a more dependable, better built engine.

**WONDERFUL
NEW ENGINE
5 YEARS AHEAD**

Direct From Factory or Any of Nine Branch Houses.

From our factory in Ottawa, one of the largest in America manufacturing kerosene engines, carload lots are shipped to our branch houses. You can have your engine shipped from the warehouse nearest you, and make a big saving in freight. You get your engine more quickly—at less cost. We ship promptly from Ottawa, Kan., Pittsburgh, Pa., Albany, N. Y., Indianapolis, Ind., St. Paul, Minn., Dallas, Tex., Atlanta, Ga., Pueblo, Colo., Portland, Ore., San Francisco, Cal.

Amazingly Low Prices. Our plan of selling direct to user and immense manufacturing facilities enable us to keep prices way down. You will be amazed at the new low prices on the 1923 Model OTTAWA Engines. They are so low now that nobody can afford to be without one. Don't consider any engine until you get our prices and full information.

Send For FREE Book and Money-Saving Offer

Our newest and best book tells why we use valve-in-the-head motor design—mechanically operated valves—automatic air venturi—larger valve openings—offset cylinder construction. Get this book at once; also our Special Money-Saving Offer. Write today! Use the Coupon!

WRITE NEAREST OFFICE

OTTAWA MFG. CO.

539-E King Street, - - OTTAWA, KANSAS.
Desk 539-E Magee Bldg., PITTSBURGH, PA.

90 Days' Trial; 10-Year Guarantee

For a long time we have been selling engines on trial, direct from our factory to the man on the farm and in the shop. Now, just as in the past, every OTTAWA Engine must make good all we guarantee, and you have 90 days (3 whole months) in which to try the engine.

Cash or Easy Terms. You will find OTTAWA Engines everywhere you go. Where they are used, you will find OTTAWA boosters. You have your choice—cash or easy terms. Our new book shows you everything about the New Ottawa.

FREE
ENGINE
BOOK

Mail this for Startling Facts!

OTTAWA MFG. COMPANY.

539-E King St., Ottawa, Kansas.
Desk 539-E Magee Bldg., Pittsburgh, Pa.

Without obligation to me, send me your new book, "How to Know Better Engines"; also your Special Money-Saving Offer.

Name

Address

THE OLD CHRISTMAS SONGS

Will be broadcasted all over the country

"Better Than The Best"

The AERIAL-A

Price Complete

\$35.00

(Including Phones, Tube, Aerial and Batteries)

The Radio Tube Set



That Made Good In a Night

receiving set is the simplest set to operate on sale and one of the most efficient. As a Christmas gift it is very acceptable because it is sold complete in every detail from the aerial to the batteries.

Do You Need Radio Supplies?

Mail orders must include postage. TERMS:—Money Orders with Orders—checks not accepted. All Merchandise offered is Standard, Guaranteed, and is of perfect workmanship.

| | | | | | |
|---|---------|---|--------|---|---------|
| \$45.00 Magnaves..... | \$12.50 | 50c Mica Condensers..... | \$.25 | \$1.50 Twin Adapter..... | \$ 1.15 |
| \$24.00 A Battery, 100 amp., 6 V..... | \$4.75 | \$1.50 All Moulded V. T. Sockets..... | .25 | \$1.25 Universal Plug..... | .35 |
| \$19.00 A Battery, 80 amp., 6 V..... | \$1.45 | \$1.50 MICROSTATS..... | .50 | \$18.00 WESTINGHOUSE BATTERY | |
| \$14.50 A Battery, 60 amp., 6 V..... | \$.75 | Spagetti, per length..... | \$3.75 | CHARGERS..... | \$3.75 |
| \$1.50 Rheostat..... | .45 | \$2.00 Checon Lightning Arrestors..... | 1.25 | \$19.50 WESTINGHOUSE BATTERY | |
| Switch Arm..... | .40 | HOMECHARGER..... | \$1.95 | CHARGERS for A & B Batteries..... | \$5.80 |
| 75c High Quality Eial..... | .20 | \$6.00 Moulded Variocoupler highest | 4.50 | 70c Open Circuit Jack..... | .60 |
| \$2.00 21-pl. Variable Condenser..... | 1.45 | quality..... | | 85c Closed Circuit..... | .65 |
| \$2.50 41-pl. Variable Condenser..... | 1.95 | \$8.00 Moulded Variometer, highest | 4.50 | \$1.00 2 Circuit Jack..... | .80 |
| \$4.50 Variometer, guaranteed high quality. | 2.40 | quality..... | | Knobs..... | .67 |
| \$4.25 Variocoupler, guaranteed high | 2.25 | Panel, guaranteed insulation, 7x10; | | 125 ft. Coils, No. 14 Phosphor Bronze | .40 |
| quality..... | | 70c, 9x10, \$1.50; 8x9, 70c; 7x9, 70c; | | Tinned Wire..... | .14 |
| Disassembled Variocoupler, complete..... | 1.90 | 7x11, \$1.35; 6x11..... | .80 | Magnet Wire.....20 per cent discount off | List |
| Disassembled Variometer, complete..... | 1.25 | HOMECHARGER DE LUXE..... | \$1.25 | Rectors..... | .15 |
| Insulators..... | .40 | \$4.50 Thoradson Transformers..... | 2.35 | \$2.50 Radio Frequency Transformers..... | 1.45 |
| Contact Points dozen..... | .34 | Thoradson Grid Condensers..... | .25 | \$2.50 Radio Frequency Radiophone Plug..... | .75 |
| Bronze Bus Bar, sinned, ft..... | .32 | \$1.50 Thoradson Vernier Rheostat..... | 1.10 | 75c Battery Hydrometer..... | .25 |
| 75c Sockets..... | .25 | \$2.50 Fort Wood Tuning Coil..... | 1.50 | \$1.65 Improved Potentiometers..... | 1.10 |
| \$3.00 BATTERY, 225V, VARIABLE, | | \$3.00 Knockdown 2-slides Tuning Coils..... | 1.50 | Knife Switch, R. F. S. T..... | .14 |
| HIGHEST QUALITY, GUARAN- | | 4-in. Composition Red Fibre Tube..... | .45 | Knife Switch, S. F. S. T..... | .22 |
| TEED, LARGE SIZE..... | 1.45 | 3 1/2-in. Composition Red Fibre Tube..... | .42 | Knife Switch, D. F. D. T..... | .35 |
| \$1.75 B Battery, 225V, variable, high- | | 3-in. Composition Red Fibre Tube..... | .38 | \$6.50 Wesco Audio Transformers, high- | |
| est quality, guaranteed, small size..... | .75 | John-Manville Blk. Comp. Tubes, 4-in..... | .35 | quality, guaranteed..... | \$2.25 |
| 2-plate Vernier Variable Condenser..... | .70 | John-Manville Blk. Comp. Tubes, 3-in..... | .25 | \$6.75 Westinghouse Storage Battery..... | \$2.85 |
| Guaranteed Genuine Bakelite Panels- | | \$1.75 Crystal Detector..... | 1.10 | \$8.00 Broadac Phones..... | \$2.75 |
| 7x10, \$1.25; 7x11, \$1.85; 9x10, \$1.45; | | 75c Crystal Detector..... | .35 | \$5.00 Shamrock Variocoupler..... | 2.75 |
| 6x8, .47; 5x9, .95; 6x12, \$1.25; 7x9, | | \$1.50 Multi Jack..... | 1.15 | | |
| \$1.10; 12x14, \$3.00; 7x24..... | 1.00 | | | | |

W.E. Supply & Service Corp

Dept. PM

18 Murray Street

New York City



VULCANIZE Your Punctures and Cuts in Five Minutes

Do not "stick on" a cold patch when you can make a VULCANIZED repair that *will not come off*. You need only a match. No danger of fire.



\$1.50 at All Accessory Stores

C. A. SHALER CO., 2012 FOURTH ST., WAUPUN, WIS.

TREASURE CHEST—RADIO'S GREATEST VALUE

FOUR CAN LISTEN-IN AT ONCE

ONLY \$18.75
Delivered, including Everything.
NO EXTRA HEAD PHONES TO BUY



Enjoy songs, bands, operas, lectures, and news from miles away. Ready for home, office, hotel, rooming, or trips. Splendid extra-sensitive and distinct Radio outfit. No batteries. Mounted in beautiful red and yellow gold colored metal clad chest. Made by experienced radio manufacturers.

FREE—Write for Full-Size Illustrations in Colors, Today

ELECTRA MANUFACTURERS, Dept. C, 536 Lake Shore Drive, Chicago

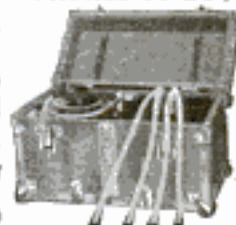



What About Your Future?

You Are the Only Man on Earth
Who Can Answer That Question.
IT'S ENTIRELY UP TO YOU!

A YOUNG MAN came to see me about a job and when I asked him about his future, he hardly knew how to answer. Like thousands of fellows he had failed to realize that his success was entirely in his own hands. He thought all doors of opportunity were closed to him, until I showed him a wonderful opportunity right in front of him.

That has been the case with thousands regarding the Automobile Business. Comparatively few fellows realize the opportunities in this, the world's Greatest Industry.

Some Facts Worth Remembering

Today there are nearly 12 million automobiles in the United States alone, and thousands of trucks and tractors. Everyone of those machines require expert attention. They must have service continually, and yet there are only about 50,000 garages and service stations throughout the country to take care of them.

And not every Tom, Dick and Harry is qualified to repair and adjust these machines;—there's too much money involved. That's why garages and service stations are continually calling on us for trained men. Then think of the millions of tires and batteries to be repaired. The total is tremendous!

When These Facts Meant Opportunity

Geo. Purvis was tired of just an ordinary job. He came to Detroit and learned the Automobile Business. After graduating, he opened a garage in Vancouver, later selling out and coming back to a job of Electrical Expert with the Packard Motor Co.

F. W. Johnson was a "pen pusher" at \$13.50 per week. A few months after finishing our Course he was getting \$42.50 per week.

John Grahek could hardly make a living, yet he scraped together enough money to take our Course, afterward opening a garage in which he is making from \$350 to \$400 per month.

J. S. Steekle of Coplay, Pa.—learned the Automobile Business at the M. S. A. S. and jumped from \$18.00 per week to \$365 per month.

What's that you say;—"That's all right for youngsters, but I'm too old"? Are you? Harry Hooper was 45 and his father was 66, yet BOTH TOOK OUR COMPLETE COURSE. Today they have a garage and sales agency at Mitchell, S. D.

I could tell of hundreds more like these.—stories of men who always worked hard with their hands until our Course taught them how to work with both head and hands. Thousands of our graduates have stepped into better jobs all because of this training.

Do You Want a Better Job?

—one that will pay from \$2,000 to \$10,000 yearly? Plenty of our graduates are doing as well or better.—If you are willing to get down to brass tacks and dig instead of drift, you will have no difficulty in making good.

What We Teach—and How

Our students are taught all about construction, assembly, operation and repair of every kind of automobile, truck, tractor and gas engine. They work on real machines and learn by actual practice.

Then we have special Courses covering Tire and Battery Repair, Brazing, Welding, and Machine Shop Practice. When a man graduates from our School, he is capable of handling any kind of Auto repair work.

Endorsed by the Auto Factories

When we established the Michigan State Automobile School, our first step was to consult the big manufacturers to get the benefit of their experience. The idea appealed to them strongly and they gladly co-operated in outlining our Courses and have always endorsed our School. This close contact with the big Auto Factories proves that Detroit,—the Heart of the Auto Industry—is the logical place to learn the automobile business.

This Is Your Opportunity

I could go on for hours telling about our School and what our graduates have accomplished. I never tire of telling the story. If you could meet these fellows and hear them tell their story, you too would get enthusiastic. Men have come to us who didn't know the first thing about an automobile, but after finishing our Course, have gone home to better jobs or to businesses of their own. It is truly inspiring to read the letters they write back to us,—makes a fellow glad to have helped them.

And so my message to every man is this:—If you have grit and gumption, and want to get into a real job, or into a business of your own, fill out and mail this coupon and you will receive a copy of our Catalog, which is really a book of golden opportunities. But don't wait and dream about it. Get busy! Get this Coupon in the mails TODAY.

A. G. Zeller, President

Michigan State Automobile School
1501 Auto Bldg. Detroit, Mich.

Michigan State Automobile School
1501 Auto Bldg., Detroit, Mich.

Gentlemen: Send me your FREE Catalog telling all about the opportunities in the Auto Business.

Name.....

Street or R. F. D.....

City..... State.....

See our announcement on pages 52 and 53 advertising section.

NEW KIND OF HEAT!

Does Away With Dirty Coal and Wood

No more fires to build, bank or watch—no more dirty heavy coal to carry and lift—no more clouds of ashes to breathe or back-breaking scuttles to empty—no more heating problems—no more cold rooms in Winter—no more suffering from lack of quick fires in uncertain Fall and Spring—no more worries about coal shortages, poor quality or high prices since this Wonderful New Invention.

3 Times the Heat of Coal—at Turn of Valve

Here is the amazing new kind of heat that has ended forever the days of woman's back-breaking servitude to a hot mussy, stove of furnace! The wonderful invention of Mr. B. M. Oliver of St. Louis, in one minute, turns any coal or wood burner into a modern, up-to-date gas stove.

Cheaper Than Coal and Wood

Mr. Oliver calls his invention the Oliver Improved Oil-Gas Burner, because it uses 95% air and only 5% coal oil (ordinary kerosene)—the cheapest fuel there is, turning them into an actual gas that burns with an intensely hot, clean flame. Saves its cost in cleaning bills alone.

Fits All Stoves—Any Kind or Size

Mr. Oliver's wonderful invention is made in sixteen different models to fit any kind of cook stove, heating stove or furnace. Doesn't change your stove. Simply sets in firebox. Easily slipped in, in one minute. Absolutely safe. It lasts a lifetime. Saves your stove.



16 Models—one for every heater, range or furnace

Hotter than Coal

You can absolutely depend upon your Oliver to heat your rooms in coldest Winter weather—it gives three times the heat of coal. And you needn't worry about the high price of coal. Install this amazing new kind of heat and you can snap your fingers at coal shortages, poor quality or high prices.

AGENTS Oliver agents earn as high as \$300 a month—\$25 a day spare time is easy. Exclusive territory—Big, all-season seller. Write for Specs to Oliver.

Your Oliver burns the cheapest and most reliable fuel there is, kerosene. Just turn the valve and you have heat—as much or as little as you need. Physicians recommend the Oliver as a sure safeguard against colds, influenza, etc.

Use It 30 Days—FREE

Now, once and for all time do away with household dirt and drudgery. End ashes, dirt, smoke, odor, chopping, shoveling, carrying, dirty, heavy coal and wood. Send immediately for the FREE ATTRACTION BOOKLET, "New Kind of Heat," telling all about this amazing new invention. Shows exactly how it works, how it is different from all other burners and tells how you can use it in your stove. 30 days FREE. The famous Oliver Iron-Cast Money-Back Guarantee protects you.

Send for Big Offer

If you write at once you will be in time to receive Mr. Oliver's very low, introductory price offer and 30-day Free Trial. Get your Oliver installed immediately, before cold weather sets in.

OLIVER OIL-GAS BURNER & MACHINE CO.

Oldest and Largest Manufacturers of Oil-Gas Burners in the World
2014-A OLIVER BUILDING, ST. LOUIS, MO.



No worry about heat when you can get 3 times the heat of coal by just turning a valve. No coal, wood, ashes.



NEW WITTE KEROSENE LOG SAW

Saws 'Em Down—Cuts 'Em Up

**Runs Steadier
Cuts Faster
More Power
EASIER To Handle
Burns Kerosene
or Gasoline**

New Price \$99.50
F.O.B. K.C.
From Pittsburgh \$107.00

Our Big New Outfit

Built for Men Who Need A Rapid-Cutting Money-Making Log Saw

Portable and Easy to Operate. Use engine also to pump, grind, buzz wood, or do other belt work. Comes all set up ready to use.

Only Log Saw Sold On LIFETIME GUARANTEE—Cash or Easy Terms

See What You Get—Special 4-cycle Log Saw Engine—More power than needed—Less weight—Lever controlled clutch—Double arm swing motion and other valuable WITTE improvements. Users say: "Cut 30 cords hard maple in 8 hours"—"Downed 60 trees in 7 hours"—"Best on market"—"Runs smooth"—"Works fine". If that is the kind of a rig you want, write us. CATALOG FREE.

WITTE ENGINE WORKS
1745 Oakland Avenue, KANSAS CITY, MO.
1745 Empire Building, PITTSBURGH, PA.

Put this Parks band saw in your shop!

Constructed for real work. A fine, high-grade foot-power machine for the experienced mechanic. Sets firm and solid on any foundation. Runs fast and smoothly with little effort. 18-in. swing, cuts to center of 36-in. circle. Roomy table. Ball-Bearing disk sawguide. Takes material up to 7-in. thick. Band saw wheel covered with endless rubber bands to prevent slipping. Takes saws 12 ft. long. This machine can be furnished with pulley drive at same price. Guaranteed 10 years. 30-days' trial. Price....\$40.00



Send for complete Parks catalog

THE PARKS BALL BEARING MACHINE CO.
1500-1540 Knowlton Street CINCINNATI, OHIO
Canadian Factory, 200 Notre Dame East, Montreal

PARKS

WOODWORKING MACHINES



Electricity Needs You I WILL TRAIN YOU AT HOME

Stop right here. This is YOUR opportunity! Electricity is calling you, and the Electrical Business is in for a tremendous increase. But it needs more trained men—at big pay. By my **Home Study Course in Practical Electricity** I can train you for these positions.

Earn \$70 to \$200 a Week

You've always had a liking for Electricity and a hankering to do electrical jobs. Now is the time to develop that talent; there's big money in it. Even if you don't know anything at all about Electricity you can quickly grasp it by my up-to-date, practical method of teaching. You will find it intensely interesting and highly profitable. I've trained and started hundreds of men in the Electrical Business, men who have made big successes. **YOU CAN ALSO**

Be a Big Paid ELECTRICAL EXPERT

What are you doing to prepare yourself for a real success? At the rate you are going where will you be in ten years from now? Have you the specialized training that will put you on the road to success? Have you ambition enough to **prepare** for success, and get it?

You have the ambition and I will give you the training, so **get busy**. I am offering you **success** and all that goes with it. Will you take it? I'll make you an **ELECTRICAL EXPERT**. I will train you as you should be trained. I will give you the benefit of my advice and 20 years of engineering experience and help you in every way to the biggest, possible success.

Valuable Book Free

My book "How to Become an Electrical Expert," has started many a man on the way to fortune. I will send a copy, free and prepaid, to every person answering this advertisement.

Act Now! Good intentions never get you anywhere.

It is action, alone, that counts. **NOW IS THE TIME TO ACT.**

L. L. COOKE, Chief Engineer

**CHICAGO
ENGINEERING
WORKS**

2150 LAWRENCE AVENUE
Dept. 511 Chicago, U. S. A.

**CHIEF ENGINEER
COOKE**

Chicago Engineering
Works

Dept. 511, 2150 Lawrence Av.
CHICAGO, ILL.

Dear Sir: You may send me entirely free and fully prepaid, a copy of your book, "How to Become an Electrical Expert," and particulars about your **Home Study Course in Electricity** and **FREE Radio Course**.

FREE!

BIG ELECTRICAL OUTFIT

A fine outfit of Electrical Tools, Instruments, Materials, etc., absolutely **FREE** to every student. I will also send you **FREE** and fully prepaid —Proof Lessons to show you how easily you can learn Electricity and enter this splendid profession by my new, revised and original system of Training by Mail.

Radio Course FREE!

Special newly-written wireless course worth \$45.00, given away **FREE**. Full particulars when you mail coupon below.

Earn Money While Learning

I give you something you can use **now**. Early in my **Home Study Course** I show you how to begin making money in Electricity, and help you get started. No need to wait until the whole course is completed. Hundreds of students have made several times the cost of their course in spare time work while learning.

Name

Address

City.....State.....

How You Can Change Odd Pieces Into Masterpieces



ATTICS, store rooms and barns are full of old pieces of furniture—out of style, perhaps, but they can easily be made attractive and useful. Perhaps all they need is refinishing to conform with the present styles. This can easily be accomplished at practically no expense. All you need is a little time, a brush and

JOHNSON'S WOOD DYE

Johnson's Wood Dye is very easy to apply—it goes on easily and quickly, without a lap or a streak. It penetrates deeply, bringing out the beauty of the grain without raising it—dries in 4 hours and does not rub off or smudge.

Johnson's Wood Dye is made in fourteen beautiful shades, all of which may be easily lightened or darkened—full directions on every label.

Our FREE Book Tells YOU How

This book tells how to finish wood in artistic stained and enameled effects. Gives practical suggestions on making your home attractive, cheery and inviting. Tells just what materials to use and how to apply them. Use Coupon Below.



This book is the work of experts—profusely illustrated—contains color charts—gives covering capacities, etc. We will gladly send it free and postpaid for the name of your dealer. Fill out and mail coupon at right.

S. C. JOHNSON & SON, Dept. P. A. 1,
RACINE, WIS. (Brantford and Montreal—Canada)
Please send me free and postpaid your book on
Home Beautifying and Wood Finishing.

My Paint Dealer is.....

His Address.....

My Name.....

My Address.....

I Guarantee To Train You

Until You Are Placed in a Position Paying

\$250 to \$300 Per Month

—Chief Draftsman Dobe



Write and I'll tell you how I make you a first-class, big-money-earning draftsman in a very few months! I do this by a method no other man nor institution can imitate. I give you personal training at home by mail. And I mean just what I say—I train you until you are actually placed in a position paying from \$250.00 to \$300.00 per month. Six thousand draftsmen are wanted every month. Hurry up and register so you can start earning.

I Give YOU FREE

This \$25⁰⁰ Outfit of Drafting Tools

High-grade plated instruments. Every one you need. Packed in a handsome plush lined case. Just the kind I use myself. Write to me I'm giving it entirely and absolutely free.

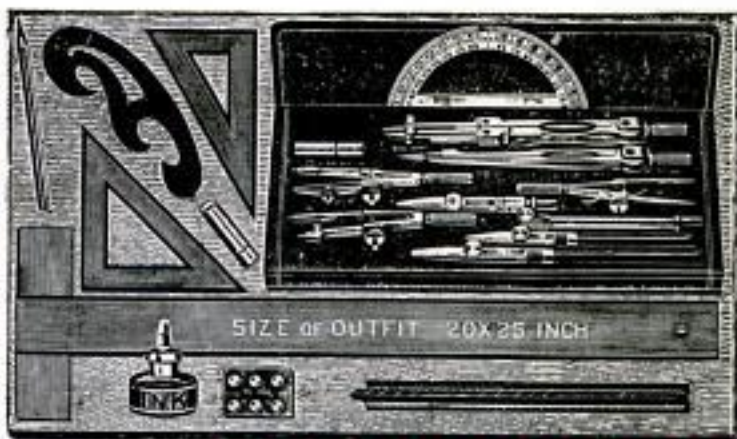

Send This Free Coupon To Me!

It costs you nothing but a stamp to send the coupon for my free book, "Successful Draftsmanship" that tells you all. It tells you how my students get the good positions and how I can afford to train you until you get YOUR position. Remember, 6,000 men wanted every month. So hurry. Register early because I can take only a few students. Send coupon NOW!

Chief Draftsman Dobe
Div. 9351 1951 Lawrence Ave., Chicago

Chief Draftsman Dobe
Div. 9351, 1951 Lawrence Ave., Chicago, Ill.

Without any obligation whatsoever, please mail your book, "Successful Draftsmanship," and full particulars of your liberal "Personal Instruction" offer to a few students.

Name.....

Address.....

Learn Electricity in the Great Shops of **Coyne**

in
3 1/2
Months

Student
Winding
Stator



**Earn
\$150
to
\$400
per
Month**

THE whole world of electricity is open to the Coyne trained man. He is trained completely. He can make big money as Power Plant Operator, Superintendent, Telephone man, Construction worker, auto, truck or tractor electrician, battery man, radio expert, or he can go into business himself as electrical contractor, dealer, auto ignition or battery expert and make from \$3,000 to \$20,000 a year. Hundreds of our graduates today are making big money and you can do the same if you grasp this opportunity—act now!

Earn \$150 to \$400 per Month!

No books or useless theory. You are trained on \$100,000 worth of electrical equipment. Everything from door bells to power plants. You work on motors, generators, house wiring, autos, batteries, radio, switchboards, power-plants—everything to make you an expert ready to step right into a position paying from \$45 to \$100 a week. Learn electricity in the electrical center of the world. Send coupon today for free catalog.

Radio Course FREE—

We include the following free with the regular course:

- (1) A complete course in auto, truck and tractor electricity and storage batteries. Greatest outlay of auto electrical and battery equipment in the country.
- (2) Course in Radio—the marvel of the age. Constructing, installing and operating. You can build your own wireless telephone set.
- (3) A life scholarship in the Coyne School. You can stay as long as you wish and return for further training any time in the future.

Earn While You Learn We help students to secure jobs to earn a good part of their expenses while studying.

Send Coupon NOW!

B. W. Cooke, President
Coyne Trade & Engineering School
1300-1310 W. Harrison St., Dept. 1351, Chicago
Dear Sir:—Please send me free your big catalog and full particulars of your special offer of 2 extra courses.

Don't delay a minute—send that coupon in right now for our big free catalog and full particulars of this wonderful offer.

Act Now!

B. W. Cooke, President—Coyne Trade & Engineering School
1300-1310 West Harrison Street Dept. 1351, Chicago, Illinois

Big New Home!

The increasing popularity of Coyne and a tremendous influx of new students simply forced us to move into larger and more spacious quarters. Here, in the big, new home, you will find added electrical equipment—new and larger departments a more complete electrical training—a school thoroughly equipped to train you for a big paying position.

