

December

25 Cents

POPULAR MECHANICS MAGAZINE

WRITTEN SO YOU CAN UNDERSTAND IT

REGISTERED TRADE MARK, GREAT BRITAIN, No. 410426

REG. U. S. PAT. OFF.

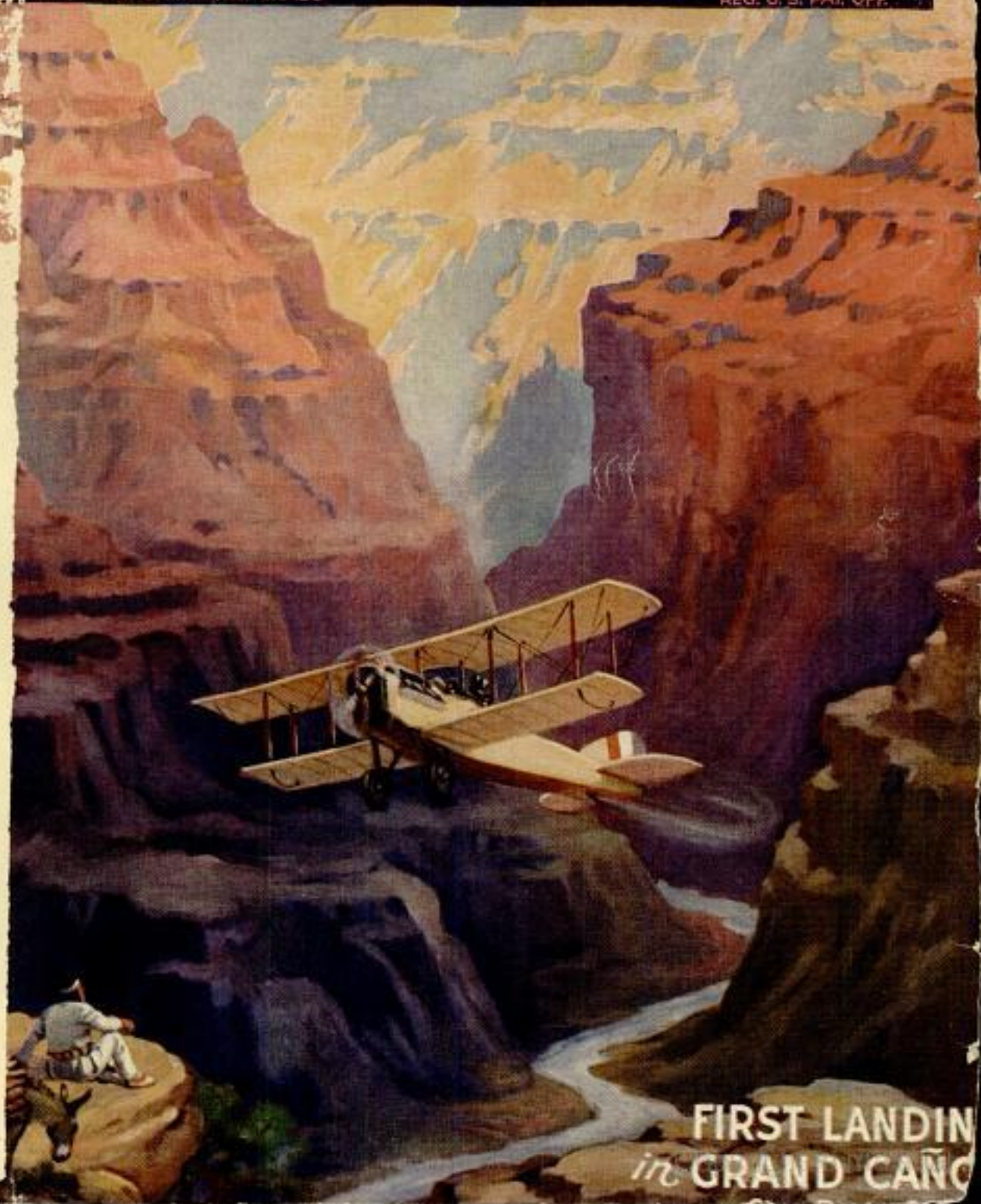

FIRST LANDING
in GRAND CAÑON

It takes *only* 8 weeks to get a big job



O. H. Justus owns a big agency and repair shop at Parkersburg, W. Va. He says "that my schools give motor secrets that will put any man 'on easy street.'"

Read what these men are doing in the Auto and Tractor Business. Here is your big chance to get "on easy street." Come to these great shops on the biggest FREE offer ever made.

Big Firms Need Trained Men

The Auto and Tractor Business is on the boom. Thousands of trained men will be needed during the next few months. I get calls every day from Garages, Battery Stations, Auto Repair, Welding Shops and other successful concerns for Rahe men. When the big fellows need high grade men they know where to come for them. They want Rahe trained men.



Emanuel Rushfeldt, Alberta, says: "Earning \$10 a day and only 20 years old."

My Training Unusual

Scientific tool training—that's the secret. You do things here according to the latest engineering standards. Thousands of dollars have been spent in modern tools and equipment. That's why my men are at home in the biggest shops in the country. If you want to succeed the way Beimer and Justus and the rest have—qualify by the same method.

I'll Pay Your Railroad Fare and Board You

In order to fill the openings that now exist, I am making an offer no one has ever made before—**Free railroad fare, Free board.** But even that is not all. I'll tell you about the rest in my letter.



W. W. Peace gets \$250 a month and expenses operating a tractor in the oil fields.

Send for **FREE** Book

My big illustrated training book tells how others are succeeding. It tells many things you ought to know about Autos and Tractors. Write for it and my **short time** offer NOW. It soon expires.

Rahe *Auto & Tractor* Schools

CHICAGO
4445 Grand Blvd.

Dept. 898 CINCINNATI
Ninth and Walnut

Rahe Auto & Tractor Schools,
Dept. 898, (address school nearest you)
4445 Grand Blvd., Ninth & Walnut,
Chicago, Ill. or Cincinnati, Ohio.

Without any obligation, send me your big free book, "The Evolution of Transportation." Also information regarding special temporary offer.

Name.....
Street.....
City.....State.....



Louis Beimer at 24 was made foreman over men many years older. That's not luck—it's Rahe training.

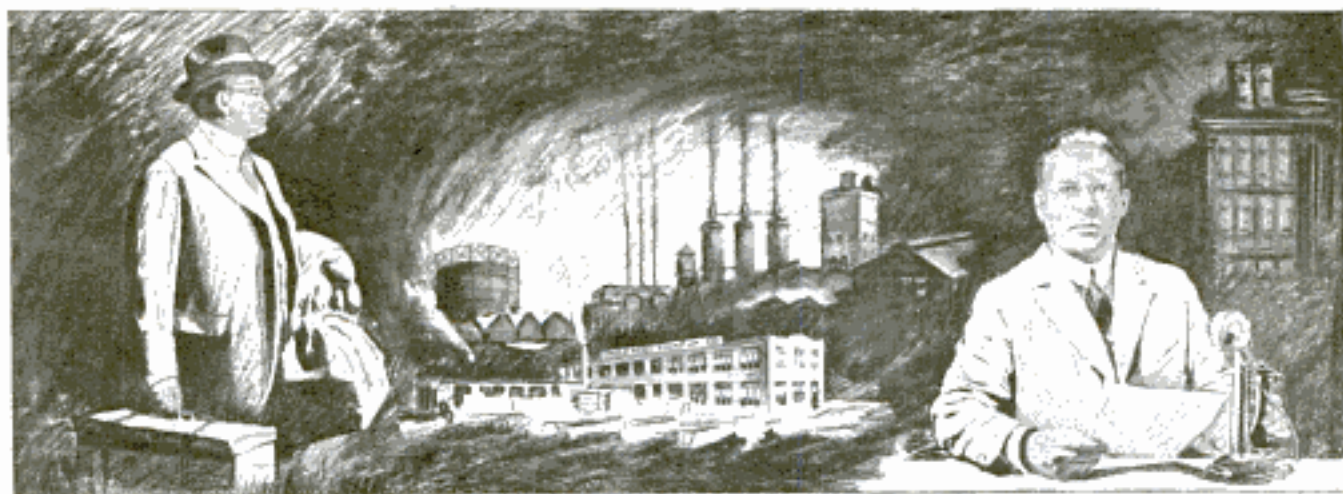

In three short years he put it across

*But he had dreamed about it for fourteen years.
Haven't YOU dreamed long enough?*

THIS is a story for salesmen; for accountants; for technical men—for any man who knows one department of business, and wonders how he is going to get to the top, either in the business where he now is, or in a business of his own.

It has to do with a man named R. Lee Smith, now Vice-President and General Manager of the United Soda Fountain Company of Boston; one of the most successful concerns of its kind in the country.

For fourteen years he worked and dreamed; then he added the training of the Alexander Hamilton Institute to his work.

And in three short years he had made the dreams of fourteen years come true.

**Thirty-eight; married;
and a family**

Starting as a salesman he became sales manager of a company making soda fountains and their equipment. He was successful in his department—sales. (Most men who enrol with the Institute are successful in the one department of business where their experience has been gained.) He was thirty-eight. (Most men who enrol with the Institute are between twenty-five and forty-

five.) He was married. (A majority of the men who enrol with the Institute are.)

And *this* was the driving power behind his decision: "I wished to afford my family advantages," he wrote, "*which otherwise they would not have had.*"

**"I had dreamed for years
of my own business"**

"For fourteen years I had been a salesman and sales manager," he continued. "I had dreamed for years of my own business organization, but my work gave me no understanding of business other than that which concerned selling.

"I knew nothing of production, financing, or business promotion. Your Course and Service gave me an understanding of these things."

He clipped a coupon from an advertisement like this. With the knowledge which the Institute brought to him, and with its encouragement and guidance, he organized the United Soda Fountain Company, erected a factory and started production. Straight thru the period of business depression the business has steadily grown; and now Mr. Smith plans to double its factory space and its output.

So three years' work *with training* did what work alone had never been able to do.

**A book that has made
dreams come true**

You who read Mr. Smith's story on this page are already familiar with the Alexander Hamilton Institute. You know how many thousand men there are who, like Mr. Smith, give it credit for having shortened their path to larger income and greater success.

The whole story of the Institute has been printed fully in a 118-page book—a book that should be in every thoughtful man's library. It is called

**"Forging Ahead in
Business"**

For any man who is asking himself "Where am I going to be in business ten years from now?" there is a copy of this book without obligation. We would like to place it in the hands of every ambitious man. It helped Mr. Smith to give his family "advantages that otherwise they would not have had." Send for your copy now.

Alexander Hamilton Institute

645 Astor Place New York City

Send me "Forging Ahead in Business" which I may keep without obligation.



Name..... *Print here*

Business Address.....

Business Position.....

Canadian address, C.P.R. Building, Toronto; Australian address, 42 Hunter St., Sydney

Copyright, 1922, Alexander Hamilton Institute

This One



QXSB-GEB-L4QS

erial

YOU'LL WANT the CYPRESS "SUGI" BOOK—

"The most usable free book ever printed for folks like you and us."

HERE'S A CYPRESS "SUGI" TRAY

THAT YOU CAN DUPLICATE FOR CHRISTMAS GIFTS by your own labor (and very little of it) and at the smallest cost.



ornate effect is
CYPRESS GRAIN.

This Wonderfully
THE NATURAL

Its tone is a Rich
Lasts forever. Done

Warm Brown.
with Torch and Brush!

"The most distinguished novelty in Wood Finish presented to the artistic public in a century." (And you can do it.) It reproduces perfectly the famous Antique Japanese Driftwood Effects.

Get your order in NOW, for VOL. 26 of the Cypress Pocket Library

so as to give you time to decide *what* articles made of *SUGI* you want to give, and whether to make it yourself or hire it done. The book tells all about it, gives many delightful ideas *what to make* of light-weight Cypress boards after applying the wonderful Japanese "Sugi" finish, and tells exactly *How To Do The Work At Home*.

(Note: The same process has been attempted on other woods but without success. This is our good fortune as well as yours. **LEARN WHY** in Volume 26.)

Southern Cypress Manufacturers' Association

1219 Poydras Bldg., New Orleans, La., or 1219 Graham Bldg., Jacksonville, Fla.

INSIST ON **TRADE-MARKED CYPRESS** AT YOUR LOCAL LUMBER DEALER'S. IF HE HASN'T IT, LET US KNOW IMMEDIATELY.



Popular Mechanics Magazine

6 N. Michigan Avenue, Chicago, U. S. A.

H. H. WINDSOR, Editor

London: Hachette & Cie,
16-17, King William Street, Charing Cross, W. C. 2

Paris: Hachette & Cie,
111 Rue Reaumur

Melbourne, Australia,
The Australasian News Co.

ISSUED MONTHLY

In United States, and its possessions, Cuba, Mexico, and Canada, per year, postpaid - \$3.00
To all other countries in the Postal Union 3.50
All subscriptions are discontinued at expiration. Please examine the date printed on your wrapper.

SUBSCRIPTION:

SINGLE COPY, 25 CENTS

Entered as Second Class Matter Sept. 15, 1903, at the Post Office at Chicago, Illinois, under Act of March 3rd, 1879.
Entered as Second Class Matter at the Post Office Department, Canada.

Published monthly by POPULAR MECHANICS CO.

Copyright, 1922, by H. H. Windsor.

Copyright in Australia.

Vol. 38

Contents for December, 1922

No. 6

Accident—Buildings, Two, Collapse with No Injuries	876
Airplane, Bombing, Largest in America, Tried Out by U. S. Army	886
Airplane Engine, Crude Oil, Developed in England	858
Airplane Landing Field Indicator, Luminous	864
Airplane Lands in Grand Canon, by R. C. Folger	898
Airplane Motors, Rebuilt, Systematically Tested	920
Anemometers, Tests Made of, to Detect Errors	920
Astronomy—Planet "Venus," Future of	944
Automobile Bumper, Self Acting, Also "Kills" Engine	899
Automobile Busses, Large Numbers on, Serve Novel Purpose	909
Automobile Headlight Controller Dims Lights Gradually	879
Automobile Radiator Device, Attractive, Warns of Overheating	928
Automobile Spring Control, Adjustable, for Small Cars	912
Automobile Stop Signal Utilizes Tail Light	884
Automobile Tires, Blow-Out Plugs and Patches for	939
Automobile Top Lining Has Spaces for Clothing	916
Automobile Wheel Lock Safeguards Tire Valve	938
Automobile Windshield, Winking Eye on, as Advertising Novelty	859
Bacteria Exhibit Contains 635 Different Types	892
Bags, Empty, Compressed Air Ram for Baling	827
Bake Ovens, Electrical, Made in Sections	848
Balloon Pilots, Army, Training Camp Established for	937
Balloon Stunt, Thrilling, by European Dare Devil	922
Bamboo Only Essential Material in Chinese Building	897
Banjos, Nonslipping Tuning Peg and Bridge for	936
Bank, Dime, in Rear Cover of New Savings Book	852
Batteries, Dry Cell, Now Inclosed in Steel Case	927
Bicycle, Early Day, Ridden on Trip to Chicago	881
Biplane, Army, Wins Air Race with Record Speed	853
Boat—Junk, Chinese, Adventurer Crosses Pacific in	822
Boat—Stern Wheeler, Homemade, Driven by Leg Power	928
Boilers, Largest Power, Now in Operation	860
Bomb, Monster Demolition, Weighs 4,000 Pounds	919
Bread Slicer, Automatic, Cuts Loaves Rapidly	884
Bridge, Bascule, Controlled by Moving Counterweight	880
Building Columns, Darkened, Illuminated by Strong Lights	848
Calculator, Demurrage, Used like Sliderule	904
Camera, Small Foreign Made, Possesses Ultra Speed	868
Candy, New Kind of, Made from Unripe Persimmons	892
Canvas, Compressed, Car Wheels and Pulleys Made of	916
Caps, Device Prevents Sagging in Front	891
Cavern, Mammoth Mexican, Fantastic Rock Formation in	854
Cement Sacks, Quantity of Cloth Required for	940
Chemical Elements, Artificial Transmutation of, by Rogers D. Rusk	917
Children's Picture Pages	942
Civic Features	930
Clock for Figuring Payrolls Has Face Divided into Decimals	904
Clothesline, Pulley, Is Motor Driven	839
Coal Meter Records Amount of Fuel Used per Hour	895
Coconuts, Forty Pound, Take Seven Years to Ripen	888
Codes, Eleven Million, New Electrical Machine Makes, by H. H. Dunn	849
Coke Cooled in Closed Tank by Noncombustible Gas	862
Colors, Psychology of, Made Subject of Study	891
Comment and Review, by H. H. Windsor	865
Computer Mounted on Clamp Attachable to Desk	895
Concrete, Buggies for Carrying, Have Pneumatic Tires	848
Concrete, Prosaic, Gives Touch of Fairyland	926
Cork Shipment Burns at Brazilian Port	874
Crane, Floating, Unloads Export Locomotives	867
Cripple, Children's Toy Vehicle Used by	830
Dentistry—Vulcanizer, New Electric	897
Derrick, Twin Barges with One Deck as Support for	831
Dinner Plate Ring, Metal, Keeps Food Hot When Serving Banquets	880
Directory Edition, Special, for City's 300th Year	824
Dirigible, Army, Destroyed After Coast Trip	852
Dock Improvements Planned for Southampton, England	874
Door Cushion, Pneumatic, on Jamb Stops Slamming	843
Drill Chuck, Nonslip, Requires No Key	912
Drilling and Grinding Machine Combined Has Many Uses	903
Engine, Aerial, Establishes New Endurance Record	879
Excavating Machinery, Modern, Promotes Work of Archaeologists	822
Explosion Causes Great Havoc in Italy	851
Eyesight, Campaign to Save, will Be Country Wide	837
Fence Is Strange "Pipe Organ" Heard on Stone Mountain	800
Fireboats, New York, High Pressure Pumps for	903
Fish, Drugged, South Sea Islanders Easily Capture	889
Flagpole, Illuminated, Is Also Wind Vane	938
Flashlight, Pocket, Swivel Clip for	940
Flourmill, State Owned, Nearing Completion	927
Flower Vases, Large, 1,000 Gallon Tanks Water	906
Fountain, Miniature, Is Humidifier and Deodorizer Combined	822
Game, Ancient Chinese, Now Fad in America	898
Garage Doors, Electrical Device Operates	905
Garbage Can Holder Prevents Theft	892
Gas, How Manufactured and Delivered	938
Gas Mask Hose Connected to Distant Blower	922
Gas Meter Valve, Automatic, Reduces Damage by Fire	933
Gases and Vapors, New Method of Cleaning	920
Gasoline Pump, Computing, for Service Stations	897
Gasoline Tank Trucks, Safety Valves for Faucets on	928
Gasoline Tanks, Safety Venting Attachment for	875
Gate, Queer, Built from Bits of Driftwood	921
Geometric Device, Improved, Is Handy Tool	932
Glass, "Mountain" of, After Fire had Razed Plant	846
Glider, British, Soars Nearly Two Hours	808
Golf Ball Scale Gives Weight and Size	941
Golf Balls, Driving Machine for Testing	913
Grab Tongs, Automatic, of New Design	910
Grapes, Mediterranean, Grow in North Carolina	929
Gun, Tiny, Easily Concealed in Palm of Hand	913
Highway Models for Engineering Colleges, by S. R. Winters	907
Hindu Tamil Procession, Gorgeous, in Ceylon	873
Home of President Monroe to be Restored	902
Homes, Shortage of, in Rome	843
House, Apartment, Dynamited to Prevent Accidents	833
Houseboat for Use of Cotton Mill Employees	881
Household Devices	935
Hunting Areas, Public, Canada Increases	896
Hydroelectric Plant, Picturesque, in France, by Allen P. Child	923

[Continued on Page 4]

DRAKE'S PRACTICAL MECHANICAL BOOKS

THEY WILL RAISE YOUR PAY—

ORDER ON 5-DAY TRIAL

The books listed below will perfect you in your chosen trade — pave the way to the big positions. Written in non-technical language—easy to read and understand. *Every book covers its subject completely. An entire course of instruction condensed into one volume.* Your choice sent postpaid — you benefit 5 days — money refunded in full if not entirely satisfactory. Order direct from this page.



Automobile Books

Automobile Ignition, by Manly	Leatherette	\$2.00
Automobile Starting and Lighting, by Manly	Leatherette	\$2.00
Brookes' Automobile Handbook	Leatherette	\$2.00
Ford Motor Car, Truck and Tractor, by Manly	Cloth	\$1.50
Starting and Lighting Troubles, Remedies and Repairs, by Manly	Leatherette	\$3.00
Automobile Battery, Care and Repair, by Manly	Leatherette	\$2.00
Automobile Catechism and Repair Manual	Leatherette	\$1.50
Tires and Vulcanizing, by Tufford	Cloth	\$2.00
Gas and Oil Engine Handbook	Cloth	\$1.50
Automobile Upkeep and Care, by Manly	Cloth	\$1.50
Motorcycle Handbook, by Manly	Cloth	\$1.50

Shop Practice Books

Sheet Metal Workers' Manual	Leatherette	\$2.00
Oxy-Acetylene Welding and Cutting	Leatherette	\$1.75
Sound Welds	Cloth	\$2.00
Slide Rule and Logarithmic Tables	Leatherette	\$2.00

Handbook for Millwrights	Cloth	\$2.00
Modern Blacksmithing	Cloth	\$1.25
Machine Shop Practice	Cloth	\$2.00
Mechanical Drawing and Machine Design	Cloth	\$2.00
Pattern Making	Cloth	\$1.50

Carpentry Books

Cloth Binding	
Modern Carpentry, 2 vols.	\$3.00
The Steel Square, 2 vols.	\$3.00
Wooden Boat and Shipbuilding	\$1.50
Modern Estimator	\$1.50
Timber Framing	\$2.00
Builder's Architectural Drawing	\$2.00
Concrete	\$1.50
Practical Bungalows	\$1.00
Low Cost Homes	\$1.00
Roof Framing	\$1.50
Stair Building and Hand Railing	\$1.50

Electrical Books

Practical Applied Electricity	\$2.00
Alternating Current	\$1.50
Electric Motor Control Systems	\$1.50
Wiring Diagrams and Descriptions	\$1.50
Electrical Tables and Data	\$1.50
Armature and Magnet Winding	\$1.50
Modern Electrical Construction	\$1.50
Modern Electric Illumination	\$1.50
Electricians' Operating and Testing	\$1.50
Motion Picture Operation	\$1.50
Drake's Electrical Dictionary	\$1.50
Electric Motors, D. & A.	\$1.50
Electrical Measurements and Meter Testing	\$1.50
Drake's Telephone Handbook	\$1.50
Modern American Telephony	\$2.00
Easy Electrical Experiments	Cloth \$1.25
Wireless Telegraph and Telephone Handbook	Cloth \$1.25
Telegraphy Self-Taught	Cloth \$1.25

Steam Engineering

Swingle's Handbook for Steam Engineers and Electricians	Leatherette	\$4.00
Examination Questions and Answers for Marine and Stationary Engineers	Leatherette	\$2.00

Steam Boilers	Leatherette	\$2.00
Swingle's Catechism of Steam, Gas and Electrical Engineering	Leatherette	\$1.50

Painting Books

Scene Painting and Bulletin Art	Cloth	\$4.00
A Show at Sho' Cards	Cloth	\$4.00
Sign Painting	Cloth	\$4.00
Strong's Book of Designs	Leatherette	\$4.00
Strong's Art of Show Card Writing	Cloth	\$4.00
Signist's Alphabets	Cloth	\$1.50
Modern Painter's Cyclopaedia	Cloth	\$2.00
Automobile Painting	Cloth	\$1.50
Estimates, Costs and Profits, Painting and Decorating	Cloth	\$1.50
New Hardwood Finishing	Cloth	\$1.50
The Amateur Artist	Cloth	\$1.50
New Stencils	Cloth	\$1.25

Farm Books

Farm Mechanics	Cloth	\$1.25
Farm Buildings	Cloth	\$1.25
Farm Engines	Cloth	\$1.25
Traction Farming	Cloth	\$1.50

Business and Reference Books

Better Business Letters	Leatherette	\$1.50
Better Business English	Leatherette	\$1.50
Better Advertising	Leatherette	\$1.50
Finger Prints Simplified	Cloth	\$2.00
Practical Bricklaying	Cloth	\$1.25
Practical Instruction for Detectives	Cloth	\$1.00
Practical Plumbing	Cloth	\$1.50
Hot Water Heating	Cloth	\$1.50
Elementary Chemistry	Cloth	\$1.50
Courses in Civil Service	Cloth	\$1.50
Cyclopedia of Recipes	Cloth	\$1.50
American Star Speaker	Cloth	\$1.50

Modern Languages

By Prof. P. S. Allen, U. of Chicago	
French without a Teacher	Cloth \$1.25
Spanish without a Teacher	Cloth \$1.25
German without a Teacher	Cloth \$1.25
Everyday French	\$1.25
Everyday Spanish	\$1.25

ORDER DIRECT FROM THIS PAGE—ON OUR MONEY-BACK PLAN

The books listed above are only a few of the many in our catalogue, which you will receive promptly after filling out and mailing us the attached coupon. For quick action order direct from this page—cross name of each book wanted and send in with price quoted. We prepay postage and send the books on our money-back plan.

FREDERICK J. DRAKE & CO.

PUBLISHERS

1008 Michigan Ave., Chicago

Drake Books Are For Sale at All Book Stores

FREDERICK J. DRAKE & CO.
1008 Michigan Avenue
Chicago, Ill.

GENTLEMEN—Please send me free, postage paid, your illustrated catalogue which lists and describes over 100 Practical Mechanical Books for Home Study.

My name is

and my address

Mail Coupon For Free Catalogue
Your Guide to Home Study

ST. LOUIS MAN DISCOVERS A NEW KIND OF HEAT



Mr. B. M. Oliver, of St. Louis, has invented an amazing device which ends forever the days of woman's slavery to dirty, mussy coal and wood fires. It sets into the firebox of any kind of heating-stove, cook-stove or furnace without changes, and just turning

a valve, it gives any degree of heat—3 times the heat of coal.

Mr. Oliver calls his invention the Oliver Oil-Gas Burner, because it burns 95% air and 5% oil (kerosene). Over 100,000 Oliver Burners are being used by American housewives. Mr. Oliver wants every woman to have the use of his invention. If you will write to him at 2014-L Oliver Bldg., St. Louis, Mo., you will receive an attractive booklet FREE that tells all about it. Mr. Oliver is now making a special Low Price Offer, including a 30-Day Free Trial. He is also looking for live distributors, and will tell you how to earn \$500 a month in full or spare time if you will request his sales plan.

ANIMATED CARTOONING EASILY LEARNED AT HOME



This interesting and highly paid profession can now be learned in your spare time. Fisher, Bray, Briggs and other noted Animated Cartoonists make big money. You have the same opportunity. Complete training given under guidance of expert Cartoonists. Write today for Special Introductory Low Price Offer and Full Information FREE.

ANIMATED CARTOONING STUDIOS,
110 McConahy Building, Kansas City, Mo.

LEARN WATCHMAKING

and become independent. Good-paying positions secured. Easy to learn. Send for FREE CATALOG.

ST. LOUIS WATCHMAKING SCHOOL, Dept. 5, ST. LOUIS, MO

[Contents—Continued from Page 4]

Solder, Simple Device for Pulverizing.....	955
Sorghum Cane, Simple Skid for Hauling.....	953
Tong Rack, Improved, for Blacksmiths.....	955
Tongs for Placing Bolts.....	953
Tractor Clutch Yoke, How to Repair.....	959
Trash Can, Easily Dumped.....	947
Truck Wheel Lock, Simple.....	964
Valves, Steam, Simple Lock for.....	946
Walls, Novel Method of Painting.....	946
Washer Cutter, Simple.....	960
Wrench, Socket, Adjustable.....	963
Wrenches, Machine, Novel Holder for.....	963

AMATEUR MECHANICS

Automobile Convertible as Bed.....	978
Automobile Grease Cups Made Convenient.....	977
Automobile, Handy Oil Gauge for.....	968
Automobile Tire Casings, Keeping Water Out of.....	978
Automobiles, Useful Hints Regarding.....	980
Book Ends Made of Angle Iron.....	982
Camera Shutter, Mousetrap Used to Trip.....	967
Candles, Simple Method of Making.....	981
Clothesline Prop, Collapsible.....	978
Concrete Reinforcement, Fence Wire as.....	968
Drill Press, Hand, Improving.....	966
Feed Box Prevents Stock from Unsetting.....	976
Flags, Small, Standards for Displaying.....	977
Garage Door Lock, Convenient.....	977
Garage, Ventilating Doors for.....	966
Gate, Sliding, Practical.....	974
Greeting Cards, Homemade.....	965
Hats, Felt, Waterproofing.....	983
Headlamp Rims, Tool for Removing.....	974
Heater, Electric Radiant, Substantial.....	982
Icebox, Device Saves Ice in.....	967
Motion Picture Camera, How to Make.....	969
Motion Picture Toy for Children.....	981
Photography—Dark Room, Improvised.....	976
Photography—Developing Tray, Improvised.....	974
Picture Frame Clamp, Simple, How to Make.....	981
Sewing Machine Belts, Keeping from Slipping.....	967
Stenciling Colored Designs on Fabrics.....	978
Switch, Four Way, Made from Old Auto Timer.....	976
Tires, Chest for Storing.....	967
Tool Rack, Convenient.....	977
Wireless Crystal, Renewing a.....	966
Wireless Dead End Switch for Inductances.....	982
Wireless Interrupter, Neat, How to Make.....	976
Wireless Telephone, Simple Battery, How to Make.....	979
Wireless Variometer Winding Form.....	975

REMNANTS 66¢ A Yd.

Beautiful assortment of serges, Tricotines and silks at less than wholesale. Blues, Wines, Gray, etc. Remnants of 4 and 5 yard lengths, sufficient to make suit or dress.

MONEY BACK IF NOT SATISFIED.

Save money. Make your own clothes. These remnants will save you up to \$1.00 a yard. WRITE FOR INFORMATION.

TEXTILE MILLS, DEPT. 602, KANSAS CITY, MO.

"THERE'S MONEY IN IT"

AT HOME LEARN TELEGRAPHY AT HOME MORSE AND WIRELESS



TEACH YOURSELF

in half usual time, at trifling cost, with the wonderful Automatic Transmitter **THE OMNIGRAPH**. Sends unlimited Morse or Continental messages, at any speed, just as an expert operator would. Adopted by U. S. Government, and leading Universities, Colleges and Telegraph Schools. 3 styles. Catalog free.

OMNIGRAPH MFG. CO.

16-22 Hudson St., NEW YORK

WANTED

**Railway Mail Clerks
\$1600 to \$2300 Year**

MEN—BOYS OVER 16

SHOULD WRITE IMMEDIATELY

Steady work. No layoffs. Paid Vacations

Common education sufficient.

Send coupon today—SURE



RAILWAY

MAIL CLERKS

FRANKLIN INSTITUTE, Dept. K177, Rochester, N. Y.

Sirs: Send me without charge, (1) sample Railway Mail Clerk Examination questions; (2) Schedule showing places in all coming U. S. Government examinations; (3) list of many government jobs now obtainable.

Name.....

Address.....

ELECTRICAL WORKERS!

HAWKINS ELECTRICAL GUIDES

START YOU ON THE UP-GRADE

Invest spare time in study NOW! Draw out dividends in dollars LATER. The way to EARN more is to LEARN more. HAWKINS ELECTRICAL GUIDES lift you to the job higher up. Hundreds of Chief Electricians, Chief Engineers, Foremen and Managers write us that they owe their jobs to the GUIDES. Just your name and address on the coupon below! No money until you are satisfied. Get out your pencil or borrow one, Mr. Electrical Worker! Take this most important step of your career this minute!

Take the
FIRST
Step
NOW!

"I must compliment you on the thoroughness and the simplicity of the Guides"—Geo. M. Rowe. "They are so plain that one can practically learn the electrical game from the Guides alone"—L. R. Burton. "Worth \$10 down and \$10 a month"—James B.

Streart. "They were the cause of a 100% increase in my salary"—A. W. Thompson. "They cover every possible subject in electrical engineering"—R. T. Van Dewoort. "Much better than a correspondence course I have been studying"—C. A. Harrington.

These books tell you all about—

Magnetism—Induction—Experiments—Dynamoes—Electric Machinery—Motors—Armatures—Armature Windings—Installing of Dynamoes—Electrical Instrument Testing—Practical Management of Dynamoes and Motors—Distribution Systems—Wiring—Wiring Diagrams—Sign Flashers—Storage Batteries—Principles of Alternating Currents and Alternators—Alternating Current Motors—Transformers—Converters—Rectifiers—Alternating Current Systems—Circuit Breakers—Measuring Instruments—Switch Boards—Wiring—Power Stations—Installing—Telephone—Telegraph—Wireless—Bells—Lighting—Railways. Also many Modern Practical Applications of Electricity and Ready Reference Index

FREE EXAMINATION

Not a cent to pay until you see the books. No obligation to buy unless you are satisfied. Send Coupon now—today—and get this great help library and see if it is not worth \$100 to you—pay \$1.00 a month for ten months or return it.



\$1 PER. MO. ENTIRE SET COMPLETE \$10.

**Flexible Covers—Pocket Size
4700 PICTURES—3500 PAGES**



SEND ONLY THIS COUPON—LOOK THIS ENTIRE SET OVER FREE!

THEO. AUDEL & CO., 72 Fifth Ave., N. Y.

Please submit for examination **Hawkins Electrical Guides** (Price \$1.00 each). Ship at once, prepaid, the 10 numbers. If satisfactory, I agree to send you \$1 within seven days and to further mail you \$1 each month until paid.

Signature

Occupation

Employed by

Residence

Reference

PM-Dec. 22

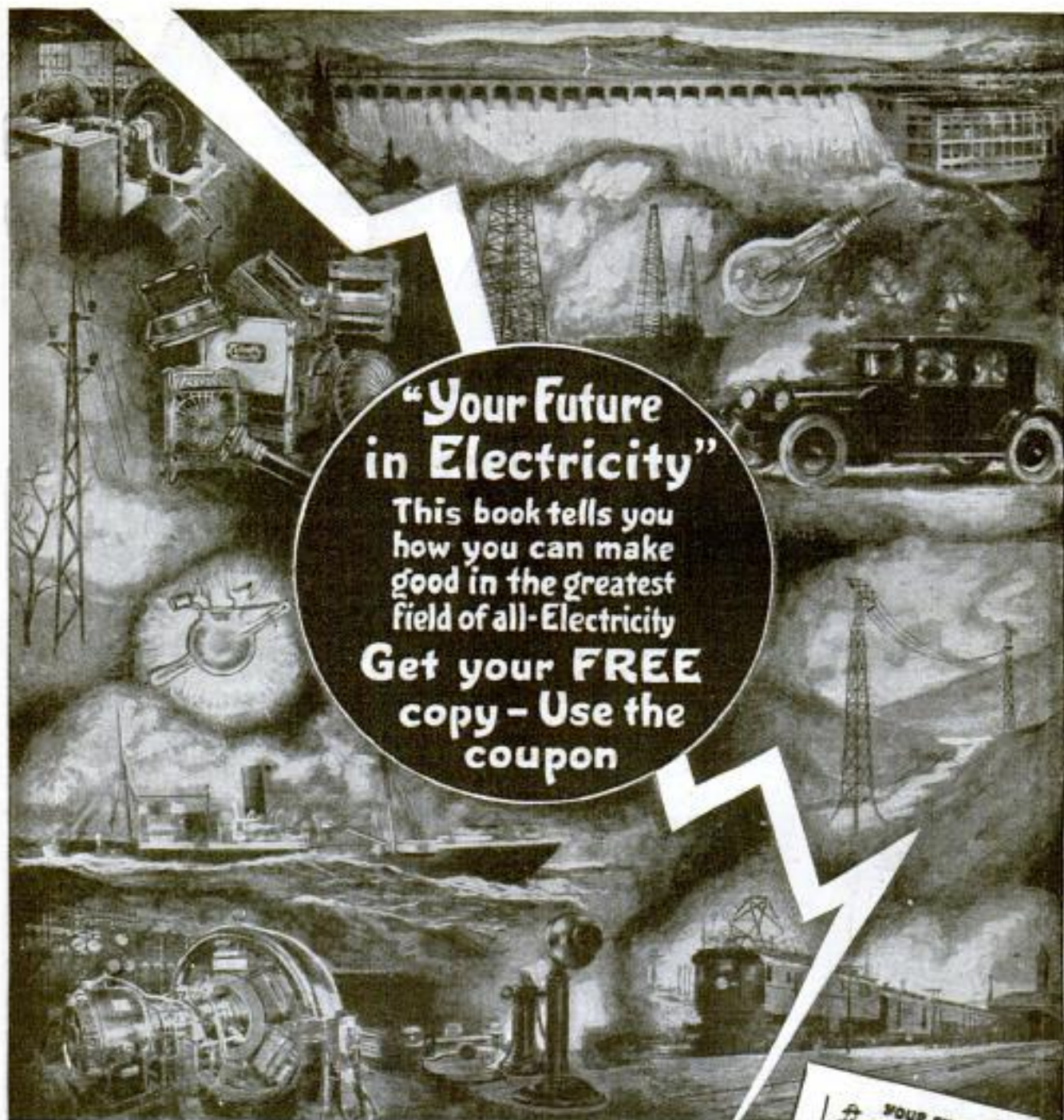

"Your Future in Electricity"

This book tells you how you can make good in the greatest field of all—Electricity

Get your FREE copy — Use the coupon

American School

Dept. E 974, Drexel Avenue & 58th Street
CHICAGO

Send me the free book "Your Future in Electricity." This request puts me under no obligation.

Name.....

Address.....

City..... State.....



Free Book

This big, handsomely printed 32-page book tells of the wonderful opportunities awaiting for you in Electricity. It tells how you may become a big pay Electrical Expert in 1 year. Send for it.



Stop Wondering How I Teach Piano; I'll Show You, FREE



YEAR after year you've seen my advertisement in all the leading publications, offering to teach you piano in *quarter* the usual time. Year after year my school has grown and grown until now I have far more students than were ever before taught by one man. In 1921 over a thousand students *graduated* from my Piano or Organ course and received their diplomas.

Yet when I first started giving piano and organ lessons by mail in 1891 my method was laughed at. Could any conservatory have grown as it has, obtained students in every state of the Union and in fact practically every civilized country of the world unless it produced very unusual and satisfying RESULTS for its students? See for yourself what it is that has brought my method so rapidly to the front. Write for free booklet and sample lessons.

Now, for the first time, you can obtain sample lessons without charge. In the past I have always been opposed to sending out free lessons, even to persons who were seriously interested in my course. But my friends have insisted that I give everybody a chance to see for themselves just how simple, interesting and DIFFERENT my lessons are, and I have consented to try the experiment for a short time. Simply mail the coupon below or write a postcard, and the 64-page booklet and sample lessons will go to you at once absolutely free and without obligation.

Within four lessons you will play an interesting piece on the piano or organ, not only in the original key, but in all other keys as well. Most students practice months before they acquire this ability. It is made possible by my patented invention the Colorotone. Another invention obtainable only from me is my hand-operated moving picture device, Quinn-dex. By means of Quinn-dex you actually see my fingers in motion on the piano, and can learn just how to train your own fingers.

When I say that I can teach you piano in *quarter* the usual time, do not think that this is too good to be true. Modern inventions and improved methods have accomplished just as great wonders in other branches of education. You at least owe it to yourself to *investigate*. Send coupon or postcard at once, before the offer of free sample lessons is withdrawn.

Quinn
Conservatory,
Studio PM 52,
598 Columbia Road,
Boston 25, Mass.

Please send me, without cost or obligation your free booklet, "How to Learn Piano or Organ," free sample lessons, and full particulars of your method.

Name.....

Address.....

Copy This Sketch



I AM anxious to find men with desire to become draftsmen. With business picking up everywhere many thousands of draftsmen will be needed at salaries ranging from \$3000 to \$3600 per year.

In asking you to copy this sketch I believe I will be able to tell from the sketch you send in what kind of an opportunity you will have in this great profession.

There are no conditions requiring you to buy anything. You are under no obligations in sending in your sketch. What I want to know is how much you are interested in drawing and your sketch will tell me that.

Ambitious boys and men between the ages of 16 to 50 are wanted by big business concerns, and the man who is ready when opportunity calls him will get the best position and the highest pay.

FREE — \$80 Drafting Course

To every student enrolling now I give an opportunity of getting an \$80 drafting course absolutely without cost to him. So send in your sketch today and learn all about this offer.

FREE — Drafting Outfit

To every student enrolling now I give an opportunity also of getting a regulation draftsman's outfit made up of the very same instruments which I use myself. Every student gets this splendid set without cost. See illustration below.

Draftsman's Pocket Rule Free — To Everyone Sending Sketch

To every man sending a sketch I am going to mail free and prepaid the Draftsman's Ivorine Pocket Rule shown here. This will come to you entirely with my compliments. With it I will send a 6x9 book on "Successful Draftsmanship." If you are interested in becoming a

draftsman, if you think you have or may attain drafting ability, sit down and copy this drawing, mailing it to me today, writing your name, and your address and your age plainly on the sheet of paper containing the drawing.

\$250 to \$300 per Month

I am Chief Draftsman of the Engineers' Equipment Co. and I know that there are thousands of ambitious men who would like to better themselves, make more money and secure faster advancement. Positions paying \$250 to \$300 per month, which ought to be filled by skilled draftsmen, are vacant everywhere. I want to find the men who with practical training and personal assistance will be qualified to fill these positions. No man can hope to share in the great coming prosperity in

manufacturing and building unless he is properly trained and is able to do first class practical work.

I know that this is the time to get ready. That is why I am making the above offer. I can now take and train a limited number of students personally and I will give to those students a guarantee to give them by mail practical drawing room training until they are placed in a permanent position with a salary of \$250 to \$300 per month. You should act promptly on this offer because it is my belief that even though you start now the great boom will be well on by the time you are ready to accept a position as a skilled draftsman. So write to me at once. Enclose sketch or not, as you choose, but find out about the opportunities ahead of you. Let me send you the book "Successful Draftsmanship" telling how you may take advantage of these opportunities by learning drafting at home.

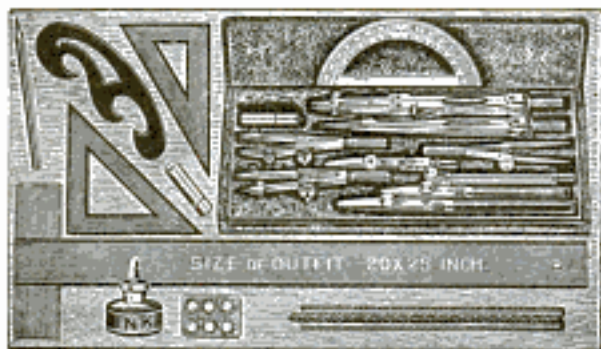

FREE this \$25 Draftsman's Working Outfit

These are regular working instruments—the kind I use myself. I give them free to you if you enroll at once. Don't delay. Send for full information today.

Mail Your Drawing at Once — and Get an Ivorine Pocket Rule Absolutely Free!

Ambitious men interested in drafting hurry! Don't wait! This is your opportunity to get into this great profession. Accept the offer which I am making now. Send in your sketch or request for free book and free Ivorine Pocket Rule.

Chief Draftsman, Engineers' Equipment Co., 4001 Broadway, Div. 1359, Chicago



“We pay him \$100 a week”

AND he's worth every cent of it. Came here several years ago asking for a job. He got just that—a small job at a small salary.

“Then I forgot about him—hardly knew he was on the payroll until one day I got a letter from the International Correspondence Schools telling me that Thomas A. Andrews had enrolled for a course and had received a mark of 98 for his first lesson.

“‘There's a man worth watching,’ I said to myself, so I began to keep tabs on his work. Pretty soon he began coming to me with suggestions. I could almost see him growing.

“Somehow, he was the first man I thought of whenever there was a position open. And he always made good because he was always preparing himself for the job ahead. We pay him \$100 a week now and he's going to be earning even a larger salary some day. I wish we had more men like him.”

HOW do you stand when your employer checks up his men for promotion? Does he think of you? Is there really any reason why you should be selected?

Ask yourself these questions fairly. You must face them if you expect advancement and more money. For now, more than ever, the big jobs are going to men with special training.

There is an easy, fascinating way for you to get this special training right at home in spare time. One hour a day, spent with the I. C. S. in the quiet of your own home, will bring you more money, more comforts, more pleasure, all that success means.

Don't let another priceless hour of spare time go to waste! Without cost or obligation, let us prove that we can help you. Mark and mail this coupon now.

----- TEAR OUT HERE -----
INTERNATIONAL CORRESPONDENCE SCHOOLS
 Box 5686-C, Scranton, Penna.

Without cost or obligation, please tell me how I can qualify for the position or in the subject before which I have marked an X:

- | BUSINESS TRAINING DEPARTMENT | |
|---|---|
| <input type="checkbox"/> Business Management | <input type="checkbox"/> Salesmanship |
| <input type="checkbox"/> Industrial Management | <input type="checkbox"/> Advertising |
| <input type="checkbox"/> Personnel Organization | <input type="checkbox"/> Better Letters |
| <input type="checkbox"/> Traffic Management | <input type="checkbox"/> Foreign Trade |
| <input type="checkbox"/> Business Law | <input type="checkbox"/> Stenography and Typing |
| <input type="checkbox"/> Banking and Banking Law | <input type="checkbox"/> Business English |
| <input type="checkbox"/> Accountancy (including C.P.A.) | <input type="checkbox"/> Civil Service |
| <input type="checkbox"/> Nicholson Cost Accounting | <input type="checkbox"/> Railway Mail Clerk |
| <input type="checkbox"/> Bookkeeping | <input type="checkbox"/> Common School Subjects |
| <input type="checkbox"/> Private Secretary | <input type="checkbox"/> High School Subjects |
| <input type="checkbox"/> Business Spanish <input type="checkbox"/> French | <input type="checkbox"/> Illustrating <input type="checkbox"/> Cartooning |
| TECHNICAL AND INDUSTRIAL DEPARTMENT | |
| <input type="checkbox"/> Electrical Engineering | <input type="checkbox"/> Architect |
| <input type="checkbox"/> Electric Lighting | <input type="checkbox"/> Blue Print Reading |
| <input type="checkbox"/> Mechanical Engineer | <input type="checkbox"/> Contractor and Builder |
| <input type="checkbox"/> Mechanical Draftsman | <input type="checkbox"/> Architectural Draftsman |
| <input type="checkbox"/> Machine Shop Practice | <input type="checkbox"/> Concrete Builder |
| <input type="checkbox"/> Railroad Positions | <input type="checkbox"/> Structural Engineer |
| <input type="checkbox"/> Gas Engine Operating | <input type="checkbox"/> Plumbing and Heating |
| <input type="checkbox"/> Civil Engineer | <input type="checkbox"/> Chemistry <input type="checkbox"/> Pharmacy |
| <input type="checkbox"/> Surveying and Mapping | <input type="checkbox"/> Automobile Work |
| <input type="checkbox"/> Metallurgy | <input type="checkbox"/> Navigation |
| <input type="checkbox"/> Steam Engineering | <input type="checkbox"/> Agriculture and Poultry |
| <input type="checkbox"/> Radio <input type="checkbox"/> Airplane Engines | <input type="checkbox"/> Mathematics |

Name.....
 Street.....
 Address.....
 City..... State.....

Occupation.....
 Persons residing in Canada should send this coupon to the International Correspondence Schools Canadian, Limited, Montreal, Canada.

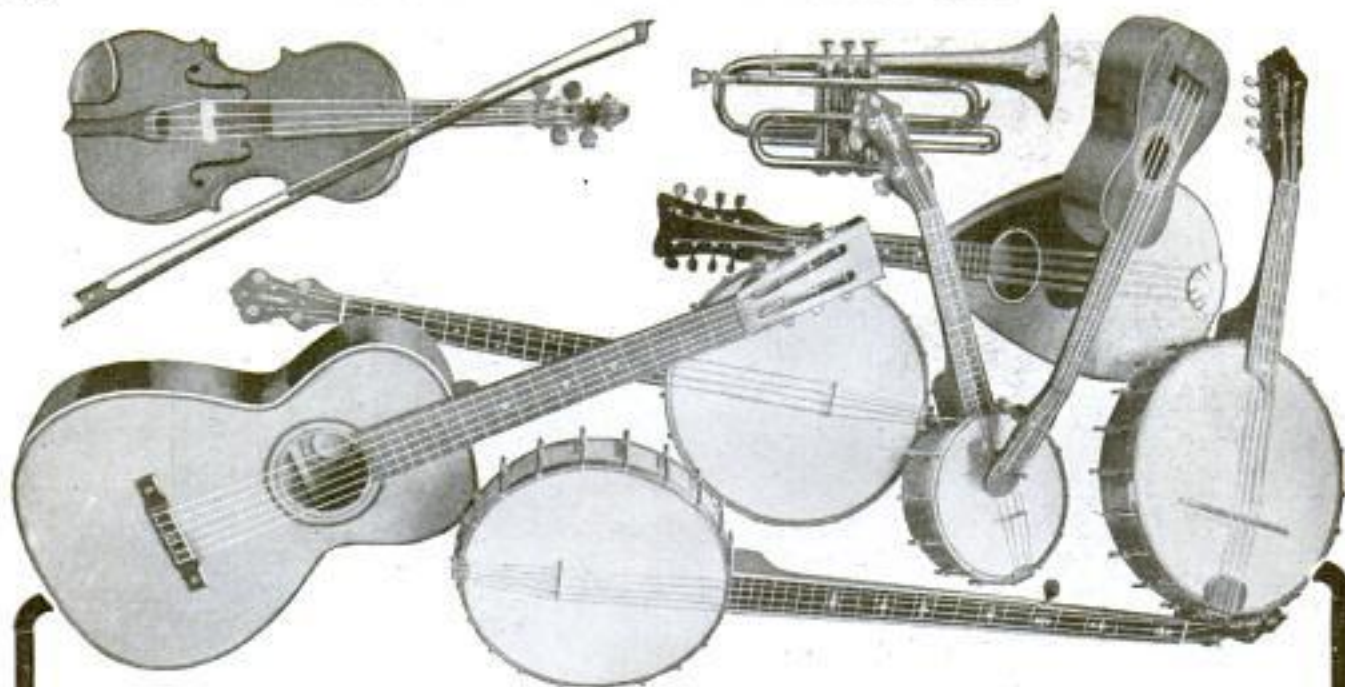

YOUR CHOICE \$ FREE 20

*Violin, Mandolin, Guitar,
Ukulele, Hawaiian Guitar,
Banjo, Banjo Mandolin,
Tenor Banjo, Cornet or
Banjo Ukulele.*

Actually given away, absolutely free, to pupils in each locality. Last year we gave away thousands of high-grade musical instruments on this sensational offer, now repeated for YOUR benefit.

We have the most wonderful new system of teaching NOTE music by mail. Take your choice of any of these magnificent instruments absolutely free and learn to play by this easy to learn method. Can have you playing standard note music in 4 lessons. A very small charge for lessons—just a few cents a week—your only expense. Your success guaranteed. Pay nothing if you fail to learn; you take no risk. Complete outfit free with every instrument. Don't wait a minute, but mail the coupon NOW.

To Advertise Our Copyrighted Course

Our plan is, \$2.00 monthly for lessons. No charge for instrument. Ukulele and banjo ukulele given free with 20 lessons at 50c a lesson. Tenor banjo, banjo and Hawaiian Guitar given free with 32 lessons at 50c a lesson; Violin, mandolin, guitar and banjo mandolin given free with

56 lessons, 43½c a lesson. Lessons are mailed one each week. Fill out the coupon and enclose \$2.00 or, we will send instrument and complete outfit subject to examination at express office C. O. D. \$2.00 for first month's lessons, and you will get an instrument you will be proud to own. At end of one week if you are not delighted with instrument and lessons, send outfit back and we will refund your money.

Do not delay, but mail the coupon today, before it is too late. Be sure to state whether you want a free Violin, Mandolin, Guitar, Ukulele, Hawaiian Guitar, Banjo, Banjo Mandolin, Tenor Banjo. We guarantee any one of these instruments positively worth \$20 or more. For cornet, piano, organ and further information, write for booklet.

SLINGERLAND'S CORRESPONDENCE SCHOOL OF MUSIC
Dept. 4, 1815 Orchard St., Chicago, Illinois

FREE INSTRUMENT COUPON

Slingerland's Correspondence School of Music
Department 4, 1815 Orchard Street,
Chicago, Illinois

Please send me one free.
(Name of Instrument)

- Plan No. 1. I am enclosing \$2.00 for first month's lessons.
 Plan No. 2. Send outfit and lesson C. O. D. \$2.00; but if I am not satisfied at end of one week's trial, I will return outfit and my \$2.00 is to be returned to me or, I will pay \$2.00 monthly until lessons are paid for.

Name.....

St..... R. F. D.....

City..... State.....



From \$100 a Month to \$8,000 a Year —and just beginning to grow!

Only one hundred a month—that was what Charles S. Jones, a Texas man, was drawing when he first took up home study training under the LaSalle Problem Method.

Three years later comes a letter from "Henry & Jones, Certified Public Accountants," and bearing the address of Jones' home city. "My income is a trifle in excess of \$8,000 a year," writes Jones, "and I am just beginning to grow. I can hardly find words to tell you of the inspiration that the course has given me. I have recently enrolled for your full Law course and expect to complete my business education with LaSalle."

His Chance is Yours!

A practical and remarkably interesting method of business training—the LaSalle Problem Method—and it gets results!

A. J. Klick, for example, writes that in three years' time his training in Higher Accountancy lifted him from a bookkeeper's job, at \$22 a week, to the position of comptroller of a good-sized New York corporation, at a salary of \$4,500 a year. Arthur J. Hammerl writes that LaSalle training increased his income 70 per cent in eight months. Other LaSalle members, thousands of them, tell of incomes doubled, tripled, even quadrupled, thru home-study training under the LaSalle Problem Method. During a period of only three months as many as 1,089 members reported definite salary increases totalling \$889,713. *The average increase per man was 56 per cent.*

If you are in earnest when you say you want to make more money, check the training that interests you, sign and mail the coupon NOW. It will

bring you full particulars of the LaSalle Problem Method, together with details of our convenient-payment plan; also your copy of "Ten Years' Promotion in One." "Get this book," said a prominent Chicago executive, "even if you have to pay five dollars for it." We will send it *free*.

Make your *start* toward that bigger job TODAY.

LaSalle Extension University

The Largest Business Training Institution in the World

Dept. 1264-HR

Chicago, Illinois

Please send me catalog and full information regarding the course and service I have marked with an X below. Also a copy of your book, "Ten Years' Promotion in One," all without obligation to me.

Higher Accountancy

Training for positions as Auditor, Comptroller, Certified Public Accountant, Cost Accountant, etc.

Other LaSalle Training Courses

LaSalle is the largest business training institution in the world. It offers training for every important business need. If more interested in any of these courses, check here:

- | | |
|--|--|
| <input type="checkbox"/> Business Management | <input type="checkbox"/> Banking and Finance |
| <input type="checkbox"/> Modern Salesmanship | <input type="checkbox"/> Modern Foremanship and Production Methods |
| <input type="checkbox"/> Traffic Management | <input type="checkbox"/> Personnel and Employment Management |
| <input type="checkbox"/> Railway Accounting and Station Management | <input type="checkbox"/> Expert Bookkeeping |
| <input type="checkbox"/> Law — Degree of LL. B. | <input type="checkbox"/> Business English |
| <input type="checkbox"/> Commercial Law | <input type="checkbox"/> Commercial Spanish |
| <input type="checkbox"/> Industrial Management Efficiency | <input type="checkbox"/> Effective Speaking |
| <input type="checkbox"/> Modern Business Correspondence and Practice | <input type="checkbox"/> C. P. A. Coaching |

Name.....

Present Position.....

Address.....

LEARN Modern Barbering the Short Way

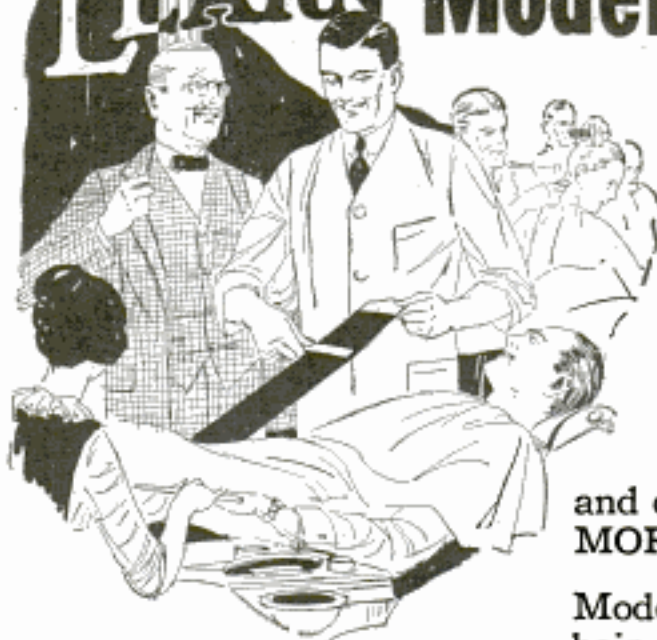

A Clean, Carefree, Good Paying Business

that you can acquire easily. A trade that enables you to **TRAVEL AND SEE THE WORLD**, one that pays in tips and commission in addition to salaries, **MORE THAN MOST MEN EARN.**

Modern barbering includes the electric hair cutter, the mechanical massage and scientific treatments. It also affords a study—if one desires—on hair and skin, and makes the barber of today a **MAN AMONG MEN.**

TO BE YOUR OWN BOSS is a worthy ambition. You can own your shop with small capital, and be independent. We equip your place on easy terms.

OUR SHORT PRACTICAL COURSE has more than doubled the earning power for thousands. We can do this for you. The average annual income exceeds most tradesmen because it is steady work the year around.

Our catalog, that we mail free, tells how we enable you to **EARN WHILE LEARNING**, how we put you into the **BEST CITY JOBS**, how we equip your shop on **EASY PAYMENTS**; in fact, how we take you just as you are, make your life work easier, better paying and more independent.

We have 33 branch schools in leading cities. We have one near you.

*Write any one of the following addresses
for our booklet B. Do it today.*

THE MOLER SYSTEM OF COLLEGES

Moler System of Colleges

Address Nearest Branch

Please send me without obligation on my part your booklet B.

Name

Address

157 Third Ave.
105 S. Wells St.
810 N. 6th St.
544 Main St.
341 W. 5th St.
215 Huron Rd.
1045 Cass Ave.
1229 17th St.
107 Nicollet Ave.
110 S. 14th St.
513 E. Water St.
1005 Canal St.
192 Marrietta St.
80 N. 2nd St.
910 Main St.
712 Franklin Ave.
727 W. Commerce St.
198 Queen St., E.

New York, N. Y.
Chicago, Ill.
St. Louis, Mo.
Kansas City, Mo.
Cincinnati, Ohio
Cleveland, Ohio
Detroit, Mich.
Denver, Colo.
Minneapolis, Minn.
Omaha, Nebr.
Milwaukee, Wis.
New Orleans, La.
Atlanta, Ga.
Memphis, Tenn.
Dallas, Texas
Houston, Texas
San Antonio, Texas
Toronto, Ont., Can.

No Need to Wait for Opportunity Technical Training will Bring It to You

Big Demand Right Now for Draftsmen, Building Experts, Engineers. Get Ready for a Better Job and More Money

IF YOU are in a small pay job, if you don't see a big future in what you are doing now—this is the time to get into a field where big opportunities are constantly coming up. Building, general construction and engineering lines are booming. Not enough technical experts are to be had to fill the important jobs. Big pay and big opportunities are ready for men with specialized training. Chicago "Tech" gives this training to ambitious men—by mail to those who cannot come to the College. Read below

Learned Drafting Makes Big Income

"My promotions came rapidly after I took up the Chicago 'Tech' course in Drafting. Soon after I enrolled, my salary was increased \$220 a month in the Architectural Department of the company which employed me. I am now in business for myself and my prospect file shows \$220,000 worth of work."

Albert S. Ross.



Was a Carpenter Now Contractor

"I was working as a carpenter—\$6 a day—when I took up your Building course. In less than 3 months I was made foreman on a big building at \$8 a day. 3 months later was superintending a reinforced concrete job covering nearly half a block. Am now in business for myself specializing in theaters."

J. D. Woodside.



He Was a Clerk Now an Employer

"When I took your course I was a clerk at \$60 a month and seemed unable to get more. After 6 or 8 months you secured me a position as Draftsman. Soon my salary doubled. Am now in business for myself employing several draftsmen. The time and money spent on your course was the best investment I ever made."

H. S. Kaapp.



From Draftsman to Chief Engineer

"When I began my Chicago 'Tech' course I was a draftsman. Later I became Chief Draftsman for another firm at twice former salary and after a few weeks accepted a position at four times my original salary. Am now Chief Engineer. The correspondence course with Chicago 'Tech' has made me an originator and designer."

Rex L. Cary.



Chicago "Tech" Will Train You by Mail

By the Chicago "Tech" method you get the direct personal instruction of practical men. You are trained to solve the kind of problems that come up every day in actual engineering and building work. You get blue prints same as used in shops, factories and on construction work. No time put in on useless theories—none on unnecessary studies. Every point is made clear; every subject thoroughly covered and you advance from one step to another as fast as you learn. No matter what you are doing you can get this Chicago "Tech" training and be prepared to step far ahead of men who are plodding in a rut or trying to pick up knowledge as they go along.

Men with expert technical knowledge are wanted now. Paying positions are open. Get ready.

Send the Coupon

Make up your mind to do bigger things—to make more money as a technically trained man. The coupon will bring catalog and full information. Mark X before name of the course which interests you and mail the coupon today.

Chicago Technical College

1230 Chicago "Tech." Bldg. Chicago

FREE Trial Lesson

If you are interested in Drafting or Building the coupon brings a free trial lesson which shows our method and enables you to see how well qualified you are to take up the course—this before you decide whether to enroll or not.



Chicago Tech. College,
1230 Chicago Tech. Bldg.,
Chicago, Ill.

Without cost or obligation on me please send instructive matter about opportunities in line I have marked with "X."

- | | |
|---|--|
| —Drafting. (The Big Salary Course.)
No experience necessary. | —Aeronautic Engineering
All about aeroplanes. |
| —Building Trade Course
for men in the building lines. | —Plumbing, Heating and Ventilating |
| —Surveying
and Map Drafting. | —Steam Engineering
for Stationary Engineers. |
| —Automobiles
Gas Engines, Starting,
Lighting, etc. | —Plan Reading for Shop
Men, for Structural Iron
workers, assemblymen, etc. |

Name.....

Address.....

Post Office.....State.....

Make Yourself Worth Your Weight in Gold



According to the chemists, a man contains enough water to wash a pair of blankets, enough lime to whitewash a chicken-coop, enough phosphorus to make a thousand matches, and enough sulphur to kill the fleas on one dog. All this material can be bought at a drug-store at the junk price of 98 cents.

On the other hand, a man weighing 150 pounds, if all gold, would be worth \$20.76 per Troy ounce or about \$50,000, which at six per cent. interest has an earning power of \$3,000 a year, almost \$60 a week.

Are you junk or gold? Many thousands of other men are proving themselves worth their weight in gold, or much more. They rise to this value by developing their Bigger Selves, by storing their minds with useful education.

Let us tell you, free of charge, how we are helping ambitious young men to become "worth their weight in gold" during their evening spare hours, through a new kind of correspondence instruction that brings "the most service for the least money." You can't afford not to avail yourself of this friendly counsel. Mark and mail the coupon.

SOME OF OUR 300 CORRESPONDENCE COURSES

Accountancy
Advertising
Banking
Better Letters
Bookkeeping
Business Arithmetic

Business Courses
Business Administration
Business English
Business Finance
Business Law
Complete Letter-Writing

Office Management
Public Speaking
Salesmanship
Secretarial
Show Card Writing
Stenography
Traffic Management

Technical and Other Courses

Agricultural Courses
Applied Psychology
Architecture
Automobile Courses
Building Construction
Civil Engineering Courses
Drafting Courses
Electrical Courses
English Courses

Factory Management
Foreign Languages
Foremanship
Highway Engineering
High School Courses
Illustrating
Insurance Courses
Mathematical Courses
Mechanical Engineering

Own-Your-Home Course
Plan Reading
Plumbing
Poultry Husbandry
Radio Engineering
Radio Telegraphy
Steam Engineering Courses
Structural Drafting
Surveying
Use of the Slide Rule
Vocational Guidance

Are you an ex-service man?



Correspondence Instruction

375 Lexington Avenue
Dept. 2-D New York City

Without obligating me, please advise regarding the course in

Name.....
Full Address.....
(Please write plainly.)

COMMERCIAL ART

Taught By Improved Methods

Many art school advertisements tell about the great and ever increasing demand for commercial artists—big pay—equal opportunity for both men and women, etc. Very good! This is all quite true, but you must *first* be properly taught. Understand? Properly taught! Few top notch artists are good instructors. Very few. By searching through many studios we have found them.

A Master Course Is Offered

Endorsed as the official training school for leading Commercial Art houses, employing hundreds of artists. Correct educational methods applied. A practical educator and a corps of top notch commercial artists, offer students the benefit of 20 to 30 years of high grade experience. Only the best instruction is good enough for you. Students finishing half of this unusual course can secure and hold desirable positions. Course can be made to pay for itself many times while studying. Either *class room or home study* instruction. *Same course. Same credits.* If you like to draw, let's talk it over. Ask for our book telling all about Commercial Art and the opportunities it presents AS WE TEACH IT. Send 6 cents in stamps for postage.

NATIONAL ACADEMY
OF COMMERCIAL ART
230 EAST OHIO ST.
DEPT. OF CHICAGO,
ILL.

Good Money } in HOTEL Good Living } WORK

for Men and Women

Many opportunities for trained people; 80,000 wanted every year. Hotel work is fascinating; offers exceptional advantages, comfortable quarters, good pay.

How to Start Right

Hotel managers demand **trained** employees; highly endorse the Hotel Operation and Management Course. Gives you complete, well-rounded preparation in short time, at home, in spare hours. Easy to understand; any average **man or woman** can qualify for good position which we help you get.

Investigate Now!

Training is inexpensive. Send coupon **today** for full information; no obligation.

STANDARD BUSINESS
TRAINING INSTITUTE
1004 Carlton Court
Buffalo, N. Y.



Standard Business Training Inst.
Buffalo, N. Y.

Send me free booklet No. 1004 giving full information about Hotel Operation and Management Course.

Name.....
Street.....
City.....

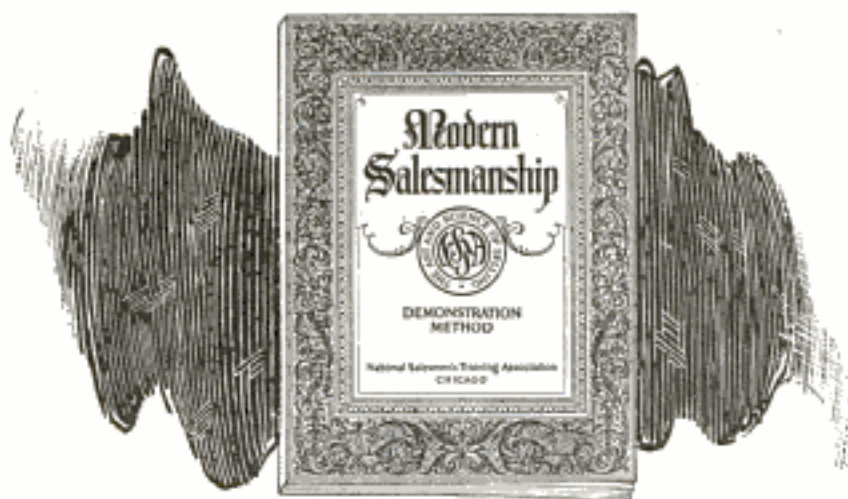

NOW FREE!

The Book That Has Shown Thousands the Way to Amazing Salary Increases

Do you want to leave the rut of routine work and start right out making more money than you ever dreamed possible? We have done exactly this for thousands of men. Here is the book which gave them their start. Read how it is now offered to you—FREE!

TAKE this situation: A man who had worked all his life in a routine job at low pay suddenly surprises his friends, by moving into a better neighborhood, taking a big house, buying a car and blossoming out as a well-to-do and influential citizen in his new community. How did he do it? What is the secret that he used? Simple enough. He knew that the biggest money in business is in Selling, and though he felt that he couldn't sell a thing, he suddenly learned the secrets that make Master Salesmen and then began to make big money.

If only one man had found inspiration enough in this remarkable book to jump to a sudden brilliant success in the Selling field—into a job paying him many times his former salary—then you might call it luck. But thousands have done it.

READ!

Charles Beery of Winterset, Iowa, stepped from \$18 a week as a clerk to a position making him \$1,000 the very first month. J. P. Overstreet of Dennison, Texas, read this amazing book, left a job on the Capitol Police Force at a salary of less than \$1,000 a year and in six weeks earned \$1,800. F. Wynn, Portland, Ore., an ex-serivice man, earned \$554.37 in one week. Geo. W. Kearns of Oklahoma City found in this book a way to jump his earnings from \$60.00 a month to \$524.09 in two weeks, and C. W. Campbell learned from it how he could quit a clerking job on the railroad to earn \$1,432 in thirty days.

Your One Chance to Make the Biggest Money of Your Life

Not one of the men whose names appear in the panel at left had ever sold a thing before—not a dime's worth. Yet every one of these men through reading this book discovered an amazingly easy way to jump suddenly from low pay to extraordinary earnings in the selling field.

Sounds remarkable, doesn't it? Yet there is nothing remarkable about it. There are certain ways to approach different types of prospects to get their undivided atten-

tion—certain ways to stimulate keen interest—certain ways to overcome objections, batter down prejudices, outwit competition and make the prospects act.

Simple as A B C

"Modern Salesmanship" tells exactly how the National Salesmen's Training Association will teach you these principles in your spare time at home.

As soon as you are qualified and ready, the Association's Employment Service helps you to select and secure a selling position as city or traveling salesman.

Now Free to Every Man Who Will Act at Once

We are not making any extravagant claims about what we will do for you. We don't have to. All of the amazing proof and many important features about Salesmanship are contained in our new salary-raising book, "Modern Salesmanship." It is yours—FREE. Send the coupon for it today. It will show you how you can quickly become a Master Salesman—a big money maker. It will tell you about the National Salesmen's Training Association system of Salesmanship training—about the National Demonstration method that gives you actual experience while studying—and all about the amazing opportunities that await you in the selling field.

This may be the one big chance of your life to leave forever behind you the low pay of a routine job for a sudden, brilliant success at a big salary.

Is it worth 2c to find out? Then mail this coupon NOW.

National Salesmen's Training Association
Dept. 12-W, Chicago, Illinois

National Salesmen's Training Association
Dept. 12-W, Chicago, Ill., U. S. A.

Please send me, without any obligation on my part, your free book, "Modern Salesmanship," and full information about the N. S. T. A. system of Salesmanship Training and Employment Service. Also a list showing lines of business with openings for salesmen.

Name

Street

City..... State.....

Age..... Occupation.....



Hotels Need Trained Men

Will You Accept One of the 40,000 Opportunities in America's 4th Largest Industry?

Do you know that in just ONE of America's big hotels there are over two thousand contented, well-paid, well-fed and well-dressed employees? Do you know that the Hotel Business is now rated as AMERICA'S FOURTH LARGEST INDUSTRY? Do you know that in the big hotels of the United States there are 40,000 EXECUTIVE positions—pleasant, high-salaried and dignified? Do you know that without the advantage of a higher education men are making \$5,000 to \$50,000 a year in the hotel business?

You Can Qualify for a Good Paying Job

Statistics show that ONE IN EVERY TEN HOTELS WILL HAVE AN OPENING FOR MANAGER THIS YEAR. The men who will fill them will be the TRAINED men. Some of them have taken years to obtain this training by slowly, laboriously "working up." Others have used their spare time to gain the knowledge that gives them a short cut to success.



Clifford Lewis
President

I Guarantee to Teach You

the valuable knowledge that it has taken some of the most successful hotel men years to obtain—men who are now making \$5,000 to \$50,000 a year. All your training will be under the personal direction of CLIFFORD LEWIS—a hotel expert of national reputation. Endorsed by managers of such hotels as Waldorf-Astoria, Biltmore, Copley-Plaza, New Willard, St. Francis. A few spare-time hours a week given to the simple, clear lessons of the Course open the way to a good position, a fine living, and a handsome salary. The training will in no way interfere with your present activities.

SEND FOR FREE BOOK

Big pay, fine living, free meals and apartment, fascinating work—all these may be yours if you will fit yourself for the thousands of opportunities in America's Fourth Largest Industry. Life membership in our Employment Bureau FREE to all graduates. We placed 3789 Lewis-Trained men and women in contact with good Hotel, Club and Tea Room positions in the last 12 months. Write today for interesting FREE BOOK—"Your Big Opportunity." Don't wait a minute—you may lose the one big opportunity of a lifetime. Mail the coupon NOW. Your whole future may depend on it.

LEWIS HOTEL TRAINING SCHOOLS

The National Institute for Hotel, Restaurant and Tea Room Training
Founded 1916

Room 340

Washington, D. C.

CLIP HERE FOR FREE BOOK

LEWIS HOTEL TRAINING SCHOOLS
Room 340, Washington, D. C.

Send me without obligation the FREE BOOK "Your Big Opportunity."

Name.....
Please print name

Street.....

City..... State.....

Learn to Write

I Teach by Mail

I CAN make a good penman of you at your home during spare time, no matter where you live or how poorly you now write. My simplified system has shown thousands of others the way to good penmanship during the past twenty years—it can and will do the same for YOU!

Beautifully Illustrated Book "How to Become a Good Penman" FREE!

It contains general information, with testimonials and beautiful specimens of penmanship showing what others have accomplished by the Tambllyn System. (Your name elegantly written on a card if you enclose stamp for postage.) WRITE TODAY. Address

F. W. TAMBLYN
418 Ridge Bldg., Kansas City, Mo., U. S. A.

F. W. Tambllyn



"I
WANT
YOU"
-Uncle Sam

\$1400 to \$2600 Year

U. S. GOVERNMENT WANTS
Railway Mail Clerks—City Mail Carriers—
Postoffice Clerks

Men, boys over 17, uneducated

Common education sufficient. Send coupon immediately.

FRANKLIN INSTITUTE
Dept. K 179, Rochester, N. Y.

This coupon, filled out as directed, entitles the reader to (1) free sample examination questions; (2) a free copy of our book, "Government Positions and How to Get Them"; (3) free list of positions now open; and (4) to consideration for Free Coaching for the examination here checked.

COUPON

.. Railway Mail Clerk (\$1600 to \$2300) .. City Mail Carrier (\$1400 to \$1800)
.. Bookkeeper (\$1400 to \$1800) .. Rural Mail Carrier (\$1800 to \$2600)
.. Postoffice Clerk (\$1400 to \$1800) .. Custom Positions (\$1100 to \$2000)

Name.....

Address..... K179

Use it before you lose it. Write plainly.



What's Your Hand Worth to You?

\$5,000⁰⁰ a Year?

The trained draftsman earns \$5000.00 a year and higher—Why? Because his hands are trained. His brain conceives an idea—the plan of a great building or a new machine. With his two hands he puts this down on paper. Then the actual manual work necessary to carry out his idea is done by hundreds of other less skillful hands. The draftsman directs, the others follow his orders. His work is easy and fascinating.

The Draftsman's sides would be worth nothing if his hands were not trained to develop it—to put it down for others to carry out. That is why training **with the hands** is the greatest training of all. It teaches you to do big things—and let other hands do the actual labor. That is the secret of real success.

Coyne School men have been always taught to **do** things with their hands. We make them practical. We know if a man is taught to use his hands he will be sure to grow into a big job.

Nothing offers such opportunities as drafting. It is your hands that draw the plans for a fine office building, or a big bridge. Before any machinery can be made or a building put up **draftsmen must draw the plans.**

Draftsmen succeed to big important positions because their training makes them think. It's the fellow who knows how to think that gets the big jobs.

And remember, drafting is easy—pleasant work—that brings you big pay—\$225.00 to \$500.00 can be made. Now is the time to get into this wonderful profession. There is a tremendous demand for draftsmen. Read our special offer.

FREE Outfit Offer

Money-Back Guarantee

We guarantee that the training of the **Coyne** Course will place you in a good position as an expert draftsman or we will refund your money.

A workman is no better than his tools. Therefore, to insure good working instruments for our students, we furnish **FREE** a complete drafting outfit. It includes a complete set of fine "professional" drawing instruments with double set of compasses and dividers all in velvet lined case. Drawing board, squares, two triangles, protractor, unicolor ink, water, proof ink, pens, pencils, and all accessories.



B. W. Cooke

President

COYNE

HOME STUDY DEPT.

TRADE & ENGINEERING SCHOOLS

Recognized Producer of Successful Men

552-598 So. Throop St., Dept. 1779, Chicago, Ill.

Expert's Complete Drafting Outfit **FREE**



Easy to Learn at Home

Coyne is a great educational institution, 23 years old, an acknowledged leader. **Coyne** originated the "Learn by Doing" method now endorsed by educators everywhere.

Coyne has graduated thousands of successful, prosperous men all over the world. Heretofore the valuable **Coyne** training could be had only at our residence school. But now, you can enjoy the advantages of the special **Coyne** training under the personal direction of our experts right in your own home, at a fraction of the cost of the residence school. You can't make a mistake if you write for the **Coyne** free book. **Coyne** students any every minute of the course was enjoyable. Some students took good positions three months before their course was finished. Here is your opportunity. Read our offer.

Coyne training makes you advance. **Coyne** Student Joseph Jehany writes: "Your drafting school put me on the road to success. I am very thankful for the instructions received and I have recommended your school to my friends."

FREE Book

Send Now for Your Copy and FREE Outfit Offer

Mail this coupon for our interesting illustrated book, "Drafting the Foundation of Industry," sent you free. It explains all about the **Coyne** home study method and shows you how to become a draftsman in the quickest and easiest way. You want to know all about the great institution. Don't put it off. Send for this book now. Get the free drafting outfit offer. It's absolutely free, no obligation. The book contains the most valuable information you will ever get in your life. Send the coupon now.

Coyne Trade and Engineering Schools, Dept. 1779
552-598 S. Throop St., Chicago, Ill.

Dear Sirs: Please send me, absolutely free, without obligation, your book, "Drafting the Foundation of Industry," also full information about the Course in Drafting and your Special Free Outfit offer.

Fill in Coupon and

MAIL NOW!

Name

Address

City..... State.....

SKILLED MEN GROW SCARCE

Labor Barometer Urges Training of Workers as Jobs Open.

DETROIT AHEAD IN PROSPERITY

Leads Every City Except New York in Recovery of Retail Sales.

G. M. C. OUTPUT OF '21 DOUBLED

Corporation Produces 115,000 Vehicles in Four Months; 40,000 in April.

MAXWELL FORGE INCREASED 2,500

Departments Being Run on 24-Hour Schedule.

Chevrolet Turning Out 1,000 Cars Each Day; Motor Prosperity Retains

Durant Plans Production of 14,000 in Second Quarter



STUDEBAKER



CADILLAC



HUDSON

Thousands of Trained Men Needed

Wonderful opportunities await thousands of men. Millions of automobiles need expert attention. Every street and road is filled with them. Government statistics show nearly twelve million automobiles in the United States which must be kept in running order; twelve million batteries needing attention; fifty million tires

to repair—and only fifty thousand garages to do this work. No wonder they need help!

Why not be one of the trained men to handle these jobs and make the big pay? Come to Detroit—the automobile center of the world—and get your training at the Michigan State Automobile School—the school endorsed by the biggest auto factories in the world.



Learn the Automobile Business

—the world's greatest industry. Automobiles are a necessity and must be properly cared for. Trained men are needed everywhere. The M. S. A. S. gives you the necessary training in a thorough and practical manner. Located in Detroit, the Heart of the Auto Industry, it is surrounded by the biggest automobile factories in the world. Factory managers and executives give our students their fullest co-operation. They give practical and helpful lectures on every phase of the auto industry—an exclusive feature with the M. S. A. S., invaluable to our students.

Experienced Instructors

M. S. A. S. instructors are thoroughly trained men—every one a specialist in his line and enthusiastic about his work. They enjoy a close, personal contact and friendly co-operation with each student which helps to make your studies pleasant and your success assured.

Complete Equipment

Our mechanical equipment is unexcelled and represents an investment of nearly a quarter million dollars. Every department is thoroughly equipped for the complete instruction of our students. Automobile engineers enthusiastically approve the completeness of our instruction.

Make \$2,000 to \$10,000 Yearly— Have a Business of Your Own

Fit yourself to step into a good paying job anywhere or manage a business of your own. Thousands of our graduates are making big money in the automobile field. More than 18,000 M. S. A. S. trained men are making good because of the practical, down-to-earth training received here at the "Old Reliable Auto School." Men have come here from India, Australia and many European countries to learn the Automobile business. They come to the M. S. A. S. because of the thorough and practical training given here at the Factory Endorsed School in the heart of the auto industry.

Auto Electrics and Radio

Practical instruction on Auto Electrics enables students to handle every problem in ignition, starting, and lighting; teaches how to find and remedy all electrical trouble quickly. Actual experience given in overhauling, repairing and rebuilding every type of electrical and mechanical equipment. Complete instruction also given on Radio work—construction, installation and repair, without extra charge.

Battery Repairing

Students may also take a complete course covering every phase of battery repair and building. This course offers unusual earning possibilities.

Machine Shop

This special course gives students a complete training in all machine work. Actual Machine Shop experience combined with practical instruction includes the making of parts and all kinds of repair work.

Tire Repairing

A separate course covers every kind of cord and fabric tire construction and repair. Many graduates make big money in tire repair business.

Brazing and Welding

Course completely covers this modern method of repairing metals. Students are taught by doing actual work. Our graduates are able to handle all kinds of brazing and welding jobs.



Good Positions Await Our Graduates

Factories, owners and service stations continually call for M. S. A. S. trained men. These positions pay good salaries and offer excellent opportunities for advancement, or to build a business of your own. There are more opportunities for trained men in Detroit and elsewhere than we can fill. Let the M. S. A. S. do you for the wonderful future of the automobile business.

—A. G. Zeller, Pres.

What We Teach—Complete Automobile, Truck and Tractor Courses

Our course covers every branch of the automobile business. Nothing is omitted. Even closely related subjects are thoroughly covered. When you have finished our complete course you will be thoroughly familiar with construction, operation, upkeep and repair of automobiles, trucks, and tractors, farm lighting plants and stationary gas engines. Actual experience with these machines makes our teaching practical. Nothing left to guess-work. Our students also visit auto factories, meet executives and service men, and learn the real things about automobiles which can only be taught right where the machines are made, in the greatest auto center of the world. In fact, the auto factories helped to outline our Course. That's why M. S. A. S. graduates make good everywhere.



Michigan State

"The School With a Heart and Helping Hand"

AUTO DEMAND NEARS RECORD

All Plants Behind in Output despite Frantic Effort to Speed Production.

STUDEBAKER CO EXPANSION TO COST 15 MILLION

Immediate Expenditure of \$3,000,000 Voted for South Bend Improvements.

PACKARD HITS PEAK OF PEAKS

Output Three Times Oversold, States President Macauley; 7,000 Men at Work.

Packard Motor Car company, according to a statement released Saturday over the signature of President Alvan Macauley, is now at the highest production point of its long and... And still, it is...

5,400 MOTORS DAILY TO BE FORD OUTPUT

Oppes To Meet Demand for 94,750 Machines for June.

rd dealers "throughout the d States have asked for a total 4,750 cars, trucks and tractors... requirements, as a re-... schedule



CHALMERS



PACKARD



FORD

Learn in Detroit—the Auto Center

Here you can visit the big factories and see just how automobiles are made. You get the benefit of factory co-operation and lectures by factory men. Here, in the heart of the auto industry, where 75% of the World's automobiles are made, you can study each different make of machine. That's why M. S. A. S. graduates make



good. They know construction, repair and up-keep of every make of car. Training counts these days and Detroit, the Auto Center, is the logical place to learn the automobile business right.



What Our Graduates Say

"Before taking your course was working in Silk Mills at \$18.00 per week. Am now making \$100.00 a week. Cleared up \$2200.00 in six months repairing cars, selling accessories, etc. Time and money spent at M. S. A. S. was best investment I ever made." J. B. Stockel, Pa.

"It is four years last month since I finished the two courses at your school. Have not had a single job I could not master. Have saved \$100 every month since I got home. I give M. S. A. S. credit for my success." J. L. Mayes, Kansas.

"Have been rushed since leaving the M. S. A. S. last November. Can easily give the M. S. A. S. credit for raising my pay from a pencil pusher at \$12.50 a week to \$42.00, which I am now getting." F. W. Johnson, Ohio.

"Since I left your school have found it takes M. S. A. S. training to get ahead in the world. Have worked with men who had fifteen years experience as mechanics, but my M. S. A. S. training put me up with them, and sometimes ahead of them. If I had it to do over again would be to M. S. A. S. ten years earlier." J. R. Navarro, West Va.

"Before entering your school was earning \$12.00 per week. I knew absolutely nothing about automobiles—didn't know the difference between carburetor and wheel base. Since I left your school have worked up through several positions, last one paying \$200 per month. Then decided to go into business myself. Present earnings is \$400 per month." H. B. Bradley, Ohio.

Start Any Time

No need to delay. Instructions begin day you enter. Our welfare department helps to arrange for board and room. No time wasted. Every minute counts. Start on the road to Success NOW!

Come Now! Don't Wait or Doubt!

If you want more money and a bigger success, become a trained man, capable of earning a trained man's salary. Write today for our free catalog telling how. Thousands of satisfied students are your best guarantee, or write any auto factory or bank in Detroit.

Be fair to yourself. Give yourself a chance. Get the facts. Don't hesitate. Start now! Get into a business with a future. Make use of every ability you possess. M. S. A. S. training will help you.



DO THIS—NOW

Fill out and mail attached coupon. Or, if you prefer, get on the train and come to Detroit. If you don't find everything exactly as represented, we will gladly refund your car fare. Don't get it off. Make a start today. Fill out and mail the coupon NOW!



SEND THIS COUPON TODAY!

Michigan State Auto School
312 Auto Bldg., Detroit, Mich.

Gentlemen: Send me your FREE Catalog telling all about the opportunities in the Auto Business.

Name.....
Street or R. F. D.....
City..... State.....

Endorsed by Big Factories Read these Letters

HUDSON MOTOR CAR COMPANY
DETROIT, MICH., U. S. A.

This school is thought very highly of by the automobile men of Detroit. You will make no mistake by entering for a course.



Detroit, Mich., U.S.A.

Do not believe you would make any mistake in attending this school if you wish to become thoroughly experienced in the automobile business.

BUICK MOTOR COMPANY

We believe the Michigan State Auto School located at Detroit would best meet your requirements, as its course in technical training is most thorough and complete in every detail.

THE STUDEBAKER CORPORATION
OF AMERICA.

We do not know a better automobile school that we could recommend to you than the Michigan State.

MONEY-BACK GUARANTEE

We guarantee that a graduate of our Automobile and Tractor Course will be qualified to fill a position as assembler, demonstrator, tester, repair man, auto electrician, chauffeur, tractor operator, or farm lighting expert, or we will refund his tuition fee.

Automobile School

312 Auto Bldg.
3729 Woodward Ave. Detroit, Mich.



"Here's an Extra \$50!"

"I'm making *real* money now! Yes, I've been keeping it a secret until pay day came. I've been promoted with an increase of \$50 a month. And the first extra money is yours. Just a little reward for urging me to study at home. The boss says my spare time training has made me a valuable man to the firm and there's more money coming soon. We're starting up easy street, Grace, thanks to you and the I. C. S."

Today more than ever before, money is what counts. You can't get along on what you have been making. Somehow, you've simply got to increase your earnings.

Fortunately for you there is an unfailing way to do it. Train yourself for bigger work, learn to do some one thing well and employers will be glad to pay you real money for your special knowledge.

You can get the training that will prepare you for the position you want in the work you like best, whatever it may be. You can get it at home, in spare time, through the International Correspondence Schools.

It is the business of the I. C. S. to prepare men for better positions at better pay. They have been doing it for 30 years. They have helped two million other men and women. They are training over 150,000 now. And they are ready and anxious to help you.

Here is all we ask—without cost, without obligating yourself in any way, simply mark and mail this coupon.

TEAR OUT HERE

INTERNATIONAL CORRESPONDENCE SCHOOLS
Box 5691-C, Scranton, Penna.

Without cost or obligation, please tell me how I can qualify for the position or in the subject before which I have marked an X:

BUSINESS TRAINING DEPARTMENT

- | | |
|---|---|
| <input type="checkbox"/> Business Management | <input type="checkbox"/> Salesmanship |
| <input type="checkbox"/> Industrial Management | <input type="checkbox"/> Advertising |
| <input type="checkbox"/> Personnel Organization | <input type="checkbox"/> Better Letters |
| <input type="checkbox"/> Traffic Management | <input type="checkbox"/> Foreign Trade |
| <input type="checkbox"/> Business Law | <input type="checkbox"/> Stenography and Typing |
| <input type="checkbox"/> Banking and Banking Law | <input type="checkbox"/> Business English |
| <input type="checkbox"/> Accountancy (Including C.P.A.) | <input type="checkbox"/> Civil Service |
| <input type="checkbox"/> Nicholson Cost Accounting | <input type="checkbox"/> Railway Mail Clerk |
| <input type="checkbox"/> Bookkeeping | <input type="checkbox"/> Common School Subjects |
| <input type="checkbox"/> Private Secretary | <input type="checkbox"/> High School Subjects |
| <input type="checkbox"/> Business Spanish <input type="checkbox"/> French | <input type="checkbox"/> Illustrating <input type="checkbox"/> Cartooning |

TECHNICAL AND INDUSTRIAL DEPARTMENT

- | | |
|--|--|
| <input type="checkbox"/> Electrical Engineering | <input type="checkbox"/> Architect |
| <input type="checkbox"/> Electric Lighting | <input type="checkbox"/> Blue Print Reading |
| <input type="checkbox"/> Mechanical Engineer | <input type="checkbox"/> Contractor and Builder |
| <input type="checkbox"/> Mechanical Draftsman | <input type="checkbox"/> Architectural Draftsman |
| <input type="checkbox"/> Machine Shop Practice | <input type="checkbox"/> Concrete Builder |
| <input type="checkbox"/> Railroad Positions | <input type="checkbox"/> Structural Engineer |
| <input type="checkbox"/> Gas Engine Operating | <input type="checkbox"/> Plumbing and Heating |
| <input type="checkbox"/> Civil Engineer | <input type="checkbox"/> Chemistry <input type="checkbox"/> Pharmacy |
| <input type="checkbox"/> Surveying and Mapping | <input type="checkbox"/> Automobile Work |
| <input type="checkbox"/> Metallurgy | <input type="checkbox"/> Navigation |
| <input type="checkbox"/> Steam Engineering | <input type="checkbox"/> Agriculture and Poultry |
| <input type="checkbox"/> Radio <input type="checkbox"/> Airplane Engines | <input type="checkbox"/> Mathematics |

Name.....
Street..... 6-26-22
Address.....

City..... State.....

Occupation.....

Persons residing in Canada should send this coupon to the International Correspondence Schools Canadian, Limited, Montreal, Canada.

Please Mention Popular Mechanics

BE AN ARTIST

We can teach you **DRAWING** in your own home during your spare time.

Our 18 years of successful teaching prove our ability. 10 Courses in Commercial and Illustrative Drawing, Teachers Normal and Applied Art. Endorsed by high art authorities. Students trained by members of our Faculty are filling high-salaried positions. Artist's Outfit FREE to Enrolled Students. Write today for Art Year Book. **18 FREE TO YOU!**

OUR HANDSOME ART YEAR BOOK

SCHOOL OF APPLIED ART
ADDUEN ART BLDG. No. 2 BATTLE CREEK MICH.

How to speak and write Masterly English

Every time you speak or write you show just what you are. Mistakes in English reveal you as a person who lacks education and refinement. Lack of language power prevents you from presenting your thoughts in the strongest possible way. No matter what you do, real command of English will help you to your goal. Stop making mistakes in spelling, punctuation, pronunciation. Increase your vocabulary.

WONDERFUL INVENTION

Only 15 minutes a day with Sherwin Cody's New Invention—and you can actually SEE your English improve. It teaches by HABIT—makes it easier to do the RIGHT way. Wonderful self-correcting lessons include Expression, Spelling, Punctuation, Grammar, Reading and Conversation.

BOOK FREE Lack of language power may easily be costing you thousands of dollars every year. See what Mr. Cody can do for you. It costs nothing to find out. Mail postal card or letter this very minute for free book "How to Speak and Write Masterly English." It will prove a revelation to you. **WRITE NOW.** Address

Sherwin Cody School of English, 512 Searle Building, Rochester, N. Y.

Keystone Institute

"The Service School"

A fully equipped school with expert instructors, organized to give intensive instruction in

2-Year Courses
Electrical Engineering
Mechanical Engineering
Accounting and Business Administration
16 weeks' course in Automotive Engineering

Day and Night Classes. Graduates are sought by large and small industrial establishments and are filling important positions in all sections of the country. Write for information on subject that interests you to Keystone Institute. Address The Vice President, 133 North 4th Street, Reading, Penna.

HIGHER EDUCATION

HOME STUDY

Courses in English, Spanish, Mathematics, Chemistry, Drawing, Education, Business and in 35 other subjects are given by correspondence. Begin anytime.

The University of Chicago

31st Year

Division 4, Chicago, Ill.

Learn Watchwork, Jewelrywork and Engraving.

A fine trade commanding a good salary, and your services are always in demand. Address HOROLOGICAL, Dept. P. Bradley Institute, Peoria, Ill., for our latest catalog.



SAVE MONEY MAKE MONEY

Anyone can do their own ELECTRICAL WORK and work for others in their spare time. ELECTRICAL KINKS tells how to do wiring and repairing of bells, lighting, garages, vacuum cleaners, washing machines, table lamps, etc. The most complete book on everything electrical in the home. Electrify your home, and make a dollar an hour working for others. ONLY \$1.50, cash or pay postman. Satisfaction guaranteed. Special Offer. Ask how you can get this book FREE. Home Book Co., 388AB Arcade Bldg., Cleveland, Ohio

**Worth thousands of dollars
to you--yours
NOW for \$29⁸⁰
only**

**Special Introductory
Bargain Price**

**8 Fine Volumes Shipped You
for 7 Days Inspection
before you consider buying our
BUSINESS MANAGEMENT LIBRARY**

Big business men realize that other men have ideas which they can use to advantage. If you want to make a real success in life you, too, will have to mold your ideas along safe, constructive lines. The world's foremost authorities on modern business have contributed to our new **Business Management Library**. It is right down to date—right off the presses. Old, obsolete ideas that were all right before the great war changed the world of commerce, have been discarded—the new ideas of a more modern era have superseded them.

The last word in modern business

That is what one of America's greatest merchants pronounced this library after giving it a thorough examination. You will marvel at the accuracy with which the conclusions in this work are drawn—how the various phases of modern business are analyzed and charted. The whole aim of this library is **Managerial Control**—the bringing together of the four big elements which make for business success. This idea is so fully detailed, so graphically outlined that every business man will instantly recognize its value in his enterprise.

Don't Send Us a Cent, Mail the Coupon

We want you to see this wonderful 8 Volume Library—we want you to examine it. Show it to the men who are engaged in the Accounting, Production, Financial and Sales work of any big company—let them tell you what they think of it. Use the library 7 whole days as though it were your own—then if you want to keep it send us the first small payment of \$2.80 and a monthly payment of \$3.00 until the books are paid for. If you feel you can afford to do without the library, send it back to us at our expense. Don't wait—send the coupon today and this magnificent business work—8 beautiful volumes, bound in flexible American Morocco will go forward to you at once. Once you see it and examine it—you'll never want to part with the Business Management Library.

American Technical Society
Dept. B-199,
Drexel Ave. and 58th Street, CHICAGO



Some of the many subjects this Great Library covers:

The business cycle	Job analysis for hiring
Forecasting depression	Personnel work
Law and industry	Rating systems
Choosing plant location	Building industrial loyalty
Installing standards	Reducing turnover
Planning production	Time and motion study
Relation of cost to prices	Training foremen
Production charts	Picking leaders
Measuring the market	Americanization
Factory transportation	Managerial control
Office layout	Vacations
Standard office forms	Cutting the sick list
Reducing office waste	Increasing unit output
Interviewing applicants	Time and piece work

See the work, then buy if it suits you!

INSPECTION COUPON

American Technical Society

Dept. B-199, Drexel Ave. and 58th St., Chicago.

You may send for my 7-day free inspection the BUSINESS MANAGEMENT LIBRARY. After a careful examination, if I decide to keep this 8-volume work, I will send you \$2.80 and \$3.00 a month until \$29.80 in all is paid. But if I do not wish to keep it, the understanding is that I may return it at your expense which will end the matter.



Name.....

Position.....

Firm.....

St. and No.....

City.....

State.....

LEARN CARTOONING the Right Way



1.

Have your ability trained by the school that has developed many famous cartoonists.

If you like to draw—if you find pleasure in picking up a pencil and paper and trying to make sketches or cartoons, don't regard it merely as a hobby. Have your ability developed and earn a good income as a cartoonist.



2.

Hundreds of nationally known cartoonists, such as Branner of the Chicago Tribune; Blosser, who draws "Freckles and His Friends"; Gene Byrnes, creator of "Reg'lar Fellers"; Thiele of the Sioux City Tribune; Fung, of the Seattle Times and others equally well known, took the Landon Course at home, in their spare time, and fitted themselves for their present positions at salaries ranging from \$50 to \$200 and more per week.

Have YOUR talent developed by the same method

What the above mentioned boys did you can do, with the same training. The Landon method of teaching makes cartooning easy to learn. By means of an extensive series of Big picture charts all the necessary details of ORIGINAL drawing are explained step by step, in a clear and simple manner.



3.



4.



5.

FACTS that determine the superiority of the Landon School:

1. Landon School Students are securing the best cartooning positions which open up everywhere.
2. The picture chart method of instruction was originated and is used exclusively by the Landon School.
3. From the very beginning, the Landon Course teaches ORIGINAL drawing. No copy work.
4. Individual attention and criticism of student's work. Personal coaching whenever necessary.
5. Specialized instruction on how to originate cartoon ideas. This is an exclusive feature of the Landon Course.
6. Practical assistance in securing positions for students and help in marketing their work.
7. The price is within reach of everyone who is ambitious to succeed. Easy payments can be arranged.

Write today for full information about the Landon Course, and sample chart by means of which you can test your own ability. Find out what the possibilities are for YOU in this interesting profession. Please state your age.

The Landon School

838 National Bldg.

Cleveland, Ohio

Play Piano New Way in 1 Hour FREE

MUSIC WITHOUT NOTES. Simple as a-b-c—300,000 children and grown-ups have learned. No knowledge of note music and no teacher required; no lessons by mail. Sent FREE on Trial, 100 famous vocal and instrumental selections printed in wonderful new EASY FORM Music in one book.

SEND NO MONEY If you don't learn in 5 days to play SEVERAL pieces send it back. Or, if you keep it, pay only 6½¢ for each selection. Act while SPECIAL HALF-PRICE OFFER LASTS! No extra charges. Be sure to state how many white keys on your piano or organ.

Easy Method Music Co., 1239 Clarkson Bldg., Chicago, Ill.



How to Box 40c

By Terry McGovern, James J. Corbett, J. Gardner Smith, M. D., Arthur P. Keeley and Gus E. Keeley.

How to Box to Win, How to Build Muscle, How to Punch the Bag and How to Stand, Walk or Run.

This interesting book written by experts is known also as "The Book of Health and Strength." It will greatly assist everyone in keeping fit, in putting them in condition to master a strenuous undertaking either physical or mental.

411 illustrations. Size 4½x7¼ in. Paper copy .125 pages
SHREWSBURY PUBLISHING CO.
8525 West Lake Street, Chicago, Ill.

LEARN WATCH REPAIRING

Be a watchmaker—you can learn this profitable trade by correspondence in a few weeks in your own home by the DeSelms Chart System. After you complete the course you will know a watch from A to Z. You will know just what the matter is and how to repair one. When you graduate you will be a practical watchmaker and repairer and competent to fill any position. Positions for our graduates.

Ask for our Free Book. It explains our system and terms.

THE DeSELMS WATCH SCHOOL
23 Perry Street ATTICA, INDIANA



12 Months to Pay

You can easily earn or save money for the small payments. Parents often advance first payment to help buy a RANGER bicycle. Choice of 44 styles, colors and sizes. FACTORY-TO-RIDER prices. DELIVERED FREE express prepaid on approval for 30 DAYS' TRIAL, actual free riding test.

Tires—best quality, at factory prices, express prepaid. Lamps, wheels, and equipment, low prices. Send No Money.

Mead Cycle Company
Dept. H18 Chicago

Write today for free Ranger Catalog, factory prices and marvelous easy payment terms.



Wonderful, new device; guides your hand; corrects your writing in few days. Big improvement in three hours. No failures. Complete outline FREE. Write C. J. Osment, D-34, St. Louis, Mo.

STAMMER

If you stammer attend no stammering school till you get my large FREE book entitled "STAMMERING, Its Origin and the Advanced Natural Method of Cure," bound in cloth and stamped in pure gold. Ask for special tuition rate and a FREE copy of "The Natural Speech Magazine." Largest, best equipped and most successful school in the world for the cure of stammering, stuttering, etc. No sing-song or time beat. Write today. The North-Western School, 2317 Grand Ave., Milwaukee, Wis.

FLEXIBLE
BINDINGPOCKET
SIZE

ENTIRE SET ONLY \$12

\$1
PER
MONTH

\$10,000. Master Set AUDEL'S ENGINEERS and MECHANICS GUIDES

THE BOOKS YOU HAVE
BEEN WAITING FOR

4750 Pages—8754 Illustrations

Just completed—Audel's New Master Set for Engineers and Mechanics!

Every Engineer, Mechanic and Electrical worker will welcome this set as a sure source of advancement and higher pay because of the complete up-to-date information that is thoroughly and easily explained on every branch of Engineering and Electrical practice.

Why a \$10,000 Library? Because it would cost the reader more than \$10,000 together with years of labor and experience to collect, plan, arrange and prepare for his own study and ready reference, the vast fund of knowledge printed in this Master Set.

The entire set costs you only twelve dollars—knowledge and instruction that has cost thousands of dollars and years of time—yours for \$12.00—\$1.00 a month.

Study This Brief Table of Contents

Theory, Practice and Operation of ALL Steam Engines, Valve Motion—VALVE SETTING; complete information on ALL engines and pumps—CORLESS ENGINES and the Theory, Construction and Operation of all Steam Engines, including UNIFLOW and POPPET VALVE ENGINES, and LOCOMOBILES—Locomotive-Marine Engines; Turbines; Rotary Engines—The Indicator—Lubrication—PRACTICAL MANAGEMENT. How to use Indicator—GAS, GAROLINE OIL, SEMI- and FULL DIESEL ENGINES—Aeroplanes and Aviation—HOW TO SELECT AN ENGINE, working instructions, drawings on STEAM ENGINE DESIGN, including rules and formulas, Theory and Construction of ALL Steam Boilers; Heat-Combustion; Fuel and Flue Gas Analysis—CO₂ recorder—Characteristics of Boilers—Materials

—Construction of all types of Boilers, (THE LATEST PRACTICE)—Boiler Construction—Mechanical Stokers—Oil Burners—Setting—Chimney—Mechanical Draft—HOW TO SELECT A BOILER—Complete instructions and drawings on BOILER DESIGN based on A. S. M. E. BOILER CODE—OPERATION, including installation, FIRING; care and repair of Steam Boilers—Pipes, Fittings and Flue Fastenings—Heating and Ventilation—Refrigeration—Cooling Towers—Condensers—Distilling Apparatus—Elevators—Cranes and Hoisting Machinery—Ropes and Cables—Splicing—electric wiring in ALL branches; compendium of practical electrical engineering, as an aid for engineers and electricians in obtaining a license—37 chapters—ready reference index, covering entire field of Modern Electricity.

*Helping Hand
Books that answer
Your Questions*

FREE
EXAM-
INATION



Send No Money—Send Only This Coupon

THEO. AUDEL & CO.,
72 Fifth Ave., New York City

Please submit me for free examination, AUDEL'S \$10,000 MASTER SET FOR ENGINEERS AND MECHANICS. Ship at once prepaid, the 8 numbers, total cost \$12.00. If satisfactory, I agree to send you \$1 within seven days and to further mail you \$1 each month until paid.

Name.....

Occupation.....

Employed by.....

Home Address.....

Reference.....

PM DEC. 22



Straight advice from a self-made Executive!

Mr. R. H. McElroy, an executive of the Standard Oil Company of Indiana, who climbed to a \$30,000 a year job from clerical work, says in the *New York Times* of July 2, 1922:

"Any young man who has the right stuff in him, who is willing to work at his job and study after working hours, who will keep his eyes open . . . can achieve the same success that I and my associates have."

In a letter to the United Y.M.C.A. Schools, Mr. McElroy adds:

"I believe the correspondence and evening schools provide a splendid opportunity for the young man of limited time and means to prepare himself for a brilliant future."

Are you willing to study after working hours? If so, we offer you just the aid you need to climb in responsibility and earnings. After a quarter-century of experience in giving young men practical training in their evening hours, the United Y.M.C.A. Schools now offer this tested service by mail on a unique plan that "gives the most service for the least money." More than 30,000 now enrolled for instruction by mail.

Send the coupon for a copy of our new catalog and our free counsel on how you can realize your ambition.

SOME OF OUR 300 CORRESPONDENCE COURSES

Business Courses		
Accountancy	Business Administration	Public Speaking
Advertising	Business English	Salesmanship
Banking	Business Finance	Secretarial
Better Letters	Business Law	Show Card Writing
Bookkeeping	Complete Letter-Writing	Stenography
Business Arithmetic	Office Management	Traffic Management
Technical and Other Courses		
Agricultural Courses	Foreign Languages	Plan Reading
Applied Psychology	Foremanship	Plumbing
Architecture	Highway Engineering	Poultry Husbandry
Automobile Courses	ing	Radio Engineering
Building Construction	High School Courses	Radio Telegraphy
tion	Illustrating	Steam Engineering
Civil Engineering	Insurance Courses	Courses
Courses	Mathematical	Structural Drafting
Drafting Courses	Courses	Surveying
Electrical Courses	Mechanical Engineering	Use of the Slide Rule
English Courses	Ow-Your-Home	Vocational Guidance
Factory Management	Course	

Are you an ex-service man?



Correspondence Instruction

375 Lexington Avenue
Dept. 74-D New York City

Without obligating me, please advise regarding the course in

Name.....

Full Address.....

(Please write plainly.)

Please Mention Popular Mechanics

\$1,500 to \$6,000 a Year

Dental Laboratory Work

Be a mechanical dentist—a high class, agreeable occupation for men or women. Course is inexpensive. Takes only short time to complete. Experience or entrance requirements unnecessary. No license required. McCarrie graduates make big successes and are in great demand everywhere. Largest and best equipped school laboratory and clinic in America; individual practical instruction; modern, up-to-date methods. Write for trial brochure offer. Find out how easy it is to fit yourself for this highly paid and dignified profession. Learn the McCarrie way. It pays.

Write for Book No. 29

Mc CARRIE
SCHOOL OF MECHANICAL DENTISTRY
34 and 36 W. LAKE STREET, CHICAGO, ILL.

SPANISH LEARNED EASILY AND QUICKLY!

Also FRENCH and ITALIAN

Another language will enable you to make more money—whether you are an employer or employee, professional man or woman, boy or girl.

A Few Spare Minutes Can Increase Your Income

Learning a new language by the Rosenthal Language Phone Method, is as easy as learning a new tune. Study when you are in the mood—in the comfort of your own home—on your own phonograph. Soon, you can talk, read and write Spanish, French or Italian.

ROSENTHAL LANGUAGE PHONE METHOD

makes rapid progress possible

Any number of people can learn at the same time—the whole family or groups of friends.

FREE 64-Page Book. It shows how easy, interesting, and profitable it is to learn a foreign language; and explains Dr. Rosenthal's world-famous method of quick study. Also details of FREE Trial offer. Send a postal—*to-day*.

FUNK & WAGNALLS COMPANY
549 Hess Building, 354 Fourth Ave., N. Y.

Play Cornet?

Trombone, Baritone, etc.? You can't afford to be without "Lip Science," Marvelous secret manual for brass players. Easy playing in the entire register. Highest notes without effort. Results guaranteed. Send postal—get free information. Act now!

W. E. HITCHCOCK, Publisher
Dept. "M" 5337 Prairie Ave., Chicago

BE AN ARTIST

Comics, Cartoons, Commercial, Newspaper and Magazine Illustrations, Paste/Crayon Portraits and Fashions. Our simple method quickly develops your talent in spare time. By Mail or Local Classes. Write for terms and list of successful students.

ASSOCIATED ART STUDIOS 87-B Flatiron Building, NEW YORK

LEARN TO GET DOLLARS OUT OF WATCHES.

WATCH-REPAIRING, ENGRAVING, JEWELRY REPAIRING.

WRITE NOW.

LEARN ENICAR TRADE SCHOOL
530 W MONUMENT SQUARE, RACINE, WIS.

13 WEEKS FOR 15 CENTS

The Pathfinder

INDEPENDENT NATIONAL HOME WEEKLY

You've heard your neighbor praise the Pathfinder, the wonderful illustrated news and story paper published at Washington for people everywhere. This paper is the **Ford** of the publishing world; has had a million subscribers. Check full of the kind of reading you want. Unequaled digest of the world's news. Question Box answers your questions. Stunts for children; real fun for all. Exciting serial story starts soon. Send 15 cents (coin or stamps) today for this big \$1 paper 13 weeks. You will be more than pleased.

PATHFINDER, 661 Langdon Sta., WASHINGTON, D. C.

If You Don't Exercise— YOU DIE!

It's the plain truth, fellows, and you might as well face it. The human body demands exercise to keep it alive just as surely as it does food. If you doubt it, tie your arm to your side for one month and watch it waste away.

There's a RIGHT way and a WRONG way

Some say, "That's all right, but you can exercise too much." Right again. You can also kill yourself by over-eating, but you eat just the same. We have been taught to eat moderately three times a day and we get the best results. But what do you know about exercise? What exercise will do **you** the most good? And how much and how often should you take it? There is only one way to find out.

SEEK THE MAN WHO KNOWS—

When you are sick you go to a doctor for advice because he has devoted his life to the study of medicine and its effect on the human system.

I have made "muscular development" my life study. I have proven my system on both myself and my thousands of pupils who are now among America's leading strong men and directing big business enterprises.

A PROVEN SUCCESS

Why do leading physicians and physical directors recommend my system so highly? There is but one answer. **It never fails.**

I don't promise strength. I guarantee it. Inside of 30 days I will add one full inch to your arms and two inches to your chest. Meanwhile I work on every muscle of your body—both inside and out. But that's only a starter. I want 90 days in all to make a real **he** man out of you. I give you a physique that will make your friends admire you and respect you. I put a flash to your eyes and a spring to your step that only come with abounding health and strength. I put real pep in your old back-bone and give you a clear thinking brain to handle any problem set before you. This is no idle prattle. Come on and make me prove it. Make me eat my words. I like it because I know I can do it. If you want to let your body rot away, keep on the way you're now doing, but if you want to be a **live** one,

Send for My Book
"MUSCULAR DEVELOPMENT"
It Is FREE

It contains dozens and dozens of full page photographs of both myself and my numerous pupils. This book is bound to interest you and thrill you. It will be an impetus—an inspiration to every red blooded man. I want every man and boy who wants to be strong to send the attached coupon and the book is his—**absolutely free**. All I ask you to cover is the price of wrapping and postage—10 cents. Remember this does not obligate you in any way. Don't delay one minute—This may be the turning point in your life to-day. So tear off the coupon and mail it at once while it is on your mind.

EARLE E. LIEDERMAN
Dept. 2012, 305 Broadway New York City

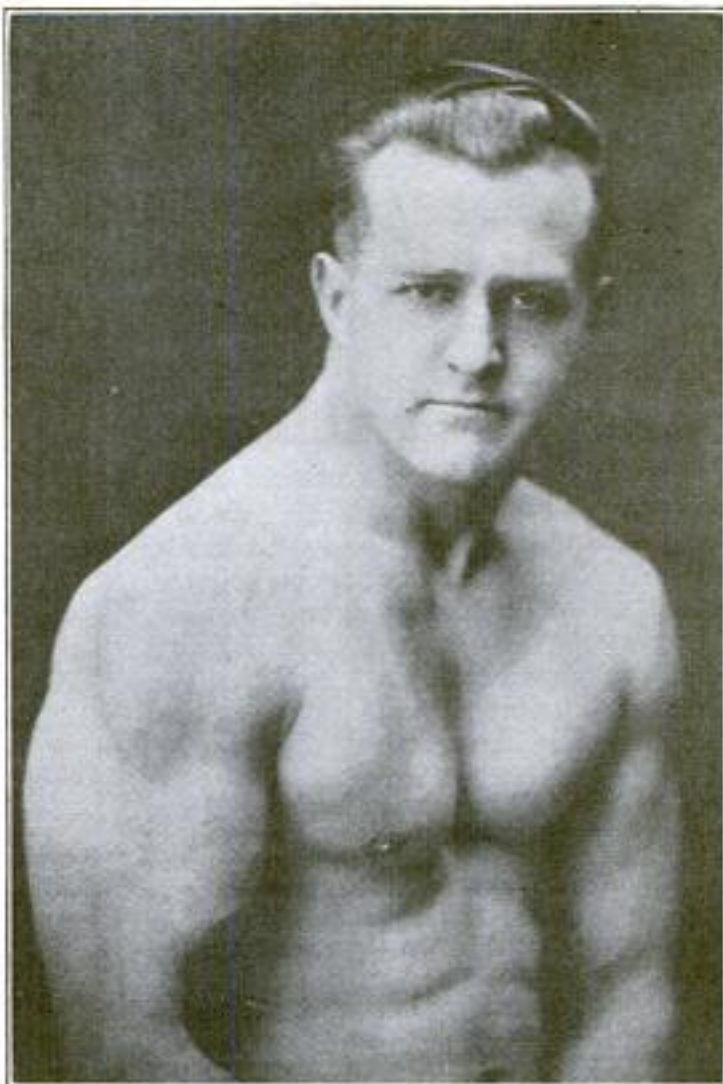

EARLE E. LIEDERMAN as he is today

EARLE E. LIEDERMAN

Dept. 2012, 305 Broadway, New York City

Dear Sir: I enclose herewith 10c, for which you are to send me, without any obligation on my part whatever, a copy of your latest book, "Muscular Development." (Please write or print plainly.)

Name.....

Address.....

City.....State.....



Don't tell me you never had a chance!

"Four years ago you and I worked at the same bench. I realized that to get ahead I needed special training, and decided to let the International Correspondence Schools help me. I wanted you to do the same, but you said, 'Aw, forget it!' You had the same chance I had, but you turned it down. No, Jim, you can't expect more money until you've trained yourself to handle bigger work."

There are lots of "Jims" in the world—in stores, factories, offices, everywhere. Are you one of them? Wake up! Every time you see an I. C. S. coupon your chance is staring you in the face. Don't turn it down.

Right now over one hundred thousand men are preparing themselves for bigger jobs and better pay through I. C. S. courses.

You can join them and get in line for promotion. Mark and mail this coupon, and find out how.

TEAR OUT HERE
INTERNATIONAL CORRESPONDENCE SCHOOLS
Box 5690-C, Scranton, Penna.

Without cost or obligation, please tell me how I can qualify for the position or in the subject *where* which I have marked an X:

BUSINESS TRAINING DEPARTMENT

- | | |
|---|---|
| <input type="checkbox"/> Business Management | <input type="checkbox"/> Salesmanship |
| <input type="checkbox"/> Industrial Management | <input type="checkbox"/> Advertising |
| <input type="checkbox"/> Personnel Organization | <input type="checkbox"/> Letter Letters |
| <input type="checkbox"/> Traffic Management | <input type="checkbox"/> Foreign Trade |
| <input type="checkbox"/> Business Law | <input type="checkbox"/> Stenography and Typing |
| <input type="checkbox"/> Banking and Banking Law | <input type="checkbox"/> Business English |
| <input type="checkbox"/> Accountancy (including C.P.A.) | <input type="checkbox"/> Civil Service |
| <input type="checkbox"/> Nicholson Cost Accounting | <input type="checkbox"/> Railway Mail Clerk |
| <input type="checkbox"/> Bookkeeping | <input type="checkbox"/> Common School Subjects |
| <input type="checkbox"/> Private Secretary | <input type="checkbox"/> High School Subjects |
| <input type="checkbox"/> Business Spanish <input type="checkbox"/> French | <input type="checkbox"/> Illustrating <input type="checkbox"/> Cartooning |

TECHNICAL AND INDUSTRIAL DEPARTMENT

- | | |
|--|--|
| <input type="checkbox"/> Electrical Engineering | <input type="checkbox"/> Architect |
| <input type="checkbox"/> Electric Lighting | <input type="checkbox"/> Blue Print Reading |
| <input type="checkbox"/> Mechanical Engineer | <input type="checkbox"/> Contractor and Builder |
| <input type="checkbox"/> Mechanical Draftsman | <input type="checkbox"/> Architectural Draftsman |
| <input type="checkbox"/> Machine Shop Practice | <input type="checkbox"/> Concrete Builder |
| <input type="checkbox"/> Railroad Positions | <input type="checkbox"/> Structural Engineer |
| <input type="checkbox"/> Gas Engine Operating | <input type="checkbox"/> Plumbing and Heating |
| <input type="checkbox"/> Civil Engineer | <input type="checkbox"/> Chemistry <input type="checkbox"/> Pharmacy |
| <input type="checkbox"/> Surveying and Mapping | <input type="checkbox"/> Automobile Work |
| <input type="checkbox"/> Metallurgy | <input type="checkbox"/> Navigation |
| <input type="checkbox"/> Steam Engineering | <input type="checkbox"/> Agriculture and Poultry |
| <input type="checkbox"/> Radio <input type="checkbox"/> Airplane Engines | <input type="checkbox"/> Mathematics |

Name.....
Street.....
Address.....

City..... State.....

Occupation.....

Persons residing in Canada should send this coupon to the International Correspondence Schools Canadian, Limited, Montreal, Canada.

Please Mention Popular Mechanics

Earn \$35-\$125 a Wk



Your Opportunity in MECHANICAL DENTISTRY

Ambitious men of all ages can rise above small salaried positions into this profession of unlimited possibilities.

Taught by actual practice—day or evening. Three months' course. Modern laboratories. No previous knowledge or experience required. No charge for tools or equipment. The men we train are in demand. Established 30 years. Catalog free.

Address your inquiry to Dept. 2

BODEE DENTAL INSTITUTE

NEW YORK, 136 W. 52d St.—PHILA., 15th & Walnut Sts.
BUFFALO, 1226 Main St.—BROOKLYN, 15 Flatbush Ave.

Music Lessons

UNDER MASTER TEACHERS

At Home

A Complete Conservatory Course By Mail

Wonderful home study music lessons under great American and European teachers. Endorsed by Paderewski. Master teachers guide and coach you. Lessons a marvel of simplicity and completeness.

Any Instrument Write telling us course you are interested in—Piano, Harmony, Voice, Public School Music, Violin, Cornet, Mandolin, Guitar, Banjo or Reed Organ—and we will send our FREE CATALOG with details of course you want. Send NOW.

University Extension Conservatory, 705 Siegel-Myers Bldg., Chicago, Ill.

HOW TO PAINT SIGNS AND SHO' CARDS

Our book gives a complete course of instructions, enabling any one to learn to paint good signs. WHY NOT MAKE YOUR OWN either for your business or for others?

CONTENTS: Alphabets, Composition, Color Combinations. How to Mix Paints, Show Cards, Window Signs, Banners, Board and Wall Signs, Ready Made Letters, Gilding, Commercial Art and Tricks of the Trade—Contains 100 alphabets and designs. Cloth bound, size 7 x 5 inches, price \$1.10 postpaid.

J. S. Ogilvie Pub. Co., 577 Rose St., New York



I TEACH BY MAIL. You can become an expert penman right in your own home by my method. Small Cost. All that is required is some of your Spare Time. Write for my book, "HOW TO BECOME AN EXPERT PENMAN." It contains specimens and tells how others became expert writers by the TEVIS METHOD. Your name written on a card if you enclose stamp. FREE BOOK. Write today. T. M. TEVIS, BOX 25K, CHILLICOTHE, MO.

STAMMERERS

For 25 years we have successfully corrected stammering by our simple and natural course of individual lessons. Attend no school until you have read our free booklet, "How to Stop Stammering."
SAMUEL A. ROBBINS, Director,
Boston Stammerers' Institute
246 Huntington Ave. Boston 17, Mass.



For trial, a sample of our style Rubens, if you send 2 cents in U. S. stamps for postage and state size wanted
Reversible Collar Co., Dept. U, Boston, Mass.

<input type="checkbox"/> Building Contractor \$5000—\$10,000	<input type="checkbox"/> Draftsman and Designer \$2500—\$4000	<input type="checkbox"/> Electrical Engineer \$4000—\$10,000	<input type="checkbox"/> General Education In One Year	<input type="checkbox"/> Employment Manager \$4000—\$10,000	<input type="checkbox"/> Mechanical Engineer \$4000—\$10,000	<input type="checkbox"/> Shop Superintendent \$3000—\$7000
---	--	---	---	--	---	---

Architect
\$5000—\$15,000

Automobile
Engineer
\$4000—\$10,000

Automobile
Repairman
\$2500—\$4000

Civil Engineer
\$5000—\$15,000

Structural
Engineer
\$4000—\$10,000

Business
Manager
\$5000—\$15,000

Certified Public
Accountant
\$7000—\$15,000

Radio and
Wireless Expert
\$2500—\$10,000

Accountant and
Auditor
\$2500—\$7000

Which One?

*Not one of these jobs is beyond your reach
Which one do you want?*

The kind of a fellow who gets ahead today—and holds one of these high positions is the fellow with *training*. Nowadays employers can find men with training very easily—because colleges are graduating them pretty fast—so the fellow who had to leave school early is handicapped unless he gets training during his idle hours.

Today you can get it in your home town, every man can, regardless of how much time he spent in school. And you can make every hour of your practical experience pay big dividends as well. American School training was made for YOU and has brought success to thousands.

Big Raise in Salary

It is easy to get, if you go about it in the right way. You have often heard of others who doubled and trebled their salaries in a year's time. You wondered how they did it. Was it a pull? Don't you think it. When a man is hired he gets paid for exactly what he does, there is no sentiment in business. It's preparing for the future and knowing what to do at the right time that doubles and trebles salaries.

Why Don't You Try It?

Why don't you see what an American School course will do for you? Our experience in helping thousands of others will surely help you get to the top. If you really want to get ahead, get busy and—

Mail This Coupon Today

Send us your name and address on the coupon. Just write underneath, in the coupon what job you want to hold. We'll tell you how you can get just the training you need right in your own home.

You'll be under no obligation—and the information you will get will do you a great deal of good. Let us help you. We are at your service—and all you need to do is to send this coupon with your name and address. Do it now—for your own sake and the man you want to be.

American School Dept. G 974 Chicago, U. S. A.

Dept. G 974

I want this job—tell me how to get it.

Job.....

Name.....

Address.....

Lawyer
\$5000—\$15,000

Steam
Engineer
\$2000—\$4000

Foreman's
Course
\$2000—\$4000

Photoplay
Writer
\$2000—\$10,000

Sanitary
Engineer
\$2000—\$5000

Telephone
Engineer
\$2500—\$5000

Telegraph
Engineer
\$2500—\$5000

High School
Graduate
In Two Years

Vocational
Guidance If You
Are Undecided

PLAY MUSIC ON A SAW

FREE

A special tempered Musical Saw, Saw Bow, Soft Hammer are furnished free with Course of Instruction. This Course is short, simple and easy. Only three lessons, one each week—no monotonous finger exercises or months of tedious practice.

C. J. MUSSEHL
315 Mack Bldg. Fort Atkinson, Wis.

YOU can produce wonderful, soft, sweet music from a common carpenter's saw with a violin bow or soft hammer, if you know how. No musical ability required—you need not know one note from another.

Easy to Learn I absolutely guarantee to teach you to play popular and classical music within 3 weeks' time. I will give you my secrets and tricks that I have learned in my ten years' success as a saw musician, secrets which I guarded carefully until I introduced "The Musical Saw." I have successfully instructed thousands and have organized hundreds of "Sawing Trios & Quartettes" for Lodges, Clubs and Legion Posts. No charge whatsoever if I fail. **MAKE BIG MONEY** and amaze your friends playing for dances, Club, Lodge and Church Entertainments. Write today for complete information "How to Play a Saw"—sent free.



\$15.00 TENOR BANJO FREE

YOU CAN PLAY THE TENOR BANJO Just Like the Experts
Because **PROF. BARKER** will help you

Our method of teaching is so simple, plain and easy that you begin on a piece with your first lesson. In half an hour you can play it! We have reduced the necessary motions you learn to only five—and you acquire these in a few minutes. Then it is only a matter of practice to acquire the wend, fascinating tremolos, staccatos, slurs and other effects that make this instrument so delightful. The TENOR BANJO plays any kind of music—melody or accompaniment.

FREE Our complete course of 52 lessons includes **FREE** a beautiful TENOR BANJO, all necessary playing equipment and 52 pieces of Music.

Special arrangement for lessons if you have your own TENOR BANJO.

This Makes A Splendid Christmas Gift

Your favorite instrument given away **FREE** with first lesson. Special courses under Famous Teachers. Learn to play Violin, Hawaiian Guitar, or Ukulele.



First Hawaiian Conservatory of Music, Inc.
223 Broadway (Woolworth Bldg.) New York
Please send me full information about your 52 easy lessons and **FREE TENOR BANJO OFFER**.

Name _____

Address _____

Town _____ State _____ P. M. 19__

ELECTRICAL men with training are in demand. For more than a quarter of a century this school has been training men of ambition and limited time, for the electrical industries. Condensed course in **ELECTRICAL ENGINEERING** enables graduates to secure good positions and promotions. Theoretical and practical Electricity, Mathematics, Steam and Gas Engines, Mechanical Drawing. Students construct dynamos, install wiring and test electrical machinery. Course with diploma, complete. **IN ONE YEAR**



Thoroughly equipped fireproof dormitories, dining hall, laboratories, shops. Over 3000 men trained. Write for catalog. 30th year opened Sept. 27, 1922.

BLISS ELECTRICAL SCHOOL
404 TAKOMA AVENUE, WASHINGTON, D. C.

5,000 FORMULAS

The 530 double-column pages in Youman's Household Guide contain nothing but formulas and processes for every phase of human effort. Many recipes hitherto unpublished. Any one of the five thousand easily worth more than the price you pay for ALL. To be without this book is costing you \$\$\$\$: Prices, postpaid, Cloth \$2.00. Heavy paper **\$1.25**

WELLS & EDWARDS, BOOKSELLERS, Dept. A
852 George Street, CHICAGO
Send for free circular and 40 page book Catalog

"STAMMERING Its Cause and Cure"

You can be quickly cured if you stammer. Send 10 cents, coin or stamps, for 238 page cloth bound book on Stammering and Stuttering. It tells how I cured myself after Stammering and Stuttering for 20 years. **BENJAMIN N. BOGUE**
744 Bogue Building, 1147 N. Ill. St. Indianapolis

LEARN WATCHMAKING AND ENGRAVING



Earn while learning. Most practical watch school. Individual instructions. Graduates in great demand. Book free. Chicago School of Watchmaking, Dept. 20, 4840 Lincoln Ave., Chicago

WANTED—RAILWAY MAIL CLERKS

\$135 to \$190 a Month for Life

Every second week off with full pay—no "lay offs" because of strikes, poor business, etc.—sure pay—rapid advancement to higher positions. City and country residents stand same chance. Common sense education sufficient—no political influence. Examinations likely everywhere very shortly.

DON'T DELAY—ACT AT ONCE

Write for free schedule of Winter examination places. Every day's delay means so much less chance of quick appointment—so write at once.
FRANKLIN INSTITUTE, Dept. K178, Rochester, N. Y.

Mail This Coupon

Write Plainly
Use It Before You Lose It

COUPON

FRANKLIN INSTITUTE, Dept. K178, Rochester, N. Y.
Kindly send me, without any obligation whatever on my part and entirely free of charge, (1) a full description of the position checked below; (2) Sample examination questions; (3) Free copy of copyrighted book "Government Positions and How to Get Them"; (4) A list of U. S. Government Jobs now open; (5) Schedule showing dates and places of all coming examinations.

.. Railway Mail Clerk (\$1600 to \$2300) .. Customs Positions (\$1100 to \$2000)
.. Postoffice Clerk (\$1400 to \$1800) .. Internal Revenue (\$1100 to \$2000)
.. City Mail Carrier (\$1400 to \$1800) .. Rural Mail Carrier (\$1800 to \$2600)
.. Income Tax Auditors (\$2040 to \$3600)

Name _____

Address _____



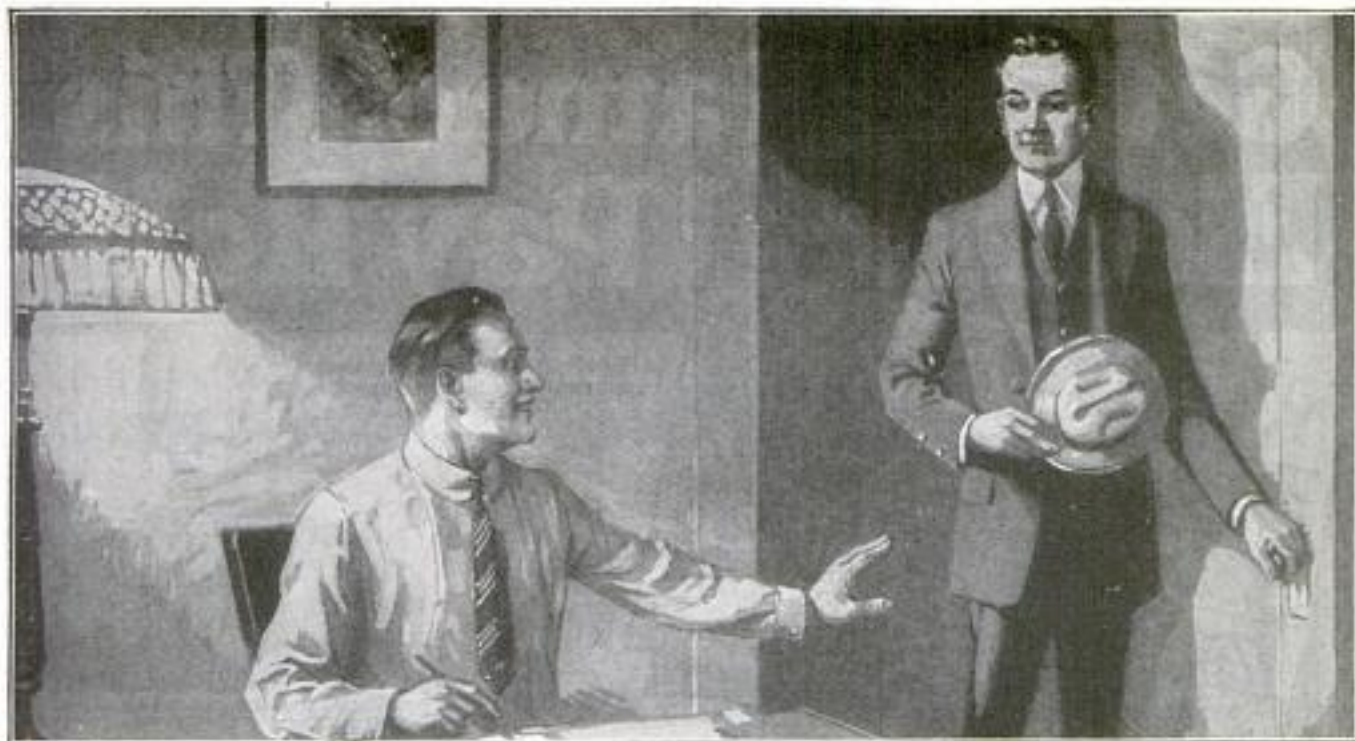

"I'm After That Raise in Pay!"

"A few years from now I want to be making at least five thousand a year—that's why I'm spending two or three evenings a week at this desk. I'm tired of being a business nobody, Jack, and I've made up my mind to stick to this game until I put it over big."

Real stuff in that young man—and the wonderful thing about it is that it's a mighty *interesting* game he's playing.

Have you ever tackled a good old-fashioned puzzle and got thoroughly absorbed in it? Then you'll understand why so many men become enthusiastic about the LaSalle Problem Method of acquiring specialized business training.

You see, by the Problem Method you don't just *read* how to do a thing, you *do* it. You are shown the *principles* that govern a situation; then under the direction of some of the ablest business men in their respective fields you work out *everyday busi-*

ness problems—just the problems you will meet on the bigger job.

That kind of training, you'll agree, is *practical*. It explains why during only three months' time 1089 LaSalle members reported salary increases totaling \$889,713 *an average increase per man of 56 per cent.*

What will *you* be doing with *your* spare time in the coming months? First thing to do, we should say, would be to *get the facts about LaSalle training.*

The coupon below will bring them to you without obligation, together with details of our convenient payment plan; also your copy of "Ten Years' Promotion in One," a book that has proved the inspiration of thousands of ambitious men. "Get this book," said a prominent Chicago executive, "even if you have to pay five dollars for it." We will send it *free.*

A stroke or two of the pencil, a letter dropped in the mail-box and you have made your start on the road to bigger things. Make that start TODAY.

—INQUIRY COUPON—

LA SALLE EXTENSION UNIVERSITY Dept. 1264-R CHICAGO, ILLINOIS
The Largest Business Training Institution in the World

Please send me catalog and full information regarding the course and service I have marked with an X below. Also a copy of your booklet, "Ten Years' Promotion in One," all without obligation to me.

- | | | |
|---|--|---|
| <input type="checkbox"/> Business Management: Training for Official, Managerial, Sales and Executive positions. | <input type="checkbox"/> Railway Accounting and Station Management: Training for Railway Auditors, Comptrollers, Accountants, Clerks, Station Agents, Members of Railway and Public Utilities Commissions, etc. | <input type="checkbox"/> Modern Foremanship and Production Methods: Training in the direction and handling of industrial forces—for Executives, Managers, Superintendents, Contractors, Foremen, Sub-foremen, etc. |
| <input type="checkbox"/> Salesmanship—Principles and Practice: Training for Sales and Advertising Executives, Solicitors, Sales Promotion Managers, Salesmen, Manufacturers' Agents and all those engaged in retail, wholesale or specialty selling. | <input type="checkbox"/> Industrial Management Efficiency: For Executives, Managers, Office and Shop Employees and those desiring practical training in industrial management principles and practice. | <input type="checkbox"/> Personnel and Employment Management: Training for Employers, Employment Managers, Executives, Industrial Engineers. |
| <input type="checkbox"/> Higher Accountancy: Training for positions as Auditor, Comptroller, Certified Public Accountant, Cost Accountant, etc. | <input type="checkbox"/> Modern Business Correspondence and Practice: Training for Sales and Collection Correspondents; Sales Promotion Managers; Credit and Office Managers; Correspondence Supervisors, Secretaries, etc. | <input type="checkbox"/> C. P. A. Coaching for Advanced Accountants. |
| <input type="checkbox"/> Traffic Management—Foreign and Domestic: Training for positions as Railroad or Industrial Traffic Manager, etc. | <input type="checkbox"/> Banking and Finance | <input type="checkbox"/> Commercial Law. |
| <input type="checkbox"/> Law: Training for Bar; LL. B. Degree. | | <input type="checkbox"/> Expert Bookkeeping. |
| | | <input type="checkbox"/> Business English. |
| | | <input type="checkbox"/> Commercial Spanish. |
| | | <input type="checkbox"/> Effective Speaking. |

Name..... Present Position..... Address.....

Get Your Name on This Electrical Pay Roll

Weekly Pay Roll	
W. E. Pence	Automotive Elect. Expert \$185 a week
C. E. Lockhart	Contracting Dept. \$120 a week
A. F. Klemz	Supt. Elect. Construction \$150 a week
Harry E. Wolf	Chief Electrician \$100 a week

"I have letters from these men and hundreds of others telling how I helped them out of small-pay jobs into these big-pay positions."

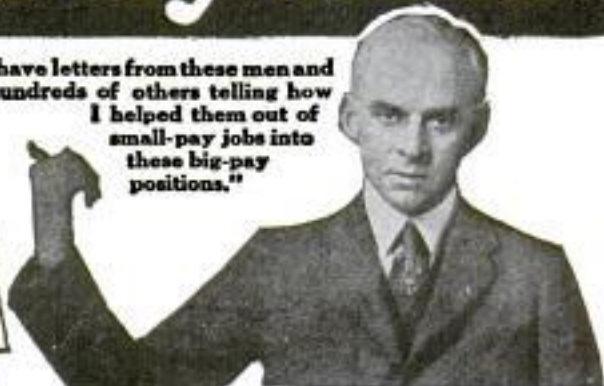

"These are the actual salaries being earned by these men today."

Electrical Experts Earn \$3,500 to \$10,000 a Year

Get out of the small-pay, hard-work class. Earn \$12 to \$30 a day as an Electrical Expert. You can do it. Trained Electrical Men are needed everywhere at the highest salaries. The opportunities for advancement are the greatest ever known. Even the ordinary electrician is highly paid, but you can be an Expert—the man who bosses the big jobs.

Let Me Help You to a Big-Pay Job

I am Chief Engineer of the Chicago Engineering Works and I know exactly what you need to insure your success. I guarantee to give you that knowledge. In a few short months I can fit you to hold down one of the finest paying jobs in the world.

Earn Extra Money While You Learn

Learn right in your own home without losing an hour's time from the work you do now. In fact early in my course I show you how to make extra money doing spare time electrical work. Many of my students earn as high as \$35 a week in addition to their regular pay.

Age or Education Makes No Difference

You don't have to be a college man—not even a high school graduate. If you can read and write English I can make a big success of you. My Electrical Course is the most simple, thorough and successful course in existence. It has revolutionized training by correspondence. It has dozens of successful features never before attempted.

Mail Coupon for My Book "Vital Facts"

Let me send you my big free book of "Vital Facts"—let me tell you more about how you can jump from a "bossed" to a "bossing" job—a regular man's size job that pays \$75 to \$200 a week. Fill out and mail the coupon NOW before you turn this page.

L. L. COOKE, Chief Engineer,
CHICAGO ENGINEERING WORKS
Dept. 19, 2150 Lawrence Ave., Chicago

FREE Electrical Outfit

You need tools, material and instruments to do the practical work I teach—these I give to you absolutely free—there is nothing for you to buy. You are also privileged to use my Electrical Laboratories without cost, as well as my students employment department which helps you land a good job.

Money-Back Guarantee

You take no risk when you enroll for my Course. Under bond, I guarantee to return every penny paid me if you are not entirely satisfied with my instruction. A Million Dollar Institution stands back of me in this guarantee.

L. L. COOKE, Chief Engineer
Chicago Engineering Works
Dept. 19, 2150 Lawrence Avenue,
Chicago, Ill.

Dear Sir: Send at once Sample Lessons, your Big Book "Vital Facts," and full particulars of your Free Outfit and Home Study Course—all fully prepaid without obligation on my part.

Name.....

Address.....



The "Cooke" Trained Man is the "Big Pay" Man

CLASSIFIED ADVERTISEMENTS

WORLD'S BEST WANT AD MEDIUM

Advertisements in this section, 25 cents per word, each insertion, minimum 10 words, payable in advance. To be inserted under proper classification in January issue, copy should be in our office Nov. 25th.

AUTOMOBILE SUPPLIES

AUTOMOBILE Owners, garagemen, mechanics, send today for free copy of this month's issue. It contains helpful, instructive information on overhauling, ignition troubles, wiring, carburetors, storage batteries, etc. Over 120 pages, illustrated. Send for free copy today. *Automobile Digest*, 506 Butler Bldg., Cincinnati.

BARGAINS—Radiators—Sport bodies. All makes and models; ask for price of your requirements. Chevrolet 490, \$17.95. Dodge and Maxwell Radiators, \$19.95. Ford, \$10.90. Wabash Radiator Co., 1117 Wabash Ave., A. Chicago.

AUTO Owner Tire Agent wanted each locality to use and take orders for hand-made Mellinger extra ply and cord tires; guaranteed by bond for 8,000 and 10,000 miles (no seconds); shipped prepaid on approval; get your tires free; no capital or experience required; make \$100 to \$300 weekly. Write for wholesale prices and sample section. Mellinger Tire Co., 929-K Oak, Kansas City, Mo.

CAR Owner in each town to demonstrate Stone's Gold Medal Patch, "Best on Earth or Elsewhere" for punctures and blow-outs, 200% profit. Send 50c for sample \$1.75 can. Box 2166, Denver, Colo.

AIR compressors, ball bearing, automatic, \$28 cash. Balance terms. Motors, battery chargers, buffers on same easy payments. Write postal to Hobart, Troy, Ohio.

AIR Compressors—Genuine Bunker Compressors, new, on very attractive terms; send post card. Brunner Mfg. Co., Dept. A, Utica, N. Y.

SAVE your broken battery jars; quickly repaired by using H. R. Cement. Also Magneto collector rings, Distributors' covers, and all Radio Hard Rubber parts. Mailed fifty cents per bottle. Duluth Accessories Mfg. Co., Duluth, Minn.

STANLEY Steamer Owners. Replace that rubber steam exhaust hose with permanent metal connection that will give in every direction. Parts procured cheaply from any plumber. Send \$2.50 for directions. A. D. Miner, Morgan Hill, Calif.

AUTOMOBILE Parts: Pistons, Rings, Wrist Pins, Ring Gears, Pinions, etc. Order direct from Detroit. Big discounts given. National Accessories Co., Box 404, Detroit, Mich.

PRONTO Series Gap Mica Spark Plugs. Guaranteed life of motor. Positively shoots through oil. 100% Government Air Mail Service test. Real dealers and distributors write. Pronto Mfg. Co., Omaha, Neb.

STEAM Automobile Owners, inclose stamp. Acme boilers. Burners, vaporizers, superheaters, fittings, engines, accessories. Complete Steamer supplies. Reasonable. "Doc" Paine, Denver, Colorado.

LIBERTY Air Compressors, for garages, tire-shops, filling stations, also paint spraying equipment. Air Compressor & Equipment Co., 1437 Carroll Avenue, Chicago, Ill. Distributors wanted.

CHALMERS Parts, 1918. Also motor complete. Christian, 116 Walnut Street, Somerville, Mass.

METZ Supplies, New Improved Roller Chain Drive. Positively will not slip. Crescent Auto and Machine Co., Centralia, Ill.

AIR compressors, for garages, tire shops etc. Price \$25, new. Shaw Mfg. Co., Galesburg, Kans.

RIMS. Rims. Our slogan is, We have it, we'll get it, or it isn't made, in the line of rims and rim parts. Send for latest catalog. Free rim information. W. P. Kastner, 2125 Michigan Ave., Chicago, Ill.

AUTOMOBILE parts, guaranteed new, for all cars. Save money; get our wholesale prices on gears, shafts and bearings. State make of car, model and parts wanted. Parts shipped immediately from stock. We refund your money, including transportation charges, if not satisfied. Mechanics Gear Co., 3708 No. Halsted St., Chicago.

BLUEPRINTS. Armature connections, 1922 Edition. Address, Charles Chittenden, 33024 Matthews, Kansas City, Mo.

BATTERY charging pays big profits. \$20 starts your business. Profits pay balance. Write us. Hobartson, Troy, Ohio.

USED Parts for Dodge Brothers' cars. 50% off list. Harris Motor Car Company, Cape Girardeau, Mo.

AUTOMOBILES

PATENTS—Write for our free illustrated Guide Book and Evidence of Conception Blank. Send model or sketch and description of your invention and we will give our opinion of its patentable nature. Highest references. Prompt service. Reasonable terms. Victor J. Evans & Co., 185 Ninth, Washington, D. C.

CYCLECAR Chassis, practically new, without motor (\$80.00). Earl Danks, West Union, Iowa.

AUTOMOBILE Owners, garagemen, mechanics, send today for free copy of this month's issue. It contains helpful, instructive information on overhauling, ignition troubles, wiring, carburetors, storage batteries, etc. Over 120 pages illustrated. Send for free copy today. *Automobile Digest*, 506 Butler Bldg., Cincinnati.

DYKE'S Automobile Encyclopedia, 13th edition, new, greater than ever, entirely rewritten and rearranged. Contains greatest array of auto facts ever published in one vol. Separate books containing same information cost \$21. Over 1200 pages and 4100 illus. Cloth \$6. Flex. Amer. Morocco \$7.50, postpaid. Popular Mechanics Book Dept., 6 N. Michigan Ave., Chicago.

REPAIRING Ford Cars, Trucks and Tractors in the most proper and efficient way is explained in a new 225-page book by the former director of the Ford Motor Co. Service School. This information is otherwise unavailable outside of the Ford plant. Written more especially for the mechanic and repairman. Price \$2, postpaid. Popular Mechanics Book Dept., 6 N. Michigan Ave., Chicago.

PATENTS—Write today for Free Instruction book and Evidence of Conception blank. Send sketch or model for examination and opinion; strictly confidential. No delay in my offices; my reply special delivery. Reasonable terms. Personal attention. Clarence B. O'Brien, Registered Patent Lawyer, Southern Building, Washington, D. C.

20% SAVED buying garage equipment direct from manufacturers. Magneto testers, chargers, gear pullers. Write for complete list and low prices. Benner Mfg. Co., Webb City, Mo.

AUTOMOBILE Repairman's Helper, In Two Vols. An excellent new work that gives every operation required to adjust or repair the troubles likely to be found in all standard cars. Vol. 1—Repairshop Practice—Passenger Cars—Trucks. 535 pp., 417 figs. Price \$3. Vol. 2—General Shop Practice—Passenger Cars—Parts and Accessories. 528 pp., 428 figs. Price \$3. Popular Mechanics Book Dept., 6 N. Michigan Ave., Chicago.

ANTI-FREEZING, nonalcoholic compound for automobiles. Huron Chemical Laboratory, 227 West Fourth, Ottumwa, Iowa.

FOR FORD OWNERS

FORD \$20 Simplex Starter Guaranteed. American-Simplex Co., Anderson, Ind.

THE wonderful newly patented Sun Automatic Spark Regulator eliminates all Timer trouble. Gives proper spark automatically for every speed of the motor. More power and greater mileage at less cost on either rough or smooth roads or when climbing hills. Prevents carbon. Does away with use of spark lever. Back-kick impossible. Outlasts all other Timers. Fully guaranteed. Sold on 30 days' trial. Agents wanted. Splendid profits. Auto Sun Products Co., Dept. C, Cincinnati, Ohio.

FORD Car Repair Book Sent Free. This complete and well illustrated valuable book explains in a simple way how to overcome Ford car troubles; Repairing, Economical Winter Driving, Cold Weather Car Starting, Equipment for Fall and Winter, Curing Piston Ring Troubles, Carburetor Adjustments and Repairs, Connecting Rods, Timers, Transmission Troubles, and practically every phase of Ford car driving, repairing and equipment. Send 25c coin for three months' trial subscription and get the valuable repair book free. Ford Owner and Dealer Magazine, 524 Montgomery Bldg., Milwaukee, Wis.

FORDS run 34 miles on gallon gasoline. Other cars show proportionate saving. Wonderful new carburetor. Starts easy in coldest weather. Fits any car. Attach yourself. Money back guarantee. Sent on 30 days' trial. Agents wanted. Air Friction Carburetor Co., Dept. 3221, Dayton, Ohio.

INSTANT Vaporizer for Fords; makes starting easy in coldest weather. Goes between carburetor and manifold. Easily attached. Price postpaid \$2.00. Ride in comfort during winter by using waste heat from exhaust. Complete heater easily attached. \$2.00 postpaid. Shaw Mfg. Co., Galesburg, Kans.

TOP Recovers, 32-ounce rubber top, material complete with back curtain, tacks, braiding. Touring, \$4.50; Roadster, \$3.50. Postpaid. C. O. Todd, Dist., Easton, Md.

100,000 MILES guaranteed service by using The Nelson Ball Bearing Timer on Ford Cars. Easy starting. Smooth running. Postpaid \$3.50 U. S. A. 620 East Water Street, Milwaukee, Wis.

CYCLE "Dynamic" hot-spot guaranteed 25 to 35 miles per gallon. Greatest hill-climber known. Cycle Manifold Co., South High, Akron, Ohio.

SPEEDSTER Fans. Don't fail to see "Red-I-Kut" ad. Page 147.

FORD Owners—Equip your Ford with priming cups. Dealers jobbers wanted. Midget Cyclecar Co., Box 103 Highland Station, Springfield, Mass.

SPRING Oilers. Stop rust, prevent breakage, car rides easier. Fit any car. Ford sets \$2.00 prepaid. Agents wanted. Federal Supply Co., Indianapolis, Ind.

FORD Owners: Use a Coyle Luggage Carrier, carry your load in the rear; only carrier of this type made. \$15.00 delivered. Agents wanted. Coyle Bro. Co., Inc., Huntsville, Ala.

FORD Owners, don't ruin your car by leaving it chattered. Correct same by installing Bredar's Ball Shim. Price \$1.10. Write for information, Nic Bredar's Son Mfg. Co., Rock Island, Ill.

MOTORCYCLES, BICYCLES AND SUPPLIES

WONDERFUL bargains in reconditioned motorcycles. Priced as low as \$35. Sidecars from \$25 up. Everyone expertly rebuilt and guaranteed in absolutely first-class condition. Don't delay. Send 2c for new big catalog showing 1923 bargains. Western Supplies Co., 539 Hayutin Bldg., Denver, Colo.

'19 INDIAN 3 Speed \$85.00. '20 Indian 3 Speed \$100.00. '21 Indian 3 Speed \$150.00. Howard A. French Company, Baltimore, Md.; Washington, D. C.

USED parts for all motorcycles, cheap. State wants. Schuck Cycle Co., 1922 Westlake, Seattle, Wash.

LARGEST stock of new and used motorcycle parts and accessories in the world at your disposal via Uncle Sam's mail. Write for quotations. Motorcycle Parts Mfg. Co., 2030-36 Wabash Ave., Chicago, Ill.

SEND for our Bargain Bulletin and Money-Saving Message. It will save you money on Motorcycles, Side Cars, Motor Wheels, Repairs Parts, and Accessories. Some used parts at less than half. Cleveland and Henderson Motorcycles our specialty. See our ad on page 147. American Motor Cycle Co., 2043-5-7 W. Chicago Ave., Chicago.

U-BICYCLE-LOCK—new, patented device for locking bicycles; fits over tire and rim. Send \$1.00 before too late. U-Bicycle-Lock Company, Upper Montclair, New Jersey.

DON'T buy a Bicycle Motor Attachment until you get our catalogue and prices. Also runs washers, pumps and shop machinery. Shaw Mfg. Co., Dept. 27, Galesburg, Kans.

USED Motorcycles. Excellent values. Cheap. List Free. Secher Hofhelms, Buffalo, New York.

AVIATION

INVENTORS desiring patents should write for our Free Illustrated Guide Book and Evidence of Conception Blank. Send model or sketch for our opinion of its patentable nature. Highest references. Prompt service. Reasonable terms. Victor J. Evans & Co., 187 Ninth, Washington, D. C.

AIRPLANE propellers, new, \$2.50 to \$10.00. Airplanes with motors, practically new, \$350.00. Curtis OX-5 motors, 8 cylinders, 90 h. p., \$150.00. Smith Machinery Co., 463 Goggan Building, Houston, Texas.

FLYING—"The Limitless Future"—Build and fly your own plane. Gain a practical aeronautical education. C. E. Lay, 3727 Saybrook, Cincinnati, Ohio.

BIGGEST best catalogue Model Aeroplanes, Parts and Supplies; 5c postpaid. Ideal Aeroplane Co., 67½ West Houston, New York.

LINCOLN-STANDARD Airplanes are now sold "Direct from Factory to Pilot." Only \$1,995 with Hispano-Suiza motor. Write for free catalog. Lincoln-Standard Aircraft Co., Lincoln, Neb.

PROPELLERS—We build and sell brand new propellers at prices nearly equal the old obsolete surplus stock of rejected, aged glue type. Why risk your life—others won't. Get our prices on new propellers, counter-shafts, sprockets, hubs, blue prints, for building sleds, motorcycle type, 75c. Ford type, \$1.00. Literature and pictures free. Address Crawford Motor Aeroplane Manufacturing, Long Beach, Calif.

SAILPLANE flies without motor! Efficient, inexpensive, easy to fly. Complete working drawings, \$1.00. Burke Aircraft Co., Downers Grove, Ill.

AMATEUR Airplane Builders see our ad on page 154. Lincoln-Standard Aircraft Co., Lincoln, Neb.

GOING to Learn to Fly? I can save you money on your course, no matter where you live. Write at once. Pilot J. DeForest Smith, St. Clair Hotel, Schenectady, N. Y.

MOTORCYCLED Motor Aerosed. 75 miles per hour. Blueprints, 50c. Burke Aircraft Co., Downers Grove, Ill.

DOPE, \$1.00; Turnbuckles, 20c; LeRhone Motors, \$100; Hall-Scott, \$150; OXX6, \$300. Speedy "Aerodrive" 83rd Blueprint, 50c. Supplies Bulletin, 2c. Ostergaard Aircraft Works, 4289 N. Narragansett, Chicago.

WANTED: Men to train for applied aeronautical engineering positions. Write Leslie Coombs, Chief Engineer, Central Airplane Works, 3254 Lincoln Ave., Chicago.

WELDING

WELDING Encyclopedia—A complete instruction book on all welding processes; oxy-acetylene, electric arc, electric resistance and thermit. Wedding of all weldable metals fully discussed. 326 pp., 375 illus. The accumulated experience of the welding brains of America is yours for \$5. Money back if not satisfied. Popular Mechanics Book Dept., 6 N. Michigan Ave., Chicago.

BOOKS AND PERIODICALS

"MAGIC." Edward M. Massey. Just published, 36 entirely new and original effects, clearly described. Illustrated with 25 full-page plates and 11 smaller illustrations. Attractively bound, elaborate gold stamping 8"x5½". \$5.15 postpaid. Spon & Chamberlain, 120 P. M. Liberty Street, New York, N. Y.

EVERYBODY'S Poultry Magazine, the highest class Poultry publication in America. Tells you how to mate, rear, house and make poultry profitable. Successful, practical poultrymen are its editors. Trial five months' subscription, 25c; one year, 75c; two years, \$1.00. Everybody's Poultry Magazine, Dept. 100, Hanover, Pa.

1,000,000 INDUSTRIAL Facts, Calculations, Receipts, Processes and Trade Secrets for every business are contained in the 1916 page book "Moore's Universal Assistant and Complete Mechanic," 500 Engravings, Cloth, Price \$2, postpaid. Popular Mechanics Book Dept., 6 N. Michigan Ave., Chicago.

BIG money in writing photoplays, stories, poems, songs. Send today for free copy Writer's Bulletin, full of helpful advice how to write, where to sell. Edward's, Publisher, 708 Butler Building, Cincinnati.

PLANS for Poultry Houses. All styles. 150 illustrations; secret of getting winter eggs, and copy of "The Pull Egg Basket." Send 25 cents. Inland Poultry Journal, Dept. 74, Indianapolis, Ind.

INDUSTRIAL Alcohol, Wright's book everybody wants. Full directions for making with drawings of necessary apparatus. \$2.50 postpaid. Spon & Chamberlain, 120 P. M. Liberty Street, New York, N. Y.

BOYS' toy-maker book, 64 pages, illustrated, 10c. Amateur Electrician, 64 pages, illustrated, 10c. Radio Sets, how to build, illustrated, 25c. Western Puzzle Works, St. Paul, Minn.

GIVE your children something worthwhile reading—194-page book Bible Stories, 179 illustrations, 17 colored. For children 3-14 years, \$1.00. Ruth Fowler, Clintonville, Conn.

RADIO books cheap. Catalogue free. Zenith Book Co., St. Paul, Minnesota.

DIRECTIONS, How to build beautiful, strong, durable and fireproof homes at reasonable cost by making use of much good building materials now wasted everywhere. Read my book on building. Price one dollar. Peter de Londe, Zion, Ill.

24,000 PERIODICALS available by subscription. List free! Local agents wanted everywhere. Tropp Magazine Agency, Middletown, N. Y.

"MAIL Order Ways," by Hurdick; full of mail order plans. Price \$1.00. A. Barnes, Helena, Ark.

MONEY-SAVING Magazine offers. Free catalogue. F. A. Johnson, 1532 East 65th Street, Chicago, Ill.

STARTING a Magazine Subscription Agency. Copy, 10c. D. D. Green, Leslie, Michigan.

BOOKS—Golden Key to Business Life, 35c. Address Playcan, 1124 Howard, San Francisco, Calif.

BOOKS, All kinds. Lists. Higene's, A241 Post Street, San Francisco.

ENCYCLOPAEDIA Britannica, India Paper, half price. Dalton Riggs, Crilly Bldg., Chicago.

OUR new catalogue listing over five hundred carefully selected practical books under eighty different subject groupings will be sent free upon request. Popular Mechanics Book Dept., 6 N. Michigan Ave., Chicago.

"ELECTRICAL Kinks" Most complete book on everything electrical in the home. See advertisement on page 22.

THINK! A Book that will teach you to Think. Postpaid \$1.00. Earn money selling Think. John James, Box 912, Nashville, Tenn.

"HOW To Make Your Own Radio Set"—Illustrated book with complete instructions. 25c. Globe Book Company, 429-P. Cabot Way, Pittsburgh, Pa.

"MIND-READING!" Any distance. 30c. "Hypnotism" controls others; 25 easy lessons, \$1.00. Science Institute, P.A.1014 Belmont, Chicago.

PICTURES AND POSTCARDS

BOYS and girls earn Xmas money. Write for 50 sets American Christmas Seals. Sell for 10c a set. When sold send us \$3.00 and keep \$2.00. Neubecker Bros., 961 East 23rd St., Dept. 88, Brooklyn, N. Y.

OUR Dollar box of fifteen distinctive Christmas Cards sent on approval. If selection pleases you, send \$1.00. If not, return box at our expense. Elizabeth Huntford Studio, 9 South Clinton, Chicago.

100 PICTURES, Postcards, Stickers, Booklets, 25c. Fred'k Young, McConnellsville, N. Y.

TEN exquisite Thanksgiving, Christmas, New Year's, Birthday or Comic Postcards, 10c; 75c per 100. Richard Lavery, Asbury Park, N. J.

JOIN Live Postcard Club; membership lists including catalog, 10c. Harvey Teeple, Decatur, Indiana.

JOIN Sunset Card Exchange Club. Receive thousands view postcards by exchanging with our thousand enthusiastic members everywhere. Fascinating pastime. 6 months' trial membership, 25c; membership list, 10c. Oliver Gandy, Crisfield, Md.

TRUE-BLUERS everywhere. Exchange postals. Organized 1908. Membership: Year, \$1; half, 50c; quarter, 25c. Hundreds listings, 10c. Ed Ericson, Elroy, Wis.

50 MAILORDER Magazines and Papers \$1.00. Address Hansen Company, Brookings, S. Dakota.

NOVELTIES, CURIOS, ETC.

SNOW animals, fine skins: Leopard, Lion, Tiger, Wolf—mounted, unmounted. Gold, Silver Basing, Jewelry, Ivory Carved Beads cheap market value, everything supplied and sold on commission. Curios, Louisiana, Ind'a.

BUDDHA, Chinese Incense Burner. Delightful Aroma. Wonderful Christmas Gift. Complete Fifty cents. Order today. T. Peters, 75 Carl St., Jamaica, L. I.

TO make friends quickly. Three packages "Alaska Novelty" 10c coin, postpaid. Voltine Co., 1258 East 61 St., Cleveland, Ohio. (Rare stamps, Lock ink, Indian relics, etc.)

GAMES AND ENTERTAINMENTS

SERPENT of India. Greatest trick in the world. Done anywhere. A common knot is tied in the body of this remarkable reptile. When held up by tail, snake slowly rises, head first, and actually unites itself. Repeats at will. Silk snake, complete with special patter. Just send a dollar bill. Our big Magic Catalog Free with every order. Address Thayer Magic Co., 334 San Pedro St., Los Angeles, Calif.

ATTENTION! We are headquarters Joker's Novelties, Magical Apparatus, for Parlor and Stage. Sensational escapes from handcuffs, ropes, jails, etc. Plays, minstrel choruses, mind-reading, amusement goods of all kinds. Buy direct from manufacturer. Get the best. Large illustrated catalog for 3 cents postage. Heaney Magic Co., Berlin, Wis.

FUN, jokers' goods, trick pencils, smell bombs, sneeze powder, sooner dogs, pills, new puzzles, shooting cigars, cigarettes, books, 100 others. Send for illustrated catalogue today. Grandefeld, 1238 Theriot Ave., W. F., New York.

VENTRILQUIISM taught almost anyone at home. Small cost. Send 2c stamp today for particulars and proof. George W. Smith, Room M 293, 125 N. Jefferson Ave., Peoria, Illinois.

200 KINDS Iron, wood and wire puzzles. Leader and illustrated list 10c. Western Puzzle Works, St. Paul, Minn.

PLAYS, musical comedies and revues, minstrel music, blackface skits, vaudeville acts, monologs, dialog, recitations, entertainments, musical readings, stage handbooks, make-up goods. Big catalog free. T. S. Denison & Co., 623 So. Wabash, Dept. 11, Chicago.

ENTERTAINING Books, Puzzles, Tricks. Catalog free. Andco, 4049-TH, North Whipple, Chicago.

SNEEZE powder, Smell bombs. Great fun makers. Per box, 10c. C. Fenner, 2401 Jefferson, Louisville, Ky.

"HOW to Read People's Minds" 30c. Popular Institute, 1014 Belmont, Chicago.

MAGIC TRICKS, BOOKS AND JOKERS' NOVELTIES

MAGIC—Tricks, Books and Supplies. For Amateurs as well as the great professionals. Anyone can learn through our instructions. Feature Acts in Mind Reading, Spiritualism, Rope Ties, etc. Large Illustrated Professional Catalog, 10c. Chicago Magic Co., Dept. B, 140 S. Dearborn St., Chicago, Ill.

TRICKS, Puzzles, jokes, magical apparatus, plays, stage supplies, mind-reading acts, and sensational escapes. 160-page illustrated professional catalog, 10c. Oaks Magical Co., Dept. 548, Oshkosh, Wis.

BARGAINS in Magic, Tricks, Secrets. Universal Magic Co., Yonkers, N. Y.

FREE—68-page Illustrated Magic Catalogue from factory. C. Pentz, Minneapolis, Minn.

MAGIC. Ventriloquial Punch Figures. Stage Money. Books, Magazines, Escapes. Secrets. Illusions. Flowers. Roll Paper. Catalogs. 10c. Address, Gilmagico, Morgan Park, Ill.

PAPER Magic—A new book by Houdini in which are described not only a large number of tricks with paper but also the amusing and puzzling articles which may be made of folded paper and tearing of paper. Paper puzzles are also included. 296 pages. Illus. Price \$2.50, postpaid. Popular Mechanics Co., 6 N. Michigan Ave., Chicago.

STAMP COLLECTING

START a Stamp Collection—63 different stamps from 63 different foreign countries, including Africa, Asia, Australia, Europe, West Indies, etc. Our pamphlet which tells "How to make a collection properly," and price list of albums, packets and sets, all for only 16 cents. Queen City Stamp Co., Room 56, 604 Race St., Cincinnati, O.

STAMPS—50 different Jamaica, Venezuela, etc., only 7c; 100 all diff., 10c; 1000 all diff., \$2.50; 100 diff. U. S., 25c; 1000 Hinges, 10c; 50 per cent approvals with every order. List free. I buy stamps. Write L. B. Dover, Dept. A, Longmont, Colo.

153 GENUINE Foreign Stamps Mexico War Issues, Venezuela, Salvador and India Service, Guatemala, China, etc., only 10c. Finest approval sheets 50 to 60%. Agents Wanted. Big 72-p. Lists Free. We Buy Stamps. Estab. 29 yrs. Hussman Stamp Co., Dept. 54, St. Louis, Mo.

BOYS! 110 different stamps, White Russia, Abyssinia, Fiume, etc. (Cat., \$2.50), perforation gauge, stamp wallet and 250 hinges, all for 15c to approval applicants only! Alling Stamp Co., 522 Bingham Ave., Sault Ste. Marie, Mich.

FREE! Sectional Loose Leaf Postage Stamp Album at the rate of 8 pages each month given with subscription to our monthly Journal. Send two-cent stamp for prospectus. United Stamp Co., 149 S. Dearborn St., Chicago, Ill.

STAMPS, 50 Varieties, Africa, Brazil, Peru, Cuba, Mexico, etc., 10c. 50 different U. S., 25c; 1,000 mixed, 40c; 1,000 hinges, 10c. List free. C. Stegman, 5948 Cote Brillante, St. Louis, Mo.

PACKET of 23 stamps, no two countries alike. Packet hinges. Set of \$1 and \$2 U. S. Rev., all for 5c. Mention paper. Miami Stamp Co., Toledo, Ohio.

115 DIFFERENT Foreign Stamps, including Zambesia, Zanzibar, Argentine, Georgia, Herzegovina, Holkar, Liechtenstein, Madagascar, Mozambique, Newfoundland, Roumania, Montenegro, Ukraine, Venezuela, 20c. Liberty, 3974 Arsenal, St. Louis, Mo.

24 VARIETIES Cuban stamps, 19 cents. List of 6,000 low-priced stamps free. Address Chambers Stamp Co., 111P, Nassau St., New York City, N. Y.

UNIVERSAL Packet, 100 varieties, all over the world, 10 cents. Covert Stamp, 39 State, Rochester, N. Y.

STAMPS, 20 unused, all different, free. Postage 2c. Mention paper. Quaker Stamp Co., Toledo, O.

LIKE Triangular Stamps? To introduce our Sudden Service Approvals we'll send triangular Fiume, set China ships, large \$1.00 United States revenue, also packet 50 foreign, millimetre scale, perforation gauge, ruler and bargain lists for only 2c! Fennell Stamp Company, Dept. P, Fullerton Bldg., St. Louis, Mo.

65c FOR 10c Abyssinian stamp, Guatemala Parrot stamp, 30 different British Colonies, packet hinges, Finest Perforation Gauge with handsome price list to introduce our exclusive approval sheets. Address Allen Sears, Dept. P, Lathrop Building, Kansas City, Mo.

1,000 MIXED. Mostly Philippines, Orient. Very few from United States, Europe. Many United States surcharged Philippines, Old Spanish, by-product of our agency, saved 25 years, postpaid 65c. \$1.00, \$3.00. Have money order favor Burt Subscription Agency, New York. Burt Subscription Agency, Box 1341, Manila, Philippine Islands.

BEST one-cent approvals in America. F. P. Hand, 1117 So. 60th St., Philadelphia, Pa.

18 VARIETIES Canadian War Tax, including \$2.00 rare, only \$1.25. Ralph Wilby, Weston, Ontario.

BARGAIN: 1,600 mixed foreign stamps only 20 cents; 11,000, \$2.00. Nielsen, 1923 Melrose, Chicago.

HONEST prices paid for stamps or collections. International, 2117 Regent Place, Brooklyn, N. Y.

50 UNUSED stamps free. All different. Postage, 2c. Fink Stamps, Toledo, Ohio.

1,000 MIXED Stamps, 150 varieties, 25c. Charles Peugh, Elma, Wash.

FOREIGN Stamp Collection Sent Free. Cornish Company, Schenectady, N. Y.

FREE Packet to approval applicants. Reid Stamp Company, Todmorden, Toronto.

FAMOUS "Alling Net Approvals," greatest values, only one and two cents each. Fine stamps and sets at 1/2 or 2/3 Cat. Alling Stamp Co., 522 Bingham Ave., Sault Ste. Marie, Mich.

LET me show you how you can increase your collection to at least 10,000 at a cost of only a few cents per stamp. Address Tubbs, 4021 First, San Diego, Calif.

U. S. 100 YAB., Cat. about \$2.00, for 15c. Jax Stamp Co., Steger, Ill.

100 DIFFERENT Stamps and Perforation Gauge, 10 Cents. Sonnee Stamp Co., 675 Ivy Street, St. Paul, Minn.

FREE "Leader" Pkt. to approval applicants sending 2c stamp. Earl Stamp Co., 1811, 26th Ave., North, Minneapolis, Minn.

STAMPS sent on approval at 70% discount. Reference required. Emory Renoll, Hanover, Pa.

BOYS! 102 different from White Russia, Fiume (Triangle), etc.; perforation gauge, stamp wallet, free to approval applicants. Postage 6 cents. Pathe Stamp Co., 521 Woodward Ave., Atlanta, Ga.

BRITISH Colonies, extra value—all different—100, 40c; 200, \$1.25; 300, \$2.50. Ted Westlake, Taber, Alberta, Canada.

LARGE perforation gauge free to applicants for finest 50% approvals and U. S. post. Scott 1923 Catalog \$1.60 postpaid. Midwest Stamp Company, Kemper Building, Kansas City, Missouri.

FREE subscription to "Postage Stamps," our monthly magazine, to all asking for our fine 50% approval sheets. W. W. Betts, Box P117, Clearfield, Pennsylvania.

51 UNITED States, 10c. Address Co-operative Stamp Co., 710 Pelham, St. Paul, Minn.

FREE! Fine set European to approval applicants. British Colonials. Latest issues. Big variety. 1c up. Penna. Stamp Co., Manor, Pa.

FREE—\$1.00 worth of stamps, Hull, 12 West 101st, New York.

500 MIXED U. S., 10c; 1,000 hinges, 10c; 100 War Stamps, 15c; Black Beauty Album, 80c. Weatherly Stamp Co., Medina, Ohio.

HUNDRED Foreign, ten cents to approval buyers. Bob Buffham, Lake Ave., Racine, Wis.

105 CHINA, etc., stamp dictionary, list. 2c. Album (500 illustrations), 3c. Bullard, Sta. A, Boston.

STAMPS Free—War Stamps, Surcharged, Unused, Pictorials, British, French Colonials, 2c postage. Midland Stamp Co., Toronto, Canada.

BIG Variety Packet Foreign Stamps free for 2c postage. Gray Stamp Co., Station E., Toronto, Canada.

150 DIFFERENT stamps, 15c; 225, 25c; 325, 50c; 550, \$1. Fred Onken, 639 79th Street, Brooklyn.

50 DIFFERENT Portuguese Colonies, 25c; 100 different French Colonies, 50c. Approvals. Eisen, 3918 Thirteenth Avenue, Brooklyn.

BEGINNERS, medium and advanced approvals. Reference necessary. Maxfield, Box 315, Amsterdam, N. Y.

FREE, 25 U. S. with approvals. References, 3c postage. St. Elmo Stamp Co., 2511 Sunnyside Ave., Chicago.

100 DIFFERENT, many rare unused, 5c. Elvin Stanton, Niantic, Conn.

FRENCH Colonies Free—Beautiful Picture set, including Native Chiefs, Tigers, Pictorials, 2c Postage. Empire Stamp Company, Toronto, Canada.

NYASSA—1921—10 var., 3c. Penny approvals. Heatherdale Co., 4040 Lyndale So., Minneapolis, Minn.

THE Fenway Packet, 105 different, including Abyssinia, Nyassa, Turkey, White Russia, etc., 250 hinges, set airplane stamps, postpaid for 12 cents to new applicants for our net approvals. Address Fenway Stamp Co., Fenway Station, Boston (17), Mass.

11 STAMPS, including new nations, to approval applicants. Alford Kohl, 329 Rice Bldg., Boston, Mass.

FREE! 20 French Colonials to approval applicants sending 2c postage. Nickles, 123 Florida, Washington, D. C.

GET free copy of fine, large stamp magazine. "Philatelic Gossip," Holton, Kan.

200 DIFFERENT Stamps, 20c; 100, 3c. Michael, 5692 Prairie, Chicago.

100 DIFFERENT Bavaria, 25c. Finest approvals, 50% discount. Lampe, 423 West 42nd, New York, N. Y.

POLAND Airpost Set Complete, also 300 different stamps for 40c. Jacob Fischer, 1539 North Lawler, Chicago.

FREE—25 different U. S. stamps with 60% approvals to reliable parties. 80 different U. S., 25c. C. Seidenberg, Merton, Wis.

\$1.00 CATALOG value, all diff. stamps, only 10c; approvals with each order; also free lists, book, gauge, etc. About \$3.00 Cat. value, 25c. \$5.00 for 75c. Hawkeye Stamp Co., Cedar Rapids, Ia.

FREE Set of Stamps to approval applicants sending 2c. Address, Richard P. Lamprocht, Valparaiso, Ind.

FREE packet to applicants for net approvals with reference. 100 var. Neurope 25c. A. E. Hussey, 3458 Wilson, Cincinnati, Ohio.

STAMPS Free—Ask for money-saving approvals. John P. Borresen, Cedar Falls, Ia.

FREE—New Europe, 20 diff., to applicants for my 1/2, 3/4, 1, and 2c approvals; also the higher-priced stamps at 50% disc. Send reference and receive extra premium. Chas. T. Egner, 1335 Pike St., Philadelphia, Pa.

BEAUTIFUL Composer set, Beethoven, Mozart, Schubert, etc., 25c. 10 Variety Nyassa, 20c. Roe, Storm Lake, Iowa.

PRICE List Free—Over Four Hundred Bargain Sets and Packets. A. E. Hardman, 7 Iowa Circle, Washington, D. C.

1,000 MIXED Foreign Postage Stamps 20 cents, 11,000 only \$2.00. Nielsen, 1923 Melrose, Chicago.

RARE COINS

\$2 TO \$300 each paid for hundreds of Old Coins. Keep all old money. Send ten cents for Illustrated Coin Value Book, 4x8. Guaranteed prices. Get posted. We pay cash. Clarke Coin Company, Avenue 2, Le Roy, N. Y.

OLD coins, large fall selling catalogue of coins for sale, five. Catalogue quoting prices paid for coins, ten cents. William Hesselin, 101B Tremont St., Boston, Mass.

CALIFORNIA gold, 3/4 size, 27c. 5/8 size, 33c. 3c piece and catalogue, 10c. Address Norman Shultz, Colorado Springs, Colo.

OLD U. S. silver coins cheap. Old bust type dimes dated before 1838, 25c. Old half dollars with lettered edge, dated before 1826, 75c. Columbia half dollars with bust of Columbus (Sold at \$1 in 1893) price 75c. Five foreign coins, 1 over 100 years old and my large 50 page Illustrated Coin Catalog for only 20c. Or catalog free with any order for above coins. All kinds of Coins and Bills for Sale. B. Max Mehl, Numismatist, Mehl Bldg., Dept. P, Fort Worth, Texas. Largest Rare Coin Establishment in the United States.

U. S. 1/2 CENT, over 100 years old, rare, for 30c with selling list. Address Fred Greenleaf, Box 297, Alton, Ill.

HERE! Imitation \$50; Slug Same Size and Shape, 65c. Grant 1/2 Dollar, \$1.00. \$1.00 Indiana Bill, Unsigned, Crisp, 10c. California Gold, 1/4, 27c. Price Lists, 4c. Al. E. Bonsall, Richmond, Ind.

CALIFORNIA gold quarter, 27c; half, 52c; set 75 cents, \$25. Jackson Turtle cent, 15c. A. Wylie, Wheaton, Ill.

ROMAN coin, 1500 years old, 25c. Durso, 25 Mulberry, New York City.

OLD coins wanted. Have you an odd or old coin or bill? It may be worth several dollars. Get posted. Send 4c for Coin Circular. May mean much profit to you. Send now. Numismatic Bank, Dept. H, Fort Worth, Texas.

FOR BOYS

BOYS build three foot model airplane at small cost. Write Aero Shop, 3450 Huribot Ave., Detroit, Mich.

MOUTH-ORGAN Instructor, 25c. Play in one hour. G. Elsea, Bowling Green, Ohio.

BOYS: Run your own "Movie" Show at home or school. Best machine complete with Film, \$35.00. Send \$5.00 deposit only. We will ship C. O. D., balance, allowing examination. A lasting Christmas present. Monarch Theatre Supply Co., 724 So. Wabash Avenue, Chicago.

BOYS!—You who like gripping, thrilling stories of achievement will want to read "Victories of the Engineer," a book that tells in a way you can understand it how the great feats in railroad engineering, building great bridges, ships, dams, canals, harbors, tunnels, mining, etc., have been accomplished. By A. Williams. 487 pp. 25¢. Price \$2.00 postpaid. Popular Mechanics Book Dept., 6 N. Michigan Ave., Chicago.

MONEY. Boys: Send ten cents for the idea. Fred Megow, Lancaster, Wis.

COMPLETE moving picture machines. \$1.50 up. Also Radio sets. Particulars. Nite Mail Order & Supply Co., 609 27th St., Denver, Colo.

BOYS, 25 cents shows you how to make several games and toys cheap. Fred Megow, Lancaster, Wis.

GREAT Fun—Magic pictures, 10 for 10¢ prepaid. Address ABC Manufacturing Co., Box 1715, Washington, D. C.

OUTDOOR Winter Sports—How to Make Devices for. Plain instructions and clear drawings for building motor-driven sleds, snow speedsters, air-propelled sleds and ice boats, ski sleds and gliders, skis and ski running, ice yachts, coasting toboggans, etc. Price 25¢ postpaid. Popular Mechanics Book Dept., 6 N. Michigan Ave., Chicago.

FILMS for Toy and Professional machines. All famous Movie stars, \$2.00 per reel and up. Big list free. Monarch Theatre Supply Co., 724 So. Wabash Ave., Chicago.

SCENERY TO RENT

SETTINGS for Opera, Plays, Minstrels. Push Drops. Address Amelia Grain, Philadelphia.

CAMERAS AND PHOTO SUPPLIES

JUST Published—Our new complete 128-page catalog and bargain book of new and used cameras and supplies. Our goods are guaranteed finest quality obtainable. We have thousands of satisfied customers. Write at once for this bargain bulletin, just hot from the press. Address Central Camera Co., 124 S. Wabash Ave., Dept. E-64, Chicago, Ill.

HAVE You a Camera? Write for Free sample of our big magazine, showing how to make better pictures and earn money. American Photography, 796 Camera House, Boston, 17, Mass.

SPECIAL Trial Offer: Any size Kodak film developed for 5c; prints 2c each. Overnight service. Expert work, Roanoke Photo Finishing Co., 299 Bell Ave., Roanoke, Va.

A 1923 THERMOMETER Calendar, made from one of your favorite film negatives, hand-tinted, for 50c. Az-u-lyk-m, Bristol, Vermont, Dept. D.

SAMPLE enlargement, dime and negative (returned). Sample 6-exposure roll finished glossy, 25c silver. Brown Studio, Lake Elmo, Minn.

MAKE photographs in natural colors with common camera. Ask for booklet. Address today! J. Herzog, 216 Pearl Street, Ypsilanti, Mich.

SILKPHOTOS! Wonderful art. Make them yourself. Recipe—special \$1.00. F. Insa, 145 Division, Elizabeth, N. J.

5x7 KODAK Enlargement, beautifully hand-painted, fifty cents. Holt Studio, Quincy, Fla.

BIG Money Saved on Photographic Lenses and Apparatus—goods exchanged; repairing done. Ralph J. Golsen, 1128 Argyle St., Chicago, Dept. P.

BEAUTIFUL Holiday Gift—8x10 colored enlargement \$1.00. Kodafin, 387 Bellevue Place, Milwaukee, Wis.

MOTION PICTURES AND SUPPLIES

SEND \$3.00 for the Cinema Hand Book. Everything pertaining to motion-picture making, taking projecting studio laboratory work. 572-page book, pocket size, only \$3.00 postpaid. Also the new complete courses of the New York Institute of Photography. Motion Picture Photography, postpaid, \$6.00. Motion Picture Projection, postpaid, \$6.00. Motion Picture Directing, postpaid, \$3.00. Screen Acting, postpaid, \$3.00. Photoplay Writing, postpaid, \$3.00. The most elaborate works ever written on this subject. Bass Special Offer: The five books at \$17.50 postpaid. Free Cinema catalog. Bass Camera Company, Motion Picture Division, 109 N. Dearborn, Chicago.

AMERICA'S Greatest Fortunes have been made in the Moving Picture Business. Small investment needed. We furnish complete theatre equipment. Easy payments. Openings everywhere. Catalog free. Monarch Theatre Supply Co., Dept. F, 724 So. Wabash Ave., Chicago, Ill.

FREE to Writers—A wonderful little book of money-making hints, suggestions, ideas; the A B C of successful story and play writing. Absolutely Free. Just address Authors Press, Dept. 12, Auburn, New York.

\$85.00 PROFIT nightly. Small capital starts you. No experience needed. Our machines are used and endorsed by government institutions. Catalog free. Atlas Moving Picture Company, 482 Morton Bldg., Chicago.

WE buy used portable suitcase and professional moving-picture machines. Highest prices paid. What have you for sale? Monarch Theatre Supply Co., 724 So. Wabash Ave., Chicago, Ill.

MAKE money writing photoplays; details free to beginners. No correspondence course. Producers League, 230 Wainwright, St. Louis.

MAKE \$50-\$100 Weekly writing motion-picture plays. Details Free, Rex Publishers, Hannibal, Mo.

FILMS For Sale—\$2.50 per Reel up. Address Queen Feature Service, Birmingham, Ala.

SEND stamp for catalog illustrating wonderful 1923 Kinograph Grand Home Movie Projector. Bargains in films. Address Werner Brothers, High Ridge, Mo.

MAKE money showing movies. Sacrificing Road Show Projector, \$50. Films, \$3. New Home Projector, \$30. Movie Camera—fastest lens—\$60. Ray, 326 5th Ave., New York, N. Y.

FILMS, Picture Machines, Asbestos, Booths, Spotlights, Stereopticons, Pathoscopes, Lenses, Rheostats, etc. Wetmore, 1108 Boylston St., Boston.

FILMS—used standard theater size, short lengths, for toy machines. List free. Hibeler, 4010 Dickens Ave., Chicago.

MOVIE Film, \$1.00 per 100 feet postpaid. Address Gamble Bros., Mt. Airy, Philadelphia, Pa.

BIG Money Nightly—Get my installment figures Complete Moving Picture Outfit before buying. Ralph J. Golsen, 1128 Argyle St., Chicago.

NEW Movie Cameras \$100, Projectors \$35. Address Gamble Bros., Mt. Airy, Philadelphia, Pa.

EDUCATIONAL AND INSTRUCTION

HAVE a business of your own; the most fascinating, best paying business-profession in the World, a foot correctionist; easy terms for training you at home in a few weeks, a new protected system that has enabled men and women to rise in one step to greater earnings than they ever thought possible; no capital required or goods to buy, no agency or soliciting. Address, Stephenson Laboratory, 1 Back Bay, Boston, Mass.

SHOW-CARD writing, a pleasant, profitable profession easily and quickly learnt by our new simple graphic block system. Artistic ability not necessary. We teach you how. Distance no object. Full particulars and booklet free. Wilson Methods, Limited, Dept. M, 64 East Richmond, Toronto, Canada.

INVENTORS—Write for our illustrated guide book and Evidence of Conception Blank. Send model or sketch and description for free opinion of its patentable nature. Highest references. Prompt attention. Reasonable terms. Victor J. Evans & Co., 167 Ninth, Washington, D. C.

BIG money in writing photoplays, stories, poems, songs. Send today for free copy Writer's Bulletin, full of helpful advice how to write, where to sell. Edward's, Publisher, 603 Butler Building, Cincinnati.

DOUBLE Entry Bookkeeping mastered in 60 hours with 8 keys; guaranteed; diplomas. Our graduates lead in bookkeeping, auditing, accountancy, balance sheets, financial statements. International Bookkeeping Institute, Dept. 8, Springfield, Mo.

WRITE articles, stories, news, in spare time for newspapers and magazines. Big pay. Copyright book free. Press Syndicate, 552 St. Louis, Mo.

WANTED: Information exchanged about commercial uses for air compressors. Address Engineering Dept., Brunner Mfg. Co., Utica, N. Y.

HARMONICA Instructor, 25c. Play in one hour. G. Elsea, Bowling Green, Ohio.

BOOKKEEPING in a week; price \$2.00. Dukas, 1857-9 Walton Ave., New York.

STUDY Bacteriology—become a laboratory expert. Course interesting, can be mastered in few months at home or in school. Good paying positions open. Degree granted our graduates. School 13 years old. Send for Announcement. American College of Bacteriology, 2923 S. Michigan Ave., Chicago, Ill.

MATHEMATICS taught by mail. Arithmetic, Algebra, Geometry, Mensuration, Trigonometry, Logarithms, and Mechanics courses. Address, Harding School, 76 Brighton, Highland Park, Mich.

ARTIFICIAL Marble, sanitary flooring instructions, ornamental casting, concrete plaster, papier-mache decorations, garden furniture, statuary, Rubber-moulds, Electrometallurgy, particulars and 200 illustrations free. Chris Mahler, Box 122, Huntington, N. Y.

BE a Laboratory Expert. Earn \$300 to \$500 a month. Interesting Extension and Residential Courses. Diplomas and Degrees granted. Bacteriology, Urinalysis, Blood Analysis, etc., quickly and thoroughly taught, 46-piece Urinalysis outfit Free. Write today for free 34-page prospectus. Physicians & Surgeons College of Microbiology, Room 971, 2246 Burling St., Chicago.

ROFF'S Calculator and Short-Cut Arithmetic shows the answer as quickly as a watch shows the time to all problems likely to occur in office, store, shop, bank, farm or factory. Price, pocket size, paper 35 cents, cloth 50 cents, leatherette \$1. Desk size, cloth \$1.50 postpaid. Popular Mechanics Book Dept., 6 N. Michigan Ave., Chicago.

WORLD-ROMIC System—Masterkey to All Languages, Primers, 16 languages, \$1.94 each language; Arabic, Chinese, Danish, Dutch, English, Scotch English, French, German, Italian, Japanese, Panjabi, Polish, Portuguese, Russian, Spanish, Swedish, Pronunciation Tables, 92 languages, 30c each language. Languages Publishing Company, 8 West 40th St., New York.

TOUCH Typewriting. Superior system, easily acquired, prize winning speed. Learn this easy home of office practice whether you are beginner or experienced. Increase efficiency, earnings. Write for information. King Institute, KY-187, Station F, New York.

BE an Artist. Big money painting pictures at home. Send 25c, sample picture and particulars. Address Duke Brothers, Studio, Box 254, Three Rivers, Mich.

BE a successful shorthand writer. Membership training; expert proficiency guaranteed; diploma. Marquette School of Business Methods, 404 Willoughby Building, Chicago.

MECHANICAL Drawing successfully taught by mail. Fifty cents each lesson. No other expense. Easy payments. Complete outfit valued at \$20.00 free with the course. One hundred blueprint lessons. Will assist you to secure a position. Send for particulars and samples. Albany Institute Mechanical Drawing, Box 84, Department "A," Albany, N. Y.

BE a Safe Expert. Quickly learned, easy fascinating work; excellent pay. Write J. Hartmann, 213 21st St., Rock Island, Ill.

MAKE \$300.00 month reading plans, designing steel and concrete; no education required. Address Chief Designer C. Beeman, 94 Brighton, Detroit, Mich.

PAINT Signs! Instructions \$2.00. Address M. Gunderson, 643 Vanderbilt Street, Brooklyn, N. Y.

USED books, educational nature, sold, rented, bought, exchanged. Bargain list free. Lee Mountain, Dept. 66, Pisgah, Ala.

CARTOONISTS—Improve your style by following the work of the greatest cartoonists found in the bound volumes of Cartoons magazine. Eight volumes, each covering six months, Jan.-June, 1917, to July-Dec., 1920, inclusive. 1,200 cartoons, 900 pages to a volume, 7 by 9½ in., 3 in. thick. New books; durable and attractive binding. Sold separately at \$2 per vol. postpaid. Supply very limited. Send at once. Popular Mechanics Book Dept., 6 N. Michigan Ave., Chicago.

SLIDE Rule. Save 75% of the time used to multiply, divide, figure percentage, proportion, etc., lessons, instruction by mail. Rule with course. Write us for information. Buffalo Engineering Institute, Buffalo, N. Y. Licensed by the New York State Dept. of Education.

LINCOLN-JEFFERSON University. Home study in Academy, College, Theological, Law, Music, Pharmacy, Business and Graduate Schools, leading to degrees. Box W, 64 W. Randolph St., Chicago.

"WHAT to Invent for Profit" free. Patent News, N. Washington, D. C.

TELEGRAPHY

TELEGRAPHY—Morse and Wireless—taught at home in half usual time and at trifling cost. Omnigraph Automatic Transmitter will send, on Sounder or Buzzer, unlimited messages, any speed, just as expert operator would. Adopted by U. S. Govt. and used by leading Universities, Colleges, Technical and Telegraph Schools throughout U. S. Catalog free. Omnigraph Mfg. Co., 18 Hudson St., New York.

WANTED—Young men and women to learn Morse and Wireless Telegraphy. Railroads and Wireless Companies in great need of operators. We teach you quickly, and procure positions at big salaries. Great opportunities for advancement. All expenses low; can earn part. Write today for free catalog. School established 1874. Dodge's Telegraph Institute, "H" Street, Valparaiso, Ind.

WIRELESS

BUILD your own electrolytic storage battery Charger. Plates and complete instructions \$1.00. Descriptive circular free. Peerless Electrical Parts Co., 105 Harris, Rochester, N. Y.

RADIO OUTFITS AND SUPPLIES

TUNER, detector, two step amplifier, direct from Manufacturer, \$55.00. Elsewhere, \$85.00. Globe Radio, 462 East 148 St., New York.

COMPLETE Radio sets knocked down, less storage battery, with complete instructions and drawings for assembling. Have received stations 700 miles away. Very clear and distinct. Simple to operate. \$35 pre-paid. C. Mathews & Son, Newportville, Pa.

STORAGE battery plates, miniature, ¼x 2½ inches, lead wires attached. For test-tube "H" storage batteries. Write today for illustrations. J. A. Ritter, Lansdowne, Pa.

RADIO Parts Manufacturing Company, 2 Park Place, Detroit, Michigan, offer surprising values. See for yourself. You'll tell your friends.

AUDION Sets, complete with Detector tube, Eveready "A" & "B" batteries and Frost Phones, \$55.00. Two Step Amplifiers with tubes, \$50.00. Patented Radium-Jewell crystal receivers, with Murdock Phones and antenna complete, \$20.00. Money Back if not satisfied. Maker to user only. Trio Radio Laboratories, 9916 E. 14th St., Oakland, Calif.

"DIAMOND Lattice" Variometers and Variocouplers. The World's most efficient. Sharper tuning and greatly increased range, without distortion. They double the efficiency of any set. At dealers, or direct from factory, \$7.50 each. Diamond Radio Products, 140 W. Van Buren St., Chicago.

LOUD-SPEAKER, complete with special powerful unit—no extras to buy—\$12.50 postpaid. Standard Spirola cabinet type, compact, powerful, beautifully finished, absolutely no distortion or tininess—clear natural tone. Money-back guarantee. Catalog Free. Donnell Company, Box 70, Ann Arbor, Mich.

CRYSTAL Receivers \$3. Detector tube set \$15. Double ear phones \$5. Everything in Radio. Prices reduced. Ray, 326 5th Ave., New York, N. Y.

BUY direct from Manufacturer the wonderful Concertina for long distance and Loud-Speaker. Send for literature. Neveel Manufacturing Co., Kansas City, Mo.

CRYSTAL—Keystone famous diamond mounts, supersensitive, loud tones only. Money refunded if not satisfied. 25c postpaid. The Keystone Products Co., 168 Gardenia Ave., Royal Oak, Mich.

\$3.85 Loud Speaker, uses your headset or unit. Cabinet Spirola—loud, natural tone, compact, beautiful. Free circular. Donnell Company, Box 70, Ann Arbor, Mich.

RADIO Books—Send for our specially selected list of 20 leading volumes among the reliable radio publications and also our complete book catalog. They are sent free upon request. Popular Mechanics Book Dept., 6 N. Michigan Ave., Chicago.

RADIO-SPOT, latest puzzle, 15 cts. Nifty Radio set complete with aerial and pair 3000-ohm phones, \$8.75, prepaid. (Money back if not satisfied.) Nifty Nov. Co., Newark, N. J.

SPECIAL, Moulded Variometers and Variocouplers \$3.35. Crystal Receiver complete with headphones \$4.99. William A. Dickson, 407 East Fort, Detroit, Mich.

A VACUUM Tube Hospital. We repair vacuum tubes and guarantee them to work. Dealers, agents wanted. George P. Porell Co., Inc., West Somerville, Mass.

2 OZ. Galena ore 50c postpaid. Will make several crystals. Archie E. Beers, Beetown, Wis.

RADIO for the Amateur—Building, Installing, Operating Stations for Radio Communication treated simply in "Practical Amateur Wireless Stations," a 136-page book compiled by Editor of Wireless Age. 115 lbs. and diag. Size 6x9 in. Price 75c postpaid. Popular Mechanics Book Dept., 6 N. Michigan Ave., Chicago.

BUSINESS OPPORTUNITIES

MANUFACTURE These Biggest Selling Specialties in all lines. It's easy with Miller's Guaranteed Formulas and simple detailed Manufacturer's Instructions. No Machinery Required. Investment Small. Stamp brings valuable information and literature relative to Magic Windshield Cloth, Carbo-Cide, Amazon Rubber Repair, Launderite Washing Compound, Bluing Paddles, Mexican Yucca Soap, Concentrated Vanilla, Beverage and Food Flavors, Coconut Creme Custard and all latest Food Products. Not the cheap trashy recipes offered by others—but Guaranteed Manufacturer's Formulas, 26 years supplying the Best. Miller, Chemist, Tampa, Florida.

DISTRICT Managers seeking an opportunity to develop along larger lines, we can offer a splendid position selling our high-grade guaranteed silk hosiery from mill to wearer—all colors, both plain and with clox's. If you know how to handle men, a hustler yourself with a record that will stand investigation, you can make good. Write us immediately with full details of your past connections. Dyx Hosiery Company, 506 Lyric Bldg., Cincinnati, O.

ENTER a new business. Earn \$3,000 to \$6,000 yearly in professional fees making and fitting a foot specialty, openings everywhere, with all the trade you can attend to; easily learned by anyone at home in a few weeks, at small expense; no further capital required, no goods to buy, job hunting, soliciting or agency. Address Stephenson Laboratory, 11 Back Bay, Boston, Mass.

\$100,000 CORPORATION wants capable man; open office; manage sales for High Class New Device. Every Home a Prospect. Big money-making possibilities for the right man. Opening in every city. Cost \$2.00, retails \$5.00. \$500 to \$2,000 necessary to finance exclusive agency. Scott Corporation, 82 W. Washington, Desk G, Chicago.

IF you have about \$1,000 and capable of organizing sales force, to sell article needed by every merchant, wholesaler and retailer, which should net you \$10,000 profits first year, write Sales Director, 826 Reaper Block, Chicago.

EXCEPTIONAL Opportunity for Sales Manager capable of handling state distribution. Marvelous new Adding Machine. Retails \$15. Work equals \$350 machine. Tremendous possibilities. Unlimited profits. Write quick for details. Lightning Calculator Co., Dept. B, Grand Rapids, Mich.

RAISE guinea pigs. Pay better than poultry or rabbits; easy to raise; little space required. We guarantee market. Particulars and booklet how to raise free. Cavies Distributing Co., 3102 Grand Ave., Kansas City, Mo.

WE Start You in Business, furnishing everything; men and women, \$30.00 to \$100.00 weekly operating our "New System Specialty Candy Factories" anywhere. Opportunity lifetime; booklet free. W. Hilber Bagdale, Drawer 4, East Orange, N. J.

A HOME Factory—Sewing Ladies! Make all soft waterproof dolls. Complete outfit, formula for cheap rubber paint, patterns, art face stencils. Complete world and domestic selling methods \$3. Novelty Shop, Prairie du Chien, Wis.

AMBITIOUS Men, write today for attractive proposition, selling subscriptions to America's most popular automobile and sportsman's magazine. Quick sales. Big profits. Pleasant work. Digest Pub. Co., 9505 Butler Bldg., Cincinnati, Ohio.

RESPONSIBLE Corporation wants general sales managers to open branch office, manage salesmen. \$500 to \$5,000 necessary; expenses allowed to Baltimore if you qualify. Address Manager, 603 N. Eutaw St., Baltimore, Md.

EMBARK in good-paying business. No goods to buy. Wonderful proposition. Details free. Walk-Easy Co., Dept. B, 1702 Q St., Washington, D. C.

MAIL Order Business is your opportunity. Brenner's Famous Handbooks teach how to start small, grow big. Sell merchandise, service, ideas; enormous profits. Spare time to begin. Get complete set, 11 books, \$3.09, and be posted. Brenner, 335 Walnut, Philadelphia. Descriptive Catalog and big batch interesting mail order information, 25c. Note free.

BECOME a Landscape Architect. Digitized, exclusive profession not overrun with competition. Crowded with opportunities for money-making and big fees. \$5,000 to \$10,000 incomes attained by experts. Easy to master through our correspondence methods. Established 1914. Get information today. American Landscape School, 56-K, Newark, N. Y.

500 FORMULAS, Resilvering Mirrors—Renewing Dry Batteries—10 Luminous Paints, 25c. Ideal Book Shop, 5501-BL North Robey, Chicago.

608 WAYS to make money—2,716 Formulas "Encyclopedia Business Opportunities," 3 volumes, \$1. Ideal Book Shop, 5501-VL North Robey, Chicago.

BE your own Boss. Learn Shoe Repairing at Home. Be Independent. You cannot Fail with our Book of Instructions. Postpaid One Dollar. American Bench Shoemakers, Dept. 2, Aurora, Ill.

WANTED—Ambitious men to work at home. Entirely new business, local or mail order. Previous experience unessential. Ordinary man made \$15 day. Write immediately. Kraft, Box 896-PM, San Francisco, Calif.

DOLLARS yearly in your backyard. No Mushroom dope. Particulars free. Metz, 313 East 89th, New York, N. Y.

GET into the specialty manufacturing business. Amazing profits. We will send you free book explaining our system. Write immediately. A wonderful opportunity awaits you. National Scientific Laboratories, 211 North Monroe, Richmond, Va.

SILVERING Mirrors! My exclusive French Tartaric method opens enormously profitable business. Booklet free. H. Barstow, 514 23d Street, Oakland, Calif.

"**SCHEMER Magazine**," Alliance, Ohio, prints big profit schemes; one subscriber making \$25,000 from three; another \$10,000 from one. Try your luck. Year, only \$1.00; three months, 25c.

MARBLE mixing instructions, covering wood or cement flooring 1/2 inch thick, fire-proof, waterproof, low cost, sanitary, all colors. Particulars, 200 Illustrations free. Chris Mahler, Box 122, Huntington, N. Y.

LEARN the collection business. Good income, quick results. Interesting booklet, "Skillful Collecting," free. National Collectors Assn., Long St., Newark, O.

MAKE Money at Home making toys. We show you how. Send \$1 for complete working drawings and designs. DeKalb Designing Co., Dept. 6, Decatur, Ga.

CHEMICAL Expert will furnish Formulas and Trade Secrets. All times. Lists Free. W. L. Cummings, Ph.D., 228 Gordon Ave., Syracuse, N. Y.

\$2,400 UPWARDS Yearly—\$500-\$1,000 single deal—I've made it—others have—so can you the coming months. Mail check today for our New "Master Dealer Course" (Twenty Lessons—Six Easy Parts) and learn just how make real estate easy—safe—more profitable. Practical Inside Secrets, Plans, Methods, Suggestions, Precautions needed in Buying, Selling, Trading, Building, Improving, Advertising, Renting, Leasing, Insuring, Promoting. Was \$30.00, now only \$3.85 on money-back guarantee. Best Legal Forms and our \$5.00 Copyrighted Listing System included Free. Be posted. Write now. Stephens System & Service, Desk M, Muncie, Ind.

PAYS \$1,000 per month to real business men. Men of ability who can manage a remarkable business. We are going to open in many places. Commodity needed for centuries. You control. It's of highest possible character. Big and clean. We work with you. \$1,500 to \$2,500 investment required. Address Postless Products Company, Kankakee, Ill.

BE a Laboratory Expert. Earn \$300 to \$500 a month. Interesting Extension and Residential Courses. Diplomas and Degrees granted. Bacteriology, Urinalysis, Blood Analysis, etc., quickly and thoroughly taught. 46-piece Urinalysis outfit Free. Write today for free 34-page prospectus. Physicians & Surgeons College of Microbiology, Room 955, 2346 Burling St., Chicago.

GET in Business for yourself, we will start you in the radio business, the greatest business in the world, from which many fortunes will be made in the next few years. Very small capital starts you at once. Standard Electric Sales Co., 842 Broad St., Newark, N. J.

ATTENTION! You can have a business of your own. Establish and operate New System Real Estate Business, brokerage and insurance agency in your community. Office at home. Earn \$5,000 year. Representatives wanted everywhere. Send stamp free booklet. Hayes Realty Association, Cincinnati, Ohio.

PROSPEROUS Real Estate business of your own or position worth \$3,500? Our graduates have choice. Training at home prepares you in short time. We help you make good. Bulletin free. Penn Realty School, 1900 Ellsworth, Philadelphia.

SALESBOARD—800 Holes. Contains 14 fine steel, two-blade Pocket Knives. Transparent, indestructible handles, showing famous actresses, etc. Sizes to please all. Sells 5c or 10c punch, \$40 or \$80. Satisfaction guaranteed. Price \$16 prepaid. Or C. O. D. collect. Avery Graham, Box 1872, Denver, Colo.

I HAVE over 100 stores paying \$5 monthly maintenance. You can do the same in your City. Month's practice qualifies. Only one person in each City chosen. Midnight Alarm System, 6411 Mack Ave., Detroit.

MAKE Thousands of Dollars selling Fired-Process Oriental Pearl Necklaces; amazing new discovery supersedes all other pearls. Sell like wildfire. Address, McCallister, Importer, Phelan Bldg., San Francisco, Calif.

NICKEL-PLATING—Profitable sideline for repair shops, garages, hardware stores, etc. Complete instructions, blue print diagrams, One Dollar. Webster Engineering Co., Webster Groves, Mo.

ADVERTISE Country town newspapers. List free. Pennell Company, Covington, Kentucky.

MANUFACTURE Extracts, and other necessities, 200% profit; we tell you how. Write White Manufacturing Drug Co., 1426 Laidlaw Ave., Cincinnati, O.

START a cleaning, pressing, dyeing shop. Splendid field, big profits. Plans free. International Systems, Dept. 19, Excelsior Springs, Mo.

BIG money; unlimited possibilities; formula, trade secret business. Co-operative Service Bureau, Kokomo, Indiana.

SALESMEN! Make big commission on special lists. Write D. H. Meeus, Prairie du Chien, Wis.

START in business. Samples and stock 15c. Cochran, Graysville, Ohio.

PATENTS—Write today for Free Instruction book and Evidence of Conception blank. Send sketch or model for examination and opinion; strictly confidential. No delay in my offices; my reply special delivery. Reasonable terms. Personal attention. Clarence R. O'Brien, Registered Patent Lawyer, Southern Bldg., Washington, D. C.

PATENTS Procured. Trade Marks Registered. A comprehensive, experienced, prompt service for the protection and development of your ideas. Preliminary advice gladly furnished without charge. Booklet of information and form for disclosing idea free on request. Richard R. Owen, 30 Owen Bldg., Washington, D. C., or 2276 R. Woolworth Bldg., New York.

GOOD money easily earned at home, spare time silvering mirrors; no capital. Free instructive book tells how. Patterson & Co., Brookville, Ky.

STATE and County Managers with car and small capital make \$100 to \$150 weekly distributing Humidifiers. Exclusive rights. Address Gunther, 2337 American, Long Beach, Calif.

MAKE \$50 to \$75 weekly. Become Expert Advertising Writer. Earn while you learn. Write today. Address Cole, 342 Pacific, Long Beach, Calif.

BE Prosperous. Learn Plating, Automobile Painting, etc. Particulars Free. Borick, 427 Carroll St., Akron, Ohio.

FREE—Formula Catalog. S. & H. Laboratories, Boylston Building, Chicago.

OPEN Clothes, Hat Cleaning and Pressing Establishment. Easy cleaning methods make clothes, hats, etc., look like new. Wonderful opportunity. Particulars free. Address Byron, 27, Sta. I., New York.

I MADE \$30 a Week Home. French Breadmaking. 15 years' experience; Free Booklet tells. Ashbrook, 67, Marengo, O.

SIGNS, Cards, Banners, easily painted with letter patterns. Samples free. Address Outdoor Adv. Service, Lockport, N. Y.

GOLDEN Coin Mail Order Plan. A real moneymaker. Send stamped envelope for particulars. Johnson Bros., 5319 Princeton Ave., Chicago, Ill.

MAKE money with your camera. Booklet free. B. Lancaster, Box 967, Los Angeles, Calif.

CHRISTMAS Money—\$5 to \$300 easily made. Write today for particulars. Flomar, 2530 Drake, Chicago, Ill.

53 GREAT Money-Making Plans Free. Universal Bureau, Boston (XI), Mass.

BUILD Bigger Business through "Agents Wanted," "Salesmen Wanted," or "Business Chances" advertisements in Sunday newspapers. Lists free. Sun Advertising Agency, 1591 Arden Bldg., St. Louis, Mo.

MADE \$600.00 on one deal without dollar of investment; let me show you how to make money the Tyraplan Way of building and financing homes. Need not interfere with your regular work. Tyraplan Corp., Minneapolis, Minn.

AMBITIOUS People \$8.00 day easy made. Plan 10c. Peters, 12 Harrison Avenue, Gardiner, Maine.

PREPARE—Sell Your Own Products—Formulas, trade secrets. Interesting catalog free. B. Thaxly Co., Washington, D. C.

CONVERT each spare moment into cash. My dignified methods requiring no merchandise nor peddling, will enable you to increase your income, tremendously, without study, capital, experience or delay. Stokely, Box 198, Dallas, Texas.

"**HOW** to Sell Patents" free. Patent News-H., Washington, D. C.

"**BACK** to Mining" with \$5; only 100 in the bunch, and you own the property. No promoters, no commissions. Send for particulars, blue prints and bank reference. H. F. Christenson, Prop., New Western Hotel, Denver, Colo.

"**WHAT** to Invent for Profit" free. Patent News-C., Washington, D. C.

CHEMISTRY

YOUR chemical problem solved and working formula furnished, five dollars. Write Me. W. Stedman Richards, Consulting Chemist, Box 2462, Boston, Mass.

FOR accurate chemical analysis, sample matching, and reliable formulas at reasonable rates, write Somers Laboratories, 169 N. Wells, Chicago, Illinois.

TRUSTWORTHY Chemical Advice and Information. Consulting Chemists, Little Falls, N. J.

CHEMICAL Analysis. Chemical and Industrial Formulas. Bursons Chemical Laboratory, 227 West Fourth, Ottumwa, Iowa.

FORMULAS AND TRADE SECRETS

STOP Tobacco. No Pills. Harmless. Formula 50c. Agents, order today! Bonanza Wallie Barnes, Fort Wayne, Ind.

3,500 FORMULAS. Moneymakers. 409 pages. \$1. Bestovall Laboratories, 4049-EL, North Whipple, Chicago.

800 FORMULAS 25c; Luminous Paint—Resilvering Mirrors—Renewing Dry Batteries—Mechanics Soap—Gas Tonic—Carbon Remover—Pumeture Plugger, 20c each. Entire collection 50c. Ideal Book Shop, 5501FL North Robey, Chicago.

FORMULAS of the better sort. Write for our free catalog. National Scientific Laboratories, 211 North Monroe, Richmond, Va.

FORMULAS—Guaranteed. Catalog free. Bestovall Laboratories, 4049-FL, North Whipple, Chicago.

FORMULA catalog free. C. A. Lutz, Apartment 464, York, Pa.

10,000 SELECTED Scientific, chemical, technological and practical recipes and processes including hundreds of so called trade secrets for every business alphabetically arranged in one large volume of 800 pages. Price \$4, postpaid. Popular Mechanics Book Dept., 6 N. Michigan Ave., Chicago.

1,000,000 FORMULAS. 1016 pages, \$2. 500 Formulas Free if you order quick. Ideal Book Shop, 5501-ML North Robey, Chicago.

5,000 FORMULAS. \$1.25. See our advertisement on page 30. Wells & Edwards, Booksellers.

FORMULA Catalog—Free. Any formula, 50c. Allen's Enterprises, 1227 Milwaukee Ave., Chicago, Ill.

CUT coal cost. Make coal saver, coal substitute, artificial coal. Eight selected secrets, \$1.00. Particulars, address, Garret Simms, Lake, New York.

20,000 RELIABLE formulas, 10c each. See also our information adv., page 50. Address General Information, Ann Arbor, Mich.

1,000,000 FORMULAS, recipes, trade secrets—1016 pages, \$2.00. Hillside Laboratories, 7621-A So. Winchester, Chicago.

FORMULAS—Candy-making formulas, 6c. Cloth, \$1.00. Address, Flavcan, 1124 Howard, San Francisco, Calif.

MORE Light—It's cheaper to make your own Gas Mantles by our process. Instructions, fifty cents. Address H. and M. Specialty Co., Box 66, Brighton, Mass.

FREE—Formula Catalog. S. & H. Laboratories, Boylston Building, Chicago.

REBLUE your gun barrels, complete recipe and instructions for \$1.00. Oscar Bentz, Wauwatosa, Wis.

BEST tonic formula free for Dr. R. O. K., Canton, Ill.

AGENTS WANTED

AGENTS—At last, big money maker; sample case free; contains 18 articles of pure food flavors, soaps, perfume, toilet goods, etc.; sell in every home; large profit on every sale; Edith Haut made \$34 in one week; Dora Kraft made \$24 in spare time; Wm. Turner placed an order for \$100; Anna Lockray made \$4 an hour; Geo. Oates took order for \$72 in one week for flavors and perfumes; all big sellers; every woman buys; sell every day in the year; big repeat business; have a steady income; order your sample case today and make some real money and build up a big business. American Products Co., 7906 Amer. Bldg., Cincinnati, O.

LARGE Shirt Manufacturer wants Agents to sell complete line of shirts direct to wearer. Exclusive patterns. Big values. Free samples. Madison Mills, 503 Broadway, New York, N. Y.

MONEY—Money—Money! Make it selling Hanslick, the new and unbeatable hand soap! Removes grease, grime, ink, paint, etc., without injuring skin. Spreads like wildfire. Cheaper than all others. Sells in cans (or bulk with dispensers) to garages, autoists, auto supply companies, mechanics, factory and office folks, to housewives, hardware stores. Huge quantities used weekly by mercantile houses. Big repeat business assured. Exclusive agencies, crews working for you, fast sales, splendid profits, permanent business for hustlers. Live ones can clean up \$500 a month. Send 10c (coin or stamps) for liberal sample can. Complete sales plan goes with it. Write quick to Solar Products Co., 124 W. Lake St., Chicago, Ill.

AGENTS—Send for sample "Fretnot"—the washday wonder. Be convinced you can do a whirlwind business. You can clear at least \$20 to \$100 weekly, according to spare or whole time. You don't have to talk; if she doesn't buy at sight, leave sample; she will be looking for you long before you are able to make the rounds again. Samples furnished free. Premiums for your customers. Exclusive territory guaranteed to agents who can produce. Credits given. Don't call. P. M. Motter & Sons, 20 E. Jackson Blvd., Chicago.

300% PROFIT—Sells like Wildfire. Kleen-Rite Magic Washing Compound. Washes Clothes Without Rubbing. Sells for 25c. You can make 15c. Sales guaranteed. "Distributing Samples Free." Premium Plan gets business. Exclusive territory. Write quick for proof and free sample. Restover Products Co., 1941-K12, Irving Park, Chicago.

AGENTS Wanted—\$4.00 to \$10.00 daily taking orders for "Super" and "Junior" Fyr-Fyter Extinguishers on our new Sales Plan. Commissions paid cash daily. Everyone who owns anything that will catch fire is a live prospect. Homes, farms, auto-owners, schools, churches, factories, all need them. Sell on sight. Sales limited only by calls you can make a day. Write today for exclusive territory and free booklet. "Building a Permanent Income as a Fyr-Fyter Representative." Fyr-Fyter Co., 1283 Fyr-Fyter Bldg., Dayton, Ohio.

WANTED—Tailoring Sales Agent—Make big money from very start—\$60.00 to \$75.00 weekly. Largest made-to-measure tailoring house, furnishing an equipment of five hundred workmen, wants you to take orders. Satisfaction guaranteed. Biggest merchants in many towns have started with our line. If you want to establish yourself permanently in business and make big money write for full particulars, giving your experience as salesman or tailor's sales agent. H. F. Foster, Sales Manager, Lock Box 483, Chicago.

AGENTS, Salesmen, Demonstrators, you will have the devil's own time trying to find a better seller than "Zippe." If there was such a thing we'd have it. 150% profit on 50c "Go Getter" repeat article that sells on ten second demonstration. Works While You Watch It. Demonstrates value, while others waste time making claims. New Discovery! Greatest Scientific Triumph of the age. It's the berries. Haven't room to tell our story here. Write immediately. Karam-Smith Co., 612 Clark St., Fort Wayne, Ind.

AGENTS—\$60 to \$200 a week. Free samples gold and silver sign letters for office windows, store fronts and glass signs of all kinds. Anyone can put them on. No experience necessary. Big demand everywhere. Over 500% profit. Fred Foley, Birmingham, N. Y., made \$485.00 first month. Albert Gibbons, Kansas City, made \$212.00 in ten days. Liberal offer to general agents. Write today for sample of our high-grade window letters. Address, Metallic Letter Co., 431-C North Clark St., Chicago, Ill.

AGENTS—\$85.00 weekly is a small income if you sell the Eradium (Luminous) Crucifix. Every Catholic will buy for \$2.00. Costs 84c. Your profit 140%. Demonstrating Case free. All homes can use Luminous Switch Plates, Bulbs and House Numbers. Quick easy sales that bring big money. The Pioneer Corporation, 6301 Yale Ave., Chicago.

\$5 TO \$15 Daily Easy—Introducing New Style Guaranteed Hosiery. Must wear or replaced free. No capital or experience required. Just show samples, write orders. Your pay in advance. We deliver and collect. Elegant outfit furnished all colors and grades, including silks—wool and heathers. Mac-O-Chee Mills Co., Desk 10612, Cincinnati, O.

A WONDERFUL Seller! Any man, woman, boy or girl can make big wages. Some agents make from \$8.00 to \$20.00 per day. Crimp Grip Clothes Line Fasteners are a simple, time-saving device for holding a rope—also used for many other purposes. It pays for itself quickly in time saved on wash days. No knots—it fastens and releases quickly. Every home a prospect. Every housewife who uses Crimp Grips—and there are thousands of them—is a booster. There is but one Crimp Grip. Write for particulars, or send 50c for one pair and a mounted sample, with full particulars to agents. Crimp Grip Company, Belvidere, Illinois.

AGENTS—Make \$60 to \$100 weekly selling Coffield Tire Protectors. Prevents punctures and blowouts, doubles mileage. Easily applied; no cement or tools required. Absolute 3-year guarantee. Big commissions. Lansing made \$562. Ackerman \$519 last month. No capital required. Coffield Tire Protector Co., 283 Court St., Dayton, Ohio.

IMMENSE Holiday Trade—Sell Beautiful Gift Boxes containing high-grade "Velva" Toilet Preparations. Both men and women are delighted. Distinctive box for each. Pleases the most fastidious, yet very reasonable in price. Sure Sellers. Profits Big. Now's the time. Get details today. Duoform Co., Dept. H-1, Attica, N. Y.

CENTRAL Indiana Manufacturers now marketing an entirely new auto accessory that makes night driving safe, eliminating glare from approaching headlights. Want general sales managers to open branch office, handle exclusive territory and manage salesmen. Some investment necessary. Profit possibilities practically unlimited. Ray Auto Filter Co., Marion, Ind.

AGENTS—\$15 a day—Easy, quick Sales—Free Auto—Big weekly Bonus—\$1.50 premium Free to every customer. Simply show our Beautiful 7 piece, Solid Aluminum Handle Cutlery Set. Appeals instantly. We deliver and collect. Pay daily. New Era Mfg. Co., 803 Madison St., Dept. 21-F, Chicago.

BIG Money-Makers. Large factory offers you big profits. Over 200 fast sellers. Toilet gift sets, flavoring extracts, remedies, soaps, bring you \$8.00 to \$25.00 daily. Howe of Illinois makes \$4.00 an hour. Sample outfit free to workers. Lincoln Chemical Works, Dept. 155, 2956 No. Leavitt, Chicago.

\$195 EARNED by Schleicher in first twelve hours. Self-selling proposition establishes new money-making records. Automatic hot or cold running water bath equipment, without plumbing or waterworks, only \$7.50. Exclusive territory. Investigate. Send no money. Terms. Write today. Allen Mfg. Co., 678 Allen Bldg., Toledo.

MEN wanted to call upon the Cigar, Periodical, Gents' Furnishing and Variety Stores, with a new novelty in great demand by every man. \$25.00 to \$40.00 per day clear profit. Sells at sight. Exclusive territory if desired. Send 25c for sample and illustrative literature. Joseph E. Miller, Inc., 43 Sabin Street, Providence, R. I.

AGENTS—If you are making less than \$300 a month our proposition on Sentinel Burglar Alarms for windows and doors will interest you. Many agents earn \$20 daily. Brand new inventions. No wires, batteries or nails. Instantly attached to any door or window. Handsomely nickel plated. Sell on sight. No competition. Provides cheap burglar insurance. Big money makers. Write today for extremely liberal terms to agents. Sentinel Alarm Co., 140 S. Dearborn St., Chicago, Ill.

EVERY Raincoat Agent should get our proposition at once. If you have never sold raincoats and waterproofed overcoats now is the time to start. Any man able to talk is able to sell raincoats. Write for our "profit sharing, collective buying, superior quality" offer. Associated Raincoat Agents, Inc., 448-A North Wells, Chicago.

\$5 TO \$15 Daily Easy—Introducing New Style Guaranteed Hosiery. Must wear or replaced free. No capital or experience required. Just show samples, write orders. Your pay in advance. We deliver and collect. Elegant outfit furnished all colors and grades including silks—wool and heathers. Mac-O-Chee Mills Co., Desk 10612, Cincinnati, O.

\$8.00 TO \$20.00 per day. A wonderful seller. Any man, woman, boy or girl can make big wages Selling Crimp Grip Clothes Line Fasteners. It is a perfect rope holder and can be used for many purposes. Crimp Grips are a simple, time-saving device. They last a life time and will not rust; it holds the line tight, and saves time on wash days. Every buyer is a booster. Send 50c for Mounted Sample and one pair of Crimp Grip Clothes Line Fasteners. Write for particulars. Crimp Grip Company, Belvidere, Illinois.

AGENTS—Earn \$25 to \$100 weekly introducing Ho-Bo-Co. toilet goods, extracts, and household necessities. Men or women wanted for full or spare time. Ho-Bo-Co. Toilet and Medicated Skin and Scalp Soap are great profit makers. Repeat orders easy and sure. Over 100 other fast sellers. Free sample case offer; free samples and advertising matter. Write today. Ho-Bo-Co. Mfg. Co., 188 Locust St., St. Louis, Mo.

CLEAN up \$100.00 weekly from now till Christmas with "Nifty Nine." Weekly average 100 sales—dollar profit each. 30-40 sales daily frequently made. Demonstrating out-clinches order. 30 other coin-coaxers. All ideal for Christmas gifts—several at each house. Big rush now starting. Get free sample outfit offer. Postal brings our unique plans. Davis Products Co., Dept. 506, Chicago.

AT Last—World's Greatest Adding Machine. Almost human. Retail \$15; work equals \$300 machine, \$500 monthly easily made, demonstrating to stores, offices, garages, factories. Simple, easy; adds, subtracts, multiplies, divides, automatically. Speedy, accurate, durable, handsome. Five year guarantee. Tremendous demand; amazing profits. Liberal trial offer. Protected territory. Write quick. Lightning Calculator Corp., Dept. F, Grand Rapids, Mich.

SALESMEN—Agents! Unusual opportunity, \$50 to \$125 weekly. Semi-automatic double vacuum washers, easily attached to tub. No cleats or posts; air pressure and suction. Superior to power machines in many ways. Easily carried; sells on sight. Guaranteed success. Selling plans, advertising free. Extremely liberal terms. Write Burlingame Mfg. Co., Dept. 2, Syracuse, N. Y.

EASY to pick up Several Extra Dollars a Day with our new Prohibition Novelty, "The Season's Best Seller." Take orders or carry stock with you. One item only, a pippen! Full particulars on request. Address Mr. Day, care Lee Importing Co., Box 166, G. P. O., New York City.

PORTRAIT agents earn big money selling our Photo medallions. Photo medallion clocks, Religious medallions, Photo pocket mirrors, Photo buttons, Photo jewelry, and Fraternal Photo medallions. Send for free catalogue. Satisfaction guaranteed. Four-day service. Address Gibson Photo Jewelry Co., Apartment 7, 608 Gravesend Ave., Brooklyn, N. Y.

AGENTS—\$6 a day. Take orders for Reversible Raincoat. Two coats in one. Latest style. Made in our own factory. Guaranteed. You take orders; we ship and collect. Pay you daily. Sample coat furnished. Write today. Liberty Mfg. Co., 880 Liberty Bldg., Dayton, Ohio.

GOOD Housekeeping Magazine has endorsed these, No Clog Salt and Pepper Shakers, Silver plated cap, instantly clearing clogged holes. Patented. Agents, Salesmen, imagine possibilities. Send 50c deposit, sample set, bonafide selling proposition. Address Mr. Kelly, Metal Products Co., Room 421, 30 Church Street, New York.

AGENTS: Enormous Profits, Permanent Repeat Business, exclusive territory, selling highest quality products at low prices. Coconut Oil Shampoo retails 56c bottle, costs \$1 dozen. Soaps, Perfumes, Extracts, etc. Address P. Verdina Company, 16 E. 13th, N. Y.

AGENTS—6,000,000 Ford's need our 25c "Greater Grip." Guaranteed 5,000-mile Fabric Fan Belt. Address Teuscher & Son, St. Louis, Mo.

27,000 RECORDS guaranteed with one Everplay Phonograph Needle; new—different; cannot injure records; \$19.00 daily easy. Free sample to workers. Everplay, McClurg Bldg., Desk 126, Chicago.

SALESMEN, Act Quick. Ten patented auto necessities. Spark plugs, visors, windshield cleaners, hose clamps, etc. Generous commissions. Jubilee Mfg. Co., 33 Sta. C, Omaha, Neb.

AGENTS—Six new fast-selling necessities; big demand; unique selling plan; makes dollar an hour; credit given; samples free. Consolidated Portrait Co., Desk E, Chicago.

WORLD'S fastest agent's seller. 300% Profit. Needed in every home and store. Establish permanent business. Premier Mfg. Co., 813 E. Grand Blvd., Detroit, Mich.

"AUTHENTIC Life of Henry Ford"—Amazing, thrilling, fastest selling book. Be first. \$100 weekly easy. Free outfit. Hortal Co., 9 So. Clinton, Chicago.

AGENTS: Big profits. Best and cheapest window letters made. Easily applied. Dime brings five samples. Particulars free. Stalbritte Co., 1115 Second Ave., New York.

A BUSINESS of Your Own—Make sparkling glass name plates, numbers, checkerboards, medallions, signs; big illustrated book Free. E. Palmer, 511, Wooster, O.

AGENTS make 500% profit handling Auto Monograms, New Pictures, Window Letters, Transfer Flags, Novelty Signs, Catalog Free. Write Hinton Co., Star City, Ind.

POLISHING Cloth—easy seller, big money. Hundred other tiptop specialties. Get this proposition. Address Newton & Co., 82 Main Street, Newark, N. Y.

EVERYBODY uses extracts. Sell Duo Double Strength Extracts. Complete line household necessities. Big repeaters. Write today. Duo Co., Dept. E1, Attiec, N. Y.

HOUSEHOLD and office necessity, endorsed by "Good Housekeeping." An article of daily use. Large profits. Everett & Barron Co., Providence, R. I.

LIVE Agents. Every call a sale. Act quick. Best seller on market today. 100% profit. Sylph Laboratories, 514 Marquette Bldg., Chicago.

AGENTS—Make 100%. Toilet articles, Perfumes, Extracts, Household necessities. Sample Case Free. LaDerma Co., Dept. A, Main and Walnut, St. Louis, Mo.

BIG Agent's and Mail Order Magazine of Opportunities and Information, including "Supply" Guide; three months, 25c. Harvey Teple, Decatur, Indiana.

LARGE manufacturer wants agents to sell guaranteed made to measure raincoats, Gabardines and Reversible top and raincoat combined. Make \$75 to \$100 weekly. Profit in advance. We deliver and collect. Outfit free. Standard Raincoat Co., 163 West 21st Street, New York, N. Y.

BIG Profits Selling New \$3.50 Automatic Adding Machine. Absolutely accurate. Fully guaranteed. Quick sales. Ten daily easy. No competition. Pocket size. Business people everywhere positive customers. Thousands being sold. Tremendous demand. Here's high-grade money-maker. Bassett Co., 1458-L, Hollywood Ave., Chicago.

AGENTS, Distributors, Energetic men every city, can earn \$50 to \$100 weekly selling new line household specialties. Start at once; large demand; sell on sight. Big Three Money-Maker sent free; selling instructions, folders furnished. The Fernald Company, North East, Pa.

AGENTS—\$1.25 an hour spare time special advertising and showing samples. Get our big sample assortment free. Tea, coffee, spices, extracts, baking powder, food products, things people eat, 240 fast sellers, Big profits. Exclusive territory. Dept. 30, Harley Company, Dayton, Ohio.

PATENTS—Write for our free illustrated guide book and Evidence of Conception Blank. Send sketch or model for our opinion of its patentable nature free. Highest references. Prompt attention. Reasonable terms. Victor J. Evans & Co., 163 Ninth, Washington, D. C.

IF you need good live agents—fellows who can get the business—ask me how others are doing it. I'll gladly render the necessary assistance. J. Roy McClellan, Mgr. Classified Advertising, Popular Mechanics Magazine, Chicago.

EASY, pleasant work for Mechanics. Shop Men, Clerks, during spare hours; will add many dollars to their salaries. Also want persons who can give full time. Big wages assured. Novelty Outfitters Co., 67 Bar St., Canton, O.

AGENTS: Get your money on the spot. \$16 daily demonstrating Sereenolas. No waiting for commission or salary checks. No delivering. No collecting. Big season just starting. Write or wire. Perry Ludlow Co., 8-1962, Dayton, Ohio.

AGENTS make \$10 daily—Big line guaranteed extracts, food products, perfumes, toilet goods, household necessities. No capital or experience needed. Free sample case and instructions. Write for amazing offer. Perkins Products Co., Desk 6, Hastings, Neb.

CLARKE made \$18 an hour selling vest-pocket windshield cleaner needed by every autoist, motorman, engineer; one rub keeps glass clear 24 hours; 60,000 sold; amazing proposition free. Security Mfg. Co., Dept. 627, Toledo, Ohio.

AGENTS—Enormous profits selling Genuine Gold Leaf sign letters. Guaranteed not to fade. Establish a permanent business or travel. Anybody can do it. Free samples. Guarantee Sign Service, A 430 South California Ave., Chicago.

AGENTS—Stamping names on Pocket Key Protectors; sample check with your name and address, 25c. Stamping Outfits, Emblem Checks, Check Fobs, Name Plates, Hart Mfg. Co., Desk 2, 303 Degraw St., Brooklyn, N. Y.

AGENTS wanted to take orders for our custom-made Raincoats, Gabardines; \$75 to \$150 weekly easily earned. Commission in advance. We deliver and collect. Outfit free. Universal Raincoat Company, 607 Broadway, New York.

AGENTS—Genuine Gold Letters anyone can put on Store Windows. Guaranteed to not tarnish. Large profits. Enormous demand. Free samples. Write today. Genuine Gold Letter Co., 429-A North Clark, Chicago.

AMBITIOUS Men, write today for attractive proposition, selling subscriptions to America's most popular automobile and sportman's magazine. Quick sales. Big profits. Pleasant work. Digest Pub. Co., 9565 Butler Bldg., Cincinnati, O.

SELL Wall Emblems. Every lodge member wants one. Make big money. Write for free sample cash bonus plan. Kier Emblem Co., Dept. PM-11, 538 S. Clark St., Chicago.

AGENTS—Clever Invention! Inkspoon makes every pen a fountain pen. Fast office seller; big profit, demand increasing everywhere. Exclusive territory offered. Sample free. H. Marui Company, Tribune Bldg., New York, N. Y.

AGENTS—Men, women, to sell Pure Silk Hosiery direct to wearer. Commissions paid daily. Full commission on all repeat orders. We deliver and collect. Write Norwalk Hosiery Mills, Norwalk, Conn.

OUR Agents make \$25 to \$50 daily and are getting it with New Marvelous Invention. Sells to everybody; low price—pocket outfit. Write Suren Co., 25 N. Dearborn St., Chicago.

AGENTS—Sell Patented Cigar Lighters and Cigar-Case Moisteners. Big Profits. Start making money at once. Write for circulars, cuts and sales plan. Drake Mfg. Co., Dept. M., Milwaukee, Wis.

MAKE 600% Profit. Free Samples. Lowest priced Gold window letters for stores, offices. Anybody can do it. Large demand. Exclusive territory. Big future. Sideline, Acme Letter Co., 2800-D, Congress, Chicago.

PORTRAIT Agents make more money. Better work, lower prices, quicker service. Also fine line of medallions, chromos, frames, etc. Catalog free. Linder Art Company, 547-557 W. Washington St., Chicago.

AGENTS—Crew men, novelty men, Gloo-Pen, a 50c mucilage fountain pen; everybody buys on demonstration. Write for big profit plan. Gloo-Pen Co., 56-FF Pine St., New York.

AGENTS make a dollar an hour. Sell Mendets, a patent patch for instantly mending leaks in all utensils. Sample package free. Collette Mfg. Co., Dept. 404-B, Amsterdam, N. Y.

AGENTS, \$25.00 a week for spare time. Suits \$13.45, pants \$3.45 up. Money-back guarantee. Guaranteed Quality. Line well known. Samples free. Write Chicago Tailors Association, Dept. 106, Chicago.

\$1,000—BEFORE Christmas. You can make it. No experience necessary. Rapid selling \$4.69 household necessity, wonderful gift. You sell, we deliver, pay daily. Eastern Kewware Co., Franklinville, N. Y.

MOST Wonderful Seller. 96c profit every dollar. No stock to carry. License unnecessary. Sample free. Mission, 3421-MP, Smith, Detroit.

MEN'S Shirts. Easy to sell. Big demand everywhere. Make \$15.00 daily. Underseil stores. Complete line. Exclusive patterns. Free samples. Chicago Shirt Co., 9 So. Clinton, Factory 205, Chicago.

WANTED—Representative to sell Automobile necessity. Kills headlight and sun glare. Write for sample. Dept. P, The Clark Products Co., Springfield, Ohio.

SELL Necessities. Everybody needs and buys the "Business Guide." Bryant cleared \$800.00 in July. Send for sample. It's free. Nichols Co., Box 4-B, Nagerville, Ill.

AGENTS—Best seller: Jem Rubber Repair for tires and tubes; superseded vulcanization at saving of over 800%; put it on cold, vulcanizes itself in two minutes, and is guaranteed to last the life of the tire or tube. Sells to every auto owner and accessory dealer. For particulars how to make big money and free sample, address Amazon Rubber Co., Amazon Bldg., Philadelphia, Pa., Dept. 565.

AGENTS, Demonstrators Making \$20 Daily selling newly patented E-Z-4-in-hands, latest, most novel Men's Neckties ever put on market. Styles take big; sell on sight. Double your money. Send \$1.00 for three trial samples. Write quick for territory. E-Z-4 Manufacturing Co., Suite 1501, 320 Broadway, New York.

TAILORING Agents—We've got a wonderful line of all-wool tailored to order suits and overcoats to retail at \$29.50. They're all one price. \$20 cheaper than store prices. You keep deposits, we deliver and collect. Protected territory for hustlers. Write J. B. Simpson, Dept. 323, 831-843 W. Adams, Chicago.

AGENTS—Full or spare time, selling guaranteed all silk white pongee shirts, direct to consumer; splendid Christmas offering. Agent's price \$2.50 with collar; money back if dissatisfied. Free sample. Pongee Shirt Co., 418 4th Ave., New York, Dept. C.

\$50,000 PICTURE Man Friedman made taking orders. Beginners can make \$100.00 weekly with my canvassing spiel, experienced men make more. Free circular. "Profits in Portraits," explains. Samples free. Picture Man Friedman, Dept. 8, 673 Madison, Chicago.

WHY work for others? Make and sell your own goods. We show you how. Enormous profits. Write quick for free book explaining everything. National Scientific Laboratories, 211 North Monroe, Richmond, Va.

AGENTS: Cost \$5.00, your profit \$89.50, transferring monograms on autos, trunks, bags, furniture, etc. No experience, no license. Write for free samples. Transfer Monogram Co., Inc., 10 Orchard St., Dept. 151, Newark, N. J.

SELL the latest nationally approved cooking utensil, the Squire Broilet. Sells on sight. Convenient to carry and show. \$99 profit weekly easy for live agents. Get full details from A. A. Squire Mfg. Corp., 280 Madison Ave., New York.

YOU can be your own boss with our Key Check outfit. Good for \$5 a day stamping names on pocket key checks, fobs, etc. Sample check with your name and address, 20 cents. Press Die Works, Dept. M, Winchester, N. H.

GALLAGHER made \$334.00 in one week selling guaranteed Collection Systems, used by all business men. Sayers Mfg., 2815 Sheffield Ave., Chicago, Ill.

AGENTS: Big Returns, fast office sellers; particulars and samples free. One Dip Pen Co., 2 Daily Record, Baltimore, Md.

RUMMAGE sales make \$50.00 daily. We start you. Representatives wanted everywhere. Permanent business. "Crosby Co.," 609 Division St., Chicago.

WE start You Without a Dollar. Soaps, Extracts, Perfumes, Toilet Goods. Experience unnecessary. Carnation Co., Dept. 201, St. Louis.

FIFTY "Ideal" Sidelines for Mail Dealers and Agents. 500% profit. K. Homo, 1957 Warren, Chicago.

TOBACCO Conquerer Tablets quickly overcome tobacco habit or money back. Harmless; inexpensive. Details free. Peerless Pharmaceutical Co., 168 Syracuse, N. Y.

FREE Sample "Rain Shield Wiper." Retail \$1.00—Costs You 25 Cents (300% Profit). Every Autoist Buys Quickly. No Cloth. No Paste. No Mechanical Attachment. (1) Rub keeps Windshields clear 48 Hours against Rain, Snow Storms, Invention Just Out. Prevents Accidents. (Williams makes \$12 Hour.) Experience unnecessary. Wonderful Pocket Sideline. Write Quick for Your Free Sample. Nu-Life (B) Corporation, Hartford, Conn.

AGENTS: Wonderful Sellers—Men's Diagonal Gas Mask Raincoats "Goodyear Brand" costs you, dozen lots up, \$1.80 each. Women's, \$2.00; Children's, \$1.65. Rubberized Aprons, \$3.00 per dozen, and Wonder 3 in 1 Bag, \$3.25 per dozen. Order samples now. Biggest season coming. Profits unlimited. Goodyear Garment Mfg. Co., 202 East 12th St., New York, N. Y.

AGENTS: Winter is coming. Good profits selling Beacon Indian Blankets, Traveling Robes or Motor Robes, Bathrobe Blankets and Jacquard Comfortables. Beacon Blankets make warm friends. Send \$5.00 for sample, specifying which is wanted. No catalogues. Mountain State Specialty Company, Inc., 1146-1148 Water St., Wheeling, West Va.

GOOD income, spare time, refinishing chandeliers, brass beds, automobiles, etc., by new method; producing amazing results; every household possible customer; experience unnecessary; simple plan of manufacturing at home starts you in big money-making business. Write for free samples, showing finishes, etc. Gunmetal Finish Co., Ave. H., Decatur, Ill.

GOOD Profits handling Beacon Indian Blankets. 65 x 80, \$4.00; 66 x 80, \$5.00. Samples sent post paid upon receipt of price. Mountain State Specialty Company, Inc., 1146-1148 Water Street, Wheeling, W. Va.

WANTED—Men and women to sell our printed cards, social and business stationery. Special drive in Xmas cards. Big commissions. Write Forman Printery, Dept. X, Plantsville, Conn.

\$36.00 PROFIT on \$1.50 outfit; gold initials for automobiles, etc. Address National, Station D, Brooklyn, New York.

FREE Booklet. Start little mail order business. Home employment evenings. Pier, Dept. 5A, 74 Cortland Street, New York, N. Y.

CHEAPEST guaranteed Seed Corn Sheller on market. Sample, 40c. Agents wanted. Star Supply Company, Lima, Ohio.

AGENTS wanted to sell our line of rubber belts for men and women. Sell at eight at 25 cents each. Over 100% profit. Much more durable than leather. Particulars and sample any style postpaid. 25 cents. Banner Rubber Company, Nankin, Ohio.

ADJUSTABLE Kuff Buttons are sensational sellers—automatically open and close cuffs, when sleeves are raised or lowered—great convenience. Big money maker. Flexo Mfg. Co., Sheboygan, Wis.

CALIFORNIA Rosebuds selling like hot cakes. Agents coming money; new stuff. Big profits. Catalog free. Mission, 2421-PM Smith, Detroit.

AGENTS, control territory, Edjol Flavors, household necessities, perfumes, creams, toilet water, famous "Edring's Health Tablets." Jet Pharmaceutical Co., Allentown, Pa.

QUICK money selling "Amazing Life Henry Ford." Illustrated, new, authentic. 25 sales daily. Outfit free. Act now. R. C. Barnum Company, Cleveland, Ohio.

HEATLESS Trouser Press, \$1.00. B. E. Israel Company, General Post Office, Box 169, New York.

AGENTS: New E. Z. Collar Buttons. Front, Back, Samples, 50c. Godwin, Summer, Wash.

\$200 WEEKLY. Free samples. Sell gold sign letters to stores, offices. No experience. Big future guaranteed. Can travel. Exclusive territory. Become our general agent. Acme Letter Co., 2890D Congress, Chicago.

PORTRAIT Agents—Sample Rolls, Sample Cases and Samples of all kinds furnished to the portrait trade. Write for catalog. Chicago Sample Roll Co., Dept. P, 57 East 18th St., Chicago.

EARN big money fast applying gold initials to autos. Every owner buys—\$1.35 profit on \$1.50 sale—particulars and samples free. Write quick. Lithogram Co., Dept. 17, East Orange, N. J.

57 MILES per gallon made with new patented gasoline vaporizer. Write for particulars. Vaporizer Co., Pukwana, S. Dak.

WANTED, agents for food and drug specialties. Write for particulars. Mahdi Products Co., Stoneham, Mass.

AGENTS Make \$75 a week selling Hood and Radiator Covers to Ford owners only. Write today. A. & T. Sales Co., Tonawanda, N. Y.

HUSTLERS! Big Money selling Cherys Quality Toilet Articles. Novel Frenchy packages. Free sample case with first order. Lee-Jackson Co., Avondale 5, Cincinnati, O.

WHY work for others? Make and sell your own goods. We show you how. Enormous profits. Write quick for free book explaining everything. National Scientific Laboratories, 211 North Monroe, Richmond, Va.

AGENTS—You can make \$10 every day selling our shoes to your friends. No experience necessary. We'll show you how. Bloodworth Shoe Co., 115 S. Dearborn St., Chicago, Ill.

AGENTS—New Invention. Harper's Ten-Use Brush Set and Fibre Broom. It sweeps, washes and dries upstairs windows, scrubs and mops floors and does five other things. Big profits; easy seller. Free trial offer. Harper Brush Works, Dept. 72, Fairfield, Iowa.

YOU can make \$10 to \$20 daily selling Rex India Fibre Brooms. Outlast three ordinary brooms. 100% Profit. Write Rex Fibre Products Company, 145-C New Jersey Ave., Brooklyn, N. Y.

MEN and Women Make Big Money from start selling exclusively Dr. Blair's famous toilet preparations for every member of the family. Complete line. Business permanent. Remarkable selling outfit. Write quick. A. B. Blair Laboratories, Lynchburg, Va.

SELL "Amenz" Shirts; best-looking, biggest value. Manufacturer to wearer. Every order nets profit \$1.50-\$2.25. Write for winning sales plan. Menzin Shirt Co., 2863-A, Third Ave., New York.

SALES Representative wanted every county to give all or spare time. Position worth \$1,200 to \$3,000 yearly. No previous experience or capital necessary. Write for full particulars. A. A. Silver-Chamberlin Co., Clayton, N. J.

BIG Money and Fast Sales. Every owner buys Gold Initials for his auto. You charge \$1.50; make \$1.85. Ten orders a day easy. Write for particulars and free samples. American Monogram Co., Dept. 40, East Orange, N. J.

LIVE Agents make \$10 Day selling Eureka Strainer and Splash Preventer for every water faucet. Takes on sight. Widely advertised and known. Get details today. A. B. Seed Filter Company, 78 Franklin, New York.

MAKE \$25 to \$50 Week representing Clows' Famous Philadelphia Hosiery, direct from mill—for men, women, children. Every pair guaranteed. Prices that win. Free book "How to Start" tells the story. George Clows Company, Desk 31, Philadelphia, Pa.

AGENTS: Big Money Monogramming by Transfer Method. Catalogue Showing Over 50 Styles and Particulars Free. Motorists' Accessories Co., Mansfield, Ohio.

100% PROFIT—Free Goods—No Investment. High grade guaranteed aluminum utensil specialties and cutlery. 10 to 15 dollars per day easily made. Perfection Aluminum Mfg. Co., Desk A, Lemont, Ill.

WHY work for others? Make and sell your own goods. We show you how. Enormous profits. Write quick for free book explaining everything. National Scientific Laboratories, 211 North Monroe, Richmond, Va.

SELFOLITE—Agents, Streetmen—Selfolite lights any fire while user sleeps, or any time. Performs surprising stunts. Newly patented. Sample 25c, postpaid; money back. Particulars, Kaytwo Mfg. Co., C195 Station A, Boston, Mass.

AUTOMOBILE Free to tailoring agents. Make \$75.00 a week and up and get an automobile free taking orders for our fine tailored to measure suits. Big assortment of all Wool Fabrics all at the one low price of \$29.75. Every order pays you big cash profit in advance. We supply finest selling outfit and give an automobile free to every man who qualifies. Write quick for our startling offer. Dept. 458, Park Tailoring Co., Chicago, Ill.

AGENTS—Crew Managers—Profits— Profits—Profits. Build Permanent, Quick Repeat, Profitable business selling All-In-One Polish. Best, quickest, sure-fire money-making proposition for live-wire salesmen on market. Every Housewife, Automobile Owner, Dealer and Garage a sure sale. Quick repeats. Absolutely non-fogging, non dust-collecting. Harmless to finest finish. Exclusive rights going fast. Write for Special Offer today. Danforth-Abbott Co., 254 W. 54th St., New York City.

"HEAT Without Coal." New kerosene burner cooks, heats, bakes, cheaper, better, cleaner than coal or wood. Coal bills cut one-half. Fits any stove or furnace. Fuel shortage makes every home buy. Amazing big profits. Demonstrating burner free. Selling experience unnecessary. Even Heat Generator Co., 5123 W. 25th, Cicero Station, Dept. 10, Chicago.

AGENTS—Drop your dead ones. The Universal Sanitary Milk Bottle Cover is the new home necessity. Converts bottle into pitcher. Cannot spill if tipped over. Sanitary and easily cleaned. Best 25c seller out. Sample 25c. Write now. E. Z. Art Needle Co., 515 N. Dearborn, Chicago, Ill.

SALES Agents, Men or Women: Year round position. No layoffs. Take orders for Jennings new guaranteed hosiery. Must wear and give satisfaction or replaced free. Write for outfit. Jennings Mfg. Co., Dept. 168, Dayton, O.

AGENTS: Sell full line of guaranteed hosiery for men, women and children. Must wear 12 months or replaced free. All styles, colors and finest line of silk hose. Often take orders for dozen pairs in one family; permanent customers and repeat orders make you steady income. Write for sample outfit. Thomas Mfg. Co., Class 462, Dayton, Ohio.

INSYDE Tyres inner armor for automobile tires. Prevent punctures and blow-outs. Double tire mileage any tire. Tremendous demand. Big profits. Sample and details free. American Accessories Co., B-178, Cincinnati, Ohio.

RARE Opportunity. Special selling plan not offered by any other firm. Makes your sales easy. Your business grows because Merit is a 100% repeater. Big pay. Exclusive territory. Wonderful future. Merit Manufacturing Co., 1041 M Douglas Ave., Providence, R. I.

YOU Are Lucky if we accept you as our agent. Send references. Write for proposition. We are sole manufacturers. Moulton Umbrella Company, Wilmington, Ohio.

PATENTS—Write today for free instruction book and Evidence of Conception blank. Send sketch or model for examination and opinion; strictly confidential. No delay in my offices; my reply special delivery. Reasonable terms. Personal attention. Clarence B. O'Brien, Registered Patent Lawyer, Southern Bldg., Washington, D. C.

TAILORING Salesmen: Make \$75.00 a week selling our strictly All-Wool Made-to-Measure Suits at \$28.50. You collect profits in advance and keep them. We supply finest Selling Outfit in America. Many exclusive money-making features. Tailoring, rain-coat and side-line men, part or full time, get in touch with us immediately. Goodwear Chicago, Inc., Dept. 192, Chicago, Ill.

AGENTS, \$6 a day taking orders for Blue Ribbon Cutlery Set. Stainless steel. Guaranteed. Aluminum handle. We deliver and collect. Pay you daily. Write quick for sample outfit. Parker Mfg. Co., 178 Awt St., Dayton, Ohio.

NO Dull Times Selling Food. The greatest, surest and safest business in the world today is selling Federal Pure Food Products, and here is your opportunity to get into this business. You can make \$3,000, \$5,000, \$10,000 or more per year—the only limit is your ability to take care of the business. We print your name and address as distributor on every package, thus making sure that you will get the thousands of dollars' worth of repeat orders which will be sent to you. No Dull Times, for the People Must Eat, and our food products are the fastest selling, surest and quickest repeat order getters in the world. Sell on sight in every home where food is used—Repeat orders immediately and every week thereafter. A Real Big Business All Year Own. Every new customer adds a great deal to your weekly income. Your business, once established, has a market value just like a store and can be easily sold. The greatest money-making opportunity of your lifetime because you risk absolutely nothing, as we guarantee your sales, and we will not let you fail. Remember! Guaranteed! Best products, biggest sellers, surest repeat orders. No capital or experience is required. We furnish capital and everything necessary for you to become a Federal Distributor. Exclusive territory will be given honest men or women who will write at once asking us to send our "Success Guaranteed" proposition. Address Federal Pure Food Company, Dept. 15, Chicago, Ill. Largest inventors of and packers of Pure Food specialties in the world. Reference, any bank, Dun or Bradstreet rating agency. Express or Railway Company in America.

SELLS Like Hot Cakes; big profits; new roofing wax pad and asbestos rest; clamps board; perfumes clothes; outfit 10c. Yankee Mfg. Co., 380 Atlantic Ave., Brooklyn, N. Y.

AGENTS: Men and women, in spare or full time, make big money selling household necessities. Every home a prospect. Quick sales, big profit. Territory open. Write for particulars. Judd & Leland Manufacturing Company, Box 21, Clifton Springs, N. Y.

A MAIL-ORDER business of your own, selling movie patrons all year anywhere; free circulars. Wondo, M 31 Times Plaza, Brooklyn, N. Y.

YOUR chance to make big money resilvering mirrors, auto reflectors, metal-plating. Outfit furnished. Write for particulars. International Laboratories, Dept. 26, 309-311 Fifth Ave., New York.

AGENTS: Big profits. Genuine Gold Leaf Window Letters anyone can put up. Scripts and 57 varieties. Chicago Agency Co., 842 Altgeld St., Chicago.

"HOW to Sell Patents" free. Patent News-O, Washington, D. C.

AGENTS take advantage of our heavy purchases of fiber, and sell our Victory Fiber Brooms, as corn is scarce and high. Now is the time. Paxson Mfg. Co., 219 Sansom Street, Philadelphia, Pa.

WINTER Expenses Reduced! "Economic-Coal-Spra" saves 2/3 coal costs. 10-25-50-1.00 packages. Secure agency now. 1053 City Hall Branch, New York, N. Y.

AGENTS—make \$75 weekly selling our famous silk knitted neckties, Pennsylvania Hosiery Mills, 20 South 17th Street, Philadelphia, Pa.

MAN or Lady in every town to distribute our 7 Piece Aluminum Handled Cutlery Set. Whole or spare time. Experience not necessary. Sells on sight. High Quality Guaranteed. \$10.00 per day to right people. Perfection Aluminum Mfg. Co., Desk A, Lemont, Ill.

100% PROFIT selling our felt rugs to homes, hotels, offices, etc. Everybody buys. We are manufacturers, not jobbers. Prices defy competition. \$75 week easy. Newark Felt Rug Company, 56-C Bergen Street, Newark, N. J.

AGENTS—Make big money the year 'round selling latest New York fashions, so smart looking and low priced no woman can resist buying. Address Strump & Co., Dept. 16, 29 West 34th Street, New York City, N. Y.

"\$10 A DAY and More," our new book, shows clearly how you may gain sure success and large profits selling Guaranteed Hosiery and Underwear, factory to family. It is Free. Write today, C. & D. Company, 41-E, Grand Rapids, Mich.

"MAKE And Sell Your Own Goods"—Tremendous Profits; No machinery; No experience; We show you how; Write quick for Free Book. Clover Laboratories, 5501 CL North Robey, Chicago.

PORTRAIT Agents, who want good work and prompt service and who desire to purchase their frames at factory prices, should write us at once for catalog and price list. W. G. Hannan Co., Dept. A-5, 57 E. 18th St., Chicago, Ill.

OUR ExCel Luminous Crucifix shines brilliantly in the dark. Churches, hospitals and individuals are only waiting for a demonstration before buying. Agents make handsome profits. W. G. Hannan Co., Dept. B, 57 E. 18th St., Chicago.

PORTRAIT Agents—Earn big money selling our Photo Medallions. Everybody buys. You charge \$3.00; make \$2.40 each sale. \$10 daily easy. Big variety designs. 4-day service. Perry Photo Novelty Corporation, Section 16, 360 Bowery, New York.

AGENTS. Get in on this nationally advertised, repeat-order proposition. In three months' time orders for Universal Products will come in by themselves. National advertising creates the demand. All repeat orders turned over to you. Exclusive territory. Write today. Universal Victor Company, 1460 East Jefferson Ave., Detroit, Mich.

ANY man handy with paint brush or light tools can start new mechanical business on nearly nothing; needed everywhere; nearly all profit; experience not required. John Bracland, 1457 So. Ninth, Philadelphia, Pa.

AGENTS, Opportunity Seekers, your success is inevitable if you follow our instructions, 200% profit. Send postal. Mail Order Specialty, 507 Mission St., San Francisco, Calif.

WHY work for others? Make and sell your own goods. We show you how. Enormous profits. Write quick for free book explaining everything. National Scientific Laboratories, 211 North Monroe, Richmond, Va.

MEN—Women, Make \$9 daily representing established hosiery corporation. Introduce guaranteed silk hosiery to friends and others. We deliver and collect. Details free. Empire Hosiery Corporation, 1819 Broadway, New York.

MANUFACTURE Biggest Selling Specialties from Our Guaranteed Formulas. All Lines. We Teach You How. Catalog Free. Allen's Enterprises, 1227 Milwaukee Ave., Chicago, Ill.

AGENTS—Big Profits, Selling Wunrub Polish, for Furniture, Woodwork, Automobiles, etc. Cleans and polishes. Write for Big Free Offer. Fritch's Laboratories, 6431 Magnolia, Chicago.

AGENTS wanted for Silk Hosiery. Mill to wearer direct. Big profits, steady business. Apply to Oxford Knitting Mills, Frankford, Penna.

AGENTS—Big money, \$8 to \$16 a day. Aluminum handle cutlery set. Brand new. You display and take orders. We deliver and collect. Pay you daily. Sample free. Try it out. Jennings Mfg. Co., Dept. 1668, Dayton, Ohio.

AGENTS: Sell the only Collapsible, Folding, Adjustable running board Luggage Carrier, \$5.00. Write E. C. Mahoney, Huntsville, Ala.

CANVASSERS—\$60 weekly. New exceptionally useful, necessary article. Housewives buy several. Address "Factory," Elizabeth, N. J.

AGENTS: Big variety Brushes, 100% profit. Producers become District Managers. Neway Brush Co., Hartford, Conn.

GET our Big Money proposition and Free Samples on Easy Applied Transfer Letters and be convinced. Auto Monogram Supply, 16 Green St., Newark, N. J.

SPIRAL Curtain Rods, broom protectors, Ironing Sheet Clips, factory prices. Other fast sellers. Address Hunt Mfg. Co., Box 1652-P, Paterson, N. J.

WANTED—District Purchasing Agents, \$250 per month. Steady employment and exclusive territory. Write now. Experience unnecessary. National Instrument Company, 4703 North Hamilton, Chicago, Ill.

AGENTS with Ford cars, boost your gasoline mileage and your income using and selling Cyclo "Dynamic" hot-spot. Greatest hill-climber known. Cyclo Manifold Co., South High, Akron, Ohio.

MAKE Money at Home making Toys and Novelties. Particulars Free. New Specialty Co., 158 E. 31st St., New York.

DISTRIBUTOR Agents: Beauty Clay is making millions. Advertised everywhere. 500% profit. Beau-T-Pak Co., 506 Lyon St., Grand Rapids, Mich.

AGENTS—Big profits, Gold Sign letters easily applied, samples free. Liberal offer to General Agents. Dept. C, Interstate Sign, 2620 No. Halsted St., Chicago.

FREE—Formula Catalog. S. & H. Laboratories, Boylston Building, Chicago.

AGENTS—Quick! New! What is it? Hundreds answered this advertisement last month; now making two dollars hourly upwards; 33c profit every 35c sale; think of it; sells on sight; repeater; sample free. Address Empire Branch, 7201 Atlantic Ventnor, Atlantic City, N. J.

WHY waste time on experiments? Needle Books always sell. We have the best flashiest and cheapest Needle Books on the market. Retail from 10c to a dollar. English make. Send for sample and illustrated catalogue. Lea Brothers, 145 East 23rd St., New York.

AGENTS, mail-order men, beginners. Something new. Valuable, inside information, free. Nite Mail Order & Supply Co., 609 27th St., Denver, Colo.

LIVE Men Wanted to handle popular fast-selling electrical handbooks; sells at \$1.00. Sample carried in pocket. Can make \$10.00 and more per day. Address, Burgess, 749 E. 42nd Street, Chicago.

EARN \$10.00 daily silvering mirrors, plating and refinishing metalware, autos, chandeliers, bedsteads, headlights. Outfits furnished. E. Declé Laboratories, 1138 Broadway, New York.

AGENTS, canvassers, crew managers. Sell needle books, quick sales, large profits. Particulars upon request. Johnson Bros., 55319 Princeton Ave., Chicago, Ill.

THE Agents' and Salesmen's Guide, tells where to buy almost everything. The most wonderful list of business opportunities ever published. Copy, 25c. Wilson Publishing Co., 1400 Broadway, New York.

AGENTS—Steady Income. Large manufacturer of Handkerchiefs and Dress Goods, etc., wishes representative in each locality. Factory to consumer. Big profits, honest goods. Whole or spare time. Credit given. Send for particulars. Address Freeport Mfg. Co., 59 Main St., Brooklyn, N. Y.

\$75.00 A WEEK. "Whirlwind sellers." Free samples. (10 new specialties.) Dollars roll into Agents. "Surprises" em all. Every home, office, automobilist, garage, accessory store buys 1 to 100. No money. No experience necessary. You get all "re-orders." Factory (A), Box 494, Hartford, Conn.

GOLD Leaf Sign Letters; make and sell; profits exceed 1,000%; immense demand; particulars free. Johnston Co., Quincy, Ill.

BIG daily commissions selling printing. Particulars free. "Adverpress," Station C-3, Milwaukee.

PORTRAIT Agents: Our goods will make you big profits. Delivery guaranteed. Rejects credited. Prompt shipments. Send for latest catalog and prices. Adam J. Kroff & Co., 602 Blue Island Ave., Chicago, Ill.

USEFUL and attractive Xmas gift. 100% profit. Cataract Auto Washer Co., Dept. P, Topeka, Kansas.

HIGH-GRADE SALESMEN WANTED

WERE you ever offered a grocery store? You can handle Sugar, Flour, Canned Goods, Dried Fruit, Coffee and entire line of groceries, as well as Paints, Roofing, Aluminum Ware and Automobile Oils, with no rent to pay; no money invested. Take large orders from samples. Goods are guaranteed and proven quality. Selling experience not necessary. Steady, profitable work for "workers." Address Hitchcock-Hill Co., Dept. 200, Chicago, Ill. Reference: Any Bank or Express Co.

MINUTES pay dollars demonstrating world's greatest specialty. Wonderful new three-pound Adding Machine. Retail \$15. Work equals \$300.00 machine. Adds, subtracts, multiplies, divides, automatically. Steady, accurate, durable, handsome. Five-year Guarantee. Tremendous demand everywhere. Amazing profits, main or sideline. Experience unnecessary. Write quick for liberal trial offer and protected territory. Lightning Calculator Co., Dept. G, Grand Rapids, Mich.

SALESMEN, Solicitors, Territory Men— at last! A Fire Extinguisher deadly to all fires, which will not get out of order, freeze, or deteriorate selling at \$1.00 and \$1.50. Quick seller to home, factory, office and garage. Attractive proposition to live hustling men. Write Red Cup Lubricator Co., 1603 S. Michigan Ave., Chicago.

EASY to sell Groceries, Paints, Automobile Oils, Roofing, Stock Food to consumers from samples, no capital or experience necessary; steady, profitable work. Commissions advanced. Satisfaction guaranteed. 50 years in business. Write for full particulars. **Loverin & Browne Co., Wholesale Grocers, 1775 S. State Street, Chicago, Ill.**

SALESMEN Wanted—Local or traveling, part or full time, to sell calendars, fans, fly swatters, brushes, rulers, etc. Over two hundred stock designs of paraffin signs, ice cards, etc., for all merchants. Fine side line, liberal commission. **The Harrison Co., Union City, Ind.**

SALESMEN—Become Independent. Own your business; experience unnecessary; selling our \$7,500 Accidental Death, \$50 Accident, \$25 Sick Weekly Benefits; \$12.50 yearly; other amounts proportionate. Guaranteed steady income from renewals. \$250,000 deposited Insurance Department. Registration Dept. A, Newark, N. J.

MAKE \$5,000 every year—\$2,000 in spare time. You share profits besides. Show "Weather Monarch" Raincoats and Waterproof Overcoats. Ask about "Duo Coat" (No. 999). Get sample raincoat free. Associated Raincoat Agents, Inc. 446-A North Wells, Chicago.

SALESMEN Can make \$5.00 a day selling our Calendars, Pencils, Signs, Advertising Novelties, Yardsticks, Whistles, etc. Liberal terms. Sells entire year. Fine side line. Local and traveling agencies. Model Calendar Co., Dept. 226, South Bend, Ind.

AMBITIOUS Men, write today for attractive proposition, selling subscriptions to America's most popular Automobile and sportsman's magazine. Quick sales. Big profits. Pleasant work. Digest Pub. Co., 5655 Butler Bldg., Cincinnati, O.

AGENTS—\$60-\$200 a week. Free samples. Gold sign letters anyone can put on store windows. Liberal offer to general agents. Metallic Letter Co., 431-E N. Clark St., Chicago.

OIL Burners—Climax for residence furnaces and stoves, described in interesting booklet, "The Burning Question," sent free. Address, E. L. Miller Mfg. Co., 2320 W. 3rd St., Kansas City, Mo.

SELL something original! Something every merchant needs—"Zim's Peerless Collection System." Exclusive collecting features has collected for 1% cost. Sells \$7.50. Creditors' Association, E-313 McKnight Bldg., Minneapolis, Minn.

SALESMEN, Act Quick. Ten patented auto necessities. Spark plugs, visors, windshield cleaners, hose clamps, etc. Generous commissions. Jubilee Mfg. Co., 32 Sta. C, Omaha, Neb.

SOMETHING New, a necessity. All business and professional men need it. Sells \$7.50, cost you \$1.40. Big repeater. Write for sample. Merchants Assn., Minneapolis, Minn.

TWO Oklahoma side line salesmen are averaging \$15.00 daily—with Rose Special Fountain Pen, selling to dealers. Try it. D. N. Rose Co., Tulsa, Okla.

SALESMEN make good side money selling small acetylene torch to garages and shops. Easy to sell. St. Paul Welding & Mfg. Co., St. Paul, Minn.

MOST Wonderful Seller, 96c profit every dollar. No stock to carry. License unnecessary. Sample free. Mission, 2421-MP, Smith, Detroit.

TERRITORIAL Salesmen with car. Commission. R. B. Carroll, Saugatuck, Mich.

\$125 TO \$300 a week. Salesmen with slight knowledge of motors who can reach car owners, can earn \$300 weekly without making a single sale. If they can also make sales, profits may reach \$25,000 yearly. Phillips, 228 W. 29th St., New York.

\$4.00 PROFIT on every \$5.00 sale. "Free Sample"—new specialty. (Money Getter). Every Storekeeper, Doctor, buys quickly. Comors made \$20.00 First Hour. Dacey made \$86.00 First Day. Experience Unnecessary. All territories now open. Drawer 596, Hartford, Conn.

SALESMEN: The Kendall Envelope Sealer appeals to every user of the mails because it seals 60 a minute. Sells \$3.00. No competition. Exclusive territory. Consolidated Co., 104EB Boylston St., Boston, Mass.

SALESMEN, Agents, 150% profit selling our Christmas and Standard Show Cards. Every merchant buys. Nelson, 353 No. State, Chicago, Ill.

RADIOLITE—Wonderful discovery startles world. Charges batteries in 10 minutes. Gallon free to agents. Radiolite Company, St. Paul, Minn.

MAKE \$150 weekly. Go-getter salesmen, demonstrate, sell practical, sensible rim tool tire changer. Retails garages, tire shops, etc. \$15. Big demand. Liberal commission. Write, Service Mfg. Co., Inc., Elkhart, Ind.

SUBSTANTIAL corporation manufacturing several articles under valuable patents, can place several more general sales managers, open branch offices, manage salesmen, \$500 to \$2,000 necessary to finance agents; expenses allowed to Chicago if you qualify. Mr. Inman, 9 South Clinton Street, Chicago, Ill.

CLOTHING Salesmen Wanted at once to sell High Grade Virgin Wool Custom Tailored suits and overcoats direct to wearer at \$28.00. Satisfaction guaranteed, big commissions; experience not necessary; exclusive territory to men who qualify. House of Campbell, 456 E. State, Chicago, Ill.

BEST Seller: Jem Rubber Repair for tires and tubes; supercedes vulcanization at saving of over 800%; put it on cold, vulcanizes itself in two minutes, guaranteed to last life of tire or tube; sells to every auto owner and accessory dealer. Get particulars how to make big money and free sample. Amazon Rubber Co., Philadelphia, Pa., Dept. 516.

SALESMAN—Household necessity. Sells readily. Cool situation creates tremendous demand. Our liberal discount permits handsome profit. Strong advertising help furnished. Write or wire for exclusive distributor proposition. Crown, Richmond, Ind.

TAILORING Salesmen: You can earn \$50.00 to \$150.00 a week selling our virgin wool line of tailored to order suits and overcoats retailing at \$29.50. None higher. All one price. Regular \$50.00 values. We have a large assortment of rich dependable fabrics. Beautiful patterns and weaves. Satisfaction guaranteed. You collect your profits in advance. We ship C. O. D. to customer for balance. No investment required. We furnish 6x9 swatch line complete with agency supplies. Protected territory for hustlers. Substantial income derived from repeat business after first season. Experience not essential. Write before your territory has been spoken for. Address, J. B. Simpson, Inc., Dept. 325, 831 W. Adams Street, Chicago, Ill.

LOCAL Representative for Million Dollar Business—One man to take charge in each county for old established line seventy-five different products, with "Sure-shot" selling-plan based on a free gift. Remarkable chance for advancement if you are honest and will work. Send full particulars of yourself and record. Sales Mgr., 1400 W. 37th St., Chicago, Ill.

SALESMEN: We want 500 men to sell Reversible raincoats direct to consumer. One side stylish Fall topcoat, other side storm-proof raincoat—2 coats for price of one. Show coat and sale is made. No experience or capital required. We deliver and collect. \$200 to \$400 monthly easy. \$10 daily easy for spare time. No waiting for your pay. Paid daily. Biggest money-making proposition ever offered an agent. Sample coat free to workers. Our new selling plan is a winner. Be first in your territory. Write quick, Mac-O-Chee Mills Co., Rain 1012, Cincinnati, Ohio.

AGGRESSIVE District Managers and Salesmen are lining up with this most unique sales plan. It makes you your own manager and provides you with yearly earnings up to \$25,000. Fascinating work where you set your own limit. It's film advertising service, screening in local theaters. Drop a postal for an interesting story too long to tell here. Territory rapidly filling. Address Alexander Film Co., 1151 Main Avenue, Spokane, Wash.

HELP WANTED

WHAT is it worth to you? Distributor, District Manager, Salesman or Agent, to have the agency for the best line of Rubber Specialties on the market. Hot-Water Bottles, Bathing Caps, Combination Shopping Bags, Pure Rubber and Rubberized Aprons, Rubber Gloves, and forty other fast-selling articles needed in every home. Profits range from 100 to 150 per cent. Write B. & G. Rubber Mfg. Co., 618 Penn Ave., Pittsburgh, Pa., Dept. 206.

SALESMEN, Independence awaits the Live Wires who grasp this opportunity. Warehouses, terminals, steamship companies, factories, hotels, cafes, etc., desperately need our scientific, positive, but simple method of extermination of rats and mice; grateful clients and long contracts await you; best exclusive territories going fast. Commission only. Write to-day, The Ratia Laboratory, Inc., 115 Broad St., New York.

\$5 TO \$15 Daily Easy—Introducing New Style Guaranteed Hosiery. Must wear or replaced free. No capital or experience required. Just show samples, write orders. Your pay in advance. We deliver and collect. Elegant outfit furnished all colors and grades including silks—wool and heathers. Mac-O-Chee Mills Co. Desk 10512, Cincinnati, O.

UNITED States Government Wants Men. Excellent positions at attractive salaries. Railway Mail Clerk Examination soon. Let our expert (former United States Civil Service Examiner) prepare you for this and other fine positions. Write today for free catalog PM. Patterson Civil Service School, Rochester, N. Y.

DISTRICT Managers: Big profits. Men capable of organizing and managing crews of lady solicitors can easily clear \$50 to \$100 per week with the B. & G. Protector, the original and best protector on the market. Every woman between fifteen and fifty needs and buys it. B. & G. Rubber Co., 618 Penn Ave., Pittsburgh, Pa., Dept. 205.

150,000 SALES of a \$12.50 household appliance in New England have paid salesmen \$25 to \$150 weekly. We want District Managers of exclusive territory elsewhere to sell direct or obtain sub-agents. The Reeves Company, 66 Broad Street, Milford, Conn.

INVENTORS desiring to secure patents should write for our book, "How to Get Your Patent," tells our terms and methods. Send sketch for our opinion of its patentable nature. Handolph & Co., Patent Attorneys, 520 F. Washington, D. C.

BE a Railway Traffic Inspector! \$110 to \$250 monthly; expenses paid after 3 months' spare-time study. Splendid opportunities. Position guaranteed or money refunded. Write for free booklet CM-46. Stand. Business Training Inst., Buffalo, N. Y.

PORTRAITS, Photo pillow tops, frames, sheet pictures, medallions, merchants' signs, waterproof and tea aprons, silk and wool hose, luminous crucifixes; catalog free; 30 days' credit. Jas. C. Bailey Co., Desk J-12, Chicago.

SIGN Letter Agents and Painters; 500% Profit. Gold and Silver Sign Letters for Stores and Office Windows. Anyone can put on. Big demand. Free samples. Metallic Letter Co., 431D N. Clark St., Chicago.

AMBITIOUS Men, write today for attractive proposition, selling subscriptions to America's most popular Automobile and sportsman's magazine. Quick sales. Big profits. Pleasant work. Digest Pub. Co., 5655 Butler Bldg., Cincinnati, O.

DISTRICT Managers, general agents, with ability to organize force of producers wanted. Old established firm. Big-paying proposition. Write for details to Fitzcharles Dry Goods Company, 615 Fitzcharles Building, Trenton, N. J.

START a pressing, cleaning and dyeing shop; excellent field, splendid profits. We tell you how. Write for booklet, Ben-Vonde System, Dept. C, Charlotte, N. C.

MEN Wanted to take up Finger Print Work. Experience unnecessary. Write for particulars explaining guaranteed position. Universal Finger Print System, Dept. FG, St. Louis, Mo.

ALL men, women, boys, girls, 17 to 60, willing to accept Government Positions, \$117-\$190, traveling or stationary. Write Mr. Ozment, 101 St. Louis, immediately.

OUR genuine gold window sign letters are an excellent money-making proposition for handy men. Slann Sign System, Bethune Ave. E, Detroit, Mich.

STORIES, poems, plays, etc., are wanted for publication. Good ideas bring big money. Submit manuscripts or write Literary Bureau, 522, Hannibal, Mo.

WANTED: Railway Mail Clerks—\$1,000 to \$2,300. Exams everywhere. Write today for full information. Patterson, Civil Service Expert, Box 4025, Rochester, N. Y.

WRITE Articles, stories, news, in spare time for newspapers and magazines. Big pay. Copyright book free. Press Syndicate, 553, St. Louis, Mo.

BOYS—Men. Become Automobile Experts. \$35 week. Learn while earning. Write Franklin Institute, Dept. K-401, Rochester, N. Y.

MAKE money writing Photo-plays; details free to beginners. No correspondence course. Producers' League, 230 Wainwright, St. Louis.

BE a Finger Print Expert—Opportunities opening everywhere. Write National System, 186 East 79th, New York.

MEN wanted to qualify for Firemen, Brakemen. Transportation furnished. Write W. Burgess, St. Louis.

SILVERING Mirrors, French plate. Easily learned. Immense profits. Plans free. Wear Mirror Works, Dept. 25, Excelsior Springs, Mo.

HOME work in spare time. Full particulars 10 cents. Helmar Company, Hoboken, N. J.

U. S. GOVERNMENT positions. Men—women over 17. \$140 to \$195 month. Steady work. No strikes. No lay-offs. Life position. Quick steady raise. Vacation with pay. Either inside or outside work. Common education sufficient. Experience unnecessary. Full unnecessary. Write Franklin Institute, Dept. L3, Rochester, N. Y.

DISTRIBUTION managers wanted for nationally advertised Beauty Clay to finance and hire agents. Beau-T-Pak Co., 506 Lyon St., Grand Rapids, Mich.

EARN \$10 daily silvering mirrors, plating and refinishing metalware, autos, chandeliers, bedsteads, headlights. Outfits furnished. E. Dele Laboratories, 1133 Broadway, New York.

MEN over 17. Become Railway Mail Clerks. Commence \$133 month. Steady. Common education sufficient. List positions free. Write immediately. Franklin Institute, Dept. L21, Rochester, N. Y.

FREE Booklet. Start little mail order business. Home employment evenings. Pier, Dept. 4A, 74 Cortland Street, New York, N. Y.

MEN—Boys over 17. Become Railway Mail Clerks. \$135 month. List positions free. Franklin Institute, Dept. L21, Rochester, N. Y.

BOYS, Girls, Men. \$8.00 daily. Christmas, Easter Post-card Packages. 10c for Samples. Dealers Supplied. Wells, 912 Magee, Philadelphia, Pa.

OPERATIVES Wanted everywhere for National Information Bureau; male and female. A. B. Fox, Secretary, Brazil, N. D.

RAILWAY Mail Clerks wanted. \$135 month. List positions free. Write Franklin Institute, Dept. L21, Rochester, N. Y.

FREE Plans. Stop Daily Grind. Silver mirrors, headlights, tableware, etc. Clarence Sprinkle, Dept. 28, Marion, Ind.

WANTED—men—women over 17. Many government jobs obtainable. Steady. \$100-\$195 month. List free. Franklin Institute, Dept. L21, Rochester, N. Y.

WANTED men to learn Motion Picture Operating. Good pay; steady work; jobs secured for competent men. Address today! Operator, Box 38, Sioux Falls, So. Dak.

\$35 WEEK. Boys—men. Become automobile experts. Learn while earning. Write Franklin Institute, Dept. L-401, Rochester, N. Y.

EARN \$15-\$50 weekly writing show cards. No canvassing. Experience unnecessary. We train you. Particulars, terms free. Shorite Sign System, Inc., 1808, Detroit, Mich.

RAILWAY Mail Clerks. Postoffice and other help wanted by Government. \$1400 to \$2300. Examinations everywhere soon. Write today for full information. Chicago Civil Service College, A-41 Kesner Building, Chicago.

BE a Finger Print Expert. Demand increasing. Write for special free offer. American Finger Print System, 1996 Broadway, N. Y.

FIREMEN, Brakemen, Baggage-men, Sleeping car, train porters (colored). \$140-\$200. Experience unnecessary. 810 Railway Bureau, East St. Louis, Ill.

LOCOMOTIVE Firemen, beginners, \$150, later \$250 monthly, for railroad nearest their homes, everywhere in United States and Canada. Address Railway Association, Desk M-1, Brooklyn, N. Y.

GOVERNMENT jobs. Men—women. Good pay. Write for information. Secretary, Box 1715-F, Washington, D. C.

SITUATIONS WANTED

AS manager of telephone exchange, 1500 subscribers or less, 16 years experience. Address Box 83, Hillsboro, Wis.

TWO energetic Young Engineers, sound commercial training. Destructors represent one or two American Firms possessing specialties. Box 2100, Popular Mechanics Magazine, Chicago.

FOR ADVERTISERS

ADVERTISE in 24 Big Sunday Newspapers, 25 words \$15.00. Catalog listing 1,000 leading Dailies, Weeklies, Magazines, 4c stamps. Union Advertising, Baltimore Bldg., Chicago.

ITEMIZED latest advertising rates every large daily, complete, 10c. Kline, Kline Bldg., Kent, Ohio.

INCH Display Advertisement 161 Magazines Thrice \$15. Year \$50. Page \$100. Wood's Popular Services, Atlantic City, N. J.

BLOTTERS will advertise your business or product. Samples for stamp. Labarro Company, Pittston, Pa.

ADVERTISE Your ad in 100 magazines for 4c per word. Sample copy 10c. Harley Snell, 1021 State Ave., Cincinnati, Ohio.

COMMERCIAL Engraving and Printing—the most practical and complete book on engraving, printing and allied subjects ever published. Over 800 pages and 1500 illustrations presenting over 3500 distinct ideas on 35 separate subjects. Cloth, Price \$15.00 prepaid. We highly recommend this book. Popular Mechanics Book Dept., 6 N. Michigan Ave., Chicago.

INTERNATIONAL—Opportunity: a live, inspiring, intensely interesting magazine! Six months, 25c. International circulation! Ads 1c word. 2279 First Ave., New York.

INFORMATION

RELIABLE information furnished on any subject or money refunded. 75c. Co-operative Service, Times Plaza, Box D64, Brooklyn, N. Y.

BUSINESS SERVICE

INCORPORATE. Our lawyers do the work, saving you time, annoyance and money in incorporating under the most liberal laws of Arizona. Laws and forms free. Southwestern Securities & Investment Co., Box D488, Phoenix, Ariz.

PURCHASES made, business commissions reliably executed in New York City and vicinity for non-resident firms, families or individuals. Edward Boyle, 309 Fifth Ave., New York.

MAILING LISTS

ADVERTISERS get our lists. Jacobus Advertising Service, Irvington, N. J.

TYPEWRITERS AND SUPPLIES

TYPEWRITERS. All Makes. Save one-half. Thoroughly Rebuilt in our factory by the famous "Young Process." Fully guaranteed. Free trial. We handle all standard makes. Cash or sold on easy terms. Write for Catalog. Young Typewriter Co., Dept. 415, Chicago, Ill.

UNDERWOOD Typewriters at far less than manufacturers' price; rebuilt, all worn parts replaced, guaranteed good as new. Cash, in-advance payments. Write for Catalog 1519. Shipman-Ward Mfg. Co., estab. 1892. Montrose and Ravenswood Ave., Chicago, Ill.

ALL makes rebuilt, refinished and guaranteed five years; thirty days' free trial allowed. Oliviers, Underwoods, Monarchs, Remingtons; others \$15.00 up. Send for our lists and agents' proposition. Typewriter Exchange, 2316 University Ave., New York City, N. Y.

TYPEWRITERS, all standard makes, \$10 up. Fully guaranteed. Free trial. Write for Illustrated Bargain List. Northwestern Typewriter Exchange, 320 West Goethe St., Chicago.

DUPLICATORS AND DEVICES

"MODERN" Duplicators save Time, Labor, and Money. Gets Business. Reproduces Typewritten or Panned Letters, Drawings, Lessons, Music, Menus, Bids, Notices, Specifications, Maps or anything in one or more colors. Prints Two per minute. Special Sale On. 30 Days Free Trial. \$2.25 up. Booklet Free. J. E. Durkin-Rewes Co., Pittsburgh, Pa.

YOU can make 50 to 100 copies of a letter, notice, etc., at a cost of three cents on a Heyer Quality Duplicator. Write for free trial offer. The Heyer Duplicator Co., 162 No. Wells St., Chicago, Ill.

ADDING MACHINES

FREE Trial. Marvelous new Adding Machine. Adds, Subtracts, Multiplies, Divides, automatically. Work equals \$350.00 machine. Price only \$15.00. Speedy, durable, handsome. Five-year guarantee. Used by largest corporations. Write today for catalog and free trial offer. Lightning Calculator Co., Dept. E, Grand Rapids, Mich.

NEW \$3.50 Automatic Adding Machine. Adds, Subtracts, Multiplies. Absolutely accurate. Capacity \$999,999.99. Fully guaranteed. 75,000 pleased users. Makes adding easy, positive, quick. Eliminates Mistakes. Saves Time. Postpaid, \$3.50. Bassett Co., 1458-K, Hollywood Ave., Chicago.

PRINTING, ENGRAVING AND MULTIGRAPHING

12 CHRISTMAS Cards. Steel Engraved design—appropriate for anyone—with greeting and name Process Engraved in Old English or script, postpaid \$1.25. Send check or Money Order. Universal Process Engraving Co., 292 So. State Street, Chicago.

REDUCED prices for better printing. 1,000 Bond letter-heads, \$5.00; 1,000 good envelopes, \$4.25; 1,000 four-page folders, 3½x6¼ inches, \$12.00. Catalogues, circulars, booklets our specialty. All printing at reduced prices. Samples free. Fantus, 525 S. Dearborn St., Chicago.

GOLD lettered advertising-pencils for you; buy direct, save entire middleman's profit. Samples free (no agents). Address: S. Musial & Co., 422 Walnut St., Yonkers, N. Y.

TRY our attractive two-color letterheads on 20-lb. watermarked bond, 2,000, \$9.50; 5,000, \$19.50. E. Fowler, Clintonville, Conn.

250 LETTERHEADS, 250 white envelopes printed and mailed, \$5.00. Samples printing free. Sunco, Mohawk, N. Y.

100 NEATLY printed name cards with beautiful card case. 50c (coin). Gem Card Co., Marion, Ind.

BETTER Printing prepaid for less money. Samples for stamp. Write today. Model Company, Manchester, Iowa.

500 GUMMED Stickers 25c. Printed with Name and Address. LeBeuf, Fairview Station, Detroit, Mich.

A CHRISTMAS Gift: Monogrammed Stationery, extra good linen, 48 sheets, 48 envelopes, \$1.00. Your choice, Blue, Buff, Gray, Lavender, Pink, Khaki or White. Schiller & Armstrong, West Boylston St., Worcester, Mass.

1,000 20-lb. BOND Letterheads, \$3.50; 5,000, \$15.00. Samples. Annville Printing Company, Annville, Pa.

IMITATION Typewritten Letters, Multigraphing, Mimeographing, Printing. Cal System, Fairview Station, Detroit.

PRE-USED Printing Presses. Typo and supplies. List for stamp. Popular Bargains, Richland, Pa.

PRINTING Outfits—Presses, type supplies, type novelties. Send stamp for catalogue. Model Press, York, Penna.

1,000 HAMMERMILL Letterheads or Envelopes, \$4.00. Full Line Samples Free. Quality Printshop, Marietta, Ohio.

1,000 LETTERHEADS or Envelopes, \$3.00. Sent Prepaid. Samples Free. Monitor Press, Morrisville, Pa.

PLATELESS Engraved and Embossed Stationery; Samples Free. "Dad" Walter, 363 Jay Street, Brooklyn, N. Y.

1,000 BOND Letterheads or Envelopes, \$3.25 prepaid. Englewood Press, Toledo, Ohio.

WE Print Envelopes, Letterheads, Folders, etc. Reasonable. Address Jofor Bureau, Longbranch, N. J.

100 BUSINESS Cards, 40c; name and address on a Rubber Stamp, one stamp pad, postpaid, 50c. Wm. Strider, Coates Bldg., Ravenna, O.

540 WATERMARKED Letterheads, Cards or Envelopes, \$2.75; 1,000, \$3.75. Ellis Printing, 255 W. 30th St., New York.

225 BOND letterheads, envelopes, bill-heads, cards, \$1.25 each. Combination, \$4.00. Economic Press, Leonia, N. J.

250 EACH 20-lb. Hammermill Letterheads and Envelopes, \$2.75. Drexton Press, Detroit, Minn.

EMBOSSED business, personal stationery. Samples, stamp. Daniels Company, Pittston, Pa.

250 HAMMERMILL letterheads, envelopes, \$1.25; 1,000, \$3.00. Troib, 98 Providence, Worcester, Mass.

We print anything. Circulars, stationery, Catalogs, Samples. Commercial Press, Batavia, Ohio.

5000 5 1/2 x 8 1/4 CIRCULARS, \$8.50; 5 1/2 x 6 1/2, \$6.50; 3 1/4 x 5 1/2 Slips, \$5.00. Special price 10,000-25,000. Bargain List, Samples Free. Good's Printery, Harrisonburg, Va.

BOOKLET, catalogue and commercial printing; reasonable prices. Printery, Bremen, Ohio.

1000 HAMMERMILL bond letter-heads or envelopes, \$3.45. Multigraphing at low prices. Samples on request. Address C. B. Hatfield, Box 353, Owego, N. Y.

FOR SMOKERS

HOMESPUN Smoking Tobacco, mild and mellow—10 lbs., \$1.50; 20 lbs., \$2.75; delivery guaranteed. We furnish free recipe for preparing. Smoking Tobacco Exchange, Sedalia, Ky.

SMOKE Real tobacco. Sample 10c. Folder free. Direct to smoker. Hast Mailing Co., Paducah, Ky.

MADE in Germany, "Columbia." New patent shagpipe, Smokes perfectly dry. No waste of tobacco. Biggest nicotine absorber. Easy cleaned. 75 cents postpaid. (Send Postal Money Order.) Dealers special price. Ben Gamm, Importer, 673 North Dearborn Street, Chicago, Ill.

FOR MEN

ARE You Old at Forty? See our advertisement on page 144 of this issue. The Electro Thermal Company, Steubenville, Ohio.

RAZORS AND BLADES

"BLADEKNIFE" utilizes your own discarded blades. Refillable. Useful tool; elegant pocket novelty; household necessity. Sample 25c. Martin Bladeknife Co., Paterson, N. J.

BLADES, resharpened, one edge 2c; double 3c. New York Edge Co., Glen Cove, N. Y.

BLADES Resharpened, 3c. Any make. Guaranteed Service. Standard Safety Razor Corporation, Pittsburgh, Pa.

BOATS AND LAUNCHES

"HOW to make your boat leakproof." Send for booklet. L. W. Ferdinand & Co., 152 Kneeland St., Boston, Mass.

16' ROWBOAT—Easily made. Construction blueprint, 30c. Weesho-Uco., West Market, Detroit, Mich.

ANTIQUES AND WAR RELICS

FOR Dens, Relics collected from Europe's Battlefields. Completely illustrated catalogue and Sample War Photographs, 25c. I also buy War Relics. Lieut. Welsh, 2117 Regent Place, Brooklyn, N. Y.

SEND 5c for may best list, coins, Indian relics, antique firearms. F. E. Ellis, Webster Groves, Mo.

PHONOGRAPHS AND RECORDS

BUILD Your Phonograph. Quality phonographs. Famous Serenado Motors. Also original Perfection Motors, Electric Motors, tonearms, reproducers, amplifiers, case material, accessories. Free blueprints and building instructions. Big saving. Wonderful results. Prompt delivery. Catalog mailed for ten cents. Hoosier Manufacturing & Supply Co., 313 Baldwin Block, Indianapolis, Ind.

BUILD a genuine Choralion phonograph and save over half. Big profit building and selling. We furnish motors, tone-arms, full instructions and all necessary parts. Send for catalog and free blueprint offer. Choralion Phonograph and Radio Co., 1222 11th St., Elkhart, Ind.

BUILD Your Own Phonograph. Big saving. Pleasant, instructive work. Complete instructions, blue-prints, etc., absolutely free. Write today. Associated Phonograph Co., Dept. AP-10, Cincinnati, Ohio.

UNASSEMBLED Phonograph Cabinets, Motors and Tonearms at wholesale. Free catalogue. Dauser, 434 W. 12th Place, Chicago.

PERFECTION Phonograph motors, tone-arms, amplifiers, cabinets, hardware, Radio specialties. Highest quality, low price. Catalog free. Federal Supply Co., Indianapolis, Ind.

PHONOGRAPH Builders for guaranteed equipment assuring finest results and Best Values. Write Superior Phonographs Co., Erie, Pa.

BUILD your own Phonograph. Our motors, tone arms, are best and lower priced. Write for catalog today. American Phonograph Co., 3513 North Crawford, Chicago.

SPECIAL values, until sold. High grade machine and 25 records, \$25. Seiber & Hofheins, Buffalo, New York.

MUSIC AND MUSICAL INSTRUMENTS

WRITE Songs. Big money and reputation. Write for information. J. Gordon Pub. Co., 201 N. Hoyne Ave., Chicago.

SONG Writers—Have you poems? I have wonderful proposition. Ray Hibbeler, D110, 4640 Dickens Ave., Chicago.

CORNETISTS — Trombonists — Saxophonists — Clarinetists. Send for "Free Pointers." Name instrument. Virtuoso School, Buffalo, New York.

MUSICIANS: New course in Harmony. Write, Frank Lüttig, Nipomo, Calif.

"MUSIC Composed" to words. Bauer Bros. (formerly of Sousa's Band), Oshkosh, Wis.

I WANT song poems. Casper Nathan, Garrick Theatre Building, Chicago.

JOIN our Sheet Music Club and receive latest popular music of all publishers, \$1.00 Year Plan. Write today for details. Sheet Music Club, Suite 703, 1545 Broadway, New York.

VIOLINS—Deep, Mellow, Soulful — on credit. Easy terms for wonderful instrument. Get details today. Gustav F. Henning, 2424 Gaylord St., Denver, Colo.

DIAMONDS, WATCHES AND JEWELRY

CHRISTMAS is coming! Importer, by extra fortunate purchase offers genuine, indestructible Japanese pearl necklaces at greatly reduced prices, 18 inch and 24 inch graduated, or evenly matched pearls, rich and lustrous, \$10.50 and \$12.50 respectively. Opera length, 70 in. "De Luxe" necklaces, composed of perfectly matched, richly colored pearls, \$30.00; cannot be duplicated at twice this price. All in handsome gift boxes, sent by insured parcel post. Send Draft, certified, or cashier's check, or Postoffice, or express money orders—other remittances not accepted. Order Now, while the supply is good and the prices low. Address, J. Bennett, 1660 Lawrence Avenue, Chicago.

FOR THE HOME

SAVE Coal. Make your own heat with kerosene burner; good for kitchen ranges and furnaces. Plans, \$1.00. Agents wanted to sell plans. McCormack Specialty Co., Guilford, Conn.

PATENT ATTORNEYS

PATENTS—Before disclosing an invention, the inventor should write for our blank form "Record of Invention." This should be signed, witnessed and returned to us together with model or sketch and description of the invention and we will give our opinion as to its patentable nature free. Our Three Books mailed free to inventors. Our illustrated Guide Book, "How to Obtain a Patent," contains full instructions regarding Patents, Trademarks, Foreign Patents. Our Methods, Terms, and 100 Mechanical Movements illustrated and described. Articles on Patent Practice and Procedure and Law Points for inventors. Our Trademark Book shows the value and necessity of trademark protection and gives information regarding unfair competition. We have direct agencies in all the principal foreign countries and secure foreign patents in the shortest possible time and at the lowest cost. Write for our illustrated guide book on Foreign Patents, sent free to any address. "List of Patent Buyers" sent free, containing unsolicited letters from manufacturers and others who are constantly writing us regarding the purchase or leasing of meritorious patents. We endeavor to assist our clients in the commercial development of their inventions. Owing to the growth of our business we have established for the benefit of our clients Branch Offices in New York City at 1697 Woolworth Bldg., Philadelphia at 714 Liberty Bldg., Pittsburgh, Pa., at 514 Empire Bldg., Chicago, Ill., at 1114 Tacoma Bldg., and San Francisco, Calif., at 1010 Hobart Bldg. Victor J. Evans & Co., Main Office, 181 Ninth, Washington, D. C.

PATENTS—"How to Obtain a Patent" is the name of a book which every inventor should have. It will be sent free upon request, and will tell you what you want to know about patents. It contains the whole story. It describes the different parts of the application and explains in simple language the prosecution before the Patent Office. It tells about joint applications, reissues, agreements, assignments, licenses, interferences, infringements, process patents, design patents, trade-marks, and prints and labels. If you are interested in patents either as an inventor, manufacturer or owner of a patent you will enjoy reading this book which was written by a lawyer who has had twenty-five years' experience in patent matters. If you have an invention and will send us a sketch, model or photograph of it we will promptly make a search of the Patent Office records and advise you whether or not, in our opinion, your invention is patentable, our charge for the service being \$5.00. We feel that our experience of twenty-five years has fitted us to render prompt and efficient service which will merit your confidence. Write today. Talbert & Talbert, 463 Talbert Building, Washington, D. C.

ROBB, Robb & Hill offer a strictly professional service to manufacturers and inventors in patenting inventions and registering trade-marks, a service which is the result of 20 years' experience. Write for free booklet and names of prominent manufacturers and inventors represented by us. Send sketch for preliminary advice, 811 McLachlen Bldg., Washington, D. C.; 1348 Hanna Bldg., Cleveland, Ohio.

PATENTS promptly procured. Personal, careful and efficient service. Highest references. Moderate fees. Send sketch or model for actual search and advice. George P. Kimmel, Master of Patent Law, 54-N, Loan and Trust Bldg., Washington, D. C.

PATENTS, Booklet free. Highest references. Best results. Promptness assured. Send model or drawing for preliminary examination. Watson E. Coleman, Patent Lawyer, 624 F Street, Washington, D. C.

900 MECHANICAL Movements and 50 Perpetual Motions illustrated and explained in my book. Inventor's Universal Educator, 5th Edition—Tells how to procure and sell patents. Government and other costs. Covers the matter from A to Z—150 pages—Elegantly bound. Contains noted decisions of U. S. Supreme and State Courts on Patent cases. Mechanical Movements greatly assist inventors—suggest new ideas that might prove of great aid in perfecting inventions. Tells how to select an Attorney. Has valuable information regarding Patent Sharks. Selling Agents and promoters. Price, \$2. Postage free everywhere. Fred G. Dieterich, 621 Ouray Bldg., Washington, D. C.

PATENTS, Trade-marks—39 years of confidential service; expert advice, prompt action, reasonable fees. Send for Free Book No. 61, Edgar Tate & Co., 245 Broadway, New York; 635 F St. N. W., Washington, D. C.

HAVE You an invention? If so, write for our free book, "How to Get Your Patent," tells our terms and methods. Send model or sketch for our opinion of its patentable nature. Randolph & Co., Dept. 144, Washington, D. C.

PATENTS. Write for free illustrated guide book. Send model or sketch and description for free opinion of its patentable nature. Highest references. Prompt attention. Reasonable terms. Victor J. Evans & Co., 157 Ninth, Washington, D. C.

UNPATENTED ideas can be sold. I tell you how and help you make the sale. Particulars free. Write W. T. Greene, 106 The Atlantic, Washington, D. C.

GET your own patents. Application blanks, complete instructions \$1. Cutting Soes, Campbell, Cal.

INVENTORS: Send sketch or model of invention for opinion concerning patentable nature and exact cost of patent. Book, "How to Obtain a Patent," sent free. Tells what every inventor should know. Established twenty-eight years. Highest references, prompt service, reasonable charges. Address Chandice & Chandice, 438 Seventh, Washington, D. C.

"**INVENTORS' Guide**," free on request; gives very valuable information and advice. Write Frank Ledermann, 15 Park Row, New York, N. Y.

PATENT, Trade-Mark and Copyright Specialist. Write at once for Free Duplex Conception Form, Personal service. M. E. Jones, Lawyer, 509A 7th St., Washington, D. C.

PATENTS Secured. Prompt service. Avoid dangerous delays. Send for our "Record of Invention" form and Free Book telling How to obtain a Patent. Send sketch or model for examination. Preliminary advice without charge. Highest References. Write Today, J. L. Jackson & Co., 244 Ouray Bldg., Washington, D. C.

INVENTORS! Write to U. S. Patent Office for free copy of "Information Concerning Patents," then engage a competent Patent Lawyer to protect your ideas. Ralph Burch, Patent Lawyer, Jenifer Bldg., Washington.

AMASA Hartwell Balcom, Patent Attorney and Engineering Counselor, 806 Munsey Bldg., Washington, D. C. Professional, individual service for inventors in Patent and Trade Mark matters. Full information on request.

BEFORE or after filing application for patent on your invention it will pay you to read over my "Inventor's Advisor No. 3," free for asking. M. Labiner, Registered Patent Attorney, 3 Park Row, New York.

PATENTS Procured. Trade Marks Registered. A comprehensive, experienced, prompt service for the protection and development of your ideas. Preliminary advice gladly furnished without charge. Booklet of information and form for disclosing idea free on request. Richard B. Owen, 30 Owen Bldg., Washington, D. C., or 2276 R. Woolworth Bldg., New York.

PATENTS—Write today for Free Instruction book and Evidence of Conception blanks. Send sketch or model for examination and opinion; strictly confidential. No delay in my offices; my reply special delivery. Reasonable terms. Personal attention. Clarence B. O'Brien, Registered Patent Lawyer, Southern Building, Washington, D. C.

MILLIONS spent annually for ideas! Hundreds now wanted! Patent yours and profit! Write today for free books—tell how to protect yourself, how to invent, ideas wanted, how we help you sell, etc. 500 Patent Dept., American Industries, Inc., Washington, D. C.

INVENTORS aided. Ideas developed and patented. Practice in all courts and departments. Richardson & Rogers, 27 Albee Bldg., Washington, D. C.

PATENTS—Trademarks. Thirty-five years' experience. Send model or sketch for opinion as to patentability. Free "Inventors Guide." Highest references and personal attention assure best results. Franklin H. Hough, 522 Washington Loan & Trust Bldg., Washington, D. C.

PATENTS—Prompt, personal, efficient service by an attorney-at-law skilled in all branches of Patent Practice. Over 18 years' actual experience; full information upon request. R. P. Fishburne, 331 McGill Bldg., Washington, D. C.

INVENTIONS Patented; Trade-marks Registered; reasonable charges; prompt service; plain advice; request detailed information. Jaynes & Jaynes, 700 Kellogg, Wash., D. C.

WOODWARD, New Book. Submit your ideas. H. L. Woodward, 714 9th St., Washington, D. C.

INVENTORS—Send for form "Evidence of Conception" to be signed and witnessed. Form, fee schedule, information free. Lancaster and Allwine, 221 Ouray Bldg., Washington, D. C.

PATENT application filed on partial payment plan. Trade-marks, copyrights, etc. Milo B. Stevens & Co., 685 F St., Washington, 352 Monadnock Bldg., Chicago. Estab. 1864.

PATENTS and Trade-marks obtained. Prompt service. Write for our new book on patents. Established in 1889. D. Swift & Co., 369 7th St., Washington, D. C.

MONROE MILLER, Ouray Building, Washington, D. C. Patent attorney, mechanical and electrical expert. Best quality of work and results. Moderate charges.

BOOKLET, "Particulars"; Sterling Book, Near Patent Office, Washington, D. C.

FOR INVENTORS

PATENTS—"How to Obtain a Patent" is the name of a book which every inventor should have. It will be sent free upon request, and will tell you what you want to know about patents. It contains the whole story. It describes the different parts of the application and explains in simple language the prosecution before the Patent Office. It tells about joint applications, reissues, agreements, assignments, licenses, interferences, infringements, process patents, design patents, trade-marks, and prints and labels. If you are interested in patents either as an inventor, manufacturer or owner of a patent you will enjoy reading this book which was written by a lawyer who has had twenty-five years' experience in patent matters. If you have an invention and will send us a sketch, model or photograph of it we will promptly make a search of the Patent Office records and advise you whether or not, in our opinion, your invention is patentable, our charge for the service being \$5.00. We feel that our experience of twenty-five years has fitted us to render prompt and efficient service which will merit your confidence. Write today. Talbert & Talbert, 464 Talbert Building, Washington, D. C.

PATENTS. If you have an invention which you wish to patent you can write fully and freely to Munn & Co. for advice in regard to the best way of obtaining protection. Please send sketches or a model of your invention and a description of the device, explaining its operation. All communications are strictly confidential. Our vast practice, extending over a period of seventy-seven years, enables us in many cases to advise in regard to patentability without expense to the client. Our Handbook on Patents is sent free on request. This explains our methods, terms, etc., in regard to Patents, Trade Marks, Foreign Patents, etc. "Scientific American" contains Patent Office Notes, Decisions of interest to inventors, and particulars of recently patented inventions. Munn & Co., Solicitors of Patents, 623 Woolworth Bldg., New York; Scientific American Bldg., Washington, D. C.; 801 A Tower Bldg., Chicago, Ill.; 611 Hanna Bldg., Cleveland, Ohio; Hobart Bldg., San Francisco, Calif.

MODEL Making and experimental work; Modern Shop; expert workmen. Manufacturing. Lamson Model and Experimental Works, 625 W. Jackson, Chicago.

"**INVENTOR'S Guide**," free on request; gives very valuable information and advice. Write Frank Ledermann, 15 Park Row, New York, N. Y.

INVENTOR, I can save you money on specifications and blueprints. P. Fonos, New Richmond, Wis.

INVENTORS: We sell patents on commission. Patent Co., Peterson, Iowa.

INVENTORS and Manufacturers: Have your invention designed for commercial use; we make Drawings to Scale, Blue Prints, Models, Dies, Tools, Fixtures and Automatic Machinery for economical Manufacturing. Automatic Coin-Controlled Dispensing Machines, designed and constructed. John Frick, Mechanical Engineer, 1105 Arch St., Philadelphia, Pa.

PATENTS Secured. Prompt service. Avoid dangerous delays. Send for our "Record of Invention" form and Free Book telling How to obtain a Patent. Send sketch or model for examination. Preliminary advice without charge. Highest References. Write Today, J. L. Jackson & Co., 243 Ouray Bldg., Washington, D. C.

WE Develop, improve and make drawings of your idea. Blueprints of all descriptions, \$4 and up. Strictly confidential. Scholtz & Co., Dugrand, Mich.

I SELL Patents. Established 1900. Address, Charles A. Scott, 773PM Garson Avenue, Rochester, N. Y.

INVENTIONS developed to practical manufacturing basis. Research and model work strictly confidential. Light manufacturing. Bellance, 138 West Broadway, New York.

PATENTS manufactured and marketed on royalty. Beer Pattern Works, Toledo, Ohio.

PATENTS Procured—Trade Marks Registered—A comprehensive, experienced prompt service for the protection and development of your ideas. Preliminary advice gladly furnished without charge. Booklet of information and form for disclosing idea free on request. Richard B. Owen, 30 Owen Building, Washington, D. C., or 2276 R. Woolworth Bldg., New York.

PATENTS—Write today for Free Instruction book and Evidence of Conception blank. Send sketch or model for examination and opinion; strictly confidential. No delay in my offices; my reply special delivery. Reasonable terms. Personal attention. Clarence B. O'Brien, Registered Patent Lawyer, Southern Bldg., Washington, D. C.

SEND sketch or search report. Get my latest book on patents. H. L. Woodward, 711 9th St., Washington, D. C.

UNPATENTED ideas can be sold. I tell you how and help you make the sale. Particulars free. Write W. T. Greene, 106 The Atlantic, Washington, D. C.

PATENTS FOR SALE

PATENT 1,328,548 for sale. Propelling Mechanism for Automotive Sleighs. The automobile is converted into an overland vehicle; designed to make possible easy and swift traveling over snow or ice covered road beds or the like. Wm. O'Brien, 83 River St., Willoughby, Ohio.

YOU have a worth-while patent, haven't you? Why don't you tell our two million readers about it? Most of them are specially interested in patents and new inventions. Ask me to tell you how other inventors successfully sold their patents. J. Roy McClellan, Manager, Classified Advertising, Popular Mechanics Magazine, Chicago, Ill.

FOR SALE: Patent No. 1427576, Post and Brush Puller. Like to hear from real and honest manufacturers and show them how easily this device is constructed and assembled. Its field is virgin territory everywhere. S. O. Bryant, Bethany, Mo.

MANUFACTURERS of Rubber Tires. Tubes, Notice. Just Patented New Accordion Inner Diverged Compression Tube; Puncture, Blowout Proof. Will sell for cash or royalty basis. G. W. Bolser, 1176 Wisconsin Boulevard, Dayton, Ohio.

PATENT No. 1,388,701 for Sale: Fence-wire clamp—a bottleless clamp that holds; simple and a time-saver; easy to manufacture. Write for particulars, Dargan P. Elliott, Rimini, S. C.

OUTRIGHT or Royalty; Patent Fountain Pen Cap; impossible to damage gold pen; eliminates repairs and replacement. Best offer accepted. Doyle, Hollisville, N. Y.

FOR Sale—Patent wire-cutting device. Useful for removing concrete forms. Paul P. Daniels, 2910 W. Ave. 34, Los Angeles, Calif.

U. S. PATENT No. 1,267,694, and Canadian, No. 192,732, on metallic clothes-pin. Price \$50,000 for both. Arthur W. Balston, Huron, S. Dak., Box 510.

PATENT for Sale: Power Attachment for Automobile. Address George Nelson, Center City, Minn.

SOLID Copper Photo-frame Basel 15c. A. F. Johnson, Hancock, Mich.

ELECTRIC Fan Patent—Makes possible "Ford of Fandom." Dissolves draft and delivers uniformly; allows combining with lighting fixture in ornamental design. Big returns await concern with facilities for exploiting. Address Richard White, Patentee, Lock Box 234, Jacksonville, Fla.

PADLOCK Protector—13,334-1; Dish Washer—13,463-1. Talbert & Talbert, Talbert Bldg., Washington, D. C.

FINE Patent for sale, cheap. R. E. B. Allen, Pensacola, Fla., Route A, Box 104.

FOR Sale on Royalty basis—patent on hay loader, enabling one man and boy to load hay as fast as can be raked. No agents answered. Address O. H. Elber, Emmerson Shop, So. Rocky Mount, N. C.

ALLOWED U. S. patent on machine—gates and trim wall paper. It is unrivalled; a great labor and time saver, efficient, simple, durable and inexpensive. Address today! D. E. Lilly, Mt. Hope, W. Va.

FOR Sale outright; only Auto Piston Fitting Tool made. Address T. S. Watson, Box 1129, Burk Burnett, Texas.

PATENTED automobile rim and tire lock, for spare tires. Want royalty. Joseph Zahler, Hudson, Wis.

ATTENTION Mfgs.: I have a patent on a new rubber construction that gives better results at a less cost. Particularly adapted for automobile wheels, running boards, shoe heels, door checks for doors of all kinds, and polished hardwood floors, protectors for furniture legs. Will sell outright or license on royalty. Address: John J. Halloran, 212 Woodrow St., Daly City, Calif.

HAND Bill Stamp and Freight Lading Labeling Machine; automatic, efficient, economical; commercial, express and railroad accessory. Sales possibilities unlimited; experimental work done, now ready for production. H. H. McMillen, 118 Ralph St., Toledo, O.

MANUFACTURERS, Take Notice! For Sale—2 recent patents, one household utility device, other cordage hitch; both one-piece propositions. Simple, cheap to manufacture. Worth investigation. Christopher W. Bauer, 1002 Hancock Street, Brooklyn, N. Y.

OUTRIGHT or Royalty. Automatic Soap Grater for Washing Machine Dasher. Big soap and labor saver. Address, G. Hoelcher, Battle Creek, Iowa.

LACEY Patent Sense. See page 158.

FOR Sale—Folding Flower Canopy patent. Mrs. Emma M. Koehler, R. 7, Box 101, Evansville, Ind.

PATENTS! Send sketch or model for search of pertinent U. S. patents and Report, including copies of patents nearest to your idea. These earlier patents may offer valuable suggestions for improving or perfecting your invention. No charge for preliminary information or advice. O'Connell & O'Connell, 314 Jenifer Bldg., Washington, D. C.

FOR Sale—Patent No. 1,416,781. Inflating Coupling. Edward C. Bevins, 3211 Chatham Ave., Cleveland, Ohio.

AUTOMATIC Pencil Calendar for Advertising. Otto Styles, 1519 Washington St., Toledo, Ohio.

MANUFACTURERS, Attention! Greatest agricultural invention in centuries. New principle. Prepares soil, one operation, for planting. Will revolutionize farming, especially in wheat belt and dry West. Royalty or partnership or might sell. Address "K." care Popular Mechanics.

PATENTED Automatic Sales Machine Selling Magazines, etc. For Sale, Cheap to Mfg. Foolproof. Self Advertising. Market unlimited. Sells 24 hours every day. W. S. Glines, 35 Verdale Ave., Providence, R. I.

NEW book on patents H. L. Woodward, 718 9th St., Washington, D. C. Submit your ideas.

PATENTS. My fees in installments. Advice book free. Frank Fuller, Washington, D. C.

BEST offer takes fine Patent, Reb. Allen, Ra. Pensacola, Fla.

PATENTS For Sale: To sell, buy or obtain patents write Patent News—P, Washington, D. C.

CONSULTING ENGINEERS

YOUR ideas and inventions scientifically worked out, working models prepared and guaranteed. Consulting Engineer, 5 West 121st Street, New York, N. Y.

SURVEYING INSTRUMENTS

NEW and used surveying instruments direct from factory. Satisfaction guaranteed or money refunded. Wissler, 619 Broadway, St. Louis.

MODELS AND MODEL SUPPLIES

WE make working models for inventors and do experimental work and carry a complete stock of brass gears and model supplies. Send for catalogue. The Pierce Model Works, Tinley Park, Ill.

INVENTORS—Write for free illustrated guide book and Evidence of Conception Blank. Highest references. Prompt attention. Reasonable Terms. Victor J. Evans & Co., 165 Ninth, Washington, D. C.

PUNCH Press work, tool and die making, model and special machine work wanted. Completely equipped with new machinery of the latest type. Prompt delivery, reasonable prices guaranteed. Quality Hardware & Machine Co., Dept. A, 6154-56 N. Clark St., Chicago.

MODEL Making and experimental work; Modern Shop expert workmen. Manufacturing. Lamson Model and Experimental Works, 625 W. Jackson, Chicago.

PRACTICAL model steam engines, boilers, blow-lamps, pumps, fittings. Send 10c in stamps for new catalogue. Model Machine Shop Co., 415-17 East 71st St., New York City.

PATENTS—Write today for free instruction book and Evidence of Conception blank. Send sketch or model for examination and opinion; strictly confidential. No delay in my offices; my reply special delivery. Reasonable terms. Personal attention. Clarence B. O'Brien, Registered Patent Lawyer, Southern Bldg., Washington, D. C.

FOR MANUFACTURERS

WANTED—Metal Stamping and Model work taken on contract basis. We are ideally located and equipped to develop patents. Meyers Company, Box 263, Bedford, Ind.

PATENT Tool that every carpenter must use. If you want to manufacture and market a practical tool in big demand, here is your opportunity. Address Hancil Cordrey, Chula Vista, Calif.

MANUFACTURING

SPECIAL Devices and Machinery Designed and Built at reasonable rates. Models made. Jigs and fixtures designed and built for interchangeable and economical manufacturing. Punches and Dies made for all kinds of metal stampings. Machine Work to order. Inventions manufactured on a production basis. Simplex Tool Co., Woonsocket, R. I.

WE manufacture metal specialties of every description, including tools, dies, etc. Let us develop your patent or model for large and economical production. Send sketch or model for prices. Superior Tool Works, 12 South Clinton Street, Chicago, Ill.

MANUFACTURING Work Wanted: We can economically manufacture, in whole or in part, articles of Wood, Iron, Brass or Aluminum. Let us figure on your requirements. For full particulars, address Seneca Camera Manufacturing Co., Rochester, N. Y.

WIRE Goods, all kinds, made to order. Cooley Mfg. Co., 524-530 N. Western Ave., Chicago.

LONG established manufacturer of auto accessories which are daily sold by practically all wholesale and retail accessory houses, will consider manufacturing and distributing new products capable of equally wide sale through same channels. Patented articles preferred. Address "Accessory Manufacturer," 1400 North American Building, Chicago, Ill.

PATTERNS, wood and metal. Models, tools and dies. Brass, bronze, aluminum and iron castings. Screw machine work, production work of all kinds. Write Modern Machine & Pattern Co., Terre Haute, Ind.

MANUFACTURER wants patented specialty to manufacture and market on royalty basis. Must be thoroughly practicable. E. A. Rice, 3961 Grand River Ave., Detroit, Mich.

PATENTED Articles, Models, Brass Work, Machine Construction; Dies Made. Baum's Metal Specialties, Kansas City, Mo.

WE design and build special machinery, make models, dies, stamping tools, do general machine work and light manufacturing. Marshall Mfg. Co., Kansas City, Mo.

IF you want dies and metal stampings, write us. Lyons Machine Works, Lyons, Ia.

GEARS, tools, metal specialties and bronze bearings. Weldon Machine Works, 2940 Herndon St., Chicago.

MACHINERY, TOOLS AND SUPPLIES

BUY—Exchange—Sell. Doubtless many of our readers have just what you want—and they may be in the market for the very articles you want to turn into cash. Remember an ad in these columns will be read by over two million readers. Write up an ad right now and mail it to J. Roy McClellan, Manager Classified Advertising, Popular Mechanics Magazine, Chicago.

DIES, Tool and General Manufacturing Model and manufacturing New Invention, our specialty. Logan Mach. Co., 222 S. Clinton St., Chicago, Ill.

FOOT power stands; portable for running small machinery, emery wheels, buffers, etc., \$15. Mustin Mfg. Co., Box 36, Newport, Kentucky.

LIGHT Power Transmission Machinery, Bearings, Hangers, Pulleys, Reducing Gears. Send for Catalog. Winfield H. Smith, Buffalo, N. Y.

WANTED: Information about new air compressors. Write for free manual. Engineers Dept., Brunner Mfg. Co., Utica, N. Y.

CONCRETE Building Block Machines and Molds. Catalogue free. Concrete Machine Co., 112 South Second St., St. Louis, Mo.

TOOLMAKERS—Machinists, investigate the Miner Patented Spring Toolholder. Manufactured by E. W. Miner, 5 Alden St., Hartford, Conn.

ENGINES, MOTOR AND DYNAMOS

ALTERNATING and direct current motor bargains. New and rebuilt. All guaranteed for one year. Special prices. Get our price list before buying. Motors exchanged and repaired. Hyre Electric Co., 633-33M South Dearborn St., Chicago.

STEAM Engines, 1 H. P., \$18.00; ½, \$12.00. James Chamberlain, 631 Monroe, Evansville, Ind.

SMALL Gasoline, Steam Engines, Dynamos, Motors, Storage Batteries, etc., new and secondhand. Bargain Bulletin 133 free. Dynamic Manufacturing Co., First National Bank Bldg., Chicago.

AUTOMOBILE Owners, garagemen, mechanics, send today for free copy of this month's issue. It contains helpful, instructive information on overhauling, ignition troubles, wiring, carburetors, storage batteries, etc. Over 120 pages illustrated. Send for free copy today. Automobile Digest, 507 Butler Bldg., Cincinnati.

ELECTRICAL

ELECTRICITY For 10c Per Hour. Mot-soo Auto Generator. Operates on any make automobile. Produces electricity for Moving Picture Machines, Theatres, Schools, Churches, Homes, Etc. Write for free particulars. Monarch Theatre Supply Co., Dept. AG 724 South Wabash Ave., Chicago.

ELECTRIC motors and supplies, including sockets, wire conduit, cleats, looms, resettes, switches. New revised wholesale prices. Illustrated Catalog free. Hyre Electric Co., 633-33M, South Dearborn St., Chicago.

ELECTRICAL Experimenters—Here is the book you have been waiting for—"How to Make Things Electrical." 256 articles, 427 pages, 358 illustrations. Size 4 1/2 x 7, cloth binding. Price \$2.50 postpaid. Popular Mechanics Book Dept., 6 N. Michigan Ave., Chicago.

BLUEPRINTS. Electrical Connecting Diagrams. Particulars free. Samples 25c. Address Charles Chittenden, M3024 Matthews, Kansas City, Mo.

ARE You Old at Forty? See our advertisement on page 144 of this issue. The Electro Thermal Company, Steubenville, Ohio.

FOR MECHANICS

PATENTS—Write for our free illustrated guide book and Evidence of Conception Blank. Send model for sketch and description of the invention for our opinion of its patentable nature free. Highest references. Prompt attention. Reasonable terms. Victor J. Evans & Co., 184 Ninth, Washington, D. C.

MECHANICS, mark your tools, saws, knives, razors, etc., with a rubber stamp by Kent's simple etching process. Particulars free. Ed. Kent, 297 Fell St., San Francisco, Calif.

PATENTS—Write today for free instruction book and Evidence of Conception blank. Send sketch or model for examination and opinion; strictly confidential. No delay in my offices; my reply special delivery. Reasonable terms. Personal attention. Clarence B. O'Brien, Registered Patent Lawyer, Southern Bldg., Washington, D. C.

BLACKSMITHS

BLACKSMITHS, Listen: Any Handy man can make more money doing hard jobs easy. Forging and welding solid, with Toy's Modern Methods of Blacksmithing. Hardening and tempering to a standard with colored tempering charts. All for one dollar. Samples Free. W. M. Toy, Sidney, O.

FOR SALE—MISCELLANEOUS

BUY — Exchange — Sell! Many of our readers have for sale or exchange the article you are looking for—and lots of them are looking for the very items you want to turn into cash. Get together! Let our two million readers know your wishes—they'll help you! Send your ad today to J. Roy McClellan, Manager Classified Advertising, Popular Mechanics Magazine, Chicago.

ADDRESSOGRAPHS, Letter Folders, Multigraphs, Envelope Sealers, Duplicators, less than half price. Guaranteed. Fruit Co., 112-B N. La Salle, Chicago.

FOR Sale, new \$20 Mechanical drawing outfit, \$6.75. National Instrument Co., 4704 N. Hamilton, Chicago.

GASOLINE Lamps and Lanterns, Catalog Free. Little Wonder Light Co., Terre Haute, Ind.

FOR THE SHOP

SHOP Notes Volume 17 contains 702 practical articles such as Half-ton Traveling Crane, Boring Machine, Toggle Press, Gas-Fired Forge, Oil-Gas Generator, Movable Table for Drill Press, etc., 224 pp. 496 Ills. 50 cents postpaid. Popular Mechanics Book Dept., 6 N. Michigan Ave., Chicago.

MAKE Phonographs, sell them to your friends, save over half. Woodwork cut to exact size. Motors, tonearms at wholesale. Free catalogue. Dauser, Canal at Roosevelt Rd., Chicago.

SHOP Notes for 1922—Bench Lathe, Electric Soldering Outfit, Jib Crane, Pump Troubles, Road Roller, Bench Grinder, Bench Miller, are among the 655 articles in this new volume, 224 pp., 50 cents postpaid. Popular Mechanics Book Dept., 6 N. Michigan Ave., Chicago.

WANTED—MISCELLANEOUS

MAIL us your discarded jewelry. Gold Crowns and Bridges, Watches, Diamonds, Silver, Platinum, War Savings Stamps and Old False Teeth. Money sent at once. Goods Ref. if offer is refused. United States Smelting Works, (Old Reliable) Dept. 71, Chicago.

MAIL order ideas and articles wanted. Buy outright, or on royalty. Send full particulars. John O. Hofbauer, Bayside, Long Island.

CHRIS TURNBULL, Kimberley, South Africa, wants fullest details and illustrations of household time savers, motor car accessories, tire repairs. All must be universally required. Latest goods. Hold stocks. Sole rights here.

CASH for Gold, Platinum, Silver, Diamonds, Liberty Bonds, War Thrift, Unused Postage Stamps, False Teeth, Magneto Points, Jobs, any valuables. Mail in today. Cash sent, return mail. Goods returned in ten days if you're not satisfied. Ohio Smelting Co., 306 Hippodrome Bldg., Cleveland, Ohio.

EXCLUSIVE Selling Rights wanted on patented novelties. Laurel Company, Branford, Conn.

WANTED—Rug Cleaning Machinery, Portable Vacuum Pump, etc. A. E. Grothe, Burlington, Iowa.

DOGS, BIRDS, POULTRY AND PETS

DOG Owner's Text Book Free; expert advice on proper care, training and feeding. Free with 3 months' trial subscription to America's popular dog and hunting magazine. Send 25c today (coin or stamps). Sportsman's Digest, 505 Butler Bldg., Cincinnati, O.

AIREDALES, Puppies and grown dogs for sale. Hillview Kennels, Route 6, Dallas, Texas.

BOSTON Terriers for sale; Pedigreed stock. W. R. Mobley, Haverhill, Mass.

BREED Squabs, Book free. E. Rice, Melrose Highlands, 77 Massachusetts.

RAT Terriers and White Spitz—male pups, \$10.00; females, \$7.50. Angora cats, rabbits, canaries, covies, poultry. Joseph Bez, Hendrum, Minn.

SILVERBLACK foxes, skunks, muskrats. Animal bait, traps. Booklet dime. Arthur Schumacher, Lockland, O.

FERRETS, white or brown, large or small; list free. E. Younger, Newton Falls, Ohio.

TRAPPER'S blueprint entitled "Eleven Good Box Traps," 30c. Weesho-Uco, West Market, Detroit, Mich.

FERRETS for Sale. Price list free. Glendale Ferret Co., Wellington, Ohio.

REAL ESTATE AND FARM LANDS

FLORIDA Oranges are most profitable as well as most delicious. Grow your own in a land of sunshine, away from winter blizzards and coal bills. Money you'll not miss will buy you land for a grove in a high, rolling, lake-jewelled land of many golden groves. If you mean business, write today for Book of Facts and Photos. Lake County Land Owners' Association, 93 Arbor Avenue, Fruitland Park, Fla.

FOR Sale—Three full sections in McKenzie County and two sections in Billings County, North Dakota. Each section contains land suitable for crops, balance for cattle. Each section has valuable deposits of lignite which some day will alone be worth many times the present value of the land. This part of the state is developing very rapidly, with good schools within easy access. An owner cannot use this land himself will sell one or more sections at a price which almost anyone can afford to pay. Address, W., care Popular Mechanics, 6 North Michigan Ave., Chicago.

SPECIAL "get-together-on Florida" farm home offer limited to 50 men. Chance of a lifetime. \$5 a month buys 10-acre farm tract in midst of beautiful lake region, where the fine oranges grow. Only \$19 an acre; limit 40 acres to a buyer. Bankers and business men say this land should bring \$100 to \$150 an acre when paved roads completed. Near Tampa. Don't wait, write. Tampa Bay Land Company, 1019 Citizens Bank Building, Tampa, Fla. Old, strong, reliable company.

\$5 DOWN, \$5 monthly; 20 acres unimproved fruit stock, poultry, woodland; \$160; Ozarks. Fishing, hunting, trapping. Address Alfred Zimmerman, 1806 N. Fifth, Kansas City, Kansas.

PROPERTY Owners—Get cash for your real estate, business or other property. To quickly sell, exchange or buy property any kind anywhere, write Western Security Co., 104, Hannibal, Mo.

SELL your property quickly for cash, no matter where located. Don't pay big commissions. Particulars free. Real Estate Salesmen Co., Desk B, Lincoln, Neb.

WANT to hear from owner having farm for sale; give particulars and lowest price. John J. Black, 11th Street, Chippewa Falls, Wis.

I WANT Farms for cash buyers; will deal with owners only. H. A. McNow, 312 Wilkinson Bldg., Omaha, Neb.

LAND Seekers! Attention! Opportunity awaits you near thriving city in Lower Michigan. 20, 40, 80 acre tracts; only \$10 to \$50 down; balance long time. Investigate. Write today for Free Illustrated booklet giving full information. Swigart Land Co., P-1259, First National Bank Building, Chicago.

WHY not grow vegetables, save coal. In Florida? Fare to buyers choicest land locations. Reliable firm, Hickman, 408 Olive, St. Louis.

ATTENTION! "Get Acquainted." Cash for your property. Farm, Hotel or Retail Store, no matter where located; confidential service. Hayes' Business Agency, Cincinnati, Ohio.

PERSONAL

TOBACCO Kills Manly Vigor. Quit easily. Cigarettes, chewing, smoking, snuff conquered or no charge. Small sum if satisfactory. Stops craving; harmless. Full treatment on trial. Perkins Co., 34-A, Hastings, Neb.

STUDY Human Nature, know people, make more money. Send 10 cents for "Personal Power," a little book that points the way. Progress League, 31-A, I. Union Square, New York.

TOBACCO or Snuff Habit cured or no pay. \$1.00 if cured. Remedy sent on trial. Superba Co., TP., Baltimore, Md.

TOBACCO Habit Quickly Cured. Any form. 25c (silver). Adolph Lonk, N-3918 Taylor, Chicago.

LIFE revelation showing your character, talents, suitable occupation, congenial life partner, etc. Send birthdate, 10c. St. Germain Society, Sharpsburg, Pa.

SELF-UNDERSTANDING, Self-mastery, and your Emotional Keynote. Explanatory literature free. Address, Robert Knox, Box 128, San Francisco, Calif.

RESTORINE clear as water restores your gray hair to its original color in a few days. Stops dandruff and falling hair. No dye, non-injurious, leaves hair soft and lustrous. Send 10c for full size package. Pay balance 50c when satisfied only. State original color of hair. The O'Neil Laboratories, Sta. G, Oakland, Calif.

JOIN our Club and learn in plain, everyday language how Applied Psychology brings Health, Happiness, Success. Personal Consultation Privileges. Common-Sense Psychological Club, 637 N. Michigan Ave., Chicago.

Learn Electricity

In **3½**
Months

Earn
\$150
to
\$400
per
Month

In the Great Shops of

COYNE

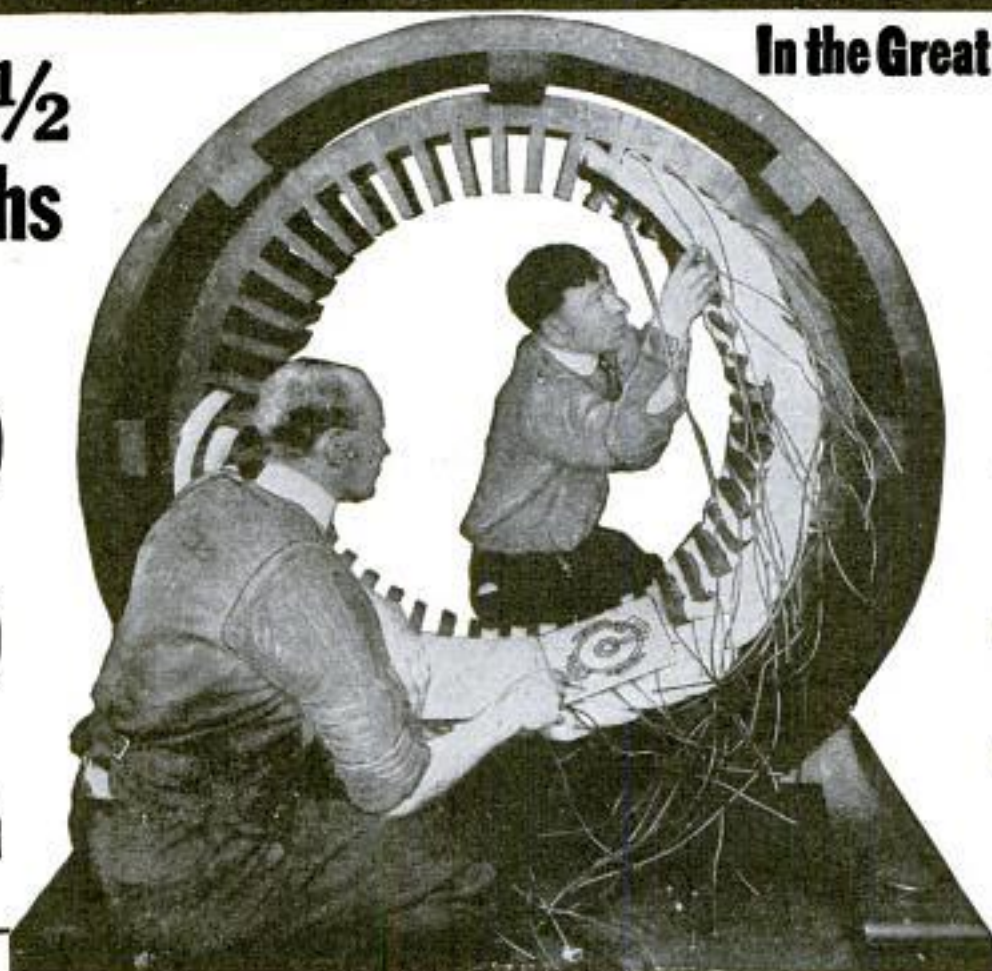

Student Winding Stator

THE whole world of electricity is open to the Coyne trained man. He is trained completely. He can make big money as Power Plant Operator, Superintendent, Telephone man, Construction worker, auto, truck or tractor electrician, battery man, radio expert, or he can go into business himself as electrical contractor, dealer, auto ignition or battery expert and make from \$3,000 to \$20,000 a year. Hundreds of our graduates today are making big money and you can do the same if you grasp this opportunity—act now.

Big New Home

The increasing popularity of Coyne and a tremendous influx of new students simply forced us to move into larger and more spacious quarters. Here, in the big, new home, you will find added electrical equipment—new and larger departments—a more complete electrical training—a school thoroughly equipped to train you for a big paying position.

Earn \$150 to \$400 per Month

No books or useless theory. You are trained on \$100,000 worth of electrical equipment. Everything from door bells to power plants. You work on motors, generators, house-wiring autos, batteries, radio, switchboards, power plants—everything to make you an expert ready to step right into a position paying from \$45 to \$100 a week. Learn electricity in the electrical center of the world. Send the coupon today for free catalog.

Radio Course FREE

We include the following free with the regular course:

- (1) A complete course in auto, truck and tractor electricity and storage batteries. Greatest outlay of auto electrical and battery equipment.
- (2) Course in Radio—the marvel of the age. Constructing, installing and operating. You can build your own wireless telephone set.
- (3) A life scholarship in the Coyne School. You can stay as long as you wish and return for further training any time in the future.

Earn While You Learn We help students to secure jobs to earn a good part of their expense while studying.

Send Coupon NOW!

Don't delay a minute—send that coupon in right now for our big free catalog and full particulars of this wonderful offer.

Act Now!



B. W. Cooke, Pres.—Coyne Trade & Engineering School
1300-1310 W. Harrison St. Dept. 1359 Chicago, Ill.

B. W. COOKE, President

COYNE TRADE & ENGINEERING SCHOOL
1300-1310 W. Harrison St., Dept. 1359, Chicago

Dear Sir:—Please send me free your big catalog and full particulars of your special offer of 2 extra courses.

Name

Address

Continued from Page 48

SOLVE Your Problems. Know your Personality, True Success Principles and Self-Revealing Chart for 10c. Address Thomson-Heywood, Dept. 985, Chronicle Bldg., San Francisco, Calif.

BALDNESS, thinning hair Try Kotalko. Watch mirror. Often astonishing growth when all else fails. Proof box mailed free. Kotalko Offices, BE-187, Station X, New York.

ARE You Old at Forty? See our advertisement on page 144 of this issue. The Electro Thermal Company, Steubenville, Ohio.

YOUR Horoscope covering full year 50c. Includes extensive reading, valuable daily guide, large pictorial chart, and special forecasts for each month. Scientific, complete. Try it! Money back if dissatisfied. Give birthdate. Address H. Daniels, Flatbush Station, Box 32, Brooklyn, N. Y.

FREE—Stop using tobacco. We will give free information how to conquer habit easily and permanently. Results guaranteed. Anti-Tobacco League, Box K, Omaha, Neb.

MISCELLANEOUS

INCORPORATING a company? Save expenses and taxes by organizing on the popular, Common Law plan under a pure Declaration of Trust. Anyone, anywhere, can fill in Demaree Standard Forms, issue shares and begin doing business at once. Insist upon Demaree Forms, the original nationally-accepted forms, approved and used by well known attorneys. Send for large, free pamphlet (C-53) containing much information that you will need. C. S. Demaree, Legal Blank Printer, 708 Walnut, Kansas City, Mo.

CUTS anybody can make. Simple, cheap process. \$1. Specimens, particulars. 2c stamp. M. Day, Windfall, Ind.

ARTIFICIAL Eyes. \$3. Booklet free. Denver Optic, 559 Barclay, Denver, Colo.

ARIZONA Incorporation completed day papers are filed, without nominal or per value shares. Least cost. Greatest advantages. Operate anywhere. Forms Free. Stoddard Incorporating Company, 8-B, Phoenix, Ariz.

ASTROLOGY Reveals. 2,000-word trial reading, only 25c. Choice of two questions considered free. State birthdate. Prof. Audrey, Section X-M, Box 834, Washington, D. C.

IF you own an Auto—play billiards—are a bookkeeper—housekeeper—anybody—anywhere and have a pair of kidneys, it will be well worth your while to look into CaXaC, The Empty Envelope, and see what is in it for you. Your address, enclosing 25 cents—silver or stamps—will bring you something—unordinary—very—giving you facts safe and sane, told in a common sense way. We give you sincere wide-awake service or refund your money. The CaXaC Company, Ten-ten Pontiac Building, Chicago, Ill.

INFORMATION. Positively anything you need know, scientific, technical, business, medical, legal, formulas, addresses, miscellaneous. Where buy, sell, 10c per question answered, or formula; none higher. Satisfaction guaranteed or money returned. Address General Information, Ann Arbor, Mich.

CHRISTMAS is coming! Importer by extra fortunate purchase offers genuine Japanese indestructible pearl necklaces at greatly reduced prices: 18 inch and 24 inch graduated or evenly matched pearls, rich and lustrous, \$10.50 and \$12.50 respectively. "Opera length" (70 inches) "De Luxe" necklaces, composed of large, perfectly matched, richly colored pearls, \$30.00—cannot be duplicated for twice this price. All in handsome gift boxes, sent by insured parcel post immediately on receipt of your order. Send draft, certified, or cashier's check, postoffice or express money order—other remittances not accepted. Order now while supply is good and prices low. Address J. Bennett, 1060 Lawrence Ave., Chicago.

ART Metal Workers—You will find our book "Metal Work and Etching" a complete manual on making book ends, desk sets, pad corners, paper knives, letter openers, stationery racks, rocking blotters, desk calendars, arts and crafts jewelry, etc., 96 pp. illus. Price 50 cents postpaid. Popular Mechanics Book Dept., 6 N. Michigan Ave., Chicago.

REPLATING jewelry, tableware. Victrola arms replated. W. Harrison, Fitzgerald, Ga.

N. O. P. Metal Polish, cleans and polishes all metals. Produces a lasting and waterproof luster. Seven-inch tube postpaid, twenty-five cents. Norwood Oil Products Company, Norwood, Ohio.

STOP! that repair bill—lower your cost of operation and be familiar with your auto by having in your vest pocket for emergency reference a copy of a new, compact little book entitled "Causes and Remedies for Ills and Ails of an Automobile." Price \$1 postpaid. Popular Mechanics Book Dept., 6 N. Michigan Ave., Chicago.

5 MASTER Keys. Work like magic in emergencies or prove whether your home is burglar-proof. Test and open thousands of locks. Send \$1 today. Novel key chain free. Master Key Co., 3 Manhattan Block, Milwaukee, Wis.

BLOWTORCH—Soldering, tempering, melting. Every mechanic and handy boy needs one. Easily made. Costs about 75c. Send 50c for shop-right and instruction. Guaranteed. B. M. Howell, Newton, Ill.

ARE You Old at Forty? See our advertisement on page 144 of this issue. The Electro Thermal Company, Steubenville, Ohio.

GUNS, SPORTING GOODS, ETC.

POCKSCOPE—the 4½ power pocket telescope indispensable to all sportsmen. Only \$2.00 plus 5c postage. Wollensak Optical Company, 60-62 Clinton Ave. No., Rochester, N. Y.

Can You Fill This One Requirement? Then I'll Pay You \$5,000 to \$10,000 a Year

I NEED 196 more salesmen immediately who want to make real money—\$5,000 to \$10,000 a year.

I am not hunting supermen—they do not have to be college graduates or even long-experienced salesmen. In return for this genuine opportunity there is just one requirement—you must be a live wire, wide awake, ambitious man, and conscientiously interested in a proposition that is making hundreds of men the biggest money they ever made in their lives.

Many of my sales representatives are averaging \$500.00 a month; others exceed that amount. Right on my desk I have a letter from F. W. Bentley, of Philadelphia, telling how he made \$215.00 in one day. One from A. M. Russell, of Hartford, Conn., who made \$660.00 in one month. I have scores of similar letters in my files. One from R. Berger, of Ontario, who makes \$250.00 a week. One from J. Carnegay, of South Dakota, telling how he is making \$1,000.00 a month, and another from W. Drew, of Michigan, who makes \$85.00 a day.

I want you to be a representative of the famous Oliver Oil-Gas Burner—an invention that instantly turns any stove or heater into an oil-gas stove—with three times the heat of coal and none of the bother or dirt.

New Invention Solves Fuel Problem Sells Like Wild Fire

Facing the highest prices ever asked and an acute coal shortage, the country is clamoring for this invention. Just think of what it means—cheaper fuel than either coal or wood, because it burns 95% air and only 5% kerosene (coal oil). Every man wants it because it means a big saving in fuel bills. Every housewife wants it because it does away with drudgery—fire-making, dirt, ashes, smoke, chopping, carrying coal and wood.

Easy to demonstrate, slips in and out of any stove in one minute. Show a woman what it will do right in her home and the sale is made. Big demand the year round—does away with the housewife's dread of a hot summer kitchen.

Write Me at Once

If you can fill this one requirement—(are wide-awake and really anxious to connect with this live proposition) then just mail the coupon today and I will promptly forward full details with absolute proof that you can make a minimum of \$5,000.00 a year as an Oliver salesman. Act at once—and be one of the 196 selected! Oliver Oil-Gas Burner & Machine Co., 2048-X Oliver Bldg., St. Louis, Mo.

Oliver Oil-Gas Burner & Machine Co.
2048-X Oliver Bldg., St. Louis, Mo.

Please send me full facts about how I can make big money representing you in my territory. Also your plan, if I wish to make big money in my spare time.

Name.....

Address.....

City..... State.....

Learn photography at home

Studio Owner



**Make \$75 a week on the side
Command a large salary
Start in business for yourself**

TODAY Photography holds a greater place in the world of big busi-

ness than ever before. During the past five years millions of dollars were paid each year for pictures. There is a great demand for *experts*. Here is a splendid big-paying opportunity for thousands of ambitious men—men who know the practical side of *Modern Photography*. Here is **your** chance to enter a high class profession that can be learned in only a few months and pays **big money** right from the start.

\$3000 to \$10,000 a Year

The opportunities in this profession are almost unbelievable. When you see old-fashioned photographers making \$4000 a year think of what the *modern expert* can make. Right now there are at least 35,000 good locations waiting. Hundreds of high paying positions are open. *During your spare time alone* you can make \$75 a week and more.

Establish Yourself Quickly



Newspaper Photographer

**No Experience
Necessary**

Some of my most successful students are men with only a common school education. When they began they knew nothing about



H. R. Vant,
one of the
leaders in
Modern Photo-
graphy.
Thousands
of profes-
sionals owe
their success
to him.

Commercial
Photographer

taking pictures. They are making big money—so can you. It takes only a few short months. In a year you can have your own studio.

**Train with a
Leading Photographer**

As Director of the International Studios, Inc., I know just the kind of training you need to be successful. I show you how to do the actual work *yourself*. Anyone can learn to take good pictures. Then it is only a step to modern professional work. You can't expect **modern professional prices** for amateur or old-fashioned work.

I'll Make You an Offer

For a short time I am making an unusual proposition to ambitious men who like to take pictures. It will be withdrawn without notice. Mail coupon today for facts and figures on Photography and offer.

H. R. VANT, Director

INTERNATIONAL STUDIOS, Inc.
Dept. 1199, 3601 Michigan Ave., Chicago, U. S. A.

MAIL AT ONCE!

Without obligation send at once facts about photography and information about your temporary offer.

Name

Address

City State



The Hour That Counts!

When you see a man putting in his noon hour learning more about his work, you see a man who won't stay down. He'll never be satisfied until he hits the top. And he'll get there!

In shops, factories, offices, stores, in every line of industry, men are holding splendid positions won through spare time study with the International Correspondence Schools. Today they are earning four or five times—yes, some of them ten times as much money as when they started.

Employers everywhere are looking for men who really want to get ahead. If you want to make more money, show your employer that you're trying to be worth more money.

For 30 years the International Correspondence Schools have been training men and women right in their own homes.

More than two million have stepped up in just this way. More than 150,000 are studying now. Can you afford to let another hour pass without making your start toward something better? Here is all we ask—without cost, without obligation, mark and mail this coupon!

----- TEAR OUT HERE -----
INTERNATIONAL CORRESPONDENCE SCHOOLS
 Box 5689-C, Scranton, Penna.

Without cost or obligation, please tell me how I can qualify for the position or in the subject before which I have marked an X:

BUSINESS TRAINING DEPARTMENT

- | | |
|---|---|
| <input type="checkbox"/> Business Management | <input type="checkbox"/> Salesmanship |
| <input type="checkbox"/> Industrial Management | <input type="checkbox"/> Advertising |
| <input type="checkbox"/> Personnel Organization | <input type="checkbox"/> Better Letters |
| <input type="checkbox"/> Traffic Management | <input type="checkbox"/> Foreign Trade |
| <input type="checkbox"/> Business Law | <input type="checkbox"/> Stenography and Typing |
| <input type="checkbox"/> Banking and Banking Law | <input type="checkbox"/> Business English |
| <input type="checkbox"/> Accountancy (including C.P.A.) | <input type="checkbox"/> Civil Service |
| <input type="checkbox"/> Nicholson Cost Accounting | <input type="checkbox"/> Railway Mail Clerk |
| <input type="checkbox"/> Bookkeeping | <input type="checkbox"/> Common School Subjects |
| <input type="checkbox"/> Private Secretary | <input type="checkbox"/> High School Subjects |
| <input type="checkbox"/> Business Spanish <input type="checkbox"/> French | <input type="checkbox"/> Illustrating <input type="checkbox"/> Cartooning |

TECHNICAL AND INDUSTRIAL DEPARTMENT

- | | |
|--|--|
| <input type="checkbox"/> Electrical Engineering | <input type="checkbox"/> Architect |
| <input type="checkbox"/> Electric Lighting | <input type="checkbox"/> Blue Print Reading |
| <input type="checkbox"/> Mechanical Engineer | <input type="checkbox"/> Contractor and Builder |
| <input type="checkbox"/> Mechanical Draftsman | <input type="checkbox"/> Architectural Draftsman |
| <input type="checkbox"/> Machine Shop Practice | <input type="checkbox"/> Concrete Builder |
| <input type="checkbox"/> Railroad Positions | <input type="checkbox"/> Structural Engineer |
| <input type="checkbox"/> Gas Engine Operating | <input type="checkbox"/> Plumbing and Heating |
| <input type="checkbox"/> Civil Engineer | <input type="checkbox"/> Chemistry <input type="checkbox"/> Pharmacy |
| <input type="checkbox"/> Surveying and Mapping | <input type="checkbox"/> Automobile Work |
| <input type="checkbox"/> Metallurgy | <input type="checkbox"/> Navigation |
| <input type="checkbox"/> Steam Engineering | <input type="checkbox"/> Agriculture and Poultry |
| <input type="checkbox"/> Radio <input type="checkbox"/> Airplane Engines | <input type="checkbox"/> Mathematics |

Name.....
 Street.....
 Address..... 6-26-32

City..... State.....

Occupation.....

Persons residing in Canada should send this coupon to the International Correspondence Schools Canadian, Limited, Montreal, Canada.

Stop Forgetting

Make Your Mind a File—Not a Pile

Let me show you how to make your mind as forget-proof as a card index file. When you wish to recall a name, place or date, must you grope in vain in a pile of miscellaneous knowledge? Summoned to give facts and figures does your mind become a blank? Be master of your mind's infinite resources—instead of a victim of its disordered details.

KNOWLEDGE IS POWER

and Memory Is the Basis of All Knowledge

I HAVE HELPED THOUSANDS

The Dickson Method of Memory and Mental Training, perfected by 20 years experience, is recognized as the most thorough, efficient of its kind. Highly endorsed—easy to master. Give me 10 minutes a day and I will train your memory so you can classify ideas, names, faces, etc., and recall them instantly. Develop self-control, concentration; overcome bashfulness.

Perfect Your Memory and Command What Salary You Will

Send name and address and I will send you free, my interesting booklet, "How to Remember," and unique, copyrighted Memory Test; also tell you how to secure free of charge my \$5.00 book, "How to Speak in Public."

Prof. Henry Dickson, Principal
DICKSON MEMORY SCHOOL
 Dept. 705
 Evanston, Ill.



Stop Forgetting

The Key to Success

New Easy Way to Play SAXOPHONE

In twenty easy lessons I teach you to play saxophone like a professional. Takes one-tenth effort to learn by this wonderful new method of personal instruction.

EARN BIG MONEY

as expert player. I will show you how. My method known from coast to coast. Write quick for full particulars—FREE.

NEWLAN SCHOOL OF MUSIC
 495 Athenaeum Bldg. Chicago



America's
 Greatest
 Saxophone
 Instructor

LEARN WATCH REPAIRING



You can learn by our modern and original system of instruction every part of the Watch Repairing Trade at home as good or better than at a shop. You can earn money while learning and secure a well paying position or start in business after completing our course of instruction. Good watch repairs are always in demand and earn from \$20 to \$70 per week. For particulars apply to the **WISCONSIN SCHOOL OF WATCH REPAIRING** 106 Mason St., MILWAUKEE, WIS.



"BECOME A LIGHTNING TRICK CARTOONIST"

MAKE MONEY CHALK TALKING. SEND \$2.00 FOR SMART! PROGRAM OF TRICK DRAWINGS WITH INSTRUCTIONS BY A PROFESSIONAL CARTOONIST. SATISFACTION GUARANTEED. CIRCULAR FREE. BALDA ART SERVICE, 21, OSKOSH, WIS.

AVIATION Information FREE

Send us your name and address for full information regarding the Aviation and Airplane business. Find out about the many great opportunities now open and how we prepare you at home, during spare time, to qualify. Our new book "Opportunities in the Airplane Industry" also sent free if you answer at once.

AMERICAN SCHOOL OF AVIATION
 Dept. 1199 3601 Michigan Ave. CHICAGO

You! can be a \$500 Auto Expert!



Automotive Mechanic



Automotive Electrician



Salesmen, Demonstrator



Garage Owner or Manager

"What's the quickest Big-Pay Work I can learn?"

LIKE machinery? Pay too small? Need more money? Then loan me an hour of your spare time a day! I'll guarantee to put you in the \$100.00 a week class quicker than you can learn any other big-pay work! **Don't quit your job! Stay home!** Thousands of men **no better than you** are making big salaries, holding down important jobs, earning enormous profits in their own business. I know how you can do the same, and I'll tell you how!

Learn Auto Repairing! Learn Automotive Electricity! Learn Vulcanizing, Welding, Battery!

My copyrighted "Job-Way" system teaches you in an hour what ordinarily takes a month to learn! The speed with which C. A. I. boys get ALL the work of the complete course has astonished educators everywhere! So simple a school-boy can understand it. Think of it! 11,000,000 autos to repair each year—11,000,000 batteries to service—11,000,000 ignition systems to keep going—50,000,000 tires to sell and repair—2,500,000 trucks to overhaul. Do you realize how hungry employers are for EXPERTS? Do you know what they're willing to pay for MASTER MECHANICS? Can you imagine the opportunities to-day to make big money in a business of your own?

Coupon brings FREE BOOK and FREE LESSON!

I don't ask you to risk a penny. I know you can learn to earn \$3,000 to \$8,000 a year as an Automotive Master Mechanic. So I guarantee in writing to return every cent of your money if you don't think it's the most profitable investment you ever made. I want you to send for my free book, read the free lesson, find out about my wonderful "Job-Way" method. See why I offer the most complete Master Mechanics course for the least money, and on easiest payments. Mail Coupon or postal today!

MEN WANTED!

Thousands of big-pay jobs open right now, all over the U.S. Our Employment Service FREE to both students and graduates, reaches employers in every part of the Country. Look at this:

Master Mechanics	\$3,000 to \$8,000
Electrical Experts	3,000 up
Garage Manager	\$3,600 up
Battery Expert	2,400 up
Expert Welder	2,400 up
Salesman	3,000 up
Tractor Engineer	2,400 up

My graduates earn money fast enough to go into business. Own your own Garage, Battery Station, Ignition Service, Repair or Welding plant.

Mail Coupon for FREE BOOK!

Bigger-Pay Coupon!

J. R. Bayston, Pres.
Chicago Automotive Institute
Dept. 102, 608 S. Dearborn St., Chicago

Without a penny of expense or the slightest obligation, please send me Free Book about your rapid course in Automotive Master Mechanics, and Free Tool Kit offer. Explain your money back guarantee. I want to see a Free Lesson, too.

Name.....

Address.....



J. R. Bayston, Pres.
CHICAGO AUTOMOTIVE INSTITUTE

I give you this Tool Kit FREE and train you to use it



18 piece Master Mechanics' Tool Kit FREE!

This Complete \$15.00 outfit doesn't cost you one penny! Full size, everything you need to do the "Jobs." 75 lessons, 150 Jobs, 12 lectures and many Free features in the C. A. I. course. And "Cigarette Money" pays for it!

CHICAGO AUTOMOTIVE INSTITUTE

J. R. Bayston, Pres., Dept. 102, 608 S. Dearborn St., Chicago

LEARN AT HOME IN 33 DAYS!!



High School Course in Two Years!

Lack of High School Training has kept thousands of men and women from attaining business and social position. Without this training you are absolutely barred from a successful business career, from leading professions, from well-paid civil service jobs, from teaching and college entrance. In fact, all preferred positions are closed to you without this vital training. You can't stand this heavy handicap nor do you have to. The American School can give you the valuable training you missed.

Put Your Idle Hours to Work You can complete our simplified High School Course within two years by spare-time study. Then you will be mentally equipped to handle a worthwhile position. This course, prepared by some of America's leading professors, will broaden your mind, give you a wider outlook and make you keen, alert and capable.

Remove Your Handicap

Whether you need High School Training or specialized instruction in your chosen line—NOW is the time to remove your handicap. You must know the HOW and WHY. Over 50,000 students owe their success to training received from the practical, money-making Courses in the coupon below. Let us tell you about this training—about the Course you are interested in. Check and mail the coupon.

American School

Dept. H974, Drexel Ave. and 58th St., Chicago

American School

Dept. H974, Drexel Ave. and 58th St., Chicago

Send me full information on the subject checked and how you will help me win success.

- | | |
|------------------------------|----------------------------|
|Architect |Lawyer |
|Building Contractor |Machine Shop Practice |
|Automobile Engineer |Photoplay Writer |
|Automobile Repairman |Mechanical Engineer |
|Civil Engineer |Shop Superintendent |
|Structural Engineer |Employment Manager |
|Business Manager |Steam Engineer |
|Cert. Public Accountant |Foremanship |
|Accountant and Auditor |Sanitary Engineer |
|Bookkeeper |Surveyor (& Mapping) |
|Draftsman and Designer |Telephone Engineer |
|Electrical Engineer |Telegraph Engineer |
|Electric Light & Power |High School Graduate |
|General Education |Fire Insurance Expert |
|Vocational Guidance |Wireless Radio |
|Business Law |Undecided |

Name.....

Address.....

Electricity

Taught by Practical Men

If you expect to become an electrical expert in three or four months you are thinking wrong. Being an electrical engineer is a real job and cannot be learned overnight. Haphazard instruction may get you by for a time, but will not give you the solid foundation for the biggest positions.

You can get the necessary training without losing a day from your present work. Learn at home in your spare time. Hundreds of Burgess trained men have proven this and are earning bigger salaries. Burgess Home Study Methods are approved by Electrical Engineers. If you are in earnest to succeed in any branch of Electricity, write us today. Let us show you how we teach men so they keep on going. Write for the Burgess catalog on "Electricity," lots of opportunities open and how Burgess Methods train you for them.



Yorke Burgess, Consulting Engineer.
BURGESS ELECTRICAL SCHOOL
744 E. 42nd St., Dept. 12, Chicago, Ill.
Canadian Branch, 201 Crawford St., Toronto, Ont., Canada.

ELECTRICAL HANDBOOK

We have prepared a pocket size note book for practical men. Contains drawings and diagrams of electrical machines and connections; over 200 formulas, with problems worked out. "THE BURGESS BLUE BOOK" contains drawings for Motor Starters, Controllers, Transformers, Reversing Switches, Lighting Circuits. Calculators include Electrical Mathematics, Units, Resistance, Wire Gauge Rules, Ohm's Law, Unknown Resistances, Dynamo Traction, Also Alternating Current Calculations, Finding Impedance, Frequency, Speeds, Power Factor; Formulas for Line Transformers. Price only \$1.00 postpaid on money back guarantee.

AGENTS WANTED: Write for special proposition to agents; cost under \$10.00 and more a day; easy work.
THE BURGESS COMPANY, Consulting Electrical Engineers
742 East 42nd Street Chicago, Illinois

Bead Making Outfit FREE



Yes, we give you free a complete bead making outfit and materials. We teach you by mail to make beautifully colored beads—jade beads, tortoise, jet and amber beads. Fascinating and profitable. More than \$15 daily can be made. We teach you every detail at every small cost. Write us now for descriptive circular free. Write now.

HOME INSTITUTE OF TRADES, Dept. 2212
345-346 Houseman Bldg. Grand Rapids, Mich.

Learn to Mount Birds



Learn at home by mail, to mount birds, animals, game heads; tax furs, make rugs and robes. Complete lessons. Easily and quickly learned by men, boys and women.

FREE Write today for Free Taxidermy Book. Tells all about it. Every Sportsman, Hunter, Trapper and Nature lover should know this wonderful fascinating art. Save your trophies. Big profits. Success guaranteed. Our school is 20 years old—25,000 graduates. Investigate today. Write for Free Book.

Northwestern School of Taxidermy 1779 Elwood Bldg., Omaha, Neb.

BIG NOVELTY BARGAIN! 8 Cts.



THROW YOUR VOICE

Into a trunk, under the bed or anywhere. Lots of Fun fooling the Teacher, Policeman or Friends. Barrels of Fun.

THE VENTRILO,

a little instrument, fits in the mouth out of sight, used with above for Bird Calls, etc. Sent with full instructions; anyone can use it, NEVER FAILS. Also a 32 PAGE BOOK ON VENTRILOQUISM. Formula for Secret Writing, 12 Money Making Secrets and the marvelous

NOVELTY X-RAY WONDER

With it you can apparently see the bones in your fingers, lead in pencil, etc.; lots of fun with this outfit. Also 10 Big Magic Tricks Free with every order. All the above Novelties by prepaid mail for 8¢

VENTRILO COMPANY
Dept. 744 South Norwalk, Conn.
LARGEST and OLDEST Mail Order House in Connecticut.

Please Mention Popular Mechanics

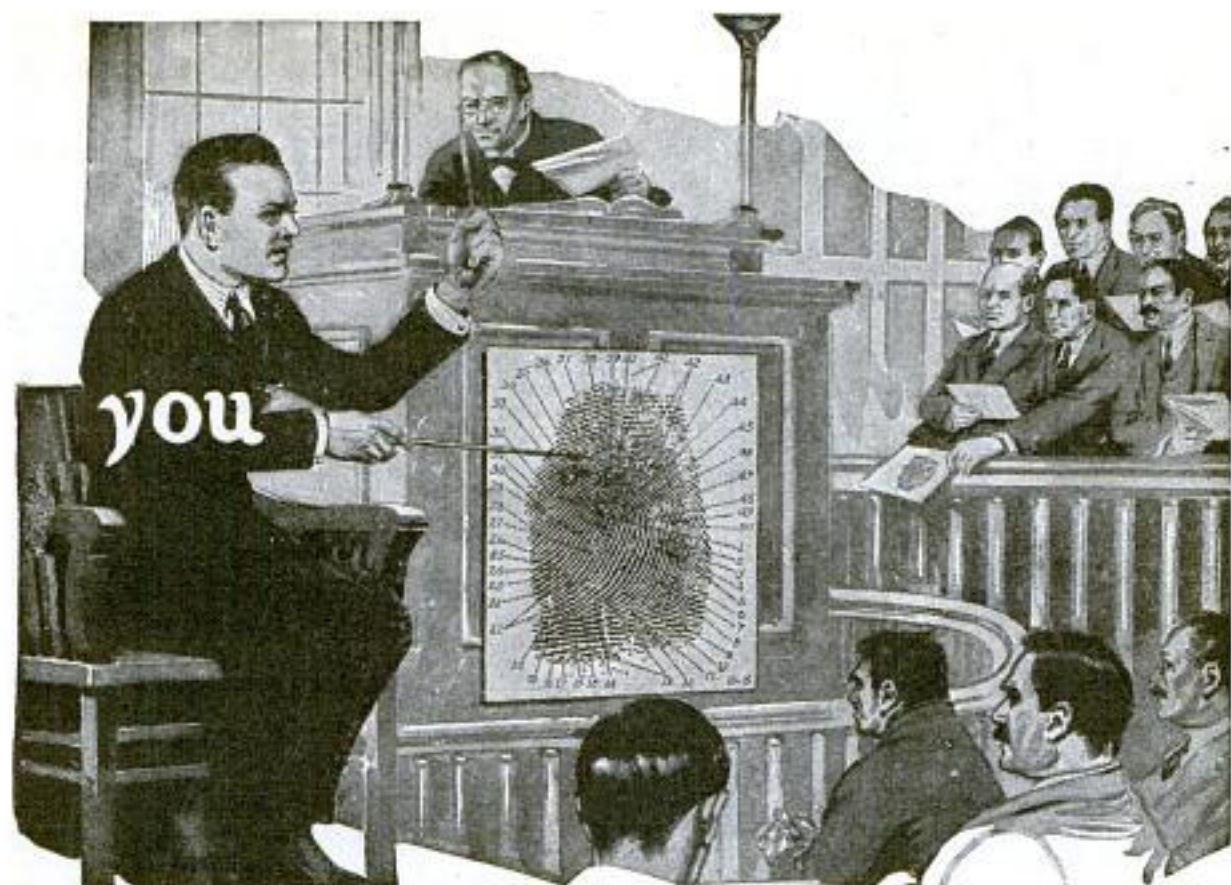

\$2500 REWARD for the Conviction of—

WHO murdered John Blake? The country was stunned by the crime mystery of the year. A rich reward was offered. There were clues a-plenty. Circumstantial evidence pointed to a dozen men. But the District Attorney didn't dare bring any one of them to trial. Then the Finger Print Expert stepped in!

With feverish excitement the crowd in the courtroom listened. Judge, jury, attorneys and onlookers leaned forward in strained silence, eager to catch every word. The young Finger Print Expert in the witness chair was the center of attraction, as with calm assurance, he gave the evidence that convicted the murderer, and brought him the \$2500 reward.



T. G. Cooke,
President

I Can Make YOU a Finger Print Expert!

I have trained hundreds of the men now prominent in the Profession. For instance, there's Harry Passano, Chief of the Iowa State Bureau. He had no previous experience—no college or high school education. He was just a country photographer. I trained him.

I can do the same for YOU. You may study right at home—in your spare time. Right NOW is the time to start. More trained men are needed to fill the positions created almost daily. Salaries are high. Chances for big rewards are frequent. The Finger Print Expert is respected and deferred to by all. I am offering you a big opportunity. Will you take it?

U. of A. S. Graduates Recently Appointed Finger Print Experts of these States and Cities.

State of Iowa
State of Idaho
State of Colorado
St. Paul, Minn.
Columbus, Ohio
El Paso, Texas
Galveston, Texas
Schenectady, N. Y.
Lincoln, Neb.
Everett, Wash.
Wilkes-Barre, Pa.
Livingston, Mont.
Alhambra, Cal.
Ogden, Utah
St. Joseph, Mo.
Houston, Texas
Butte, Mont.
Waterloo, Iowa
New Haven, Conn.
Birmingham, Ala.
Pueblo, Colo.
Pensacola, Fla.
Tulsa, Okla.
Harana, Cuba
Calgary, Alberta

Professional Finger Print Outfit **FREE**

A professional outfit, just like the Finger Print Expert uses in court, in the laboratory and at the scene of crime, is yours **FREE** with this famous course of training. Also a course in Secret Service Intelligence is **FREE** to you if you enroll early. Mail the coupon for my free book, telling all about the exploits of finger print detectives and full information about this wonderful profession, and your opportunity as a Finger Print Expert.

T. G. COOKE, President

University of Applied Science
1920 Sunnyside Avenue, Dept. 1359, Chicago, Ill.

Mail Coupon for Free Book

UNIVERSITY of APPLIED
SCIENCE,

1920 Sunnyside Ave.,
Dept. 1359, Chicago.

Gentlemen: Without any obligation whatever send me your new, fully illustrated, **FREE** book on Finger Prints and your offer of a **FREE** course in Secret Service Intelligence and the Free Professional Finger Print Outfit.



Name.....

Address.....

City & State.....Age.....



BIG PRICES PAID TO ARTISTS

YOU are indeed fortunate if you like to draw! Develop your talent—become a commercial artist! Thousands of business firms pay millions of dollars yearly for good advertising drawings and designs. Well-trained artists command \$50, \$75, \$100, \$150 a week—sometimes even more. "Top-notch" designers receive \$250, \$500, \$1000 and up for single drawings.

Learn Quickly at Home in Your Spare Time

Get into this fascinating profession which has a future as big as modern advertising and modern business. The Federal "Master Course" teaches you the methods and ideas that make your drawings worth real money. It gives you individual personal criticisms on your lessons. No previous training or experience needed. And best of all—Leading successful artists are authors of exclusive lessons in the Federal Course. They will give you the benefit of their experience and advice, only in this Course.

Get This Free Book "YOUR FUTURE"

Investigate now—by all means send for this book. It's free to anyone 16 years old or more who is in earnest about his or her future. Beautifully illustrated in colors, it gives facts about the field of commercial art, names of the famous artists who are Federal Authors, and every detail you will want to know about the Course. It is a proven result-getter. Mark and mail the coupon right now—kindly stating your age and occupation.

-----COUPON-----

Federal School of Commercial Designing
683 Federal Schools Building
Minneapolis, Minn.

Please send me "YOUR FUTURE", without charge or obligation.

Age..... Occupation.....

Name.....

(Write your address
plainly in
margin.)

LIFE-LONG POSITIONS



\$133
a month

Earn \$1600 to \$2300 Yearly Free Yearly Railroad Pass

Why work at uncertain jobs? You can pass Civil Service examinations with our help and be appointed Government Railway Mail Clerk. Expenses paid; vacations and sick-leave with full pay. No strikes or shut-downs. You are trained by men who have spent a life-time in the service. Their training enables you to pass examinations with top-notch ratings. Examinations held regularly in every state. Ages 18 to 35. Common school education is sufficient. Sample questions and full details FREE.

WRITE US TODAY

COLUMBUS INSTITUTE

O-13 Arcade Station

COLUMBUS, OHIO

RAISE POULTRY FOR PROFIT

We teach you how. Easily learned at home. Our guaranteed methods make success certain—indorsed by leading Agricultural Colleges. Send TODAY for FREE BOOK—"How To Raise Poultry For Profit."



National Poultry Institute
Dept. 312 Washington, D. C.

LAW

IN YOUR SPARE TIME
Learn law with only institution giving same course by correspondence as was given for years at resident classes of this college. **DEGREE OF LL. B. CONFERRED.** One year business law course prepares you for success in business. Law trained business men in demand. Three year university course covers preparation for bar examination. Money back guarantee if not satisfied. Low fee, easy terms, includes complete 1921 thirteen volume library, text material and all expenses. Write for **FREE BOOK.** 431 South Dearborn St. Hamilton College of Law Dept. 69 Chicago

HARMONY

In 12 Easy Lessons

Get the most out of music. Equally valuable for Players, Teachers or Music Lovers. New easy System gives you real knowledge of Harmony in shortest time. **Easy, Quick, Sure!** Short-cut System used by professional Arrangers and Composers. Results guaranteed. Write for proof and limited offer—free! **DELAMATER HARMONY SYSTEM** DEPT. "M" 5337 PRAIRIE AVE., CHICAGO

Can You Spell?

Then equip yourself by mail for a profession offering big pay and no lack of employment. **BECOME A PROOF-READER**

Men and women of ambition should write today for the free descriptive booklet entitled "Read to Live."

THE MAWSON EDITORIAL SCHOOL, 12 Wadsworth St. Cambridge, Massachusetts



Minstrel Show Guide

350 End-men's Jokes, 26 Songs, 9 Complete Sketches, 8 Monologues, 4 Stump Speeches, ~~6~~ 5 complete instructions on stage and program arrangements, rehearsals and "make-up," from beginning to end. Price 10c postpaid.

J. C. DORN, Dept. 39, 701 So. Dearborn St., Chicago

Rider Agents Wanted

Select from the 44 Styles, colors and sizes of Ranger Bicycles. Ride and exhibit sample Ranger and make money. Delivered free, express prepaid, on Approval. Factory-to-Rider prices save \$10 to \$20, 12 Months to Pay on any Ranger if desired. Boys and girls easily save the small monthly payments. Parents often advance first payment. Best quality, at factory prices, express prepaid. Tires, lamps, wheels and equipment, low prices. Send No Money, do business direct with makers.

Mead Cycle Company
Dept. H118 Chicago

Write today for free! Ranger Catalog, factory prices and marvelous easy payment terms



He thought he could throw me—



Dear Tom: You know how Ted Brown has always been saying he could throw me with one hand tied behind him, if he wanted to, and you know how he's always bullying the kids smaller'n he is. Well, yesterday, he and I had it out. Gee, I wish you'd been there. You know how much bigger Ted is than I. Well, right off the bat he grabbed hold of me and pretty nearly busted me in half. He thought he had me licked dead easy—

but



But I wriggled around and got a hold on him that I'd learned from the Farmer Burns School of Wrestling. The next second—KERFLOP, and I had Mister Ted Brown on the ground, tied up so he couldn't move and yelling for me to quit. Gee, Tom, wrestling has it all over boxing for defending yourself. Why it's a cinch to handle a fellow half as big again as you are if you know the secret holds. If I were you I'd write to Burns School for their free book about wrestling. See you next week. So long—FRED.

Learn Wrestling Secrets

from Worlds Champions *Farmer Burns and Frank Gotch*

Learn the marvelous holds, breaks, blocks and tricks that will enable you to handle big, strong men with ease. Here is a wonderful opportunity long waited for by young men and boys of America. The renowned FARMER BURNS—"father of scientific wrestling" and the greatest scientific wrestler ever known, and FRANK GOTCH the world's champion of champions, prepared a series of lessons in which they have revealed the inside secrets of training that will make YOU, too, an expert wrestler. All the great secrets of self-defense and jui-jitsu illustrated by printed word and picture. The lessons teach you how to become a great athlete, and secret knowledge enabling you to throw boys and men far larger and stronger than yourself—how to deal with bullies and ruffians so that they will positively fear you. Best of all, you can learn in your own home, in your spare time!

Start Now! A weak undeveloped body means failure. A splendid athletic physique means SUCCESS IN EVERYTHING. On the gridiron, on the base ball field, in class room, at social gatherings, in business, a strong body wins respect and admiration and helps you get ahead amazingly fast. If you already have a strong body we can still help you immensely. If you are a weakling don't delay a single day learning all about wrestling. Start RIGHT NOW!

Send for FREE Book

Our FREE ILLUSTRATED BOOK tells you all about the advantages in health, vigor and respect for you, that being able to wrestle brings one. It tells you how to learn to become a skilled wrestler in your spare time. From cover to cover it is brim full of interesting information about wrestling. Also lots of pictures. INVESTIGATE. Write today for this free book. No obligations. Tear out and mail the coupon NOW!

Farmer Burns School
1779 Railway Exchange Bldg. Omaha, Nebraska

Farmer Burns School
1779 Railway Exchange Bldg., Omaha, Neb.
Please send me at once without obligation your FREE illustrated booklet on Scientific Wrestling, Physical Culture, Self-Defense, and How to Win.

Name.....

Address.....

Age.....



He Earns \$10,000 a Year

This executive is one of the officers of a big corporation; he earns \$10,000 a year, and is still in his early thirties.

"He has a mighty good business head"—that's how the directors speak of him. "He's keen at a business problem, quick to pick out the essential points, sure in his decisions"—that's why the President is for him. "When he recommends a policy," declares the General Manager, "I know it's sound from a legal standpoint."

A big salary—\$10,000 a year—but this man has an asset that is *vital* important in the management of big affairs—he is a law-trained man.

His Chance is Yours!

Why let the really big opportunities slip away from you—simply for lack of training?

Right in your own home, under the LaSalle Problem Method, you can study the same cases you would read at the resident universities, master the fundamental principles of law set forth by some of the most eminent authorities in the profession, develop under their direction a sound understanding of business relationships, a power for keen and logical thinking, a facility for analyzing business problems that in later years will make you the man the directors pick for the bigger job.

Read these statements, testifying to the thoroughness and *income-value* of LaSalle training:

"The Problem Method increased my salary nearly 150%."

"Passed bar examination with second highest honors in a class of seventy-one."

"Salary doubled in six months."

"Passed bar examination, third in a class of twenty-three, the youngest man who ever passed the examination in this state."

Send today for full particulars regarding LaSalle home-study training, together with details of our convenient-payment plan; also your free copy of that inspiring book, "Ten Years' Promotion in One." Mail the coupon NOW.

LASALLE EXTENSION UNIVERSITY

The Largest Business Training Institution in the World
Dept. 1264-LR Chicago, Illinois

Please send me catalog and full information regarding the course and service I have marked with an X below; Also a copy of your book, "Ten Years' Promotion in One."

LAW, Degree of LL. B.

LaSalle is the largest business training institution in the world. It offers training for every important business need. If more interested in any of these courses, check here:

- | | |
|--|--|
| <input type="checkbox"/> Business Management | <input type="checkbox"/> Modern Business Correspondence and Practice |
| <input type="checkbox"/> Modern Salesmanship | <input type="checkbox"/> Modern Foremanship and Production Methods |
| <input type="checkbox"/> Higher Accountancy | <input type="checkbox"/> Personnel and Employment Management |
| <input type="checkbox"/> Traffic Management | <input type="checkbox"/> Expert Bookkeeping |
| <input type="checkbox"/> Railway Accounting and Station Management | <input type="checkbox"/> Business English |
| <input type="checkbox"/> Commercial Law | <input type="checkbox"/> Commercial Spanish |
| <input type="checkbox"/> Industrial Management Efficiency | <input type="checkbox"/> Effective Speaking |
| <input type="checkbox"/> Banking and Finance | <input type="checkbox"/> C. P. A. Coaching |

Name.....

Present Position.....

Address.....

Please Mention Popular Mechanics



THIRTY-FIVE EASY LESSONS IN RADIO 50c

A systematic course of elementary principles written in a simple and concise lesson course, easily understood. Thousands have taken up Radio for entertainment and are operating their own amateur sets.

This book embodies all the principles and application of everyday radio for the home and in business. Paper cover.

Price postpaid 50c

SHREWSBURY PUBLISHING CO.
5525 West Lake Street Chicago, Ill.



HOW TO BECOME A PROFESSIONAL PHOTOGRAPHER

Earning \$35 to \$125 a Week

An interesting illustrated booklet (free) on choosing a vocation, the exceptional opportunities Photography offers you and how to avail yourself of these advantages.

Motion Picture—Commercial—Portraiture

Three to six months' Practical course. Modern equipment. Day or evening classes. Easy terms. Call or write for Catalog No. 49.

N. Y. INSTITUTE OF PHOTOGRAPHY
NEW YORK CHICAGO BROOKLYN
141 W. 36th St. 639 So. Wabash Ave. 505 State St.

BE A PIANO TECHNICIAN



Our Tune-a-Phone Guides You to Success

Tuning, Voicing, Regulating, Finishing and General Care of Pianos Taught in ONE Complete Course. 25 years of successful Correspondence Instruction makes our guarantee worth while. Knowledge of music NOT necessary. Write for FREE BOOKLET and the plan that saves you all risk in testing our method of teaching.

NILES BRYANT SCHOOL, 24 Bryant Bldg., Augusta, Mich.



SHORTHAND IN ONE MONTH

Boyd—the Wonderful, New, Easy System. Writers hold World's record. 100 to 150 words a minute in 30 days guaranteed. New Principles—dictation first week. Best for Court Reporting and Secretaries. Also Typewriting, Bookkeeping and Commercial Law. Send today for Catalog and Money-Back Guarantee.

CHICAGO HOME STUDY SCHOOLS, 802 Resper Block, Chicago, Ill.

ARTIST'S OUTFIT FREE

Write quick for our remarkable offer. Learn NOW at home, in spare time, by our new instruction method. Commercial Art, Cartooning, Illustrating, Designing. Delightful fascinating work in big demand. \$50.00 paid for one drawing. Hand-some book free explains everything. SEND FOR IT TODAY.

WASHINGTON SCHOOL OF ART, Inc.
1934 Marden Bldg. Washington, D. C.

MINSTRELS

Musical Comedies and Revues, with full instructions for staging. You can stage your own show with our books. Full line of plays, music, cross-fire, monologues, afterpieces, vaudeville acts and make-up. CATALOGUE FREE.

T. S. DENISON & CO., 623 So. Wabash, Dept. 19, Chicago

STAMMER NO MORE

Kill the fear of stammering. Re-education the key. The widely famed Hatfield Method fully outlined in an accurate, dependable, worthwhile book—"HOW TO STOP STAMMERING." It has inspired thousands. Free copy today.

THE HATFIELD INSTITUTE, 109 N. Dearborn, Chicago, Ill.

**Auto
Repairman**
\$50 a week



**Expert
Chauffeur**
\$40 a week



**Garage
Owner**
\$150 a week



9,000,000 Autos Need Help!

Earn \$40 to \$150 a Week!

Think of it—over 9,000,000 automobiles are in use in the U. S. There never was a better opportunity for money making than the automobile field offers you right now. Think of the money spent every year to keep all these cars in a going condition. Think of the chances for the repairmen, chauffeurs, engineers and garage owners. Look at the autos being sold—both old and new. Look at the garages springing up here and there. This all means money, money, money for the fellows in the game. Get your share now. Men like you are needed everywhere to fill big paying jobs.

Easy to Learn We have made it easy for you to fit yourself for a job paying from \$40.00 to \$150.00 a week. You don't have to go to school. You don't have to serve an apprenticeship. Everything is worked out for you by fifteen great automobile engineers so you can become an auto expert in your spare time and keep on earning while you learn.

Auto Books SIX VOLUMES Sent FREE

Now ready for you—the new 6-volume Library of Automobile Engineering—right up-to-date, showing all the new cars and the latest and best ways of doing things. It covers the construction, care and repair of every kind of automobile, truck and motorcycle. Just check full of advance information on Ignition, Starting and Lighting Systems, Garage Design and Equipment, Welding and other repair methods. Everything that a mechanic or any man interested in automobiles should know. Written in simple language that anyone can understand. 2700 pages and 2400 pictures, plans, blueprints and wiring diagrams, all bound in tough, wear-resisting material and stamped in gold. Over 75,000 sets have been sold on our free trial—no money down plan.

10c a Day If Pleased

First you see the books in your own home or shop. Just mail coupon. You can read them and use them for 7 whole days before you decide. If you like the books, send only \$2.80 in 7 days and \$3 a month until the special reduced price of \$21.80 has been paid. (Regular price \$45).

No Money in Advance

Don't take our word for it that you can make money with the help of these books. Just mail the coupon and see the books without cost. Then talk it over with some of your friends and get their opinion. Don't waste a moment in sending for the books though. Put the coupon in the mails today. Send no money—just the coupon.

AMERICAN TECHNICAL SOCIETY
Dept. A-199 Chicago, Illinois

A Few Things Taken From the Books

Explosion Motors
Welding
Motor Construction and Repair
Carburetors and Settings
Valves, Cooling
Lubrication
Fly-Wheels
Clutch
Transmission
Final Drive
Steering Frames
Tires
Vulcanizing
Ignition
Starting and Lighting Systems
Wiring Diagrams
Shop Kinks
Commercial Garage Design and Equipment
Electrics
Storage Batteries
Care and Repair
Motorcycles
Commercial Trucks
Glossary

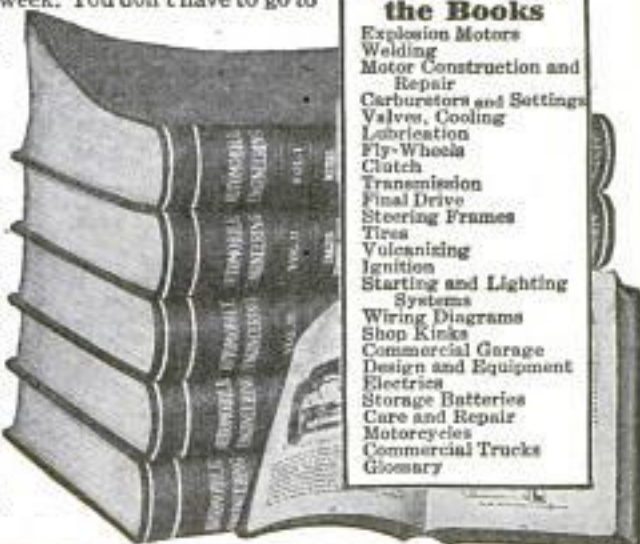

FREE EXAMINATION COUPON

American Technical Society, Dept. A-199, Chicago, Ill.

Send me the 6-volume set of Automobile Engineering books for a week's free trial, by express collect. I will either return the books in one week at your expense or send you \$2.80 as first payment and \$3.00 every month until a total of \$21.80 has been paid.

Name.....

Address.....

City..... State.....

Employed by.....

BE A RAILWAY TRAFFIC INSPECTOR

YOU CAN EARN UP TO \$250 PER MO.

Expenses Paid

POSITION GUARANTEED



HUNDREDS OF OPENINGS!

Railway Traffic Inspectors earn **good money**, enjoy most interesting work, have splendid chances for advancement. Travel, see the country or remain near home. Healthful, outdoor work; something new every day. **More men are wanted** than are trained. Start at \$110 per month minimum, expenses paid. Meet big railway officials. Earn up to \$250 and \$300 per month as you gain experience.

EASY TO QUALIFY

Prepare in 3 months' spare-time study at home. Any average man can qualify. Position is then **guaranteed** paying at least \$110 per month and expenses or enrollment fee is refunded! You have nothing to lose.



READ WHAT M. C. EVES SAYS:

"I have never found work so interesting as my present position has been since I became familiar with the system used on these lines. Your Course of Study on Traffic Inspection together with the experience received here and in Providence fits me for most any position in this line of work which I may have offered me."

YOU TAKE NO RISK

Send coupon today for Free Booklet. Remember, if position is not secured you, your enrollment fee is returned. That is our **Guarantee**. Don't delay; investigate now.

Standard Business Training Institute
Buffalo, N. Y.



Standard Business Training Institute
Buffalo, N. Y.

Send me, entirely free, Booklet No. D-727 giving full particulars about course in Railway Traffic Inspection.

Name.....
Street.....
City.....

WE TEACH COMMERCIAL ART

Meyer Both Company, the largest commercial art organization in the field, offers you a different and practical training. If you like to draw, develop your talent. Study this practical course—taught by this widely known institution, with twenty-two years success—which each year produces and sells to advertisers in the United States and Canada over ten thousand commercial drawings. Who else could give you so wide an experience? Commercial art is a business necessity—a highly paid, intensely interesting profession equally open to men and women. Home study instruction. Get facts before you enroll in any school. Write for our illustrated book, "YOUR OPPORTUNITY"—for one-half the cost of mailing—four cents in stamps.

MEYER BOTH COMPANY

Department of Art Instruction
Michigan Ave. at 20th St., Dept. 16 CHICAGO, ILL.

NOTE—To Art and Engraving Firms; Secure practical artists among our graduates. Write us.

MUSIC LESSONS FREE



IN YOUR
OWN
HOME

You can read Music like this quickly
Piano, Organ, Violin, Mandolin, Guitar, Banjo, etc.
Beginners to advanced players. One lesson weekly. Illustrations make everything plain. Only expense about 2c per day to cover cost of postage and music used. Write for **FREE** booklet which explains everything in full.
AMERICAN SCHOOL OF MUSIC, 51 Lakeside Building, CHICAGO

Learn Autos and Tractors



Wonderful opportunities constantly offered trained men; we train you thoroughly to start your own business or make good money as motor expert, driver, shop foreman, etc.

7,000 Graduates making good. Catalog Free

Cleveland Automobile School, 1814 E. 24th St., Cleveland, O.

TELEGRAPHY

(Morse and Wireless) and RAILWAY ACCOUNTING taught thoroughly. Big salaries; great opportunities. Oldest, largest school. Endorsed by Telegraph, Railway, Radio, and Government officials. Expenses low—opportunities to earn large portion. Catalog free.
DODGE'S INSTITUTE, Dyke Street, Valparaiso, Ind.

OH BOYS-GIRLS GREAT SPORT

THROW YOUR VOICE



Into a Barrel, under the Table, Back of a Door, into a TRUNK, DESK in SCHOOL, Any Old Place. Great FUN fooling the TEACHER, Friends, EVERYBODY with Our **CLAXOPHONE**

Which Sets On your Tongue Unseen, it NEVER FAILS Anybody. Imit. Birds, etc. The CLAXOPHONE, with Full Instructions, a Set of SECRET-WRITING TRICKS (boats, lars, ink) a MAGIC-DIAL Trick, (a Great Money maker), ALSO This Marvelous Novelty.

NEW SCIENTIFIC WONDER

"X-RAY" CURIO



3 FOR 25c. BIG FUN

CLAXO TRICK CO. DEPT. XP NEW HAVEN, CT.
WE GIVE The BEST and MOST for The MONEY.

With IT you Apparently see thru Clothes, see the bones in your Fingers, Lead in Pencil, etc. No end of fun. WE SEND ALL A BOYS CURIO 10c pre-paid Mail for 2 for 25 cts. A nice Souvenir Free with each 25 ct. order.

LEARN WIRELESS By Practice at Home

Our Wonderful Outfit Makes It Easy Gentlemen's Work with Big Pay—\$2,400 to \$10,000 a Year

THOUSANDS of wireless experts will be needed next year. Do you want to be ready to jump into one of these big, easy jobs next Spring? Why not? All you need to start with is a common school education. You can travel or you can stay at home. Radio provides you with a valuable training and gives you a trade that will last a lifetime, and besides as a radio operator you can save big money right from the very start. It is nothing uncommon for radio men to save \$1,000 the first year they work. And why not? All expenses are paid in addition to salary. An operator's time is almost all his own with lots of spare time to study for the high positions of Radio Engineer, Technicians and Executives receiving from \$6,000 to \$10,000 a year. **You earn \$110.00 a month with your board and expenses paid. You start at that salary.** Are you making that much now? You can probably save more than you earn now in wireless.

If you want to work in one of the large land stations, there is plenty of room for you. Or, perhaps one of the newspapers in your home town will employ you. Next year 50% of the newspapers in this country will have wireless stations.

**WE
SUPPLY
ENTIRE
OUTFIT**

Be Entertained With Radio Concerts While You Learn

The wireless era is upon us. It is wireless, wireless, wireless everywhere. Music, vaudeville and speeches are in the air at all times. You can listen to these and entertain yourself while you are learning wireless. **This entertainment is actual practice.** We send you the parts for a regular radio set, you assemble it yourself and then you learn to use it. With it you can listen in on the commercial world. Think of sitting in your warm home this winter combing messages out of the cold sky. You train yourself by practice. We supply you with four wonderful instruments. These represent four steps to a big-paying wireless job. No work could be more fascinating than wireless. No dirty hands, scarred fingers or aching back in the wireless game. You won't have to worry about getting a job. The job is waiting for you now.

**We
Supply
Entire
Outfit**

You learn at home by the aid of five wonderful inventions that have helped ten thousand other men to better-paying positions.

Practical Spare Time Instruction By Mail

We have trained ten thousand men since 1914. Our school is at the Nation's capital, center of all wireless development. We are in touch with everything that is new. Our method of training by mail is endorsed by government officials. Our school is officially recognized. We have succeeded in bringing the subject of wireless to a point where every man who can read and write can learn this wonderful work. We have humanized the subject. Our course reads like a story. Our wireless experts will be ever ready to help you. And then, don't forget the four Wonderful Instruments that make our course so practical and fascinating. You can easily learn in four months. Next Spring you will be ready to fit into a real job. Thousands have found it easy. You can too. The National Radio Institute is the oldest and largest institution of its kind in America. Our course is the greatest piece of educational literature of its kind in the world. We have sugar-coated the subject of Radio.

Five New Inventions Make Radio Easy To Learn

With our famous short cut course are furnished five "Automatic Teachers."

1. The Learner's Transmitter which teaches you sending and code in half the usual time.
2. The Learner's Receiver makes the most difficult part of wireless pure fun.
3. The Nardola Radio Parts Outfit (that you assemble yourself into a regular set).
4. The Wonderful Natrometer (pictured below) builds up your receiving speed. Sends 600 combinations of messages at speeds varying from 3 to 30 words per minute.
5. The National Radio Receiving Set gives you the actual practice of taking real messages from the air.

These inventions make wireless study automatic. They make you learn in such an easy way that you will be a trained wireless man before you realize it. Then comes the big pay and the short hours. Act now. Don't permit another minute to pass. Start your training immediately.

Let Us Mail You This Big Book

Let us send you our big book free. It will tell you all about wireless, all about our course, what our students have done, and the wonderful opportunities waiting for you in Wireless. Don't put it off, mail the coupon below today.



FREE

**National Radio Institute
Dept. 1278, Washington, D. C.**

Send me your FREE book, "How to Learn Radio at Home." Tell me about your Home Study Course in Radio and your special Short-Time Offer.

Name.....

Address.....

Age.....

City..... State.....

The Natrometer is only one of the "automatic teachers" furnished with our course. You learn at home by the aid of these Five Wonderful Inventions that have helped ten thousand other men to better-paying positions.

NATIONAL RADIO INSTITUTE
Dept. 1278 Washington, D. C.

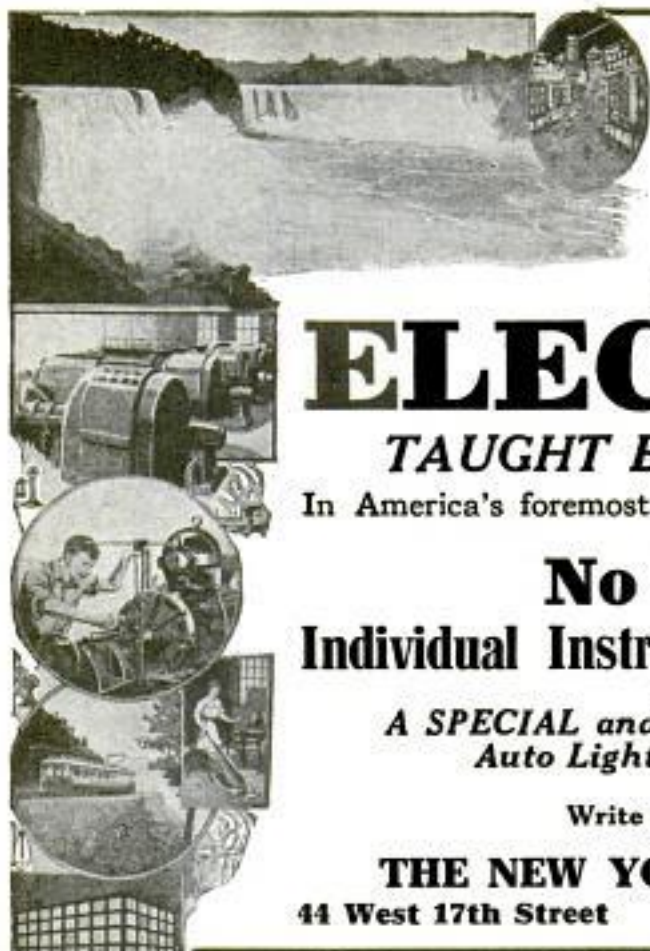

LEARN BY DOING

Every phase of all branches of

ELECTRICITY

TAUGHT BY ACTUAL PRACTICE

In America's foremost and oldest institution for trade training.

No Books Used

Individual Instruction

Start Any Day

A *SPECIAL* and *SEPARATE* Course in Ignition, Auto Lighting and *STARTER* Systems.

Write for FREE 64-Page Catalog.

THE NEW YORK ELECTRICAL SCHOOL

44 West 17th Street

NEW YORK CITY

UNITED

Earn Money at Home In Your Spare Time

Our men are making as high as \$500 per month—all and part time. Anyone can make and sell sign, name and number plates by our new United method. **No art training needed.** Big demand for signs, everyone wants a United. Write today for full details about our complete, fascinating course in sign making and selling by our easy system.

UNITED LETTERING COMPANY, 1092 Jones Law Bldg., Pittsburgh, Pa.

PLAY PIANO BY EAR in 4 Weeks!

Young and old can now learn to play piano by ear without notes or music by our brand new quick and easy 10 lesson method. Send now for

FREE Sample Lesson!

and play real chords at once. The World's simplest, easiest method. Nothing else like it. No musical experience necessary, play piano as easy as you hum or whistle a tune. Be a ragtime artist. Send for FREE sample lesson now before edition is gone. Don't delay.

DAVID PIANO COURSE 503 CUTLER-HAMMER BLDG. CHICAGO, ILLINOIS

AUCTIONEERS MAKE BIG MONEY

16 years one of the largest Auction Schools in the World. Four weeks term opens January 1st. 67 page Catalog FREE. MISSOURI AUCTION SCHOOL, KANSAS CITY, MO.

ILLINOIS COLLEGE OF PHOTOGRAPHY

Established 1893. Photography or Photo-Engraving complete in six months. Salaries of \$35 to \$100 on graduating. College assists in locating positions. Tuition and living expense low. Address LE GRAND A. FLACK, Pres., Box 4112, Effingham, Ill.

Whatever Your Question;—be it the pronunciation of Bolsheviki, the spelling of a puzzling word, the location of Murman Coast—the meaning of blighly, ace, tank, ukulele, etc., this Supreme Authority—

WEBSTER'S NEW INTERNATIONAL DICTIONARY

contains an accurate, final answer 400,000 Words, 2700 Pages, 6000 Illustrations. Regular and India-Paper Editions. G. & C. MERRIAM CO., Springfield, Mass.

Write for specimen pages, prices, etc. and FREE Pocket Maps per Popular Mechanics



WANTED

Railway Mail Clerks \$1600 to \$2300 Year

MEN—BOYS OVER 16

SHOULD WRITE IMMEDIATELY

Steady work. No layoffs. Paid Vacations

Common education sufficient:

Send coupon today—SURE



FRANKLIN INSTITUTE, Dept. K176, Rochester, N. Y. Sit: Send me without charge, (1) Sample Railway Mail Clerk Examination questions; (2) Schedule showing places in all coming U. S. Government examinations; (3) list of many government jobs now obtainable.

Name.....
Address.....



B. W. Cooke
Pres.

**I Train You
In Your
HOME!**

Don't give up your present employment. Just give me some of your spare time—a few hours each evening—and I will make you a "Cooke Trained Auto Expert."



Be An Auto Expert

I WILL MAKE YOU ONE!—by my complete, practical, simple, easy, auto truck and tractor course—which you can master in your home—at your leisure—without giving up your present job. I will make you a "Cooke Trained Expert." With that title you can command respect—and big money.

When you work with me, you don't just "learn" things. YOU DO THINGS! YOU BEGIN TO ACHIEVE RIGHT FROM THE START.

Choose Your Career NOW!

Think of it! Eleven million motor driven vehicles in this country today—and any one of them is liable to need attention any minute. The automobile field is a "gold field." **STAKE YOUR CLAIM NOW AND AVOID THE RUSH.** Choose the right career—show some "pep" and enthusiasm—and you can be your own boss. Any one of the following careers is open to you.

Owner or Manager of a Garage; Demonstrator and Salesman; Tractor Engineer; Auto Mechanic; Auto Electrician; Battery Expert; Welder; Tire Vulcanizer; Truck Driver; Chauffeur.

\$150 in 3 Days! Men who have worked with me are now earning big incomes. You just ought to read the heart warming letters I receive from grateful students who feel that they owe their success in life to me. One tells of making \$150 in three days. Another says: "The man I used to assist is now my helper!" And that's just the point! One man, under my guidance, goes ahead, while the self-satisfied fellow stands still—or goes backward! Enroll with me and go ahead! I promise to push you ahead!

Send for my free book and learn all about my course—just how I work with my men—how I give them practical work to do—how they secure the aid and advice of my big corps of experts—etc., etc. I can't tell you all about it here—**BUT SEND FOR MY BOOK!**

FREE!

Auto Design—4 Horse Power Gasoline Engine

Write me at once and learn how you can get this gasoline engine FREE! It's essentially like the biggest auto motors made—but, on account of its smaller size and the fact that it is mounted on a block, it is much more convenient to work with. I make you this remarkable offer because I want you to DO THINGS—instead of merely learning routine "lessons." **No text books—but real work!** That's my method. That's how I make "Cooke Trained Experts." **FIND OUT ABOUT MY FREE MOTOR OFFER AT ONCE!**

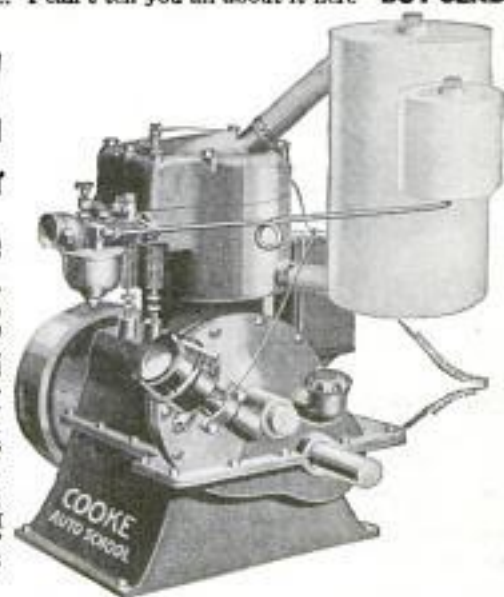

Send For FREE BOOK!

NOW is the time to get started on a career. Send for my free book, and learn all about the possibilities—yes—the certainties in the automobile field. You just didn't realize they were there—but I SHOW YOU IN MY BOOK! SEND THE COUPON TODAY!

B. W. COOKE, President

THE COOKE AUTO SCHOOL
Dept. 1359
500-530 S. Throop Street, Chicago

THE COOKE AUTO SCHOOL, B. W. COOKE, President,
Dept. 1359, 500-530 S. Throop St., Chicago.

Please send me your free book on your complete Automobile Course and full information on the FREE Gasoline Engine.

It is understood that I am not under the slightest obligation in asking for this information.

Name

Address

YOU CAN DRAW

A Comic Face
If You Follow This Method
TRY IT



Take your pencil and draw lightly a square (any size). Then add to it with pencil as shown in the small squares above. Erase all pencil guide lines after the drawing is completed. You can draw any kind of comic face by simply changing the shape of the nose, forehead, chin, etc.

Send in your drawing and let us see what you can do. You may have more natural ability than you think you have. Some of the **cleverest cartoonists** are former students. They started right at the bottom, and are now making good money. It is not hard to learn to draw **originals** when you are shown in a **practical way**. The method above is only one of many **simple methods** explained in the first part of the course.

We don't offer any "grand prizes," or "free materials" to encourage enrollments. The school is endorsed by well known cartoonists because they know what **Cartoonist Evans can, and will do**. This School was established in 1907.

Send six cents in stamps for **Portfolio of Cartoons** and full information about the school, and learn how to draw pictures which you can sell. The Course Is Not Expensive.



THE W. L. EVANS SCHOOL OF CARTOONING

"The School That Has the Reputation"

821 Leader Bldg.

CLEVELAND, OHIO



Be a MUSICIAN In Half Usual Time

Amazing new method gives you musical skill so quickly that one delighted student says "It's like being made a musician while you wait!" You learn by playing actual musical compositions right from the start—instead of tiresome exercise.

As simple as A, B, C, and as enjoyable as a game. *Learn at home, by mail.*

This FREE BOOK Is a Revelation

It shows you how to surprise even your closest friends by playing music before they suspect that you've started to learn. It explains our new invention "Automatic Finger Control"—the musical wonder of the century—whereby your fingers are trained and guided until they fall in place almost automatically. Nothing like it ever known before. Send for it now. There is no obligation to buy anything. But act today—before the free books are exhausted. Instruments supplied if desired, cash or credit. Address **U. S. School of Music, 712 Brunswick Bldg., New York City.**

PLAY by NOTE
Piano, Organ, Violin, Cornet, Mandolin, Harp, Cello, Trombone, Flute, Clarinet, Piccolo, Saxophone, Ukulele, Guitar, Harmony and Composition, Banjo, Tenor Banjo, Voice and Speech Culture, Drama and Traps, Automatic Finger Control, etc.



High School Course in Two Years

This simplified, complete High School Course—specially prepared for home study by leading professors—meets all requirements for entrance to college and the leading professions.

30 Other Courses

Whether you need High School training or specialized instruction in any trade or profession the American School can help you. Check and mail coupon for Free Bulletin.

American School
Drexel Ave. and 58th Street
Dept. H974A
Chicago

American School, Dept. H974A, Drexel Ave. and 58th St., Chicago
Send me full information on the subject checked and how you will help me win success.

- | | |
|------------------------------|-----------------------------|
|Architect |Lawyer |
|Building Contractor |Machine Shop Practice |
|Automobile Engineer |Photoplay Writer |
|Automobile Repairman |Mechanical Engineer |
|Civil Engineer |Shop Superintendent |
|Structural Engineer |Employment Manager |
|Business Manager |Steam Engineer |
|Cert. Public Accountant |Foremanship |
|Accountant and Auditor |Sanitary Engineer |
|Bookkeeper |Surveyor (and Mapping) |
|Draftsman and Designer |Telephone Engineer |
|Electrical Engineer |Telegraph Engineer |
|Electric Light & Power |High School Graduate |
|General Education |Fire Insurance Expert |
|Vocational Guidance |Wireless Radio |
|Business Law |Undecided |

Name

Address

Become An Automotive Electrician

\$75 to \$100 a Week

GET into the highest paying branch of the continually expanding automobile industry. 78% of all automobile repair work is electrical. Yet not one out of fifteen garage men know enough about automotive electricity to cash in on this field. No matter what you now know about automobiles, this is your big chance to quickly qualify for this uncrowded, big money field. \$75 to \$100 a week is gladly paid to men who know how to repair batteries, ignition, lighting and starting systems, magnetic gear shifts, signalling systems and other electrical units.



PREPARE—AT HOME OR IN CHICAGO

Enjoy the thousand pleasures and broadening educational advantages of America's great western metropolis, while you learn a business that will put you far ahead in the Automotive Field.

Visit the immense stockyards. See the great mile long Municipal Pier, the interesting exhibits in the new Field Museum, the old Masters in the Art Institute. Attend the theatres—spend Sundays at your favorite sport. There is no place like Chicago. It is the playground and the Educational Center of the West. Come to Chicago and have the happiest and most profitable visit of your life while you learn Automotive Electricity in America's most practical and thorough school.

PROOF

Earns \$75 to \$100 a Week

I have earned \$75 to \$100 a week ever since I left school.
N. Bletcher, Chicago.

Doubles Salary in Two Weeks

Before I went to Ambu my salary was \$50.00 a week. In two weeks I was raised twice to \$100.00. Now doing even better in my own business.
Wm. Haas, Louisiana.

Ambu Course Gets 70% Increase

Earning 70% more than ever before. The course at Ambu did it.
S. E. Kilgore, Batavia.

Big Dividends in New York

Went to work in largest service station in New York the day after nine men were let out. My course at Ambu is paying big dividends.
Lewis D. Jones, New York.

Ambu Men in Demand

Believe me, they sure grab you off when you say you've been thru Ambu.
J. L. Bailey, Rockford.

Ambu: Then Double Earning

My earning capacity has been more than doubled since my training with Ambu.
E. M. Bernhardt, Greenmash.

\$1000 a Month

I'm starting my own business as my boss has been taking in over \$1,000 clear profit every month.
Wynona J. Eillard

Forced to Open Service Station

After graduating, I just did spare time work. But my reputation spread so fast that I had to open a service station of my own.
Ernest Cameron.

Gets 50% More Than Before

With wages going down all over the country my electrical repair business is booming. Thanks to Ambu. My earnings are 50% more than ever before.
Eugene A. Clayton, Holyoke.

Increased Income 4 Times

Have my own shop. Earning four times what I did before I went to Ambu.
Willard W. Ludlow.

NEW EASY WAY TO LEARN In Chicago or at Home

The automobile business is here to stay. The last few years have been only a start. Tremendous additional expansion is on the way. **And the highest paid and uncrowded branch of this enormous field needs you.** There are plenty of auto mechanics to take up a bearing, tighten a bolt, grind out carbon. **But**, suppose your starter won't start, your battery won't charge, your lights won't light. Just try to get his aid. They're a Chinese puzzle to the average mechanic. You'll visit from 5 to 10 garages before you find an **Automotive Electrician**. In a short time you too can become a highly-paid Automotive Electrician who knows his work and his worth—not a dabbler or a guesser. The special method developed by the Ambu Engineering Institute does not saturate you in theories and rules—it shows **how** to do things and **why** to do them. Things ordinarily considered complicated are now made amazingly easy.

FREE BOOK ABOUT AUTOMOTIVE ELECTRICITY

12,000,000 cars in America are equipped with electrical units constantly getting out of order and defying the ingenuity of the ordinary garage men. The specialist is the man who makes money today. The Automotive Electrician is a specialist and the demand is far ahead of the supply.

Mail the coupon for FREE book about this big money field. If you want to learn at home the special Ambu Method has made it practical and thorough. If you want to learn at our school in Chicago, a staff of experts (the same men who developed our Home-Study method) will take you in hand. ANY man with a common school education can now become an Automotive Electrician in eight short weeks. The facts about this field are so interesting and can mean so much to you that you should inquire about them right away. A special limited time offer is open now—so mail the coupon at once.

This 22-page book tells all about the field of Automotive Electricity and how hundreds of men have broken out of the rut and entered this field with good money and a fine future. Already 18% of them own their own businesses. Mail this coupon at once for full facts and special limited time offer.



Ambu Engineering Institute,
Dept. 112, 2632 Prairie Ave.,
Chicago, Illinois.

Please send me FREE booklet and complete information on Automotive Electricity. Tell me of the rich rewards which await me in this uncrowded field. I am interested in your

- Residence Course,
 Home Study Course.

Name
Occupation
Address City

AMBU ENGINEERING INSTITUTE
Dept. 112, 2632 Prairie Avenue
Chicago, Illinois

FREE Five Dancing Lessons

To Prove You Can Learn To Dance At Home in One Evening

1. The Secret of leading
2. How to gain confidence
3. How to follow successfully
4. The correct dancing position
5. A fascinating new Fox Trot Step

For a limited time, Arthur Murray, America's greatest teacher of social dancing, makes this special offer to prove anyone can learn by his remarkable new easy method, at home in a few hours, to be a really good dancer. Even if you don't know one step from another, by Arthur Murray's method you can quickly and easily master any dance without partner and without music. **More than 60,000 have learned this new way. Your own success is guaranteed.**

Arthur Murray's method is so amazingly simple, it is revolutionizing the teaching of dancing. It is easier and much less expensive than a personal teacher. All the

very newest dances and the standardized popular dances, such as the Fox Trot, Waltz, One Step, etc., can be mastered at home in one short evening. You can teach your children while you are learning. In fact, many whole families have become really good dancers from one set of instructions.

There is no need of being a wallflower. Everyone admires and wants to meet and dance with an accomplished dancer. Learn in private and surprise your friends. Be more popular by becoming a good dancer soon. This offer of five free lessons may be withdrawn at any moment. Send for your lessons (mailed in plain wrapper) today! **No obligation**—the lessons are yours to keep. To pay the cost of handling, mailing, etc., send 25c.

ARTHUR MURRAY, Studio 514, 100 Fifth Ave., N. Y.



Be FIT If You Would Have A Happy Home



Strongfort
The Perfect Man

No man can be happy in his home or make the members of his family happy, unless he is physically fit. Peevishness, grouchiness, uncontrollable fit of temper are almost impossible to avoid, when a man is suffering from chronic ailments that make his life a burden. Don't be a bilious bugbear to your wife and children, killing all of their joy in life and having no real happiness yourself. Stop—think and act before it is too late. You can regain your health and retain your happiness with

STRONGFORTISM—The Modern Science of Health Promotion will banish your ailments and fit you for the joys of life. I guarantee it.

Mark the subjects on the free consultation coupon (write additional ailments on extra line) on which you want special information and send with 10c (one dime) to help pay postage, etc., on my book, "Promotion and Conservation of Health, Strength, and Mental Energy." It's a home-maker and a life-saver. Send for my free book **Right Now TODAY.**

LIONEL STRONGFORT

Physical and Health Specialist
Founded 1895

Dept. 1092

Newark, New Jersey

~~~~~ Cut out and Mail this Coupon ~~~~~  
FREE CONSULTATION COUPON

Mr. LIONEL STRONGFORT, Dept. 1092, Newark, N. J.—Please send me your book, "PROMOTION AND CONSERVATION OF HEALTH, STRENGTH AND MENTAL ENERGY," for postage on which I enclose a 10c piece (one dime). I have marked (X) before the subject in which I am interested. Also on those I may write on extra line below.

- |                         |                         |                         |
|-------------------------|-------------------------|-------------------------|
| .. Colds                | .. Pimples              | .. Rheumatism           |
| .. Catarrh              | .. Diabetes             | .. Falling Hair         |
| .. Asthma               | .. Blackheads           | .. Neurasthenia         |
| .. Hay Fever            | .. Insomnia             | .. Weak Eyes            |
| .. Obesity              | .. Short Wind           | .. Fear                 |
| .. Headache             | .. Flat Feet            | .. Gastritis            |
| .. Thinness             | .. Stomach              | .. Heart Weakness       |
| .. Rupture              | .. Disorders            | .. Poor Circulation     |
| .. Lumbago              | .. Constipation         | .. Skin Disorders       |
| .. Neuritis             | .. Biliousness          | .. Despondency          |
| .. Neuralgia            | .. Torpid Liver         | .. Round Shoulders      |
| .. Debility             | .. Indigestion          | .. Lung Troubles        |
| .. Flat Chest           | .. Nervousness          | .. Stoop Shoulders      |
| .. Deformity (Describe) | .. Weaknesses (Specify) | .. Muscular Development |
| .. Increased Height     | .. Poor Memory          | .. Great Strength       |

Mention other ailments here .....

Name .....

Age ..... Occupation .....

Street .....

City ..... State .....



## FREE! LEARN TO MAKE SHOW CARDS

I WILL TEACH YOU HOW FREE! Give one half hour of time daily for six days and pay small amount cash for supply colors, brushes, etc. I will give you free complete mail course in show card and sign writing, fifty lessons, reproductions of beautiful hand No correspondence course its equal, no matter what price. Big demand for students everywhere, earning \$10 or more daily. I help you establish show card shop of your own. You can learn! No Failures! Grasp this opportunity at once.

G. W. MILLER, Proprietor of THE EMPIRE M. INSTITUTE OF LETTERING  
101-103 E. 125th St., New York

## DO YOU STAMMER?

Sane Methods based on many successful years' experience and scientific research, for the correction of all Speech Defects employed in the Speech Clinics at the Ithaca Conservatory of Music under the direction of

**DR. FREDERICK MARTIN,**

(himself once a confirmed stammerer)

Formerly Director of Speech Improvement, Board of Education, New York City. Lecturer, Post-graduate Medical Hospital, New York City. Normal Courses for Teachers of Speech Improvement. Dormitories and complete equipment.

**MARTIN INSTITUTE FOR SPEECH CORRECTION**  
440 Dewitt Park, Ithaca, N. Y.

If you need a book on some mechanical subject and do not know where to find it, write  
**POPULAR MECHANICS BOOK DEPARTMENT**  
78 E. Madison St., Chicago



## BECOME A RAILWAY MAIL CLERK

Examinations soon. \$1600 to \$2300 a year. No strikes or lockouts. Common education sufficient. No "pull" necessary. Mail coupon for catalog.

Patterson Civil Service School  
Dept. 812, Rochester, N. Y.

Sirs:—Send me without charge your Catalog, describing this and other fine U. S. Government positions.

Name .....

Address .....

Dept. 812  
Patterson Civil Service School  
Rochester, N. Y.



# Secure a Preferred Position at Highest Pay



*be a Master Automobile Mechanic  
Earn \$50 to \$125 a week*

Splendid openings in the automobile business. More calls for competent men than we can supply. Greer trained men are making good money. Greer graduates are successful—they get the pick of waiting positions or start their own businesses and become financially independent.

**START A REPAIR SHOP OF YOUR OWN.** The immense increase in production and use of automobiles, trucks and tractors—the establishment of motor freight and passenger routes—motor mail routes—the extensive building of hard surface roads in various states—all these activities make an enormous and continuing demand for capable mechanics and repair men.

**EASY TO LEARN THE AUTOMOBILE AND TRACTOR BUSINESS.** Eight to ten weeks' training by the Greer shop method enables the average man to master all the principles of motor mechanics.

**GREER COLLEGE OF AUTOMOTIVE ENGINEERING** has most complete equipment. New building. Master Mechanic instructors insure personal, individual training. Small classes. Practical shop work on autos, trucks, tractors, all types of motors, ignition and starting systems.

## HERE IS THE COMPLETE COURSE:

Truck, Tractor and Automobile Repairing and Overhauling, Automobile Driving, Roadside Repairs, Primary Ignition, Vulcanizing and Tire Repairing, Electric Lighting and Starting Systems, Machine Shop Practice, Acetylene Welding and Cutting, Storage Batteries, Salesmanship.

Be a certified Automotive Engineer. The Greer Diploma insures your success

**FREE BOOK** Just off the press, newest and most interesting. "How to Succeed in the Automobile Business" is a book you'll find a real guide to a better job at bigger pay. Use the coupon and mail today.

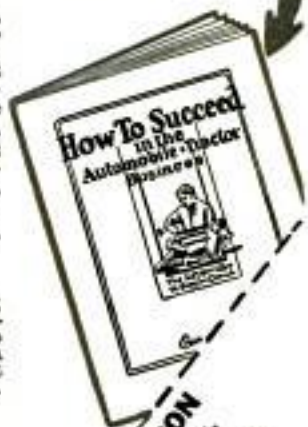

**NET PROFIT  
FOR FIRST YEAR \$5,200**

Gentlemen:  
About a year ago we graduated from your school. Realizing the automobile business offered many splendid opportunities, we decided to go into business for ourselves. As our capital was limited, we were obliged to start on a small scale. Business came in right from the start. At the end of a year our net profit was \$5,200. Our business has already outgrown our present quarters and we must seek a larger building.  
(Signed) Carlson & Simon.

**WRITE AT ONCE** Greer College is more than an "Automobile School." We specialize in quick training for men of all ages. No previous experience necessary.

# GREER COLLEGE

*of Automotive Engineering*

2062 South Wabash Avenue, Chicago, U. S. A.

**MAIL THIS FREE BOOK COUPON**  
Greer College of Automotive Engineering,  
2062 So. Wabash Ave., Chicago, Ill.  
Send me Your Free Book, "How to Succeed in the  
Automobile Business" and Special Tuition Offer.

Name .....

Address .....



# 10,000 Trained Men Wanted in the Electrical Industry



Wayne C. Robinette,  
President  
WORLD TECHNICAL INST.

**Salaries  
\$72 to \$200  
Per Week**

Never before in the history of electricity have salaries been so high. Never has there been such an insistent demand for trained men. Nearly one billion dollars per year are being spent in the electrical field, and yet the nation's demand has not been met.

**YOU! Young man and old—are you seeking independence? Are you helping yourself?**

This is your opportunity. Waste no more valuable time in thinking and talking about what your life work is going to be. In electricity your success is assured.

**Technical educators are amazed**

"I am amazed at the manner in which the World Technical Institute instructs students in the most difficult problems in electricity without the use of higher mathematics," says one of the principal vocational educators of America.

**Ten years ahead of all similar courses**

Endorsed by the Vocational Training Center of the U.S. Army, the Chicago Board of Education, the Charleston Board of Education, the Southern California Edison Company and more than a score of other large educational bodies.

**Correspondence instruction at last standardized**

A dependable, exact and thorough course of training, whose educational value equals those of college or university. And you become a seasoned, trained expert in six to ten months, using only your spare time.

Free Instruments and Material, Free Employment Service, Diploma and Money-Back Guarantee Bond.

**Free—56-page book. Merely return the coupon below**

## FREE COUPON

WORLD TECHNICAL INSTITUTE,  
Fuller Bldg., Jersey City, N. J.

Gentlemen:—Send to me postpaid and without obligation, your valuable illustrated book entitled, "Electricity Taught by a Master Teacher," also full particulars in regard to your course and the remarkable offers you are making to students.

Name.....

Address.....

PM 13-22

## FREE a Ten Lesson Course in PUBLIC SPEAKING



A postal will bring you my wonderful book, "How to Speak in Public," de Luxe edition, 300 pages, colored illustrations. Introduction by **ELBERT HUBBARD**. Tells secrets of oratory, how to prepare speeches, overcome bashfulness, address lodge meetings, clubs, etc. Contains ready made speeches for all occasions. Chapter by **ORISON SWETT MARDEN**, "Self Improvement Thru Public Speaking."

**NO MONEY IN ADVANCE**

Pay your postman \$2 when book arrives, this pays in full for the book. Examine it for ten days. If not satisfied return it to me and I will at once refund you \$2.00. If you keep the book, then I will send you my Ten Lesson Public Speaking Course, with full scholarship privileges **ABSOLUTELY FREE.**

**PROF. HENRY DICKSON**  
Dept. 705-P, 1041 Davis St. EVANSTON, ILL.



## New Way to learn Violin, Mandolin, Mandolin Banjo.

**Play for Money in 2 Months** Marvelous new way to be a Musician. I give you my instructions on **PHONOGRAPH RECORDS**. Nothing ever like it. First lesson will convince you that you will be able to play music. Play real pieces in a few days. In 60 days play as professional and make big money. Any phonograph will do. My records and instructions do the work!

**INSTRUMENT GIVEN ABSOLUTELY FREE**

Let me give you a fine Violin, Mandolin or Mandolin Banjo **FREE**. Write today for my special offer and full description of my wonderful new method of teaching these instruments. A post-card will do. No obligation. My name known to whole music world of America and Europe. Write me today.

**F. M. SCHNEIDER, Director, Schneider School of Music**  
238 Vermont St., Blue Island, Ill. (A suburb of Chicago)



## \$30 to \$60 a Week

for spare time work alone. Professional drummers are in demand everywhere and make big money. You can quickly and easily learn to play hand, orchestra and dance music through my home study course of 20 interesting lessons. Write for particulars of easy payment plan.

**The Herman H. Rinne Correspondence School of Modern Drumming**  
3154 Park Ave. Indianapolis

## I Make Strong Men

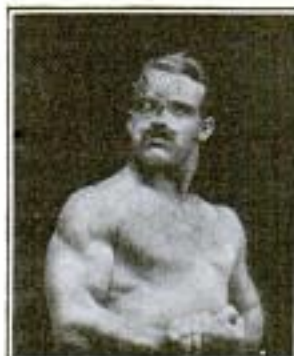

That is my business. I make no other claims. But what I promise, I fulfill. I will increase your arm one full inch in 30 days and your chest in proportion. In three months I will make you a finished strong man. Are you interested? Read my book "Physical Perfection." It tells you how. All I ask is 10 cents to cover postage and wrapping. Don't put it off. Send today.

**Arthur L. Hyson**  
100 Langdon Bldg. New York City



**RADIO**  
HEAD SETS, JACKS, PLUGS,  
MICROPHONES

Manufacturers  
**American Electric**  
COMPANY  
State and 64th Sts., Chicago, Ill.

## AMATEUR MECHANICS

A book for those who like to make things. 132 separate articles tell how to build electrical and mechanical devices, read furniture, fishing tackle, hammocks, etc. 128 pp., illustrated. 25 cents postpaid. Popular Mechanics Book Dept., 6 N. Michigan Ave., Chicago



# You Can Play the Hawaiian Guitar Just Like the Hawaiians!

## Because Our Native Hawaiian Instructors Will Help You

OUR STUDENTS SAY

Konover School,  
214 So. Franklin St.,  
Chicago, Ill.

First Hawaiian Conservatory of  
Music, Inc.

I shall certainly be very glad to recommend your course whenever the chance is mine to do so. Mr. W. R. Johnson does not phone me yet, and if he does not phone in a day or so, will write him. Am sending a letter to Miss Helen Blavik today which I think may help to secure her enrollment, and I shall be glad at any time to write a personal letter to anyone whom you may suggest.

Your former student,  
W. L. Walker.

San Quentin, Calif.

First Hawaiian Conservatory of Music,  
903 Woolworth Building, N. Y. City.

Dear Sirs:—

Lessons 18 and 19 come last evening and I was pleased to see that they are beginning to get hard, or at least a little bit more to learn in them. I have a great deal of spare time to put in on the guitar and I enjoy it. Your course is the simplest and most interesting I have ever tried to learn. I am getting along fine and can play every lesson up to the last one and I can readily see that when I have finished with all of the lessons I will be able to play most anything and play it good. I am, in appreciation,

Yours truly, J. E. FERGUSON.

P. S. If at any time you wish to use my name as a reference for your course you may do so, as I think that any one who takes it up will derive a great benefit from it and never regret it.

Our improved method of teaching is so **simple, plain and easy** that you begin on a piece with your first lesson. **In half an hour you can play it.** Thousands of successful students prove this to be true.

**ONLY 4 MOTIONS** necessary motions you learn to only four, and you acquire these in a very few minutes. Then it is only a matter of a little practice to acquire the wail, fascinating, tremolos, staccatos, slurs and other effects that make this instrument so delightful. **The Hawaiian Guitar plays any kind of music, both the melody and the accompaniment.**

**FREE** Just think of it. 52 lessons on this wonderful guitar. You get a beautiful large sized **Genuine Hawaiian Guitar absolutely free as soon as you enroll for the lessons.** All the necessary picks, the steel playing bar and 52 pieces of music are included **without cost to you.**

**Special Arrangements for Lessons if You Have Your Own Guitar  
This Makes A Splendid Christmas Gift**

## Play Any Music

In half an hour after you get the free Hawaiian Guitar and the first lesson, **you can play Hawaiian Melodies.**

In a very short time after a little practice **you can play any kind of music** as well as Hawaiian, both the melody and accompaniment.

[TEAR OUT COUPON]



Your favorite instrument given away **FREE** with first lesson. **SPECIAL COURSES UNDER FAMOUS TEACHERS.** Learn to play VIOLIN, BANJO or UKULELE.

First Hawaiian Conservatory of Music, Inc.  
233 Broadway (Woolworth Bldg.), New York City

Please send me full information about your 52 easy lessons and **FREE GUITAR OFFER.**

NAME .....

ADDRESS .....

TOWN ..... STATE .....

Print name and address clearly. P.M. 12

# Learn an Auto Trade

**Big  
Pay  
Jobs  
Open  
in  
California**

## Learn It Right---at National Automotive

Come to Los Angeles, one of the most interesting cities in the world, where wintertime is like a glorious summer day.

Learn auto business. Thousands of opportunities to earn \$100 to \$400 a month in this big industry. Everywhere in California auto men are wanted. It's almost a new country—and growing fast. Good jobs at big pay open now. Garages needed. Auto experts can't be trained fast enough to supply demand. You're needed now in this money-making business. Be an electrician, mechanic, ignition expert, garage foreman or used car appraiser. Be independent—and earn big pay.

Learn in National Automotive's big practical training shops. Actual work on Packards, Cadillacs, Fords, etc. Use tools; not books. Expert mechanic instructors give you thorough training. You know autos after National training.

### Special 19th Anniversary Low Tuition Offer

Train in big new National Bldg.—ready Jan. 1, 1923. Across the street from 130 acre Exposition Park. Stadium, ball grounds, swimming pools, entertainment—all FREE to you. Take advantage of big 30-day reduction in tuition. SEND FOR BIG FREE AUTO BOOK—explains everything. 72 pages full of auto facts, and illustrations of auto construction. Tells how you can earn your room and board, and a little more, while learning. How National finds YOUR job for YOU. Get this wonderful auto book now—it's FREE. Send the coupon today.

## Free Auto Book

National Automotive School  
Dept. 25, 811 S. Figueroa,  
Los Angeles, Cal.

Please send me your 72-page illustrated auto book—absolutely FREE.

Name .....

Street No .....

City ..... State .....





# \$4800 to \$12,000 Per Year

Would you like to make \$4,800 to \$12,000 a year? Then read these vital facts. Unlimited opportunities await you in the field of salesmanship. A good salesman **names his own price.** Why? Because a business needs sales to make money and the salesman is the man who sells. He is the important man and he gets the big money. Read below—learn how YOU can get into the big money class.

**In a few months you can be an Expert Salesman. Anyone who is willing is qualified. Here is your chance.**

## Secrets of Selling

One of the most important secrets of Successful Salesmanship is "Specialization". Very few salesmen are highly successful in more than one field. Do not make the mistake of thinking that even a trained salesman can sell anything. The salesman who makes Big Money is not only trained in salesmanship, but he knows all there is to know about the product he handles. Learn these simple secrets and Success is sure to come to you.

## Position Guaranteed!

Here, at last, is a practical training course that teaches you how to sell goods. A master sales manager who has sold thousands of dollars worth of goods himself will show you how. You can cash in on his wealth of experience. You will learn no mere theories. You learn the actual methods that have brought success to hundreds of other men. Arthur Greene says, "I have reached the position of District Manager through training and personal instruction I received." F. D. Jacaway says, "From the selling position which you formed for me I have earned at the rate of \$3,000.00 a year." Just think — these remarkable results were accomplished by following the simple methods told in this course. There isn't any reason why you can't do the same. Earn Big Money!

There is such a demand for men trained under this unusual method, that we can **POSITIVELY GUARANTEE** that as soon as you finish training, we can place you on the selling staff of a reliable company.

The Power  
of Salesmanship



# FREE BOOK

Write today for this free illustrated book. It is packed full of vital information. It tells you all about the secrets of successful salesmanship.

It tells you how you can master these simple secrets in just a few months. It tells you how men who formerly worked for little or nothing, now enjoy large incomes — \$4800 to \$12,000 a year. You, too, can earn big money, if you will simply take advantage of this opportunity. Send now for "The Power of Salesmanship." Find out about our positive guarantee to put you on the selling staff of a successful business. You will be under no obligation in sending for this book; surely this opportunity which may mean financial independence to you is worth a 2c stamp now. Send that coupon at once.

**Cleveland Salesmen's Training School**  
1775 Gordon Square Bldg., Cleveland, Ohio

Without obligation to me send your Free Book, "The Power of Salesmanship" and free details of your guaranteed position offer.

Name.....

Address.....

City..... State.....

Please Mention Popular Mechanics

# SHOP MANUALS

## for the AUTOMOBILE ELECTRIC SERVICE STATION

### Automobile Ignition



Adjustment, timing, wiring, care, lubrication and repair of each type of the eighteen makes of both battery and magneto ignition equipment now in use. Includes eighty-three diagrams of internal and external connections and more than one hundred illustrations of construction and design.

Explanations of operation are given by description and explanation of equipment in actual service.

439 pages, 4½" by 6¾", bound in flexible leatherette.

Price \$2.00 Postpaid

### Automobile Battery Care and Repair

Practical repair methods from the time of opening the cells until the final reassembling. Explains methods of testing with hydrometer, voltmeter, ammeter, discharge set and cadmium stick; showing symptoms by which each kind of trouble can be recognized. Includes rules for charging new, used and repaired batteries; also instructions for the use of all types of charging equipment.

Among the tables are those showing effect of temperature, time and rate on capacity; required capacity for starting and lighting; discharge rates and voltage drop during tests; charging rates determined by battery size, heating, time available and line rate; gravity secured by various proportions of acid and water and gravity used in repair work.

335 pages, 4½" by 6¾", 160 illustrations, bound in flexible leatherette.

Price \$2.00 Postpaid

### Starting and Lighting Troubles, Remedies and Repairs

One hundred and five special diagrams show the internal wiring, also the connections between all the units of each type and make of electrical equipment from 1912 to the present time.

Opposite each diagram is a description including the normal amperage and voltage, the method of regulation, the type of cut-out and their adjustments.

Trouble location charts are based on the action of lamps and starter without the use of testing instruments.

Over two hundred pages of instructions for testing and locating faults in any part of the starting and lighting equipment. Includes sixty-four diagrams showing tests and repairs, also sixty illustrations of operating principles.

459 pages, 4½" by 6¾", bound in flexible leatherette.

Price \$3.00 Postpaid

### Automobile Starting and Lighting

Gives an elementary working knowledge of the construction and action of each part of all types of starting and lighting systems.

In addition to the subjects mentioned in the list of contents, this book gives a brief description of the systems that have been used, together with internal diagrams of dynamo, motors, cut-outs and current regulators.

It also includes definitions of two hundred and twenty-six words and terms used in automobile electrical work.

388 pages, 4½" by 6¾", bound in flexible leatherette.

Price \$2.00 Postpaid

**POPULAR MECHANICS BOOK DEPT.**  
6 N. Michigan Avenue, CHICAGO







## HOW TALL WILL YOU BE

When The Boss Comes A-measuring With His Salary Yard-Stick?

When you were a little lad the old folks used to scratch a mark and measure your height with a yard-stick.

You've got your full physical growth now. But how about your growth in **business**? Are you growing? Your weekly salary will show you that.

**Mechanical Drawing** is your chance to grow "tall" on salary. In a short time the Columbia School of Drafting can help you measure up to the \$3,200 a year mark. One of our students recently received \$275 for one drawing that took him only three days to draw. And that was an **extra**, outside of his salary.

**MAKE \$35 TO \$100 A WEEK.** We will train you to be an expert Draftsman in your spare time at home by mail. There's lots of room for you if you begin **now**.

**PROMOTION IS QUICK.** WE'LL QUALIFY YOU for a high-salaried position in the drafting field and keep you in touch with openings for Draftsmen in the big machine shops, industrial plants and United States Government departments. Men who start as Draftsmen are often advanced to Chief Draftsmen, Chief Engineers, Production Managers and so on.

**GET THE RIGHT TRAINING.** Mr. Claffin, the founder and director, stands personally in back of the Columbia School of Drafting. You spend no time in long-winded theories—useless and expensive to you. You start on actual drawing the day you receive your first lesson.

**YOU NEED NO PREVIOUS TRAINING.** The course is easy to understand and easy to follow. Many students are qualified even before they complete the course.

**SUCCESS CALLS MEN OF ACTION ONLY.** If you are a man of action clip the coupon now and show that you are a man of action. Keep right on top of this opportunity to make real money. Don't go looking for a pair of scissors. Tear off the coupon and mail it right now. We have a special offer for those who reply promptly. Get started now.

### WHAT WE GIVE YOU

**PRACTICAL PROBLEMS.** You are carefully coached in practical Drafting work.

**DIPLOMA.** The diploma we give you on completing the course attests to your proficiency as a Draftsman. It is an "entering wedge" to success.

**WE HELP YOU GET A JOB.** We help you get a position as a practical Draftsman as soon as you are qualified.

**PERSONAL INSTRUCTION AND SUPERVISION THROUGHOUT THE COURSE.**

You receive the personal instruction and help of Roy C. Claffin, president of the Columbia School of Drafting and a practical Draftsman of many years' experience.

**DRAFTSMAN'S EQUIPMENT.** We furnish you with a full set of Drawing Equipment and Drafting instruments as shown in the picture below when you enroll. You keep both sets on completing the course.

**CONSULTATION PRIVILEGES.** You are free to write us at any time for advice and suggestions regarding your success.

**FREE SUBSCRIPTION TO DRAFTSMAN'S PUBLICATION, "THE COMPASS."**

You are given free a subscription to our helpful, inspiring publication, "The Compass."

### FREE BOOK

Send in this coupon today. Immediately on receipt of it we will send you our book, "Your Future in Drafting," which tells you all about our new method of teaching Mechanical Drawing and gives full details of our special offer to those who reply promptly.

## COLUMBIA SCHOOL OF DRAFTING

Roy C. Claffin, President

Dept. 1879, 14th and T Sts., N. W., Washington, D. C.



**FREE Drafting Outfit**

We give you free with our course this professional Drafting outfit. It is yours to keep when you complete the course.

### Free Book Coupon

COLUMBIA SCHOOL OF DRAFTING,  
Dept. 1879, 14th and T Sts., N. W., Washington, D. C.

Enter my name for a free subscription to "The Compass" and also send me without charge your illustrated book on Drafting, telling me how I can secure your complete Home Study Course and your help in securing a position as Draftsman.

Name ..... Age .....

Address .....

City ..... State .....



# NAVIGATION



**Taught  
in Your  
Home  
or on  
Board  
Ship**

## Salaries to \$315.00

**Per Month and Expenses**

Sail the Seven Seas as a ship's officer. See the world and get an education which can be secured in no other way. Earn more money than you can on land.

### Join America's Mighty Merchant Fleet

America's great, modern passenger and freight vessels now sail to all parts of the world—India, Africa, Asia, China, Japan, Europe, South America, Australia, New Zealand, etc.

### Course Adopted by U. S. Navy Education System

The U. S. Navy officials, in search for the simplest, most thorough, best course, on Navigation for the use of enlisted men, have officially adopted the Sheppard Course on Ocean and Coast Navigation. It is the only course of its kind in the world. It enables you to completely master the most fascinating subject in existence in six months or less, during your spare time.

### First Lesson Free

First lesson of 52 pages and 36-page illustrated prospectus will be sent free without obligation, upon receipt of coupon below.

Lose no time. You can begin actual training in navigation upon receipt of this free lesson.

### "Shove Off"—Join America's Mighty Merchant Fleet—Return This Free Coupon Today

**WORLD TECHNICAL INSTITUTE,  
Fuller Building, Jersey City, N. J.**

Send by return mail free booklet, entitled, "Your Future Is on the Seven Seas," which gives every particular about Captain Warren Sheppard's Course on Ocean and Coast Navigation, also Lesson No. 1 of the Course.

Signature .....

Address .....

Present Position ..... PM 12-22

# No Better Holiday Present for \$3.00

than a year's subscription to

## Popular Mechanics Magazine

Containing 3600 Pictures  
and 3600 Articles

Much of it Interests Everybody  
Most of it Interests Anybody  
All of it Interests Somebody

A Christmas card containing name of the donor will be mailed by the Publisher without additional charge.

Order through your Newsdealer or  
address the Publisher

**POPULAR MECHANICS CO.**  
6 N. Michigan Avenue Chicago, Ill.

Use the coupon below

Popular Mechanics Co.

6 N. Michigan Ave., Chicago, Ill.

For the enclosed \$3.00 send your magazine for one year to

Name .....

St. and No. ....

City and State .....

Send card containing the following name



How to Read Blueprints and Plans.

How to Use the Steel Square Successfully.

What You Should Know About Carpentry and Building.

How to Build a Frame or a Brick Structure.

What You Should Know About Sheet Metal Work.

How to Be a Successful Building Superintendent.

What You Should Know About Heating and Ventilating.

How to Write and Read Building Specifications.

What You Should Know About Water Supply and Drainage.

How to Estimate the Cost of a Building.

What You Should Know About Plastering and Painting.

How to Know Material and Select the Best.

How to Build of Concrete and Steel.

How to Care for Tools.

# A Thousand Things You Ought to Know

EVERY day in your work you get up against new problems—sometimes it is only some old "sticker" coming in a new way. Just the same, though, it takes a lot of time to figure them out. **Don't do it.** Here's everything worked out for you. Every problem, big or little, that you will meet in a day's work. Hundreds of new ideas and better ways of doing things. Hundreds of ways the other fellows are making money. Hundreds of ways you can make more out of the same work you are doing now.

## CARPENTRY AND CONTRACTING

Five great big volumes flexibly bound in genuine American Morocco with 2,138 pages and more than 1,000 blueprints, plans, pictures and diagrams. It is the newest, most complete, most practical work of its kind ever published. Twenty-five well-known experts prepared these great books, gathering the material from hundreds of different sources. Every man in the shop and on the job should have them. Written in such plain language that anyone can understand them.

### 7 Days' FREE Examination

Send the coupon for these great Carpentry and Contracting books TODAY. You can't afford to be without them and you don't take any risk at all. The coupon brings the whole set by express collect for a week's free examination. Use the books a week and notify us to get them back if they don't please you. If you like them, send us only \$2.80 and \$3.00 each month thereafter until \$19.80 is paid. If you prefer to pay cash with order, send only \$17.80. The return privilege holds good just the same. Send the coupon NOW. Remember—sending for the books does not obligate you to buy.

**AMERICAN TECHNICAL SOCIETY, Dept. G-199, Chicago**



**American Technical Society,  
Dept. G-199, Chicago**

Please send me the five-volume Cyclopaedia of Carpentry and Contracting, shipping charges collect. I will send you \$2.80 in seven days and \$3.00 each month thereafter until \$19.80 has been paid, or return the books at your expense.

Name .....

Street and No. ....

City and State .....

Reference .....

(Please fill in all lines.)



# Men Wanted

## \$150 to \$400 a Month

is actually being made by good mechanics—not just in a few cases but as a general rule. Hundreds of letters from our former students prove that "Iowa State" trained men are getting the big-paying jobs or making a success of their own business. The whole United States is a field of opportunity for you, once you learn motor mechanics right. Trained men are wanted everywhere.

**Be a trained man**—learn a trade—get out of the low-wage class and earn real money. We extend a real helping hand—we help you get ahead thru your own efforts—that's the greatest assistance that can be offered to any man—to help him **help himself**—that's the one big reason for this school's existence.

If you could read all the inspiring letters we get from former students—how quickly they spot trouble, how successfully they perform all kinds of repair jobs, what big money they're making—you'd be confident of your own chances for success. For instance, read this letter from Burke Grieme:—

"My \$23,000 garage and equipment is the result of my course in the Iowa State Auto & Tractor School. I had no gas engine experience, but I had the ambition to get ahead, so I took a seven weeks' course in the Iowa State Auto & Tractor School and went into business for myself. Today I own and conduct a big business."

## Master Big Shop Standard Methods in 7 Weeks

Here you get a thorough, standard, practical training in the care, repair and operation of autos, trucks, tractors, stationary gas engines and aeroplane mechanics, all in one course—all for one small price. You work with tools and modern equipment—not books. Our test and trouble work alone is worth the price of the entire course. No education or experience required. No age limit. Life scholarships. **Y. M. C. A. Membership** and a night Business Course included—no extra charge.

**Big free book**—Tells all about the big opportunities of motor mechanics and our practical big shop standards of instruction. Write for it.

**F. D. HENNESSY, President and Manager**  
**IOWA STATE AUTO, TRACTOR & ELECTRICAL SCHOOL**

739 Nebraska Street,  
Sioux City,  
Iowa

"The  
Quality  
School"



F. D. HENNESSY  
739 Nebraska St.  
Sioux City, Iowa

Fill Out  
and Mail  
TODAY

Name.....

Address.....

Please Mention Popular Mechanics



New friends, new pleasures, new and interesting experiences, invitations galore—dinners, dances, week-end parties, outings,—are some of the good things playing a Gibson brings into your life.

**Gibson**  
Instruments

are easily learned in spare time without previous knowledge of music. A few weeks of pleasant, interesting study and you'll be able to play. And there's no other joy in life quite equal to hearing music you make on your own instruments.

**\$5.00 Monthly** buys a Gibson. The ultimate in construction, finish, tone quality and volume. Built like a violin. **Guaranteed for life.** Non-Gibson instruments exchanged.

**Make \$25 to \$200** weekly selling, playing, teaching. Own a stock, advance, help sell, carry accounts. Gibsons easily sold on residential credit plan.

Send for FREE catalog, FREE music and information about Mandolin, Mandola, Mando-cello, Mando-bass, Guitar, Harp-guitar, Mandolin-banjo, Tenor-banjo, Cello-banjo, Guitar-banjo. If interested in Agency, check here.....Teacher?..... Clip, check and mail this ad today! Address all mail to Kalamazoo.

**Gibson Mandolin-Guitar Co.**  
1372 Parsons St. Foreign Dept.  
Kalamazoo, Mich. 25 Broad St., N. Y. City

## LEARN SHOW CARD WRITING and DISPLAY ART BY MAIL OR LOCAL CLASSES

Study under the direction of Arnold Binger, the leading expert in the line. Positions await competent students. Write for our beautiful illustrated booklet and terms.

**BINGER SCHOOL OF SHOW CARD & DISPLAY ART**  
2115 Flatiron Building, Broadway & 23rd Street, NEW YORK CITY

## FREE OUTDOOR MAGAZINE

Every person interested in **Dogs, Hunting, Fishing and Outdoor Sports** will be sent a copy of **SPORTSMAN'S DIGEST Free**. Send name and address to **Sportsman's Digest, 505 D Butler Bldg., Cincinnati.**



## MECHANICS FOR YOUNG AMERICA

Plain and complete directions for building boats, water motors, wind mills, searchlight, burglar alarm, ice boat, water bicycle, cabins, camps, kites, etc. 6x9 in. Illustrated. 25c, postpaid. Popular Mechanics Book Dept., 6 N. Michigan Ave., Chicago

## Mathematics Made Easy by ROPP'S CALCULATOR AND SHORT-CUT ARITHMETIC

Shows the Answer as Quickly as a Watch shows the Time to all Problems likely to occur in the Office, Store, Shop, Bank, Farm, or Factory. **Over 2,000,000 Sold**



Explains and simplifies every principle in Arithmetic, Mechanics, and Measurement.

**PRICES POSTPAID**  
Desk Size...\$1.50  
Leatherette, Pocket Size...\$1.00  
Pocket Size, Cloth...\$0.50  
Pocket Size, Paper...\$0.35

Popular Mechanics Book Dept., 6 N. Michigan Ave., Chicago



# \$80 Drafting Course Free

Write to me for this offer I am now making to every one of my students. I do exactly as I tell you—give you an opportunity to get an \$80 drafting course free.

# Drawing Outfit Free

I am also offering to each student a complete drawing outfit which I believe cannot be purchased any place for less than \$25.

## A Special Ivorine Pocket Rule FREE!

for sending copy of drawing shown at left hand side

**C**OPY this drawing today and send it to me, giving me your age. There are no conditions requiring you to buy anything. So, if you are interested in drawing, send in your sketch right away. I will give you free, just for sending a copy of this drawing, a 6-inch Ivorine Pocket rule and a 6x9 book on "Successful Draftsmanship."

Chief Draftsman Dobe, of the Engineers' Equipment Company, is making this offer to interest ambitious men who would like to better themselves at bigger salaries, doing work which brings big pay and at the same time leading to greater advancement. There will be thousands of positions open this year paying from \$3,000 to \$3,600 a year. The great building boom all over the country is causing this great demand, and industrial activity in the mechanical line makes it worth your while to give this opportunity your immediate attention.

## \$250 to \$300 a Month

Positions paying \$250 to \$300 per month, which ought to be filled by skilled draftsmen are vacant everywhere. There are in every part of this country ambitious men, who with practical training and personal assistance, will be qualified to fill these positions.



Copy this sketch



Mr. Dobe is very much interested in finding these men and calling to their attention the great future in draftsmanship—how when a man enters into this profession, he is in an uncrowded field and how with surprisingly little effort he may rise to the salary of from \$3,000 to \$3,600 a year.

Ambitious boys and men, between the ages of 16 and 50, are wanted by great business concerns, and the man who is ready when opportunity calls him, gets the high grade positions and highest pay.

No man can hope to share a part in the great coming prosperity in manufacturing and building, unless he is properly trained and able to do first class, practical work and is ready when he is called.

Mr. Dobe knows now is the time to get ready and he knows that few men realize this so well as he. So in order to interest men everywhere he wants to see if your copy of the drawing shown above indicates you might have drafting ability.

If then, Dobe believes that you do possess this ability he will tell you how he will train you personally. This training is given by mail and he guarantees to train a limited number of students under this agreement to give practical drafting room training UNTIL placed in a permanent position at a salary of \$250 to \$300 per month.

To any student that Mr. Dobe accepts for his personal training, he will furnish a complete draftsman's working outfit absolutely free. This outfit consists of all instruments and tools required by any first class draftsman, and Mr. Dobe believes it cannot be duplicated for less than \$25.

Considering that Mr. Dobe selects and limits the number of students for training, it is very important that you act promptly and send in your reply either with your sketch or without a sketch at once, asking for full particulars.

He will send you at once a free book entitled "Successful Draftsmanship" in addition to all other information, telling you how you may learn drafting at home.

**Mail Your Drawing At Once—**  
and Get Ivorine Pocket Ruler Absolutely FREE!

Ambitious men, interested in drafting, hurry! Don't wait! This is your opportunity in this great profession. Accept this offer which Mr. Dobe makes. Send in your sketch or request for FREE Book and Ivorine Pocket Rule. Address:

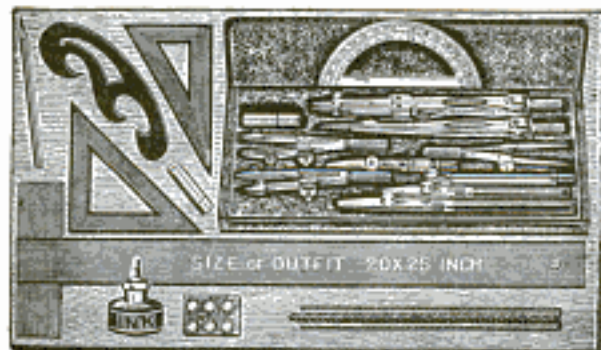

**FREE—this \$25**  
**Draftsman's Working Outfit**

These are regular working instruments, the kind I use myself. I give them free to you if you enroll at once. Don't delay. Send for full information TODAY!

Chief Draftsman, Engineers' Equipment Co., 4001 Broadway, Div. 9359, Chicago, Ill.





*One Year Ago Every One of These  
You Are Reading Now — Today  
mechanics, Many Owning Their Own*

**STUDY THIS PICTURE** Do you not want to join the crowd of keen, ambitious, energetic young men who are learning to be expert mechanics at this world-famous trade school? Take up the work you like. Every day you hesitate and delay is that much time lost. Learn Auto-Mechanics by the—



## Sweeney System of Practical Experience

The Great Million Dollar School, world famous, and the success of my thousands of graduates are due to the Sweeney System.

This is what you get here and can't get anywhere else. I have taught 50,000 men to be expert repairmen, chauffeurs, tractor engineers, etc. I am proud of the fact that I was selected by the U. S. Government to train 5,000 men for mechanical work in the service. I teach by using tools, not books. You learn as you do the real work with your hands.

### LEARN A TRADE

Now is the time for you to learn a trade. I teach men to be successful auto mechanics. Can you make a tire? Can you weld a broken crank case? Can you build a battery? Can you repair an automobile? Can you go anywhere in the U. S. and get a job in a garage, repair shop, auto agency, tire shop, welding concern? Can you get a job as a driver or chauffeur?

**LEARN A**  
**Sweeney**  
**SCHOOL OF AUTO**  
**1133 SWEENEY BLDG.**





## Men Read an Advertisement Just as These Men Are Trained Auto Me-Independent Prosperous Business

**Hundreds of Good Jobs paying \$50.00 a Week and More are open to Sweeney Trained Men. You need no previous experience. I train you in 8 weeks with tools, not books**

### I PAY YOUR RAILWAY FARE

I want you to come now—not to wait and postpone—I am making it easy for you—I will help you—the first step is to send for my free catalog.

I am now paying your Railroad fare to Kansas City and giving a free radio course. No extras. No books. You are sure of getting a job when you graduate. I can't tell it all here, but send for my big catalog. Investigate this real opportunity.

# FREE

The first step is to send me the coupon or write a postcard for my 72-page illustrated catalog. It tells all about this

Million Dollar Trade School. How thousands of men just like you, without any special knowledge, but simply a liking for mechanics, MADE A LIFETIME SUCCESS as a result of this simple training.

I don't care how old you are. I don't care how small your education, for I teach with TOOLS, NOT BOOKS. I need 5000 salesmen and representatives to handle Sweeney batteries and radio supplies. I want managers for branch offices. I will hire you if you are in earnest and will qualify. And if you are willing to go to work. I WILL PAY YOUR RAILWAY FARE to Kansas City. Write me NOW! No colored students accepted.

You cannot get the SWEENEY SYSTEM OF PRACTICAL EXPERIENCE anywhere else—the system that trains men in eight weeks for big paying jobs.

**E. J. SWEENEY,**  
President

**This FREE Book Tells You Everything**

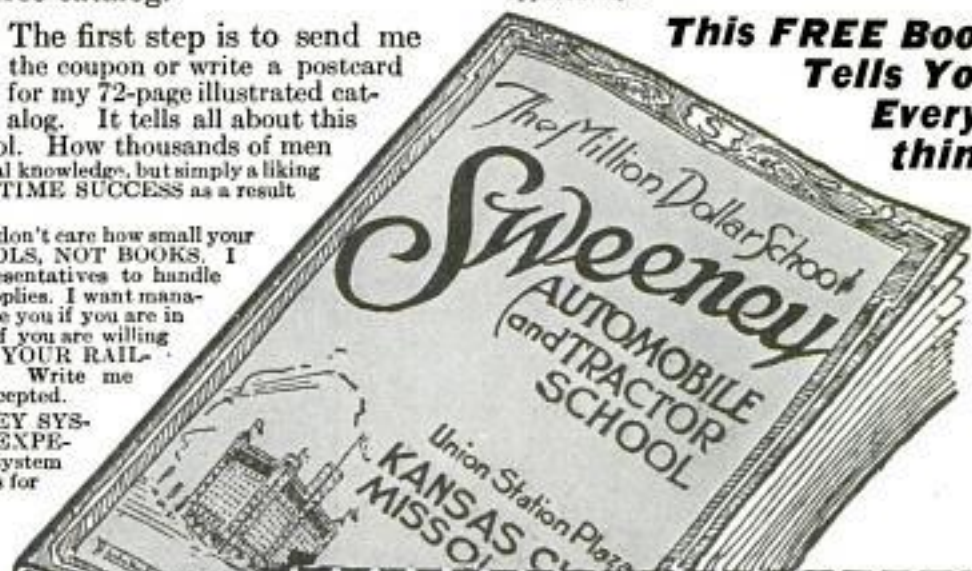

**EMORY J. SWEENEY, President**  
1133 Sweeney Bldg., Kansas City, Mo.

Send me your offer of a guaranteed position, your big free catalog and full details of the Sweeney eight weeks' course leading to an immediate money-making opportunity.

Name.....

Address.....

**TRADE**  
**Sweeney**  
**TRACTOR-AVIATION**  
**KANSAS CITY, MO**



**INTERNATIONAL CORRESPONDENCE SCHOOLS**  
 Box 5688-C, Scranton, Penna.

Without cost or obligation on my part, please tell me how I can qualify for the position or in the subject before which I have marked an X:

**BUSINESS TRAINING DEPARTMENT**

- |                                                                           |                                                 |
|---------------------------------------------------------------------------|-------------------------------------------------|
| <input type="checkbox"/> Business Management                              | <input type="checkbox"/> Salesmanship           |
| <input type="checkbox"/> Industrial Management                            | <input type="checkbox"/> Advertising            |
| <input type="checkbox"/> Personnel Organization                           | <input type="checkbox"/> Better Letters         |
| <input type="checkbox"/> Traffic Management                               | <input type="checkbox"/> Foreign Trade          |
| <input type="checkbox"/> Business Law                                     | <input type="checkbox"/> Stenography and Typing |
| <input type="checkbox"/> Banking and Banking Law                          | <input type="checkbox"/> Business English       |
| <input type="checkbox"/> Accountancy (inc. C.P.A.)                        | <input type="checkbox"/> Civil Service          |
| <input type="checkbox"/> Nicholson Cost Accounting                        | <input type="checkbox"/> Railway Mail Clerk     |
| <input type="checkbox"/> Bookkeeping                                      | <input type="checkbox"/> Common School Subjects |
| <input type="checkbox"/> Private Secretary                                | <input type="checkbox"/> High School Subjects   |
| <input type="checkbox"/> Business Spanish <input type="checkbox"/> French | <input type="checkbox"/> Illustrating           |

**TECHNICAL AND INDUSTRIAL DEPARTMENT**

- |                                                                    |                                                                      |
|--------------------------------------------------------------------|----------------------------------------------------------------------|
| <input type="checkbox"/> Electrical Engineering                    | <input type="checkbox"/> Architect                                   |
| <input type="checkbox"/> Electric Lighting                         | <input type="checkbox"/> Blue Print Reading                          |
| <input type="checkbox"/> Mechanical Engineer                       | <input type="checkbox"/> Contractor and Builder                      |
| <input type="checkbox"/> Mechanical Draftsman                      | <input type="checkbox"/> Architectural Draftsman                     |
| <input type="checkbox"/> Machine Shop Practice                     | <input type="checkbox"/> Concrete Builder                            |
| <input type="checkbox"/> Railroad Positions                        | <input type="checkbox"/> Structural Engineer                         |
| <input type="checkbox"/> Gas Engine Operating                      | <input type="checkbox"/> Chemistry <input type="checkbox"/> Pharmacy |
| <input type="checkbox"/> Civil Engineer                            | <input type="checkbox"/> Automobile Work                             |
| <input type="checkbox"/> Surveying and Mapping                     | <input type="checkbox"/> Airplane Engines                            |
| <input type="checkbox"/> Metallurgy <input type="checkbox"/> Radio | <input type="checkbox"/> Agriculture and Poultry                     |
| <input type="checkbox"/> Steam Engineering                         | <input type="checkbox"/> Mathematics                                 |

Name.....

Street Address.....

City..... State.....

Occupation.....

Persons residing in Canada should send this coupon to the International Correspondence Schools Canadian, Limited, Montreal, Canada.

## The World's Most Famous Coupon

You have seen it in the magazines for years—this world-famous coupon of the International Correspondence Schools.

It is just a little thing in size, but mighty in possibilities. For it has been the means of bringing advancement and more money to thousands upon thousands of men in all circumstances and in every part of the world.

Can you still turn away from Opportunity? Can you still go on, putting in your days at the same old grind, getting the same pay envelope with the same insufficient sum, when such a little thing can be the means of changing your whole life?

Make up your mind right now that not another day shall pass until you find out what the I. C. S. can do for you.

The first step is to choose the work you like best in the coupon ABOVE and mark and mail it here and now.

**INTERNATIONAL CORRESPONDENCE SCHOOLS**

Box 5688-C, Scranton, Penna.

## WHY USE STORAGE BATTERIES?

# UNECO TUBE ADAPTER



Enables you to use the famous dry cell vacuum tube in any radio set and eliminate the storage battery.

This saves you time, money and the necessity for re-wiring.

Directions:—Insert tube in Adapter insert Adapter in socket. Tube circuit is automatically adapted to conform to your set.

**Price \$1.50 each**

Write department "M" enclosing money order if your dealer cannot supply you.

Dealers write for proposition

**SUN EQUIPMENT COMPANY**

 67 Exchange Place  
 New York

## INSTANT HEAT

for Soldering,  
Radiator  
Repairing,  
Etc.



### TORIT TORCH OUTFIT No. 13

Whether the job is lead burning, battery sealing, fender straightening, radiator soldering or loosening a rusty or corroded nut, the Torit No. 13 Torch is always ready at a second's notice to serve you, and the price is wonderfully low. It is handy for soldering tinware, babbiting, joining light tubing, aluminum soldering, soldering electrical connections, etc.

#### USES ACETYLENE ONLY

A splendid use for discarded auto acetylene tanks. Many owners make the Torit No. 13 pay for itself in a single day. Torch with 4 different tips, soldering copper, 5 ft. tubing and connection for auto acetylene tank. **\$7.50** In U. S. \$10 in Canada

ORDER TODAY FROM YOUR JOBBER, OR

**ST. PAUL WELDING & MFG. CO.**  
 177 W. Third St. St. Paul, Minn.



Special Offer

**\$6<sup>95</sup>**Regular Value  
**\$10.00**

# All-Wool Heavy Jumbo Sweater Coat

Only

# 50c

## DOWN

Send only 50c with the coupon, This heavy, pure virgin wool jumbo sweater comes on approval. Money back instantly if you ask for it. Don't be too late—order now.

### Heavy Pure Wool

This is a splendid big sweater at a bargain price. Every fibre pure wool. Heavy rope stitch. Large fashioned shawl collar. Two large lined pockets. Close knitted wristlets. Ivory buttons to match. Made in big full size in rich fast colors. Nothing so practical for fall and winter wear. Sold by most stores for \$10.00, all spot cash.

Sizes 34 to 46. Colors: Dark Maroon or Navy Blue. Order by No. F-12. Send 50c with coupon, \$2.15 monthly. Total price, \$6.95.

## Easy Payments

Learn to buy the Elmer Richards way as thousands of well satisfied men are doing. Everthing you need in clothing or shoes and you pay in monthly sums so low you will never miss them. Strictly dependable qualities only. See this big sweater bargain on approval. Send coupon now.

## ← Send Coupon

Don't miss this. The supply is limited. You take no risk. We stand back of this sweater. Money back if you say so. Send coupon now with 50c. Don't be too late; send coupon now.

**Elmer Richards Co.**  
Dept. 1779 West 35th Street, Chicago, Ill.

Write for our Free Bargain Catalog of men's, women's and children's clothing and shoes. Everything on small monthly payments.

**Elmer Richards Co.**  
Dept. 1779 West 35th Street, Chicago, Ill.

I enclose 50c.  
Send Heavy Wool Sweater No. F-12. Size..... Color.....  
If I am not satisfied when I receive the sweater, I can return it and get my payment back with charges. Otherwise, I will pay the advertised terms, 50c with coupon, \$2.15 monthly. Total price, \$6.95.

Name.....

Address..... State.....



# UNLIKE ALL OTHERS!

One to Six Pump-Strokes Compresses Air to Any Shooting-Force Desired

Three Strokes for  
Ordinary Shooting



## THE BENJAMIN

This illustration shows an inch block of wood (double size) penetrated to different depths by a Benjamin Air Rifle using one to six charges of air.

*This Is a Feat No Other Air Rifle Can Duplicate*

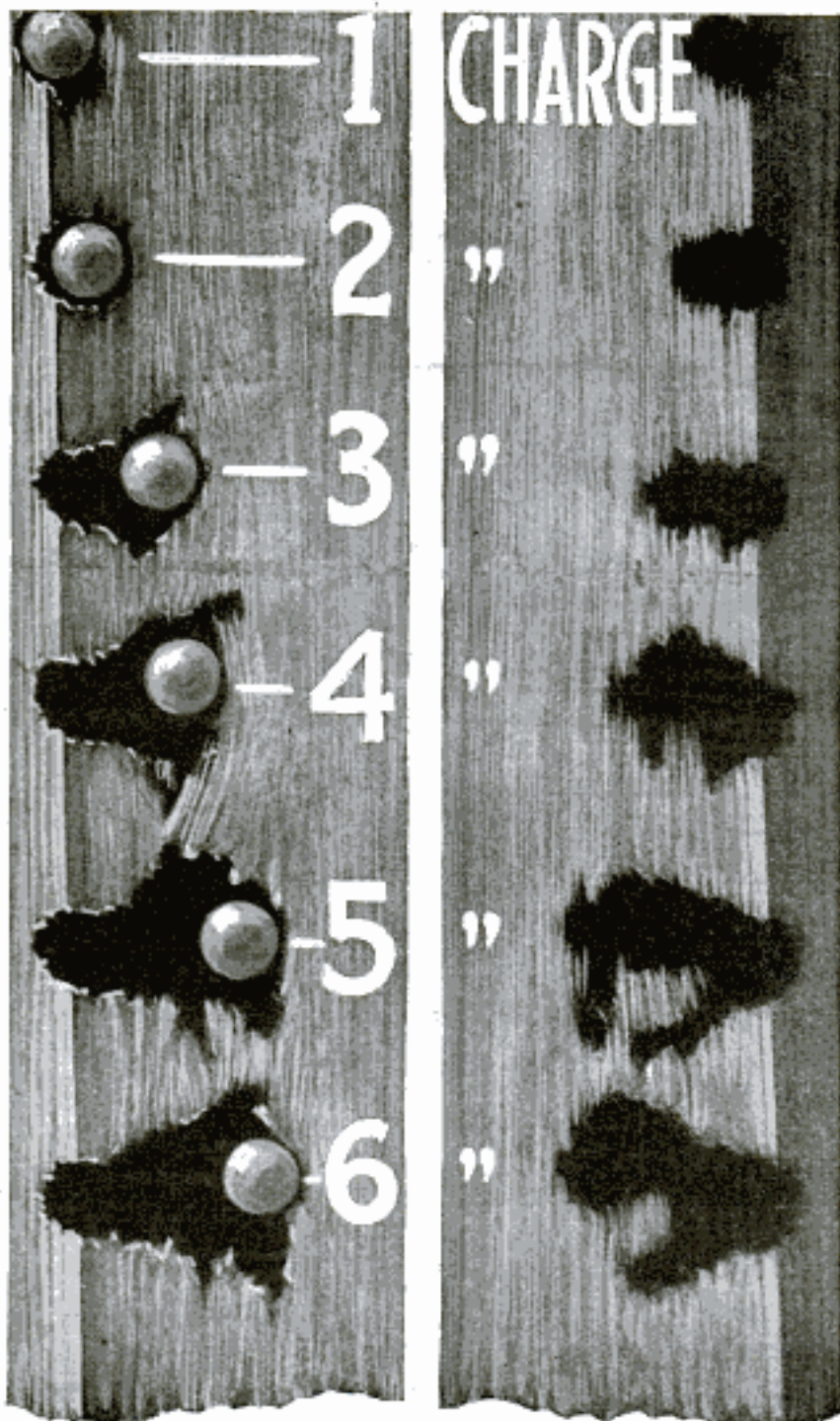

is the gun you have been looking for. For target practice and for hunting rabbits, squirrels, gophers, rats and frogs it has no equal. It is the most powerful, accurate and reliable compressed air rifle made. It has a far greater shooting range than any other. Imagine bringing down rabbits with an air rifle! You can do it with a Benjamin.

### The BENJAMIN

is the ONLY PUMP GUN MADE using compressed air. SIMILAR TO AIR DRILLS AND HAMMERS. It does not lose shooting force after long use. The BENJAMIN is the only air rifle with the shooting force under the operator's control. It can be loaded to shoot weak or powerful as desired, from one to six strokes of the pump giving all the power wanted. It is absolutely safe; accidental discharge is impossible. Furthermore, after being charged with air, it is ready for instant use at any time after the shot is placed in the barrel.

### The BENJAMIN

is mechanically perfect. It is the only air rifle not requiring frequent repairs, customary in all spring guns.

Price **\$5<sup>00</sup>** Post-Paid

Write for descriptive folder giving full details of this wonderful air rifle.

## BENJAMIN

AIR RIFLE & MFG. CO.  
651 N. Broadway,  
ST. LOUIS, MO., U. S. A.

Pacific Coast Representative  
THAYER & BOWER  
Los Angeles, Cal. & San Francisco, Cal.



di. no. Mariano Fortuny, Societa  
Leonardo da Vinci

# Popular Mechanics Magazine

REGISTERED IN U. S. PATENT OFFICE

WRITTEN SO YOU CAN UNDERSTAND IT

Milano, Italy.

Vol. 38

DECEMBER, 1922

No. 6

9516

## Realistic Sky for the Stage

**I**N order to give a much better representation of the sky in theatrical stage settings than is possible with customary scenery, a Spanish painter conceived the

idea of using as a background for the stage a structure in the form of half a cupola with its concave side turned toward the spectators. This vaulted sur-

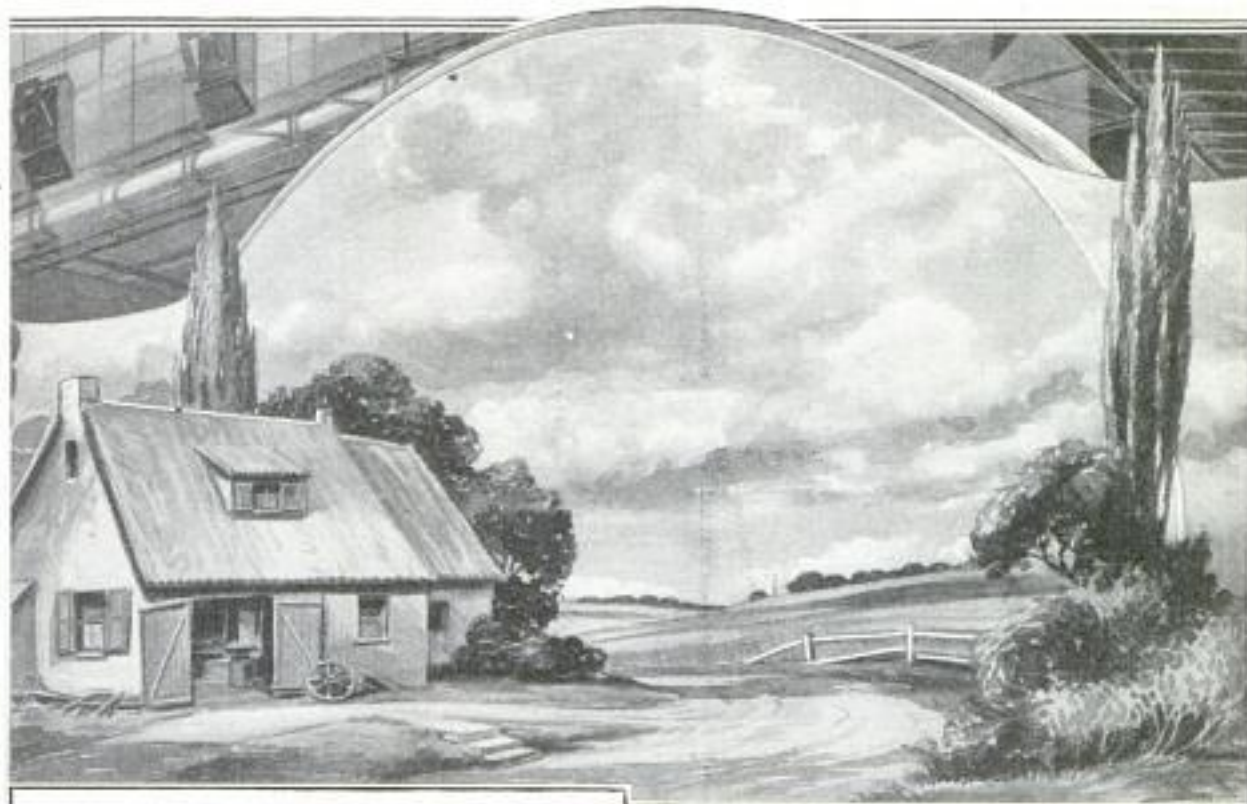

Above is a Lifelike Reproduction of the Sky in a Rural Stage Setting by the Use of an Illuminated Vaulted Background. It is Shown in Section at the Lower Left, and at the Right is Seen Folded

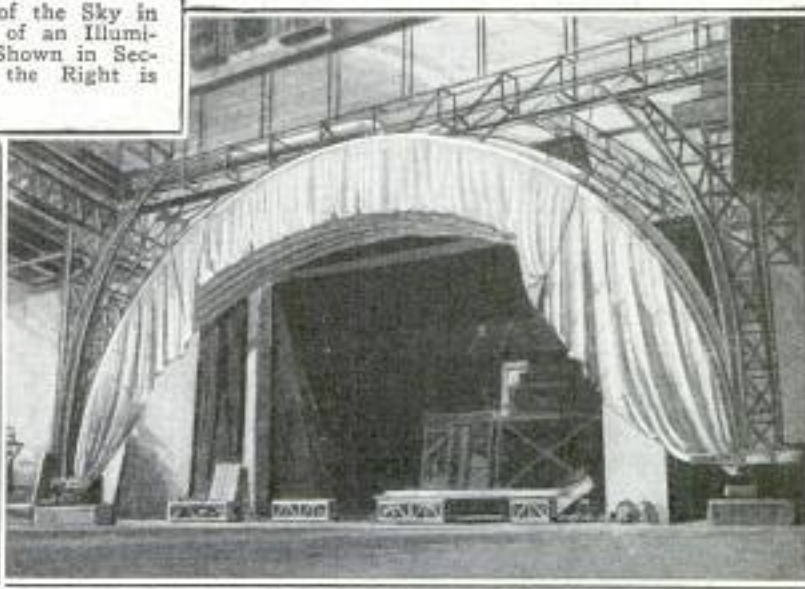
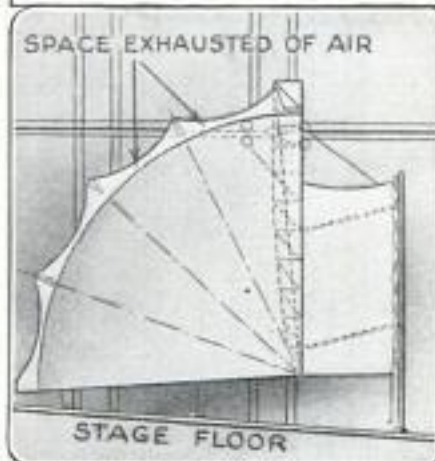

REBRAWN BY COURTESY OF LAROUSSE MENSUEL



face is illuminated by light reflected from the upper axial point of the semicupola, and therefore uniformly distributed over the entire surface, giving a natural representation of the vaulted sky. The most recent example of an installation of this kind is at La Scala theater, in Milan, Italy, the second largest theater in Europe, built in 1778, and with a seating capacity of 3,600. The cupola consists of a frame with five arched steel ribs shaped spherically and all pivoted at the two lower diametric points of the semicupola, which has a span of 69 feet. Of these

ribs the front one is fixed and the others are movable. The outer and inner surfaces of these ribs are entirely inclosed between two sheets composed of an airtight fabric. They are so shaped that when the air in the space between them is partially exhausted, by means of a suction fan, the under sheet is inflated into true spherical form, and the outer sheet is supported by the ribs. To fold the apparatus, first the lower rib is raised by a cable and winch, then the other three are drawn up successively until all come together at the fixed front rib.

421  
**HUMIDIFIER AND DEODORIZER  
 IS MINIATURE FOUNTAIN**

Humidifying and deodorizing the air in a home, theater, hotel lobby, and similar

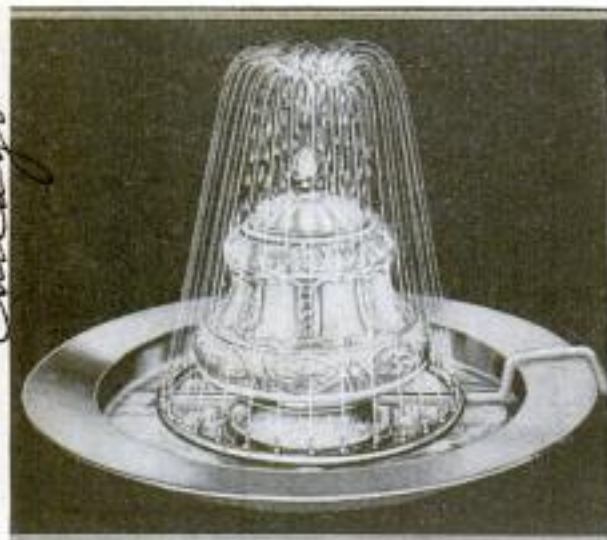

Humidifier in Action, Showing How the Fine Sprays of Water are Thrown into the Air by the Small Motor Concealed in the Dome

places, may be efficiently accomplished by the use of an appliance which operates as a miniature fountain. It resembles the now rather commonly seen electric foun-

tains, except that instead of a score of water jets, it throws 50 fine sprays of perfumed water into the air. The height of these sprays is regulated by a small centrifugal pump, driven by a  $\frac{1}{30}$ -horsepower motor, which in turn is controlled by a rheostat. The entire outfit weighs only 15 pounds. To increase the artistic appearance, two lamps are mounted under an art-glass or ivory-tinted dome, the whole yielding a beneficial effect.

597  
**MODERN MACHINERY PROMOTES  
 WORK OF ARCHÆOLOGISTS**

Few of the difficulties that have hitherto interfered with the work of exploration in Mesopotamia will have to be contended with by the joint expedition of the British Museum and the University of Pennsylvania Museum, in their exploration of the ruins of the city of Ur, the ancestral home of the patriarch Abraham. This expedition will be fully equipped with excavating machinery and means of transportation that will make comparatively easy the exploration of these ruins that have been buried for 3,000 years. A military railway and motor trucks will maintain communication with headquarters of the expedition at Bagdad.

451  
**ADVENTURER CROSSES PACIFIC IN A CHINESE JUNK**

Rivaling the most daring exploits of history is the feat of Capt. George Waard, world adventurer, who, with his wife, a nine-year-old son, and a crew of three, has completed a 5,300-mile voyage in a frail Chinese junk. He arrived at Victoria, B. C., recently, 91 days from Shanghai. Christopher Columbus in his voyage across the Atlantic had a ship of 100 tons and a crew of 52 men, experienced sailors. Of Captain Waard's crew of three, two had never been beyond the

confines of Hongkong harbor, and his fantastic-appearing boat is of but 23 tons. The trip, made in exceptionally rough weather, stuns the imagination. At the very start, the treacherous typhoons of the East swept the frail craft far northward. Three times the rudder was carried away, while great heavy swells broke over the boat, threatening to capsize it at every turn. Numerous storms were encountered. That he should arrive at all, seems to many to be almost a miracle.



451 Cmt. W. L. Mc Naughton  
242 Beechwood Ave, Victoria, B.C.,  
Canada

The Chinese Junk "Amoy,"  
in Which Captain George  
Wward Recently Made a  
Thrilling Voyage from Shang-  
hai, China, to Victoria,  
British Columbia



A Close-Up of the Party: The  
Captain is Shown in the Center  
with His Son. In the Right  
Foreground is His Wife, a Na-  
tive of China. The Three Men  
Acted as Sailors, Though Only  
One had Been to Sea Before



Capt. S. W. Winters  
702 District National

821 POPULAR MECHANICS

304 *Frank Peltz*  
BROADCASTING PHOTOGRAPHS  
AND MOTION PICTURES  
*Washington, D.C.*

The broadcasting of motion pictures by radio has been given interesting possibilities by the use of prismatic rings. This new optical shape of glass was



Copyright, Harris & Ewing  
The Feature of This Radio Set for Broadcasting Photographs and Motion Pictures, Is a Prismatic Annular-Rim Rotated at High Speed.

but recently perfected and has already been applied to high-speed photography, continuous motion-picture projection machines, direct-reading ground-speed meters for airplanes, and seems adapted to a rather wide use in scientific and engineering work.

The warped contour of this circular ring of glass, when rotated across a beam of light, is equivalent to a prism with constantly changing angles between its faces, and gives an oscillating effect to the ray of light emerging from it. Thus a ray of light striking the surface of a picture, will travel across the picture from top to bottom or from one side to the other, depending upon whether the axis of rotation of the prism is horizontal or vertical. In the instrument for the broadcasting of pictures, two of these prismatic rings are used with their axes at right angles, and one is rotated many times faster than the other, giving the effect of covering the picture with that many parallel strips by the beam of light. Sending and receiving sets consist of a pair of the prismatic rings, a photoelectric cell, and a beam of light. Current flowing through the sensitive-to-light cell of the sending set, fluctuates under the influence of the various light values of

the picture, and is thus impressed on the wireless waves, which are picked up by the receiving station and translated in a similar manner into picture values on the screen, resulting in a reproduction of the picture at the sending station.

SPECIAL DIRECTORY EDITION  
570 FOR CITY'S 300TH YEAR

Commemorating the city's 300th year, the 1923 edition of the New York Directory will possess several striking and interesting features. The book will have photographs of the first city directory, which was published in 1786 and contained the names of such historic personages as Aaron Burr and Alexander Hamilton. The story of the city will be represented by reproductions of announcements and advertisements that appeared during successive years, from the time when New York was only a village down to the present period.

*NY Times 16/2/22 P. 10*  
232 WINDMILL ATOP CITY HOME  
FEEDS ELECTRIC LIGHTS

Electric light practically without cost is obtained by a resident of East Cleveland, Ohio, who has erected on his roof a large windmill which provides enough energy to furnish light for all the lamps in his home. A special one-kilowatt generator is used, and the house bulbs, of standard make, consume 32 and 40 watts. The windmill itself consists of eight perpendicular "sails" attached at top and bottom to circular revolving frames. The entire structure is about 15 feet high, and is 50 feet from the ground.



Eight-Vane Windmill Which Supplies Electric Current to the Dwelling on Which It is Erected

Owner - J. J. Fisher  
188 5 Perroce St.  
East Cleveland, Ohio

C. Francis Jenkins, Washington, D.C.



467 Cont. Francis W. Wilson  
927 in St. W. Washington, D.C.

# STUMPS 10,000 YEARS OLD

By Francis W. Wilson

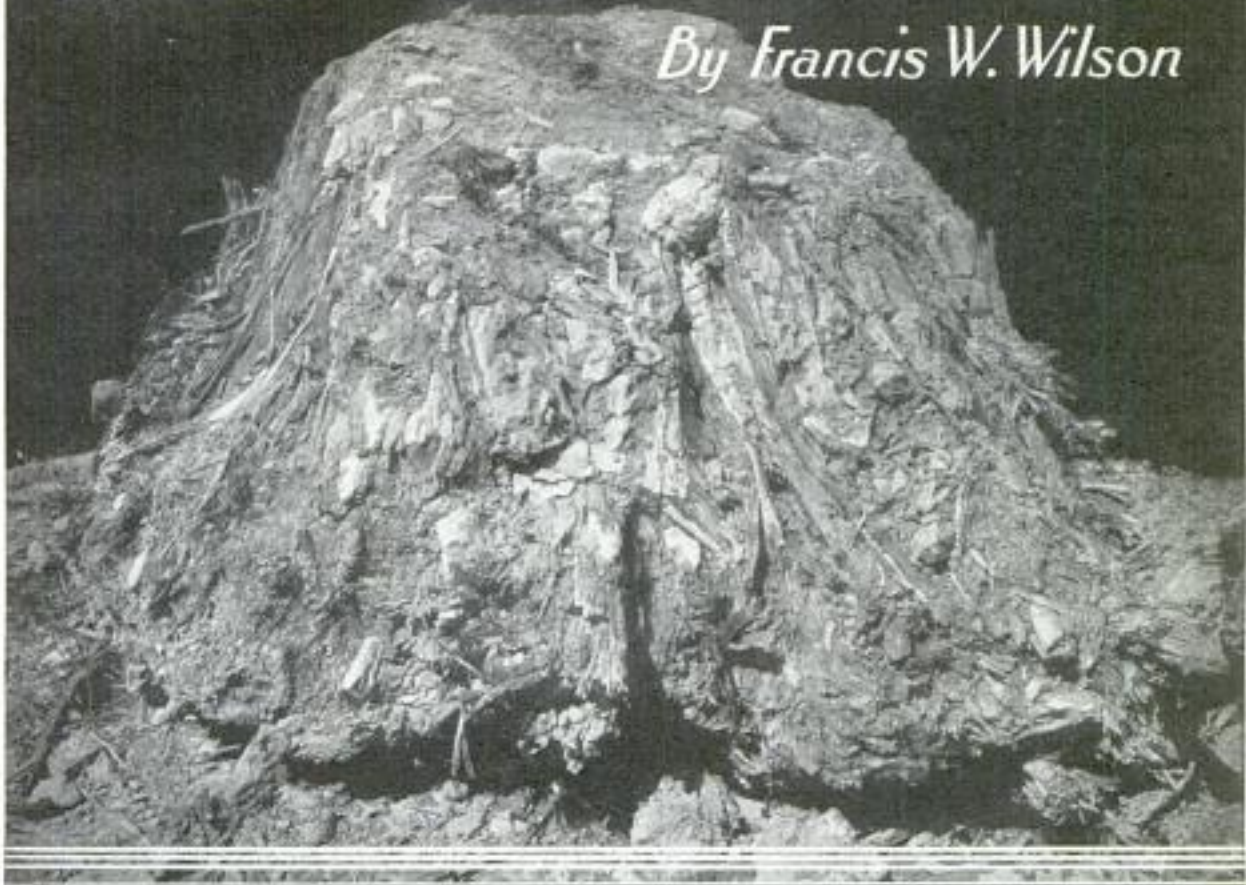

Fragment of a Tree Stump, Estimated to Be at Least 10,000 Years Old, Which was Recently Found 40 Feet below the Surface in Excavating for Building Foundations at Washington, District of Columbia: The Original Tree Was More than 14 Feet in Diameter

467  
**STUMPS** ten thousand years old, in Washington, D. C.!

How do we know they are that old? Geologists from the Geological Survey are responsible for that estimate. Perhaps even this age is underestimated. The stumps, excavated from a depth of 40 feet below the present surface of the ground, have probably been immersed in water ever since some stupendous convulsion buried them. Kept constantly wet, they would be preserved indefinitely.

Four of these stumps, uncovered in excavating for the foundations of a new hotel, at the corner of Connecticut Avenue and De Sales Street, were more than 14 feet in diameter.

Forty-four feet in girth!

Try to picture the site of our capital city, as it looked in the day when these forest giants towered higher than the Washington Monument. Imagine forests about the site of the White House, rivaling in impressiveness the world-famed California redwoods.

That is not the only amazing thing in this, today's, unearthing of these gigan-

tic stumps; for the Bureau of Standards asserts that they are the remnants of trees of tropical growth.

Certainly the wood resembles none which American inhabitants have ever found in this latitude. In fiber it is similar to cypress, and slivers flake off from the short bit of trunk above the roots, much as cypress would. Even in the tropics of Central America, trees 14 feet in diameter would be a startling discovery in the present age. No portions of the tree trunks belonging to these big stumps were found in the excavations, excepting the short portion attached to the roots. The stumps were found imbedded in a solidly compacted mass of wood.

This stratum of wood is 12 feet thick. Over the stratum of wood is a bed of marl, 8 feet thick; and above that, the remaining depth is made up of sandy clay mixed with some gravel. For a depth of several feet below the ground surface, the fill is man-made, and comparatively recent.

It was necessary to dynamite the



stumps and remove them in small sections. On that account no photograph showing a complete stump was obtainable. The largest fragment is a relatively small portion of one stump, and yet it measures more than 5 feet in diameter.

Engineers and contractors, accustomed to the local conditions in Washington, all agree that nowhere else in the city has any similar discovery been made, although excavations elsewhere have frequently been made to greater depths.

Looking down into the broad foundation trenches, I watched the workmen digging and pulling away at pieces of the tough wood densely packed and inter-twisted in the 12-foot-thick layer of prehistoric forest. And watching them, many questions suggested themselves.

How many centuries have elapsed since the site of Washington was a tropic locality, growing trees of such mammoth proportions?

What disaster overwhelmed the vast forest and crumpled it into a solid mass of crushed wood—shearing off these big trees as a man might cut grass with a scythe?

And last, but no less puzzling—what

became of the immense tree trunks? No portion of them was found in the excavations. Aside from the four stumps, the stratum of wood seems to consist solely of crushed and broken limbs.

### 609 WORLD'S GREATEST STADIUM BEING BUILT IN ENGLAND

Now under construction in England is the world's largest athletic stadium. It will be 800 feet long and 300 feet wide, with a seating capacity of 125,000, and is being built on the 200-acre site of the British Empire Exhibition, which is to be opened early in 1924. The stadium is to be of brick and concrete—a permanent building. For such events as boxing, occupying only the central part of the great oval, the seating capacity could be increased to 175,000. The exhibition buildings and stadium are to be located at Harrow, about 10 miles northwest of London, and it is intended to have the road leading to the grounds widened and extended, besides connecting it with specially constructed railroad lines. American athletic officials have been consulted, and many of their ideas may be adopted.

*H. G. James 10/15/02*



The Point in the National Capital Where the Trees were Found, Showing Several Large Fragments in the Foreground: The Location Is at Connecticut Avenue and De Sales Street





Four Police Officers in the New York Training School Practicing Marksmanship with an Animated Target: On the Screen are Thrown Moving Pictures of Officers Scuffling with Criminals. Every Hole Made in the Target is Shown by Means of a Light That Flashes for a Period of Three Seconds

*International*  
**NEW YORK POLICE DEPARTMENT HAS ANIMATED RIFLE TARGET**

In the New York police-training school an animated target has been installed to give lifelike practice in rifle and pistol marksmanship. The target is composed of a small movie screen at the back of a darkened canopy. On this screen are thrown motion pictures of police officers tackling criminals, and scuffling with them. The officers in training are stationed at the front of the canopy, with pistols or rifles, and try to hit the criminal without injuring the officer. Every hit is scored by means of a light which flashes and remains visible for three seconds.

*449*  
**COMPRESSED-AIR RAM USED FOR BALING EMPTY BAGS**

Empty cement, or other, bags can be baled very rapidly and economically by the use of a compressed-air ram designed for that purpose. Under the vertical ram, a hundred or more bags may be piled, whereupon a lever is pulled, and the ram comes down, leaving the bags

ready to be tied and trucked away. In cement plants where the ram is in operation, the compressed air can be used for



Compressed-Air Ram Used in Cement Plants for Baling Empty Bags: At Least a Hundred Bags can be Baled at One Time in This Machine

other purposes. The ram occupies little space and is easily operated.

*Used in plant of Portland Cement Co., Lincoln*  
 Copyrighted material



466

Royal Dutch Shell Oil Co } Long Beach  
Signal Hill Oil Field } Calif.  
USING A DYNAMITE EXPLOSION TO BLOW OUT  
AN OIL-WELL FIRE

BY FRED A. HERR,

333 Locust Ave  
Detroit Mich.



Workmen Approaching Burning Oil Well in the Fight to Extinguish the Flames Which Rose 100 Feet above the Mouth of the "Gasser"

A CONCUSSION that reverberated from the walls of San Gabriel Mountains and shook houses in Long Beach, Calif., ten blocks away, occurred when an oil company exploded 100 pounds of gelatin dynamite over the blazing mouth of Wilbur No. 1 oil well in the Signal Hill oil field recently, to extinguish the fire.

The oil well broke out as an uncontrollable "gasser" while bailing for a water test was under way at the 2,400-foot level. When the cement plug had been drilled out and bailing started, the gas burst forth, belching volumes of mud and water 125 feet into the air. It came at the rate of 30,000,000 cubic feet daily, with a force of 3,000 pounds to the square inch. It demolished the derrick, tossed rig irons and drilling tools around like matches, and spouted heavy sections of cement and rock formations from the well. For 12

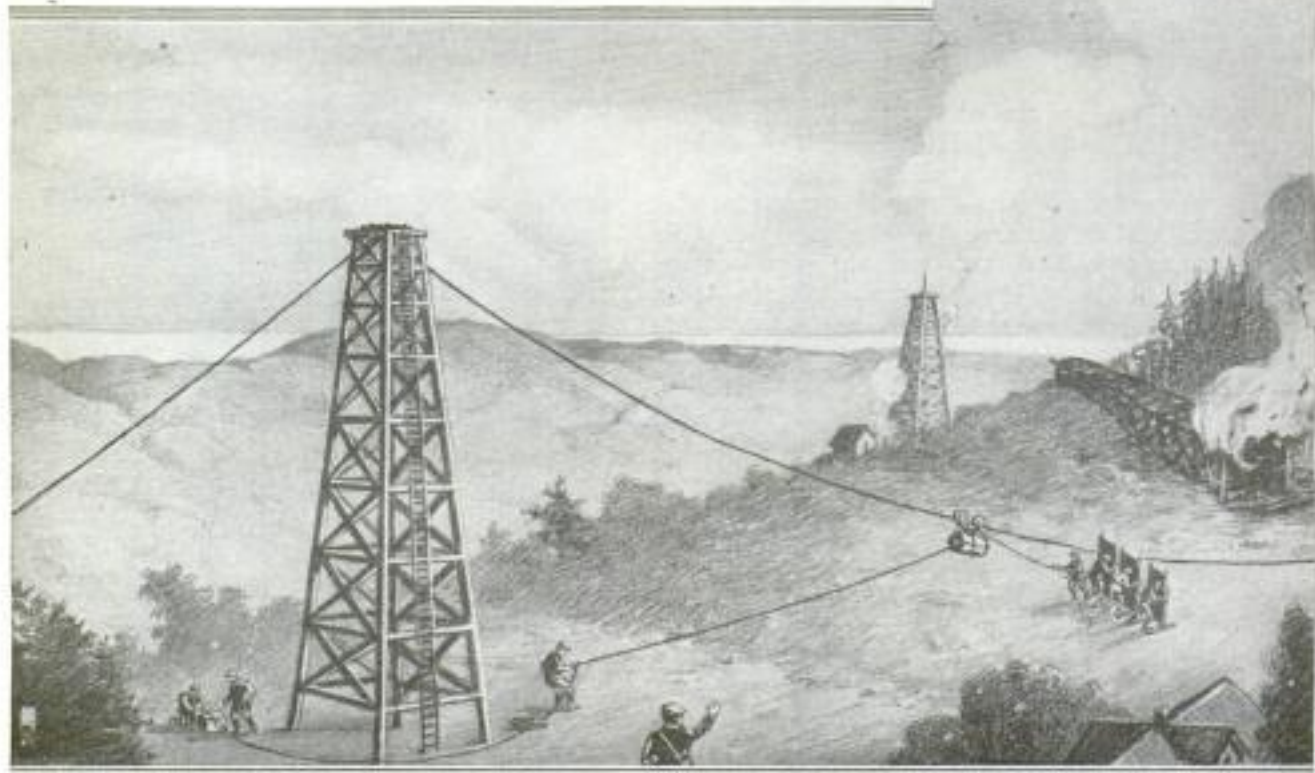

In the Above Picture Workmen are Seen Hauling a 100-Pound Package of Dynamite in an Asbestos Container, along Exploded as It Hung within a Foot of the Well, and the Force of the Explosion



hours the gas roared forth with undiminished force.

Two minutes after midnight, while the oil company with a picked gasser crew made efforts to "kill" the gas with introductions of heavy mud and water, a spark from a rock striking against the casing, ignited the vapor. In a twinkling the seething tower was transformed into a livid pillar of flame, shooting more than 100 feet into the air. For 12 more hours the burning gasser roared defiance to the efforts of the crew to kill it. Its light was seen by seamen off the coast of San Diego, 150 miles south.

Two near-by derricks soon fell, their bases burned away. An oil-field fire seemed imminent. In this emergency the

oil company resorted to heroic measures.

At Taft, Calif., in the heart of the central California oil country, lives Ford Alexander, king of gas-well conquerors. He was summoned to Long Beach and given free rein to put out the intense fire.

Alexander brought his own crew down from Taft, and dressed in fireproof asbestos coat and trousers to resist the intense heat, he himself approached the flaming gasser to inspect the crater and well fittings. He determined to extinguish the fire by exploding a charge of dynamite over the well to snuff out the blaze in the same manner that a heavy gust of wind blows out a candle.

Two 30-foot wooden towers were erected on either side of the well and a one-inch steel cable strung between them. One hundred pounds of gelatin dynamite was wrapped in asbestos paper, connected with a detonator and attached to a reel running along the cable. Asbestos-clad workmen, approaching behind asbestos shields which they pushed out before them, pulled the dynamite along the cable till it hung suspended within a foot of the well. A wire connected the charge to the detonator 100 feet away.

When the dynamite charge was exploded by pressing the detonator, it blew out the flame with a terrific blast, tearing a 15-foot hole in the side of Signal Hill. The force of the explosion acted to separate the column of fire by blowing part of the gas back into the well. When the gas returned to the surface, the flames had been dispersed. The well spouted gas and sand for several hours more before it was completely killed with mud and water.

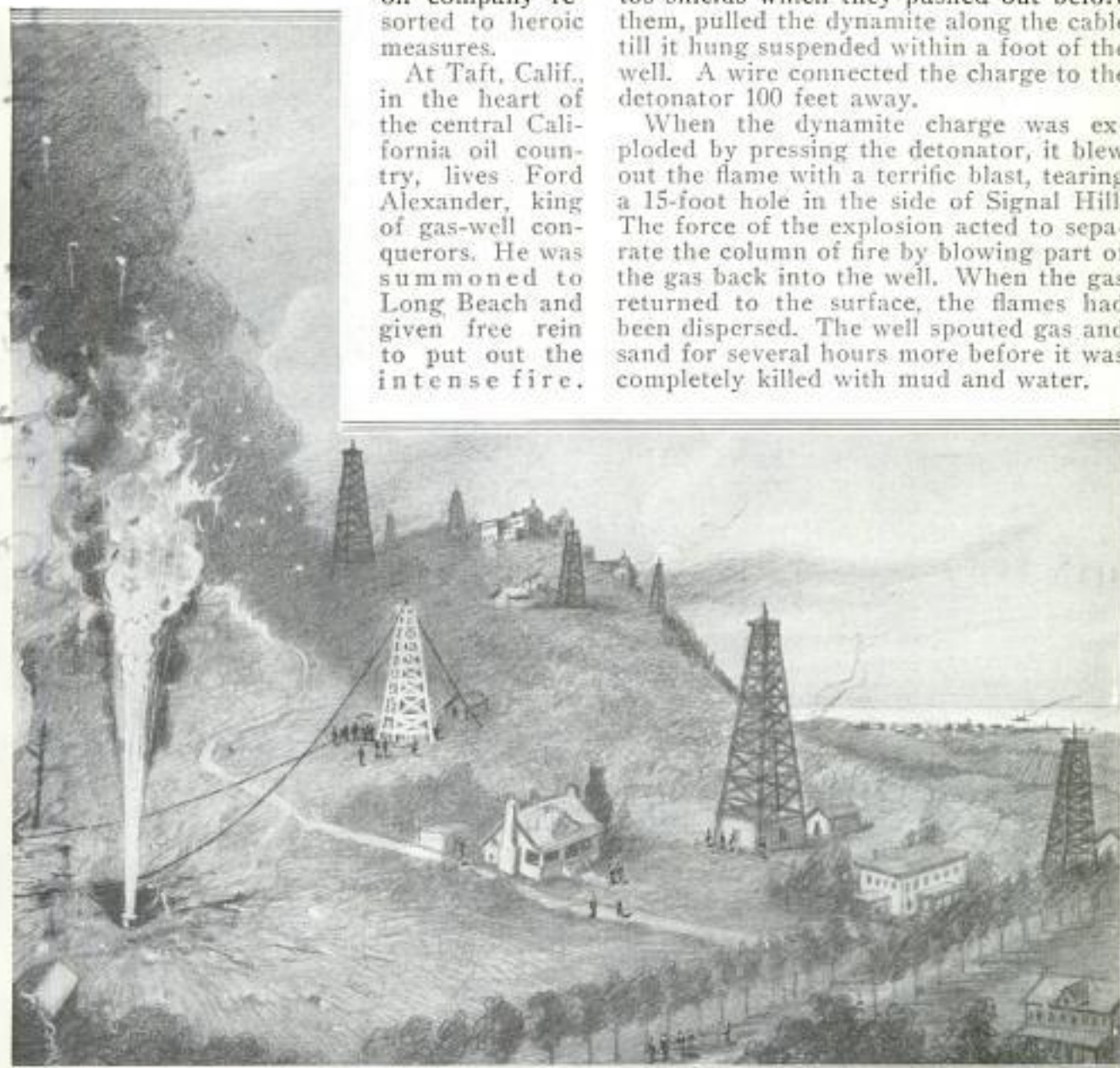

a Cable Suspended between Two Temporary Towers Erected in Line with the Burning Oil Well. The Dynamite was Effectively Put Out the Flames Which had been Burning for Over 12 Hours



Cont. *Chas. Claude Wagner*  
 4731 S. Vermont Ave.  
 Los Angeles, Calif.  
 POPULAR MECHANICS  
 CHILDREN'S TOY VEHICLE  
 USED BY LAME MAN

*Johnson Associates*  
 Inc. 557 10th St.  
 New York City

*830*  
*556*

A toy vehicle, popular with children, is being used practically by a man in a



The Second Seat on This Toy Makes It a Convenient Means of Getting About for the Lame Man

western town who has partly lost the use of his lower limbs. Sitting on a second seat, built a foot or so above the original low one, he finds that he can easily propel himself with the aid of his crutches. The vehicle also furnishes a means of exercising the limbs, which otherwise might be neglected.

**ELECTRIC SOLDERING MACHINE**  
**428 FOR JEWELERS' USE**

An improved machine for use in the manufacture and repair of chains, catches, rings, silverware, and other jew-

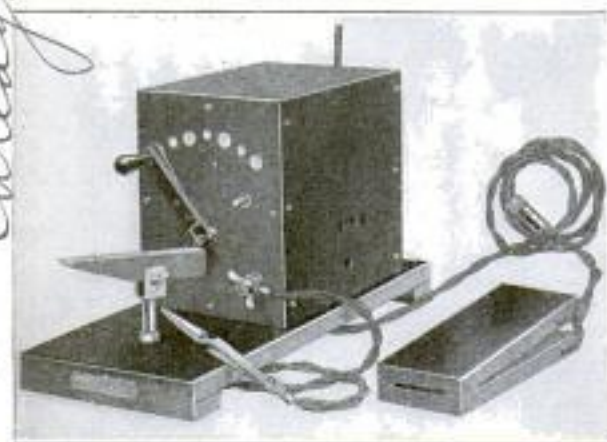

This Electric Soldering Machine Has Three Different Heats for the Repair of Jewelry, Which It Accomplishes Quickly and Neatly

*Smartchild & Co.*  
*29 E. Madison St.*  
*Chicago*

elry, provides three different heats for electric soldering and is said to be shock-proof. A suitable piece of solder is placed upon the carbon electrode, the article is gripped by the tweezers that form the other terminal of the circuit, flux is applied, the joint of the article is put in contact with the solder, and the current is turned on by a foot switch. As soon as the solder flows, the circuit is broken by releasing pressure on the switch.

**MUCILAGE SPREADER UTILIZES**  
**489 ATMOSPHERIC PRESSURE**

Cleanliness and economy are claimed to be the distinguishing features of a new mucilage container which is also a mucilage spreader. The device consists of a bottle, at the neck of which is stretched a piece of fabric. It is kept, neck to the bottom, in a neat nickelplated receptacle. When removed, atmospheric pressure is sufficient to keep the mucilage from oozing through the fabric. This resistance is overcome, however, when the neck touches the paper or whatever is to

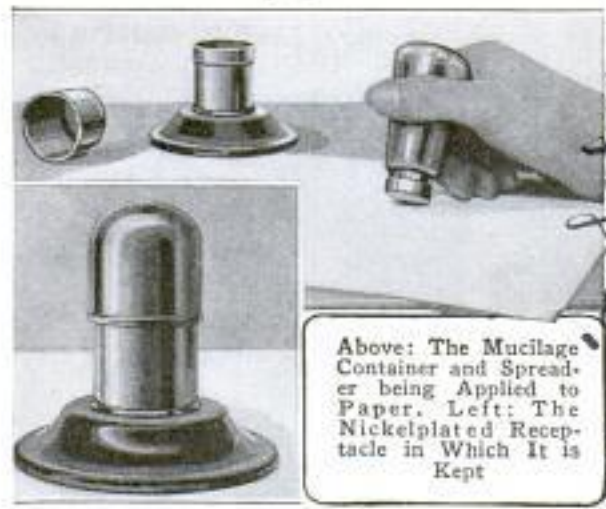

Above: The Mucilage Container and Spreader being Applied to Paper. Left: The Nickelplated Receptacle in Which It is Kept

receive the application. Druggists have often used an old bottle and gauze in a similar way.

**WALRUS HIDES ARE VALUABLE**  
**544 FOR METAL POLISHING**

Walrus hides are constantly increasing in value for metal-polishing purposes, despite the fact that the process of tanning them requires from one to two years' time. When properly tanned, however, the flexible fiber of this leather will satisfactorily hold such materials as pumice, crocus, emery, etc., and these, together with its own peculiar abrasive qualities, produce on any metal a brilliant and durable polish.

*Esrene, Tweedy & Co.*  
 109 Duane St.  
 New York City

*Info - Johnson Associates, Inc.*  
*557 10th St.*  
*New York City*

Copyrighted material



Oregon City Ore.

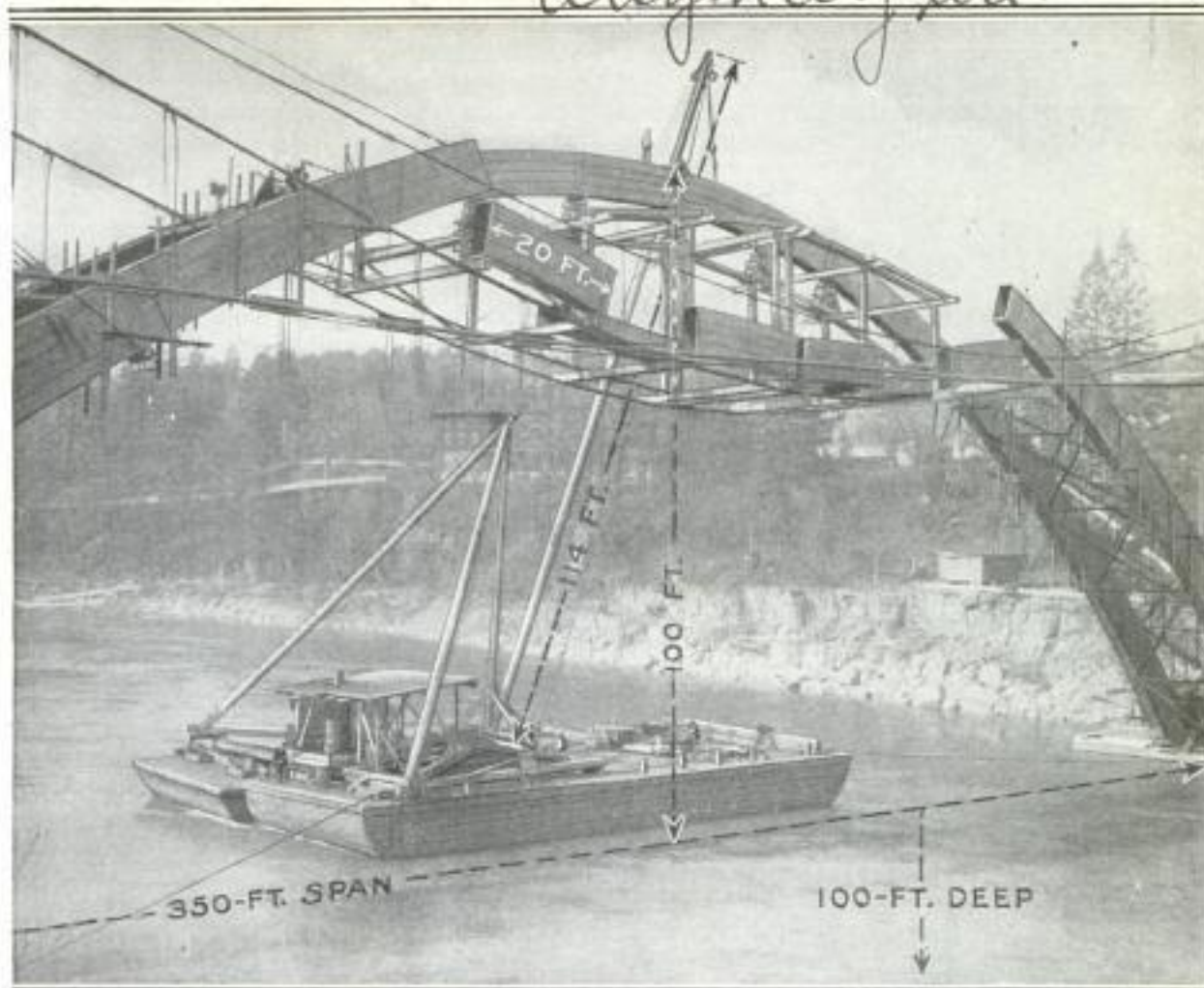

Method of Hoisting into Place Each of the 20-Foot Sections of the Steel Arch from the Deck of Twin Barges: One Barge Was Not Wide Enough to Furnish an Adequate Base for the Tripod of the Derrick, and So Two were Lashed Together in the Manner of a Catamaran

### 546 TWIN BARGES WITH ONE DECK AS SUPPORT OF A DERRICK

In the building of the long-span, concrete-steel bridge at Oregon City, Ore., described in the July, 1922, issue of this magazine, where the water was too deep for the erection of falsework, twin barges, in the nature of a catamaran, were used for hoisting the 20-foot sections of the steel arches that formed the main members of the central 350-foot span. The twin barges were decked over, and supported a powerful derrick with a 114-foot boom, allowing the tripod of the derrick to be widely spread so as to fully counteract the one-sided pull from the weight of the arch sections when swung sideways into position. Each of these 20-foot steel arch sections, of box-girder construction, was 2 feet 7 inches wide, with a depth varying from 6 to 10 feet, and a weight varying from 6 to 13 tons. In this manner the arch was built up section by section, riveted together, and when complete, was covered with a con-

crete coating. The support for this coating was formed of a wire mesh tied to a network of  $\frac{1}{4}$ -inch rods that were spot-welded directly to the plates forming the walls of the steel arch.

### 464 LINEN TESTER HAS POINTER TO HELP COUNT THREADS

A new linen tester for counting the threads in the fabric is designed with a movable pointer, which makes this work easier. The device consists of the usual two parallel surfaces held a few inches apart with the magnifying glass in the upper surface while in the opening of the lower plane has been arranged a movable pointer. The pointer can be moved to indicate the threads as they are counted.



Wm. William Hoffman  
A. 515-1265 Broadway,  
New York City



*L. Allen & Co.*  
*7th & Chestnut*  
*Philadelphia, Pa.*  
 1882  
 9214

**POPULAR MECHANICS**

**EDGING MACHINE TRIMS SOD FROM SIDEWALK BORDER**

Trimming sod from the border of sidewalks has been simplified by an appliance



having a long handle to which is affixed a circular steel cutting disk. The disk has a flange which rests on the edge of the walk, permitting the sharp tool to be guided along the side as it cuts away the turf, thus improving the

appearance of the lawn and providing a drain along the edge of the sidewalk.

**ELECTRICAL INCUBATOR VERY SIMPLE IN CONSTRUCTION**

516

A new electrical incubator, wired to connect to any lamp socket, is in the form of a box, 16½ inches square, 12 inches high, and weighing empty only 22 pounds. It has a capacity of 50 eggs, which are placed upon a layer of sand in the bottom

of the lower half of the box. The upper half, hinged to the lower, has mounted inside it a large, bright-metal concave reflector, insulated with cotton batting, and facing the lower half of the box when closed. A thin metal plate covers the upper half of the box, and has on the side facing the reflector a socket for an electric lamp, and wired to this on the other side, a novel contact breaker, triangular in shape, the point of which curls up when overheated, cutting off the circuit, so that the incubator never exceeds the proper hatching temperature.

**EXHIBIT OF 655 DIFFERENT TYPES OF LIVE BACTERIA**

As many as 655 different kinds of live germs have been collected by the American Museum of Natural History at New York, and are being transferred to the Society of American Bacteriologists at Washington. This germ collection includes practically every well-defined type of bacteria that is known. Following its customary policy, the museum sent cultures and subcultures, free of charge, to bacteriological workers all over the country, and more than 700 different institutions have taken advantage of this liberal policy. A service of this kind enables students of biology to work with official material, and extends the field of usefulness of the museum.

*H. H. James 10/14/22*

*R.C. Spraling, Attleboro, Mich.*



Left: Electrical Incubator with Its Upper Half Closed, Showing the Triangular Contact Breaker That Acts as a Thermostat to Maintain a Uniform Temperature of 103 Degrees. Right: Upper Half with Its Cover Down, Showing the Heating Lamp, and the Bright-Metal Concave Reflector with Cotton-Batting Insulation





One of the Immense Platforms Which are to be Seen on Easter Island and Which Consist of Huge Blocks of Squared Stone That have been Cleverly Joined without the Use of Cement of Any Kind

## MYSTERIOUS EASTER ISLAND

BY FRANCIS DICKIE

AT the end of August, 1922, a cable reached America from Sydney, Australia, bringing probably the last scientific word about that most mysterious of places, Easter Island, that lonely dot in the Pacific 2,300 miles west of Chile, and when discovered by Roggeveen in 1772, removed by 1,500 miles from the nearest inhabited land.

The cable reported the arrival at Sydney of Prof. Macmillan Brown, who has been carrying on for some time extensive research work on Easter Island, investigating the huge platforms and unfinished gigantic sculptures which are found among the finished images that lie scattered in considerable numbers on the island.

Around these great stone monuments centers the mystery of Easter Island. Since 1772, when the island was discovered, various scientific men for 200 years have been continually occupied theorizing regarding the relics of a lost people represented by these sculptures, a people believed to have been entirely

different from the races dwelling today in the South Seas. Through these gigantic stone images the truth of the belief in Atlantis—that wonderful continent supposed to have sunk eons ago—seems to be borne out.

The cable from Sydney quotes Professor Brown as having finally arrived at the conclusion that a bygone Pacific empire ex-



Two of the Many Images Which have been Found in Caves on the Mysterious Easter Island and Which Show the Tendency of the Workman to Portray a Certain Type



isted, one of great extent, which disappeared in the dim past when a great submergence took place. Of this great continent, Easter Island was evidently a part. The submerged-continent theory is strikingly borne out by certain of the sculptures being in an unfinished state. Both the completed and the incompleting ones are to be seen scattered in various parts of the island in large numbers. They are cut out of a solid gray lava which is found in the extinct crater of Hoti Iti. The images vary in size from 5 to 38 feet in height, but are mostly from 15 to 20 feet, while some are as short as 5 feet.

In the crater are many unfinished images still undetached from the face of the pit as though some great catastrophe had overtaken the ancient men while at work, killing them instantly, or forcing them to leave, never to return. One unfinished carving is 68 feet in length and 10 feet wide. The design of all is that of a human body, ending at the hips, the arms close to the sides. The head is flat, surmounted with a crown of red stone

brought from another crater. Upon the face of each image is a well-defined look of disdain. A great many of the images are now thrown down, but here and there some remain upright. In addition to the images are immense platforms of squared stone facing the sea. Like all the work of ancient peoples, the stones are cleverly joined and held together without the use of cement. The platforms are rectangular, being in some cases 300 feet long, 20 to 30 feet wide, and about as high. Upon the platforms many images lie overthrown.

The eminent traveler and antipodean explorer, Clement Wragge, who returned

in 1912 from Easter Island, was persuaded that the rock carvings he discovered near the Bay of Islands, and the cyclopean monuments on Easter Island, are of very ancient date. Discussing the origin of these relics, he writes: "The people who built the wonderful statues and cut the marvelous inscriptions on Easter Island had nothing to do with the Polynesians, but are allied to those peoples dwelling in Central and South America long ages ago. In fact they are to be referred to an Atlantian race."

Dr. Paul Schliemann, a grandson of the archaeologist, Heinrich Schliemann, and

who has given much attention to this subject, writing in the London Budget about the same time, tells us: "I am as satisfied as I am that I exist, that before the beginning of the Eocene Age, perhaps in the Cretaceous period, a great continent inhabited by a civilized race existed. The American Indians are descendants of this race."

These earlier reports by such authorities as Wragge and Schliemann, and the words just recently cabled

about Prof. Macmillan Brown, fortunately can be still further added to by the report of a noted Canadian traveler, Frank Burnett, Sr., of Vancouver, B. C., maker of the world's greatest South Sea collection, and who has for many years been interested in the mystery of Easter Island. Like the men already mentioned, Mr. Burnett has been impressed by the theory of a once existing continent near, or perhaps joining, South America, of which Easter Island and some others in the South Seas are evidently survivals of the tremendous cataclysm which ages ago carried this empire beneath the sea, leaving only these abruptly deserted monuments as



Frank Burnett, Senior, of Vancouver, British Columbia, Who is Said to Be the Possessor of the Largest Collection of South Sea Curios, and Who is Interested in Easter Island



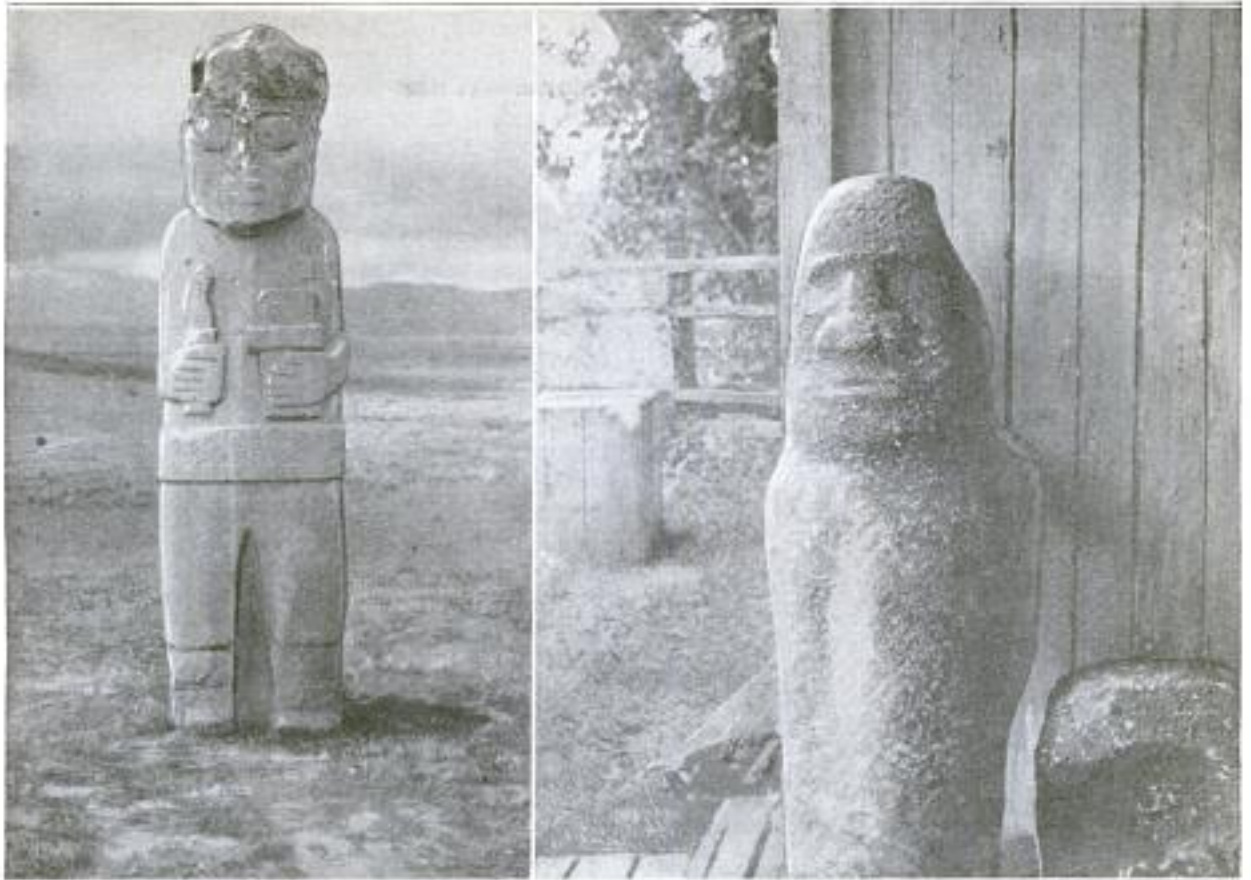

At the Left is Seen a Stone Image Which was Found in South America and Which is Believed to Be the Work of a Race Closely Related to the Ancient People of Mysterious Easter Island. At the Right is an Unfinished Easter Island Monument, the Lines of Which Are Strikingly Similar to the Other

proof of a people infinitely older than the present Polynesian people who inhabit the near-by South Pacific islands.

During the last 25 years, Mr. Burnett has spent much time in the South Seas. In 1919 he traveled through Central and South America examining a great many of the there existing ancient monuments in an endeavor to establish a connection between the early races dwelling here and that people who carved the sculptures and built the platforms on Easter Island. From this journey he arrived back in Vancouver only a short time ago.

Believing that the first inhabitants of Easter Island were of a kindred stock to the prehistoric inhabitants of South America and were not Polynesians, Mr. Burnett substantiated his theory in a personal interview as follows:

"For my part," he said, "having seen the Easter Island sculptures and those at the ruins of Tiahuanaca, near Lake Titicaca in Bolivia, and having noted their great resemblance, I am in favor of the theory that they are both the handiwork of a race that inhabited portions of South America and the eastern groups of the South Pacific when the latter comprised a much greater land area than they do at present; a race that dwelt in a great

empire and passed away ages before the rise of the Inca empire, and before the Polynesians left their Asiatic home to wander eastward on their long, long drift to the Pacific islands. The principal, in fact the only, difference between the Easter Island images and those of Tiahuanaca, consists in the design of the ear. At the latter place, this organ is depicted in the natural shape, while on Easter Island the lobe is largely distended, in the same manner that the present-day Solomon Islanders and some of the New Guinea tribes are accustomed to treat their ears. I am fully in agreement with Prof. Macmillan Brown regarding the possibility of a bygone continent being submerged, and that all available evidence points that there was a sudden abandonment of the work, very probably due to a cutting off of food supplies. Perhaps the workmen were forced to eat each other, and all finally died. When the Polynesians came is, of course, also a matter of conjecture, but their arrival must have been ages later. I have just finished a book, 'Summer Isles of Eden,' which I have been engaged upon for many years, which incorporates all the information gained in 25 years of travel in the South Seas, and none of the



very extensive material of great interest there was of more fascinating interest than endeavoring to solve satisfactorily the strange mystery of Easter Island."

That a highly civilized people of vast antiquity dwelt upon the continents of North and South America, is now indisputable. That they peopled also a continent which has vanished, seems very probable. Of this, Easter Island seems to tell. This is one of the most fascinating stories in the vivid history of the race of man. In the limited space here permitted, it is still possible to give a complete, yet concise, summing up of the whole subject to which Easter Island sculpture has given rise, for the Canadian archaeologist, W. D. Harris, D. D., LL.D., in the "Annual Archaeological Report" of the province of Ontario for 1913, had already made out a very remarkable case in favor of all the facts which the investigation of Macmillan Brown, Frank Burnett, Wragge, Schliemann, and others have borne out. He writes as follows:

"In the ruins of the pre-Columbian cities of Yucatan and Central America we see the most elaborate forms of sculpture, the remains of a people skilled in architecture, sculpture, and drawing, and, beyond doubt, excelling in arts that have perished. The architecture and system of writing of these prehistoric people are

different from those of any other known race, ancient or modern. They stand alone. Without models or masters from abroad, their architecture originated among themselves. The regions now known as Yucatan, Chiapas, and Tabasco were the cradle land of primitive American civilization. In these regions we find the tidal remains of an ancient race, which welled up from its primal springs and overflowed and rolled on over the entire continent (North and South America). All European, African, and Asiatic languages have been traced back to their sources, but the Nahuatl and its cognate tongues of America stand alone, and throw no light on the origin of the people. Philologists say it differs radically from all other known languages. Comparison with the Sanskrit, the Hebrew, the Phœnician, Japanese, Chinese, Celtic, or Scandinavian languages establishes no affinity between them and any primitive American tongue."

Though the above-given facts regarding Easter Island seem to be about the last word on a most fascinating subject, perhaps in the future some still more interesting evidence may be brought to light regarding the wonderful men who in dimaged time carved the great works of stone, and who were still working upon them when the continent sank.

## APARTMENT HOUSE DYNAMITED TO PREVENT ACCIDENTS

Dynamite was resorted to in the wrecking of a condemned four-story apartment

house in Cincinnati, the foundations of which were weakened by the excavations of a rapid-transit company. With the streets in the vicinity roped off and policemen stationed at every intersection, the

work of demolishing the building was carried on before thousands of spectators. Several persons, onlookers a block distant, were slightly injured by the flying débris, while the firemen stood by in readiness to quench any resultant flame. Three days of dynamiting, which rocked the other structures in the locality, were required before the building was leveled.

Great quantities of acorns, harvested from the extensive oak groves along the lower Columbia River this fall, were used to fatten hogs, turkeys, and chickens.



Apartment House Which was Dynamited by Wrecking Crews, Showing Part of the Structure Demolished



575 The Sea Sleds Co

**HYDROGLIDERS WITH SURFACE PROPELLERS**

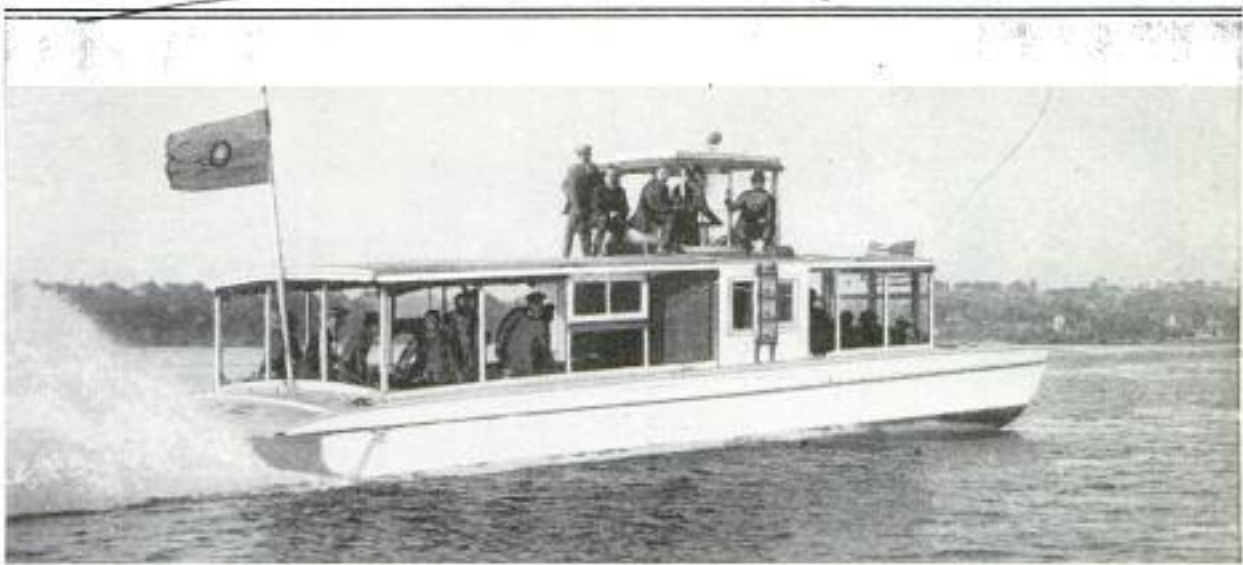

First of a Fleet of Seasleds That are being Built for Service on the Shallow Rivers of Colombia, South America: The Boat Has Accommodations for 20 Passengers and Their Baggage

The first of a fleet of newly designed seasleds to be built for high-speed transportation of passengers and freight on the shallow rivers of Colombia, South America, was recently launched in Connecticut. These seasleds, like the hydrogliders described in Popular Mechanics Magazine for February, 1922, when traveling at high speed skim the surface of the water instead of plowing through it, but unlike the hydrogliders which are driven by aerial propellers, the seasleds are driven by four surface propellers, of special design and method of installation. The hull of these new seasleds is 50 feet long, 12 feet wide, and its bottom section is of the inverted-V type that does not displace the water sideways, maintaining, therefore, a positive pressure beneath the bottom of the boat, which is of advantage in its operation as a glider. The steering is done with side-plate rudders that are practically extensions of the sides of the hull, and in straight-ahead traveling offer no resistance to the water. Each seasled carries 20 passengers and their baggage, a total weight of 5,500 pounds, together with 500 gallons of gasoline, at a speed of 30 miles an hour. The power plant consists of four six-cylinder motors, staggered in their installation, and each of

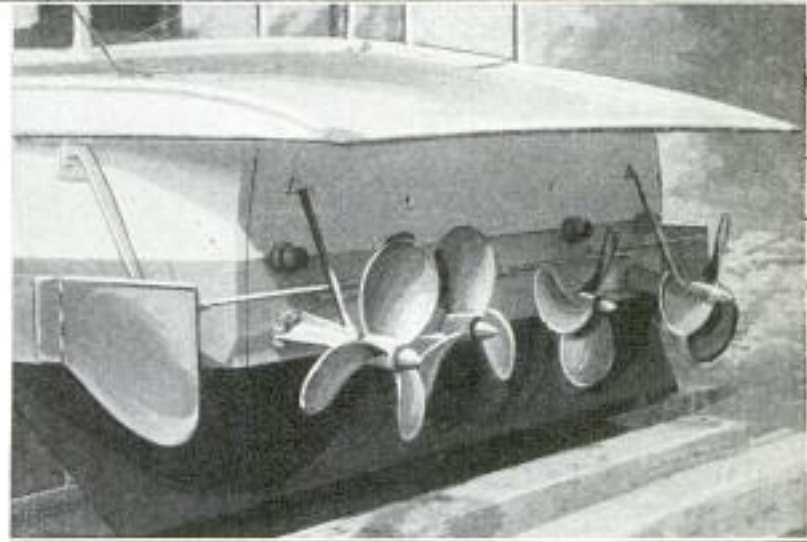

Stern View of the Seasled, Showing Its Four Staggered Propellers, and Also One of Its Side-Plate Rudders: The Propellers Have Unusually Heavy Bearings That are Lubricated from an Inboard Mechanical Oilier

200 horsepower, directly connected to its individual propeller.

**CAMPAIGN TO SAVE EYESIGHT  
WILL BE COUNTRY-WIDE**

A nation-wide campaign of eye conservation is planned by the Eye Sight Conservation Council of America in an effort to prevent blindness in this country resulting from avoidable causes. Figures gathered by the council show that, in 1910, there were 57,272 blind persons in the United States, or 623 per million of the total population. There were 52,617 in 1920, or 498 for every million of population. Coöperation in the movement has been promised by the Federal Bureau of Education, the Bureau of Standards, several universities, and various civic organizations.

*W.M. Jones p. 16*  
*10/13/22* Copyrighted material

*January, 1924 - 25*  
*1923 - 57*  
*December 1922 - 83*  
*June, 1922 - 204*  
*February, 1922 - 243*  
*Oct. 1921 - 585*



436  
Capt. H. J. Hoopes, 1411  
Ave., Chicago



(Royal D. Thomas)

IT may seem like painting the lily that anything man might accomplish would add to the thrill experienced in contemplating the grandeur of the Grand Cañon of the Colorado River, of which it has been written: "Those who have long and

## AIRPLANE LANDS

Treacherous Air Currents Spectacularly  
Motion-Picture Operator—

BY R. C.

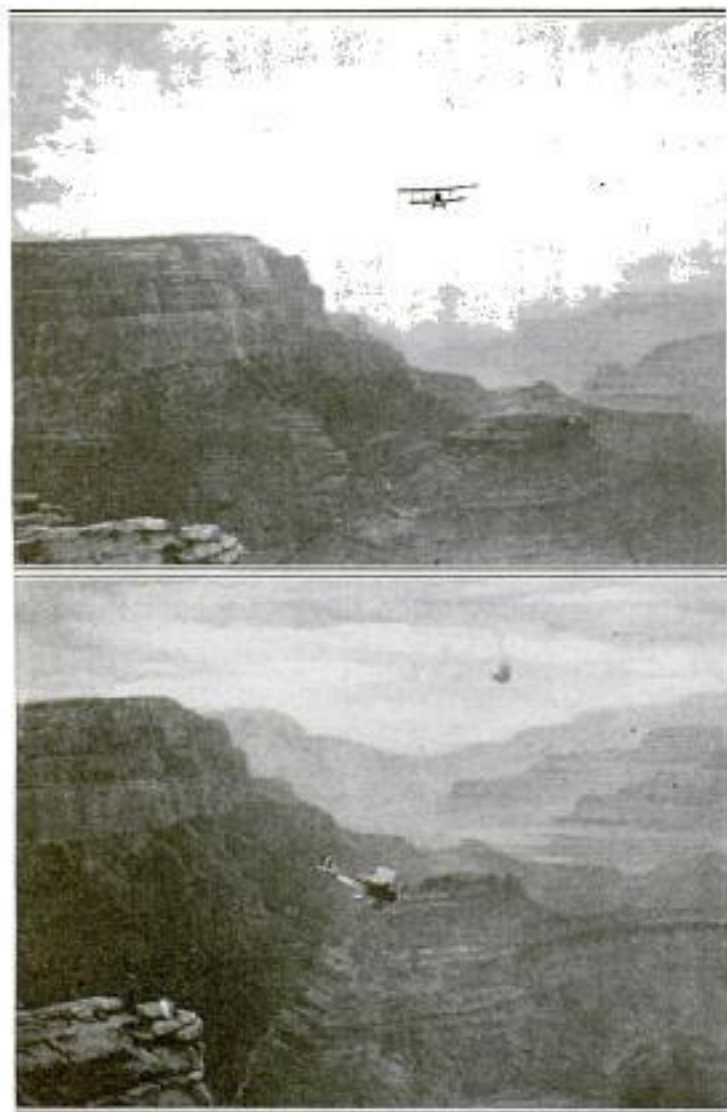

PHOTOS COPYRIGHT, FRED HARVEY, COURTESY SANTA FE SYSTEM LINES  
Above: The Plane is Seen Circling above the Rim of the Grand Cañon. Below: The Plane at the Beginning of Its Drop into the Cañon

carefully studied the Grand Cañon of the Colorado do not hesitate to pronounce it by far the most sublime of all earthly spectacles." This extraordinary sensation was provided for those who were privileged to view an airplane, circling several times above the cañon, suddenly turn and, flying close over the rim, swiftly descend into the depths below until within a few hundred feet of the bottom, where it straightened out and began a spiral climb of 3,000 feet before making a tailspin, from which it turned to a short flight through the cañon, finally making a safe landing on Plateau Point. To the Indians who had assembled in their best paint and feathers, it must have been an awe-inspiring sight, similar to that of earlier generations of red men who saw the centaurlike cavaliers of the Spaniards and the steam train for the first time.

Previous to this flight an airplane had once flown over and slightly below the rim, but no one had dared to attempt flying a plane down into the cañon, on account of the treacherous air currents that were known to exist there. Many rumors were current of small balloons liberated at the bottom, being torn to shreds by the tortuous currents. A flight upward from the bottom was considered equally difficult because of the improbability of being able





(Anthony Ugren)

## IN GRAND CAÑON

Negotiated by Former Army Airman and  
Indians Gather to Witness Feat

FOLGÉR

to "take off" from the floor of the cañon. In the face of these adversities, Royal D. Thomas, a young man from Kansas who joined the U. S. air service at the outbreak of the war, and with a later record as an acrobatic flier, became interested to perform this well-nigh impossible feat. After some time spent in studying the air currents and in the selection and preparation of a landing place at the bot-

tom of the gorge, he made his plans for the historic flight. On the morning of August 18, Thomas, accompanied by Anthony Ugren, a motion-picture photographer, left Williams, Ariz., in his 180-horsepower plane, and about a half hour later arrived over El Tovar hotel at the rim of the cañon. For the benefit of the cameraman, he made two complete circles and then flew over the forest back of the rim before starting his real flight. As he piloted his plane over the edge of the cañon, an air current rocked the ship, but he was in nowise disturbed, for when high in the air, he turned nose down and shut off his motor as he shot past the rim. This down current of cool



COPYRIGHT, FRED HARVEY

Scene at the Bottom of the Grand Cañon Where Royal D. Thomas is being Photographed with His Plane and Photographer Companion, after the Memorable Descent into the Cañon by Airplane: Other Pictures Showed He Made a Perfect Three-Point Landing



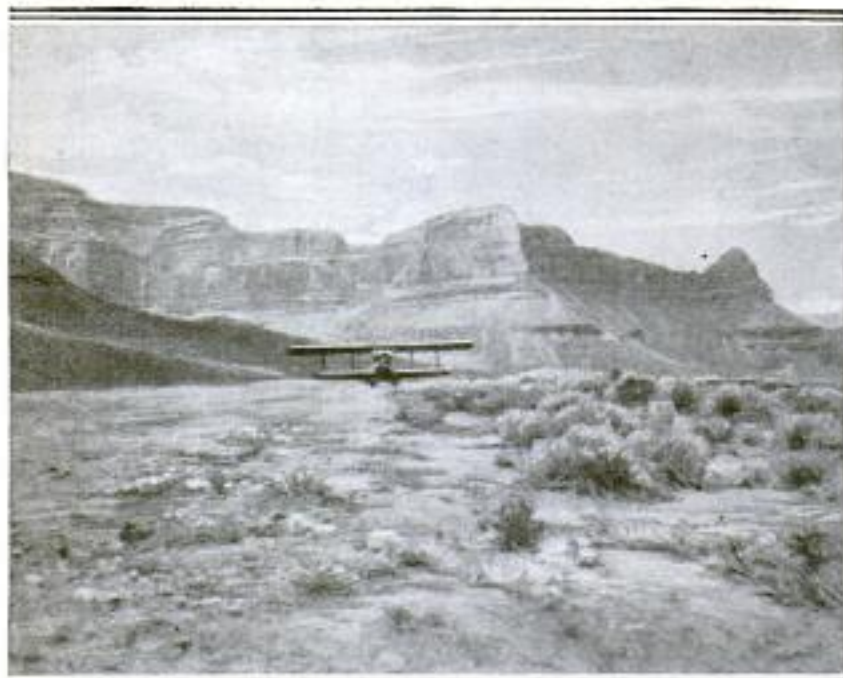

air caused the plane to drop over 1,000 feet into the cañon with such terrific speed that it was found impracticable to take pictures of it during that part of its flight, and the actual descent was accomplished in a little more than a minute. Starting out early the next morning, Thomas completed his flight, ascending from the bottom of the gorge in his plane, the upward flight taking about  $4\frac{1}{2}$  minutes. He estimates it would have taken him at least one minute longer on the ascent but for an upward current of air that actually lifted the plane for a vertical distance of nearly 1,500 feet.

THE PLANE AS IT FLATTENED OUT ABOVE ITS LANDING PLACE AT PLATEAU POINT, AFTER ITS RAPID DESCENT INTO THE GRAND CAÑON, WHICH LASTED A LITTLE LONGER THAN A MINUTE

COPYRIGHT, FRED HARVEY

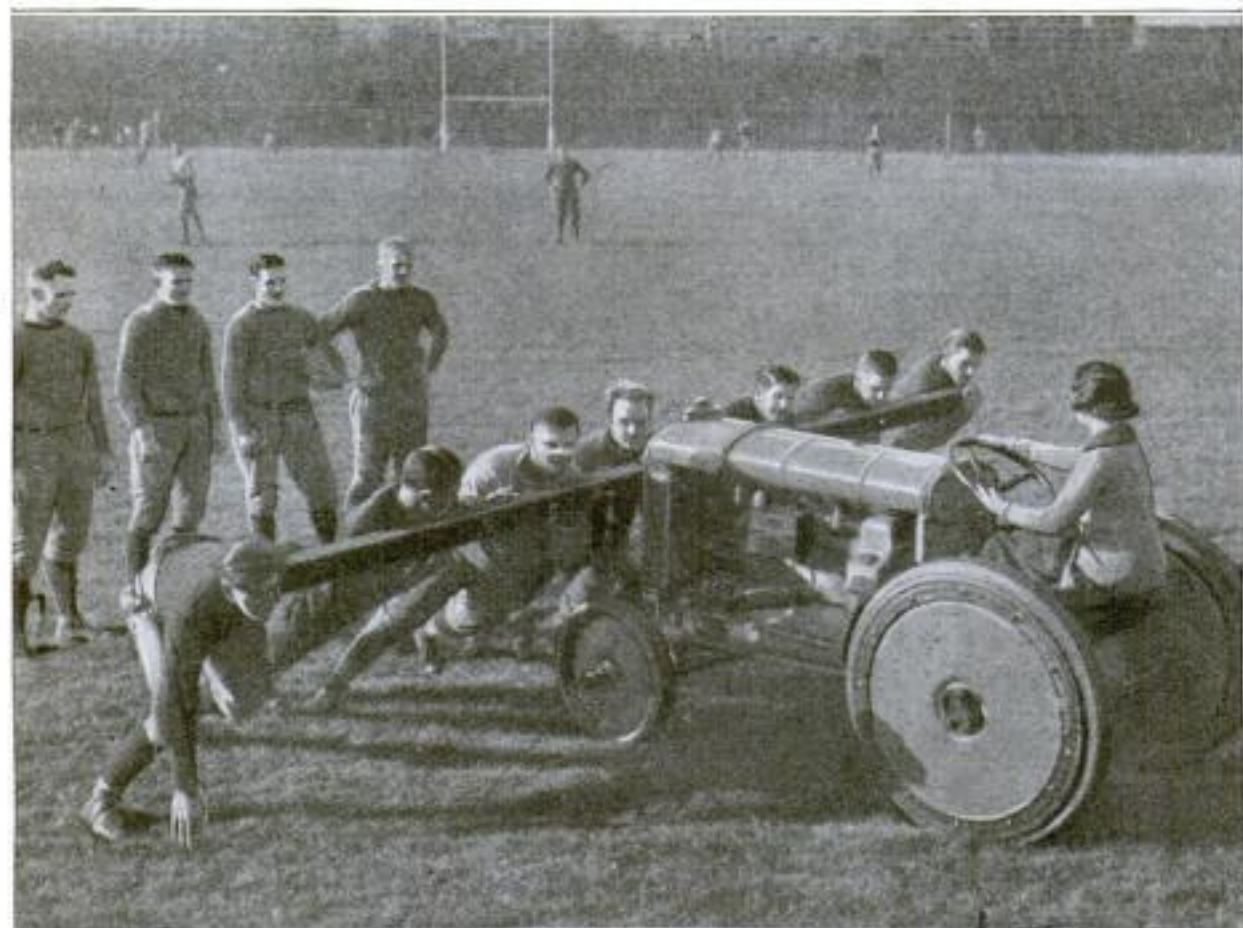

CALIFORNIA VARSITY LINEMEN HOLD TRACTOR FOR DOWNS

WHEN the husky linemen of the University of California's football eleven "had it out" recently with what is claimed to be a powerfully built tractor, the tractor found it could make little progress toward the enemies' goal posts. The football men, bucking a timber stretched across the radiator, were not only able to prevent the machine from going enough to make downs, but when, after a few moments of play, they had gotten worked up into the spirit of the game, they also managed to run it back for a loss.



Light  
Electric

566 General Electric Co, Schenectady, N.Y.  
National Lamp Works of General



On the Flagstaff Is One of the 30,000-Watt Incandescent Lamps, First Shown at the Convention of Illuminating Engineers, at Swampscott, Massachusetts. The Circles of Light were Caused by the Moving Searchlight of a Battleship, a Half Mile Out in the Harbor. Note the "Whitecaps" in the Background

## LARGEST INCANDESCENT LAMP IN THE WORLD

566

By BERNARD G. PRIESTLEY,

241 Wachuset St  
Melrose, Mass.

A 30,000-WATT incandescent-light bulb, having a capacity of 60,000 candle-power, was shown as one of several striking electrical features of the 16th annual convention of the Illuminating Engineering Society, recently held at Swampscott, Mass.

The bulb is the largest of its kind ever made. The amount of light it produces equals that of 4,000 ordinary electric lights of the same type, giving sufficient light to illuminate 200 average homes.

The power required to operate one of the bulbs is equivalent to that needed to run the average trolley car. Two special generators, of ample capacity, were loaned by the army to operate the lamp at Swampscott. The bulb was suspended from a pole in front of the hotel where the electrical experts were holding their convention. The light it produced at night was so powerful it could be seen for sev-

eral miles. Objects a quarter to half a mile distant were readily discernible.



One of the 30,000-Watt Incandescent Lamps, Which Makes a "Lapful" for the Young Woman, and Illustrates Its Size

When the lamp is lighted, a temperature of about 3,500° C. is generated in the filament. The heat is so great that an electric fan is used on the light holder to cool the bulb. Otherwise the glass would soften and the filament would blow out. The glass part of the lamp is approximately 1½ feet long and 12 inches in diameter.

The giant light was made in the same manner as the ordinary-size bulb. It has four coils of drawn tungsten wire. The wire used is .1 inch in diameter, or 50 to 100 times as thick as that of the ordinary bulb. Each coil is 5 inches in length. The bulb is filled with argon gas, as is common with ordinary incandescent lights. Even with the use of a fan for cooling the light, there is danger of it burning out from overheating after it has been lighted 15



minutes to half an hour. The ordinary "hard glass" of the type found in the ordinary incandescent light is used. The glass is no thicker, comparatively, than that of a 40-watt household lamp.

Although the amount of power needed to operate one of the bulbs is many times that needed for the household light, the voltage used is only 110, the same as that on the average power circuit in the home.

Thirteen of the lights like the one exhibited have been made, it was announced at the convention. They are designed for use in motion-picture studios. It is claimed that such lights are more suitable than arc lamps because of the absence of the flicker caused by carbon filaments and the softer tone of the light rays.

Two mammoth U. S. Army searchlights, each equipped with a 60-inch projecting mirror and having a lighting capacity figured by electrical experts at 400,000,000 to 500,000,000 candlepower, were used in the illuminating effects for the convention. These lights were set up on the seashore in front of the hotel that served as headquarters for the electrical experts. Three big searchlights were also in operation on the U. S. destroyer "J. Fred Talbot," which lay half a mile out in Swampscott harbor to cooperate in the illuminating program, and was outlined by 350 electric lights. More than a score of smaller searchlights which were operated

from the roof of the hotel building, provided additional light for the display.

Fifty floats, 6 feet in diameter, were anchored in the water a quarter of a mile from shore. Three separate circuits of wires for colored lights were strung to these floats from portable generating stations on the shore. The colors of the lights on the floats were alternated at frequent intervals. The lights were so placed that they formed the initials of the society, I. E. S., these being entirely surrounded by a flare of red fire.

The battery of big searchlights, each operating independently of the others and changing its angle of light projection frequently, produced some striking effects against the background of darkness. Points of land, a half mile to several miles away, were illuminated so brightly that they appeared as natural as in daylight.

#### HOT-WATER HEATING FROM 557 OPEN-GRATE FIRE

The advantage of hot-water heating has been ingeniously combined with the cheerfulness of the open-grate fire in a new heating apparatus which is adaptable for any width of fire-grate opening.

It consists of a sectional boiler with hollow grate bars and an iron front and doors. The rear, sides, and fire basket are hollow and filled with water connected to an expansion tank located in

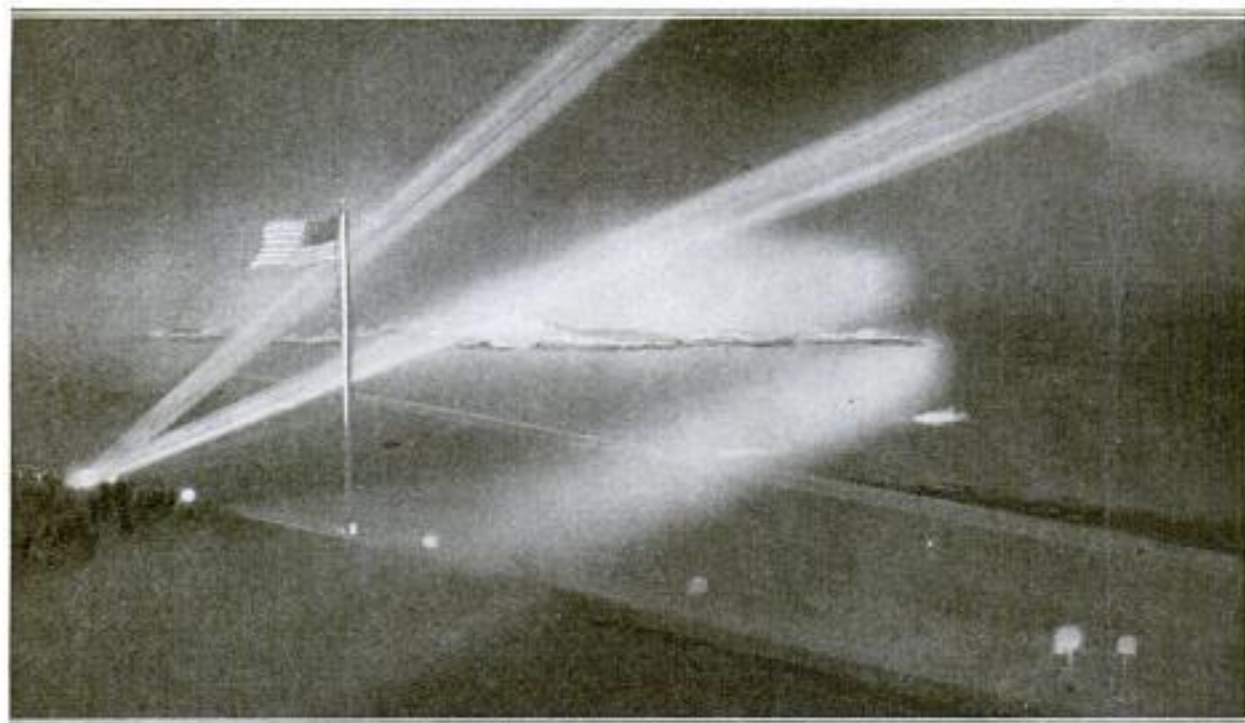

Another Lighting Effect Produced at the Convention: Battery of Searchlights Thrown on the American Flag; the General Lighting of the Surroundings Was So Brilliant That a Chain of Rocks Extending a Half Mile Out into the Ocean, is Plainly Seen in the Background



557

Fire Heater, Radiator, Heating Corp. 913 Jacksonboro St. POPULAR MECHANICS Knoxville Tenn 843

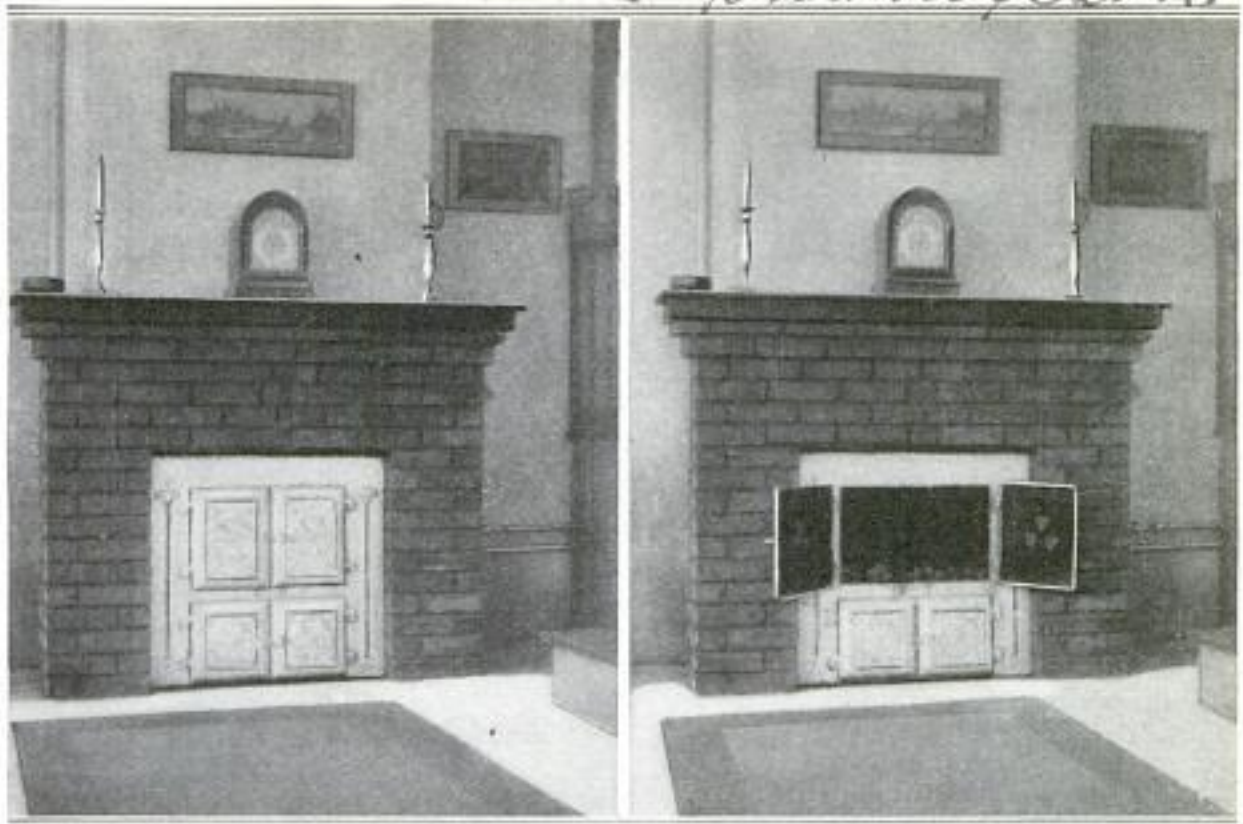

At the Left is Seen the Fireplace Which Houses the Grate of the Hot-Water Heating System, the Doors of Which are Closed. At the Right, the Upper Doors are Shown Opened, Displaying the Large Aperture for the Fuel, the Burning of Which Yields a Cheerful Open-Grate Fire

the attic. The usual system of piping to the various radiators throughout the house operates in the same manner as any other hot-water system. A coil is placed in the rear of the heater and connected to the regular hot-water tank, and thus hot water is available at all times. The water gauge and thermometer are installed at a convenient point near the heater. As the grate opening (usually in the living room) is located on the first floor, it requires a minimum of attention. A slight raking with the poker on the underside of the hollow fire basket is sufficient to lower and remove the ashes. No dirt or ashes blow into the room, as the draft in any fireplace is greater than the draft in a furnace, due to the larger flue opening.

years. The government has attempted to meet the unfortunate situation by appropriating \$160,000,000, which fund is loaned at three per cent to workmen and civil-service employes as a means of stimulating the much-needed home building.

**PNEUMATIC CUSHION ON JAMB 592 STOPS DOOR SLAMMING**

Slamming and rattling doors are simply eliminated by means of a small pneumatic cushion made to fit the door jamb. The device consists of an angular piece of metal with a hollow hemisphere of rubber inserted in the larger side lying against the door jamb, and a smaller similarly shaped piece on the other side which projects at right angles to the jamb. The air inside the spherical rubber pieces deadens the force of the impact. As they wear out, they can be easily replaced by others.



**639 SHORTAGE OF HOMES SERIOUS IN ROME**

A shortage of 100,000 rooms is the problem now facing Rome, Italy, according to a municipal councilor of that city. The present state of affairs is a consequence of the late war. The rise in price of building materials, simultaneously with that country's entrance into the great conflict, was the cause of a practical cessation of all construction activities. This condition has prevailed for nearly eight

Chicago Daily Journal 10/12/20

Edw. John Halloran 212 Woodrow St. Calif.



497  
844

Cmt. H. Colin Campbell,  
301 7/8 Oak Park Ave.  
POPULAR MECHANICS  
Oak Park, Ill.

### TALLEST CON- CRETE TOWER FOR JAPANESE RADIO

The tallest reinforced-concrete tower in the world has recently been completed in Tokyo, Japan, and will be used to support the aerial of a wireless station. It is 672 feet in height. The lofty structure is built in the form of a chimney, having an inside diameter at the base, of 55 feet, and tapering to 3 feet 6 inches at the top. The wall thickness graduates from 33 inches at the bottom, to 6 inches at the apex. A spiral steel stairway winds up through the interior, landings being located approximately every 150 feet, these connecting to exterior balconies, from which sight-seers can view the surrounding country. Engineers are said to be preparing plans for two similar towers, which, however, will be almost twice as tall, since the success of the initial structure has led them to believe that reinforced-concrete towers 1,200 feet in height are practicable.

*Venus*

9703

### THE FUTURE OF OUR NEAREST SISTER PLANET

When several years ago the British Association for the Advancement of Science held its session at Toronto, Can., Lord Kelvin gave a remarkable address in which he stated that it had been found that the primeval rocks of the world contained cavities the contents of which were water, salt, hydrogen, car-

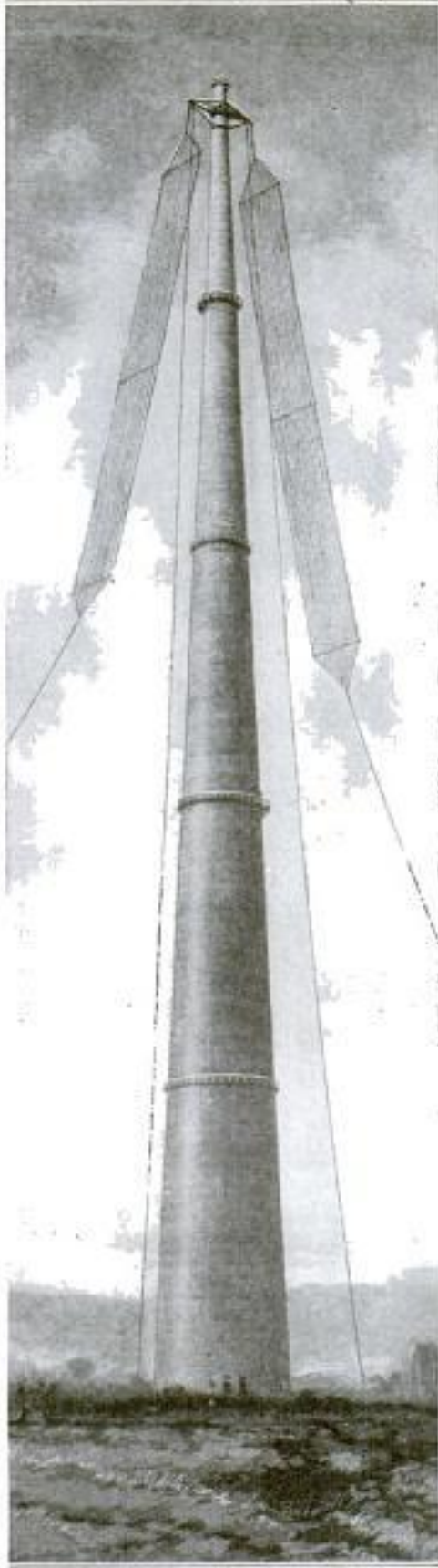

Reinforced-Concrete Tower, Showing the Method of Fastening the Radio Aerials at the Top of the Lofty Structure, and Also the Balconies for Sight-Seers

bonic-acid gas, and some argon, but no oxygen. He repeated "no oxygen." As these cavities were formed when the rocks were about to change from the melted, boiling condition into solid rocks, they are bubbles in which were imprisoned samples of the primeval atmosphere of the world, which, therefore, contained hydrogen, nitrogen, carbonic-acid gas, water vapor, and argon, but no oxygen. Billions of tons of oxygen is now mixed with the other gases of the earth's atmosphere.

The venerable lecturer then said that the only agency with which we are acquainted which could unlock the oxygen from the chemical combinations in which it was held, such as carbonic-acid gas and metallic oxides, is plant life using the energy of the sun, and the greater part of the oxygen now in the air came from the separation by vegetable growth of carbonic-acid gas of the atmosphere into its oxygen and the world's deposits of coal.

Since Lord Kelvin died, the methods of estimating the period of time which has elapsed since the primeval rocks first solidified, have grown more exact. The latest estimate sets it in the neighborhood of one billion years.

Recent studies of our nearest sister planet, Venus, suggest some very interesting speculations. The future oceans of the planet are wholly, or in part, in a state of steam and cloud which enswathes the planet and so completely hides the sur-

face that it has been impossible to determine the rate of rotation of the planet,

Cmt. W.W. Andrews, Regina, Sask., Canada.  
Copyrighted material



and, therefore, the length of its day. The rocks may yet be in a molten state or still hot after solidification. Most exact spectroscopic study of the atmosphere of Venus has demonstrated the absence of oxygen. Venus, therefore, is in about the same state of development as the earth was from one hundred to a thousand millions of years ago. As both the earth and Venus are parts of the same primeval nebula, the atmosphere and rocks of

Venus will contain combined oxygen in the same manner as the earth. Plant life or some similar agency, the nature of which we cannot guess, must slowly pick out the oxygen, molecule by molecule, if any development of animal life is to occur in the long future which evidently lies before the planet. Venus, therefore, is a younger sister and may repeat with variations our long history, till it reaches the earth's present stage of maturity.

515  
**NEW FLYING BOAT IS NAMED  
 FOR WILBUR WRIGHT**

The new Wright flying boat, which was recently launched at the Columbia Yacht

club, on the Hudson River, New York City, was named the "Wilbur Wright," in honor of the pioneer American airman. The christening was done by Miss Katherine Wright in the presence of her brother Orville Wright, the survivor of the famous brothers; Percy Mackaye, the poet-dramatist, and Capt. Vilhjalmur Stefansson, the arctic explorer. After the christening, Miss Wright took a ride in the new craft, which embodies

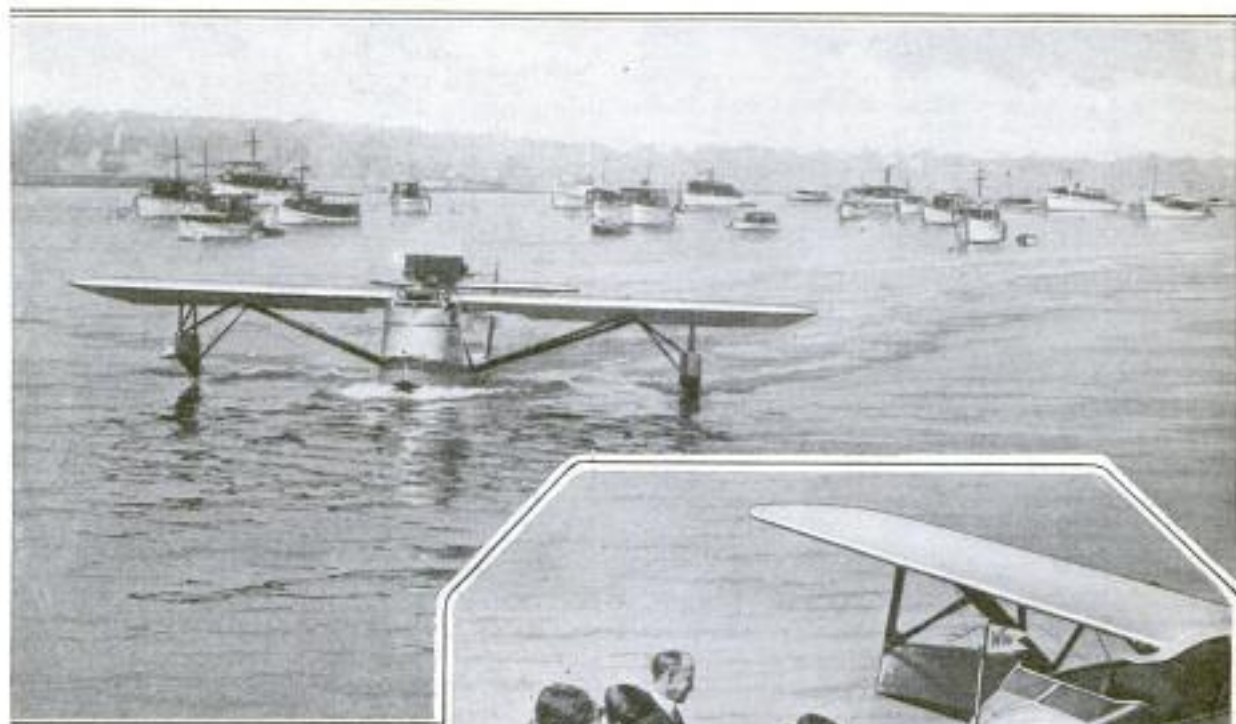

The New Flying Boat "Wilbur Wright," Traveling on the Surface of the Hudson River Preparatory to Making a Flight

ated with her brothers as "business member of the firm."

ber of the firm."

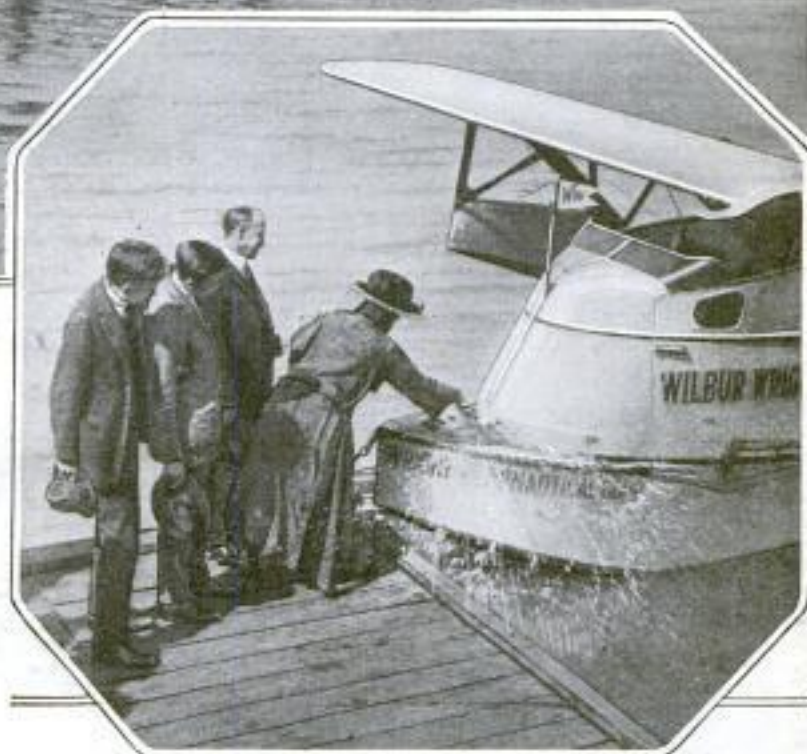

PHOTOS COPYRIGHT, UNDERWOOD & UNDERWOOD

Miss Katherine Wright, Sister of the Famous Brothers, in the Act of Christening the New Flying Boat "Wilbur Wright"

Wright Aeronautical Corp.  
 Paterson, N.J.

Copyrighted material



The A. J. Penote Co.  
6715 Quincy Ave

846 POPULAR MECHANICS

540 Cleveland, Ohio  
**PNEUMATIC TIRES ON BUGGIES  
USED TO CARRY CONCRETE**

Regular buggies used for carrying concrete are being equipped with pneumatic

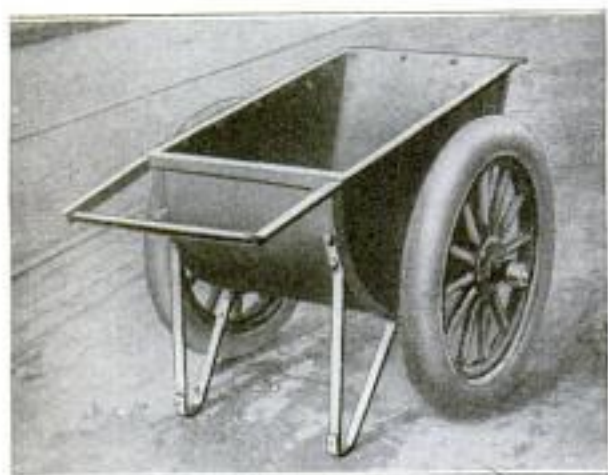

Buggies for Carrying Concrete, Equipped with Pneumatic Tires, as Shown Above, are Found to Be Easier to Handle

tires by a Cleveland contractor, who finds that the buggies so equipped are easier to handle than the old type. In wheeling over rough streets it was also found that the tires help to keep the mixture from separating. This allows the concrete to be carried a much greater distance than formerly.

ual requirements. The rifle has a heavy barrel, 26 inches in length, tapered from 1 1/8-inch diameter at the chamber to 7/8 inch at the muzzle. It is of finely finished nickel-steel, made to government requirements in bore and groove measurements, and is capable of firing an unusually large number of shots before losing its accuracy. Although the rifle is heavy, weighing 11 pounds, this weight is distributed so as not to be uncomfortable in any firing position.

528 **FIND GLASS "MOUNTAIN" AFTER  
FIRE HAD RAZED PLANT**

After fire had completely destroyed extensive glass works at Utica, Ohio, there was discovered an interesting rocklike formation. A huge vat of molten glass had boiled over during the fire, and running down the sides had formed a miniature "mountain of volcanic lava." When cooled, it was found to be a peculiarly shaped mound, a delicate sea green in



The Miniature "Mountain" Shown Above was Formed during a Fire at a Glass Plant in Ohio, When a Huge Vat of Molten Glass Boiled Over

508 **NEW SUPERACCURATE RIFLES  
OF U. S. STANDARD CALIBER**

For special use by snipers, on account of its extreme accuracy, a new rifle of standard U. S. government caliber, is now being manufactured. There are two types of the new rifle, one for fitting to a remodeled standard stock, and the other to a handmade stock to suit any individ-

color. The glass breaks off easily, much to the pleasure of souvenir hunters.  
*Harley Sims, Howard Ohio.*

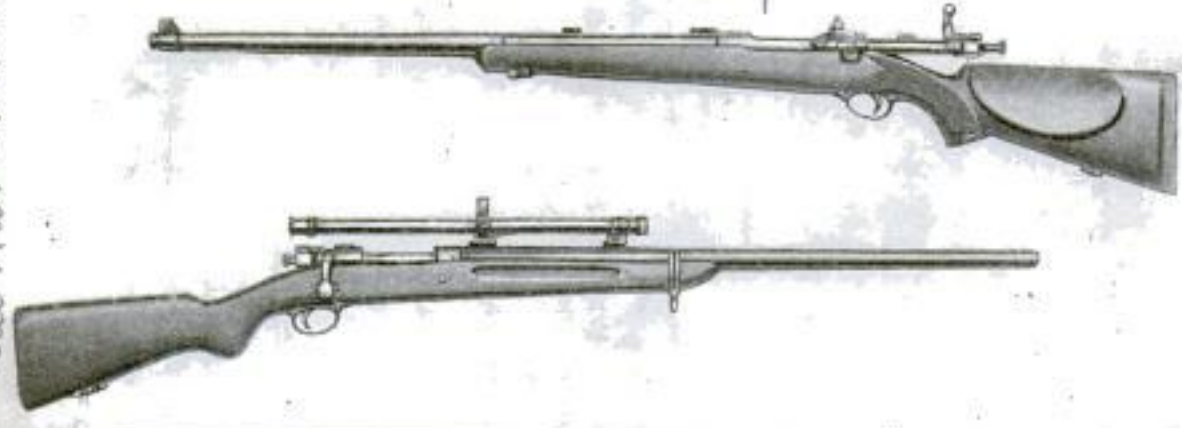

Two Views of the New United States Caliber Sniper's Rifle Barrel, the Lower One Showing It Fitted to a Remodeled Service Stock with a Sighting Telescope, and the Upper One Attached to a Handmade Stock, with Fittings to Suit Any Purchaser's Requirements: The Breech is Shown Open in the Latter Case

Prices from: *Shooting Promotion*  
*Union*

Winchester Repeating Arms Co.  
New Haven, Conn.

Copyrighted material



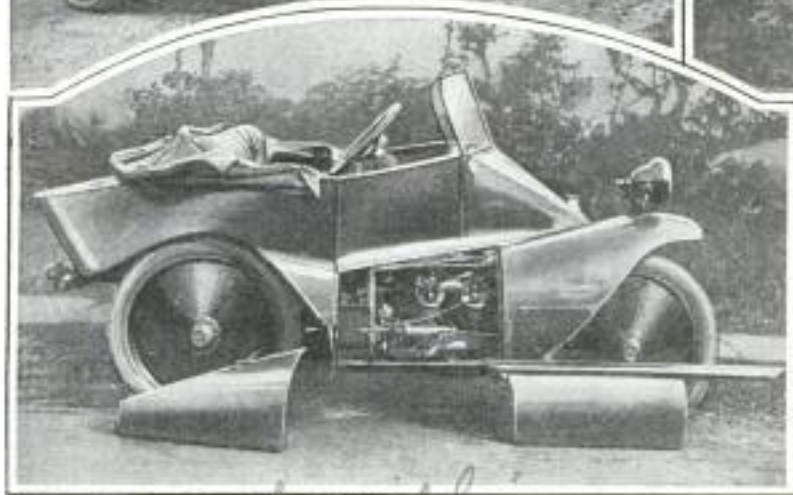

The illustration above and to the left gives a good idea of the mobility of the car. By noting the lines made in the roadway it is seen that the car is able to turn completely around with the third wheel remaining practically in a fixed position. Above: Rear view of the car, showing luggage compartment, collapsible top, and controlling mechanism. Below, left: Removable section taken out, showing the easily accessible motor, a 10-horsepower two-cylinder design

*Small*  
**LIGHT AUTO IS EVOLVED FROM MOTORCYCLE AND SIDECAR**

469

Starting where the motorcycle and sidecar "left off," an English inventor has built an attractive light car which combines the comfort of the auto with the economy and mobility of the sidecar. The usual three wheels are retained and the chassis frame is made up of a series of triangles. The body is modeled on that of a runabout, with slanting radiator hood, windshield, wide cushioned seat, collapsible top, and rear compartment for luggage or extra tires. The controlling mechanism resembles that of the larger machine, and the engine, a 10-horsepower two-cylinder design, is water-cooled like that of larger cars. A removable strip in the body below the driving wheel makes the engine easily accessible.

520

**BENCH MEASURING MACHINE OF EXTREME PRECISION**

For making measurements accurately to .0001 inch, a micrometer, in the form of a bench measuring machine, is now on the market. It is composed of two measuring heads, one adjustable with a stationary spindle and anvil, and the other

stationary with a spindle that can be adjusted by means of a large graduated wheel. It has a range of 8 inches between the anvils, and a height of 3 3/4 inches between the anvils and the work tables that are clamped to the bed of the

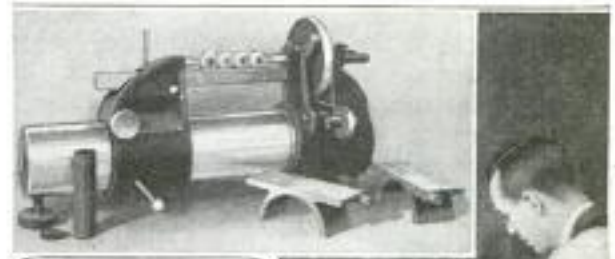

Above: Measuring Machine Shown Adjusted for Small Work. Right: The Machine in Operation on Large Work

machine when required for large work. For supporting small work, a channeled bar is inserted in a hole in the adjustable measuring head under its spindle and anvil. This bar extends across any opening between the two measuring heads and supports a standard cylindrical inch gauge that is accurate within a limit of .000005 inch.



Capt. Wheeler O. North  
 Guadalupe, Zacatecas, Mexico.

also N. Colin Campbell  
 301 Oak Park Dr.  
 Oak Park Ill.



Conical Concrete Silos for the Storage of Corn in Mexico: They are Well Built, of Concrete Made with the Best Portland Cement, and Preserve the Corn for Use in Lean Seasons

**CONCRETE SILOS IN MEXICO FOR STORAGE OF CORN**

To prevent depredation by rats, and other rodents, silos for the storage of corn in Mexico are made of concrete. They are conical in shape, well finished and constructed, and of considerable height and capacity. Their purpose is to store corn in seasons of plenty for use in lean seasons, that might cause famine. In some places several are built near together in rows.

Manufactured by  
 Detroit Equid Co  
 Detroit Mich

495



The Projecting Columns Shown Above are Strongly Illuminated at Night So That Passers-By need Not Fear Loiterers Who might be Hiding near the Building

**COMPANY CHASES "BOGY-MAN" FROM BUILDING**

So that passers-by need not fear loiterers who might be hiding in the dark shadows made by the projecting columns of its building, a Detroit company sets a good example by lighting these sections each night. By using standard 200-watt lamps and powerful reflectors, the company is able to concentrate a strong light near the sidewalk. The projectors are set in the building 24 feet above the street.

*National X-Ray Reflector Co  
 239 W. Jackson Blvd. Chicago*  
**ELECTRICAL BAKE OVENS MADE IN SECTIONS**

Electrical bake ovens are now being manufactured in sections having, at the top and bottom, inclosed heating units which are so distributed as to give a uniform temperature throughout the baking chamber. The sections are built with capacities of 20 and 60 loaves. This new oven makes possible the purchase of as many sections as are needed; for instance, one for the small bakery, two for the larger shop, etc., and in addition the baker is enabled to increase his equipment in proportion to the expansion of his business by merely buying more sections. Each section is equipped with motor-operated snap switches, a thermometer, and a thermostat for controlling the temperature.

Westinghouse Electric Co  
 1000 East Pittsburgh Pa

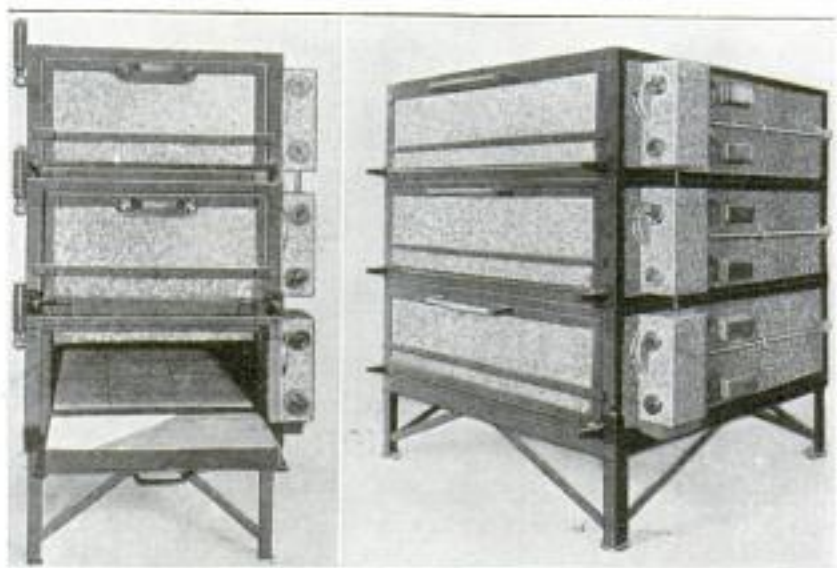

At the Left is Seen an Electrical Bake Oven Having Three 20-Loaf Sections, Mounted One above the Other, While at the Right is Shown an Oven Consisting of Three 60-Loaf Sections



## ELECTRICAL MACHINE CAN MAKE ELEVEN MILLION CODES

BY H. H. DUNN, <sup>2722 France St. Berkeley, Calif.</sup>

IT is written in the chronicles of the Civil War that a code message sent by General Grant to Washington has not yet been deciphered. It is known that in the naval engagement off Jutland, in the World War, the code system was discarded after the first hour of use, and some of the code messages were not deciphered for three days after that first hour. In a recent sham battle off San Diego, the records show that it was nearly six months before some of the code messages sent during this naval "engagement" were reduced to understandable English. That is to say, the code as used in written messages during the war of 60 years ago, and the radio codes used during the late war, were not always, nor uniformly, successful.

For this reason, unusual interest attaches to patents recently issued to a Californian, Edward H. Hebern, of Oakland, for a code-sending and receiving machine, for use with either wire or wireless. This machine sends its messages in a code which is capable of 11,881,376 changes, so that it is possible, by working all of these alterations, to obtain and use on this one machine a practically unlimited number of different codes, the key to any one of which is not the key to any other one. The operator of the sending machine writes his messages in plain English, on the keyboard, just as he would write them on the typewriter. By means of a "master wheel," or "key wheel," these messages are sent, by wire or radio, in a code which this wheel writes.

The receiving machine at the other end—sending and receiving apparatus being combined into one machine smaller than a typewriter—receives the wire or wireless messages in code, and presents them to the operator at that end spelled out on an illuminated keyboard, in plain English again. That is, the message is written into the machine, put into code by the machine, transmitted in code, decoded by the receiving machine, and presented to the receiving operator as originally writ-

ten by the sender without possibility of error. If any machine yet devised can think, this one does, or seems so to do. In appearance, it is not unlike one of the early phonographs, records for which were made on wax cylinders, instead of on flat disks. There is, however, no wax cylinder, composition disk, or other recording attachment. Whatever is sent into the machine is buried within it, as soon as the master wheel has coded the message and sent it on its way along the wires or through the ether.

The secret of the invention is in the master wheel, a small spool, not unlike that on which typewriter ribbons are wound, containing 26 apertures in either side, and a similar number in the rim, the whole wheel being about 3 inches in diameter. Each letter is wired in combination with other letters, the whole machine being electrically operated, and it is in this wiring that the secret of the instrument lies. The receiving operator has racked in front of him any number of these spools or wheels, wired to correspond to a similar number of other wheels. Letters common to two spools are first sent; by

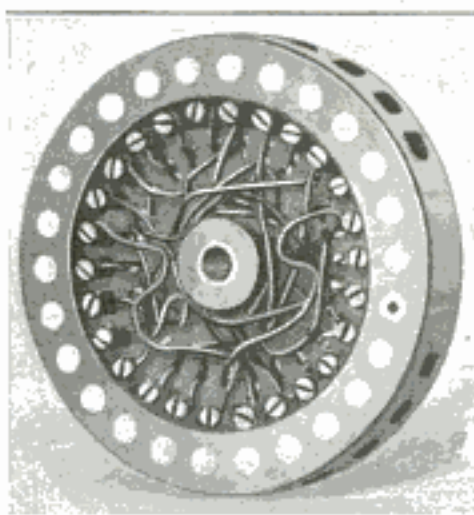

The Key, or "Master Wheel," of the New Coding Machine, and Its Intricate Electrical Wiring, in Which Lies the Secret of the Instrument

these the receiving operator knows which wheel is being used to send, and drops into the machine the similarly wired spool from his rack. Only two spools similarly wired will work together.

At a demonstration in the inventor's office, the sending operator wrote the word "N-O-O-N" on his keyboard. Ten different wheels, selected at random from a rack full of them, sent this out over a wire in ten different combinations of letters, as follows: VYDT, EFHW, LJSM, RQZK, YZFD, GCKG, MEZE, HKMZ, BCFH, and UFEE. It will be noticed that in only one of these code sendings does the same letter appear twice in such position as to indicate a comparison with any two letters in the original word. That is in the combination GCKG, when the two G's take the place of the two N's, yet the two O's are represented by two different letters, C and K.



When the corresponding key wheel had been inserted in the receiving instrument and the message came over the wire, the letters "N-O-O-N" flashed up from the

is useless; the wheel without the machine is nothing but a little metal bobbin.

"To solve any one message sent out between any two of these machines, and plucked from the air or the wires by ordinary wireless or wire instruments, would require exactly 11,881,376 experiments, and it would require all the time of a staff of code experts for 100 years to make these experiments. This statement, which is exactly true, will give you some idea of the work of attempting to decode one message, even one word out of a message, without the aid of the receiving instrument."

Representatives of five governments have been in Oakland within the past six months, studying the machine, but the inventor will transfer it

to the United States government alone, though he is working on another type of machine for the transmission and translation of ordinary commercial codes, to facilitate the sending and receiving of business and personal messages, either by land wires, cable, or radio.

The development of this wonder-work-



The Inventor is Shown Here with His Code-Sending and Receiving Machine, Which is Equipped to Operate Either by Wire or by Radio. The Machine, with the Proper "Key Wheel" Inserted, Translates the Coded Message from Any Similar Machine Immediately on Receipt. The Typewriter, to the Left, Gives an Idea of the Size of the Coding Machine

receiving board, where each letter appears on a small opaque glass, light throwing each letter into prominence as the word is decoded. In order that there may be no telltale record in the machine, the operator may copy the English words as they appear, or, if necessary, both sender and receiver may retain the text of the message in their minds. The complications contained in one of these messages may possibly be understood a little better when it is said that agents of the United States secret service worked 15 months over one code message, printed from the little wheel without being able to decipher it.

The instrument, for which a name has not been chosen, works on the principle of the electric typewriter, but all it borrows from this machine is the application of the electric current. "It is merely," says the inventor, "the application of the electric current in certain combinations, which causes the machine at the receiving end to reproduce in understandable words an apparently meaningless, yet systematic, jumble of words sent out by the operator of the sending machine. Neither the sending nor the receiving operator knows the letters that are going through the air; that is the secret of the machine, the secret, rather of the two little, electrically synchronized wheels, a dozen of which can be carried in a man's coat pocket. The machine without the wheel



The Coding Machine Complete: The "Key Wheel" is Seen Clamped on Top. Below Is the Receiving Apparatus, Consisting of the Letters of the Alphabet on Opaque Glass, Illuminated from Behind, and at the Bottom the Sending Keys

ing machine has taken only a comparatively short time. The first one, completed about four years ago, was 6 feet high by 3 feet square, while the type now described is smaller than the ordinary typewriter, being about 8 by 10 by 6 inches in dimensions. It also weighs less, and fits in a carrying case.



591 International newsreel Corp  
526 William St.  
New York City

GREAT HAVOC WROUGHT BY EXPLOSION IN ITALY



These Ruins Appeared in the Wake of the Recent Disastrous Blast of High Explosives at Port Falconara, in Italy. The Tremendous Force of the Explosion Wrecked Buildings for Miles Around, Killing 200 Persons and Injuring 700 More. Above are Seen Some of the Ruined Dwellings, the Roofs of Which were Literally Blown Off, and the Walls, in Many Cases, Torn Down. The Picture Below Shows a Few of the Great Number of Small Boats That were Thrown Up on Shore by the Terrible Blast





Campbell & Smith, Mitchell's  
rebarrow, d. rd.

Cont. C. A. Briggs  
1521 Oak St. N. W.

852

POPULAR MECHANICS Washington

358

CONVENIENT KITCHEN CABINET HAS NEW FEATURES

UNDISTORTED SOUNDS GIVEN BY NEW PHONE RECEIVER

535

An improved kitchen cabinet embodies many practical suggestions for the con-

The outstanding problem in conveying human speech appears to be in the receiver which converts electrical impulses back into sound waves.



This Kitchen Cabinet Has a Disappearing Ironing Board, a Built-In Alarm Clock, a Double Socket for Electric Light and Iron, a Coffee Mill, and Numerous Other Conveniences

venience of the housekeeper. A desk section holds cookbooks and account books for ready reference, and a built-in alarm clock not only tells the hour of the day but serves as a reminder when the roast or baking is done. A double socket at the top provides for light and an electric iron at the same time, while a disappearing ironing board is always at hand.

By far the greatest part of the distortion is imposed on the sound by the diaphragm generally used for reproducing it. This gives added interest to a new form of diaphragm which has been devised for converting electrical impulses into sound. The arrangement consists of two flat coils, placed close together, and through which a direct current is passed to produce a radial magnetic field between them. In the magnetic field in the disklike space between the coils is placed a nonmagnetic-metal diaphragm. The vibrating electric current used to set up the sound is superposed on the continuous current through the coils. This induces currents in the diaphragm which, reacting with the magnetic field, set up vibrations which produce the sound.

It is reported that this device gives very pure notes; and it may be that this scheme can be developed for general use in reproducing with great exactness speech, music, and other sounds, conveyed by wire or radiophone.

TRAINMEN'S SIGNAL LANTERN CARRIES OIL IN HANDLE

A signal lantern recently invented utilizes the handle of the lantern as an oil reservoir. The wick is fed from a small cylindrical receptacle which in turn communicates with the tubular handle. One of the principal objects of this arrangement is to produce a signal light for trainmen which will cast but a small amount of shadow from the bottom of the lantern, for which reason the base of the lantern also is made small and open.



ARMY DIRIGIBLE DESTROYED AFTER COAST TRIP

After completing a trip from the east coast to the Pacific without mishap, the army dirigible airship "C-2" was totally destroyed by fire at Brooks Field, San Antonio, Tex., while maneuvering to get out of the hangar. There were no serious injuries, although a number of the men had narrow escapes, especially several officers who were in the car of the airship at the time the fire broke out. While longer sustained flights have been made by other dirigibles, the transcontinental performance of the "C-2" is particularly noteworthy in America, inasmuch as it involved the hazardous crossing of the Rocky Mountains. The ship is reported to have cost 270,000 dollars.

Physical Review Jan. 1922 p. 358  
Articles by C. D. Hallett, University of Iowa, Iowa City, Iowa.

Dr. John C. Frosted  
Copyrighted material  
no street address given

M. J. Jones 10/18/22 Page 1 of 28

322 N. 21st Ave, W.



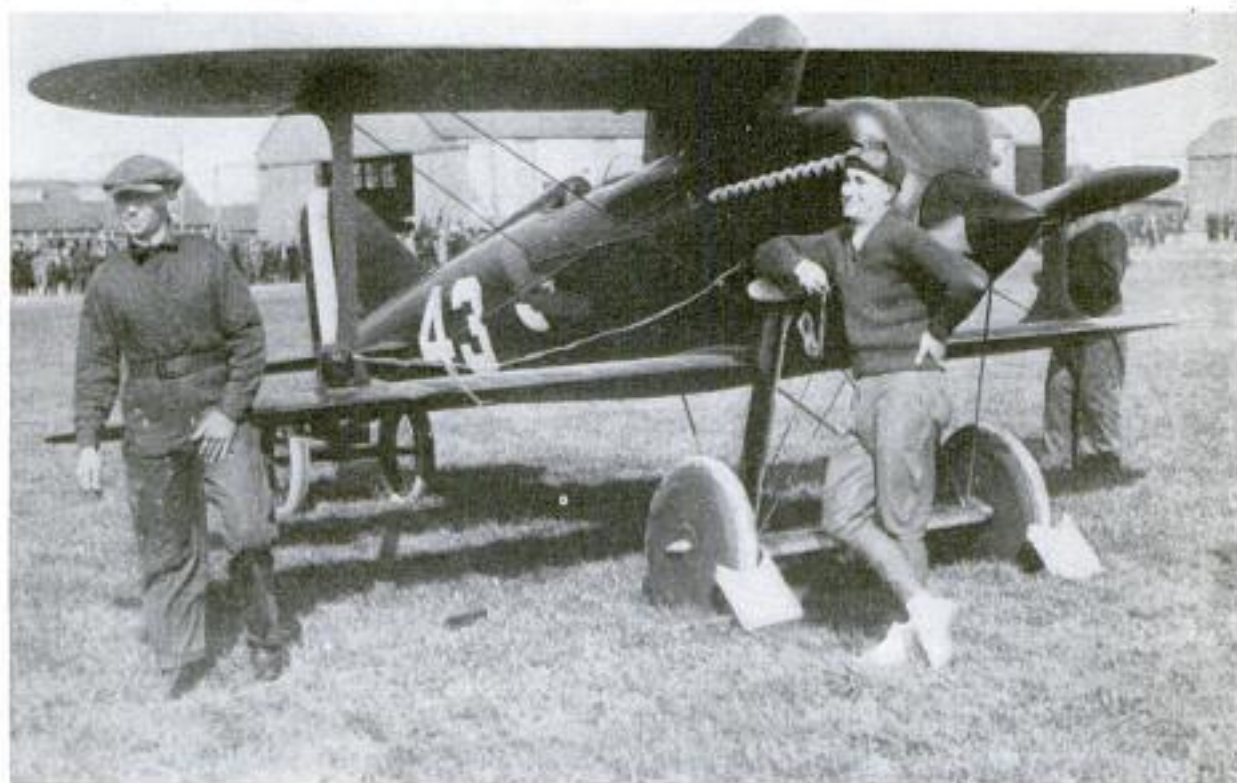

Lieutenant Maughan and the Curtiss Biplane in Which He Won the Pulitzer Race This Year with an Average Speed of 206 Miles an Hour: Two Days Later He was Timed at the Rate of 248.5 Miles an Hour

**ARMY BIPLANE WINS AIR RACE  
 WITH RECORD SPEED**

Traveling at the astonishing rate of 248.5 miles an hour over a measured course of one kilometer (.62 miles), Lieut. R. L. Maughan, a United States Army pilot, established an unofficial new world's airplane speed record on October 16, at Detroit. In order to show that this pace could be maintained, he continued his flight, which was timed at 232.2 miles an hour for four laps, while his average for eight laps was at the rate of 229 miles an hour. This record was made in the same plane with which Lieutenant Maughan won the Pulitzer trophy race two days previously with an average speed of 206 miles an hour. The machine is a Curtiss army biplane driven by a 400-horsepower Curtiss motor.

**DEVICE FOR THREAD CUTTING  
 ATTACHABLE TO ANY LATHE**

A device to facilitate thread cutting on engine lathes consists of a cast-iron bracket supporting a brass sleeve and dial, a steel shaft, and a brass worm gear suited to the pitch of the lead screw of the

lathe to which it is attached. All the operator has to do is to close the nut on the lead screw at the proper time, as shown by the dial, and then open it when the tool has traveled the required distance. The lathe runs continuously, and there is no necessity of stopping and reversing it at the completion of each cut. The device is attachable to the carriage

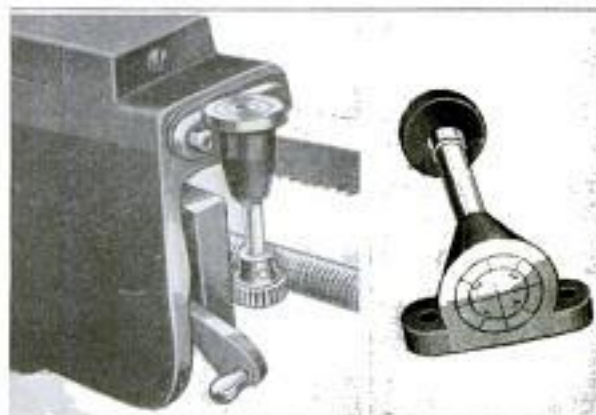

Left: Threading Dial Shown Attached to the Carriage of a Lathe. Right: Enlarged View of the Attachment, Showing the Dial That Guides the Operator

of any lathe, and can be used for internal or external, odd or even, right or left threads, regardless of length or diameter.



472 *Com. James M. Nuttyre*  
*apartado 216,*

FANTASTIC ROCK FORMATION IN THE VAULTED

*Tampico, Tamps, Mexico*



Entrance, 70 Feet High and 150 Feet Wide, to the Mammoth Cavern, 30 Miles from Cuernavaca, in Mexico, near an Indian Hamlet on the Foothills of a High Mountain Range



Close-Up of Part of the Wall of One of the Cavern Chambers Composed of a Solid Mass of Stalactites Depending from the Roof and Giving It a Curtainlike Appearance



More Distant View of the Stalactite Formation That Has the Appearance of a Huge Hanging Curtain: It is So High That It Dwarfs the Crowd of Visitors beside It



## CHAMBERS OF A MAMMOTH CAVERN IN MEXICO



One of the Largest of the Chambers in the Depths of the Cavern, Notable for the High Monolith, at the Base of Which Three Men are Seen: It is Called the Lighthouse



Another of the Chambers in the Mammoth Cavern: On Top of the Pile of Stalagmitic Incrustations of Lime Is a Seat. Hence This has been Called the Throne Room



The Chamber Nearest to the Entrance of the Cavern is Called the Goat Room, Because the Indians Saw in the Rocky Pile Dominating It the Semblance of a Goat



Fields

512

# INGENIOUS TOYS FOR

BY STRATFORD

**A**MONG the bewildering number of Christmas toys displayed this year are many which engage the attention of the grown-up as well as that of the boy or girl. A toy loom recently brought out is a good example. This seemingly very practical device, modeled on the regular factory loom, weaves a fabric 8 inches wide and is suitable for an almost endless variety of patterns. The base measures 15 by 10½ inches, and the height is 13 inches.

It is a four-treadle type, meaning that there are four controlling levers and four main sets of interweaving heddles, which arrangement, by the way, permits a greater variety of design than would be possible with a loom of fewer controls. The yard beam holding the material to be woven is easily detachable by means of a screw and nut at each end, as is the cloth beam which receives the finished product. The whole device is carefully built of steel and finished in black and blue enamel. Complete instruction books are, of course, furnished with each outfit.

Another evidence of careful construction is seen in the designing of miniature steam autos. There are both trucks and touring cars, with the boiler in each case under the radiator hood and heated by two small wicks fed from a tank of denatured alcohol. The autos, controlled by a lever in imitation of the regular gear shift, run backward or forward, and the driving

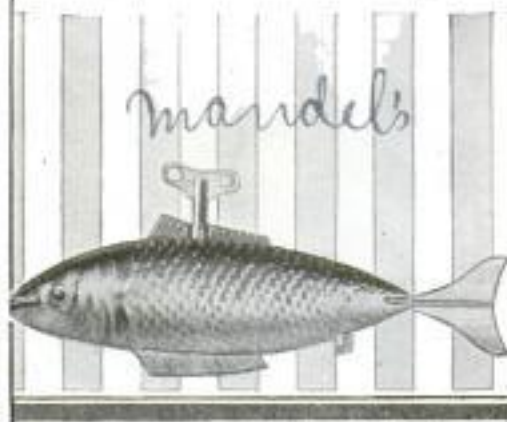
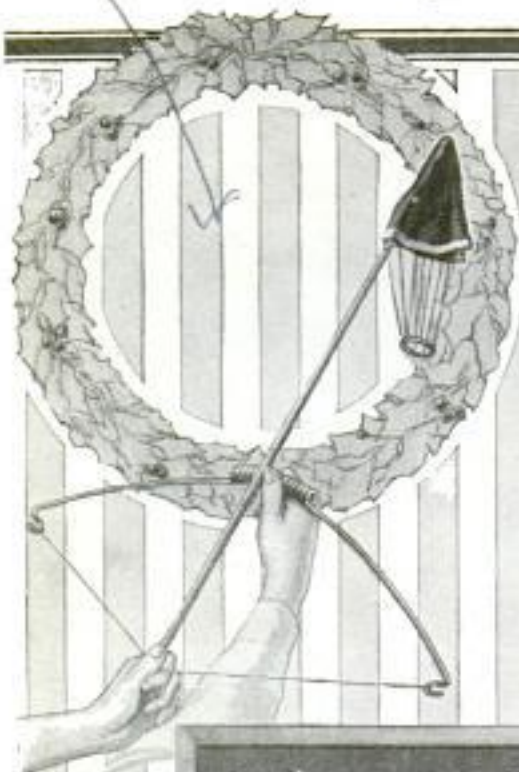

An Interesting Toy Displayed This Year Is the Small Parachute Shown at the Top. Beneath Is a Blackboard Which Has an Attractive Painting on Its Opposite Face, as Shown Immediately Below. The Loom Pictured to the Left Weaves a Number of Useful Articles and is Easily Run. The Fish Shown to the Right Swims in a Realistic Manner

Structo  
Mfg. Co.  
71 reiporb. d ll.



# CHRISTMAS SHOPPERS

F. CORBETT

wheels can be locked to any desired curve.

There are again the usual number of elephants that move their trunks and other animals that move one part of their body or another. A large giraffe has on its back a negro huntsman holding a spear; both move their heads and mouths.

For the nursery there have been made blackboards which have an attractive picture painted on one side, so that after being used, the unsightly blackboard can be turned to the wall. The pictures, which are framed, illustrate scenes from popular fables.

A small parachute that is shot into the air with a bow and arrow is one of the many devices for outdoor sport. The bow is of steel, and the arrow of light wood, so that a high-altitude jump is possible.

Other indoor toys present many evidences of ingeniousness. A fish that swims under water, wagging its tail and vibrating in a realistic manner, is one. A lady bug that "sees" is another. This mechanical insect rolls along a table until its feelers run off the edge, whereupon it very promptly turns and sets off in another direction. It seems uncanny when first seen. The trick is worked by means of a weight and lever suspended in the forepart of the device.

When the feeler goes over the edge it unbalances the weight so that the lever catches the inner of the two wheels. The outer wheel, still moving, turns the bug onto the table again.

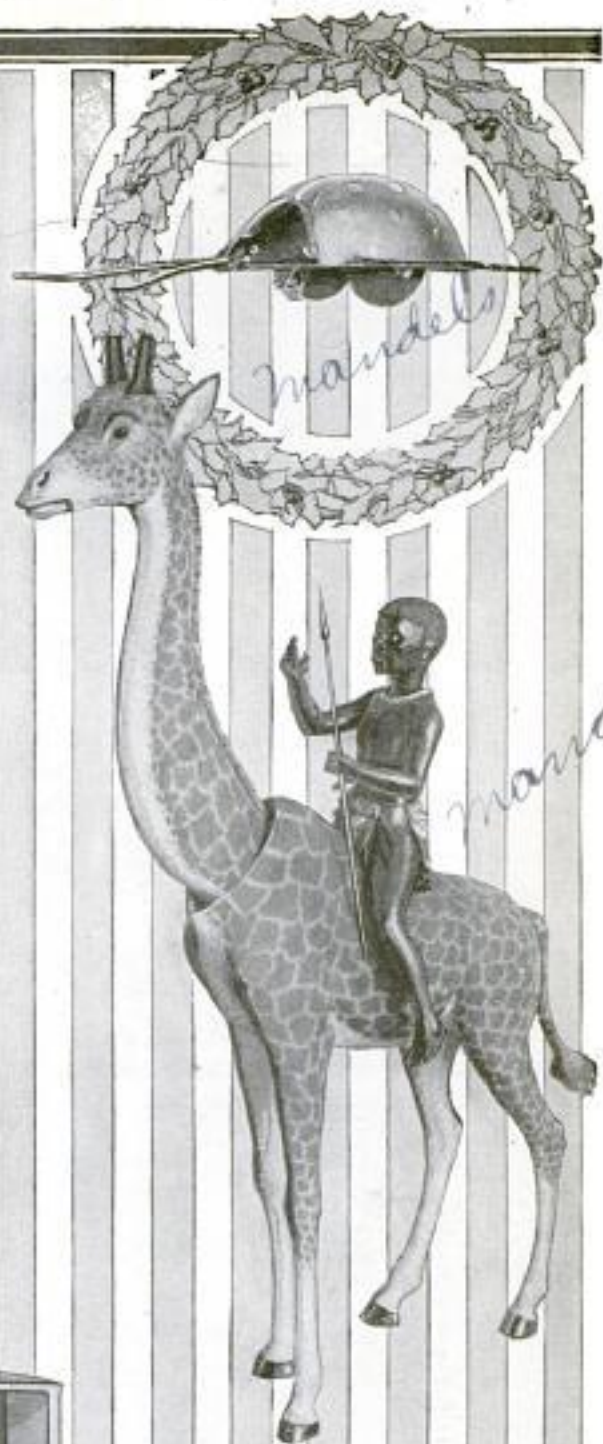

*mandel's*

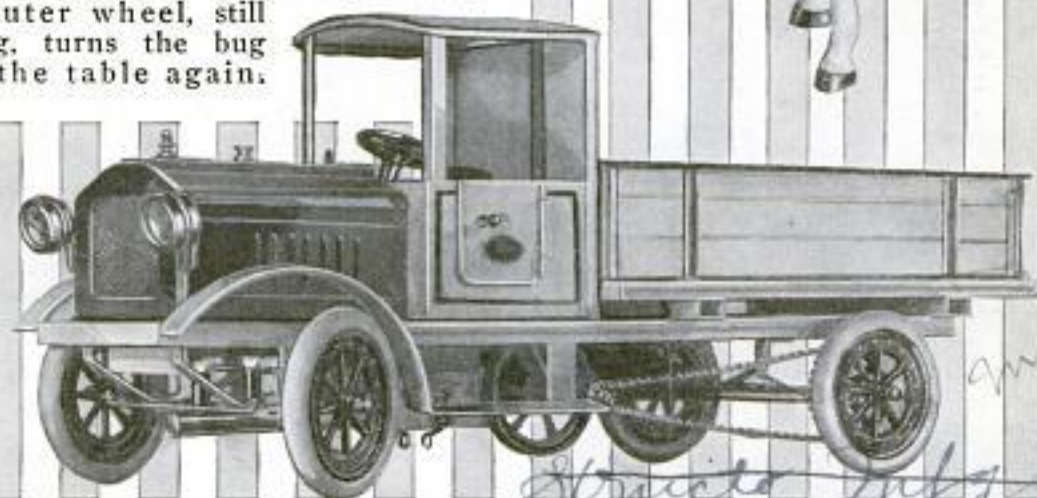

*mandel Bros.*

*Strickland Mfg Co*  
*150 West 11th St*  
*St. Louis, Mo*

One of the Cleverest Toys Is the Bug at the Top, Which Automatically Shies from the Edge of a Table. Below Is a Large Giraffe Which Moves Its Head and Mouth While the Negro Huntsman Appears to be Shouting Abuse. The Auto Shown Here is Run by Steam Generated with Denatured Alcohol. The Wicks can be Seen under the Radiator



United American  
Metal Corp. Hammond St.

The Engineer

9/22/22

*at 100 meters*

858

POPULAR MECHANICS

+ Meserole Inc.

635

SOLDERING FLUX IN STICK

CRUDE-OIL AIRPLANE ENGINE

OFFERS ADVANTAGES

DEVELOPED IN ENGLAND

485

*Brooklyn, N.Y.*

A new soldering flux just placed on the market, is made in convenient stick form

It is reported that a manufacturing concern, in conjunction with the British air ministry, has produced a promising type of crude-oil air engine. For the present, details of its construction are withheld, but it is understood to be a six-cylinder motor developing from 750 to 1,000 horsepower. It is known that, at the royal air-craft establishment, experiments have been in progress for a long time on engines of the Diesel type using shale oil, and also on the solid injection of a fuel containing 95 per cent alcohol. The advantages of these fuels are their greater safety from fire, and their economy of running cost.

*500 ————— 2100000*

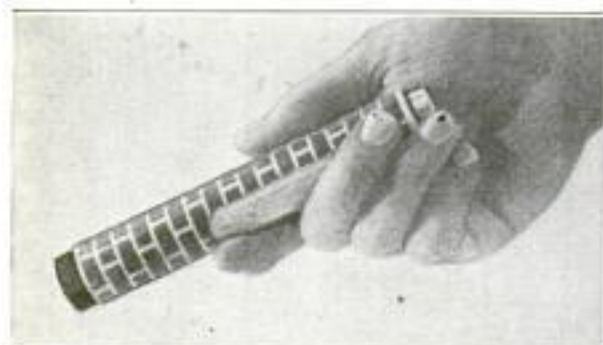

This Soldering Stick is Incased in Soft Lead, Which can be Peeled Off in Strips as the Stick Wears Down

and has some other advantages. The container is of soft lead so made that it can be peeled off in strips as the stick wears down, exposing the fresh flux which is rubbed over the parts to be soldered. It is claimed always to remain fresh and firm, even in hot weather, to be practically noncorrosive, and to produce no fumes injurious to the health of the worker.

### POWERFUL LOCOMOTIVES USED IN SWITZERLAND

Switzerland possesses powerful locomotives of the latest types, one of these being electrically driven, and another having a combination of gasoline and electric propulsion. The first is used on narrow-gauge roads, while the other is made for standard-width rails. The narrow-gauge

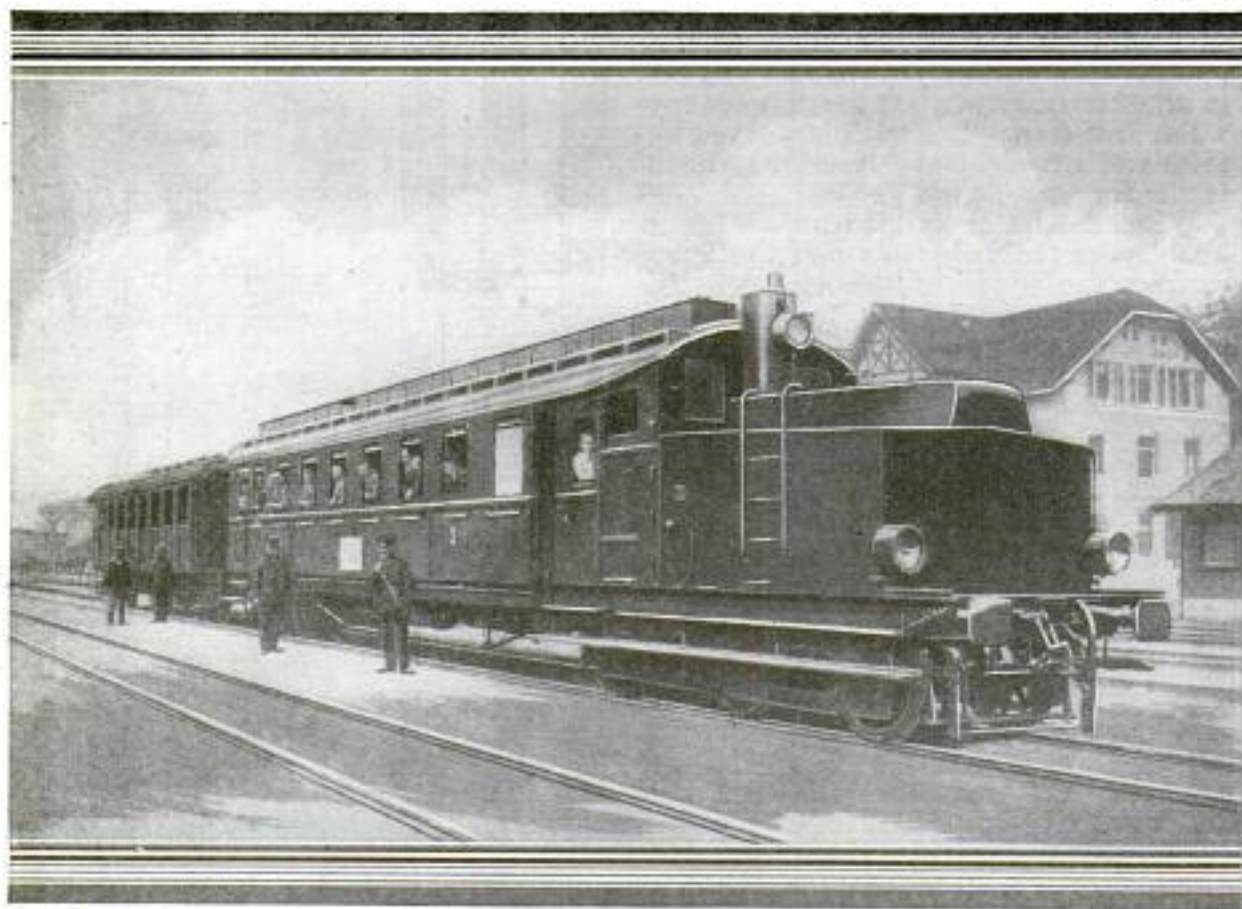

One of Switzerland's Powerful Locomotives, Which Has a Combination of Gasoline and Electric Propulsion and Which was Designed for Standard-Gauge Roads: Note How the Engine and the Coach are Combined



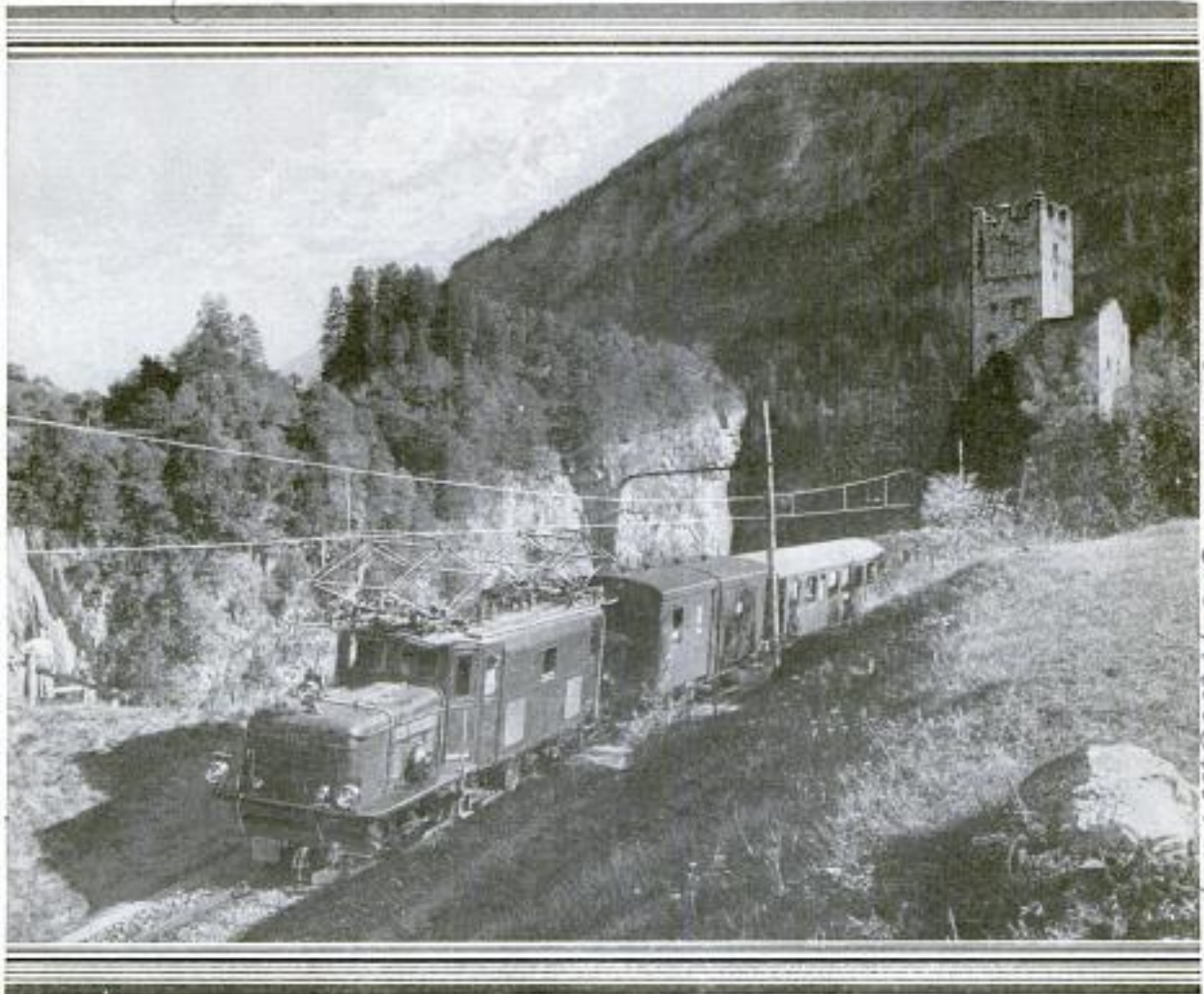

One of the Powerful Electric Locomotives Which have Recently been Put in Operation over the Rhaetian Railway, in Switzerland, Shown with Its Train of Cars, in the Thusis District of the Grisons Canton: These Engines are Declared to Be the Most Efficient Ever Built for Narrow-Gauge Railroads

engine, which weighs only 65 tons, draws a train weighing 200 tons up a 3.5-percent grade. Its speed is approximately 19 miles an hour. Up a 4.5-percent incline, which is the maximum grade of the Rhaetian Railway in that country, this efficient engine will haul a load of 150 tons. The locomotive, propelled by a combination of gasoline and electricity, is equipped with a Diesel motor which drives an electric generator. Sufficient power is furnished by the generator to attain a speed of 43 miles an hour under ordinary conditions.

**WINKING EYE ON WINDSHIELD AS ADVERTISING NOVELTY**

A large winking eye placed on automobile windshields is being used as an advertising novelty in Missouri. The poster in its usual position depicts a large wide-open eye, above and below which is printed the advertising matter. The eyelid is hinged at one end of the eye while the other end is held raised by a rubber

band. By means of a string attached to the rubber band the lid can be pulled down by the occupant of the automobile, and as soon as the pull is released, the rubber band draws it back into normal position.

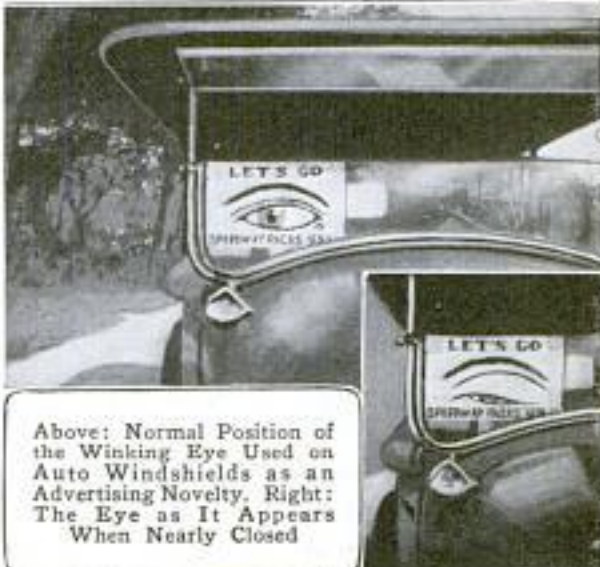

Above: Normal Position of the Winking Eye Used on Auto Windshields as an Advertising Novelty. Right: The Eye as It Appears When Nearly Closed

Société Suisse pour la Construction de Locomotives et de Machines, Winterthur, Switzerland.



459

George B. Ladd Co  
First National Bank Bldg  
Pittsburgh Pa.



Left: Blast-Furnace Plant for Making Pig Iron. Center: Partly Completed Steam-Generating Plant and Power Station. Right: Powdered-Coal Preparation Plant, at the Works of a Detroit Automobile-Manufacturing Company

## LARGEST POWER BOILERS NOW IN OPERATION



This Picture, Showing Eight Automobiles Parked in the Furnace of One Boiler, Gives an Idea of the Unusual Proportions of the Boiler

Four of the contemplated 12 largest power boilers ever constructed, have already been placed in successful operation at a Detroit industrial power plant. These gigantic boilers having a normal rating of 2,650 horsepower, have been operated at more than four times that rating and have developed, in consequence, over 10,000 horsepower each.

The boilers are of the five-drum type, having four steam and water drums, 5 feet in diameter by 26 feet long, with shell plates  $1\frac{1}{16}$  inch thick, and one top steam-collecting drum, 3 feet in diameter by 26 feet long. Interconnecting the drums is a

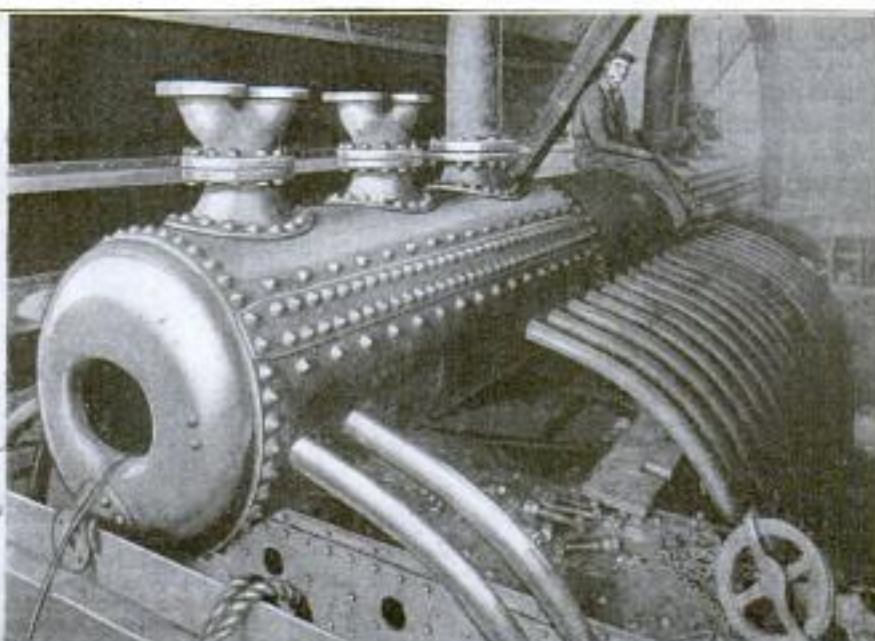

Left: Diagram Illustrating Toggle-Suspension Hangers, Which Permit a Total Play of  $1\frac{1}{2}$  Inches to Take Care of Drum Expansion. Right: Immense Steam-Collecting Drum of Boiler, Rated at 2,650 Horsepower



459

nest of 3¼-inch diameter tubing, which if placed end to end would be nearly six miles long. These tubes constitute most of the 26,470 square feet of heating surface of each boiler, which is the total amount provided, not including the superheater and economizer. Steam is generated at 240 pounds per square inch, boiler pressure, and is superheated to 200° Fahrenheit.

The furnace is approximately 23 feet by 24 feet inside and about 55 feet high above the ash pits, which allows about 5 cubic feet of combustion space per normal rated horsepower, after the proper deductions have been made. The floor space occupied by each unit is only 29 by 31 feet. Mounted over each boiler is a brick-lined steel stack, 11 feet in inside diameter, with the top reaching more than 300 feet above the ash-floor level. The complete structure of the boiler, superheater, and setting is supported entirely on the building steel, the total weight of each unit—exclusive of the stack—being approximately 1,100 tons. Not including the steel for the building, superheaters, or stack, the material in each boiler required 28 railroad cars for transportation.

It is intended to use blast-furnace gas as the main fuel, supplemented by pulverized coal, for which purpose an up-to-date powdered-coal preparation plant is provided.

At one time four fuels—powdered coal, blast-furnace gas, by-product tar, and fuel oil—were burned, and this is believed to be the only instance where so many fuels of such different characteristics, have been used simultaneously under a boiler.

An interesting feature of the construction is the method of suspension for the drums, which are carried on hangers that permit longitudinal and transverse movement, due to the elongation of the drums and the increase in center-to-center dimensions of the supports, without any

appreciable expansion strains. The first four of the proposed 12 boilers to be installed, have been in operation for about 18 months. The second series of four boilers have been contracted for and are now in process of manufacture. The last four will be added later.

The completed plant of 12 boilers, when operated at 400-per-cent rating, will

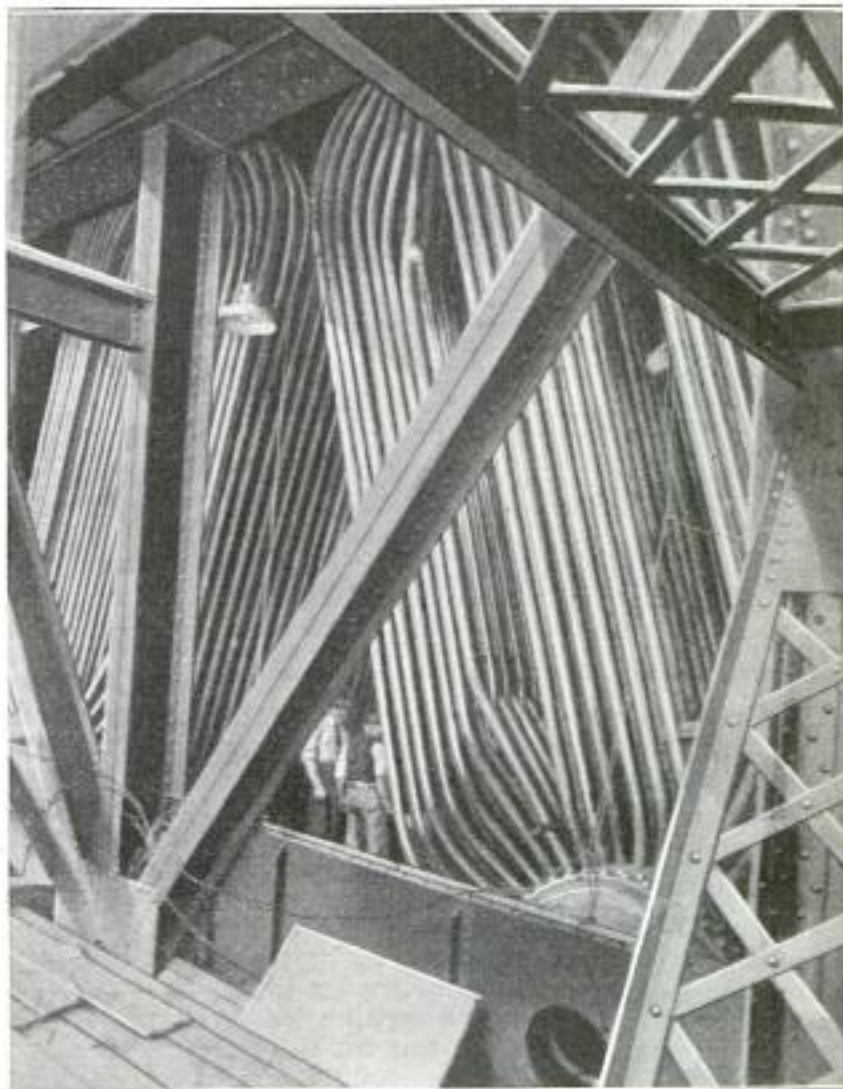

A Partial View of the Nest of Tubes Which Constitutes Most of the 26,470 Square Feet of Heating Surface of the World's Largest Boiler: If All the 3¼-Inch Tubing in This Boiler were Placed End to End, It would Form a Tube Nearly Six Miles Long

be capable of developing approximately 130,000 boiler horsepower.

623  
 A drydock now under construction at Havre, when completed, will be the largest in France, and one of the largest in the world. It is to be 1,020 feet long, with 111 feet width of entrance, and will accommodate vessels with a draft up to 44 feet. The dock will be emptied in four hours by eight electrically driven centrifugal pumps, each with a capacity of 6,000 cubic feet per minute.

*nauticus* 9/30/22  
 Copyrighted material



*I. M. George & Sons  
Snap Flourery,*

862  
483 *W. Winchester, Va.* POPULAR MECHANICS

**WASTEFUL ICE PICK REPLACED  
BY POWER-OPERATED SAW**

An electrically driven saw has been developed to meet the demand for a quick

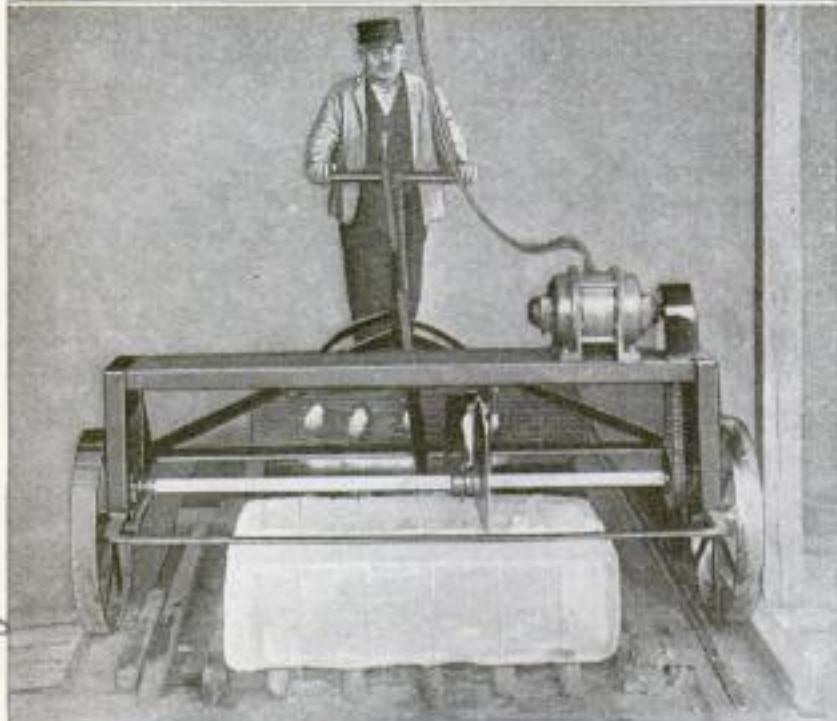

This Motor-Driven Saw Cuts Only About Halfway through the Block of Ice, Leaving It as a Unit, Yet Divided into Cakes of Any Desired Size, Thereby Reducing the Melting Loss during Delivery

and efficient method of cutting ice into pieces for retail trade. A circular saw slides on a square axle and is adjusted to the desired size of cake, by the operator with a hand lever. The saw cuts little more than halfway through the cake, leaving the block as a unit until ready to be taken from the delivery wagon, when a pick inserted in the saw cut easily removes the desired amount. Keeping the block as a unit, reduces the melting loss during delivery. The outfit can cut 10 to 15 tons an hour.

**COKE COOLED IN CLOSED TANK  
BY NONCOMBUSTIBLE GAS**

According to a new process for cooling coke, devised at a Swiss engine factory, the glowing coke is transferred from the retort to a closed tank, through which a stream of gases not supporting combustion is passed. The heated gases then deliver their heat to a steam boiler directly connected to the tank, and are recirculated through the coke until it is cool enough so that it will not ignite when exposed to the atmosphere. This method is said to involve little expense,

and to improve the quality of the coke as well as utilize considerable heat which would otherwise be lost. One ton of coke cooled in this manner is reported to yield sufficient heat to generate steam equivalent to over 25 boiler horsepower.

**SOLDERING IRON  
CHEMICALLY**

62 HEATED

A small soldering iron just introduced into this country from Germany, is supplied with heat evolved from the reaction of a mixture of chemicals. A tin box holding a measured quantity sufficient to last 10 minutes, is placed in a cavity cast in the head of the iron, and the mixture is ignited by means of a special match inserted through a hole in the lid. The resulting reaction produces an intense white glow, sufficient to heat the iron ready for use in seven seconds. It is

not expected to replace the iron and torch used by mechanics, but to be a handy device for workmen who have to make quick repairs. The idea is on the order of the thermit-welding process, although it is understood to have an improvement in that the proportion of chemicals to produce a given amount of heat has been determined. It is planned



This Soldering Iron is Supplied with Heat from the Reaction of Chemicals

to extend the application of this principle to many other interesting purposes.

921 *International Sales Co.  
Southern Bldg.  
Washington, D. C.*

*Germany.  
St. Cajuli Market, Hamburg 4.*



## SALVAGING A U-BOAT TO SINK IT

By EDWARD G. MAXWELL

*Box 1057, Norfolk Va.*

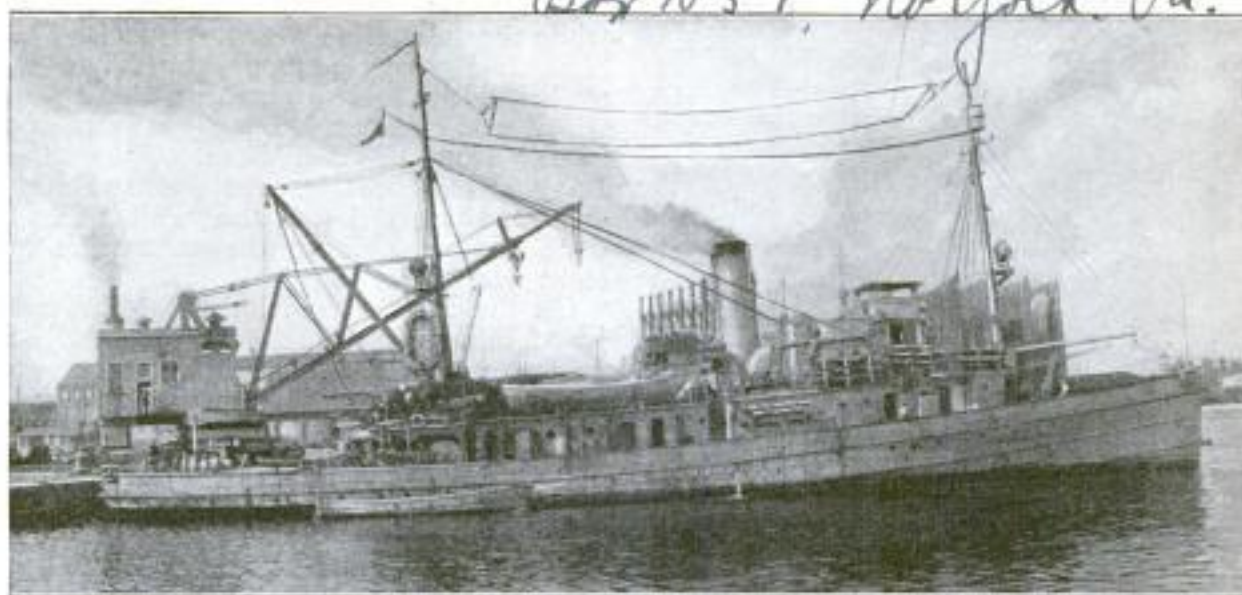

The United States Ship "Falcon," the Navy's Salvage Ship, which is equipped with the most modern devices and is manned by a crew of experts, selected from the whole personnel of the Navy

**T**HOUGH equipped with the most modern devices for raising sunken vessels and manned by a crew in which are specialists drafted from the whole navy, the U. S. S. "Falcon," the navy's salvage ship, was two months in floating the ex-German submarine "U-111" which once attempted to cheat the executioner. The teredo, aquatic auger of southern waters, was to blame.

The "U-111" was brought to the United States, following the

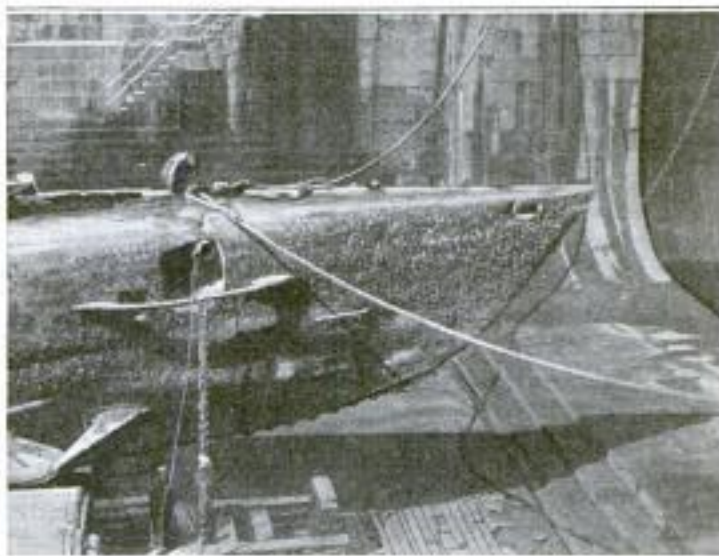

Above: Barnacle-Covered Prow of the Ex-German Submarine "U-111," as It Lay in Drydock. Left: The Submarine in Drydock at the Norfolk Navy Yard, Where It Was Completely Dismantled to Discover Its Secrets

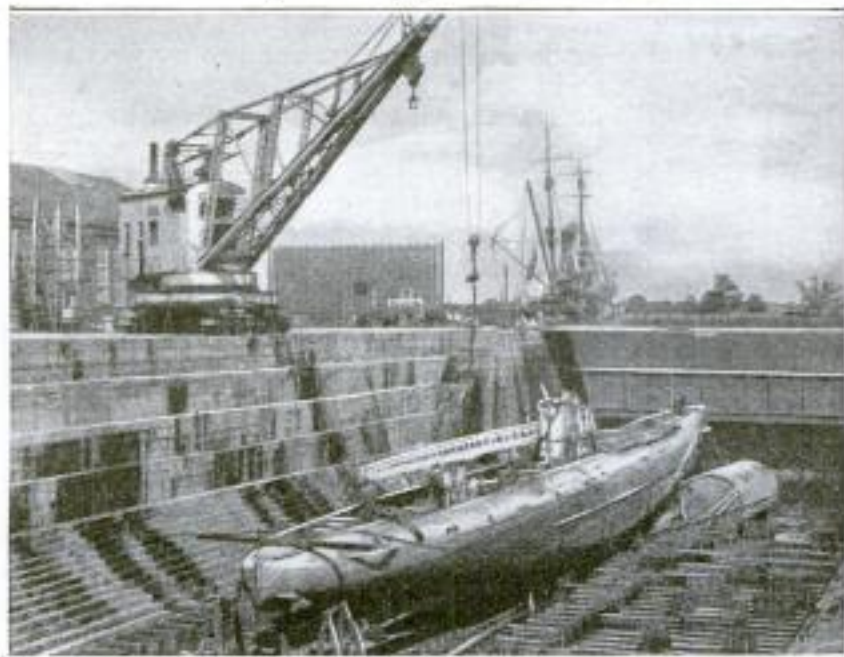

armistice, with a number of other war vessels which had flown the kaiser's flag until turned over to the allies at Scapa Flow. It was taken to the Norfolk Navy Yard, where the men who design American fighting craft pried around inside it to find out what made the German undersea fleet the terror of the world. In their quest for structural secrets they removed all



Missouri Farm  
Nov 9/13/22

pipe and with wooden plugs stopped up the holes where the pipe went through



Commander of the United States Ship "Falcon," Standing on the Deck beside the Conning Tower of the Ex-German Submarine "U-111"

the hull. There were 80 outlets, altogether.

Nearly two years ago the "U-111," which was a commerce raider during the war, was towed out from Norfolk in company with the other ex-German vessels, to be sunk in deep water in accordance with the treaty terms. Its companions were destroyed, as scheduled, by bombs dropped from naval airplanes, but the "U-111," a stubborn craft, sank in 40 feet of water while being towed to sea.

The navy knew that the grave into which the submarine had cast itself was not deep enough to satisfy the treaty provisions, but the "Falcon" was busy on other assignments, and it was nearly 18 months before the salvage ship, a converted minesweeper, was ordered to raise the last of the ex-Germans. The sinking of the submarine in shallow water, it was thought, was due to the slipping of one of the wooden plugs, and the "Falcon" was expected to meet no difficulty in again plugging the hole and pumping the craft out so that it would rise. The existence of the teredo was ignored in these calculations.

But during the time the "U-111" had lain on the bottom, the teredo, which is a sort of shellfish with an unappeasable

appetite for wood, had cut into sawdust, to the last plug, the 80 stoppers put in while the submarine was in drydock. The "Falcon's" crew, among whom are 18 skilled divers, had to patch up something which was far from being a boat and not so far from being a sieve. When the Navy Department learned the true conditions, all agreed that the "Falcon" had done well in floating the submarine in eight weeks.

On the surface again, the "U-111" enjoyed but a short life. As soon as the patches put in under water by the divers were strengthened to prevent a recurrence of the first accident, the "Falcon" towed it offshore and sank it, with a mine, out beyond the 200-fathom line.

636

**IMPORTS INDICATE GROWTH OF SOY-BEAN INDUSTRY**

The rapid growth of the soy-bean industry is shown by the increase in the value of soy-bean oil imports which was \$635,882 in 1913, and \$25,280,085 in 1920. In the past, most of the soy-bean oil imported has been used in the soap industry, but it can be used to replace, in part, linseed oil in the manufacture of paint, and it is regarded by many as superior to linseed oil for mixing enamels.

471

**LUMINOUS DEVICE AIDS NIGHT LANDING OF AIRPLANES**

An English firm has developed an automatic ground-wind indicator for use on emergency and other landing fields where there are no attendants. It is built in the shape of the letter "T" in a form approximating that internationally agreed upon to indicate landing zones, and has a rudder causing it to head into the wind. The three vanes are mounted so as to receive upon their upper surfaces light projected through the lenses fitted around the light source, which is derived from a gas supply sufficient to last six months to a year.



This Landing-Field Indicator can be Seen from Normal Flight Heights, at a Range of Five Miles by Day and 12 Miles at Night

Accumulators & Gas Co. Ltd.  
Beacon Works, Brentford, England.



# COMMENT AND REVIEW

[These pages were printed October 25, 1922.]

**T**HE 192-foot Army dirigible, the "C-2," which, starting at Langley Field, Va., flew to San Francisco, and returning had reached San Antonio, Tex., was destroyed by fire as it was about to make an exhibition flight. The ship is a complete wreck, with no salvage whatever. As in some other similar disasters, there is more or less doubt as to the exact initial cause, though none whatever as to the result.

## Another Dirigible Disaster

It would appear that on taking the dirigible from its hangar the wind proved to be stronger than expected, and an attempt was made to return it to its housing. In doing so "the fabric to which the windward handling guy was attached pulled loose, another handling guy broke under the sudden pressure, and the third handling guy failed," etc.; in brief the bag was torn, the car broke in two, and in 30 seconds the ship was a mass of flame. Most fortunately none of the 11 passengers was killed, though eight were somewhat injured in the jump of 20 feet to ground.

The event affords one more example of the fact that a dirigible must always be a "plaything of the winds," a strictly fair-weather vehicle. In its earlier days the dirigible, which was an adaptation of the balloon, promised to become the leading type of airship.

For efficiency and dependability the heavier-than-air craft has now so clearly demonstrated its superiority that there seems little excuse for spending any more money or effort on the dirigible type. There remain few, if any, functions of which the dirigible is capable which cannot be performed by planes or captive balloons.



**P**ROBABLY the most outstanding accomplishment at the recent aviation meet at Mt. Clemens, Mich., was the flight of Lieutenant Maughan, a U. S. Army pilot, who broke all world's records by flying at the rate of four miles a minute. This means 352 feet, or an ordinary city block, in one second—while you count one, two, three, four! No other human ever traveled so fast and survived to receive the honor so richly deserved. Could this terrific speed be maintained, it would reduce the time between Chicago and New York to two hours 40 minutes. At present such speed cannot be maintained to exceed a very few minutes, which would probably be the life of any engine we have now. What developments may occur in the next few years

## Four Miles a Minute

would be hazardous to predict, though of course there is a limit somewhere to all things made by man.

While the human mind seems obsessed with anything which makes for speed, the practical utility of an excessive rate of travel quickly reaches its limitation. Even the cheaper types of automobiles can on occasion do 100 miles an hour, but 30 or 35 miles is quite sufficient for all ordinary purposes. Excessive speed is too expensive to become common; for instance, there are only a few really fast trains in the world—two in this country—which undertake any considerable distance on regular daily schedule; and even these owe much of their so-called speed to an elimination of the stops made by other trains on the same roads. How many really fast ocean liners? The records made in auto races are impractical in daily service. Without in any way detracting from the glory of accomplishment in breaking world's records—and America holds its full share—the public is more interested in a much less speed which can be depended on under all conditions.

The airplane has accomplished great things when measured by the early efforts of the Wright brothers, but the continuous record of fatalities of which one reads two or three times a week, can only mean that we have much yet to learn in the operation, and probably construction, of planes. These distressing accidents, moreover, are by no means confined to stunt fliers and amateurs, but a majority of them include either fliers in actual Army or Navy service, or pilots with war records; men who have had long and varied experience, and yet who, in spite of all that, come down in fatal crashes of one kind or another. Much has been done, but a lot yet remains to do before flying can hope to become even relatively as safe as speed boats, locomotives, and automobiles. Those who are giving their



efforts and lives to the working out of this problem deserve the greater praise and encouragement, but the layman can be forgiven if it sometimes seems to him, that the progress of safeguarding travel by air since the armistice has been less than he could hope and expect.



**O**N a recent Sunday, almost within the limits of a single city, eight people were killed in automobiles at four grade crossings of railroads. Almost daily, the papers describe similar accidents in all parts of the country. The annual list grows into hundreds.

*Grade-Crossing Accidents*

The automobile has become indispensable, and with something like ten million cars in service, it is inevitable that thousands of drivers are either careless, too venturesome, deaf, have poor eyesight, or possess one or more of a score of weaknesses which sooner or later lead to accidents. Familiarity with any danger breeds contempt, and the driving of an automobile is no exception. It is obviously of little use to talk of punishment to drivers who take reckless chances at grade crossings, for sooner or later they are killed and their cars utterly destroyed. Unfortunately they usually carry passengers who have no voice in the control of the car and who also lose their lives, because of somebody's mad desire to cross a railroad track ahead of a train. It might help some if all automobiles were required to come to a full stop before crossing a track, but the observance of the rule would after all have to be practically a voluntary one, for the majority of unguarded crossings are in the country. Railroads have a rule about stopping a train before it crosses another railroad, or passing over a drawbridge, and although there are thousands of trains making such crossings daily, accidents at such points are extremely rare.

In England highways are not permitted to cross a railroad track at grade, and usually are carried overhead. Moreover, it is a trespass for any but employes to walk upon a track, a law which is strictly enforced. The result is, accidents that are constant here, seldom occur there. It would be an incredible hardship to expect our railroads, with their hundreds of thousands of highway crossings at grade, to provide bridges to carry vehicle traffic overhead, but it would seem that each state might set aside a part of the immense revenue it receives annually in license fees from automobile owners to safeguard such crossings, selecting the most dangerous places first, and each year constructing as many as possible.

Cement has now lessened the cost and difficulty of such construction, and as the years go on, the safeguarding would grow to really worth-while proportions. In the meantime it behooves all who tour in cars to not only "Stop, Look, Listen," but be sure they both see and hear before proceeding.



**T**HE "Association of Tropical Medicine" is a German society devoted to the study of diseases peculiar to the tropics. At its recent convention in Hamburg the announcement was made of the discovery of a cure for sleeping sickness which seems so unusually promising, as to give its possessors the belief that they have the "Key to Africa." It was also urged that Germany should demand the return of its African colonies as the price for giving the cure to the world.

*Cure for Sleeping Sickness*

Fortunately, this selfish position is not likely to prove very successful, as French and English scientists are also making such good progress along the same line that the secret is not nearly so exclusive as the society believes. The other countries can be depended on to give a discovery of such tremendous importance freely to the world.

H. H. WINDSOR





**FLOATING CRANE UNLOADS  
494 EXPORT LOCOMOTIVES**

**TRAVELING LAMP ILLUMINATES  
LATHE WORK**

In unloading a shipment of electric locomotives, recently received at Santos, Brazil, from the United States, it was necessary to resort to the use of a floating crane because the ship could not anchor close enough to permit the use of the wharf crane. Although there were some fears about the ability of the crane to handle the heavy loads, the bodies and trucks of the locomotives were successfully transferred from the ship to the wharf some distance away. There the parts were loaded on flat cars and hauled to their destination, where they were reassembled and immediately put in service, apparently none the worse for the long journey. The

A simple device has been designed to provide constant and adequate lighting

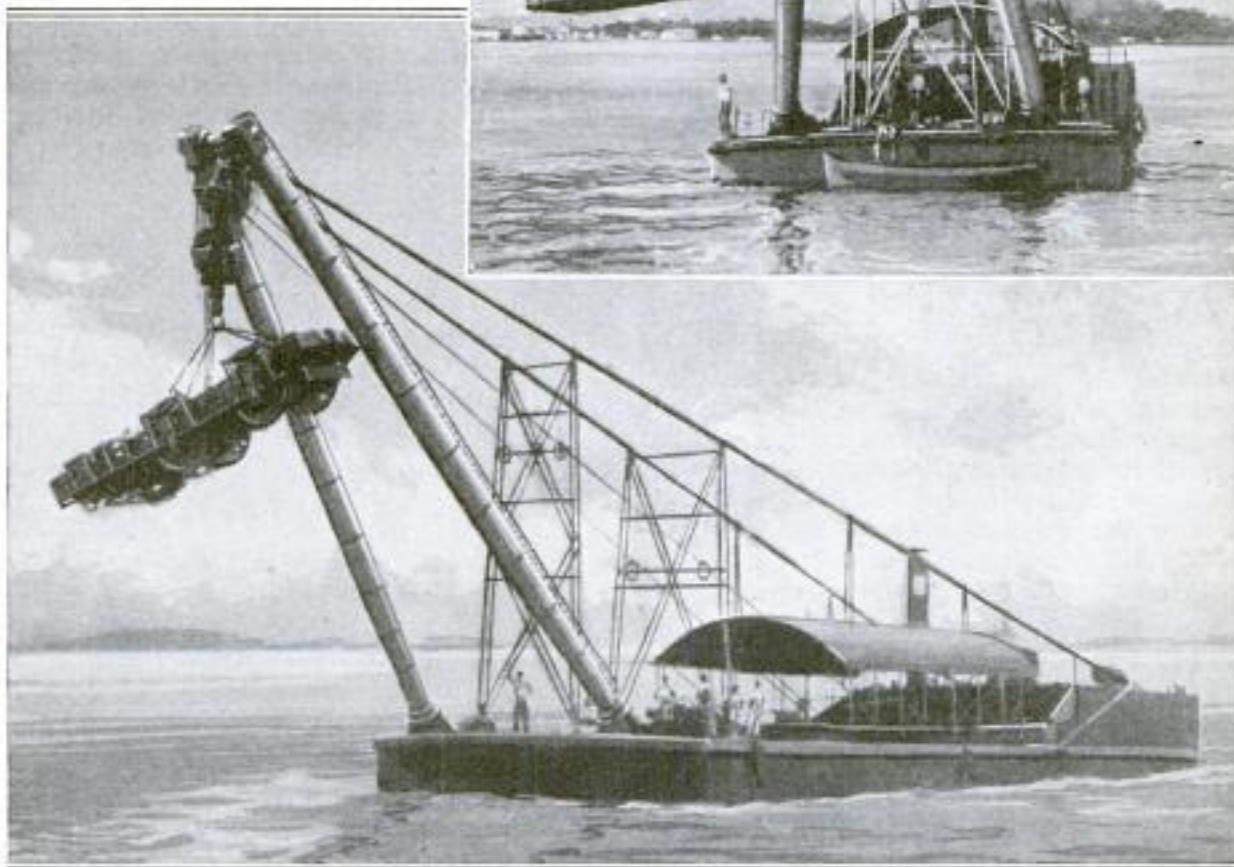

Above: Floating Crane Holding the Crated Body of an Electric Locomotive Just after having Lifted It from the Deck of the Ship. Below: Floating Crane Carrying a Truck of One of the Locomotives to the Wharf

bodies of the locomotives were wrapped in waterproofed paper and securely crated before leaving the factory, and, as they could not be passed through the hatchways, made the sea voyage lashed to the deck of the ship.

for the benefit of mechanics who have to do machine work on a lathe. The lathe carriage is fitted with a spring-controlled reel, from which a flexible twin conductor cord is unwound as the carriage travels toward the tailstock.

*The Electrician 9/29/12*



Heinrich Ernemann  
 Ach. Ges. für Camerafabrikation  
 Schandauerstr. 48  
 868  
 Dresden Germany

POPULAR MECHANICS

SMALL FOREIGN-MADE CAMERA  
 POSSESSES ULTRA-SPEED

830

All the improvements of the large high-speed cameras are incorporated in a small foreign-made camera, which takes a plate

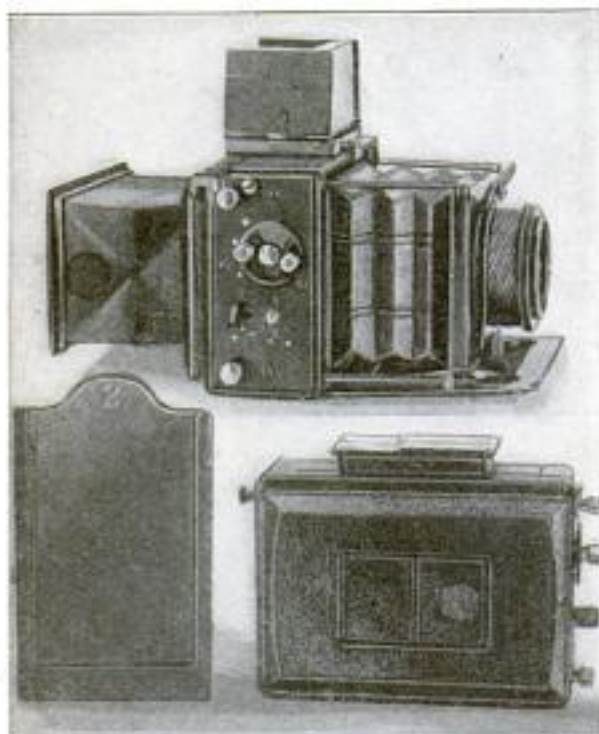

Top: Miniature Ultra-Speed Camera, Shown Ready for Operation. Lower Left: Plate Holder of Camera. Lower Right: Camera Closed

only 2 by 3 inches in size. The miniature outfit is equipped with a focal-plane, or curtain, shutter. This is an unusual departure for a little camera, as most appliances of this kind have the ordinary shutter that opens from the center. Another feature of the tiny product is the incorporation of a ground-glass plate on which the subject may be centered, instead of the common method of using the meter or range finder.

RADIO LOOP AERIAL USED  
 IN STEEL TRAIN

63

Radio messages were received on a loop aerial set up in the steel coaches of a train en route between New York and Chicago, recently. This event marks an epoch in the development of wireless. Hitherto, the reception of all radio messages on speeding trains has been accomplished by the aid of outside aerials, or antennæ, strung along on top of the coaches. The new equipment consisted of a tuned 18-inch loop aerial, three steps of radio-frequency amplification, vacuum-tube detector, and two steps of vacuum-

N.Y. Times 10/14/22 P. 1

tube frequency amplification. During the trip, an entire 45-minute concert was heard from Newark, N. J., a ship was "picked up" on Lake Superior, and while at a distance of 200 miles from Chicago, the operator successfully tuned in to the Great Lakes Naval Station.

BRITISH SAILPLANE SOARS  
 FOR NEARLY TWO HOURS

Captain Raynham remained in the air with his glider for 1 hour 53 minutes in a gliding contest near Lewes, England, on October 17, and he was at times 300 feet above his starting point. He was as much surprised as the spectators, for he had entered the meet with a little monoplane fitted with temporary controls which the duration of the flight taxed his endurance to hold.

N.Y. Times 10/18/22 P. 3

VALVE GRINDING IN GARAGES  
 WITH SPEED AND ACCURACY

564

Specially useful in garages and service stations is a new valve grinder that, with two individual motors, is entirely self-contained, and occupies a space of only two square feet. A ball-bearing motor drives the grinding wheel at a peripheral speed of 5,300 feet per minute. The other motor drives the work head, and with this combination each valve and seat can be re-ground in about two minutes. The work head holds the valve firmly, and guides it so that it is ground at the correct



Valve Grinder with an Individual Motor for the Six-Inch Grinding Wheel, and Another for the Work Head, the Whole Occupying a Space of Two Square Feet

angle. The reamer for the valve seat is ground by the machine also to exactly the same angle as the valve, assuring a good running fit. The machine is furnished with one chuck, one reamer attachment, and one truing diamond.

Fleming Machine  
 Springfield, Mass.



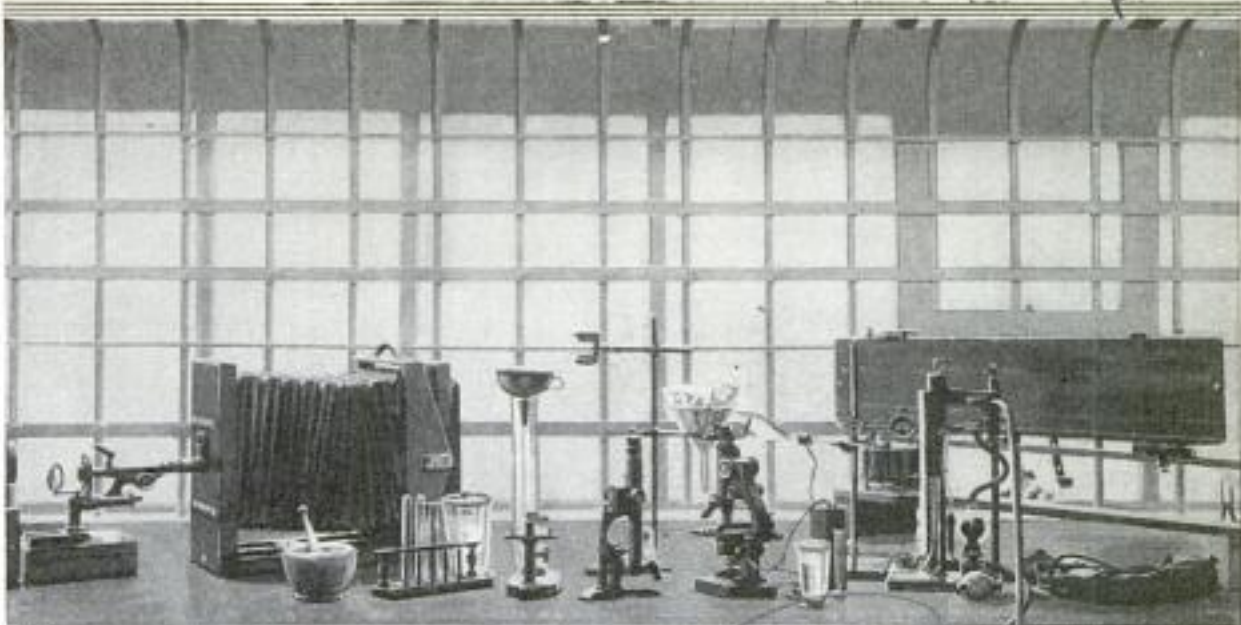

## SCIENCE BECOMES POLICEMEN'S FIRST AID

By JOHN ANSON FORD

*4 16 Union League Bldg.  
Los Angeles, Calif.*

**B**ELIEVING that the work of a policeman is a technical profession and not a "job," and that the proper application of science and education to police problems will effectually prevent "crime waves," the police department of the city of Berkeley, Calif., has made a remarkable record in recent years in crime control and crime prevention. By the establishment

of a police school, by the introduction of such instruments as an especially designed "lie detector," the microscope, and wire-

less telephones, this remarkable group of police officers, under the guidance of Chief August Vollmer, have actually reduced crime percentages in their city during a period when many other growing cities were suffering from "reigns of terror" and ap-



A Prisoner being Tested by the "Lie Detector," Which Records the Variations in Heart Action and Breathing, as the Suspect is Plied with Questions



Graphic Record from Lie Detector: Top Line Represents Breathing, Second Line Blood Pressure, and on the Bottom Line is Indicated the Instant of Asking Each Question. Note the Irregularities in the Lines Which Indicate That Questions 10 and 12 have been Untruthfully Answered



palling increases in murder, burglary, theft cases, and the like.

Chief Vollmer is one of those responsible for the establishment of the state bureau of criminal identification, and is a member of the board of managers. This bureau performs a tremendous service to the law-abiding interests of the state in maintaining "modus-operandi" information files. In accord with conclusions reached after years of study of the subject in Berkeley police circles, Vollmer has been able to confirm and elaborate the interesting theory, known as the modus-operandi system of criminal identification, which is now recognized throughout California. The underlying principle of this theory is that every confirmed criminal unconsciously falls into certain distinctive habits of operation. In other words, every murder, every robbery, or every forgery, done by a confirmed criminal will have certain "trade-marks" which if known and recognized will unmistakably indicate the perpetrator of the offense. As an instance in point, a typical case may be cited. Not long ago the Berkeley police caught a man who had been burglarizing for several months. They were able to fasten 14 crimes upon him because all of the 14 had these characteristics in common: The houses robbed were all homes temporarily unoccupied; the burglar never broke doors or windows, always using a pass key; he confined himself to jewelry and money, and always removed drawers that he searched to a lower front room from which he could keep a close lookout.

Before mention is made of the absorbingly interesting methods employed by this police department, it should be explained that the members of this force are "hand-picked" men. In place of the burly club-swinging individual, regarded a few years ago as typical of the police calling, Chief Vollmer has gathered about him clean-cut, intelligent men, more than half of whom have had some college training.

Some of the work of these men reads like fiction. During the war, for example, a rooming house occupant disappeared. Because he was suspected as a spy it became imperative that he be located. But so little had he been seen on the premises that no description could be obtained of his appearance or habits.

One of the first steps of the men who set out to find him in the name of the law was to carefully sweep the room from which the man had fled, taking all of his belongings with him. These

sweepings were gathered up with the greatest precaution and taken to the police laboratory for examination. Here the microscope, which Chief Vollmer regards as one of the greatest of police aids, was brought into service. One by one the tiny fragments of material in that handful of carpet sweepings was put under the powerful magnifying glass and studied until each had been definitely classified. The task was one requiring the greatest skill and a knowledge of how thousands upon thousands of different substances look under the microscope.

The Berkeley police department maintains a course of study for all of its men, and one of the subjects in which many of the officers specialize is the use of the microscope. When they have finished the course they can identify a hundred different kinds of fabric, human and animal hair, blood from humans and animals, scores of different wood fibers, chemicals and metals in their various forms, and even the particles of dirt that collect under the finger nails (often a most important piece of evidence).

It was such expert knowledge that was brought to bear on the sweepings from the rooming house, and when the analysis had been completed, here is what the investigators deduced: The room had been occupied by a middle-aged man who wore a gray suit and gray felt hat; he wore a beard which was partly gray and was kept neatly trimmed in Van Dyke style; he was a man of neat appearance and of some leisure; his pastime was making excursions into the country on foot, and he might be designated as an amateur botanist.

At first thought it seems almost unbelievable that so much could be safely deduced from floor sweepings. But fortunately the analysis of the evidence in this case is such that even a layman can understand and appreciate the methods and logic of the police. The fact that the deductions eventually led to the arrest of the individual sought, gave opportunity to verify their accuracy. They proved to be correct in practically every detail. The kind of suit and hat worn by the alleged spy were determined by gray-wool threads, and animal hair found in the sweepings. The former were recognized as having come from men's suiting, and the latter as part of the "fur" used in making a felt hat.

The personal habits of the individual, his approximate age, and the style of his beard were revealed in a microscopic study of particles of hair found on the



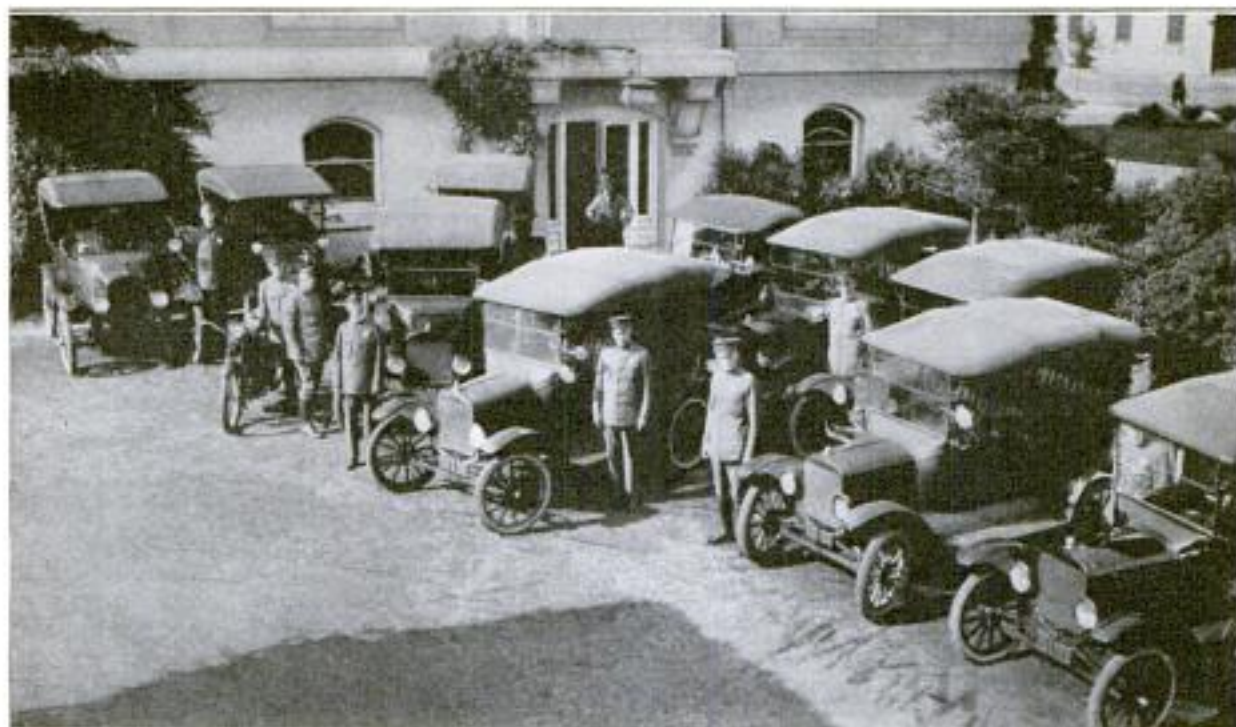

These Cars, Parked in the Courtyard of the Berkeley Police Station, Are Part of the Fleet Used by the Officers in Traveling Their Beats, for Each Officer Covers His Assigned Territory in an Automobile Instead of on Foot

floor. These police have made a special study of hair, and by the diameter of a specimen, the condition of the pith, etc., can tell the sex and age of the person from whom the hair was taken. The thickness of these hair fragments showed that they came from the beard; the finer ones from the cheeks, and coarser ones from the chin. A study of lengths and the angle of the cut plainly indicated that the man wore a Van Dyke beard. The fact that the hair ends were freshly cut and not frayed, showed that the beard was trimmed frequently and not allowed to become irregular and untidy. Since a well-barbered man is almost certainly a neat individual, the police safely deduced that this man was of neat, cleanly habits; while the quality of the cloth in his suit showed that he was well dressed.

In studying other particles in the sweepings, the investigators were taken into a decidedly different field of microscopic analysis. The two things which led to the conclusion that this escaped roomer made trips into the country on foot and was an amateur botanist, were

fine particles of soil and mold, together with a large variety of pollen. The soil particles, these experts recognized as coming not from city streets but such as one would accumulate on the shoes while tramping through fields and forests. The mold particles, once identified, led to the



Berkeley Police Car Fitted with a Wireless-Telephone Outfit, with Which It is Expected Each Car will Shortly be Equipped: Note the Receiver on the Head of the Officer. The City of Berkeley is Reported to Have the Only Completely Motorized Police Force in the United States

same conclusion, while other tiny bits were found, under the microscope, to be pollen. The clever policemen went even further and identified the pollen as coming from a number of different wild flowers, not from hothouse blooms. Hence their deductions.



But the microscope is not the only piece of scientific apparatus employed. While not the only police department employing such a device, the Berkeley police have been among the first successfully to utilize an apparatus called the lie detector. The scientific name is the cardio-pneumo-psychograph. The Berkeley apparatus is distinctive from any other apparatus used for a similar purpose and probably has been more extensively employed, having been used in more than 500 actual criminal cases. In not a single instance has it failed to record the fact when a suspect has told a falsehood.

Briefly, the lie detector, by means of sensitive needles, makes a graphic record of a subject's respiration and blood pressure while answering a series of questions, some of which relate to the crime under investigation and some entirely irrelevant. So accurately is this instrument timed that it reveals exactly the lapse of time between questions and answers. It will show the slightest increase in heart action and respiration, regardless of the outward calm of the subject. Admittedly it requires an expert to operate and interpret this instrument and its record. One physician with the research bureau of the Berkeley police school, is such an expert. He never yet has failed to detect when a heart flutter of a subject indicates that he or she is telling a falsehood, and when it is merely natural excitement due to being questioned. What the psychoanalysts call a mental "complex"—a mental disturbance due to conflicting emotions, such as that of fear of detection, or the effort of the mind quickly to formulate a falsehood in place of a truth that normally rises first in the thoughts—such complexes make record on the detector chart that an expert recognizes as unmistakable evidence of falsifying.

In view of the remarkable accuracy of this instrument, Chief Vollmer believes the day will come when its reliability has been so definitely established that its records will be admitted into court as legal evidence. At the present time it is employed in the private examination of prisoners, and is invaluable in giving the police "leads" in the solution of various crimes.

Still another instance of the use of scientific methods is found in this police department's improved method of classifying finger prints. The usual practice is to file the prints of all prisoners by basing the classification on the five or 10 prints of the fingers and thumbs taken as a whole. By the new system, which has

been worked out by Dr. J. A. Larson and R. A. Abbey, each separate finger print is given its own classification, and when a single print or even a portion of a single print is brought to the police from the scene of a crime, the department can tell immediately whether or not it has the prints of that individual on file. The obvious advantage afforded by this more comprehensive system of classification has resulted in identifying the perpetrators of many crimes who otherwise would have escaped.

Another modern innovation in police methods is the use of automobiles by all of the Berkeley officers. None of the men travels his beat on foot. While in a large congested district police patrolling by motor car would not be practical, the Berkeley method is capable of wide adoption, particularly in residential and manufacturing districts. These "mounted" officers cover ten times as much ground as when they traveled on foot and do it with less fatigue. At certain points on each beat the officer "dismounts" and explores an alley or mounts a stairway on foot, thus keeping as careful a watch of the hidden corners as under the old system.

Within a short time it is expected that each policeman's car will be equipped with a radio-receiving outfit. This will enable headquarters to keep in touch with its men at all times, and in case of a sudden need for men in any quarter of the city the commanding officer can start his men on their way without a moment's delay. None has to wait for a street car or patrol wagon, and there are no waits at headquarters due to officers not reporting over the police telephone system.

There are many other ways in which the Berkeley police have utilized science and mechanical devices in making police work a profession. The efficiency of their work is commented on by all who have given it study. Perhaps the best proof of what these advanced methods can do is found in the crime statistics which show a steady decrease in law-breaking, compared with the population. The figures for stolen property are typical of the entire list. In 1909, with a population of 38,000, the value of property stolen was \$19,637; in 1910, population, 40,000, stolen property, \$12,158; in 1914, population, 63,000, stolen property, \$21,492; 1922, population, 75,000, stolen property, \$36,000. These figures are in marked contrast to those of most cities, and yet the showing is even better than first appears, because of the big rise in values of all kinds of merchandise in recent years.





Above: In Preparation for a Hindu Tamil Procession at Colombo, Ceylon, One of the Most Ancient Customs of the Country, the Sacred Elephants are being Bathed before being Clad in Their Gorgeous Draperies. Below: The Tamil Procession in Progress at Colombo, Showing the Native Dancers in the Lead, Followed by Tom-Tom Players

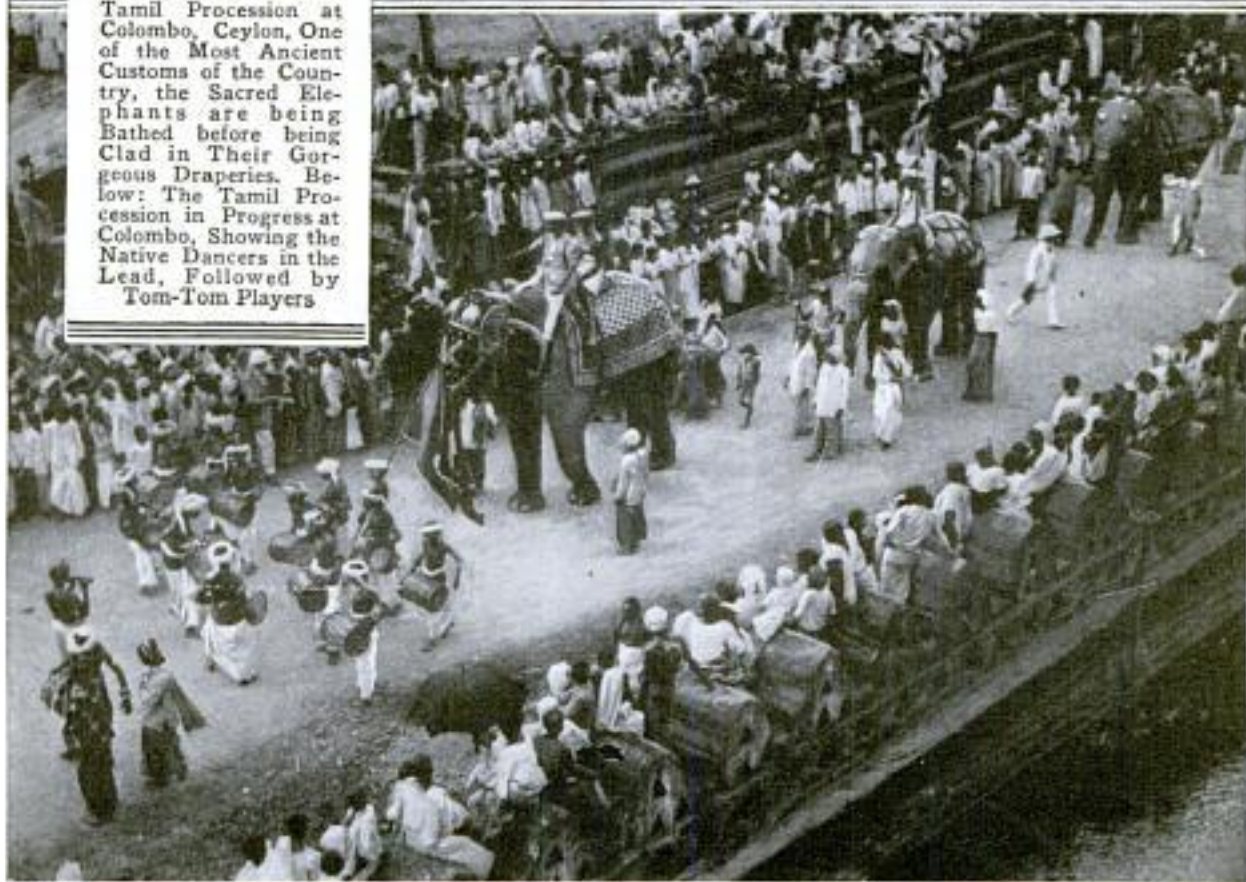



Cmd. H. C. Oetsloff, 130 W. Walnut St.

874

POPULAR MECHANICS

397

### CORK SHIPMENT BURNS AT BRAZILIAN PORT

A cargo of cork slabs, 2 inches thick, 10 inches wide, and 3 feet long, valued at \$36,000, just shipped from Spain to Rio Grande, Brazil, and piled near the docks of that city, was burned recently when, it is believed, a spark from a switch engine near by was carried to the immense pile. The fire department of Rio Grande did not possess equipment adequate to handle a conflagration of such size. In four hours the entire cargo had crumbled to ashes, while 11,000 cement barrels standing close by were also ruined. The cork had been consigned to a cold-storage company and was to be used for insulation in its plant.



Cargo of Cork Slabs as It Appeared While Burning at the Rio Grande, Brazil, Docks, Showing the Laborers Striving to Save as Much as Possible of the Valuable Shipment from the Flames

600

### DOCK IMPROVEMENTS PLANNED FOR SOUTHAMPTON, ENGLAND

A specially large floating dock is projected for use in the harbor of Southampton, Eng., that will be capable of lifting from the water the White Star liner "Majestic," the largest ship afloat. The dock is to have a length of 960 feet, a width of 170 feet, and will be built entirely of structural steel. Other harbor

improvements planned for Southampton are in connection with a proposed deep-water quay in the bay at the entrance of the estuary of the river Test. It is proposed to reclaim an area of 460 acres along the river bank where there will be constructed five jetties, each 1,000 feet long and 300 feet wide. Each jetty will be equipped with double-story transit sheds, fully equipped for rapid transshipment of passengers and cargo.

411

### QUEER IDOLS BROUGHT BACK BY MISSIONARY

Very odd in appearance is a group of African idols recently brought to this country by a missionary. They were carved by natives of Nigeria. One of the group, "Ifa," a queer-looking image with a high-crowned hat, was the principal deity of Nigeria when the missionaries began their work there. Besides "Ifa," the collection includes an odd-shaped club, feared by the natives as the god of thunder and lightning. Another is a brass image, "Oshubgo," a mystical feminine deity who rules over a society of fanatics. In contrast to these, the missionary also secured several crucifixes carved from ivory by Christianized natives.



Collection of Queer African Idols and Christian Crucifixes, Which were Carved from Various Woods and Ivory by the Natives of Nigeria and Brought to This Country by a Missionary

Times Trade Supplement, 9/30/22

Cmd. H. E. Thomas, 911 Shuckley Ave. Portland, Ore.





Test of Safety Venting Device on a 50-Gallon Drum, Containing 25 Gallons of Gasoline, before Government Officials: A Brisk Fire under the Drum Caused the Gasoline to Burn without Exploding

### SAFETY VENTING ATTACHMENT FOR GASOLINE CONTAINERS

A spectacular test of a venting device that safeguards from explosion cans, drums, or tanks containing gasoline or other volatile liquids, was recently made at the Bureau of Standards in Washington. A brisk fire was ignited beneath a 50-gallon drum, containing 25 gallons of gasoline. When the drum became heated, the gasoline, instead of exploding, first blew off a safety cap, and then shot out in the form of a large jet of flame. The safety appliance that is screwed into the bung-hole, or other opening, is fitted with a gauze screen similar to that used in mine safety lamps, thus preventing the passage of flame into the container. This gauze-covered opening is closed with a cap soldered into place with a metal that melts at a temperature lower than the explosive temperature of the gasoline.

430

### TURBINE AND DYNAMO UNITS FOR TRAIN ILLUMINATION

Small enough to be mounted almost anywhere on a locomotive is a compact unit consisting of a direct-connected dynamo and steam turbine, that has been produced in Switzerland to provide for train lighting. In the housing for the turbine, between it and the dynamo, is an

air fan for cooling the shaft bearing at this point, and which acts also as a stuffing box for the turbine. The turbine is very simple, and the steam requires no control, for the air fan acts as a governor, preventing racing, and keeping the speed uniform at all loads. The lamps in the train remain remarkably steady, and there is a very small variation of voltage, no

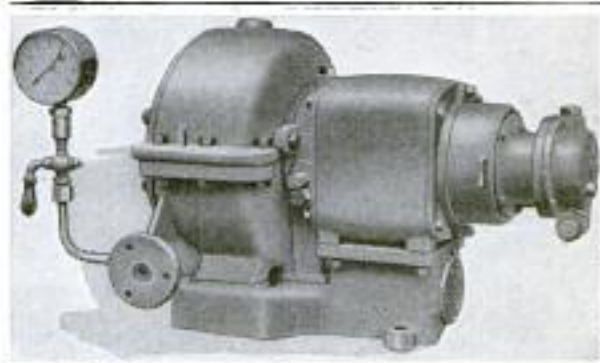

Electric Generating Unit, Showing the Turbine at the Left, Which is Direct-Connected to the Dynamo, with a Fan between Them, All in One Housing

matter how many or how few lamps are in operation.

For use in places difficult to reach with the ordinary screwdriver, a wood screw has been provided that has a square socket in the head, instead of the usual groove. The screwdriver is particularly adapted for overhead work.

*Maschinenfabrik Oerlikon, Aeliers de Construction Oerlikon, Switzerland*

*U.S. Jacob Kohler, London England.*



Com. Harry Seaman  
798 Hunterdon St.

POPULAR MECHANICS

Newark N.J.

*See page 10*



Ruins of the Two Buildings Which Collapsed Because of Excavations being Made underneath One of Them, Showing the Havoc Caused and the Narrow Escape of the Inmates

## TWO BUILDINGS COLLAPSE WITH NO INJURIES

Two four-story buildings collapsed recently, in Newark, N. J., the disaster being caused by excavations under one of the structures. One of the buildings contained a saloon and the other a restaurant. When the workmen detected a slight trembling of the walls, at 8:00 o'clock in the evening, they were terrified and rushed up to the street, shouting a warning. The actual crash, however, did not come until 2:00 o'clock in the morning.

## LEGION MEN LODGED ON TRAINS AT NEW ORLEANS

The provisions made for housing soldiers, sailors, and ex-service men at the annual convention of the American Legion held this year at New Orleans, had one feature which is believed to be an innovation in hotel arrangements. Several hundred specially chartered sleeping cars of the Illinois Central Railroad were sidetracked in one of the company's large yards. Close by, warehouses were fitted with extra lavatories, lockers, shower

baths, laundries, pressing stalls, barber shops, reading rooms, telephone booths, and other conveniences. The regular porter service was further strengthened by a squad of messengers, dining cars were kept going in full blast, and everything possible arranged for the comfort of the guests. For example, a taxi service was maintained to the business and theatrical district. The "hotel on wheels" accommodated more than 3,000 persons.



Regular Sleeping Cars "Parked" in the Company's Yards at New Orleans during the Recent Knights Templar Convention When the Scheme was First Tried Out on a Small Scale: The Heart of the City can be Reached by a Few Minutes' Walk

506  
Blata from Mr. Corbett, Advertising Manager of Illinois Central R.R. d.c. Building, 12th St. Chicago





A Branch Office of a Laundry and Clothes-Preserving Company was Opened in This Stall, Especially Built for the Purpose

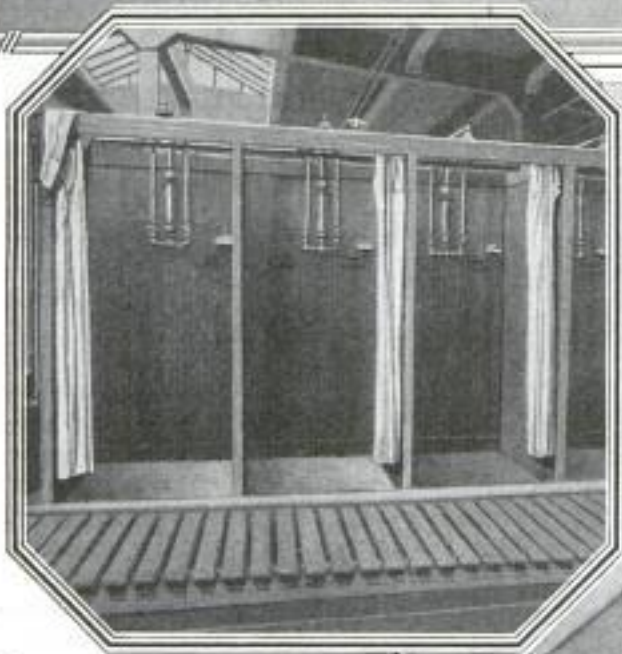

Above: One of the Numerous Groups of Shower Baths Placed So as to be Reached Easily from the Trains

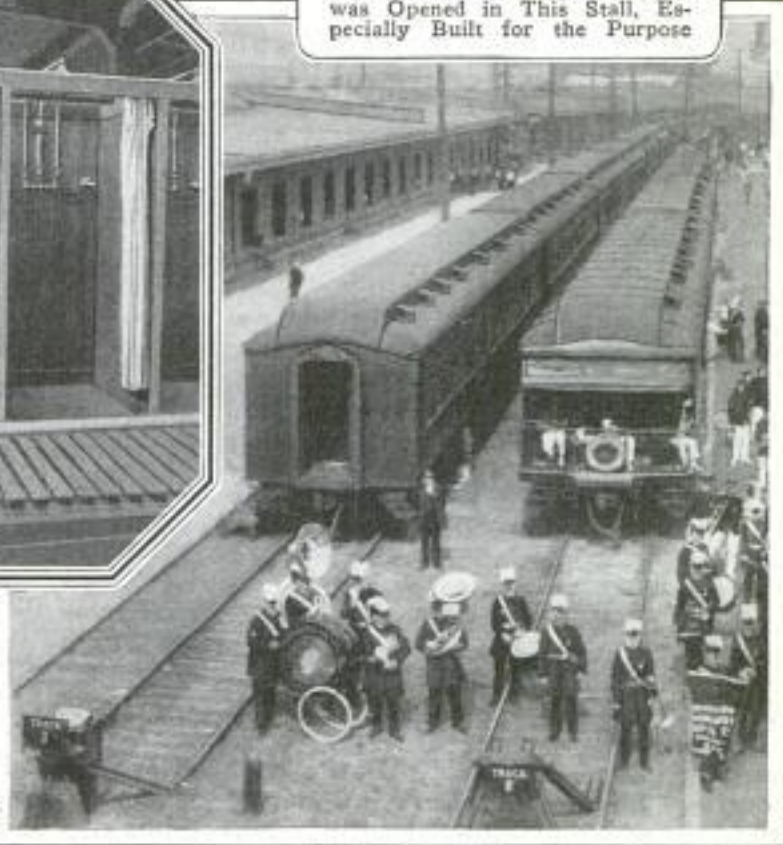

Right: Looking down the Yard, Showing to One Side the Warehouses Which Had Many of the Conveniences of a Large Hotel

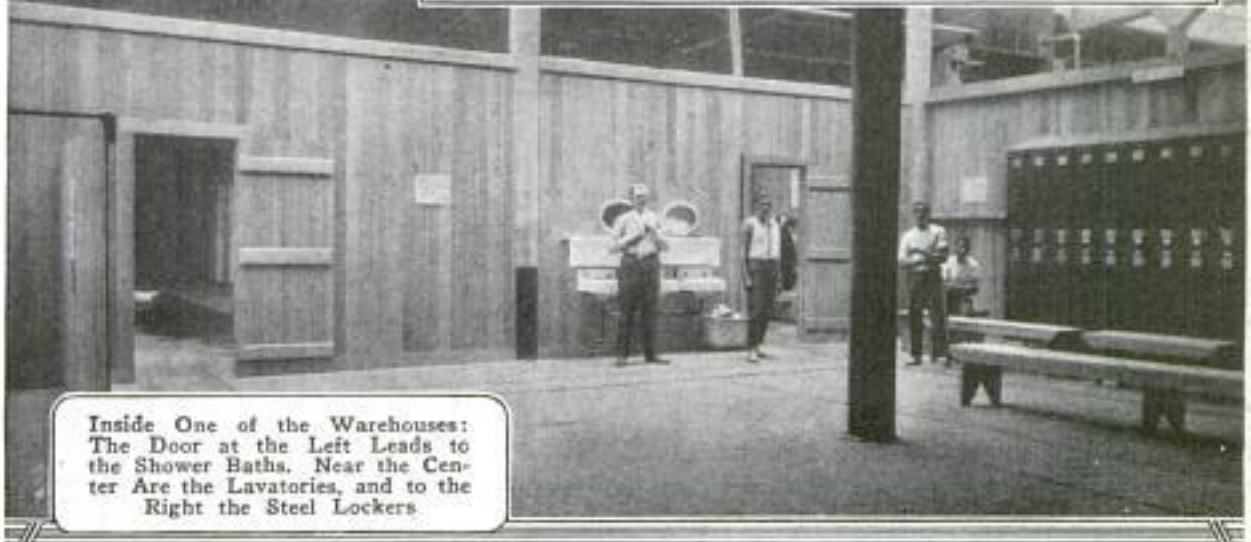

Inside One of the Warehouses: The Door at the Left Leads to the Shower Baths. Near the Center Are the Lavatories, and to the Right the Steel Lockers



Emb. of L. Harbour  
102 Lincoln Ave.

Dr. George Wermelin  
1615 Clarkson St.

878 **POPULAR MECHANICS**  
Fall River, Mass.  
**OLD CAN MADE INTO LANTERN**  
**BY BOYS IN ASIA MINOR**

423

That necessity is the mother of invention is well illustrated by a youth of Sivas, in Asia Minor, who from an old



gasoline can, which would certainly have been discarded in a more prosperous land, has fashioned an ornamental lamp. The top, cut with triangular figures, and bordered with a spiral fringe, is surmounted by a small house which forms a base for the handle. Running down the side are other spirals, while the base section has

also been changed into a series of fancy designs. The lamp is but one of many ingenious articles from bits of scrap made by the boys and men of this country.

**FILM-REWINDING ATTACHMENT**  
**—STOPS MISFRAMED MOVIES**

Movie pictures that become divided on the screen, or get "out of frame," are caused by improper splicing of the ends of cut or broken film. A west-coast inventor now has completed a little machine for overcoming this annoying trouble. An idler sprocket, with a stand for clamping to the table, is placed between

the two film reels in rewinding, and the film is threaded over it and held in place by small rollers. The sprocket has a circumference equal to 18 film pictures, and lines marked across its face to indicate correct divisions between the pictures. When, in rewinding, a splice passes the rollers, the operator is warned by a click, and viewing the splice by the aid of a tiny lamp below, is able to check its accuracy and correct it if wrongly made, assuring a complete reel of film without a misframe. The detector is also useful in making "fade-outs," where the picture has a slowly diminishing border.

207 **ROTATING ATTACHMENT PLUGS**  
**FOR ELECTRIC FIXTURES**

The twisting and consequent breaking of wires attached to electric appliances such

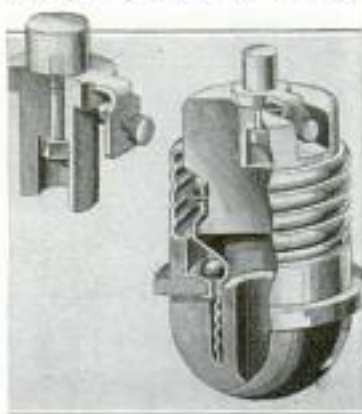

as flatirons, toasters, heaters, etc., is a universal annoyance. To remedy this, an inventor has produced a rotating attachment plug, of which the center portion turns freely when the wires are

twisted, thus keeping them from breaking or pulling loose from the binding screws.

ⓀThe New York post office has decided to reopen the pneumatic mail tubes which were closed four years ago by Postmaster-General Burleson. It is thought that use of the tubes will speed up mail deliveries and at the same time aid in reducing the volume of traffic on the city streets.

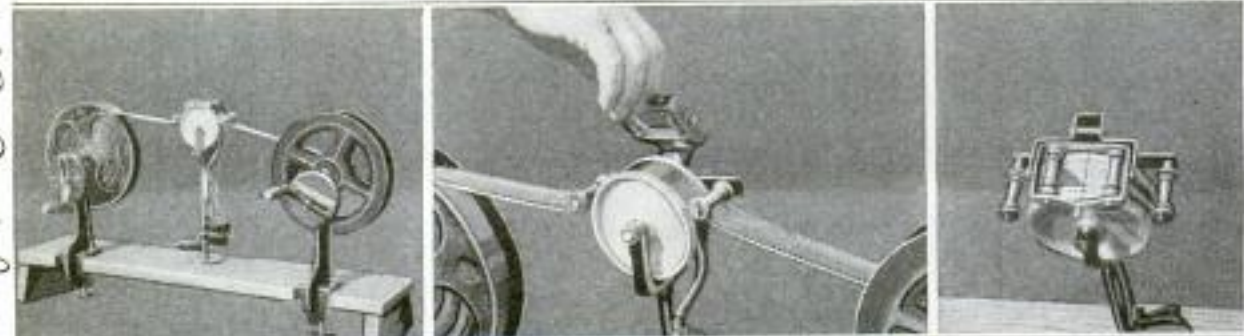

From Left to Right: The Misframe Detector Shown Mounted between the Two Film Reels; the Operator in the Act of Lowering the Clamp That Holds the Film in Place; Looking Down upon the Detector, Showing the Small Rollers That Guide the Film, and the Light from the Tiny Lamp Below

Francisco  
California  
4988  
Wright H. Gibbs  
60 Elgin St. San Francisco

545 Q. Farwell St.



Mr. Aeromarine Plane + Motor Corp., Keyport N.J.

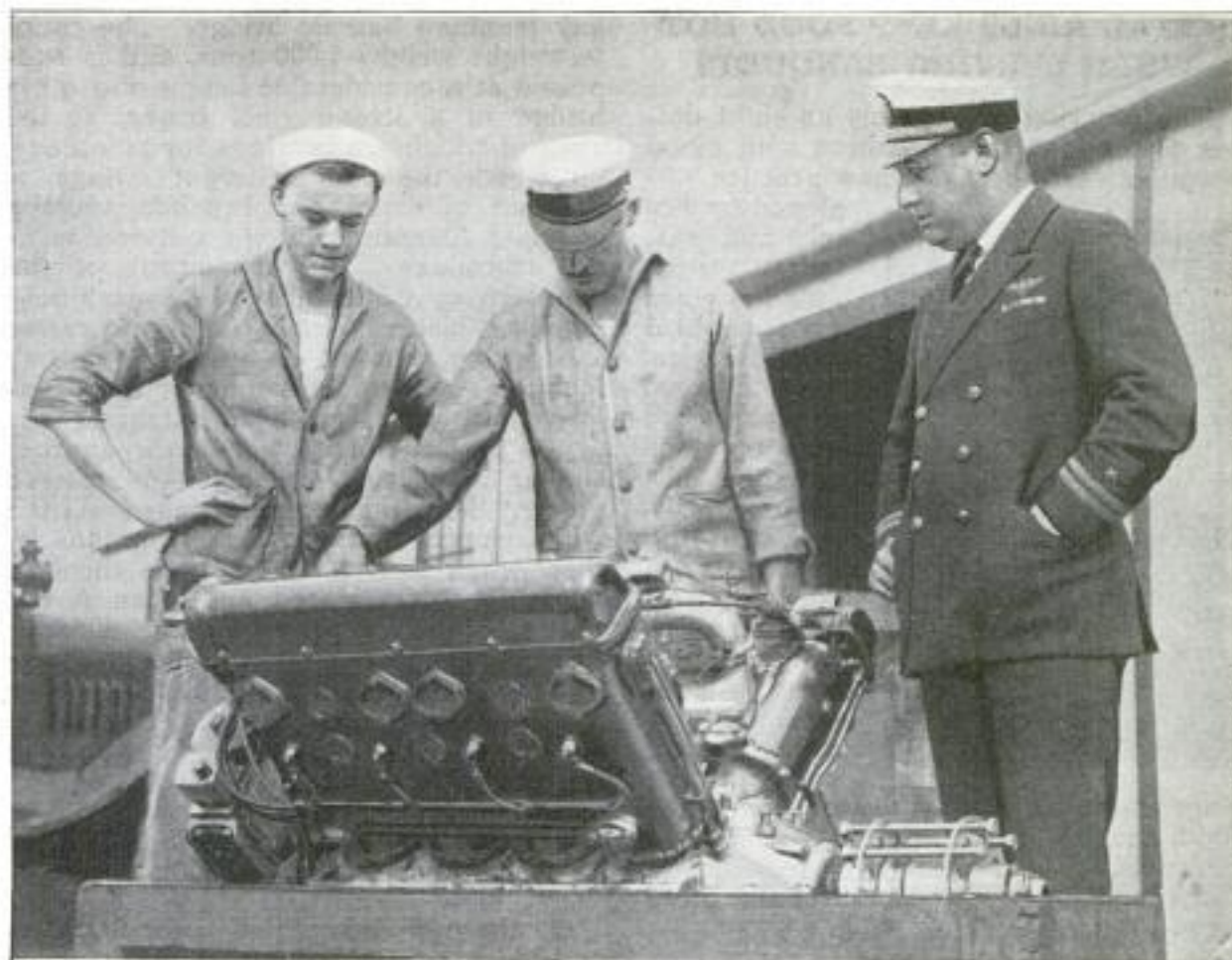

COPYRIGHT, UNDERWOOD & UNDERWOOD

New Eight-Cylinder Air-Craft Engine Recently Tested by the Naval Bureau of Aeronautics: After a Total Run under Load Lasting 300 Hours, the Engine was Found to Be in Perfect Condition

### AERIAL ENGINE ESTABLISHES NEW ENDURANCE RECORD

Realizing that the most important present development in air-craft engines is their durability, the Naval Bureau of Aeronautics recently increased their endurance tests to as much as 300 hours, in three runs of 100 hours each. The purpose of such a long test was to run the engine to destruction, and thus determine its exact length of life. But to the surprise of the bureau, one engine, designed originally for the airship "ZR-1," instead of being run to destruction, was still in perfect condition at the end of the 300-hour test. Experts of the bureau state that this new air-craft engine has established a world's record for fuel economy, as well as for durability. It is, they say, the best air-craft power equipment ever developed. The engine is of the 8-cylinder, V-shaped type, and develops an average horsepower of 175. This would be sufficient to propel a five-passenger airplane at a speed of about 80 miles an hour, which in 300 hours would be equivalent to flying around the world.

### HEADLIGHT CONTROLLER DIMS 488 LIGHTS GRADUALLY

Too abrupt dimming of automobile headlights is a menace to the driver on account of the sudden change from brightness to darkness, and a headlight controller is now being manufactured that enables the driver to dim the lights gradually to any degree necessary. The hands of the driver never being off the steering wheel, a touch with one finger of a lever on the steering post is all that is necessary to dim the lights as gradually as desired. The controller can be installed on any steering post in five or ten minutes, a screwdriver being the only tool needed. It is strongly made and has a highly polished nickelplated finish.



Universal Headlight Controller Co. High Quality  
57th St Broadway New York



Zoia Banquet Co.  
2812 Cedar Ave.

880

POPULAR MECHANICS

Cleveland, Ohio.

METAL RINGS KEEP FOOD HOT  
WHEN SERVING BANQUETS

555

The carrying of as many as eight dinner plates in pyramid fashion with metal rings between them is a new practice employed by hotels and restaurants to insure warm food and quick service.



The rings, about 2 inches high, are made of either aluminum or silver, with top and bottom edges lined with rubber. In addition to being a convenient way of carrying the plates, the

rings form an air-tight wall about the food, keeping in the original warmth and moisture. The system is especially advantageous in serving banquets and other large parties.

BASCULE BRIDGE CONTROLLED  
BY MOVING COUNTERWEIGHT

A new bascule railroad bridge, with a span of 162 feet, across the Rouge River at Detroit, Mich., the first of its kind ever built, has a movable counterweight which controls the raising and lowering of the bridge. In every other respect it is like

any trunnion bascule bridge. The counterweight weighs 1,000 tons, and is supported at a considerable height above the bridge in a strong steel tower, at the apex of which are bearings for trunnions, on which the counterweight swings at the end of connecting brackets radially at some distance from the center line of the trunnions. This movement of the counterweight is controlled by machinery installed inside a cabin on a transverse steel girder, that travels up and down two inclined steel supports moving the counterweight with it. The machinery is driven by a 50-horsepower motor, another similar one being provided for reserve power. Thus the counterweight is shifted with relation to the bridge trunnions so that, when it is directly above them, it holds the bridge closed, and when moved to a position at some angular distance from the bridge trunnions, opposite to the bridge, its downward pull forces the bridge upward, opening it. The tower supporting the counterweight is above the approach, which is 73½ feet long.

NEW LEEWARD ISLAND STAMPS  
DEPICT HISTORICAL ERROR

On the new stamps issued for St. Kitts and Nevis, two of the Leeward Islands in the British West Indies, their discoverer, Christopher Columbus, is depicted with a telescope in his hands. Quite justifiably the French Astronomical Society expresses surprise at such a display of ignorance. As a matter of fact the first practical telescopes were made in Holland more than a century later than the discovery of the Leeward Islands in 1498.



Left: New Type of Bascule Bridge Operated by a Moving Counterweight, Shown Open with the Counterweight Moved Down into the Supporting Tower. Right: The Bridge is Shown Closed with the Counterweight Moved Radially Upward, So That It Hangs Directly above the Bridge Trunnions

American Bridge Co. New York City  
71 Broadway

Postage  
money

H. H. Herald  
10/8/22



*Spartanburg, S.C.*

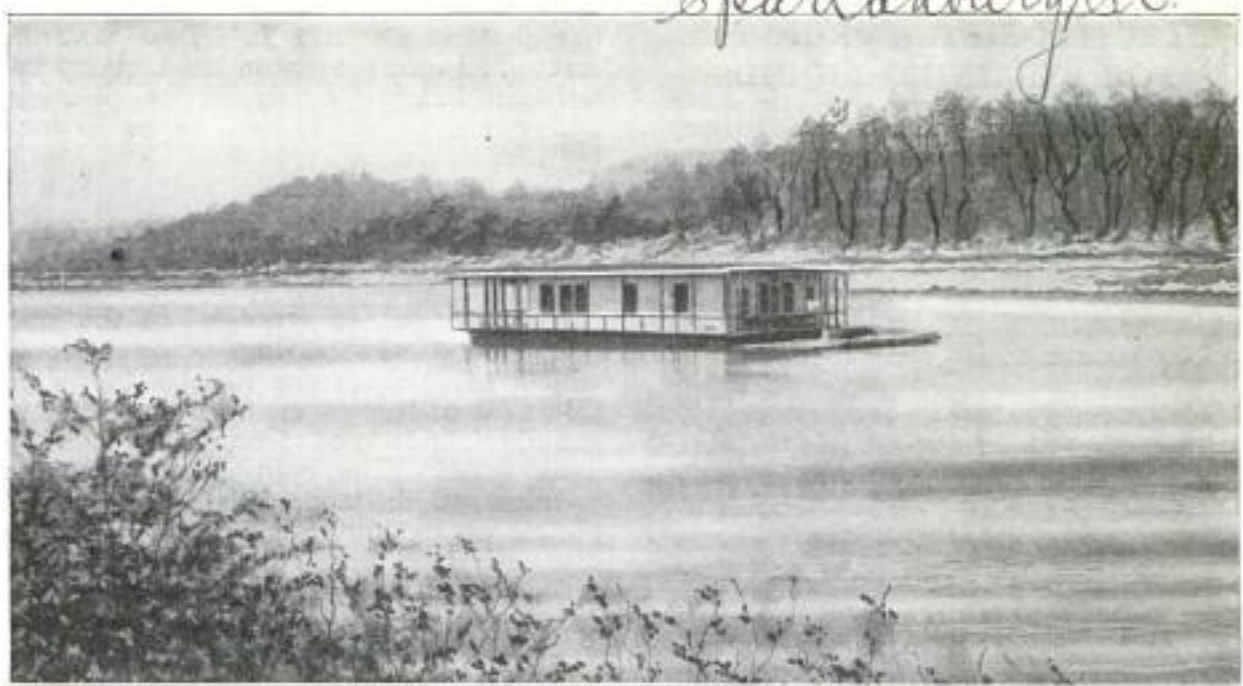

The Employees of a Southern Cotton Mill may Stay a Week on This Houseboat during Their Vacation Period, Paying Only a Dollar for Food and Necessities. The Boat is Owned by the Mill and is Kept on Lake Summit, North Carolina

391  
**COTTON MILL HAS HOUSEBOAT FOR USE OF EMPLOYEES**

For the vacation pleasure of its employes the use of a 60-foot electrically lighted houseboat with six sleeping rooms, a kitchen, living room, and porch, is granted, practically without charge, by a South Carolina cotton mill. Arrangements are made so that each employe may spend a week on the boat, paying for this privilege only the nominal sum of one dollar, which is used for food and other necessities. The boat is kept on Lake Summit, North Carolina, in the beautiful "Sapphire" country, often spoken of as the "Land of the Sky." Excellent recreational possibilities are to be found in this section. The floating home has two large staterooms fitted with bunks, one for boys and the other for girls, while two smaller rooms are for family use. Then there are two rooms for chaperons, a kitchen, a good-sized living room, and a porch which extends all about the structure.

504

**EARLY-DAY BICYCLE RIDDEN ON TRIP TO CHICAGO**

Riding a high-wheel bicycle from Indianapolis to Chicago was the rather exciting task recently assigned to an employe of an electric railway. The trip, made for advertising purposes, consumed eight days, with a convention of electric-railway companies in Chicago as the final stopping place. Procuring the bi-

cycle was not an easy matter, and special tires had to be made before it could be used. But the journey itself was the most difficult part of the scheme. The rider, of course, had to sit quite a few feet from the ground, so that wending in and out of traffic, and spinning down high hills without any brakes, was not without its thrills.



This Old-Time High-Wheeler was Recently Ridden from Indianapolis to Chicago. The Absence of Brakes Helped to Make the Trip an Exciting One

*Indianapolis Street Railway  
Indianapolis, Ind.*



431

### ELECTRIC-SIFTER PRINCIPLE FOR STRAINING LIQUIDS

A manufacturer of a successful electric sifter, which has been used as a sand



Left: Electric Sifter in Use as a Riddle for Molding Sand. Right: Close-Up of Sifter Which can be Inclosed for Liquids

riddle on the molding floor of foundries and for similar purposes, has developed this idea in making a device that sifts out material suspended in liquids. The machine is wholly inclosed except for the half-closed top which prevents the liquid from splashing over, and the delivery spouts for the oversize and the material that passes through the screen.

295

### ADJUSTABLE PISTON CONTROLS COMPRESSION-SPACE VOLUME

For experimental purposes, it is frequently desirable to regulate the volume of the compression space in an internal-combustion motor, particularly in testing with different grades of fuel. A new design of piston combines the head and skirt in one piece, which is internally threaded and provides an easy adjustment with the wristpin and wristpin bear-

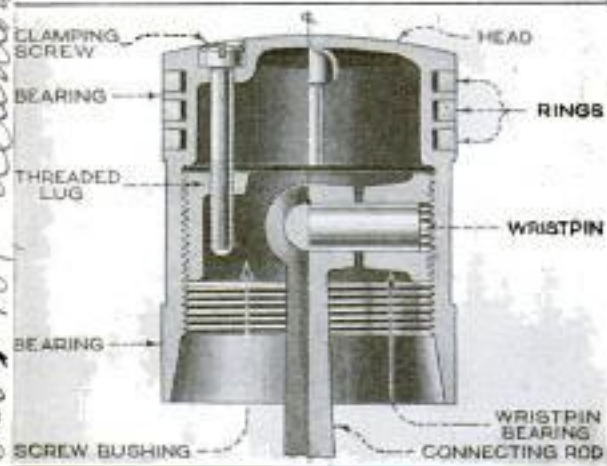

An Adjustment between the Wristpin Holder and the Body of This Piston Makes It Possible to Vary the Compression Space

ing that screw into it. Two machine screws, let into the piston head, clamp the wristpin bearing firmly in its position, which may be varied as little as  $\frac{1}{32}$  inch by a half-turn.

### DIME BANK IN REAR COVER OF NEW SAVINGS BOOK

A dime bank is arranged in the rear cover of a new savings-account book, which, aside from the slightly increased thickness of this cover, does not differ in general appearance from the ordinary bank book. The coin, inserted in an opening at the top, falls into a small pocket on the outer edge of a revolving disk, which is then turned by means of a small knob on the outside of the cover. An opening above the knob shows the



Above: Inserting Coin in Bank; Notice Registering Dial Just over the Knob. Right: A Close-Up of the Book

amount in the bank after each insertion of a coin. To remove the savings, a sealed label is cut by the bank cashier.

### PRECISE CONTROL OF DOSAGE IN X-RAY THERAPY

Precise control of dosage in X-ray therapy is now possible by the use of apparatus that includes a rectifier which is absolutely constant in its form of wave rectification and by which anything from the longest length of wave down to the shortest, may be given. Much of this is due to an improved spark gap. Instead of the pointed, revolving spark gaps seen on the rectifiers of the past, the new outfit contains spherical stationary electrodes, while the revolving electrodes are arc-shaped. An air condenser, in conjunction with a crest voltmeter and a precision milliammeter, is also included. These efficient appliances, which have been mounted compactly in and on a cabinet and control stand, should prove a valuable aid to X-ray work.

J. W. D. Romney, Route 5, Box 187, Allentown, Pa.



350 International X-Ray Corp.  
 326 Broadway, New York City

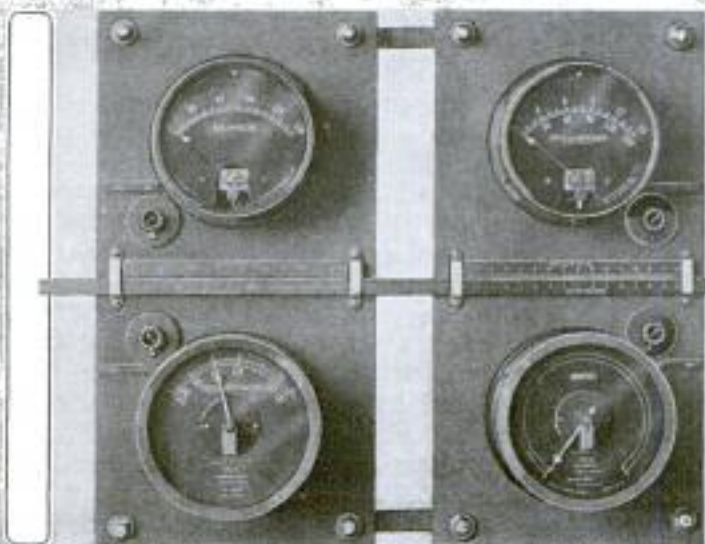
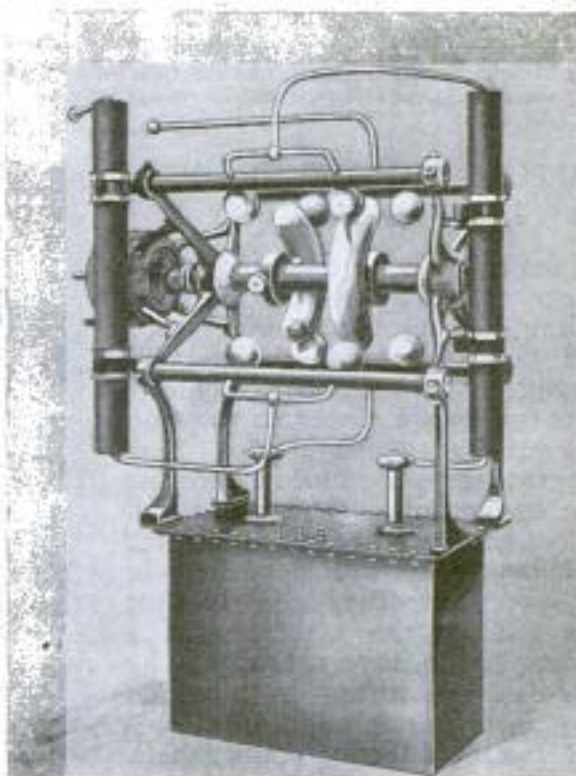
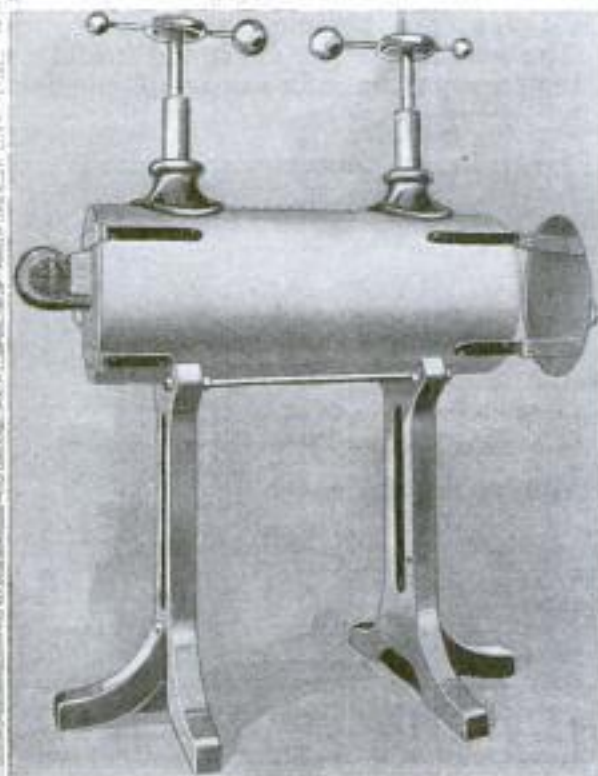
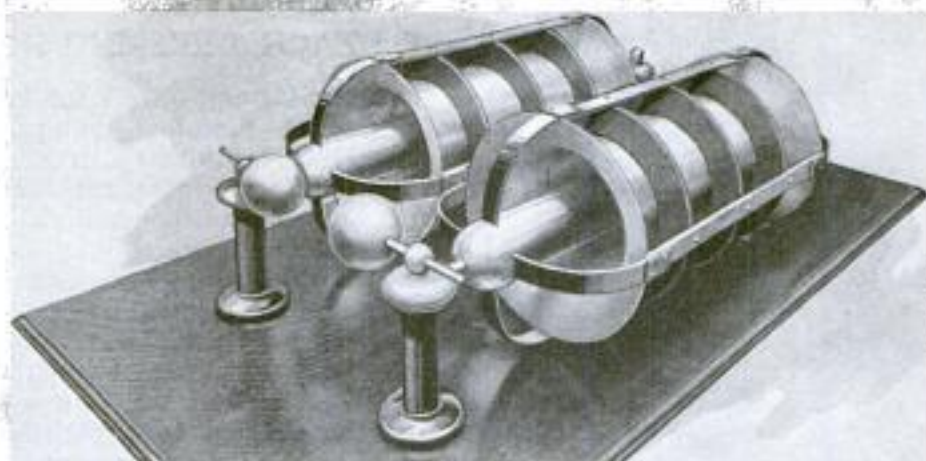

At the Top is Seen the Air  
 Condenser of the Precision  
 X-Ray Apparatus Which Accu-  
 rately Measures the Dos-  
 age

Center Left: Protective Tube  
 Holder Which Confines All  
 of the Intense X-Rays Not  
 Wanted for Treatment

Center Right: Rectifying  
 Unit of the X-Ray Appara-  
 tus, Showing the Peculiar  
 Design of the Spark Gaps

Bottom: Meter Panels of the  
 Installation, Showing the  
 Sliderule Which Yields Accu-  
 rate Calculation



558



The Woman Bather Stands before the Collapsible Tent Which Makes a Convenient Dressing Room

**SMALL, EASILY ERECTED TENT AS BEACH DRESSING ROOM**

For motorists and others fond of country bathing, a one-piece collapsible tent which when set up forms a dressing room, is an attractive manufactured article. It is 3 feet square and 6 feet high. On the interior sidewalls are hooks on which to hang clothing, and two large pockets for miscellaneous possessions. Guy ropes and pegs are furnished for use in windy weather. When folded, the tent is about the size and shape of a golf bag and can be carried conveniently on the running board of an auto, over the handlebars of a bicycle, or in other ways. The tent might also be found useful as a temporary ticket office or telephone booth.

319  
**AUTOMATIC SLICER CUTS LOAVES RAPIDLY**

A mechanically operated bread slicer, driven by a motor or other suitable power, has been designed for use in places where large quantities of bread are required. The loaves are placed in rows on a conveyor which carries them lengthwise to the knife where the slicing is done. The slices fall into pans on a second and lower conveyor and are deposited in a basket or other container at the end of the machine. The slicing knife is controlled by brakes on slanting bars, which are moved back and forth by a link operated from a crank wheel.

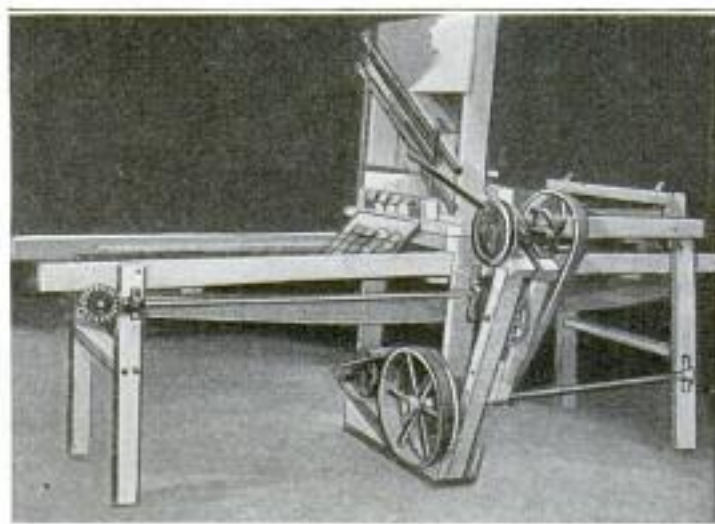

This Slicing Machine Has Two Conveyors, One above the Other, on the Upper of Which Loaves of Bread are Deposited in Rows and Carried to a Power-Driven Slicing Knife at the Front

267  
**AUTOMOBILE STOP SIGNAL UTILIZES TAIL LIGHT**

An exceptionally conspicuous automobile stop signal has been designed recently. It is mounted in front of the regular tail light, and is composed of a large, flat, circular frame with its center below the light and a semicircular opening in front of it. Inside this is mounted a rotating disk, which in its normal position has a circular glazed opening directly in front of the tail light. The disk is connected by a cable to either the brake pedal or the emergency-brake lever, and the application of the brake rotates the disk, exposing its lower half, on which is the word "Stop" in letters of red glass set in an opaque background. The warning can be read a block away.

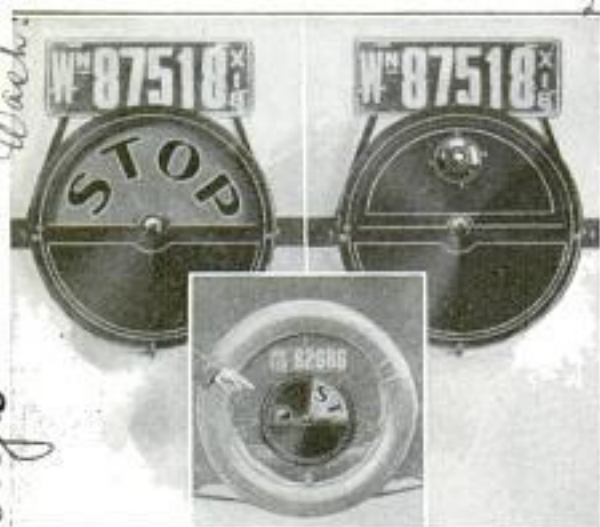

Three Views of Automobile Signal, Showing It with the Stop Signal Exposed; in Normal Position with Tail Light Showing, and in Operation

Mrs. H. E. Bjorklin, Alameda, Minn.  
 Mrs. W. E. Root, 400 Pacific Block, Seattle, Wash.



## DEVICE CONVERTS TRACTOR INTO TRENCH DIGGER

*Wayton, Ohio. Box 842*

**B**Y means of a new attachment, it is now possible to convert a small tractor of the agricultural type into a mechanical trench digger with nothing more than a monkey wrench and without any alterations to the tractor. The compactness and light weight

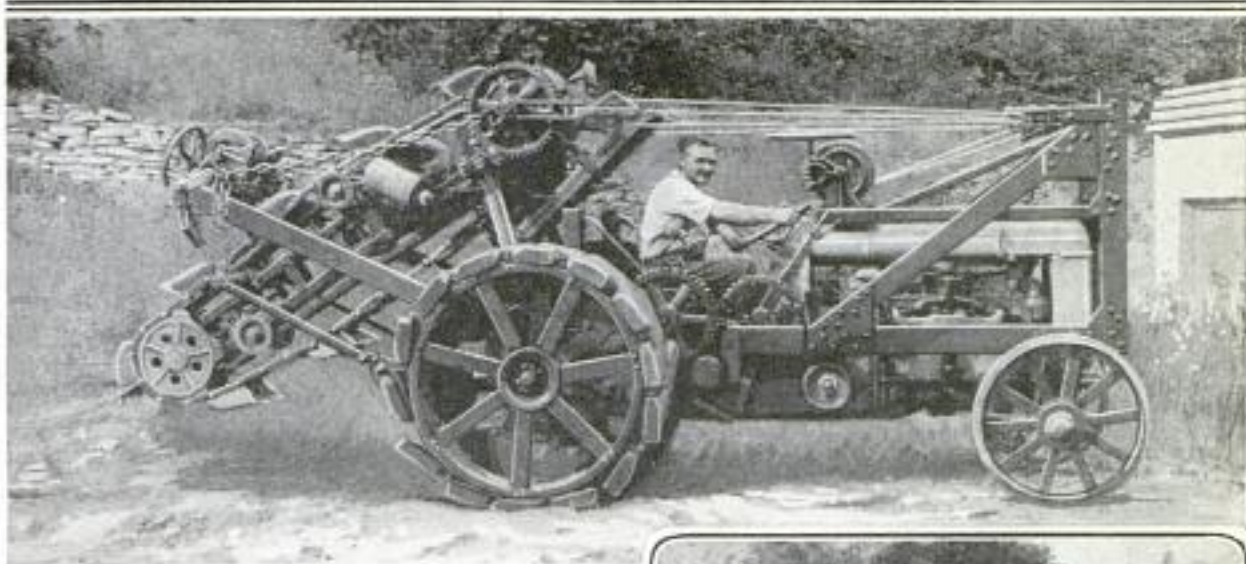

Above: A Tractor, Equipped with New Trench-Digging Machinery, is Here Shown Ready to be Transported. Right: Tractor Trench Digger at Work on Deep Vertical Ditch. Below: Another View of the Tractor with the Attachment by Which It is Converted into a Trench Digger in an Hour

ditch digger that is capable, it is claimed, of doing the work done by machines weighing two or three times as much. The new ditching device is so constructed that it can be attached to the tractor in about an hour

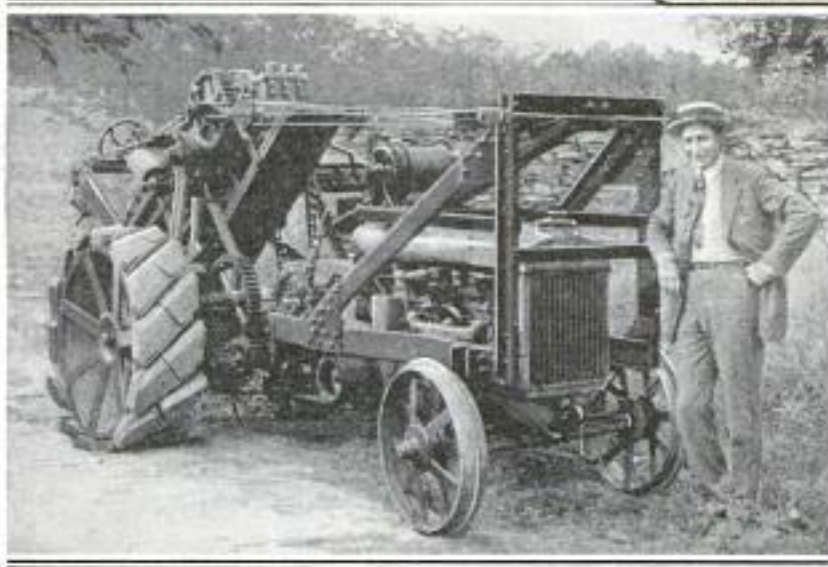

of this machine enable it to do many kinds of work not feasible with the heavier machines, such as shallow trenching for surface drains and concrete curbing, and it can also dig deeper ditches without the necessity of keeping the traction wheels level. Its short turning radius of 17 feet is an advantage in many places, and it can be transported either by its own power or on almost any flat-bottom 3 or 5-ton motor truck.



385

Aeromantic

International Newsreel Corp

military

LARGEST BOMBING PLANE IN AMERICA

New York City

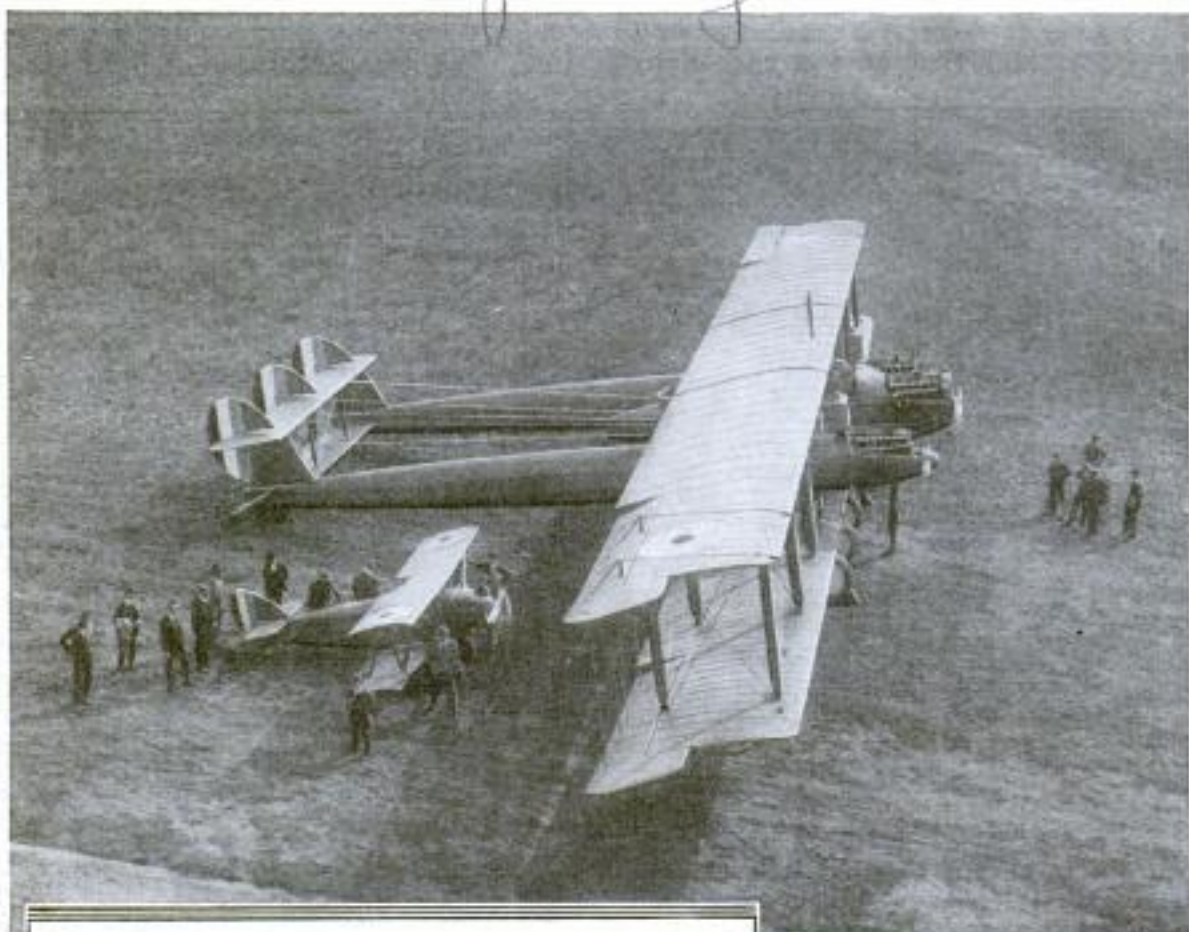

**T**HE largest bombing plane in the country, recently completed for the U. S. Army Air Service, was given a preliminary test and try-out on September 21, at Mitchell Field, Mineola, L. I., before a number of interested spectators, including Maj. Gen. Mason Patrick, chief of the service. This new bomber, which represents the last word in planes of its type, is powered by three Liberty motors, enabling it to attain a speed of 106 miles an hour, and can carry two 4,000-pound bombs. The "Owl," as the new machine is called, is expected to take a prominent part in an interesting demonstration of night bombing soon to be given. In the picture above, the "Owl" is shown on the ground with the "Sperry Messenger"—the smallest airplane in the U. S. Air Service—alongside. At the left, General Patrick is seen, followed by Lieutenant Melville, climbing into the cockpit of the "Owl" for a trial flight. It is 53 feet 9 inches long, has a wing spread of 106 feet 8 inches, and weighs over 10 tons.

It has been announced that another and larger bombing plane—probably the largest airplane in the world—is expected to be ready for a try-out the latter part of November. This new bomber is of the triplane type, with a wing spread of 120 feet, a height of 28 feet, a length of 65 feet, and a fuselage 10 feet in diameter. It will carry 10,000 pounds of bombs and is motored with six 400-horsepower Liberty engines which will consume 180 gallons of fuel an hour.



## TRIED OUT BY UNITED STATES ARMY



Major General Mason Patrick, Chief of United States Army Air Service, inspecting the "Owl," the largest bombing plane yet built for the service: it is the last word in machines of its type, is powered with three Liberty motors which will give it a speed of 106 miles an hour, and will carry two 4,000-pound bombs



814 WINDMILLS ON COLUMBIA RIVER FOR IRRIGATION

Along the banks of the Columbia River it is planned to erect large windmills near

the water's edge for the purpose of irrigating the high bluffs that line the river

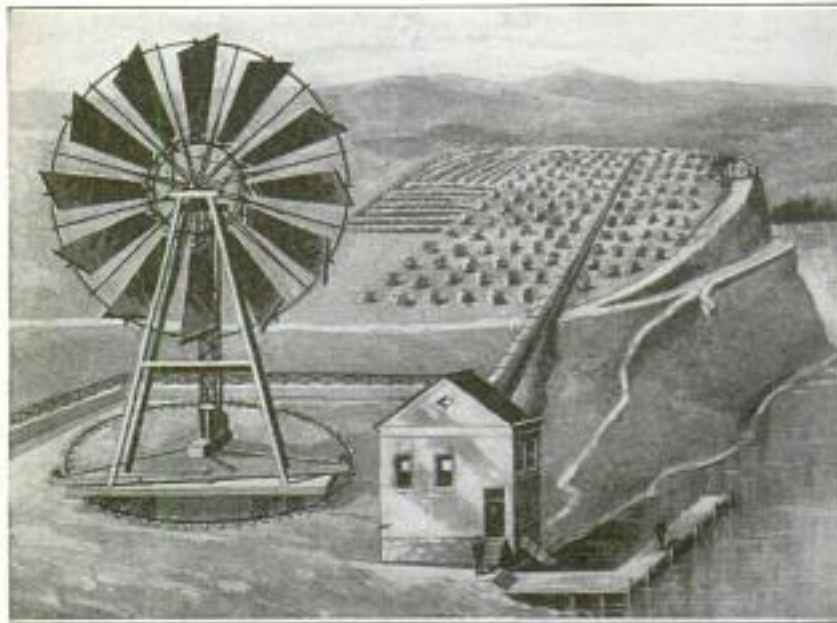

One of the Projected Windmills and Pump Houses for Irrigating the High Bluffs That Line the Columbia River for Many Miles: The Tower of the Windmill Swings upon the Circular Track

9993

VACUUM-CLEANING APPARATUS USED ON CITY STREETS

Huge vacuum outfits have recently been put in operation at St. Louis, Mo., for street-cleaning purposes. The odd-appearing appliance is mounted on the chassis of a motor truck and includes a two-wheeled trailer, which carries the

sults have been attained with these new cleaners, that other cities are said to be considering similar equipment.

485 FORTY-POUND COCONUTS TAKE SEVEN YEARS TO RIPEN

The "coco de mer," a variety of coconut which made famous the island of Mahe of the Seychelles Archipelago in the Indian Ocean, weighs 40 pounds or more, requires seven years to ripen, and grows on trees that attain a height of 100 feet and do not show their enormous fernlike leaves until 35 years old. This "coconut of the sea" was known long before the islands were discovered, because of the sea-borne specimens cast up on the east coast of Africa, where they were thought to grow on a submarine palm. They were valued as an antidote to poisons and commanded exorbitant prices among the



Two of the Huge Vacuum-Cleaning Outfits Which are Used on the Streets of St. Louis, Showing the Large Suction Fan Mounted on the Motor Truck, and the Compartment for Refuse on the Trailer

compartment for the deposition of the picked-up refuse. Such remarkable re-

native tribes, whose medicine men made much of them.

The White Motor Truck Co. Cleveland, O.

furnish truck with power takeoff which can be used to operate cleaner.

national Geographic Release. Aug. 14th



Canada



A Party of Fiji Islanders on a Fishing Expedition: They First Put into the Water a Quantity of Tuba Poison, Which So Stupefies the Fish That, after About Five Minutes, They are Easily Speared and Picked Up in the Shallow Water

7206

### SOUTH SEA ISLANDERS EASILY CAPTURE DRUGGED FISH

When natives of the Fiji Islands and certain sections of Borneo start out to make a big catch of fish, which is one of their main sources of food, they dump into the water a quantity of tuba poison obtained from the roots of a local plant. In about five minutes, the fish come to the surface in a dazed condition and are speared and picked up by members of the fishing party. After the fishermen are satisfied with the haul, the remaining fish are left to recover with apparently no ill effects. In Borneo this method is used in small streams where the natives assemble in 20 to 50 canoes above a point where a latticework barrier has been placed across the river to catch any fish that escape the spears. The Fiji islanders wade into the shallow water along the seashore to get the stupefied fish.

— 9591

### THREE-LIGHT SIGNAL MARKS RAILWAY CROSSING

To warn motorists at night that they are approaching a railway crossing, as distinguished from a regular boulevard intersection, a special street signal is now being tried out in Detroit, Mich. The

usual large red globe is supported some distance above a massive concrete base, while near the top of the base there are two additional smaller red lights.



This Street Signal Has the Usual Large Red Globe and Two Additional Smaller Red Lights near the Base, to Indicate a Railway Crossing

W. L. Potts, Supt. Detroit Police Signal Bureau, Detroit, Mich. Copyright material



249 *Madison Wis*  
**CIRCULATION OF KILN AIR  
 SHOWN BY ACID FUMES**

Determining the movement of air in dry kilns by the use of a combination of



Lumber Dry Kiln, Showing Apparatus for Blowing Hydrochloric Acid across Ammonia to Produce Fumes for Determining Whether the Air is Circulating in a Proper Manner

hydrochloric acid and ammonia fumes, is the method developed at the Forest Products Laboratories, at Madison, Wis. These fumes, being of approximately atmospheric temperature, remain practically

motionless in the air unless disturbed by air currents, thus readily indicating the presence, or lack, of proper circulation for lumber-drying purposes.

460  
**CAST-IRON PROPELLERS MADE  
 AS SMOOTH AS BRONZE**

The surface of a cast-iron ship's propeller can be made as smooth as one of bronze by the use of an enamel coating, recently produced in Europe. Besides providing the cast-iron propeller with a permanently smooth surface, the enamel is sufficiently strong to withstand the vibration, a property commonly lacking in other such coatings. The enamel is anti-fouling, as well as anticorrosive. With equal efficiency, an enameled cast-iron propeller costs about half as much as a bronze one. It is, therefore, not surprising to learn that this enamel is being increasingly adopted.

337 *31197*  
**ADJUSTABLE FULCRUM FEATURE  
 OF NEW CAR PUSHER**

The feature of a recently invented car pusher, now on the market, is the adjustable fulcrum which can be varied from one to six inches by the simple turning of the handle. By taking advantage of this, a short stroke with a long leverage can be used for starting the car, and a longer stroke with a correspondingly shorter leverage can be applied as soon as the car is in motion. The car pusher automatically grips the rail when the car is being pushed, but readily releases it when being advanced to follow up the wheel. With it one man can start four loaded cars and keep them moving at a walking speed.

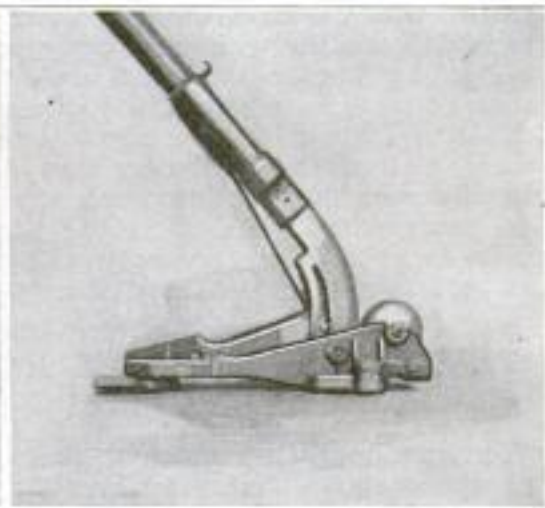
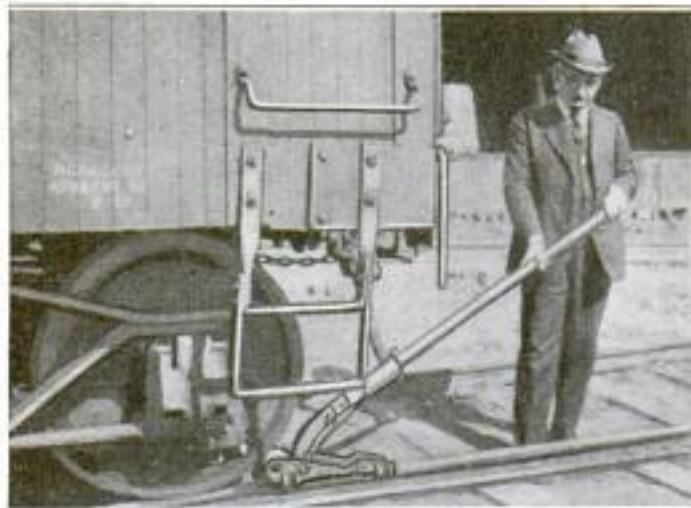

Left: With This Car Pusher One Man can Start and Keep in Motion Four Loaded Cars. It is Operated by Working the Lever Up and Down. Right: Close-Up of Car Pusher Which Automatically Grips the Rail and Has an Adjustable Fulcrum

*The Specially Mfg Co 11400 Madison Ave  
 Cleveland, Ohio.*

*Delix. Marchenbar. Co.  
 Berlin, Germany  
 (no other address)*



Foreign Letters  
8/19/22

Campbell Electric Co.  
Lynn,  
Mass.

**PSYCHOLOGY OF COLORS MADE  
442 SUBJECT OF STUDY**

The psychology of colors and the proper use of them in decorating the interiors of hospitals, sanitariums, schools, and even homes, has been made the subject of study in Germany. Notable facts were discovered concerning their different effects on the mind and the emotions. White makes a room appear larger and lighter, but cold and empty, while yellow gives an appearance of sun warmth and produces a sense of comfort. A crimson hue imparts an air of delicacy. Children in a room with crimson-tinted shades were observed to work eagerly and more than was customary. Orange exerts the most marked effect of warmth and cheerfulness. Red represents spontaneous youthful joy, but is said to be the hardest on the eyes. Blue has a calming and soothing effect. Violet is extremely depressing, while, on the other hand, green possesses a restful influence. Gray, if it covers a wide area, is barren and dreary, and persons in a room of this description soon become downcast and evince lack of interest in their activities or well-being. Although these conclusions may not be universally true, they at least deserve attention among thinkers, since the acknowledged goal of human effort is efficiency.

**MEN'S SOFT CAPS PREVENTED  
FROM SAGGING IN FRONT**

To take the place of tissue paper that is often inserted in men's soft caps to prevent the front of the cap from sagging, and thus spoiling its appearance, a stiffener, made of fiber covered with a waterproof fabric, is now on the market. When inserted under the front of the soft cap, this holds it in proper shape. The device is light, flexible, and easily kept clean.



**IMPROVED X-RAY EQUIPMENT  
3071 FOR MEDICAL USE**

An improved X-ray plant for physicians has a tilting table that can either be changed quickly by hand to

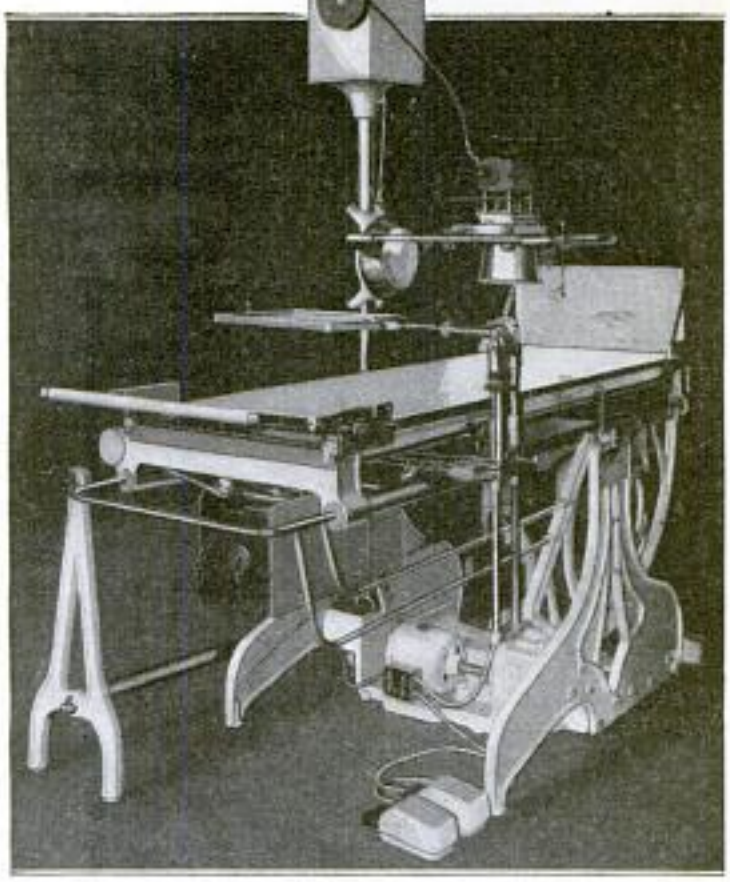

In This Improved X-Ray Machine All the Moving Parts are Counterbalanced and Mounted on Ball Bearings

any position between the horizontal and vertical, or slowly moved by an electric motor, while a diagnosis is being made. The moving parts are counterbalanced regardless of angle. A 75,000-volt transformer supplies a radiographic tube above the table, the holder of which is universally adjustable and indicates the accurate placing of the tube. The apparatus is equipped with an automatic plate-changing device. A 65,000-volt transformer supplies the fluoroscope tube, placed beneath the table, for use without a photographic plate. Both tubes are adjustable to any part of the table and, like all the moving parts, are mounted on ball bearings.

In Czecho-Slovakia, where Bohemian glass is manufactured, the important discovery has been made of a silica with which raw glass can be manufactured without the aid of other ingredients. The mineral is of volcanic origin, and there are very extensive deposits of it.

The Rappaport Agency  
2073 S 55th St  
Chicago



Way + Pertle Mfg Co  
6701 Moneta Ave.

314 892 *Los Angeles Calif* POPULAR  
HOLDER KEEPS GARBAGE CAN  
FROM BEING STOLEN

By means of a new metal frame, garbage cans may be fastened to a wall, post, or tree, making theft difficult if not impossible.



The frame encircles the bottom of the can, which is held a few inches from the ground, and then runs up and above the can itself. The side braces, of which there are three, form guides for the lid whenever it is to be raised. Under no conditions can the lid be removed, though

with the cover raised the can itself may be lifted out of the frame to be emptied.

408 CHOCOLATE-PERSIMMON BARS  
A NEW KIND OF CANDY

In spite of its astringency, the unripe fruit of the persimmon has been made into candy in one of the southern states in which the tree abounds. After several unsuccessful attempts to remove this quality from



the persimmon, it was finally done by means of a chemical preparation that releases cream of tartar, which is an essential in

candy making. Sufficient sugar was then added to make a sweet paste, from which a delicious chocolate-coated confection was made without any trace of the persimmon astringency. Methods of preserving the candy have been developed, and it is intended to form an organization for gathering the fruit on a large scale, and merchandising the candy.

*Mr. H. H. Kenty  
Sealena, Kans*

Cohn. Hall, Marx Co  
93 Franklin St  
MECHANICS New York.  
M. E. Haskel  
OPERATE COTTON-GOODS LOOM  
243 BY WIRELESS

Wireless control of a cotton-goods loom was a feature of a fashion show recently held in Baltimore, and excited considerable comment among the spectators. An ordinary automatic loom was used. The starting and stopping of the machine, which was effected every 15 minutes, was under the control of an operator located in a distant section of the city.

162 ELECTRIC WATER HEATER  
FITS ON FAUCET

Heating water as it passes out of the faucet, is possible with the use of a small electric appliance that can be fitted over the end of any ordinary spout. The heating element consists of graphite plates, over which the water flows, instead of the usual wire-coil type, the electrical connection being made by the passage of the water. The entire outfit, including the extension cord for attaching to any light socket, weighs less than two pounds. Thus



the contrivance should be an ideal portable heater for use in emergency surgical cases, or on any occasion where hot water is needed on short notice.

3218 *Mr. Union Electric Co*  
POPLARS NEAR SIDEWALKS  
"OUTLAWED" IN DETROIT

The poplar is never content unless its roots are plugging sewers and breaking sidewalks and pavements, according to the Detroit Department of Parks and Boulevards, so the city council was recently prevailed upon to pass an ordinance "outlawing" 40,000 of the trees located between the sidewalks and curbstones in that city. The resolution gives authority to chop down the trees whenever they seem to be causing trouble.

*Detrock news*  
Copyrighted material  
9/8/22

*Mrs. W. A. Kenty  
Sealena, Kans*

*New Orleans*

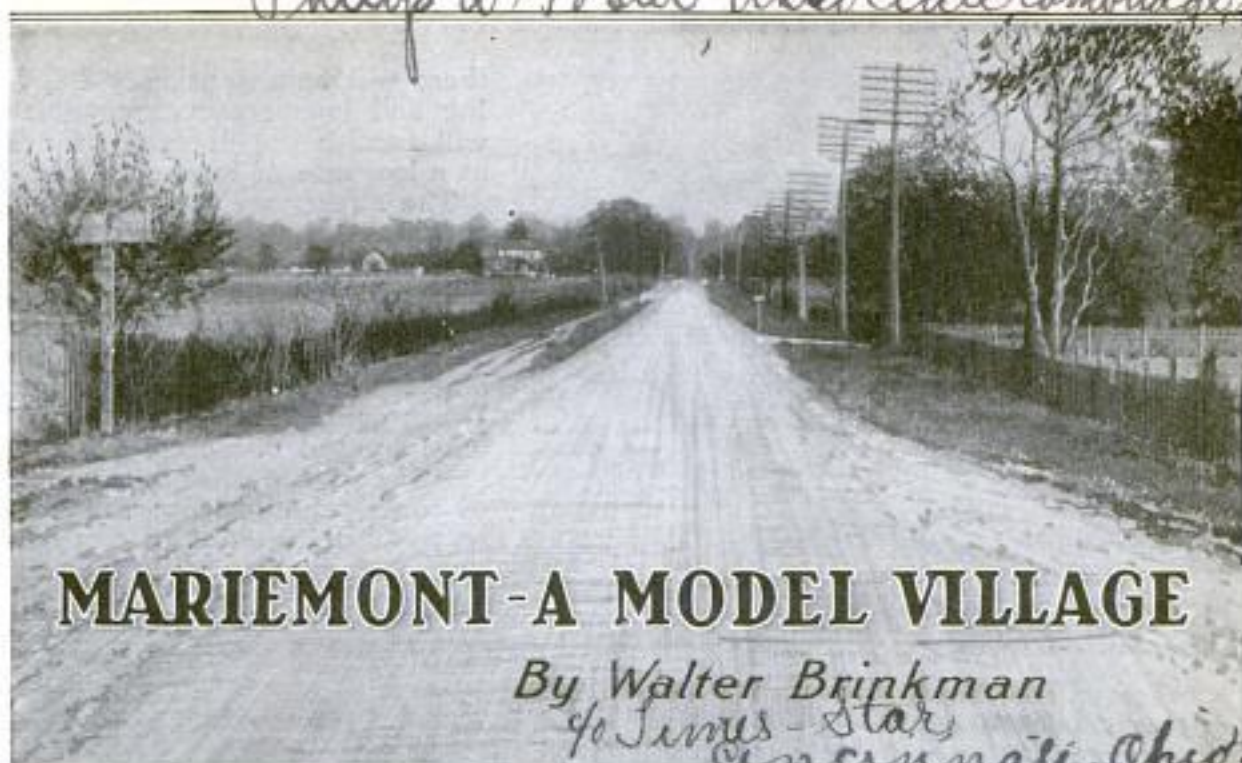

9547

John Nolan, City Planner.  
Philip W. Foster, Associate, Cambridge, Mass

## MARIEMONT-A MODEL VILLAGE

By Walter Brinkman

of James - Star  
Cincinnati, Ohio.

Looking along Wooster Pike Where It Crosses the 365-Acre Site of the Projected Model Town of Mariemont: The View Shows the Farm Buildings and Fields as They Were When the Land was Acquired

**I**N an attempt to solve the housing problem by the formation of a community in which people of moderate means may obtain good homes with attractive surroundings, either by rental or purchase, at small cost, the model town of Mariemont, adjoining Cincinnati, Ohio, has been planned. The enterprise is not intended to be philanthropic in its nature, but is to be conducted so that the members of the community will be provided with hygienic and attractive homes at little more than actual cost, while leaving a reasonable margin of profit on the funds furnished for the project. When completed, it is hoped it will be a demonstration to be imitated.

The general plan covers a tract of about 365 acres, providing for a town center with its village green, library, community building, public market, bank, hotel, theater, town hall, post office, and a business center with all kinds of stores, and above

them apartments. Just outside this center is a school, and beyond it a large stadium, besides a football field, tennis grounds, and a running track. The

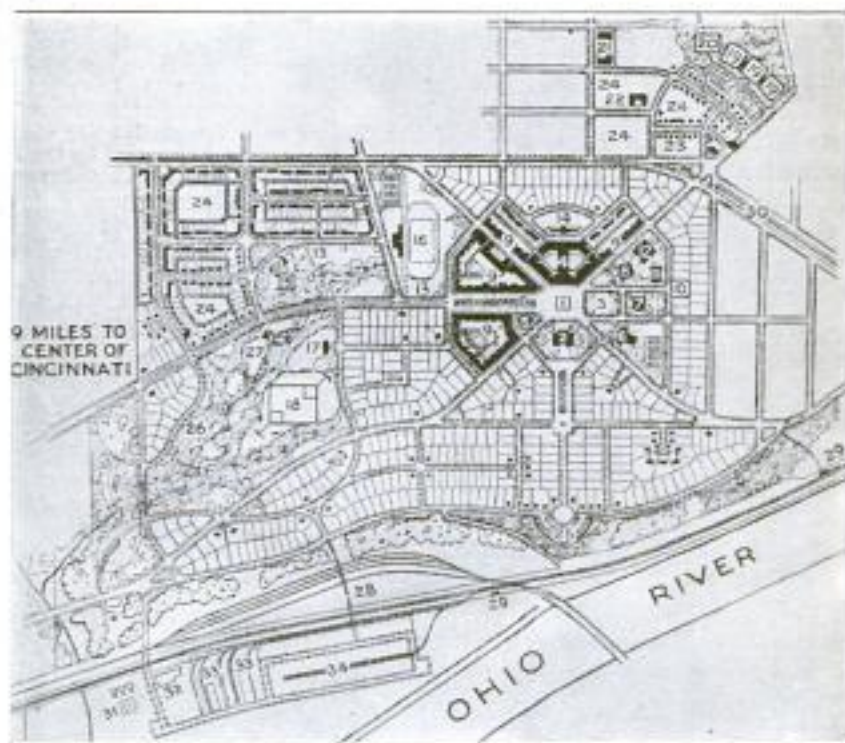

Objects of Interest on Town Site, Shown Numbered as Follows: 1, Town Center; 2, Town Hall; 3, Village Green; 4, Theater; 5, Bank; 6, Community Building; 7, Library; 8, Post Office; 9, Stores; 10, Fire Station; 11, Churches; 12, Hotel; 13, Schools; 14, Market; 15, Cemetery; 16, Stadium; 17, Field House; 18, Athletic Field; 19, Hospital; 20, Convalescents' Home; 21, Convalescents' Workshop; 22, Barn; 23, Pensioners' Cottages; 24, Gardens; 25, Concourse; 26, Park; 27, Lagoon; 28, Railroad Yards; 29, Railroad Stations; 30, Street-Car Line; 31, Sewage-Disposal Plant; 32, Garbage-Disposal Plant; 33, Freight Yards; 34, Industrial Section





The Hospital Group of Buildings Which are Situated near the Convalescents' Home

there will be a subsidiary building and loan association, which will furnish the necessary funds at a low rate of interest.

The streets are to be from 40 to 150 feet wide, and will have a total length of over  $8\frac{1}{2}$  miles. All will be boulevarded and adorned with trees, the widest having car lines that will furnish ample means of transportation. When completed, Mariemont will have a population of about 5,000. It will certainly offer an example of town planning that will possess unusual interest to city officials and community promoters.

churches will be in the outlying residential quarters, where there will also be a public park of over 50 acres, including athletic fields, a bathhouse, and a lagoon. There will be 759 house lots, some with from 50 to 80-foot frontages, 120 feet deep, and others smaller for semi-detached buildings. All the houses will be of brick or other permanent material. To aid purchasers of homes,



Sketch Drawn as a Suggestion for the Design of the 50 Cottages for Pensioners Who will be Supported by the Funds from an Endowment Granted by the Originator and Chief Promoter of the Community Project

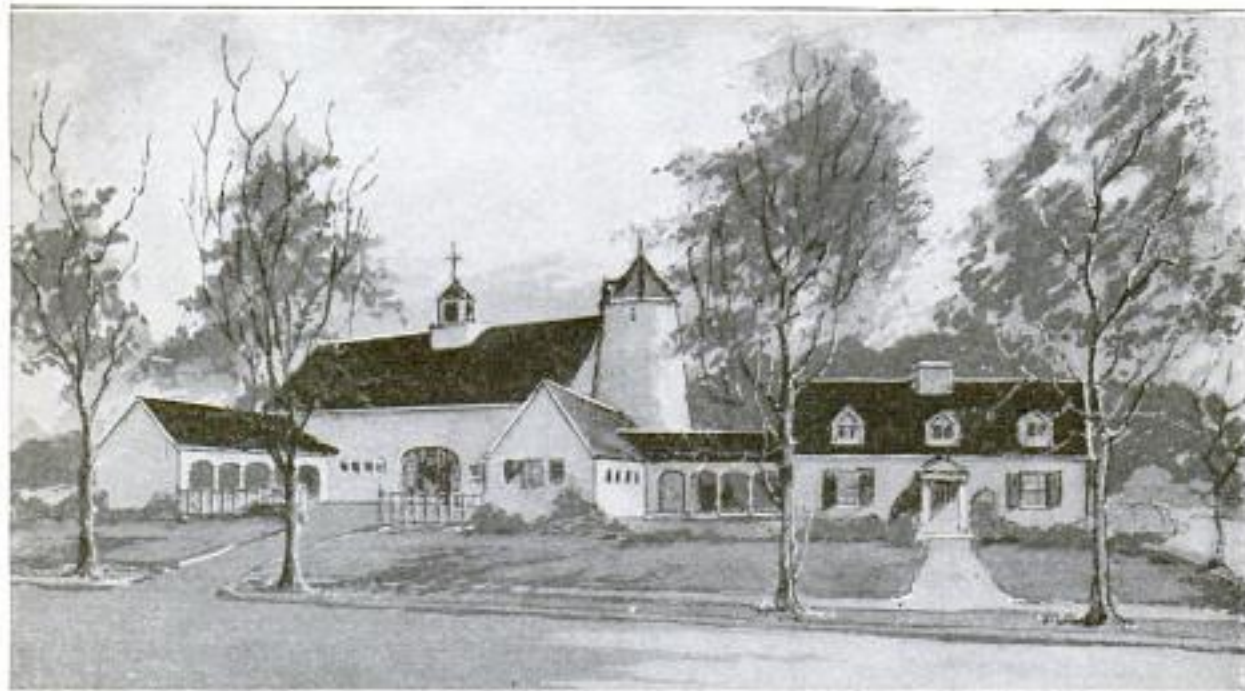

Group of Buildings in the Pensioners' Section of the Town, Showing a Dwelling House, and to the Left, the Large Building with Wings, Which will be Used as a Barn, with Stables and Sheds for the Pensioners' Implements, Cattle, and Horses



Manchester, England

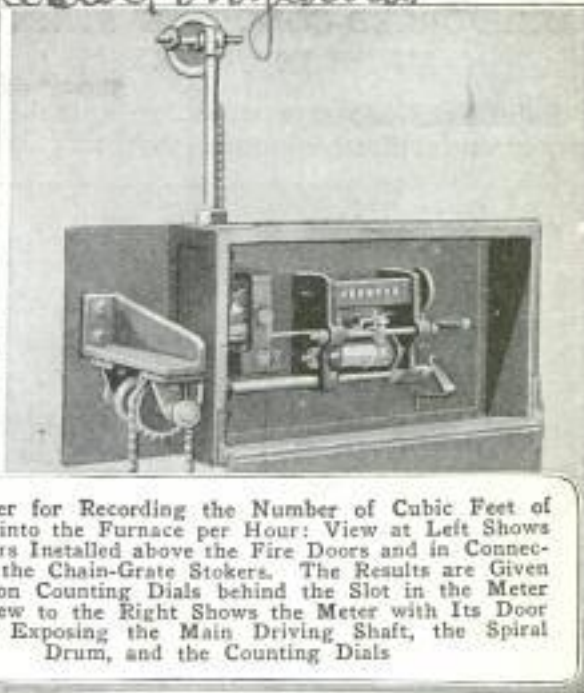
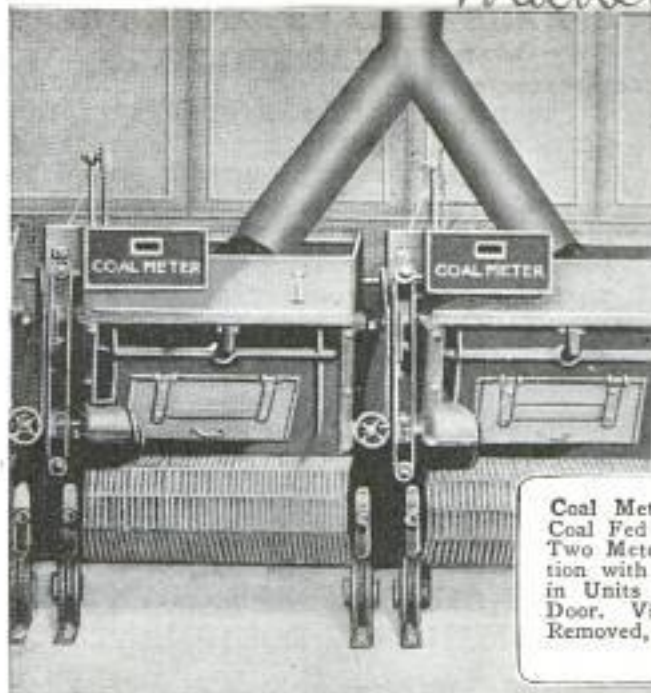

Coal Meter for Recording the Number of Cubic Feet of Coal Fed into the Furnace per Hour: View at Left Shows Two Meters Installed above the Fire Doors and in Connection with the Chain-Grate Stokers. The Results are Given in Units on Counting Dials behind the Slot in the Meter Door. View to the Right Shows the Meter with Its Door Removed, Exposing the Main Driving Shaft, the Spiral Drum, and the Counting Dials

**COAL METER RECORDS AMOUNT OF FUEL USED PER HOUR**

For attachment to chain-grate stokers of boilers, and actuated by the stoker itself, a coal meter that records continuously the cubic feet of coal consumed, has been installed in several of the largest power plants in England. The fundamental principle of the meter is the establishment of an orifice for the coal of known area in square feet, calculated by multiplying the width of the stoker chain by the height of the opening under the fire door. This is then multiplied by the velocity at which the grate moves in feet per hour. In the meter, this velocity is transmitted to a spirally toothed drum. A counting wheel, gearing with a spiral drum below and a counting box above, is mounted upon a drawbar directly connected to the fire door, and as this is opened or closed the counting wheel is moved across the spiral drum, which revolves it in accordance with the opening made by the height of the fire door. The consumption of coal in cubic feet is shown behind a slot in the meter.

344

**COMPUTER MOUNTED ON CLAMP FOR ATTACHMENT TO DESK**

Said to be more accurate than the common sliderule, a new computer with circular dial plates, set flush and rotating concentrically the one inside the other, is made so that it can be operated by one hand when mounted on an aluminum

desk clamp. A radial arm, with a fine hair line engraved on a transparent celluloid plate above the dials, is revolved and set like the slide of a sliderule, and has the advantage of a thumb lock for clamping it when set. Above the computer is mounted a magnifying glass, adjustable in any direction, that makes readings appear larger than ordinary



Computer Shown Mounted on Its Aluminum Desk Clamp and being Operated with the Thumb of One Hand: After being Set, the Readings are Seen through the Magnifying Glass Larger than Ordinary Typewriting

typewriting. Supplied with the computer is a leather case in which it can be packed for carrying in the pocket, after removal from the clamp.

weight 1 1/2 lbs.

9" diameter

Computer Mfg. Co. 340 Sansome St. San Francisco, Calif. \$28.50.



**REINFORCED-CONCRETE STEPS  
 MADE IN UNITS**

214 Reinforced-concrete steps are now being manufactured in units that may be

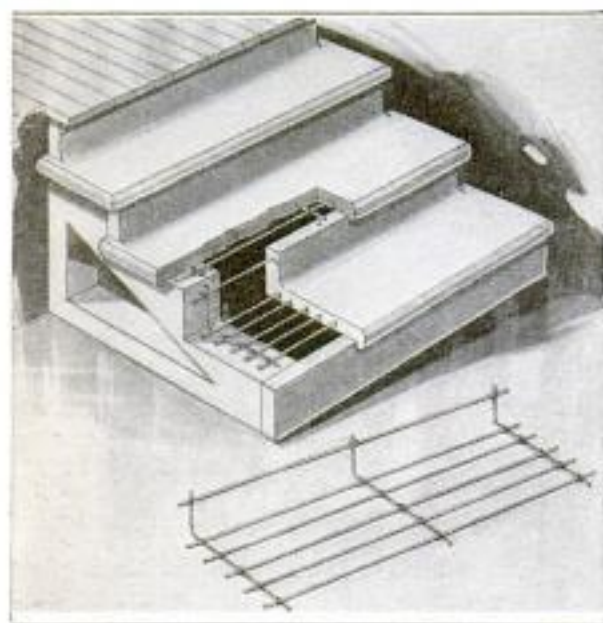

Reinforced-Concrete Steps Which are Manufactured in Units, Showing How the Round Iron Rods are Placed in the Product

joined in such a manner as to present an appearance of a solid flight of stairs when completed. Each unit consists of a tread and the riser above it. The steps are reinforced by 1/4-inch round iron rods, and while constructed strong enough to meet any ordinary requirements, are so light that they may be easily handled by two men. A gritty granite surface is used which makes them practically slip-proof and, at the same time, a careful curing process renders them sufficiently hard to resist abrasion, thus giving the product additional wearing qualities.

**CANADA RESERVES MORE AREAS  
 FOR PUBLIC SHOOTING**

498 The action of the authorities of the provinces of Manitoba, Saskatchewan, and Alberta in recently granting approval to the reservation of marshlands and other breeding points for migratory birds, for public shooting areas, is particularly important. It not only provides hunting grounds during the open seasons, but also affords protection to the birds during the nesting season on one of the principal breeding grounds on the North American continent. The idea is to preserve natural conditions and increase the underbrush on these areas as much as possible in the next few years.

*Arrow points across*  
**NAVY AIRMEN EXPERIMENTING  
 WITH NEW EQUIPMENT**

896 Navy airmen are actively experimenting with new equipment for seaplanes and airships. A winch for hoisting the anchors of seaplanes is one of the latest devices tested by the Naval Air Station at Pensacola, Fla.

This anchor weighs in the neighborhood of 75 pounds. Hoisting this weight from a river or sea bed without some mechanical assistance is not an easy task. Speed in hoisting the anchor is also, at times, an essential requirement. So it was decided to experiment with a special type of winch.

Weight and space requirements, however, are very important elements in deciding on air-craft equipment. The experiments with the winch have not, as yet, convinced the naval authorities that the assistance it renders justifies the additional weight and the space it occupies.

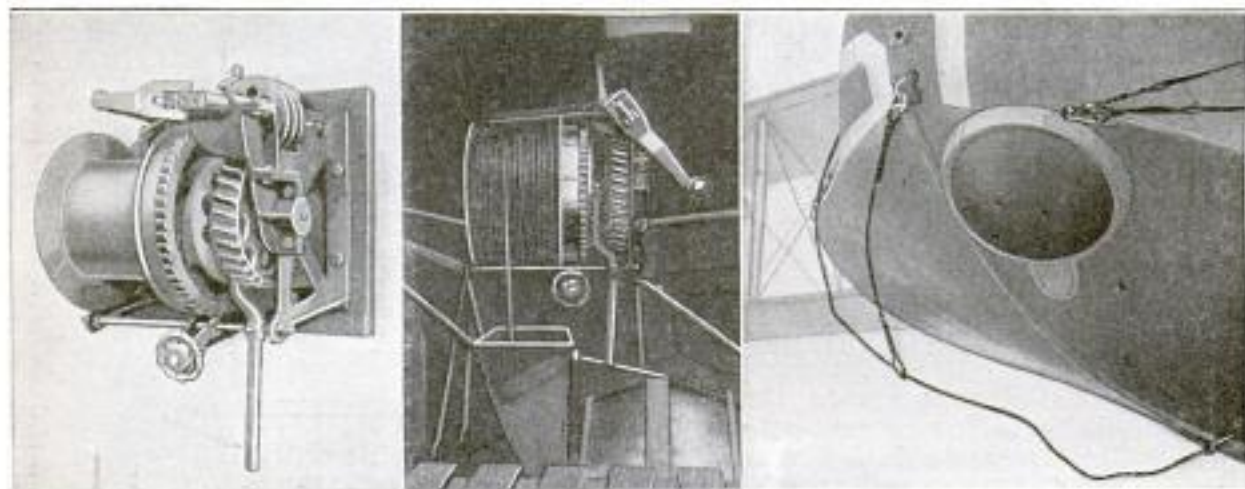

Left: Special Winch Designed for Hoisting the Anchor of a Navy Seaplane. Center: Interior View of Navy Seaplane, Showing the Mounting of the Anchor Winch. Right: The Mushroom-Shaped Object Hugging the Body of the Seaplane—Is the 75-Pound Anchor

*Cont. Jno. W. Keau, Bureau of Navigation  
 Navy Dept, Washington, D. C.*



9249 Cont. Roy C. Bennett.  
1208 N. 5th St.

POPULAR MECHANICS

Philadelphia, Pa. 897

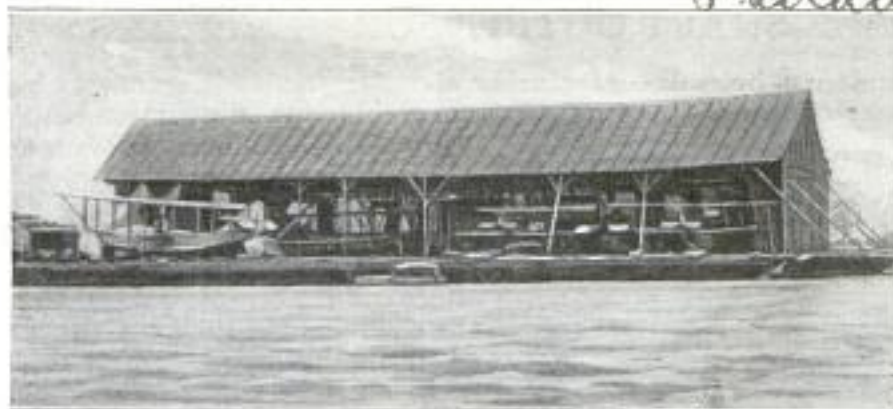

Hangar in Canton, China, Built Entirely of Bamboo, to House Four Large Seaplanes: The Poles are Notched Together, and the Framework Has a Grass Covering

9249  
**BAMBOO THE ONLY ESSENTIAL  
IN A CHINESE BUILDING**

Plenty of bamboo is about all a Chinese builder needs for any kind of construction. Recently a highly ornamental archway, surmounted by a pagodalike tower, all built entirely of bamboo, was erected over a street in Canton in honor of the leader of the Cantonese army when he visited the city. Not a nail nor a peg was used in the whole structure, the bamboo poles being tied together with strips of bark. The covering was of oil-coated paper pasted onto bamboo frames. Similar in construction is a Cantonese hangar built to house four large seaplanes. This hangar has gone through two or three fairly severe storms without damage.

409  
**NEW ELECTRIC VULCANIZER  
FOR THE DENTIST**

Dentists should be interested to learn that there is now available to them a new

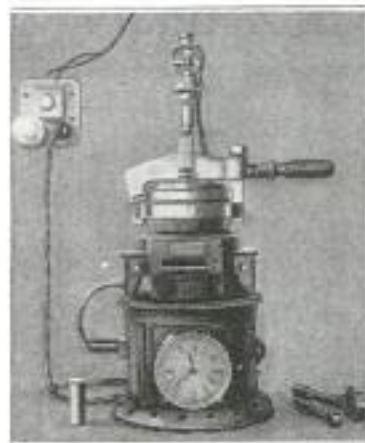

electric vulcanizer which scientifically and automatically times the exposure of a plate to the heat. The device is operated from the ordinary service current. With this appliance, the dentist is enabled to

work freely with his expensive material without any fear that it may be ruined by the fault of overtiming the vulcanizing process, thus adding to the general efficiency of his work.

The Buffalo Dental  
Mfg. Co. 587 Main St.  
Buffalo, N.Y.



Bamboo Archway and Tower over a Street in Canton: There Is Not a Nail Nor a Peg in the Entire Structure. The Covering Is of Oiled Paper

112  
**COMPUTING GASOLINE PUMP  
FOR SERVICE STATIONS**

Computing scales that show the money value of any given weight have for some time been in use in all kinds of provision stores, and now the same idea is being carried out in selling gasoline at automobile-service stations. A dial on a gasoline pump, that has a capacity of 5 gallons, is graduated in gallons and fractions of gallons. Radially in line with these, other graduations at each fractional point show the money values of the various measurements. These are on a separate inside dial which is graduated for a certain price per gallon. As the price changes, this dial is changed accordingly.

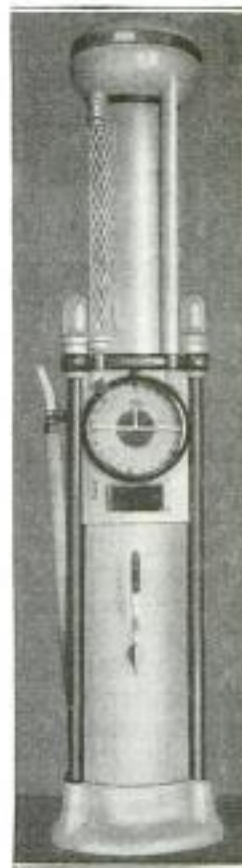

Copyrighted material

The Measurite Co. of  
Louisville, Ky. 622



William Dixon, Jr.  
 32 E. Kinney St.  
 Newark, N.J.

898

POPULAR MECHANICS

**NEW FLEXIBLE-SHAFT OUTFIT FOR JEWELERS**

A new flexible-shaft outfit has been designed specially for the use of the manu-

facturing jeweler and silversmith, but equally

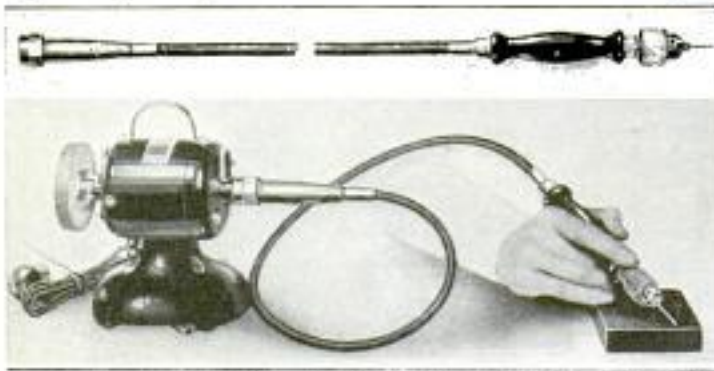

Jewelers' and Die Sinkers' Flexible-Shaft Outfit with Light Sheath and Cable: The Handle Chuck Has a Capacity up to One-Eighth Inch. A Heavy Sheath and Cable is Shown Above

adaptable for die sinking and drilling in tool shops. It operates with a 1/10-horsepower motor, having speeds of from 2,000 to 10,000 revolutions per minute. The motor will run on either direct or alternating current, taken from any electric-light socket. Connected to the motor is a flexible cable with an interchangeable chuck for holding the required tool. At the other side of the motor, on its shaft, provision is made for various kinds of grinding wheels. The assembled weight is 10 1/2 pounds.

291 **STEEL TUBING FOR LIGHTING COMES ALREADY WIRED**

Store owners who desire an effective system of display lighting for their win-

dows now may avail themselves of an improvement along this line, that has many merits. The fixture consists of square steel tubing which comes completely wired.

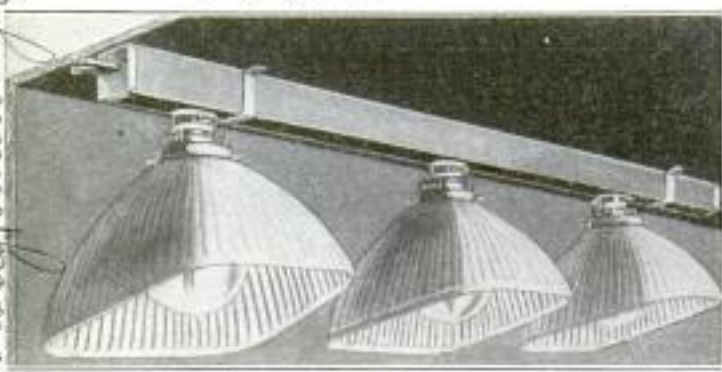

Steel Tubing for Window-Display Lighting. Showing the Strap Hangers, Which, besides Connecting the Wires to the Mains, Are All That is Needed to Complete the Work

After the dimensions of the windows are taken and the spacing of the outlets, or lamps, agreed upon, the storekeeper, or the electrical contractor doing the work, merely sends these details to the company that manufactures the tubing. When the tubing arrives, all that is necessary is the placing of a few screws in the hangers and the connection of the wires extending from the end to the main circuits of the building. Thus the merchant is enabled to obtain, at low cost, a complete equipment.

**ANCIENT CHINESE GAME NOW FAD IN AMERICA**

An ancient Chinese game dating back to the time of Confucius but only recently introduced here after the translation of its rules into English, seems to be becoming the fad of the hour in America. The game has been likened to a "glorified game of rummy" and is played with ivory tiles, with picturesque trimmings in the form of dragons, the four winds, flowers, birds, and other characters. Many leading stores are exhibiting the game sets in their display windows amid Oriental decorations. Some sets are selling for about \$15; others are higher-priced.

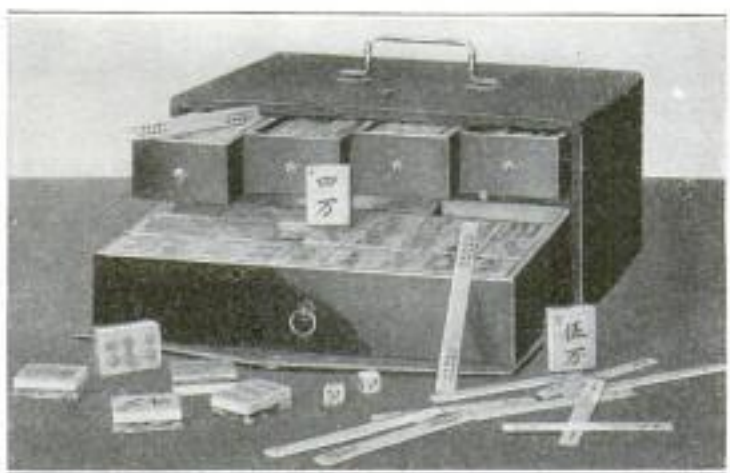

The Tiles and Other Parts of the Game in the Illustration All Have Picturesque Names. When Not in Use, the Set is Placed in a Box, as Shown Above

Mah-Jongg Sales Co. of America  
 112 Market St.  
 San Francisco, Calif.

Pittsburgh Reflector  
 Illuminating Co.  
 Downman Bldg. Pittsburgh, Pa.  
 Joseph Debevoise

Copyrighted material



The Safety Appliance Co.

38-40 Clinton St. Newark, N.J.

387 *Geo. Reichstetter Jr.*  
*Reichardt & Anderson,*  
POPULAR MECHANICS 899  
*23 Whitney St. Newark N.J.*



Left: Self-Acting Automobile Bumper Installed on a Motor Truck, Showing How the Lattice Gate Drops When Pressure is Exerted against the Bumper Rod. Right: Another View of the Apparatus, Demonstrating How the Gate Prevents the Body from being Crushed by the Truck Wheels

387  
**SELF-ACTING AUTO BUMPER**  
**ALSO "KILLS" ENGINE**

Indignant pedestrians may now experience a slight satisfaction in automatically "killing" the engine of a motor car which has rudely given them unsought impetus when they were crossing the street; that is, providing the car has been fitted with the latest automatic bumper. This innovation consists of an iron latticework gate, or fender, which is fastened behind a bumper rod and which is released when pressure is exerted against the rod. The pressure is furnished by the unsuspecting foot traveler. The impact of his body against the bumper rod causes the fender to drop to within about two inches of the pavement, thus keeping the body away from the wheels, while at the same time an auxiliary ignition switch is opened, which immediately stops the engine.

545  
**LIGNITE FUEL CARBONIZED**  
**AT REDUCED COST**

In the course of lignite investigations conducted by the Bureau of Mines, cooperating with the University of North Dakota, two carloads of lignite were recently carbonized at a rate of 10 tons per day and at an approximate cost of \$5.50 per ton. A similar residue was produced at a cost of approximately \$6.25 per ton in the furnace used in the experiments conducted during the summer of 1921. Large reserves of this low-grade fuel await utilization.

*U. S. Bureau of Mines, Washington, D. C.*

390  
**ARRANGE ALL POULTRY FEED**  
**ON CONVENIENT STAND**

All the usual poultry feed is conveniently provided for in a new poultry feeder which consists of a galvanized-iron stand with three small troughs at the top for grit, oyster shell, and charcoal, beneath which extends a larger one for dry mash, while a few inches from the ground is another for wet mash. About midway



The Top Rack of This Feed Holder Provides for Grit, Oyster Shell, and Charcoal. The Center Trough Is for Dry Mash; the Lower One for Wet Mash

from the ground to the top, at the height of the middle trough, is a wooden rail to which the chickens can hop. The trough at this level has a pair of hinged lids so that it can be closed when desired. The bottom container is made revolvable to facilitate cleaning.

*Jno. C. Hostler, Box 24, Altoona, Pa.*

*d.m.*



**STRANGE "PIPE ORGAN" HEARD  
ON STONE MOUNTAIN**

361 A giant "pipe organ," with a strange medley of notes, is formed by the long



When the Wind Plays through the Small Slits in the Posts of This Fence That Guards a 1,000-Foot Bluff, Strange Music is Heard

barbed-wire fence that guards the 1,000-foot bluff at the summit of Stone Mountain, near Atlanta, Ga. The hollow iron posts supporting the wires of the fence have in them slits of about half an inch on the side facing the bluff. These form a series of whistles when struck by the wind. And as the slits are at varying heights and every shift of the wind includes a new group of posts, a weird, ever-changing sound is produced. The fence was ordered built after several persons had fallen to the rocks, nearly 1,000 feet below.

On the side of the bluff, Gutzon Borglum, the American sculptor, is now engaged in cutting the mammoth memorial to the southern Confederacy, the plans for which were described and illustrated in the Popular Mechanics Magazine for April, 1916. Beginning about 50 feet from the small shack shown in the accompanying picture, a series of stairways lead down the almost perpendicular cliff for a distance of 350 feet to a platform on which the workmen engaged in cutting the memorial stand.

**LARGE OIL TANKS ERECTED IN NEW ZEALAND**



Engine Room and Boiler House of Station Which Pumps Oil through a 12-Inch Pipe Line from the Wharf to the Tanks

Two oil tanks, each having a capacity of 2,000,000 gallons, together with a third which holds 70,000 gallons, have recently been erected at Miramar, Wellington, New Zealand. The larger containers are 150 feet in diameter and 30 feet in height. Each tank is surrounded by a bank, or wall, so that in event of a fire,

the burning oil will be prevented from flowing over the adjacent territory. In addition, the entire installation is protected by a fire-extinguishing system that effectually smothers any flame by the use of chemicals which, produc-

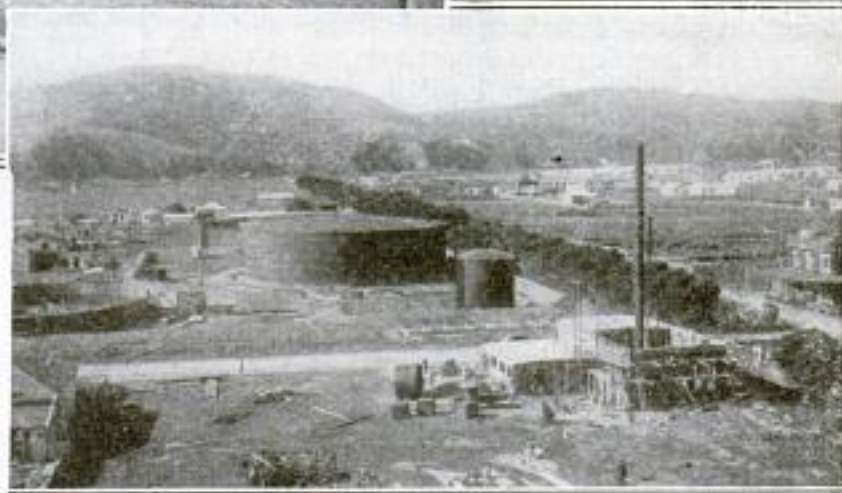

General View, Showing the Pumping Station in the Foreground, and in the Background, Two Completed Tanks and a Third in Process of Construction

ing a foamlike substance, spread rapidly over the blazing liquid.

Owners - Vacuum Oil Co. New Zealand. 308  
Miramar, Wellington.



## HOW TREE SEEDS LIVE THROUGH FOREST FIRES

BY W. I. HUTCHINSON

**A**FTER eight years of scientific research, Dr. J. V. Hofmann, director of the Wind River Forest Experiment Station, at Stabler, Wash., has discovered a way of reforestation of cut-over timberlands without the expense of artificial planting. Entirely new methods of investigation were used, which sought to solve the problem of how much heat coniferous seed, particularly of Douglas fir, will stand without loss of vitality. The results obtained prove conclusively, it is claimed, that the elimination of repeated forest fires is practically all that is necessary in most cases to secure a new forest.

The foresters of the Wind River Station found that great quantities of tree seed, chiefly of Douglas fir which retain their vitality for many years, are stored in the moss and duff of the forest floor. Where lumbering operations open the dense stand and permit the sunlight to penetrate to the ground, a new crop of little trees is almost sure to spring up. But should a forest fire sweep over the area and destroy the little seedlings and

936 7 21  
Washington, D. C.  
nature, unassisted, is forever lost, and planting by hand is the only method by which the land can then be restocked.

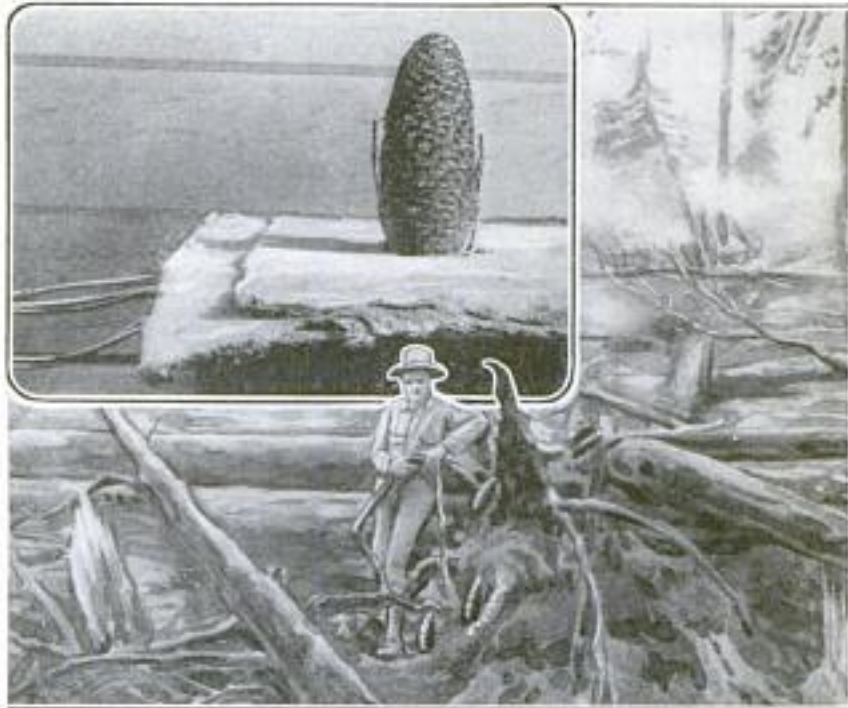

Insert: Test Cone Arranged for Determining Temperatures That Destroy Vitality of Seed. Below: In the Wake of a Forest Fire at a Point Where Thermocouples were Located to Measure Temperatures Existing at the Time the Fire was Passing through There

Through a series of tests made under conditions similar to those on commercial logging operations in the Pacific Northwest, Doctor Hofmann first determined the heat intensity of forest fires. For this purpose an instrument known as a potentiometer, which measures electric energy, was used in conjunction with thermocouples, or short loops of fine wire made out of two metals, which react to the influence of heat. These thermocouples were placed in the path of real forest fires, and connected by means of long wires to the potentiometers. The flames acting on the metal loops set up an electric current that was recorded on graduated dials. With these instruments it was found that forest fires range in heat intensity from 900 to 1,500° F. Also, that such high temperatures are of short duration, since the dry and green tops of trees—which always produce the greatest heat in a fire—burn out in from 15 to 60 seconds.

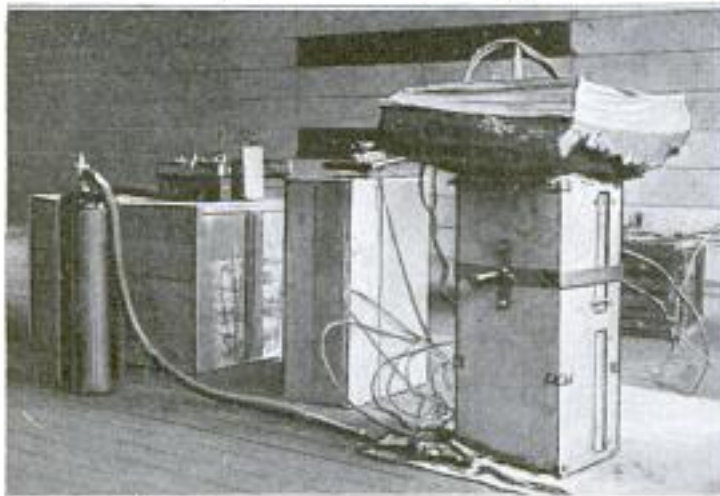

Apparatus for Temperature Tests on Seed Cones: It Includes an Electric Hot-Plate Heating Device in Which the Cones are Placed, a Potentiometer, a Rheostat, Switches, and a Gas-Supply Cylinder for Testing the Inflammability of Materials

also the few trees that are left, the possibility of the renewal of the forest by

After measuring the heat produced by different kinds of fires, the next step was



to determine accurately the temperatures that destroy the vitality of coniferous seed. In these tests the same instruments were again brought into play. A large number of unopened Douglas-fir and other tree cones were used, and the desired experimental temperatures were obtained by means of a special heating apparatus equipped with electric plates. Each cone was mounted on an asbestos base, and loops of the thermocouple wires placed one on each side of the cone, with a third wire loop running up through its center. The cone was then subjected to the various degrees of heat generated by forest fires, after which the seeds were removed from the cone and tested between wet blotters and in damp earth, to find out what temperatures were necessary to kill the seeds.

These experiments proved that the seeds in an unopened coniferous-tree cone would stand no less than 1,100° F. for periods of from 5 to 8 minutes without losing their vitality completely. While such high temperatures are common even in small forest fires, they last only for much shorter periods, so that it actually takes a fierce fire to damage the seeds inside a cone so that they will not sprout and grow. It was also found that all seeds that fall to the forest floor from cones that ripen on the trees, are almost entirely consumed by even light ground fires; but that the seeds that are buried deep in the litter and duff are little affected by such fires.

These experiments prove, Doctor Hofmann claims, that in the northwestern forests all that is needed to bring back a second growth of timber is to control fires. In logging operations, brush and debris resulting from cutting must be burned when the woods are damp, in order to protect the stored seed, which is the most important factor in perpetuating the forest. But care must be taken to prevent a second fire from sweeping over

the land. If this is done, natural reforestation will follow with no outlay of money other than the amount usually spent for effective forest protection.

The importance of this discovery can be more fully appreciated when it is con-



Second-Growth Douglas-Fir Trees Coming Up in a Tract on Which the Timber was Once Destroyed by Forest Fires: Investigation has Shown That the Trees will Reproduce Naturally If Fires are Later Kept from Reburning the Area

sidered that 50 per cent of the remaining timber in the United States lies in the three Pacific-coast states of Washington, Oregon, and California; that we are cutting our timber more than four times as fast as it is being grown, and that there are, today, 81,000,000 acres of waste forest land that should be

growing trees. The solution of the nation's forestry problem, foresters state, lies in preventing fires and in giving nature a chance to reclothe the timberlands.

53/

#### TO RESTORE MONROE HOME, NOW RAG-SORTING SHOP

An old battered-looking house in downtown New York, once the home of James Monroe, fifth president of the United States, and now being used as a junk and rag-sorting shop, is soon to be restored by the Sulgrave Institution. This society, which was organized to promote good feeling between English-speaking peoples, intends raising a fund to buy the building so that it can be dedicated on Dec. 2, 1923, the 100th anniversary of the signing of the Monroe Doctrine. The house, a two-story brick in Colonial style, stands at Prince and Lafayette streets, in what at one time was the most fashionable residential neighborhood in the city.

*Christian Science Monitor*  
9/18/22

Without including government ships being built for the U. S. Shipping Board, American shipyards, on Sept. 1, 1922, were building, or were under contract to build, for private owners, 131 steel vessels of 249,394 gross tons. Thirteen new contracts were let, and two vessels were completed, during the month of August.



333 Todd Shipyard Corporation,  
 25 Broadway,  
 POPULAR MECHANICS  
 New York City

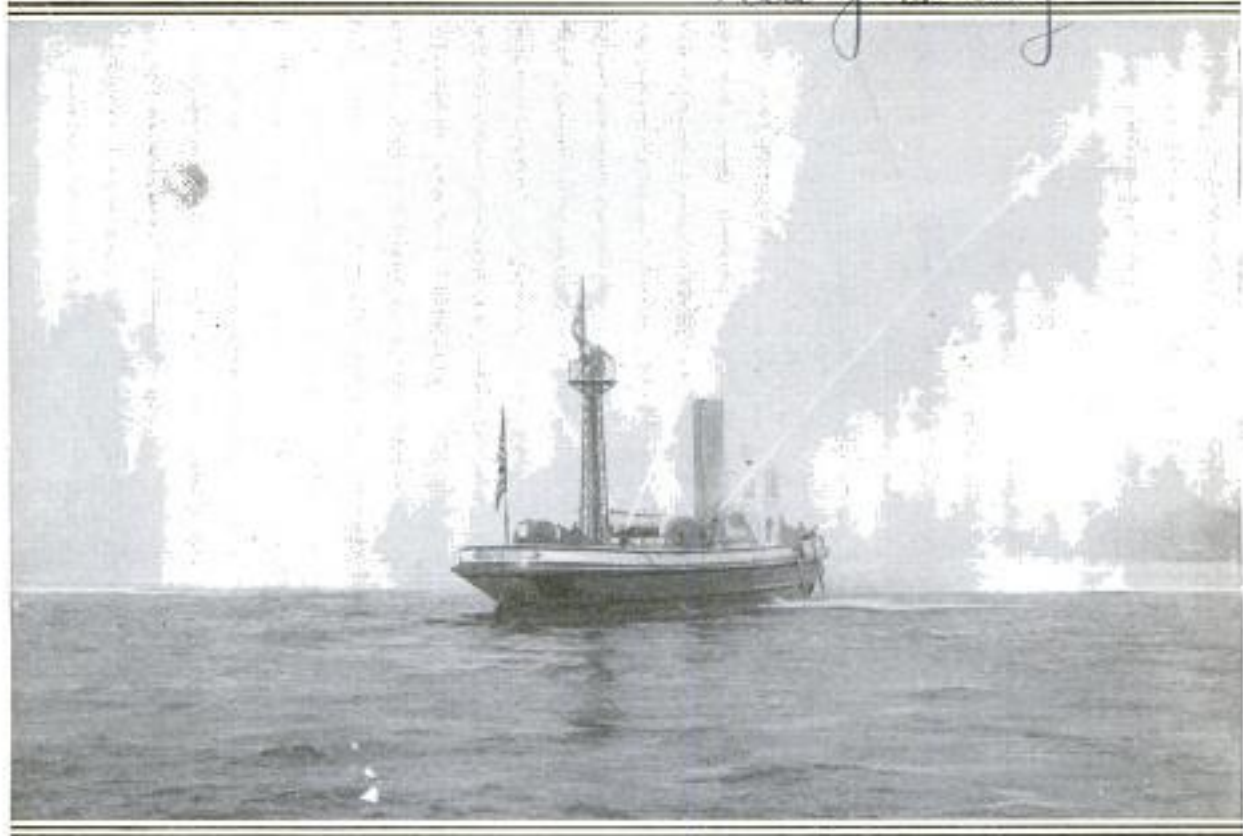

HIGH-PRESSURE PUMPS FOR NEW YORK FIREBOATS

NEW high-pressure pumps were recently tested on the fireboat "James Duane," belonging to the New York Fire Department. These pumps have a capacity of 9,800 gallons per minute, and from the hose nozzles they throw a stream of water to an exceptionally great distance. The tests were perfectly satisfactory. Eventually all the fireboats of the department will be equipped with these new pumps.

7700 Combination

THREE MACHINE TOOLS IN ONE FOR SMALL REPAIR WORK

One self-contained machine, that stands only 24 inches high and weighs altogether only 135 pounds, has a combination of operating mechanisms that enable it to do almost any kind of grinding, many kinds of drilling, and some forms of turning, thus making it a tool that alone will do most of the work required in a motor-repair shop or a garage. It has an upper spindle that is in direct connection with its 1/4-horsepower motor, by which it is belt-driven, and which can be set to operate at any angle. This carries the various grinding wheels, but these can be replaced by a drill chuck, making many small drilling or milling operations possible. The lower spindle, which can also be set at any de-

sired angle, is driven from a small grooved pulley on a shaft extension at the lower end of the motor through a double idler pulley hooked to a spring on an adjustable shaft, giving suitable belt tension in

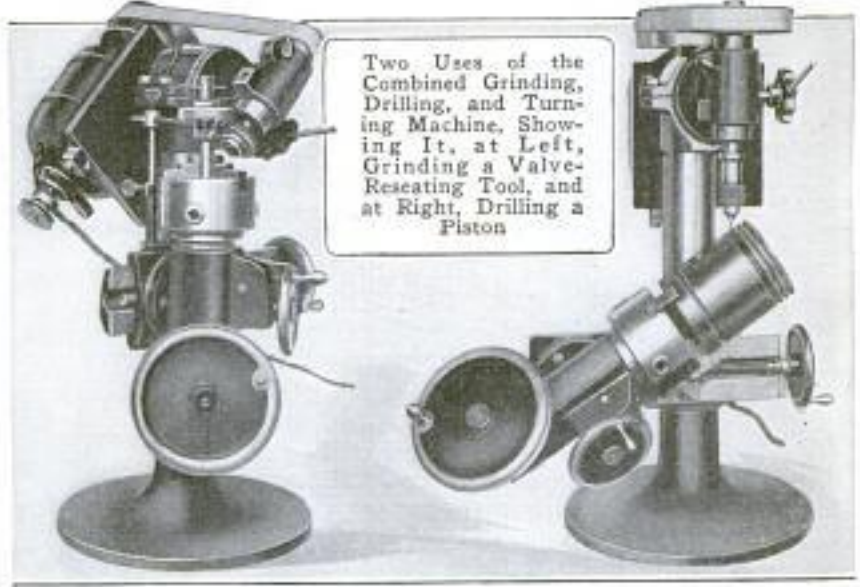

any position. A lug on the upper spindle holds a cutting tool for small turning operations on work on the lower spindle.

Ex. Cell. O Tool + 1/4 hp. Detroit Mach.  
 1214 Beaubien St.



304  
433

**TIME-KEEPING IN DECIMALS  
FOR FIGURING PAYROLLS**

For making time calculations by the decimal system, instead of by the much more complicated hour-and-minute system, the dials of all the clocks in a large factory have been divided into 10 six-minute periods, shown with figures alongside the conventional 12 five-minute subdivisions. Thus the hours remain



the same, but any fraction of an hour can be read in decimals. For instance, when the time reads 18 minutes past 9, the decimal figures show it to be 9.3, in which manner it is recorded for making payroll calculations.

**432 NEW LIGHTWEIGHT PISTONS  
WITH CURBED EXPANSION**

In lightweight pistons made of any aluminum alloy, trouble may occur from the excessive expansion characteristic of this metal. This means that in these pistons a greater clearance has had to be allowed between the piston and cylinder than with iron pistons. A lightweight piston, recently patented, has been designed that takes care of this



trouble by cutting vertical slots, on opposite sides of the piston wall, extending from the bottom piston ring to the end of the skirt. Two continuous steel bands of smaller diameter than the piston are cast in it, one above the wristpin boss, and the other at the bottom of the skirt. These control the expansion of the piston so that it is said to be actually less than that of the cylinder, with the result that

there is greater clearance in a heated engine than in a cool one, permitting adequate lubrication when it is most needed.

**904 COLLAPSIBLE TABLE HANDY  
FOR CAMP OR PICNIC**

Campers and picnickers will welcome a handy collapsible table which may be folded into a box, 10 by 12 by 36 inches



in size, so that it can be easily carried on the running board of an automobile. It weighs less than 25 pounds. When opened, three sides of the box form a top surface of 33 by 36 inches, while above this, an

adjustable shelf can be mounted to accommodate extra dishes. Four legs give the table proper stability. Besides ample space for knives, forks, and small cooking utensils, the outfit includes a screened inclosure in which food may be stored, safeguarded against animals and insects.

**375 DEMURRAGE CALCULATOR USED  
LIKE A SLIDERULE**

In the nature of a sliderule, a demurrage calculator that is now in use can be set to show at one reading the number of days' demurrage on a car, with the amount due. It has both a straight-demurrage and an average agreement-demurrage table, and it enables the operator to deduct Sundays and all legal holidays in accordance with either system. The slide is tabulated for 12 months, six on one side and six on the other. Only three months show through the opening



Calculator That, by Adjustment of Its Slide, Shows at One Reading the Number of Days' Demurrage on a Car, with the Amount Due

in the face of the calculator, and succeeding periods of three months are shown by reversing the ends of the slide.

Ans. John W. Warman  
Marcellus, Ill.

Butler Mfg. Co. 323 4 W. Washington St.  
Indianapolis, Ind.



**ELECTRICAL DEVICE OPERATES GARAGE DOORS**



Automobile Approaching a Garage Entrance, and Opening the Door by the Action of a Plate Pressed Down by the Weight of the Car

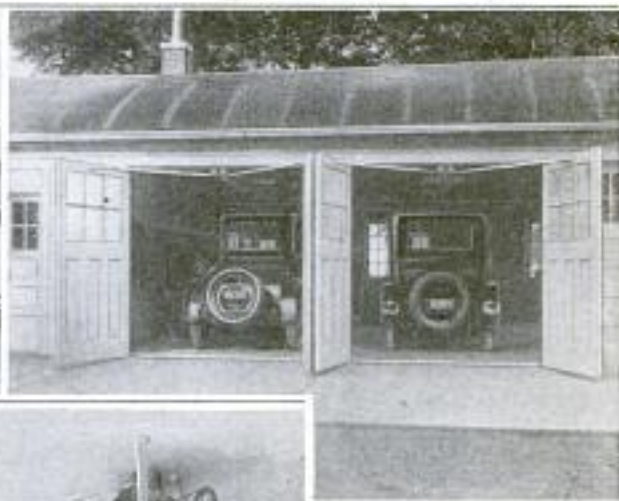

Two Cars have Entered the Garage Simultaneously, Each Opening the Folding Doors by Passing over a Plate in the Driveway

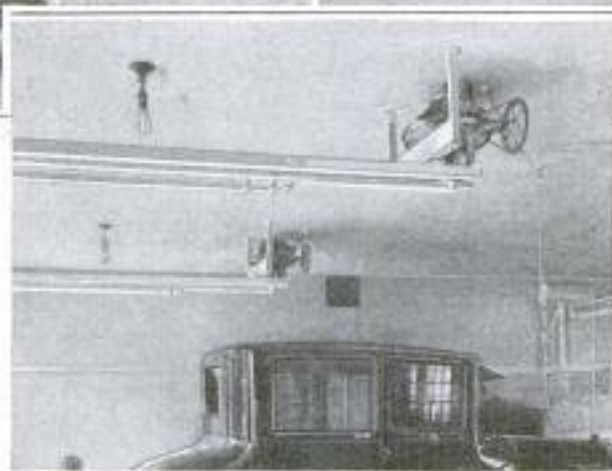

Interior of the Garage, Showing, Suspended from the Ceiling, Two Motors and Housings for the Gears That Operate a System of Levers for Opening the Doors: The Control Switches Are inside the Garage

An electrical means of opening and closing garage doors, recently patented, consists of a small motor installed by the side of a housing, both being suspended from the ceiling of the garage at some distance from the doors. Inside the housing are gears that operate a system of levers which open or close the doors when the motor is run-

ning. The motor is controlled by a switch inside the garage. Outside the garage, on the roadway in front of the door, is a plate which, when pushed down by the weight of an entering car, operates a switch that throws on the current. A strong spring prevents the switch from operating by any weight less than that of a car.

107

**NEAT OVERALL SUIT MADE IN TWO PIECES**

An overall suit which has no bibs, strings, suspenders, double folds, or buckles, is now available. The outfit, consisting of a jacket and trousers, can be fastened together with buttons and put on or taken off as a one-piece garment if desired. Under the waistband of the jacket are tabs which are buttoned to the trousers, thus forming a close and neat-fitting connection and making the garment practically dust-proof. The two parts of the suit may be washed separately, and, owing to the absence of buckles to rust or elastics to rot, are claimed to be very durable. Due to its design, the wearer is permitted unusual freedom of action.



Left: Neat-Fitting Overall Suit, Shown in Full-Length. Center: Jacket of Suit, Displaying the Flaps under the Waistband. Right: Trousers of Suit, Showing Buttons Which Fasten into the Flaps

Cuddy Over-Suit Mfg. Co.  
Victor Bldg. Kansas City, Mo.



*Mp. Inst. Coventry, England.*

**305 DIRECT-READING INSTRUMENT MEASURES FLOW OF FLUIDS**

A European manufacturer has brought out something new in the way of a meter for measuring and regulating the flow of

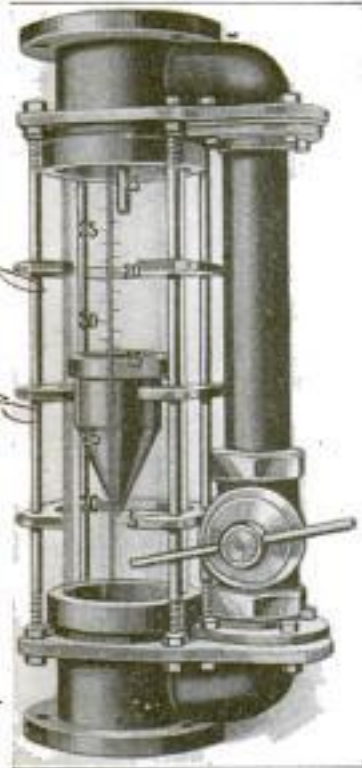

gases and liquids either at atmospheric or higher pressure. The fluid passes upward through a tapered orifice at the bottom of a vertical glass tube, and raises a float to a height which is proportional to the flow. Graduations on the outside of the glass tube indicate the rate of flow. The accuracy of the instrument is largely due to the construction of the

float, which is kept in rotation and prevented from touching the walls of the tube by the action of the fluid, thereby reducing friction to a minimum. It can be made in a wide range of sizes, and because of its sensitive and instantaneous operation, is adaptable to laboratory work as well as to commercial purposes.

**306 BLOWERS ON ARMATURE KEEP MOTORS CLEAN AND COOL**

When electric motors are used in locations where there exists dust or refuse of any kind, they have to be carefully inclosed to keep the working parts clean. A motor is now made for use under such



Armature with Projecting Fan Blades at Each End That Act as Blowers, and Expel Dirt or Dust through Openings in the Frame of the Motor

conditions which, instead of being inclosed, has special openings in its frame through which dust, or any foreign substance, is blown out. A number of small projecting fan blades are connected to each end of the armature. These form blowers that immediately expel through the openings in the frame any foreign substance that gets inside it. This method of keeping the parts clean has the advantage of also keeping them from overheating by the constant current of cool air.

**477 SEA LIONS SHOT FROM BOAT CARRYING MACHINE GUN**

Off the northwestern coast of British Columbia a machine-gun veteran of the late war has utilized the skill he acquired in this occupation by helping to kill 220 sea lions. He was one of a party sent north for the purpose by the government fisheries, because the sea lions destroy the nets. The firing was done from small boats, lying to leeward of schools of these animals, the men using one machine gun as well as ordinary shotguns. Sea lions have surprising vitality, and as a rule it took several shots to kill one.

*Comd. Francis B. Lichie*  
*Imperial Bay, B.C. Canada*  
**TANKS HOLDING 1,000 GALLONS**

**399 WATER LARGE VASES**

While it may sound like an exaggeration to say that flower vases exist which require 1,000-gallon water tanks to sup-

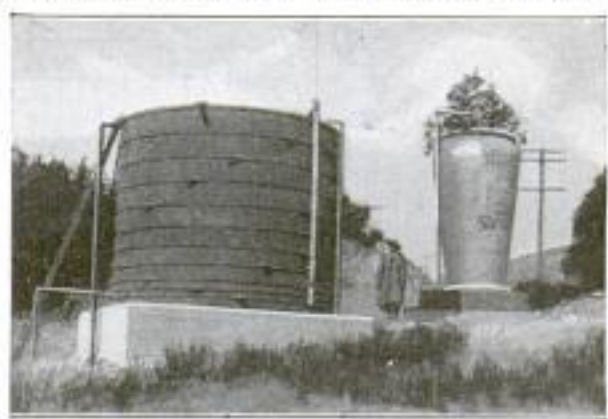

One of the Big Vases Placed along a California Highway for Advertising Purposes: Each is Watered from an Individual Storage Tank

ply moisture to each one, the statement is literally true. The vases, 12 feet in height, are placed along a California highway for advertising purposes. Beside each of them a big water tank has been built, and a siphon arranged leading into the vase. At frequent intervals an attendant waters the plants.

*Comd. Frank B. Howe*  
*412 Mason Opera House*  
*Los Angeles, Calif.*

*Comd. Major Johnstone Taylor, The Bungalow, Underdale, Shrewsbury, England.*

*Wagner Electric Co. St. Louis, Mo.*



370 *Thos. H. McDonald, Chairman*  
*Bureau of Public Roads, U. S. Dept. of Engineering*  
**HIGHWAY MODELS FOR ENGINEERING COLLEGES**

By *S. R. WINTERS, 703 Electric National Bank Bldg., Washington, D. C.*

IT is proposed to supplement the conventional methods of instructing the students of engineering colleges in highway construction by supplying these colleges with portable models which are miniature reproductions of sections of various kinds of highways, showing the successive stages of their construction. Every kind of roadbed will be reproduced faithfully, to a greatly reduced scale, and, outside of the actual manual labor in connection with the work, the models will furnish an indoor equivalent to an outdoor study of the roadway itself. These models have been specially made for this purpose by the Bureau of Public Roads, and include, besides the types of roadbeds, models of culverts, of a concrete bridge, and of other things in connection with highway construction. The models comprise concrete, brick on a concrete-cement base, macadam resurfaced with bituminous material, bituminous macadam, waterbound macadam, sand-clay, and gravel types of road construction. The bridge is the T-beam reinforced-concrete type, and besides a concrete-pipe, there are models of arch and box culverts.

This group of models typifies the development of modern highway construction, which has depended so much upon the work of the Bureau of Public Roads. The bureau was first constituted in 1893, at which time the annual appropriation for its maintenance was only \$10,000. This, of course, was greatly increased as the scope of the work done by the bureau developed, some idea of which may be gathered from the fact that, during the

year 1921, the bureau supervised the expenditure of over \$100,000,000 appropriated by Congress as Federal aid in the

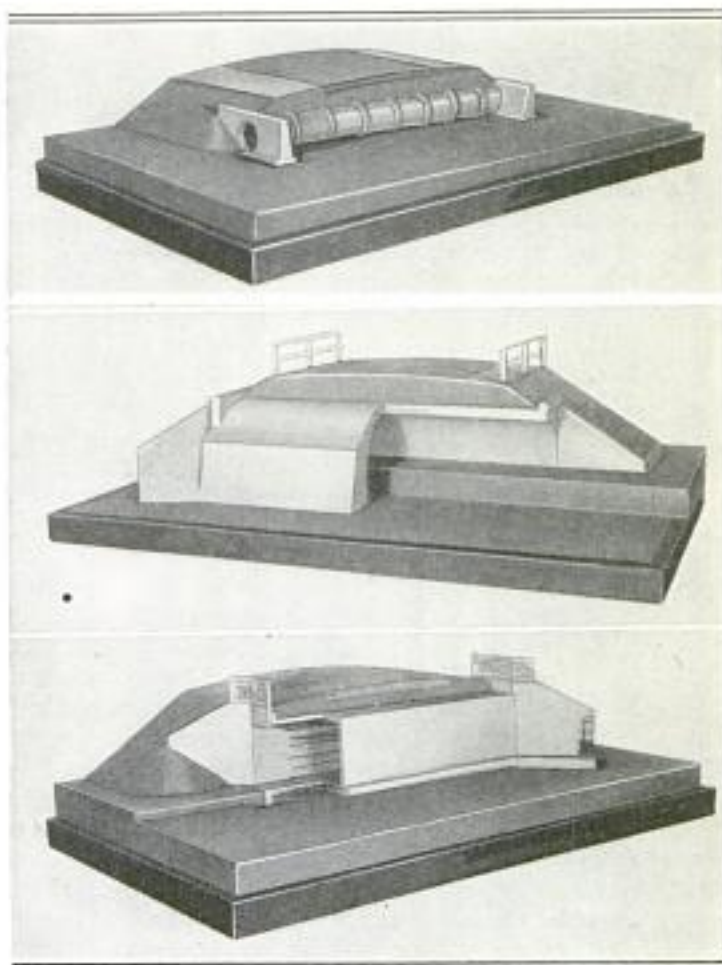

Models of Various Types of Road Construction for Engineering Schools: Top: Model Illustrating Concrete-Pipe Culvert Construction. Center: Model of Concrete-Arch Type of Culvert. Bottom: Model of Box Form of Culvert Construction

national highway-construction program, and of an even larger sum appropriated by the legislatures of the respective states for their individual road building.

The bureau is not concerned with any particular type of road, but with all types used in the United States, favoring al-

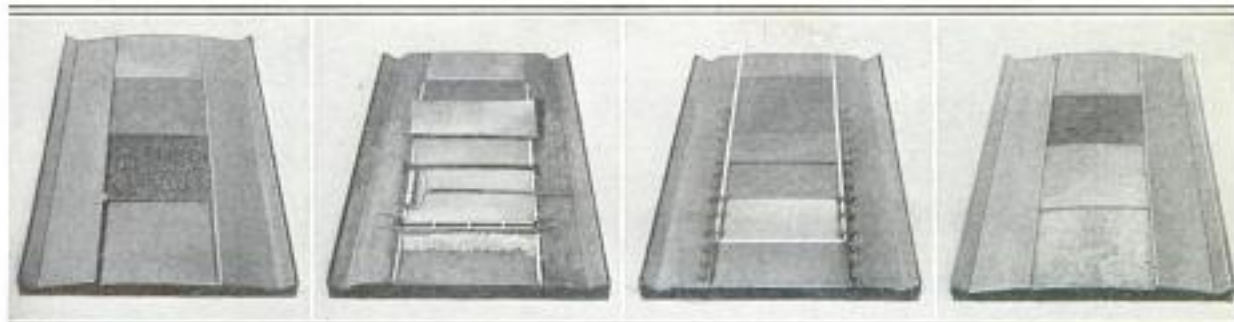

Models Showing the Elements of Four Different Types of Roadbed Construction, Made for the Instruction of Students in Highway Engineering: From Left to Right, Plain Gravel Road; Solid-Concrete Road; Paving Brick Laid on Concrete Base, and Macadam Base Surfaced with a Bituminous Material



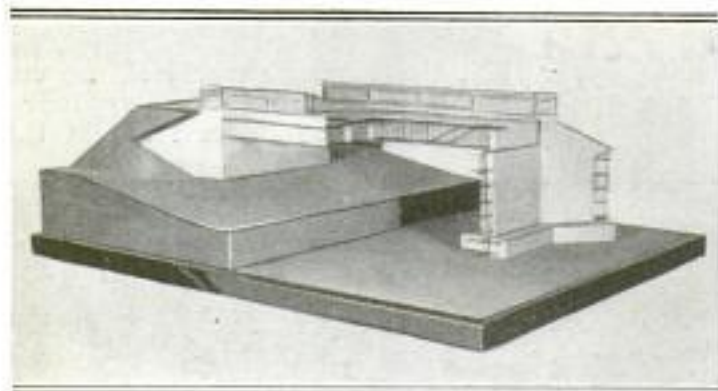

Miniature Reproduction of a Concrete Highway Bridge, the Vertical Section of Which is Designed in the Shape of the Letter "T"

ways that best suited to local conditions. Of the various types, earth, sand-clay, and gravel constitute about 66 per cent; cement, brick, and bituminous concrete, 24 per cent, and other types the remaining 10 per cent, of all highways built in the United States. It is thus evident the majority of our highways is not of the so-called improved type, and that for some time to come the dirt and gravel roads will continue to be the solution of the road problem.

410

### TWO OLD LIGHTHOUSES USED IN BUILDING COTTAGE

Two lighthouses were used in the construction of a cottage, recently built,



The Tower Wings of This House Were the Base Sections of Two Condemned Lighthouses Which the Owner Was Able to Buy for a Small Sum

overlooking the ocean near North Eastham, on Cape Cod, Mass. The encroachment of the sea had made it necessary for the government to condemn the two old lighthouses in favor of another more se-

curely located. Hearing of this, a resident of the cape bought them for a small sum, moved them back, and used the base sections as tower wings for his residence.

349

### SHOCK LOADER ECONOMICAL FOR THE FARMER

Time and labor may be saved by the farmer if he makes use of a recently developed grain or hay loader which has been given practical working tests. The outfit is constructed entirely of iron and steel. An elevating carrier frame extends upward and around a 45° curve at a sufficient height to overhang the ordinary wagon containing a rack. The implement is hauled by a team of horses. In operation, the rake mechanism automatically picks up the shocks of grain, or the hay, which lie in its path and deposits them on the rack wagon which is driven alongside. The farmer is thus enabled to reduce his expenses considerably during the harvest season and at the same time to take care of his crop in the proper manner.



Left: Loading Machine, Showing How the Implement Picks the Shocks of Grain or Hay from the Ground and Carries Them up the Incline for Deposition on the Wagon Which is Driven Alongside. Right: Rear View of the Loading Machine, Clearly Illustrating the 45° Curve in the Carrier

Albertson Loader Co 844 Seal St  
St. Paul, Minn.

Harold F. Blanchard  
Sudbore, N.Y.





365 Interior of a Box Car Converted into a Classroom in the Yards of the Atlantic Coast Line Railroad at Lakeland, Florida: The Class is Composed of Mechanics from the Railroad Shops, Who Made the Desks and Stools, and Fitted Up the Classroom to Serve Its Purpose Effectively

### RAILWAY BOX CAR CONVERTED INTO A HANDY CLASSROOM

A number of ambitious mechanics employed in the Atlantic Coast Line Railroad shops at Lakeland, Fla., were anxious to study mechanical drawing, blueprint reading, mathematics, and the rules of the American Railway Association. They were numerous enough to form a class, but nothing in the nature of a classroom was available. So it occurred to them to appeal to the company for the loan of a box car. The request was granted, and they mounted the car on blocks in the yard. The doors were filled in, windows were installed in the side walls, and a doorway at one end. At the other end a blackboard was placed on the wall. The men made their own desks and stools in the shops. The interior was painted a light and attractive color and electric lights were installed. 357

### LARGE NUMBER ON AUTO BUS SERVES NOVEL PURPOSE

Maintaining that the good will of the public is its largest stock in trade, an intercity motor-bus company of California has painted large numbers on the baggage rack of its busses and invited

the public to report any breach of the unwritten "laws of the road." The drivers are all good men, says the company, but the knowledge that every motorist is



The Large Number Makes It Easy for Other Motorists to Identify the Bus When Reporting Discourtesy or Careless Driving

watching a big No. 18 or No. 12, makes them just a bit more anxious to please. The numbers are about 2 feet high.

*D. R. Curtis, Santa Rosa, Sausalito  
Stage Co., San Francisco, Calif.*



Emb. 9793  
458

Refus E. Steering  
3017 Prospect Ave  
Kansas City, Mo

910

POPULAR MECHANICS

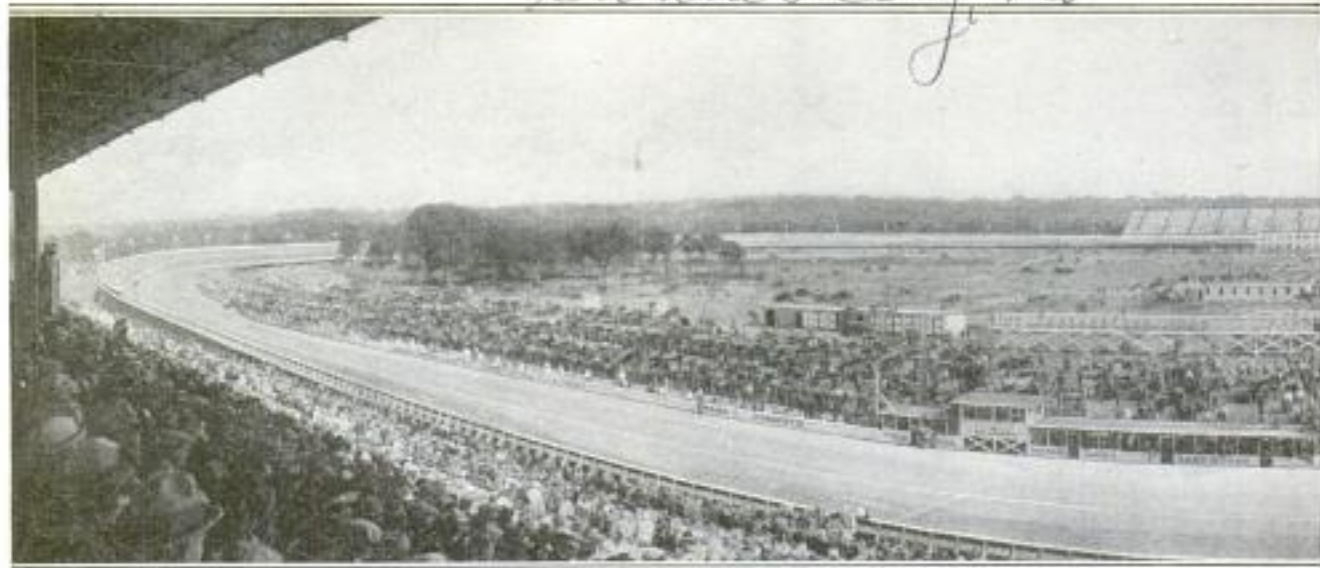

COPYRIGHT.

Speedway Recently Erected and Dedicated at Kansas City, Missouri, and Which has been Declared the Fastest Track in the World. This Panoramic Picture, Taken from the Grand Stand, Shows a Number of the Speeding Machines Bunched Together, and a Large Number of Private Cars, Parked While the Owners Watched the Event, Together with the

9793 **MAGAZINE STOVE WILL BURN SAWDUST FOR FUEL**

The ever-increasing cost of coal has led to the development of a heating stove that will burn sawdust or the lower grades



Left: Magazine Stove Which Burns Sawdust or Lower Grades of Coal. Right: Magazine of Stove, Showing the Removable Core

of coal that are unsuited for use in the ordinary stoves. There is a separate magazine inside the drum of the stove, and this can be taken out and packed with fuel. A removable core is placed in the magazine before the fuel is packed in, and is withdrawn when the magazine is replaced in the stove. The space occupied by this core forms a central draft opening through the bed of fuel, and insures good combustion. The magazine is adjustable by a lever which varies its distance above the grate.

Pyro Mfg. Co. 72 W. Washington Chicago

544 **ITALY TO DRAIN MARSHLAND UNUSED FOR 2,500 YEARS**

Along the Appian Way from Rome to Naples, between the Lepini Mountains and the Tyrrhenian Sea, lie the Pontine Marshes. Although numerous plans have been advanced to reclaim these lands, since the canals and ditches of the Volsci were destroyed during the 150 years' war of the Roman conquest, they have never been realized. At the present time Italy is actively engaged in making productive over 6,000 acres of this area, and the complete project calls for the construction of a large reservoir to catch the drainage from the mountains, which will be used for irrigation during the dry season and to supply power for pumping when there would otherwise be an excess of water on the land.

La Nature 8/5/22 P. 38

458 **WORLD'S FASTEST SPEEDWAY STAGES FIRST EVENT**

"The fastest track in the world!" declared Tommy Milton, winner of the automobile classic at Kansas City, Mo., as he clambered out of his overheated and steaming racer, after traveling the 300 miles at a rate of 108 miles an hour. Other nationally known drivers voiced practically the same opinion of this new speedway. Built of wooden planks, which are laid on edge and end to end, the 1 1/4-mile track is properly banked at the turns to assure apparent safety to the dare-devil drivers who risk their lives for the large money prizes. Nevertheless, during the dedication race on Sep-





C. ANDERSON  
 in the World by Tommy Milton, Winner of the Dedication Race, and Other Well-Known Racing Drivers: This Panorama at the Steeply Banked Turn at the Right. In the Track Inclosure may be Seen the Thousands of Numerous Garages for the Racers, and in the Background the Large Bleachers

tember 17, one man was killed and eight injured. Of 16 entries, only eight finished. The grand stand, erected at a cost of \$350,000 and seating 17,000 persons, was filled to overflowing, it being estimated that 56,000 spectators crowded into the grounds to see the event.

278  
**NEW MACHINES FOR CUTTING METAL SHEETS**

Sheet-metal workers will be interested in several new shop tools that are being introduced by an English manufacturer. Each one is provided with rotary cutters

operated through a ratchet by means of a powerful leverage, and as there are practically no throat restrictions, sheets of any commercial size can be successfully cut. One is built solely for straight cuts on flat sheets; another, intended for cutting curves or figures of irregular outline, has the overlapping cutters set at an angle to the sheet; a third machine is designed for particularly heavy work and has a pair of rotary double-edged cutters, the upper one of which is driven by an internal ratchet by means of the forked handle. The latter is well adapted to the shearing of corrugated iron.

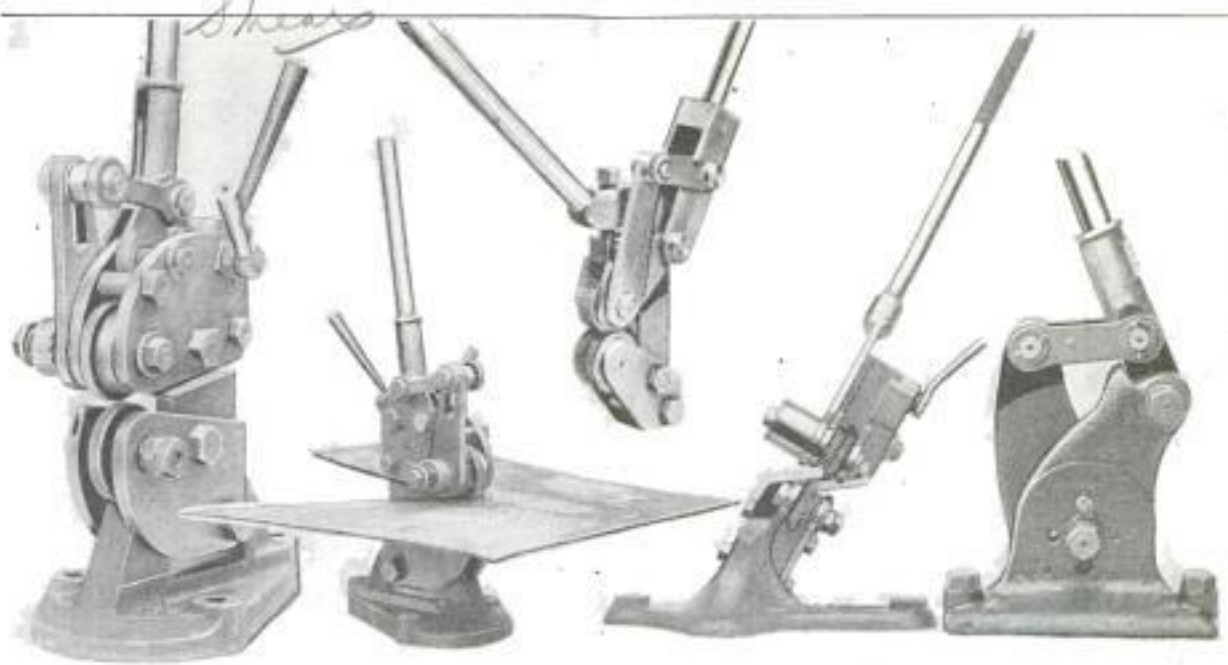

From Left to Right Are Sheet-Metal Shears Adapted to the Following Uses: The First Two for Straight Cuts on Flat Sheets; Cutting Flat Sheets Heavier than 20-Gauge and Corrugated Sheets; Irregular Shapes from Flat Sheets; Shearing Round or Square Rods

*The Tangle Tool Engineering Co. Ltd.  
 Keynsham, Somerset, England.*



The Wellman Weber Checkers Co. Manchester  
 7016 Euclid Ave. Guardian Weekly.  
 264<sup>912</sup> POPULAR MECHANICS Sept. 16, 1922  
 Cleveland, Ohio

**ADJUSTABLE SPRING CONTROL FOR SMALL CARS**

*Auto* "Thank you mams," the violent bumps that toss persons in the rear seat up against the top of an automobile, need

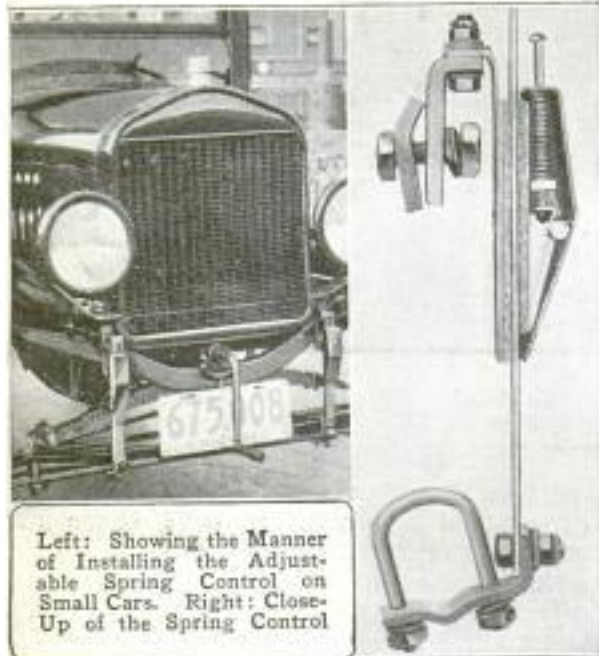

Left: Showing the Manner of Installing the Adjustable Spring Control on Small Cars. Right: Close-Up of the Spring Control

cause no annoyance to occupants of small cars. The remedy consists of an adjustable spring control. These devices may be installed on a machine in 20 minutes and do not require the removal or change of any parts, nor the drilling of holes in the frame or body. They are attached directly to and between the body and axles. All sidesway, or the objectionable rebound, is claimed to be eliminated when traveling over the roughest roads, by means of a frictional resistance which has a "checking" effect upon the springs of the machine.

**NONSLIP DRILL CHUCK REQUIRES NO KEY**

A neat and convenient chuck, adapted to the use of small and moderate-sized twist drills, has lately been offered to the

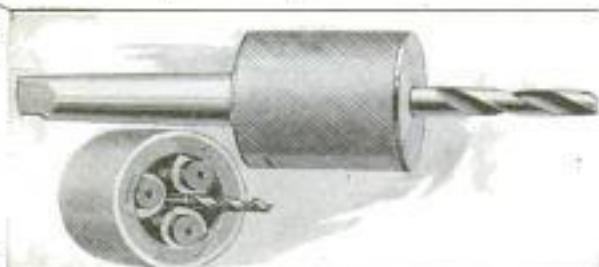

This Simple Drill Chuck Is Self-Centering. Requires No Key, and Takes Straight or Taper-Shank Drills

trade. It consists of three controlled cam jaws, having a journal and inclosing ring at each end, which grip the drill shank. The outside knurled surface of the ring provides a handgrip on the chuck, which is so easily operated that straight-shank drills can be changed without stopping the spindle.

**RETURN FROM THE ANTARCTIC OF THE ILL-FATED "QUEST"**

On Sept. 16, 1922, just a year after the departure of the "Quest" from Plymouth, Eng., to carry out its antarctic expedition under the command of Sir Ernest Shackleton, the little vessel sailed back into that port. The death of this great explorer, January 5, on board the "Quest," was not its only visitation of ill fortune, for on the contrary it seemed to be pursued by bad luck from the beginning of its 25,000-mile cruise to its end. Unfavorable weather attended it all the way, and when the antarctic was reached, there were encountered exceptionally unfavorable ice conditions. Nevertheless, Commander Wild states that scientific results of great importance were obtained.

**FACTORY-MADE TRUCK SKIDS ARE STRONG AND DURABLE**

Homemade truck skids may be replaced to advantage with a skid manufactured with a steel frame and malleable-iron legs, the whole installation being strong and



Factory-Made Truck Skid with Steel Frames and Malleable-Iron Legs: Inset Shows a Compact Nest of 15 of Them

durable. The frame is made of 2 1/2 by 2 by 5/16-inch steel angles, upon which heavy planking is bolted. Riveted to the frames are four rigid legs, made of malleable iron, 1 1/2 inch wide and 1/4 inch thick. The legs are properly located for using the skid to best advantage with lift trucks and otherwise.

Cowan Truck Co.  
 7 Water, Holyoke, Mass.

*Eastern Tube & Tool Co., Inc.  
 594 Johnson Ave., Brooklyn, N.Y.*



9/15/22

332

POPULAR MECHANICS

913

Forest Products Laboratory Madison, Wis

POISONS MIXED IN PARAFFIN AS WOOD PRESERVATIVE

GOLF BALLS TESTED BY MEANS OF DRIVING MACHINE

Discovery of a new wood preservative, consisting of a mixture of soluble poisons and liquid paraffin, has just been announced by the Smithsonian Institution. The poisons used in the experiments thus far are iodide of arsenic and iodide of copper. As is well known, arsenic is deadly to all animal organisms, while the effectiveness of copper salts for the destruction of plant life is equally common knowledge. It is therefore apparent that organisms attacking wood which has been treated with this mixture will virtually commit suicide. Specimens of piling, after receiving the paraffin treatment, have been submerged for some time by the side of untreated specimens, at Key West, Fla. While the untreated piles show clear evidence of the destructive work of the teredos, or marine borers, those treated with the new solution are in as good condition as when they were placed in the water. It is thought that this treatment would also be efficient for wood used in seaplanes, because it would prevent moisture from penetrating the joints and causing them to become weakened.

TINY GUN EASILY CONCEALED IN PALM OF HAND

One of the many strange exhibits at the recent police convention in New York City, and one which attracted considerable attention, was a tiny gun of peculiar make.



It was so small that it could be easily concealed in the palm of the hand. With this miniature but deadly weapon, 12 shots may be fired with great rapidity, and it is thought that there are few guns of this kind in existence.

no information on maker

In England a mechanical device is used for testing golf balls. The club is at-

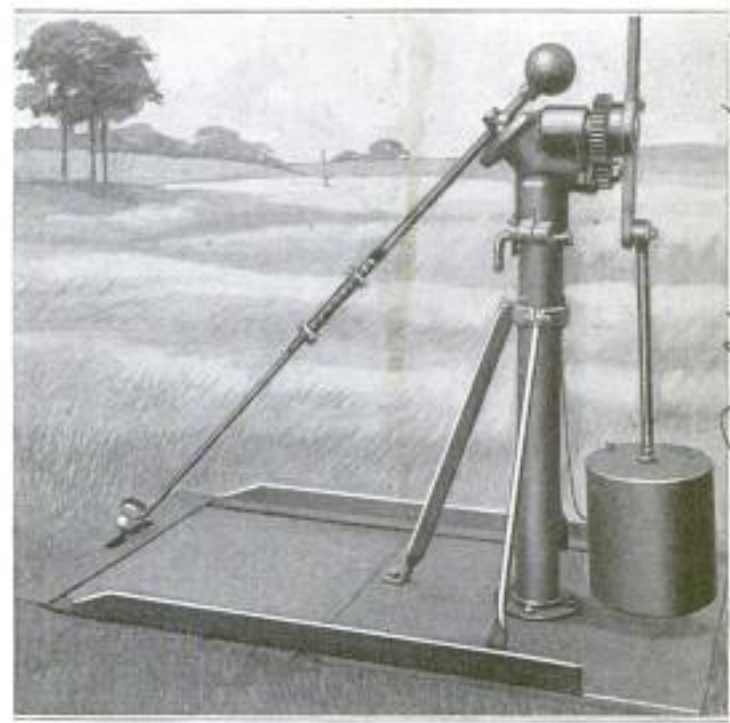

The Above Machine has been Designed to Test Golf Balls under Conditions to Which They are Subjected in Actual Play. The Length and Force of Stroke are Adjustable

tached to the machine and adjusted to give the desired swing and timing according to the variations of the human stroke. The force and length of the stroke are thus measured, and the different factors entering into the manufacture of the balls determined, under conditions identical to which they are subjected in actual play.

GOVERNMENT OIL LANDS YIELD LARGE ROYALTIES

Under the leasing acts, which are an important innovation for the petroleum industry, the royalties obtained from government-owned lands vary from 12 1/2 to 33 1/3 per cent, according to the rates of production. Of the amounts received, 10 per cent goes to the Federal government, 37 1/2 per cent to the state in which the oil is produced, and 52 1/2 per cent to the U. S. Reclamation Service. During the fiscal year ended June 30, 1922, the total government royalty amounted to approximately \$4,000,000, and in the month of August, \$778,378.11 was turned into the U. S. Treasury in addition to the sums received by the different states and the reclamation service.

Publicity Bureau of News Washington, D.C.

Dr. W. W. Bartock, Smithsonian Institution, Washington, D.C.  
 name on gun - Turbians, taken from an American criminal in France

Dunlop Tire & Rubber Corp. of America, 17 E. 42nd St. New York City



021  
Cmt. Francis P. Mann.  
12, Boulevard Arago.

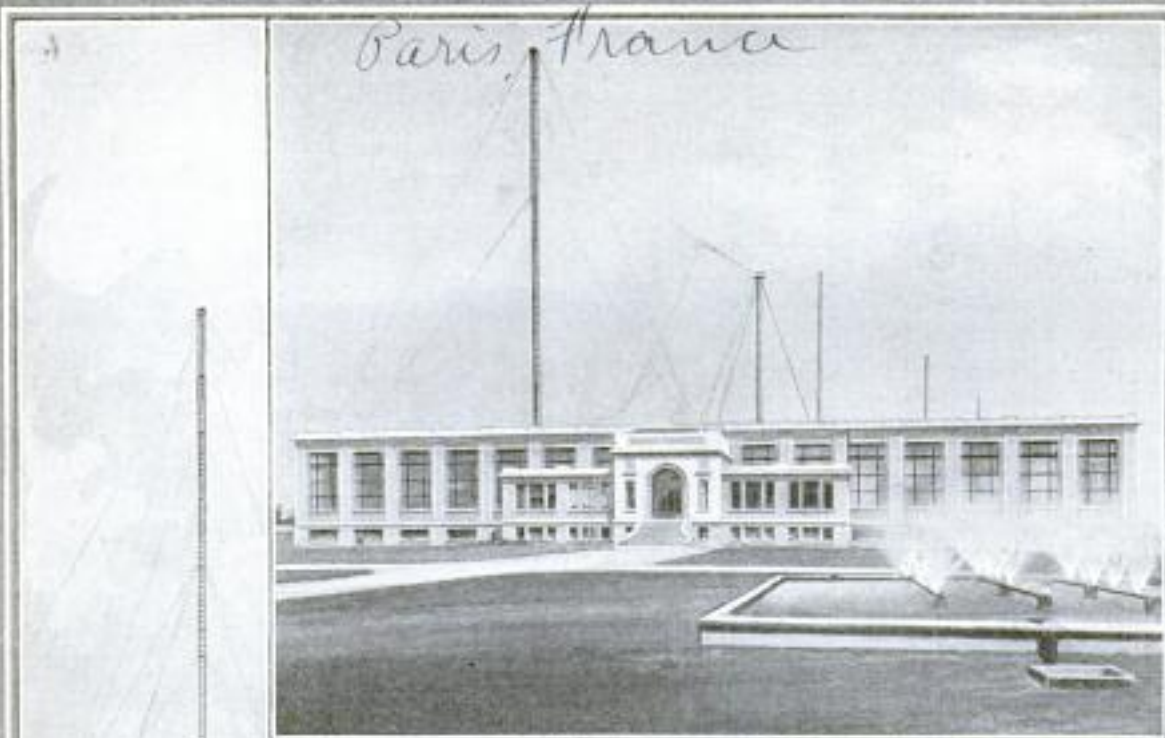

**WIRELESS PLANT AT SAINTE-ASSISE  
HAS WORLD-WIDE CONNECTIONS**

**H**AVING four times the capacity of any other in Europe, the new French radio station at Sainte-Assise, several miles from Paris, is controlled entirely from the city by means of automatic apparatus. All parts of the world are reached from the main building, shown above, while the European work is done in the smaller building, with its 800-foot tower, shown to the left. The main building contains high-frequency alternators, shown below, of special design, and with exceptional capacity.

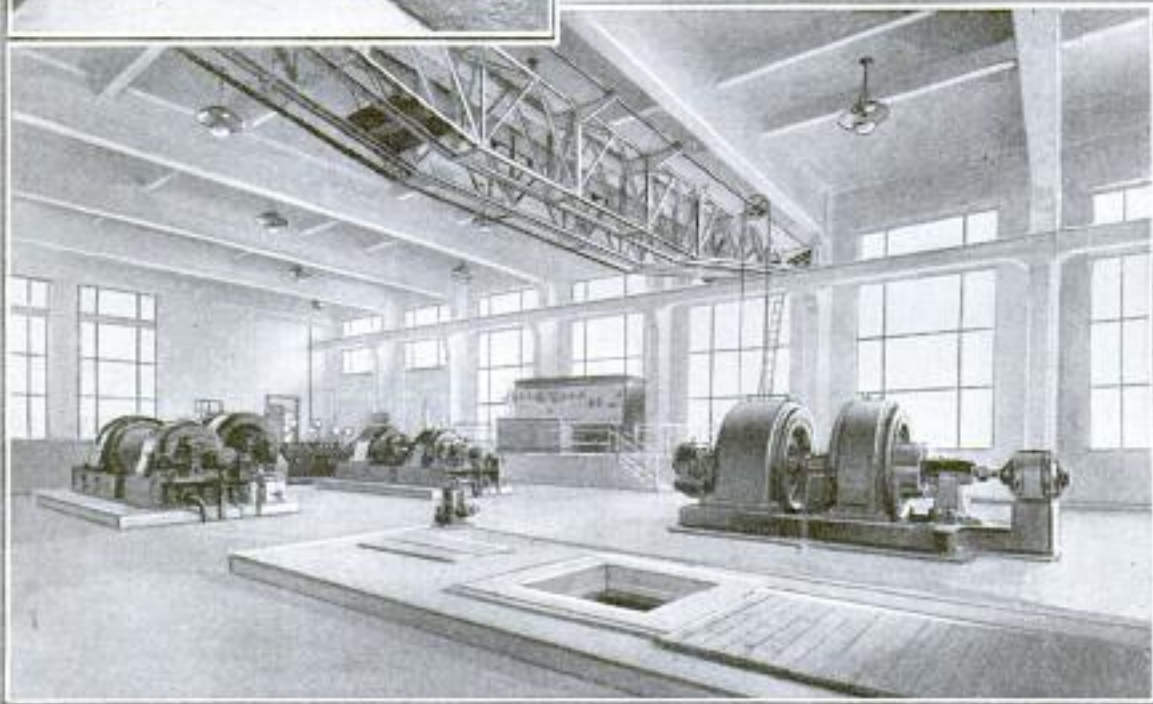



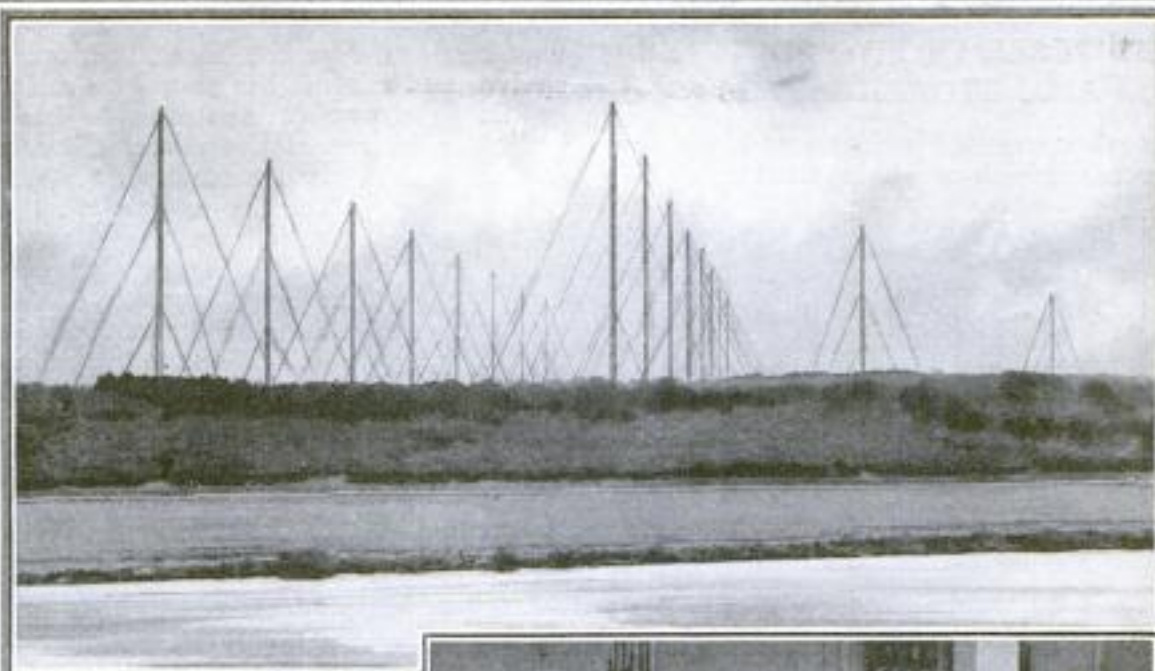

The aerial of the plant, shown above, covers many acres of ground, and is composed of 40 miles of wire, weighing 16 tons. High-speed automatic apparatus at the Paris office, shown to the right, operates over wires to the Sainte-Assise plant. Here the receiving plant, consisting of six buildings, seen below, each containing a large movable frame coil and a set of special tuning apparatus, is located at some distance from the main plant.





*Dr. W. P. Walker,  
Wilson's Drug Store,  
Spartanburg,  
S.C.*

**SHOWCASE IN TWO SECTIONS  
AIDS STOREKEEPERS**

336

Storekeepers will be interested in a new showcase which appears similar to the

two sections. In the front section, the shelves and mirrors are placed so as to be in the prospective customer's line of vision as he enters the store. The rear section is a miniature stockroom. When



the buyer indicates the article in the case that he desires, the clerk merely opens a small door at the rear, directly behind the indicated merchandise, and is enabled to hand out the goods without having to disturb the display scheme, which would necessitate a rearrangement of the showcase. By this method, the exhibited merchandise always presents a neat and attractive appearance, while at the same time, the customer may be served rapidly.

At the Left the Showcase, Which is Made in Two Sections, is Seen with Both Parts Pushed Together, Making the Whole Appear as One Structure. At the Right, the Sections are Shown Separated

usual display case from the front, but differs greatly at the rear. It is made in

pearance, while at the same time, the customer may be served rapidly.

*239  
Auto "Upper North Co."  
4154  
Los Angeles Calif.  
Minnesota Calif.*

**AUTO-TOP LINING WITH SPACES FOR CLOTHING**

Intended to hold clothing, hats, and other articles, a double lining strip, to be strung immediately under the auto top, is now being placed on the market. There are three compartments in the space between the bottom and top strips for clothing and wraps, while straps along the underside of the sections are designed to hold hats. In addition, there are four convenient pockets for odds and ends.

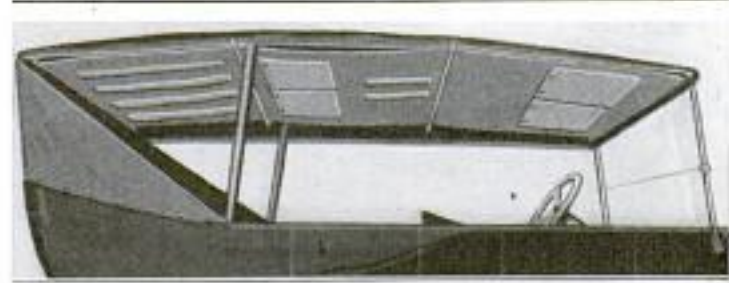

The Double Lining, Pictured Above, was Designed to Hold Clothing. The Straps at the Left are Intended for Hats, and Another Pair of Straps is Strung near the Center. Four Pockets Provide for Miscellaneous Articles

9806

**COMPRESSED-CANVAS WHEELS FOR CAR OR PULLEY**

Noiselessness and practical indestructibility are features of compressed-canvas

wheels now being placed on the market by an eastern company. These wheels, made with and without cloth flanges, are suitable for all kinds of factory trucks, special pulleys, sheaves, and the like, and can be driven over polished floors without leaving scratch or mark of any kind. Mining activities during the late war were aided by the use of these soundless wheels, which were mounted on the small cars that operated over wooden tracks in the sappers' trenches. So far as is known, these are the first cloth-flanged cushion wheels to be manufactured for operation over rails.

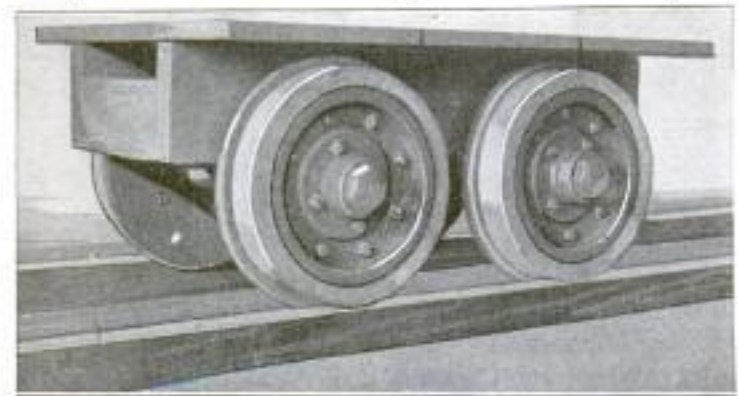

Compressed-Canvas Wheels Which Are Noiseless and Practically Indestructible, Shown Fitted with Cloth Flanges for Use on a Narrow-Gauge Track

*Stevens Brothers Co., Utica, N.Y.*



## TRANSMUTING THE ELEMENTS

BY ROGERS D. RUSK,

*The Connellsville, Pa.*

"THE artificial transmutation of the chemical elements is thus an established fact," says Prof. O. W. Richardson, in speaking of the work of Sir Ernest Rutherford, who has recently succeeded in breaking up some of the chemical elements, and has obtained traces of hydrogen from some of them. It was the dream of the alchemists of old to transmute the elements, particularly the baser metals, into gold and silver, but their aim was never attained. Probably

the actual changing of lead to gold is the thought farthest from Rutherford's mind as he works in his laboratory, but his discoveries have already made the world very much richer in the knowledge of the secrets of matter which have been revealed, and the possibilities of the future. Furthermore, it is just such a beginning which often leads to the most startling achievements of science.

The scientists of today are showing that the dreams of the alchemists were not so vain and foolish as once was thought. Indeed nature has been practicing alchemy since the dawn of

existence and has been continually changing matter from lower forms to higher forms and back again. Radioactivity is nothing more than the transmutation of complex atoms into simpler forms. When a complex atom grows old and begins to decay, it breaks up and throws off some of its particles in the form of rays. The remaining particles form an entirely new atom, which is lighter in weight than the old one. This process continues until the particles which remain form so stable a combination that they refuse to break up further, and then all radioactivity has ceased.

What nature has been doing spontaneously in radioactive substances Sir Ernest Rutherford has now succeeded in

doing by artificial means. For a long time after the discovery of radioactivity, scientists were only able to watch the process continue spontaneously. They could not stop or start it, nor could they change one element into an entirely different one as nature does. Now it appears that this may be possible, though not on a very large scale nor as a commercial enterprise, perhaps. It thrills one to think that the scientist has at last been able to wave the

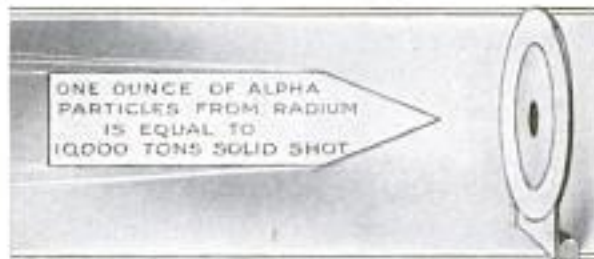

Graphic Illustration of the Fact That One Ounce of the "Alpha" Particles from Radium Is Equivalent to 10,000 Tons of Solid Shot Moving at the Speed of a Rifle Bullet

magic wand of his knowledge over matter of one kind and change it into an entirely different kind, even though the change can only be detected by the most sensitive means.

Rutherford's method is to subject the atoms of a substance to a bombardment of very swift-moving particles. Now the swiftest-moving particles known to science that have any appreciable weight are the "alpha" particles shot off from radium. These particles have the same weight as a helium atom, but they travel at a speed of 12,000 miles per second, and hence are endowed with a tremendous

amount of energy in comparison with their size. Rutherford calculates that an ounce of these particles would be equivalent to 10,000 tons of solid shot moving at the speed of a rifle bullet (i. e., about two-thirds of a mile per second). Small wonder that these particles, on striking ordinary atoms, cause them to break up and change their form!

In this manner phosphorus and nitrogen were found to give off hydrogen and an unknown residue. Many other substances were tested, some with doubtful, some with negative results. The appearance of hydrogen in several cases lends support to the theory that hydrogen is one of the chief constituents of the atoms of the chemical elements, and one of the leading theories of the day is that all the

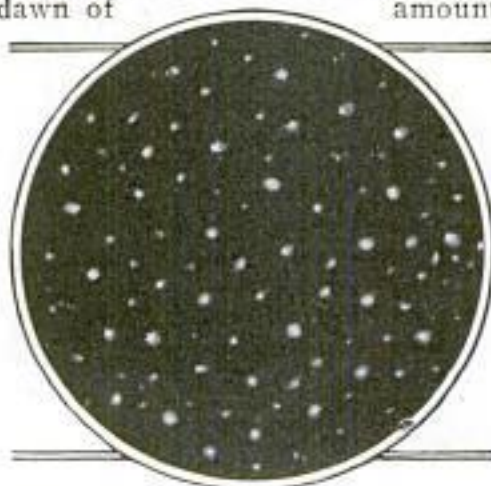

Screen of Zinc Sulphide in the Spintharoscope: When Struck by the Alpha Particles from Radium, the Effect of Countless Flashing Stars is Produced on the Screen



atoms of all the elements are built up of hydrogen and helium atoms firmly bound together.

Rutherford's biggest problem was the detection and identification of any new particles which were produced by this process of bombardment. The new particles formed by the collisions of alpha particles and ordinary atoms were, of course, also forced by the collision to travel at very high speeds, and the distance they would travel in the air could be calculated from a knowledge of their weight and speed. Fortunately such high-speed particles have the property of making their presence known when they strike a screen of zinc sulphide. Each particle as it strikes the screen produces a little flash of light and these flashes may readily be counted with a microscope. A small bit of radium on a needle point near such a screen produces an effect like a myriad

of scintillating stars, and an instrument to make the effects of radioactivity visible is called a spinthariscopes.

The product of all radioactive changes is a substance which will not decay further, and which has been found to be the same chemically as lead. Now the weight of an atom of lead is just a little more than an atom of gold, but the radioactive processes of nature stop with the substance lead. If it were possible under a bombardment of alpha particles to make lead decay further, it would form in turn the chemical elements thallium, mercury, and then gold.

So it is that the dream of the alchemists was not so far astray after all, but it should be said for any who may still be dreaming dreams, that the world would be no better off if all the lead were turned to gold, for then everybody would be seeking a way to turn it back again.

9589  
MODELS OF SPLASH DAM AND POWER PLANT



ton. The two projects in miniature were built exactly to scale, the logging camp having an actual road, splash dam, creek, tiny pine trees, and other realistic scenery. The power plant was constructed mostly of concrete, and thoroughly demonstrated the use of this material for dams, power houses, roads, tunnels, bridges, flumes, and poles for carrying the transmission lines.

Above: Miniature Splash Dam Built by Students of the Forestry College and Engineering Branch of the University of Washington. At the Right Is the Working Model of a Water-Power Plant, Together with a Roadway, Tunnel, Bridge, and Transmission Poles, All Made of Concrete

Working models of a logging camp and a hydroelectric power plant, together with necessary details, were recently placed on exhibition by the students of the forestry college and the engineering branch of the University of Washing-

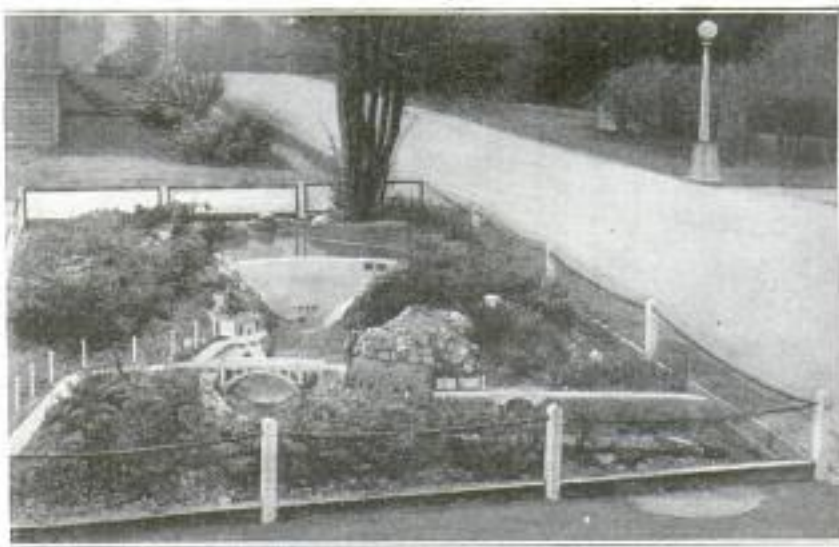

Emb. C. C. Harris, 41220-9th Ave, N.E. Seattle, Wash.



396 Lamer. Fonda, Johnstown & Groversville R. R. Co.

POPULAR MECHANICS

Groversville N.Y.

919

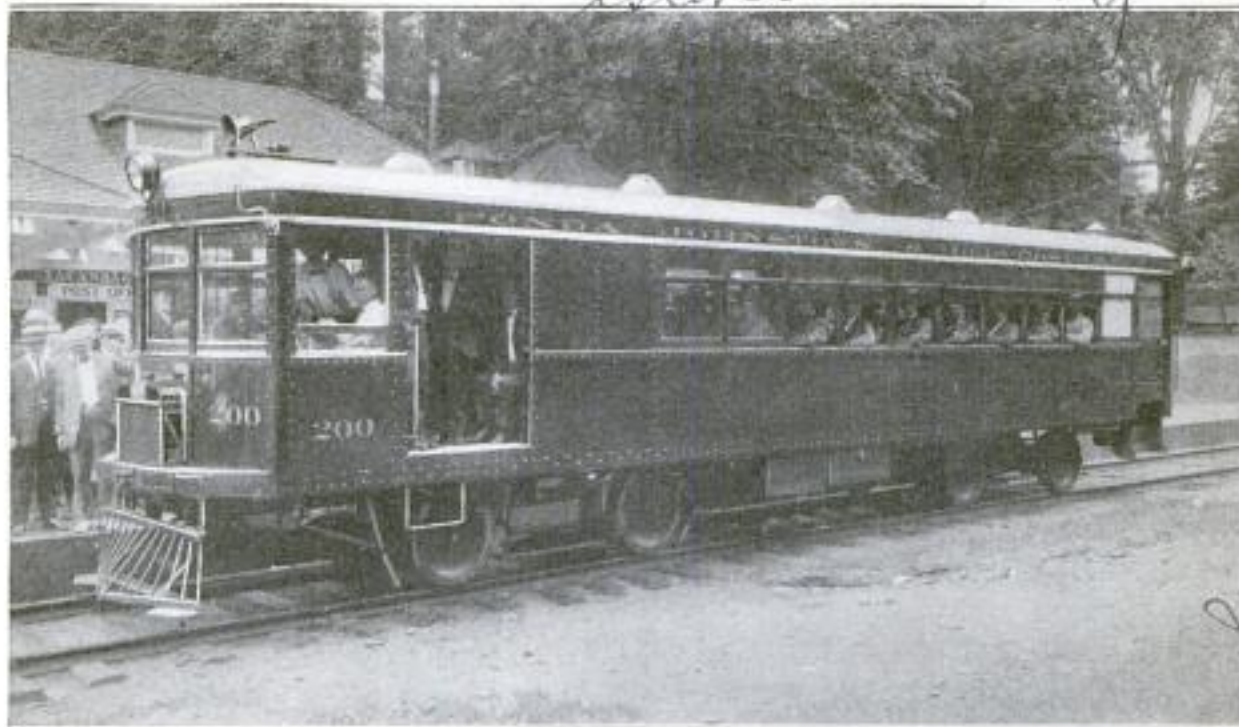

One of Two Gasoline Passenger Cars in Service on the Fonda, Johnstown & Groversville Railroad: The Car is Built of Steel and is Fitted with Air Brakes, Electric Lights, and All Standard Equipment. The Four Wheels of the Front Truck are Driven by a Powerful Engine of the Automobile Type

396

### GAS-DRIVEN RAILROAD CAR FOR PASSENGER SERVICE

One more example of the gasoline railroad cars that are becoming more and more popular is a four-wheel, double-truck car, two of which have been placed in service on the Fonda, Johnstown & Groversville Railroad. The powerful engine is of automobile type, driving similarly through a clutch and transmission. The car body is of steel, and is of modern construction, carried on two four-wheel pivoted trucks, the wheels of the front truck taking the drive. The normal speed is 35 to 40 miles with a maximum of 50 miles an hour. Each car, with a crew of two men, carries 46 passengers comfortably seated, as well as one ton of baggage. The cars run six miles per gallon of gasoline, and 400 miles per gallon of oil.

381

### MONSTER DEMOLITION BOMB WEIGHING 4,000 POUNDS

At the ordnance-proving grounds, Aberdeen, Md., is a demolition bomb made by the U. S. Ordnance Department that is the most powerful and destructive in the world. It weighs 4,000 pounds, and would sink almost any battleship if used as similar, but much less powerful, bombs were used last year to sink battleships off the Virginia capes. At the Aberdeen

proving grounds gun tests are made annually before an assembly of the foremost American engineers.



Largest and Most Powerful Demolition Bomb in the World. Made by the Ordnance Department: It Weighs 4,000 Pounds, and Dwarfs the Soldier Who is Standing beside It

Ordnance Dept. Ordnance Proving Grounds, Aberdeen Md.

Purchased from Service Motor Truck Co. Philadelphia, Pa.



Wide World Photos  
New York City

Manchester Guardian  
Commercial  
8/17/22

920

POPULAR MECHANICS

REBUILT AIRPLANE MOTORS  
SYSTEMATICALLY TESTED

NEW METHOD OF CLEANING  
444 GASES AND VAPORS

68 An English manufacturer has established a system for the thorough testing

An improved process for removing dust, tar, and other foreign matter from

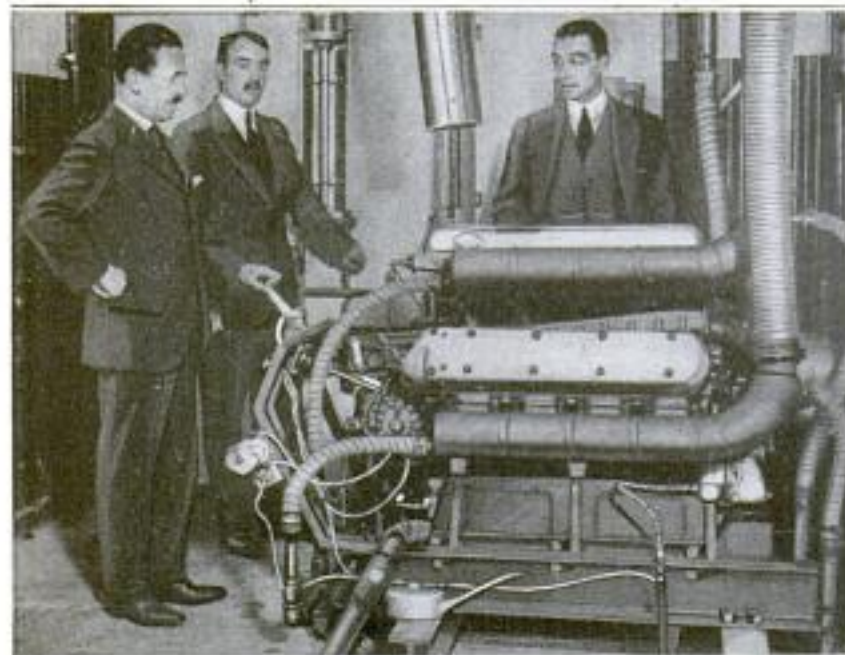

gases employs a filter composed of a hollow wrought-iron ring of rectangular cross section subdivided by partitions into several compartments. Inside this, and concentric with it, is a rapidly rotating ventilator wheel, having clearance between it and the filter proper. The compartments of the filter are fitted with either organic or inorganic materials, depending upon the kind of substance to be separated. On the upper lid is a sprinkler. By the evaporation of a small portion of the washing liquid, the gas becomes more efficient, and its heating value is increased. The rotating

By Means of This Equipment, an English Manufacturer Systematically Tests, under Conditions Equivalent to Full Flying Speeds, Rebuilt Motors Before They are Placed in the Planes

of all rebuilt airplane engines, after they have been overhauled and before they are reassembled in the flying machines. In this way, the performance of the motor is checked for capacity and efficiency, and its reliability determined.

filter is more efficient, is cheaper to install, and occupies less space than static cleaners.

9643  
NEW BURGLAR-PROOF WINDOW  
WITH DISAPPEARING BARS

A burglar-proof window which permits the sash to be opened to any desired height is now on the market. Protection is insured by a set of iron bars, 5 inches apart, that are raised or lowered with the

440 TESTS MADE OF ANEMOMETERS  
TO DETECT THEIR ERRORS

Experimental values of the factors or constants of anemometers throughout the range of wind velocity occurring in nature, are now available for the first time, as the result of elaborate tests made by the Weather Bureau, with the cooperation of the Bureau of Standards. About 30 of the anemometers in general use, of various dimensions, were tested in wind tunnels, and also at Mount Washington, N. H., for comparison in the very high winds prevailing there. These investigations proved that the anemometers now in use record the velocities about 22 per cent too high, and it is now intended to design an improved standard instrument that will record them correctly. The three-cup will replace the present four-cup pattern.

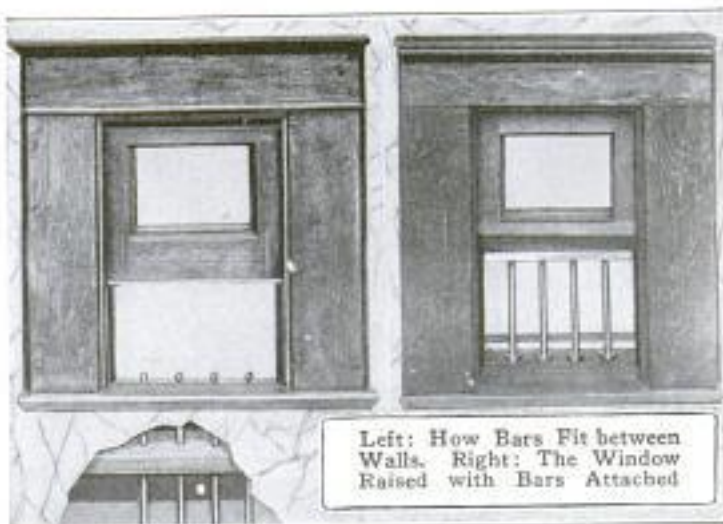

Left: How Bars Fit between Walls. Right: The Window Raised with Bars Attached

When the window is down, the bars are telescoped between the wall and

Wm. C. R. Handy  
1409 Holmes St. Kansas City, Mo.

since 8/18/22



*Ent. C. J. Blanchard  
3083 - 16th St. N. W.  
Washington D. C.*

**POPULAR MECHANICS**

921

**QUEER GATE BUILT FROM BITS OF DRIFTWOOD**

Using driftwood that had been washed up on the western shore of Flathead

woodwork. Mortised and locked, at all times, to a heavy strip of metal fastened at the bottom of the sash, the window can scarcely be forced. A heavier sash weight, substituted for the ordinary weight, makes it easy to open and shut the window. The bars can be disconnected from the inside, if desired.

**WOOD IGNITED THROUGH SAND 530 BY TAR HEATER**

Recent experiments by the Bureau of Standards have shown that a tar heater is likely to set fire to woodwork below unless insulated by at least 6 inches of sand. Tests were made with a sand cushion varying from 2½ to 6 inches, laid over double metal sheets on two thicknesses of 1¾-inch wood flooring, and in each instance the sand was covered with roofing slate ¾ to ½ inch thick. The burner was 2½ inches above the top of the slate. Fire was noticed in less than 5½ hours with the sand cushion 2½ inches thick, and with a 6-inch layer a temperature of 350 to 390° F. developed at the end of 10 to 12 hours.

*Eng News Record 9/8/22*

**CRANE ATTACHED TO TRACTOR GREAT AID TO FARMER**

9581

By attaching a crane to a small agricultural tractor, a Missouri farmer has created a combination that is a great aid around his place. The crane has a 10-foot arm, a lifting capacity of 1,000 pounds, can pick up a load 12 feet below level and elevate it to the same distance above ground, the entire mechanism being conveniently and easily controlled from the driver's seat.



The Queer Gate Pictured Above was Made by a Resident of Montana with Bits of Driftwood Washed Up on the Shores of a Lake near His Home

Lake, near Dayton, Mont., a resident there has constructed on the gate to his home a curious jumble of snarled wood, freak-shaped serpents, and hideous-looking heads, of varying sizes. The wood, which in some cases was slightly whittled, is mostly from the root branches of pines and aspen. To add to the grotesque effect, serpent "eyes," that flash in the sunlight, were made from old spectacle lenses or the heads of steel nails.



Crane Attachment for a Tractor, Shown Lifting a Heavy Reel of Wire: This Contrivance has Proved to Be a Great Help around the Owner's Farm, in Picking Up Barrels, Boxes, Crates, Sacks of Grain, and the Like, and Provides an Inexpensive Method for the Farmer to Lighten His Daily Tasks

*Chas. Herbert Lessman  
90 Peggy Ave, 725 Oak Park Ave  
Des Moines, Iowa*



*Mine Safety Appliance Co*  
*Chamber of Commerce Bldg.*  
 922 **POPULAR MECHANICS**  
*Pittsburgh, Pa.*  
**GAS MASK HOSE-CONNECTED  
 TO A DISTANT BLOWER**

303 Gas masks, for industrial use, are now being made with a hose connection to a

blower, and without any chemical canister, such as was used in the gas masks during the late war. The face piece of the mask is similar to the improved army model that fits all faces equally well, and has much less dead-air space than any mask previously developed. Nose clips and mouth-pieces have also been eliminated, making the mask much more comfortable for the wearer. The hose that supplies fresh air from the blower to the mask is of the flexible-metal type, and is therefore noncrushable. The complete apparatus is packed in a trunk, with a rotary blower in one corner of it, and its crank handle outside, so that it can be operated by hand at any required distance from the wearer of the mask. It has proved to be a perfect protection against the most deadly and penetrating gases, such as carbon bisulphide, hydrocyanic acid, carbon monoxide or ammonia, and is equally effective against dust and smoke. Fifty feet of hose is supplied with the outfit, but if it is desirable, much greater lengths can be used.



Left: Wearer of the Hose-Connected Gas Mask Climbing Out of a Chemical-Treating Tank after having Cleaned It. Right: Complete Apparatus Packed in Its Trunk, with the Rotary Blower in One Corner

8625 **A THRILLING  
 BALLOON STUNT  
 BY EUROPEAN  
 DARE-DEVIL**

It would almost seem that the possibilities of air stunts had been exhausted, but Harry Piel, European stunt maker, has come forward with a new one in which he rescues an unconscious person from the top of a tall chimney, using a balloon to travel in.

—USA  
 443 **"STRANGE LIZARD"  
 STUDIED NEAR  
 A DEAD SEA**

Searching the arid southwestern section of Santo Domingo in the vicinity of a dead sea, the bottom of which is 100 feet below sea level, an expedition from the New York Museum of



With the Gas Bag Swaying Overhead, This Stunt Maker Rescues an Unconscious Person from the Top of a Tall Chimney

Natural History hopes to secure pictures and data concerning the "rhinoceros lizard," the existence of which is said to be confined to that country. This lizard is of large size and its head features resemble those of a rhinoceros. The same expedition plans to journey through the mountains of the northeast to secure information regarding the life of the giant tree frog, also an exclusive inhabitant of this land. Little is known of this creature, although it is one of the largest and most interesting of the frog family. It is said to be 8 to 10 inches long. The material collected will be used for the construction of two habitant groups in the Hall of Reptiles.

Science 8/18/22  
 p. 78 4



*Societe Hydro-Electrique de Lyon*  
*31 Rue Ferrandière, Lyon, France*

## PICTURESQUE HYDROELECTRIC PLANT IN FRANCE

5346

By ALLEN P. CHILD

*Box 73, Station E  
Kansas City, Mo.*

ON THE River Fier, near Seyssel in the department of Haute-Savoie, France, and not far from the confluence of that stream with the Rhône, operations were commenced, in 1913, for the building of a hydroelectric plant which is of unusual interest because of the scenic beauty of the surroundings and some of the construction problems involved. The work was suspended in 1914, and although it was resumed during the latter days of the war, the difficulties in obtaining materials delayed completion until a comparatively short time ago. On account of the scarcity and excessive cost of coal, the availability of this constant and cheap power is particularly welcome in France, where this development is of added importance in giving impetus to the utilization of other resources of a like nature, thereby bringing relief to many of the distressed industries of that country.

Advantage was taken of the difference in water level that existed as the Fier wound its rapid course through the gorges of

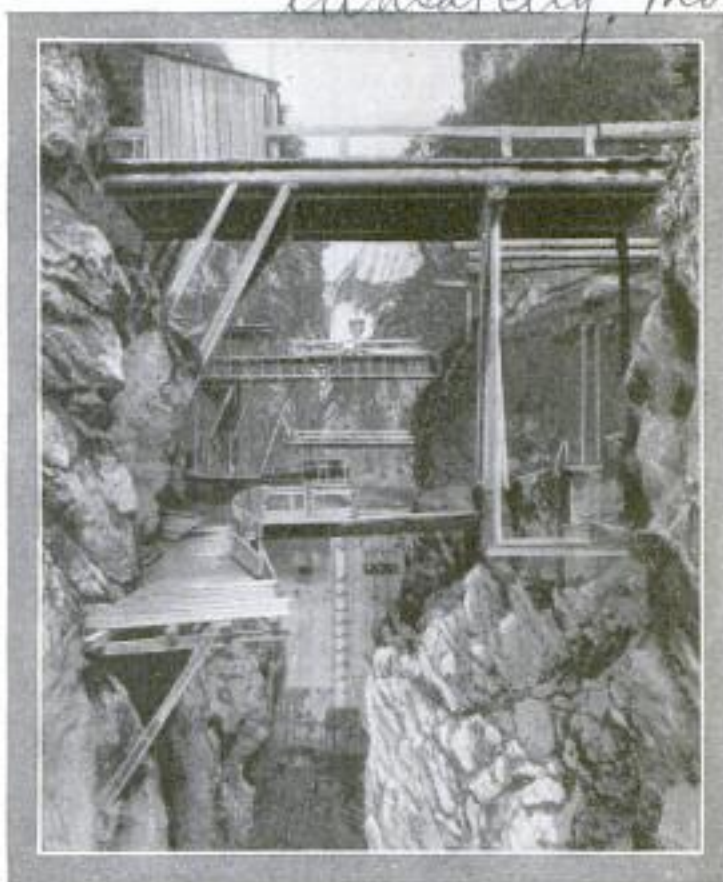

A View of the Gorge, Showing Temporary Bridges for Transporting Materials Used in the Construction of the Dam and Tunnels of a French Hydroelectric Development

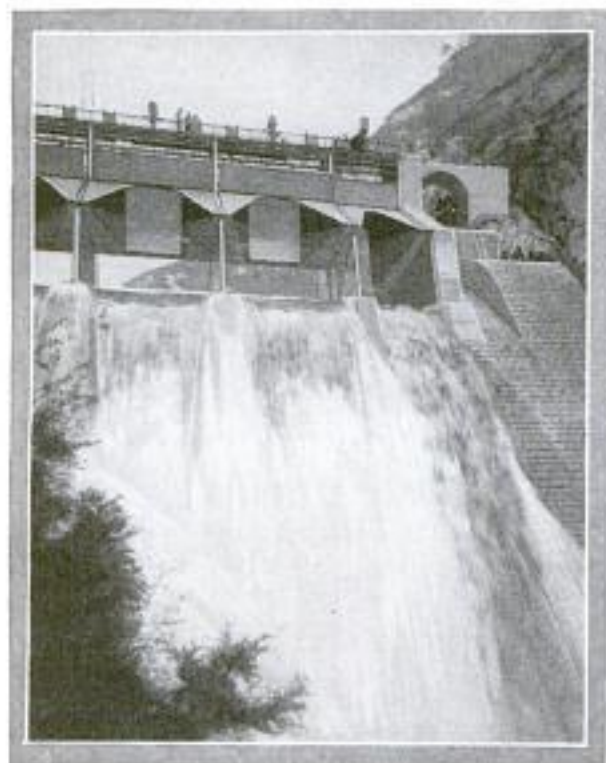

Water Flowing through the Spillways of Completed Dam of Power Development on the River Fier, Haute-Savoie, France

that region, by building a dam between the precipitous sides of a deep-walled chasm, the preparation of whose rocky bed for the base of the dam was one of the most laborious undertakings. In lowering the caissons for the cofferdam work, it was necessary to inject cement into the gravel so that the work chamber could be deepened to bedrock below the river bottom and a firm footing provided for the foundation of the dam. The removal of the material from within the cofferdam was largely a matter of work by men with picks and shovels. To divert the flow of the river from the dam site during the construction period, a tunnel had to be cut through the solid rock on either bank. The water raised by the dam is carried 450 feet through a mountain, by a tunnel of 100 square feet area and connecting to a chamber above the power plant, the turbines of which are supplied by five penstocks, each about 380 feet long and  $3\frac{1}{2}$  feet wide. The ultimate development of this power site contemplated a capacity of 27,000 horsepower to be delivered by five turbine units, of which only four, of 5,000 horsepower each, were to be in-



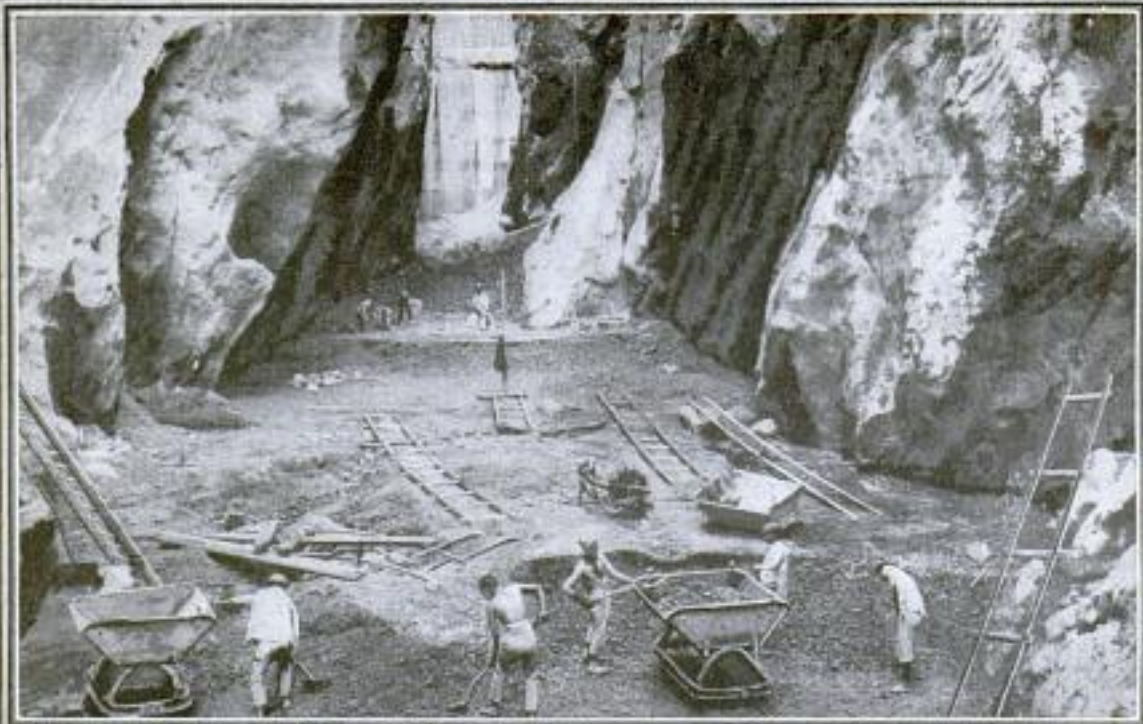

Clearing the Débris of Centuries from the Bed of the Fier River, So as to Provide a Firm Footing for the Dam at That Point: In Sinking the Caissons, Cement was Injected into the Gravel in Some Places



Hydroelectric Plant on the Fier River in France: On the Side of the Mountain can be Seen the Bulkheaded End of the Tunnel, and the Penstocks Which Conduct the Water to the Turbines in the Power House Below



5346

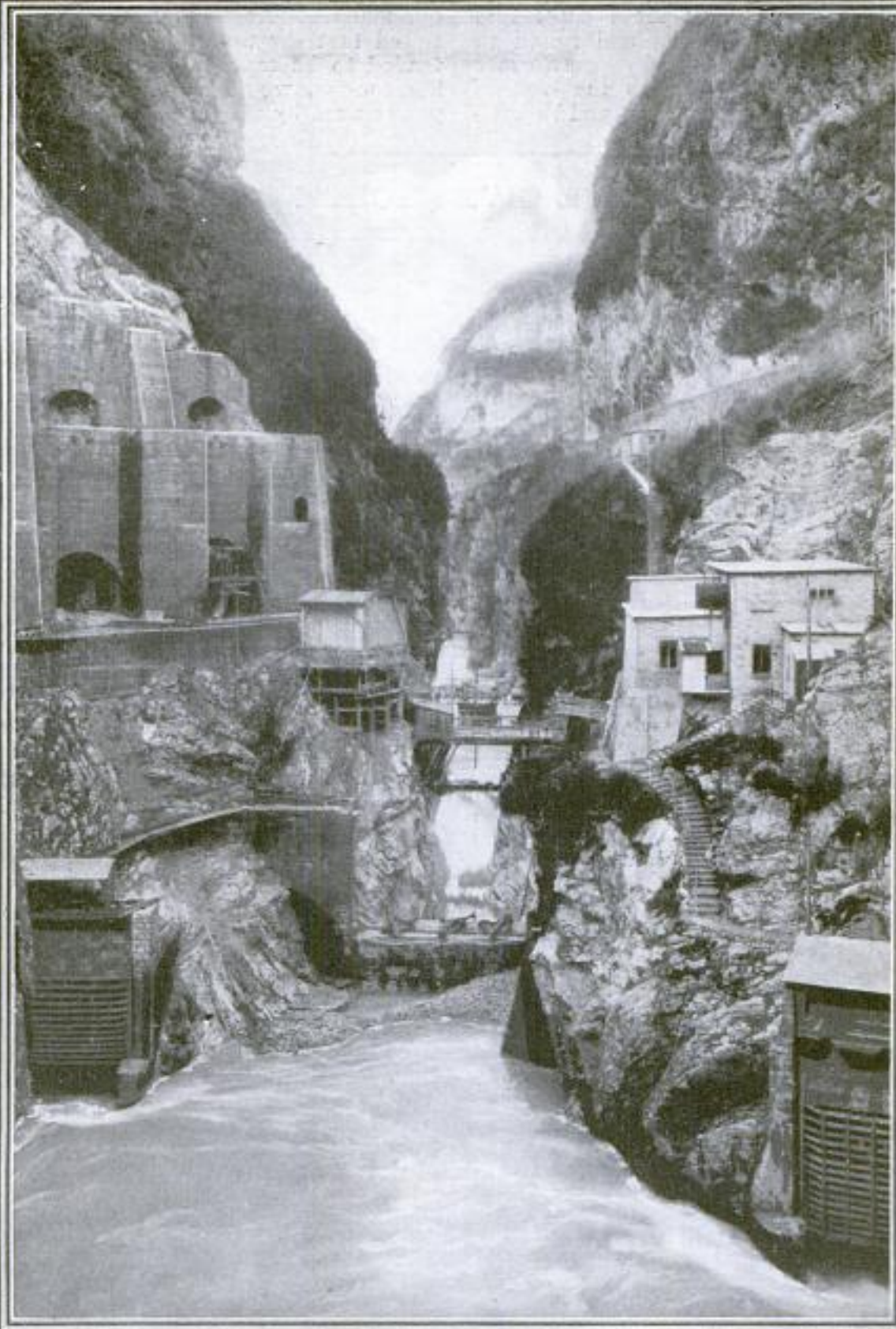

General View of Fier River Power Development during Construction at the Dam Site: Note, at Lower Edges of Picture, Outlets of Tunnels on Either Side of the River, Used to Divert the Flow during Construction



stalled at first: Three-phase current is generated at 10,000 volts and raised to 75,000 volts in the near-by transformer station, for distribution to the city of Lyon, some 50 miles distant, and to vari-

ous manufacturing plants in Savoy. It is stated that the fifth generating unit, intended to be capable of delivering 7,000 horsepower, would supply one-third the power used by the city of Lyon.

9617

## PROSAIC CONCRETE GIVES TOUCH OF FAIRYLAND

The remarkable effects that can be produced by the skillful use of concrete are strikingly shown at a country residence, near North Glendale, Calif. Here, across the mouth of a green cañon, stretches a solid wall whose gateways of dazzling brightness frame a fairy palace set at the foot of

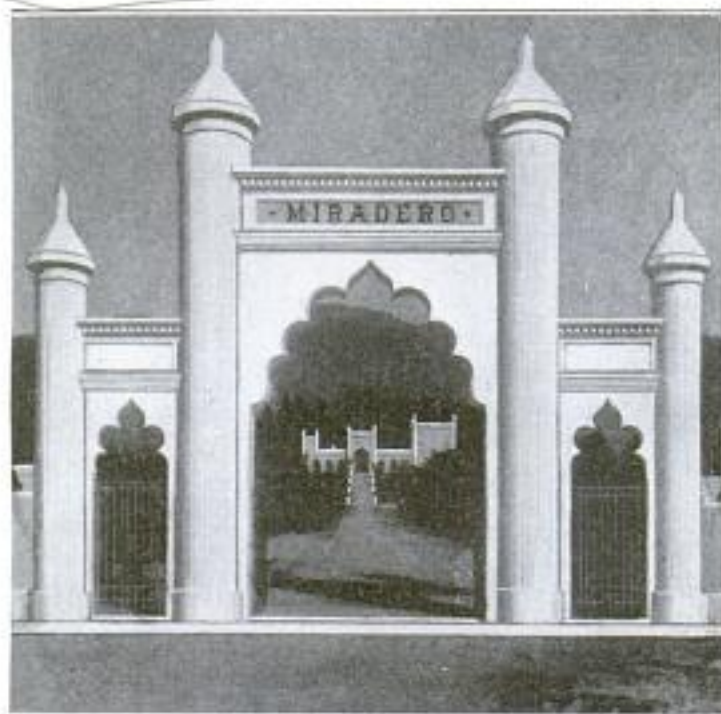

the giant hills. Round about this stately dwelling stretch the orange groves. The white walls and slender towers stand out in sharp contrast to the dark green of the tropical foliage. From far down the valley can be seen this enchanted palace of Miradero, silhouetted in white against the green hills beyond.



Above: Entrance to a California Estate, Which is Made of Concrete and Ornamental Ironwork. The Large Pillars Are 26 Feet High and the Smaller Ones 16 Feet High. Below: The White Walls and Slender Turrets of This Castlelike Home are Built of Concrete



Encl. Isaac C. C. C.  
106 North St  
4775 W. Lafayette  
Ind.

**STATE-OWNED FLOURMILL  
NEARING COMPLETION**

Three years ago the North Dakota legislature provided for the establishment of a system of elevators, mills, factories, and warehouses, owned and controlled by the state, for the purpose of placing the agricultural products more directly in the hands of the consumer, and authorized the building of a large modern grain elevator and flourmill, in order to give the idea a "fair trial." There was not much progress for some time, owing to difficulties in financing and other delays, but this \$2,500,000 undertaking is now nearing completion and it is expected that it will be operating in a few months.

The plant, located at Grand Forks, will include an elevator for the storage of 1,500,000 bushels of wheat and a flourmill of 3,000-barrels-per-day capacity, consisting of two 1,000-barrel spring-wheat units, and one 1,000-barrel macaroni unit. The plans call for a main mill building 42 by 160 feet and eight stories high, with a basement wing 42 by 200 feet on either end. Reinforced-concrete type of construction, with brick-and-tile curtain walls and steel sash and doors, will make the structure fireproof. A feature of the design is the location of all cleaning machinery in the stories above the bin floor, and the location of the packers on the second floor.

Native bullock carts in Colombo, Ceylon, are being fitted with rubber tires to allow of easier movement and to check the damage done to road surfaces.

**TANK EQUIPPED WITH RADIO  
LATEST WAR MACHINE**

Tanks equipped with radio apparatus are the latest addition in warfare and are being extensively used at present in sham battles and army maneuvers, to determine their practicability. The machines are of the ordinary "baby" type, and although they carry no guns, are heavily armored with steel to protect the occupants. Two men constitute the crew of these battle scouts, one a radio operator and the other a driver. Their function is to be an intermediate in the relaying of messages between the advancing fighting tanks and the main receiving and transmitting station at headquarters. A mast to support the aerial is

raised on the tank, and the equipment has a sending and receiving range of 25 miles, which distance is thought to be sufficient to permit of efficient communication during any battle.



"Baby" Tank Which is Equipped with a Complete Radio Outfit. Having a Sending and Receiving Range of 25 Miles, Showing How the Perpendicular Antenna is Mounted

raised on the tank, and the equipment has a sending and receiving range of 25 miles, which distance is thought to be sufficient to permit of efficient communication during any battle.

**DRY BATTERIES NOW INCLOSED  
IN STEEL CASE**

A leading manufacturer of dry-cell batteries is introducing a new battery that is put up in a steel case, which has a number of advantages over a fiber container. It is constructed to withstand the roughest service, the full life of the battery being assured by the steel case, which also protects against exposure to moisture and the elements. The materials used in lithographing the container serve as an electrical insulation for the outer surface.

International  
National Carbon Co. Inc.  
Thompson and Barton St.  
London, England



Amer. Capt. Carl Knechler,  
1026 Columbia Ave.

Engineering  
New-Record  
8/14/22  
J. W. Kelly  
Foreign

928  
9909 New York, N.Y.  
POPULAR MECHANICS  
HOMEMADE STERN-WHEELER  
DRIVEN BY LEG POWER

BRITISH GUIANA WATERWORKS  
446 OF UNUSUAL CHARACTER

Built to resemble a miniature steam-boat, with pilothouse, cabin, and stern paddle wheel, is a homemade man-pro-

The waterworks of Nabaclis, British Guiana, have some novel and interesting features. In an artesian well, 600 feet deep, having an 8-inch casing, the water contains much iron in the ferrous state, and has a temperature of 95° F. The iron is removed by first precipitating it by aeration of the water, and then causing it to flow onto a flat concrete table, perforated with 1/2-inch holes, through which it flows onto a layer of gravel and fine sand underneath, which removes the precipitated iron. Thence the water flows to a concrete and iron storage tank, from which it passes through 6-inch mains to the village. The water is pumped directly from the mains by hand pumps

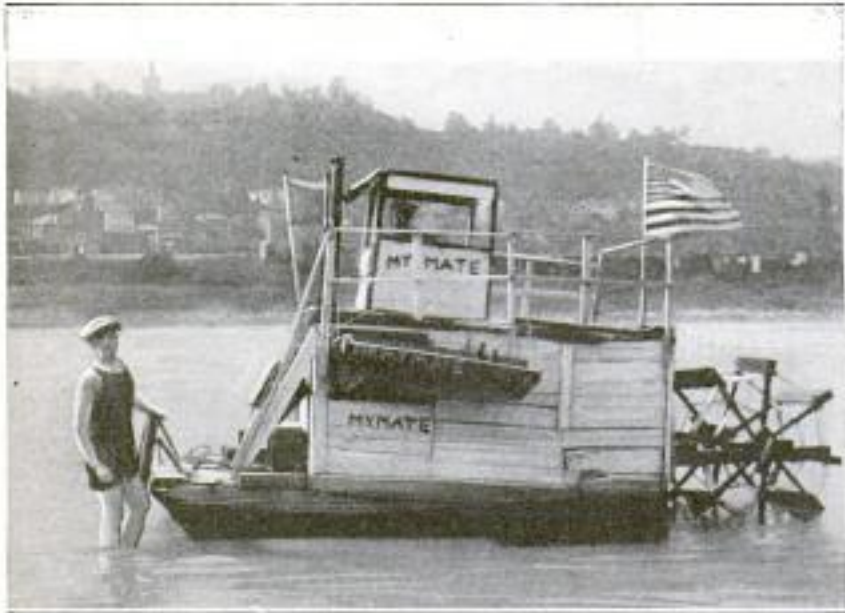

Man-Propelled Homemade Stern-Wheeler for Use around Bathing Beaches during the Summer: The Driver Sits at the Stern of the Boat and Rotates the Paddle Wheel with His Feet

elled craft used by its Cincinnati owner around the bathing beaches in summer. Seated at the stern, the driver rotates the wheel by pushing on the paddles with his feet; and the speed of the boat depends upon the dexterity with which this is done.

located at suitable points in the village. To avoid pitting of the iron pipes, the 6-inch mains are lined with bitumen.

415 SAFETY VALVES FOR FAUCETS OF GASOLINE-TANK TRUCKS

Now that the tank truck is the general mode of transporting gasoline, and other volatile fluids, it is of importance to have

safeguarding appliances in case of accident. One of such appliances is for preventing the discharge of the gasoline from a tank in case

of damage by collision, or otherwise, to its faucet. Besides the ordinary poppet valve in the faucet, there is an auxiliary safety valve which is operated normally by an extension of the plunger rod on which the faucet valve is mounted. Should the faucet be broken, this safety valve automatically closes.

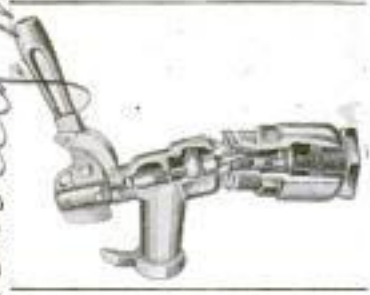

8/3 ATTRACTIVE RADIATOR DEVICE WARNS OF OVERHEATING

A new radiator device consists of an eagle, mounted on the radiator cover, with a bull's-eye in its breast which instantly colors red when the water in the radiator reaches 210° F. This effect is obtained by means of small disks in the radiator cap which expand and so raise a metal shaft. The shaft in turn pushes a hinged plate behind the bull's-eye up-



Three Views of Indicator, Showing Appearance from Driver's Seat at Normal Temperature and When Overheating Threatens, and from the Front with Filler Cap Open

ward, so that its lower half, which is red, replaces the normally visible upper half, which is white and radium-treated.

The Synhameter Corp.  
2306 Ohio St., Chicago

Columbian Steel Tank Co  
Kansas City, Mo.



*Illucator Lsa.*  
MEDITERRANEAN GRAPES GROW  
IN NORTH CAROLINA

Mediterranean grapes, said to thrive nowhere else in the United States, are successfully grown on the mountainsides near Tryon, N. C. The reason for this phenomenon is a locally termed "thermal belt." This title is a misnomer, however, as the temperature differs little from that of the surrounding section, where fruit that grows readily in the belt would not survive the first frost. Frost and dew are never experienced here. Air currents are formed on the mountainsides when the cold atmosphere from the Asheville plateau, about 2,500 feet above sea level, rushes through the gap between the Tryon and Saluda ranges, to the lower and warmer country to the south. These air currents evaporate the moisture that would form frost or dew. Other semi-tropical fruits, which can be cultivated only in Florida and southern California,

produce profusely on these mountains, although they are covered with snow the greater part of each winter.



Map Showing Parts of North and South Carolina in Which is Located the "Thermal Belt," Where Mediterranean Grapes are Grown

296

### INTERESTING CHINESE TOMB IN NEW ORLEANS

A tomb that is never used for burials in the usual sense of the word and which is fitted with a fireplace that is not used for heating purposes, is one of the interesting attractions for tourists in the picturesque Greenwood cemetery at New Orleans. It is the temporary resting place for the bodies of



The Entrance to a Chinese Tomb in the Greenwood Cemetery at New Orleans, Used as a Temporary Resting Place for Bodies Later Sent to China

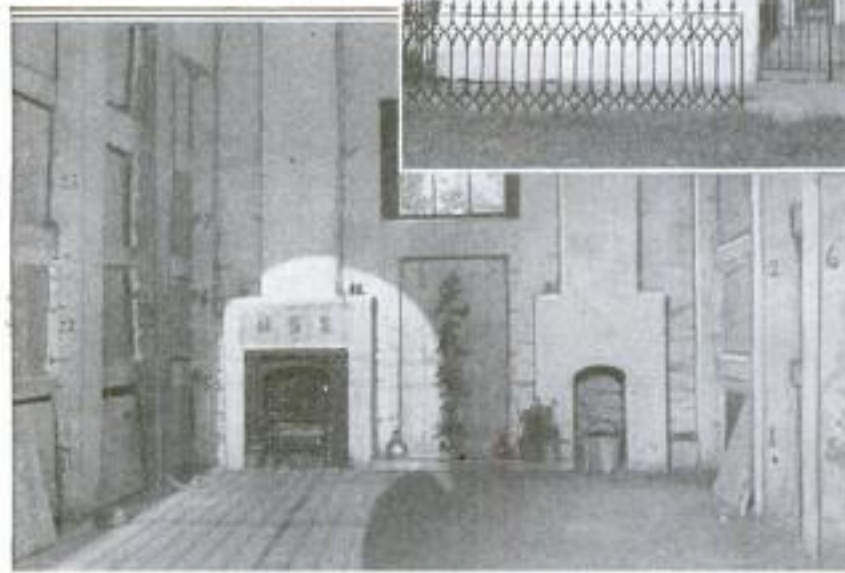

Interior of the Tomb: To the Left Is the Fireplace Which is Only Used for the Burning of Printed Prayers

dead Chinese, which are later sent back to China for interment in Buddhist burial places, and the fireplace is for the burning of printed prayers. The structure, large and plainly built, has individual vaults for the coffins.

*Greenwood Cemetery, New Orleans La.*



## CIVIC FEATURES THAT PROMOTE THE COMFORT



New Gymnasium Just Completed at the Illinois Wesleyan University at Bloomington, Illinois, the Oldest Educational Institution of the Methodist Episcopal Church in the Mississippi Valley



Exact Replica of the Cottage in Ayrshire, Scotland, in Which Robert Burns was Born, Erected at Atlanta, Georgia, as a Memorial to the Poet, by the Burns Club of That City



One of Two Boundary Marks at Salem, Massachusetts: The Sign Is of Wood, 15 Feet High, Painted to Represent a Symbolical Colonial Doorway with a Salem Witch on Its Steps

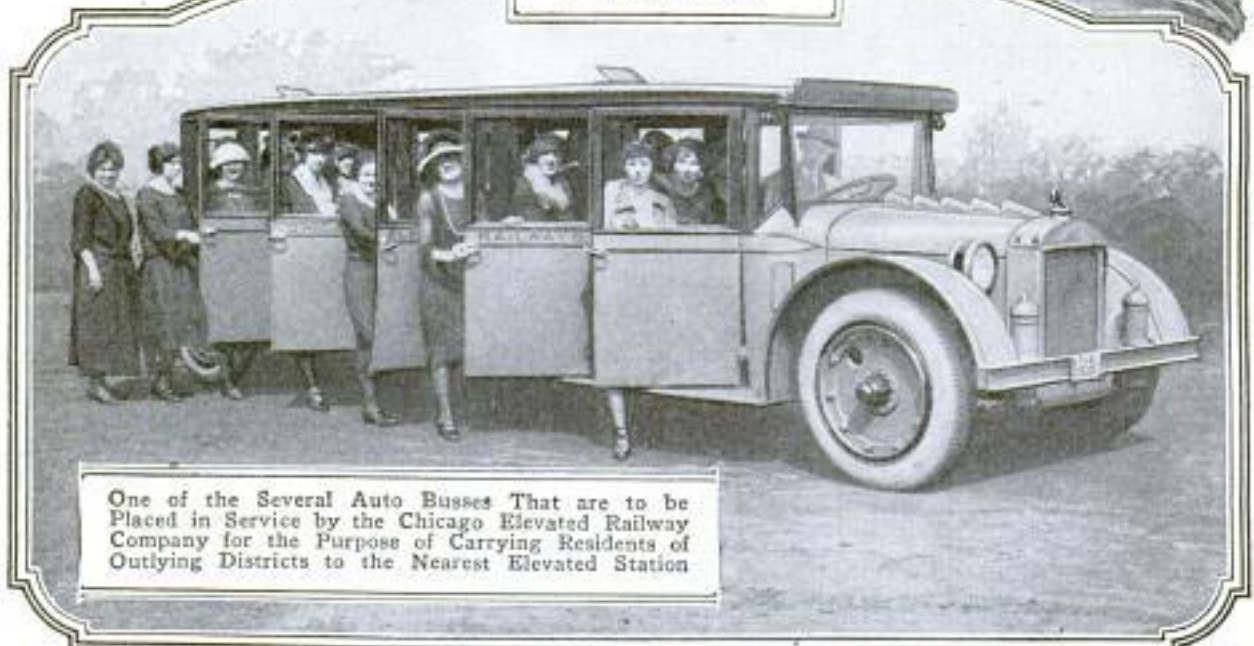

One of the Several Auto Buses That are to be Placed in Service by the Chicago Elevated Railway Company for the Purpose of Carrying Residents of Outlying Districts to the Nearest Elevated Station



## AND ENJOYMENT OF VISITORS AND RESIDENTS



COPYRIGHT, BEINE 2905.

Head of a Parade of 200 Automobiles Entering Green Bay, Wisconsin, at the Formal Opening of Highway 15, Which Is the Last Link in the Concrete Road That Connects It with St. Louis, Missouri

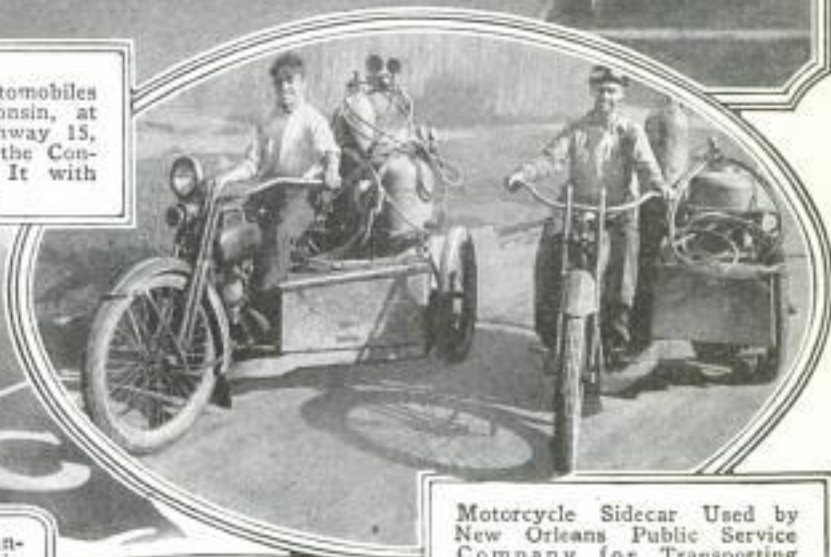

ABC, as a Traffic Sign at All Dangerous Crossings and Corners in Detroit, Stands for "Always Be Careful"

Motorcycle Sidecar Used by New Orleans Public Service Company for Transporting Welding Outfits



Public Radio-Receiving Station at Greenfield, Indiana, Installed on a Signboard on the Principal Street of the Town; Just below the Horn Is a Bulletin Board Giving Schedules of Programs



*dr. Frederic Stanton  
1321 Park Blvd.*

9826 <sup>932</sup>Camden, N.J. POPULAR MECHANICS

**IMPROVED GEOMETRIC DEVICE IS A HANDY TOOL**

Mechanics and others having to lay out and measure work, will be interested in a combination geometric instrument. A

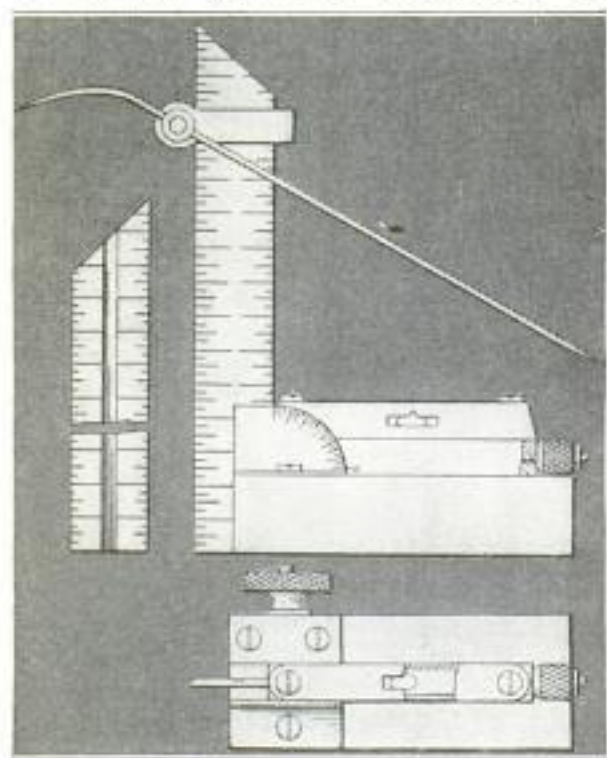

This Handy Shop Tool Combines the Essentials of a Number of Measuring Instruments Used in Laying Out Work

A self-contained unit has been devised that includes all the essentials of a rule, scriber, level, plumb, square, inclinometer, surface and depth gauge, bevel, and protractor. The convenience of such a tool lies in the facility with which it can be assembled and operated.

863 **LADDER FOOT THAT CANNOT SLIP OR INJURE FLOOR**

Feet for the bottom of a ladder have been devised to prevent it from slipping



Ladder Feet That Prevent Slippage, in Use at Left, and Enlarged Below

*dr. Frederic J. Cameron  
San Diego, Calif.*

or marring the surface of the ground outside, or the floor inside, a building. At the bottom of each leg of the ladder is a bent-plate attachment that has on its outer center a socket that fits over a partly spherical projection from the top of a cast-iron circular support. The bottom of this support is covered with rubber which prevents slippage, and it can be used safely with a board under it to prevent damage to the ground or floor from pressure.

447 **FREE MEDICAL ADVICE SENT TO SHIPS BY RADIO**

Free medical service by radio for ships at sea has recently been established by the United Fruit Company to assist vessels that do not carry surgeons. The service is also at the disposal of ships carrying medical officers, who may, in the case of an obscure malady or in other emergencies, desire the benefit of consultation with other physicians.

*nauticus 8/19/22 used for*  
272 **SMALL TRACTOR CONVERTED INTO A ROAD ROLLER**

That a small gas tractor can be readily changed into an efficient light roller for road work was demonstrated recently in

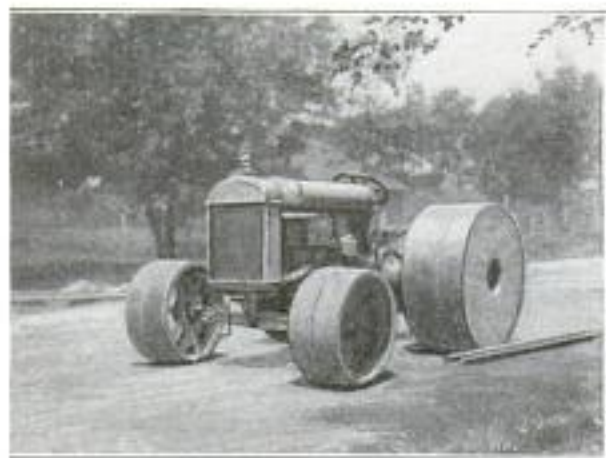

Small Gas Tractor That was Converted into a Road Roller by Substituting for Its Ordinary Traction Wheels Golf-Course Wheels Filled with Cement

a very simple manner. Each of the traction wheels was replaced by a golf-course wheel with extension rims that had been filled with cement inside the rim, so as to make its outer face smooth, and like a stone roller with a tread of 20 inches. The cement brought the weight of the tractor up to 5,000 pounds, and this proved to be quite suitable for doing the road-rolling work required.

*demonstrated by  
Mautz & Crew, Effingham, Ill.*



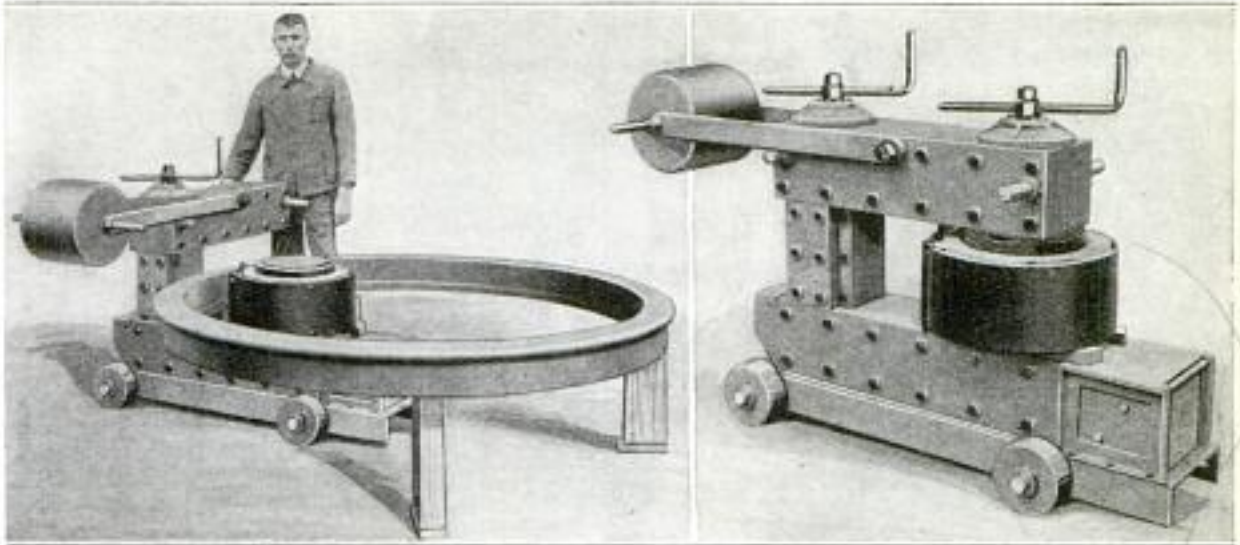

Left: Electrical Transformer Shown with Its Upper Arm Swung Around, Permitting the Introduction of the Railroad-Car Wheel Tire for Heating, and Subsequently Mounting It by Shrinkage. Right: The Arm is Shown Swung Back, Putting the Transformer into Operative Position

*Railroad Car Wheel*  
**TIRES ELECTRICALLY HEATED  
 AND FITTED BY SHRINKAGE**

For heating railroad-car wheel tires before mounting them by the shrinkage process, an electrical method is in use in France in which the tire forms the secondary of a transformer, being heated by the induced current. The transformer has two laminated horizontal arms, one above the other, connected by a pair of vertical cores. The upper arm is pivoted and counterbalanced so that it can be swung around to permit the introduction of the tire. It is then swung back, putting the transformer into operative position. The heating is quite uniform, and can be readily controlled.

*2/2*  
**AUTOMATIC GAS-METER VALVE  
 REDUCES DAMAGE BY FIRE**

To obviate the danger, during a fire, of the gas meter or its lead connections melting,

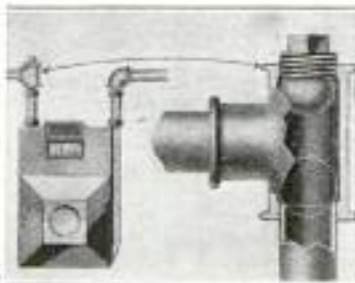

ing, and allowing the gas to flow freely into the burning building, a valve has been devised that closes the inlet pipe automatically under a temperature of 130° F. The valve takes the place of the ordinary pipe elbow on the inlet side of the meter. Screwed into the top of the new elbow is a plug that has soldered onto the bottom of it a copper-plated steel ball. Directly below the ball

is the open end of the nipple that connects the inlet pipe with the meter. The heat of a fire fuses the solder, causing the ball to drop onto the nipple, shutting off the gas, and being held there securely by its pressure.

*280*  
**NEW AUTOMOBILE-WHEEL LOCK  
 SAFEGUARDS TIRE VALVE**

For safeguarding automobiles and spare tires, a new wheel lock has been devised that, besides embracing the wheel rim and tire so as to prevent the wheel from rolling on the ground, also makes the tire valve inaccessible. The lock consists of two steel arms, which are pivotally connected outside the tread of the tire. When closed together, they embrace the tire and, with a projection inside the rim, completely inclose the dust cap on the valve tube. In this position the device is locked with a key, and it is then impossible to turn or move it, and equally impossible to get at the valve so as to deflate the tire, and thus make the device movable.

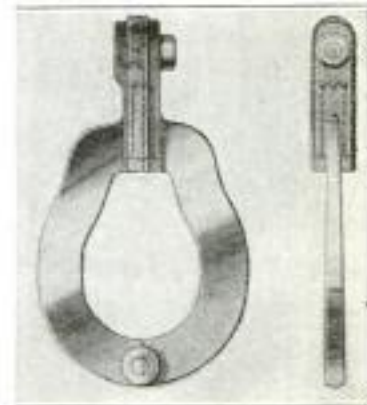

Whenever you find that you wish to know more about any article in the magazine, write our Bureau of Information.

*Automatic Gas Valve Co.  
 137 Pearl St. Boston  
 Mass.*

*Arthur M. Cumming, Aberdeen, Md.  
 of mfr.*



# SOME NOVEL AND LITTLE-KNOWN ACCESSORIES



Cast-Aluminum Tea-kettle Which may be Filled under Any Faucet without Burning the Hand with Steam



Sweet-Corn Slicer That Quickly Cuts the Corn from the Cob: It Has an Adjustable Blade, Guarded to Prevent Accidents



Three Views of the Collapsible Baby Carriage, Showing the Many Convenient Ways of Using It: The Entire Outfit Folds into a Space No Larger than a Suitcase, and Weighs Only 23 Pounds. In Winter, Steel Runners may be Attached to the Frame



All-Metal Dressing Table, One of a Series of Home Furnishings That are being Introduced in the Interest of Sanitation

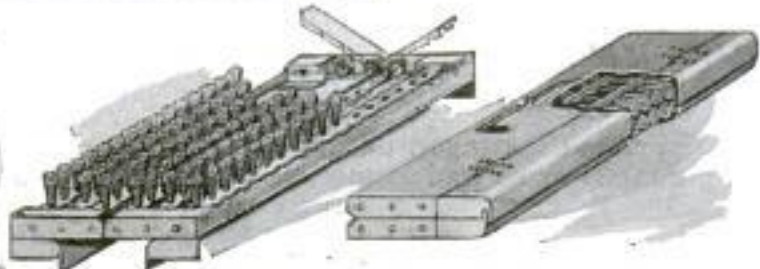

Hairbrush, with Renewable Bristles, That Opens and Closes Like a Book: When Closed, It Takes Up Less Space than the Ordinary Spectacle Case and may be Carried in the Vest Pocket

Magnetic Scissors with Which Needles may be Picked Up from the Floor: It Also Has a Self-Threading Attachment for Needles

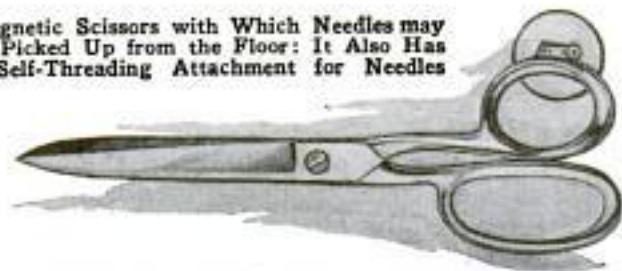

Anyone wishing further information on devices described in the editorial pages can



INTENDED FOR THE HOME AND ITS MEMBERS

C.



Vegetable and Fruit Slicer with Adjustable Guard That may be Set So as to Cut to Any Desired Thickness

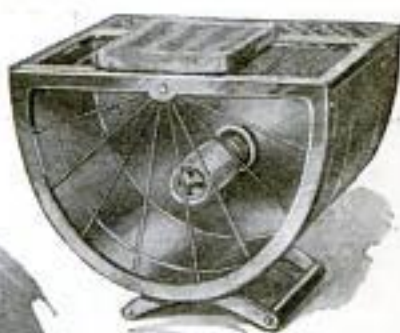

Two Views of Electric Appliance, Showing How It may be Used Either as a Heater or a Toaster



Heat-Retaining Dish in Which the Housewife may Prepare Food before Mealtime and, Due to the Vacuum Insulation of the Dish, Keep the Edibles Steaming-Hot until the Proper Serving Time

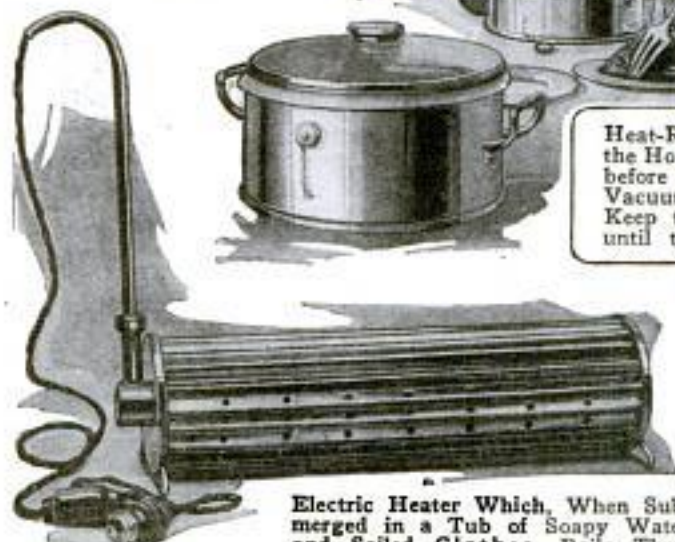

Electric Heater Which, When Submerged in a Tub of Soapy Water and Soiled Clothes, Boils Them

Leather Saddle Strap That Fits Neatly over Any Oxford, Thus Giving It the Appearance of a Sport Shoe



Machine That Washes, Sterilizes, and Bleaches the Clothes in One Operation, and Is Noiseless



Fresh-Air Bed, for Adults, with Removable Screens, Which Makes an Inexpensive Sleeping Porch



221

Emp. R. Franklin Munday.  
110 S. Andrew Ave.

936

POPULAR MECHANICS

Kansas City, Mo.

PUMP STATION ON INCLINE FOLLOWS WATER LEVEL

In providing water supply for a construction camp at a dam on the Tuolumne River in California, the records showed

that the water level in the stream varied as much as 52 feet at this point. As the water supply was to be in use for more than one season, it was decided to put the pumping plant on a platform that could be moved up or down an incline when the water level changed. Timber rails, bolted to sills anchored to the bank, formed guides to which were fastened, with safety driftpins, the skids that carried the platform and pump house. A hand-operated winch with a self-locking worm served to raise or lower the plant. A flexible high-pressure hose was arranged to connect the pump discharge to "Y's" at 10-foot intervals on the 4-inch delivery pipe laid between the rails. The suction was provided with a foot valve and strainer and also with a priming pipe from the pump discharge. The centrifugal pump was belt-driven from an electric motor.

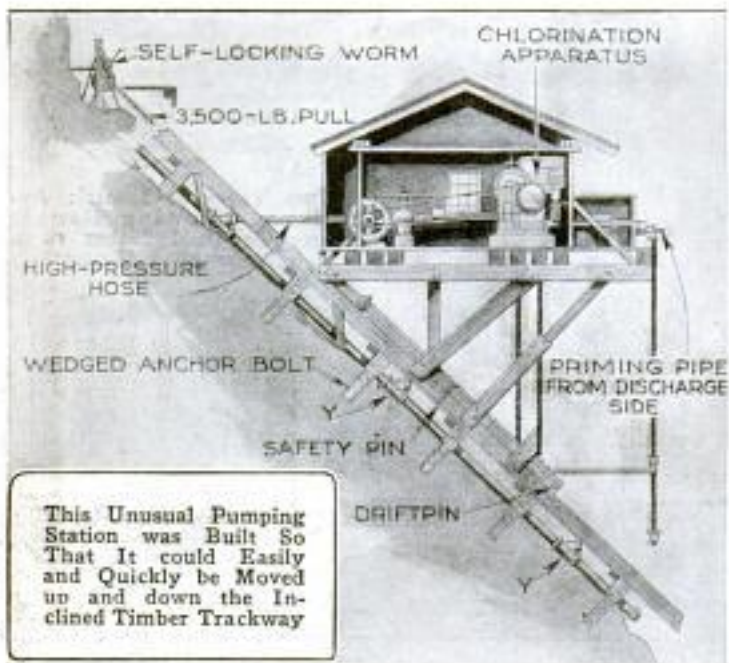

This Unusual Pumping Station was Built So That It could Easily and Quickly be Moved up and down the Inclined Timber Trackway

NONSLIPPING TUNING PEG AND BRIDGE FOR BANJOS

Tuning pegs for banjos, violins, and similar stringed instruments, are now being made so that they will never slip.

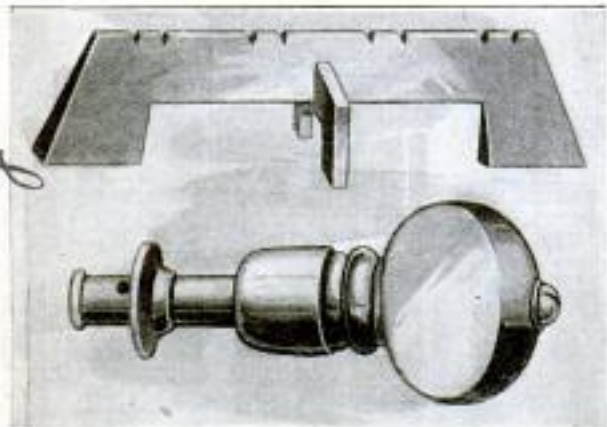

Below: Tuning Peg for Stringed Instruments. It cannot slip, and maintains perfect tuning. Above: Nontipping Banjo Bridge

In connection with the peg is a strong spring that exerts a constant gripping pressure on the peg head. On the stem of the peg is a washer that centers it. Nontipping bridges are also being made that keep the banjo strings tight, and that cannot get out of position while the instrument is being played.

COMBINED HAND AND BENCH VISE FOR SMALL WORK

A combined hand and bench vise for use in machine or woodworking shops, and consisting of two main parts, is now on the market. One part, with an anvil attachment, is clamped to the workbench, and contains a tapered dovetail slot, into which fit corresponding shoulders on the vise proper. No setscrews are needed, and the vise can be slipped into this slot and held there securely when used as a bench vise, or be lifted out to be used as a hand vise. The jaws of the vise, open or closed, are held parallel by pivoted diagonals.

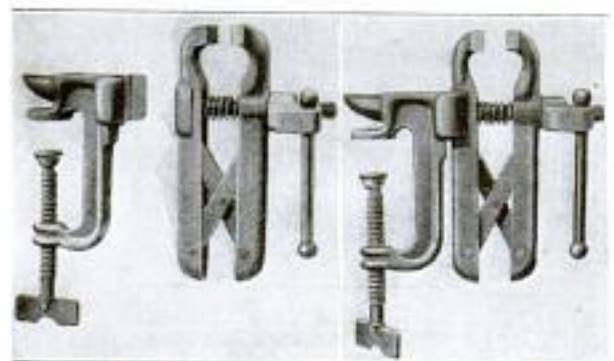

From Left to Right: The Anvil Attachment for Clamping to the Workbench; the Vise Separated from This Attachment; the Two Parts Fitted Together

Malleable Iron Fittings  
Co., Bradford, Conn.

A. R. Lerover. Long Island City, N.Y.



**LIGHT PORTABLE SCAFFOLD  
 IS EASILY MOVED**

A number of uses suggest themselves for a portable one-man scaffold that has lately been designed and is now being manufactured. Two upright extension ladders are supported at the ends of a light steel frame and suitable braces are provided to hold them rigidly when extended. The frame is supported on three

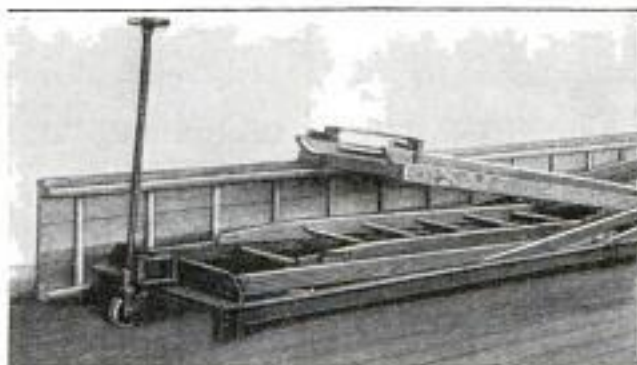

Above: Portable Scaffold Collapsed, Showing Steering Handle and Wheel. Right: Scaffold Shown Solidly Erected, Ready for Use



small wheels when being moved, but is so arranged that it rests solidly on two wheels and two legs when erected. When the scaffold is to be moved some distance, it can be collapsed, and a steering handle is provided for pulling it about.

**TRAINING CAMP ESTABLISHED  
 FOR ARMY BALLOON PILOTS**

The U. S. Army is concentrating its efforts in lighter-than-air craft flight by establishing, at Scott Field, near Belleville, Ill., the only training school for that branch of the service. The camp will be known as the Air Service Balloon and Airship School, and already large detachments of officers and men have arrived there from Ross Field, Calif., and Langley Field, W. Va., everything being complete except the huge hangar that is being erected to house the balloons. The student course covers a period of not less than two weeks.

Christian J. Scovel  
 monitor 9/3/22  
 A former English war pilot is the leader of a movement to finance a north-polar expedition. He estimates that a dirigible airship, making 50 miles per hour and carrying a crew of 10 and supplies, could make the final 700-mile dash.

**QUARTZ MILL FOR PROSPECTORS  
 CARRIED BY BURROS**

Gold prospectors may now transport their own quartz mill by way of the common "burro-back" route, a portable and inexpensive outfit having been made for the purpose. The total weight of the assembled mill is only 1,800 pounds, the heaviest piece weighing but 185 pounds, which can easily be carried on any moun-

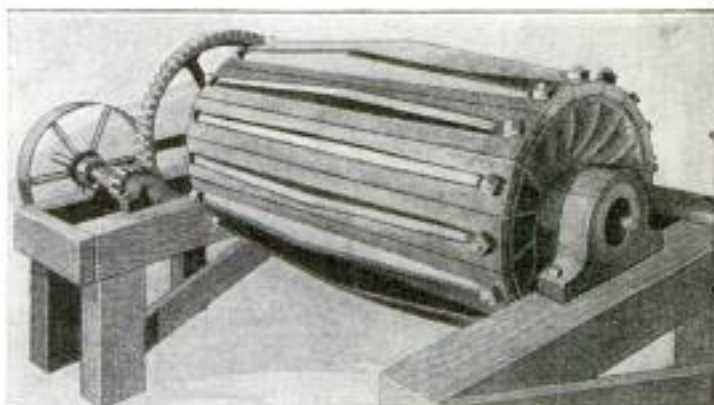

Barrel-like Quartz Mill Which Has a Capacity Equal to the Usual Three-Stamp Mill, and Which was Designed as an Inexpensive Outfit for the Use of Prospectors

tain trail that a burro can scale. A gasoline engine of 1½ horsepower, for operating the mill, is included in the outfit, which thus enables the miner to grind his quartz "prospects" himself.

Chas. E. Troubridge  
 Medford, Oregon

Medford Oregon works

Mr.

Copyrighted material



367 Smithsonian Institution  
Washington, D. C.

Released 9/17/32

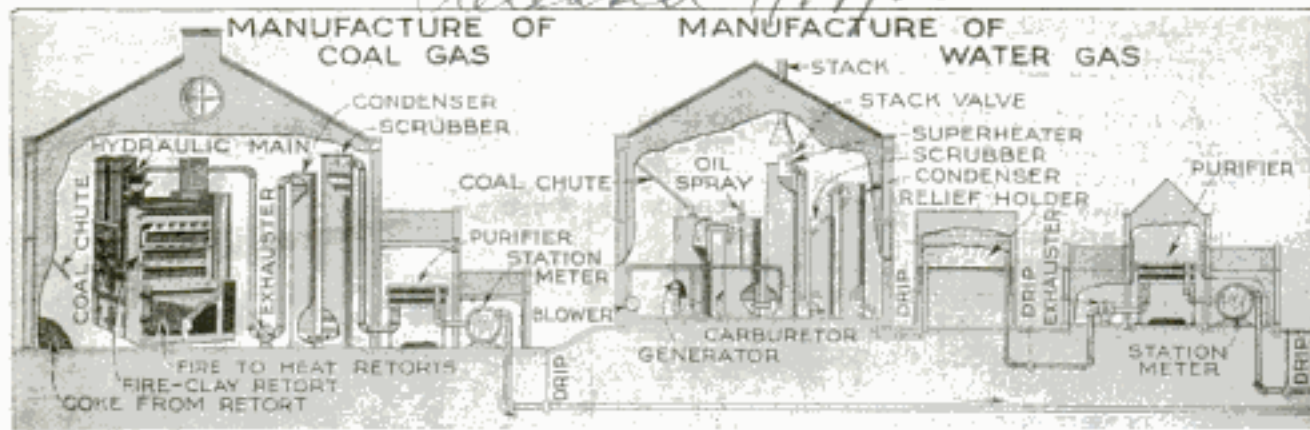

18 5 FLAGPOLE IS ILLUMINATED AND FORMS WIND VANE

An improved flagpole, especially adapted for supporting service flags, is so constructed that the flag can be easily raised or lowered.

Chas. Ernest H. Raguel,  
 Summit, Ill.

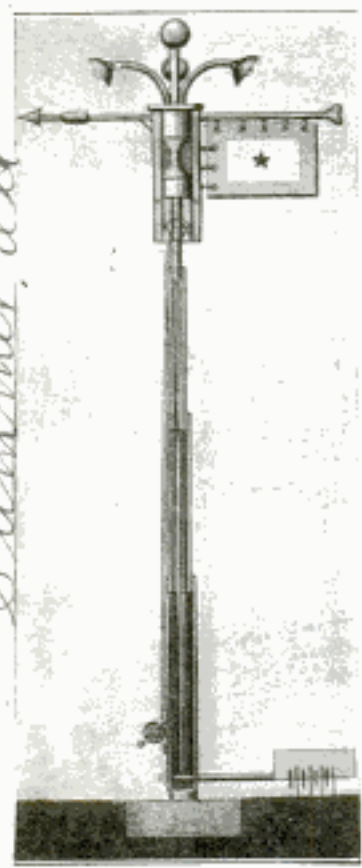

top of the sleeve are brackets that support electric lamps which are connected to wires extending through the hollow pole from any source of electricity.

□ A motion-picture organization, which is stated to have ample financial backing, has been formed whose aim is "to provide clean pictures for clean people." The pictures will be distributed among church congregations, schools, and colleges.

367 MANUFACTURED GAS: HOW IT IS MADE AND DELIVERED

On account of the rapid exhaustion of natural gas, the time is not far distant when many towns now using it will have to depend entirely upon the manufactured product. With the object of instructing the layman in the salient features of the manufacture of gas, and its use in the home, the Smithsonian Institution has placed on exhibition a model that shows the whole process from the retort in the gas house to the lamps and stoves in the dwelling house. First is shown an air-tight fire-clay retort charged with bituminous coal, the gas, after four hours' heating, passing into the hydraulic main, from which it is withdrawn by the exhauster and pushed on to the condenser. Here it is cooled, and the tar is extracted from it before going through the purifier, where the sulphur is removed, and then on through the station meter, which measures the volume, into the large storage gas holder.

In some plants coal gas only is manufactured, in others water gas only, and in many both are made and mixed. The basic feature of the water-gas process is the bringing of steam into contact with red-hot coke or coal, and thus making an inflammable gas. This is done in the generator, from which the gas produced passes to the carburetor where it is enriched by a fixed gas made by spraying oil under pressure over hot brickwork. Thence the gas passes successively to the scrubber and the condenser, where it is treated in much the same way as in the case of the coal gas. From the condenser the gas goes into the relief holder, where pressure on the gas is produced and its delivery to the purifier beyond is made uniform. The process is then complete, and the gas goes through the station meter to the large storage holder.



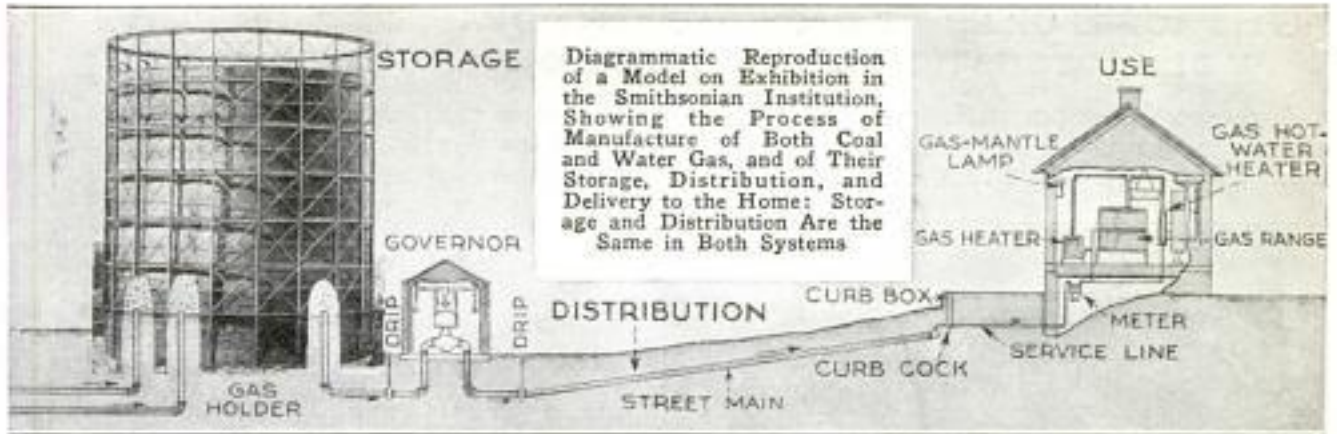

From the storage holder the gas passes to the governor, where the pressure is regulated and kept uniform. From the governor it goes into the street mains, through the curb cock, service line, house meter, and to the consumer's appliances.

**PULLEY-CLOTHESLINE OUTFIT**  
9807 HAS MANY MERITS

Many merits are incorporated in a pulley-clothesline outfit invented by a Utah man, which may be so arranged as to be driven by a motor. Both sides of the line can be used with the new device, and any piece of the wash may be

439 —  
**DIRECT WIRELESS SERVICE TO AUSTRALIA**

Direct commercial wireless service to Australia from North America and England, with feeder stations in many of the large intermediate cities, are the essentials of a development contemplated by an English concern. This company has agreed to carry all messages between England and Australia at 33 1/3 per cent less than existing charges, with a corresponding reduction on press and government exchanges. It is also its announced intention to introduce wireless telephony throughout the southern continent for public and private convenience.

**AUTOMOBILE TIRES HAVING FIXED BLOW-OUT POINTS**

An inventor's idea of minimizing injuries to tires is to provide certain places on the sides of the shoe where the wall is weakened. A blow-out, due to any cause except direct puncture, is thus confined to one of these spots. Special arrangements are made to repair the rupture, easily and effectively, with suitable plugs and patches, which may be applied either from the outside or inside of the tire.

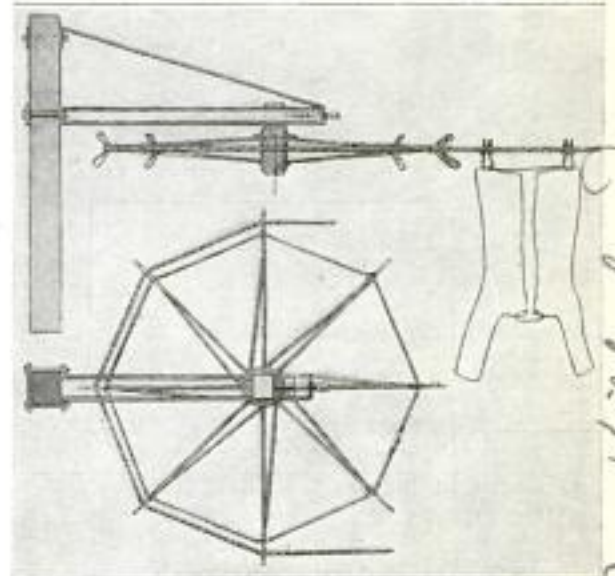

Pulley-Clothesline Outfit, Showing How the Garments may be Hung below the Line and Thus Not Come in Contact with It

removed without disturbing the remainder. The clothespins provided with the outfit, are made of a special nonrusting spring-wire material, so adjusted that they suspend the clothes below the line. This eliminates the necessity of cleaning the line every time the clothes are hung out to dry, as the washing does not come in contact with it. In addition to the foregoing, the clothes may be attached to the pins while yet within the house, this fact being an obvious improvement, which will be welcomed in inclement weather, as wet hands need not be exposed to the frosty air.

Dr. G. F. Johnson,  
188 S. 10th Ave.  
New Rochelle, N.Y.

London Times Eng & up  
8/10/22

M. Kilfoyle, Mantle, Utah

Chas. A. Red



Blaw-Knox Co.  
Pittsburgh, Pa.

940  
9849

POPULAR

Portland Cement  
Assn. 111 W. Washington  
St. Chicago Series no. 11.  
no. 2, Aug. 28.  
1922

**GRAB TONGS OF NEW DESIGN  
WORK AUTOMATICALLY**

A recent development in material-handling devices is being marketed in the form of grapple tongs that operate auto-

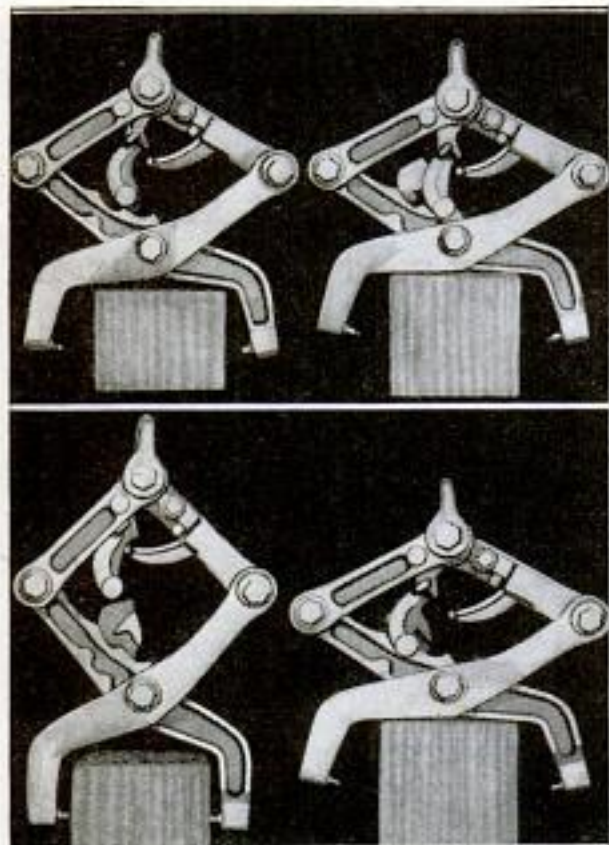

Above: Grab Tongs being Lowered Preparatory to Picking Up Work. Below: Tongs Holding Work and Just After It has been Released

matically, dispensing with the services of one man. The action is controlled by a link and pin, which disengage from a cam as the tongs are lowered against the work, when the tongs are free to grip it. In setting down the work, the tongs are again lowered against it, and the pin, guided by another link, locks with the cam.

445

**BRITTLENESS OF TINFOIL  
TRACED TO ALUMINUM**

Brittleness in tinfoil a few days old, which, when freshly rolled, was soft and pliable, led to interesting investigations and developed the fact that it was due to the presence of a trace of aluminum in the tin. The conclusion was that electrolytic action between the tin and the aluminum converted the aluminum into aluminum oxide which caused a splitting action, commencing at the surface and gradually working toward the center.

The Engineer  
9/18/22

**LARGE QUANTITIES OF CLOTH  
USED FOR CEMENT SACKS**

402

The cotton cloth used in the manufacture of bags for the cement trade, last year, would make a strip 30 inches wide and 17,000 miles long, or one that would reach two-thirds around the earth at the equator. In order to maintain the necessary stock of 200,000,000 sacks, the cement industry yearly orders approximately 30,000,000 new sacks. This is equivalent to 30,000 bales, or 15,000,000 pounds of cotton, which would keep busy 1,600 looms weaving it into cloth every day for an entire year.

202

**SWIVEL CLIP NOW AVAILABLE  
FOR POCKET FLASHLIGHT**

Holding a flashlight in any desired position without the aid of the hands, is possible with the use of a swivel clip which has been designed so that it can be hooked to the belt, pocket, or sleeve of a person's clothing. The person carrying the flashlight thus has both hands free to

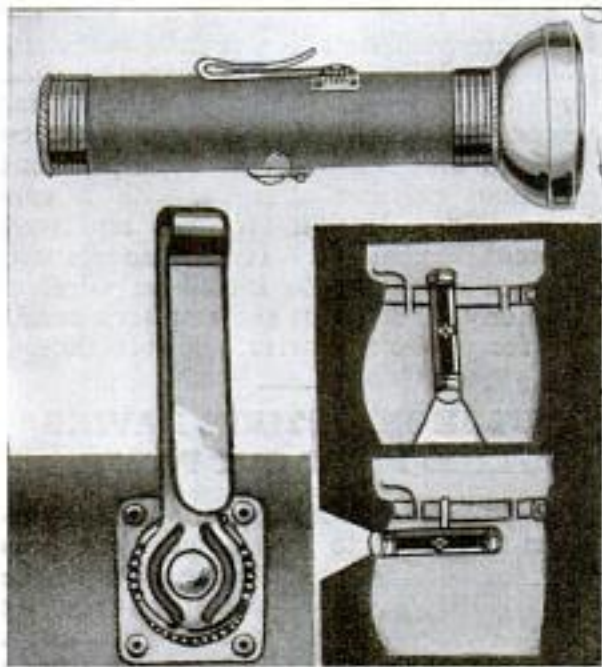

Top: Swivel Clip Attached to a Pocket Flashlight. Bottom: Close-Up of the Clip, and Different Methods of Fastening It to a Belt

1876  
Specialty Co. Newark, N.J.  
Diamond Electric & Appliance Co. 101 S. Orange.

do necessary tasks in places where there is no illumination.

Popular Mechanics Magazine does not publish the name of maker or seller of any device described in its pages, but this information is kept on file and will be furnished free by addressing our Bureau of Information.



Chesnee Cotton Mill  
Spartanburg Co

The Robert Wrench Co.  
71 Murray St  
New York City 941

POPULAR MECHANICS

392 VACUUM CLEANERS USED ON COTTON LOOMS

What is presumed to be the first cotton mill in the world to have its machinery and floors cleaned daily with vacuum cleaners is at Chesnee, in Spartanburg County, South Carolina. The mill uses 440 looms and 20,000 spindles, all of which are cleaned regularly. There are 130 hose connections through which the dust, ravelings, grime, and lint are carried into a large waste room. A one-horsepower fan furnishes the suction. It is estimated that the new system operates at a cost of about 70 cents per spindle per year.

265

GOLF-BALL SCALE GIVES WEIGHT AND SIZE

Determining whether a golf ball is of the proper weight and size to comply with the specifications of the United States Golfing Association, is possible with the use of a specially designed scale. With this instrument, tournament officials can rapidly examine all balls entered in any event, to ascertain whether they exceed the specified weight limit of 1.62 ounces, or fall below the permissible minimum of 1.62 inches in diameter. This method also eliminates all doubts for sporting-goods dealers.

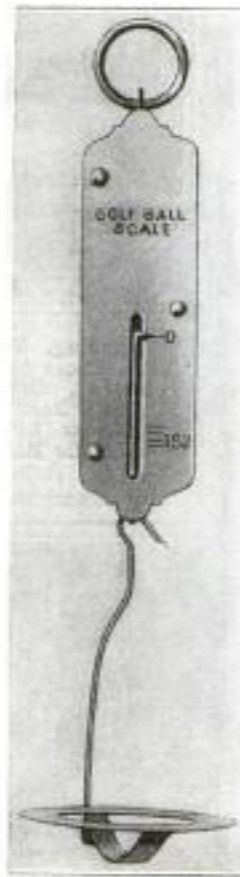

441

RADIOACTIVE MINERALS FOUND IN ITALY

A bill recently presented to the Italian government, has for its object the utilization of deposits of minerals having radioactive properties, that are known to exist in some sections of the country. The most important of these seems to be that of a mineral called "autunite," found in a cave in the province of Cuneo, and which, Mme. Curie says, has radioactive properties superior to the minerals of America and Portugal and inferior only to those of Bohemia.

Ludwig Series Trade  
& Eng. Supplement  
11/2/22

8177 SELF-ADJUSTING WRENCH GRIPS AT ANY ANGLE

Of the many various modifications of pipe and nut wrenches that are constantly being placed on the market, one that is novel, and certainly entirely self-adjusting, consists of a straight handlebar with a jaw hinged to it by means of two links, each pivoted in nearly parallel position at one end on the handle, and at the other on the jaw. These links are connected by a coiled spring, the purpose of which is principally to make it possible to fit the jaw onto a pipe or nut with the use of only one hand.

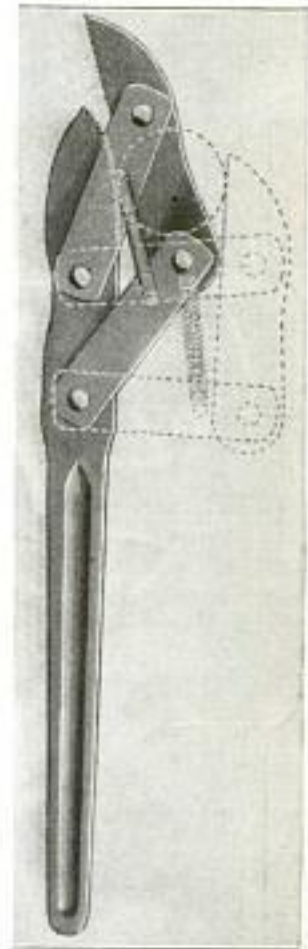

TOOL HANDLES RETIGHTENED WITHOUT CHANGING WEDGE

A wedge that will retighten the handle of a hammer, or similar tool, as often as may be required, without the necessity of replacing it with larger wedges as the wood of the handle shrinks, has recently been patented. The wedge is in the form of a conical headless screw, slotted for the accommodation of a screwdriver. A hole is drilled in the handle to fit this screw, but somewhat deeper than its length, so that the screw can be driven farther into the head at any time to compensate for shrinkage. If the screw becomes loose, it is readily retightened.

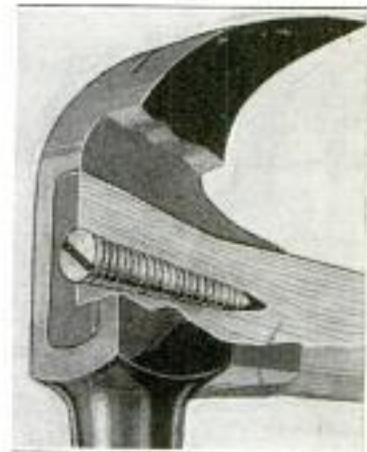

Hayette & Shumway, Inc.  
Buckner & James, Phila.

John Shattuck & Sons,  
25 West 51st St., New York



## CHILDREN'S PICTURE-STORY DEPARTMENT

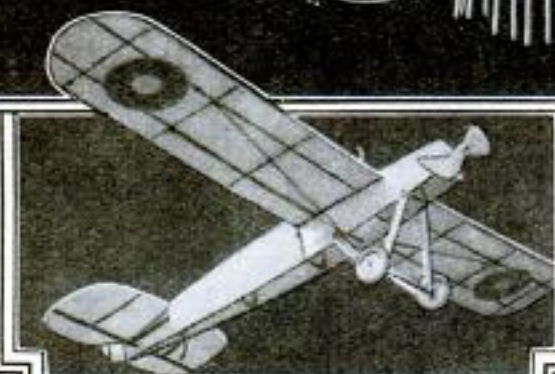

Toy Airplane, with a Wing Spread of  $3\frac{1}{4}$  Feet, Shown Assembled in the Bottom View: Center View Shows Its Parts, and Upper View Shows the Plane Complete without Its Covering



Occupying, When Not Out Riding, the Best Room in the Home of a Resident of Portland, Oregon, This Gander, Fondly Called "Bobbie" by His Owner, Has a Particular Liking for Auto Riding. He Keeps His Balance on the Hood When the Auto is Traveling Rapidly



At the Recent National Conference of Boy-Scout Executives in Blue Ridge, North Carolina, Daniel Carter Beard was Presented by James E. West, Representing All the Other Executives, with a Solid-Gold Eagle Badge



6 PAGES

entor, Miss Theresa  
9th Ave., Miami, Fla.  
entor, Montague Palmer,  
Electric Light & Power C o.,  
New York City.  
entor, R. A. Summers,  
Exeter, Calif. 943

CHICAGO

THE PAPER



State

Magazine one year to the following  
the month of

CHICAGO

Please pay no attention to this notice



# F OF MODERN ACTIVITIES AND INTERESTS

Toy

Ad.

Side



Luxurious New Monkey House, with a Hospital Annex, at the Zoo in Cincinnati, Ohio: It is More Like a Hotel than a Cage, being Equipped with Electric Lights, Baths, and Other Conveniences. In Other Ways, Also, the Monkeys are Treated Like Human Beings



Stilts with Adjustable Footrests, So That Any Boy Using Them can Put Them at Any Height He Likes from the Ground, and Even can Have Them at Different Heights, Like the Boy in the Picture



Some Pussy Cat! With Luminous Eyes, Both of Which can Roll, and Either One of Which can Wink: In the Dark They Are Very Startling. Pussy is Black in Color, with Back and Tail Raised



Something New, and Decidedly Convenient, in the Way of a Sidecar: It was Built in England, and the Youngster in the Car is being Transported by His Elder Brother, in the Saddle, along Fleet Street in London's Famous Newspaper District. The Youngster has Stopped Driving to Allow This Photo to be Taken



*Metzger Register Co.  
Essex, Rapids,  
22<sup>911</sup> Mich.*

*Chas. B. McCarty  
410 Franklin St.  
Gainesville, Fla.*

**POPULAR MECHANICS**

**"END-GRAIN" WOODEN WHEELS FOR FACTORY TRUCKS**

Noiselessness, durability, and absence of any factor that might have a tendency

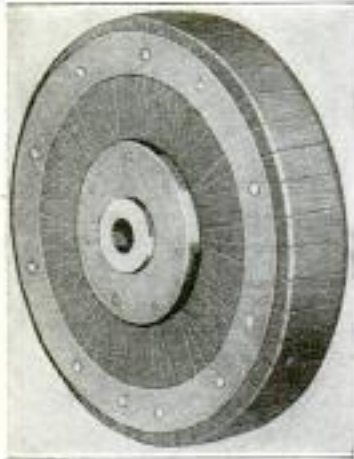

to wear out floors, are merits claimed for a new wooden wheel manufactured expressly for factory trucks. The wheel, which has also been used successfully as a motor pulley, is so designed that the wear-

ing surface is diagonal with the grain, hence the term "end-grain."

**RADIATOR VALVE CONTROLLED BY A TOUCH OF THE FOOT**

122

The adjustment of a new radiator valve is done with a touch of the foot instead of by turning the customary handwheel.

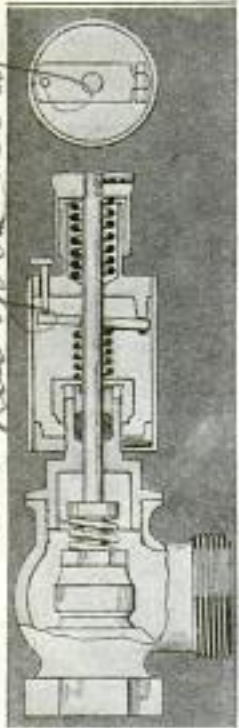

The valve is normally held closed by a coiled spring housed at the top of its spindle. Sliding over this housing is a cap which is screwed onto the top of the spindle, and when pressed down by the foot, compresses the spring and closes the valve. The valve is held closed by the action of a small steel bar, through a hole in the center of which the spindle slides. This bar is hinged at one end in such a manner that a coiled spring below it forces it up and out of the horizontal, so that the sharp corners of the hole grip the spindle

and prevent it from being raised by the spring at the top. When in this position, this spring may be caused to open the valve by a little pressure on a button which forces the bar into a horizontal position, allowing the valve spindle to

slide freely. A third spring at the bottom of the spindle takes care of any tendency to move upward before the spindle is gripped by the horizontal bar.

214

**SIMPLE DEVICE FOR WASHING JEWELRY AND WATCHES**



A young jeweler has invented a simple device to assist in the rapid and effective cleaning of small pieces of jewelry and parts of watches. It consists of a tube, closed at the upper end by a removable cap, in which a plunger can be moved up and down by means of a rod passing through an opening in the cap. The parts to be washed are placed in the lower removable end of the cylinder, which is fitted with fine wire mesh on the sides and end. When placed in a cleaning solution, movement of the plunger produces a washing action on the parts to be cleaned. It is believed that it fills a long-felt need.

*329 Adams*

**SWIMMING DEVICE FITS OVER BODY LIKE SUSPENDERS**

Fitted over the shoulders like a pair of suspenders, a new lightweight swimming device seems to have combined practicality with a goodly measure of comfort.



Four tubes, two in front and two in back, are inflated by the wearer while on the body, through two valves attached to the front tubes. The lightness and shape of the device permit easy movement of the body both in and out of water. It was also designed for emergency use on vessels.

*Thos. E. Wilson Co.  
701 N. Sangamon  
Chicago*

*P.A. Pacing Ave  
454 7 Park  
New York City*

*Chas.*





## Homemade Stern-Wheeler for Construction Work

By GEORGE F. PAUL

**A** CONTRACTOR, working on the new bridge over the Missouri River at Yankton, S. D., solved the problem of conveying men and materials out to the piers in midstream in an ingenious way.

A flat-bottomed boat, 30 ft. long, of 5-ft. beam, was bought at a cost of \$30. The engine of a light automobile was removed, overhauled, and placed on sills, or chocks, bolted to the bottom of the boat, and the "rear end" of the car, without the

auto, with the exception, of course, of the brake. The engine served excellently for the short trips back and forth from the piers, although it showed a tendency to overheat. This could easily be cured, however, by fitting any one of the types of circulating pumps made for this engine, and the boat would thus be adapted for much longer trips.

The gasoline tank was fastened firmly to a wooden frame, beside the flywheel,

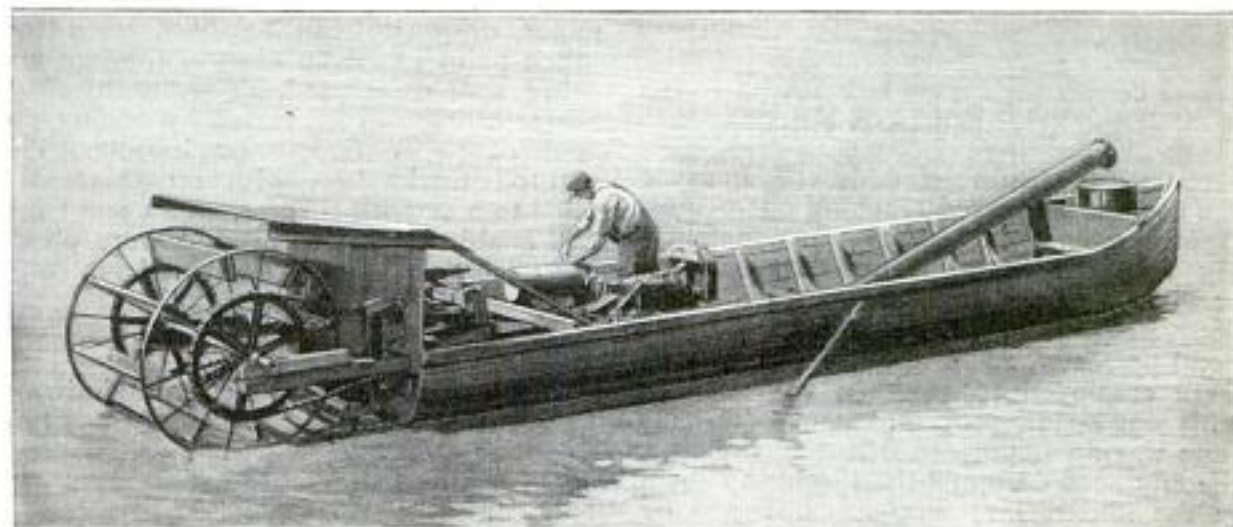

A Homemade Paddle Boat, Fitted with an Engine Taken from a Popular Car, Transports Men and Materials to the Piers of a New Bridge over the Missouri River. The Stern Wheel is Made by Bolting Boards to a Pair of Old Cultivator Wheels

wheels, connected to it again. A paddle wheel, made by bolting boards to a pair of old cultivator wheels, was mounted on a shaft and set in bearings, fastened to brackets projecting from the stern of the boat. Sprocket wheels were attached to the rear-axle shaft in place of the auto wheels, and drive chains run from these over two large sprockets keyed to the paddle-wheel shaft. A splasher was built over the paddle wheel, as shown, and the chains were run through guides bolted to the splasher, and through slots in the splasher itself. Two rudders, operated by one tiller, were fitted ahead of the paddle wheel. The transmission, driveshaft, and rear axle all functioned exactly as in the

at about the same height as in the car, so as to retain the gravity feed.

The operator sits in about the same position as he would in the car, with his feet on the pedals, but with one hand on the tiller, and has the engine under complete control at all times.

In order to make the operation a little more convenient, the original steering column and wheel might be retained and the rudders controlled through wires, attached to the drag link, and run around small pulleys. This would enable the steersman to control the engine through the regular spark and throttle-control rods, which, for short trips, would be of advantage.



### Roughening Smooth Concrete Surface

A large manufacturing concern found it necessary to replace a layer of several inches of asphalt on its receiving plat-

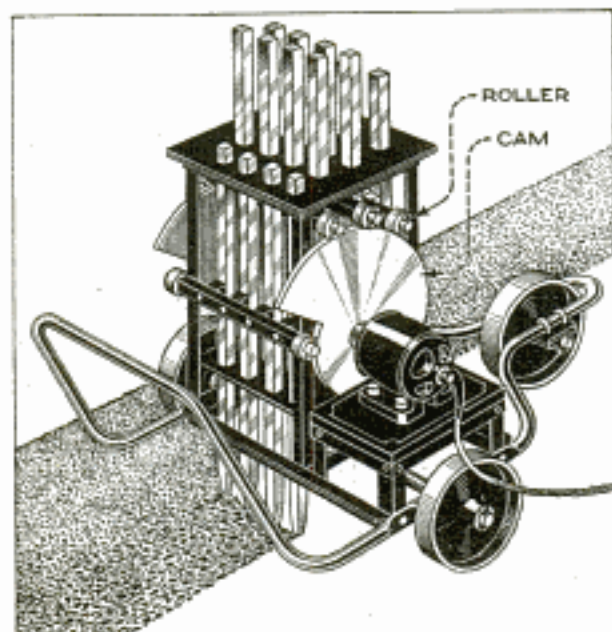

Smooth Concrete Surfaces can be Roughened by This Machine, Which is Operated by One Man, and Virtually Does the Work of Thirty-Two

form with reinforced concrete, because the asphalt hampered trucking operations. Upon removing the asphalt, the constructing engineer found a perfectly smooth base. It was not advisable to lay the new floor upon this, as the two would not bond perfectly, and therefore several men were employed to roughen the surface. This was a slow process, however, and, as time was an important factor in the case, the engineer designed the machine shown in the illustration, that was operated by one man and virtually accomplished the work of thirty-two. The machine was built, in a few days, from materials found around the plant.

Sixteen crowbars, vertically arranged in sets of four, are fitted into square openings cut in the top and bottom plates of the machine, and are fastened at the center to square crossbars that carry a roller at each end. These rollers run on the surfaces of the two cams shown, which are carried on a shaft running between the sets of crowbars, and are driven at a suitable speed by a 1-hp. electric motor. As the cams revolve, they lift and drop the crowbars automatically. The bars are sharpened at their lower ends, and, as the machine is pushed over the concrete surface, they chip it deeply enough to make a good bond with the new surface layer.—R. V. Hurr, Chicago, Ill.

### Novel Method of Painting Walls

An attractive finish for smooth, painted walls makes use of an undercoat that is lighter or darker than the top or finish coat, the latter being mottled so that the contrasting bottom coat shows through. At first glance this would seem to be a rather difficult effect to obtain, but it is really quite simple. The first coat of paint is applied and allowed to dry hard, and then the second coat is put on. The mottling is done while the second coat is still quite wet. A piece of fairly stiff wrapping paper is crumpled up thoroughly and rolled into a ball that can be easily held in the hand, or a ball of waste may be used. The ball is pressed firmly against the wet paint for a second and taken away. If the paper is crumpled up into a loose ball, the flat surfaces of the paper will come in contact with the wet paint, which will adhere to it and be removed, showing the contrasting undercoat, at those places. The same piece of paper or waste can be used until too much paint has been absorbed, when another should be used. The "texture" of the mottling can be varied by rolling the wad of paper tightly or loosely. The method works best with oil paints applied to a smooth surface, and a few trials will enable anyone to produce very pleasing effects with but little trouble.

### Locking Steam Valves

Main steam or gas valves should always be securely locked in the closed position before men are permitted to work on any part of the line. It is not sufficient to hang a warning sign from the valve wheel, as this may be accidentally removed, and the valve afterward opened, with possibly serious results.

A simple lock, which will fit several sizes of valves, is shown in the drawing. It consists of a flat-iron strap, with a hole near one end large enough to fit over the bonnet nut of the largest valve

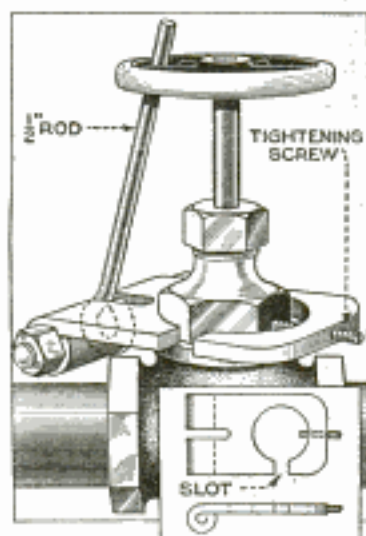



it is designed to protect. A hole for a tightening screw is drilled and tapped at this end, and a slot cut on the side to allow the device to be slipped past the stem of the valve. The opposite end is heated and bent over the stem of a bolt, as indicated, and a slot cut in it. A length of rod has an eye formed on one end to fit the bolt, after which the lock is assembled, and the nut on the bolt tightened.

To lock a valve, the rod is pushed between the spokes of the wheel, the slot in the strap is slipped over the stem, the strap placed on the valve bonnet, and the screw tightened on one of the bonnet-nut flats. This should force the rod against a spoke and keep the valve closed; if not, the device should be moved around the bonnet until the desired result is obtained. With this lock in place, the valve cannot be opened accidentally.

### An Easily Dumped Trash Can

The method of handling waste cans shown in the drawing has several advantages,

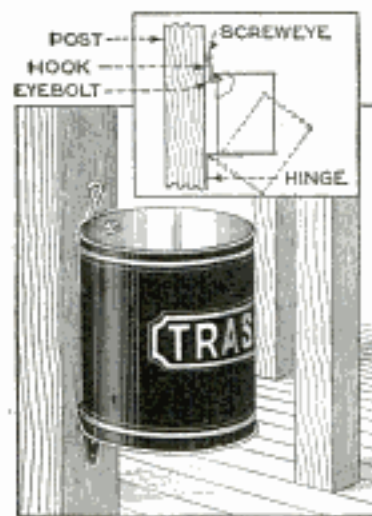

The cans are hinged at the bottom to a post or wall, and held vertically by a hook and eye at the top. They are placed high enough above the floor to permit the contents to be dumped into a box or barrow.

### Wall Fixtures in Garage Substituted for Hoists

When building a brick garage, the owner had a number of heavy bent steel rods imbedded in the walls, as shown in Fig. 1. The purpose of these was not evident until the garage was completed, when the owner fitted to them forged steel hooks, made as in Fig. 5, and thereby formed removable supports that were used in place of hoists or jacks.

Other bent steel rods were made to be hooked under the car frame or body,

after it had been elevated by means of a jack. In this way the body could be left suspended, as shown in Fig. 2, while the wheels, axles, springs, and other parts of the chassis were removed. As several

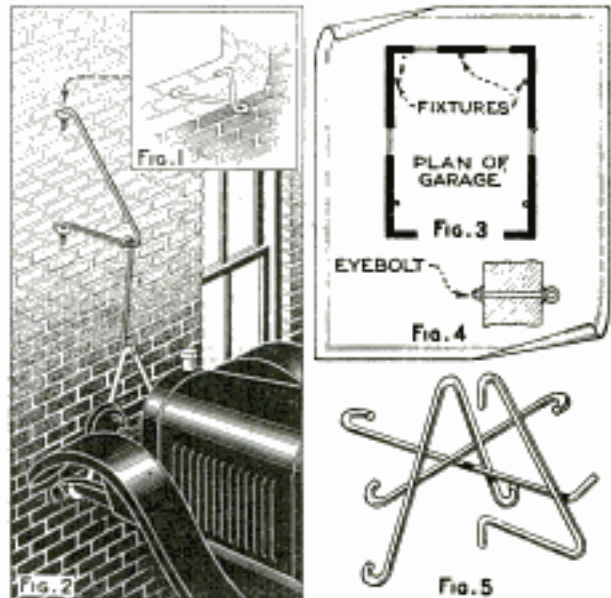

ILLUSTRATING USE OF FIXTURE AS CAR SUPPORT. FRONT AXLE REMOVED

BENT STEEL RODS FOR USE IN SUPPORTING CAR

Steel Hooks, Attached to the Walls of a Garage at Several Places, Serve Very Satisfactorily as Supports When Working on the Car Chassis

cars could be suspended at one time, it was possible to do much more repairing than before these fixtures were used.

They can easily be installed in a garage already built by cutting holes through the walls for large eyebolts, as indicated in Fig. 4, and fastening them with large washers and nuts.

### Tire Repairman's Fabric Knife

While intended primarily for tire repairmen, for use in cutting up cotton tire fabric, a knife of the type illustrated can be used with equally satisfactory results in cutting linoleum, artificial leather, and other materials. The blade is made of tempered sheet steel, in the form illustrated, and fitted with a file handle.

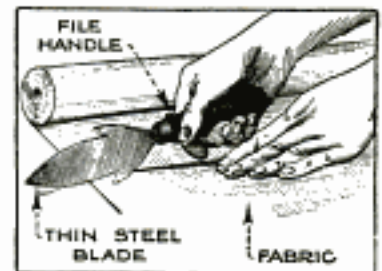

In use, the material being cut is placed on a flat surface, and the knife is pushed along the line to be cut, the edges of the cut being held down behind the knife.



### Relining Brake Bands

The fixture shown in the illustration will facilitate the work of inserting,

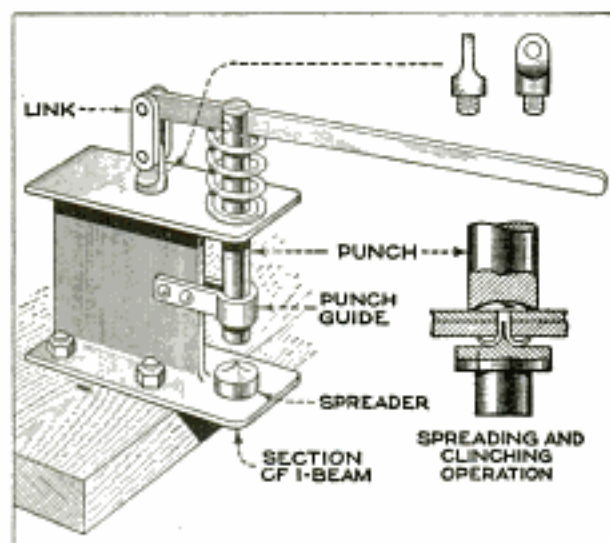

A Fixture for Inserting, Spreading, and Clinching Rivets Used in Relining Brake Bands That Greatly Reduces the Time Required for This Operation

spreading, and clinching the bifurcated rivets used in relining brake bands.

The frame is made from a short length of I-beam, with the web cut away at one end. A tool-steel anvil, machined to the shape shown, is driven into a hole drilled in the bottom flange, to serve as a spreader, and, directly in line with the center of the latter, a hole is drilled in the upper flange for the punch.

The punch is turned concave at the lower end, to fit the rivet heads, and is guided by a flat-iron guide riveted to the web of the frame. It is pivoted to the hand lever, which is, in turn, pivoted between two links that swing on a stud screwed into the upper flange of the I-beam. A strong coil spring is placed over the punch between the upper flange and the lever, to lift the punch automatically after the rivet is clinched.

The fixture is bolted firmly to the workbench, and will reduce, by almost half, the work required on brake bands.

### Ship Tonnage

The question is often asked, "What is the meaning of the various terms used in speaking of ship tonnage?" Briefly, there are four kinds of tonnage terms used afloat—dead-weight tonnage, displacement tonnage, gross tonnage, and net registered tonnage. Dead-weight tonnage is the weight that the vessel can actually carry in tons of cargo, plus stores and bunker coal, or oil in the case

of an oil-burning vessel. Displacement tonnage is the weight of the water that a ship displaces when floating full of cargo, and is equal to the weight of the hull, plus the dead-weight tonnage. The weight of the water displaced by a body is, of course, exactly equal to the weight of the body. Gross tonnage is based on the cubic contents of the hull, 100 cu. ft. of inclosed space making 1 ton. Net registered tonnage is gross tonnage with the crew and machinery spaces deducted; that is, it is a measure of the space actually available for carrying cargo. Gross tonnage is often called register tonnage, because it is recorded in the Register of Merchant Vessels of the United States. A ton, nautically speaking, is always the long ton of 2,240 pounds.

### Making Patterns from Dry-Sand Cores

A foundryman had to hang a pair of heavy gates in his plant, and as no hinges were at hand sufficiently heavy for the purpose, he used an interesting method of making a pattern in order to cast the hinges. No lumber being available from which to make the patterns, he made them from dry-sand cores.

The outline of the hinge was traced on a slab core, A, the core cut to shape with a hacksaw, and finished with a file. The hinge-pin hubs were cut and shaped from square cores, then pasted in place on the hinge-plate slabs. When finished, the patterns were carefully placed on a bottom board, and the molds made in the

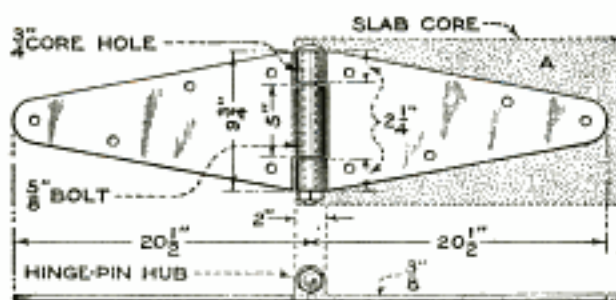

Pattern for Heavy Steel Hinges Made from Dry-Sand Slab Cores; a Simple Method for Single Jobs, Where Accuracy Is Not a Factor

usual way. Five-eighth-inch stud cores were pressed into the drag, to make the holes for the  $\frac{1}{2}$ -in. bolts used to fasten the hinges to the gate, and  $\frac{3}{4}$ -in. cores made the holes for the  $\frac{5}{8}$ -in. hinge pin. The castings were made of steel.

☞ The temper is drawn from hardened brass by heating to a cherry red and plunging it into water.



## Screw Pipe Joints

In spite of many persons' belief to the contrary, it is the "dope" that makes a pipe joint tight. If a joint is made without first coating the threads, it will certainly leak, and if proper jointing material is applied, it will stay tight. Another common fallacy is that the compound should be applied to the female thread; it should be applied to the male thread, for otherwise some of it is likely to be pushed into the pipe, where it hardens and forms an obstruction—a serious defect in a long line.

## Alining Holes in Castellated Nuts

While fitting a new connecting rod in my car, I found difficulty in alining the castellations on the nut with the pinholes in the bolts. After several attempts, I sawed a slot in the bolt, and drilled three holes in the nut, as in the drawing. This is the opposite of the usual practice, but I found it much handier, as the holes in the nut and the slot in the bolt can be seen at all times. An additional advantage is, that there is no need to use two wrenches should the bolt turn while being tightened, as a screwdriver can be used in the slot while turning the nut with the wrench.—Irving R. Butler, Forestville, Conn.

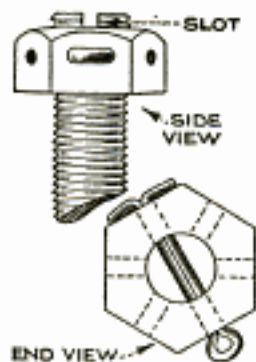

## Holder for Handling Hot Rivets

Setting small hot rivets in place with tongs is not very satisfactory, owing to the difficulty of grasping the button head properly while inserting the stem into the hole. This results in dropping many rivets and makes progress slow. The holder shown was found to be successful in practice. It is made of thin steel tubing, cut and bent as shown.

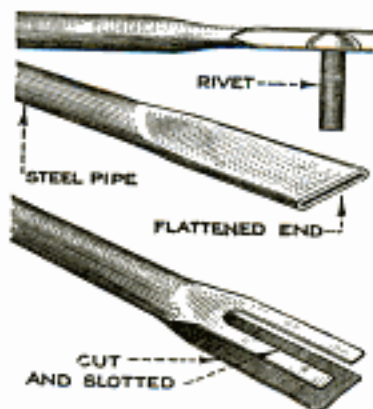

## Making a Jaw-Clutch Pulley

The jaw-clutch pulley is well adapted for use in small shops, and other places

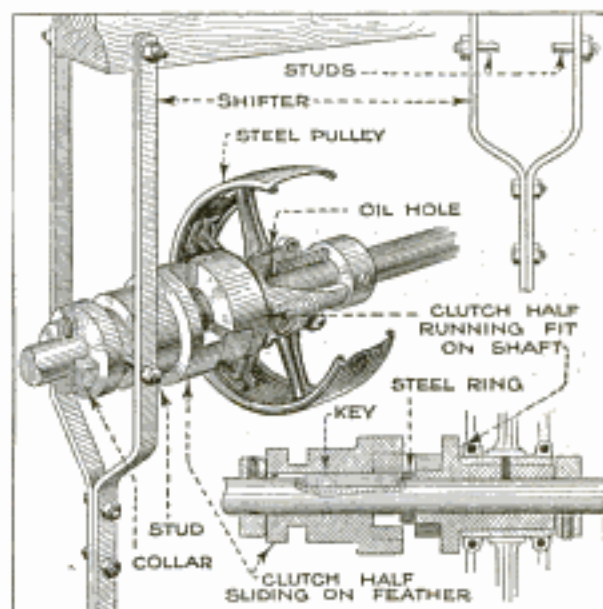

A Jaw Clutch for the Small Shop, or Other Place Where Power from a Single Lineshaft is Used to Operate More than One Machine

where power for more than one machine is taken from a single lineshaft. The only trouble is that it is comparatively difficult to obtain, as only a few firms list it. The drawing shows how a strong and simple jaw-clutch pulley may be made in the shop.

A standard jaw-clutch shaft coupling is used, and the hub of the stationary half is turned to fit the bore of the pulley used, the latter being clamped to the turned hub, and the whole running loose on the shaft. The sliding half is keyed to the shaft and is prevented from sliding off the key at the rear by a safety set collar. Between the two halves of the coupling and in front of the key, a steel ring or washer is placed; this prevents the loose, free-running half from shifting against the key. A safety set collar is also used to hold the loose half in position on the shaft. An oil hole should be provided for the pulley half of the clutch, and an oil groove should be chipped through the bore to assist in spreading the lubricant over the whole bearing surface.

A simple yoke lever for shifting the clutch can be made of  $\frac{3}{8}$  by 2-in. flat iron. Three-eighth-inch capscrows, with their heads cut off, make good studs for running in the groove; when worn thin, the studs can be easily replaced by others of the same kind. The cost of such a clutch is considerably less than that of a good friction clutch.





## A MOTOR-DRIVEN JIG SAW

By J. V. ROMIG



**T**HE jig saw, as a woodworking tool in the pattern shop, is used mostly for work too large to be swung on the band saw. It is also used for interior cut-outs, where a hole is first drilled in the work and the saw blade inserted in it.

The machine described in this article will be a very valuable addition to any small woodworking or pattern shop, as there is no limit to the variety of work that can be turned out on it. Furthermore, as it is motor-driven, many of the objectionable features of the older designs, such as slipping belts and rattling countershaft, are eliminated.

The main frame of the machine consists of a base and column cast in gray iron, with the motor base and the table-adjusting screw bracket cast integral with it. The pattern is split on the line of the front face of the column, and the casting, with sufficient draft, will pull easily out of the sand. There is very little machine work necessary on this piece; the seat for the lower slide, as well as the lower pivot-arm bosses, are shaped square, and the necessary drilling and tapping, such as the holes for the adjusting screw and crank-bearing bolts, motor-support slots, and lag screws, is then done.

The table is also cast from a simple pattern, and has two ribs extending lengthwise across the bottom. The upper pivot bosses form part of these ribs. The table is planed down to about  $\frac{7}{8}$  in. thick, and should be made straight and true. The pivot bosses are drilled square with the top surface, and after being alined with the bosses on the frame, are held in place by bolts or pins. It is best to drill the holes in the bosses a little undersize, and ream to size while the table is blocked in position, to insure that the pins will fit properly.

The crankshaft is built up of a 5-in. machine-steel disk, a  $\frac{5}{8}$ -in. crankpin, and a  $\frac{7}{8}$ -in. shaft, the pin and shaft being welded, or brazed, and pinned in holes drilled through the disk. The crankshaft runs in two small pillow blocks bolted to the frame, and is kept in place by the crank disk and the outer pulley.

The pitman, which is preferably made

of oak, is drilled and split at one end, as shown, to fit the crankpin, and is held in place by means of a washer and flat-head screw. The adjustment of this bearing for wear is made by means of a clamping screw that passes through the split end. The upper end of the pitman is fitted with two  $\frac{1}{4}$  by  $\frac{3}{4}$ -in. metal strips, forming a yoke for the bottom of the lower slide, and is connected to the slide by a  $\frac{7}{16}$ -in. wristpin.

The guide bearing for the lower slide is made of cast iron; a groove;  $\frac{3}{4}$  in. square, is cut in it, as shown, and made a good fit on the lower slide. A steel plate is fitted to the bearing as a cover, and the whole is screwed to the frame with 6 long fillister-head screws, passing through both units.

Both upper and lower saw slides are made of cold-rolled steel,  $\frac{3}{4}$  in. square, filed true and polished. After drilling a  $\frac{1}{4}$ -in. tapping hole at one end of each slide, a small portion of the end is cut out as shown. The parts cut out are drilled  $\frac{1}{4}$ -in. clearing size, and by passing a thumbscrew through both sections, a vise is formed for holding the saw blade. A  $\frac{7}{16}$ -in. hole is drilled in one end of the lower slide to receive the wristpin. The upper end of the other slide is drilled and tapped, as shown, for a  $\frac{1}{4}$ -in. eyebolt.

The upper part of the machine consists of a length of 3-in. pipe, fitted with a flange on each end; the upper flange is fastened to a beam or crosspiece overhead, and the lower one has holes drilled near the edge for guy wires, each of which is fitted with a turnbuckle. An oil hole is drilled through the side of the pipe to permit oiling of the slide.

A guide for the upper saw slide is made by broaching a  $\frac{3}{4}$ -in. square hole in a cast-iron bushing. This bushing is then fitted into the pipe and screwed to the lower flange.

The end of a heavy coil spring is fastened to the eyebolt on the upper slide, and from the upper end of the spring a  $\frac{1}{8}$ -in. steel cable, running over a 2-in. sheave fitting in a bracket in the wall of the pipe, is led to the tension device. This device, a winch arrangement, is a great



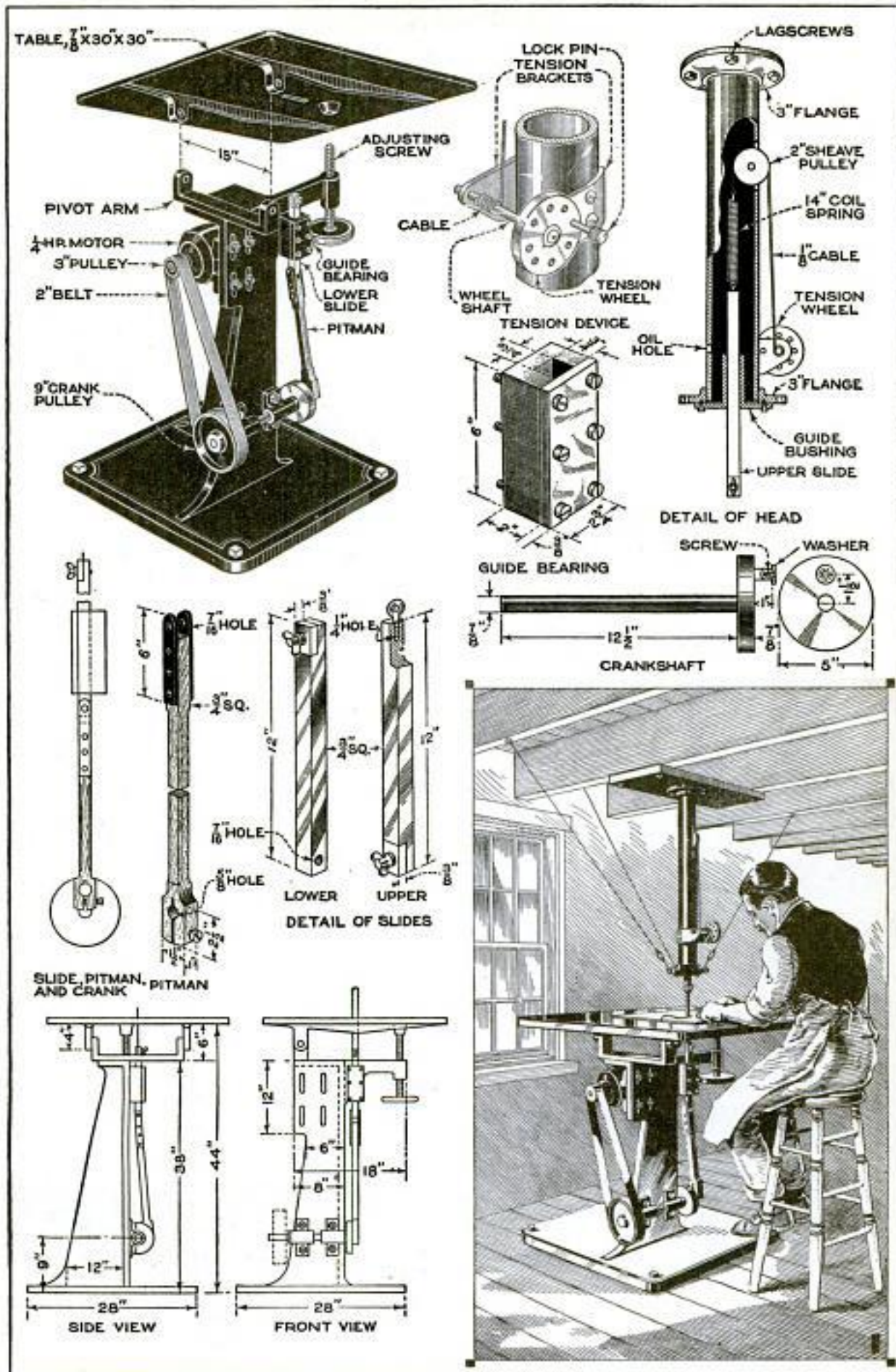

This Jig Saw will Prove to Be a Valuable Addition to the Equipment of Any Small Woodworking or Pattern Shop, as a Great Variety of Work can be Turned Out with It. It is So Designed That Many of the Objectionable Features of Older Models are Eliminated



improvement upon the older models that use a long threaded rod reaching through the floor above. It consists of two steel plates, screwed to the pipe, a  $\frac{3}{4}$ -in. shaft, a handwheel, and a lock pin. A hole is drilled through the shaft, so that the end of the cable can be passed through and knotted, to prevent it from slipping. When the handwheel is turned sufficiently, and the lock pin put in place, the spring is put under tension, and the saw blade held tightly. In operation, the pitman pulls the saw blade downward, and the spring pulls it up again. The tension must not be too light, or the blade will be bent and broken. This device is very convenient when inserting new blades. Blades 8 in.

### Shoveling Stand for Corn

The shoveling stand illustrated is a great convenience to the farmer, as with

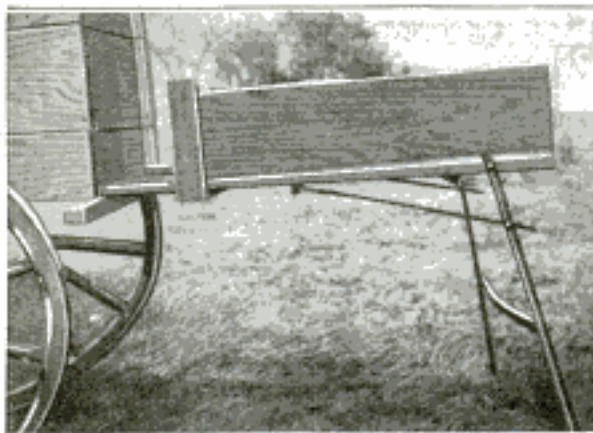

A Handy Homemade Stand for the Farm, for Use in Unloading Corn from the Wagon: A Stand of This Type Prevents Waste of Time and Corn

it he can start unloading corn with a shovel as soon as the wagon is backed up to the crib. A frame, of 2 by 4-in. lumber, 5 ft. long, and as wide as the wagon box, is made and covered with 1-in. boards, to form the platform.

Pieces of 2 by 4-in. lumber, or other suitable material, are used for the legs, and any rough boards will serve for the sides. The side members of the frame should extend far enough to rest on the rear sill of the wagon.

### Fruit Trees Injured by Winter Sun

Many young fruit trees are lost every year through lack of foresight. Winter sunshine is responsible for a large percentage of losses that are frequently laid to other causes.

The low temperature of the winter months drives the sap down into the

in length will answer very well for most work. The pivoted table makes it possible to cut any desired draft angle in the work. The adjusting screw is of cold-rolled steel,  $\frac{7}{8}$  in. in diameter; it should be equipped with a lock pin or screw to prevent it from being turned accidentally.

A  $\frac{1}{4}$ -hp. electric motor, of about 1,750 r.p.m., fitted with a 3-in. pulley, is fastened to the frame by bolts, passing through the slots cut for this purpose. The crankshaft pulley, which is fastened in line with the motor pulley, is 9 in. in diameter, and a 2-in. endless fabric belt, of single thickness, is used for the drive. A snap switch can be mounted in a convenient place underneath the table.

roots, leaving the tree itself in a dormant state. On a bright sunny day the bark becomes warm, and this draws the sap up into the trunk, where it freezes during the night, before it has time to get back to the root. In freezing, the sap expands, which splits the bark and causes severe injury to the tree.

As a precaution against this danger, the trunk should be wrapped with tar paper, or some similar material, to deflect or absorb the sun rays, thereby maintaining a more constant temperature.

### Reducing Pulpwood Decay by Proper Storage

Improper storage conditions at pulp mills are primary causes for pulp losses, which sometimes mount as high as 400 lb. per cord of wood, in addition to inestimable losses through the manufacture of poor qualities of paper. Pulpwood is generally piled directly on the ground, which is usually poorly drained and overgrown with weeds. Some wood is also allowed to remain in storage for several years, because it is not used in rotation.

In order to prevent this unnecessary decay, it is recommended that the logs be peeled, if possible, as this prevents borers from attacking the wood, and also hastens air-drying. In the storage yards, soil moisture should be reduced, through proper drainage, and weeds should be kept down. This can easily be accomplished by filling in the yard with cinders. The wood should not be piled directly on the ground but on stringers, supported by concrete piers or creosoted-wood blocks. The stringers should be pressure-treated with coal-tar creosote. The piers or blocks should be high enough to raise the stringers at least 12 in. from the ground



and thus allow proper ventilation. Marking each pile with the date that the logs were received will aid considerably in using up the wood in rotation. Upon removal of the pile of wood, the accumulated waste should be burned, lest it be a source of infection for fresh wood. All infected skid logs should be removed. Where timber is placed in conical piles by conveyors, a possible remedy may be to keep the wood saturated with water by means of an overhead sprinkler system. Wood saturated with water will not rot because there is not enough air within the timber to allow the fungi to grow. Whether it is commercially possible to wet the piles sufficiently and maintain them in this condition, must, however, be demonstrated by actual test.

### Hauling Sorghum Cane

In the Southwest sorghum cane is the principal feed crop, and is usually stacked in small piles for two or three weeks before being stored in large stacks.

Hauling the cane with a frame wagon during these operations means double handling, and for this reason, some farmers use the simple skid shown in the photograph to haul the cane. Its width

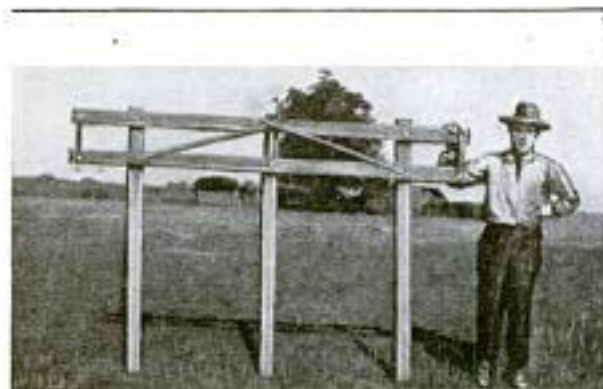

A Simple Skid Used by Farmers to Transport Sorghum Cane: Much Handling is Saved by the Use of This Simple Device

is 10 ft., and the three pieces of 2 by 4-in. stuff that form the main skid members are 5½ ft. long. These pieces are connected, at the rear, by a frame made of the same material, braced as indicated, and are beveled on the front ends, to ride easily over the ground.

A ring is fastened to the frame, on each side, and in use, a 7-ft. trace chain, with a singletree, is attached to each ring. The traces are led forward, parallel with the skid members, and the reins adjusted to allow the horses or mules to "broad-walk." The pile of cane is then "scooped" on the skid, and dragged to the stack.

### An Emergency Wood-Drilling Tool

When no brace and bit are available, a very satisfactory substitute can be improvised from an ordinary twist drill, a tap

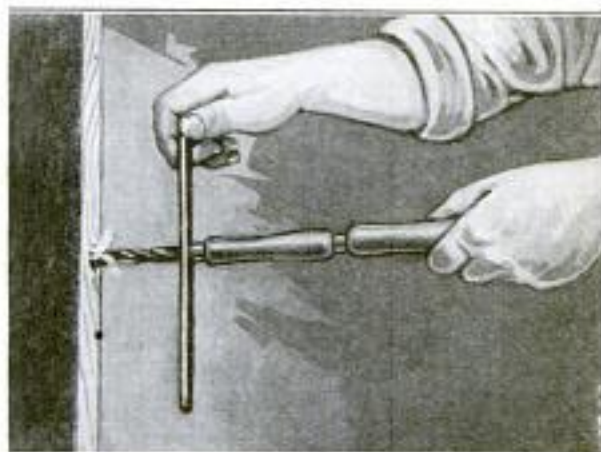

An Improved Wood-Drilling Tool That Makes a Very Satisfactory Substitute for a Brace and Bit, When the Latter Are Not Available

wrench, two file handles, and a short piece of ¼-in. steel or iron rod.

The twist-drill shank is ground square, and tapered for such a length that, after the tap wrench is fitted on, the end will still project far enough to be inserted securely in the file handle. A hole, 3 in. deep, is drilled lengthwise into the top of this handle, to receive a 5-in. iron rod, that fits loosely in the hole. A metal disk is inserted into the bottom of the hole to take the thrust. The rod is then fastened securely into a hole drilled in the other file handle, allowing about 3 in. to project. The outer handle can then be held firmly in the left hand, and will not turn, while the other part of the tool is being turned by means of the tap wrench.

### Removing Broken Screws

When a screw breaks off flush with the surface of the part into which it fits, the usual method of removing it is to back it out by means of small chisels, or drill it out. The following method should be tried first, however:

Sharpen a twist or flat drill, so that it will cut when the drill press is reversed, allowing a little more clearance than usual, in order that the point may have a digging effect. After the drill is placed in the chuck, and the machine reversed, the drill point should be brought down against the broken screw by a quick movement of the spindle. By this means the screw will be released, if it is soft enough to allow the drill point to catch in it.—L. M. Steffen, Dayton, Ohio.



### Handling Heavy Boxes

While most shops possess facilities, such as trucks, etc., for transporting boxes of heavy material around the plant,

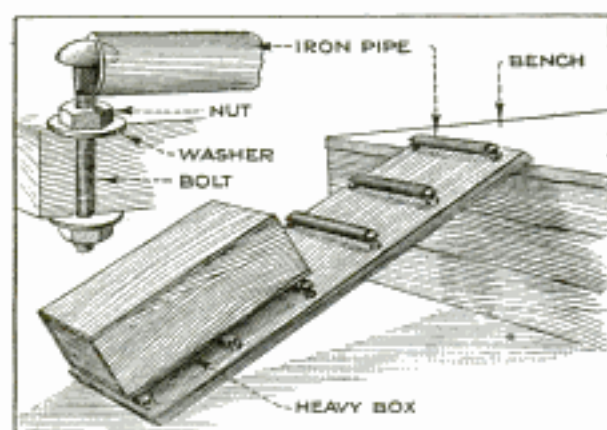

A Method of Reducing the Labor Required to Elevate Heavy Boxes to the Workbench, by Means of an Easily Built Skid

very few have provided any particular means of placing the boxes on a workbench, when necessary. With the device shown, which can be made at very small cost, one man can roll a heavy box onto the bench, a task that would ordinarily require the services of two or three men.

A 2 by 12-in. plank, a number of  $\frac{3}{8}$ -in. round-head bolts, with nuts and washers, and some  $\frac{3}{8}$ -in. piping, are the only materials required. Material of larger or smaller size can, of course, be used where necessary, taking care, however, that the radius of the bolt heads is suitable for the internal diameter of the pipe used. The plank is drilled on each side to take the bolts, at suitable intervals, the piping is cut into lengths, and the edges are rounded. When assembling, two bolts, with upper nuts and washers in place, are placed in opposite ends of a length of pipe, the assembly is placed in position, the upper nuts are adjusted for height, and the bottom nuts run on and tightened. The end nuts, at the top and bottom, prevent the device from moving when a box is being pushed up onto, or lowered from, the bench. If kept well greased, the pipe rollers run very easily.

### Making Babbitt Run Freely

After considerable experimenting with different methods, it was found that a handful of sal ammoniac, dropped into the ladle of melted babbitt just before pouring, made it run much more freely and resulted in a smooth job, free from lines. A piece of resin, about the size of a walnut, has the same effect.

### Repairing Crankshafts

Repair jobs are always the most difficult of machine-shop work, as the shops making a specialty of this work are not usually so well equipped to repair a part of a machine as the factory making the part. One of these tough jobs consists in putting a new pin in a center crankshaft, one that has cast-iron disks with the pin and shaft pressed in. By the time the pin has loosened enough to be replaced, it has worn out the holes in the disks so that they must be rebored. These holes must be bored exactly parallel with the shaft in both directions, and be precisely the same distance from the center of the shaft. If these conditions are not fulfilled, the shaft will run out of true when the pin is inserted.

Both ends of the shaft are put in the lathe, and the faces of the disks trued. At the same setting, with the shaft running in the steady-rest, a hole, about  $\frac{3}{4}$  in. in diameter, is bored true in the center of each part of the shaft; this is for a dowel pin to hold the two parts together in perfect alignment. Next, two or three

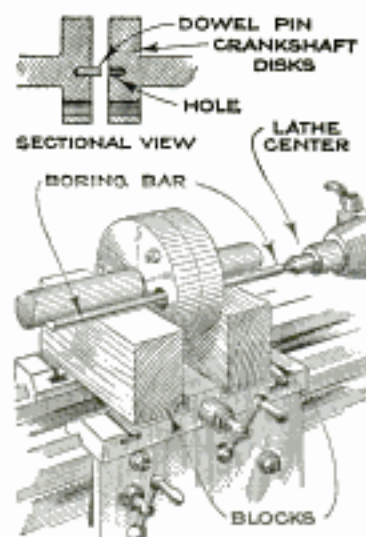

holes are drilled through the disks, so that they may be bolted together with the two dowel holes in line, the dowel holding them centrally, and the trued faces insuring that both shafts are in line. Two wooden blocks are bolted to the lathe carriage; these are of such a height that the center of the shaft will be about the same level as the lathe center. The two shafts, bolted together, are put on the blocks, and clamps are arranged to hold them in place. A boring bar is put between centers, and the holes to be bored are trued up approximately. The bed of the lathe is tested for level, and the shaft adjusted to correspond. This makes the shaft parallel with the bar on one plane. Caliper between the bar and ends of the shaft to the same distance at both ends, that is, if the ends of the shaft are of the same size; if they are not, the necessary allowance must be made.



Now, the shaft is exactly parallel with the bar, and when the holes are bored, they will be both the same distance from the center of the shaft and parallel to it.

The only remaining requirement for a perfect job is to put in the pin and still have the centers of both shafts coincide. Before the disks are taken apart, a keyseat is cut through both disks at the same time. This can be done most accurately on the planer, supporting the shaft on V-blocks. The pin is turned up, and a keyseat milled on both ends at the same setting; keys are made, and the shaft is ready to press together. If a reasonable amount of care is taken to see that the keys do not shear in pressing together, the shaft will run perfectly true, but if the keys are allowed to shear, an error will be present in the finished work.

### An Improved Tong Rack for Blacksmiths

Since using the rack shown in the drawing, it has been possible, in a smith shop employing a number of men, to keep the tongs in a manner at once convenient, orderly, and safe.

Usually the tongs are held on a horizontal rail near the water trough, and because the jaws are forced open by this rail, it becomes necessary for the workman to lift several tongs before finding a pair that will fit the work, thus losing considerable time. In making the selection, further-

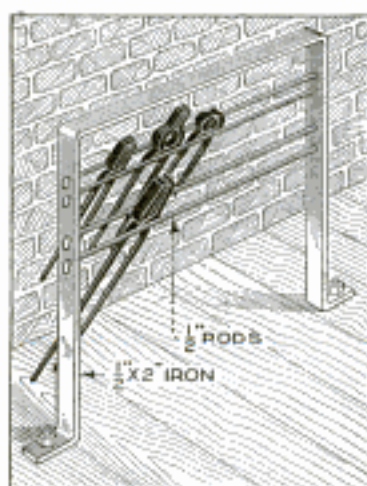

more, he is frequently burned by grasping the hot jaws of tongs dropped on the rail a moment before by a fellow workman. If the shop is equipped with a rack made as shown, there will be less time lost

and less danger of burns, as the tongs must be grasped by the jaws to insert them between the bars of the rack, and this compels each workman to cool his tongs before returning them. Arranging the smaller tongs at the top, and the larger ones at the bottom, will prove of additional assistance in eliminating lost time, as a suitable pair may be selected at once.

### A Simple Device for Pulverizing Solder

Pulverized solder, which is not easily obtained at all times, can be made by a simple apparatus constructed almost en-

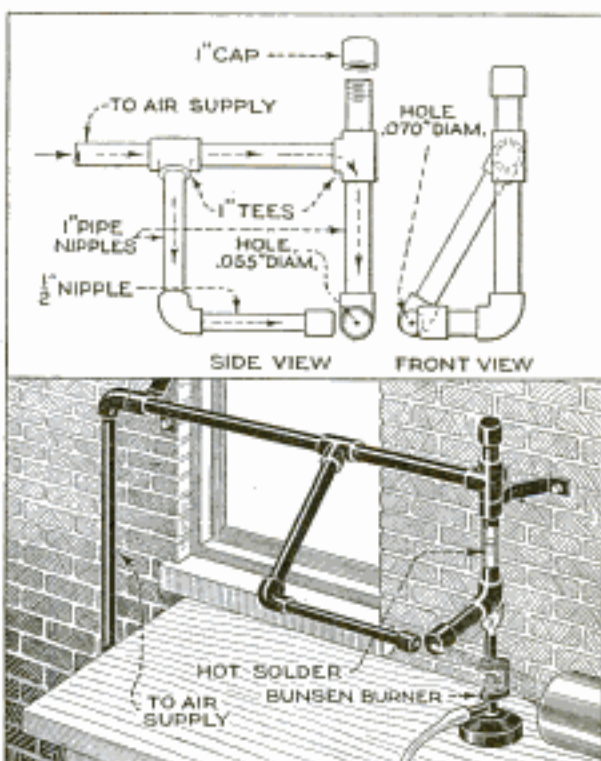

A Simple Device, Made of Pipe and Fittings and Using Air, to Pulverize Melted Solder, Which may be Used to Make Self-Fluxing Solder

tirely of pipe and fittings, as shown in the drawing.

Melted solder is poured into the vertical pipe, after a small wooden plug has been inserted into the .055-in. hole shown, to keep the solder from running out. A Bunsen burner or gasoline torch is used to keep the solder in a molten condition while in the pipe. Having screwed the cap down tightly, the air, which should be at a pressure of about 50 lb. per square inch, can be turned on, and the plug withdrawn. The result is that the solder, forced through the small hole, is broken up into very fine particles, and at the same time cooled, by the strong jet of air directed against it through the .070-in. hole in the air nozzle. The particles of solder can be caught in some receptacle placed in the position shown.

A very good self-fluxing solder can be made by mixing this pulverized solder with vaseline and a little zinc chloride. If a self-fluxing bar is desired, mix the solder with powdered resin and glycerin to form a stiff mass, which can be rolled into bar form, and used like ordinary bar solder, but without a separate flux.—L. M. Case, Anglesea, N. J.



### Lathe Turret Held in Tailstock

The drawing shows the construction of a turret toolholder for the tailstock of a lathe, the turret holding six different

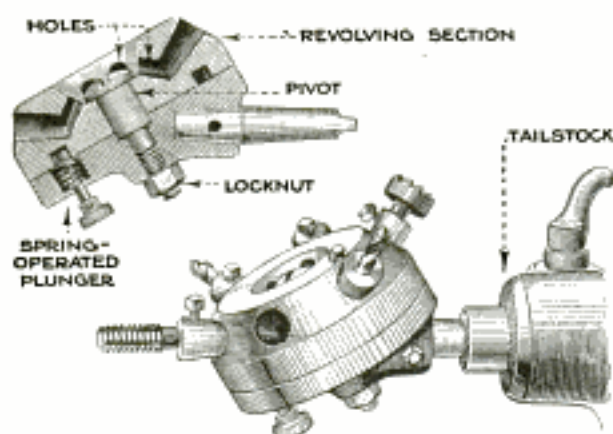

Turret Fixture Held in the Tailstock Spindle of an Ordinary Lathe: The Toolholder is Mounted So That the Tool in Use Is Exactly in Line with the Center of the Work

tools. This fixture was designed for use on an ordinary back-geared engine lathe, but the same thing could be adapted for a wood-turning or speed lathe.

The fixture consists of a circular plate supported in the tailstock spindle by means of a standard taper shank. At the center of this plate, which is tilted at an angle, is a fixed stud that keeps the tool-holding section in place. The toolholder is free to revolve, and is held in any one of the six positions by means of a spring-operated plunger on the underside of the fixture. The entire device is placed at such an angle to the center that the tool being used will be exactly aligned with the lathe centers. The openings for the tools are machined by tools held in the chuck of the lathe, in order to obtain correct alinement, and are tapered for standard taper-shank tools, or collets. By setting up as many tools as required in this fixture, it is possible to perform drilling, tapping, threading, facing, counterboring, and countersinking without the loss of time occasioned by using individual tools.

### How to Make an Electric Drill

There is no handier tool in the workshop or laboratory than a small electric drill, but unfortunately its high cost puts it beyond the reach of most. A very serviceable tool of this type can be made from an electric motor of from  $\frac{1}{10}$  to  $\frac{1}{8}$  horsepower.

For these small motors, a chuck with a capacity up to  $\frac{1}{4}$  in. should be used, and the drill speed should be about 600

r.p.m.; the motor speed is reduced by means of simple gearing, as illustrated. The motor is mounted centrally, on a cold-rolled steel frame, with capscrews, and it should be doweled in place. On the forward end of the frame is mounted the bearing block, two flat-head machine screws being used to fasten it to the frame; this block is drilled for the spindle shaft, and is of bronze, which makes a fine long-wearing bearing. On the spindle, which is made of cold-rolled steel, casehardened, a collar is turned that rides against the ball-thrust bearing. The reduction gear is fastened to the inside end of the chuck spindle, and the pinion to the motor shaft. These gears can be bought from stock, and 20-pitch gears should be suitable for this light drive. A brass pinion, running on a steel gear, will make a well-wearing assembly. Care should be used in the assembly, so that the teeth will mesh properly. A handle, made from a suitable length of  $\frac{3}{4}$ -in. pipe, is welded to the rear end of the frame. A well-balanced tool results from the underslung mounting of the motor, making the use

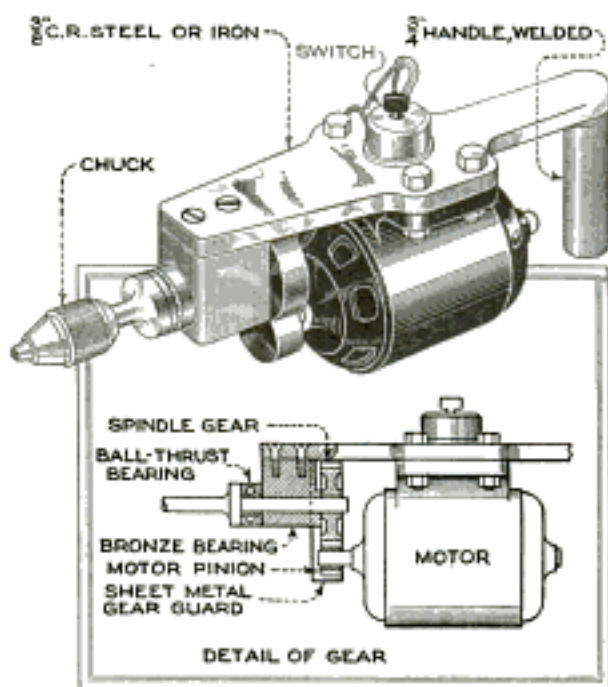

A Fractional-Horsepower Electric Motor, Adapted to Make a Serviceable and Satisfactory Drill That will Serve as Well as an Expensive Tool for Light Work

of the tool safe and easy. A sheet-metal guard is fastened over the gears, as shown, with small screws; this is necessary, not only to keep drill chips from getting between the teeth, but also to prevent injury to the operator. If desired, a simple snap switch can be mounted on the flat top of the frame, as shown, for controlling the operation of the motor.



## How to Make an Electric Muffle Furnace

"Kromore" or 193 Alloy Wire  
By CHAS. E. MULLIN

ONE of the most useful pieces of apparatus for general experimental and shop work is an electric muffle furnace. As these are rather expensive to purchase, although they are comparatively easy and cheap to build, I build my own. A furnace of the type described has been in hard use for over a year in my own laboratory, and has given entire satisfaction. The only precaution necessary to observe in its use is to avoid temperatures higher than about 1,800° F. It operates on alternating current of 110 volts, but will work equally well on direct current. It will reach a temperature of 1,800° in about two hours, on a 5-ampere current, which means a total cost of about 14 cents, at the rate of 12 cents per kilowatt-hour.

The muffle was purchased from a laboratory-supply house. It is a D-shaped alundum muffle, 4.5 in. long, 3.5 in. wide, and 3 in. high. These muffles may be obtained in various sizes. In case a cheaper unit is desired, a fire-clay muffle may be used. For the heater winding, about 110 ft. of No. 17 "kromore" wire or ribbon is used. Wind the muffle as shown in the upper figure, securing the ends of the wire in place with tie wires. If the furnace is to be used for a variety of work, tap the winding near one end. This avoids the use of a separate rheostat or other resistance, in many cases, while, if an outside resistance must be used, a much smaller one will do, than if the taps are not provided. The taps cannot be soldered to the wire, on account of its high temperature when in use; it is best to double and twist the wire at the tapping points, allowing enough of the doubled wire to reach the binding posts, before proceeding with the winding. If ribbon is used, it is doubled, and the doubled portion, close to the muffle, secured with a small clamp, or a wire tie.

Both ends of the muffle should be

wound somewhat closer than the middle, especially at the open end, and the taps should be taken off starting at the latter, so that the back of the furnace will always be hottest.

When the winding is in place, cover the whole muffle outside with a stiff layer of alundum cement, about  $\frac{1}{8}$  to  $\frac{1}{4}$  in. thick. Allow the cement to dry for about 24 hours in the air. Then put it in a warm place; for instance, above a furnace or stove, for another 24 hours. Next bake it for 5 or 6 hours in an oven, to drive out all moisture. If any small cracks develop in the muffle after baking, fill them up with thin alundum cement.

If the furnace is to be permanently set in one place, an excellent casing can be built of fire brick or common brick. The casing should be about 12 by 12 by 12 in. in inside dimensions. The muffle is packed in the casing with waste asbestos or magnesia, such as

used for pipe covering. As my laboratory is small, and I must move the furnace out of the way when not in use, I made a 12 by 12 by 12-in. sheet-iron box for it, as shown.

The inside of the arched doorway has the same height, width, and shape as the inside of the muffle.

The walls are  $\frac{3}{4}$  in. thick and built around coarse wire-screen reinforcing, as shown. The doorway is 4 in. high.

The door is a solid block of alundum cement, reinforced with wire screen, and fits loosely into the doorway. It is provided with an iron-ring handle, set into the face, as indicated. After molding, the door and doorway are dried in the same way as the muffle. All surface cracks are filled, and the outside smoothed on a grinding wheel. The inside of the doorway may be smoothed, before it gets too hard, with a coarse file. The doorway is held in place by the sheet-metal casing and by the magnesia packing.

The taps from the heating coil are

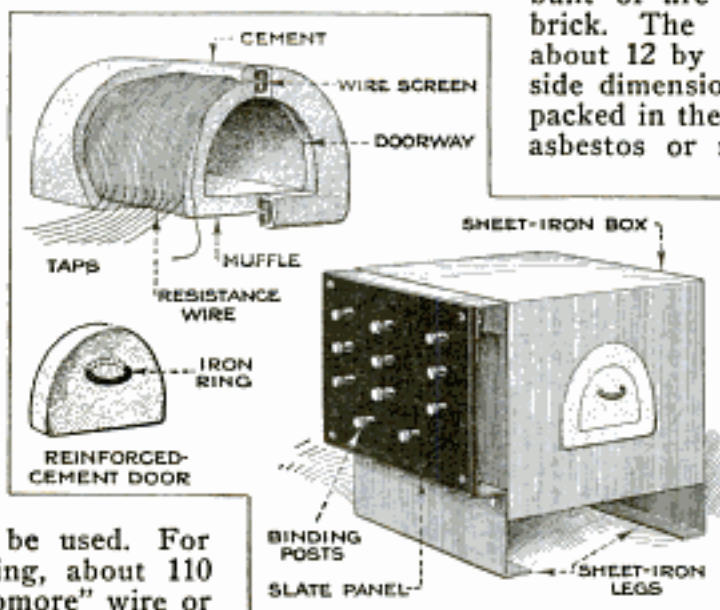

Upper Left: Winding of Muffle, Cement Covering, and Construction of Doorway. Lower Left: Muffle Door. Right: The Complete Furnace, Showing How the Panel and Legs are Attached to the Casing



brought out through the side of the casing, and are insulated with asbestos board. They are attached to binding posts on a slate panel, fastened to the side of the casing by sheet-iron straps, as illustrated. The casing is supported by sheet-iron legs, riveted to the sides.

### Attachment for Squaring Stock on Grinder

Using small and easily made attachments, an ordinary bench grinder can

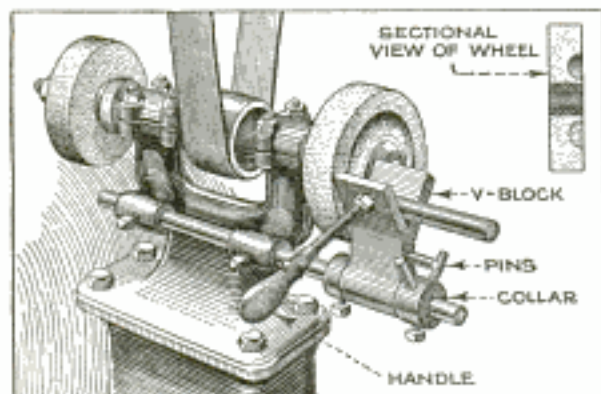

An Attachment for Grinding Wheels Illustrative of Similar Devices That can be Used in Place of the Standard Tool Rest

be rigged up to do more than the usual simple grinding operations. One of the jobs frequently met with in the shop is the squaring of the ends of stock previous to centering, as the hacksaw or parting tool generally leaves a burr and a rough surface which it is desirable to remove. As most grinder heads are designed with a T-rest for supporting the work, the rest can be removed and the bearings used to hold the attachments. In the case of the fixture illustrated, the V-block is a casting, which is prevented from moving horizontally by two collars, fastened to the shaft with setscrews. The outer collar is provided with two stop pins, and the swinging V-block has its movement limited by a pin inserted into it parallel with the shaft. A handle attached to the front face of the V-block allows the whole fixture to be swung back and forth, carrying the work across the face of the grinding wheel.

### A Reverse Counterbore

The plant that uses the counterbore illustrated finds it necessary to drill several holes through a casting into a recess, and to spot-face, or counterbore, the bottom surface. Several different types of counterbore were tried, but this one has proved to be the best, as the cutters sel-

dom break, and the bars, with proper usage, will last a long time. It has the added advantage that there is nothing to lose out of the bar once it is assembled, as the key can only be removed by pushing the plunger down with a flat, pointed piece of steel, inserted through the hole in the upper end of the bar. There is, however, no necessity for removing the key unless the bar should break. The cutter is notched, the notch being a sliding fit over the smallest part of the bar. Small grooves or notches are also cut in the bar. They can be filed or milled easily and hold the cutter in a central position. The cutter is made a sliding fit in the slot that accommodates it, the slot being made slightly wider than the cutter, but very little, say, about .01 in. The key shows the position of the cutter at all times, so it is not necessary to look under the work to find its position. The bar is made from a good grade of common steel, casehardened. The plunger, cutter, and key are made of tool steel, hardened.

The upper drawing shows the counterbore ready for use. The taper key is tapped into position with a hammer, bringing pressure to bear on the plunger. The spring is slightly compressed, and the cutter is held down firmly; the bar is then brought up and the hole spot-faced, or counterbored. The lower drawing shows how the cutter is released by tapping the key in the opposite direction, so that the pressure against the cutter is

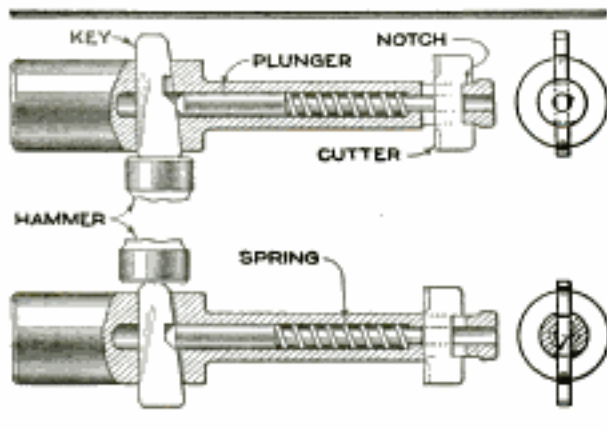

An Efficient Counterbore That Has No Loose Parts to Drop Out: This Tool is Designed for Spot-Facing, or Counterboring, the Underside of Drilled Holes relieved, making it easily removable.—Galen D. Watson, Bath, Me.

ⓄThe speed of a revolving toothed cutter is governed by the material to be milled or cut; generally, the harder the material, the slower the cutter runs, and the lighter the feed.



### Testing Work in Lathe

When it is necessary to set a piece of work in a lathe accurately parallel with the line of travel of the carriage, and with the lathe bed, the custom is to use a dial, or other indicator, clamped to the toolpost, first sliding it along the side of the work, adjusting this until the indicator shows parallelism, then shifting it to the top and adjusting the work vertically. The second adjustment often throws out the first one, requiring much trying to set the work parallel both ways. A better method, in which two dial test indicators are used simultaneously, is shown in the drawing; one contact point slides along the side and the other along the top of the work, one end of which is centered and runs on the tailstock center, while the other is held in a four-jaw independent chuck. In this instance the

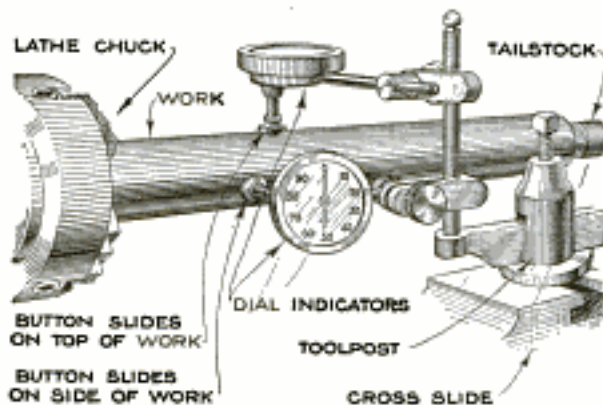

Testing Work Held in a Lathe Chuck for Parallelism by Means of Two Dial Test Indicators, Which Show Top and Side Adjustments Simultaneously

work was not to revolve in the lathe, but was to be held stationary while a keyway was cut by a toolpost milling attachment; the bar was adjusted by shifting the jaws of the chuck slightly. When using two indicators, if one adjustment throws the other out, the fact is noticed, and a correction made at once, without waiting to change the position of the dial.

### Hydraulic Shop Hoist

Practically every shop is provided with water mains delivering water at pressures of from 40 to 80 lb., and the drawing shows how this pressure can be applied by means of a hoist to the lifting of heavy work. The cylinder can be made from a piece of pipe, about 6 in. in diameter. This is fitted with a piston, made from a cup-shaped piece of leather which is clamped on the piston rod between two metal plates. The lower plate should be screwed on the rod, and the upper one

an easy fit. A simple stuffing box, made from a large and a small pipe cap and a nipple, is provided at the lower end, and the upper end of the cylinder is closed

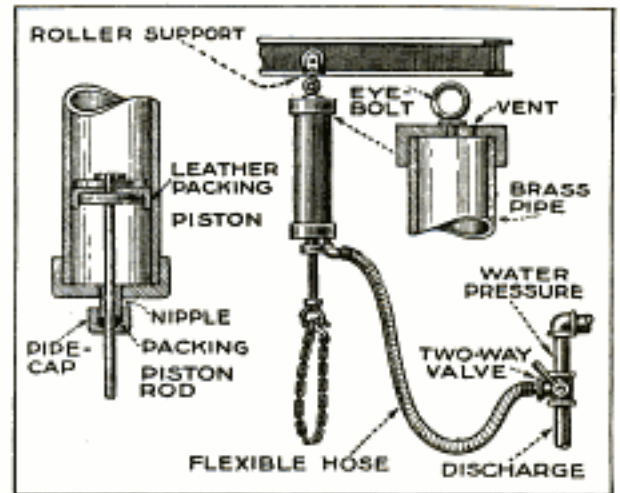

A Hydraulic Hoist for the Shop or Garage for Lifting Heavy Weights and Parts: The Whole Device can be Made from Standard Pipe and Fittings

with another pipe cap. The hoist is connected to the water-supply pipe as shown in the drawing, through a two-way valve. When a load is to be lifted, water is admitted to the cylinder, raising the piston and the object attached to the rod. When the load is to be lowered, the valve is turned to allow the water to run out of the cylinder into a drain, causing the weight to descend gradually and smoothly.

### Repairing a Tractor Clutch Yoke

In the midst of wheat-seeding operations, the yoke of the speed-shifting device of the tractor, which had become worn, broke.

As the part was a malleable-iron casting and could not be welded at the forge, the two broken pieces were riveted together, as shown at A, to serve until a new yoke could be made. The new yoke was made from a piece of  $\frac{5}{8}$ -in. round iron, as shown at B, forging it to conform to the old part. Then it was heated and fitted into the yoke arms C, so that it would work in the grooved pinion.—G. G. McVicker, North Bend, Neb.

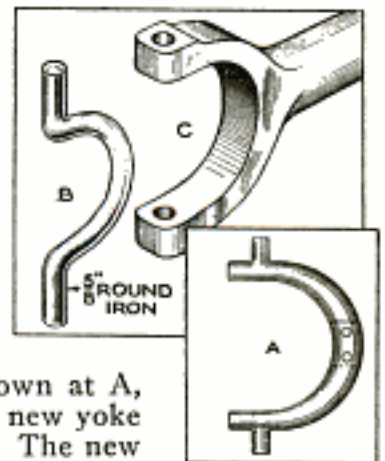



### Pneumatic Opener for Garage Doors

Heavy garage doors can be opened and closed by a mere twist of the wrist and

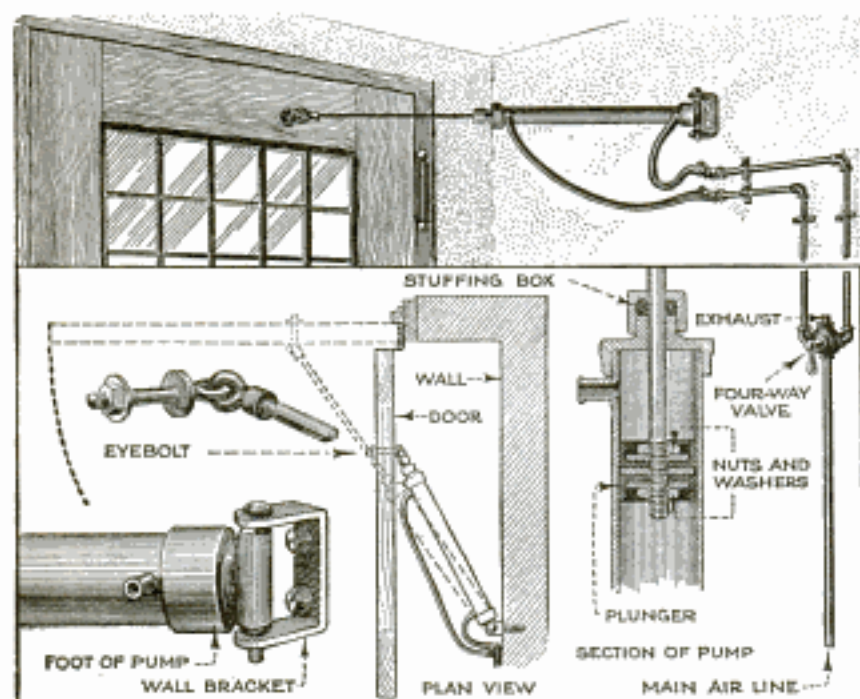

Arrangement for Opening and Closing Heavy Garage Doors by Means of a Pneumatic Cylinder Employing the Garage Compressed-Air Supply: A Four-Way Valve Makes It Possible to Control the Doors from a Distance

at a considerable distance away. Use is made of a pneumatic cylinder, for which the ordinary compressed-air supply of the shop will be sufficient. A single-cylinder

automobile pump can be modified for the purpose, or, if this is not sufficiently heavy or long enough, a cylinder can be made up easily from a piece of iron pipe and the proper fittings. Air outlets must be provided at each end of the cylinder, and double piston leathers are required; also, a stuffing box, made from a pipe bushing and cap, must be provided, to prevent escape of air through the piston-rod opening. One end of the cylinder is hinged to the wall, and the end of the piston rod is fastened to the door with an eyebolt, as shown. Hose connections are used for joining the cylinder to the air-supply pipes. For controlling the action of the cylinder, a four-way valve is necessary. A turn of the valve handle admits air to either side of the piston, depending on whether the door is to be opened or closed. The resistance caused in forcing the dead air on the opposite side of the piston through the exhaust allows the door to be opened or closed gradually.

### Simple Washer Cutter

A simple tool for cutting leather or fiber washers, or small gaskets, is shown in the drawing.

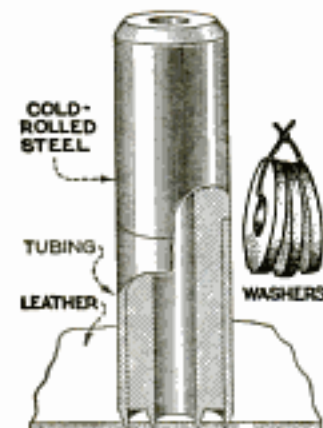

The outer cutter is made from a piece of seamless-steel tubing, and the inner one of cold-rolled steel. To cut a washer, a piece of leather is laid on the end grain of a block of wood, the punch placed in position, and, while holding the outer cutter down, the inner one is lifted a few inches, then brought down sharply. This drives both cutters through the leather, making the washer complete in one blow. The disks in the center are forced up through the hole in the punch.

### Breaking Out Tight Ball Races

In some of the cheaper makes of automobiles the old cup-and-cone type of ball bearings

is used in the front wheels, and if these bearings are run to destruction, it will be found that the outer races will spin up so tightly in their cavity that, when one attempts to remove them, the

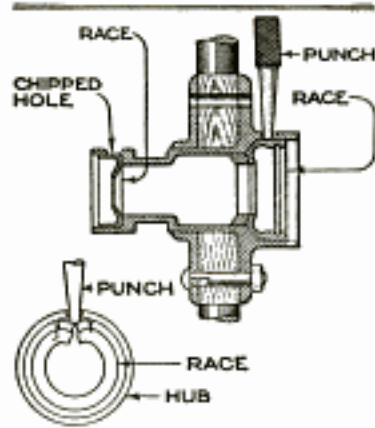

flange will break without in the least affecting the position of the races.

As there is no other way of removing the sticking part, drastic measures must be employed, and the drawing shows how the "seized" races may be broken out.



A sharp cape chisel, or a drill, is used to make a hole on either side of the hub, and as this is made of malleable iron, it is easily done. A stout punch is then inserted through the hole, and a few hard blows from a heavy hammer will suffice to break the race. The holes in the hub do not weaken it any, and as the race covers the inside, water cannot enter.

### Fixture for Working on Flywheel Gears

Frequently, when working on the toothed rim of the flywheel from an automobile engine, there is considerable fitting to be done. As the work is too large and heavy to be held safely in a vise, some means must be provided for holding the flywheel, if the work is to be

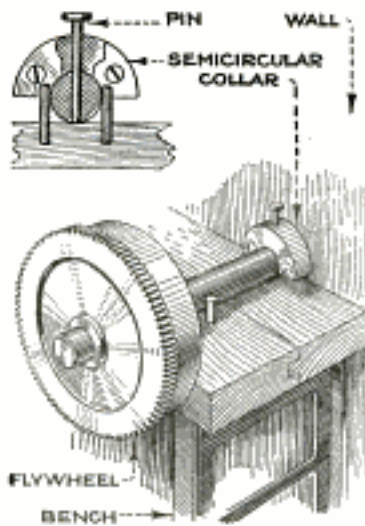

done conveniently and in a minimum of time.

The drawing shows a fixture that has been used with satisfactory results in one repair shop. The wheel is supported beyond the edge of the workbench by a piece of shafting. A semi-

circular steel collar is permanently fastened to the wall back of the bench. The piece of shafting that forms the support for the work is prevented from pulling out of the collar by a pin inserted through holes drilled in both pieces. Pins are inserted through holes in the bench on either side of the shaft, and prevent it from moving. When not in use, the fixture, with the exception of the collar, is removed, leaving the bench clear for other work.—E. N. Davey, Montreal, Can.

### Making Shaper Cut on Draw

In order to shape work accurately to layout lines marked on the front, the special shaper head shown in the drawing was made and successfully used. The object was to have the shaper make the cut on the draw instead of on the forward stroke; as no burr or ragged edge, thrown up by the tool, will then appear on the front of the work, it is much easier to

work close to the lines. The attachment is in the form of a casting which has the general appearance of the regular shaper

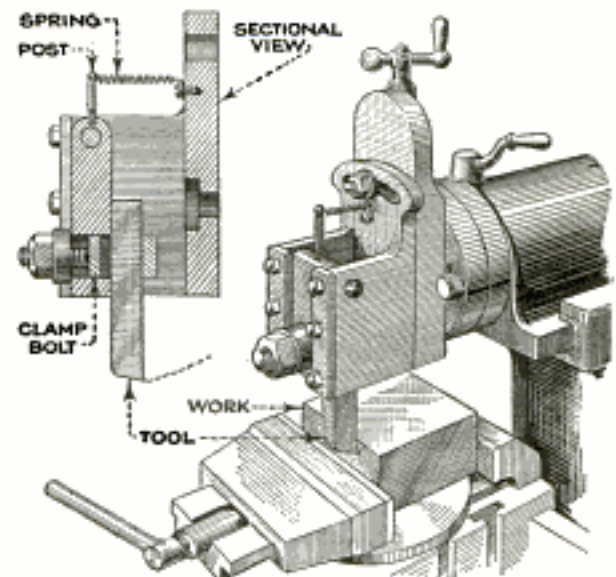

A Fixture for the Shaper, to Make It Cut on the Draw Stroke, Allows the Mechanic to Work Accurately to Layout Lines with Greater Ease

head, except that the sides are longer, to make room for the toolpost clapper box, which is, of course, reversed. A special toolpost is made which fits the opening in the apron and is tightened by a nut on the outside. A light spring is attached to the top of the box, to bring the tool down quickly at the end of the outward stroke of the ram. The back of the box rests against two plates fastened to the casting with capscrews. An arrangement of this kind is particularly handy for punch and die work.

### Preventing Damage to Arbors

A handy attachment for the arbor press that prevents arbors from falling on a hard floor and thus becoming nicked and burred, is shown in the drawing. Two specially made eyebolts are screwed into the arbor-press bed in line with the ram. The lower ring is filled with melted babbitt, and the upper one prevents the arbor from falling onto the floor.—Geo. H. Sloane, W. Bridgewater, Mass.

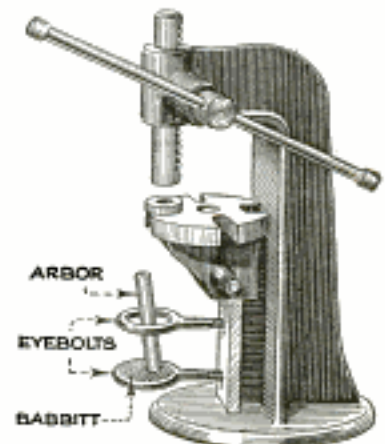



### Handy Live-Stock Loader

Live-stock raisers and farmers will find the loader illustrated a very convenient one. It can be wheeled to any pen or



A Substantial Homemade Stock Loader That can be Moved to Any Point on the Farm

yard on the farm, thus making it unnecessary to provide permanent loaders at each point.

The loader should be from 30 to 40 in. wide, so that a large cow or bull can pass through it. Two-inch planks, 8 to 10 in. wide, should be used for the bottom of the runway, the lower ends being beveled parallel with the ground surface; 2 by 4-in. material for the framework, and common 1-in. boarding for the sides. The axle brackets should be well braced to the front legs, and a crosspiece put between the legs. A hook or clevis can be attached to this so that a horse can be hitched to the loader.

### Chip Cleaner for Small Wood-Turning Lathe

The use of a blower on a small foot-operated lathe being impracticable, the simple method shown in the illustration is applied by a mechanic in a small shop for cleaning the chips from the toolpost and bed. A piece of leather is slit, as illustrated, and pushed over the live

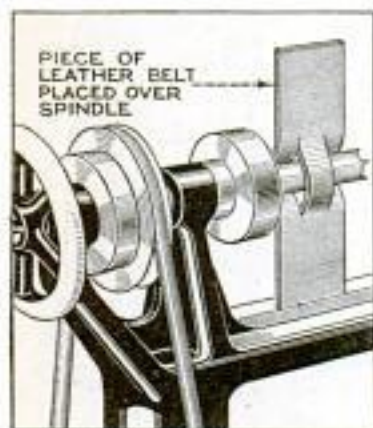

spindle. When rotating, this will produce a current of air sufficient to blow the chips aside. As the cleaner is flexible, there is no danger in its use.

### Marking Holes for Drilling

When laying out holes in one part of a machine, using as a template holes already drilled in another part, as must often be done in assembling, it is sometimes impossible to use a scribe, as, for example, when the holes already drilled are "blind." In such cases, the following method will prove of value: The holes already drilled are filled with powdered chalk, the upper part placed in position, and lightly tapped with a hammer. This leaves very distinct outlines of the holes, marked in chalk, on the underside of the piece, which is then prick-punched and drilled in the usual manner.—J. F. Knorr, Brooklawn, N. J.

### A Novel Machine-Wrench Holder

Much annoyance and lost time are caused by failure to return borrowed wrenches belonging to some particular machine. This habit, unless checked, becomes chronic, and one finds, in shops afflicted with the borrowing habit, a deplorable condition, with machine operators continually inquiring the whereabouts of wrenches required at the moment. All this may be avoided by a little supervision, and the use of a holder that practically compels the operator to keep the wrenches in an orderly manner. Sheet metal, about  $\frac{1}{8}$  in. thick, is required for the body of the holder.

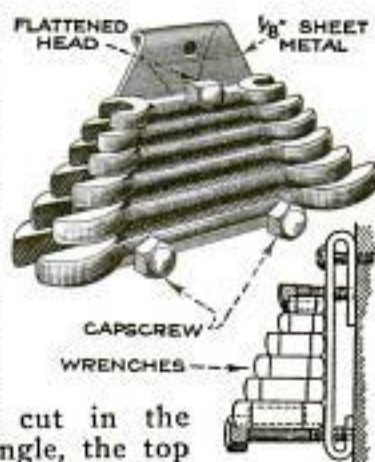

It is cut in the form of a triangle, the top and bottom ends being turned back, as shown. Two holes are drilled and tapped in the bottom, and one at the top, to take hexagon-headed screws, and a plain hole, at the top, above the tapped one. The distance between the lower and upper tapped holes is determined by the total thickness of all the wrenches. These are piled as shown, the largest at the bottom. The upper screw head is filed away on one side, approximately flush with the threads, so that the wrenches can be removed when this side is down, but are securely locked in place when it is turned up. If one wrench is missing, it is, of course, impossible to



tighten the screw on the others to keep them in place. The holder is fastened at a suitable place on the machine, preferably near the tool tray, by a screw through the upper hole in the body.—Harry Moore, Montreal, Can.

### Proofing Engravings Easily

Advertising men and business firms can take proofs of their engravings or "cuts" quickly and easily without a proof press. It is only necessary to place a sheet of paper on a piece of blotting paper, or similar material, with the carbon surface of a sheet of carbon paper in contact



with the paper. The cut, from which the proof is to be made, is laid on the back of the carbon paper and given several

sharp, firm blows with a mallet to transfer the design to the paper. This method, of course, is most effective with line cuts, but even with halftones, a better proof is obtained than can be obtained by the usual stamp-pad method.—Herbert Lang, Cincinnati, Ohio.

### An Adjustable Socket Wrench

A handy socket wrench that will fit several different sizes of nuts and bolt heads can be

easily made from a piece of flat steel. The flat stock is bent over to form the main part of the wrench, and an opening, of the shape shown, is cut through the end. Between the two parts

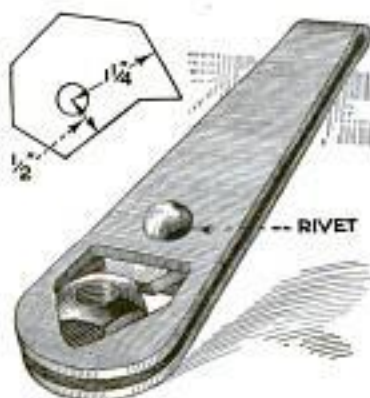

of the wrench a piece of flat metal, cut to form a cam, as shown at the upper left, is riveted, so that, when turned, it will adapt the tool to nuts of different sizes. Each of the sides of the cam is at a different distance from the rivet hole. In use, two sides of the nut or screw head bear against the opening in the wrench, and a third against one face of the cam.

### A Simple Farm Gong

The illustration shows the very simple gong in use on a farm to call the work-

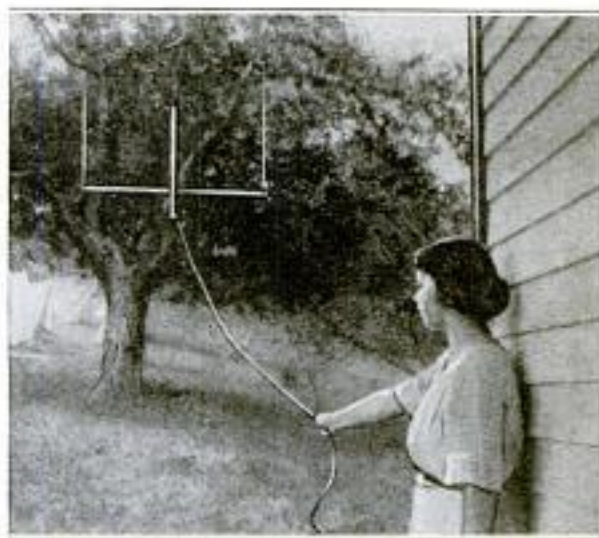

Two Pieces of Iron Pipe, Suspended from the Branches of a Tree, Make an Excellent Farm Gong

ers from the fields. It consists of two pieces of 3-in. iron pipe, 4 or 5 ft. long. One piece is suspended horizontally, by two wires, from the branches of a tree a short distance from the porch, while the other is hung vertically, at the center of the first.

A cord, fastened to the bottom of the vertical pipe, runs to the porch, and when this cord is pulled and released, a loud tone is produced that can be heard clearly for over a mile. The pipes are painted with bronze paint, to prevent rusting.

### Tongs for Placing Bolts

A practical tool for placing bolts in places that are hard to reach can be made from an old pair of blacksmith's tongs. The tips of the tongs are drawn out and bent as shown, to fit closely under and around the head of the bolt.—H. J. Engel, New Braunfels, Texas.





### A Truck-Wheel Lock

The device shown in the illustration is designed to prevent four-wheeled trucks from rolling off platforms. It is easily

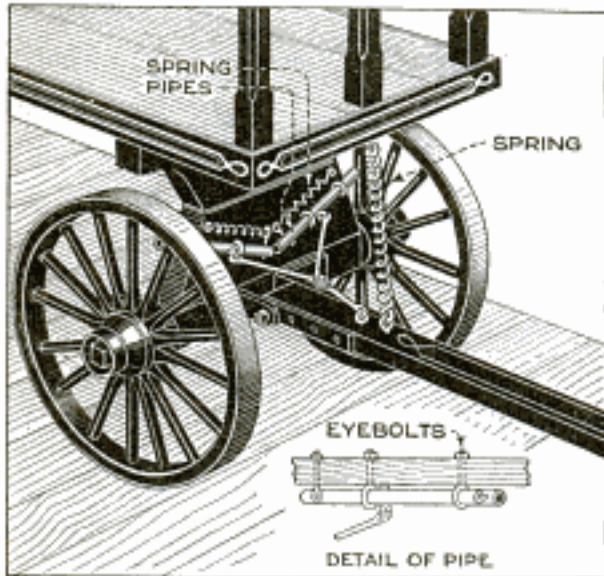

A Simple and Positive Method of Locking the Wheels of Baggage Trucks, to Prevent Them from Rolling off Platforms

made, and has proved much more convenient than the common hook and chain. The locking members are two short lengths of pipe, held at an angle on the front of the axle bracket by eyebolts, in which they slide. The pipes are of such a length that, when the inner ends touch, the outer ends clear the spokes by about 1 in. Riveted through each pipe are two eyebolts, as shown. To one eyebolt is attached a spring, the other end of which is fastened to the angle bracket.

The pipes are actuated by short iron rods, which hook onto the other eyebolts, and are jointed, as shown, to a third rod attached to the truck tongue. When the tongue is raised, the pipes are thrust between the wheel spokes, thus locking the wagon. A strong coil spring may be fastened to the top of the tongue and the underside of the platform, as shown. This will pull the tongue up as soon as it is released, making it impossible to forget to lock the truck.—J. B. Butler, Winchester, Ky.

### Machining and Finishing Fiber

Hard fiber is, in general, a hornlike material of great strength and endurance. It is made from a cotton or linen base and is practically pure cellulose that has undergone a molecular change and has been condensed to a fraction of its original volume. It may be worked with the

usual metal-working tools, and turned, milled, drilled or tapped with more speed than metal. Owing to its elasticity, however, it yields somewhat to the tool, causing friction beyond the cutting edge which very quickly heats the tool; therefore very hard tools with good clearance are necessary, diamond-pointed tools being best for turning. Oil may be used to keep the tools cool and does no harm to the fiber. Fiber may be readily sawed with a woodworkers' band saw, but circular saws heat quickly, and must be of special design. Under pressure, the better grades of fiber will flow to a considerable extent, especially when heated to 300° F., and may be embossed and pressed into many shapes.

Owing to the tendency of fiber to shrink and swell with changes in temperature and humidity, one cannot expect extreme accuracy in the size of the finished pieces. For instance, a washer or hole may be accurately turned to 2 in. in diameter and in a day's time it may be .005 or .01 in. over or under the original size. In designing fiber parts, therefore, there must be an allowance, for machine finish, of at least .01 in., and, for sawed or rolled plates, from  $\frac{1}{64}$  to  $\frac{1}{32}$  in. Before finishing parts in which accuracy is important, the fiber should be dried for several hours at a temperature of less than 200° F., and covered with lacquer immediately after finishing. Fiber also warps under atmospheric changes, and cutting away large sections from one side of a piece has a similar effect. In many cases this warping is serious, and must be considered in designing.

Oils, paraffin, gasoline, and similar products have no effect upon fiber, and cannot be made to penetrate it. Water, however, when in contact with fiber for some time, is absorbed and causes it to swell. Upon drying, the fiber resumes its former density. Different qualities, of course, will differ widely in this respect. When exposed to moist air for 24 hours, fiber increases in weight from one to five per cent. Acids and salts soluble in water will penetrate fiber and frequently injure or destroy the texture. Fiber appears to increase in strength with age. Many attempts have been made to waterproof fiber, but without practical results. A surface coating of varnish or lacquer offers only temporary protection.

Fiber under prolonged dry heat, at 300° F., will lose some of its strength, and will begin to disintegrate at 400° F., to smoke at 500° F., and burst into flame at a temperature 50° higher.





## Homemade Greeting Cards

By W. C. HARRIS

**I**F one wishes to get away from hackneyed printed or engraved greeting cards during the holiday season, it is a comparatively simple matter to make most attractive cards by photography.

The first step, if elaborate cards are to be made, is to build up the "dummy." The negative, or a finished print, is laid on a sheet of drawing paper and a layout of the lettering, etc.,

is made around it. The lettering, monograms, etc., that are to appear on the design may be drawn on separate pieces, and the whole arranged to best advantage around the photo. When the desired arrangement is completed, the loose parts are inked in, stuck down on the bristol board together with the print, and a negative made of the whole layout. This is used to print the greeting



Left: Greeting Card with White Letters, Made by In on Enlargement. Right: Letters Printed in Black by Double Printing. Below: Combining Two Films. Top: Letters Inked. Below: A "Dummy," from Which Large-Sized Cards are Made



cards. If the lettering is to appear on the print itself, an enlargement, of reasonable size, is made on a good smooth-finish paper, upon which the lettering is inked, making the sentiment expressed suit the picture used, as shown in the illustrations. From this, a copy negative, the exact size of the desired card, is taken, and contact prints made. These should be mounted on rough cover paper, contrasting in color with the print.

The lettering may be printed in white through some thin part of the original negative, by making a positive of the lettering, on commercial film, and then laying it over the picture negative so that the lettering comes in the proper position. It is necessary to make the posi-

tive film larger than the negative, so that no edge may show in the finished print, and to keep it all clear except for the letters, by masking the negative from which it is printed. The letter positive and picture negative are bound together, and the cards printed through both.

It is best to make the card prints on double-weight, linen-finish buff or white paper, and it is well to make the prints to suit a particular size of envelope, as it is usually easier to do this than to find an envelope to suit the print.

Should any difficulty be encountered in making the prints stay flat, it may be overcome by dampening the backs, and putting them between blotters, under a weight, and allowing them to dry.

### Ventilating Doors for Garage

The garage doors shown in the illustration are somewhat unusual in that a lattice gate is hinged to the edge of one



A Lattice Gate, Hinged to One Garage Door and Hooked to the Other, Keeps Undesirables Away When the Owner is Working on the Car

door, and, when the doors are opened, may be hooked to the edge of the other.

This gate is made of wood strips, set in a light frame at an angle of 45°. When the doors are shut, or opened full, the gate is folded back against the door to which it is hinged. This arrangement admits plenty of light and air while working on the car, and at the same time prevents the entrance of unwelcome visitors.

### Renewing a Radio Crystal

When the galena crystal of a small radio set has become dull and dirty, so that it is almost impossible to find a sensitive spot, a simple but very effective method can be used to renew it.

The mounted crystal should be held over a flame, in an old spoon, until the

metal begins to run. The crystal can then be turned over with a piece of wire, thus exposing an entirely new sensitive area. A mold can be used to keep the melted metal in the original shape and size, so that it will fit in the detector cup. Care should be taken not to heat the metal too much beyond the melting point, as this will impair the sensitiveness of the crystal.

### Improving the Hand Drill Press

The photograph shows a method by which a small hand drill press can be more conveniently operated. With the

drill press as bought, a clamp is provided for holding the work, as it is necessary to use both hands, one to turn the crank and the other to feed the drill by pressure on the lever. By drilling a hole in the feed lever and attaching a strap, or chain, running from the lever to a pedal on the floor, the necessary pressure of the drill against the work is obtained by pressing

on the pedal. This makes it unnecessary to clamp the work, except in special cases, and leaves one hand free to hold it while the other is used to turn the drill.—C. R. Gains, Colfax, Ia.

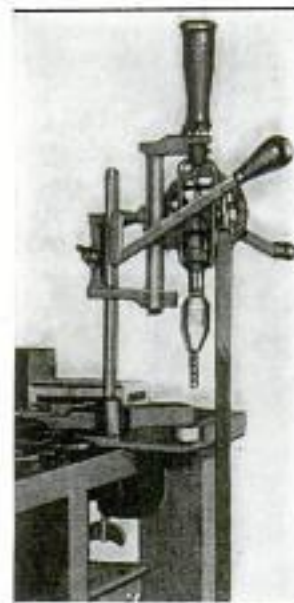



### Keeping Sewing-Machine Belts from Slipping

Sewing-machine belts, especially new ones, occasionally will slip off the upper pulley, even though the belt has been properly tightened. This can easily be overcome by stretching a flat rubber band, about  $\frac{1}{8}$  in. wide and  $2\frac{1}{2}$  in. long, around the top pulley, and laying it in the groove. After replacing the belt, the slipping will be found to be entirely eliminated, owing to the strong adhesion between the rubber band and the belt.

### A Chest for Storing Tires

Every owner of an automobile has felt the need of a safe and convenient place for storing tires not in use, as they are



injured by oil, heat, and light, as well as by standing under weight continuously. Many owners lay their cars up for the winter, and when this is done, the tires should be removed from the wheels, and stored in a chest of the design shown, in which they can be suspended. It should be made large enough to provide ample space for five or six tires. The lumber used in constructing it is tongued-and-grooved stock, to make the box light-tight. A crossbar, longer than the box, slides through slots cut at each end, and can be raised by small pieces of wood, as shown, so that the tires can be lifted to clear the bottom of the box. Small bolts, screwed to the wooden pieces, fit into holes drilled in the crossbar, to hold it steady. A padlock should be provided to protect the tires against theft.—M. V. Tessier, Nyack, New York.

### Mousetrap Trips Camera Shutter

In photographing wild birds and animals, it will be found that a mousetrap can be used to advantage for automatically releasing the camera shutter, when the object to be photographed is at the proper focal distance from the lens and directly in line with it.

As shown in the photograph, the

mousetrap is attached to the bellows track by a clip. A strong thread is attached to the shutter trigger and mousetrap, and is adjusted so that it is just tight



A Common Mousetrap Attached to a Camera may be Used to Trip the Shutter Automatically When Photographing Wild Birds and Animals

enough to snap the shutter when the trap is sprung. Another string is attached to the bait pan or hook, and, after being passed around a pin on the trap base, is led to the nest or lure. Only a slight movement of the string is required to spring the trap and release the shutter.

With a shutter speed of  $\frac{1}{50}$  second, and the lens open at U. S. 4, the negative will receive ample exposure in the shade.—W. W. Baumeister, Cambridge, Mass.

### Making Icebox More Efficient

A simple and effective method of saving ice in the household refrigerator is shown in the drawing. A rubber tube is fitted over the drip pipe, and the lower end is placed in a cup set in the drip pan. The cup is always kept full, and there is thus a water seal at all times on the drip pipe, preventing warm air from ascending the latter and melting the ice. Before this device was used,



we consumed an average of 175 lb. of ice per week. Since fitting it, this has dropped to 125 lb. per week.—W. S. Wilson, Woodlawn, Pa.



### Handy Oil Gauge for Light Car

Keeping the proper amount of oil in the crankcase at all times becomes a very

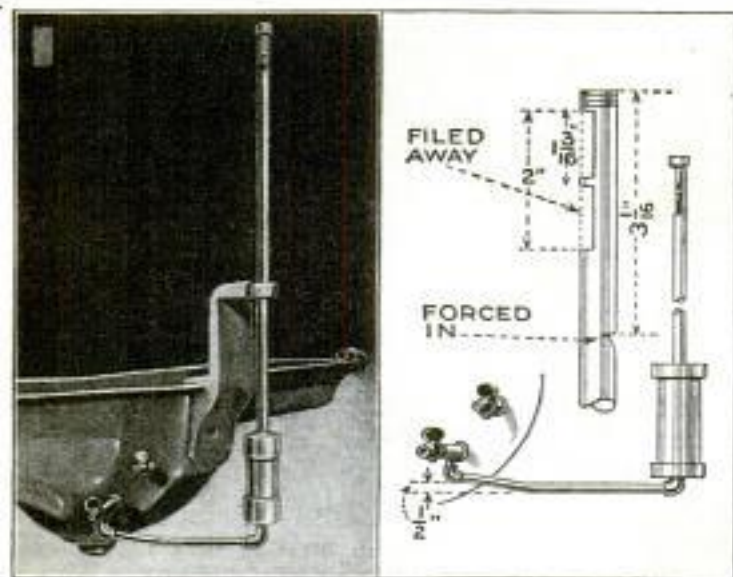

A Handy Oil Gauge for a Popular Car, Mounted on the Dash, Reminds the Driver of the Amount of Oil in the Crankcase

simple matter when an oil gauge, mounted on the dash in full view of the driver, is used. The gauge shown in the drawing, which can be made at very small cost, has been found to be accurate and substantial, and has given entire satisfaction.

A piece of  $\frac{1}{4}$ -in. brass pipe, about 20 in. long, threaded on both ends, is cut and filed as shown. A portion of pipe below the small cut is bent in to hold a glass tube which must fit exactly in the bore. This cut also serves as an air vent to allow the oil in the gauge to rise to the same height as that in the crankcase.

A  $1\frac{1}{4}$ -in. nipple,  $3\frac{1}{2}$  in. long, which is used as a float chamber, is fitted with two caps, each being bored and tapped in the center, the top one to receive the brass pipe and the lower one a  $\frac{1}{8}$ -in. elbow. Then a length of  $\frac{1}{8}$ -in. pipe, a tee, and another elbow are used to connect the float chamber to the crankcase at the lower-petcock hole; the cock is removed and screwed into the end of the tee. All joints should be made oil-tight, when the gauge is finally assembled, by applying red lead mixed in linseed oil, to the threads. The iron pipe must be bent approximately as shown, so that the lower cap of the float chamber is slightly below the petcock and just in front of the right crankcase arm. The brass pipe must be perfectly vertical and close against the dash, to which it is attached with pipe clips. All parts of the gauge should be fastened securely, so as to prevent undue vibration.

A piece of No. 12 aluminum wire, 2 ft. long, is taken, and one end fastened securely into the center of a cork,  $1\frac{1}{8}$  in. in diameter. After the cork has been well shellacked and dried, it is placed in the float chamber so that the wire extends vertically in the brass pipe. Oil can then be poured into the crankcase until it rises high enough in the float chamber to just raise the cork. The top of the wire should now be cut off so that  $\frac{1}{4}$  in. will show at the bottom of the glass tube. This is to indicate the lowest safe oil level. The end of the wire can be colored with some bright paint. When this colored portion is near the center of the glass, it indicates that the correct amount of oil is in the crankcase, and when it reaches the top of the glass, shows that the oil has reached the level of the upper petcock. The oil level should never be allowed to get below

the middle point.—Edmund D. Haigler, Watertown, Mass.

### Fence Wire as Concrete Reinforcement

Finding it necessary to provide a safe place for his gasoline and coal-oil tanks, so as not to increase the rate of insurance on adjoining property, a progressive Iowa farmer used woven fence wire for reinforcement in the concrete walls and roof of the structure, and found this to be just as satisfactory as the much more expensive reinforcement that he had used previously in similar work. The strength of the concrete reinforced in this way is shown by the fact that there is not a crack in the roof, although it was made over 15 years ago, and is only 3 in. thick.

A water tank, eight years old, similarly reinforced with a liberal quantity of woven wire and old iron rods, also has proved to be very strong, as not a crack can be seen in it, while other concrete tanks, built later, and not reinforced in this way, are cracked and useless.

The crumbling stone wall of one of the barns was renewed in a similar manner. A trench was dug outside of the old wall, and a form, made of boards, was built, as high as the wall and 3 in. from it. After having inserted three thicknesses of woven wire, on edge, into the form, it was filled with thin concrete. The top of the concrete was then beveled away so as to carry off the rain.—Ed. Henderson, Lake Mills, Ia.



materials from: Bell & Howell  
1803 LaSalle Ave. Chicago



Williams, Brown & Eadie  
918 Chestnut, Philadelphia, Pa.  
**A HOMEMADE  
MOTION-PICTURE  
CAMERA**

Case Camera Co  
By R.E. Best  
109 N. Dearborn

Chicago Great Works  
1117 Canal Chicago  
Case - 700 N. Dearborn

**T**HE making of a moving-picture camera and projecting apparatus that will do work quite favorably comparable with that of high-priced machines, is not so difficult an undertaking as might at first appear, nor does it involve great expense. By the use of ordinary tools, the expenditure of a little time, and by careful work, a very satisfactory piece of apparatus may be produced.

The camera here described uses standard motion-picture film, and will contain 100 ft. at one loading. The magazine can be removed and the camera itself used to project the pictures, which will be found to be practically as satisfactory as the use of a separate projector. The dimensions are taken from a camera made by the author;

a slight variation may in some cases be necessary, depending on the material used, and the focal length of the lens.

Standard motion-picture film is 1 3/8 in. wide, and perforated on both edges. The pictures are 1 by 3/4 in., and there are 16 pictures to the foot. The film must be moved past the lens with an intermittent motion at the rate of a foot a second. A rotary shutter is provided to cut off the light when the film is moving, in order to avoid blurring the pictures. There are several ways in which this intermittent motion may be produced, but

the one described will be found the most practical for amateur construction.

The lens can be borrowed from an ordinary camera. Since the pictures are of such small size, the lens must be of short focal length, preferably from 2 1/4 to 4 in. A combination of two lenses of 6 or 7-in. focal length will give the desired result. The box is best made of

maple about 1/4 in. thick, although any thin close-grained boards will do. The joints should be mortised, as shown in the illustrations, to prevent any possibility of light leakage.

The gears can be obtained for a modest sum from any house selling standard gears. The sprockets can be made by one who has access to a lathe, but it is

better to buy them from a motion-picture supply house. The other materials can be obtained from any hardware dealer.

The following materials will be needed:

- 1 7/8-in. gear, 32-pitch.
- 2 3-in. gears, 32-pitch.
- 1 3/4-in. gear, 32-pitch.
- 1 pair bevel gears, 1/2 by 2 in.; that is, ratio 1 to 4.
- 2 standard motion-picture sprockets, 16-tooth, with idlers.
- 1 3/4-in. gear, 48-pitch.
- 1 rack, 6 in. long, 3/8 in. square, 48-pitch.
- 1 bushing, 7/16-in. inner, and 3/8-in. outer diameter.
- 3 lb. babbitt.
- Brass rod, 7/16 in., 1/4 in., 3/16 in., and 3/8 in. in diameter.

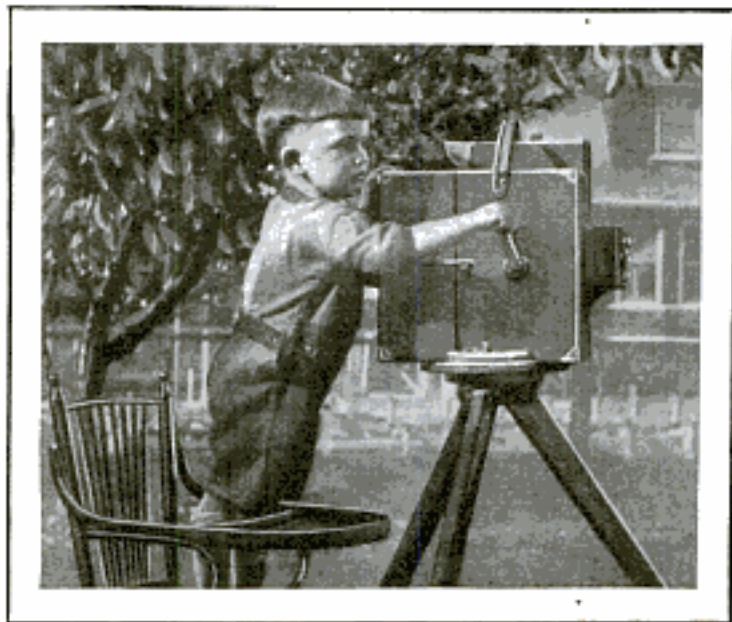

The Finished Camera Set Up and in Operation: Note the Heavy Tripod, Which Is Necessary to Insure Steady, Even Pictures

Albaugh - Leaver & Lake Chicago  
972 N. Lake

Albaugh - Leaver & Lake Chicago  
972 N. Lake  
Copyrighted material  
1117 Canal Chicago



First make the box, 12 by 7 in. inside dimensions, the front portion containing the mechanism to be  $7\frac{3}{4}$  in. deep and the rear portion, or magazine, 5 in. deep. One side of the front portion should extend 2 in. above the top of the box to form one side of the finder. A groove,  $\frac{1}{8}$  in. deep and  $\frac{1}{2}$  in. wide, should be cut in the top and bottom of the front,  $2\frac{1}{4}$  in. from the right side, looking from the back, before the box is assembled, to allow the plate that holds the gears, sprockets, etc., to slip in and out. A rectangular hole,  $3\frac{1}{2}$  by  $4\frac{1}{8}$  in., is cut in the front to allow the focusing device to be set in, and an opening for the inspection door in the left side. All joints should be glued and made light-tight. The rear portion should have a  $\frac{3}{4}$ -in. strip set around the inside to project about  $\frac{1}{4}$  in., so that when the two parts of the box are brought together, this strip will come inside the front and back portions, and make the joint light-tight. It would be well to face the edge of the box with felt.

Set the lens in the front of a box, constructed of  $\frac{1}{4}$ -in. material, 3 by  $3\frac{5}{8}$  in. by  $1\frac{1}{2}$  in. in outside dimensions. The bottom edge of this box should extend about  $\frac{1}{8}$  in. beyond the sides. A piece of the 48-pitch rack,  $\frac{1}{8}$  in. square and  $1\frac{1}{2}$  in. long, should be set flush in the center of the bottom. This box should slide quite easily in a  $3\frac{1}{2}$  by  $3\frac{1}{2}$  by  $4\frac{1}{8}$ -in. box which is set in the front of the camera. The base of this outside box is bored in the center to take the pinion, and a hole drilled at right angles to this for the pinion shaft; grooves are also cut in the sides to fit the projecting bottom of the box holding the lens. The box should have a block,  $2\frac{3}{4}$  by  $2\frac{1}{4}$  by  $1\frac{1}{4}$  in., bored with a hole somewhat larger than the outside diameter of the lens, fastened to the inside of the back. This block should be fitted so that the box containing the lens will not bind in sliding back and forth. The back of the outside box should have a hole cut in it, of sufficient size to let the light from the lens fall on the film in the film gate, yet small enough to keep the light from spreading over other parts of the camera.

The pinion can be made by soldering a  $\frac{1}{4}$ -in., 48-pitch gear to one end of a short piece of  $\frac{1}{8}$ -in. brass rod. If a knurled brass button for the other end cannot be obtained, a button can easily be cast from babbitt.

This arrangement will be found to permit the lens to move quite freely in focusing and will admit no light to the camera except through the lens. When the cam-

era is complete, the proper position of the lens for objects at various distances can be determined by trial, and the positions marked.

The gears, sprockets, film gate, striker, shutter, etc., are all supported by one piece or plate which can be removed from the box as a unit. Make this plate of  $\frac{1}{2}$ -in. hardwood,  $12\frac{1}{4}$  by 6 in. Fit it to slide in the grooves in the camera box, where it can be fastened in place with screws when the mechanism is finished. Another plate of the same material,  $11\frac{3}{4}$  by 6 in., should be fastened to the first by means of blocks, separating the two plates  $1\frac{5}{8}$  in. The blocks must be located carefully, to avoid interference with the gears, and held in place by screws. Mark out the location of the four shafts, and bore holes in both plates,  $\frac{1}{2}$  in. or larger in diameter. Make bearings of babbitt or heavy brass, bored to the size of the shaft and shaped so they can be fastened to the wooden plates by means of screws. These bearings can be moved until the gears mesh properly before they are permanently fastened in place.

The shaft to which the crank is attached should be of  $\frac{5}{16}$ -in. brass rod. This shaft carries the 6-in. gear and the 2-in. bevel gear, and extends outside the camera to take the crank.

The crank should be turned at the rate of two turns a second, and, as the sprockets have 16 teeth, representing 3 in. of film, or four pictures to the turn, the sprocket shafts should turn twice as fast as the crankshaft in order to feed the film at the rate of 16 pictures a second. These two shafts are  $\frac{1}{4}$ -in. brass rod and carry 3-in. gears. The lower shaft should have a 2-in. pulley placed between the sprocket and the bearing plate to drive a round belt running to the take-up reel. This pulley can be easily made of two circular pieces of cigar-box wood, glued together and grooved.

A  $\frac{3}{16}$ -in. hole should be bored in the edge of the bearing plate for the shutter shaft, and the plate must be cut away in the center to allow the  $\frac{1}{2}$ -in. bevel gear attached to this shaft to mesh with the 2-in. bevel gear on the crankshaft. The hubs of all the gears should be fitted with setscrews, and it is well to file flats on the shafts under these screws to prevent slipping.

The idlers should be attached to strips of heavy sheet brass and placed against the sprockets in the position shown. The strips should be pivoted at one end on a screw, and held in place with small coil springs.



The shutter should be cut from a 4-in. disk of sheet brass, bored with a  $\frac{1}{8}$ -in. hole in the center and soldered to the end of the shaft, which should be shouldered to fit the hole. It must be designed in such a manner that it will shut off the

small pieces to the back. It is quite important that the wheel be balanced to prevent vibration, which produces unsteady pictures.

The film must be held stationary and perfectly flat when the exposure is made.

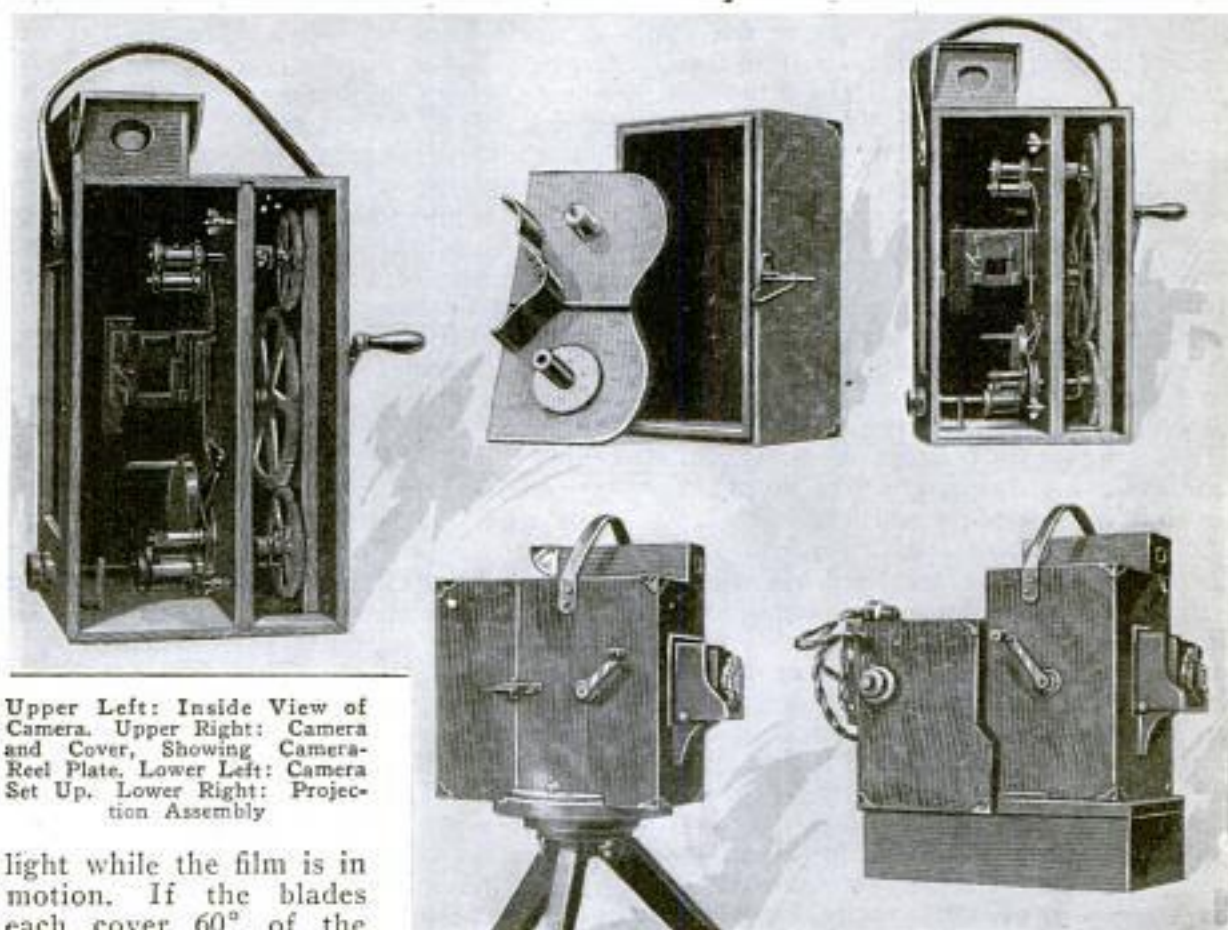

Upper Left: Inside View of Camera. Upper Right: Camera and Cover, Showing Camera-Reel Plate. Lower Left: Camera Set Up. Lower Right: Projection Assembly

light while the film is in motion. If the blades each cover  $60^\circ$  of the circle they will be found to be sufficiently large. The shutter has two blades and consequently should turn four times as fast as the crankshaft.

The striker serves not only to pull the film down through the film gate as it is taken up by the lower sprocket, but acts also as a flywheel. For this reason it should be heavy and well-balanced. It should be  $2\frac{3}{4}$  in. in diameter by  $\frac{3}{8}$  in. thick, and may be cast from babbitt in a wooden mold (do not use pine or any wood containing pitch for molds). The arm that comes in contact with the film may be made of sheet brass, and soldered to the edge of the wheel. It should be filed away slightly in the middle for a distance of 1 in. so that it will only come in contact with the edges of the film and not scratch the pictures. After the striker has been bored and fitted to the end of its  $\frac{3}{16}$ -in. shaft, it should be trued up on a lathe if one is available, and carefully balanced by boring holes or soldering

It must also be allowed to move quite easily when pulled down by the striker. This is done by means of the film-gate assembly, which consists of three parts: the film gate, cast in babbitt, the pressure plate, and the cover, made of heavy sheet brass. The film gate is fastened rigidly to the main bearing plate by means of screws; the pressure plate holds the film against it and is allowed to give slightly as the film moves through. One edge of the cover fits into a groove or notch in the film gate, and the other edge is held down by means of a thumbscrew.

It requires a little ingenuity to build the mold to cast the film gate, but by combining blocks of wood of the proper size and shape, a mold can be built up which will make a very nice casting. When the casting is finished, smooth it up with a file and cut a groove in the base with a hacksaw for the edge of the cover. The surface around the "frame"



and along the edges of the passageway for the film must be carefully smoothed, as these parts come in contact with the film, which is very easily scratched. The rectangular hole, or frame, should be 1 in. by a little less than  $\frac{3}{4}$  in., to avoid any overlapping of pictures.

The pressure plate should fit quite loosely in the film passageway in the film gate. Its upper edge is curved to avoid scratching the film, and it is fitted with four short posts of  $\frac{1}{8}$ -in. brass rod, which reach through the cover and come in contact with flat springs. These springs keep the pressure plate tightly against the film, yet allow it to give when uneven parts of the film, such as splices, come through. The frame for the picture is cut through both the cover and pressure plate as well as the film gate, to allow the light to go through in projecting the pictures. The side of the pressure plate which comes in contact with the film should be highly polished to avoid any possibility of scratching the film.

The cover consists of a piece of sheet brass to which are attached the springs that hold the pressure plate against the film. These springs are pieces of watch spring, supported in the center and inclosed at each end. The center supports can be cut from sheet brass and soldered in place. The little boxes inclosing the ends of the springs can also be made of sheet brass, and soldered to the cover. This arrangement will be found to hold the springs in their proper place without the necessity of boring the hard steel. The springs must be bent until they put the proper pressure on the film; this will have to be determined by experiment.

Build a box, 2 by  $2\frac{1}{2}$  by 8 in. inside dimensions, on top of the main camera box, to inclose the finder. Fasten a small double-convex lens of 5 or 6-in. focal length in the front of this finder, and leave a hole, about 1 in. in diameter, behind the lens to admit light. A lens suitable for this purpose can be obtained from any optician or may be taken from an old bicycle lamp or flashlight. The screen for the finder can be made by removing the emulsion from a piece of film and roughening it with fine sandpaper. It should be placed in the finder at the focal distance of the lens. When the camera is all complete and assembled, a black border should be painted on the screen to allow only those parts of the image to show that are thrown on the film in the frame by the main lens. The back of the finder should be inclosed to shut out the light, and a peephole, about

1 in. across, should be cut in it. A brass hood will add to the appearance and allow the finder to be closed when not in use.

The camera is now ready to assemble. Fasten the film gate to the bearing plate in such a position that the frame will come directly behind the lens, and at such a distance that the range of the focusing device will permit objects at any distance to be focused on the film. Put in all the shafts, gears, sprockets, etc., attach the crank, and adjust the bearings until all the gears mesh properly and run smoothly.

Now remove the crank and crankshaft, insert the bearing plate in the camera box, and fasten it in place by screws at top and bottom. Locate the position of the crankshaft on the side of the camera, and bore a hole somewhat larger than the shaft. Cast a circular piece of babbitt, 1 in. in diameter and  $\frac{3}{16}$  in. thick, and bore a  $\frac{3}{16}$ -in. hole in the center. This is placed on the outside of the box, the shaft inserted, and the gears set in place. The circular piece of babbitt can then be fastened to the outside of the camera by means of screws, to act as a bearing and prevent the leakage of light around the shaft. The shutter should be properly timed when the bevel gears are meshed.

A 6 by 11 by  $\frac{3}{16}$ -in. plate should be fastened to the back of the main bearing plate for the purpose of holding the supply and take-up reels. Thumbscrews should be used for this purpose, as the plate must be easily removable when the camera is used for projection purposes. The pulley on the take-up reel must, of course, line up with that on the shaft in the camera, and a small belt be fitted.

The fastenings that hold the cover should be designed to pull the two parts of the camera tightly together. Fasteners can be made of heavy wire and small pieces of strap iron, as shown in the illustration. The tripod must be of heavy construction and quite rigid, as a wobbly tripod will produce jerky, unsteady pictures.

By removing the plate holding the supply and take-up reels, the camera can be used for the projection of the finished film, and if the work has been carefully done, the resulting picture will be as clear and steady as those made by professional apparatus. The best light for home use is a 250-watt stereopticon lamp, set behind a pair of condenser lenses. These can be taken from a stereopticon, or purchased at the optician's. The box must be well ventilated, and should be



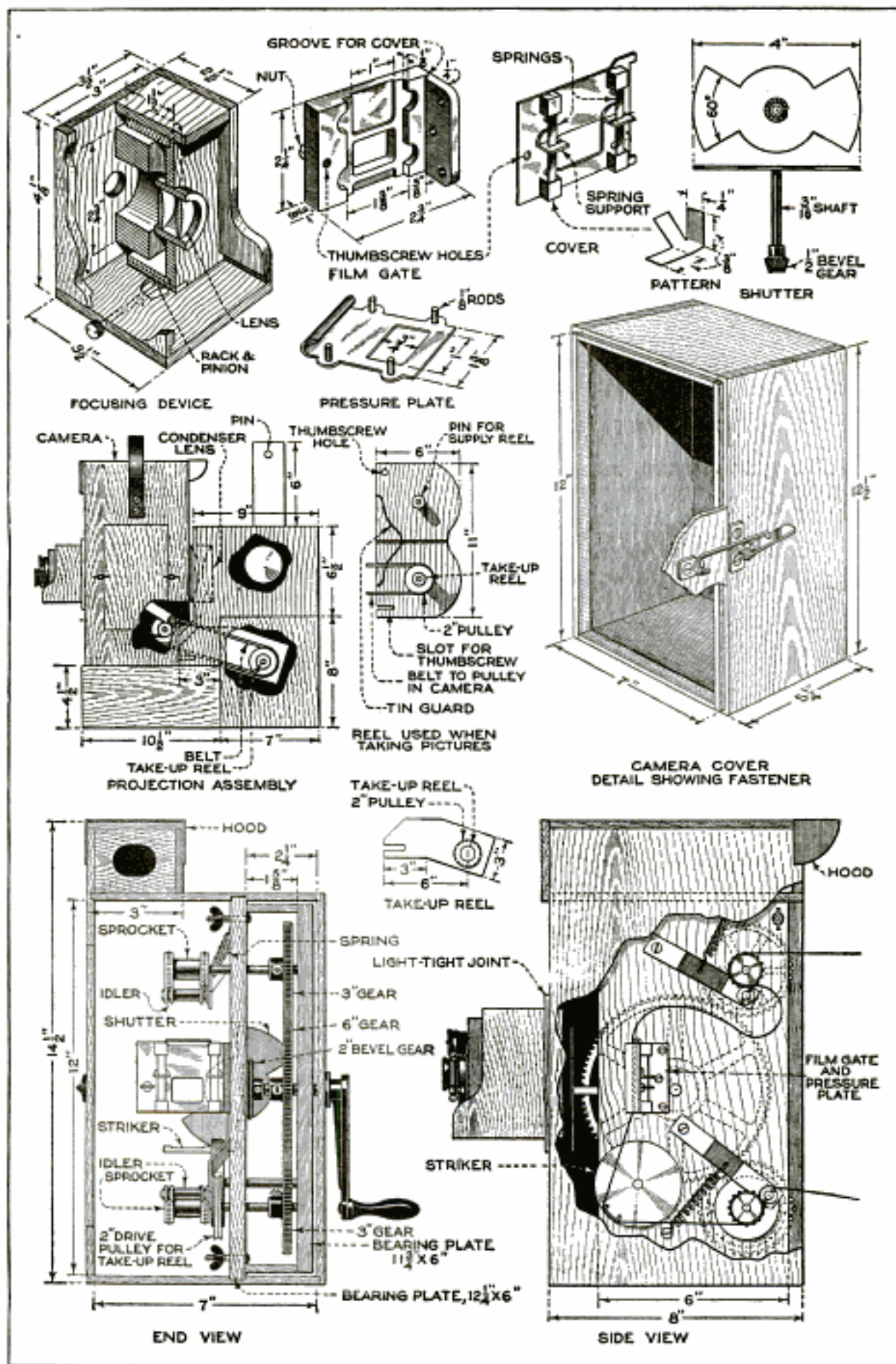

Complete Details of the Motion-Picture Camera and Projector: Upper Drawings Show the Construction of the Focusing Device, Film Gate, and Shutter; Center Drawings, Projection Apparatus, Picture-Reel Plate, and Camera Cover, and Lower Drawings, Side and End Views of the Camera Completely Assembled



lined with asbestos, as it gets very hot if used for any length of time. A supply reel and a take-up reel must be arranged, and the latter can be run by a belt from the pulley in the camera.

If one expects to develop and finish the film in his own dark room, some sort of apparatus must be constructed to handle the wet film. In handling small quantities, of 50 ft. or less, the most economical way is to construct a cylindrical reel 15 to 24 in. in diameter and about 2 ft. long. Let this rest in a frame so that, as it turns, it dips into a pan containing

the chemical. The film can be wound on the reel, emulsion side out, and passed through the successive baths of water, developer, and hypo, and then dried without being disturbed.

When the negative film is developed and dried, it must be printed on positive film before being projected. It can be printed in the camera by running the positive and negative films through together past a light, but it will be found more economical to send the negative to a laboratory, where the printing will be satisfactorily done for a few cents a foot.

### A Practical Sliding Gate

The sliding gate shown in the drawing has decided advantages over many styles

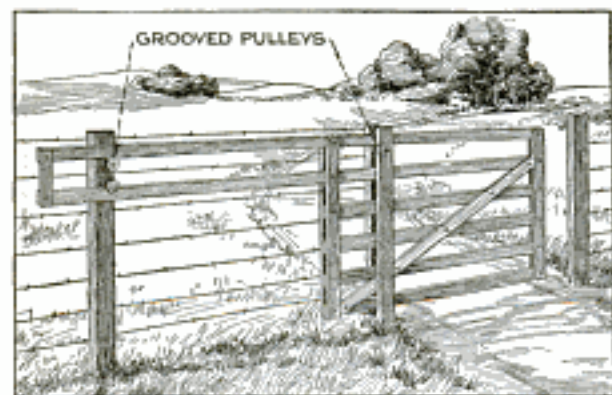

A Type of Sliding Gate Which Is Neat in Appearance and Easy to Handle, as There Is Very Little Friction in the Parts

of similar gates now in use. It is neat in appearance and easy to open and close, as there is very little friction.

If a clear 10-ft. opening is desired, the posts on each side of the driveway should be about 11 ft. apart. One gatepost is made double to prevent the gate from being dislodged, and has a pulley in the center, to carry the top bar of the gate. Both upper bars are 22 ft. long and extend to another post, placed 11 ft. from the double one, where they are held in place by two grooved pulleys, as shown. A crosspiece must also be provided on the gate to prevent it from sagging.

### An Improved Developing Tray

A photographer, having broken one of his glass developing trays, and being unable to obtain another immediately, made a tray of paraffin to serve as a temporary substitute.

After melting about a pound of paraffin, it was poured into a large pan of hot

water, until the layer of paraffin floating on the surface was about  $\frac{1}{4}$  in. thick. When the paraffin had cooled down until it was fairly hard but still pliable, it was removed and pressed into a glass developing tray, the inside of which had been moistened with water to prevent the paraffin from adhering to it. The surface of the layer of paraffin was smoothed, and the edge cut even with the glass edge. After hardening, the paraffin was removed and found to form a serviceable tray that could be cleaned very easily and was not affected by the chemicals.

### Tool for Removing Headlamp Rims

The removal of the bayonet-lock type of headlamp rim is one of the stubborn jobs that tries the patience and skill of practically every auto repairman or service man. The drawing shows a tool by means of which the rim is gripped with a uniform pressure at all points, and it is only necessary to grip and turn the handles to loosen even a tightly "frozen" rim, without damage. The tool is made from the transmission band of a light automobile, and fitted with a new, soft, white lining. The ears of the band are knocked off and their place taken by a pair of flat-iron grips, and on the opposite side of the band a handle is riveted.

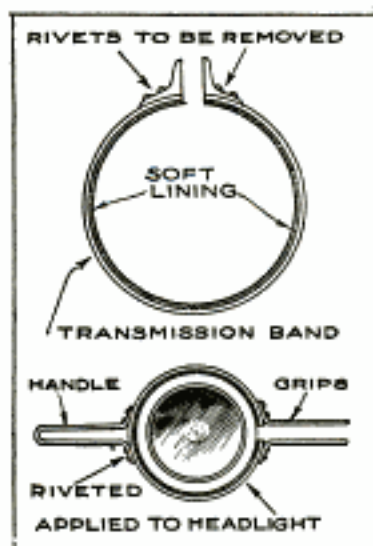



### Variometer-Winding Form

Amateurs who wish to build their own radio instruments will find the stator-coil winding form illustrated a great convenience. The larger piece is the form proper; it is made of hardwood, the radius of the section on which the wire is wound being the same as the radius of the winding seat in the stator half, less twice the over-all thickness of the wire used. A cylindrical section, a few inches long, is turned on the smaller side of the form, and the face on the larger side is recessed to take the plug shown. This plug may be of hardwood or metal, as preferred; it is drilled to fit a driving pin driven into the form, and is

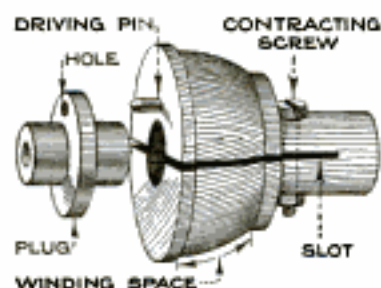

centered, as is the opposite end of the form, to permit winding between lathe or other centers. The form is slotted, as shown, for a portion of its length, and fitted with a screw and nut. When the form has been wound, and the stator half coated with adhesive, the form is dropped into place and weighted or clamped until the cement is dry. Then the contracting screw is tightened, and the form can be removed very easily.—H. F. Lowe, Washington, District of Columbia.

### Four-Way Switch Made from Old Automobile Timer

For low-voltage circuits, where there are not more than four different lines over which the current is to be distributed, an old timer from a light automobile can easily be converted into a four-way switch.

Make a base of some insulating material, about 8 in. square and 1 in. thick, and drill a hole through the center as large as the end of the shaft over which the timer roller fits. Counterbore this hole large enough to take a bolt head, and cut a similar depression in the top of the base; both should be concentric with the hole. Get a bolt over which the timer roller will just slip, and  $\frac{1}{2}$  in. longer than the distance between the bottom of the base and the top of the timer shell when the latter is set on the base. Cut the threads the entire length of the bolt, file the head down to a thickness of about

$\frac{1}{4}$  in., and drill a small hole  $1\frac{1}{2}$  in. from the head. Push this bolt through the

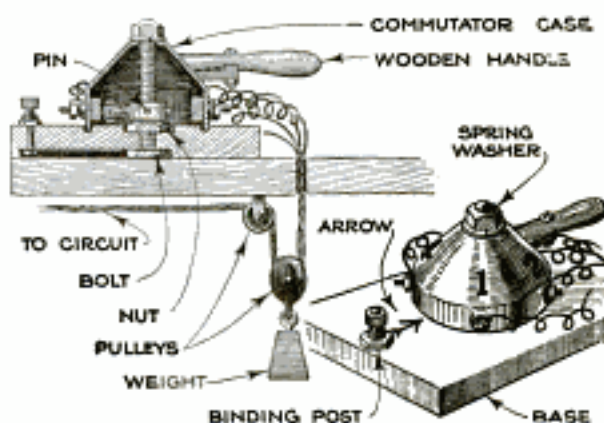

Four Electrical Circuits Controlled from One Switch: The Switch is Made from a Timer Taken from a Light Automobile

hole from the bottom of the base, and run on a locknut to hold it securely in position. Then put on the roller, and pin it to the bolt through the small hole. Be sure the roller points exactly toward one side of the base, and then lock the bolt in that position. Connect the bolt head to a large binding post in the base, just forward of the roller; this is the ground-wire post. Paint an arrow pointing from this post toward the center. Drill a hole, to fit the bolt, through the shell, place it in position, and run a pencil around it to mark its outline on the base. Scribe a second circle inside the first,  $\frac{1}{8}$  in. away from it. A circular groove,  $\frac{1}{8}$  in. deep, is cut out to serve as a track for the edge of the shell. Cut a wooden handle to fit over the timer-rod arm, and bolt it in position. Paint numerals on the shell in the order shown, opposite the terminals. Finally, slip the shell over the bolt, put on a spring washer, and run on the nut, turning the latter down just enough to hold the shell in the track and allow it to be turned around easily with the handle. Fasten the base to the table, or bench, and drill a hole in it, one on each side of the base.

Connect flexible cords to the timer terminals, allowing plenty of slack, and run them through the holes, where they are looped over the weighted pulley shown. Each cord is then fastened to the underside of the bench. Set a knife switch in the ground line beyond the base.

To operate, open the ground switch, swing the number of the circuit desired around toward the arrow, throw in the switch again, and only that circuit will be in operation.—L. B. Robbins, Harwich, Massachusetts.



### A Neat Radio Interrupter

The radio interrupter illustrated is made from common materials and pre-

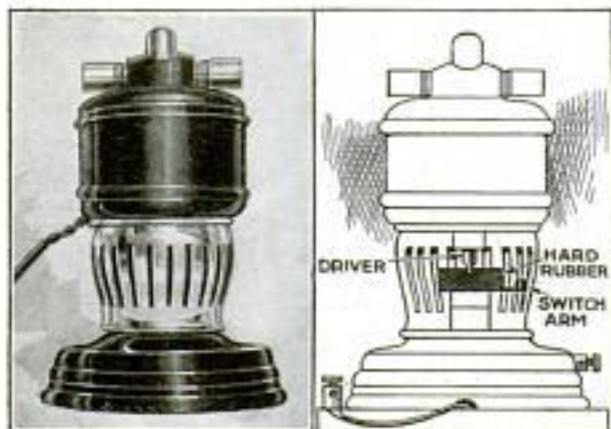

An Electrically Operated Interrupter for the Amateur Radio-Transmitting Set That is Made from an Electric Motor, the Metal Guard of an Old Casserole, and Miscellaneous Electrical Parts

sents a very attractive appearance when finished.

The base, made from a wood or hard-rubber fixture base, has mounted in its exact center a discarded switch arm, knob, and bearing, from which a wire connection runs to a binding post at the edge of the base. Soldered to the end of the switch arm, which clears the slotted metal guard by  $\frac{1}{8}$  in., is a small piece of spring brass, about  $\frac{1}{40}$  in. thick by  $\frac{1}{4}$  in. wide. This is so arranged as to make and break contact with the small silverplated casserole guard, which is mounted between the motor and base, and to which a binding post is soldered for the second connection. The shaft of the small fan motor used is connected at the lower end to the knob of the rotating switch arm by means of a tube, forced over the shaft and flattened at the end. This end fits into a slot in the hard-rubber switch knob, so that there is no direct electrical connection between the switch and motor.

In case a device such as this is to be used on a high-voltage lighting or other circuit, it will be best to insulate the motor from the slotted casserole cover. This can be done by placing heavy-paper washers and bushings on the motor bolts.—R. U. Clark III, Newton, Mass.

### Keeping Water Out of Automobile Casings

Automobile owners are frequently troubled by water in the tire casings, admitted through the opening for the valve stem. This water and the rust that results, cause much wear on the inner tube.

An excellent method of preventing this trouble is to cut several washers, about 2 in. in diameter, from an old inner tube. A small hole is cut in the center of each, so that it can just be forced over the valve stem, making a tight fit. When the rim is put in place on the wheel, the washers will be compressed in the space between the felly and rim, making it impossible for the water to enter.

### An Improvised Dark Room

For changing plates, loading holders, and even developing negatives, when there is no dark room at hand, an ordinary coat and a wash boiler, box, or similar light-tight vessel, can be made to answer. The

coat is buttoned up and the skirts are securely tied around the top of the wash boiler, in the case shown in the photo, or the box, after the plates and holders and a small light-tight box have been put in. The operator runs his arms



down through the sleeves of the coat and changes the plate or removes exposed films from the film pack, placing them in the box. In the case of film packs, single films can be developed by placing them in a tumbler of developer that is mixed as for a tank; other tumblers are provided for clear water and for the fixing bath.—Hallie H. Holt, Salem, Ill.

### Feed Box That will Not Overrun

It is frequently desired to have a feed or salt box in a feed lot or pasture. Some animals seem to delight in upsetting the usual type of box, but one made according to the drawing, with the sides extending beyond the corners, will be proof against the mischievous antics of the stock. The pieces for the box



are cut just twice the length required for the actual dimensions of the box.



### A Convenient Tool Rack

The rack for holding tools shown in the photo has all the advantages of a tool box, none of its drawbacks, and several advantages of its own.

A piece of scrap lumber is used for the rack; it is fitted with two feet, one at each end, made of strap iron, and with a handle, taken from a screen door, at the top. The tools are held on the board by means of canvas straps, nails, and wire hooks.

All tools are instantly accessible, and the rack can be picked up and carried to any part of the house, so that there is no running back for the tool that is always forgotten. Room for more tools can usually be made.

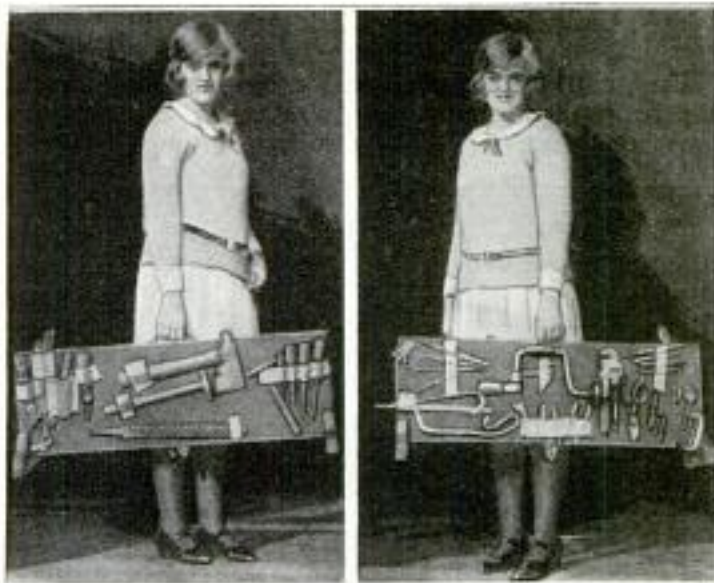

A Rack That Keeps the Household Tools Always at Hand: The Tools Are Instantly Accessible, and the Rack can be Carried Anywhere, as It is Provided with a Handle

### Screwing Down Grease Cups

Most automobiles have several grease cups located under the floorboards, and these must be screwed down occasionally. This operation is often neglected, because the floorboards must be lifted in order to get at the cups.

To overcome this difficulty, a small hole should be drilled and tapped in the center of each grease-cup cap. A machine screw is screwed into this hole and riveted securely on the inside. If holes, large enough to admit the end of a screwdriver, are then bored through the floorboards, the screwing down of the caps becomes the work of a few minutes.

### Standards for Displaying Small Flags

When decorating the exterior of a house with small flags it is not usually desired to nail the staffs to the building because the nails split the sticks. The trouble can be overcome by using standards of the type illustrated, which are made from wooden doorstops. Remove the rubber tip and drill a hole to a depth of at least 2 in. and just large enough to fit the flagstaff. A setscrew, made from a screw-eye, prevents the staff from becoming loose and falling out. Several such standards can be arranged on a board if it is desired to prevent marring walls or exterior finish.



### Convenient Garage-Door Lock

It is hard to improve on two stout wire hooks for fastening a sliding door on a garage after the car has been run in, but when the car has been taken out, and the driver wishes to get away in a hurry, the hooks are inconvenient, as he must go inside again in order to fasten them. A

quickly operated fastener, secure enough for use in a single garage when the car is out, can be made from a common door lock and a few pieces of flat iron. A

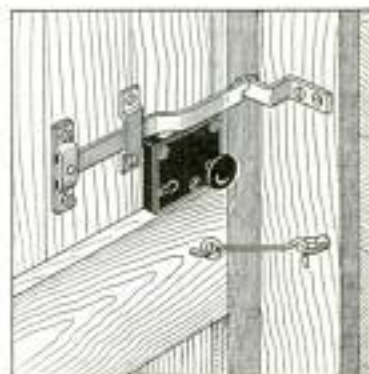

latch is made from the flat iron, as shown in the drawing, and the lock is screwed to the door so that the bolt comes directly under the latch. When the bolt is raised with the key, the latch is lifted and the door may be shut. Turning the key then withdraws the bolt, and the latch drops down over a strap screwed to the lintel. A notch is cut in the end of the latch to fit over this strap, preventing the door from being opened without the key.

☐ A  $\frac{1}{2}$ -in. hole, cut in the middle of one edge of a towel and sewed like a button-hole, makes it possible to hang the towel so that it cannot fall.



### Utilizing Small Car as Bed

Frequently finding occasion to use his car for sleeping quarters, and soon discovering that it did not afford enough



The Back of the Front Seat is Cut at Sides and Bottom So That It can be Lowered When the Occupants Desire to Use the Car for Sleeping

space for this purpose, an open-air enthusiast made the changes in the front seat shown in the photograph.

The back of the front seat was cut out, the edges being turned in and the cushions upholstered in such a manner that the finished job presented a neat appearance. Large door hinges with removable pins were fastened to the sides and bottom, so that the back could be dropped down from its normal to a horizontal position, resting on the edge of the rear-cushion frame. The side hinges lock the back when raised. By doing this, it was possible to utilize the entire car space for sleeping quarters. Mosquito netting, hung all around the car, was provided as a protection.—A. C. Brundage, La Crosse, Wisconsin.

### Stenciling Colored Designs on Fabrics

The art of stenciling colored designs on fabrics offers limitless possibilities for the decoration of curtains, table covers, and other articles, or even the decoration of feminine wearing apparel. The stencils can easily be cut, after a little practice, from original designs, or from pictures, or they can be purchased at small cost.

Common tube oil colors are used, and they are applied by means of a stiff, round brush, rather stubby, but not too large. Before mixing the paint, it is squeezed out on a piece of blotter, to absorb the free oil and prevent the cloth from looking greasy. Gasoline is used to thin the paint, which should be made as thin as possible without running on the work. Experiments can be made on a small piece of the goods first, in order to get the paint of the proper consistency. This is the most particular part of the whole process, as, should the paint be too thin, it will creep on the fabric, and, if too thick, will not flow easily, nor color evenly.

The stencil itself must be coated with linseed oil and allowed to dry thoroughly before using. The material to be stenciled is stretched taut on a table or board with thumbtacks, and the stencil is then placed in position and fastened in the same way. The brush, or brushes, if different colors are used, is then used to scrub the material lightly until colored sufficiently. On very thin material, the brush should be tapped on the cloth until the color is spread evenly.

Stencils must be cleaned carefully on both sides after each application, as subsequent work might be blurred or daubed if they are permitted to become dirty. Cheesecloth, cotton scrim, or soft, loosely woven muslin, are good materials to use for stenciling. They may be dyed any desired shade and then stenciled. The result is durable, artistic, and inexpensive. Washable goods can be laundered without injury to the stenciling.

### A Collapsible Clothes Prop

A clothes prop that can be folded and stored away in the laundry or outbuilding is an improvement over the usual clothes-line support, because it can be lengthened or shortened to meet varying requirements. Such a prop is made in two parts, one of which is provided with a series of notches into which a link pivoted on the other member fits. A metal strap, in addition to the link, holds the parts together, and serves as a stop to prevent them from being separated.—Harold Jackson, Kankakee, Ill.

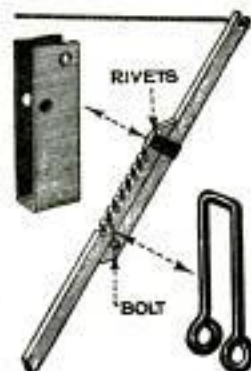





# A SIMPLE BATTERY RADIOPHONE

By F. L. BRITTIN

**A**N experimental radiophone transmitter, operated on dry cells and a storage battery, can be built for approximately \$35, if all the parts are purchased; this does not include the cost of the batteries, and can be reduced somewhat by using homemade parts. With an instrument of this type, conversation can be carried on over distances up to 10 miles. This is the type of radiophone the amateur should build while learning

parts of this set, such as the inductance, the fixed and variable condensers, the transmitting tube, choke coil, modulation transformer, microphone, and the resistances.

The panel, which is made of  $\frac{1}{4}$ -in. bakelite, is 10 by 12 in. in size, and is attached to the  $\frac{3}{4}$  by 8 by 10-in. wooden base by means of angle brackets. The binding posts for the batteries, aerial, and ground are arranged on the front of

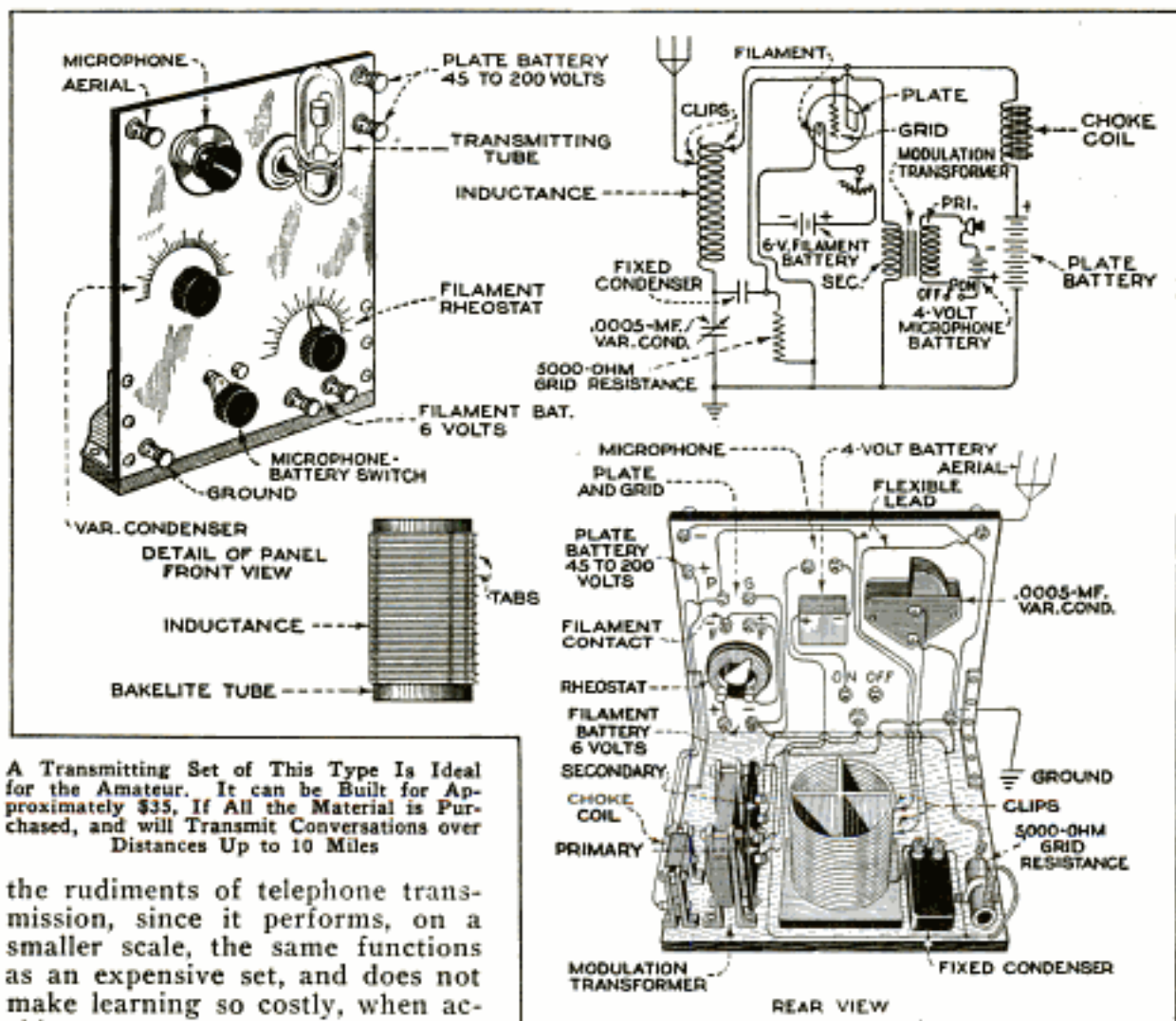

A Transmitting Set of This Type Is Ideal for the Amateur. It can be Built for Approximately \$35, if All the Material is Purchased, and will Transmit Conversations over Distances Up to 10 Miles

the rudiments of telephone transmission, since it performs, on a smaller scale, the same functions as an expensive set, and does not make learning so costly, when accidents occur to the instrument.

Before attempting to construct this set, the reader should study the wiring diagram carefully, and should, at least in a general way, understand the principles involved in radiophone work, besides knowing the functions of the various

the bakelite panel, as shown in the drawing. The inductance is wound on a threaded bakelite tube,  $4\frac{1}{2}$  in. in diameter and 7 in. long. If not already threaded when purchased, the tube should be put on the lathe and threaded, so that it will take



80 turns of stranded "litzendraht" wire, or the same amount of No. 16 bare copper wire, if the former is not available. At every five turns, a small tab of sheet copper is soldered to the wire, so that the clips of the aerial and plate can be snapped on at different points, to vary the inductance.

The lower end of the inductance coil is connected to one terminal of the variable condenser and also to the fixed condenser. The other terminal of the variable condenser is connected to the ground post. The second terminal of the fixed condenser is connected to three points: to the grid, to one terminal of the secondary coil of the modulation transformer, and to the grid resistance. The remaining terminals of the secondary coil of the transformer and the grid resistance are connected to the ground.

The six-volt storage battery is connected to the filament, care being taken to connect the negative terminal directly to the filament binding post, and the positive terminal to the filament rheostat. The negative terminal must also be connected to the ground.

The B-battery consists of at least four 22½-volt units, such as used for receiving sets. Several units can be used, as the greater the voltage supplied to the plate, the greater the distance spanned by the message. For this reason the plates on transmitting tubes are designed to stand high voltages, as high as 500 volts for the 5-watt size used in this set. The units are connected in series, the negative terminal being connected to the

ground line, while the positive lead passes through the choke coil to the plate, and also to the inductance coil, to which it is attached by means of a helix clip.

The simple matter of connecting the microphone circuit remains. This is done by placing a 4-volt battery, consisting of 3 dry cells, an on-and-off switch, the microphone, and the primary coil of the transformer in series on a separate circuit, as shown.

The variable condenser used is of .0005-mf. capacity, panel-mounting type, and should be able to stand a high voltage. A stop should be used to prevent it from shorting at 90°, as some condensers on the market are designed to do.

The fixed condenser is also of .0005-mf. capacity, especially designed for high voltage. The type used consists of several strips of copper foil between mica, the whole being bolted between two metal plates.

The 5,000-ohm grid resistance is of standard vitrified type. The filament rheostat is of 7 ohms' resistance. The choke coil is of the 150-milliamperere type. If the builder desires, he may use an anti-capacity switch in the B-battery circuit, to permit throwing the battery current from the transmitting to the receiving set. The latter, of course, is a separate instrument.

It should also be kept in mind while wiring, that, although the wires are shown running parallel in the diagrams, for the sake of simplicity, they should be kept at right angles to each other as much as possible, in order to reduce induction.

#### LIST OF MATERIALS

- |                                                            |                                                         |
|------------------------------------------------------------|---------------------------------------------------------|
| 1 ¼ by 10 by 12-in. bakelite panel.                        | 1 5-watt transmitting tube.                             |
| 1 ¾ by 8 by 10-in. wood base.                              | 1 4½ by 7-in. bakelite tube.                            |
| 2 6 by 6-in. angle brackets.                               | 1 5,000-ohm vitrified resistance unit.                  |
| 6 binding posts.                                           | 1 modulation transformer.                               |
| 1 filament rheostat.                                       | 1 6-volt storage battery.                               |
| 4 contact points.                                          | 3 dry cells.                                            |
| 2 switch levers, with knobs.                               | 4 22½-volt B-batteries.                                 |
| 1 .0005-mf. variable condenser.                            | 1 150-milliamperere standard choke coil.                |
| 1 .0005-mf. fixed condenser, C. W. type, for high voltage. | 3 helix clips.                                          |
| 1 microphone.                                              | Litzendraht wire for inductance, or No. 16 copper wire. |
|                                                            | 1 tube socket, for panel mounting.                      |

#### Useful Hints for the Motorist

A blow-out patch in an automobile casing will last much longer if a piece of old inner tube is cut and laid between the patch and the inside of the casing. This will prevent the ragged edge of the hole in the casing from wearing through the patch.

The solderless connections that hold

the flexible copper tubing to the gasoline tank and carburetor, often have a tendency to work loose, owing to the constant vibration. By substituting a piece of graphited asbestos-cord packing, such as is used to pack water-pump glands, for the slip ring, it will be found that the joint will not leak, nor will it work loose as quickly as before.—Wm. Byers, Kansas City, Mo.



### Simple Method of Making Candles

Very serviceable candles, that produce a flame four or five times as large as that of an ordinary wick candle, can be made in the following manner: About 1 lb. of paraffin—such as is used for canning purposes—is melted in a flat pan. A long sheet of tissue paper, about 6 in. wide, is grasped at each end, and is slowly passed through the melted wax several times, each layer being allowed to cool before the paper is passed through again. When the thickness of the wax is about  $\frac{1}{8}$  in., the sheet is allowed to cool, and is then cut into pieces from 6 to 12 in. long, depending upon the size of candle desired, and rolled into cylinders.

When dipping, the wax should not be too hot, as it would then melt the layers previously applied, instead of adding a new one. It is best to melt the wax over water, at a temperature of about 212° F. To expose the paper wick for lighting, revolve the end of the candle in a flame until some of the paper lights; it is then ready for use.

### A Simple Picture-Frame Clamp

The illustration shows a device that has proved to be very satisfactory for clamping glued picture frames. Four pieces of hardwood, 3 by  $1\frac{1}{4}$  in., are cut and grooved as shown. Two pieces of soft steel, or iron, about 5 in. long and 1 in. wide, are drilled at each end. A bolt, about 8 in. long, threaded full length, passes through the center of one plate,

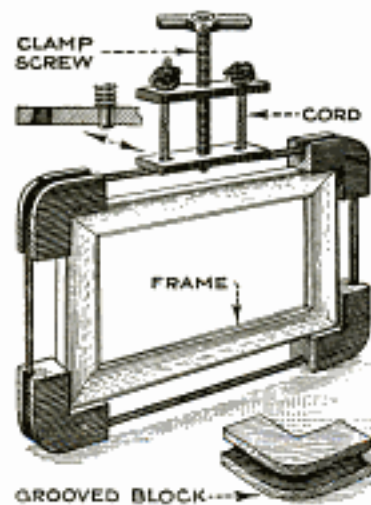

which is drilled and tapped to fit it. The bolt is then turned down at the end and seated in a hole drilled through the other plate. A rope is passed around the grooves and through the holes and knotted securely, and the apparatus is assembled as shown. The turning of the bolt will tighten the rope and bring equal pressure upon all four corners of the picture frame. If the clamp screw and the rope are long enough, various sizes of frames can be clamped in the device.

### "Moving-Picture" Toy for Children

A very interesting "moving-picture" toy for the small child can be made of cigar

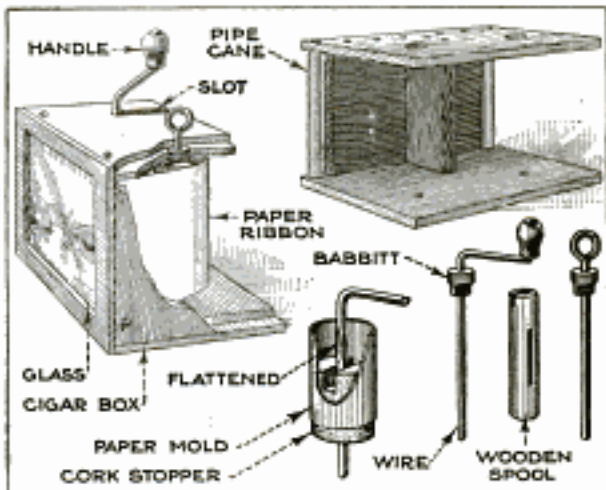

A "Moving-Picture" Toy for the Small Child, That Is Instructive as Well as Amusing, and That can be Very Easily Made from Scrap Materials

boxes, some wire, babbitt or lead, and a few pieces of pipe cane.

A rectangular opening is cut in the bottom of a cigar box, of the size made to contain 100 cigars, and a piece of window glass, cut to fit, is placed behind the opening and held in place by tacks. A frame, shown at the upper right, made of cigar-box wood, fits neatly into the box; this holds the picture ribbon against the glass and carries the spools on which the ribbon is wound. A piece of pipe cane is mounted at each corner of the frame, to serve as a roller.

The spindles, one of which has a crank formed on one end, are made of No. 9 galvanized wire, and are provided with babbitt or lead "keys" to turn the wooden spools on which the ribbon is wound. To make these keys, a portion of the wire should be flattened, as shown. A cork stopper is then taken, and, after a groove is cut in the top and a hole drilled through the center, it is pushed on the wire directly underneath the flattened portion. By wrapping heavy paper around this cork, a cup is formed, into which the babbitt can be poured. The wooden spools upon which the ribbon is wound can be made from old film spools, cut at one end to fit the babbitt key.

Children can be amused for hours with this little toy, which can be made instructive as well as amusing. Pictures cut from the comic or rotogravure sections of newspapers, and pasted to the ribbon in order, make very interesting moving pictures of this kind, although, of course, any suitable pictures may be used.



### A Substantial Electric Radiant Heater

Many electric radiant heaters are made with porcelain cores in several parts, and these are very easily broken. After breaking one of these cores several times, it was found possible to remodel the heater so that the risk of breakage was reduced to a minimum.

A hard-maple block, 5 by 2½ in., was turned in a lathe to the shape shown, the middle part being made 5 by 1½ in., and

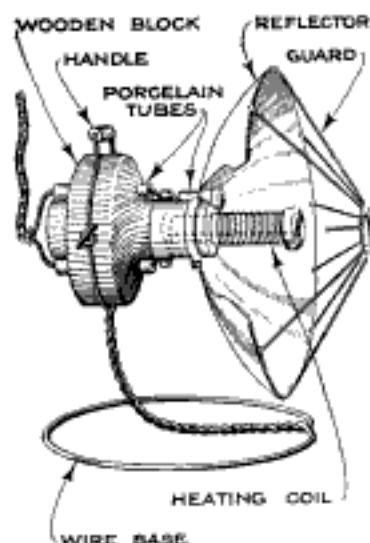

the ends turned down to about 1⅞-in. diameter. On each side of this block a hole was bored. A porcelain wall receptacle was obtained, and all the copper lining, except the lower part of one pole, was removed, a type of receptacle that had the screw hole in the

center being used. A common porcelain tube was wrapped on one end with asbestos, and this end was glued firmly into the wall receptacle. The wire of the old heating coil was wound around the tube, care being taken to have sufficient space between the turns to prevent short circuits. Both ends of this wire were brought back to the pole screws of the receptacle, one end through a small porcelain tube in the reflector, and the other through the center of the heating-unit tube. The outer covering of the extension cord, but not the insulation, was cut away, and the single conductors were brought through porcelain tubes fixed in the holes in the wooden block, and connected to the pole screws of the receptacle. Soldering the wires to the pole screws made them secure. A thin collar and a clamp screw were used to attach the reflector to the receptacle. An attractive and rigid base was then made of No. 4 copper wire, twisted as shown, and attached to the wooden block with thumb-screws, in such a manner that the heater could be adjusted and locked at various angles. The wire was also brought around the top to hold a wooden handle. The exposed pole screws should be taped and varnished to protect the user.

### Book Ends Made of Angle Iron

A neat pair of book ends can be made from two pieces of angle iron, the size varying according to the size of the volumes to be supported. The pieces are ground smooth on a grindstone or emery wheel, and then painted or enameled to give them a neat appearance. A layer of felt, glued to the bottom, will prevent them from scratching the finished surface of a table or desk.

### Dead-End Switch for Inductances

The efficiency of a radio-receiving set can often be improved to a considerable extent by the use of a dead-end switch to short-circuit the unused turns of the inductance. The switch illustrated can be added to the set without disturbing the existing arrangement, and at a negligible cost. It consists simply of a piece of spring brass, bent as indicated, and soldered to the knob shaft, at the back of the panel. Small pieces of brass, bent to a right angle, are drilled and fastened under the head of each contact-point screw, to provide positive contacts for the spring-brass wiper. A little care

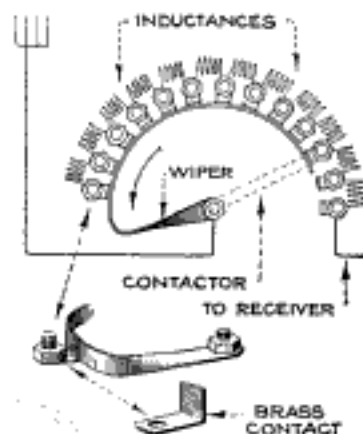

is necessary to insure that each contact piece is placed correctly, and that the wiper is in the proper position, relative to the regular switch contactor, to short-circuit the unused turns and to touch all the contact pieces.

This switch can be used with any multipoint switch in which the points are arranged in an arc, and where contact is made by a rotating switch arm.

### Waterproofing Felt Hats

An old hunter uses the following method of waterproofing felt hats: A solution made by dissolving half a bar of common soap in water is liberally applied to the inside of the hat. When this is dry, a second solution, made by dissolving a cupful of powdered alum in water, is brushed on over the first. The soap is thus hardened, and becomes waterproof.



# PRIZE OFFERS AND ANNOUNCEMENTS

## PEARL NECKLACES OFFERED AS PRIZES FOR BEST TITLES FOR A PICTURE

Local prizes to the value of \$50, and national prizes to the value of \$1,750, are offered by a Chicago jewelry firm for the most appropriate titles for a picture, a copy of which will be furnished on application. The national prize-winning titles will be selected from the winning titles in the contestant's town or city. The local prizes consist of pearl necklaces to the value of \$25, \$15, and \$10, and the national prizes of necklaces to the value of \$1,000, \$500, and \$250. All titles must be submitted by Nov. 20, 1922, on an official blank, which may be obtained, together with a copy of the picture, by application to local jewelers, or by addressing C. D. Peacock, State and Adams Sts., Chicago, Ill.

## MANY PRIZES OFFERED FOR RECIPES FOR CHOCOLATE CONFECTIONS

Every person who uses chocolate, or cocoa, for beverages, cakes, candies, or desserts, may participate in a recipe contest in which 100 prizes aggregating \$1,000 in value are to be awarded. In each of the above four classes there will be a first prize of \$100, and for each of the best cake, candy, and dessert recipes there will be other prizes of from \$25 to \$2. The final contest closes Dec. 1, 1922. As many recipes as desired may be submitted, and each recipe must be accompanied by the blue label from a package of the chocolate made by the prize giver, namely, W. H. Baker, Inc., Washington, D. C.

## FINANCIAL AID TO TECHNICAL STUDENTS BY EMPLOYMENT IN STEEL MILLS

To assist students working their way through the Carnegie Institute of Technology, arrangement has been made to give them employment in the mills of the Jones & Laughlin Steel Company, of Pittsburgh, Pa. The students may work in the shifts of 10 hours' length, on Friday and Saturday nights, or all day Saturday. This arrangement will not only assist the students financially, but will also furnish them with practical engineering experience that will supplement the theoretical knowledge acquired at the institute.

## WINNERS OF THE KNIGHTS OF COLUMBUS PRIZES FOR HISTORICAL ESSAYS

The \$500 prize offered by the Knights of Columbus National History Commission for the best essay on an American historical subject written by a student of an American college or university, has been awarded to Louis Morton Hacker, of Columbia University. The title of the winning essay is "The Genesis of the Interstate Commerce Act." The prize in the contest open to professors of history was won by Samuel Flagg Bemis, of Whitman College, Washington.

## \$1,000 IN PRIZES OFFERED FOR SLOGANS BY ELECTRIC TRUCK ASSOCIATION

Concerns interested in the electric-truck industry have set aside \$1,000 to be awarded in prizes for the best slogans not longer than 10 words, indicating the advantages of electric as compared with other trucks. The prizes offered are: First, \$500; second, \$200; third, \$100; and 40 others of \$5 each. Publicity literature in this connection is being circulated by the Electric Truck Association, New York City.

## \$2,000 IN CASH PRIZES IS OFFERED FOR MANY KINDS OF NEEDLEWORK

For crochet, knitting, embroidery, or tatting work done with any cotton threads made in America, prizes aggregating \$2,000 in cash are offered by the Star Needlework Journal. All articles submitted must be newly made for the purpose of entering them in this

contest. There will be altogether 162 class prizes, of from \$100 to \$1 each, awarded, and, in addition to these, three special prizes of \$100 each will be given. Competitors may enter in as many of the classes as desired, but only the winners of the special prizes, will receive more than one prize. The contest will close Dec. 31, 1922. Competitors must fill an entry blank, which may be obtained by applying to Star Needlework Journal, 260 West Broadway, New York City.

## CONTESTS PREVIOUSLY ANNOUNCED

**Medals, Diplomas, and Money Awards:** Announced August issue, 1921; awards offered by the Franklin Institute. The Franklin medal is for workers in technology; the Elliott Cresson is for original research work and invention the Howard N. Potts is for important development of previous discoveries and inventions. Each award consists of a gold medal with a diploma. There are also a silver medal, and a Certificate of Merit awarded for meritorious discoveries, and cash premiums for certain work in optics.

**One Million Francs for Best Motor:** Announced January issue, 1922; closes June 1, 1923; address, Aero Club of France, Paris.

**Research Thesis by a Woman:** Prize \$1,000; announced October issue, 1921; awarded annually; address, Dr. Lilian Welsh, Goucher College, Baltimore, Maryland.

**Annual Commercial Airplane Contest for "Italy's Great Trophy":** Announced July issue, 1922; address, Aero Club of Italy.

**Best Novel by an American Author:** Prize \$2,000; announced August issue, 1922; closes March 1, 1923; address, Harper & Brothers, New York City.

**Designs for Chicago Tribune Building:** Prizes, \$100,000; announced August issue, 1922.

**Best Essay on a Historical Novel:** Prize \$100; announced September issue, 1922; closes Dec. 1, 1922; address, Kenyon College, Gambier, Ohio.

**Competition for American Composers:** Prizes from \$1,000 to \$100; announced October issue, 1922; closes Dec. 15, 1922; address, Mrs. Edwin B. Garigues, Room 201, Bellevue-Stratford, Philadelphia, Pa.

**Best Symphonic Composition:** Prize \$1,000; announced October issue, 1922; closes Jan. 1, 1923; address, Balaban & Katz, 175 N. State St., Chicago, Illinois.

**For Musical Compositions:** 24 prizes; announced October issue, 1922; closes Dec. 1, 1922; address, The Etude Prize Contest, 1712 Chestnut St., Philadelphia, Pa.

**Reward for a Book of Self-Revelation:** Prize £250 advance royalties; announced November issue, 1922; closes Dec. 15, 1922; address, Messrs. A. M. Philpot, Ltd., 69 Great Russell St., London, W. C. 1, Eng.

**For Best Professional Name for a Young Screen Artist:** \$375 in prizes; announced November issue, 1922; closes Dec. 1, 1922; address, Motion Picture Editor, The People's Home Journal, 80 Lafayette St., New York City.

Although France seldom fails to do honor to its great originators, it has suddenly been discovered that one has been neglected—no less a man than Mr. Marcel, the inventor of the universally known "wave." Amends are to be made by the observance of a "Marcel Week," one feature of which will be a "marcel" contest among hairdressers for a prize of 30,000 francs.

On page 305 of our August, 1922, issue, appeared an article entitled "Automatic Gas Lighter for Type-setting Machines." This was contributed by F. W. Inversetti, of Ripon, Wis., who claims that the invention is his own.

It now appears that patent No. 568,931, series of 1915, Div. 23, issued to R. S. Starks, Berlin, Wis., controls the manufacture and sale of this device. Our readers are therefore cautioned against its unauthorized use.

When answering prize offers please mention Popular Mechanics Magazine

Closed in Oct. to Broadway, New York City  
 15th St. New York City  
 P. S. Clark

618

482

621844

P. S. Clark

616 Boston, Mass.

879 Broadway 486



514

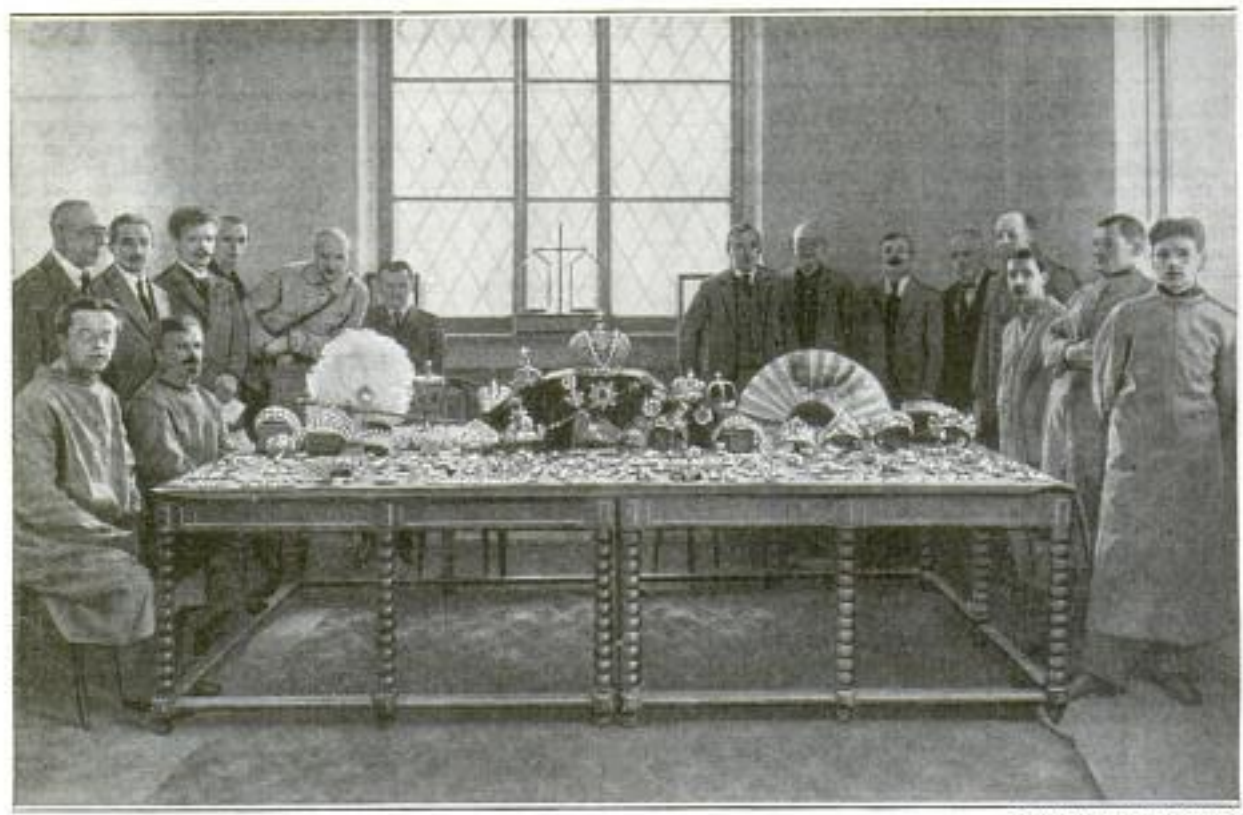

COPYRIGHT, WIDE WORLD PHOTOS

RUSSIAN CROWN JEWELS HAVE FABULOUS WORTH

THESE Russian crown jewels have an estimated worth of \$60,000,000,000, according to a French jewel expert who recently appraised this wonderful collection of precious stones in their matchless settings. This valuation, however, is factitious. Nearly all of these gems would lose much of their ascribed value if they were placed on the market, because of their extreme size, weight, and cutting. They are of too great a magnitude for anything but just what they are—crown jewels. For instance, the crown of the late czar, which is shown elevated in the center of the display, contains 32,800 carats of diamonds, of which 12 stones average 30 carats each.

C.A. Briggs 1521 Oak St.  
 N.W. Washington, D.C. 8049

**LATEST DEVELOPMENTS IN SCIENTIFIC RESEARCH**

**MILLIONTH SECOND COUNTS  
IN GEODETIC-SURVEY WORK**

Can you measure time accurately to one-millionth of a second? Can you devise a simple apparatus for carrying into the field which will time events with such precision? This is a practical question. If you can achieve this, you can be of service in increasing the efficiency of the United States Coast and Geodetic Survey, which is the branch of the government concerned with the problems of the earth—its size, form, and many other of its physical particulars. Scientists and engineers depend upon this institution to determine the value of gravity in different parts of the country, which enters into most of their physical units, such as those used for determining the strength of a bar of steel or the horsepower of an engine. Gravity is now determined from the time of swing of a special form of pendulum which is carried about and allowed to vibrate at the stations chosen for the purpose. The time of swing is determined with the high degree of precision necessary, by counting the number of swings which take place in a period of many hours. For this purpose the equipment includes an imposing array of astronomical instruments for obtaining the time from the stars. This apparatus has to be installed on masonry piers and adjusted and used with special care, which de-

mands training and skill beyond the experience and conception of the ordinary person. Moreover, in order to verify the work and insure the absence of disturbing elements and consequent errors, the observations must be repeated a number of times. In fact, the determination of gravity is scientific work of the highest character, and the exactness with which time has to be measured corresponds to about one part in a million. An error of one-tenth of a second in ten hours is too great. Furthermore, bad weather obscuring stars with clouds stops the work. The Coast and Geodetic Survey is anxious to increase the precision which has been obtained by improvements which will increase the efficiency. If an arrangement can be devised which will permit the swing of the pendulum to be determined to a millionth of a second, it will be necessary to swing the pendulum only for one or two seconds; and instead of ascertaining the value of gravity at three stations a month, it will be possible to get at least ten times this number. Maj. William Bowie, in charge of this work, believes that the required timing methods as well as a portable equipment, weighing far less than the present outfit of 1,500 pounds, and dispensing with astronomical paraphernalia, can be devised eventually, but he is anxious to determine whether or not it can be developed with present knowledge and facilities.

IN accordance with the editorial policy of this magazine never to accept compensation in any form for what appears in our reading pages, and also to avoid all appearance of doing so, we are obliged to omit the name of the maker or the seller of any article described. This information, however, is kept on file and will be furnished free, by addressing Bureau of Information, Popular Mechanics Magazine, Chicago. [Editor.]



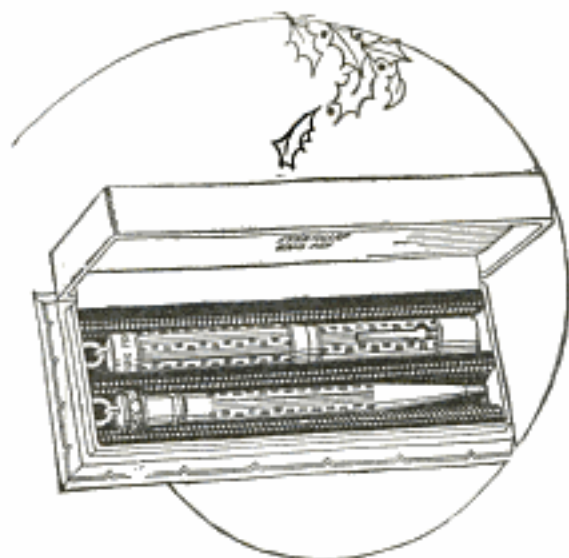

# Gifts

## \$1 to \$50

The gifts of *perfect writing* are here; at your price—in one perfect quality—in many forms of beauty—and with a name that is known wherever people write.

Give **EVERSHARP**—and your gift is supreme in quality; no other pencil has the exclusive rifled tip that keeps the lead from wobbling. Even if he has an **EVERSHARP**, give him another for his watch chain or for desk use. Ladies, from fourteen up, wear **EVERSHARP** on a ribbon, chain, or cord, for convenience and style.

Give **WAHL PEN** to match **EVERSHARP**. The indestructible all-metal barrel of **WAHL PEN** holds more ink, positively prevents leaking and will last forever. The iridium-tipped point writes as smoothly as a 2B lead. Priced as low as \$4.

**WAHL PEN** and **EVERSHARP** make superb presents, singly, or matched in engraved designs, in velvet-lined Gift Boxes. Finished in gold or silver. See them at your dealer's.

Made in U. S. A. by THE WAHL COMPANY, Chicago  
Canadian Factory, THE WAHL COMPANY, LTD., Toronto

**EVERSHARP**  
matched by  
**WAHL PEN**

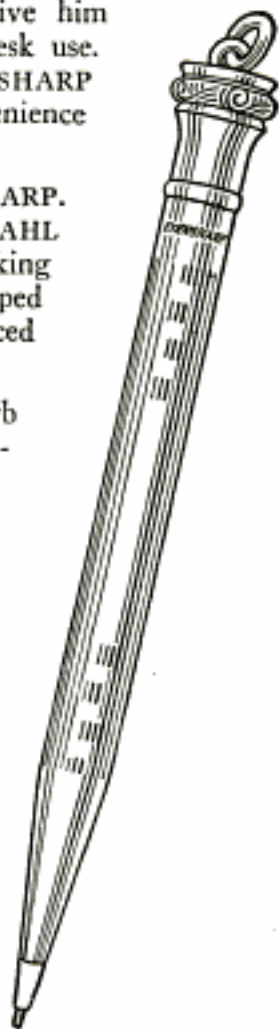
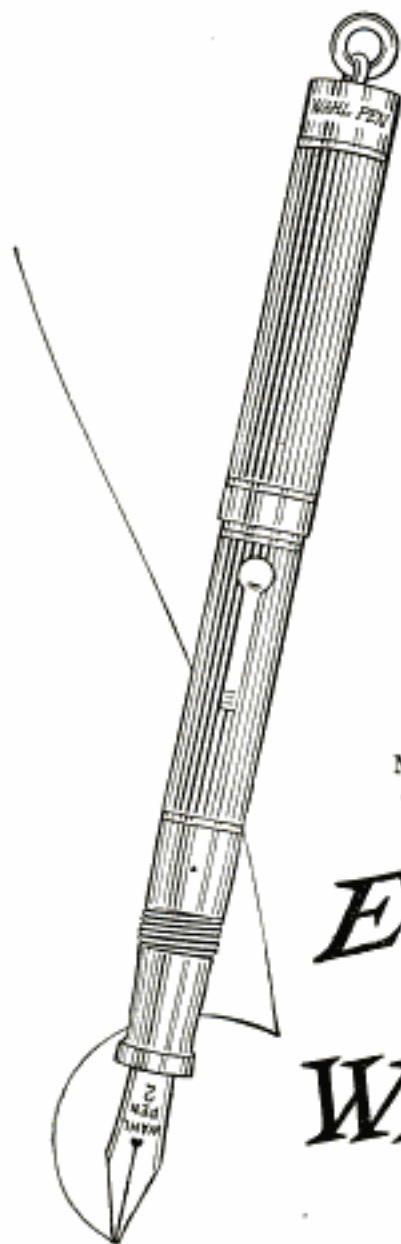





# The Dollar

The daily actions of most of us are influenced by the messages received over the telephone, and yet few of us stop to think of the men and women, and the mechanisms, which help to make that daily service possible.

Maintenance, repairs, and the work of handling calls, must constantly be carried on in good times or in bad, and they must be paid for, in order that your telephone service may be continued.

The average dollar will buy to-day less than two-thirds of what it would buy before the war. This

means that it costs, on the average, half as much again to buy most of the things that are necessary for keeping the country going; but the advance in telephone rates is far less than this average.

In fact, gauged by the present purchasing power of the dollar, telephone service in the country as a whole is costing the subscriber less than it did in 1914.

The Bell System generally has been able to meet higher commodity prices and increased wages by means of new economies in operation and the increased efficiency of loyal employees.

“ BELL SYSTEM ”

**AMERICAN TELEPHONE AND TELEGRAPH COMPANY  
AND ASSOCIATED COMPANIES**

*One Policy, One System, Universal Service, and all directed toward Better Service*





# The Gift This Year

## The AnSCO Memory Kit

Truly a token of high esteem. And totally unlike any gift of any Christmas gone by.

**T**HE AnSCO Memory Kit—a pleasing assembly of high-quality equipment wherewith happy memories of people, places, and episodes may be perpetuated in pictures.

These three things make up an AnSCO Memory Kit: (1) Your choice of three fine AnSCO Cameras, as set forth in the paragraphs at the right; (2) a supply of

AnSCO Speedex Film; (3) a handy and supremely handsome compartment-receptacle of solid mahogany, for keeping camera and extra films always conveniently together; the lid embellished with a burnished metal nameplate for the recipient's name or initials.

Verily a combination ardently-to-be-desired. An AnSCO Memory Kit is this year's most coveted gift, and certain to be prized far beyond the price.

AnSCO makes a complete line of Cameras, ranging from \$1.50 to \$65—each model a standard for quality and value at its price.

Have you tried the new AnSCO Speedex Film? "Fits the light, dull or bright"—a better film that gets better pictures.

*Any AnSCO dealer will gladly give you a complimentary copy of the AnSCO catalog—or write to us*

**ANSCO COMPANY, Binghamton, New York**



### At \$15

—the camera compartment of the Memory Kit contains the widely popular AnSCO Vest Pocket Junior—a remarkably capable little camera that is producing fine pictures the world around. By an exclusive device it combines a fixed focus with an adjustable focus, providing for both beginners and skilled users. Special finish, Rapid Rectilinear Lens, Speed U.S. 4, in Deltax Shutter. *In Canada, \$16.*

### At \$20

—the Memory Kit includes the AnSCO Vest Pocket Junior in special finish equipped with the brilliant AnSCO Anastigmat Lens, Speed F. 7.5, in Gammax Shutter.

*In Canada, \$22.50.*

### At \$40

—it's an AnSCO Vest Pocket Speedex No. 3—a camera of the highest grade and widest efficiency, yet in compact size. AnSCO Anastigmat Lens, Speed F. 6.3.

*In Canada, \$45.*

### Ask To See Them

Each takes a picture  $2\frac{3}{4} \times 3\frac{1}{4}$ . Covered in genuine leather. Genuine leather bellows. Beautifully designed, accurately built for precision, scope, and service.





# BUY TODAY 10 MONTHS TO PAY



B11—Gent's Tooth Ring set with perfectly cut blue-white Diamond. . . . . \$35



B12—Solitaire Cluster, 7 fine Diamonds set in Platinum in a fancy 18K White Gold mounting. \$65



B13—Artistic Platinum top Friendship Ring set with 5 blue-white Diamonds, White Gold Shank. \$135



B14—Superior fine Diamond in beautiful hand-engraved Platinum ring. \$100



B15—Gent's hand-carved Belcher Ring set with fine blue-white Diamond. \$45



B16—Sweet Engagement ring set with fine blue-white Diamond. . . . . \$35



B17—"Sweetheart" Platinum ring set with superior fine Diamond. . . . . \$150



B18—Unique Platinum top Green Gold ring set with 1 fine Diamond. . . . . \$40



B20—Beautiful lavaliers genuine pearls, fine Diamond. . . . . \$28



B19—Solitaire Cluster, 7 fine Diamonds set in Platinum \$85



B21—Four White Gold inverted hearts set with 1 superior quality sparkling Diamond. . . . . \$75



B22—Ladies' Belcher ring set with 1 fine Diamond. . . . . \$25



B23—Genuine Black Onyx set with fine Diamond in Platinum bezel. . . . . \$33



B24—Solitaire Cluster, 7 fine Diamonds set in Platinum. . . . . \$48.50

## Beautiful Xmas Gifts

On Credit—at Cash Prices

YOUR choice of any of these blue-white, perfectly cut Diamonds sent on APPROVAL. NO RISK, NO MONEY IN ADVANCE. If satisfied after examination, pay one-fifth the price and keep the article, sending us the balance of the money in ten equal monthly payments. Otherwise, if not pleased, simply return and examination will have cost nothing.

This complete stock is no further away than your nearest mail box.

### Beautiful Christmas Catalog FREE

98 pages in colors, crowded with thousands of wonderful bargains in Diamonds, Watches and Jewelry—gifts you will be proud to give. Ten months to pay on everything. Write NOW for your FREE copy.



Address Dept. 62-7

L.W. Sweet, Inc.  
New York City  
Capital, \$1,000,000



B25—Sweet Engagement ring set with one superior fine Diamond. . . . . \$85



B26—Beautiful hand-engraved White Gold mounting set with 1 fine superior Diamond. \$90



B27—Sweet Engagement ring set with one superior fine Diamond. . . . . \$65



B28—Sweet Engagement ring set with one superior fine Diamond. . . . . \$100



B29—Superior Diamond set in 18K White Gold top. . . . . \$50



X38—14K Solid White Gold case with sapphire jewel crown, 15 jewel, Rectangular adjusted movement, Fancy engraved Dial, Special Price. . . . . \$72.50

# L.W. SWEET INC. "THE HOUSE OF QUALITY"

1650-1660 BROADWAY, N.Y.





## Waterman's Ideal Fountain Pen

*"The Daddy of them all"*

**T**HE most acceptable of all Christmas presents. Its superior quality, beauty and unfailing reliability are life-long reminders of your thoughtfulness and good judgment.

*Regular, Safety and Self Filling Types:* \$2.50 to \$25.00

*Special Christmas Wrapping*

*Selection and Service at Best Dealers the World Over*

**L. E. Waterman Company**

191 Broadway, New York

Boston

Chicago

San Francisco

No. 52  
\$2.50

No. 42  
with  
ring  
\$3.25

No. 55  
with  
clip  
cap,  
\$5.25

No. 12  
with  
clip  
cap,  
\$2.75



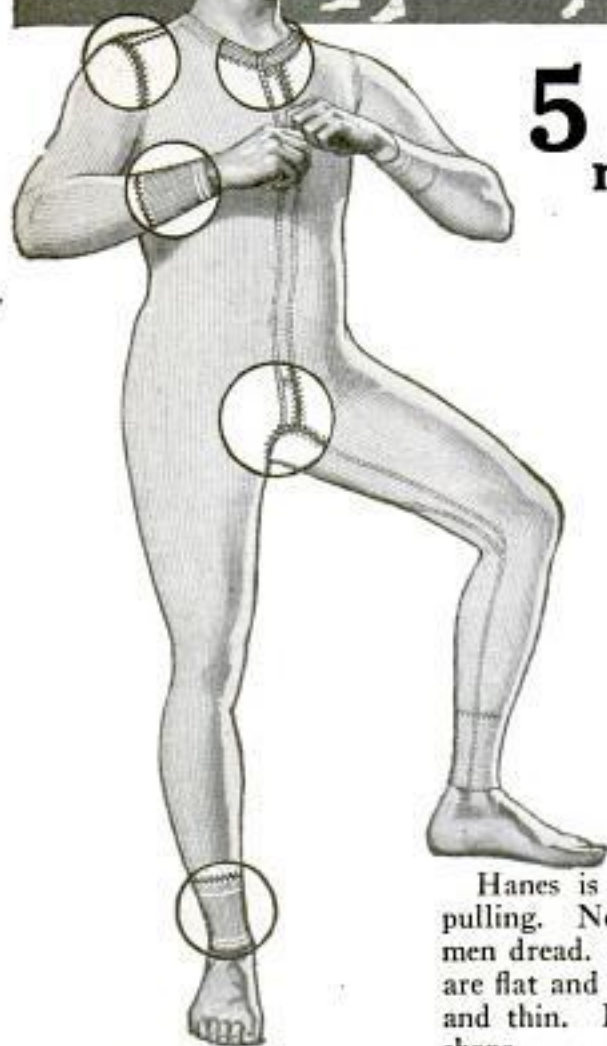
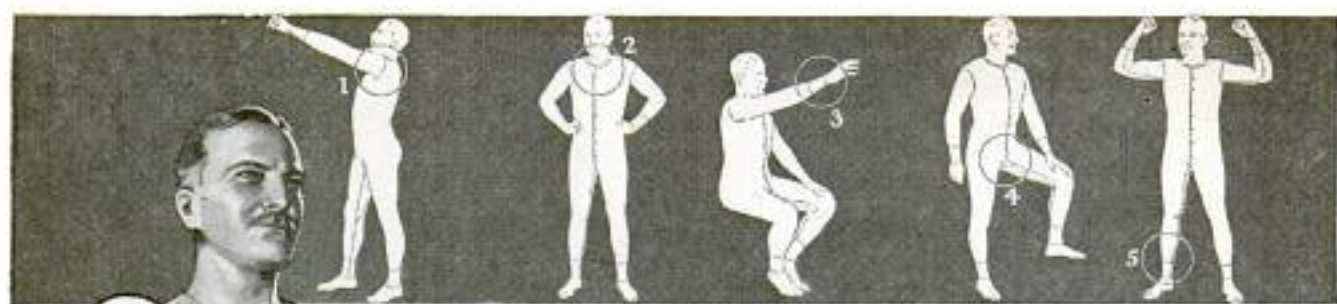

## 5 HANES features that mean Real Winter Comfort

- 1 Hanes Staunch Elastic Shoulders** are made with service-doubling lap seam. They fit right, with plenty of "give" for every motion.
- 2 Hanes Tailored Collarette** won't gap or roll. Fits snugly around your neck always, and keeps the wind out.
- 3 Hanes Elastic Cuffs** are made far stronger and better than the usual cuff. They fit the wrist firmly and won't flare or rip from the sleeve.
- 4 Hanes Closed Crotch** is cut and stitched in a special way that really keeps it closed.
- 5 Hanes Elastic Ankles** hold their shape through repeated washing. They never bunch over your shoes, but always fit.

**Y**ES, sir! These are mighty big advantages. You find them combined in no other popular-priced underwear. But they're not the only Hanes points of superiority. Here are some others.

Hanes is made to fit—does it, too, without binding or pulling. None of that bagging, sagging discomfort that all men dread. Every strain-point is strongly reinforced. Seams are flat and can't irritate you. And they hold through thick and thin. Buttons are on to stay. Buttonholes keep their shape.

And last but not least—each Hanes garment is backed by the Hanes money-back guarantee.

Stop in at your dealer's to-day and choose from the Hanes line. It includes heavy shirts and drawers and heavy union suits in two weights. If your dealer can't supply you, write direct to us and we'll see that you're supplied.

Youngsters will like Hanes—warm, comfortable, long-wearing union suits for boys. Two weights—heavy and extra heavy; sizes 2 to 4 have drop seats. Also knee length and short sleeves.

**HANES GUARANTEE:** We guarantee Hanes Underwear absolutely—every thread, stitch and button. We guarantee to return your money or give you a new garment if any seam breaks.

**P. H. HANES KNITTING CO., Winston-Salem, N. C.**

TRADE MARK  
**HANES**

ELASTIC KNIT  
**UNDERWEAR**

Remember—Hanes Underwear sells at popular prices

Next summer wear Hanes full-cut athletic Union Suits!



# Sent on Approval

No  
Money  
Down

## 21 Jewel Santa Fe Special

Without one penny of advance payment let us place in your hands to see, to examine, to inspect, to admire, to approve a real masterpiece in watch creation.

Our determination to this year double our sales of the world famous *Santa Fe Special* and *Bunn Special* Watches prompts this matchless offer.

While other watch dealers are raising their prices, asking you for larger monthly payments, and making payment terms harder for you to meet, we are offering you our new model *Santa Fe Special*, no advance in price, no money down, easier terms and smaller monthly payments. WE realize the war is over and in order to double our business we MUST give you pre-war inducements, better prices, easier terms, and smaller payments.

### Page 12 of Our Watch Book Is of Special Interest to You!

Ask for our Watch Book free—then select the watch you would like to see, either the famous *Santa Fe Special* or the 6 position *Bunn Special*, and let us explain our easy payment plan and send the watch, express prepaid, for you to examine. NO money down.

**REMEMBER** No money down—easy payments buys a master timepiece—a 21 Jewel guaranteed for a lifetime at about half the price you pay for a similar watch of other makes. No money down. A wonderful offer.

### SANTA FE WATCH COMPANY

Dept. C 6, Thomas Bldg.

Topeka, Kans.

MAIL COUPON TODAY

SANTA FE WATCH CO.,  
Dept. C 6, Thomas Bldg.,  
Topeka, Kans.

Please send prepaid and without obligation your Watch Book free, explaining your "No Money Down" Offer on this *Santa Fe Special* Watch.

Name.....

Address.....





# Radio

## Catalogue

# FREE

One copy of this complete Catalogue of Radio Outfits, parts, Dictionary of Radio Terms, Instruction Book, and Guide to Successful Radio Work—one copy is yours Free.

Simply write us a post card and we will mail the complete book to you Free, by return mail.

It quotes the lowest prices, amazingly low prices on everything for the expert and the amateur. Every improved part, the most up-to-date outfits, everything that is needed of the most modern type—at the lowest possible prices.

It gives a list of broadcasting stations, and gives much information about radio construction and operation. Every one interested in Radio needs this complete catalogue and book of instruction.

### Why Pay Higher Prices?

Montgomery Ward & Co. has for fifty years dealt on a Money-Back basis, absolutely guaranteeing everything they sell. With quality absolutely assured, why pay higher prices elsewhere? Write today for this Free Radio Book and see for yourself the Saving it will bring you.

One copy is yours Free. You need only write us a post card.



Write to the house nearest you  
ADDRESS DEPARTMENT 6-R

Chicago Kansas City St. Paul  
Fort Worth Portland, Ore.

# Montgomery Ward & Co.

== The Oldest Mail Order House is Today the Most Progressive ==



# "Some present from Dad"

WHAT a wonderful thing it will be for any boy whose Dad makes it possible for him to take his first lesson on Christmas day on his very own

## BUESCHER

### True-Tone Saxophone

Every boy should play some musical instrument. Of all musical instruments, the True-Tone Saxophone is a boy's instrument. It is the one that just fits a boy, to which he takes naturally and which he easily masters.

The technique of the Saxophone interests and tempts a boy's ambition. It brings out and develops his latent musical talent.

A Saxophone will help keep your boy at home and occupied with things worth while; it will teach him to improve his time instead of wasting it; it will bring him in contact with better, cleaner associates.

### Easiest to Play

The Buescher Saxophone is so perfected and simplified that it is the easiest of all musical instruments to learn.

It is the one instrument that everyone can play—and it wholly satisfies that craving everybody has to personally produce music.

Your boy can learn the scale in

### \$500 to \$1000 Weekly for Two Hours a Day

is not uncommon for musicians of ability to earn. True-Tone Buescher Instruments have helped make famous Paul Whiteman, Tom Brown, Joseph C. Smith (Brunswick Records), Vincent Lopez, Clyde C. Doerr, Bennie Krueger (Brunswick Records), Ben Selvin, Dan

an hour's practice, play popular music in a few weeks and take his place in an orchestra or band within 90 days, if he so desires.

Nothing can take the place of the Saxophone for home entertainment, church, lodge, school. It increases the pleasure you get out of life, increases your popularity and your opportunities.

Russo (Brunswick Records), Paul Specht, Donald Clark, Art Hickman, Clay Smith, Guy Holmes, Henry Santrey, Carl Fenton (Brunswick Records), Gene Rodemich (Brunswick Records), and thousands of others. Your boy might develop equal ability.

### Free Trial—Easy Payments

We make it easy for you to get your boy a Saxophone this Christmas. You may order any Buescher Saxophone, Cornet, Trumpet, Trombone or other Band or Orchestral Instrument without paying in advance, and try it six days in your own home without obligation. If perfectly satisfied, pay for it on easy terms to suit your convenience.

**75%** of all popular phonograph records are played with Buescher Instruments.



Joseph C. Smith

Director Joseph C. Smith's Orchestra, always famous for fine dance records and now making Brunswick Records exclusively, using Buescher Band Instruments and Saxophones.



Bennie Krueger

Director Bennie Krueger and His Brunswick Orchestra, Brunswick Records. Hear the Jazz Wizard with his Buescher Saxophone.



Gene Rodemich

Director of Gene Rodemich's Orchestra. Hear them in Brunswick Records (for dancing) playing Buescher Instruments.

### Saxophone Book Free

After nearly 300 years' supremacy, string instruments are almost entirely displaced by Saxophones in all nationally popular orchestras. Our Free Saxophone Book tells which Saxophone takes violin, cello and bass parts, and many other things you would like to know. Ask for your copy.

**Buescher Band Instrument Company**  
2537 Buescher Block Elkhart, Indiana

Makers of Everything in Band and Orchestral Instruments

Buescher Band Instrument Co.  
2537 Buescher Block, Elkhart, Ind.

Gentlemen: I am interested in the instrument checked below:

.....Saxophone .....Cornet .....Trombone .....Trumpet  
(Mention any other instrument interested in)

Name .....

Street Address.....

Town..... State.....



# Ives Toys make happy boys

**A**N IVES Railroad System is just what every boy wants. They suit any purse, too, ranging from \$1.75 to \$50.00 in price. There are spring locomotives that whiz around on "O" gauge track and monster electrics, that operate on "O" gauge and standard 2 gauge track—exact copies of the latest New York Central models. The Ives Railroad Systems have a dazzling variety of passenger and freight cars, bridges, tunnels, switches, stations, signals, lights and railroad equipment. The cars like the locomotives are also exact copies. The freight cars are painted like the real ones on principal railroads, coal cars, tank cars, stock cars, flat cars, lumber cars, cabooses.

Our beautiful 1922 catalog ablaze with color will tell you all about these wonderful trains as well as the Ives Boats. Remember that the Ives Trains can be operated either indoors or out. After the indoor season their substantial construction makes them an ideal outdoor toy. Boys can build a railroad running a spur track to the edge of a pond or brook, ship the freight to a miniature wharf and load it on an Ives merchant ship—an entire transportation scheme all with Ives equipment. No other manufacturer furnishes this complete outfit. Additions may be made from time to time as all equipment may be bought as separate units.

*Send 10c right now for our dandy 1922 catalog in colors, showing The Ives Trains and Boats.*

**THE IVES MANUFACTURING CORPORATION**  
198 Holland Avenue Bridgeport, Conn.



### *A Special \$15 Outfit as Shown Below*

**West of the Mississippi  
\$16.50**

*AN IVES Electric Train Outfit 31 inches long, consisting of reversible locomotive with electric headlight, 3 cars with automatic couplers. 14 feet of track, station, tunnel, semaphore, danger signal and 6 telegraph poles. If your dealer will not supply you, send us the money and we will see that you are taken care of.*



# Ives Trains



# Let DIAMONDS say Merry Xmas

642AD—18" indestructible quality Pearls of unusual sheen and lustre with White Gold clasp set with genuine Perfect cut diamond. **\$14.50**



643AD—Premier Diamond Ring, Blue-white Quality Diamond. **\$95.00**



644AD—Engraved Premier Diamond Ring, Blue-white Diamond. **\$37.50**



645AD—Green Gold Hexagon Platinum Top with Blue-white Diamond. **\$55.00**



651AD—Solid Platinum Trueheart Ring with exquisite Blue-white Perfect cut Diamonds. **\$118.50**



649AD—Cluster Ring, 7 Blue-white Diamonds set in Platinum. **\$73.50**



650AD—Green Gold Gypsy Cluster, 7 Blue-white Diamonds. **\$87.50**



647AD—Substantial Round Belcher Ring, Brilliant Blue-white Diamond. **\$80.00**



653AD—18 kt. White Gold Hexagon Ring, 7 Blue-white diamonds set in Platinum. **\$59.50**



654AD—Gent's Ring, finest quality Blue white Perfect cut Diamond. **\$110.00**



652AD—Popular 14kt. White Gold rectangular Wrist Watch, very much in demand, 15-jewel guaranteed imported nickel movement. Special Price **\$33.65**



646AD—Engraved Belcher Ring, Blue-white Perfect cut Diamond. **\$60.00**

## NO MONEY DOWN

Any of the startling diamond values pictured here can be yours without risking a single penny. Each item is ideally suited for Christmas and will make a charming gift. No matter what you select, you pay **only a few cents a day**. Your selection sent on your simple request without a single penny down. If you don't agree that it is the **biggest bargain** you have ever seen, return it at our expense. If you keep it, pay at the rate of **only a few cents a day**.

### YEARLY DIVIDENDS

You are guaranteed 8 per cent yearly increase in value on all diamond exchanges. Also 5 per cent bonus privilege.

**MILLION DOLLAR BARGAIN BOOK FREE**

Send coupon for your copy today to Dept. 1779.

**Special Discount** of 15% on all cash sales for this month only.

**J. M. LYON & CO.**  
2 - 4 MAIDEN LANE, NEW YORK  
In Business Nearly 100 years

SEND FOR  
MILLION  
DOLLAR

BARGAIN  
BOOK

FREE

**J. M. LYON & CO.**  
2-4 Maiden Lane, Dept. 1779  
New York, N. Y.

Please send me at once your big 125-page MILLION DOLLAR BARGAIN BOOK, showing thousands of America's greatest diamond and jewelry bargains.

Name

Address

City  State



# Indian Scout

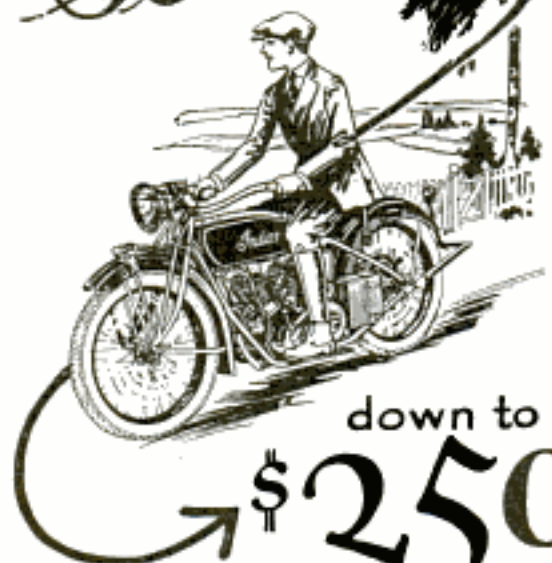

down to

\$250

Electrically Equipped \$285

## The Motorcycle that's different

*You've been waiting for this wonderful motorcycle—at this wonderfully low price*

- biggest value for the least money
- lower, lighter by 100 pounds than the average motorcycle
- economical, yet powerful
- 75 miles to the gallon, all upkeep low
- easy to ride and handle.

Your dealer will gladly demonstrate

Write Dept. 37  
for your nearest dealer's name.

**Hendee  
Manufacturing Co.**

*Largest Motorcycle  
Manufacturer in the World*

Springfield, Mass. U. S. A.

An Indian Sales Franchise is too good a proposition to be passed by a live dealer. Write for full particulars.

## Play Safe!

"Evinrude"—the name, itself, assures ten years of outboard motor service, plus unsurpassed power and speed.

Why experiment with untried motors any more than with guns and fishing tackle? Be sure! Evinrude motors have always made good—that's why more than 140,000 have been sold. Of this number all but some of the first few, built 12 years ago, are in use today.

Through important refinements, made each year, the Evinrude Motor has ever maintained its recognized leadership. Be sure you get the **genuine** Evinrude—the motor of proven value.

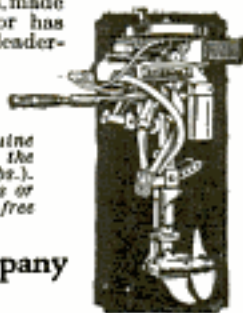

*There are two models of the genuine Evinrude—the Standard and the Lightweight (weighs only 60 lbs.). See them at your sporting goods or hardware dealer's. Or write for free catalog.*

Evinrude Motor Company  
767 Evinrude Bldg.  
Milwaukee Wisconsin

**EVINRUDE** Standard and Lightweight  
DETACHABLE MOTORS FOR WATERCRAFT

**DISTRIBUTORS:**

69 Cortlandt St., New York, N. Y. 119 Broadway, Oakland, Cal.  
180 Commonwealth Ave., Boston, Mass. 211 Morrison St., Portland, Ore.

# DEAF?

**"I Now Hear Clearly"  
You, Too, Can Hear!**



500,000 satisfied users have testified to the wonderful results obtained from the "Acousticon." We therefore feel perfectly safe in urging every deaf person, without a penny of expense and entirely at our risk, to accept the

## 1923 ACOUSTICON

**For 10 Days' FREE TRIAL**  
*No Deposit—No Expense*

Just write saying that you are hard of hearing and will try the "Acousticon." The trial will not cost you one cent, for we even pay delivery charges.

**WARNING!** There is no good reason why everyone should not make as liberal a trial offer as we do, so do not send money for any instrument for the deaf until you have tried it.

The "Acousticon" has improvements and patented features which cannot be duplicated, so no matter what you have tried in the past send for your free trial of the "Acousticon" today and convince yourself—you alone to decide.

**DICTOGRAPH PRODUCTS CORP.**  
1307 Candler Building, 220 W. 42nd St., New York City





# Harris Homes Beautiful

## Permanent Built! —Now Within Your Reach

The combined efforts of these great departments in experimenting and testing materials and methods of construction have produced for you a **GUARANTEED** home, expert machine cut, bundled and marked—the last word in building economy.

### Not One Penny in Advance

So sure are we of the super-excellence of our material and our **GUARANTEED Ready-Cut System** that we will ship you any **HARRIS HOME** without the payment of one cent down. Our plan Book explains our liberal terms fully.

### BUILDING MATERIAL!

For over a quarter of a century, thrifty wise buyers have realized that here is the open door to real economy, whether it be a brand new home or material for improvements or repairs.

### FREE BOOK OF PLANS!

The latest edition is waiting for you, contains our **FREE PLAN OFFER** and photographic reproductions, with floor plans and specifications of 100 beautiful homes. Mail coupon today.

## Plumbing and Heating!!

Hot water and heating systems, warm air heating plants, pipeless furnaces and plumbing material of every kind—the product of America's leading makers. Our mammoth plumbing stock offers unlimited possibilities for you to save money. Our heating plants are guaranteed to heat your home in any weather with big fuel economy.



### Bathroom Outfit Complete!

Consists of white porcelain enameled bathtub, 5 ft. long, complete with fittings, washdown closet outfit with white vitreous china earthenware bowl and tank fitted with mahogany seat and cover. Lavatory complete with indexed faucets, trap and supply pipes. Outfit \$67.50. Tub only, \$22.50. Closet outfit.....\$25.00. Tub with fittings, \$30.00. Lavatory...\$13.50.

### MAIL THIS COUPON

#### HARRIS BROTHERS CO.

Dept. PG-7, Chicago

These books are **FREE** and sent postpaid. Mark an "X" in the squares to indicate which ones you wish.

- Harris Home Book of Plans  
 Building Material Catalog  
 Book of "Presto-up" Houses and Garages  
 Plumbing and Heating Book

Name.....

Address.....



### Expert Engineers Waiting to Help You

A rough sketch of your building showing number and size of rooms, doors, windows and height of ceiling is all we need to give you complete information and low prices.

At a small rental charge, we loan you the tools to do your own work in installing our plumbing and heating systems.



## Free Book of Plans





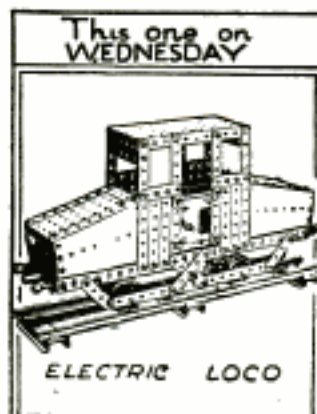
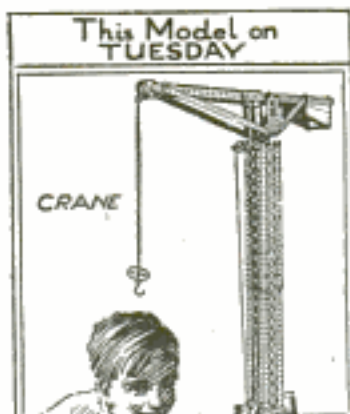
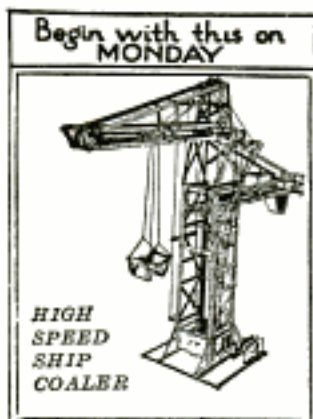

# MECCANO

## A MASTERPIECE EVERY DAY

A perfect crane one day, a splendid transporter bridge the next—then a wonderful tower with a running elevator, and so you go on every day for a year without once repeating a model. You do all this with the same interchangeable and unbreakable parts that always fit exactly where you want them and never get out of order.

Every part of Meccano is a real engineering piece—pulleys, gears, strips, girders, rods, couplings and cranks, all perfectly designed and accurately made.

**FULL INSTRUCTIONS.** A big illustrated Book of Instructions goes with each outfit, making everything perfectly clear. No study is necessary.

### Send for These Free Books

1. Meccano Products: All about model building. 2. Dick's Visit To Meccanoland: A boy's fascinating experiences at Meccano headquarters. 3. Radio: How to make a complete receiving set with Meccano to receive concerts, etc. All three books sent free if you will send us the names and addresses of three of your chums. Put No. 35 after your own name for reference.



### MECCANO PRICE LIST

|                              |       |        |
|------------------------------|-------|--------|
| No. 0 builds 70 models       | - - - | \$1.50 |
| No. 1 builds 105 models      | - - - | 3.00   |
| No. 1X (with electric motor) | - - - | 3.00   |
| No. 2 builds 151 models      | - - - | 6.00   |
| No. 3 builds 196 models      | - - - | 9.00   |
| and up to \$40.00            |       |        |

Sent prepaid on receipt of price if not at your dealer's.

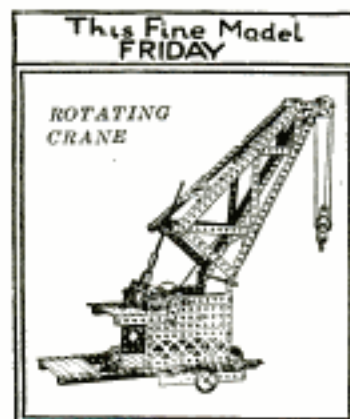
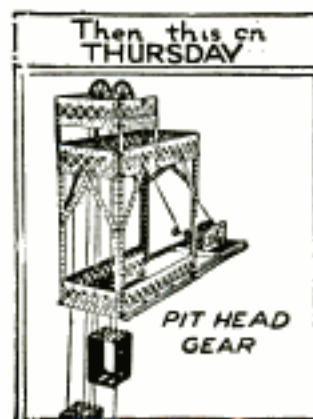

Division H, MECCANO COMPANY, INC., ELIZABETH, N. J.

In Canada: MECCANO Ltd., 11 Colborne St., TORONTO



# XMAS GIFTS

## Buy NOW Take a FULL Year To Pay



C1 — First quality blue-white diamond set in genuine Onyx, 14K setting . . . \$14.50



C2 — Ladies' 18K white gold ring set with two diamonds and one genuine sapphire . . . \$70.00



C3 — Ladies' 18K white gold band engraved set with two first quality diamonds . . . \$45.00



C4 — Ladies' 7 diamond cluster resembling 2CL solitaires, 14K white gold mounting \$57.50



C5 — Gentlemen's 7 diamond cluster set in solid platinum, 14K gold mounting . . . \$55.00



C6 — Ladies' 7 diamond cluster set in solid platinum, 18K white gold mounting . . . \$48.50



C7 — First quality perfect cut diamond set in 14K solid gold mounting . . . \$100.00



C8 — Beautiful rectangular wrist watch of 14K solid white gold, fitted with guaranteed movement of 15 ruby and sapphire jewels . . . \$25.00



C9 — Elite ring of 14K solid gold set with first quality perfect cut diamond . . . \$35.00



C10 — Hand engraved of 18K solid white gold; perfect cut, blue-white diamond . . . \$50.00



C11 — 8 diamonds surrounding 4 French blue sapphires set in solid platinum, 18K white gold shank . . . \$57.50



C12 — Gentlemen's 14K tooth ring set with first quality blue-white diamond . . . \$45.00



C13 — Gentlemen's engraved Belcher of 14K solid gold; perfect cut diamond . . . \$25.00



C14 — First quality blue-white diamond set in 14K solid gold mounting . . . \$75.00



C15 — Ladies' solid platinum ring set with perfect cut, blue-white diamond . . . \$67.50



C16 — Beautiful design of 18K white gold set with perfect cut diamond . . . \$75.50



C17 — Ladies' Tiffany Belcher of 14K solid gold; perfect cut diamond . . . \$25.00



C18 — Ladies' 18K white gold band engraved set with perfect cut, blue-white diamond . . . \$55.00



C19 — "Loveheart" betrothal ring of solid platinum, perfect cut, blue-white diamond center; 4 diamonds on sides . . . \$110.00



C20 — Ladies' 18K white gold set with perfect cut, blue-white diamond . . . \$25.00



C21 — White and green 14K Invallee; diamond center, pearl drop, complete with 14K neck chain . . . \$75.00



C22 — Ladies' 18K white gold set with first quality blue-white diamond . . . \$57.50



C23 — Gentlemen's 14K green and gold; perfect cut diamond in center; white gold with perfect cut diamond . . . \$100.00



C24 — Scarf Pin set in solid platinum with perfect cut diamond . . . \$27.00

### Pay Next Year for your Christmas Gifts!

Order Now  
Don't Send a Penny

—goods come to you for examination. Pay (1/2) 20% only if you are satisfied. —Take a full year to pay the balance. "ROYAL" diamonds are genuine first quality blue white perfect cut. Every article an exceptional value. All goods sent on approval for 30 Days' Trial. Satisfaction guaranteed. No references demanded—no red tape—no money in advance. 10% Discount for Cash.

8% yearly Dividends in exchange allowance guaranteed on every diamond purchased from us.

### FREE "Royal" Xmas Catalog



The most complete catalog ever published of Diamonds, Watches, Jewelry, Silverware, Cameras, Ivory Toilet Sets, etc., sent free. Prices the lowest—quality the highest. 30 Days' Trial and a full year to pay on everything you order from our \$2,000,000.00 stock.

Send for your free copy today

Address Dept. 648

Established 1735

# ROYAL DIAMOND & WATCH CO.

35-37-39 Maiden Lane - New York



REGISTERED TRADE MARK

# CHEMCRAFT

THE CHEMICAL OUTFIT

Harry K. Nolan,  
Chief Chemist West Side  
Chemcraft Chemist Club,  
and his Club Members at  
a regular meeting.



## Let these Boy Chemists show you the Wonders of Chemistry!

**C**HEMICAL experimenting is more fun than anything you ever did. It will keep you busy and interested all the time and open to you the wonders and mysteries of chemical science. It will give you reliable and useful information and show you how chemistry produces everything you eat, wear and use. Be an Amateur Chemist and learn about the most absorbing science there is today. Thousands of boys say chemistry beats everything else for real fun.

A CHEMCRAFT outfit makes you an Amateur Chemist. You can work all kinds of fine chemical experiments just like a real chemist. You can test foods, earth, water, cloth and other things; make soap, dyes, and inks; and do many other practical experiments that will interest, amuse and instruct you. You can join the Chemcraft Chemist Club, too, and start a local chapter of your own with yourself as Chief Chemist, just as Harry Nolan did. You'll get the Club Magazine and can exchange ideas and experiments with other boy chemists all over the world. Plan now to get your outfit this Christmas, so you can start at once and get in on the Prize Contest for Boy Chemists.

### This is CHEMCRAFT Outfit No. 3

A dandy, big one with many costly chemicals and a lot of apparatus. The Manual tells how to do 256 different experiments. Get No. 3 for Christmas and join these Boy Chemists!



Put CHEMCRAFT at the top of your Christmas list and tell everyone that's what you want. There are five outfits to select from: No. 0, 75c; No. 1, \$1.50; No. 2, \$2.50; No. 3, \$5.00; No. 4, \$10.00. Each outfit is complete and contains a large assortment of chemicals, laboratory apparatus and a Manual of Instruction. There are no explosive, poisonous or dangerous chemicals in any outfit. CHEMCRAFT is the original and leading chemical outfit; offers the greatest value and is scientifically correct in every particular. Look for CHEMCRAFT outfits in the toy store.

**CHEMCRAFT-MAGIC** is another dandy outfit you'll like to have. It shows you how to run a chemical magic show and contains all the tricks and apparatus to run it with. The tricks are fully explained and are as good as any performed by professional magicians. There's a Magic Wand, too, that does startling things for the boy who knows its secret. CHEMCRAFT-MAGIC is a new and separate outfit and costs only \$3.00. Look for it in the toy store.

If you cannot find CHEMCRAFT or CHEMCRAFT-MAGIC in your store, we will be glad to fill your order direct upon receipt of price. West of Denver, Colo., and in Canada, the above prices are 10% more.

### Send for Free Copy of the Club Magazine

A dandy book full of lively stories, ideas and news from boys and girls. It's the official Club magazine and will tell you what the Club is doing. Write for your copy now. It's Free.

**THE PORTER CHEMICAL COMPANY**  
Porter Products Put Science at Your Service  
115 Washington St., Hagerstown, Md.



Trade Mark Registered  
**WURLITZER**  
 200 YEARS OF MUSICAL INSTRUMENT MAKING

**Professional and Amateurs  
 Praise Wurlitzer Instruments**

"I am proud to be the owner of one of your new cornets. The tone, tune and valve action are positively superior to any I have experienced in all my years of cornet playing."

*Harry L. Jacobs*  
 (Soloist with Sousa's Band, Brooke's Marine Band, Chicago Grand Opera)

"If I could not get another like it, my Wurlitzer saxophone could not be bought from me for \$200.00."

*J. Russel David, Rockford, Ind.*

"Without your credit system it would have been impossible for me to own this beautiful instrument."

*Arthur M. Samp, Madison Wis.*



*Any Musical Instrument*

# On Trial

**W**URLITZER will send you *any instrument* for a week's trial in your own home. No obligation to buy—no expense for the trial—you do not risk a penny. Wurlitzer instruments are known the world over for artistic quality and excellence of workmanship. Used by the greatest musicians, bands and orchestras. The House of Wurlitzer has made the finest musical instruments for over 200 years.

## Easy Payments

Payments are conveniently arranged in small monthly sums—a few cents a day will pay. All instruments to you at lowest factory prices. Special combination offers on complete musical outfits—velvet lined case, all accessories, self-instructor, etc.—everything you need at practically the cost of the instrument alone.

## Send for New Catalog!

The greatest musical catalog ever published! Over 3,000 articles—every known instrument described and illustrated—many of them shown in full colors.

Wurlitzer has stores in over thirty cities, but no matter where you live, Wurlitzer is no farther than your nearest mail box. Send the coupon today!

**The Rudolph Wurlitzer Co., Dept. 1779**

117 E. 4th St., Cincinnati — 329 So. Wabash Ave., Chicago  
 120 W. 42nd St., New York — 250 Stockton St., San Francisco

Send me your new catalog with illustrations in color and full descriptions of every known musical instrument, also details of the Wurlitzer Free Trial Easy Payment Plan. No charge, no obligation.

Name .....

Address .....

(State musical instrument in which you are interested.)



Copyright 1922  
 The Rudolph Wurlitzer Co.





**C**OMPARING a Starrett Steel Tape with an old-fashioned woven tape is like comparing a 1922 sport model with the wheezing one-lunger that flourished in 1900.

Here's a tape that is guaranteed not to shrink or stretch, that is accurate and well made (you know Starrett quality) and is so handy to use you'll

wonder how you ever got along without it. Figures are unusually large and easy to read—clean cut on a jet black background. The foot measure beside each inch mark (see picture in lower left corner) reduces the chance of error still further. No broken finger nails or searching for a knife blade to open the handle—a slight pressure on the opposite push button (a Starrett feature) with hand or glove opens the handle instantly.

There's a Starrett Steel Tape for every purpose—for mechanics, builders, engineers, etc. Every tape is carefully inspected and tested before it leaves the factory.

If you want accurate measurements you need a Starrett Steel Tape. It will cost a little more than an ordinary tape but it's worth the difference.

*Write for Catalog No. 22 A.P. and the Supplement describing the new Starrett Tools*



## THE L. S. STARRETT CO.

*The World's Greatest Toolmakers  
Manufacturers of Hacksaws Unexcelled  
ATHOL, MASS.*



# Use Starrett Steel Tapes



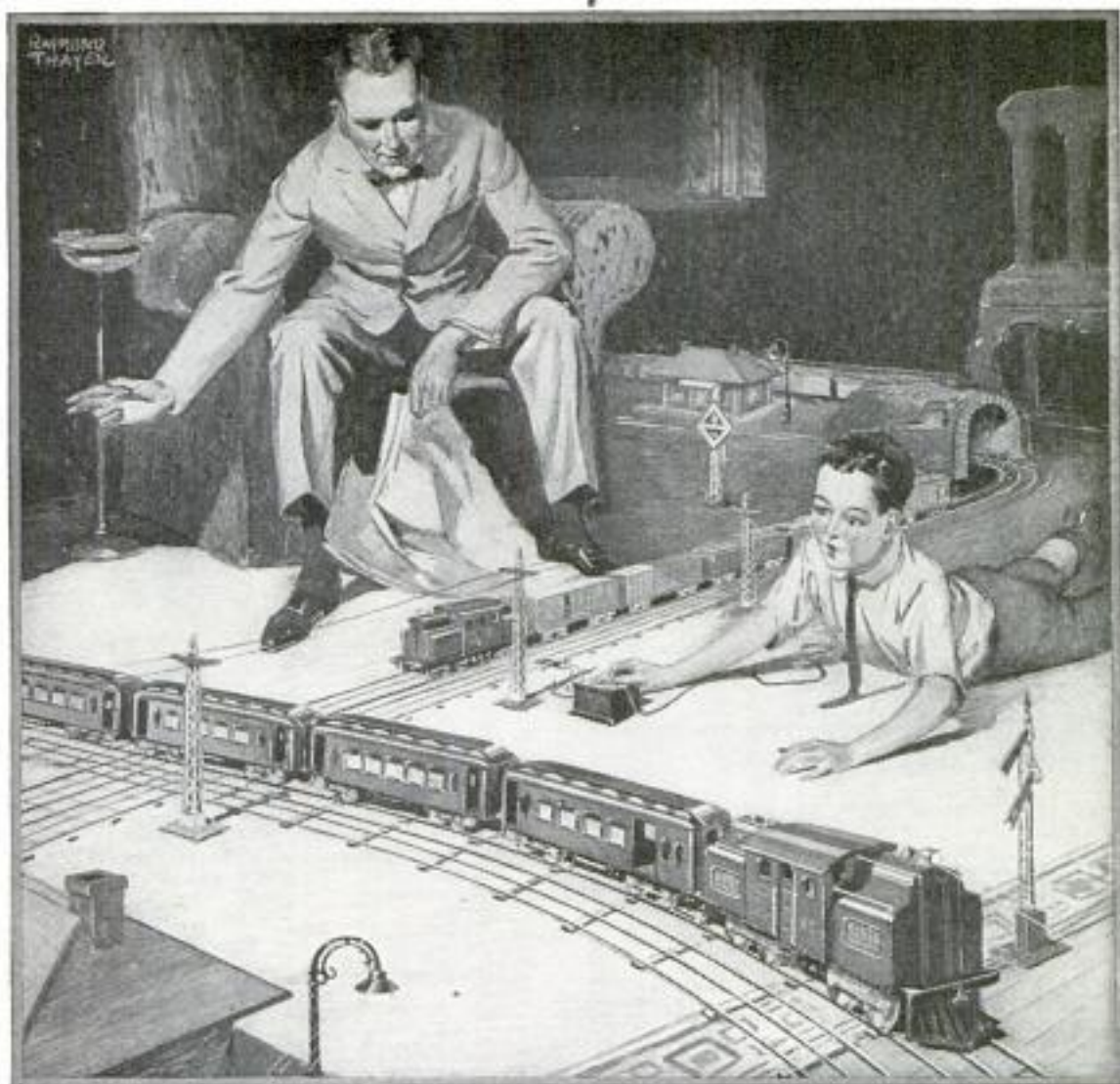

**J**UST look at this wonderful Lionel Outfit—with its “Twin-Motor” locomotive! Think of the fun of running a real railroad of your own with this big “Twin-Motor” locomotive that pulls twenty cars. The amazing thing is that a Lionel outfit with “Twin-Motor” locomotive costs no more than outfits of like size with single motor locomotives of other makes. (There are ten types of powerful Lionel single motor locomotives in addition to the “Twin-Motor.”)

Your Dad will be right with you on Christmas morning. He'll agree with you that only Lionel trains are good enough. He'll understand the superiority of Lionel one-piece all-steel car and locomotive body construction and the hand-enameled and baked finish of all Lionel trains—just like automobile finishes.

Lionel train outfits and accessories can be run from any electric light socket with a Lionel “Multivolt” Transformer—or from dry or storage batteries.

**Demand Lionel Trains at your dealers**—Be sure of satisfaction. There's a Lionel Outfit priced to fit every purse.

*Be sure to send post card for the handsome  
Lionel 40-page catalog printed in four colors.*

**THE LIONEL CORPORATION**

**52-C EAST 21st STREET  
NEW YORK CITY**

**LIONEL ELECTRIC TOY TRAINS**  
*& Multivolt Transformers*





## Make sure the tires are Vitalics!

**T**HAT'S the one thing thousands of boys who ride bicycles insist upon. They know from their own experience that Vitalic Bicycle Tires give long and satisfactory service.

Vitalic Tires are noted for their easy riding qualities and for the way they resist punctures and stand up under the hardest wear. That's why we say—

"Vitalic Tires are tougher than elephant hide."

Vitalic Tires are made in both Cord and Fabric type—they are standard equipment on many well-known bicycles, and they are sold and recommended by leading bicycle and tire dealers everywhere.

Insist on Vitalics. The extra service and satisfaction you get will be worth it.



Write us for this booklet. It tells an interesting story about bicycle tires.

CONTINENTAL RUBBER WORKS  
1938 LIBERTY STREET      ERIE, PA.

# VITALIC

TRADE MARK REGISTERED

# Bicycle Tires



TRADE MARK  
"Tougher than  
elephant hide"



# Santa Headquarters

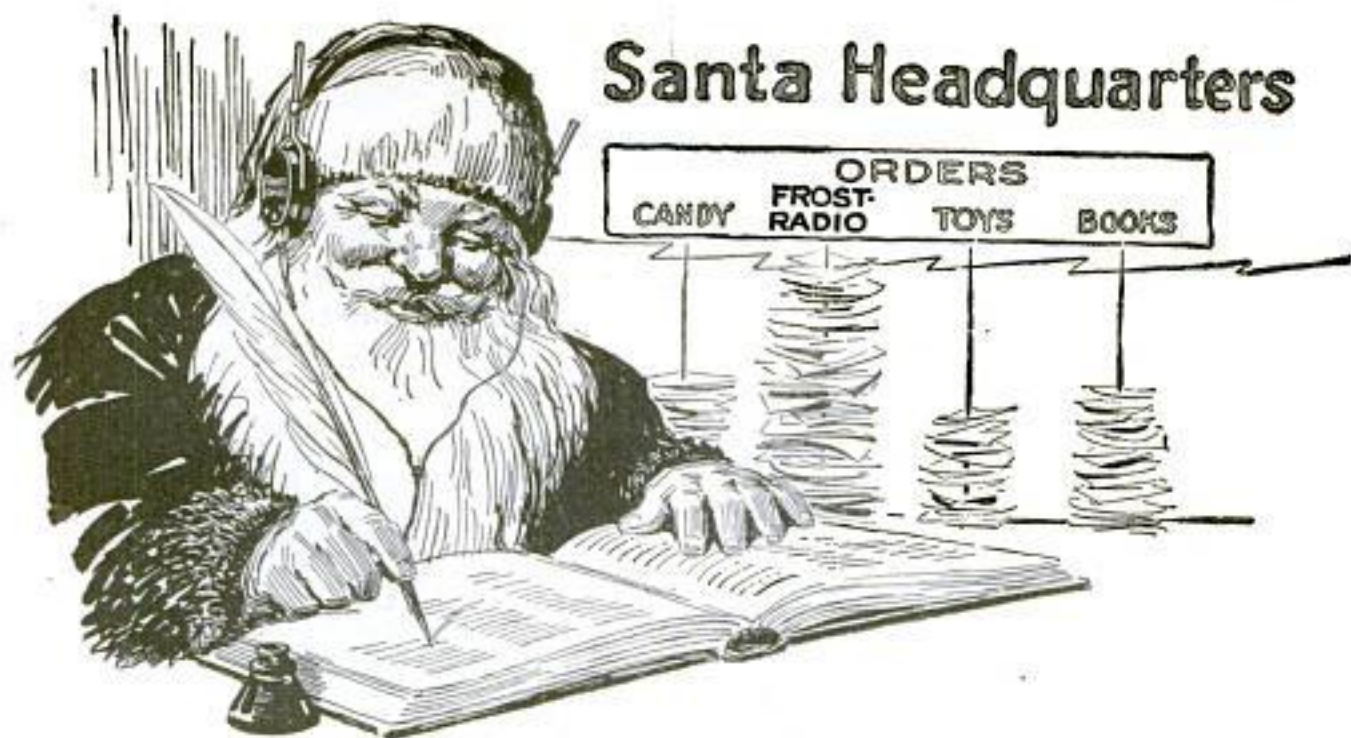

## Santa's Taking His Orders by Radio This Year —And They Are Demanding **FROST-RADIO**

These Radio accessories are the big hit of the season. They win the whole-hearted approval of every Radio "fan." The reason is simply that every item is built to perform best the particular function for which it is intended—priced to satisfying trade-holding levels and quality unsurpassed.

*FROST-RADIO is the Front Door Key to Radio Satisfaction!*

### **FROST-RADIO Plug!** Arrived In Time for Christmas!

This plug (shown below) will be the talk of the Radio field. Priced within reach of every purse. A handsome, highly finished, strong, light weight plug with conductive parts of machined brass. Handle is one piece and turned from solid insulating rod. Screw binding post terminals take cord-tips and terminals of all types. Adjustable brass thumb screws connect wire to plug and insure positive contact. No tools needed. Unnecessary to cut telephone tips. Not affected by body capacity and fits any standard jack. The new member of the Frost-Radio family.



No. 139—All Terminal Plug—60c



Showing screw binding post terminals with phone cord tips inserted.

### A New Plug for 60c!

Your Local Dealer Can Supply You



No. 162  
2000 Ohm  
Set.. \$5.00

No. 163  
3000 Ohm  
Set.. \$5.00



# HERBERT H. FROST

NATIONAL FACTORY DISTRIBUTORS  
TO THE ELECTRICAL-RADIO JOBBER

154 W. LAKE ST. CHICAGO, ILL.



# A Good Bookcase

for the price of a good book!



\$1.75 Per Section  
without Doors

With Disappearing  
Glass Doors \$2.75 Per Section

On Approval—Direct to User

## Lundstrom

IT GROWS WITH YOUR LIBRARY

### SECTIONAL BOOKCASE

Endorsed by Over 100,000 Users

Made for and universally used in the finest homes and offices throughout the country. Made in sections of different sizes, combining utility, economy and attractive appearance. Style shown above is beautifully finished in SOLID OAK. Price complete as shown with top, base and three book sections with non-binding, disappearing, felt-cushioned glass doors (Sections dust-proof) \$12.75. Price for same combination, without doors, \$9.75. Other styles in different grades and finishes at correspondingly low prices. Shipped direct from factory ON APPROVAL, at a considerable saving TO YOU.

Write for new catalog No. 21.

The C. J. LUNDSTROM MFG. CO., Little Falls, N.Y.  
Mfrs. Sectional Bookcases and Filing Cabinets

## HUNTING COATS

Made of 8 oz. olive tan duck; lined; front opening pockets, corduroy collar, three flap pockets, double stitched, strong and serviceable. Sizes 36 to 46.

2.95

GET OUR LOW PRICES

Other outdoor clothing for general wear at similar low prices. Write for FREE big catalogue 112 and winter supplement.

RUSSELL'S, Inc.

ARMY—NAVY—CAMP—SPORTING GOODS  
245 W. 42d Street New York



### PLUMBING & HEATING

Buy Direct—Save 50%

\$66.95 Complete Bathroom Outfit \$66.95

Send NOW for our FREE Catalog "A" of Wholesale prices

Satisfaction Guaranteed

LAMPLOUGH BEAUMONT COMPANY  
39 So. Portland Ave. Brooklyn, N. Y.

### THE AJAX EYELET FASTENER

BINDS AND INSERTS AJAX EYELETS IN PAPER, CARDBOARD, LEATHER OR CLOTH

It Saves Time by Punching the Hole, Feeding the Eyelet and Clinching It in One Operation.

Drop the eyelets into the magazine and go right ahead. Order from your stationer or direct.



PRICE WITH 1500 AJAX EYELETS. \$10.00 DELIVERED IN U.S.A.

Write for our catalogue of office tools

MACHINE APPLIANCE CORPORATION

351-353 Jay St. Spec. Dept. Brooklyn, N. Y.

### Agents—Big Money

Brand New Oil Burner



Fits any heating stove. Easy to install. No plumbing or pipe fitting necessary. Burns common (coal oil) Kerosene or distillate. Cheapest fuel known. Set burner on grate of stove—turn on oil. Regulate by valve. Simple, safe, clean. Nothing to get out of order.

Five Year Guarantee

A new invention that has perfected the method of burning oil in any heating stove. Our agents having wonderful success. No experience necessary. Work spare time or full time. Big money every day. Write for agency. Jennings Mfg. Co., Burner 226, Dayton, Ohio

Pepsodent

The New-Day Dentifrice

## 60% of Market Price

Will Buy Diamonds Here

This 3/4-1/16 Ct. perfectly cut diamond, a snag or blazer solitaire, at \$43.65 among bargains in our lists. See the many big amazing values some as low as \$50 per Carat, other higher per Carat bargains. This 35 year oldest largest Diamond Exchange firm in all the world lends money on diamonds. Thousands of unpaid loans and other bargains. Must sell NOW.

Why Pay Full Prices

Costs Nothing To See. Any Diamond sent for absolutely free examination at our risk. No obligation. No cost to you. Latest Listings—Unpaid Loans. Sent Free. Describes Diamond Bargains in Detail, gives cash loan values guaranteed. Exchanges unlimited exchange privilege. Write Today. Postal card will do.

Jos. De Roy & Sons, Only Opposite Post Office

1953 De Roy Building Pittsburgh, Pa.

This Ring \$42.65 3/4-1/16 Carat Perfectly Cut



# Win \$5,000



*Sam Ross  
Did!*

19 year old Sammie Ross, Hackensack, N. J., who won \$5,000 in a former Reefer Contest.

## \$10,000 Bank Guarantee

Producers and Consumers Bank  
PHILADELPHIA, PA.

To the Public:

E. J. Reefer has deposited \$10,000 in this bank to be used in awarding all the prizes in the "C" letter contest.

This Bank guarantees that no part of this \$10,000 will be used for any purpose until all the prizes have been paid by E. J. Reefer.

Very truly yours,

PRODUCERS AND CONSUMERS BANK  
by Benj. S. Bowman, Treasurer.

*Mrs. Young  
Got \$5,000*



Mrs. F. R. Young, of Girard, Pa., another winner of a \$5000 Reefer Contest Prize.

**How Many Objects in This Picture Can You Find Beginning with the Letter "C"**  
There is Cap, Cornet, Cane. How many more can you find? Write them down and send them in as soon as possible. See how easy it is. Everything is in plain sight. No need to turn picture upside down. This is a game of skill. Effort and perseverance will win.

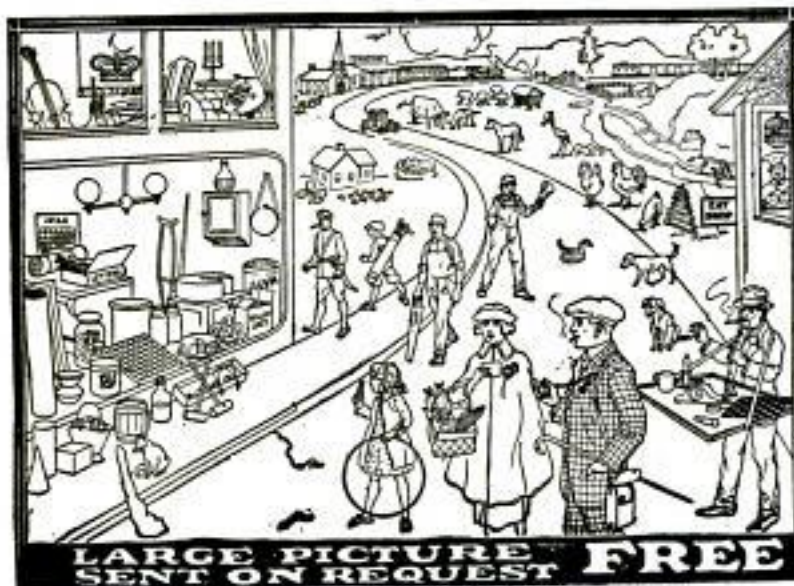

**LARGE PICTURE FREE SENT ON REQUEST**

## Costs Nothing to Try!

If you send in your list of "C" words and the judges decide your list is the largest which correctly names the visible objects beginning with "C", they will award you first prize in whatever column you qualify. If your list is second best list, they will award you one of the second prizes, etc. Get started right now.

## Win the \$5000

You don't have to buy anything to win a prize in this contest. If you have bought nothing, first prize is \$50. If you send in a \$1 order for either Washing Tablets or "More Eggs" Tonic, and win first prize, you get \$250. If you send in a \$2 order, first prize is \$600. But if you send in a \$5 order, for either product and your list is judged best, you win \$5000. Study the Prize List. See, there are 36 other prizes. Every prize in every column will be awarded. 40 in all, totaling \$10,000 will be paid.

## \$10,000 in Prizes!

|                          | If no order is sent | If a \$1 order is sent | If a \$2 order is sent | If a \$5 order is sent |
|--------------------------|---------------------|------------------------|------------------------|------------------------|
| 1st prizes               | \$50                | \$250                  | \$600                  | \$5000                 |
| 2nd prizes               | 35                  | 100                    | 250                    | 1250                   |
| 3rd prizes               | 30                  | 60                     | 125                    | 500                    |
| 4th prizes               | 25                  | 50                     | 75                     | 375                    |
| 5th prizes               | 15                  | 35                     | 50                     | 250                    |
| 6th to 10th prizes, each | 10                  | 25                     | 40                     | 100                    |

Every prize in every column will be awarded. 40 prizes in all, totaling \$10,000 will be paid.

## Observe These Rules

1—Any one excepting our employees and their relatives may enter this contest. There is no entrance fee of any kind.

2—All word lists must be received through the mail by E. J. Reefer, 9th & Spruce Sts., Philadelphia, Pa., and envelopes must be postmarked by post office closing time, February 15, 1925.

3—Contestants who have sent lists or orders before February 15th will be qualified for the higher prizes provided orders are received through the mail, postmarked on or before February 28th.

4—Only English words will be counted. Obsolete, hyphenated or compound words will not be counted. Only the singular or plural of a word may be used, but both singular and plural will not count. Each article or object can be given only one name. Single words made up of two separate words or objects, such as teaspoon, teaspoon, or teakings will not count. Webster's International Dictionary will be the final authority. Where several synonyms are equally applicable to an object shown in the picture, a person submitting any one of such synonyms will be given credit for one word only.

5—The largest list of words which correctly name visible objects beginning with the letter "C" will receive first prize, and so on down the list of prizes. The winning list will be made up from among the words submitted by the contestants and not controlled by any predetermined list of words selected by the judges, as being the "correct" or "master" list.

6—For each wrong word a percentage will be deducted from the total number of correct words.

7—Two or more people may co-operate in answering the puzzle. However, only one prize will be given to any one household or any one group.

8—You must use only one side of paper. You must number each page and object in a consecutive notation. Your full name and address must be written on each page in the upper right hand corner. An enlarged picture will be furnished free upon request.

9—The final decision will be made by three judges entirely independent of and having no connection whatever with the E. J. Reefer Company. They will judge the answers submitted and award the prizes at the end of the contest. Each participant entering this contest agrees to accept the decision of the judges as final and conclusive, without argument or question. All answers will receive full consideration, whether or not merchandise is purchased. At the close of the contest, when all lists have been graded, the list winning first prize and the names of the prize winners will be published, and a copy of such list and prize winners' names and addresses will be sent upon request to any participant who sends us a self-addressed, stamped envelope.

10—An additional prize of not over \$500 for promptness, as specified above, will be awarded.

11—In case of tie for any prize offered, each trying contestant will receive full amount of the prize so tied for.

## \$600 Extra for Promptness!

Your word list may be mailed any time up to February 15th, but every day before February 15th that your order is received, a special prize of \$10 for each day (not exceeding \$600) will be added if you win the \$5,000 prize. Send order today and word list later.

**Goods You Get** Either one of these products may be ordered to qualify in this contest, but combination orders will not be accepted.

**Washing Tablets** Take all the back-breaking work out of washday. Just use one tablet to a tub of water. Results will delight you. So simple and easy! Blues at the same time it cleanses. No wear on the daintiest garments. Dirtiest clothes come out whiter than before, with only 15 minutes work. No boiling. No toiling.

Family size \$1 Economy size \$2 Jumbo size, same as 7 large \$1 pkgs. \$5 prepaid . . .

"More Eggs" Tonic A scientific poultry tonic already used by half a million poultry raisers to increase egg production in Fall and Winter. Wonderful results produced. Two \$1.00 pkgs. \$1 Five \$1.00 pkgs. \$2 Economy size, or 20 \$1 pkgs. prepaid . . . \$5

**FREE**

Everyone, sending for a large size picture will receive, fully prepaid, sample package of a world-famous, exquisitely scented, high-priced Complexion Powder. Send for it.

**E. J. Reefer, 9th and Spruce Streets  
Dept. 1779 Philadelphia, Pa.**

No goods bought during this contest are subject to exchange, refund, approval or C. O. D.



# W. L. DOUGLAS

**\$5 \$6 \$7 & \$8 SHOES FOR MEN AND WOMEN**

are actually demanded year after year by more people than any other shoe in the world

**BECAUSE:** For style, material and workmanship they are unequalled.

Protection against unreasonable profits is guaranteed by the price stamped on every pair.

Years of satisfactory service have given them confidence in the shoes and in the protection afforded by the W. L. Douglas Trade Mark.



**W. L. DOUGLAS** shoes are put into all of our 110 stores at factory cost. We do not make one cent of profit until the shoes are sold to you. It is worth dollars for you to remember that when you buy shoes at our stores

**YOU PAY ONLY ONE PROFIT.**

No matter where you live, shoe dealers can supply you with W. L. Douglas shoes. They cost no more in San Francisco than they do in New England.

**COMPARE** our \$7.00 and \$8.00 shoes with any \$10.00 or \$12.00 shoes made.

If not for sale in your vicinity, send for free catalog.

**TO MERCHANTS:** If no dealer in your town handles W. L. Douglas shoes, write today for exclusive rights to handle this quick selling, quick turn-over line.

Boys Shoes \$4.00 & \$4.50

*W. L. Douglas name and portrait is the best known shoe Trade Mark in the world. It stands for the highest standard of quality at the lowest possible cost. The name and price is plainly stamped on the sole.*

*W. L. Douglas*

President  
W. L. Douglas Shoe Co.,  
125 Spark St., Brockton, Mass.



W. L. DOUGLAS  
PEGGING SHOES AT  
7 YEARS OF AGE.

## BIG BARGAINS IN BAND INSTRUMENTS



Check the instrument in which you are interested, and send us your name and address. We will send you only the best instruments, but give you the SERVICE that can be obtained only from EXPERIENCED BANDERS.

**THE DIXIE MUSIC HOUSE, 230 South Wabash Ave. CHICAGO**

- |                       |                             |
|-----------------------|-----------------------------|
| Flutes and Piccolos   | Alto and Soprano Saxophones |
| Clarets               | Trombones                   |
| Bassoons              | Euphoniums                  |
| Cellists              | Baritone                    |
| Saxophones            | Drums                       |
| Concerts and Trompets | Bells, Xylophones, Etc.     |

Name \_\_\_\_\_  
 Town \_\_\_\_\_ State \_\_\_\_\_  
 Additional Address \_\_\_\_\_

## SELF-FILLING INK PENCIL "INDEPENDENT"

Meets all requirements. Self-filling, non-leakable, safety cap. Attached clip. Smooth writing gold Style point.

Guaranteed Improved Fountain Pen. Eliminates fatigue. Promotes efficiency. Writes uniform. A business necessity.

\$2.00 by Mail

Your Name in Gold—25 Cents Extra

AGENTS WANTED

J. C. ULLRICH & CO., 161 Washington St., New York

## AGENTS BIG MONEY SURE

Taking orders for fastest selling Ford and Auto accessories manufactured. Browning, Ill., cleared \$20.40 first 3 hrs. Become General Agent. Sell to jobbers, dealers, car owners. Big profits. Strongly patented. No competition. Exclusive. Get into the big paying auto accessory business now. Write for samples today. Car owners, give make. Mr. Vixon, Suite 212, 716 Madison, Chicago

**STERLING**  
**30 DAY TRIAL**  
**FINE STROP FREE**

STERLING razors are hand forged from special cutlery steel, hollow ground, tempered and finished by experts. Thousands used by barbers and self shavers. We will send you a STERLING on 30 days trial. If satisfactory, costs \$1.07. If not, costs nothing. Barber's double swing household strop FREE with each razor. Write today. Sterling Company, Dept. 209 Baltimore, Md.

## Prophy-lactic Tooth Brush

Direct at Factory Prices

This \$2 KNIFE \$1.18 Postpaid  
 Hand Forged Razor Steel Blades  
 Handy shaped Blade makes this knife best for mechanics, sportsmen and farmers; light but strong; re-sharpened easily. Stag handle. German silver finish; blades file tested hand forged from razor steel and warranted.

Sample \$1.18 3 for \$3.00 Postpaid.

Send for our 100-page List and "HOW TO USE A RAZOR" **FREE**

MAHER & GROSH CO., 106 A St., Toledo, Ohio



A GENUINE \$2 KNIFE  
 FOR  
 \$1.18 POSTPAID



# A Real Gift—



Rex No. 11

**1" BROWN & SHARPE  
MICROMETER CALIPER**

*High Accuracy—Low Price*

**One you take  
pleasure in giving  
and receiving**

For the boy who is an apprentice, for the mechanic, toolmaker, technical student, automobile repair man, whom you want to remember, it makes an ideal, inexpensive gift whose accuracy daily helps him. A handy pocket case, leather covered, gives it an added Christmas appearance.

For yourself this Rex Micrometer makes an ideal gift. Suggest it to your friends when they ask you what you want. Our No. 28 Catalog showing our complete line of over 2000 tools sent to anyone interested in tools.

**BROWN & SHARPE MFG. CO.**

Providence, R. I., U. S. A.



## Agents

**L**ARGE MANUFACTURER OF SHIRTS wants Agents to sell complete line of shirts direct to wearer. Exclusive patterns. Big values. No capital or experience required. Write for free samples.

**MADISON SHIRT MILLS**  
507 Broadway New York, N. Y.

## HAWAIIAN IM. DIAMONDS



No. 8110  
Special price \$2.98

The Greatest Discovery the World Has Ever Known  
Just an advance from finest im. diamonds we will send you one of these 14K gold 1. rings, postage paid. When it arrives pay postage \$2.50 C.O.D. charges to cover cost etc. Only 10,000 rings given away. Money refunded if you can tell it from a genuine diamond. Head one of finger.

**KRAUTH & REED**  
Dept. C  
Masonic Temple Chicago



No. 9031  
Special price \$2.98

*Nu-Way*  
STRETCH

## Suspenders and Garters

Unequaled for Comfort and Long Wear. One Year's Lasting Stretch Guaranteed.

Thousands get two and three years wear.

Suspenders, 75c. Garters, 50c.

Ask Your Dealer—If he hasn't them, send direct giving dealer's name. Look for "NU-WAY" on buckles. Accept no substitutes.

**Nu-Way Stretch Suspender Co.**  
Dept. E412 Adrian, Mich.





**It Clamps  
Everywhere  
stands  
anywhere**

**The  
LAMP  
With the  
CLAMP**



Pat. U. S. A.  
Canada and Foreign  
Countries

## Adjusto-Lite

A FARBBERWARE PRODUCT

Adjusto-Lite is the handy, economical light for home, office, store, studio—everywhere good light is needed. HANGS—CLAMPS—STANDS. The name says it—it's quickly adjustable. A turn of the reflector sends the light exactly where you want it. No glare—no eyestrain. And—economy.

Solid brass; handsome, durable and compact. Clamp is felt-lined—can't scratch. 5-yr. guarantee. Complete with 8-ft. cord and screw socket with 2-piece standard plug.

Get an Adjusto-Lite today. If your dealer doesn't carry it order direct.

**S. W. FARBBER**

141 So. Fifth St. Brooklyn, N. Y.

Prices in U. S. A. and Canada: brass finish, \$5; bronze or nickel finish, \$5.50; West of Mississippi and Canadian Rockies and in Maritime Provinces, 25c per lamp additional.

TRADE MARK



## Roofing Book FREE

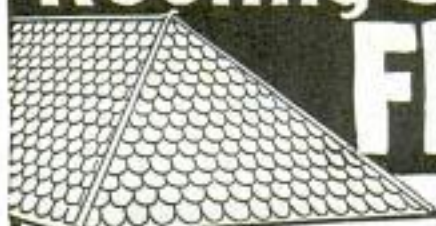

**World's**

### Best Roofing at Factory Price

Don't buy Roofing of any kind until you get our big Free Roofing Book, describing full line of Edwards Famous "Tightcote" Galvanized Roofings, Sidings and Ceilings, and our lowest factory prices. Then see for yourself how much we save you by selling direct and saving you all in-between dealers' profits.

### EDWARDS "REO" Metal Shingles

Absolutely rust proof. By our patented "Tightcote" process, edges as well as sides of metal sheets are heavily coated with zinc—not a space the size of a pin point exposed to weather. Fire and lightning proof. Outlasts three ordinary roofs. Forever wind and weather proof. Need no repairs—end all roofing expense. Patent INTERLOCKING DEVICE makes water tight seams—all nail heads covered—no chance for rust or leaks.

#### EDWARDS Galvanizing Test

Edwards "Tightcote" Galvanized Roofing can be bent, twisted or struck by lightning, and the galvanizing will not crack or flake. Bend it or hammer it—you can't loosen or scale the galvanizing. No other galvanized roofing can withstand this test.

#### Low Priced Garages

Wide variety of styles, all sizes of Portable Fireproof, Metal Garages. Lowest prices ever made. Postal brings Big Garage Catalog free.

Write Today for free samples and proof that we can save you a lot of money on any kind of roofing siding or ceiling you may need. Ask for Roofing Book No. 100.

**THE EDWARDS MFG. CO.,**  
1200-1250 Pike St., Cincinnati, O.

**FREE**  
Samples &  
Roofing Book



## MYSTERIOUS CHARM

Gold-Plated and Aluminum

**\$1.00**  
each

Write for free catalogue of Masonic publications, Jewelry and paraphernalia.

**REDDING & COMPANY**

200 Fifth Avenue Dept. P New York City

**Moore Push-Pins**  
Glass Heads—Steel Points  
**Moore Push-less Hangers**  
To hang up things  
Ask your dealer to show them  
Sold Everywhere **10¢** per packet  
Moore Push-Pin Co.  
Wayne Junction Philadelphia



## BURROWES

### Home Billiard & Pool Tables

Magnificently made in all sizes, at all prices. Game exactly same as standard table. Become expert at home. Use in any room, on any house table or on its own folding stand. Quickly leveled. Put up or down in a minute. Small amount down, easy payments. Ask your dealer or WRITE TODAY for Catalog.

**E. T. BURROWES CO., 52 Free St., Portland, Maine**



## GENUINE KEYSTONE MOVIEGRAPH

(PATENTED)

SHOWS BIG SIZE MOVING PICTURES

Safe for **\$9.89** Non-Inflammable Safety Films  
the Home — Wm. S. Hart — Chaplin — Tom Mix  
Machine and Four Reels Complete for **\$9.89**



Price for Machine  
and Reels \$9.89  
complete, prepaid.  
Genuine Keystone  
Moviegraph Patent-  
ed 1919, 1920, 1921

The following reels are included with each machine and are genuine, posed by the actors themselves. The film is the same size as used in the theatres.

- 1 Reel Charlie Chaplin in "Fun in the Bakeshop"
- 1 " Wm. S. Hart in "The New Sheriff"
- 1 " Tom Mix in "The Battle on Horseback"

Also Colored Slides, Drawing Slides, Theatre Tickets, etc., included. Every live boy should have at home or at your club a Keystone Moviegraph that shows pictures the same as in the movies with powerful French lenses and constructed along professional lines.

The Electric cord is included for connecting to any lamp socket your electric bulb will fit. Can also be had for easy Dry Cell Batteries for the home without electric current. Nothing to get out of order. No complicated parts.

We have the largest comedy film service in the country for home machines. Size of

machine all set up is 15"x9".  
Weight 3 lbs.

Send Money Order or check.

Guaranteed to give good big pictures or

your money back. Reference Commonwealth Trust Co., Boston, Mass. Order your machine today in time for Xmas.

**WARREN MANUFACTURING CO.**  
Dept. M

115 E Brookline St., Box 240, Sta. A, BOSTON, MASS.



*Hot lunch from an Icy-Hot  
makes the afternoon work go fast!*

**W**HETHER your job is inside or outdoors this cold weather you need something hot under your belt to keep the long afternoon from "getting you."

Have a piping hot, stimulating dinner from an Icy-Hot Lunch Kit! It warms you up, makes your blood move faster—and it's quitting time before you know it.

Take hot coffee, and stimulating hot soups, for lunch in your Icy-Hot Lunch Kit. Good hot home-cooked meals from your Icy-Hot mean plenty to eat at noon, and save you money.



The Icy-Hot Lunch Kit is all metal, built for real service every day, sanitary, easy to clean, and is sold and guaranteed by dealers everywhere. Send coupon for Icy-Hot catalog.

**THE ICY-HOT BOTTLE CO.**  
195 West Second Street, Cincinnati, Ohio.

## ICY-HOT VACUUM PRODUCTS

Made in America, of American Material, by American Labor. Built for Lifetime Service

The Icy-Hot Bottle Co.  
195 W. Second St., Cincinnati, Ohio  
Please send complete catalog of Icy-Hot products.

Name \_\_\_\_\_  
Street and No. \_\_\_\_\_ State \_\_\_\_\_  
P. O. \_\_\_\_\_

**KEEP CONTENTS HOT 24 HOURS; COLD 3 DAYS.**

Please Mention Popular Mechanics

**MONEY  
IN  
MUSHROOMS**

**NOW TIME TO START**

**BIG DEMAND. HIGH PRICES BEING PAID**

An uncrowded occupation. Exceptional opportunities for live men and women. Raised at home. Only small space needed. Small expenditure will start you in a profitable money-making enterprise. No need to. Booklet telling all free. Write

**Nat'l Spawn Co., Dept. 12, Waban, Mass.**

## GREATEST WONDER

THE ONLY GENUINE INSTRUMENT!  
Latest European Invention.  
Become Popular. Play  
this JAZZY FLUTE!  
Wonderful tone

No Lessons  
Required. Great  
Entertainment for Parties  
**15 POPULAR SONGS FREE**  
SEND NO MONEY. Pay Postman on arrival.  
B. B. ORIOL CO. 15 PARK ROW, N.Y.C. 1003

**PLAY IT WITHOUT LEARNING**

# WINDOW SIGNS



## AGENTS

\$60-\$200 a week. Free  
Samples **GOLD SIGN  
LETTERS** for store  
fronts and office windows.

Anyone can put them on. No experience necessary. Big demand.  
LIBERAL OFFER TO GENERAL AGENTS.  
**METALLIC LETTER CO., 433B, N. Clark St., CHICAGO**





### Get This Wonderful Ring. If You Can Tell It From a Genuine Diamond Send It Back

These amazing, beautiful CORODITE diamonds positively match genuine diamonds in every way—same blazing flash and dazzling play of living rainbow fire. They, alone, stand the diamond tests, including terrific acid test of direct comparison. Lifetime experts need all their experience to see any difference. Prove this yourself.

#### Wear a Corodite Diamond 7 DAYS FREE

Make this test. You risk nothing. Wear a genuine Corodite and a diamond side by side on the same finger for 7 days. If you or your friends can tell the difference, send it back; you won't be out a single penny. That's fair enough. If you keep the ring, price printed here is all you pay. No installments. Remember, Corodites alone have the same cutting as genuine stones.

No. 1—Ladies' Tiffany Style 14K Gold S. Ring . . . . . \$2.94  
 No. 2—Gents' Heavy Bolivar 14K Gold S. Ring . . . . . \$3.48  
 No. 3—Gents' Masonic Emerson Gypsy Ring . . . . . \$3.27  
 No. 4—Ladies' Hand-Carved Basket Setting, platinum finish . . . . . \$3.96  
 No. 5—Ladies' Tiffany Orange Blossom Engraved . . . . . \$3.34

Carat size gems. Beautiful mounting of most modern design. Choice of gold or latest white platinum finish. Unqualified 20-year guarantee. Hand some of leather case free with each ring.

**SEND NO MONEY** Keep your money right at home. Just send name, address and number of ring wanted and size as shown by slip of paper, fitting end to end around finger joint. Your ring will come by return mail. When ring arrives deposit amount shown above with postman. If you decide not to keep ring after 7 days' wear, send it back and your money will be immediately returned. Send today.

**E. RICHWINE CO.**

333 S. Dearborn Street, Dept. 364, Chicago, Illinois  
 Sole Importers Genuine Corodite Diamonds

# \$1,860.40

in 60 days

Made by four box ball bowling alleys in a town of

8,000 population. This shows the possibilities of this marvelous new bowling alley. Scores of people are doing as well. The game is fascinating. Everybody plays. Go in to this business for yourself and make these big profits. Little money required. We help you start.

#### Box Ball Bowling Pays Big Profits!

Big profits. Small expense. No pin boys, no helpers, alleys automatically operated. Games are played fast, no delays, quicker profits, quickly installed. Start in a vacant store room.

Box ball is better than bowling, cost less than half to install. Great game for bankers, lawyers, merchants, doctors, clerks—men and women, too. Fun, excitement.

Pay as you earn.

Reasonable down payment starts you on the opportunity of your life-time.

Get in on this wonderful proposition now and soon be independent.



Write Today—  
 Postcard or  
 Letter.

**HOLCOMB & HOKE MFG. COMPANY**  
 3100 Van Buren Street Indianapolis, Ind.

## AGENTS: \$60 A WEEK



taking orders for guaranteed  
 hosiery for men and women.

All styles, colors and finest line of silk hose.

**GUARANTEED ONE YEAR** Must Wear 12 Months or replaced free

Often take orders for dozen pairs in one family. Permanent customers and repeat orders make you steady income. Whether you devote spare time or full time, it will pay any man or woman to handle this line. No experience necessary. Get started at once. This is the best season of the year. Write quick for samples.

**THOMAS MANUFACTURING CO., H-248, Dayton, O.**

## STOPS LEAKS

### SMOOTH-ON IRON CEMENT NO. 1

stops leaks, cracks and breaks in pipes, stoves, furnaces, sinks, kitchen utensils, etc.



You can make lasting repairs with Smooth-On around the home and garage, easily and quickly, at a considerable saving of time and money.

Write for FREE Book and learn how.

Sold by Hardware and General Stores in 6 oz., 1 lb., and 5 lb. tins. Also in larger sizes.

**SMOOTH-ON MFG. CO.**  
 Dept. 27-A, Jersey City, N. J., U. S. A.



**1000 SHOT  
 ALL STEEL  
 MAGAZINE  
 AIR RIFLE**

**WE GIVE  
 TO BOYS  
 WITHOUT COST**

**HAMILTON  
 22 CAL.  
 HUNTING  
 RIFLE**

Choice of six guns (on four easy plans) for selling our Magic Healing Wave-lens at 25c box. We Trust You! Order Seven Boxes Today On Postal Card—we send promptly, prepaid. Easy to sell—used in every home. Return money as instructed, choosing your gun according to one of the plans shown in our Big Premium List. Also 200 other Gifts or Big Cash Commission if you prefer. If you are prompt, a special Free Gift.

Waverly Co., 218 Towner Bldg., Monongahela, Pa.

### EVERY TOOTHBRUSH FAILS BETWEEN TEETH



This new Ivory device called "Smo" cleans the 30 danger spaces BETWEEN TEETH where 90% of all FATAL decay starts—Also prevents Bad Breath—Non-metallic—Safe—Avoid toothpicks—Price only 50c complete—Lasts a lifetime. New 4 months tins 15c. In Genuine Pyralin Ivory Finish with Leather Pocket case \$1.00—In gold case \$2.50. Special Agents Assortment only \$1.50. News Free. Nearly a million sold. Profits over 100%. Dental Book Free.

**FLOSSY DENTAL CO., (Dept. 20) Evanston, Ill.**

## AGENTS BRAND NEW KNIFE SHARPENER

Here's the simplest and most practical Knife Sharpener ever invented. Puts a keen edge on any kind of knife. Wonderful Seller—every home wants—show it—a sale is made. Big profits for hustlers—easy to make \$2.00 an hour. 350 other fast selling Household Articles. Get the Agency—your chance to clean up. Write quick—today—territory going fast.

**The American Products Co.**  
 7225 Third St. Cincinnati, O.





# Every Boy's IDEAL Airplane

3 1/2 ft. Wing Spread  
Weight 10 1/2 ounces

No Tools  
No Nails  
No Wire  
Needed  
to Build



## BOYS A New Idea in Model Airplanes for Boys!

The Simplest, Easiest to Make and Most Perfect Flying Toy Airplane Ever Made. Every Boy can Clip the Parts Together; No Tools Needed; and Have this Airplane in the air in Two Hours!

EVERY Boy can now have a lot of fun flying his own model Airplane without trouble building it. If you have hesitated to tackle the job of building your own Airplane, here's your chance to get one with all the difficult work done for you.

You need only clip the ready-formed parts of "Every Boy's" Airplane together, put on the covering and your plane is finished. All the hard work is eliminated. No staining and bending wood parts; no plans to follow; no nails, wire, glue or tools needed. This is a strong, sturdy Monoplane Type Airplane, made largely of aluminum and when finished will look like the picture above. Guaranteed to rise from the ground by its own power and fly in the air. Comes in a handy box with complete instructions for assembling and flying.

Costs only \$5.00—at your Dealer's or Direct from Factory (In Denver and West of Denver—\$6.50)

Ask at your Toy Store for "EVERYBOY'S" Ideal AIR-PLANE, or we will fill your order direct upon receipt of price.

### Plans for IDEAL Models of Famous Planes

For Boys who want to completely build their own 3 ft. Model Aeroplanes, we have IDEAL Scale Drawings and Building and Flying Instructions for the following:

Curtiss JN4D-2 Training Plane; DeHavilland Battle Plane; NC-4 Naval Seaplane; Curtiss Military Transport; Bleriot, Nieuport or Taube Monoplane; also Cecil Peall Racer

IDEAL Catalogues of Plans, Parts and Supplies for Model Aeroplanes sent postpaid for 2c. Lists all kinds of Flying Toys for Christmas. Send for your copy today.

**25¢**  
EACH  
POSTPAID

### IDEAL AEROPLANE & SUPPLY CO.

159 Wooster St., Cor. West Houston St., New York City

## New Mint Vending Machine Makes You \$10 to \$20 a Day

Pays Rent for Store Owner

Install one in your store or any public place and get this easy profit. Requires no attention. Always works. Machine's profits pay the rent. Write us about rebuilt penny and nickel machines. Finished like new. In excellent running order. Pay their cost in 10 days.

Write or wire today for full particulars. \$25 down payment. Balance C. O. D. Mints \$15 per case—1,000 5 cent packages, \$2.50. Single boxes, 100 5 cent packages, \$2.50.

SILVER KING NOVELTY CO.  
400 Williams Bldg. Indianapolis, Ind.



The  
**Ingersoll**  
TREE

Look for it in Store Windows

THERE'S no gift like a watch, nothing used so much, consulted so often, carried so long.

The Ingersoll you give now will be ticking Christmas Greetings next July—next September, and so on through the years to come.

Your dealer can show you Ingersolls to fit every purse and purpose. Sizes for men, women, boys and girls. Radiolite dials that tell time in the dark. Jeweled models in nickel and gold-filled cases.

Prices \$1.50 to \$9.00

Ingersoll Watch Co., Inc.  
New York San Francisco Chicago



INGERSOLL  
YANKEE  
\$1.50



INGERSOLL  
WATERBURY  
\$4.00



## TYPEWRITERS

We Save You 50%

FREE TRIAL—EASY TERMS

Your choice of all STANDARD MAKES, UNDERWOOD, EGYPT, SIKES, L. C. SMITH, Best starting RIMINGTON, etc. Rebuilt by the Famous "Young Process." Guaranteed good as new. Lowest cash prices. Time payments or rentals with special purchase privilege. Largest stock in U. S. Write for special prices and terms.

YOUNG TYPEWRITER CO., Dept. 480 CHICAGO



GREEN  
AUTOMATIC  
MACHINE



## ADD TO YOUR INCOME

WITH LITTLE EFFORT  
\$5 to \$10 A DAY MADE  
EASY WITH

## New Improved Green Automatic Machine

Sharpens, Honors and Strops all kinds of safety razor blades, in one operation, from four to six blades per minute. For both Quality and Quantity, this machine is in a class by itself. There is nothing like it on the market. Let us send you our descriptive literature explaining everything, including the "AMERICAN" Key Cutter—cuts square, angular or round slots.

AMERICAN SHARPENING MACHINE CO. (Inc.), Dept. 12, 114 W. Washington St., CHICAGO





**1/2 SAVED****BUY  
DIRECT  
GET BIG BOOK**

## DO YOUR OWN PLUMBING & HEATING AT LOW COST

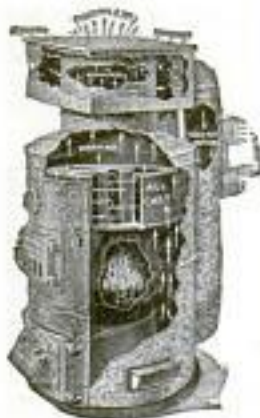

Pipeless Furnace

Send for our big instructive 250-page well-bound **HANDY-MAN Book-Catalog**. Every home-owner, contractor, farmer, mechanic, institution, etc., needs it. Shows over 10,000 fixtures and supplies in plumbing and heating at wholesale; how to save skilled labor, hard work and unnecessary material by our new

### Cut-To-Fit Method

This wonderful encyclopedia on plumbing and heating helps you select and install the proper plumbing, water system, hot air, water or steam plant. Besides being our wholesale catalog, it has many practical plans, diagrams, sketches, elevations, handy hints, etc., showing how to do the work this newer easy way. Any handy man with a few tools can do his own installing with the aid of this

### Big Handy Man Book

We have spared no effort, and have gone to a **GREAT EXPENSE** to compile this valuable book, and to keep from sending it to uninterested persons, we request 25c, which will be refunded on your first order, or send for our free bulletin.

Write today and save.

**HARDIN-LAVIN CO.**  
50 Years at 4547-4557 Cottage  
Grove Avenue, CHICAGO

\$500,000 Plants Behind  
Our Guarantee



Hot Water Boiler

### Fibre-Lite Limbs

Easy Payments—Do Nature's Work.  
**AGENTS WANTED** who use Artificial Leg. **GOOD PAY.**  
FREE Fibre Sample. **WORMAN CO.** 252-P HENNEPIN AVE.  
DESCRIBE STUMP TO **MINNEAPOLIS, MINN.**

Only  
**\$2**  
Down

Play Well in  
4 Weeks

—Ten months to pay

Write for Free Catalog Folder telling all about the **Masterbilt**—the world's finest Saxophone outfit. Price now (lowest ever quoted—5 days' trial—very easy monthly payments. No interest to pay—no extras. Outfit includes finest make, trimmed and richly lined Case, Instruction Book, Album of Popular Saxophone Solos, Music Lovers, Carrying Case, Mouthpiece and three fine Reeds.

### "Masterbilt" Saxophones

Used by leading Bands and Orchestras. Highest quality, built in perfect tune, assembled and tested by experts. All latest key improvements, light, quick action and beautiful finish. Write today for **FREE** Catalog Folder fully describing these handsome **Masterbilt** outfits.

The Saxophone Shop, 429 S. Wabash Ave., Chicago  
Largest Exclusive Dealers in Saxophone Supplies in the World

## 300 Candle Power Light From Common Kerosene or Gasoline



A steady white light more brilliant than city gas or electricity at a fraction of the cost.

**EQUIPPED WITH AUTOMATIC CLEANING NEEDLE** Makes and burns its own gas. Safe, simple and easy to operate.

**OUR AGENTS MAKE BIG MONEY**

selling our complete line of lamps, lanterns, lighting systems, tanks and **Doud Kerosene Oil Gas Burners for Cooking and Heating.**

Write for full particulars and **FREE TRIAL OFFER.**

**DOUD LIGHTING CO.**  
1458-1461 Congress St., Chicago



## BALBA bouquet perfume



Get Our Money-Making Agency Offer  
**Balba Sales Machines**  
Make \$200 to \$1000 Monthly

This new plan of selling high quality perfume has taken the country by storm. Men everywhere are jumping at the opportunity to get into this big money-making field.

Over 500 Cities Already Taken

Remember the first who qualify get the exclusive sales rights. We do the local newspaper and national advertising. Get full particulars **NOW.**

**BALBA CORPORATION of AMERICA, Inc.**  
Dept. 44, Adams and Jackson Sts.  
TOLEDO, OHIO, U. S. A.

## ALCOHOL DISTILLED FROM FARM PRODUCTS

A practical handbook containing description of the processes of Malting; Mashing and Maseerating; Fermenting and Distilling Alcohol from Grain, Beets, Potatoes, Molasses, etc., with chapters on

**Alcoholometry and the DENATURING OF ALCOHOL** for use in Farm Engines, Automobiles, Launch Motors, Heating and Lighting, with a Synopsis of the New Free Alcohol Law and its Amendments and the Government Regulations. **Price \$2.50 Prepaid.**

**FREE**—Write for Illustrated Catalog and Recipe Booklet R-108  
**HAGEN IMPORT CO. of PENNA., 42 North 8th St., Phila., Pa.**

## Are YOU Old at 40?



A very common cause of early old age is the disturbed condition of an important gland. Even big strong men are not exempt from this serious irregularity. Our plainly written, interesting educational

### FREE BOOK

"Why Many Men Are Old at Forty" may bring a priceless message to you. It tells of a simple sensible way by which thousands have corrected this prostate gland condition. It tells how sciatica, backaches, foot pains, interrupted sleep, mental depression, etc., are so often due to this gland. Sold for over five years upon a money back-if-not-satisfied plan. Do not confuse it with massage, medication, violet rays, etc. No obligation. Write today.

**The Electro Thermal Company** **Thermalaids**  
2116 Main St., Steubenville, Ohio



The Second Edition of These Wonderfully  
Helpful Charts Now Ready for Distribution

## LOWER GOLF SCORES

Insured by

### STRAIGHT LINE GOLF CHARTS

Used by crack players as well as beginners. Easily understood. Drawings show use of every club. How to slice or hook—how not to—how to drive high or low ball—push shot—chip shot—pitch and run—out of sand—hand and foot positions. All golf shots made easy.

Just send \$1.00 to  
**Straight Line Golf Charts**  
12812 Forest Hill Ave. E. Cleveland, O.

## THIS WONDERFUL INVENTION



converts any cook stove into a gas stove. Oxo-Gas made from kerosene and air is cheaper, cleaner and more efficient than coal. Send for catalog illustrating Oxo-Gas appliances for all purposes where coal is used. We have openings for General Sales Managers and distributors. Only those who can finance themselves considered.

Gas appliances for all purposes where coal is used. We have openings for General Sales Managers and distributors. Only those who can finance themselves considered.

### GLORIA LIGHT COMPANY

111-119 N. MAY ST. CHICAGO, ILL.

## Standard Typewriters

Save \$25 to \$60.



\$3.00 Down—Balance \$5.00 Monthly

Underwoods, Royals, Remington—all makes. Rebuilt in our factory; practically good as new. Every machine guaranteed. Prices now lower than ever! Write for Special Bargain List and particulars on 3-day Free Trial. Write today!

WYNN TYPEWRITER EXCHANGE  
12 Reliance Bldg. Kansas City, Mo.

FREE TRIAL ~ Write Today!

## Beautiful HOUSES \$900 and BUNGALOWS

CAN BE BUILT FOR AND UP  
This and many others in my new book, Building Plans for Modern Homes, will save you hundreds of dollars. One of the most complete and comprehensive books of plans ever published by any architect. New edition just off the press. Nearly 500 floor plans and photographs of bungalows, Colonial houses, etc. costing from \$200 up; gives sizes and cost to build.



FREDERICK H. GOWING  
ARCHITECT

Sent postpaid for \$2.00 161 Tremont St., BOSTON, MASS.

## MUSIC LESSONS FREE

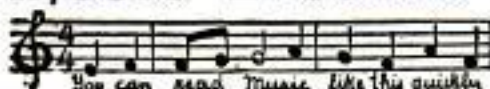

IN YOUR  
OWN  
HOME

Piano, Organ, Violin, Mandolin, Guitar, Banjo, etc. Beginners or advanced players. One lesson weekly. Illustrations make everything plain. Only expense about 2c per day to cover cost of postage and music used. Write for FREE booklet which explains everything in full.

AMERICAN SCHOOL OF MUSIC, 50 Lakeside Building, CHICAGO

## WHITE FLAME

BURNERS make your old kerosene lamps and lanterns give a brilliant, white light better than electricity or gas. Doubles your light. Saves oil. NO MANTLE TO BREAK. Guaranteed Safe and Reliable. Delights every eye. Send now for complete sample postpaid 50 cents, stamps or coin. 2 for \$1.25. Money Back if Not Satisfactory. Live Representatives Wanted. Exclusive Territory. WHITE FLAME LIGHT CO., 68 Clark Bldg., Grand Rapids, Mich.



# DIAMONDS

# WATCHES

## LOFTIS

BROS. & CO. EST'D. 1858

Credit at  
Cash Prices

The Best  
Christmas  
Gift of All  
AGENUINE  
DIAMOND

We import Diamonds direct from Europe and sell direct to you. Our immense buying power is your gain. Customers testify to Loftis Values. Your interests are safeguarded when you deal with Loftis. Satisfaction Guaranteed or Your Money Refunded.

Send for  
Christmas  
Catalog

Over 2,000 illustrations of Diamond-set Jewelry, Watches, Wrist Watches, Pearls, Mesh Bags, Silverware, etc.—gifts by which you will always be remembered. There is something appropriate for everyone. Select as many articles as you wish and have all charged in one account. Sent prepaid for your Free Examination. Liberty Bonds Accepted.

Descriptions of  
Articles Shown

The Genuine Diamonds in these Rings are brilliant, blue white, perfect cut, of gorgeous color and luster. All White Gold mountings are Solid 18-Karat; Green and Yellow Gold mountings are Solid 14-Karat. WE INVITE COMPARISON OF QUALITY AND PRICES.

Pearls  
for  
Gifts

LIBERTY  
BONDS  
ACCEPTED

DIAMOND RINGS: 1—White Gold, \$125. 2—White Gold, or Green Gold with White Gold prongs, \$201. 3—White Gold, \$100. 4—White Gold, \$125. 5—Cluster, Yellow Gold, Diamonds set in Platinum, \$100. 6—Platinum, 5 Diamonds, \$150. 7—Yellow Gold, \$50. These rings can be furnished at other prices to suit your requirements. 8—WEDDING RING, Platinum, \$25; Solid Gold, \$5 up. 9—Green Gold filled, 17 Jewels, \$25. 10—18-k White Gold, 17 Jewels, \$29; 14-k, 15 Jewels, \$22. 11—Watch, chain and knife, gold filled, 12 size watch, 12-Jewel heart, guaranteed 25 years, \$28.50. 12—"Blue Bird" Pearls, 18 in., \$10 to \$20; 22 in., \$12.50 to \$22.50; 24 in., \$12.50 to \$25; same with Diamond-set clasp, \$15, \$18, up.



**LOFTIS** THE OLD RELIABLE ORIGINAL  
CREDIT JEWELERS  
Dept. G-894  
BROS. & CO. EST'D. 1858 108 N. State Street, Chicago, Ill.  
Stores in Leading Cities

Credit terms: One-fifth down, balance within eight months.

Please Mention Popular Mechanics





Queen Anne  
Cane Rocker

## Useful—Beautiful For 2 Dimes a Day

Beautifully upholstered in Blue or Mulberry Striped Velour Sofa and Chair to match. Get our big, helpful, 104 page Larkin Book of Better Homes. Shows this Rocker and 1200 other desirable furnishings. This beautifully illustrated Book has guided thousands to coaly furnished homes. Convenient monthly payments. Check below offer interested in.

### Lower Prices Now On

- Furnishings  Symphonic Player Pianos  
 Symphonic Pianos  Symphonola Phonographs  
(Check offer and mail ad Today)

Let us quote our money-saving Factory-to-Family prices on these Furnishings and famous Musical Instruments.

### 1 to 4 Years Time to Pay

Mail this ad—check offer—and give full name and address NOW for Big FREE Book.

*Larkin Co Inc.*

Dept. FPM-1222 BUFFALO, N. Y., Peoria and Chicago, Ill.



## "Lighting Fixtures"

READY TO HANG

(Direct from Manufacturers)

Completely wired, including glassware. New designs. Send for catalogue No 24. Send for DEALERS' proposition.

**ERIE FIXTURE SUPPLY CO.**

STA. A. ERIE, PA.

## Can You Sell Coal at 1/2 Its Market Price?

The opportunity is here. Cash in on it. You practically sell coal at reduced prices by becoming distributor for the CROWN Fuel Saver.



### Easy to Sell

Easy to install. Saves at least 20% of fuel. Fits any furnace or boiler door (see illustration). Thousands in use. Users claim fuel saving up to 50%. The principle of this efficient fuel saver endorsed by U. S. Government.

Put yourself on a paying basis. Establish a permanent, profitable business. Distributors backed by advertising and selling helps. Exclusive territory. Write or wire for details.

CFSCO, 15 N. 10th St. Richmond, Indiana

## Burns Water in Autos

Amazing scientific invention. Uses water gases with present carburetor. Oxygen dispels carbon, hydrogen exploded for power. **Astounding, unbelievable results.** Carbon deposit eliminated. No plug cleaning, no carbon cleaning, no valve grinding. **Mileage increased 1/3 to 1/2. FORD CAR MADE 32 MILES ON 1 GALLON.** Other cars equally good. A scientific device of genuine merit approved by highest engineering authorities. Sent on 30 days' trial. **Car owners, write me for one today.** Give make of car and carburetor. Address **WALTER CRITCHLOW, Inventor, Suite 206, 716 MADISON, CHICAGO**



## Buchstein's Fibre Limb

is soothing to your stump—strong, cool, neat, light. Easy payments. Braces for all deformities.

Send for Catalog Today

**D. BUCHSTEIN CO.**  
113 5th St. S., MINNEAPOLIS, MINN.

## "Best" Hand Lantern



A powerful portable lamp, giving a 300 candle power pure white light. Just what the farmer, dairyman, stockman, etc., needs. Safe—Reliable—Economical—Absolutely Rain, Storm and Bug proof. Burns either gasoline or kerosene. Light in weight. Agents wanted. **Big Profits. Write for Catalog.**

ADOPTED BY THE U. S. GOVERNMENT  
**The Best Light Co., 324 E. 5th St., Canton, O.**

## Why Pay What Others Save?

No one can make better stoves, ranges and furnaces—than Kalamazoo. And no one can give you more for your money than manufacturers dealing direct with you from the factory.

**Write for the Kalamazoo Catalog** and just find out what wonderful bargains you can get this year in our new designs—blue and gray porcelain enamel ranges—beautiful heaters, etc. Also new pipeless furnaces \$52.95 and up. 400,000 pleased customers. Cash or easy payments. 30 days' trial—**money-back guarantee.** Ask for Catalog No. 473

**"A Kalamazoo  
Direct to You"**

**KALAMAZOO STOVE COMPANY**  
KALAMAZOO, MICH.



24-Hour  
Shipments



# 345 3 Piece SUIT MADE TO ORDER SAVE

To prove our unbeatable values and get your steady trade, will make 3-piece suit consisting of coat, pants and vest to your measure for only \$13.45. Style shown in the picture or any one of 156 style combinations to select from. Absolute satisfaction guaranteed or every penny back—quick.

## NO EXTRA CHARGES

You pay just what we say, not one penny of extras for anything. We even pay all postage and express. You save one-half—like before the war.

## Earn \$60 Cash Weekly

You can take orders easy for these clothes in spare time and make \$1000 a year and up at home. Friends and neighbors buy an eight. Young Fred Green made \$174.50 in seventeen days. **SEND NO CASH.**

## FREE—BIG SAMPLES

New samples show latest styles and 50 real cloth samples. Buy at inside Wholesale prices. Write now for Big Free Outfit.

**WASHINGTON TAILORING CO.**  
Wholesale Tailors Dept. M-345 Chicago



## The hard solder for tough jobs— Briggs Silver Solder

1 oz. Tape—5 ft. long,  $\frac{3}{4}$  in. wide, 3/1000 in. thick, in non-waste, metal box, \$1.25

**J. Briggs & Sons Co., Mfrs.**  
67 Clifford St. Providence, R. I.

## ALVAN CLARK TELESCOPES

Famous throughout the world as the highest grade Astronomical and Terrestrial Instruments. Now bringing to you at a reasonable price, these wonderful instruments—a source of pleasure and education—for the home—the school—the college. Send for circular and prices.

**ALVAN CLARK & SONS CO.**  
Makers of the great "VERRES" and "LICK" Telescopes  
55 Henry Street Cambridge, Mass.



## MAKE YOUR FORD INTO THIS SPORT CAR \$ ONLY 6.40

Other types down to \$7.50. Famous wire fit, *Red-Red* life-size patterns and simple picture instructions show how. You can easily convert your Ford into this fast, sexy Sport Car as hundreds have done with a few dollars worth of material from the hardware store. No need to lay up the car. The "PAL" with optional disc wheel patterns. Pressed Metal Streamline Rear only \$6.40 delivered. Built low, rides wonderfully easy. Order NOW while we can make good delivery. Send 5c coin for illustrated prospectus of Sport Reduc "Zifty".



## MOTORCYCLE BARGAINS

Save 25% to 65%

on Slightly used and Rebuilt Motorcycles, Side Cars, Johnson Motor Wheels, Evans Power Cycles, Bicycles. Send for Free Bargain Bulletin and Money Saving Message. Listing hundreds of Bargains in used, rebuilt and new machines, supplies, accessories, etc.

**AMERICAN MOTOR CYCLE CO.**  
Dept. 1214 2047 W. Chicago Avenue, CHICAGO



## Delivered to You Free

for 30 days trial on approval. You can have your choice of 44 Styles, colors and sizes of the famous **RANGER Bicycles**. Express prepaid. Factory-to-Rider Prices save you \$10 to \$25 on your bicycle.

**12 Months to Pay** if desired. Many boys and girls benefit. Parents often advance first payment.

best quality, at factory prices, express prepaid. Tires, Lamps, wheels and equipment, low prices. Send No Money, do business direct with makers.

**Mead Cycle Company**  
Dept. H103 Chicago



Write today for free Bargain Catalog. Factory prices and marvelous easy payment terms.



# Pay Nothing

An amazing new offer—wear this GENUINE DIAMOND for a week at our expense—absolutely no risk to you—deposit nothing—**READ EVERY WORD OF THIS OFFER:**

**Send No Money**

**Pay No C.O.D.**

## Mail the Free Trial Coupon Below

Just send the coupon below—do not enclose a penny—and we will send you on approval at our expense your choice of these diamonds

The ring illustrated above is the most beautiful hand engraved solid gold ladies' ring you ever saw, set with a fine, large, genuine blue-white diamond. **Pay nothing when it arrives.** Merely accept the ring and wear it for a week, at our expense. After a week decide. If you return the ring, that ends the matter. **You have risked nothing.** But if you keep the ring, send us only \$3.75 a month until you have paid the amazingly low price of \$38.75 for this regular \$50 value. The ring is an elaborate pierced model in solid 14K green gold with hand engraved white gold top. A striking new model. The diamond is a beauty—extra brilliant, blue white, perfectly cut—a remarkably big value.



Men's extra massive 14K solid gold fitted ring with 18K hand cut white gold top set with extra fine perfectly cut blue-white genuine diamond. Extra Big Value. Now \$38.75—\$3.75 a month. Send no money. Pay no C.O.D. A week's trial absolutely FREE. Mail coupon now.

Just mail the Free Trial coupon below. Be sure to enclose finger size. **SEND NO MONEY—pay nothing on arrival.**

\*\*\*\*\*  
**Harold Lachman Co., Dept. 1779 204 S. Peoria St., Chicago**

Send me absolutely free and prepaid, for a week's trial, the genuine diamond ring checked below. I am to pay nothing when it arrives. After one week I will either return the ring by registered mail and that ends the matter, or I will send you \$3.75 each month until \$38.75 has been paid. Title remains with you until fully paid. **I ENCLOSE MY FINGER SIZE.**

Ladies' Ring No. A4350

Men's Ring No. A4450

Name.....

Address.....

Age..... Occupation.....

Copyright 1931, Harold Lachman Co.

## NEW SINGLE PHASE A. C. MOTORS

$\frac{3}{4}$  H. P.—110 volt, 60 cycle, 1725 speed, complete with cord, plug and grooved pulley... \$13.00

### General Electric

$\frac{1}{4}$  H. P., \$16.50  
 $\frac{1}{2}$  H. P., \$39.00



**ONE YEAR GUARANTEE**

### EMERSON

$\frac{3}{4}$  H. P., \$58.00  
1 H. P., 62.00  
 $1\frac{1}{2}$  H. P., 75.00  
2 H. P., 89.00

Include Pulley and Base—All Motors,  $\frac{1}{2}$  H. P. or larger, 110-220 Volt Rep. Ind. Type.

**Satisfaction guaranteed or money refunded**

Illustrated Catalog of Motors and Supplies FREE  
**HYRE ELECTRIC CO., 615-M So. Dearborn St., Chicago**

Please Mention Popular Mechanics



# forget

Your old conception of a gasoline engine and consider only

The Air-Cooled, Multi-Purpose  
**New-Way**  
Engine in 1



Compact as an electric motor—flexible, dependable and light in weight. Especially designed to operate portable machinery, semi-portable, traction and stationary.

Operates by direct power or generator electric motor driven units and tools in remote places.

Variable control, 2 to 5 horsepower. Weight ready to mount on any equipment, 248 lbs. Write for Circular C-20.

**The New-Way**

Motor Company  
Lansing, Mich., U. S. A.  
Eastern and Export Office,  
Woolworth Building  
New York

Manufacturers and Users

Universalize your product with the "New-Way" Engine and sell to the world.

Our engineering staff has had wide experience in the application of power to machinery of all kinds. They will be glad to help you.

## Your Hardware Dealer Carries UNION TOOL CHESTS

They are built for service. As substantially made as the finest tools. Made from strong, durable materials. Everyone who works with tools needs and appreciates the Union Chest.

Ask your hardware dealer to show you his assortment, or if he hasn't them, write us for illustrated literature.

**UNION TOOL CHEST CO.**  
22 Mill St. Rochester, N. Y.



**How to Run a Lathe:**—New 80-page book, Revised Edition No. 24, for 10 cents postpaid, silver or stamps.



**THE - WOMAN - WHO - KNOWS** always has her Bernards handy. Pliers with the vise-like grip, the uncanny cutting power, and the open throat. Ask your hardware dealer.

MADE IN SEVEN SIZES

Send for illustrated Plier Booklet M



**BERNARD  
PLIERS**

Wm. Schollhorn Co.  
NEW HAVEN, CONN.



PARALLEL JAWS

OUTSIDE CUTTER

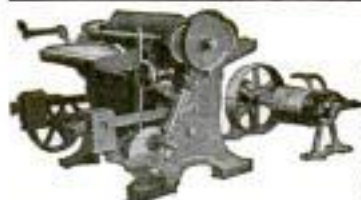

It is the well known quality of **CRESCENT** machines that justifies you in selecting one of them each time you have need for wood working machinery. The **CRESCENT** line is better than ever and will always give you satisfaction in every particular. Ask today for catalog of hand saws, saw tables, joiners, shapers, planers, borers, planers and matchers, swing saws, disk grinder, cut off table, hollow chisel mortiser, variety wood worker, Universal wood workers.

THE CRESCENT MACHINE CO., 93 Columbia Street, Leetonia, Ohio

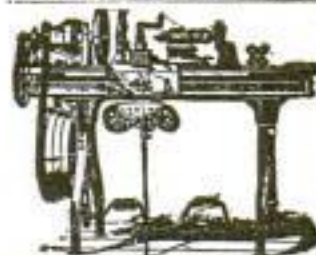

## LATHES

9 to 18-inch Swing

List price \$165 and up according to size. When ready to buy send for Lathe Catalog and prices.

**W. F. & John Barnes Co.**  
100 Ruby Street, ROCKFORD, ILL.

## SOUTH BEND LATHES Screw Cutting Engine Lathes

### STANDARD CHANGE GEAR

|                    |           |
|--------------------|-----------|
| 9'x 3' Lathe.....  | \$ 176.00 |
| 11'x 4' Lathe..... | 228.00    |
| 13'x 5' Lathe..... | 304.00    |
| 15'x 6' Lathe..... | 376.00    |
| 16'x 8' Lathe..... | 452.00    |
| 18'x10' Lathe..... | 656.00    |
| 21'x12' Lathe..... | 933.00    |
| 24'x14' Lathe..... | 1254.00   |

### QUICK CHANGE GEAR

|                    |           |
|--------------------|-----------|
| 9'x 3' Lathe.....  | \$ 216.00 |
| 11'x 4' Lathe..... | 273.00    |
| 13'x 5' Lathe..... | 354.00    |
| 15'x 6' Lathe..... | 431.00    |
| 16'x 8' Lathe..... | 512.00    |
| 18'x10' Lathe..... | 721.00    |
| 21'x12' Lathe..... | 1016.00   |
| 24'x14' Lathe..... | 1353.00   |

Catalog No. 77 sent free to any address

**SOUTH BEND LATHE WORKS**

625 E. Madison St.

**SOUTH BEND, IND.**





A Happy Boy! The beautiful finish of a Keen Kutter knife will make his eyes shine. Its sturdiness will please him for many a Happy Christmas to come.



Simmons Hardware Company  
**KEEN KUTTER**

**9 CORDS IN 10 HOURS**



BY ONE MAN. IT'S KING OF THE WOODS. Saves money and backache. Send for FREE catalog No. B115 showing low price and latest improvements. First order gets agency. Felding Sawing Machine Co., 1005 East 75th St., Chicago, Ill.



The Midget "FIVE-IN-ONE" Slide Rule is a combination Mannheim, Log-Log, Add and Subtract, Polyphase and Binary Slide Rule. It will instantly add, subtract, multiply and divide any combination involving whole numbers, fractions, decimals and mixed numbers. Gives every possible root and power of every quantity. The graduations are printed on metal, coated with white celluloid and are grease and waterproof. While it is the most versatile calculator ever invented, its operation is simple and easily understood. Diameter 4 inches. Price with Empire Instruction Book, \$1.50. Leatherette carrying case \$0.50 extra. Catalog free. Your money back if you are not satisfied. GILSON SLIDE RULE CO., Niles, Mich.

**BURN YOUR NAME ON TOOLS WITH ARKOGRAF**

Protect your tools from theft. Write any name, engrave any design on metal with electricity like writing on paper with pen or pencil. Complete outfit \$2.50, prepaid anywhere. Interesting descriptive circular free. Write today. Agents Wanted. Arkograf Pen Company 1007 Yeon Building Portland, Oregon



Have You SEEN  
**SELFLO**

the Alcohol Torch that BLOWS ITSELF  
In 20 Seconds after Lighting gives  
1,400° F. flame.

Hot enough to run any solder. No pumping, no priming. No blowing a rubber tube. Invaluable for many purposes besides soldering.

Price - \$2.00

In Canada, \$2.50

If your dealer does not carry SELFLO, send us his name and cash or money order, and we will send you one by parcel post prepaid.

HUNT-LASHER CO., Inc.  
70-72 Willow St., Lynn, Mass.

Trademark goods are your protection. Ask for SELFLO by name and be sure you get it.

# ATKINS SILVER STEEL SAWS

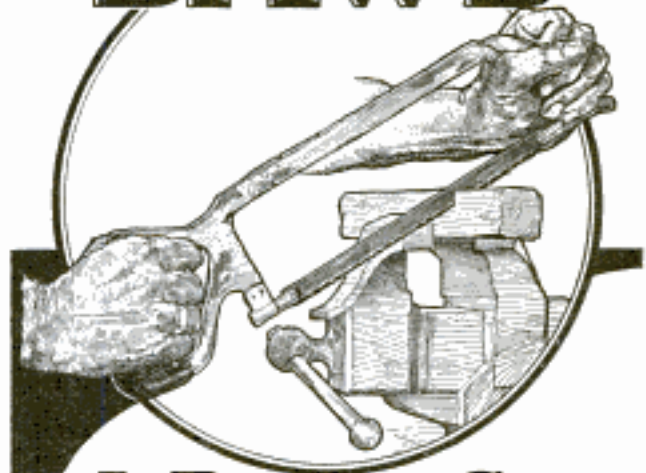

## A Better Saw for Every Use

No matter what kind of a saw you require—hack saw, hand saw, cross-cut saw, circular saw, buck saw, meat saw, pruning saw, portable drag saw machine, or in fact any saw for any wood or metal cutting purpose—Atkins offers you a saw that will do the work quicker, better and easier.

The famous "Silver Steel," used exclusively in Atkins Saws, is the highest grade saw steel that man ever devised. That's why an Atkins Saw takes a keener edge, cuts faster, runs easier, stays sharp longer and needs less filing to keep it in shape.

Learn more about the time and money-saving advantages of Atkins Saws. Get these FREE books. Write your name and address on margin of this page, state which book you want and give dealer's name. Mail today.



## Get These FREE Books on Saws

"Saw Sense" shows the best saw for every use and gives helpful facts on building. "Care of Saws" tells all about care of cross-cut and hand saws. "Hack Saw Chart" shows correct blades for metal cutting.

E. C. Atkins & Co., Inc.  
Dept. P. Indianapolis, Ind.  
Makers of "Silver Steel" Saws and Tools.







"Red Devil" Rapid Boring Auger Bits are 33 1/4% easier boring, have 10% greater clearance, and bore with or against the grain of any wood. Style 2400—10/16 in., shown here, 75c.

## Red Devil

REG. U. S. PAT. OFF.

### Slip Joint Plier

One pair for the home,  
One pair for the car.



**T**HERE are many occasions when you need a pair badly. You will find "Red Devils" as useful as your right hand for a great many odd repair jobs.

The slip joint extends the jaws beyond those of the average plier, multiplying its handiness. Has a thin nose, handy for working in tight places.

The newly designed, well-proportioned handles fit the hand snugly and increase the leverage power.

The name "Red Devil" on a plier is a pledge that it is the best of its kind made,—that it is well balanced and expertly designed and manufactured. Forged of steel for strength and backbone.

Your hardware dealer will gladly show you a pair, or send \$1.00 direct for a pair. Mention style 1024 - 6 1/2 inch

Mechanics' Tool Booklet Free

"Red Devil" Tools  
— American Made

**SMITH & HEMENWAY CO., Inc.**

Manufacturers of "Red Devil" Tools  
260 Broadway, New York, N. Y.

"Red Devil" Glass Cutters—the glaziers' standard tools of the world. "It's all in the wheel."  
Made in 40 styles. No. 024 shown here, 20c.



Please Mention Popular Mechanics

## For the Garage or Home Workshop—Choose This MONARCH Jr. Lathe

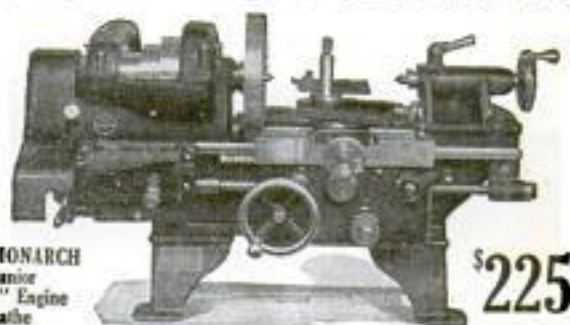

MONARCH  
Junior  
9" Engine  
Lathe

\$225

An ideal, compact, trouble-proof tool—install it right on your work bench—instantly ready to turn out the small parts required by **Inventors, Experimenters, Mechanics and Auto Repairmen.** The MONARCH Junior 9" Engine Lathe is time-tested and proven—it exactly meets all small lathe work requirements—will turn out work with 1/1000 of an inch accuracy. It is fully equipped, has 2 1/2 foot bed—semi-quick change gear—bench legs—and automatic safety devices. Also built with bed lengths up to 5 feet.

The MONARCH Junior Lathe is also made in a larger size, with 11 inches swing, at slightly higher price

Write at once for your **FREE** copy of the MONARCH Lathe Catalog. MONARCH Lathes are built up to 30 inches swing.

**THE MONARCH MACHINE TOOL CO.**  
400 Oak Street Sidney, Ohio



## SOLDERALL

For Radio

Most wonderful Solder Ever Invented  
Solders Wires and Radio Connections

At Your Dealer's or Sent Postpaid for 25c Tube  
**SOLDERALL CO., Dept. P, Newark, N. J.**

## Interlox

QUICK AND ACCURATE  
INSIDE

MASTER SLIDE RULE

MEASUREMENTS!



USE IT for all measuring—inside or out. The only interlocking, sliding Rule. Ideal for Carpenters, Mechanics, Engineers, Electricians, etc. If not at dealer's, send his name and 25c per ft. for rule sent prepaid (any length, from 2 to 8 ft.).

**MASTER RULE MFG. CO., INC.** (FORMERLY DAHL MFG. CO.)  
841-43 E. 136th St., NEW YORK CITY  
Dealers and Agents: Write for Liberal Proposition

## MYERS WONDERFUL SEWING AWL

Tools in Handle



A complete repair shop in itself. Sews anything heavy or light, leather, shoes, harness, buggy tops, canvas, bolts, etc. \$1.00 Postpaid.  
**G. A. MYERS COMPANY, 6339 Woodlawn Ave., Chicago, Ill.**



## TOOL CHESTS

for Machinists & Toolmakers

Every tool arranged in order. No up-to-date mechanic should be without one. A Gerstner Case costs no more than some tools, and will last a lifetime. Catalog free.

**Gerstner & Sons**

717 Columbia Street DAYTON, OHIO





# 2 TIRES FOR \$9.95

## FREE TUBE WITH EACH TIRE

**Sensational Cut in Standard Tire Prices!**  
Two tires for less than the usual cost of one, and a free inner tube with each tire! No double tread or second tire. Our big volume means best tire value! Act now and cut your tire cost in two. Thousands of steady customers are getting full mileage out of their tires and you, too, can get it!

### 8,000 MILES

**Note Special Price on Two Tires, Same Size**

| Size       | 1 Tire  | 2 Tires | Size       | 1 Tire  | 2 Tires |
|------------|---------|---------|------------|---------|---------|
| 28 x 3     | \$ 8.75 | \$ 9.95 | 34 x 4     | \$12.85 | \$19.70 |
| 30 x 3     | 8.95    | 10.95   | 32 x 4 1/4 | 12.95   | 20.95   |
| 30 x 3 1/2 | 7.85    | 12.95   | 33 x 4 1/4 | 13.45   | 21.65   |
| 32 x 3 1/2 | 9.25    | 14.95   | 34 x 4 1/4 | 13.95   | 22.35   |
| 31 x 4     | 10.45   | 16.75   | 35 x 4 1/4 | 14.45   | 23.95   |
| 32 x 4     | 11.85   | 17.85   | 35 x 5     | 15.45   | 25.95   |
| 33 x 4     | 12.35   | 18.75   | 37 x 5     | 15.95   | 26.50   |

State whether straight side or clincher

**SEND NO MONEY!** Shipment C.O.D. express or parcel post. Examine tires on arrival and if not fully satisfied return same at our expense and your money will be promptly refunded. **DON'T DELAY! ORDER NOW!**

ALBANY TIRE & RUBBER COMPANY  
1506 So. Michigan Ave. Dept. 164P Chicago, Illinois

### Only \$45.00 For This Job Complete

Save exorbitant freight rates and one-half original cost by buying Ford Speedster Bodies knocked-down. Simple, complete instructions furnished, all parts cut to exact fit. Any one can assemble this job. Complete with hood, radiator shell, instrument board, speedometer, metal parts, wood parts, bolts, screws, etc. Flat radiator shell furnished made up. Designed low with lack of wind resistance. Price set up \$90, further particulars on request.



Not Paper Patterns All Parts Complete

The Central Auto Supply Co., Eng. Dep. 120, Louisville, Ky.

### THE SHAW MOTOR ATTACHMENT

#### Makes Your Bike a Motorcycle

A high grade 2 1/4 H. P. Motor attachment quickly clamped to any bike frame. Speed 4 to 40 miles an hour. 90 to 125 miles per gallon of gas.

**Special Low Price Now!** Write today for Complete Description and Special Low Prices on SHAW Motor Attachments and the Shaw Complete Motorbicycle.



SHAW MFG. CO., Dept. 37, GALESBURG, KANS.

## MOTORCYCLES

**RELIABLE STANDARD MAKES** that you can **DEPEND** on. Enjoy the glorious experience of going wherever you like—whenever you like. The price is within your means—35% to 50% less than others. These machines are slightly used, thoroughly overhauled or rebuilt. Send for catalogue.



MYEROW BROS.,  
256 Columbus Ave., Boston, Mass.

# SHALER

## 5 MINUTE VULCANIZER



### VULCANIZES Cuts or punctures in Five Minutes

No tool-kit is complete without a Shaler 5-Minute Vulcanizer. It is a necessity and the greatest convenience ever offered to the motorist.

The Shaler 5-Minute Vulcanizer is easy to use—you need only a match. Always ready—never bothered by wind or storm. Cannot injure or burn the tube. No gasoline—no danger of fire.

### Costs Only \$1.50

Get a Shaler 5-Minute Vulcanizer from your dealer. It will soon repay for itself by the saving of time, trouble and tire repair bills.

**C. A. SHALER CO.**  
2011 Fourth Street Waupun, Wis.

## Ends Tire Troubles

Wonderful patented invention doubles life of tires, old or new. Blowouts eliminated. Punctures forgotten. Thoroughly practical and selling like wildfire where introduced. Agents, big money. Write quick for sample. Car owners, give size.

**Doublewear Inside Tires, Suite 209, 716 Madison, Chicago**

## STOP Radiator Leaks Instantly

Four contents of 75c can of liquid Radiator Neverleak in radiator. Saves big repair bills. Guaranteed. Carry a can for emergencies. At all dealers or sent direct.



**RADIATOR NEVERLEAK** 357 Elliott St. Buffalo, N. Y.

# 8 HOUR Battery Charging Pays Big Monthly Profits

## Increases Trade—Cuts Expenses—Beats Competition

HB 8 Hour Constant Potential Battery Charging brings a **big increase in your monthly profits**. Reduces current consumption and labor cost. **Saves half on rental battery investment.**

**Charges batteries perfectly in 6 to 8 hours against competitors' 2 or 3 days.** Improved Service brings new trade—puts you ahead of competition, boosts profits. Results guaranteed. **You can order on 15 days free trial with ironclad satisfaction-or-money-back guarantee.** Order your HB 8 Hour charging outfit now on free trial with positive money-back guarantee. **Be first with 8 hour Charging Service.** Make those big increased profits. **Easy monthly terms allow profits to pay for outfit.** Furnished complete, ready to operate. No special experience necessary. Handles all batteries. **Write us today for full information and free trial offer.** Don't delay.

HOBERT BROS. CO., Box M 12, Troy, Ohio



## Profits Easily Carry Small Monthly Payments





Above is the Boice Pony Bench Machine—six machines in one—saw, sander, drill, grinder, polisher and buffer. Height, 19"; top, 10"x12"; saws 1 1/2" stock; easily driven with 1/4 H.P. or 1/3 H.P. motor.

## Boice-Built Bench Machines

### Saws—Drills—Jointers—Band Saws

Each a practical machine designed for speedy and accurate handling of all sorts of bench work, including sawing, ripping, rabbeting, grooving, mitring, tenoning, jointing, grinding, buffing, sanding and drilling. Equally efficient in handling wood, fiber and soft metals.

Hundreds of Boice-Built machines are in daily use in shops (both industrial and private), schools, factories, print shops, etc. Their size, absolute accuracy and low cost provides an economical means for producing a better job. Boice saws are made in six models to meet every requirement,—are portable and attach to any light socket.

Write today for descriptive literature and prices on the Boice Pony Bench Machine and other Boice-Built Bench Machines and Motors.

**W. B. & J. E. Boice** Dept. P. M. 12  
114 Twenty-third Street Toledo, Ohio



## Agents Wanted

Here is your opportunity to sell a line of merchandise that is practically without competition—the world famous "Wizard" Quicklit Gasoline and Kerosene Lamps, Lanterns and Lighting Systems. Discovery of "Thena" Metal makes possible new and exclusive automatic cleaning device. No more throwing away generators because of carbonization. No more lights going out from fuel feed clogging. Here is the light that never fails—a better, brighter light. You sell to both dealers and consumers. Chance to organize sales force and multiply your income. Men now making \$60 to \$130 a week. Write for our proposition, including amazing story of "Thena" metal. Act quick—territories going fast.

**The Nagel-Chase Manufacturing Co.**  
250 East Erie Street CHICAGO



## NEW LIGHTNING CALCULATOR

No more brain-fag. No more costly errors. No more wasted hours from useless mental drudgery. **USE AND ENJOY THIS WONDERFUL NEW \$15.00 ADDING MACHINE FREE ON TWO WEEKS' TRIAL**

**ADDS  
SUBTRACTS  
MULTIPLIES  
DIVIDES**

Observe how it automatically handles every calculation with speed, accuracy and efficiency. Note its every-day usefulness and life-long durability.—its unique features of handiness and portability. **SEND NO MONEY**—just your business card or letterhead. The machine will reach you all charges prepaid. If it doesn't pay for itself within two weeks, send it back by parcel-post and you will owe us nothing. **ACT TO-DAY IF YOU WANT PROMPT DELIVERY.** Address Dept. W.

Only  
**\$15.00**

**LIGHTNING CALCULATOR CO., GRAND RAPIDS, MICH.**

**EQUALS WORK OF \$350.00 MODELS**

## MOVIES OH BOY!!



**Movies in Your Own Home**

A great idea for the Holidays. Real moving picture machines in five models—as low as \$5.00. **FILMS** lowest prices in the country. Write now for free literature that explains everything.

**PARAMOUNT MFG. COMPANY**  
Dept. M, Box 1371, Boston, Mass.

## AGENTS-WE START YOU WITHOUT A DOLLAR

Soaps, Extracts, Perfumes, Toilet Goods. Extensive Line  
100% profit. Experience unnecessary. Catalog Free.  
**Carnation Company, Dept. 380 St. Louis, Mo.**

## GENUINE DIAMONDS on Credit

\$48.50

\$12.50  
Down  
\$3.00  
Mo.



**SAVE 1/3  
BUY DIRECT**

Either of these beautiful hand engraved 14K Solid Gold, Genuine Diamond Rings—we will ship immediately upon receipt of first payment—balance in 12 months. Merely send your name, address, age and occupation.

**The Klein Way—A YEAR TO PAY—Write Today**

Our immense buying power and direct importing enables you to get the very best at lowest prices. Our money back guarantee protects you fully.

**Send for Catalog—Free** Klein's Beautiful DeLuxe Catalog illustrated in colors containing a complete display and detail descriptions of the highest quality of Diamonds, Watches, Jewelry at rock bottom prices, will be sent you promptly at your request. Write for it now.

**KLEIN & CO.**

Department C-712, 122 W. Madison Street, Chicago, Ill.  
Nearly 1-6 Century Same Location

**NO RED TAPE  
NO DELAY**

\$40.75  
Cash or Credit

Lady  
Lorraine

Ring 14k  
Solid Gold,  
Large clear  
blue white  
diamond of  
highest brill-  
iance.  
Wear it  
Now. Pay  
Later

\$10.00  
Down  
\$2.50  
Mo.





ONLY  
\$ **3**  
DOWN  
and you  
keep this  
typewriter



DIRECT  
to you  
from our  
Factory  
Electric  
Desk Lamp  
FREE

## Yes, we will ship you this Genuine Underwood

Rebuilt in our own factory just like new for  
**ONLY \$3 down—NOT ONE CENT MORE**

Until you have tried the machine 10 full days at our expense



Our Factory

**EVERY MACHINE** is fully guaranteed. New parts wherever needed. New enamel, new nickel, new lettering, new platen, new key rings—a complete, perfect typewriter. Impossible to tell it from a brand new Underwood either in appearance, durability or quality of finished work.

An up-to-date machine with two-color ribbon, back spacer, stencil device, automatic ribbon reverse, tabulator, etc. In addition we furnish **FREE** waterproof cover and special Touch Typewriter Instruction Book. You can learn to operate this Underwood in one day.

**Electric Desk Lamp  
FREE**



For a limited time only we offer this handsome flexible arm electric desk lamp free with a guaranteed Shipman-Ward Rebuilt Underwood. Lamp has flexible arm, can be moved in any position and comes complete with 6-foot cord, shade, plug, etc., but without bulb. You can have your choice of lamp in four finishes. Send in the coupon quick and learn about this great free offer. Remember, we have only a limited number of these handsome lamps.

**Shipman-Ward Mfg. Co.**  
"Typewriter Emporium"  
Montrose and Ravenswood Aves., Chicago

### Write Right Now

and learn how it is possible for us to ship you this Underwood Typewriter upon our free trial plan and our direct-to-you money saving methods. Get the full details now—just sign the coupon and mail today. Get all the facts—then decide.

### No Obligation

—to buy. You don't have to order. Just sign the coupon, send it to us and we will mail you our big catalog absolutely free, or we will ship the machine at once if you will check the coupon showing you want it without waiting for the catalog.

Send the  
Coupon  
Today

**10 Days'  
Free Trial**

You have ten full days in which to try the typewriter before deciding whether you want to keep it. Give it every test—see for yourself—make the Underwood prove its worth to you. Don't take our word for it—put the Underwood before you and see if you don't think it the greatest typewriter bargain ever offered.

This is the genuine Underwood Typewriter. We offer you the same three models of the Underwood Typewriter being made and sold by the manufacturers today. **Standard 4-row single shift keyboard. Absolutely visible writing—the full line of typewriting is visible at all times.** All the improvements and attachments that any high grade typewriter ought to have.

### Big Saving to You

Our plan of selling to you direct makes possible enormous savings, which are all for your benefit. Send in the coupon and we will send you prepaid our big catalog, including "A Trip Through Our Factory." This shows how the Shipman-Ward Rebuilt Underwood is the best that can be produced at our Special Price.

**You** don't have to do a thing to get our big **FREE** catalogue and complete details of our amazing

typewriter offer except to sign and send in the coupon. There is no obligation.

**FREE TRIAL  
COUPON**

SHIPMAN-WARD MFG. CO.  
2129 Shipman Bldg., Chicago

Please send me **FREE**, all charges fully prepaid, your **BIG NEW** catalog of **UNDERWOOD TYPEWRITERS** and complete details of your **free trial offer**. It is understood that I am under no obligation whatever and that this is to be sent without one cent of cost to me.

Name.....  
Street.....  
City..... State.....





## BE AN AIRPLANE BUILDER AND PILOT

This is your first and only opportunity to own a REAL HIGH-GRADE AIRPLANE worth several thousand dollars for the price of a motorcycle. We have NEW PARTS to assemble 500 airplanes. Send for a set of parts today and have the pleasure of building and flying your own airplane. Hundreds of these planes are in use every day. If you are interested in this wonderful opportunity to enter aviation, write for particulars.

**LINCOLN STANDARD AIRCRAFT CORP.**  
LINCOLN, NEBR.

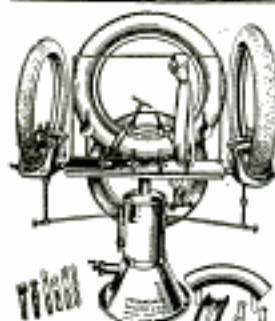

Duncan No. 10 or No. 3 will cure with sand bag as a pressure medium, equally as well as with air bags. Will cure twice as many tires per day as any other three curable moulds; will cure two 3-1/4 or three 4's or two 4's either FABRIC OR COILD TIRES, perfect to size, form, width and contour.

### OWN YOUR OWN BUSINESS ON A SMALL INVESTMENT

Income \$600 and up Monthly

Duncan No. 10 or No. 3 Combination Shop Equipment is compact and complete in every way; will turn out quantity as well as quality work, guaranteed for mileage and wear. Experience not necessary. We teach approved factory methods of tire repair. Big field open for progressive men to start in business for themselves on a small investment. EASY TIME PAYMENT PROPOSITION IF DESIRED. Old moulds taken in trade. While you hesitate someone is making big money. SPECIAL LOW PRICE OFFER. On all orders received before Jan. 15, 1923. Write now for descriptive folders and prices of DUNCAN SECTIONAL MOULDS.

**F. M. DUNCAN COMPANY**

341-49 East Ohio Street, Department P, Chicago, U. S. A.

### RADIO & AUTO Storage BATTERIES CHARGED

FROM A LAMP SOCKET At Home For a Few Cents, With An F-F BATTERY BOOSTER, a FULL WAVE Automatic Magnetic Rectifier for 100-125 Volt 40 Cycle A. C. Type A-B Charges 6 Volt "A" & Auto & Up to 120 Volts of "B" & Lead Storage Batteries in Series Inductively At Home Overnight, Disconnecting & Multiple Connections Unnecessary. No Grounds, Charging Circuit Simple. No Skill Needed. **AMMETER** eliminates GUESS WORK. Infusible Electrodes Rectify Current. Will Charge & Dead Battery. Leave Battery Connected. Screw Plug In Lamp Socket, Snap Receiver Clips On Terminals, Turn Switch & Battery is Charged in Morning. Nothing Like It Made. Is It Not Grand To Feel Your Radio Batteries Are Ready For All Radiophones, Music & News? Never Having To Tell Friends Your Batteries Are Dead? Fully Charged Batteries, By Starting Car Quick, Require Fewer Expensive Replacements. Do Not Think Your Battery is Dead & Worn Out Because It Will Not Start Your Car. Buy a BOOSTER. Watch Bills It Will Give You More Than Its Cost & Lasts A Lifetime. 7 TYPES BUILT BY A MASTER OF THE ART & POPULARLY PRICED.

Charges Auto & Radio Batteries. The Larger Types are recommended for heavy Batteries, or where time is limited. Shipping Weights Complete with **AMMETER & BATTERY CLIPS** 11 to 15 pounds. Purchase from Your Dealer or Mail Check for Prompt Express Shipment. If for Parcel Post add Postage & Insurance Charges. Or **ORDER** us to forward **TYPE** desired. C.O.D. **ORDER** Now or **WRITE** Immediately for **FREE** Descriptive **BULLETINS** 24 & 24A. **THE FRANCE MFG. CO., CLEVELAND, OHIO, U.S.A.**

**Auto Supplies**  
Knowing **HOW** to buy is merely knowing **WHERE**  
This is Chicago's Great Wholesale House.  
**AUTO SUPPLIES AND MOTOR PARTS**  
**WHOLESALE ONLY**  
Dealers send today for this big money-saving book  
**ACCELL AUTO ACCESSORIES COMPANY**  
507 1/2 South Michigan Avenue  
**CHICAGO**

### FORDS run 34 Miles on Gallon of Gasoline



Wonderful new carburetor. Reduces gasoline bills one-half to one-third. Increases power of motors from 30 to 50%. Start easy in coldest weather.

**SENT ON 30 DAYS' TRIAL**

Fits any car. Attach yourself. Fords make 34 miles to gallon. Other cars show proportionate saving. Send make of car. Special 30-day trial offer. Agents wanted.

**AIR FRICTION CARBURETOR CO.**

Dept. 3780

Dayton, Ohio

### TIRE Agents Wanted

An auto owner in each locality to use and introduce

**Mellinger EXTRA-PLY and CORD Tires** Make big money part or full time. No capital or experience needed. Sample Sections furnished. **GUARANTEED**

**8,000 and 10,000 Miles** (No Seasons)

Hand made. Finest materials. Shipped prepaid on approval.

**FREE Tires for Your Car** to one user in each locality for taking a few orders. Be first to write quick for Special Agents Offer and Low Wholesale Prices.

**MELLINGER TIRE & RUBBER CO.**

910 North Oak Street

Kansas City, Mo.



### 16,000 MILES without a Puncture



Wonderful invention. Insyde Tyres—Inner Armor for auto tires. Positively prevent punctures and blowouts. Give double tire mileage, any tire—old or new.

**Over 100,000 Satisfied Customers**

Will not heat or pinch. Use over and over again. Old worn-out casings will give 3 to 5,000 miles more service. Low priced. Agents wanted.

**American Accessories Co., B-2176, Cincinnati, Ohio**

### CUSTOM TAILOR MADE To fit your individual car

Made in our custom shops after your order is received. **\$4.40 and up** We ship ordinarily in 2 or 3 Parcel days. Perfect fit guaranteed Post Paid when correct name, year and model of car is given. You can easily apply it yourself. We furnish instructions and all necessary tacks, welts and fasteners. Our catalog No. 11, with samples, is free for the asking.

**LIBERTY TOP & TIRE CO., Dept. E-7, Cincinnati, O.**

### SEND for the INTERNATIONAL CATALOG

Factory to Consumer direct—



Our net price list of auto bodies and body supplies at Wholesale Prices.

Save big money by buying Direct from Factory

**FOR FORD, CHEVROLET and DODGE.** **PRICES FROM \$27.85 UP** **International Body Works** 914 W. Ohio Street, Dept. 7 **Chicago, Ill.**



Dependable **Champions** For Every Engine Everywhere

Ask your dealer to sell you a full set



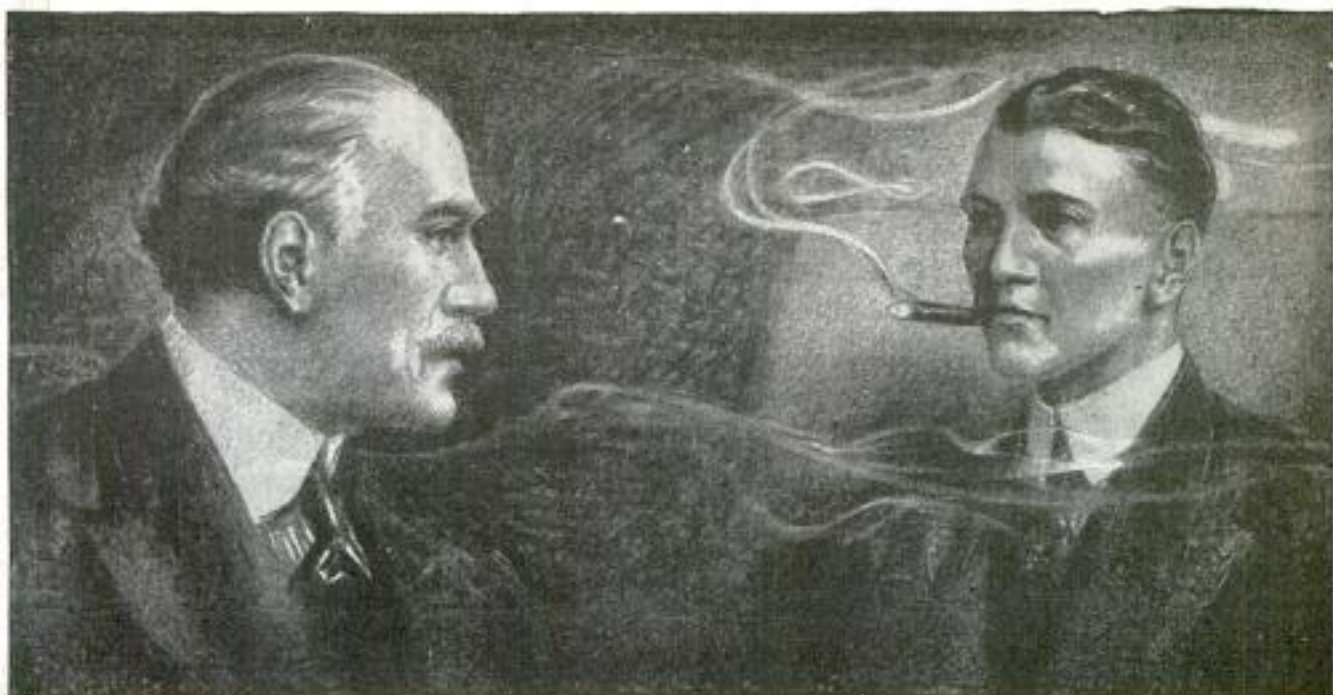

## Tobacco Is Hurting You

Look at the facts square in the face, Mr. Tobacco User. You may think tobacco is not hurting you.

That is because you haven't as yet, perhaps, felt the effects of the nicotine poison in YOUR system. For you know that nicotine, as absorbed into the system through smoking and chewing tobacco, is a slow working poison. Slow, yes—but sure.

Tobacco is lowering your efficiency. It slows a man down. Makes it harder for you to concentrate your mind on your work. You haven't near the amount of "pep" and energy you would have if you stopped using it. There's many a man twice as old as you in years who's twice as young in energy, simply because he lets tobacco alone.

Some day you will realize to what an alarming extent tobacco has undermined your system.

When your hands begin to tremble—  
and your appetite begins to fail—  
and your heart seems to "skip a beat" now and then—  
and slight exertion makes you short of breath—  
then you have a right to suspect that  
**TOBACCO** is getting the upper hand.

Any well-informed doctor will tell you that these are only a few of many symptoms of tobacco poisoning.

And YOU know that the use of tobacco in any form is an expensive, utterly useless habit. You know you ought to quit.

## Tobacco Habit Banished Let Us Help You

It doesn't make a particle of difference whether you've been a user of tobacco for a single month or 50 years, or how much you use, or in what form you use it—whether you smoke cigars, cigarettes, pipe, chew plug or fine cut or use snuff—**Tobacco Redeemer** will positively remove all craving for tobacco in any form in a very few days. Not the slightest shock to the nervous system. Your tobacco craving will usually begin to decrease after the very first dose—there's no long waiting for results.

**Tobacco Redeemer** contains no habit-forming drugs of any kind and is marvelously quick, scientific and thoroughly reliable.

It is in no sense a substitute for tobacco. After finishing the treatment you have absolutely no desire to use tobacco again or to continue the use of the remedy. It helps to quiet the nerves and make you feel better in every way.

**Results Guaranteed** A single trial will convince you. Our legal-binding, money-back guarantee goes with each full treatment. We will refund every cent you pay for the treatment if after taking it according to the easy-to-follow directions, it should fail to banish the tobacco habit completely.

**SEND Coupon for Free Proof** Let us send you our free booklet on the deadly effects of tobacco, together with testimonial letters from men all over the country telling how they have been absolutely freed from the tobacco habit by this simple home treatment. You could not ask for stronger proof that **Tobacco Redeemer** will free you from the habit than the evidence we will gladly send on request. Just mail the coupon—or a postal will do.

**NEWELL PHARMACAL CO.**  
Dept. 300 St. Louis, Mo.



## Free Book Coupon

**NEWELL PHARMACAL CO.**  
Dept. 300 St. Louis, Mo.

Please send, without obligating me in any way, your free booklet regarding the tobacco habit and proof that **Tobacco Redeemer** will positively free me from the tobacco habit or my money will be refunded.

Name .....

Street and No. ....

Town..... State.....



# PATENTS

Booklet Free

Highest References

Promptness Assured

Best Results

Send drawing or model for preliminary examination

**ALL BUSINESS GIVEN PROMPT AND PROPER ATTENTION**

**WATSON E. COLEMAN, Patent Lawyer, 624 F St., Washington, D. C.**



## You Can Be Alluring

Increased circulation, enriched blood and banishment of disease will clear your complexion, increase the lustre of your eyes and make you feel and look young.

### RenuLife Violet Ray

is easy to use in the treatment of rheumatism, neuritis, neuralgia and over one hundred diseases of the nerves and blood. It is probably the only really scientific treatment that can be used in your own home with immediate results. Write today for full information.

**RenuLife Electric Co.**  
1214 Newberry Bldg.,  
Detroit, Michigan  
(In Canada: Pitt St. E.,  
Windsor, Ontario.)



**SEND NO MONEY**

**If You Can Tell it from a GENUINE DIAMOND Send it back**

To prove our blue-white MEXICAN DIAMOND cannot be told from a GENUINE DIAMOND and has some DAZZLING RAINBOW FIRE, we will send a selected 1 carat gem in ladies Solitaire Ring. (Lat. price \$5.00) for Half Price to introduce, \$2.63, or in Girls Heavy Tooth Hecker Ring (Lat. Price \$6.00) for \$3.25. Our finest 1/2 Gold Filled mountings. GUARANTEED 50 YEARS. SEND NO MONEY. Just mail postcard or this ad, State Size. We will mail at once. When ring arrives deposit \$1.00 for Ladies ring or \$1.25 for Girls with postman. If not pleased return in 5 days for money back less handling charges. Write for Free catalog. Agents Wanted. MEXICAN DIAMOND IMPORTING CO., Dept. ET-Las Cruces, N. Mex. (Exclusive controllers Mexican Diamonds)

## Build Your Own PHONOGRAPH

### IT'S EASY WITH OUR HELP

A few hours' interesting work saves over half and gives you a machine to suit your ideas. We furnish motors, tone arms, case material, blue prints and full instructions. Plays any record. Make fine profit building phonographs for your friends.

Write today for our **FREE** Blue print offer.

**GET YOUR RADIO SUPPLIES FROM US**

**Choraleon Phonograph & Radio Co.**  
1222 1st St., Elkhart, Ind.



## PATENTS If You Have an Invention and Desire to Learn How to Secure a Patent

Send for our Guide Book, **HOW TO GET A PATENT**, sent Free on request. Tells our terms, methods, etc. Send model or sketch and description of your invention and we will give our opinion as to its patentable nature.

**RANDOLPH & CO.**  
600 F St., N.W., Washington, D. C.

NAME.....

STREET.....

CITY..... STATE.....



# PATENTS TRADE-MARKS AND COPYRIGHTS

## OUR OFFER—Free Opinion as to Patentable Nature

Before disclosing an invention, the inventor should write for our blank form "Record of Invention." This should be signed and witnessed and if returned to us together with model or sketch and description of the invention, we will give our opinion as to its patentable nature.

## Our Three Books Mailed FREE to Inventors

OUR ILLUSTRATED GUIDE BOOK

### HOW TO OBTAIN A PATENT

Contains full instructions regarding Patents, Trade-Marks, Foreign Patents, Our Methods, Terms, and 100 Mechanical Movements illustrated and described; Articles on Patent Practice and Procedure, and Law Points for inventors.

### OUR TRADE MARK BOOK

Shows the value and necessity of trade-mark protection and gives information regarding unfair competition.

### OUR FOREIGN PATENT BOOK

We have direct agencies in all the principal foreign countries and secure foreign patents in the shortest possible time and at the lowest cost. Write for our illustrated Guide Book on Foreign Patents, sent free to any address.

### LIST OF PATENT BUYERS SENT FREE

Containing unsolicited letters from manufacturers and others who are constantly writing us regarding the purchase or leasing of meritorious patents. We endeavor to assist our clients in the commercial development of their inventions.

### Specialization—Our Staff

The field of invention is so vast that it is impossible for any one man to become an expert in all the different classes of invention. For this reason Victor J. Evans & Co. employ a number of patent lawyers and mechanical experts who have been selected for their special knowledge and ability in certain lines of invention. Each case is placed in charge of experts in the classes to which the invention relates.

### THE VALUE OF YOUR PATENT

will depend much upon the skill and care with which your case is prepared and prosecuted in the United States Patent Office. That every case entrusted to us receives our best efforts, and that our work is done consistently, skillfully, and thoroughly is evidenced by the many unsolicited letters of commendation that we receive constantly from our clients. We will furnish upon request lists of clients from any State in the Union for whom we have secured patents.

### Our New York, Philadelphia, Pittsburgh, Chicago and San Francisco Offices

Owing to the growth of our business we have established for the benefit of our clients Branch Offices in New York City, Philadelphia, Pa., Pittsburgh, Pa., Chicago, Ill., and San Francisco, Cal. These branch offices being located in these large commercial cities together with our Main Office located near the U. S. Patent Office, in Washington, enables us to more promptly handle the business of our clients, particularly as the branch offices are in constant touch with the Main Office and fully equipped to handle patent business in all its branches.

**Highest References — Prompt Attention — Reasonable Terms**

---FREE COUPON---

## VICTOR J. EVANS & CO., Patent Attorneys

NEW YORK OFFICES  
1007 Woolworth Building

CHICAGO OFFICES  
1114 Tacoma Building

PHILADELPHIA OFFICES  
714-715 Liberty Bldg.

PITTSBURGH OFFICES  
514 Empire Building

SAN FRANCISCO OFFICES  
Hobart Building

MAIN OFFICES: 765 9<sup>TH</sup> STREET, N.W., WASHINGTON, D. C.

Gentlemen: Please send me FREE OF CHARGE your books as described above.

Name.....Address.....





# PATENTS

**I**F YOU HAVE AN INVENTION which you wish to patent you can write fully and freely to Munn & Co., for advice in regard to the best way of obtaining protection. Please send sketches or a model of your invention and a description of the device, explaining its operation.

All communications are strictly confidential. Our vast practice, extending over a period of seventy-seven years, enables us in many cases to advise in regard to patentability without any expense to the client. Our Hand-Book on Patents is sent free on request. This explains our methods, terms, etc., in regard to **Patents, Trade Marks, Foreign Patents, etc.**

## If you are a reader of the SCIENTIFIC AMERICAN

you are probably aware of the fact that it has a special appeal to the inventor. Each issue contains a description of a large number of recently patented inventions. Pending patent legislation as well as the most recent rulings of the Patent Office and the courts are considered in its columns.

## MUNN & CO.

SOLICITORS OF PATENTS

672 Woolworth Bldg., NEW YORK  
Scientific American Bldg., WASHINGTON, D. C.  
801 A Tower Bldg., - - CHICAGO, ILL.  
611 Hanna Bldg., - CLEVELAND, OHIO  
582 Market St. SAN FRANCISCO, CALIF.

## PATENTS

TRADE-MARKS COPYRIGHTS

Send for our free book of patent information.

**Beale & Park** 802 F St., Washington, D. C.  
16 S. Broad St., Philadelphia, Pa.

## PATENTS

**C. L. PARKER**  
Formerly Member Examining  
Corps, U. S. Patent Office  
**PATENT LAWYER**  
MCGILL BLDG.  
WASHINGTON, D. C.

Patents, Trade Marks, Copyrights, Patent Litigation

Handbook for Inventors, "Protecting, Exploiting and Selling Inventions," sent free upon request.



## PATENTS

Send us sketch or model for patentability opinion and exact cost of patent. Our book "How to Obtain a Patent," Sent Free on request. It tells how to apply for Patents, Trade Marks, Foreign Patents, Copyrights, etc.; gives information on Patent Procedure; tells what every inventor should know. Thousands of Inventors, who are our clients, are our references.  
**Chandlee & Chandlee, 25 Years Experience.**  
435 7th St. Washington, D. C.

## PATENTS and TRADE-MARKS

As one of the oldest patent firms in America, and representing a clientele extending to all parts of the country, we afford inventors and manufacturers, at lowest consistent charges, a service noted for efficiency and results, evidenced by many well-known Patents and Trade Marks of extraordinary value.

Lacey & Lacey, 646 F St. Washington, D.C.

ESTABLISHED 1869  
Our book Patent Sense - Free



## GEARS ALL KINDS SMALL

The most accurate made and prices reasonable. We carry a complete line of gears in stock for immediate shipment. Can also quote on special gears of all kinds. Send us your inquiries.

WRITE FOR CATALOGUE.

CHICAGO STOCK GEAR WORKS  
105-109 S. Jefferson St., CHICAGO



## "BOW LEGS and KNOCK-KNEES" UNSIGHTLY

SEND FOR BOOKLET SHOWING PHOTOS OF MEN WITH AND WITHOUT THE PERFECT LEG FORMS

PERFECT SALES CO.

140 N. Mayfield Ave., Dept. S, Chicago, Ill.



Clear-Tone  
FOR

**PIMPLES**  
Your skin can be quickly cleared of Pimples, Blackheads, Acne Eruptions on the face or body, Enlarged Pores, Oily or Shiny Skin. \$1,000.00 Cold Cash says I can clear your skin of the above blemishes. WRITE TODAY for my FREE Booklet—"A Clear-Tone Skin"—telling how I cured myself after being afflicted for fifteen years.

**FREE**

**E.S. GIVENS, 129 Chemical Bldg., Kansas City, Mo.**



# INVENTORS

**PROFIT FROM YOUR OWN IDEAS.** We show you how. Thousands of men, and women, too, have ideas that would bring in fortunes if properly developed and protected.

**HAVE YOU AN IDEA FOR THE IMPROVEMENT OF ANY THING? HAVE YOU AN IDEA OF SOMETHING ENTIRELY NEW?** The smallest improvements, or new ideas, sometimes bring the biggest fortunes.

**Can you think of a simple, practical idea** that will fill one of the many requests we have on file for new inventions? Thousands of things are needed, NOW.

**WE SHOW YOU HOW TO PROTECT YOUR IDEA; HOW TO GET THE MOST OUT OF IT.**

**FREE**

**SEND FOR THIS FREE BOOK**

Tells you all you want to know about inventions, patents and trade marks. Valuable information. Patents advertised, for our clients, free, in "INVENTION and MANUFACTURING," a magazine for inventors, for the man with an idea. (One year's subscription 50c.)

A postal will do; but **DO IT NOW; IT MAY MEAN THE STEPPING STONE TO FUTURE SUCCESS.**

**AMERICAN INDUSTRIES, Inc.**  
517 KRESGE BUILDING, WASHINGTON, D. C.



## PATENTS Secured

Prompt service. Avoid dangerous delays. Send for our "Record of Invention" form and Free Book telling How to Obtain a Patent. Send sketch or model for examination. Preliminary advice without charge. Highest references. Write TODAY. J. L. Jackson & Co., 327 Ouray Bldg., Washington, D. C.



## FOIL BURGLARS

Most locks offer no protection. Test yours with this wonderful set of Master Keys. 5 keys in all, and each one different. Open and prove thousands of locks as worthless. Recommended

by users in ten different nations. Novel key chain FREE. Send only \$1 today.

MASTER KEY CO., 26-L Manhattan Block, Milwaukee, Wis.



## NO MORE BALD HEADS



**WHEN** our VACUUM CAP is used a few minutes daily. We accept no pay until you have tried the Cap 60 days and are satisfied. The Vacuum Cap is an appliance that draws the blood to the Hair Roots and starts a new healthy crop of hair. It stops Dandruff, stops the hair from falling out.

Bought by Doctors and men who know that it is the only reasonable HAIR GROWER known to science. No Drugs Used. Write for application, blank testimonials, and booklet on "HAIR" sent sealed in plain envelope, FREE.

**THE MODERN VACUUM CAP CO.**  
E 559 BARCLAY, DENVER, COLO.

Please Mention Popular Mechanics

## PATENTS

### To the Man with an Idea

I offer a comprehensive, experienced, efficient service for his prompt, legal protection and the development of his proposition.

Send sketch, or model and description, for advice as to cost, search through prior United States patents, etc. Preliminary advice gladly furnished without charge.

My experience and familiarity with various arts frequently enable me to accurately advise clients as to probable patentability before they go to any expense.

Booklet of valuable information and form for properly disclosing your idea free on request. Write today.

**Richard B. Owen, Patent Lawyer**  
9-303 Owen Building, Washington, D.C.  
2276-E Woolworth Bldg., New York City



# U.S. PATENTS

## PROTECT YOUR IDEAS

Avoid Delays. Profit From Your Invention. Write today for free book "How to Obtain a Patent." Send Sketch or Model of your idea for preliminary examination and my report. Your rights will be carefully safeguarded and held in strict confidence. Highest references. Prompt Personal Attention to each case.

### CLARENCE A. O'BRIEN

Registered Patent Lawyer

798 SOUTHERN BUILDING, WASHINGTON, D. C.

**FREE**

**WRITE  
TODAY**



## U.S. PATENTS



SEND FOR THIS FORM

### DON'T LOSE YOUR RIGHTS TO PATENT PROTECTION

Before disclosing your invention to anyone send for blank form "EVIDENCE OF CONCEPTION" to be signed and witnessed. A sample form together with printed instructions will show you just how to work up your evidence and establish the same before filing application for patent. As registered patent attorneys we represent hundreds of inventors all over the United States and Canada in the advancement of inventions. Our schedule of fees will be found reasonable. The form "Evidence of Conception," sample, instructions relating to obtaining of patents and schedule of fees sent upon request. Ask for them—a post card will do.

PATENTS AND TRADE MARKS

**LANCASTER & ALLWINE**

204 Ouray Bldg. Washington, D. C.  
Originators of forms "Evidence of Conception."

Please Mention Popular Mechanics

## NO JOKE TO BE DEAF

—Every Deaf Person Knows That I make myself hear, after being deaf for 25 years, with these Artificial Ear Drums. I wear them day and night. They are perfectly comfortable. No one sees them. Write me and I will tell you a true story, how I got deaf and how I make you hear.



Medicated Ear Drum  
Pat. Nov. 3, 1906  
GEO. P. WAY, Artificial Ear Drum Co. (Inc.)  
80 Adelaide St., Detroit, Mich.

## TOBACCO

### Habit Cured or No Pay

Any form, cigars, cigarettes, pipe, chewing or snuff Guaranteed. Harmless. Complete treatment sent on trial. Costs \$1.00 if it cures. Nothing if it fails. SUPERBA CO. E-41 BALTIMORE, MD.

## Don't Wear a Truss

Brooks' Appliance, the modern scientific invention, the wonderful new discovery that relieves rupture, will be sent on trial. No obnoxious springs or pads.



MR. C. E. BROOKS

### Brooks' Rupture Appliance

Has automatic Air Cushions. Binds and draws the broken parts together as you would a broken limb. No salves. No lies. Durable, cheap. Sent on trial to prove it. Protected by U. S. patents. Catalog and measure blanks mailed free. Send name and address today.

BROOKS APPLIANCE CO., 1266 State St., Marshall, Mich.



# \$47<sup>25</sup> Profit in 4 Hours

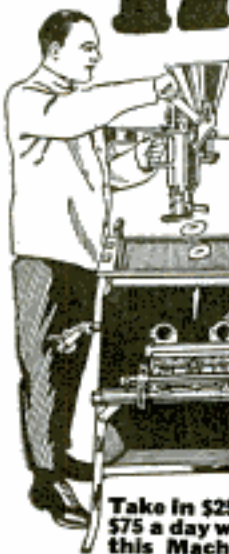

Doughnut Making business has wonderful possibilities. Doughnuts have taken the country by storm. Enormous demand. \$25.00 to \$75.00 a day. Capacity 900 doz. a day. Doughnuts sell fast at 30c to 40c a doz. 100% profit. No experience needed. Flour ready prepared—add water—put dough in hopper—turn crank—out dough sweet, savory, golden doughnuts.

## AMAZING PROOF FREE

Money-making possibilities unlimited. Put this Automatic Doughnut Machine in display window. Attract crowds. Exciting odor whets appetite. You take in money fast. Pay for the machine the first week. *Joe. P. Demery, Pa., says: "Made \$47.25 profit in four hours. Others report earnings equal or better. Big money wholesaling."*

Take in \$25 to \$75 a day with this Machine

**WRITE NOW** Get in on a ground floor—act quickly before others start. These machines pay big anywhere—no towns too small. Get full details of this new, profitable business—costs nothing to investigate. Write today.

**BUTLER & BUTLER, 5650-A Lake St., Chicago**

## NEW INVENTION

### 4 DRAWING INSTRUMENTS IN 1

Newest aid to quick and easy drawing. Does the work of a whole drawing outfit. You can draw circles, divide them into segments, construct angles or do any kind of mechanical drawing from 25 to 50% quicker and more accurate with the Golden Combination.

Endorsed by architects, civil engineers, artists and educators everywhere. Nothing like it ever before offered. Equally valuable for professional or student.

Save its price quickly in increased output. Sent postpaid for \$3. Money refunded unless you agree it is just what you want.

**Golden Compass Co., 430  
Monger Bldg., Elkhart, Ind.**

**FREE BOOK EXPLAINS IT**

Our moneyback offer makes it to your advantage to order at once but if you wish further details, explanations and samples of work done, write for our free booklet.

## \$4.50 Guns for Brush Hunting

**Famous U. S. Cal. 45-70**

rebores smooth, to shoot Bird shot, total length 41 inches, weight 7 lbs. \$4.50  
Bird shot cartridges for the above 3c each.

Rifle Barrels interchangeable for above \$2.00  
U. S. Army Krag Rifle, like new \$15.00

Send for Catalogue

**W. Stokes Kirk 1627-P.M. N. 10th St.  
Phila., Pa.**

## "BAM-BEE-NO" Real Baseball on any table

Just out. New game. Interests all. Miniature baseball. Including 18P-Book of all plays known. Excitement. Fun. Thrills Galore! Send \$1.50 for complete outfit. Play 3 games; if not all we say return game and money will be refunded. A \$50 Xmas gift for any ball fan. Folder and testimonials free.

Dept. 6122 **THE BAMBEENO SALES CO.** Toledo, Ohio

## AGENTS: \$72 A WEEK

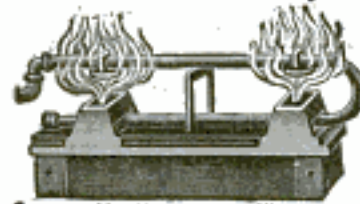

### New Can't Clog Coal-Oil Burner Newest Invention

Most perfect burner ever invented. Intense blue flame. Can't clog up. Turns any coal or wood stove into a gas stove. Heats oven to baking point in ten minutes. Cheapest fuel known. Low priced. Sells everywhere. Nothing else like it. Not sold in stores. Write quick for agency.

**PARKER MFG. CO., BURNER 578, DAYTON, OHIO**

"Will say I am highly pleased; find it does the work of \$100 machines. Have had several friends to see it; they were surprised that I got such a good machine for the money."

AMAZING  
VALUE

"I had an opportunity to investigate the other makes of typewriters and have come to the conclusion there is more real value in your machine at the price."

"I am well pleased with the typewriter and my friends have expressed surprise that a machine of such value could be turned out for the price. My son at the State Normal School says it is the smoothest running machine he ever tried and in many respects superior."

"Am pleased with typewriter; will take another five machines."

Brand-  
New:  
From  
Factory  
To  
You



## BIG SAVING - FREE TRIAL

This beautiful machine is the only brand-new (unused), standard, full-size typewriter with a 4-row, 42-key, 84-character Universal keyboard that you can buy for less than \$100. It comes direct from factory to you at practically the wholesale price of other high-grade typewriters—a remarkable saving. Use Annell' on your work at our expense, put it to the test for ten days; then if it doesn't satisfy you in every way, return it to us and we will refund even the express charges. You take no risk. Could anything be fairer?

### Easy Terms

While you are enjoying the use of the machine, small monthly payments (much less than 20c per day) make it easy and convenient to own this full-size, brand-new (unused), 4-row, standard-keyboard typewriter.

### Mechanical Marvel

Strength and simplicity are the outstanding qualities of this machine. Every essential operating convenience is possessed by Annell', including the 4-row, 42-key, 84-character Universal standard keyboard. This good Annell' is made so well and lasts so long that the cost—if spread over the machine's lifetime—is less per day than the price of a postage stamp. And remember, the Annell' is fully guaranteed.

## Send Coupon Today

for complete information about the greatest of all typewriter offers. Don't miss it. Act now.



NOT AN ORDER - MAIL TODAY

**ANNELL' TYPEWRITER CO.**  
708 No. 230 East Ohio Street, Chicago.  
Send me free catalog and complete information about your wonderful typewriter offer; this places me under no obligation.

Please Mention Popular Mechanics



## Hit the Snowbound Trail!

**YOU WINTER SPORTSMEN**—double the thrills of skiing, skating, ice boating, tobogganing—ride to and from your sport on a Harley-Davidson. Speed with the snowflakes, over trails or roads—get there before the crowds—and home again in a jiffy. No radiator troubles with a motorcycle! Harley-Davidson 1923 models, with 10 improvements, are the finest motorcycles ever built—yet the prices are lower.

See your dealer or write for new literature and **REDUCED** prices.

**HARLEY-DAVIDSON MOTOR CO.**  
Milwaukee Wisconsin

(Attractive dealer proposition for unassigned territories.  
Address Desk A-2.)

### Harley-Davidson

World's Champion Motorcycle



**1923 Models<sup>and</sup>**  
**FINAL PRICE**  
**REDUCTION**



**Rabbit Book FREE**

Illustrated. Facts about the easy, profitable home industry—growing domestic hares for meat, fur, fancy. Little space—cheap equipment. Big demand. We buy all you raise at \$7 to \$18 per pair. Turn your spare time into cash. Book free—write now.

**STANDARD FOOD & FUR ASS'N**  
407B Broadway New York City

## MAKE OVER \$800 MONTHLY



Owning and operating an Anderson Vulcanizing Station. We guarantee the Anderson as the best money-making vulcanizer made.

Write us for Terms and Prices.

**ANDERSON STEAM VULCANIZER CO.**  
Pop-Williams Building Indianapolis, Ind.  
An Anderson School is near you.

## FREE MEAT CURING BOOK

To learn the best methods of curing meat, write to E. H. Wright Co., 826 Broadway, Kansas City, Mo., and get absolutely free a new \$1 book, "Meat Production on the Farm," which tells all about meat curing. Free to farmers only. Send name today.



## RAISE BELGIAN HARES

New Zealand Reds—Flemish Giants—American Blues.  
**BIG PROFITS, WE PAY \$1.50 TO \$8 EACH.**  
Also Carries, Mink, Skunk, Fox, Muskrat, Etc.  
Easily raised anywhere. 32-**FREE!**  
page Catalog and Contract  
Illustrated, book "COMMON SENSE RABBIT  
RAISING," quarterly journal, and copy of  
America's leading small stock magazine, all for 10 cents. Address  
Outdoor Enterprise Co., 1005 S. E. BLDG., KANSAS CITY, MO.

## Give Him One for XMAS!

Your brother, your chum or your Dad would be delighted to get one of these latest smoke cases for Xmas. It's a dandy!

## EJECTOR CIGARETTE CASE

"Press the Button"

and up comes a fresh smoke. Keeps 'em moist and perfect. Works smoothly, noiselessly. Every smoker needs one. Fine for driving; you can extract the cigarette with the lips. Mailed to you in high grade nickel for \$1.50 if not at your dealer's. Initials engraved, 50c extra. Others in gold and silver up to \$20.

**\$1.50**



(Dealers, write)

**THE LYONS MFG. CO.**

342-MP YORK ST.,

New Haven, Conn.

## Prices Are Down

Choose from 1923 models, 44 styles, colors and sizes world famous Ranger and Pathfinder Bicycles. Shipped Free on approval for 30 days free trial. Protect yourself at these rock bottom prices.

**12 Months to Pay** If desired. Many boys and girls can't carry the small monthly payments. Parents often advance first payment. Best quality, at factory prices, express prepaid. Lamps, wheels and equipment, low prices. **Send No Money, do business direct with makers.**

**Mead Cycle Company**  
Dept. H-11 Chicago

Write today for free Ranger Catalog, factory prices and marvelous easy payment terms





**FREE****Concerts To-Night!**

—in New York City, Pittsburgh, Atlanta, Detroit, Denver, Schenectady, Newark, Chicago, and 50 other Cities.

**Listen In!** All you need is an Easy Chair and a Radiopera Outfit. We'll sell you one on instalments. Lyon & Healy Outfits insure the finest musical results. They are especially adapted to the needs of ardent music lovers who wish the most practical form of hearing the wonderful musical entertainment that will be broadcasted this Winter. They are the most economical!

Radio Outfits Priced from \$72.50

Sold on Easy Monthly Payments

Our Radio Department—Distributors for  
Radio Corporation of America      Westinghouse Co.  
Western Electric Co.      Radak      General Electric Co.

**Lyon & Healy, CHICAGO**63-72 Jackson Blvd.  
[signing off till you call]**Clip and Mail**

Lyon & Healy, Chicago  
63-72 Jackson Blvd.  
Please send Radio  
Catalog and map  
FREE.

Name .....

Address .....

**SQUAB BOOK FREE**

Squabs are selling at the highest prices ever known. Breed them and make money. Write at once for free book, prices, etc.  
Plymouth Rock Squab Co., 634 Howard St., Melrose Highlands, Mass

**PLANS FOR POULTRY HOUSES!**

All styles 150 Illustrations; secret of getting winter eggs, and copy of "The Full Egg Basket." Send 25 cents.  
INLAND POULTRY JOURNAL, Dept. 74, Indianapolis, Ind.

**World's Best Poultry Journal**

You be the Judge!

**6 Months' Trial Subscription 25c**

ONE CENT U. S. STAMPS ACCEPTED

Tells how to keep poultry with greatest profit; 100 to 160 pages monthly; 24th year. Best articles; expert advice; profusely illustrated. 1 yr., \$1.00; 3 yrs., \$2.95.  
Reliable Poultry Journal Pub. Co., Dept. 118 Dayton, Ohio

For the Tourist, Hunter, Motorist, Boy Scout, Farmer, etc.

**POCKESCOPE POCKET TELESCOPE 4x POWER**

Length Closed 3 1/4 in.; Extended 5 in.; Brass throughout. Ideal Xmas Gift finished in black, crystallized lacquer in gray suede leather case. Sent postpaid on receipt of \$2.00.  
WATRY & HEIDKAMP, Dept. P 17 W. Randolph St., Chicago

**American Poultry Journal OLDEST, LARGEST and BEST 4 MONTHS' TRIAL 25 cents**

1 Yr. 75c. 2 YEARS \$1 5 Yrs. \$2

Averages over 100 pages per issue—tells how to feed, house and breed; how to secure high egg production; how to hatch and rear poultry successfully. Established 1874. Only 25 cents for 4 months. Stamps accepted.  
American Poultry Journal, 14-523 Plymouth Ct., Chicago

**Free Book Tells How to Get More Eggs!**

Send Now!

96 Pages

**H**OW to save feed and get double egg yield. How to cull out poor layers. How Mrs. Hume made \$2000. How Mr. Luttrell makes \$5 net profit per hen. This book explains Prof. Quisenberry's system now being used by 46,000 successful poultry raisers. 1000 money-making secrets.

**Write Today!** Simply send name, a postcard will do, for this 96-page free book, "Dollars and Sense in the Poultry Business." No cost, no obligation. Address

American Poultry School, Dept. 185 Kansas City, Mo.

**Home, Farm & Garage Necessity COMPLETE SAW MILL**

Attach to Lighting Circuit to Operate.

**Hundreds of Uses**

Rips, Crosscuts, Bevels, Miters, Grooves, with accuracy and despatch.

14", 3" or 4" Saws may be used.

**CAPACITY OF SAWS:**

| Saws   | Thickness |
|--------|-----------|
| 2 1/2" | 3/8"      |
| 3"     | 1/2"      |
| 4"     | 3/4"      |

Weight of complete equipment 32 lbs.

All saws made by Henry Dierker & Sons Co. Sold with or without Motor.

**SAW & SPECIALTY MFG. CO.**  
1029-31-H MELON STREET PHILADELPHIA, PA.



Saw Machine with 3" Saw

without Motor, \$14.50

etc.

With 1-6 H.P. Motor, Bidding

Pillows, \$45.00

Card &amp; Flag

Mounted on Oak \$47.50

Base

All orders shipped F.O.B.

Philadelphia.

State whether A.C. or D.C.

Current is used.



# DIAMONDS

**ONLY \$2 DOWN AND 10 MONTHS TO PAY**

Send only \$2.00 deposit as a guarantee of good faith and we will send your choice of the \$49.00 cluster diamond ring, or the \$50.00 beautiful solitaire diamond ring, or the \$12.00 wedding ring, or the \$25.00 wrist watch. Pay the balance in ten equal monthly payments. For the \$100.00 solitaire blue white diamond, send \$20.00 deposit. For the \$75.00 diamond, send \$15.00 deposit. Men's rings with same diamonds will be supplied at same price. Hundreds of similar bargains are described in our new catalog.

**30 DAYS FREE TRIAL**

Wear any article of your choice on trial for 30 days. If not satisfied send it back and we will return every cent you paid. Free examination at bank or express office before paying deposit, if desired. Written guarantee that if any other jeweler in the U. S. can sell you equal merchandise for less money, you can get your money back. On this guarantee you cannot lose.



14 Karat solid white gold rectangular wrist watch. 15 jeweled movement. Worth \$40.00. Full length indestructible pearls \$5.00. Our prices are the same for credit as for cash. Order article of your choice by letter and give size wanted. Everyone's wonderful bargain. Rings A-B-C-D are 18 Karat white gold. Ring E 14 Karat yellow gold. Thousands of similar values in our beautiful catalog.

Write for our big catalog  
\$1,000,000.00 and 43 yrs experience back of our guarantee

## B. GUTTER & SONS

Wholesale Jewelers & Diamond Importers  
172 NASSAU ST., DIV. 374, NEW YORK

Swing 4 in.; 11 in. between centers, 17 in. total length. Shipping weight 13 lbs. Bed of lathe is machined. Workmanship first-class. Equipped with wood turning chuck. Can be fitted with 3 in. face plate and drill chuck as special equipment. Order one today.



Price \$6.00 cash with order  
Made also in larger sizes.  
**SYRHER MFG. CO.**  
Dept. D Toledo, Ohio

## TIRRO

THE IDEAL MENDING TAPE

At Drug Stores  
**BAUER & BLACK, 2500 DEARBORN ST., CHICAGO**



## World Batteries

for  
**RADIO OR AUTOMOBILE**  
**SAVE YOU 50%**

Buy direct from factory. Get highest quality—lowest prices and 100% battery service.

**WRITTEN TWO-YEAR GUARANTEE**

| AUTOMOBILE PRICES |         |
|-------------------|---------|
| 6 Volt, 11 Plate. | \$12.50 |
| 6 Volt, 13 Plate. | 14.50   |
| 6 Volt, 15 Plate. | 16.00   |
| 6 Volt, 17 Plate. | 18.00   |
| 6 Volt, 19 Plate. | 20.00   |
| 6 Volt, 21 Plate. | 22.00   |
| 6 Volt, 23 Plate. | 24.00   |
| 6 Volt, 25 Plate. | 26.00   |
| 6 Volt, 27 Plate. | 28.00   |
| 6 Volt, 29 Plate. | 30.00   |
| 6 Volt, 31 Plate. | 32.00   |
| 6 Volt, 33 Plate. | 34.00   |
| 6 Volt, 35 Plate. | 36.00   |
| 6 Volt, 37 Plate. | 38.00   |
| 6 Volt, 39 Plate. | 40.00   |
| 6 Volt, 41 Plate. | 42.00   |
| 6 Volt, 43 Plate. | 44.00   |
| 6 Volt, 45 Plate. | 46.00   |
| 6 Volt, 47 Plate. | 48.00   |
| 6 Volt, 49 Plate. | 50.00   |
| 6 Volt, 51 Plate. | 52.00   |
| 6 Volt, 53 Plate. | 54.00   |
| 6 Volt, 55 Plate. | 56.00   |
| 6 Volt, 57 Plate. | 58.00   |
| 6 Volt, 59 Plate. | 60.00   |
| 6 Volt, 61 Plate. | 62.00   |
| 6 Volt, 63 Plate. | 64.00   |
| 6 Volt, 65 Plate. | 66.00   |
| 6 Volt, 67 Plate. | 68.00   |
| 6 Volt, 69 Plate. | 70.00   |
| 6 Volt, 71 Plate. | 72.00   |
| 6 Volt, 73 Plate. | 74.00   |
| 6 Volt, 75 Plate. | 76.00   |
| 6 Volt, 77 Plate. | 78.00   |
| 6 Volt, 79 Plate. | 80.00   |
| 6 Volt, 81 Plate. | 82.00   |
| 6 Volt, 83 Plate. | 84.00   |
| 6 Volt, 85 Plate. | 86.00   |
| 6 Volt, 87 Plate. | 88.00   |
| 6 Volt, 89 Plate. | 90.00   |
| 6 Volt, 91 Plate. | 92.00   |
| 6 Volt, 93 Plate. | 94.00   |
| 6 Volt, 95 Plate. | 96.00   |
| 6 Volt, 97 Plate. | 98.00   |
| 6 Volt, 99 Plate. | 100.00  |

Batteries shipped immediately express C. O. D. Thousands of satisfied users. Mail your order today!

**World Battery Company** 1219 S. Wabash Ave., Dept. P  
CHICAGO, ILL.



*Nifty Nine in Display Case*

## \$20 A DAY

Few choice openings as local Distributor of the celebrated Davis Products. Men and women making more money than they ever dreamed possible with our plan. W. H. Marion, a beginner, made \$36 in three hours his first day! \$60 to \$100 a week dead easy for workers. **Nifty Nine** (illustrated above) in beautiful box 11x12½ ins. is leader. 30 other wonderful packages.

## FORD AUTO GIVEN

No contest. No limit to number given. No time limit. Every Davis producer gets brand new Ford Touring when he proves up. Most liberal offer ever made by any manufacturer.

### SPECIAL OFFER—WRITE NOW

Make cleaning during Holiday season. Get busy quick! Waste no time! Send for Complete Outfit including Display Case of Nifty Nine, postpaid for \$2.00. At least write quick for full details explaining our unique plans. **ACT NOW!**

**E. M. DAVIS COMPANY**

Dept. 5699

CHICAGO

## FOR HIS CHRISTMAS

**BARTLETT DROP-FORGED SNIPS \$2.70 to \$9.50**

Made of high-grade Crucible Tool Steel, accurately tempered. Cuts metal up to 16 gauge easily. 7 in. size just right for household use. 7-inch stamped, \$2.70. 8-inch, forged, \$4.00. 10-inch forged, \$6.00. 12-inch, \$8.00. 14-inch, \$9.50.

Your dealer has them, or can get them from his jobber. If he will not we will ship prepaid in U. S. at above prices.



**FOLDER ON REQUEST**

Bartlett Mfg. Co., 20 E. Lafayette Ave., Detroit, Mich.

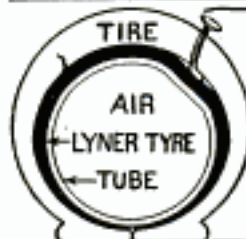

## AGENTS!!!

One wanted in every county to introduce **LYNER TYRE**. Prevents 90% of punctures. Guarantee against blow-outs. Doubles tire mileage. No tools needed. Easy to sell, repeat orders, large commission. Protected territory. Write for proposition. Full or spare time.

**PELLETIER TYRE COMPANY**  
115 S. Dearborn Chicago

## New 300 Candle Power Lamp



**Make \$60 to \$100 a Week**

Introducing this wonderful new lamp. Gives soft, brilliant light; restful to eyes; ideal illumination.

**Burns Kerosene or Gasoline**

Clean, odorless, economical. Burns 96% air, 4% fuel. Absolutely safe. Lights with match. 100 times brighter than wick lamps. Patented. Greatest improvement of age.

Table lamps, hanging lamps, lanterns.

Work all or spare time. You simply take orders. We deliver by Parcel Post and do collecting. Commissions paid same day you take orders. No experience necessary. Get started at once. Big season now on. Write today for catalog and special agent's offer.

**THE AKRON LAMP CO.**

112 Lamp Bldg. Akron, Ohio

**AGENTS** Send for FREE Offer



**1 Down ONLY \$7 A MONTH**  
**STANDARD Artist's Model SAXOPHONE**

Learn in an Hour!

The Saxophone is so easy to learn you can actually play tunes after an hour's instruction and practice! Most popular instrument in history of music. Favorite on stage, at dances, in the home—even in churches!

**Make Extra Money**  
 Saxophone players make BIG MONEY! Nothing you can learn so quickly pays so well! And all doors are open to the fellow or girl who can contribute Saxophone music to the evening's fun. The world holds new pleasures for those who can play!

**10 Months TO PAY**

Standard Artists' Model. The choice of professionals and teachers everywhere because of its golden tone, perfect pitch and easy fingering and blowing. Now offered for only \$84.50, payable \$7 per month, only \$1.00 down! No interest, no extras! And you get FREE \$10 case, instruction book, extra reeds, pearl finger tips and leather strap. And we give you 6 days' FREE trial besides to prove that no Saxophone can equal this one. So show you how quickly you can learn Illustrated Catalog and complete information Free! Write today!

**STANDARD MUSIC CO.**  
 Dept. 522, P. O. Box 503, CHICAGO, ILL.

**Dulce-Tone Jr.**  
 Only \$15.00

MUSIC MARKET REPORTS RADIO NEWS CONCERTS

**Makes a Loudspeaker of Your Phonograph**

Your phonograph instantly becomes the finest of loudspeakers when you attach Dulce-Tone Jr. Music fills the room—even to the farthest corners—with cello-like sweetness, for Dulce-Tone Jr. utilizes the wonderful sound-box, tone arm and needle that took science years to perfect.

Dulce-Tone Jr. is attached instantly. Complete—nothing else to buy. Simply place needle of phonograph on center element of Dulce-Tone Jr. and attach wires to receiving outfit. Entertains whole roomful of guests without additional head phones. Various volumes produced by regulating field current. Current is supplied by "A" battery on receiving set, and never exceeds 1/2 ampere. Exclusively made and guaranteed under KAEHNI circuit inventions and patented applications.

**A \$50 Loudspeaker for \$15**  
 No excessive profit—sold direct from factory to you. Order now and begin to get full value out of your radio and phonograph. Mail coupon now—attach a dollar and this wonderful instrument comes by return mail at \$14.00 C.O.D. Or send for literature. Mail the coupon—today!

**THE CLEVELAND RADIO MFG. CO.**  
 152 St. Clair Ave., N. E. Cleveland, Ohio

**The Cleveland Radio Mfg. Co.,**  
 152 St. Clair Ave., N. E. Cleveland, Ohio.  
 Enclosed is \$1.00, send me a Dulce-Tone Jr. (balance C.O.D. \$14.00.)  
 Send me your folder "Waves to You Through Your Phonograph." State name of your set and number of stages of amplification.

Name.....  
 St. & No.....  
 Town.....State.....

**Crane's Handisaw**

—a practical little bench saw of surprising capacity for all kinds of light sawing. Completely equipped with adjustable rip guide, combination cut-off and miter guide, 4 in. saw, and 3-8 in. grooved pulley. Top 6 in. by 3 in. Saw projects 11-4 inch. Cut 1 inch stock easily. Specially designed hand cranks saw and provides self-feeding dust chute. Adjustment screw elevates top for grooving. Cuts maximum groove 1-8 inch wide. All parts nicely finished. Grease cup lubrication. Easily operated with 1-6 H. P. motor. Adapted for small shops or home use. Speedy and accurate—precision adjusted. Nothing to get out of order. High grade in every respect—Fully guaranteed. Send today. Money back if not satisfied.

Only \$14.50  
 Money back guarantee.  
 Shipping weight 21 lbs.

**BOICE BROS., 1512 Boice Bldg., 114 23rd St., Toledo, Ohio**

**BOYS AND GIRLS** Look at this Air-Plane. Flies 300 ft. Loops the loop. Glides and returns like a real one; lots of fun. Ask your parents to get you one for Xmas.

25c by mail. Money Order. **A. O. KOECHER, 510 E. 44th Place, Chicago, Ill., Dept. 204.** Send for it now.

**5 Magic Keys**

Work like magic in emergencies or prove whether your door or padlocks are burglar-proof. Open and test thousands of different locks. Recommended by users in ten different nations. Most wonderful and only keys of their kind. Send \$1 today. Novel key chain FREE with set. **MASTER KEY CO., 25L Manhattan Block, Milwaukee, Wis.**

**Taxidermy Book FREE.**

**Stuff Beautiful Birds.** Learn by mail to stuff and mount all kinds of birds, animals, fish and game heads, make rugs, tax skins. Mount your own specimens and make money preserving for others. Men, women and boys learn easily and quickly. Success guaranteed or no tuition. Write today for our wonderful FREE book "How to Learn to Mount Birds and Animals. N.W. School of Taxidermy, 9779 Elmwood Bldg., Omaha, Neb.

Write Today.

Please Mention Popular Mechanics

**PROTECT YOUR HOME & FAMILY FROM BURGLARS**

With Burglar Proof Key Attachment. Key Cannot Be Pushed Out. Prevents Burglars From Entering. Do You Feel Safe From Burglars? Do You Feel Secure At Night? Better Than Watch Dogs Or Watchmen. Absolutely Reliable. An Acceptable Gift. Great Money Maker For Agents. Does Not Mar Finest Door. No Tools Or Screws Required. Snaps Quickly Into Place. Safeguard Your Home With Burglar Proof Key Attachments.

**SAMPLE 25c.**

Set Of 5 \$1 Postpaid. Do Not Put It Off. Write Your Name & Address On Margin Of This Page & Mail With Remittance To

**KEY ATTACHMENT CO., MARSHALL BLDG., CLEVELAND, OHIO**







Norco  
Jr. Radio

\$4.95

### Wonderful Radio Bargain

This is positively the greatest radio bargain ever offered. The Norco Junior receiving set is made of the very finest materials obtainable. Comes to you knocked down with blue print and complete instructions for setting up. Requires no expert knowledge, just a few minutes time and you have a complete radio receiving set as illustrated. Besides it's lots of fun putting it together. Send for the Norco Junior today and enjoy the radio concerts that are being broadcasted all over the country. You will be proud of the Norco Junior. So simple a boy of ten can put it together in a few minutes time. Buy one for a Christmas present.

**\$15 Value for Only \$4.95**

Think of the fun you can have with the Norco Junior and then remember that it is equal in every way to radio outfits that are retailing for \$15.00 and more. Look what you get at this remarkable bargain price. Highest grade materials and workmanship throughout; finest copper wire sliders and rods of the highest grade brass; complete instructions for setting up, including blue print; two ends grooved to fit coil; sufficient wire to complete set; one condenser; one tuning coil complete; 4 in. diameter, 6 in. long; 100 ft. hard drawn copper aerial wire not shown in cut; 1 base, 16 in. x 5 in. x 1 in.; high class detector; two sliders of best grade brass; solid brass binding posts; screws to complete set. If you want to save at least \$10.00 on your receiving set rush your order at once for the Norco Junior. This special bargain price is made to quickly introduce the Norco in every locality and may be withdrawn at any time. Send draft or money order for \$4.95 and we will ship you the Norco all charges prepaid. Fully guaranteed.

Norco Radio Factory  
Rogers Park Sta. Chicago, Ill.



Seventeen years ago you could have given Murdock Headsets as Christmas gifts. You can do so this year and be sure that any radio enthusiast will be mighty pleased to receive a real Murdock Headset for Christmas. Tried and proven for 17 years by experts and amateurs alike.

Get a pair from your dealer or send direct if he does not have them.

\$5.00

2000 OHMS

WM. J. MURDOCK CO.  
349 Washington Ave.  
1270 Broadway  
New York

\$5.50

3000 OHMS

WM. J. MURDOCK CO.  
Chelsea, Mass.  
509 Mission St.  
San Francisco

**MURDOCK RADIO**

STANDARD APPARATUS SINCE 1904

The Versatile  
**HAMMOND**  
Folding Portable  
Typewriter

MULTIPLEX HAMMOND'S  
Instantly changeable type  
Many styles, many languages  
Just turn the knob to change

Hammond Typewriter Corp., 569A East 69th Street  
New York City, N. Y., U. S. A.

**BUILD YOUR OWN  
RADIO**



\$20

Save  
Money

Complete parts ready to assemble. Panel drilled and neatly lettered. Everything complete with full instructions. Servo driver and gears are all tools needed. Shipped prepaid. Send your order today. Illustrated folder on request. With each set we give FREE the \$5.00 LoFar Radio Handbook.  
WAVELAND RADIO COMPANY (INC.)  
1348 N. Clark St., Dept. 14, Chicago, Ill.

**BATTERIES**

Direct From **FACTORY**  
AT WHOLESALE PRICES

Finest materials and workmanship.  
Long life—easy charging. **Guaranteed 24 mos.**

- 11 Pl. (6V.)—Ford, Chev., Mitchell, Hupp, Grant, Velsie, Saxon - - - - - **\$12**  
13 Pl. (6V.)—Buick, Cleve., Ho, Paig, Dort, Nash, Hudson, Stude. - - - - - **\$14**  
7 Pl. (12V.)—Dodge, Franklin, Royal, Briccoe, Crow Elkhart - - - - - **\$17.50**

Send year and model of car.

Radio Batteries

80 amperes, \$11. 100 amperes, \$13

Shipped express C. O. D. day order is received.

**WESIDE BATTERY CO., Dept. 25**  
4445-47-49 W. Madison St. Chicago, Ill.



**DUCK'S** NEW NO. 16—256-PAGE COMBINED RADIO TEXT-BOOK AND CATALOG

All Other Catalogs in One

Our new catalog is truly the wonder catalog. You can spend more than a dollar for other catalogs and yet you will not have the equal of this catalog. There are over 50 pages of diagrams and data on wireless. As a radio book alone it is priceless. The complete catalog of the Radio Corporation of America, with circuits and information for making powerful wireless telephone transmitters, the Remler, Murdock, Firth, and in fact all other catalogs are incorporated in this catalog, not to mention over 70 pages of our own goods.

Send 25c in coin carefully wrapped for this catalog today. Not sent otherwise.

The William B. Duck Company, 223-227 Superior St., Toledo, Ohio





# DICTOGRAPH Radio HEADSET

Was \$12.00 **NOW** →

**Why this Sensational Reduction in Price!**

A SWEEPING cut of \$4.00 in the price of the Dictograph Radio Head Set! The tremendous endorsement of radio enthusiasts has made possible this sensational reduction. To meet the demand, production has been planned on a new, gigantic scale. Great manufacturing economies establish the new price—only \$8.00.

A wonderful bargain! And above all, a wonderful head set—the world's standard of supreme quality for super-sensitive and accurate sound transmission.

The same quality, the same guarantee, the same supreme Dictograph head set in every respect but the price. Type R-1, 3,000 ohms, for all types of receiving sets.



## DICTOGRAPH Radio LOUD SPEAKER

**THE PERFECT LOUD SPEAKER FOR THE HOME**

Public demand has made possible the Dictograph Loud Speaker at the low price of only \$20.00, complete with 5 ft. flexible cord. A handsome instrument that reproduces every sound in crystal-clear, natural tones, full volume, and free from distortion or noise. Ask for demonstration at reliable radio dealers. Get world-famous DICTOGRAPH quality and still save money.

Dealers: Order through your jobber or write direct for names of authorized distributors.

**DICTOGRAPH PRODUCTS CORPORATION**

220 West 42d Street (Branches in all principal cities) New York, N. Y.

The Standard of the World

Note: Plans are now under way for the production of the new 4,000 ohms Dictograph SUPER-TONE Head Set, the most perfect radio head set that can be made. For the most delicate work, the most exacting requirements. A new standard of super-sensitiveness!

List Price, \$12.00

## "Superior" Receiving Set, \$4.75

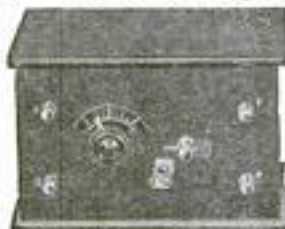

In Cabinet Complete as Shown

Guaranteed to bring in signals as loud or louder than any other crystal set made, regardless of price. We will prove this to your satisfaction or refund your money.

Parts for "SUPERIOR" set ready for assembling \$3.25  
Vacuum Tube Detector Unit \$5.50. Unassembled \$3.90  
Detector and Two Stage Amplifier \$22.50. Unassembled \$16.80  
2000 Ohm Headset \$5.90; 3000 Ohm \$4.50;

1000 Ohm Phone \$1.75

Catalog FREE at your Dealer's or

STEINMETZ WIRELESS MFG. CO., 5706 Penn. Ave., Dept. R, Pittsburgh, Pa.

DOUBLE HEAD PHONES



## BOYS! A REAL RADIO SET ABSOLUTELY FREE

RUSH your name and address and we will tell you HOW you can get this RADIO SET ABSOLUTELY FREE.

RADIO SET comes to you complete, with single slide tuning coil, crystal detector and phone condenser. AND DOUBLE HEAD PHONES. No batteries required; no experience.

Write Today for Free Radio Plan  
HOME SUPPLY CO.  
131 Duane St., Dept. 200  
New York City

## FREE Radio Catalog



Describes and illustrates our large complete stock of Radio Equipment of all kinds. We can make immediate shipments of proven, reliable equipment. Protect yourself against disappointment by taking advantage of our experience and reliability.

Send \$5.00 for Genuine Cunningham or Radiotron Detector Tube. Free catalog sent on request.

**JULIUS ANDRAE & SONS CO.**

116 Michigan St. In business since 1860 Milwaukee, Wis.

# Treasure Chest RADIO



## FOUR CAN LISTEN-IN AT ONCE

Enjoy songs, bands, operas, lectures, and news from miles away. Ready for home, office, hotel, rooming, or trips. Splendid extra-sensitive and distinct Crystal Radio set. No batteries. Mounted in beautiful red and yellow gold colored metal clad chest. Made by experienced radio manufacturers. Price

**Only \$18.75**

delivered, including everything. No extra head phones to buy.

**FREE**

Write for full-size illustration in colors, today.

**Electra Mfgs.**

Dept. C.  
536 Lake Shore Drive, Chicago





# BUILD YOUR OWN RADIO

The Radio Specialty Company—RASCOS for short—specializes in small orders; in fact, 50% of our orders are for less than one dollar. 24-hour service guaranteed.

This Company specializes in small parts for radio, selling only the highest class of materials. This Company is aware of the fact that very high prices prevail in radio now. By buying material from us you not only save anywhere from 50 to 75% on the cost of the instruments, but you have the fun and instruction of making them yourself.

Our quick, 24-hour service means satisfied customers. We have no Complaint Department. Hundreds of letters such as the following, unsolicited, are in our files:

41 Rodney St., W. St. John, N. B.  
Dear Sirs:  
Enclosed you will find one (1) dollar for which please send me 1 dozen binding posts No. 201 at \$1.00 per dozen and oblige,

George B. Ingraham.

P. S.—Rasco Service is sure all it is cracked up to be. I have received three different orders from Rasco and I am still waiting for an order from another Company which was sent in before the first Rasco order. Yours truly,  
G. B. I.

Quincy, Pa.  
Gentlemen: I wish to inform you that your "Rasco" baby detector works as well as any high-priced detector, and is an absolute bargain. It's just what I was looking for and works to perfection on my set. I will constantly tell others about it.

Yours very truly,  
T. Bayard Beatty, Jr.

Our prices are low and all goods are shipped prepaid. You deal with the oldest and only Company exclusively manufacturing the small parts in their own two big factories. Our big 64-page Catalog, No. 7, containing over 300 illustrations, will save you money. This catalog also contains

75 Diagrams of Vacuum Tube Hook-Ups

not to be found in any catalog, only found in expensive text books. This catalog sent only upon receipt of 15c. Once you have tried the RASCOS service you are a customer for life. 85% of our customers always come back.



DETECTOR  
50c

Radio Specialty Co.

98 E. PARK PLAGE, NEW YORK CITY



## HOMCHARGE YOUR RADIO BATTERY for a Nickel

ENJOYABLE Radio Concerts and Maximum Receiving Range are obtained only when your battery is fully charged. The

RADIO  
HOMCHARGER  
DE LUXE

charges your "A" or "B" battery over night. Silent and clean in operation—requires no watching—may be used right in your living room.

Connects to any lamp socket. Self-polarizing—fully automatic—cannot overcharge or injure the battery.

Entirely enclosed—approved by Underwriters. Unconditionally GUARANTEED. Lasts a lifetime.

Beautifully finished in Mahogany and Gold—the most efficient and handsome rectifier ever produced. Bulletin 637 proves it—send for your copy today—IT'S FREE. Sold by all good dealers or shipped prepaid for \$18.80, complete.

Dealers—Jobbers: The HOMCHARGER Merchandising Plan offers the best proposition in the entire radio field—send for details.

THE AUTOMATIC ELECTRICAL DEVICES CO.

129 West Third Street  
Cincinnati, Ohio

Over 50,000 HOMCHARGERS in Use



## BOYS: VOLTAMP

### How about a Railroad of your own

Get your locomotives, cars, tracks and signals direct from VOLTAMP. Our railways are sturdier and more real looking. Lots of power and "pep." Loads of fun.

Write for our 16 page, four color folder showing you all VOLTAMP models.

Voltamp Electric Manufacturing Co., Voltamp Bldg., Baltimore, Md.

See your dealer for information about  
RADISCO Radio Products  
THE RADIO DISTRIBUTING CO.  
Newark, N. J. U. S. A.

## WESTINGHOUSE BATTERIES

RADIO—Beautifully finished instruments direct to you at manufacturers prices and equal to those sold at double the price. Name of manufacturer on every instrument.

| Instrument        | Reg. Price | Spec. Price |
|-------------------|------------|-------------|
| Variometer        | \$5.50     | \$3.75      |
| 150° Variocomplex | 3.50       | 2.75        |
| 50° "             | 2.50       | 2.00        |

Send for circular. If not satisfactory money refunded.

Ker-o-el Sales Co., 8405 Detroit Ave., Cleveland, O.

## Complete \$750 Wireless Outfit

Listen to music and speeches sent from any broadcasting station within 20 or 30 miles of your home. Loads of fun and entertainment. Enjoy the benefits of this latest world wonder.

BUFFALO JUNIOR WIRELESS

For receiving only. A surprise to everyone. Folks can hardly believe an outfit as good can be sold at such a low price. Only specialized manufacture of this size outfit alone makes this price possible.

Outfit is complete, ready for attachment to any aerial. Includes 1000-Ohm receiver and three-foot cord; fixed condenser; inductance coil; and detector with tuned system. Receives up to 300 Meters. Complete instruction and code book included.

Fully reliable. Can't be outwitted at price. More sport than piano or photograph. Money back if not satisfied. Best postal anywhere in United States on receipt of Post Office or Express money order for \$7.50.

BUFFALO RADIO COMPANY P. O. Box 308, North Tonawanda, N. Y.

Please Mention Popular Mechanics





## The Future of RADIO

The fun and entertainment that you and your friends get from Radio should never be marred by failure of your apparatus to properly do its part—and it won't fail if it is properly made.

The Radio "fans" of today will be the Radio experts of the future—*provided* the equipment used *now* gives service and satisfaction. If you are interested—much or little—in Radio, don't let inefficient equipment discourage you. Insist on SIGNAL parts and SIGNAL sets.

Every SIGNAL item is made in a factory that has grown up with "wireless." One of the earliest manufacturers of such equipment, SIGNAL offers you, now, Radio parts and Radio sets that are *right*, and are *dependable*. To insure getting all there is—to be confident that nothing goes by you without your consent—say SIGNAL, and stick to it, when you buy equipment of any kind.

# SIGNAL Electric Mfg. Co.

Factory and General Office:  
1910 Broadway  
Menominee, Mich.

Atlanta, Boston, Cleveland, Chicago, Minneapolis, Montreal,  
New York, Pittsburgh, St. Louis, San Francisco, Toronto.

You'll find our local address in your Telephone Directory



### Signal Junior Detector Units

For the amateur, and also the rapidly growing commercial field, we have developed an entirely new

line of apparatus, in which is incorporated the very latest advancement of the science of Radio.

Each individual unit is primarily a separate and distinct device, complete in itself, yet by adding one to another any combination may be obtained, from the simple crystal detector through all the stages of radio-frequency and audio-frequency amplification.

Seasoned knowledge and experienced handcraft are built into these units—the product of a plant and an organization whose history in Radio dates back to the earliest days of "wireless."

### COUPON FOR GUIDE TO RADIO SATISFACTION

Please send, without obligation, your interesting book about SIGNAL parts and sets, to the name and address written in the margin of this page.

## BUILD THIS RECEIVER



Fully assembled \$25.00. Unassembled, except cabinet, \$12.63. Brings in all big stations. We manufacture Regenerative and non-regenerative receivers, audion detectors, crystal detectors, radio and audio amplifiers. Blue prints

25 cents each. All six for \$1.25. Catalog 10 cents.

Dept. N **TRIBUNE AIRPHONE COMPANY** Owego, N. Y.

## 3000 OHM SETS \$3.98

PLUS 20 CTS. POSTAGE AND PACKING  
Satisfaction Guaranteed or Money Back.



We mail phones the day your order arrives. Every pair tested, matched, and guaranteed as sensitive as \$8 to \$10 Sets. Circular Free.

**Tower Mfg. Company**  
35 STATION ST. BROOKLINE, MASS.

## THE REMARKABLE PLAN-O-PHONE NEW RADIO LOUD SPEAKER



Here is the sensation of the Radio World in both the remarkable results and amazing price. For \$3.50 you can now equip any 2 stage amplified receiving set to entertain a roomful of people with the broadcasting program. Insert any good phone receiver in the PLAN-O-PHONE and you have a good loud speaker. Nothing half so satisfactory at anywhere near the price.

**FULLY GUARANTEED**  
THE PLANET POWER AMPLIFIER

Cord and Phone not included

Sent prepaid if your dealer cannot supply you.

Price  
**\$3.50**

Weight 2 1/2 lbs. Height 11 in. Bell diam. 6 in.

### DISTRIBUTORS

BOSTON—Beaudette & Graham Co., 225 Boylston St.  
BALTIMORE—Jesse Klee & Radio Mfg. Co., 118-20 E. Lexington St.  
DETROIT—R. E. Polyzanski & Co., 204 Capitol Theatre Bldg.  
GRAND RAPIDS, MICH.—Wolverine Elec. Corp., 21 Division St.  
KANSAS CITY, MO.—Western Radio Co., 3 W. 14th St.  
PEORIA—Isaiah E. Sup. Co., 204 Capitol Theatre Bldg.  
ST. LOUIS—The McGraw Co., 2018 Locust St.  
NEW YORK CITY—Harold M. Schwab, Inc., 419 W. 42nd St.  
NEWARK, N. J.—General Mfg. Co., 142 Market St.

Order from your nearest distributor or write  
**PLANET RADIO CORPORATION**  
1223 So. Wabash Ave., Dept. C-1, Chicago, Ill.  
Dealers write for attractive proposition.



An essential unit for receiving sets that do not produce sufficient volume. Constructed so that either a five-watt power tube or an amplifying tube can be used, depending upon the volume desired. Price (without tube) = \$27.50



# BULLDOG Pipeless Furnace

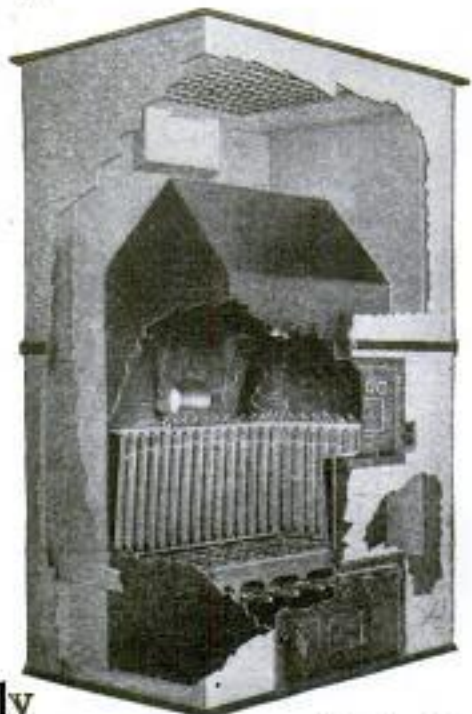

Only  
**\$10** Puts the  
**BULLDOG**  
**Pipeless**  
**Furnace**  
in Your Home!

If you are even thinking of a furnace, write for our free catalog. The Bulldog is one furnace you must investigate. Heats without pipes! Comes completely erected. An extraordinary development in heating. Built on the foundation of common sense. Write for our catalog now before you forget.

## Two Hours to Install

You do it yourself with nothing but a hammer and a saw. Rectangular shape (one of the common sense principles) allows passage through any door. The man desiring a warm, cheerful home at the very minimum of installation and fuel expense cannot afford to consider the purchase of any furnace until he finds out about the Bulldog.

## Fits Any Floor Height

No matter what the depth of your basement or cellar may be—the Bulldog fits it. The adjustable casing (another common sense feature) takes care of this. When you read our catalog we think you will agree that this alone should be sufficient to influence you to choose the Bulldog. Mail this coupon TODAY!

**Babson Bros.**

19th and California Sts., Dept. 1359, Chicago

Without obligating me in any way, please send me your free catalog and \$10 down offer on the Bulldog Pipeless Furnace.

Name \_\_\_\_\_

Address \_\_\_\_\_

## Over 3,000,000 Users Endorse New Kerosene Light

Beats Gas or Electricity



MAKE your home bright and cheerful, saving one-half on oil. Scientific tests prove this wonderful new Aladdin 5 times as efficient as the best round wick open-flame lamps. 60 candle power pure white light for 50 hours on a gallon of common kerosene. No odor, smoke, noise or pumping up. Won't explode. **Guaranteed.**

## 10 Days' Free Trial

Prove to yourself by free trial that Aladdin has no equal as a white light. If not satisfied return at our expense.

**Get Yours Free** We want one user in each locality to whom customers can be referred. In that way you may get your own without cost. Be the fortunate one to write first for 10 day free trial and learn how to get one free.

**AGENTS WANTED** To demonstrate the Aladdin in territory where oil lamps are used. Experience or capital unnecessary. Many agents average five lamps a day and make \$500 a month. Write quick for territory and samples.

**\$1000.00** Will be given to **REWARD** anyone showing us an oil lamp equal to this Aladdin in every way. (Full details of this offer given in circular.)

THE MANTLE LAMP COMPANY OF AMERICA  
304 Aladdin Bldg., 609 W. Lake Street, Chicago, U. S. A.

## STOP USING A TRUSS

Do Away With Steel And Rubber Bands

## FREE TRIAL



Inner surface is made adhesive to secure the PLAPAO-PAD firmly to the body, keeping the PLAPAO continually applied and the pad from slipping. No straps, buckles or springs attached. Soft as velvet—easy to apply.

It's the Non-Slipping, yet Non-Rigid Pad and What is Within It That Counts

## FREE to 5,000 Truss Sufferers

To the extent of 5,000 sufferers who may apply I will send, ABSOLUTELY FREE, a sufficient quantity of the Plapao to positively convince them that this is the only logical, common-sense way of treating rupture. Plapao is a highly astringent medication placed within the Plapao-Pad and being absorbed through the skin, creates a wonderful feeling of relief and at the same time tends to strengthen the weakened muscles and thus permanently close the rupture opening. The process of recovery is natural, so you'll have no use for a truss—you can throw it away forever! Old and young have testified under oath that the Plapao-Pads cured their rupture—many of them long-standing, aggravated cases—without delay from work. Patent allowed in U. S. and foreign countries. Awarded Gold Medal at Home and Grand Prix at Paris.

**Send No Money**—for a sufficient quantity of the Plapao is sent without charge to enable you to give it a thorough test; you pay nothing for this trial now or ever. Write for it and full information today. Address Plapao Laboratories, Block 1427 St. Louis, Mo.



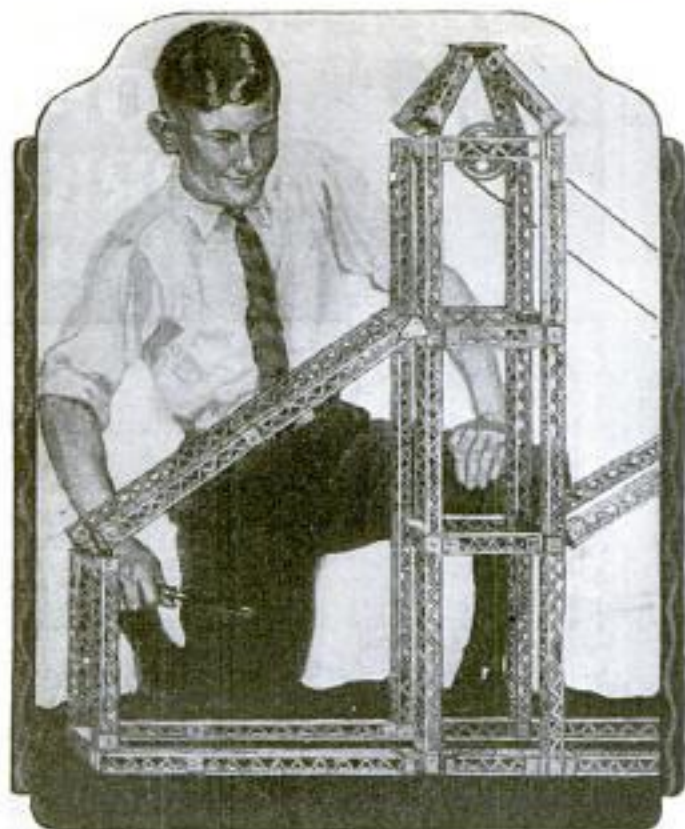

## ERECTOR

WHEN you buy a Gilbert Toy, we should prefer to have you order direct from a dealer. If you do not find it convenient to go shopping, just send us a list of ten boys (or any other number), enclose your check for as many Gilbert No. 4 Erector Sets with motor as you wish sent at \$5.00 each. These sets will be delivered before Christmas either by a local dealer, or direct from our factory.

# Investments in boys bring sure results

**M**AKE ten boys happy this Christmas. Give each of them a \$5 Erector set with motor. It is the most fascinating toy any boy ever played with. Boys can build wonderful bridges, skyscrapers, derricks, towers—any engineering feat can be duplicated. They see these wonderful structures take form and they taste the joy of achievement.

Gilbert Toys are fun, but they are more than fun. They are toys that stimulate the imagination. Boys who were playing ten years ago with Gilbert Toys, today are among the leaders in Engineering, Chemistry, Electricity. Pick ten boys today that you believe will be among the leaders of tomorrow. Back your judgment with your cash. Help these boys to be leaders. Can any man or woman make a more unselfish Christmas gift than that?

Are you willing to invest in boy power? Are you willing to back your own judgment? If you only pick one winner in ten, it will pay 1000% in dividends.

Gilbert Toys have been famous for a decade. There are wonderful sets in Chemistry, Electricity, Carpentry, Magnetism, Magic. Gilbert Toys can be found in all department and toy stores in your neighborhood. Gilbert Erector, the only steel construction toy with the square girder, is the leader. You can buy Gilbert Toys from \$1.00 to \$30.00.

If you want to know more about Gilbert Toys, send 10c for Gilbert Boy Engineering Book for 1923. In addition to being a complete catalog of Gilbert Toys it contains wonderful articles on Engineering, Chemistry, Wireless, Sports, Magic and many other fascinating things. Any boy will be delighted with it.

A. C. GILBERT, Pres.

THE A. C. GILBERT CO.  
104 Blatchley Ave., New Haven, Conn.

# GILBERT TOYS

THE A. C. GILBERT CO.  
104 Blatchley Ave., New Haven, Conn.  
Enclosed is 10c. Send the 1923 Year Book to

Name .....

Street .....

City ..... State .....

P. M. Dec.





## \$70 to \$90 Daily

FLESSNER Brothers have hit their stride. Under date of Aug. 29, 1922, they say: "Did \$300 last week. Have averaged this amount during the past few weeks. Some days we take in \$70, \$80 and \$90." Others coining money too. Ira Shook's place regular magnet. On holidays receipts run high as \$375. My CRISPETTE machine does the trick! Makes those wonderfully delicious, toothsome confections that sell right and left.

### Big Money in Crispettes

Money—lots of it—for those who start the CRISPETTE business. Gibbs writes: "Sold \$50 first night." Master's letter says: "Sold \$40 in one hour." Erwin's boy (going to school) makes \$35 every Saturday afternoon.

### I Start You in Business

I furnish everything—secret formula, equipment, supplies, etc. Experience not necessary. It's a project you can handle. Amazing successes everywhere—cities, small towns, and so on. CRISPETTE habit grows and sticks wherever introduced.

### \$1,000 Month Easily Possible

You are successful from the very start. No slow building-up process. Business grows by leaps and bounds. Some men wholesale to stores, others do direct retail business. All reap wonderful financial harvest. Raw materials plentiful and cheap. Profits enormous. Do not do another thing until you have clipped and mailed coupon.

**LONG EAKINS CO.**  
1228 HIGH STREET  
SPRINGFIELD  
OHIO



**JUST MAIL THIS COUPON**

**LONG EAKINS CO.**  
1228 High St., Springfield, Ohio

Please send me at once full details of the CRISPETTE business.

Name \_\_\_\_\_

Address \_\_\_\_\_

Please Mention Popular Mechanics

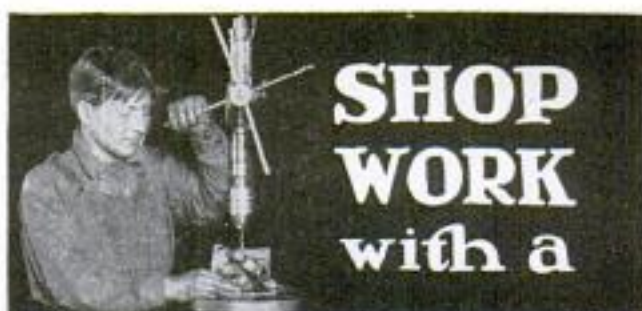

## SHOP WORK with a

## CARNES ARTIFICIAL ARM

FOR nearly ten years a Carnes Artificial Arm has kept Mr. Pahbe Yazze of Lawrence, Kan., on the payroll as a draftsman and machinist at a good salary. Thousands of other mechanics, artisans, office workers, farmers and laborers owe their independence to this improved arm.

### Life-Like in Action and Appearance

The Carnes Arm cannot be detected from the natural except by close inspection. Its user can dress himself, use knife, fork, pen, pencil and keys; pick up large or small objects, carry grips—in fact, do virtually everything that was possible before. He can bend the elbow of the Carnes Arm, bend and turn the wrist and open and close the fingers at will, even if the amputation is at the shoulder.

**192-Page Book FREE.** A book of 192 pages, profusely illustrated with photographs showing what can be done with this remarkable invention, will be sent free to any person interested. Send for it now.

**CARNES ARTIFICIAL LIMB CO.,**  
208 Carnes Bldg., Kansas City, Mo.

## "I Would Not Part With It For \$10,000"

So writes an enthusiastic, grateful customer. In like manner testify over 100,000 people who have worn it. Conserve your body and life first.

## The Natural Body Brace

Overcomes WEAKNESS and ORGANIC AILMENTS of WOMEN and MEN. Develops an erect, and graceful figure. Brings restful relief, comfort, energy and pep, ability to do things, health and strength. Does away with the strain and pain of standing and walking; replaces and supports misplaced internal organs; reduces enlarged abdomen; straightens and strengthens the back; corrects stooping shoulders; develops lungs, chest and bust; relieves backache, curvatures, nervousness, ruptures, constipation, after effects of Flu. Comfortable and easy to wear.

### Costs You Nothing to Try It

Write today for illustrated book, free, with full information and measurement blank. Address

**HOWARD C. RASH, Pres. Natural Body Brace Co.**  
223 Raah Building SALINA, KANSAS



For  
Children  
Also

## STOP TOBACCO

If you cannot stop it, do you know why? Do you know its effect on efficiency? This subject discussed in common-sense manner in booklet written by one who conducted anti-cigarette clinic for L. A. Police Dept. for over a year. Treated thousands—all forms. Booklet free as long as they last. Write

Dr. T. H. Truwith, Black Bldg., Los Angeles, Calif.



## Don't Take A Chance With Your FURS

GET wise, fellows—make those extra dollars yourself. We need your furs. You need the money. We are right in the heart of the New York Fur Manufacturing Industry. They are right at our door ready to take your furs as they come in and pay the right prices.

Your check goes back by return mail and you get one hundred cents on the dollar. We pay right because we sell right. This means we get all your shipments and do the business. Ask the trapper who knows. Once a Struck & Bossak shipper and you're always one. Our trappers have no poor years. They know in advance that we give a square deal and every shipment brings good money.

Send us your name and address. Get our Price Bulletins, Shipping Tags and full particulars. Do it right now. This means real dollars to you, so don't put it off. Write today.



**Struck & Bossak, Inc.**  
155 West 28th Street  
New York, N. Y.

Get more for furs

Highest market prices—highest possible grading—quicker returns. No commission, spot cash. 20 years in business. Write for Rogers' Dependable Market Report and Price List.

**ROGERS FUR CO.**  
471 N. Main St., St. Louis, Mo.



## Ship Your FURS NOW

### Prices are Soaring!

Early demand is largest and stocks lowest in years. **BIGGS** at Kansas City wants your furs as soon as ready. Highest prices. No commissions. Our "Hold Separate" plan guarantees your satisfaction. If requested on tag or letter inside package when you ship, we will hold your furs separate until you have had time to get our check and to know you are satisfied. Write Today for latest Fur Price List.

**Big Premium List** and Trapper's Catalog FREE. **BIGGS** pays Highest Market Price for furs and 5% Extra in **BIGGS** Cash Coupons. Write for particulars about how to get Traps, Guns, Baits, etc., absolutely FREE.

**FUR MAGAZINE FREE!**

Write today for free subscription to "Trapper's Exchange," full of trapping secrets, stories, game laws, etc., etc. Send yours NOW.

**E. W. BIGGS & COMPANY,**  
887 Biggs Bldg.  
KANSAS CITY  
MISSOURI



# FREE to trappers

HERE'S something for YOU, Mr. Trapper and Fur Shipper—something very important to YOU. Raw fur prices are high this season, so get all the furs you can, BUT to get the most money for your furs you must be accurately posted on market conditions and market prices. Make this your big, best season by reading "The Shubert Shipper" regularly. It costs you nothing—it's FREE—and it will make money for you. It's the greatest publication of its kind in the world. It quotes highest authentic market prices and contains market information that you cannot afford to be without.

## Write SHUBERT

"The Shubert Shipper" Today will put you in position to sell your furs at the highest prices at all times—you will always know just what prices your furs should command. Isn't such information worth money to you? The market reports published in "The Shubert Shipper" are always based on true facts concerning conditions existing in all the fur markets of the world. It also contains pictures of fur-bearing animals in beautiful colors. Just sign and mail the coupon below and a copy will come to you by next mail. You need it. Don't be without it.

WRITE FOR YOUR COPY AT ONCE

**A. B. SHUBERT, INC.**  
THE LARGEST HOUSE IN THE WORLD DEALING EXCLUSIVELY IN  
**AMERICAN RAW FURS**  
25-27 W. AUSTIN AVE. - CHICAGO, U.S.A.

MAIL COUPON TODAY

A. B. SHUBERT, Inc.  
25-27 W. Austin Ave., Chicago, U. S. A.

Without obligation send me "The Shubert Shipper" and keep me posted on Raw Fur Market conditions during the Fur Season of 1922-1923.

Name \_\_\_\_\_  
(PLEASE PRINT NAME)

Post Office \_\_\_\_\_

State \_\_\_\_\_ R. F. D. \_\_\_\_\_

© 1922, A. B. S., Inc.

(141)

Please Mention Popular Mechanics



**\$1.00 DELIVERS to Your Home**



**Complete Outfit**

# Violet Ray

**ONLY \$1.00** brings this complete, scientific Violet Rays outfit to you. Treat yourself and family at home, save delay, costly doctors and medicines. Thousands use Violet Rays at home to relieve pain and sickness. The identical outfits doctors have bought from us for years and with which they successfully treat many ailments, including those listed below.

### QUICK RESULTS—No Medicine

Violet Rays work quickly, it's scientific, goes after the cause. That's why results are quick, permanent. Dr. Duncan, Kewanee, Ill., writes, "Violet Rays is the finest thing I ever used to relieve pain, treatments are so pleasant all my patients like it." Use it yourself at home, you save Doctor's bills.

#### BEAUTY AID

Brings natural, magnetic beauty of health, no dieting, exercise or drugs. **FREE** book tells in detail how high priced beauty specialists use it to improve scalp and skin.

#### EARN CASH

Men, women, without experience earn liberal profits in spare time showing Violet Rays to neighbors. Proves results first demonstration. Sells on sight. Get attractive offer and wholesale prices now.

### SEND FOR FREE BOOK

Explains how Nikola Tesla discovered Violet Rays, how it works, why it heals. Tells what doctors and plain folks accomplish in conquering pain, disease and nervous trouble with Violet Rays.

**Reveals Marvelous Scientific Discovery** Shows charts of human body, explains where pains start, how to banish them. Offered **FREE** for a limited time only, to introduce Violet Rays. Send for **FREE** copy.

**Check Your Ailment Below for Free Advice** Here is a partial list of ailments successfully treated with Violet Ray:

|              |              |             |                |
|--------------|--------------|-------------|----------------|
| Catarrh      | Eye Diseases | Lumbago     | Skin Diseases  |
| Chilblains   | Falling Hair | Nervousness | Sore Throat    |
| Colds        | Hay Fever    | Neuritis    | Sprains        |
| Constipation | Headache     | Paralysis   | Tonsillitis    |
| Earaches     | Goitre       | Piles       | Whooping Cough |
| Eczema       | Insomnia     | Rheumatism  | Asthma         |

### Mail Coupon—Send No Money

**VI-REX ELECTRIC COMPANY**  
326 West Madison St., Dept. 222, Chicago

Please send me without cost or obligation your free book describing your VI-REX Violet Ray outfits, and details of your \$1.00 offer.

Name \_\_\_\_\_  
Address \_\_\_\_\_  
City \_\_\_\_\_ State \_\_\_\_\_

# WANTED

## Raw Fur Buyer...

We want a country raw fur buyer in every county of your state, to represent us this season. A big opportunity for those who qualify. Write at once for our proposition.

**CHARLES S. PORTER, INC.**

133 West 27th St., New York City

# TRAPPERS!

make this  
Your biggest year!

Ship all your furs to McCullough & Tumbach. Make this the most profitable year you've had. You know our policy:

### A Square Deal to Every Shipper

We'll give you honest grading by fur experts. We'll pay top market prices the day we get your furs. No delay. And in the long run we'll make more money for you.

Ship early—ship often—ship every skin to us.

### We Keep You Posted

Write for **free** shipping tags, price lists, and market reports. **Write today.**

**McCullough & Tumbach**  
129 N. Main Street  
St. Louis, Mo.

**4 BIG 4 CO.**



# Revitalize

## Overcome Weakness and Ill-Health

Drive out aches, pains, soreness and stiffness with this wonderful healing Electric Tonic treatment. Positively shockless and harmless, yet powerfully effective. Thousands of people have brought themselves to buoyant health. Learn how you can help yourself in your own home, building bodily strength and beauty.

## Ra-Tone The Electric Tonic The Perfected Violet Ray

—makes available to you, in their most pleasant and beneficial form, the health-building forces of electricity.

## Get Big Free Book

Our 64-page book on Health Building explains the cause and treatment of 100 common disorders.

Among these are rheumatism, neuritis, lumbago, nervous disorders, falling hair, catarrh, and many others equally troublesome.

Send for a copy now.

**Ra-Tone Electric Co.** 1210 Park Place West  
Detroit, Michigan

# 5 Master Keys

Work like magic in emergencies or prove whether your door or padlocks are burglar-proof. **Open and test thousands of different locks.** Recommended by users in ten different nations. Most wonderful and only keys of their kind. Send \$1 today. Novel key chain FREE with set.

**MASTER KEY CO.**

21 MANHATTAN BLOCK Milwaukee, Wis.



## MECHANIC'S POCKET SECRETARY

Constructed of finest steel. Just push the button and out comes the article you require. Worth \$1.00. Postpaid

25c

Get One Today



25c  
10 in 1 —

Adjustable Pencil, pen, paper knife, ink eraser, pencil sharpener, nail file and cleaner, mechanic's marking point, fine compass with screw attachment, foot rule.

Universal Co., Box 532, Stamford, Conn.

# Ship Furs

Split your next shipment skin for skin grade for grade. Send one half to the house you've been shipping to and the other half to Fouke at once. See how much more you get from Fouke. Let

the checks tell the story. You will get a whole lot more for the furs you ship to Fouke, you can bet your bottom dollar on that. "Prices don't mean nuthin"—it's the grading that counts and Fouke grading always makes your fur checks bigger. **SHIP NOW!**

Order traps and baits now. Send coupon below at once, for lowest prices on trappers supplies, get free samples NOXENT (kills human scent) and REMOV-A-SMEL (destroys skunk smells instantly). Get free Trapper's Partner showing all kinds of traps and new paste baits, game laws, how to trap and grade furs. We keep you posted on fur market all season. **ALL FREE! SEND COUPON TODAY TO**

# FOUKE

**FUR Co.** 714 FOUKE BUILDING  
ST. LOUIS, MO.

—FOUKE FUR COMPANY—  
714 Fouke Building, St. Louis, Mo.  
Send me samples of NOXENT and REMOV-A-SMEL, "Trapper's Partner," and tags. Keep me posted on the fur market all season. All FREE.

Name \_\_\_\_\_

Town \_\_\_\_\_

State \_\_\_\_\_

R.F.D. \_\_\_\_\_

Box \_\_\_\_\_

## Save \$10 to \$25 On Custom-made Re-covers

Easily attached; instructions sent. Top and back with 7x14 beveled plate glass, tacks, welts, etc. \$10 and up. Fords \$5.20 and up. Ask for prices and samples—give name and year of car.



**S-C PRODUCTS COMPANY**

1273 Nicholas Bldg. Toledo, Ohio

## This Palatial

# Florida Home

can be purchased at a very reasonable price. It is the finest estate in a community of 30,000 situated amid 5 acres of orange, grape fruit, sweet bay, palmetto and a large variety of semi-tropical trees and foliage. A water front of 400 feet, with entrance from a Boulevard, affording every modern convenience. House recently completed and never occupied. Has every modern improvement, large sun parlors, sleeping porches and 8 bath rooms. Inexhaustible supply of soft water, steam heat, high, light basement under entire house. Surf bathing all winter within 5 minutes walk.

For full details, photographs and price address the owner,

**H. H. WINDSOR,**  
6 N. Michigan Ave. CHICAGO, ILL.





# USE YOUR CREDIT NOW

You Don't Need The Cash To Buy Your Xmas Gifts Here



50—Solid Gold Diamond Lullabyer and Chain. \$18



51—Diamond Beltaire Cluster, set in Platinum 14K White Gold Mounting. \$75



52—Two Diamond and Sapphire set in 14K White Gold. \$50



53—Fine Diamond set in 14K White Gold. \$30



54—Diamond 14K Tooth Ring. \$30



55—"LaFontaine" Fine Instructable Pearls 28 inches. White Gold Diamond set clasp. \$12.50



57—Diamond Cluster Ring set in Platinum. \$75

## BUY NOW—FOR CHRISTMAS

SEND NO MONEY—EXAMINE FREE

Just rush your name and address with number of article desired and it will be sent without delay.

No obligation. If satisfied pay 1/3 the price and the balance in 8 months. Your money refunded if dissatisfied.

No Red Tape—No Delay—No Risk.

DeLuxe Xmas Catalog Free

Write Dept. P. M. L.

Est. 32 years.



56—Solid 14K White Gold, 15 Jewel

adjusted movement extra fancy dial. \$25



58—"The Fifth Avenue," 19 Jewel Illinois, 25 year Green Gold engraved Case, Lifetime Guarantee. \$45



59—Diamond Tiffany Ring. \$100

**AMERICAN WATCH & DIAMOND CO**  
6 MAIDEN LANE—NEW YORK

## The F-B Oil Saver for FORDS

Patent Pending



\$1.00

STOPS OIL PUMPING  
STOPS SPARK PLUG FOULING  
SAVES 50% LUBRICATING OIL  
SAVES TIME—SAVES MONEY

Thousands are using them. Write today for one on 30-day trial, post-paid for \$1.00. Money back if not satisfied. No cost to install. Replaces breather cap on oil filling pipe.

Dealers Wanted

PENINSULAR CORPORATION, Penobscot Bldg., Dept. E, Detroit, Mich.  
For \$1.00 enclosed send me an F-B Oil Saver on your money-back guarantee if not satisfactory.

Name \_\_\_\_\_

Street No. \_\_\_\_\_ City and State \_\_\_\_\_

## GET YOUR BOY ONE (For Yourself)

Anyone Can Build This

### 20" CAT-BOAT

With Our COMPLETE Construction Set

\$5.00

Everything but the Paint. Other sizes of boats, also boilers, engines, locomotives, etc.

Catalog 25c. Abridged Catalog Free  
**BOUCHER, Inc.**  
415 Madison Ave., New York City



GREAT  
2 IN 1  
LAMP

## THE SECRET of QUICK SALES

Remove Shade for Outdoor Use  
300 Candle Power

Burns 97% Air



There's a way that brings quick and certain sales of our brilliant Combination Handy-Lite. It's building profitable business for our agents—in spare time. This lamp meets the demand for a light brighter than gas or electricity but needing no wiring or piping. Lights with match. Smokeless, compact, handsomely nicked, durable. Write for supreme selling secret and attractive agency proposition.

ENTERPRISE TOOL AND METAL WORKS, Dept. 412  
126-8 So. Clinton St. Chicago, Ill.





Max Fisher



Henry Halstead



Freddie Carter

Leading orchestra directors of Los Angeles, shown above use and endorse Conn instruments.

## Here's Your Chance For Extra Money

There's a bigger demand than ever for players of saxophone, trumpet, trombone or tuba in dance and theatre orchestras. You can qualify for a well paying engagement, either whole or part time, through a short period of pleasurable practice with a Conn. Easiest playing instruments made. Used by leading symphony and jazz orchestras.

**Free Trial; Easy Payments.** Send for free book and details; mention instrument.

C. G. CONN, LTD.  
1231 Conn Bldg., Elkhart, Ind.

Get this Free Book



# CONN

WORLD'S LARGEST MANUFACTURERS OF HIGH GRADE BAND AND ORCHESTRA INSTRUMENTS



## Factory Sale

AIR TIGHT

SCREW TOP



## Copper Oil Kettles

All made of 16, 18, 20 and 22 gauge best cold rolled heavy solid copper. Non-explosive. All solder outside. 5 inch air-tight screw cap. Absolutely guaranteed to be the best and strongest kettle made.

Goods shipped the day order is received. Packed in strong, plain boxes. Above are lowest factory cash prices. Send money order or draft with order.

Catalog of other goods at cut prices FREE, upon request. Price of copper going up. Order now before prices advance. Order at once.  
**THE HOME MANUFACTURING COMPANY**  
Dept. D-21 2650 No. Halsted St., Chicago

Reference: Cosmopolitan Bank, Chicago, Ill.



Another \$50 Raise!



## Make That Dream Come True!

"Another \$50 raise! Why, that's the third increase I've had in a year."

**WOULDN'T** you like to be able to say that? *You can!* Not by just wishing for promotion or dreaming of it, but by getting the special training that employers everywhere are looking for and are glad to pay for.

One hour a day, spent with the International Correspondence Schools in the quiet of your own home, will prepare you for the position you want in the work you like best.

Yes, it will! Put it up to us to prove it. Without cost, without obligation, just mark and mail this coupon.

TEAR OUT HERE  
INTERNATIONAL CORRESPONDENCE SCHOOLS  
Box 5087-C, Scranton, Penna.

Without cost or obligation, please tell me how I can qualify for the position or in the subject before which I have marked an X:

### BUSINESS TRAINING DEPARTMENT

- |                                                                           |                                                                           |
|---------------------------------------------------------------------------|---------------------------------------------------------------------------|
| <input type="checkbox"/> Business Management                              | <input type="checkbox"/> Salesmanship                                     |
| <input type="checkbox"/> Industrial Management                            | <input type="checkbox"/> Advertising                                      |
| <input type="checkbox"/> Personnel Organization                           | <input type="checkbox"/> Better Letters                                   |
| <input type="checkbox"/> Traffic Management                               | <input type="checkbox"/> Foreign Trade                                    |
| <input type="checkbox"/> Business Law                                     | <input type="checkbox"/> Stenography and Typing                           |
| <input type="checkbox"/> Banking and Banking Law                          | <input type="checkbox"/> Business English                                 |
| <input type="checkbox"/> Accountancy (including C.P.A.)                   | <input type="checkbox"/> Civil Service                                    |
| <input type="checkbox"/> Nicholson Cost Accounting                        | <input type="checkbox"/> Railway Mail Clerk                               |
| <input type="checkbox"/> Bookkeeping                                      | <input type="checkbox"/> Common School Subjects                           |
| <input type="checkbox"/> Private Secretary                                | <input type="checkbox"/> High School Subjects                             |
| <input type="checkbox"/> Business Spanish <input type="checkbox"/> French | <input type="checkbox"/> Illustrating <input type="checkbox"/> Cartooning |

### TECHNICAL AND INDUSTRIAL DEPARTMENT

- |                                                                          |                                                                      |
|--------------------------------------------------------------------------|----------------------------------------------------------------------|
| <input type="checkbox"/> Electrical Engineering                          | <input type="checkbox"/> Architect                                   |
| <input type="checkbox"/> Electric Lighting                               | <input type="checkbox"/> Blue Print Reading                          |
| <input type="checkbox"/> Mechanical Engineer                             | <input type="checkbox"/> Contractor and Builder                      |
| <input type="checkbox"/> Mechanical Draftsman                            | <input type="checkbox"/> Architectural Draftsman                     |
| <input type="checkbox"/> Machine Shop Practice                           | <input type="checkbox"/> Concrete Builder                            |
| <input type="checkbox"/> Railroad Positions                              | <input type="checkbox"/> Structural Engineer                         |
| <input type="checkbox"/> Gas Engine Operating                            | <input type="checkbox"/> Plumbing and Heating                        |
| <input type="checkbox"/> Civil Engineer                                  | <input type="checkbox"/> Chemistry <input type="checkbox"/> Pharmacy |
| <input type="checkbox"/> Surveying and Mapping                           | <input type="checkbox"/> Automobile Work                             |
| <input type="checkbox"/> Metallurgy                                      | <input type="checkbox"/> Navigation                                  |
| <input type="checkbox"/> Steam Engineering                               | <input type="checkbox"/> Agriculture and Poultry                     |
| <input type="checkbox"/> Radio <input type="checkbox"/> Airplane Engines | <input type="checkbox"/> Mathematics                                 |

Name.....  
Street.....  
Address.....

6-26-22

City..... State.....

Occupation.....

Persons residing in Canada should send this coupon to the International Correspondence Schools Canadian, Limited, Montreal, Canada.



# BIG ENGINE SALE

The Greatest of All Engine Sales is on!

Right now is the time to get your OTTAWA Engine at Big Saving! Better built to do more work, using less fuel. Every piece and part of highest quality, constructed to give maximum efficiency under any and all conditions. Thousands in use giving dependable service. Immense production and selling direct from factory, enables us to give better quality at a lower price.

Thousands of Satisfied OTTAWA Owners Everywhere.

## OTTAWA

Shipped from  
Ottawa, Kan.  
— and —  
Pittsburgh,  
Pa.

2 H-P.  
\$38<sup>50</sup>

F. O. B. Ottawa  
\$48.50 from  
Pittsburgh

All Other  
Sizes up to 22 H-P  
at Proportionally  
Low Prices

FREE  
Engine  
Book

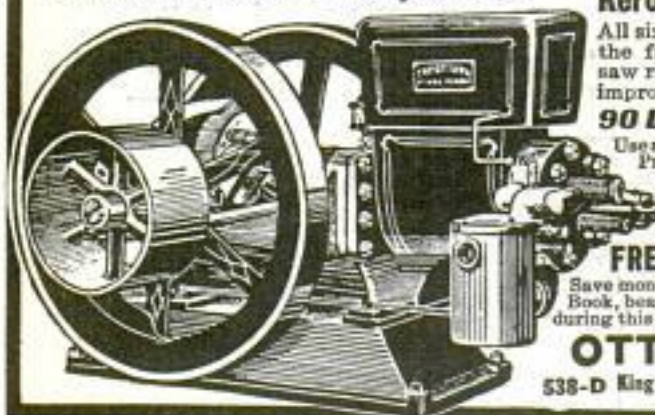

Kerosene—Gasoline—Distillate

All sizes for all uses in shop, factory and on the farm. Any style—stationary, portable, saw rig. Big surplus over rated H-P. Many improved features. Easy to start; easy to keep running.

90 Days' Trial—10-Year Guarantee

Use an OTTAWA Engine at your own work for 3 months. Prove to yourself that it is a better engine. Every OTTAWA sold on our 10-Year Guarantee and backed by largest Engine Factory in the world selling direct to user. Cash or Easy Terms. Learn all about the OTTAWA before you buy any engine.

FREE BOOK AND SPECIAL OFFER.

Save money by acting now. Write for fine Free Engine Book, beautifully illustrated; also Big Special Offer during this sale. Send a postcard, now.

OTTAWA MFG. CO.

538-D King St., OTTAWA, KAN., PITTSBURGH, PA.

Alfred's Ice King

Trade Name for the Outfit Made by  
**The Alfred Johnson Skate Co.**  
Dept. M 2812 W. North Ave., Chicago, Ill.



\$11.50  
Complete

The Finest Tubular Skate and Shoe Made. Used by the World's Greatest Amateur and Professional Skaters. For Sale by All Good Dealers or Direct from Factory.

Not Connected with Original  
Nestor Johnson Mfg. Co.

You'll Like This Job



Become a **DEMONSTRATING AGENT** for the outboard motor which sportsmen everywhere are talking about — which sells everywhere and everywhere — the **ELTO LIGHT TWIN**. Ole Evinrude's outboard motor. Light, fast, rugged — the "silver motor". Exclusive territory. Enjoyable, interesting work. Highest profits. Write immediately for Elto catalog and attractive proposition waiting for you. **ELTO OUTBOARD MOTOR CO.** Dept. AA, Mtn. Home Bldg. Milwaukee, Wis.

Designed  
by Ole  
Evinrude

**Elto**  
LIGHT TWIN



\$700 in 2 Hours

That's what Ryan made by wearing this Mystic Egyptian Luck Ring. Why Be Unlucky? **FAME — FORTUNE — HAPPINESS — SUCCESS IN LOVE & BUSINESS** are said by many men and women to have come to them with this **SACRED SCARAB RING**. Wear It And See. Makes A Desirable Gift. **GUARANTEED STERLING SILVER**. Cash with Order \$1.45, C.O.D. \$1.55; Two Rings, Cash, \$2.75, C.O.D. \$2.85; Money back if not satisfied. Order Today.

CHALENS SUPPLY HOUSE

Dept. 114, 7 S. Dearborn St., Chicago, Ill.

**110 FOR THIS Extra Quality Steel RAZOR** SEND FOR **FREE CATALOG** of other Bargains

Fine quality German steel razor at a bargain price. Has edge so keen you will hardly know you are shaving. Tempered to perfection. You will always enjoy a smooth, comfortable shave. Send no money. Order by No. 72X. Send name and address. Pay postman \$1.50 plus few cents postage. Money back if not satisfied.

**FREE HONING STONE**

**PARAMOUNT TRADING CO. 34 W 28th St. New York**



# FREE

## 300 Candle Power Sunray Lantern

As a special introductory offer, a 300 Candle Power **SUNRAY** Lantern worth \$8.50 will be given absolutely Free with the first purchase of a **SUNRAY** Lamp. Lights up the yard or barn like a search-light. Brighter than sun light—burns 30 hours on a few cents worth of kerosene or gasoline. Lights with match or torch. No wicks to trim—no chimneys—no smoke—no smell. Find out about this great special offer.



## Better Than Gas or Electricity

Whitest light ever produced. Nothing to wear—simple—absolutely safe—you can burn it upside down. Get rid of drudgery and poor light—see the **SUNRAY**—flood your home with light—save your eyes.



No Wicks to Trim  
No Smoke  
No Smell

## 15 Days' Trial

Absolute satisfaction guaranteed. If you don't like it, send it back. Our money-back guarantee protects you—no red tape.

**Write Today** Send for special introductory offer on **FREE** Lantern and agency proposition, also free literature on the cheapest and best way to light the home. Act Now!

**KNIGHT LIGHT CO.**  
Dept. 1359 Chicago, Ill.

## BLANK CARTRIDGE PISTOL

Protection against Burglars, Tramps, & Dogs

PRICES  
50c.  
\$1.00



POST-PAID

Well made and effective; modeled on latest type of Revolver; appearance alone is enough to scare a burglar. When loaded it may be as effective as a real revolver without danger to life. It takes standard .22 Cal. Blank Cartridges obtainable everywhere. Price 50c., Superior quality \$1.00 post-paid. Blank Cartridges, by express, 50c per 100.

Johnson Smith & Co., Dept. 941, 3224 N. Halsted St. Chicago

## BURN Home Made GAS COAL STOVES

Change your coal or wood stove into a gas stove in 3 minutes. A Child can do it. Burn kerosene Vapor Gas—hotter than coal or wood and costs less. Safe and simple.

### FREE TRIAL

Just turn a valve and get even heat instantly. No ashes, no dirt, no smoke, no wood to chop or carry. No fires to build and feed. No fuel wasted. Cooks and bakes better. No damage to stoves. Makes its own gas from common coal oil, cheapest, cleanest fuel. Guaranteed five years. Money back if not satisfied after 30 days trial.

Write for **FREE** folder with proof and **SPECIAL OFFER**

**SIMPLEX UTILITIES MFG. CO.**

1210 Simplex Bldg. 2837 S. State St., Chicago

Please Mention Popular Mechanics



## CHECK-PROTECTOR Security FOUNTAIN PEN

Safety and Satisfaction—that's what this pen will mean to you.

Safe because the patented check protector in cap enables you to write a check—and protect it with the same pen.

This pen possesses patented features that provide for smooth, continuous writing and long, satisfactory usage.

The Security has been titled, "The pen without a fault"—as shown by the following five major points of construction and design.

### Points of Perfection

- 1 Check protector concealed in cap. Equal to any expensive machine on the market.
- 2 Screw pressure filling device. Fills and cleans with a turn of the bottom.
- 3 14-karat tempered iridium tipped gold pen. Made by secret process.
- 4 Rolled gold spring clip. The clip with a grip.
- 5 Patented air cushion feed bar. Ends forever the curse of leaks and blots.

\$3.00  
No. 200

### Other Models

No. 300—\$3.25  
No. 400—4.00  
No. 500—4.50  
No. 600—5.00

Long or short styles

### Ideal Christmas Gift

Banks, trust companies, and similar institutions will find the Security pen a splendid gift for customers or employees.

If your dealer cannot supply you, mail this coupon

**KRITIKSON BROS., Inc.**  
122 W. Illinois St., Dept. P, Chicago, Ill.

Gentlemen: Enclosed check or money order—please send me one Security pen, No. .... guaranteed for five years.

Style of point preferred  
 Fine  Medium  Coarse  Med. Stub  Broad Stub  Slant  Posting, if feasible, or still  section, long  or short  model.

Name.....

Address.....

**AGENTS WANTED** We have an interesting proposition to offer to high grade specialty salesmen for the distribution of Security pens. Upon request we will furnish full information regarding exclusive territory.

**KRITIKSON BROS Inc**  
CHICAGO ILLINOIS



# Only 227 Motors

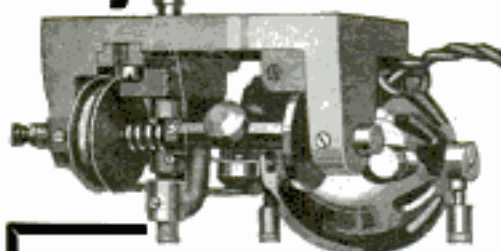

Left at  
**\$10**  
Each

Ideal for home-made phonographs, experimental purposes and combination **phonograph-radio** sets.

We have 227 small motors which are greatly under-priced for quick clearance. You will never again equal this low price, when this lot is sold.

They are universal motors, 110 volts, 60 cycle single phase, complete with turntable, cord and socket for immediate use. 1400 R. P. M. Motor has 1" pulley with flange for  $\frac{1}{4}$ " flat belt. Housed in highly polished, nickel-plated shell.

Don't lose out on this remarkable offer. Order your motor today. Tomorrow may be too late. **DO IT NOW!** Price in U.S.A., \$10.00 f. o. b. Steger, Illinois. Foreign \$12.50.

Industrial Division

**Steger & Sons Piano Manufacturing Company**  
Dept. 94, Steger Building Chicago, Illinois

## Starting a Company?

Save expenses and taxes by organizing on the popular, **COMMON LAW** plan under a pure **DECLARATION OF TRUST**. No experience required to fill in **DEMAREE STANDARD FORMS**, issue shares and begin doing business at once. Genuine **DEMAREE FORMS** are nationally known, approved by attorneys, and utilized by successful concerns throughout the United States. Send for large, free pamphlet (D-53) containing valuable information that you may need. **C. S. DEMAREE**, legal blank publisher, 708 Walnut, Kansas City, Missouri.



### DIAMONDS WATCHES CASH or CREDIT

"Sylvia"  
Diamond Ring  
Blue white, radiant,  
perfect cut diamond.  
The ring is 18-k Solid  
White Gold, crested and  
pierced. Extra special  
at \$100. Credit terms:  
**\$2.50 A WEEK**  
Others at \$75,  
\$150, \$200  
50.

**Genuine Diamonds GUARANTEED**  
**15 DAYS FREE TRIAL**  
This exquisite Diamond ring is only one of a multitude of fancy and conservative designs at bargain prices fully described in our **Free—Large Catalog**

Every article ideally suitable for Christmas Gifts or personal wear and sold on **LIBERAL CREDIT TERMS**

of one-fifth down, balance in equal payments within eight months. Satisfaction or your money back.

Liberty Bonds Accepted

**LOFTIS** THE OLD RELIABLE CREDIT JEWELERS  
Dept. 5-894  
108 N. State St. CHICAGO, ILL.  
Stores in Leading Cities

## Jewel 22 in. Band Saw \$75

Here's the machine for your shop at a moderate price. Strongly constructed to last a lifetime. Angle-steel frame, electric welded. Build on your own bench-top to suit your special needs. Roomy table with tilting adjustment for sawing bevels. Band saw has 22 in. swing cutting to center of 44 in. circle. Hand-wheel tension regulator. Will take material up to 7 in. thick.



Price with  $\frac{3}{8}$  in. band saw, \$75.

Send for complete catalog of Parks machines

**THE PARKS BALL BEARING MACHINE CO.**  
1500-1540 Knowlton Street CINCINNATI, OHIO  
Canadian Factory, 200 Notre Dame East, Montreal

48

# PARKS

## WOODWORKING MACHINES



## Build This Phonograph Yourself

TREMENDOUS SAVING IN COST

Easy, fascinating work with our **SIMPLIFIED PLANS**. We furnish blue prints, diagrams, motor, cabinet pieces, ready-built horn, etc. You don't need to be a cabinet maker. A few hours assembling and you will have a fine instrument at one-quarter the regular retail price. **AGENTS MAKE MONEY** making and selling these instruments. Write today for full details and our **FREE OFFER**. Address: **MODERN PHONOGRAPH SUPPLY CO.** 213 N. Morgan St. Dept. 703 CHICAGO, ILL.

## TYPEWRITERS



**\$50** buys a brand new Corona, the Personal Writing Machine. Fold it up, take it with you, typewrite anywhere! Write for free booklet No. 8.

Corona Typewriter Co., Inc.  
GROTON, N. Y.

## YOU'LL LIKE "LYON" BODIES

FOR Fords, Chevrolets and Dodges

**\$68.50**

(For Fords)  
Painted with hood and special shell as shown. \$22.50 additional for Chevrolet. \$50.00 additional for Dodge.

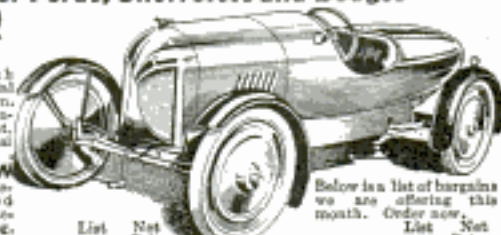

**SEND NOW** for our completely illustrated body and accessory catalog.

| List Price | Net Price |
|------------|-----------|
| \$12.50    | \$ 9.35   |
| 12.00      | 9.25      |
| 15.00      | 9.25      |
| 60.00      | 36.50     |

Below is a list of bargains we are offering this month. Order now.

| List Price | Net Price |
|------------|-----------|
| \$25.00    | \$15.55   |
| 12.00      | 6.99      |
| 5.00       | 2.85      |
| 60.00      | 32.00     |

Desires will find a ready sale for our bodies. Buy direct from the factory.  
**AUTO TIRE SALES CO., Dept. P3.** 1346 S. Michigan Ave. Body Division Chicago



# Baby Grand Lathes

**FOR METAL OR WOOD  
HIGHEST QUALITY—LOWEST PRICE**

A precision machine tool at a price within the reach of everyone, everywhere.

**A Practical Tool For Universal Use**

A dependable, low priced lathe for use by those engaged in light manufacture, model making, experimenting, repairing, etc., as well as the requirements of the amateur, the inventor and the student.

**Ideal For Use in the Home**

Interesting, instructive and profitable employment for your spare time.

**Develop Your Ideas in Private**

Build your experimental models with your own hands.

**Add \$5 to Your Income**

In spare time make salable products, radio equipment, Xmas gifts, etc.

**Lasts a Life Time**

A sturdy machine built for real work.

**Write NOW  
For Prices  
and  
Details**

6-in. Swing  
12 in. or 18 in. Between Centers  
20 in. or 26 in. Bed



**THE WATSON MFG. CO.**  
32 Post Street, Toledo, Ohio, U. S. A.

## RADIO MESSAGE

**SPECIAL OFFER**  
Fordspeed Equip-  
ment. Tremendous  
Reductions

Ford Sport Bodies,  
Beautiful, Highgrade Models  
\$37.50 up



8-16  
Overhead Valves  
Selective Transmissions

Sport Fenders Underlung  
Sport Fenders Standard  
Crankshaft Counterbalances

### SPECIALS

|                        | Price   | Now    | Underlung Fictura       | Price   | Now    |
|------------------------|---------|--------|-------------------------|---------|--------|
| Disc, Cover, enameled  | \$ 2.25 | \$1.65 | 2-1, also 2 1/2-1 Gears | \$15.00 | \$9.95 |
| Speed-Power Crankshaft | 16.50   | 9.95   |                         | 17.50   | 7.75   |

M. K. FORD SPEED & POWER EQUIP. MFRS., 250 W. 54th St., New York City, N. Y.

## MOTORCYCLES

### ONE YEAR TO PAY

Know the joy of owning—for business or pleasure—  
—a HARLEY-DAVIDSON, EXCELSIOR, HENDERSON,  
INDIAN, CLEVELAND, or any other standard  
make; thoroughly rebuilt in our own factory.  
Write for Free Bureau Bulletin and Easy Payment Plan  
**HAVERFORD CYCLE COMPANY**  
America's Largest Cycle House  
Established 26 Years  
503 Market St., Philadelphia, Pa. Dept. P. M.

## Miller's Poultry Guide

**FREE** Tells how experts hatch, feed and raise poultry for profits. Also quotes low prices on baby chicks, pure bred poultry, eggs for hatching, incubators, Mammoth hatchers, poultry supplies, etc. Fully illustrated. Write today.  
**J. W. MILLER CO., Box 12, Rockford, Ill.**



## Why Burn Coal

When you can get twice the heat at half the cost, by installing, in 5 minutes time, Uni-Hete Oil-Gas Burner in your range or heater. Thousands of homes now ending coal expense! Uni-Hete generates gas from common kerosene—cheapest fuel known. Red hot fire instantly. Cooks, bakes, heats. Sets in fire box of any stove. **FREE TRIAL.** Saves its small cost in 30 days. Lasts for years. Made by factory making heating devices for 33 years.



**Agents—Special Offer—Act Quick**  
High coal cost makes Uni-Hete a big profit maker for agents. **Write at once.**

**Acorn Brass Mfg. Co., 1267 Acorn Bldg., Chicago, Ill.**

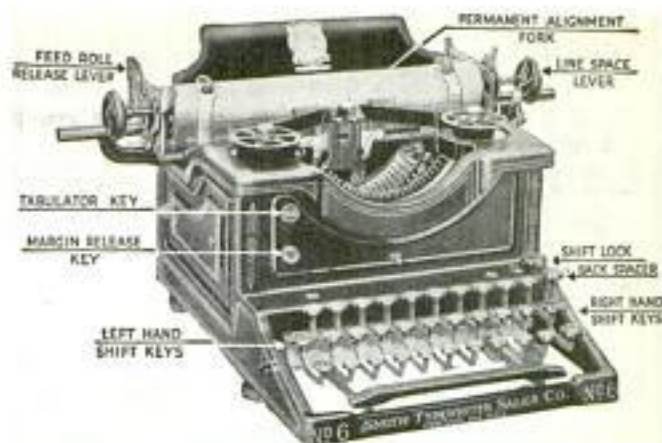

## TYPEWRITER SENSATION!

*Free Trial—Use as You Pay*

Send us only \$4.00 a month until the low total price of \$48.85 is paid, and the machine is yours.

This is absolutely the most generous typewriter offer ever made. Do not rent a machine when you can pay \$4.00 a month and own one. Cash price \$44.00, just a little less than half its original price.

## (STANDARD) SMITH Model No. 6

Perfect machines, Standard size, Keyboard of Universal arrangement, writing 84 characters. The entire line of writing completely visible at all times, has the tabulator, the two-color ribbon, the back spacer, in fact every late style feature and modern operating convenience. Comes to you with everything complete; tools, cover, operating book and instructions—nothing extra to buy. **You cannot imagine the perfection of this beautiful reconstructed typewriter until you have seen it. We have sold thousands of these perfect late style machines and every one of these thousands of satisfied customers had this beautiful, strictly up-to-date machine on five days' free trial before deciding to buy it.** We will send it to you F. O. B. Chicago for five days free trial. It will sell itself, but if you are not satisfied that this is the greatest typewriter you ever saw, you can return it at our expense. You won't want to return it after you try it, for you cannot equal this wonderful value anywhere.

## SEND NO MONEY Put In Your Order Now

**\$4.85 AFTER TRIAL**

When the typewriter arrives deposit with the express agent \$4.85 and take the machine for five days' trial. If you are convinced that it is the best typewriter you ever saw keep it and send us \$4.00 a month until our bargain price of \$48.85 is paid. If you don't want it, return it to the express agent, receive your \$4.85 and return the machine. We will pay the return express charges. This machine is guaranteed just as if you paid \$100.00 for it. It is standard. These typewriters are samples the manufacturer had at their branch offices throughout United States and have never been used except for demonstration purpose. Just like new but at extremely low price. **The supply at this price is limited, the price will probably be raised when next advertisement appears, so don't delay. Fill in the coupon to-day—the typewriter will be shipped promptly.** There is no red tape. We employ no solicitors—no collectors—no chattel mortgage. It is simply understood that we retain title to the machine until full \$48.85 is paid. You cannot lose. It is the greatest typewriter opportunity you will ever have. **Do not send us one cent. Get the coupon in the mails to-day—sure.**

SMITH TYPEWRITER SALES CO., Dept. 288, 360 East Grand Av., Chicago, Ill.

SMITH TYPEWRITER SALES CO., Dept. 288, 360 East Grand Av., Chicago, Ill.

Ship me the Standard Visible Smith Model No. 6, F. O. B. Chicago, as described in this advertisement. I will pay you \$4.00 monthly as rent until the \$44.00 balance of the Special \$48.85 sale price is paid. The title to remain in you until fully paid for. It is understood that I have five days in which to examine and try the typewriter. If I choose not to keep it I will carefully repack it and return it to the express agent. It is understood that you give the standard guarantee.

Name .....

Street Address .....

City..... State .....

Occupation or Business.....



# THIS BIG $\frac{1}{4}$ H.P. MOTOR A Little While \$13.50 Longer at ... **\$13.50**

(No Telling When Prices Will Advance)

Steadily increasing cost of fuel, power, labor and material may force us to raise our price on this big, sturdy, 28-lb., 60 cycle split-phase A. C. Motor; but we'll hold the price down to this competition-defying level as long as we can.

A wonderful fan-cooled, squirrel-cage motor, tested for 50% overload before leaving factory, and guaranteed for 1 year.

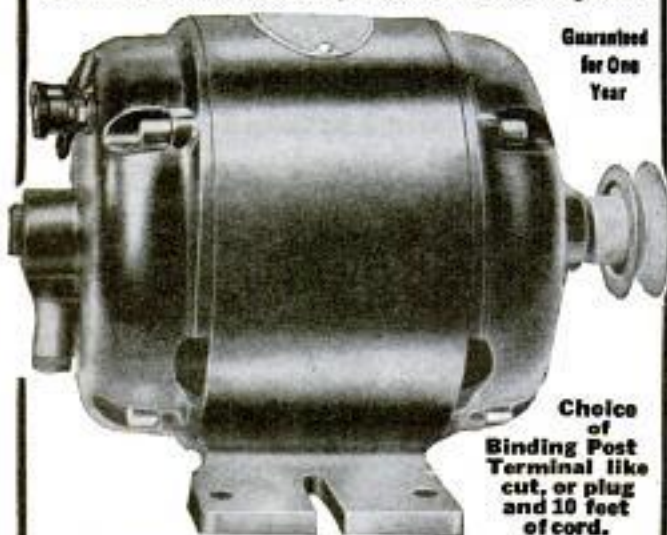

Guaranteed  
for One  
Year

Choice  
of  
Binding Post  
Terminal like  
cut, or plug  
and 10 feet  
of cord.

Its speed of 1740 r. p. m. fits it exactly for such service as drills, small lathes, fans, blowers, forges, household washing machines, cream separators and all forms of motor drive calling for  $\frac{1}{4}$  h. p. and a capacity for temporary overload.

## Prices F. O. B. Chicago

|                                             |         |
|---------------------------------------------|---------|
| 110 volt, 60 cycles single phase A. C. .... | \$13.50 |
| 220 volt, 60 cycles single phase A. C. .... | \$14.50 |
| 110 volt, 25 cycles single phase A. C. .... | \$15.50 |
| 32 or 110 volt direct current .....         | \$16.00 |

## Combined Grinder and Buffer \$25.00 Complete With Above Motor



Machine has handy on-and-off lever in front, with switch enclosed in and protected by base. Grinding wheel is 6 in. in diameter, with  $\frac{1}{2}$  in. face; Buff  $7\frac{1}{2}$  in. unsewed. Motor is same as described above except that it is totally enclosed and dust proof.

Also ask for our line of Motors and Generators for RADIO Service.

Send Cash with Order, as these low prices permit of no booking, billing or collection expense. Our money-back plan and our guarantee fully protect you.

**NORTHWESTERN ELECTRIC COMPANY**  
408 So. Hoyne Ave. Chicago



1 **BUSINESS OR SPORT WATCHES** 2

Don't miss this opportunity to purchase one of these fine elegant TIMEPIECES at less than HALF OF ORIGINAL PRICE. High Grade nickel lever movements, scientifically built, jewelled, adjusted and regulated. No. 1 MEN'S WRIST WATCH O size round nickel case, 10 Jewels, RADIUM DIAL, \$5.95; or solid Sterling Silver, \$7.75. No. 2 Nickel Cushion Shape, \$7.85; or solid Sterling Silver, \$10.75. With 15 Jewel Movements, \$1.00 extra. Free: 2 fine leather straps. No. 3, EXTRA THIN MODEL GENTS' WATCH, 14 size, 7 Jewels, GOLD FILLED, GUARANTEED 10 years, \$7.25; or 20 yr. case, \$9.75; or Nickel case, \$5.25. With 15 Jewel movement, \$1.00 extra. FREE: Gold Filled Watchmaker chain.

**SATISFACTION GUARANTEED OR MONEY REFUNDED**  
Watches are our EXCLUSIVE SPECIALTY. Buy your watch from WATCHMAKERS. You will save money and get a better watch. Order today, pay Postman on arrival. If you are not entirely pleased after 10 days' trial return watch and we will exchange it or refund your money. Illustrated FACTORY PRICE LIST of Ladies and Gents' watches mailed free.

UNEEDA WATCH CO., Dept. P, 217 Eighth Ave., NEW YORK CITY

## 30 DAYS' FREE TRIAL TO FORD OWNERS SEND NO MONEY



What we say in print we back up. We will ship you, postpaid, one Hastings Ford Stabilizer. Pay nothing to the postman—not one cent. For 30 full days let the Hastings Stabilizer steer you steadily and safely over any road in any weather. Compare it with other stabilizing devices. At the end of 30 days you send it back—or, send us \$3.75.

Special 30 Day Trial Offer. Our dealers are authorized to sell genuine Hastings Stabilizers at this price and on this 30 Day Free Trial basis. Get your Hastings Stabilizer now from your dealer or the

**HASTINGS MANUFACTURING COMPANY**  
45 E. Mill St. Hastings, Michigan

**AUTO SUPPLIES  
WHOLE SALE  
3000 BARGAINS** SEND FOR THIS CATALOG—  
**it's FREE!**  
Everything you need in Auto Supplies at Amazingly LOW PRICES.  
**NEMCO BARGAIN SUPPLY HOUSE**  
1017 Jackson Boulevard • Chicago, Ill.

**SLOW** **AGENTS** Make Big Money  
**LR**  
Selling D-REX-U Safety Signal to automobile owners; complies with safety laws; guaranteed. Write today for wholesale price to agents and get territory quick. Big Winter Seller. Address Comstock-Bolton Co., Dept. K, 1925 E. 15th St., Kansas City, Mo.

**Lost Your Keys?**  
One way to avoid this inconvenience is to supply yourself with a set of **DEVIL'S COMBINATION MASTER KEYS**, which by actual test has opened and saved THOUSANDS OF Locks. Used to great advantage throughout the most popular sections. The most wonderful set of **5 MASTER KEYS** in the world. Buy mail \$1.00.  
**B. URICH KEY CO.**  
232-3rd Street, Milwaukee, Wis.  
Largest Exclusive Key and Lock Shop in America





## Help Her to Save More Lives

Last year over 100,000 lives were saved with the aid of Tuberculosis Christmas Seals. Tuberculosis is being controlled. The death rate has been cut in half. If you and others join the fight, it can be stamped out.

Buy Christmas Seals. When you see someone selling them, help the fight along by buying all you can.

Your help, the help of every happy, healthy person, is needed; and it will count.

Stamp out  
Tuberculosis  
with  
Christmas  
Seals



THE NATIONAL, STATE, AND LOCAL  
TUBERCULOSIS ASSOCIATIONS OF  
THE UNITED STATES

Please Mention Popular Mechanics

## A Home and Income For You in Sunny Florida



**Be Independent—Own a Grapefruit and  
Orange Grove—A Truck or Poultry  
Farm. Increase Your Income**

**You Can Start a Grove Today Under  
Our New Plan**

Develop a profit-earning fruit farm without leaving your present position—provide for your future. A small payment now and a few dollars invested each month.

A profit-producing fruit grove is a permanent investment and provides protection against old age.

**THE RIGHT LAND  
IN THE RIGHT LOCATION AT  
THE RIGHT PRICE**

**We Have It—Any Size Farm**

These splendid lands are suburban to Tampa, the metropolis of South Florida. Here you find the most healthful, the most delightful climate in North America. For ten years we have been right here helping develop Hillsboro—the banner agricultural County of Florida, and we are still here to serve you and to help you obtain the farm you want, on very easy payments extending over 2 or 3 years' time to suit.

**Groves Developed for Non-Residents**

If you want to remain in your present position for a few years we can develop a grapefruit and orange grove for you. When you are ready we will clear your land, furnish fruit trees, plant and care for your grove until you are ready to look after it.

**We Raise Our Own Guaranteed Citrus  
Trees in Our Own Nurseries**

This insures every purchaser the best fruit trees that can be grown. This also insures a successful grove. We can save you money on planting and caring for your grove.

**\$300.00 to \$500.00 Per Acre Profit**

This is not an unusual return for truck farmers in the Famous Tampa district. All kinds of vegetables can be grown. Big prices are paid for early potatoes, winter cabbage, Bermuda onions, tomatoes, celery and dozens of other vegetables during the Winter and early Spring, when the north is covered with ice and snow. Strawberries, Melons, and other small fruits also yield large profits.

**Write for Facts About Sunny Florida**

IT COSTS YOU NOTHING TO LET US PROVE TO YOU that we have the land you want—in the location you want—at a price you can afford to pay and on the easiest terms you can imagine. Let us show you.

Fill out and mail us the coupon today and receive our large descriptive book FREE!

**NORTH TAMPA LAND CO.**

Suite 510 Monon Bldg.

CHICAGO

*Coupon for FREE Book on Florida*

**NORTH TAMPA LAND CO.**

Suite 510 Monon Bldg., CHICAGO

Please send me your large illustrated book, "The Call of the Southland," on choice Citrus Fruit and Truck Farms suburban to Tampa, Florida, and information on how I can have a grove developed on the monthly payment plan. P.M. 12-22.

Name.....

St. No.....

City.....

State.....



## Complete Regenerative Radio Receiving Set

Manufactured under Armstrong License U. S. Patent 1,113,149

Everything you need—No parts to buy. Comes with easily followed directions so you can set it up and listen to concerts, operas and lectures, news items, stock reports and bedtime stories for the children.

310 sending stations throughout the country supply programs every afternoon and evening.

### EASY PAYMENTS—\$15 down—\$10 month

The **SENSITONE** is equal to any complete set you could buy at \$150.00, yet our price is only \$95.00 and you can pay for it \$15.00 down and \$10.00 month, or if you prefer send \$90.00 cash.—*Enjoy it while paying for it.*

**ORDER TODAY**—You are buying from a reputable concern rated in Dun & Bradstreet's or any bank will tell you.

Folder on request

**HAROLD R. WAKEM & CO., 835 Washington St., CHICAGO**

# RADIO

\$15 Down  
\$10.00  
a Month



**SENSITONE Long Distance Receiving Set**

## BUY DIRECT FROM MANUFACTURER

Listen to the Outside World on a Micro-Phone Crystal Detector Set

The most wonderful one-piece cast



Aluminum Radio Receiver Set manufactured at a price within the reach of everyone. Long winter evenings made one of joy and entertainment. The best and most appreciated Christmas gift to any member of the family.

Special Price while 500 last Complete with Headset \$15.00

**FREE CATALOG**—A complete line of Micro-Phone Radio parts at a saving of 50%. Send 10c in stamps for 40 of the latest lookups.

**ALDINE RADIO & MFG. CO., Aldine Square, Dept. F12, Chicago, Ill.**

## ELEGANT 7-JEWEL WATCH

\$7.95



C.O.D.

This handsomely designed thin model 7-jewel watch for only \$7.95. Genuine gold filled case; open face; screw back and bezel; stem wind and set—A dandy watch and fine timekeeper of exceptional value. Guaranteed to wear for years.

**FREE** If you set at once, beautiful knife and chain with order. **SEND NO MONEY.** Pay on arrival only \$7.95. If not delighted, return at once and get your money back on our irrevocable guarantee. Jewelry and gun catalog free.

United Buying Ass'n., 220 W. Ontario St., Dept. 230, Chicago

## THROW YOUR VOICE

Under the table, down in the cellar, into a trunk or any old place. With our **VENTRILO** which fits into the mouth you can have lots of fun fooling your friends. Also full instructions in the art of Ventriloquism, and big book of jokes. Sent by mail for 10 cts. Stamps or coin.



## WONDERFUL WIRELESS TELEGRAPH



Two instruments and 2 Codes in a box. Can Telegraph from room to room or house. Full instructions. By mail 12 cents.

## NEW INVENTION!!

For Seekers of

# Health Beauty Power

At last! Elco Health Generators are ready! Get our book about them. Leave bad health and weakness behind forever. These great inventions generate Violet Rays, Vibration, Electricity and Ozone—combined or separate. 4 greatest curative agents. Operate on electric light or on their own power.

**FREE BOOK**—Ask for the book about these inventions. Tells you how an Elco Health Generator re-vitalizes you.

Send for the book today



**LINSTROM & COMPANY**  
442-448 No. Wells St., Dept. 1358, Chicago

## FREE TRIAL



Cut out and mail this ad to us with your name and address—send no money—and we will send you this fine Razor for 30 days' FREE trial. When satisfied after using, send \$1.95 or return razor. Order today.

**AMERICAN RAZOR WORKS, Dept. N-3**  
1575 Ogden Ave., Chicago

Our **BUREAU OF INFORMATION** will answer all questions regarding articles appearing in this magazine. Address Bureau of Information, Popular Mechanics Magazine, Chicago.

## AERIAL AIRSHIP

UP IT GOES!

Climbs in the air by its own power. The propeller spinning automatically at a lively rate.



Floats around a room or outdoors. Lots off un. By mail 10c.

## Invisible Ink

Letters written with this ink look like blank paper. Can be brought out plainly by heating over lamp or stove. Bottle in wooden box, 10 cents.



## SKULL RING



The eyes in this ring are either Emeralds or Rubies and would scare the timid. Either Roman Gold or Oxidized Silver. 25c by mail.

**All the Above by Mail for 50c. Stamps or Coin.**  
**UNIVERSAL DISTR., Dept. 705, STAMFORD, CONN.**



# TURNER "MASTER" BLOW TORCH

## Torch of a Thousand Uses Safe — Speedy — Economical Burns Kerosene or Gasoline 400° More Heat



For brazing, soldering, lead-burning, paint-burning, light heat-treating, thawing frozen pipes and countless other uses—amateur or professional.

"HOT SPOT HUMP" in combustion chamber, converts low grade fuel into hot, dry gas. (Turner Patent)

SEPARATE NEEDLE VALVE prevents enlarging orifice (so common an occurrence with ordinary torches.)

SAFETY VALVE AND AIR RELEASE prevent explosion and avoid fuel leaks. (Turner Patent)

Only one opening in Tank, (and that above fuel line).

COST NO MORE THAN ORDINARY TORCHES.

**No. 45 Torch,  
like cut.  
F. O. B.  
factory  
\$8.25**

SEND FOR THE TURNER CATALOG OF "MASTER" TORCHES AND FURNACES  
When you write, give us name of your dealer

**THE TURNER BRASSWORKS**  
Sycamore, Ill. U. S. A.  
Cedar Street

### Be A Floor Surfacing Contractor



New unexcelled field. Contractors prefer to sublet floor surfacing to American Universal Contractors. Machine does work of 6 men. Works quickly, easily. We set you up in business of your own, furnish office terms, advertising, etc.

**Make \$5,000 to \$15,000 or More—Yearly**

Prepares for big building basements. Make new floors perfect, old floors like new. Every floor a prospect. Big money in old floors. No town too small. Beginners often pay for machines first month with profit besides. Get full information.

**THE AMERICAN FLOOR SURFACING MACHINE CO.**  
523 So. St. Clair St. Toledo, O., U. S. A.

### Health? Take Turkish Bath



**at Home—Only 2 Cents**

Physicians are abandoning drugs for this new treatment. If your mind or body is tired, open your pores and feel the rapid change in your condition, at cost of 2c a bath. The Robinson Bath Cabinet is the only scientifically constructed bath cabinet ever made for the home. **Great 52 Book Sent Free**—"The Philosophy of Health and Beauty." Write Today. Agents Wanted. The Robinson Household Mfg. Co. Room 1087, Huron & Cherry Sts., TOLEDO, O.

### DEAFNESS IS MISERY



I know because I was Deaf and had Head Noises for over 30 years. My invisible Antiseptic Ear Drums restored my hearing and stopped Head Noises, and will do it for you. They are Tiny Megaphones. Cannot be seen when worn. Effective when Deafness is caused by Catarrh or by Perforated, Partially or Wholly Destroyed Natural Drums. Easy to put in, easy to take out. Are "Unseen comforts." Inexpensive. Write for Booklet and my sworn statement of how I recovered my hearing.

**A. O. LEONARD, Suite 226, 70 5th Avenue, New York City**



### Does Your Camera Shutter Work?

Seneca, Kodak, Premo, Ansco or Ingento Shutters repaired and adjusted. Any style or size. Expert work done and guaranteed. Prompt Service. Reasonable Prices. Send your shutter in today.

Address Shutter Division  
**SENECA CAMERA MFG. COMPANY**  
Rochester, N. Y.

### The CAXAC EMPTY ENVELOPE

with something in it for you  
See Classified Ads Miscellaneous Column



#### ULTRA-LENS MICROSCOPES

Give enormous magnification at low power. Made possible by a new system of lens construction on which patents are pending. Powers from 2,500 to 250,000 times surface area (50 to 600 diameters) are available. Especially suited for students, experimenters or anyone scientifically inclined. Will duplicate work of instruments of a dozen times their cost. Complete outfit at \$1.00, \$4.00 or \$15.00 according to number of objectives furnished. Shipped postpaid and guaranteed. Interesting circular PM sent on request.

At your dealer or by mail direct.

**THE SPECIALTY MFG. CO., Reg. MILTON, PA.**

### Watch Charm Pistol

SILVER AND GOLD  
PLATED

WITH 24  
CARTRIDGES \$2.55



ACTUAL SIZE

No. 309

The very latest and most unique novelty out. This miniature "Break Open" pistol is the smallest pistol in the world—shoots blanks and makes loud report like a regular 25 Cal. gun; can be used as watch charm; appeals to every sportsman and arouses the interest of all. Made of hard metal beautifully finished in silver and electro plated in 14k gold, with charm ring attachment. Rush your order with remittance, \$2.55, today or you will be disappointed. No C. O. D.'s accepted. Quantity limited. Going fast.

First Come—First Served. No others obtainable.

**Edwards Import Trading Corp.**  
258 Broadway New York





**"It's  
What You Get  
For Your Money  
That Counts"**

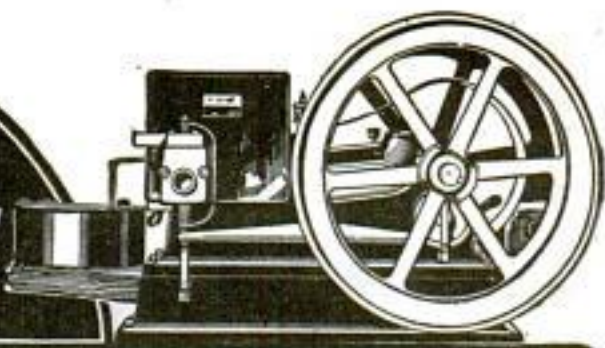

**2 H-P.** Chas. Beaulieu, Wis., says: "Good as the first day I had it."

**3 H-P.** M. W. Kopecky, Tex.: "Easy to start—stop—regulate."

**4 H-P.** Geo. A. Nester, Va.: "Used it 7 years. Not a penny for repairs."

**6 H-P.** Wm. Mittelstadt, Iowa: "Had several makes, but Witte is best."

**8 H-P.** Ralph Milliken, Calif.: "Engine gives splendid service."

**12 H-P.** A. B. Trest, Ala.: "Runs smooth as a sewing machine."

**16 H-P.** J. C. Clark, Va.: "I like the 16 H-P. fine."

**22 H-P.** J. F. Brown, Ark.: "Engine is just what you told me."

**30 H-P.** T. E. Walton, Miss.: "It is surely a fine puller."

**Engine Value Depends On EASY OPERATION,  
LOW FUEL COST and DURABILITY**

Records for 37 years show that WITTE Engines not only stand up, giving long service, but they have big surplus power, operate easy, cost less to operate, and sell for less. No matter what size engine or power outfit you need or where you live, I can supply you direct at a saving—make Immediate Shipment—Cash or Easy Terms, as you wish—in sizes 2 to 30 H-P.—most any style you want.

**WITTE Engines are sold on a Straight  
Lifetime Guarantee**

This guarantee applies to every size and style outfit I make—Stationary, Portable, Portable Buzz Saw, Log Saw, Tree Saw, Stationary Cutoff Saws, Power Stump Borers and my New "Power-Lite" Engine used on electric light plant. I furnish this new light plant complete, with engine, generator and batteries ready to attach to your wiring, at a big saving in price. Use it for both power and light. If you need power for any purpose—write to WITTE—get an engine you know is time-proven, reliable and durable. Read what users say.

**Tell Me What  
You Want  
I Guarantee  
Safe Delivery  
Anywhere.  
CATALOG  
FREE**

**WITTE ENGINE WORKS, 1740 Oakland Avenue, KANSAS CITY, MO.  
1740 Empire Building, PITTSBURGH, PA.**

**EASY FOR YOU TO OWN A  
FINE INSTRUMENT!**

YEARS ago the famous King Brass Instruments were sold only for cash to famous musicians. But now due to our easy payment plan anyone can own one of these wonderful instruments.

**SAVE MIDDLEMAN'S PROFITS**

Simply order direct from the factory. You save middleman's profit—and you get a fine, new, sound-laboratory tested, acoustically perfect King Instrument. With it goes our guarantee plus free factory-service.

**IT'S EASY TO OWN A KING**

Rebuilt instruments, refinished to look like new, we sell for cash at low prices. New instruments on the easy payment plan. Thus it's "easy to own a King". Send for our latest complete catalog and list of special bargains.

**THE H. N. WHITE COMPANY  
5243 Superior Avenue Cleveland, Ohio**

**KING**  
BAND INSTRUMENTS



Please Mention Popular Mechanics

**XMAS TREE OUTFIT \$1.75**



**ENJOY A SAFE CHRISTMAS—**

**Don't Burn Dangerous Candles**

Outfit: 8 decorated tungsten lights. Battery or house current. Complete 10 ft. extra wire and attachment plug. Free 1 extra bulb. 14 light set—2 Bulbs Free—\$3.49.

SEND NO MONEY. Pay postman \$1.75 when delivered. Send for FREE XMAS GIFT CATALOG.

**UNITED LIGHTING FIXTURE CO., INC.**  
280 Bowery, Dept. 521. New York City



**CATALOG No. 22  
IS READY**

Small Steam and Gasoline Engines, 1/4 H. P. up. Pumps, gears, model makers' supplies. Sent postpaid (2 dimes preferred) or 20c stamps.

**Modern Engine & Supply Co.**  
314 Menasha Bldg., Chicago



**SAVO AIR MOISTENER**



Saves Health, Furniture, Pianos, Fuel, Paintings, Plants, etc. Fill with water, hang on the back of any Radiator out of sight. Others for Hot Air Registers. Tens of thousands now in satisfactory use.

Write for FREE Booklet.  
**SAVO MANUFACTURING COMPANY**  
Dept. "E," 111 W. Monroe Street, Chicago, Illinois

**ALONG LOOKED FOR INVEN-  
TION HAS  
IMPROVED  
the STRADIVARIUS VIOLIN**

The Virzi "Tone Producer" installed in the violin or piano will render the tone free and clear as a bell, mellow, beautiful and brilliant—more than any other existing in the world. Try it and compare. It is recommended and used by Kreisler, Casals, Heifetz, Betti, Thibaud and other great artists. Write for booklet. If not satisfactory money refunded. We send instructions. **J. & J. VIRZI BROS.** No. 507 Fifth Ave., NEW YORK CITY  
Inventors, sole owners and distributors.





# 10,000 Handsome Coffee Percolators FREE

Are to be given away one with each order for our **"Big 25" Aluminum Combination**

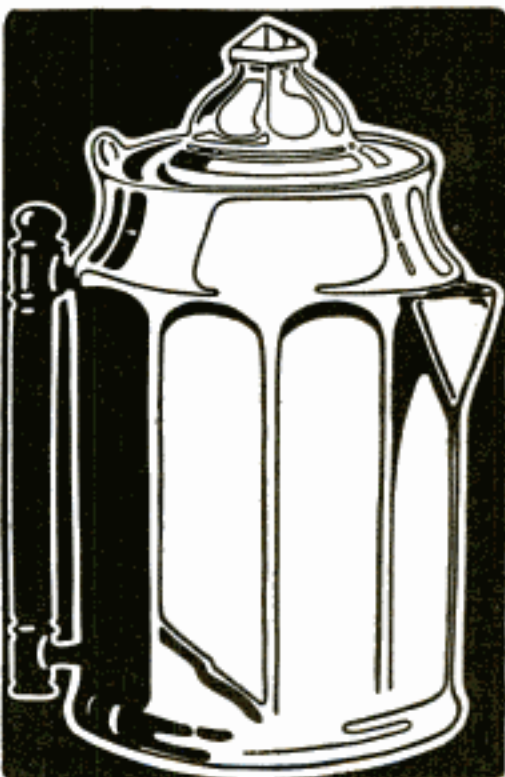

## World's Greatest Aluminum Bargain

## "BIG 25" Kitchen Combination Only \$4.99

Here is the most remarkable bargain we have ever offered. While these 10,000 sets last we are offering the wonderful "Big 25" Kitchen Combination at only \$4.99, and with every order we will give a handsome double paneled Coffee Percolator FREE. It is the pride of every housewife who owns one. Meets your every kitchen need. Think of the many ways you can use this handsome set of Aluminum Ware—what delicious dishes you can prepare with it. Used for baking, roasting, preserving, baking bread, cake making, biscuits, etc. Every piece of high-grade brilliantly polished aluminum, with beautiful new Sun Ray Finish on the inside, easy to keep clean. Let us send you a set entirely at our own risk and expense.

## Makes Ideal Wedding, Xmas or Birthday Gift

Send your order today for a set for yourself or to give to some friend or relative. Remember the "Big 25" is made of pure high grade solid aluminum. Guaranteed for life. This remarkable set works into hundreds of different kitchen uses including 6-qt., 4-piece, Ten Combination Paneled Cooker, Baking and Biscuit Pan, Colander, Cake Pan, Steamer, Double Boiler, Stew Pan, Drip Pan, Casserole, Cereal Cooker, Tea Pot, Muffin Pan, Pudding Pan, Corn Popper, Preserving Kettle, Fudge Pan, Coffee Roaster and hundreds of other different uses, some of which are shown above. No other set is like the "Big 25." It is the greatest Aluminum Ware bargain ever offered.

## Don't Send One Penny

You are not asked to send a single penny in advance. Simply fill in your name and address on the coupon or write letter or postal asking us to send you the set, and it will come to you by first mail and delivery charges prepaid. When your own postman delivers the package to you, pay him only \$4.99—not a cent more, and remember we will include in the shipment the Big Handsome Double Paneled Coffee Percolator. We predict a big advance in the price of aluminum and can only agree to deliver this handsome set at this ridiculously low price while these 10,000 sets last. So rush your order TODAY.

A. LESTER & CO., Dept. 206, 19 S. Wells St., Chicago

## FREE Percolator Coupon!

A. LESTER & COMPANY, Dept. 206  
19 South Wells St., Chicago, Illinois.

Gentlemen: Please send me your "Big 25" Kitchen Combination, all delivery charges prepaid. You will also kindly include the Handsome Double Paneled Coffee Percolator FREE. When the postman delivers the complete set to me I will pay him \$4.99, and if after examining it I am not convinced it is a wonderful bargain I will return it to you within 5 days in good condition and you guarantee that my \$1.99 will be immediately refunded.

Name .....

Town .....

State .....

St. No. or R. F. D. ....

(Please print name and address)



*Your Ailing Friend or Relative*  
*What better Gift can you present than*  
**HEALTH-BEAUTY-VITALITY**



**17.50**

Shelton Laboratory Model attaches to any electric light socket.

*Shelton*  
*Violet Ray*

Provides the means for the alleviation of pain and illness, and is an aid to Health and Beauty. *Shelton Violet Ray* should be in every home for immediate relief of sprains, rheumatism, bronchitis, headaches, constipation, lumbago, anaemia, neuralgia, eczema, asthma. It is the gift that will be most appreciated.

*Shelton Violet Ray*—radiant, visible electricity—Nature's own handmaid, is endorsed by leading physicians and beauty specialists who use this wonderful rejuvenator in their daily practice.

Use the *Shelton Violet Ray* in the privacy of your own home. The perfected SHELTON LABORATORY MODEL, originally sold only to the profession, can now be yours for only \$17.50.

**SEND NO MONEY**

Just send us your name and address, requesting the genuine SHELTON LABORATORY MODEL. Then when it arrives, you simply pay the postman \$17.50.

You take no risk when you buy *Shelton Violet Ray*. The Shelton guarantee protects you fully.

Send today for the genuine SHELTON LABORATORY VIOLET RAY so that you will receive it in time for the Holidays. Don't merely wish your friend Happiness. Provide the means for attaining Health—Energy—Vitality—Happiness.

*Shelton Electric Laboratories*

Dept. B 16 East 42nd Street New York

**Reduce Your Waist**  
**in 10 Seconds**



**BEFORE**



**AFTER**

You can actually do it now with the "Wonder" Health Belt. It will take only the time required for adjusting the belt around your waist to accomplish this reduction and to bring relief from the strain of excess weight, which your abdominal muscles are carrying. You will be agreeably surprised at the immediate relief from bodily fatigue and discomfort. You will know the satisfaction of again having a well poised figure. And, best of all, the fat begins, at once, to depart. Then good healthy muscular tissue replaces it. In a month or so, you can take from 4 to 6 inches off your waist.

**THE "WONDER" HEALTH BELT** will do these things. It is scientifically constructed from strong, light-weight fabric. Easily adjusted and easily washed.

**FREE TRIAL OFFER**

Send your name, address and present waist measure. If no tape is handy cut a piece of string to the proper size and mail it to us. We will send you a "Wonder" Health Belt by return mail. At the end of five days if you are thoroughly delighted with the belt, remit \$2.00 in full payment. If not, return the belt to us and you will not owe us a penny.

**Weil Health Belt Company**  
 912 Hill St., New Haven, Conn.

**The WONDERFUL**

**ERICKSON PATENT LEG**

Will not chafe, overheat, nor draw end of stump.



ERICKSON ARTIFICIAL LIMB CO., 38 Wash. Av. N., Minneapolis, Minn.

**How to Get Rid of Moles**



A simple, safe home treatment—15 years' success in my practice. Moles (Also BIG Growths) Dry Up.

Ask for Free Booklet of Full Particulars

**WM. DAVIS, M. D.**

124-5 Grove Ave., Woodbridge, N. J.

**TOBACCO**  
**OR SNUFF HABIT**

Any form quickly conquered. No long waiting for results. Costs \$1 if it cures. Nothing if it fails. Perfectly HARMLESS. Full treatment on approval.

**DR. C. M. SIMPSON CO., 209 W. 4th St., CLEVELAND, O.**



**Do Your PRINTING**

Cards, circulars, labels, tags, book, menus, paper, Press, \$12. Larger \$35. Job Press \$150 up. Save money. Print for others, BIG PROFITS. All easy, rules sent. Write factory TODAY for press catalog, TYPE, cards, paper. **THE PRESS CO., D-37, MERIDEN, CONN.**



**Big Money**

Made by agents selling our wonderful Facial Soap, Perfumes, Toilet Articles, Spices, Extracts, etc. Free cake of soap and agents' terms mailed to any address.

**LACASSIAN CO., Dept. 455 ST. LOUIS, MO.**

**Deafness**



Perfect hearing is now being restored in every condition of deafness or defective hearing from causes such as

**Relaxed or Sunken Drums, Roaring or Hissing Sounds, Perforated, Partially Destroyed Drums, etc.**

**Wilson Common Sense Ear Drums**

"Little Wireless Phones for the Ears"—require no medicine but effectively replace what is lacking or defective in the natural drums. They are simple devices, which the wearer easily fits into the ears where they are invisible. Soft, safe and comfortable to wear at all times.

Write today for our 168 page FREE book on DEAFNESS, giving you full particulars and plenty of testimonials.

**WILSON EAR DRUM CO., Incorporated**  
 403 Inter-Southern Building LOUISVILLE, KY.

Please Mention Popular Mechanics



**NEW WITTE**  
KEROSENE  
**LOG SAW**

*Runs Steadier  
Cuts Faster  
More Power  
EASIER To Handle  
Burns Kerosene  
or Gasoline*

Saws  
'Em  
Down—  
Cuts  
'Em  
Up

Our  
Big  
New  
Outfit

**New Price**  
**\$99<sup>50</sup>**  
F.O.B.  
K.C.  
From Pittsburgh  
\$107.00

**Built for Men Who Need A Rapid-Cutting Money-Making Log Saw**  
Portable and Easy to Operate. Use engine also to pump, grind, buzz wood, or do other belt work. Comes all set up ready to use.

**Only Log Saw Sold On LIFETIME GUARANTEE—Cash or Easy Terms**

**See What You Get**—Special 4-cycle Log Saw Engine—More power than needed—Less weight—Lever controlled clutch—Double arm swing motion and other valuable WITTE improvements. Users say: "Cut 30 cords hard maple in 8 hours"—"Downed 40 trees in 7 hours"—"Best on market"—"Runs smooth"—"Works fine". If that is the kind of a rig you want, write us. CATALOG FREE.

**WITTE ENGINE WORKS**  
1745 Oakland Avenue, KANSAS CITY, MO.  
1745 Empire Building, PITTSBURGH, PA.

# A WHOLE TOWN FINGER PRINTED



This picture shows a Finger Print Expert starting to take finger prints of every male resident of Glen View in an attempt to locate the murderer of the Glen View Bank cashier. Photo by courtesy of Chicago Tribune.

## BE A FINGER PRINT EXPERT LEARN AT HOME IN YOUR SPARE TIME

Imagine the big fees paid to finger print experts capable of handling an assignment like the one mentioned above. A common assignment is that of finger printing all the employees of a large company. Assignments of this kind mean real money to the finger print expert. Why not prepare yourself to reap the big rewards that fall to trained men in this fascinating profession.

## POSITIONS GUARANTEED

We absolutely guarantee positions in connection with finger print bureaus to our graduates. We have deposited \$1,000 with the Phillips State Bank, in Chicago, to back up this guarantee.

## FREE-SECRET SERVICE COURSE

A valuable course in Secret Service Intelligence is given FREE of charge to students of our course. This information in itself is worth more than the cost of our complete course. Take advantage of your opportunity NOW.

**\$1000  
BACKS OUR  
GUARANTEE**

## FINGER PRINT OUTFIT FREE

With our course of study you are given a complete set of working tools FREE of charge. These professional tools will be used for practice work during your course of study and thereafter in the practice of your profession.

## U. S. School of Finger Prints

Room 439 7003 No. Clark St., Chicago, Ill.

## MAIL THIS COUPON

For actual reports telling about the adventures of secret service operator No. 2188 and how the great secret service detectives solve the mysteries of crimes committed by the cleverest of rogues. Find out how you can become a finger print expert in a very short time at home and about my guaranteed position offer. Special limited offer. Send this coupon NOW.

## U. S. School of Finger Prints

Room 439 7003 No. Clark St., Chicago, Ill.

Name ..... Age .....

Address .....

Town ..... State .....

**LUCKY HORSESHOE RING**

**Change Your Luck**

The famous Kosmos Lucky Ring is a thing of beauty; it's odd, it's attractive. Made of solid Gold and Silver, set with Sparkling Garnet. It's the symbol of good luck in business, love or anything... Send your ring measure (strip of paper around finger) and we will send you this wonderful Ring. This special price of \$3.97. Wear it seven days and follow the seven rules which come with it. If not fully satisfied, your money back. Be in luck—order now!

**KOSMOS CO., Dept. 128, 154 W. Randolph St., Chicago**

## Put a CARTER OIL GAUGE

on your instrument board. Absolutely accurate in any kind of weather. Only \$4.95 for Ford, Dodge Only \$5.95 for Buick, Oakland, Chevrolet, and Chandler. You can attach one without special tools in 15 minutes. Satisfaction guaranteed or money back.

**CARTER MOTOR ACCESSORIES, Inc., 390 Pearl St., Buffalo, N. Y.**

**First-aid**

Whether skin is broken or bruised or muscles tired, apply a few drops of Absorbine, Jr. It is both antiseptic and liniment. Safe; of pleasant odor; cannot stain. Keep handy. \$1.25 at druggists or postpaid. Liberal trial bottle, postpaid, 10c.

**W. F. YOUNG, Inc.,**  
147 Temple Street  
Springfield, Mass.

**Absorbine, Jr.**  
THE ANTISEPTIC LINIMENT





## The Game of a Thousand Wonders

### The Ancient, Honorable and Royal Game of China Has Become the New Fascinating Game of America

Long before the days of the great Roman Empire, the cultured Chinese were captivated by this marvelous game with the click of its ivory tiles and its "Pung" and "Chow." Succeeding generations have been held by its spell.

Locked from the rest of the world during the centuries, because of the necessity of knowing the Chinese language in order to play it, it remained for one Joseph Babcock, who realized with what eagerness our game-loving Americans would grasp this interesting test of skill, to codify a book of rules that unlocks to us the mysteries of Mah-Jongg.

### The Unique Gift of the Season

Mah-Jongg, the game with a Million Thrills, has infinite possibilities in scoring. An ordinary hand scores from 100 to 1000 points, but the "Hand from Heaven" counts over a million. Can be played by two, three or four players. Simple enough to learn in twenty minutes, yet intriguing enough to keep you studying its possibilities for many years. A book of rules is furnished with each set.

To describe its appearance, it consists of 144 bone and bamboo tiles (like dominoes) hand made, hand engraved in truly Oriental fashion, wee Chinese dice and a set of counters, all redolent of the mysterious, never failing charm of the Orient.

An expert Auction Bridge player says of the game, "Do you know, since playing Mah-Jongg, I cannot find any kick in bridge. In Auction, when the hand is dealt, the game is over. In Mah-Jongg, when the hand is dealt, the game begins."

### Prices of Mah-Jongg sets are as follows:

POPULAR MECHANICS BOOK DEPT.,  
6 N. Michigan Ave., Chicago

Enclosed find \$..... for Mah-Jongg,

Style.....

Name.....

Address.....

**Style 99**—One complete imported set, packed in a lacquered three colored box, prepaid - - **\$10**

**Style 103**—Complete set packed in a beautiful hardwood box with carved and gilded Chinese ideographs on the lid, prepaid - - - - **\$16**

**Style 105**—A complete set packed in a beautiful five-drawer cabinet of Chinese hard redwood. A thing of beauty. Better quality throughout than Styles 99 and 103, prepaid - - - - **\$35**

*Mail your order and remittance to*

**POPULAR MECHANICS BOOK DEPARTMENT**  
6 N. Michigan Ave. **CHICAGO, ILL.**



**Bench Vise  
No. 168  
Price \$7.40**

Jaws are of tough steel, scored and case hardened. They open  $2\frac{1}{4}$  inches.

Smaller clamp-on Bench Vises are made with jaw openings running from 1 inch to  $2\frac{1}{4}$  inches.

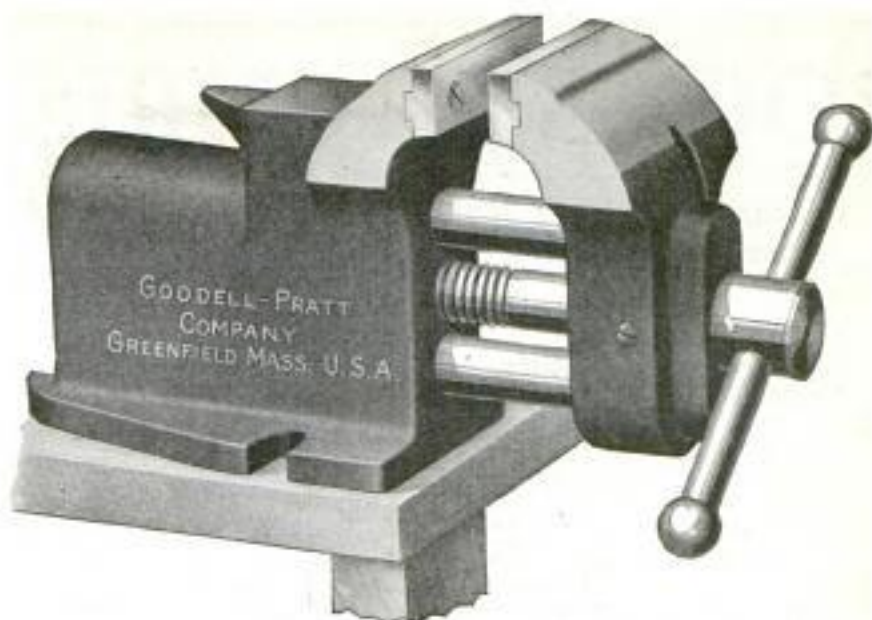

## “Pry these jaws apart if you can”

“You can try to separate them,” says Mr. Punch, “but you’ll have a tough job on your hands.” This Goodell-Pratt Bench Vise is a regular bulldog when it comes to holding on to metal. And it will hold a hair just as tightly.

This Bench Vise is the only one made with the same two-guide-rod construction. These  $\frac{5}{8}$ -inch steel guide-rods are pressed into the movable jaws and run in long reamed holes back under the small anvil, so that no play is possible. Special threads on the feed screw

and diameter of the guide rods give unusual strength.

The design, workmanship, and finish of this and all other Goodell-Pratt Tools make them splendid investments for men who want good tools. They are made by men who are first in their profession—men who know a good tool and appreciate what it can do.

Your hardware dealer has Goodell-Pratt Tools or can easily get them. Meanwhile, write for a copy of our free illustrated catalog No. 14, fully describing all the Goodell-Pratt 1500 Good Tools.



GOODELL-PRATT COMPANY, Greenfield, Mass., U. S. A.

*Toolsmiths*

**GOODELL-PRATT**  
**1500 GOOD TOOLS**



# BOOKS *for* CHRISTMAS

*A carefully chosen book is always a pleasing gift. This specially prepared list is offered to aid you in making an appropriate selection.*

For the chauffeur, automobile owner, repairman or student:

## Dyke's New and Greater Automobile Encyclopedia

Long a standard work on the automobile, truck and tractor, the new 13th edition, entirely rewritten, is the most complete single volume on the subject in the world to-day. Separate books covering the material found in this one would cost about \$21.00. The price of Dyke's book with over 1200 pages, 4,100 illustrations, size 7x10 inches and 2 inches thick, in handsome cloth binding is..... **\$6.00**  
Bound in flexible American Morocco..... **\$7.50**

For the boy of mechanical bent hundreds of interesting things to make and do are described in

## The Boy Mechanic, Books 1, 2 and 3

Each book is complete in itself and contains nothing found in either of the others. The subject matter covers mechanics, electricity, sports, arts and crafts, magic, games, etc. Each volume is uniform in size with the others, 7x10x1½ inches and has 480 pages. Handsome cloth binding.

Book 1 contains 700 Things to Make and Do and has 800 illustrations.

Book 2 contains 1000 Things to Make and Do and has 995 illustrations.

Book 3 contains 800 Things to Make and Do and has 802 illustrations.

Price, per volume..... **\$2.50**

The banker, business man, merchant, lawyer, mechanic, farmer, laborer or artisan will appreciate

## Ropp's Commercial Calculator

For it shows the answer as quickly as a watch shows the time to all problems likely to occur in the office, store, shop, bank, farm or factory. The pocket size, leatherette binding, is..... **\$1.00**

Desk size, cloth binding is..... **\$1.50**

The radio enthusiast who wants to know how to construct and operate a receiving set successfully will be delighted with

## Radio for the Amateur

This book has been selected because it teaches radio in a unique way by means of illustrations, one showing something you know about and the other showing something about radio by comparison. 207 pages. Cloth binding. Price..... **\$1.50**

For the amateur entertainer or for the amusement of children

## Houdini's Paper Magic

Covers the whole art of performing with paper, including paper tearing, paper folding, and paper puzzles. 206 pages, illustrated. Cloth binding. Price..... **\$2.50**

The motor boat enthusiast will revel in

## Motor Boats and Boat Motors

A complete handbook considering all details of modern hulls and marine motors, boat design and construction, installation of engines, boat and engine maintenance and repair, operation, etc. 524 pages, 6x9, 372 illustrations. Cloth. Price..... **\$4.00**

For the mechanic, the manufacturer, the artisan, the housewife and the general home worker

## Henley's 20th Century Home and Workshop Formulas, Recipes and Processes

Contains money making facts for everybody. A techno-chemical recipe book containing 10,000 recipes for the manufacture of valuable articles for every-day use. 800 pages, 6x9. Cloth. Price..... **\$4.00**

The student of drawing or the young cartoonist will find inspiration in portfolios of the work of the greatest cartoonists.

## Bound Volumes of Cartoons Magazine

Each contains upwards of 1200 cartoons from the pens of Darling, Cesare, McCutcheon, Carter, Kirby and other masters. Seven separate volumes from 1917 to 1920 including part of world war and reconstruction periods. Every volume has 900 pages (7x9½ inches) 3 inches thick, handsome, durable binding. Price, per volume..... **\$2.00**

For anyone who is fond of winter sports

## How to Make Devices for Outdoor Winter Sports

Provides the necessary instructions for building a pleasing variety of craft such as motor-driven sleds and ice boats, ice yachts, ski gliders, coasting toboggans, bobsleds, skis, ice gliders, etc. Paper. Price **25c.**

Every carpenter, builder, contractor, needs

## The New Building Estimators' Handbook

in order, with confidence, to prepare estimates from information based on actual, present-day conditions. The 1922 edition of this book has over 1,000 pages, 467 illustrations, 600 tables, flexible binding. Price..... **\$6.00**

The printer, engraver or allied tradesman or business man who uses their products will get much real practical help in his work from

## Commercial Engraving and Printing by Hackleman

Most practical and complete book on engraving and printing and related lines of work ever published. Nearly 900 pages, and 1000 illustrations, presenting over 3500 distinct ideas on 35 separate subjects. We highly recommend this book. Cloth. Price..... **\$15.00**

The one indispensable book for anyone who works in a machine shop or drafting room is

## Machinery's Handbook

The greatest collection of practical mechanical data ever published covering the entire field of shop practice and machine and tool design. 1400 pages, illustrated, indexed. Flexible binding. Price..... **\$6.00**

Every welder or welding engineer needs

## The Welding Encyclopedia

Second edition, greatly improved, just published. It is the most complete and authoritative reference and instruction book on all forms of welding. 326 pages, 375 illustrations. Size 6x9 inches. Flexible binding. Price..... **\$5.00**

For the amateur lathe operator

## Lathe Work for Beginners, by Yates

is the one volume devoted to the master tool in a way that will interest and instruct the layman. 240 pages, 167 illustrations. Cloth. Price..... **\$2.50**

The amateur or professional mechanic who is interested in model making will value highly a copy of

## Model Making, by Yates

It gives the various processes and operations involved in model making and the actual construction of numerous models such as steam engines, speed boats, guns, locomotives, cranes, etc. 350 pages. 303 illustrations. Cloth. Price..... **\$3.00**

ABOVE PRICES POSTPAID

*Mail Order and Remittance to*

**POPULAR MECHANICS BOOK DEPARTMENT**  
6 N. MICHIGAN AVE. CHICAGO



# This Stylish, Goodyear All Weather Coat **FREE!**



For advertising purposes we offer to send this handsome Goodyear All Weather Coat Free to one person in each locality who will show and recommend it to friends and take orders. It is a beauty, of rich triple texture tweed, cut in the season's latest style with all around belt, semi-dent lapels, convertible collar and storm tabbed sleeves. Guaranteed rain, dust and wind proof. A handsome topcoat, overcoat, raincoat and motor coat combined. Good for all year 'round wear.

## **Send No Money**

Write your name and address in the coupon below and mail today. Send no money. Prove by your promptness that you are the one we seek. **MAIL IT NOW.**

## **Big Pay for Spare Time**

When people see your wonderful sample All Weather Coat they will admire it, ask about it, and want one like it. That is why we make this Unparalleled Free Offer.

You can make big money just taking these orders. Have all the money you want to spend. Don't lag behind and miss this great offer. Fill in the Coupon and Mail NOW!

**THE GOODYEAR MFG. CO.**  
1740-R Goodyear Bldg.  
KANSAS CITY, MO.

Here's  
the  
**BigFREE  
COUPON**

**THE GOODYEAR MFG. CO.**  
1740-R Goodyear Bldg.  
Kansas City, Mo.

Without any obligation on my part please send me by return mail your FREE COAT and AGENCY OFFER.

**Don't  
Lose  
Time  
Act  
NOW  
!**

**Mail The Coupon NOW!**

**This Sensational Free Offer  
May Never Be Made Again.**

*Tear out here and mail before you forget it.*

NAME \_\_\_\_\_

ADDRESS \_\_\_\_\_

TOWN \_\_\_\_\_

STATE \_\_\_\_\_



USED BY THE U. S. GOVERNMENT

**Let This Outfit  
Work for  
You and  
Make Big  
Money this  
Winter.**



## A Better, Faster Cutting Log Saw

Learn at once about this World's Champion Log Saw and know how fast, easy and cheap you can saw logs, fall trees and buzz up branches. The New, Improved 1923 Model OTTAWA is creating a sensation among farmers and woodsmen everywhere. Starting new improvements—greatest Log Saw ever designed. Here's a real money-getter for you. Harvest your wood crop this winter; put money in the bank. You can, with this wonderful OTTAWA working for you.

### Mechanically Operated Valves

Now, inlet as well as exhaust valve opened mechanically—like automobile and tractor motors—not used on other log saws. Starts easier; uses less fuel; develops more power.



## OTTAWA LOG SAW

**Saws the Human Way.** The 1923 Model OTTAWA has a Power Force Feed. Saws as two men would, only many times faster and with greater force. The OTTAWA not only makes more cuts a minute, but cuts deeper into the log each stroke. Lever Controlled Friction Clutch enables you to start or stop saw while engine runs. Throttling governed Engine burns Kerosene or Distillate.

**30 Days' Trial 10-Year**

**Guarantee.** Every OTTAWA sold direct from factory to you at Big Saving. 30 Days' Trial. 10-Year Guarantee backed by the largest engine and log saw factory in the world. Cash or Easy Terms.

**10 Quick Shipping Points**

We ship immediately from our Factory or Branch House nearest you: St. Paul, Minn., Dallas, Tex., Albany, N. Y., San Francisco, Calif., Atlanta, Ga., Portland, Ore., Ottawa, Kans., Indianapolis, Ind., Pueblo, Colo., Pittsburg, Pa.

**Make Money Sawing Wood.**

Right now is the time to cash in on the demand for wood for fuel. Put an OTTAWA to work! Build up your bank account like hundreds of OTTAWA owners are doing. Big demand now for wood, because coal is scarce and high.

**FREE Book!** Send a Postcard at once for your Free "Wood Sawing Encyclopedia," beautifully illustrated. Also Big Special Offer. Know the Big Opportunities open to OTTAWA owners. Send today.

**OTTAWA MFG. CO.,**  
1748-S Wood Street,  
OTTAWA, KANS., PITTSBURGH, PA.

**FREE  
WOOD  
SAWING  
ENCYCLO-  
PEDIA**

### Own a Wood Business of Your Own!

Be independent—be successful. From a small start you can soon own a profitable business. Get an OTTAWA Log Saw—and start your own Wood Business. We have made hundreds successful—let us help you. Send for Free Encyclopedia—complete information given you.





# Learn In the Great Shops of COYNE

**YOU CAN DO  
THE SAME**

**Read  
These  
Letters**



"Now the same man is my helper; my pay is bigger than his. He had been in the shop 2 years, but I'm a 'Coyne Man.'"—M. B. K.



"Eight years ago my time card read 'Laborer'—\$1.50 a day. Today my business turnover runs into thousands of dollars."—J. C. M.



"I'm taking care of generators and switchboards at Edison's, earning \$249 a month, thanks to Coyne."—D. O.

**T**HE whole world of electricity is open to the Coyne trained man. He is trained completely. He can make big money as power Plant Operator, Superintendent, Telephone man, Construction worker, auto truck or tractor electrician, battery man, radio expert, or he can go into business for himself as electrical contractor, dealer, auto ignition or battery expert and make from \$3,000 to \$20,000 a year. Hundreds of our graduates today are making big money and you can do the same if you grasp this opportunity—act now.

## Earn \$150 to \$400 a Month

No books or useless theory. You are trained on \$100,000 worth of electrical equipment. Everything from door bells to power plants. You work on motors, generators, housewiring, autos, batteries, radio, switchboards, power plants—everything to make you an expert ready to step right into a position paying from \$15 to \$100 a week. Learn electricity in the electrical center of the world. Send the coupon today for free catalog.

## Big New Home

The increasing popularity of Coyne and a tremendous influx of new students simply forced us to move into larger and more spacious quarters. Here, in the big, new home, you will find added electrical equipment—new and larger departments—a more complete electrical training—a school thoroughly equipped to train you for a big paying position.

## Radio Course FREE

We include the following free with your regular course:

- (1) A complete course in auto, truck and tractor electricity and storage batteries. Greatest outlay of auto electrical and battery equipment in the country.
- (2) Course in Radio—the marvel of the age. Constructing, installing and operating. You can build your own wireless telephone set.
- (3) A life scholarship in the Coyne School. You can stay as long as you wish and return for further training at any time in the future. The aim of the Coyne School is to turn out men completely trained in all branches of electricity—capable of succeeding in the highest paid positions.

## Earn While You Learn

We help students to secure jobs to earn a good part of their expenses while studying.

## Send Coupon NOW!

Don't delay a minute—send that coupon in **right now** for our big free catalog and full particulars of this wonderful offer;—Act Now.—Make up your mind to come to Coyne to learn electricity. Send coupon today.

**B. W. COOKE**  
President

**COYNE TRADE &  
ENGINEERING SCHOOL**  
1300-1310 W. Harrison St.  
Dept. 9359, Chicago, Ill.

Dear Sir:—Please send me free your big catalog and full particulars of your special offer of 2 extra courses.

**B. W. COOKE**  **PRESIDENT**

**COYNE**  
TRADE AND ENGINEERING SCHOOL

Dept. 9359, 1300-1310 W. Harrison St., Chicago, Ill.

**SEND  
COUPON  
TODAY**

Name.....

Address.....



# \$258<sup>00</sup> PROFIT

## EVERY WEEK FOR BERGER



Bentley, of Philadelphia, earned \$215 in one day and Berger, of Ontario, has a standing weekly order that nets him \$258.00 profit every week.

### New Kind of Heat!

No dirty, heavy coal to carry and lift—no fires to build, bank or watch—no clouds of ashes to breathe—no heating problems—no cold rooms in winter—no more worry about coal shortage or high prices since the new heating invention.

### Big Profits--Quick

Wonderful invention gives three times the heat of coal at turn of valve and burns ordinary kerosene (coal oil). Cheapest fuel there is. No wonder housewives buy on sight. No wonder agents make \$5,000 to \$10,000 a year.

## Amazing Invention Pays \$5,000 a Year

### OTHERS MAKE FORTUNES

**\$215.00 in One Day**  
"Ye gods—some seller! I made \$215 today!"  
F. W. Bentley, Philadelphia, Pa.

**\$11.75 in Ten Minutes**  
"I took order for a neighbor. \$11.75 profit in ten minutes."  
Mrs. N. B., Hattiesburg, Miss.

**\$43 in One Evening**  
"I made \$43 last night selling Oliver Burners."  
N. B., Chelan, Wash.

**"Sells Like Beer in a Dry Town"**  
"Am sending today for 7 Oliver's. This is one day's orders (\$85 profit). Selling like beer in a dry town."  
W. H. Drew, Mich.

**Mr. T's 28th Order in Six Months**  
"Ship 52 Oliver's: 10 No. 30; 6 No. 1; 12 No. 2; 24 No. 4." (Mr. T's profit on this order alone is \$711.)  
G. T., Ottawa, Ont.

**Russell Earned \$3300 in Six Months**  
"Have averaged \$660 profit a month for last six months."  
A. M. Russell, Conn.

**Carnegie—\$1,000 a month**  
"Am making \$1000 per month. I have made big money before but did not expect so much. Your Burner is just the thing."  
J. Carnegie, S. D.

**N**O WONDER this amazing new invention is bringing fortunes to agents. All over the whole country this new device is doing away with old-fashioned methods of heating with coal stoves, ranges and furnaces. Already over \$1,000,000 worth have been sold. You can readily understand why this new invention—the Oliver Oil-Gas Burner—is sweeping over the country like wildfire. It does away with all the expenses and uncertainty of coal when it is almost impossible to get at any price—making every heating stove, cook stove, and furnace a modern oil-gas burner. Saves money, time and drudgery. Three times the heat of any other method. No wonder agents are riding in on the tide of big Oliver profits.

### It Sells Itself

Agents find it no work at all to sell this amazing invention—the Oliver new improved Oil-Gas Burner. They just show it—taking only one minute to connect it—then light it. And the sale is made! This new invention is its own salesman. It sells itself! It burns 95% air and only 5% oil—the cheapest fuel there is. It saves a woman work now in times when she is looking for just such things. Just as much or as little heat as wanted, off and on instantly by simply turning a valve.

### The Secret of Big Money

Of course, now that you know the facts you yourself can understand why Berger makes \$258.00 profit every week; why F. W. Bentley made \$215.00 in one day. Why J. Carnegie made \$1,000.00 in one month and why hundreds of other agents are cleaning up big too.

These men know the secret of big money. They know a good thing when they see it. They know that the time is ripe for this new Oliver improved Oil-Gas Burner.

### Big Profits Made Quickly

You, too, can use this secret of big money. You do not need to be a high-powered salesman. We have a definite number of open territories which we are ready to dispose of to those who act quickly. Every territory allotted is filled with big-money opportunities. And this big money comes easily. Because not only does this invention practically sell itself on sight but when you have sold one this one will sell several others as soon as your customer's friends and neighbors see it. And thru our special plan you get credit and commissions for every sale in your territory.

### Spare or Whole Time

You can also make big money just by using your spare time. Note how Norton Brown made \$43.00 in one evening.

### Coupon Brings Full Offer

If you want to make at least \$5,000 a year easily, mail this coupon now for our offer. We believe that your common sense will indicate a good proposition to you when you know about it. We want to give you all the facts. Won't you write us? And by doing so quickly you will be allotted an exclusive territory with private selling rights. But mail the coupon at once and clean up on this wonderful new invention.

### Oliver Oil-Gas Burner and Machine Co.

Dept. 2014-X Oliver Building, St. Louis, Mo.

Please send me full facts about how I can make at least \$5,000 a year representing you in my territory. Also your plan if I just wish to make big money in my spare time.

Name \_\_\_\_\_

Address \_\_\_\_\_

**OLIVER OIL-GAS BURNER AND MACHINE CO.**

Dept. 2014-X Oliver Building, St. Louis, Mo.



# Be a Certificated "Electrical Expert"

You, Too, Can Learn  
to Boss This Job

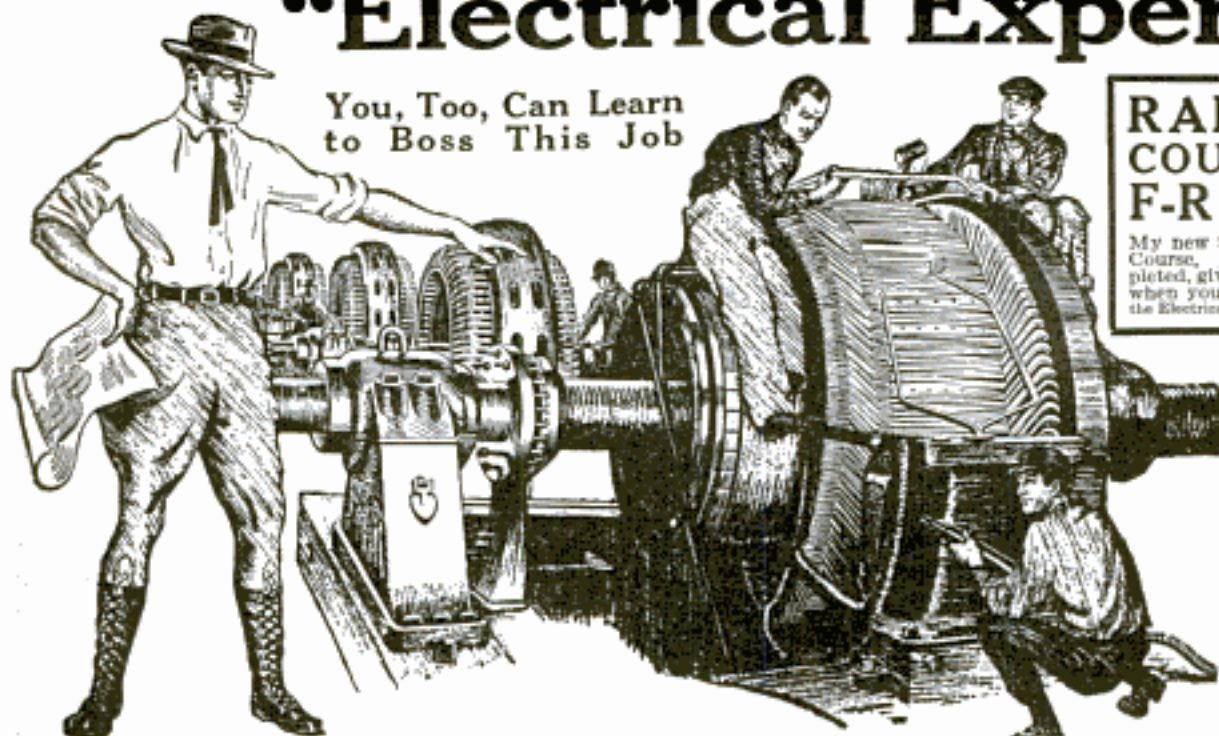

**RADIO  
COURSE  
F-R-E-E**

My new \$45 Radio Course, just completed, given FREE when you enroll for the Electrical Course.

## "Electrical Experts" Earn \$12 to \$30 a Day WHAT'S YOUR FUTURE

Trained "Electrical Experts" are in great demand at the highest salaries, and the opportunities for advancement and a big success in this line are the greatest ever known.

"Electrical Experts" earn \$70 to \$200 a week. Fit yourself for one of these big paying positions.

### Be an "Electrical Expert"

Today even the ordinary Electrician—the "screw driver" kind—is making money—big money. But it's the trained man—the man who knows the whys and wherefores of Electricity—the "Electrical Expert"—who is picked out to "boss" ordinary Electricians—to boss Big Jobs—the jobs that pay.

**\$3,500 to \$10,000 a Year**

Get in line for one of these "Big Jobs" by enrolling now for my easily learned, quickly grasped, right-up-to-the-minute, Spare-Time Home-Study Course in Practical Electricity.

### Age or Lack of Experience No Draw-Back

You don't have to be a College Man; you don't have to be a High School graduate. My Course in Electricity is the most simple, thorough, and successful in existence, and offers every man, regardless of age, education or previous experience the chance to become, in a very short time, an "Electrical Expert," able to make from \$70 to \$200 a week.

### I Give You a Real Training

As Chief Engineer of the Chicago Engineering Works I know exactly the kind of training a man needs to get the best positions at the highest salaries. Hundreds of my students are now earning \$3,500 to \$10,000. Many are now successful ELECTRICAL CONTRACTORS.

### Your Satisfaction Guaranteed

So sure am I that you can learn Electricity—so sure am I that after studying with me, you, too, can get into the "big money" class in electrical work, that I will guarantee under bond to return every single penny paid me in tuition if, when you have finished my course you are not satisfied it was the best investment you ever made.

### FREE—Electrical Working Outfit—FREE

I give each student a Splendid Outfit of Electrical Tools, Materials and measuring Instruments absolutely FREE. I also furnish them with Supplies, examination paper, and many other things that other schools don't furnish. You do PRACTICAL work—AT HOME. You start right in after the first few lessons to WORK AT YOUR PROFESSION in a practical way.

### Get Started Now—Mail Coupon

I want to send you my Electrical Book and Proof Lessons both FREE. These cost you nothing and you'll enjoy them. Make the start today for a bright future in Electricity. Send in coupon—NOW.

L. L. COOKE, Chief Engineer,

**CHICAGO ENGINEERING WORKS**

Dept. 519 2150 Lawrence Ave., CHICAGO, ILL.

**YOU CAN DO IT**

Name.....  
Address.....  
Occupation.....

L. L.  
COOKE,  
Chief Eng.  
Chicago Engi-  
neering Works,  
Dept. 519  
2150 Lawrence Ave.,  
Chicago, Ill.

Dear Sir: Send at once Sample Lessons, your Big Book, and full particulars of your Free Outfit and Home Study Course, the Free Radio Course—all fully prepaid, with-out obligation on my part.

**USE THIS "FREE OUTFIT" COUPON**



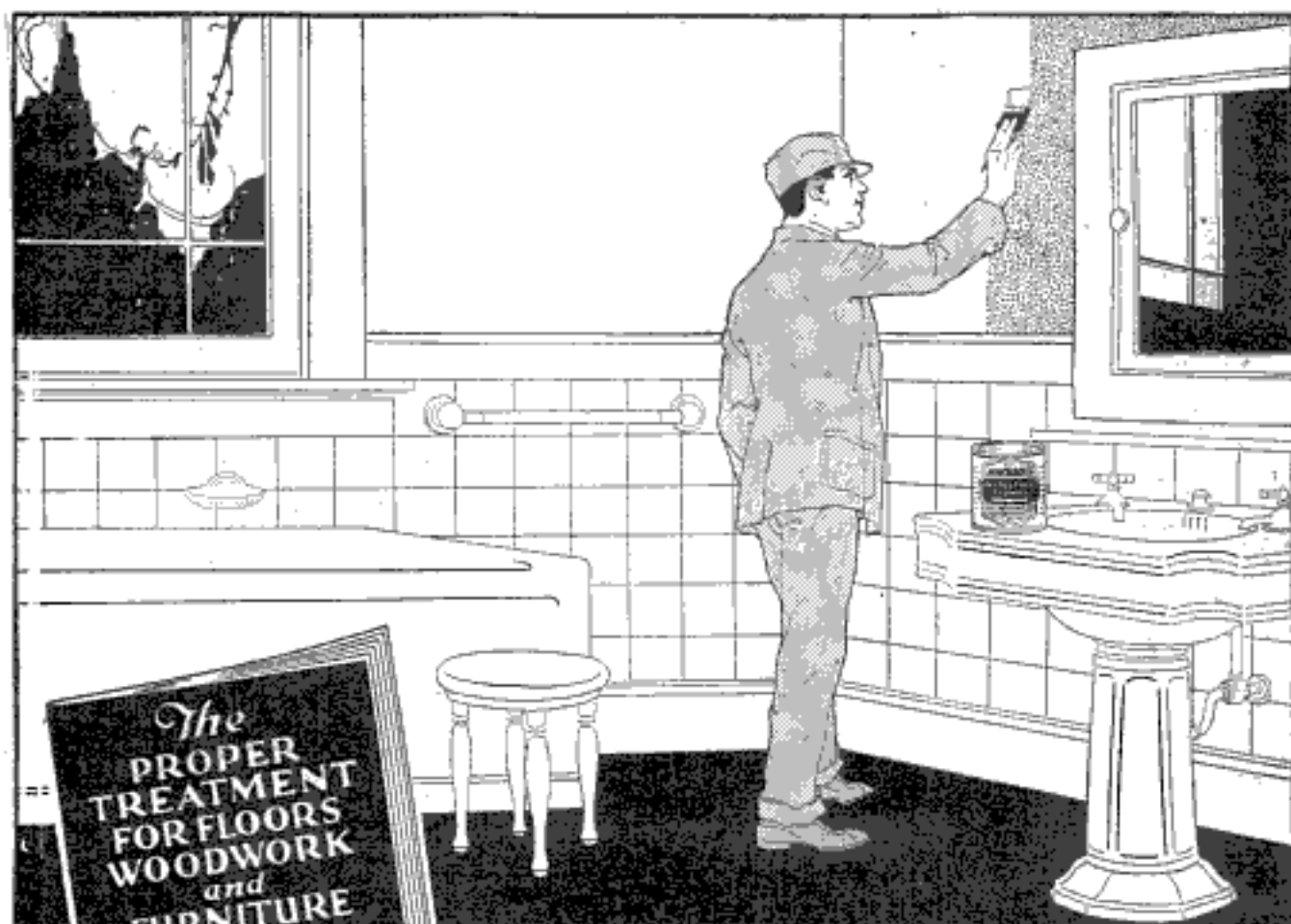

## This Beautiful Book on Wood Finishing FREE

**G**IVES complete instructions for finishing all wood—hard or soft, old or new. Explains just what materials to use and how to apply them. Tells how inexpensive soft woods may be finished so they are as beautiful and artistic as hard wood. This book is the work of experts—illustrated in color. Gives covering capacities, includes color charts, etc.

### JOHNSON'S ENAMEL

Johnson's Perfectone Undercoat and Enamel is the ideal finish for wood, plaster and metal. It will not chip, check, crack, peel or change its color. Gives a beautiful, germ-proof

S. C. JOHNSON & SON, Dept. PA12, Racine, Wis.  
Please send me, free and postpaid, your Instruction  
Book on Wood Finishing. The best dealer in paints

here is.....

My Name.....

My Address.....

City and State.....

porcelain-like finish which is impervious to hot soapy water, iodine, ammonia, etc.

Fill out and mail coupon for a free copy of "The Proper Treatment for Floors, Woodwork and Furniture."

**S. C. JOHNSON & SON**  
"The Wood Finishing Authorities"  
Dept. PA12, Racine, Wis.  
Canadian Factory—Brantford





## Brings This Richly Upholstered 6-Piece Suite

Chairs Have Spring Seats

Send only \$1 for this complete suite of 6 splendid pieces. Use it 30 days, then if not satisfied, ship it back and we will return your \$1 and pay transportation charges both ways. If you keep it, take

## Nearly a Year to Pay

on our easy terms. Table scarf and candlesticks are FREE. The suite, consisting of table, 36-inch x 23-inch top, 2 rockers, 2 chairs and waste basket, made of selected quarter-sawn and solid oak. Very solidly built. Fumed oak finish. Chairs and rockers upholstered in imitation Spanish brown leather and have padded, spring seats and cut-out panels in back. All roomy, full size pieces. Shipped (fully boxed, "knocked down" to lessen freight charges) from factory in Indiana or Chicago warehouse. Order by No. 105DDMA18. Price \$34.95. Send \$1.00 now. Balance \$3 monthly. Table Scarf and Candlesticks are FREE.

## FREE Beautiful Velour Table Scarf—2 Candlesticks to Match Set

FREE Gifts With Catalog Orders

We want to prove that Hartman's prices and terms are the most liberal ever known. That is why we make this extra inducement. A handsome 48 in. x 16 in. blue velour table scarf with floral tapestry ends and gold braid binding; also 2 solid oak candlesticks to match furniture ABSOLUTELY FREE! No other offer like this. Send quick!

## Send Post Card for 368-Page Free Bargain Catalog

This 368-page book offers the world's greatest bargains in furniture, rugs, silverware, kitchenware, etc., also farm machinery—all sold on our easy monthly payment terms and on 30 days' free trial. Also explains how you can get absolutely FREE with purchases, fine sets of Glassware, Dishes, Lemonade Sets, Silverware, Tablecloths, Napkins and other elegant and useful articles. Send postal for it today.

"Let Hartman Feather YOUR Nest"

## HARTMAN Furniture & Carpet Co.

Dept. 4970 Chicago, Illinois

Enclosed find \$1 as first payment. Send the 6-piece Living Room Suite No. 105DDMA18 and with it, absolutely FREE, the beautiful Table Scarf and Candlesticks, all as described. I am to have 30 days' free trial. If not satisfied, will ship all back and you will return my \$1 and pay freight both ways. If I keep it, I will pay \$3 monthly on the suite alone until the full price, \$34.95, is paid. Title remains with you until final payment is made.

Name..... Occupation.....

R. F. D., Box No. or Street and No. ....

Post Office..... State.....

If your shipping point is different from your post office, fill in below.

Send shipment to .....

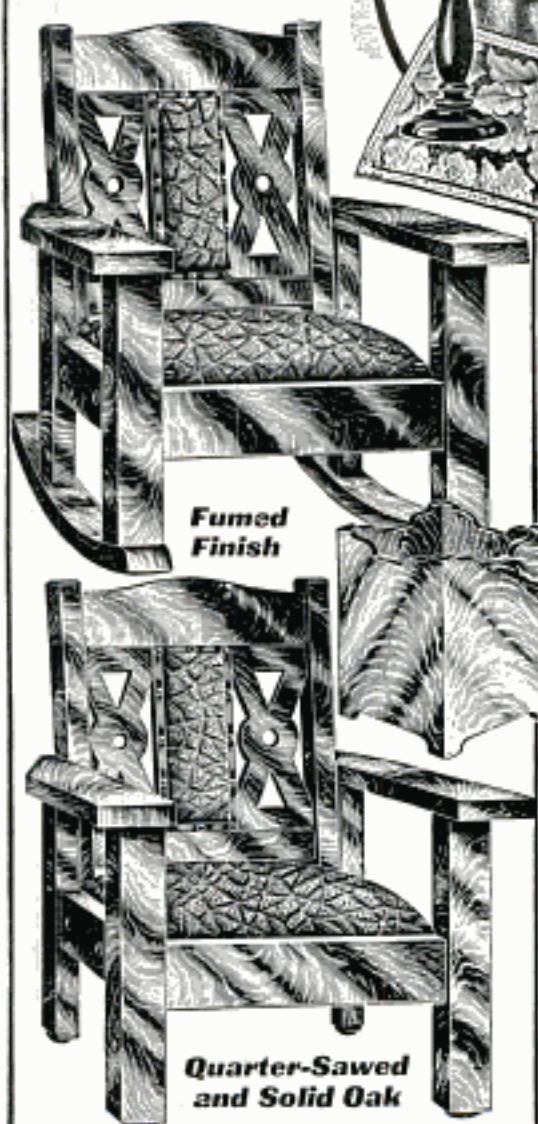

Fumed Finish

Quarter-Sawn and Solid Oak

**HARTMAN FURNITURE & CARPET CO.**  
Dept. 4970 Chicago, Ill.

Copyright, 1927, by Hartman's, Chicago





—and now  
 harmony replaces discord!

"Boy! this is wonderful! No hissing, no screeching — and the weather doesn't seem any TOO good today."  
 "Well, Bill, most of the noises in your set are battery noises — not static or interference."  
 "How do you DO it, John? It can't be all in the tuning."  
 "It isn't in the tuning at all. It's Radiobats "A" and "B". Try 'em and HEAR!"

**M**USIC—clear as a bell; speech—every word is marvelously distinct; jazz—uninterrupted syncopation; opera—with full-toned quality and beauty in strong relief.  
 Clear radio reception is a matter of batteries. Elimination of most noises is a matter of batteries, rather than static or other interference.  
 Irregular voltage output, natural in ordinary "B" batteries, causes noises. Unvarying current output stops these noises—and this marvelously clear and life-like reception results.  
 Because RADIOBATS "A" and "B" are the only batteries able to act correctly, we urge you to

listen to a demonstration at your dealer's. There is no way to hear such reception till these new-principle batteries are hooked in. RADIOBATS "B"—as well as "A"—are leak-proof because they have the only solid electrolyte; and are more economical, because, like "A" Batteries, they are indefinitely rechargeable at home.  
 Send your dealer's name and address that we may arrange an immediate demonstration.

Multiple Storage Battery Corporation  
 350-B Madison Avenue, New York



Equip your set with "A" and "B"

Send for this intensely informative book. It is absolutely FREE.

# RADIOBATS

The Permanent Radio Power-UNIT