

November

25 Cents

POPULAR MECHANICS MAGAZINE

WRITTEN SO YOU CAN UNDERSTAND IT

REG'D. TRADE MARK. GREAT BRITAIN. No. 410426

REG. U. S. PAT. OFF.



HOW FAR CAN
A LOCOMOTIVE
JUMP ?
See Page 675

It takes *only* 8 weeks to get a big job



O. H. Justus owns a big agency and repair shop at Parkersburg, W. Va. He says "that my schools give motor secrets that will put any man 'on easy street.'"

Read what these men are doing in the Auto and Tractor Business. Here is your big chance to get "on easy street." Come to these great shops on the biggest FREE offer ever made.

Big Firms Need Trained Men

The Auto and Tractor Business is on the boom. Thousands of trained men will be needed during the next few months. I get calls every day from Garages, Battery Stations, Auto Repair, Welding Shops and other successful concerns for Rahe men. When the big fellows need high grade men they know where to come for them. They want Rahe trained men.



Emanuel Rushfeldt, Alberta, says: "Earning \$10 a day and only 20 years old."

My Training Unusual

Scientific tool training—that's the secret. You do things here according to the latest engineering standards. Thousands of dollars have been spent in modern tools and equipment. That's why my men are at home in the biggest shops in the country. If you want to succeed the way Beimer and Justus and the rest have—qualify by the same method.

I'll Pay Your Railroad Fare and Board You

In order to fill the openings that now exist, I am making an offer no one has ever made before—**Free railroad fare, Free board.** But even that is not all. I'll tell you about the rest in my letter.



W. W. Peace gets \$250 a month and expenses operating a tractor in the oil fields.

Send for **FREE** Book

My big illustrated training book tells how others are succeeding. It tells many things you ought to know about Autos and Tractors. Write for it and my **short time** offer NOW. It soon expires.

Rahe *Auto & Tractor Schools*

CHICAGO
4445 Grand Blvd.

Dept. 897, CINCINNATI
Ninth and Walnut



Louis Beimer at 24 was made for a man over men many years older. That's not luck—it's Rahe training.



Rahe Auto & Tractor Schools,
Dept. 897, (address school nearest you)
Chicago, Ill., or Cincinnati, Ohio.

Without any obligation, send me your big free book, "More Money." Also information regarding special temporary offer.

Name

Street

City State



This actually happened in a directors' room

It helps to explain why executives are turning to the Alexander Hamilton Institute in larger numbers than ever before

IN the quiet, almost luxurious, directors' room the department heads of a certain large manufacturing company were called together by the general manager.

One after another the production manager, the purchasing agent, the head of the planning department and the sales manager expressed themselves. The burden of each man's excuse was the same: "If I had received proper co-operation from the other departments we would have met our quota easily."

The general manager spoke last, a keen aggressive man of thirty-eight, who had been brought in from the outside.

"Gentlemen, you have told me far more than you imagine," he said. "It's perfectly clear what is the matter with this concern. You men have forgotten that it is a *business* and not merely a collection of departments. You are first-class specialists, crackerjacks in your own departments, but

Gentlemen, you are mighty poor business men"

They were too stunned to answer.

"I'll repeat it," the general manager said. "You—all of you—are poor business men. You're

a group of stars but you aren't a team. Each of you knows his own viewpoint; he knows his work and knows it well. But you do not know enough about each other's problems to make this company an effective business unit.

"The sales department has got to know more about production, and accounting and costs; the production department has got to think more in terms of sales and credits—each one of you has got to get some *vision of business as a whole*, in all its varied and inter-related departments. That's what this company needs—and it needs it badly."

The next day, at the general manager's invitation, a representative of the Alexander Hamilton Institute visited that office; and every department head enrolled for the Modern Business Course and Service.

More than 24,000 executives enrolled

The Alexander Hamilton Institute was founded by a group of business leaders who recognized that modern business was tending to produce specialists rather than to develop executives.

Its appeal has been always to successful men, to men of mature years who had already made a favorable start in their chosen line of work. More than 24,000 senior executives have enrolled, many of them in company with their most trusted associates.

This is the significant thing, however: *In the past six months, the number of enrolments received by the Institute has been larger than that at any similar period in its history; the average age of the men enrolling has been higher; their present position in business higher on the average than ever before.*

As never before, the leaders of business enterprises are demanding better business training for themselves and for the men on whom they most depend.

Will you spend an evening with the facts?

The facts about the Institute's Course and Service are condensed into a 118 page booklet that aims to answer every question which a thoughtful, ambitious man is likely to raise.

To promote a wider understanding of its training, its purposes and its results, the Institute offers a copy of this booklet to any reader of this publication who will request it. In a single evening you can have the full facts. The booklet is called

"Forging Ahead in Business"

Just what the Modern Business Course and Service is and does; just how it has helped to solve the problems of hundreds of businesses in every line; just how individuals have used it to increase their own progress and earning power—all this is contained in "Forging Ahead in Business." It is a book worth adding to any business library; for your convenience in sending for your copy a coupon is attached.

Alexander Hamilton Institute

628 Astor Place New York City



Send me "Forging Ahead in Business" which I may keep without obligation.

Name..... *Print name*

Business Address.....

Business Position.....

Canadian address, C.P.R. Building, Toronto; Australian address, 42 Hunter St., Sydney

Here's a "dandy" Free Text
Book for "Home Carpenters"

12 WORKING DRAWINGS
 VOL. 36
CYPRESS
 POCKET LIBRARY
 "THE WOOD ETERNAL"

**"SHORT CUTS" TO
 GOOD CARPENTRY**

BOX SILL CONSTRUCTION
 SELF SUPPORTING BARN FRAMING
 JOIST
 ROOF TRUSS
 CORNICE DETAIL
 CYPRESS SHINGLES

"Short Cuts to Good Carpentry"—
 (Vol. 36, Cypress Pocket Library)
 48 pages of authoritative instruction (simple, clear and stimulating) fully illustrated and with big Supplement, 24 x 36 in. with detailed Working Drawings that show how to make twelve "hard jobs" easy, safe and economical of both labor and Lumber. Read what "Rural Life," (Rochester, N. Y.) says of

**"SHORT CUTS to
 GOOD CARPENTRY"**

"It is a guide book for the man or boy who can handle a saw or hammer and wants to know how to use them to the best advantage." Ten topics pertaining to the house and 4 about barns. Sent free with our compliments.

**WE TRUST YOUR
 OWN JUDGMENT
 and SELF-INTEREST to
 INSURE CYPRESS on YOUR job.**
 "The Wood Eternal" keeps values going up by keeping the place from running down."

When planning a Mission, a Bungalow, a
 Farm, a Sleeping-Porch or just a Fence, remember—
USE CYPRESS you WOULD BUY ONCE—TRY IT.

Let our "ALL ROUND HELP'S DEPARTMENT" help YOU. Our resources are at your service with Reliable Counsel,
SOUTHERN CYPRESS MANUFACTURERS' ASSOCIATION
 1219 POYDRAS BLDG., NEW ORLEANS, LA., or 1219 GRAHAM BLDG., JACKSONVILLE, FLA.
 (Please address nearest office)

INSIST ON TRADE-MARKED CYPRESS AT YOUR LOCAL DEALER'S. IF HE HASN'T IT—LET US KNOW

Popular Mechanics Magazine

6 N. Michigan Avenue, Chicago, U. S. A.

H. H. WINDSOR, Editor

London: Hachette & Cie.
16-17, King William Street, Charing Cross, W. C. 2

Paris: Hachette & Cie.
111 Rue Reaumur

Melbourne, Australia,
The Australasian News Co.

ISSUED MONTHLY

SUBSCRIPTION:

SINGLE COPY, 25 CENTS

In United States, and its possessions, Cuba, Mexico, and Canada, per year, postpaid - \$3.00

To all other countries in the Postal Union 3.50

All subscriptions are discontinued at expiration. Please examine the date printed on your wrapper.

Entered as Second Class Matter Sept. 15, 1903, at the Post Office at Chicago, Illinois, under Act of March 3rd, 1879.

Entered as Second Class Matter at the Post Office Department, Canada.

Published monthly by POPULAR MECHANICS CO.

Copyright, 1922, by H. H. Windsor.

Copyright in Australia.

Vol. 38

Contents for November, 1922

No. 5

Airman, Army, Makes Record One-Stop Flight.....	688	Camp Fire Stake, Metal, Has Three Adjustable Racks	769
Airplane Flight Shown by Gyroscope Instrument.....	778	Cattle Breeding, Cooperative, in North Dakota, by	
Airplane Fuel, Petroleum Used as.....	709	Allen P. Child.....	718
Airplane Landing Gear Dropped in Flight.....	695	Cement from Returned Bags Builds Concrete Shed..	716
Airplane Mail Service Goes Year without Fatal Accident	722	Cement Kilns, Rotary, Cleaned with Shotgun.....	737
Airplane Pressures, Multiple Manometer Records....	606	Cheese, Swiss, X-Ray Machine to Examine.....	738
Airplane Speed, Accurate Method of Timing.....	733	Children's Picture Pages.....	776
Airplane Station, Famous Trading Post Is.....	669	Civic Features.....	766
Airplanes, Wind Tunnel for Testing.....	721	Clod Crusher and Leveler Operates with Harrow....	717
Airship Mooring Mast, New Navy, by Ernest Jones.	692	Coal Substitutes, Hard, Caution Users of.....	696
Apples are Monogrammed in Western Orchard.....	710	College Near Arctic Circle Opened by Alaska.....	673
Armor Grinding Machine Is Largest in the World...	772	Comment and Review, by H. H. Windsor.....	701
Automobile Battered, Bent, and Broken Makes Record	708	Concrete, Lightweight, Has Slag in Place of Gravel.	743
Automobile, Church-Like Body Built on.....	709	Concrete Piers Replaced by Unusual Method.....	747
Automobile Control, New, Operates Pneumatically...	694	Concrete Walls Destroyed Pneumatically.....	758
Automobile Dash Instrument Is Speed and Flow	716	Concrete Walls, Hollow, Form for Pouring in Courses	715
Meter.....		Cooking Utensil Heats Extra Water in Cover.....	716
Automobile Decking, Knockdown, for Use in Shipping	719	Corn Cleaner Removes Shucks and Silk from Ear...	663
Automobile Exhaust Pipe Cooker Has Three Large	739	Corncob Seen as Source of New Industry.....	765
Pans.....	704	Corncribs, Argentine, Built as Self Feeders for Hogs.	736
Automobile Gradient Meter Mounted on the Dash...	747	Cotton, Record Stalk of, Has 700 Bolls.....	696
Automobile Heater Vaporizes Heavy Particles of	747	Crusher, Concrete Surface, for Road Repair.....	723
Gasoline.....	773	Dates, Cultivation of, Is Paying Enterprise.....	720
Automobile Radiator Attachment Blows Whistle	673	Dam, Wilson, by R. C. Folger.....	670
When Overheated.....	673	Deaths, Accidental, Toll of, Reaches High Mark....	756
Automobile Robe Rolls into Cylindrical Footrest....	607	Diamond Setting Alloy of Low Melting Point.....	664
Automobile Route Proposed from Juarez to Mexico	684	Door Lock Strike Plate Is Easily Adjustable.....	773
City.....	684	Dredge Clears River Channel and Also Builds Levees	749
Automobile Speedway Built under Difficulties.....	730	Drill and Marker, Small, for Garden Use.....	678
Automobile Springs Oiled in Effective Manner.....	742	Electrical Shock, Fatal, from Peculiar Cause.....	664
Automobile Supporting Jacks Add to Life of Tires.	743	Exposition, Brazilian International, Opened at Rio	
Automobile Tank, Auxiliary, Used as Footrest.....	738	de Janeiro.....	668
Automobile—Taxicab, De-Luxe, Fitted Up like Parlor	712	Eye-glasses, Color and Shape, to Match Hairdress.	658
Car.....	710	Fire Car, Proving Ground, Has Complete Outfit....	700
Automobile Tire Filler, Fool Proof, Prevents Accidents	714	Fire Escapes and Balcony Attractively Combined...	664
Automobile Trailer for Tourists Makes Camping Easy	725	Firemen, Central Station Drills to Train.....	658
Automobile Trip, 6,000 Mile, across Empty Continent	725	Flood Control, Rio Grande, Texas Plans.....	707
Automobiles Hoisted in Air for Underside Repairs..	725	Flower Display Holder Fits Any Size Pot.....	730
Automobiles, Hot Water Now Heats.....	672	Forest Service, "Recreation Engineer" Added to...	663
Band without Instruments in Student Parade.....	708	Fountain Pen and Refillable Pencil Combined.....	765
Banjo Bridge, Adjustable, and Clothing Guard.....	691	Furnaces, Electric, Copper Pipes as Conductors for...	668
Banjo Heads, Bracketless, Adjusted with One Key...	720	Fuse, New, Prevents Polyphase Motor from Single	
Banjo Strings, Peg-Hor, and Other Instruments.....	722	Phasing.....	772
Barrel, Mammoth, as Refreshment Stand.....	722	Gas Booster, New, Advantageous to Large Plants...	755
Eathing Beach, Philadelphia's Public, Is Largest in	750	Gauge, Depth, Adaptable for Various Liquids.....	762
Country.....	721	Gliders and Soaring Flight, by R. C. Folger.....	679
Bathing Suit, Nonsinkable, for Timid Swimmers...	775	Gulls Drop Clams on Roofs to Open Them.....	691
Bathroom Seat, Convenient, Folds into Wall.....	744	Hav. Electric Blower Fan Used to Cure.....	728
Bible, Rare Copy of, Donated to American Library..	695	Highways, Motor, Honduras Now Building.....	663
Bicycle, Odd Appearing, Man Makes to Carry Family	739	Hose Roller Clamp, Garden, Replaces Clumsy Reel..	736
Binder, New Grain, Cuts 35 Acres per Day.....	695	Household Devices.....	770
Biplane, Six Passenger, First American-Made.....	709	Ice, Purest, Manufactured Economically.....	775
Boat Race, Pacific Fleet, Closely Run.....	726	Incinerators, Perambulating, in California Vineyards.	708
Boats, Various Models of, Used by South Sea	772	Iron Ore, Low Grade, Reclaiming, by Earl Christmas	
Islanders.....	722	"Kapok" Fiber, Textile Industry Trying to Spin....	752
Boiler Feed Water Purifier Reduces Scale Troubles..	722	Lenses, Instrument Measures, by Light Waves.....	700
Boiler Scale, Carbon Dioxide Softens.....	686	Lock Mortiser, Portable, Used on Door Jambs....	747
Bridge, New Columbia River, Eliminates Last Ferry	732	Locomotive, How Far can It Jump.....	674
on Yellowstone Trail.....	753	Log Rolling—New "King of the White Water"....	657
Bridge, Reinforcement for, Assembled on Barges....	686	Loom Shuttle, Blasts of Compressed Air Replace....	677
Buildings, Adobe, Long in Ruins, Remodeled.....	710	Lumber Barge Wrecked by Storm Strews Cargo on	
Cable, Damaged Transmission, Spectacular Repair	732	Beach.....	732
Task of.....	783	Mail Pouch, Small, for Sending Souvenir Cards...	775
Camp and Recreation Sites Given State of Michigan.	704	Mallet, Rubber, for Auto Use Saves Tires and Rims..	717
		Man, World's Largest, Takes Airplane Spin.....	820

[Continued on Page 4]

This One



P95A-S68-ZFQ5 ghted material

DRAKE'S PRACTICAL MECHANICAL BOOKS

THEY WILL RAISE YOUR PAY— ORDER ON 5-DAY TRIAL

The books listed below will perfect you in your chosen trade — pave the way to the big positions. Written in non-technical language—easy to read and understand. **Every book covers its subject completely. An entire course of instruction condensed into one volume.** Your choice sent postpaid — you benefit 5 days — money refunded in full if not entirely satisfactory. Order direct from this page.



Automobile Books

- Automobile Ignition, by ManlyLeatherette \$2.00
 Automobile Starting and Lighting, by Manly.....Leatherette \$2.00
 Brookes' Automobile Handbook.....Leatherette \$2.00
 Ford Motor Car, Truck and Tractor, by Manly.....Cloth \$1.50
 Starting and Lighting Troubles, Remedies and Repairs, by ManlyLeatherette \$3.00
 Automobile Battery, Care and Repair, by Manly.....Leatherette \$2.00
 Automobile Catechism and Repair Manual.....Leatherette \$1.50
 Tires and Vulcanizing, by TuffordCloth \$2.00
 Gas and Oil Engine Handbook.....Cloth \$1.50
 Automobile Upkeep and Care, by Manly.....Cloth \$1.50
 Motorcycle Handbook, by ManlyCloth \$1.50

Shop Practice Books

- Sheet Metal Workers' Manual.....Leatherette \$2.00
 Oxy-Acetylene Welding and Cutting.....Leatherette \$1.75
 Sound WeldsCloth \$2.00
 Slide Rule and Logarithmic TablesLeatherette \$2.00

- Handbook for Millwrights.....Cloth \$2.00
 Modern Blacksmithing.....Cloth \$1.25
 Machine Shop Practice.....Cloth \$2.00
 Mechanical Drawing and Machine DesignCloth \$2.00
 Pattern Making.....Cloth \$1.50

Carpentry Books

- Cloth Binding
 Modern Carpentry, 2 vols.....\$3.00
 The Steel Square, 2 vols.....\$3.00
 Wooden Boat and Shipbuilding.....\$1.50
 Modern Estimator\$1.50
 Timber Framing\$2.00
 Builder's Architectural Drawing.....\$2.00
 Concrete\$1.50
 Practical Bungalows\$1.00
 Low Cost Homes.....\$1.00
 Roof Framing\$1.50
 Stair Building and Hand Railing\$1.50

Electrical Books

- Practical Applied Electricity.....\$2.00
 Alternating Current\$1.50
 Electric Motor Control Systems.....\$1.50
 Wiring Diagrams and Descriptions\$1.50
 Electrical Tables and Data.....\$1.50
 Armature and Magnet Winding.....\$1.50
 Modern Electrical Construction.....\$1.50
 Modern Electric Illumination.....\$1.50
 Electricians' Operating and Testing\$1.50
 Motion Picture Operation.....\$1.50
 Drake's Electrical Dictionary.....\$1.50
 Electric Motors, D. & A.....\$1.50
 Electrical Measurements and Meter Testing\$1.50
 Drake's Telephone Handbook.....\$1.50
 Modern American Telephony.....\$2.00
 Easy Electrical Experiments.....Cloth \$1.25
 Wireless Telegraph and Telephone Handbook.....Cloth \$1.25
 Telegraphy Self-Taught.....Cloth \$1.25

Steam Engineering

- Swingle's Handbook for Steam Engineers and Electricians.....Leatherette \$4.00
 Examination Questions and Answers for Marine and Stationary Engineers.....Leatherette \$2.00

- Steam Boilers.....Leatherette \$2.00
 Swingle's Catechism of Steam, Gas and Electrical EngineeringLeatherette \$1.50

Painting Books

- Scene Painting and Bulletin ArtCloth \$4.00
 A Show at Sho' Cards.....Cloth \$4.00
 Sign PaintingCloth \$4.00
 Strong's Book of Designs.....Leatherette \$4.00
 Strong's Art of Show Card WritingCloth \$4.00
 Signist's Alphabets.....Cloth \$1.50
 Modern Painter's Cyclopaedia.....Cloth \$2.00
 Automobile Painting.....Cloth \$1.50
 Estimates, Costs and Profits, Painting and Decorating.....Cloth \$1.50
 New Hardwood Finishing.....Cloth \$1.50
 The Amateur Artist.....Cloth \$1.50
 New StencilsCloth \$1.25

Farm Books

- Farm Mechanics.....Cloth \$1.25
 Farm Buildings.....Cloth \$1.25
 Farm Engines.....Cloth \$1.25
 Traction Farming.....Cloth \$1.50

Business and Reference Books

- Better Business Letters.....Leatherette \$1.50
 Better Business English.....Leatherette \$1.50
 Better Advertising.....Leatherette \$1.50
 Finger Prints Simplified.....Cloth \$2.00
 Practical Bricklaying.....Cloth \$1.25
 Practical Instruction for DetectivesCloth \$1.00
 Practical PlumbingCloth \$1.50
 Hot Water Heating.....Cloth \$1.50
 Elementary Chemistry.....Cloth \$1.50
 Courses in Civil Service.....Cloth \$1.50
 Cyclopaedia of Recipes.....Cloth \$1.50
 American Star Speaker.....Cloth \$1.50

Modern Languages

- By Prof. P. S. Allen, U. of Chicago
 French without a Teacher.....Cloth \$1.25
 Spanish without a Teacher.....Cloth \$1.25
 German without a Teacher.....Cloth \$1.25
 Everyday French.....\$1.25
 Everyday Spanish.....\$1.25

ORDER DIRECT FROM THIS PAGE—ON OUR MONEY-BACK PLAN

The books listed above are only a few of the many in our catalogue, which you will receive promptly after filling out and mailing us the attached coupon. For quick action order direct from this page—cross name of each book wanted and send in with price quoted. We prepay postage and send the books on our money-back plan.

FREDERICK J. DRAKE & CO.

PUBLISHERS

1008 Michigan Ave., Chicago

Drake Books Are For Sale at All Book Stores

Mail Coupon For Free Catalogue
Your Guide to Home Study

FREDERICK J. DRAKE & CO.
1008 Michigan Avenue
Chicago, Ill.

GENTLEMEN:—Please send me free, postage paid, your illustrated catalogue which lists and describes over 100 Practical Mechanical Books for Home Study.

My name is

and my address



Agents

**"Ye Gods,
—some seller!
I made \$215 to-day"**
—writes Bentley

The Oliver Oil-Gas Burner

does away with coal and wood. Burns 95% air—5% oil. Turns any range, furnace or stove into a gas stove. 16 different models. Burns kerosene (coal oil). Gives much or little heat by simply turning valve. Think of the appeal you can make in every community. Solves fuel problem. Cheaper than coal, wood or gas—a absolutely safe. Does away with drudgery—no fires to make, no ashes, dirt, smoke, chopping, carrying coal and wood. Easy to install. Doesn't change stove. Protects health. Easy to demonstrate—slips in or out of stove in one minute. Show any woman what it will do right in her own home and sale is made. Big demand all year. Let the fuel shortage make you big money.

Big profit. Some Oliver agents earn as high as \$1000 per month. \$21 a day is easy.

Free Sample Case Offer
and book "New Kind of Heat"
Write for them now.

Oliver Oil-Gas Burner & Machine Co.
Oldest, largest Manufacturers Oil-Gas Burners in the world.
2048-W Oliver Building,
ST. LOUIS, MO.

Read what these Oliver agents say:

\$660 a month
"Have averaged \$660 profit a month for last six months."
A. M. Russell, Conn.

\$1000 in 4 weeks
"Am making \$1000 per month. I have made big money before, but did not expect so much. Your Burner is just the thing."
J. Carnegie, S. Dak.

Buys car with profit
"Have earned enough in one month to buy me a new auto."
R. W. Knappen, Col.

Sells like beer in a dry town
"Am sending today for seven Oliver's. This is one day's orders (\$85 profit). Selling like beer in a dry town."
W. H. Drew, Mich.

\$43 in one evening
I made \$43 last night.
N. B. Chelan, Wash.

Play in 8 Lessons

Prove It Yourself—FREE

Write at once for Free Sample Lesson—take it to your Piano and Play Three Melodies in 15 minutes. A Master Discovery makes it easy—Play Piano in 8 Lessons. Endorsed by World-famous Musicians and 50,000 Students. NOT numbers, chords or "by ear"—you Play a Waltz from Real Notes in First Lesson. Prove it yourself—Send for FREE Sample Lesson and Booklet—Now.

Give name, address, age—state if ever took lessons.

NAT. CONSERVATORY OF NUWAY MUSIC
209H Sharon Bld., San Francisco, Cal.

LEARN The BUSINESS of Advertising



QUICKLY BY MAIL

We guarantee to teach you. It's easy to learn—and easy to get into! Make the start *this week*. This free book tells how.

\$75 to \$100 a Week

—frequently paid beginners. There is no limit to opportunities which men and women trained in advertising meet on every hand.

FREE AD-WRITER'S COMPLETE WORKING OUTFIT

Wonderful outfit of working instruments gives free on special offer. Write for details before offer expires. We will also send you free and prepaid this stirring book on advertising. Tells you everything you want to know about getting into this fascinating field. Write today. Post-card will do.

PAGE-DAVIS SCHOOL, Dept. A23, Page Bldg., Chicago

[Contents—Continued from Page 4]

AMATEUR MECHANICS

Automobile Auxiliary Piping Prevents Overheating..	801
Automobile Auxiliary Seat for.....	808
Automobile Axle, Bent, Fixture for Straightening....	811
Automobile Engine, Device for Priming.....	817
Automobile Headlight Reflectors, Furnished, Restoring	816
Automobile, Pulling Out of Mud.....	802
Automobile Rims, Split, Spreader for.....	812
Automobile Trouble Lamp Used as Headlight.....	818
Barbed Wire, Fastening to Iron Posts.....	817
Beeswax, How to Bleach.....	803
Books, Leather Bound, Care of.....	810
Bookshelf Accessory, Handy.....	816
Brooder, Feather Dusters as, for Little Chicks.....	816
Brush Hook Made from An Old Saw.....	813
Catapult, Toy, How to Make.....	811
Coil Winding, Wheatstone Bridge for.....	812
Dice, Thought Transference with.....	808
Electric Lamp Holder, Handy.....	817
Eye-glass Spring, Broken, Repair for.....	801
Fish, How to Bake in Clay.....	804
Flash Papers, Varicolored, Making for Stage Effects.....	803
Golf Clubs, Identifying.....	817
Incinerator for Camp Site.....	809
Lamp, Reading, Made from Music Rack.....	809
Light Bowls, Keeping Insects from.....	803
Match Box Holder and Lighter.....	802
Motor Wheel Serves as Home Shop Power Plant.....	799
Pearls, Artificial, How to Make.....	808
Photography—Double Exposures, Cork Prevents.....	808
Photography—Negatives, Enlarged Photographic.....	818
Photography—Print Washer, Novel Photo.....	810
Rag Strips, Joining for Weaving.....	801
Reel, Cord, Two Handled.....	802
Saw Cut, Starting Smoothly.....	801
Sewing Kit Made from Cigar Box.....	809
Shoe Guard Prevents Soiling and Damage.....	817
Shooting Gallery for Toy Pistols.....	804
Spark Plug Points, Sharpening of, Improves Efficiency.....	805
Swing Stand Used for Hanging Clothing.....	804
Table, Dining, Made from Small Gate Leg Table....	808
Tricks, Card, Two Effective.....	812
Trousers Press, Simple.....	816
Windmill Controlled from the House.....	811
Wire Stretcher, Simple.....	804
Wireless Block for Using Multiple Phones.....	818
Wireless Crystals, Fusible Alloys for Setting.....	811
Wireless Loud Talkers, How to Make.....	805
Wireless Receiver, Simple, How to Build.....	814
Wrench, Socket, for Connecting Rods.....	808

DRESSMAKING Made Easy



Wonderful new method. You learn at home to make distinctive, becoming clothes for yourself and others for just the cost of materials—prepare for a position or have a shop of your own and earn \$25 to \$40 weekly. Thousands have learned. Write to-day for 64-page free booklet.

WOMAN'S INSTITUTE
Dept. 114-L, Scranton, Penna.

REMNANTS 66¢ A Yd.

Beautiful assortment of serges, Tricotines and silks at less than wholesale. Blouses, Wines, Gowns, etc. Remnants of 4 and 5 yard lengths sufficient to make suit or dress. **MONEY BACK IF NOT SATISFIED.** Save money. Make your own clothes. These remnants will save you up to \$1.50 a yard. **WRITE FOR INFORMATION.** **TEXTILE MILLS, DEPT. 601, KANSAS CITY, MO.**

Free Book—LAW

Send for this Free 128-Page Book

It tells how you can gain a thorough knowledge of law in your spare time, as 45,000 others are doing. Splendid opportunities in the profession of law. Business today needs law trained men. Free book gives experiences of successful law trained men, and tells how you can read law under guidance of Ex-President Taft and 50 other eminent authorities. Easy terms.



Blackstone Institute
Dept. 48, 4733 Grand Blvd., CHICAGO



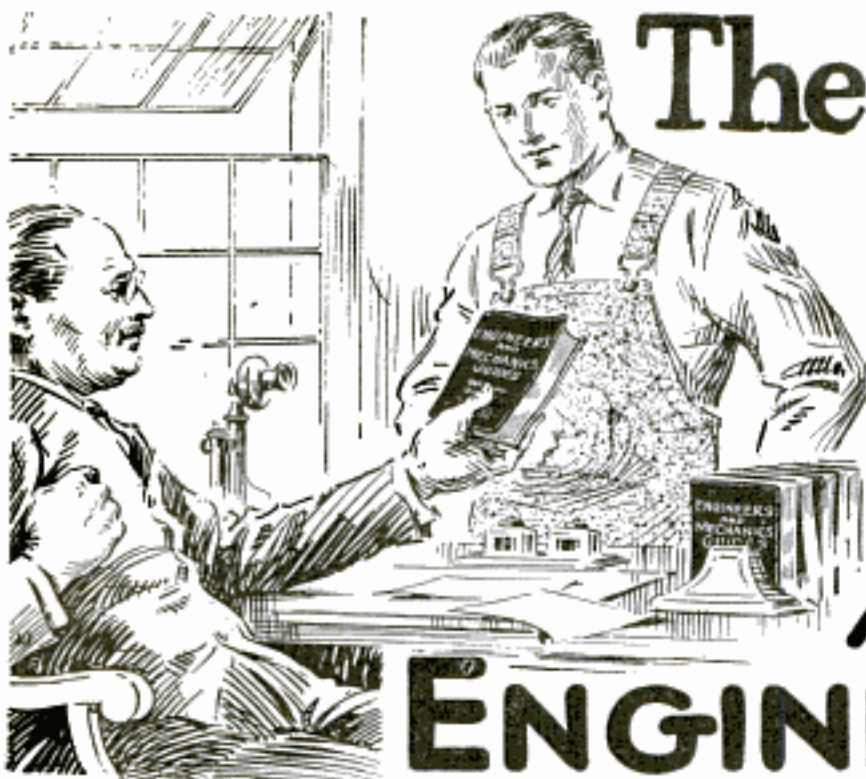

The CHIEF said—

"Tom, the way to **earn** more is to **learn** more. Audel's Engineers' Guide will help you. The biggest favor I can do you is to advise you to send for this Master Set. Remember—What you are tomorrow depends on what you think and do today."

AUDEL'S ENGINEERS and MECHANICS GUIDES

—the Master Set for the man on the job. Just completed. Contains latest practical information on every phase of Modern Engineering and Electrical Theory and Practice. Solves your problems. Answers your questions. Fits you for the **job higher up**. Points the way to better pay. Highly recommended by **Chief Engineers, Master Mechanics and Instructors**. Every engineer, mechanic and electrical worker that owns and uses this set will begin immediately to be a more valuable man.

"Gives fundamentals more clearly than any other set"—R. H. Wilson. "Should be in the house of every man on power house work"—Barney Meyer. "Gave me more common sense knowl-

edge than any other books"—Neil Crottean. "You certainly give a square deal; I'm delighted"—W. D. McGrew. "Congratulate you on such complete set at such low price"—W. H. Hailley.

THESE BOOKS TELL YOU ALL ABOUT—

Theory, Practice and Operation of ALL Steam Engines, Valve Motion—VALVE SETTING; complete information on ALL engines and pumps—CORLISS ENGINES and the Theory, Construction and Operation of all Steam Engines including UNIFLOW and POPPET VALVE ENGINES and LOCOMOTIVE MOBILES—Locomotive-Marine Engines; Turbines; Rotary Engines—the Indicator—Lubrication—PRACTICAL MANAGEMENT. How to use Indicator—GAS GASOLINE OIL, SEMI- and FULL DIESEL ENGINES—Aeroplane, and Aviation—HOW TO SELECT AN ENGINE, working instructions, drawings on STEAM ENGINE DESIGN including rules and formulas. Theory and Construction of ALL Steam Boilers; Heat-Combustion; Fuel and Flue Gas Analyser—CO₂ recorders—Characteristics

of Boilers—Materials—Construction of all types of Boilers. (THE LATEST PRACTICE.)—Boiler Construction—Mechanical Stokers—Oil Burners—Setting—Chimneys—Mechanical Drafts—HOW TO SELECT A BOILER—Complete instructions and drawings on BOILER DESIGN based on A. S. M. E. BOILER CODE—OPERATION, including Installation, FIRING; care and repair of Steam Boilers—Pipes, Fittings and Pipe Fitting—Heating and Ventilation—Refrigeration—Cooling Towers—Condensers—Distilling Apparatus—Elevators—Cranes and Hoisting Machinery—Ropes and Cables—Splicing, Special Features in Volume No. 8—A compendium of practical electrical engineering, an aid for engineers and electricians in obtaining a license—67 chapters—ready reference index, covering entire field of Modern Electricity.

FREE EXAMINATION

We want these books to be their own salesmen! Look them over yourself free—without any obligation—just as if you borrowed them from a library or a friend. If you like them send us \$1—and then \$1 a month. If you don't like them send them back. Each book is pocket size, gilt edged, clearly printed on light weight paper with flexible binding.

POCKET SIZE 4750 PAGES 8754 ILLUSTRATIONS FLEXIBLE

\$1 Per Month



\$12 Complete

THEO. AUDEL & CO., 72 Fifth Ave., New York City
 Please send me for free examination, AUDEL'S MASTER SET FOR ENGINEERS AND MECHANICS. I will pay you \$1 per month for the books, plus postage. If satisfactory, I agree to send you \$1 per month when they are delivered.
 Name _____
 Home Address _____
 Employed by _____
 Occupation _____
 Reference _____
 P. M. Nov. 22, 1914



A Big Raise in Salary!

Is Very Easy to Get, If You Go About It in the Right Way

You have often heard of others who have doubled and trebled their salaries in a year's time. You wondered how they did it. Was it a pull? Don't you think it. When a man is hired he gets paid for exactly what he does, there is no sentiment in business. It's preparing for the future and knowing what to do at the right time that doubles and trebles salaries.

Remember When You Were a Kid

and tried to ride a bike for the very first time? You thought that you would never learn and then—all of a sudden you knew how, and said in surprise: "Why it's a cinch if you know how." It's that way with most things, and getting a job with big money is no exception to the rule, if you know how.

We Will Show You How

Without loss to you of a single working hour we can show you a sure way to success and big pay. A large number of men in each of the positions listed are enjoying their salaries because of our help—we want to help you.

Make check on the coupon against the job you want and we will help you to get it. Write or print your name on the coupon and send it in today.

American School

Dept. G. 874, Drexel Ave. and 58th St., Chicago

American School, Dept. G. 874, Drexel Ave., and 58th St., Chicago

Send me full information on the subject checked and how you will help me win success.

.....Architect
Building Contractor
Automobile Engineer
Automobile Repairman
Civil Engineer
Structural Engineer
Business Manager
Cert. Public Accountant
Accountant and Auditor
Bookkeeper
Draftsman and Designer

.....Electrical Engineer
Electric Light and Power
General Education
Vocational Guidance
Business Law
Lawyer
Machine Shop Practice
Photoplay Writer
Mechanical Engineer
Shop Superintendent
Employment Manager

.....Steam Engineer
Foremanship
Sanitary Engineer
Surveyor (& Mapping)
Telephone Engineer
Telegraph Engineer
High School Graduate
Fire Insurance Expert
Wireless Radio
Undecided

Name..... Address.....



Stop Wondering How I Teach Piano; I'll Show You, FREE



YEAR after year you've seen my advertisement in all the leading publications, offering to teach you piano in *quarter* the usual time. Year after year my school has grown and grown until now I have far more students than were ever before taught by one man. In 1921 over a thousand students *graduated* from my Piano or Organ course and received their diplomas.

Yet when I first started giving piano and organ lessons by mail in 1891 my method was laughed at. Could any conservatory have grown as it has, obtained students in every state of the Union and in fact practically every civilized country of the world unless it produced very unusual and satisfying RESULTS for its students? See for yourself what it is that has brought my method so rapidly to the front. Write for free booklet and sample lessons.

Now, for the first time, you can obtain sample lessons without charge. In the past I have always been opposed to sending out free lessons, even to persons who were seriously interested in my course. But my friends have insisted that I give everybody a chance to see for themselves just how simple, interesting and DIFFERENT my lessons are, and I have consented to try the experiment for a short time. Simply mail the coupon below or write a postcard, and the 64-page booklet and sample lessons will go to you at once absolutely free and without obligation.

Within four lessons you will play an interesting piece on the piano or organ, not only in the original key, but in all other keys as well. Most students practice months before they acquire this ability. It is made possible by my patented invention the Colorotone. Another invention obtainable only from me is my hand-operated moving picture device, Quinn-dex. By means of Quinn-dex you actually see my fingers in motion on the piano, and can learn just how to train your own fingers.

When I say that I can teach you piano in *quarter* the usual time, do not think that this is too good to be true. Modern inventions and improved methods have accomplished just as great wonders in other branches of education. You at least owe it to yourself to *investigate*. Send coupon or postcard at once, before the offer of free sample lessons is withdrawn.

Quinn
Conservatory,
Studio PM 51,
598 Columbia Road,
Boston 25, Mass.

Please send me, without cost or obligation your free booklet, "How to Learn Piano or Organ," free sample lessons, and full particulars of your method.

Name.....

Address.....

NAVIGATION

Taught
by
mail
in a few
weeks

Join America's Mighty Merchant Fleet

America has suddenly become a great maritime nation. The American flag has been unfurled on nearly 30,000,000 gross tons of merchant ships. This tonnage is increasing by millions every year. Now is your chance to "shove off," to get ready to see the world as a ship's officer. The seas now afford permanent opportunities that have never before been presented to ambitious men who are willing to study navigation. The free coupon below brings to you a very valuable illustrated booklet telling just how much a knowledge of navigation means to you.

THERE IS BIG PAY AND ROMANCE ON THE SEVEN SEAS

American ships now go to every nook and corner of the seven seas—India, Africa, Asia, China, Japan, Italy, Europe, South America, Australia, New Zealand, and every other imaginable port.

Immediately upon the completion of Captain Sheppard's Course on Ocean and Coast Navigation, it was adopted by the U. S. Navy Educational System, which, in our estimation, stamps it as being the only 100% extension course on navigation ever constructed. Enrollments are coming in like wildfire from men all over the world, men who haven't the time and money to attend a resident nautical school.



CAPTAIN WARREN SHEPPARD
Author of Course on Ocean and Coast Navigation, and Chief Instructor. Formerly instructor for the U. S. Shipping Board, appointed by the Dean of the Massachusetts Institute of Technology. Every one of his students became officers. Not one failed.

Easy Terms



CAPTAIN THOMAS FLEMING DAY

Chairman Advisory Board, World Technical Institute. Formerly editor of *Rudder*, the great yachting magazine. The first man to cross the Atlantic in a 30-foot dory. Originator of Bermuda yacht races.

If you can read and write, Captain Sheppard and Captain Day can teach you all there is to know about navigation in 24 weeks, during your spare time.

EVIDENCE THAT COUNTS—

Dear Captain Sheppard:—When I enrolled for your Course I knew nothing of navigation. Before I had half finished the Course I passed the Steamboat Inspectors' Examination in Boston. A few days later your letter of recommendation enabled me to get on the Steamer *Castle Point* as third mate. I am sailing tomorrow for China.

Yours truly,
R. P. GRUBAUGH.

Endorsed by Naval and Shipping Authorities in All Parts of World, Including:—

Admiral Albert Gleaves, Captain Russell Patterson, U. S. Shipping Board; Commander C. C. Soule, Annapolis; Commander E. F. Eckhardt, Washington State Nautical School; Superintendent Chas. H. Brown, Royal Technical College, Glasgow, Scotland; Garrett P. Service, world famous astronomer; officers of the U. S. Steamboat Inspection Service throughout the country—and by thousands of officers and students in the merchant marine and navy.

WORLD TECHNICAL INSTITUTE
Fuller Building Jersey City, N. J.

FREE EMPLOYMENT SERVICE

We help students procure positions on coast, ocean and lake vessels. We have never yet failed to place any student who has applied to us.



Typical officers' quarters on board an American merchantman. Big pay, the finest of accommodations, expenses paid, and the world as a class room.

This is the one great opportunity of your life. Do you realize it? Don't waste another day of valuable time. Fill out this coupon and mail to us at once. We will immediately send you one of the most interesting illustrated booklets ever published. It contains every detail about a most remarkable course on navigation. It contains an enrollment blank which will enable you to begin your training at once for ship's officer.

World Technical Institute,

Fuller Building, Jersey City, N. J.

Send by return mail free booklet, entitled, "Your Future Is on the Seven Seas," which gives every particular about Captain Warren Sheppard's Course on Ocean and Coast Navigation.

Signature

Address

Present position..... PM 11-22

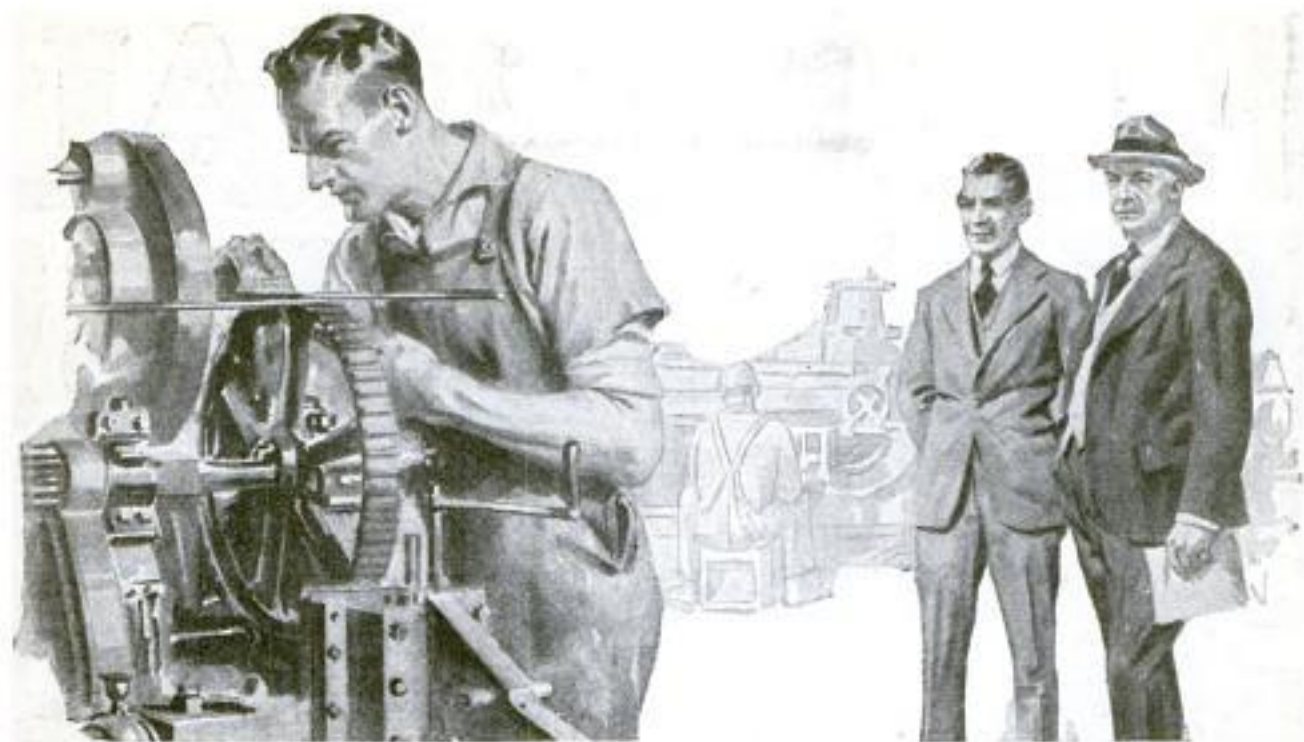

"He's Already Patented Four Inventions"

"**F**UNNY thing, too . . . When he first came here he was just an ordinary worker. For a time, when things were slack, I even thought that we might have to let him go.

"Then, gradually, I noticed an improvement in his work. He seemed to really understand what he was doing.

"One day he came into my office and said he had worked out a new arm for the automatic feeder. I was a little skeptical at first, but when he started explaining to me, I could see that he had really discovered something. And when I started questioning him, I was amazed. He certainly did know what he was talking about.

"So we sat down and talked for over an hour. Finally, I asked him where he had learned so much about his work. He smiled and took a little book from his pocket.

"There's no secret about it," he said. "The answer's right here. Four months ago I saw one of those advertisements of the International Correspondence Schools. I had been seeing them for years, but this time something inside of

me said, *Send in that coupon.* It was the best move I ever made—I knew it the minute I started my first lesson. Before, I had been working in a sort of mental fog—just an automatic part of the machine in front of me. But the I. C. S. taught me to really understand what I was doing."

"Well, that was just a start. Three times since he has come to me with improvements on our machines—improvements that are being adopted in other plants and on which he receives a royalty. He is certainly a splendid example of the practical value and thoroughness of I. C. S. training."

Every mail brings letters from students of the I. C. S. telling of advancements and larger salaries won through spare-time study. There's still a chance for you, if you will only make the start.

Just fill out and mail the coupon printed below and, without cost or obligation, get the full story of what the I. C. S. can do for you. To-day—not To-morrow—is the day to take that first definite step toward Success.

These inventors and many others once studied with the I. C. S.

JESSE G. VINCENT

Vice-president of Packard Motor Car Co., inventor of the Packard Twin-Six and co-inventor of the Liberty Motor.

JOHN C. WAHL

First vice-president of The Wahl Co., inventor of the Wahl Adding Machine, the Eversharp Pencil and the Wahl Fountain Pen.

W. J. LILLY

Inventor of the Lilly Mine Hoist Controller.

H. E. DOERR

Chief Mechanical Engineer, Scullin Steel Co., St. Louis.

— TEAR OUT HERE —

INTERNATIONAL CORRESPONDENCE SCHOOLS, BOX 5678-C, SCRANTON, PA.

Without cost or obligation on my part, please tell me how I can qualify for the position or in the subject before which I have marked an X in the list below:—

- | | | | |
|---|---|---|---|
| <input type="checkbox"/> Automobile Work | <input type="checkbox"/> Civil Engineer | <input type="checkbox"/> Business Management | <input type="checkbox"/> Salesmanship |
| <input type="checkbox"/> Gas Engine Operating | <input type="checkbox"/> Surveying and Mapping | <input type="checkbox"/> Industrial Management | <input type="checkbox"/> Advertising |
| <input type="checkbox"/> Airplane Engines | <input type="checkbox"/> Mine Foreman or Engineer | <input type="checkbox"/> Traffic Management | <input type="checkbox"/> Stenography and Typing |
| <input type="checkbox"/> Radio | <input type="checkbox"/> Marine Engineer | <input type="checkbox"/> Business Law | <input type="checkbox"/> Teacher |
| <input type="checkbox"/> Electrical Engineering | <input type="checkbox"/> Architect | <input type="checkbox"/> Banking and Banking Law | <input type="checkbox"/> Civil Service |
| <input type="checkbox"/> Electric Lighting | <input type="checkbox"/> Contractor and Builder | <input type="checkbox"/> Accountancy (including C.P.A.) | <input type="checkbox"/> Railway Mail Clerk |
| <input type="checkbox"/> Mechanical Engineer | <input type="checkbox"/> Architectural Draftsman | <input type="checkbox"/> Nicholson Cost Accounting | <input type="checkbox"/> Common School Subjects |
| <input type="checkbox"/> Mechanical Draftsman | <input type="checkbox"/> Structural Engineer | <input type="checkbox"/> Bookkeeping | <input type="checkbox"/> High School Subjects |
| <input type="checkbox"/> Machine Shop Practice | <input type="checkbox"/> Chemistry | <input type="checkbox"/> Business English | <input type="checkbox"/> Illustrating |
| <input type="checkbox"/> Railroad Positions | <input type="checkbox"/> Pharmacy | <input type="checkbox"/> Business Spanish | <input type="checkbox"/> French |

Name..... Street Address.....

City..... State..... Occupation.....

Persons residing in Canada should send this coupon to the International Correspondence Schools Canadian, Limited, Montreal, Canada.

ELECTRICAL WORKERS!

HAWKINS ELECTRICAL GUIDES

START YOU ON THE UP-GRADE

Invest spare time in study NOW! Draw out dividends in dollars LATER. The way to EARN more is to LEARN more. HAWKINS ELECTRICAL GUIDES lift you to the job higher up. Hundreds of Chief Electricians, Chief Engineers, Foremen and Managers write us that they owe their jobs to the GUIDES. Just your name and address on the coupon below! No money until you are satisfied. Get out your pencil or borrow one, Mr. Electrical Worker! Take this most important step of your career this minute!

Take the
FIRST
Step
NOW!

"I must compliment you on the thoroughness and the simplicity of the Guides"—Geo. M. Rowe. "They are so plain that one can practically learn the electrical game from the Guides alone"—L. R. Burton. "Worth \$10 down and \$10 a month"—James B.

Streart. "They were the cause of a 100% increase in my salary"—A. W. Thompson. "They cover every possible subject in electrical engineering"—R. T. Van Dewoort. "Much better than a correspondence course I have been studying"—C. A. Harrington.

These books tell you all about—

Magnetism—Induction—Experiments—Dynamos—Electric Machinery—Motors—Armatures—Armature Windings—Installing of Dynamos—Electrical Instrument Testing—Practical Management of Dynamos and Motors—Distribution Systems—Wiring—Wiring Diagrams—Sign Flashers—Storage Batteries—Principles of Alternating Currents and Alternators—Alternating Current Motors—Transformers—Converters—Rectifiers—Alternating Current Systems—Circuit Breakers—Measuring Instruments—Switch Boards—Wiring—Power Stations—Installing—Telephone—Telegraph—Wireless—Bells—Lighting—Railways. Also many Modern Practical Applications of Electricity and Ready Reference Index

FREE EXAMINATION

Not a cent to pay until you see the books. No obligation to buy unless you are satisfied. Send Coupon now—today—and get this great help library and see if it is not worth \$100 to you—pay \$1.00 a month for ten months or return it.

SEND ONLY THIS COUPON—LOOK THIS ENTIRE SET OVER FREE!

THEO. AUDEL & CO., 72 Fifth Ave., N. Y.

Please submit for examination **Hawkins Electrical Guides** (Price \$1.00 each). Ship at once, prepaid, the 10 numbers. If satisfactory, I agree to send you \$1 within seven days and to further mail you \$1 each month until paid.

Signature

Occupation

Employed by

Residence

Reference

PM-Nov. 22

\$1 PER. MO. ENTIRE SET \$10. COMPLETE

**Flexible Covers—Pocket Size
4700 PICTURES—3500 PAGES**



HOME-STUDY COURSES

THAT LEAD TO BUSINESS CAREERS

**More Than
50,000
Enroll
Annually—
Why?**

LaSalle training means specialized business education of University grade.

LaSalle training has directly helped many thousands of ambitious men to worth-while advancement the world over.

LaSalle trained men can be found in responsible positions with every large corporation and business firm in America.

The LaSalle "Problem Method" of home study has proved itself to be the speediest and most practical plan of business training known to educational science. What LaSalle training has done for men in all walks of business life is proof of what it can do for you. Find out about it today.

350,000 Enrolled · Resources \$7,500,000

LaSalle Extension University

The Largest Business Training Institution in the World

INQUIRY COUPON

LASALLE EXTENSION UNIVERSITY Dept. 1164-R CHICAGO, ILL.

Please send me catalog and full information regarding the course and service I have marked with an X below. Also a copy of your booklet, "Ten Years' Promotion in One," all without obligation to me.

- | | | |
|---|---|--|
| <input type="checkbox"/> BUSINESS MANAGEMENT: Training for Official, Managerial, Sales and Executive positions. | <input type="checkbox"/> HIGHER ACCOUNTANCY: Training for positions as Auditor, Comptroller, Certified Public Accountant, Cost Accountant, etc. | <input type="checkbox"/> RAILWAY ACCOUNTING AND STATION MANAGEMENT: Training for Railway Auditors, Comptrollers, Accountants, Clerks, Station Agents, Members of Railway and Public Utilities Commissions, etc. |
| <input type="checkbox"/> SALESMANSHIP—PRINCIPLES AND PRACTICE: Training for Sales and Advertising Executives, Solicitors, Sales Promotion Managers, Salesmen, Manufacturers' Agents and all those engaged in retail, wholesale or specialty selling. | <input type="checkbox"/> TRAFFIC MANAGEMENT—FOREIGN AND DOMESTIC: Training for positions as Railroad or Industrial Traffic Manager, etc. | <input type="checkbox"/> PERSONNEL and EMPLOYMENT MANAGEMENT: Training for Employers, Employment Managers, Executives, Industrial Engineers. |
| <input type="checkbox"/> LAW: Training for Bar; LL. B. Degree. | <input type="checkbox"/> INDUSTRIAL MANAGEMENT EFFICIENCY: For Executives, Managers, Office and Shop Employees and those desiring practical training in industrial management principles and practice. | <input type="checkbox"/> BANKING AND FINANCE |
| <input type="checkbox"/> COMMERCIAL LAW: Reading, Reference and Consultation Service for Business Men. | <input type="checkbox"/> MODERN FOREMANSHIP and PRODUCTION METHODS: Training in the direction and handling of industrial forces—for Executives, Managers, Superintendents, Contractors, Foremen, Sub-foremen, etc. | <input type="checkbox"/> EXPERT BOOKKEEPING |
| <input type="checkbox"/> MODERN BUSINESS CORRESPONDENCE and PRACTICE: Training for Sales and Collection Correspondents; Sales Promotion Managers; Credit and Office Managers; Correspondence Supervisors; Secretaries, etc. | | <input type="checkbox"/> BUSINESS ENGLISH |
| | | <input type="checkbox"/> COMMERCIAL SPANISH |
| | | <input type="checkbox"/> EFFECTIVE SPEAKING |
| | | <input type="checkbox"/> C. P. A. COACHING FOR ADVANCED ACCOUNTANTS |

Name..... Present Position.....

Address.....

PLAY MUSIC ON A SAW

FREE

A special tempered Musical Saw, Saw Bow, Soft Hammer are furnished free with Course of Instruction. This Course is short, simple and easy. Only three lessons, one each week—no monotonous finger exercises or months of tedious practice.

C. J. MUSSEHL
315 Mack Bldg. Fort Atkinson, Wis.

YOU can produce wonderful, soft, sweet music from a common carpenter's saw with a violin bow or soft hammer, if you know how. No musical ability required—you need not know one note from another.

Easy to Learn I absolutely guarantee to teach you to play popular and classical music within 3 weeks' time. I will give you my secrets and tricks that I have learned in my ten years' success as a saw musician, secrets which I guarded carefully until I introduced "The Musical Saw." I have successfully instructed thousands and have organized hundreds of "Sawing Trios & Quartettes" for Lodges, Clubs and Legion Posts. No charge whatsoever if I fail.

MAKE BIG MONEY and amaze your friends playing for dances, Club, Lodge and Church Entertainments. Write today for complete information "How to Play a Saw"—sent free.



PROF. HENRY DICKSON
foremost authority on Mental Training, Psycho-Analysis and principal Dickson Memory School

secrets that took me a lifetime to unveil; you develop hidden powers hitherto unknown to you, increase your influence, change your whole life! You learn what types of persons you should cultivate as friends, and what types to avoid; you learn what type to marry for a successful, happy marriage and perfect mating. Be master of your destiny instead of its victim. Decide for yourself your position and earning power.

SEND NO MONEY

After five days you may return the course to me, or remit only \$2.00, which pays for the Course **IN FULL**, including my **CORRECTION OF YOUR WORK**, and a **COMPLETE PSYCHO-ANALYSIS OF YOURSELF**, which you can compare with your own self-analysis as shown by the self-measuring Chart. Not a penny to send. Just your request brings these lessons for the 5 days' free reading. Send now!

PROF. HENRY DICKSON
1041-K Chicago Ave. Evanston, Ill.

ARE YOU IN THE RIGHT JOB?

Psycho-Analyze Yourself. My self-measuring Chart shows you how. A postcard brings you my new Course in **Psycho-Analysis and Character Reading** lavishly illustrated with Photographs, complete with charts and diagrams for five days' free examination. **KNOW YOURSELF! BE MASTER OF YOUR DESTINY**

Are you in the right job? Getting all you are capable of earning? Overcoming failure?

Are you overcome by circumstances, or, like Napoleon, do you make circumstances? Through my Psycho-Analysis you learn

secrets that took me a lifetime to unveil; you develop hidden powers hitherto unknown to you, increase your influence, change your whole life! You learn what types of persons you should cultivate as friends, and what types to avoid; you learn what type to marry for a successful, happy marriage and perfect mating. Be master of your destiny instead of its victim. Decide for yourself your position and earning power.

SEND NO MONEY

After five days you may return the course to me, or remit only \$2.00, which pays for the Course **IN FULL**, including my **CORRECTION OF YOUR WORK**, and a **COMPLETE PSYCHO-ANALYSIS OF YOURSELF**, which you can compare with your own self-analysis as shown by the self-measuring Chart. Not a penny to send. Just your request brings these lessons for the 5 days' free reading. Send now!

PROF. HENRY DICKSON
1041-K Chicago Ave. Evanston, Ill.



Learn Photography at HOME

Make \$75.00 a Week on the Side

Establish yourself as a Photographic Expert quickly—during your spare time—under a leading photographer. I'll show you how to start your own business—or command a large salary. Send for my unusual offer—it's only temporary. Act at once. A postal will do. **H. R. VANT.**
INTERNATIONAL STUDIOS, Inc.
Dept. 1199, 3601 Mich. Ave., Chicago, U.S.A.



STAMMER NO MORE

Kill the fear of stammering. Re-education the key. The widely famed Hatfield Method fully outlined in an accurate, dependable, worthwhile book—"HOW TO STOP STAMMERING." It has inspired thousands. Free copy today.

THE HATFIELD INSTITUTE, 109 N. Dearborn, Chicago, Ill.

FREE BOOK!

This illustrated, instructive book on how to select, train and feed your dog will be mailed you **FREE** with a 3 months' introductory subscription to America's most popular **DOG, HUNTING and FISHING** Magazine. Send 25c (stamps or coin) today.

SPORTSMAN'S DIGEST PUBL'G CO., 3548, Butler Bldg., Cincinnati, O.



FREE "Linene" COLLAR

For trial, a sample of our style Rubens, if you send 2 cents in U.S. stamps for postage and state size wanted.

Reverber Collar Co., Dept. U Boston, Mass.



"BECOME A LIGHTNING TRICK CARTOONIST"

MAKE MONEY CHALK TALKING. SEND \$1.00 FOR SNAPPY, ORIGINAL, TRICK DRAWINGS WITH INSTRUCTIONS BY A PROFESSIONAL CARTOONIST. SATISFACTION GUARANTEED. CIRCULAR FREE. BALDA ART SERVICE, Q.L. OSHKOSH, WIS.

Whatever Your Question;—be it the pronunciation of Bolsheviki, the spelling of a puzzling word, the location of Murman Coast—the meaning of blighty, ace, tank, ukulele, etc., this Supreme Authority—

WEBSTER'S NEW INTERNATIONAL DICTIONARY

contains an accurate, final answer 400,000 Words, 2700 Pages, 6000 Illustrations.
Regular and India-Paper Editions. **G. & C. MERRIAM CO., Springfield, Mass.**
Write for specimen pages, prices, etc. and **FREE** Pocket Maps per Popular Mechanics



WANTED! Get \$1600 to \$2300 a Year

U.S. RAILWAY MAIL CLERKS

MEN--BOYS OVER 16 SHOULD MAIL COUPON IMMEDIATELY

Franklin Institute, Dept. J178, Rochester, N. Y.

Sirs: Send me, without charge, (1) sample Railway Mail Clerk Examination questions; (2) schedules showing places of coming U. S. Government examinations; (3) list of many Government jobs obtainable.

**STEADY WORK NO LAYOFFS
PAID VACATIONS**

Common Education Sufficient
Send Coupon Today--SURE

Name.....
Address.....



Get Expert Training in DRAFTING

Raise Your Income

Here is a great and highly paid profession open to you. **Learn Drafting now.** No matter where you live or what you are doing you can become a master-draftsman by spare time study at home. No previous experience necessary. If you can read and write you can become a high-salaried expert draftsman by Chicago Tech's quick and easy method. In twenty years we have trained thousands who are now top-notchers in the drafting business.

Construction Lines are Booming—Get Ready

Drafting is the very foundation of building and construction lines. The architectural, structural steel, mechanical and electrical industries are all calling for expert draftsmen. There is a boom coming in these lines—it's here now! This is a real opportunity which every ambitious man should grasp.

Let Us Send You this Big High Grade Drawing Outfit



We furnish this highest grade drawing outfit to our students in Drafting—no extra charge. Same tools in every particular that are used by high-salaried expert draftsmen.

Free Radio Course

Latest Up-to-the-minute Radio Course; just out. Tells how to build and operate your own set. We offer this big course FREE to our home-study students for limited time only.

Easy to Learn, Quick Results

By Chicago Tech's easy method you can learn Drafting quickly in your spare time right at home. Even though you cannot come and study Drafting in the day and evening classes of our big Chicago school, the same system of lessons used there with such pronounced success are sent to you. The same expert teachers guide you in your work at home.

Act Now. Mail the Coupon

Big jobs are waiting. We can train you to fill them. It takes only a little of your spare time. No experience or previous education required. Put your name on the coupon and get full information; it costs you nothing.

Building Experts Wanted

The Building Business is booming. Splendid opportunities are open. Big money will be made in the next five years by men in the building trades who know how to read plans, make estimates, superintend jobs, take contracts, etc.

Special Offer for Men in Building Trades

We have a special plan of great interest to Bricklayers, Carpenters, Plumbers, Plasterers, Foremen, Superintendents, Contractors and other men in building lines.

Send Coupon For Free Book and Blue Prints

Mark "X" in the second square of the coupon if you have had experience in any building trade. We will send you free and postpaid, a book of drawings and blue prints, also our big new book, "How to Read Blue Prints." Tell every builder you know to send for these books—they're free to men in the building trades.

Chicago Tech. College, 1130 Chicago Tech. Bldg., Chicago, Ill.

Without cost or obligation to me please send instructive matter about opportunities in line I have marked with "X".

- Drafting. (The Big Salary course)**
No experience necessary.
- Building Trade Course**
For men in the building lines.
- Surveying and Map Drafting.
- Automobiles, Gas Engines, Starting, Lighting, etc.
- Aeronautic Engineering.
All about aeroplanes.
- Plumbing, Heating and Ventilating.
Plan Reading, Estimating, etc.
- Steam Engineering.
For Stationary Engineers.
- Plan Reading for Shop Men.
For Machinists, Assemblymen, etc.

FREE Trial Lesson



While other schools ask you to enroll and send money first, we send the free lesson first. Read it, practice the exercises, and then decide for yourself whether to take the course or not.

Name.....

Address.....

Post Office..... State.....



"Another \$50 Raise!"

"Why, that's the third increase I've had in a year! It shows what special training will do for a man."

Every mail brings letters from some of the two million students of the International Correspondence Schools, telling of advancements won through spare-time study.

How much longer are you going to wait before taking the step that is bound to bring you more money? Isn't it better to start now than to wait for years and then realize what the delay has cost you?

One hour after supper each night spent with the I. C. S. in your own home will prepare you for the position you want in the work you like best.

Without cost, without obligation, mark and mail this coupon. Do it right now!

----- TEAR OUT HERE -----

INTERNATIONAL CORRESPONDENCE SCHOOLS
Box 5679-C, Scranton, Penna.

Without cost or obligation, please tell me how I can qualify for the position or in the subject before which I have marked an X:

BUSINESS TRAINING DEPARTMENT

- | | |
|---|---|
| <input type="checkbox"/> Business Management | <input type="checkbox"/> Salesmanship |
| <input type="checkbox"/> Industrial Management | <input type="checkbox"/> Advertising |
| <input type="checkbox"/> Personnel Organization | <input type="checkbox"/> Better Letters |
| <input type="checkbox"/> Traffic Management | <input type="checkbox"/> Foreign Trade |
| <input type="checkbox"/> Business Law | <input type="checkbox"/> Stenography and Typing |
| <input type="checkbox"/> Banking and Banking Law | <input type="checkbox"/> Business English |
| <input type="checkbox"/> Accountancy (including C.P.A.) | <input type="checkbox"/> Civil Service |
| <input type="checkbox"/> Nicholson Cost Accounting | <input type="checkbox"/> Railway Mail Clerk |
| <input type="checkbox"/> Bookkeeping | <input type="checkbox"/> Common School Subjects |
| <input type="checkbox"/> Private Secretary | <input type="checkbox"/> High School Subjects |
| <input type="checkbox"/> Business Spanish <input type="checkbox"/> French | <input type="checkbox"/> Illustrating <input type="checkbox"/> Cartooning |

TECHNICAL AND INDUSTRIAL DEPARTMENT

- | | |
|--|--|
| <input type="checkbox"/> Electrical Engineering | <input type="checkbox"/> Architect |
| <input type="checkbox"/> Electric Lighting | <input type="checkbox"/> Blue Print Reading |
| <input type="checkbox"/> Mechanical Engineer | <input type="checkbox"/> Contractor and Builder |
| <input type="checkbox"/> Mechanical Draftsman | <input type="checkbox"/> Architectural Draftsman |
| <input type="checkbox"/> Machine Shop Practice | <input type="checkbox"/> Concrete Builder |
| <input type="checkbox"/> Railroad Positions | <input type="checkbox"/> Structural Engineer |
| <input type="checkbox"/> Gas Engine Operating | <input type="checkbox"/> Plumbing and Heating |
| <input type="checkbox"/> Civil Engineer | <input type="checkbox"/> Chemistry <input type="checkbox"/> Pharmacy |
| <input type="checkbox"/> Surveying and Mapping | <input type="checkbox"/> Automobile Work |
| <input type="checkbox"/> Metallurgy | <input type="checkbox"/> Navigation |
| <input type="checkbox"/> Steam Engineering | <input type="checkbox"/> Agriculture and Poultry |
| <input type="checkbox"/> Radio <input type="checkbox"/> Airplane Engines | <input type="checkbox"/> Mathematics |

Name
Street
Address C-25-22

City State

Occupation

Persons residing in Canada should send this coupon to the International Correspondence Schools Canadian, Limited, Montreal, Canada.

Please Mention Popular Mechanics



New Simplified Method Of Learning Drawing

Amazing shortcut method now teaches you Illustrating, Cartooning, and designing in half usual time. You learn at home in spare time, yet your work receives the personal criticism of one of America's foremost Artists. No matter what your previous experience or education has been, this method qualifies you for the fascinating, high-salaried profession—Commercial Art.

FREE BOOK

Write today for our handsomely illustrated Free Booklet, which tells you how at the cost of but a few cents a day you can learn to draw pictures that bring you from \$50 to over \$500. Read about the big demand for Artists by Newspapers, Magazines, Department Stores, Advertising Agencies and Business Concerns—about the amazing success of our students. Special short time offer of Complete Artist's Outfit Free to new students. Write for Free Booklet and details of this offer. Mail card today. Address

Washington School of Art, Inc.
1912 Marden Bldg. Washington, D. C.

Can You Spell?

Then equip yourself by mail for a profession offering big pay and no lack of employment.

BECOME A PROOF-READER

Men and women of ambition should write today for free booklet to

THE MAWSON EDITORIAL SCHOOL, 12 Wadsworth St.
Cambridge, Massachusetts

BIG PROFITS FROM POULTRY

We Teach You How; Easily Learned at Home;

our guaranteed methods make success

certain; write for free book,

"How to Raise Poultry for

Profit," Free. Don't delay;

write today.

The National Poultry Institute, Inc., Dept. 312 L,
Washington, D. C.

MINSTRELS

Musical Comedies and Revues,

with full instructions for staging.

You can stage your own show with

our books. Full line of plays, music, cross-fire, monologues,

afterpieces, vaudeville acts and make-up. CATALOGUE FREE.

T. S. DENISON & CO., 623 So. Wabash, Dept. 19, Chicago

MOVING PICTURE MACHINE GIVEN

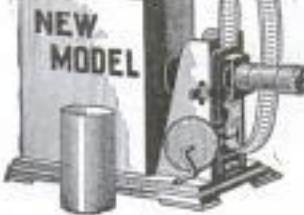

New Model Oil or Electric Moving Picture machine with non-inflammable film—ALL GIVEN for selling 28 pkgs. Bluine at 10c a pkg. Write for them. We send them postpaid. When sold return \$2.50 and we send machine, film and extra premium free of set of admission tickets, all charges prepaid.

Bluine Mfg. Co., 259 Mill St., Concord Jct., Mass.



An Amazingly Easy Way to Earn \$10,000 a Year

Let Me Show You How FREE

TO the average man the \$10,000-a-year job is only a dream. Yet today there are a surprising number of men earning five figure salaries who were merely dreaming of them a short while ago. The secret of their success should prove a startling revelation to every ambitious man who has ever aspired to get into the \$10,000-a-year class. There is nothing "different" about the man whose salary runs into five figures. He is made of the same stuff as you and I. For example, take J. P. Overstreet, of Dallas, Texas. A few short years ago he was a police officer earning less than \$1,000 a year. Today his earnings are in excess of \$1,000 a month—more than \$12,000 a year. C. W. Campbell, Greensburg, Pa., was formerly a railroad employe on a small salary—last month his earnings were \$1,562.

Why Don't YOU Get into the Selling Field?

Read These Amazing Stories of Success

Earned \$524 in Two Weeks

I had never earned more than \$50 a month. Last week I cleared \$200 and this week \$524. You have done wonders for me.—Geo. W. Kinross, Oklahoma City, Okla.

I Now Earn as High as \$100 a Day

I took your coupon two years ago. Was very busy with work. Am now a member of the largest firm in U.S. I have cleared over \$100 in a day. You opened up my position. One Sales Manager in a grade school years.—J. L. DeHone, Chicago, Ill.

Earns \$1562 in Thirty Days

My earnings for the past thirty days are \$1,562.00, and I was Second Prize in March, although I only worked two weeks during that month.—C. W. Campbell, Greensburg, Pa.

Earned \$1,800 in Six Weeks

My earnings for March were over \$1,000 and over \$1,800 for the last six weeks, while last week my earnings were \$2,500. I traveled eleven months out of the year, working 5 days a week.

The N. S. T. A. dug me out of a rut where I was earning less than \$1,000 a year and showed me how to make a success.—J. P. Overstreet, Dallas, Texas.

Mr. Overstreet, Mr. Campbell, and the others whose letters you see on this page are all successful salesmen. They have stepped into the \$10,000-a-year class—and they never sold goods before! It is hard to believe that such big success could come so quickly and easily. Yet it was all amazingly simple! Ask them the secret of their sudden success. They will tell you they owe it to the National Salesmen's Training Association. This is an organization of top-notch salesmen and sales managers formed expressly for the purpose of training men to sell and helping them to good selling positions. It has taken hundreds of men from all walks of life and

made them Master Salesmen—it has lifted them out of the rut and shown them the way to magnificent earnings, to fascinating careers and big selling positions.

We Train You and Help You Land a Job

What these men have done you can do! In your spare time at home you can easily master the secrets of selling that make Star Salesmen. Whatever your experience has been—whatever you may be doing now—whether or not you think you can sell—just answer this question: Are you ambitious to earn \$10,000 a year? Then send me your name quick! I will prove to you without cost or obligation that you can easily become a Star Salesman. I will show you how the Salesmanship Training and Free Employment Service of the N. S. T. A. will help you to wonderful success in selling.

Free Book on Salesmanship

Just mail the coupon or write for our great illustrated book, "Modern Salesmanship," which we will send you free. Let us prove to you that regardless of what you are doing now you can quickly become a Star Salesman. Let us show you how you, too, can step into the ranks of the big money makers of business. See how easily you can learn this fascinating, big pay profession at home in your spare time. Learn what we have done for others and what we stand ready to do for you. Don't put it off until tomorrow—write us today. Mail the coupon at once.

National Salesmen's Training Association
Dept. 12-S, Chicago, Ill., U. S. A.

National Salesmen's Training Association
Dept. 12-S, Chicago, Ill., U. S. A.

Please send me, without any obligation on my part, your free book, "Modern Salesmanship," and full information about the N. S. T. A. system of Salesmanship Training and Employment Service. Also a list showing lines of business with openings for salesmen.

Name.....
Street.....
City..... State.....
Age..... Occupation.....

\$80 Drafting

To every student enrolling now I give an opportunity of getting an \$80 drafting course absolutely without cost to him. So send in your sketch today and learn all about this offer.



Drawing Outfit Free!

To every student enrolling now I give an opportunity also of getting a regulation draftsmen's outfit made up of the very same instruments which I use myself. Every student gets this splendid set without cost. See illustration above.



Draftsman's Pocket Rule FREE! -To Everyone Sending the Sketch

To every man sending copy of sketch shown on next page I am going to mail free and prepaid the Draftsman's Ivory Pocket Rule shown here. This will come to you entirely with my compliments. With it I will send a 6x9 book on "Successful Draftsmanship." If you

are interested in becoming a draftsman, if you think you have or may attain drafting ability, sit down and copy the drawing on next page, mailing it to me today, writing your name and your address and your age plainly on the sheet of paper containing the drawing.

Read Next Page for Full Particulars 

Course FREE

Copy This Sketch

I AM anxious to find men with desire to become draftsmen. With business picking up everywhere many thousands of draftsmen will be needed at salaries ranging from \$3000 to \$3600 per year.

In asking you to copy this sketch I believe I will be able to tell from the sketch you send in what kind of an opportunity you will have in this great profession.

There are no conditions requiring you to buy anything. You are under no obligations in sending your sketch. What I want to know is how much you are interested in drawing and your sketch will tell me that.

Ambitious boys and men between the ages of 16 to 50 are wanted by big business concerns, and the man who is ready when opportunity calls him will get the best position and the highest pay.

Mail Your Drawing At Once
—and Get an *Ivory* **FREE!**
Pocket Rule Absolutely

Ambitious men interested in drafting, hurry! Don't wait! This is your opportunity to get into this great profession. Accept the offer which I am making now. Send in your sketch or request for FREE book and FREE Ivory Pocket Rule. Mail the coupon TODAY!



Copy this sketch

\$250 to \$300 per Month

I am Chief Draftsman of the Engineers' Equipment Co., and I know that there are thousands of ambitious men who would like to better themselves, make more money and secure faster advancement. Positions paying \$250 to \$300 per month, which ought to be filled by skilled draftsmen, are vacant everywhere. I want to find the men who with practical training and personal assistance will be qualified to fill these positions. No man can hope to share in the great coming prosperity in manufacturing and building unless he is properly trained and is able to do first class practical work.

I know that this is the time to get ready. This is why I am making the above offer. I can now take and train a limited number of students personally and I will give to those students a guarantee to give them by mail practical drawing room training until they are placed in a permanent position with a salary of \$250 to \$300 per month.

Send Coupon for Free Book

Send coupon for my free book, "Successful Draftsmanship". Also full information as to how you can get an \$80 Draftsman's Course Free. Even if you don't send in a sketch send the coupon for the free book.

Chief Draftsman, Engineers' Equipment Co.
4001 Broadway, Div. 1358 Chicago, Ill.

You should act promptly on this offer because it is my belief that even though you start now the great boom will be well on by the time you are ready to accept a position as a skilled draftsman. So write to me at once. Enclose sketch or not, as you choose, but find out about the opportunities ahead of you. Let me send you the book "Successful Draftsmanship" telling how you may take advantage of these opportunities by learning drafting at home.

I Guarantee

to train you until you are placed in a position paying \$250 to \$300 per month.

Chief Draftsman, Engineers' Equipment Co.
4001 Broadway, Div. 1358, Chicago, Ill.

Without any obligation to me please mail your book "Successful Draftsmanship" and full particulars of your liberal "Personal Direction" offer to a few students. Also full information as to how I can get an \$80 Drafting Course Free.

Name.....

Address.....

Age.....



"I'm Going to Make More Money!"

"I'm tired working for a small salary. I know I have just as good a head on me as Fred Moore and Bob Roberts, for we used to work side by side. But they've gone far ahead of me.

"Why? Because they saw the value of special training, and I didn't.

"But I know better now. If the International Correspondence Schools can raise the salaries of men like Fred Moore and Bob Roberts, they can raise mine, too!

"If they have helped others to advance, they can help me. Today—right now—I'm going to send in this coupon and at least find out what the I. C. S. can do for me."

TEAR OUT HERE

INTERNATIONAL CORRESPONDENCE SCHOOLS
Box 5680-C, Scranton, Penna.

Without cost or obligation, please tell me how I can qualify for the position or in the subject before which I have marked an X:

BUSINESS TRAINING DEPARTMENT

- | | |
|---|---|
| <input type="checkbox"/> Business Management | <input type="checkbox"/> Salesmanship |
| <input type="checkbox"/> Industrial Management | <input type="checkbox"/> Advertising |
| <input type="checkbox"/> Personnel Organization | <input type="checkbox"/> Better Letters |
| <input type="checkbox"/> Traffic Management | <input type="checkbox"/> Foreign Trade |
| <input type="checkbox"/> Business Law | <input type="checkbox"/> Stenography and Typing |
| <input type="checkbox"/> Banking and Banking Law | <input type="checkbox"/> Business English |
| <input type="checkbox"/> Accountancy (including C.P.A.) | <input type="checkbox"/> Civil Service |
| <input type="checkbox"/> Nicholson Cost Accounting | <input type="checkbox"/> Railway Mail Clerk |
| <input type="checkbox"/> Bookkeeping | <input type="checkbox"/> Common School Subjects |
| <input type="checkbox"/> Private Secretary | <input type="checkbox"/> High School Subjects |
| <input type="checkbox"/> Business Spanish <input type="checkbox"/> French | <input type="checkbox"/> Illustrating <input type="checkbox"/> Cartooning |

TECHNICAL AND INDUSTRIAL DEPARTMENT

- | | |
|--|--|
| <input type="checkbox"/> Electrical Engineering | <input type="checkbox"/> Architect |
| <input type="checkbox"/> Electric Lighting | <input type="checkbox"/> Blue Print Reading |
| <input type="checkbox"/> Mechanical Engineer | <input type="checkbox"/> Contractor and Builder |
| <input type="checkbox"/> Mechanical Draftsman | <input type="checkbox"/> Architectural Draftsman |
| <input type="checkbox"/> Machine Shop Practice | <input type="checkbox"/> Concrete Builder |
| <input type="checkbox"/> Railroad Positions | <input type="checkbox"/> Structural Engineer |
| <input type="checkbox"/> Gas Engine Operating | <input type="checkbox"/> Plumbing and Heating |
| <input type="checkbox"/> Civil Engineer | <input type="checkbox"/> Chemistry <input type="checkbox"/> Pharmacy |
| <input type="checkbox"/> Surveying and Mapping | <input type="checkbox"/> Automobile Work |
| <input type="checkbox"/> Metallurgy | <input type="checkbox"/> Navigation |
| <input type="checkbox"/> Steam Engineering | <input type="checkbox"/> Agriculture and Poultry |
| <input type="checkbox"/> Radio <input type="checkbox"/> Airplane Engines | <input type="checkbox"/> Mathematics |

Name.....
Street.....
Address.....
City..... State.....
Occupation.....

Persons residing in Canada should send this coupon to the International Correspondence Schools Canadian, Limited, Montreal, Canada.

Please Mention Popular Mechanics



MORE THAN \$100 a Day!

CLARE BRIGGS, the man who draws "When a Fellow Needs a Friend," receives more than \$100 a day. There are Many other cartoonists making incomes that would look good to a bank president.

If you have ideas and like to draw, you may have in you the making of a great cartoonist.

Federal training gives you the opportunity to develop your ability under the guidance of 60 of America's leading artists and illustrators. What this school will do for you by mail in your spare time is told in the 32 page book, "A Road to Bigger Things." It contains studio pictures of Briggs, McCutcheon, Sid Smith, Fontaine Fox, and many other stars on the Federal staff. Write for your FREE COPY to-day. Just tear out this advertisement. Write your name, address and age in the margin and mail it now.

Federal Schools, Inc.

1103 Federal Schools Bldg. Minneapolis, Minn.

LAW High-Grade Instruction

By Correspondence
Prepares You for the Bar—Est. 1892
University Methods.

Standard Text-Books. Approved by Bench and Bar. Graduates practicing in every state. Send today for Free Catalog and Rules for Admission to the Bar.

Chicago School of Law
520 Reaper Block Chicago, Ill.



Rider Agents Wanted

Select from the 44 Styles, colors and sizes of Ranger Bicycles. Ride and exhibit sample Ranger and make money. Delivered free, express prepaid, on approval. Factory-to-Rider prices save \$10 to \$25.

12 Months to Pay
No Money, do business direct with makers.

Tires
best quality, at factory prices, express prepaid. Lamps, wheels and equipment, low prices. Send

Write today for free Ranger Catalog, factory prices and marvelous easy payment terms.



Mead Cycle Company
Dept. H108 Chicago

STAMMER

If you stammer attend no stammering school till you get my large FREE book entitled "STAMMERING, Its Origin and the Advanced Natural Method of Cure," bound in cloth and stamped in pure gold. Ask for special tuition rate and a FREE copy of "The Natural Speech Magazine." Largest, best equipped and most successful school in the world for the cure of stammering, stuttering, etc. No sing-song or time beat. Write today. The North-Western School, 2317 Grand Ave., Milwaukee, Wis.

Learn Autos and Tractors



Wonderful opportunities constantly offered trained men; we train you thoroughly to start your own business or make good money as motor expert, driver, shop foreman, etc.

7,000 Graduates making good. Catalog Free

Cleveland Automobile School, 1814 E. 24th St., Cleveland, O.



Be An Auto Expert

I WILL MAKE YOU ONE!—by my complete, practical, simple, easy, auto, truck and tractor course—which you can master in your home—at your leisure—without giving up your present job. I will make you a "Cooke Trained Expert." With that title you can command **respect—and big money.**

When you work with me, you don't just "learn" things. YOU DO THINGS! YOU BEGIN TO ACHIEVE RIGHT FROM THE START.

Choose Your Career NOW!

Think of it! Eleven million motor driven vehicles in this country today—and any one of them is liable any minute to need attention. The automobile field is a "gold field." STAKE YOUR CLAIM NOW AND AVOID THE RUSH. Choose the right career—show some "pep" and enthusiasm—and you can be your own boss. Any one of the following careers is open to you. TAKE YOUR CHOICE:

Owner or Manager of a Garage; Demonstrator and Salesman; Tractor Engineer; Auto Mechanic; Auto Electrician; Battery Expert; Welder; Tire Vulcanizer; Truck Driver; Chauffeur.

\$150 in 3 Days!

Men who have worked with me are now earning big incomes. You just ought to read the heart warming letters I receive from grateful students who feel that they owe their success in life to me. One tells of making \$150 in three days. Another says, "The man I used to assist is now my helper!" And that's just the point! One man under my guidance, goes ahead, while the self-satisfied fellow

stands still—or goes backward! Enroll with me and go ahead! I promise to **push** you ahead.

Send for my free book and learn all about my course—just how I work with my men—how I give them practical work to do—how they secure the aid and advice of my big corps of experts—**No text books—but real work!** That's my method. I can't tell you all about it here—**BUT SEND FOR MY BOOK!**

Send for FREE BOOK!

NOW is the time to get started on a career. Send for my free book, and learn all about the possibilities—yes—the **certainties** in the automobile field. You just didn't realize they were there—but I SHOW YOU IN MY BOOK! You can have my **Complete Auto Course**—or you can have a **Special Electric-Auto Course** or a **Special Battery Course.** SEND THE COUPON TODAY!

B. W. COOKE, President

THE COOKE AUTO SCHOOL
Dept. 1358, 500 to 528 S. Throop St., Chicago

THE COOKE AUTO SCHOOL
B. W. COOKE, President
Dept. 1358, 500-528 S. Throop St., Chicago

Please send me your free book and full information as to how I can become an auto expert.

I am interested in:

- Your COMPLETE automobile Course, which covers everything.
 Your SPECIAL Auto-Electric Course.
 Your SPECIAL Battery Course.
(Put a cross in front of the course you want!)

It is understood I am not under the slightest obligation in asking for this information.

Name.....

Address.....



Be Master of a Real Job

Then you can walk confidently into the office or the plant, knowing that you are needed and appreciated—that there is a growing future ahead of you, one that holds more power, better pay, bigger leadership.

You won't have to "cool your heels" in waiting-rooms looking anxiously for a job at "almost anything," which is what men usually say when they are not masters of their work.

Good Advice from One Who Climbed

R. H. McElroy, one of the vice-presidents of the Standard Oil Company, who climbed from a clerical position to \$30,000 a year, says (*N. Y. Times*, July 2, 1922): "Any young man who has the right stuff in him, who is willing to work at his job and study after working hours, who will keep his eyes open . . . can achieve the same success that I and my associates have." In a letter to us, Mr. McElroy adds: "I believe the correspondence and evening schools provide a splendid opportunity for the young man of limited time and means to prepare himself for a brilliant future."

After a quarter-century of experience in aiding men through spare hours to become their Bigger Selves, the United Y. M. C. A. Schools offer this tested service by mail, so that wherever you may live, whatever you may need or whatever your hours of employment are, you can now get this valuable aid.

Mark and mail the coupon for free copy of our new catalog and our friendly counsel.

SOME OF OUR 300 CORRESPONDENCE COURSES

Business Courses		
Accountancy	Business Administration	Practical Speaking
Advertising	Business English	Salesmanship
Banking	Business Finance	Secretarial
Better Letters	Business Law	Show Card Writing
Bookkeeping	Complete Letter-Writing	Stenography
Business Arithmetic	Office Management	Traffic Management

Technical and Other Courses		
Agricultural Courses	Foremanship	Plumbing
Applied Psychology	Highway Engineering	Poultry Husbandry
Architecture	ing	Radio Engineering
Automobile Courses	High School Subjects	Radio Telegraphy
Building Construction	Illustrating	Radio Telephony for Amateurs
Civil Engineering Courses	Insurance Courses	Stream Engineering Courses
Drafting Courses	Mathematical Courses	Structural Drafting
Electrical Courses	Mechanical Engineering	Surveying
English Courses	Own-Your-Home Course	Use of the Slide Rule
Factory Management	Plan Reading	Vocational Courses
Foreign Languages		

Are you an ex-serviceman?



Correspondence Instruction

375 Lexington Avenue
Dept. 2-N New York City

Without obligating me, please advise regarding the course in

Name.....

Full Address.....

(Please write plainly.)

COMMERCIAL ART

Taught By Improved Methods

Many art school advertisements tell about the great and ever increasing demand for commercial artists—big pay—equal opportunity for both men and women, etc. Very good! This is all quite true, but you must first be properly taught. Understand? Properly taught! Few top notch artists are good instructors. Very few. By searching through many studios we have found them.

A Master Course Is Offered

Endorsed as the official training school for leading Commercial Art houses, employing hundreds of artists. Correct educational methods applied. A practical educator and a corps of top notch commercial artists, offer students the benefit of 20 to 30 years of high grade experience. Only the best instruction is good enough for you. Students finishing half of this unusual course can secure and hold desirable positions. Course can be made to pay for itself many times while studying. Either class room or home study instruction. Same course. Same credits. If you like to draw, let's talk it over.

Ask for our book telling all about Commercial Art and the opportunities it presents AS WE TEACH IT. Send 6 cents in stamps for postage.

**NATIONAL ACADEMY
OF COMMERCIAL ART**
230 EAST OHIO ST.
DEPT. 2 CHICAGO,
ILL.



HOW TO BECOME A PROFESSIONAL PHOTOGRAPHER

Earning \$35 to \$125 a Week

An interesting illustrated booklet (free) on choosing a vocation, the exceptional opportunities Photography offers you and how to avail yourself of these advantages.

Motion Picture—Commercial—Portraiture

Three to six months' Practical course. Modern equipment. Day or evening classes. Easy terms. Call or write for Catalog No. 49.

N. Y. INSTITUTE OF PHOTOGRAPHY
NEW YORK CHICAGO BROOKLYN
141 W. 36th St. 630 So. Wabash Ave. 505 State St.



Wonderful, new device, guides your hand; corrects your writing in few days. Big improvement in three hours. No failures. Complete outline FREE. Write C. J. Oament, D-34, St. Louis, Mo.

LEARN WATCHMAKING AND ENGRAVING

Earn while learning. Most practical watch school. Individual instructions. Graduates in great demand. Book free. Chicago School of Watchmaking, Dept. 20, 4510 Lincoln Ave., Chicago

LAW
IN YOUR SPARE TIME
Learn law with only institution giving same course by correspondence as was given for years at resident classes of this college. **DEGREE OF LL. B. CONFERRED.** One year business law course prepares you for success in business. Law trained business men in demand. Three year university course covers preparation for bar examination. Money back guarantee if not satisfied. Low fee, easy terms, includes complete 1921 thirteen volume library, text material and all expenses. Write for **FREE BOOK.**
Hamilton College of Law
431 South Dearborn St.
Dept. 68 Chicago

Which job can you fill?

All these jobs were advertised in a single issue of a Chicago newspaper under "Help Wanted."

Which one can you fill?

There are good jobs like these with big pay everywhere for men capable of holding them. Why don't you get one? If you haven't the knowledge necessary to make you capable of holding down the best kind of a job, *make up your mind right now to get it.* There is a set of Home Study Books listed below that will quickly fit you to hold any job you want—spare time only is needed.

These books were written by some of the greatest experts in each line. Nothing but plain everyday English is used—thousands of pictures, diagrams and tables help to make everything as simple as A B C. You can't go wrong with these books before you—they explain everything you need to know. Pick out the set you want and see our free trial offer below.

Cut Prices on Practical Books

Carpentry and Contracting, 5 vols., 2138 pp., 1600 pict. Was \$37.50. Now \$19.80
Civil Engineering, 9 vols., 3900 pages, 3600 pictures. Was \$67.50. Now \$34.80
Electrical Engineering, 8 vols., 4100 pages, 3300 pictures. Was \$68.00. Now \$29.80
Automobile Engineering, 6 vols., 2600 pp., 2000 pictures. Was \$45.00. Now \$21.80
Machine Shop Practice, 6 vols., 2500 pp., 2500 pictures. Was \$45.00. Now \$21.80
Steam and Gas Engineering, 7 vols., 3300 pp., 2500 pict. Was \$52.50. Now \$24.80

Law and Practice (with reading course), 13 v., 6000 p., illus. Was \$97.50. Now \$19.80
Fire Prevention and Insurance, 4 vols., 1500 pp., 600 pict. Was \$30. Now \$14.80
Telephony and Telegraphy, 4 vols., 1728 pp., 2000 pict. Was \$30.00. Now \$14.80
Sanitation, Heating, Ventilation, 4 vols., 1051 pp., 1400 pict. Was \$30. Now \$14.80
Accountancy & Bus. Management, 7 vols., 2700 p., 800 pict. Was \$32.50. Now \$20.80
Drawing, 4 vols., 1578 pages, 1000 pictures, blueprints, etc. Was \$30.00. Now \$14.80

7 DAYS' FREE TRIAL

We'll gladly send you any set of these books you want for seven days' free examination. Don't send us a cent. Just pay the small shipping charges when the books arrive. Examine them carefully. Use them at your work for an entire week. If you feel that the books are not worth more than we ask for them, send them back at our expense. If you keep them, pay only the bargain price on the easy terms explained below.

75c a Week That's all you pay if you keep the books you select. Send \$2.80 within 7 days and the balance of the cut price at the rate of \$3.00 a month (75c a week). Did you ever hear of a more generous offer? Remember, you take no chances—you don't pay us anything if you don't keep the books. *Mail the coupon NOW—before you turn this page.*

AMERICAN TECHNICAL SOCIETY, Dept. X-198, Chicago

Wanted

Office Men

Auditors, Accountants, Office Managers, Credit Men, Cashiers, Bookkeepers and Cost Clerks—\$2,000 to \$7,500 a year.

Factory Men

Electrical and Mechanical Engineers, Factory Managers, Superintendents, Foremen, Designers and Draftsmen—\$2,000 to \$12,000 a year.

Construction Men

Civil and Structural Engineers, Transmittmen, Construction Superintendents and Foremen, Estimators, Designers and Draftsmen—\$2,500 to \$10,000 a year.

Trades

Marinists and Toolmakers, Auto Repairers, Electricians, Stationary Engineers, Firemen, Plumbers, Carpenters, Pattern Makers and Telephone Men—\$2,000 to \$4,000 a year.

A Real Bargain

The price of these Pay Raising Books is cut in half



SPECIAL DISCOUNT COUPON

AMERICAN TECHNICAL SOCIETY
Dept. X-198, Chicago, U. S. A.

Please send me set of.....

for 7 DAYS' examination, shipping charges collect. I will examine the books thoroughly, and, if satisfied, will send \$2.80 within 7 days and \$3 each month until I have paid the special price of \$..... If I decide not to keep the books I will return them at your expense at the end of one week. Title not to pass to me until the set is fully paid for.

Name.....

Address.....

City..... State.....

Employed by.....

Please fill out all lines

This Amazing Radio Book FREE

Wonderful new method now teaches you Radio in spare time at home. Big opportunities are open—free pay is offered for those who are trained. The coupon below for FREE Book, "How to Learn Radio at Home," tells all about the opportunities open and how you can share them!



Radio Made Easy by Wonderful New Method

RADIO is spreading all over the world like wild-fire. Every day you read of some new invention, or some new field where Radio has entered. But do you realize what a wonderful opportunity is waiting for YOU in this great profession? Do you know that YOU can quickly qualify for one of the splendid, big-pay positions on land or sea? The National Radio Institute, America's first and largest Government-recognized Radio School, has devised a remarkable new method that makes it **easy for anyone to learn Radio** in spare time at home.

Under our remarkable method, prominent Radio experts give you personal instruction, help you in every way to become a successful Radio man. Lessons, so fascinating they read like an interesting story, take you quickly and surely through every step of Radio.

And with this thorough and complete course you are loaned *free*, four wonderful practice Radio Instruments which give you real practice in actual Radio operation, construction, maintenance and repair.

Among these instruments are the Marola Receiving Set, which you put together yourself, and which lets you in on all the entertainments broadcasted every night, and the only device ever patented which gives you an exact reproduction of the Radio work of two famous Trans-Atlantic professional operators, and which quickly gives you the accuracy and speed of a professional.

Endorsed by the United States

Our course of instruction is officially endorsed by the Government, and we stand first on the list of Radio Schools recommended by the Department of Commerce. Our Diploma of Graduation is awarded five to ten credits at all Government Commercial License examinations. Our Free Employment Service receives letters every day from employers all over the country asking for our students and graduates. The amazing success of our graduates (as shown in the panel at the left) tells you the success YOU CAN WIN in Radio.

If you are genuinely and sincerely interested in making Radio your life's profession, send for our book, "How to Learn Radio at Home" which tells you in detail all about our shortest course of instruction, the four Radio Instruments loaned you free, our Free Employment Service, the splendid opportunities in Radio and how you can qualify for a fine position in your spare time at home.

NATIONAL RADIO INSTITUTE
Dept. L-15 Washington, D. C.

National Radio Institute, Dept. L-15,
Washington, D. C.

Send me your free book, "How to Learn Radio at Home" which explains your short-cut course in Radio, your four Radio Instruments, your Free Employment Service, the opportunities in Radio, and how you will qualify me for a first-class commercial license in my spare time at home.

Name.....Age.....
Address.....
City.....State.....

Please Mention Popular Mechanics

Learn to Dance! at home

to music



FREE PROOF record teaches you to dance in one hour

All your friends dance. Why don't you? Surprise them with the latest steps. You can easily learn by yourself without embarrassment. It's not necessary to know the first thing about dancing.

Just slip these wonderful records on your phonograph—and do as they say. That's all there is to it.

I'll Prove It FREE

Convince yourself at my expense how remarkably easy my unusual method is. For a short time I will send my first lesson, including ten-inch record, free and prepaid. Try it out for 5 days and decide whether you wish to learn dancing the modern way. You may then enroll or return the record. I have set aside only a few hundred for this special offer. You must write at once.

WILLIAM CHANDLER PEAK

"The Man Who Makes Better Dancers"

Studio 35 4737 Broadway, Chicago, U. S. A.

WM. CHANDLER PEAK, M. E. The Originator of Dance Instruction by Mail.

Nationally known—he is an outstanding figure in teaching dancing at home, having taught over 60,000 men and women of high social standing.

He is Special Instructor in the oldest and most exclusive dancing association—the American Society of Teachers of Dancing, New York. Also President of the new famous Peak School of Dancing, Inc., established since 1890.

Be a Taxidermy Artist



Marvelous Book Sent FREE

You can now learn Taxidermy, the wonderful art of mounting birds, animals, tanning skins, etc. Learn at home, by mail. The free book tells how. Mount your own trophies. Decorate home and den. Hunters, trappers, nature lovers, you need taxidermy. Interesting, fascinating, big profits. Join our school. 55,000 students. Success guaranteed. Get our free book without delay. Send right now—today.

N. W. School of Taxidermy, 1778 Elwood Bldg., Omaha, Neb.

STAMMERERS

For 55 years we have successfully corrected stammering by our simple and natural course of individual lessons. Attend no school until you have read our free booklet, "How To Stop Stammering."

SAMUEL A. ROBBINS, Director,
Boston Stammerers' Institute
246 Huntington Ave. Boston 17, Mass.

LEARN WATCHMAKING

and become independent. Good-paying positions secured.

Easy to learn. Send for FREE CATALOG.

ST. LOUIS WATCHMAKING SCHOOL, Dept. 5, ST. LOUIS, MO

Play Cornet?

Trombone, Baritone, etc.? You can't afford to be without "Lip Science," Marvelous secret manual for brass players. Easy playing in the entire register. Highest notes without effort. Results guaranteed. Send postal—get free information. Act now!

W. E. HITCHCOCK, Publisher
Dept. "M" 5337 Prairie Ave., Chicago

SPEED TYPEWRITING

Learn at Home

Write 80 to 100 words a minute. Big money for speed typists, trained by the Tulloss "New Way." Learn in spare time at home. 10 easy lessons. Costs little. Many Tulloss pupils make double former pay. Send for big catalog. Tells you all. Shows how to train for best positions. Write today.

THE TULLOSS SCHOOL 1141-T College Hill Springfield, Ohio

How Strong Are You

Can You Do These Things?

- Lift 200 or more overhead with one arm;
- Bend and break a horse shoe;
- Tear two decks of playing cards;
- Bend spikes;
- Chin yourself with one hand.

Can you do any of them? I can and many of my pupils can. It is remarkable the things a man really can do if he will make up his mind to be strong. Any man. It is natural for the human body to be strong. It is unnatural to be weak. One leading writer on physical culture says: "It is criminal to be weak." I have taken men who were ridiculed because of their frail make-up and developed them into the strongest men of their locality.

I Want You For 90 Days

These are the days that call for speed. It once took four weeks to cross the ocean—now it takes less than one. In olden days it took years to develop a strong, healthy body. I can completely transform you in 90 days. Yes, make a complete change in your entire physical make-up. In 30 days I guarantee to increase your biceps one full inch. I also guarantee to increase your chest two full inches. But I don't quit there. I don't stop till you're a finished athlete—a real strong man. I will broaden your shoulders, deepen your chest, strengthen your neck. I will give you the arms and legs of a Hercules. I will put an armor plate of muscle over your entire body. But with it comes the strong, powerful lungs which enrich the blood, putting new life into your entire being. You will have the spring to your step and the flash to your eyes. You will be bubbling over with strength, pep and vitality.

A Doctor Who Takes His Own Medicine

Many say that any form of exercise is good, but this is not true. I have seen men working in the mills who literally killed themselves with exercise. They ruined their heart or other vital organs, ruptured themselves or killed off what little vitality they possessed. I was a frail weakling myself in search of health and strength. I spent years in study and research, analyzing my own defects to find what I needed. After many tests and experiments, I discovered the secret of progressive exercising. I have increased my own arm over 6½ inches, my neck 3 inches and other parts of my body in proportion. I decided to become a public benefactor and impart this knowledge to others. Physicians and the highest authorities on physical culture have tested my system and pronounced it to be the surest means of acquiring perfect manhood. Do you crave a strong, well-proportioned body and the abundance of health which go with it? Are you true to yourself? If so spend a pleasant half hour in learning how to attain it. The knowledge is yours for the asking.

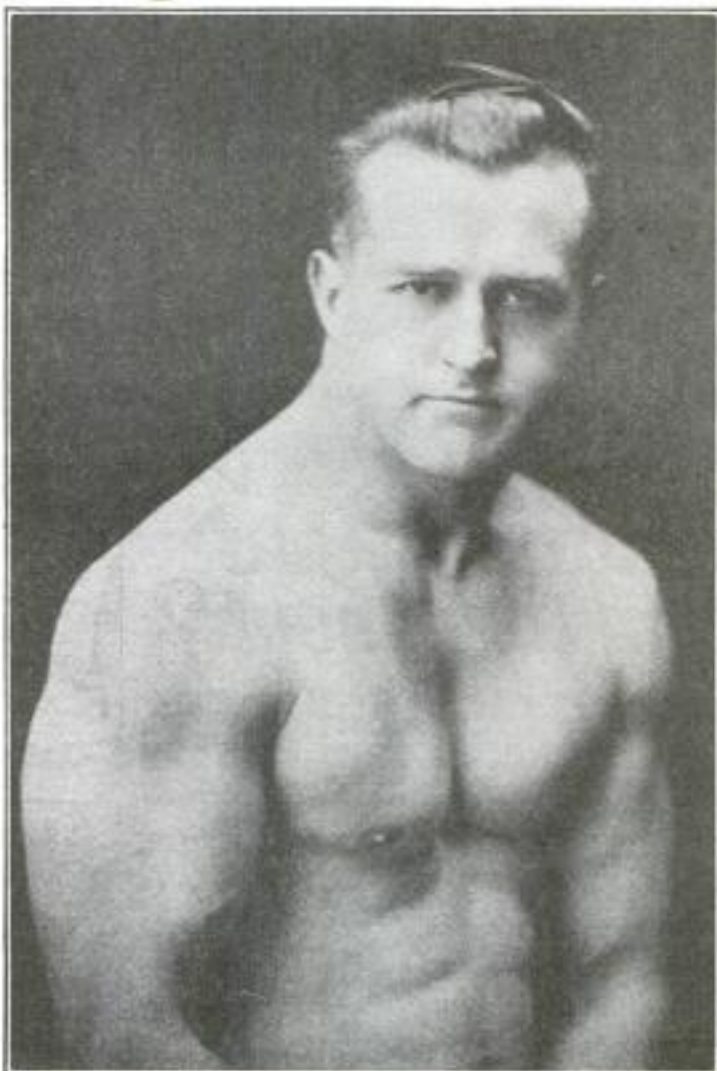

Earle E. Liederman as he is to-day

Send for My Book "MUSCULAR DEVELOPMENT"

It Is FREE

It is chock full of photographs both of myself and my numerous pupils. Also contains a treatise on the human body and what can be done with it. This book is bound to **interest** you and **thrill** you. It will be an **impetus**—an **inspiration** to every **red-blooded man**. I could easily collect a big price for a book of this kind just as others are now doing, but I want every man and boy who is interested to just send the attached coupon and the book is his—**absolutely free**. All I ask is the price of wrapping and postage—10 cents. Remember, this does not obligate you in any way. I want you to have it. **So it's yours** to keep. Now don't delay one minute. This may be the turning point in your life. Tear off the coupon and mail at once while it is on your mind.

EARLE E. LIEDERMAN
Dept. 2011, 305 Broadway, New York City

EARLE E. LIEDERMAN

Dept. 2011, 305 Broadway, N. Y. City

Dear Sir:—I enclose herewith 10 cents for which you are to send me, without obligation on my part whatever, a copy of your latest book, "Muscular Development." (Please write or print plainly.)

Name.....

Address.....

City.....State.....



What Are You Thinking About?

Day-dreaming led many a man to make plans that brought him big success. Don't be ashamed when your thoughts are wandering away, when you dream that you are a leader of men—a doer of big things in the business world—a builder of lasting structures. Your day-dreams are an indication of your ambition and of your desire to accomplish things. The man who never dreams has no imagination, he will not get very far. But you can make your dreams real—You can materialize your ambition.

Just dreaming alone won't do. Hitch your dreams up to facts and you will go far. You will get the facts through special training along the line in which you want to succeed. And the place to get just that training is the American School. This is proven by the quarter of a century of successful experience we have in helping many thousands of men and women gain an enviable place in the business and social life.

Another reason why the American School is the place to get your training—it is not a business corporation but a chartered Educational Institution, incorporated not for profit.

Space here is too limited to tell you of all the advantages you will gain by getting your training from the American School, but the coupon will bring you full information and a descriptive book, without cost or obligation to you. Fill out and mail the coupon NOW, while you are thinking about it. *No agents will bother you.*

American School

Dept. G874a, Drexel Ave. and 58th St., Chicago

American School

Dept. G874a, Drexel Ave. and 58th St., Chicago

Send me full information on the subject checked and how you will help me win success.

- | | |
|------------------------------|----------------------------|
| Architect | Lawyer |
| Building Contractor | Machine Shop Practice |
| Automobile Engineer | Photoplay Writer |
| Automobile Repairman | Mechanical Engineer |
| Civil Engineer | Shop Superintendent |
| Structural Engineer | Employment Manager |
| Business Manager | Steam Engineer |
| Cert. Public Accountant | Foremanship |
| Accountant and Auditor | Sanitary Engineer |
| Bookkeeper | Surveyor (& Mapping) |
| Draftsman and Designer | Telephone Engineer |
| Electrical Engineer | Telegraph Engineer |
| Electric Light & Power | High School Graduate |
| General Education | Fire Insurance Expert |
| Vocational Guidance | Wireless Radio |
| Business Law | Production Manager |
| Advertising Manager | Undecided |

Name

Address

Please Mention Popular Mechanics



Learn by Mail to Play Your Favorite Instrument

Of all the arts, *music* has the widest popular appeal. You hear orchestras, bands, singers, instrumental soloists everywhere you go—at dances, in theaters, hotels, amusement parks, etc. There has never been such a great demand for musicians as now. Play *any* instrument and the way is open to you for earning big money.

The University Extension Conservatory now places at your disposal the teaching experience of some of the greatest Master Musicians of both America and Europe—lessons that are no less than marvelous in their simplicity and thoroughness, leading you from the first rudiments of music to a complete mastery of your favorite instrument. Endorsed by Paderewski. You are taught and coached every step of the way by the individual instruction of a specialist.

What Instrument Interests You?

Write, telling us the course you are interested in—Piano, Harmony, Voice, Public School Music, Violin, Cornet, Mandolin, Guitar, Banjo or Reed Organ—and we will send our Free Catalog together with *proof* of how others, both beginners and those more or less advanced in music, have made wonderful headway under our instruction methods.

University Extension Conservatory
683 Siegel-Myers Building, Chicago, Ill.

ELECTRICAL men with training are in demand. For more than a quarter of a century this school has been training men of ambition and limited time, for the electrical industries. Condensed course in **ELECTRICAL** ENGINEERING enables graduates to secure good positions and promotions. Theoretical and practical Electricity, Mathematics, Steam and Gas Engines, Mechanical Drawing. Students construct dynamo, install wiring and test electrical machinery. Course with diploma, complete.

IN ONE YEAR

Thoroughly equipped fireproof dormitories, dining hall, laboratories, shops. Over 3000 men trained. Write for catalog. 30th year begins Sept. 27, 1923.

BLISS ELECTRICAL SCHOOL
404 TAKOMA AVENUE, WASHINGTON, D. C.



SHORTHAND IN ONE MONTH

Boyd—the Wonderful, New, Easy System. Writers hold world's record. 100 to 150 words a minute in 30 days guaranteed. New Principles—dictation first week. Best for Court Reporting and Secretaries. Also Typewriting, Bookkeeping and Commercial Law. Send today for Catalog and Money-Back Guarantee. CHICAGO HOME STUDY SCHOOLS, 802 Resper Block, Chicago, Ill.

Learn Watchwork, Jewelrywork and Engraving. A fine trade commanding a good salary, and your services are always in demand. Address HOROLOGICAL, Dept. P, Bradley Institute, Peoria, Ill., for our latest catalog.

LEARN WATCH REPAIRING



You can learn by our modern and original system of instruction every part of the Watch Repairing Trade at home as good or better than at a shop. You can earn money while learning and secure a well paying position or start in business after completing our course of instruction. Good watch repairers are always in demand and earn from \$50 to \$70 per week. For particulars apply to the WISCONSIN SCHOOL OF WATCH REPAIRING 166 Mason St., MILWAUKEE, WIS.



Be an auto expert Get into business for yourself

**FREE
BOOK**
Tells You
how

I'll show you how! My course is practical—no frills—no big talk nor technicalities—just simple, easy, complete, personal instruction on autos, trucks and tractors. You can master this course *at home—in your spare time*—and keep right on with your present job. I'll train you the C. A. I. way—that means you are fitted for the *job ahead*. You know how to go into business for yourself—how to make a small beginning—earn while you learn—*create a big pay business on your earnings!*

Plan Your Career—NOW!

Decide to learn the automobile business from the ground up. Get in on the ground floor of the *second largest industry*—yet one of the *youngest*. The future of America is linked with the internal combustion engine. New inventions—new needs—greater demands are swamping this industry daily—*it is yet an infant*. Get your eye on a goal in this big pay field. Decide *NOW* that you will get out of the low-salary class—be your *own boss*—with *brains* and C. A. I. training as *capital* you are bound to build a sound business of your own.

These Jobs Are Open to C. A. I. Grads. Pick Yours—THEN ACT

Demonstrator and Salesman; Tractor Engineer; Auto Mechanic; Auto Electrician; Battery Expert; Truck Driver; Chauffeur; Welder; Tire Vulcanizer; OWNER or MANAGER of a GARAGE!

You Can Earn \$2,000 to \$10,000 a Year In the Automobile Business

Don't be satisfied with a small-pay job always. Look beyond the specialists job. Don't cramp your *ambitions*—learn the *entire profession*—every *branch*—know the *job ahead*—*determine* to have your *own business*—make \$2,000—\$10,000 a year—you can. There are *12 million automobiles* in the U. S.; *50 million tires* to be repaired; *12 million batteries*; *12 million ignition systems*—yet there are only *38 thousand garages* to look after this enormous market! Motorists will spend more than *5 billions of dollars* in 1922! Half again as much *next year*. Will you get your share?

With My "Jobway" of Instruction You Do Things From the Start

I instruct you *personally*. I, a practical Automotive Engineer, have gone through the "mill." I know how grease feels on the hands, and will diagnose and cure motor ills with

J. R. BAYSTON, President

Chicago Automotive Institute, 608 So. Dearborn St., Chicago

any of them. My experience goes back to the garage where I did everything from polishing the brass to overhauling the whole job—then as an Automotive Engineer I've been consultant, designer, instructor. My course is the result of all this experience; cuts out all the frills, and is boiled down to the stuff that gets you into a big-pay job quickly.

My Guarantee Means Something

The "Jobway" is the strongest unwritten guarantee you could get. It *proves up* every thing you learn—gives you confidence—shows your progress so the most hard-to-convince person in the world would know you were learning. The "Jobway" enables you to get a job in a short time after you begin the course. When you have finished, and receive your diploma, you are a **PROVEN AUTO EXPERT**, and the world will recognize this, because you graduated under the C. A. I. "Jobway." Further than that I guarantee to refund your money if you aren't *absolutely satisfied* that you got your money's worth.

Get my FREE BOOK!

Now is the time to get started, because it is *NOW*. Decide to make the first effort toward a big future. Would you sign a contract for your present salary for the rest of your active life—in your present job? No? That's a good sign. But big money calls for *training*. To *boss* the job you must *know* the job. My FREE

BOOK shows the way—the short cut to bigger pay. Without experience—special education—without quitting your job, I'll show you how to be an Auto Expert. You can succeed under my *personal direction*. My free book tells all. Send the coupon *NOW*, or your name on a post card will do. Tear out the coupon *before you turn the page*.

YOUR OPPORTUNITY
The "JOBWAY" to
Bigger Pay



J. R. Bayston,
President
Chicago Automotive
Institute

Dept. P. 1122

Please send me your free book and full information about your Complete Automobile Course, and explain the "Jobway." This places me under no obligation whatever.

Name

Address



Do you want to be a Surveyor?

ARE you fond of outdoor work? Would you like to become a Civil Engineer? Then take up Surveying. It is a profession that not only pays big salaries itself, but it is the stepping stone to something even better. Probably 99 out of every 100 Civil Engineers were surveyors first.

Fill out the coupon below and let us tell you how you can prepare for success in Surveying, Engineering, Drafting, Chemistry, etc., through spare-time study at home with the I. C. S.

----- TEAR OUT HERE -----

INTERNATIONAL CORRESPONDENCE SCHOOLS
Box 5683-C, Scranton, Pa.

Without cost or obligation on my part, please tell me how I can qualify for the position or in the subject before which I have marked an X in the list below:

- | | |
|---|--|
| <input type="checkbox"/> SURVEYING | <input type="checkbox"/> ADVERTISING |
| <input type="checkbox"/> DRAFTING | <input type="checkbox"/> Salesmanship |
| <input type="checkbox"/> Mechanical Engineering | <input type="checkbox"/> BOOKKEEPING |
| <input type="checkbox"/> Civil Engineering | <input type="checkbox"/> Civil Service |
| <input type="checkbox"/> ARCHITECTURE | <input type="checkbox"/> Railway Mail Service |
| <input type="checkbox"/> Electrical Engineering | <input type="checkbox"/> Pharmacist |
| <input type="checkbox"/> Stationary Engineering | <input type="checkbox"/> Traffic Manager |
| <input type="checkbox"/> CHEMISTRY | <input type="checkbox"/> Business Management |
| <input type="checkbox"/> Automobiles | <input type="checkbox"/> Certified Public Accountant |
| <input type="checkbox"/> STENOGRAPHY | <input type="checkbox"/> Airplane Engines |
| <input type="checkbox"/> High School Courses | <input type="checkbox"/> Radio |

Name.....

Address.....

Occupation.....

Persons residing in Canada should send this coupon to the International Correspondence Schools Canadian, Limited, Montreal, Canada.

Please Mention Popular Mechanics

WE TEACH COMMERCIAL ART

Meyer Both Company, the largest commercial art organization in the field, offers you a different and practical training. If you like to draw, develop your talent. Study this practical course—taught by this widely known institution, with twenty-two years success—which each year produces and sells to advertisers in the United States and Canada over ten thousand commercial drawings. Who else could give you so wide an experience? Commercial art is a business necessity—a highly paid, intensely interesting profession, equally open to men and women. Home study instruction. Get facts before you enroll in any school. Write for our illustrated book, "YOUR OPPORTUNITY"—for one-half the cost of mailing—four cents in stamps.

MEYER BOTH COLLEGE OF COMMERCIAL ART
Michigan Ave. at 20th St., Dept. 16 CHICAGO, ILL.

NOTE—To Art and Engraving Firms: Secure practical artists among our graduates. Write us.

Keystone Institute

"The Service School"

A fully equipped school with expert instructors, organized to give intensive instruction in

2-Year Courses
Electrical Engineering
Mechanical Engineering
Accounting and Business Administration
10 weeks' course in Automotive Engineering

Day and Night Classes. Graduates are sought by large and small industrial establishments and are filling important positions in all sections of the country. Write for information on subject that interests you to Keystone Institute. Address The Vice President, 133 North 4th Street, Reading, Penna.

"STAMMERING Its Cause and Cure"

You can be quickly cured if you stammer. Send 10 cents, coin or stamps, for 288 page cloth bound book on Stammering and Stuttering. It tells how I cured myself after Stammering and Stuttering for 20 years. BENJAMIN N. BOGUE
745 Bogue Building, 1147 N. 11th St. Indianapolis



\$30 to \$60 a Week

for spare time work alone. Professional drummers are in demand everywhere and make big money. You can quickly and easily learn to play band, orchestra and dance music through my home study course of 20 interesting lessons. Write for particulars of easy payment plan.

The Herman H. Rinne Correspondence School of Modern Drumming
3154 Park Ave. Indianapolis



New Easy Way to Play SAXOPHONE

In twenty easy lessons I teach you to play saxophone like a professional. Takes one-tenth effort to learn by this wonderful new method of personal instruction.

EARN BIG MONEY

as expert player. I will show you how. My method known from coast to coast. Write quick for full particulars—FREE.

NEWLAN SCHOOL OF MUSIC
495 Athenaeum Bldg. Chicago

He thought he could throw me—



Dear Tom: You know how Ted Brown has always been saying he could throw me with one hand tied behind him, if he wanted to. Well, yesterday, he grabbed hold of me and we had it out. Gee, I wish you'd been there. You know how much bigger Ted is than I. He thought he had me licked dead easy—

but



I wriggled around and got a hold on him that I'd learned from the Farmer Burns School of Wrestling. The next second — KERBLOP, and I had Mister Ted Brown on the ground, yelling for me to quit. It's a cinch to handle a fellow half as big again as you are if you know the secret holds. If I were you I'd write to Burns School for their free book about wrestling. So long—FRED.

Learn Wrestling Secrets from Worlds Champions Farmer Burns and Frank Gotch

Learn the marvelous holds, breaks, blocks and tricks that will enable you to handle big, strong men with ease. The renowned FARMER BURNS—"father of scientific wrestling"—and FRANK GOTCH the world's champion, have prepared a series of lessons in which they reveal the inside secrets of training that will make YOU, too, an expert wrestler. All the great secrets of *self-defense* and *jui-jitsu* illustrated by printed word and picture. The lessons teach you how to become a *great athlete*, and secret knowledge enabling you to throw boys and men larger and stronger than yourself.

Send for FREE Book

Our FREE ILLUSTRATED BOOK tells you all about the advantages in health, vigor and respect that being able to wrestle brings one. It tells you how to learn to become a skilled wrestler *in your spare time*. Brim full of interesting information about wrestling. Also lots of pictures. INVESTIGATE. Write today for this free book. No obligations. Tear out and mail coupon NOW!

Farmer Burns School 1778 Railway Exchange Bldg.
Omaha, Neb.

Farmer Burns School
1778 Railway Exchange Bldg., Omaha, Neb.

Please send me at once without obligation your FREE illustrated book on Scientific Wrestling, Physical Culture, Self-Defense, and How to Win.

Name

Address

Age

AT HOME

"THERE'S MONEY IN IT" LEARN TELEGRAPHY MORSE AND WIRELESS

AT HOME



TEACH YOURSELF

in half usual time, at trifling cost, with the wonderful Automatic Transmitter THE OMNIGRAPH. Sends unlimited Morse or Continental messages, at any speed, just as an expert operator would. Adopted by U. S. Government, and leading Universities, Colleges and Telegraph Schools. 3 styles. Catalog free.

OMNIGRAPH MFG. CO.

16-22 Hudson St., NEW YORK

WANTED—RAILWAY MAIL CLERKS

\$135 to \$190 a Month for Life

Every second week off with full pay—no "lay offs" because of strikes, poor business, etc.—sure pay—rapid advancement to higher positions. City and country residents stand same chance. Common sense education sufficient—no political influence. Examinations likely everywhere very shortly.

DON'T DELAY—ACT AT ONCE

Write for free schedule of full examination places. Every day's delay means so much less chance of quick appointment—so write at once.

FRANKLIN INSTITUTE, Dept. J181, Rochester, N. Y.

Mail This Coupon

Write Plainly
Use It Before You Lose It

COUPON

FRANKLIN INSTITUTE, Dept. J181, Rochester, N. Y.

Kindly send me, without any obligation whatever on my part and entirely free of charge, (1) a full description of the position checked below; (2) Sample examination questions; (3) Free copy of copyrighted book "Government Positions and How to Get Them"; (4) A list of U. S. Government jobs now open; (5) Schedule showing dates and places of all coming examinations.

.. Railway Mail Clerk (\$1600 to \$2300) .. Customs Positions (\$1100 to \$2000)
.. Postoffice Clerk (\$1400 to \$1800) .. Internal Revenue (\$1100 to \$2000)
.. Postoffice Carrier (\$1400 to \$1800) .. Rural Mail Carrier (\$1100 to \$2000)
.. Income Tax Auditors .. (\$2000 to \$3000)

Name

Address



Hotels Need Trained Men

Will You Accept One of the 40,000 Opportunities in America's 4th Largest Industry?

Do you know that in just ONE of America's big hotels there are over two thousand contented, well-paid, well-fed and well-dressed employees? Do you know that the Hotel Business is now rated as AMERICA'S FOURTH LARGEST INDUSTRY? Do you know that in the big hotels of the United States there are 40,000 EXECUTIVE positions—pleasant, high-salaried and dignified? Do you know that without the advantage of a higher education men are making \$5,000 to \$50,000 a year in the hotel business?

You Can Qualify for a Good Paying Job

Statistics show that ONE IN EVERY TEN HOTELS WILL HAVE AN OPENING FOR MANAGER THIS YEAR. The men who will fill them will be the TRAINED men. Some of them have taken years to obtain this training by slow y, laboriously "working up." Others have used their spare time to gain the knowledge that gives them a short cut to success.



Clifford Lewis
President

I Guarantee to Teach You

The valuable knowledge that it has taken some of the most successful hotel men years to obtain—men who are now making \$5,000 to \$50,000 a year. Ad your training will be under the personal direction of CLIFFORD LEWIS—a hotel expert of national reputation. Endorsed by managers of such hotels as Waldorf-Astoria, Biltmore, Copley-Plaza, New Willard, St. Francis. A few spare-time hours a week given to the simple, clear lessons of the Course open the way to a good position, a fine living, and a handsome salary. The training will in no way interfere with your present activities.

SEND FOR FREE BOOK

Big pay, fine living, free meals and apartment, fascinating work—all these may be yours if you will fit yourself for the thousands of opportunities in America's Fourth Largest Industry. Life membership in our Employment Bureau FREE to all graduates. We placed 3789 Lewis-Trained men and women in contact with good Hotel, Club and Tea Room positions in the last 12 months. Write today for interesting FREE BOOK—"Your Big Opportunity." Don't wait a minute—you may lose the one big opportunity of a lifetime. Mail the coupon NOW. Your whole future may depend on it.

LEWIS HOTEL TRAINING SCHOOLS
Founded 1916 CLIFFORD LEWIS, President
Room 340 Washington, D. C.

CLIP HERE FOR FREE BOOK

LEWIS HOTEL TRAINING SCHOOLS
Room 340, Washington, D. C.

Send me without obligation the FREE BOOK "Your Big Opportunity."

Name.....
Please print name

Street.....

City..... State.....

Please Mention Popular Mechanics

SPANISH LEARNED EASILY AND QUICKLY!

Also FRENCH and ITALIAN

Another language will enable you to make more money—whether you are an employer or employee, professional man or woman, boy or girl.

A Few Spare Minutes Can Increase Your Income
Learning a new language by the Rosenthal Language Phone Method, is as easy as learning a new tune. Study when you are in the mood—in the comfort of your own home—on your own phonograph. Soon, you can talk, read and write Spanish, French or Italian.

ROSENTHAL LANGUAGE PHONE METHOD

makes rapid progress possible

Any number of people can learn at the same time—the whole family or groups of friends.

FREE 64-Page Book. It shows how easy, interesting, and profitable it is to learn a foreign language; and explains Dr. Rosenthal's world-famous method of quick study. Also details of FREE Trial offer. Send a postal—*to-day*.

FUNK & WAGNALLS COMPANY
549 Hess Building, 354 Fourth Ave., N. Y.



BE AN ARTIST

We can teach you **DRAWING** in your own home during your spare time.

Our 18 years of successful teaching prove our ability. 30 Courses in Commercial and Illustrative Drawing. Teachers Normal and Applied Art. Endorsed by high art authorities. Students trained by members of our Faculty are filling high-salaried positions. Artist's Output FREE to Enrolled Students. Write today for Art Year Book.

OUR HANDSOME ART YEAR BOOK FREE TO YOU!

SCHOOL OF APPLIED ART
APPLIED ART BLDG. NO. 2 BATTLE CREEK MICH.

LEARN WATCH REPAIRING

Be a watchmaker—you can learn this profitable trade by correspondence in a few weeks in your own home by the DeSelms' Chart System. After you complete the course you will know a watch from A to Z. You will know just what the matter is and how to repair it. When you graduate you will be a practical watchmaker and repairer and competent to fill any position. Position for our graduates.

Ask for our Free Book. It explains our system and terms.
THE DeSELMS WATCH SCHOOL
23 Perry Street ATTICA, INDIANA



12 Months to Pay

You can easily earn or save money for the small payments. Parents often advance first payment to help buy a **RANGER** bicycle. Choice of 44 styles, colors and sizes. **FACTORY-TO-RIDER** prices. **DELIVERED FREE** express prepaid on approval for **30 DAYS' TRIAL**, actual free riding test.

Tires best quality, at factory prices, express prepaid. Lamps, wheels, and equipment, low prices. **Send No Money.**

Mead Cycle Company
Dept. H108 Chicago

Write today for free Range Catalog, factory prices and marvelous easy payment terms.



13 WEEKS FOR 15 CENTS

The Pathfinder
INDEPENDENT NATIONAL HOME WEEKLY

You've heard your neighbor praise the Pathfinder, the wonderful illustrated news and story paper published at Washington for people everywhere. This paper is the **Ford** of the publishing world; has half a million subscribers. Chuck full of just the kind of reading you want. Unequaled digest of the world's news. Question Box answers your questions. Stunts for children; real fun for all. Exciting serial story starts soon. Send 15 cents (coin or stamps) today for this big \$1 paper 13 weeks. You will be more than pleased.

PATHFINDER, 661 Langdon Sta., WASHINGTON, D. C.



Doubled His Salary— Then Doubled it AGAIN!

Sounds too good to be true, doesn't it?

Nevertheless, it *is* true—and that's the wonderful thing about the field of Higher Accountancy, once a man is ready to take advantage of his opportunities. What's more, many a LaSalle-trained man will *tell* you so—from his personal experience.

W. A. Twelkemuir, of Missouri, writes as follows:

"As a result of my taking the LaSalle course in Higher Accountancy, my salary has increased 400 per cent, and through your training in Income Tax I have made as much on the side in consultation fees as was my annual salary when I started. It has meant a tremendous thing to me in mental development and financial profit."

Charles S. Jones, of Texas, was earning only \$100 a month when he undertook LaSalle training. Three years later, on the letterhead of Henry & Jones, Certified Public Accountants, comes the following enthusiastic message:

"My income is a trifle in excess of \$8,000, and I am just beginning to grow. I can hardly find words to tell you of the inspiration that the course has given me."

Samuel Bonow, Head Accountant of the Standard Process Steel Corporation, has had much the same experience. He writes:

"My income today is about five times as much as it was when I started the course in Higher Accountancy a little more than three years ago. No one who expects to hold a managing position at some time in the future could make a bigger mistake than not to complete your course in Higher Accountancy."

You Have the Same Big Opportunity

Men like Twelkemuir and Jones and Bonow are pointing the way to business leadership. They are making good not because of "pull" or "luck," but because of *training*.

Why step aside while these other men step ahead—to the big-pay jobs? *You* can train just as well as *they!* Right in your own home, by the LaSalle Problem Method, you can master Higher Accountancy under the direct supervision of William B. Castenholz, A. M., C. P. A., former Comptroller

and Instructor, University of Illinois, assisted by a large staff of Certified Public Accountants, including members of the American Institute of Accountants. You will be guided step by step through every phase of modern Accounting Practice—Auditing, Cost Accounting, Business Law, Organization, Management, Finance and Income Tax Procedure. You will handle practical accounting problems lifted bodily from business life. You will be given special preparation for the C. P. A. examinations.

Send for our book entitled "Success Reports," showing hundreds of letters from LaSalle-trained men who are making good in the field of Higher Accountancy. With it we will send you full particulars of LaSalle training, together with details of our *convenient payment plan*; also your copy of that inspiring book, "Ten Years' Promotion in One," all without obligation. Nothing is so important to your future happiness as real achievement. Will you "put it off"—or "put it over?" Mail the coupon NOW.

LaSalle Extension University

The Largest Business Training Institution in the World
Dept. 1164-HR Chicago, Illinois

Please send me catalog and full information regarding the course and service I have marked with an X below. Also a copy of your book, "Ten Years' Promotion in One," all without obligation to me.

Higher Ac- } Training for positions as Auditor, Comptroller, countancy } Certified Public Accountant, Cost Accountant, etc.

Other LaSalle Training Courses

LaSalle is the largest business training institution in the world. It offers training for every important business need. If more interested in any of these courses, check here:

- | | |
|--|--|
| <input type="checkbox"/> Business Management | <input type="checkbox"/> Modern Business Correspondence and Practice |
| <input type="checkbox"/> Modern Salesmanship | <input type="checkbox"/> Modern Foremanship and Production Methods |
| <input type="checkbox"/> Traffic Management | <input type="checkbox"/> Personnel and Employment Management |
| <input type="checkbox"/> Railway Accounting and Station Management | <input type="checkbox"/> Expert Bookkeeping |
| <input type="checkbox"/> Law—Degree of LL. B. | <input type="checkbox"/> Business English |
| <input type="checkbox"/> Commercial Law | <input type="checkbox"/> Commercial Spanish |
| <input type="checkbox"/> Industrial Management Efficiency | <input type="checkbox"/> Effective Speaking |
| <input type="checkbox"/> Banking and Finance | <input type="checkbox"/> C. P. A. Coaching |

Name.....

Present Position.....

Address.....



Public Buildings Are Big Users of Electricity



Great Power Plants Need Experts to Operate Them



Hydro-Electric Plants Being Built Everywhere



Electrical Construction Needs Trained Experts

Be a Certificated Electrical Expert

Earn \$3500 to \$10000 a Year

In This Big Pay Field

Trained "Electrical Experts" are in great demand at the highest salaries, and the opportunities for advancement and a big success in this line are the greatest ever known.

"Electrical Experts" earn \$70 to \$200 a week. Fit yourself for one of these big paying positions.

Learn at Home to Earn \$12.00 to \$30.00 a Day

Today even the ordinary Electrician—the "screw-driver" kind—is making money—big money. But it's the trained man—the man who knows the whys and wherefores of Electricity—the "Electrical Expert"—who is picked out to "boss" ordinary Electricians—to boss Big Jobs—the jobs that pay. You too, can learn to fill one of these jobs—spare-time only, is needed. Be an "Electrical Expert"—Earn \$70 to \$200 a week.

Age or Lack of Experience No Drawback

You don't have to be a College Man; you don't have to be a High School graduate. If you can read and write English, my course will make you a big success. It is simple, thorough, and

Electrical Course in existence, and offers every man, regardless of age, education, or previous experience, the chance to become in a very short time, an "Electrical Expert," able to make from \$70 to \$200 a week.

I Give You a Real Training

As Chief Engineer of the Chicago Engineering Works, I know exactly the kind of training a man needs to get the best positions at the highest salaries. Hundreds of my students are now earning \$3500 to \$10000 a year. Many are successful ELECTRICAL CONTRACTORS.

FREE Electrical Working Outfit FREE

I give each student a Splendid Outfit of Electrical Tools, Materials and Measuring Instruments absolutely FREE. I also furnish them with all supplies including examination paper, and many other things that other schools don't furnish. You do PRACTICAL work—AT HOME with this Outfit. You start right in after the first few lessons to WORK AT YOUR PROFESSION in a practical way.

Get Started Now Mail Coupon

I want to send you the "Vital Facts" of the Electrical Industry including my

Electrical Book, Proof lessons and a sample of my guarantee bond all FREE. These cost you nothing and you'll enjoy them. Make the start today for a bright future in Electricity. Send in the coupon—NOW.

L. L. COOKE, Chief Engineer
CHICAGO ENGINEERING WORKS
 Dept. 18 2150 Lawrence Ave. Chicago, Ill.

L. L. Cooke, Chief Engineer
 Chicago Engineering Works, Dept. 18
 2150 Lawrence Ave., Chicago, Ill.

Dear Sir:—Send at once the "Vital Facts" containing Sample Lessons, your Big Book, and full particulars of your Free Outfit and Home Study Course—all fully prepaid, without obligation on my part.

Name.....
 Address.....
 Age..... Occupation.....

Some Features of My Course That Make SUCCESS Certain

1. Practical Money-Making Instruction—no useless, high-sounding theory.
2. Free Electrical Outfit—Finest outfit ever sent out for home experiment, and practical use.
3. Free Employment Service. (Helps you get a good job.)
4. Free Consulting Service. (No chance to get stuck on anything, while studying or afterward.)
5. Free Engineering Magazine.
6. Free use of my Electrical Laboratory.
7. Extra Courses Free—Radio—Electrical Drafting.
8. Spare time work—Special cars-while-you-learn lessons.
9. Reduced prices on all Electrical Supplies.
10. Cash Refund Guarantee Bond.

These features are all explained in my big Free Book.

Your Satisfaction Guaranteed

So sure am I that you can learn Electricity—so sure am I that after studying with me, you too can get into the "Big Money" class in electrical work, that I will guarantee under bond to return every single penny paid me in tuition if, when you have finished my course you are not satisfied that it was the best investment you ever made.

The "Cooke" Trained Man is the "Big Pay" Man

CLASSIFIED ADVERTISEMENTS

WORLD'S BEST WANT AD MEDIUM

Advertisements in this section, 25 cents per word, each insertion, minimum 10 words, payable in advance. To be inserted under proper classification in December issue, copy should be in our office Oct. 25th.

AUTOMOBILE SUPPLIES

AUTOMOBILE parts for all makes and models of cars. We save you 10 to 90% and ship same day your order is received. We have gears, shafts, springs, pistons, pins and rings, cylinder head gaskets, bushings, clutch leathers, radiators, coils, magnets, Timken, Hyatt, New Departure and connecting rod bearings, crank cases, crank shafts, connecting rods, Atwater Kent, Connecticut, Delco and Remy ignition systems and parts. When you want auto parts, write us, giving make, model and year of car and what parts are wanted. We will quote prices before making shipment, if you desire. We guarantee to please you or money refunded. Auto Tire & Parts Co., 561 Broadway, Cape Girardeau, Mo.

AUTOMOBILE parts, guaranteed new, for all cars. Save money; get our wholesale prices on gears, shafts and bearings. State make of car, model and parts wanted. Parts shipped immediately from stock. We refund your money, including transportation charges, if not satisfied. Mechanics Gear Co., 3708 No. Halsted St., Chicago.

AUTO Owner Tire Agent wanted each locality to use and take orders for hand-made Meilinger extra ply and cord tires; guaranteed by bond for 8,000 and 10,000 miles (no seconds); shipped prepaid on approval; get your tires free; no capital or experience required; make \$100 to \$300 weekly. Write for wholesale prices and sample section. Meilinger Tire Co., 929-K Oak, Kansas City, Mo.

SAVE your broken battery jars; quickly repaired by using H. B. Cement. Also Magneto collector rings, Distributors' covers, and all Radio Hard Rubber parts. Mailed fifty cents per bottle. Duluth Accessories Mfg. Co., Duluth, Minn.

INSYDE Tires inner armor for automobile tires. Positively prevent punctures and blowouts. Guaranteed double tire mileage. Any tire. Enormous demand. Low priced. Write for particulars. Agents wanted. American Accessories Co., B-778, Cincinnati, Ohio.

AUTOMOBILE Owners: Save 20% of your gasoline. Write us for information. Southwestern Research Laboratories, Norman, Okla.

LARGEST stock of automobile ornaments in country. Simon Supply, 207 North Seventh, St. Louis, Mo.

AIR compressors, ball bearing, automatic, \$28 cash. Balance terms. Motors, battery chargers, buffers on same easy payments. Write postal to Hobart's, Troy, Ohio.

AUTOMOBILE Owners, Garagemen, Mechanics, Repairmen, send for free copy of our current issue. It contains helpful, instructive information on overhauling, ignition troubles, wiring, carburetors, storage batteries, etc. Over 140 pages, illustrated. Send for free copy today. Automobile Digest, 505 Butler Bldg., Cincinnati.

AIR Compressors—Genuine Brunner Compressors, new, on very attractive terms; send post card. Brunner Mfg. Co., Dept. A, Utica, N. Y.

BATTERY charging pays big profits, \$20 starts your business. Profits pay balance. Write us. Hobbartson, Troy, Ohio.

PROTECTION from the wind, dust, rain and snow. Use "Wear Me" windshield wings and motor with pleasure. Fully guaranteed. Money back if not satisfied after ten days' use. Regular set, \$12.50; Ford special, \$10.00. Wear Me Auto Specialty Company, No. 1602 Broadway, Pittsburgh, Pa. See "Ad." page 151.

AUTOMOBILE Parts, Buy Direct and Save Money. Valves, Gears, engine bearings, piston rings, piston pins and bushings for all makes of passenger cars and trucks. All parts guaranteed. Write for Dealers Proposition. Auto Replacement Parts Co., 2011 Washington Blvd., Chicago, Ill.

AUTOMOBILE Repairshop Shortcuts—Over 1,500 time and labor saving hints from more than 1,000 of the best Repairshops in the U. S., 256 pp., 1,300 figs., Price \$3.50 postpaid. Popular Mechanics Book Dept., 6 N. Michigan Ave., Chicago.

BE Your Own Boss. Sontree guards engine efficiency. Condenses vapor in radiator. Keeps water supply constant. Warns of engine overheating. Retail \$5.50. Write for agents discount. Sontree, 609 N. LaSalle St., Chicago.

CRAFT Filters Reclaim Used Crankcase Oil. Absolute regeneration. Make your own filter at no cost. Blueprint and complete instructions \$1.00. Descriptive circulars free. Saturn Specialty Co., 257 N. First St., San Jose, Calif.

NEW overhead valve spring compressor, quickest on the market, \$2.00. Pujek special compressor 67c. Satisfaction guaranteed or money back. Marston K. Foss, Wilder, Minn.

AUTOMOBILES

DON'T wash your car. Dri Kleen It. New product cleans cars without water. Tremendous demand. Agent wanted. Sample and details free. P. Murray, Sales Manager, Station "A," Cincinnati, Ohio.

PATENTS—Write for our free illustrated Guide Book and Evidence of Conception Blank. Send model or sketch and description of your invention and we will give our opinion of its patentable nature. Highest references. Prompt service. Reasonable terms. Victor J. Evans & Co., 185 Ninth, Washington, D. C.

AUTOMOBILE Mechanics, Owners, Garagemen, Repairmen, send for free copy America's Popular Motor Magazine. Contains helpful, instructive information on overhauling, ignition, wiring, carburetors, batteries, etc. Automobile Digest, 505 Butler Bldg., Cincinnati.

PATENTS. Protect your rights. Before disclosing invention write for booklet and blank form. Evidence of Conception to be signed, witnessed and returned with rough sketch or model of your idea, upon receipt of which I will promptly give opinion of patentable nature and instructions. No charge for preliminary advice. Highest references. Prompt, personal attention. Clarence R. O'Brien, Registered Patent Lawyer, Southern Building, Washington, D. C.

AUTOMOBILE Repairman's Helper. In Two Vols. An excellent new work that gives every operation required to adjust or repair the troubles likely to be found in all standard cars. Vol. 1—Repairshop Practice—Passenger Cars—Trucks, 335 pp., 417 figs., Price \$3. Vol. 2—General Shop Practice—Passenger Cars—Parts and Accessories, 528 pp., 428 figs., Price \$3. Popular Mechanics Book Dept., 6 N. Michigan Ave., Chicago.

200% SAVED buying garage equipment direct from manufacturers. Magneto boxes, chargers, gear pullers. Write for complete list and low prices. Bruner Mfg. Co., Webb City, Mo.

REPAIRING Ford Cars, Trucks and Tractors in the most proper and efficient way is explained in a new 229-page book by the former director of the Ford Motor Co. Service School. This information is otherwise unavailable outside of the Ford plant. Written more especially for the mechanic and repairman. Price \$2 postpaid. Popular Mechanics Book Dept., 6 N. Michigan Ave., Chicago.

START! Auto Toy Building—new invention. Write Schives, 19 S. La Salle St., Room 1229, Chicago.

DYKE'S Automobile Encyclopedia, 12th edition, new, greater than ever, entirely rewritten and rearranged. Contains greatest array of auto facts ever published in one vol. Separate books containing same information cost \$21. Over 1,200 pages and 1,100 illus. Cloth \$6. Flex. Amer. Morocco \$7.50 postpaid. Popular Mechanics Book Dept., 6 N. Michigan Ave., Chicago.

FOR FORD OWNERS

THE wonderful newly patented Sun Automatic Spark Regulator eliminates all Tinner trouble. Gives proper spark automatically for every speed of the motor. More power and greater mileage at less cost on either rough or smooth roads or when climbing hills. Prevents carbon. Does away with use of spark lever. Back-kick impossible. Outlasts all other Timers. Fully guaranteed. Sold on 30 days' trial. Agents wanted. Splendid profits. Auto Sun Products Co., Dept. C, Cincinnati, Ohio.

ELIMINATE overheated motors. You can now install the genuine Nims Water-Circulating Pump on your Ford car or truck for \$5.00 complete. The most simple and practical pump on the market. It assures your Ford the same effective and positive cooling system as found on expensive cars. Send for yours to-day. You will never regret it. Will send C. O. D. Money back if not satisfied. Mignola Sales Co., Dept. C, Salinas, Calif.

CYCLE "Dynamo" hot-spot guarantees 25 to 35 miles per gallon. Greatest hill-climber known. Cycle Manifold Co., South High, Akron, Ohio.

ELECTRIC Primer starts Fords instantly in coldest weather. Circular on request. Simon Supply, 207 North Seventh, St. Louis, Mo.

FORD Car Repair Book Sent Free. This complete and well illustrated valuable book explains in a simple way how to overcome Ford car troubles; Repairing, Economical Winter Driving, Cold Weather Car Starting, Equipment for Fall and Winter, Curing Piston Ring Troubles, Carburetor Adjustments and Repairs, Connecting Rods, Timers, Transmission Troubles, and practically every phase of Ford car driving, repairing and equipment. Send 25c coin for three months' trial subscription and get the valuable repair book free. Ford Owner and Dealer Magazine, 525 Montgomery Bldg., Milwaukee, Wis.

FORD Owners, don't ruin your car by having it chatter. Correct same by installing Kreber's Ball Shim. Price \$1.10. Write for information. Nic Kreber's Son Mfg. Co., Rock Island, Ill.

FORD owners send twenty-five cents to cover cost of mailing and we will send for free trial one Jules Oil Circulator for Ford Cars, guaranteed to stop oil pumping, spark plug fouling, and double your oil mileage. Use 30 days. If satisfied, remit \$1.75. If not, return to us. Electric Machine Corporation, Indianapolis, Ind.

SENT for your inspection The Superior Ford Foot accelerator accurately machined from bronze and steel. Balanced and operates perfectly, easily installed. If satisfactory pay expressman \$1.50. Also our attractive carburetor control from instrument board, no reaching under dash; a convenience that will pay for itself, saving on gas and battery; \$1.50 postpaid. Dwyer Mfg. Co., Alhambra, California.

FORD owners, equip your car with the Peter Prim Tire Pump. Engine driven—attached to crank shaft. 60 pounds air pressure in 90 seconds. Low in price—high in efficiency. Send for circular. George Clagett Manufacturing Co., 681 Pennsylvania Avenue, Washington, D. C.

SPEEDSTER Fans. Don't fail to see "Red-I-Kur" ad. Page 149.

MOTORCYCLES, BICYCLES AND SUPPLIES

REAL Motorcycle Repairing. Factory tool equipment and genuine factory parts for Harley and Indian repair work. Generator, magneto and carburetor work a specialty. Also large stock used and new parts, all genuine. New Briggs Stratton motor scooter. \$85.00. New Merkel motor wheel. \$69.00. Bargains! J. B. Dahl, 3667 Archer Ave., Chicago, Ills.

LARGEST stock of new and used motorcycle parts and accessories in the world at your disposal via Uncle Sam's mail. Write for quotations. Motorcycle Parts Mfg. Co., 2930-36 Wabash Ave., Chicago, Ill.

'19 INDIAN 3 Speed \$85.00. '20 Indian 3 Speed \$109.00. '21 Indian 3 Speed \$150.00. Howard A. French Company, Baltimore, Md.; Washington, D. C.

SEND for our Bargain Bulletin and Money-Saving Message. It will save you money on Motorcycles, Side Cars, Motor Wheels, Repair Parts, and Accessories. Some used parts at less than half. Cleveland and Henderson Motorcycles our specialty. See our ad on page 148. American Motor Cycle Co., 2945-5-7 W. Chicago Ave., Chicago.

NEW motorcycles have been reduced 10%. Our prices have been reduced 35%. Send for big bargain list of rebuilt motorcycles. Western Supplies Co., 359 Hayutin Bldg., Denver, Colo.

DON'T buy a Bicycle Motor Attachment until you get our catalogue and prices. Shaw Mfg. Co., Dept. 27, Galzburg, Kan.

MOTORCYCLE cylinders ground, fitted with new piston and rings, \$8.00. Guaranteed. Muncie Piston Co., Muncie, Ind.

USED parts for all motorcycles, cheap. State wants, Schuck Cycle Co., 1922 Westlake, Seattle, Wash.

AVIATION

AT last! Your chance to learn to fly. Don't fail to write to Varney Aircraft Co., Peoria, Ill., for particulars of this great opportunity.

INVENTORS desiring patents should write for our Free Illustrated Guide Book and Evidence of Conception Blank. Send model or sketch for our opinion of its patentable nature. Highest references. Prompt service. Reasonable terms. Victor J. Evans & Co., 187 Ninth, Washington, D. C.

BIGGEST, best catalogue Model Aeroplanes, Parts and Supplies; 5c postpaid. Ideal Aeroplane Co., 67 1/2 West Houston, New York.

88 PROPELLERS, New, \$8. For Sport-planes, Aerobleds, etc. Diameter 6 1/2 feet. Requires 25-30 horsepower, direct drive, or 10-15 geared down. Made of ash, copper-tipped, for War Department. Cost about \$25 each. We purchased entire lot. Hence low price. Two propellers for \$15. One propeller and set of plans for building Ford Motored Sport Biplane, \$10. Order immediately. Aviation Engineering Co., Lawrence, Kan.

PROPELLERS for Aeroplane Propulsion. Practice or Professional type. 4 1/2 ft. diameters \$10; 6 ft. \$15; other sizes in proportion. Our astonishing prices free. Motorcycle sleigh blue-prints 75c. Ford type \$1.00. Refunded on purchase of Propeller. Send for Pictures of speedy windwagons and sleighs free. Crawford Motor Aeroplane Manufacturers, Long Beach, Calif.

GASOLINE Engines, 3/4 Horsepower, weight 2 lbs. Send stamp for circular. Weiss Mfg. Co., 327 Washington St., Brooklyn, N. Y.

SAILPLANE flies without motor! Efficient, inexpensive, easy to fly. Complete working drawings, \$1.00. Burke Aircraft Co., Downers Grove, Ill.

50 H.P. Motors, new, \$175.00. Weighs 188 lbs., complete. Rogers Aircraft, Rt. 1, Box 8, Ft. Worth, Texas.

"SPORTFORD Tractor Biplane." Plans for Building, \$2.50. Knockdown Planes sold on Installments. Aviation Engineering Co., Lawrence, Kan.

FLYING Instruction on Curtiss Biplane, \$100. Write for particulars. Aviation Engineering Co., Lawrence, Kan.

"MOTORCYCLE Engine and Monoplane." Plans and Flying Instructions, \$1. Aviation Directory, Lawrence, Kan.

AEROPLANE for Sale. One passenger, without motor. Eugene Shank, Morgan, Minnesota.

REMARKABLY fast and efficient Aerodrive Sled Blueprint 50c. Aircraft Supplies Bulletin for stamp. Ostergaard Aircraft, 4269 North Narragansett, Chicago.

WELDING

WELDING Encyclopedia—A complete instruction book on all welding processes; oxy-acetylene, electric arc, electric resistance and thermit. Welding of all weldable metals fully discussed. 326 pp., 875 Ills. The accumulated experience of the welding brains of America is yours for \$5. Money back if not satisfied. Popular Mechanics Book Dept., 6 N. Michigan Ave., Chicago.

BOOKS AND PERIODICALS

BIG money in writing photoplays, stories, poems, songs. Send today for free copy Writer's Bulletin, full of helpful advice how to write, where to sell. Edward's, Publisher, 708 Butler Building, Cincinnati.

24,000 PERIODICALS available by subscription. List free! Local agents wanted everywhere. Teejig Magazine Agency, Middletown, N. Y.

THINK! A Book that will teach you to Think. Postpaid \$1.00. Earn money selling Think. John James, Box 912, Nashville, Tenn.

PLANS for Poultry Houses. All styles, 150 illustrations; secret of getting winter eggs, and copy of "The Full Egg Basket." Send 25 cents. Inland Poultry Journal, Dept. 71, Indianapolis, Ind.

"MIND-READING?" Any distance, 30c. "Hypnotism" controls others; 25 easy lessons. \$1.00. Science Institute, PM 1014 Belmont, Chicago.

TRAPPERS! With my method mink are no harder to trap than opossum or skunk. My 6,000-word book contains methods of trapping other small animals. One man trapped 153 mink in one season; another, 78 in 7 weeks. My book worth hundreds of dollars to purchasers last season. Price only 50c per copy. Order today! David S. Pugh, Lawrence, Kan.

"MAGIC" Edward M. Massey, Just published, 36 entirely new and original effects, clearly described. Illustrated with 25 full-page plates and 11 smaller illustrations. Attractively bound, elaborate gold stamping 8 1/2 x 5 1/2. \$3.00 postpaid. Spou & Chamberlain, 129 P. M. Liberty Street, New York, N. Y.

OUR new catalogue listing over five hundred carefully selected practical books under eighty different subject groupings will be sent free upon request. Popular Mechanics Book Dept., 6 N. Michigan Ave., Chicago.

NEW Book—Shaver's Mail Order Directory tells where to buy almost everything imaginable at wholesale. Prepaid only 35c. Copy of book and best Mail Order Plan ever devised for 65c Money Order. G. O. Shaver, P. M. 20, Oil City, Louisiana.

DON'T discard old magazines or books. Join our club and exchange for new ones. Send 25c for life membership to Magazine Exchange Club, Box 1, Alvert Sta., Denver, Colo. No other fees.

INDUSTRIAL Alcohol. Wright's book everybody wants. Full directions for making with drawings of necessary apparatus. \$2.50 postpaid. Spou & Chamberlain, 129 P. M. Liberty Street, New York, N. Y.

1,000,000 INDUSTRIAL Facts, Calculations, Receipts, Processes, and Trade Secrets for every business are contained in the 1,000-page book, "Moore's Universal Assistant and Complete Mechanic," 500 Engravings, Cloth, Price \$2 postpaid. Popular Mechanics Book Dept., 6 N. Michigan Ave., Chicago.

BOYS' toy-maker book, 64 pages, illustrated, 10c. Amateur Electrician, 64 pages, illustrated, 10c. Radio Sets, how to build, illustrated, 25c. Western Puzzle Works, St. Paul, Minn.

USED books or educational matter of all kinds bought, sold, exchanged; free bargain price list, 1,000 items. Students' Exchange, 47 West 42nd St., New York, N. Y.

EXCEPTIONAL Book, Blueprints 9"x12". Turning wood Candle-sticks, table-lamps, etc., full size templates, \$1.00 postpaid. H. B. Gregg, 241 Lincolnton St., West Lafayette, Ind.

LOST Mail. Write immediately if anything ordered not received, Catalogues, 2c. Sovereign Company, 40 Broadway, Buffalo, N. Y.

RADIO books cheap. Catalogue free. Zenith Book Co., St. Paul, Minnesota.

BOOKS, All kinds. Lists. Higene's, A241 Post Street, San Francisco.

PICTURES AND POSTCARDS

BOYS and girls earn Xmas money. Write for 50 sets American Christmas Seals. Sell for 10c a set. When sold send us \$3.00 and keep \$2.00. Neubecker Bros., 961 East 23rd St., Dept. 88, Brooklyn, N. Y.

TEN exquisite Thanksgiving, Christmas, New Year's, Birthday or Comic Postcards, 10c; 75c per 100. Richard Lavery, Asbury Park, N. J.

JOIN Live Postcard club; Sample paper, list, catalog, 10c. Harry Teeple, Decatur, Ind.

TRUE-BLUERS everywhere. Exchange postals. Organized 1908. Membership: Year, \$1; half, 50c; quarter, 25c. Hundreds of items, 10c. Ed Eriksen, Elroy, Wis.

FREE postcard club and postcards. Stamp appreciated. Central Bureau, 233, Champaign, Ill.

10,500 MEMBERS, 119 countries, belong to Parisian Club; exchange postcards, stamps, letters, Particulars free. Neveu, 163 Sawyer, New Bedford, Mass.

POSTCARDS: Beautiful imported French girls; Samples; Literature; 25c. None free. Smiths Novelties, 6735 South Elizabeth St., Chicago.

NOVELTIES, CURIOS, ETC.

MYSTERIOUS Japanese Wonders—When dropped into water turn into fish, flowers, animals. Dozen assorted, 15c package. Heinemann, 7242 Pingree, Chicago.

FOR your den: Chinese Buddha Incense Burner. Delightful aroma, complete, fifty cents. Order today! T. Peters, 75 Carl St., Jamaica, L. I.

SUPERIOR, solid gold, self-filling, fountain pen. Direct at wholesale, \$1. Money refunded if dissatisfied. Address Sunny South Service, Madison, Fla.

SPECIAL—Indian blankets, 64x78 inches, price, \$3.50. Order today! Peerless Specialty Co., 28 Opera Place, Cincinnati, Ohio.

MAGIC TRICKS, BOOKS AND JOKERS' NOVELTIES

JEWISH nickels, 10c. 24 Mystic girl photos, 25c. Microscopic Watch Charms, 25c. Catalogs. Smiths Novelties, 6735 South Elizabeth St., Chicago.

TRICKS, Puzzles, jokes, magical apparatus, plays, stage supplies, mind-reading acts, and sensational escapes. 160-page illustrated professional catalogue, 10c. Oaks Magical Co., Dept. 548, Oakbrook, Wis.

TRICKS, jokes, magic, puzzles, cards, books. Catalog free. C. Penner, 2401 Jefferson, Louisville, Ky.

MAGIC—Tricks, Books and Supplies. For Amateurs as well as the great professionals. Anyone can learn through our Instructions. Feature Acts in Mind Reading, Spiritualism, Rope Ties, etc. Large Illustrated Professional Catalog, 10c. Chicago Magic Co., Dept. B, 140 S. Dearborn St., Chicago, Ill.

FREE—68-page Illustrated Magic Catalogue from factory. C. Penta, Minneapolis, Minn.

\$7,000 STOCK magical goods. Catalogues 15c. Address, Gilmaglio, Morgan Park, Ill.

GAMES AND ENTERTAINMENTS

MYSTERIOUS Wonder Showings, when dropped into water turn into fish, flowers, animals. Dozen assorted, 15c package; three, 35c. Excellent for dinner party favors; creating talk. Dozen packages, \$1.00. Heinemann, 1212 Pluegee, Chicago.

MAGICAL Apparatus—Mind reading, Crystal Gazing, Sensational Escapes, Joker's Goods, Card Tricks, Books, Novelties, Plays and Amusement goods. Large illustrated catalog free. Heaney Magic Co., Berlin, Wis.

LARGE professional catalog of magic and amusement goods free. Write today. Heaney Magic Co., Berlin, Wis.

PLAYS, musical comedies and revues, minstrel music, blackface skills, vaudeville acts, monologs, dialogues, recitations, entertainments, musical readings, stage handbooks, make-up goods. Big catalog free. T. S. Denison & Co., 623 So. Wabash, Dept. 19, Chicago.

INVISIBLE Ink; writes secretly; 25c coin. Mid-West Novelty Co., Kenilworth, Ill.

VENTRILQUISM taught almost anyone at home. Small cost. Send 2c stamp today for particulars and proof. George W. Smith, Room M-292, 125 N. Jefferson Ave., Peoria, Illinois.

200 KINDS Iron, wood and wire puzzles. Leader and illustrated list 15c. Western Puzzle Works, St. Paul, Minn.

ENTERTAINING Books, Puzzles, Tricks. Catalog free. Andco, 4949-TK, North Whipple, Chicago.

FORMULAS—Guaranteed. Catalog free. Bestovall Laboratories, 4049-FK, North Whipple, Chicago.

STAMP COLLECTING

SET 14 Ukrains, 25c; Belgium Olympic Games Set, 20c; Set 8 Nyassa Unused, 20c; 4 Fiume, 5c. See, 501 Ontario, Storm Lake, Iowa.

25 WORTH stamps for \$1; \$30 catalogue for \$5. No trash or common. All different. A. Arnold, Metuchen, N. J.

BEST one-cent approvals in America. P. P. Hand, 1117 So. 60th St., Philadelphia, Pa.

STAMPS Free—Ask for money-saving approvals. John P. Boerssen, Cedar Falls, Ia.

FREE, large Pictorial Jamaica Postage Stamp. Nielsen, 1923 Melrose, Chicago.

FREE Hinges to approval applicants. Oklahoma Stamp Company, Ardmore, (3) Okla.

158 GENUINE Foreign Stamps Mexico War Issues, Venezuela, Salvador and India Service, Guatemala, China, etc., only 10c. Finest approval sheets 50 to 60%. Agents Wanted. Big 72-p. Lists Free. We Buy Stamps. Estab. 29 yrs. Hussman Stamp Co., Dept. 54, St. Louis, Mo.

STAMPS—50 different Jamaica, Venezuela, etc., only 7c; 100 all diff., 10c; 1000 all diff., \$2.50; 100 diff., U. S., 25c; 1000 Hinges, 10c; 50 per cent approvals with every order. List free, I buy stamps. Write L. B. Dover, Dept. A, Longmont, Colo.

\$1.00 CATALOG value, all diff. stamps, only 10c; approvals with each order; also free lists, book, gauge, etc. About \$3.00 Cat. value, 25c. \$5.00 for 75c. Hawkeye Stamp Co., Cedar Rapids, 39, Ia.

150 DIFFERENT Argentine and Uruguayan stamps, cataloging over \$40, mailed for \$5 Bill. Will exchange medium and rare stamps with collectors in all countries. Base Scott. James Collins, 318 Brandzen, Quilmes, Argentine Republic.

PACKET of 23 stamps, no two countries alike. Packet hinges, Set of \$1 and \$2 U. S. Rev., all for 5c. Mention paper. Miami Stamp Co., Toledo, Ohio.

24 VARIETIES Cuban stamps, 10 cents. List of 6,000 low-priced stamps free. Address Chambers Stamp Co., 111P, Nassau St., New York City, N. Y.

FREE "Leader" Pkt. to approval applicants sending 2c stamp. Earl Stamp Co., 1811, 28th Ave., North, Minneapolis, Minn.

20 UNUSED stamps free. All different. Postage, 2c. Fisk Stamps, Toledo, Ohio.

100 DIFFERENT Stamps and Perforation Gauge, 10 Cents. Sornee Stamp Co., 975 Ivy Street, St. Paul, Minn.

SNAPS—150 different stamps, 15c; 60 different United States Stamps, 12c. With each order we give free our price list of sets, packets, albums, etc., and our pamphlet which tells "how to make a collection properly." Queen City Stamp Company, Room 26, 694 Race, Cincinnati, Ohio.

THE Fenway Packet, 105 different, including Abyssinia, Myassa, Turkey, White Russia, etc., catalog value, \$3.00, 200 hinges, set airplane stamps, postpaid for 12 cents to new applicants for our net approvals. Address Fenway Stamp Co., Fenway Station, Boston (17), Mass.

FREE—New Europe, 20 diff., to applicants for my 1/2, 1, and 2c approvals; also the higher-priced stamps at 50% disc. Send reference and receive extra premium. Chas. T. Egner, 1335 Pike St., Philadelphia, Pa.

45c FOR 10c Algeissian stamp, Guatemala Parrot stamp, 30 different British Colonies, packet singles, Finest Perforation gauge with handsome price list to introduce our exclusive approval sheets. Address Allen Sears, Dept. P, Lathrop Building, Kansas City, Mo.

FREE! Sectional Loose Leaf Postage Stamp Album at the rate of 8 pages each month given with subscription to our monthly Journal. Send two-cent stamp for prospectus. United Stamp Co., 140 S. Dearborn St., Chicago, Ill.

STAMPS, 50 Varieties, Africa, Brazil, Peru, Cuba, Mexico, etc., 10c. 50 different U. S., 25c; 1,000 mixed, 40c; 1,000 hinges, 10c. List free. C. Stegman, 5918 Cote Brillante, St. Louis, Mo.

100 VARIETIES stamps, 10c (\$1.25 catalog value), also price list with attractive approval selections at 50% discount. J. A. Goldsmith, Box 313, Kansas City, Mo.

FREE packet to applicants for net approvals with reference. 100 var. Neptune 25c. A. E. Hussey, 3458 Wilson, Cincinnati, Ohio.

1,000 VARIETIES \$1.00, no seconds. Satisfaction guaranteed. Try our 60% approvals, 1,800 var. Premiums, lists free. Wilmar Edgar, Cherokee, Ia.

HUNGARIAN Soviet Set, featuring European Bolshevik leaders; also 300 different stamps for 50c. Jacob Fischer, 1539 North Lawler, Chicago.

SELECT packet stamps catalogue, \$5. None common or cheap. Price \$1. Order today. Goldstein, 1233 Pacific Ave., Tacoma, Wash.

6 VARIETIES Poland, 5c; 20 varieties Hungary, 10c; try "Midland 50% Approvals"; Midland Milliken, Foster Bldg., Denver, Colorado.

FREE—25 different U. S. stamps with 60% approvals to reliable parties. 80 different U. S., 25c. C. Seidenberg, Merton, Wis.

100 DIFFERENT Wars, 10c. P. Buffham, Lake Ave., Racine, Wis.

READ about Stamps, Collectors and Dealers in "The Amateur Stamp Collector," Bethlehem, Pa. Latest issue free.

JOIN International Stamp Club, 25 cents, members in every country. 4002 Brooklyn Ave., Seattle, Wash., U. S. A.

FREE Dollar packet given with half catalog approvals. References required. Harlan, 5297a S. Marshallfield, Chicago, Illinois.

105 CHINA, etc., stamp dictionary, 144, 2c. Album (500 illustrations), 3c. Ballard, Sta. A Boston.

STAMPS, 20 unused, all different, free. Postage 2c. Mention paper. Quaker Stamp Co., Toledo, O.

TRY approvals around one-third catalogue. Reference required. John Sessot, 3051 Que. Washington, D. C.

STAMPS sent on approval at 70% discount. Reference required. Emory Renoll, Hazlet, Pa.

FIFTY stamps from fifty different countries, 10c. Mogensen, 414 North 14th, Omaha, Neb.

50c WORTH of stamps for 3c. Hull, 12 West 191st, New York.

100 DIFFERENT, 8c. Co-Operative Stamp Co., 710 Polham, St. Paul, Minn.

50 DIFFERENT stamps free. Postage 2c. Michael, 5692 Prairie, Chicago.

14 UKRAINE 20c. Approvals, Cassell, 331 Lumber Exchange, Minneapolis, Minn.

150 GOOD mixed foreign stamps, 3c. Elvin Stanton, Niantic, Conn.

LIKE Triangular Stamps? To introduce our Sudden Service Approvals we'll send triangular Flame, set China ships, large \$1.00 United States revenue, also packet 50 foreign, millimetre scale, perforation gauge, ruler and bargain lists for only 6c! Fenway Stamp Company, Dept. P, Fuller-100 Bldg., St. Louis, Mo.

4,000 MIXED (pound) 250 varieties 60c. 1,000 different \$1.00. Registration extra. Address Lyons, Marlton, New Jersey.

500 MIXED U. S. 10c. 1,000 Hinges 10c. 100 War Stamps 15c. Stamp Album 15c. 100 Foreign 10c. Weatheroy, Medina, Ohio.

FRENCH Colonies Free—Beautiful Picture set, including Native Chiefs, Tigers, Pictorials, 2c Postage. Empire Stamp Company, Toronto, Canada.

STAMPS Free—War Stamps, Surcharged, Unused, Pictorials, British, French Colonies 2c postage. Midland Stamp Co., Toronto, Canada.

BIG Variety Packet Foreign Stamps free for 2c postage. Gray Stamp Co., Station E, Toronto, Canada.

SAVE Old Stamps. Cole's Approvals will Satisfy. W. Jay Cole, 3019 Wallace St., Chicago.

FREE Set of Stamps to approval applicants sending 2c. Address, Richard P. Lauprecht, Valparaiso, Ind.

FREE—Eight Egypt to approval applicants enclosing postage. Emery, 567 Oakwood Ave., Toronto.

NEWFOUNDLAND stamp bargains! Lists sent. Rev. Butler, St. Georges, Newfoundland.

RARE COINS

DID you ever see a 10-cent greenback note? A genuine U. S. Greenback ten-cent bill? These were issued during the Civil War and are still legal tender. As a special "get-acquainted offer," I'll send you a good specimen and my 50-page illustrated Coin Catalog for only 25c. Send now, R. Max Melt, Numismatist, Melt Bldg., Dept. J, Fort Worth, Texas. Largest rare coin establishment in the United States.

OLD coins, large fall selling catalogue of coins for sale, free. Catalogue quoting prices paid for coins, ten cents. William Hedgesin, 1018 Tremont St., Boston, Mass.

1 LARGE Cent, over 200 years old, 25c; hundreds of other bargains. Address Fred Greenleaf, Box 297, Alton, Ill.

\$2 to \$500 each paid for hundreds of Old Coins. Keep all old money. Send ten cents for Illustrated Coin Value Book, 148. Guaranteed prices. Get posted. We pay cash. Clarke Coin Company, Avenue 2, Le Roy, N. Y.

40 OLD coins, all different, \$1.00, 100 old coins, all different, \$3.00. Claud Deuney, Box 315, Dallas, Texas.

CALIFORNIA gold quarter, 27c; half, 52c; 16c Washington, 30c; 1835 1/2c, 20c. A. Wylie, Wheaton, Ill.

10 DIFFERENT foreign coins, 25c postpaid. Otto Goldstein, Dallas, Texas.

OLD coins wanted. Have you an odd or old coin or bill? It may be worth several dollars. Get posted. Send 4c for coin Circular. May mean much profit to you. Send now. Numismatic Bank, Dept. H, Fort Worth, Texas.

CAMERAS AND PHOTO SUPPLIES

USE your prints with new Holiday Greeting. Send address, Harper Syndicate, Columbus, Ohio.

KODAK Prints 3c, Postcards 5c, developing 3c. Alpine Photo Co., Dept. P, 1822 Kinsey, Cincinnati, Ohio.

JUST Published—Our new complete 128-page catalog and bargain book of new and used cameras and supplies. Our goods are guaranteed finest quality obtainable. We have thousands of satisfied customers. Write at once for this bargain bulletin, sent hot from the press. Address Central Camera Co., 124 S. Wabash Ave., Dept. E-83, Chicago, Ill.

HAVE You a Camera? Write for Free sample of our big magazine, showing how to make better pictures and earn money. American Photography, 790 Camera House, Boston, 17, Mass.

ESTABLISH yourself—at home as an Expert Photographer and train with R. Vant, director International Studios, 343-B—3601 Michigan Ave., Chicago.

KODAKS, Cameras, Lenses, Photo Supplies, Radio outfits. Ask for bargain list, Hyatt's Supply Co., 417 N. Broadway, St. Louis, Mo.

BEAUTIFUL Holiday Gift—8x10 colored enlargement \$1.00. Kodafin, 287 Bellevue Place, Milwaukee, Wis.

CAMERAS, lenses, binoculars at lowest prices. Write your wants now. Emil Busch, eight power army officers' field glasses while they last, \$15.00. National Camera Exchange, 20 Washington Ave., South, Minneapolis, Minn.

SPECIAL Trial Offer: Any size Kodak film developed for 3c; prints 2c each. Over-night service. Expert work. Roanoke Photo Finishing Co., 209 Bell Ave., Roanoke, Va.

MAKE photographs in natural colors with common camera. Ask for booklet. Address today! J. Herzog, 216 Pearl Street, Ypsilanti, Mich.

SAMPLE enlargement, dime and negative (returned). Sample 6-exposure roll finished glossy, 25c silver. Brown Studio, Lake Elm, Minn.

FINE 5x7 Folding Camera, Cooke Lens, sell cheap or exchange. Elmer Bechtolt, Germantown, Ohio.

CAMERAS, New and used. Send for our bargain list. G. Walker, Box 633, Cincinnati, Ohio.

NEW Movie Cameras \$100. Projectors \$35; also Radio Equipment and Supplies. Write Gamble Bros., Mt. Airy, Philadelphia, Pa.

HIG Money Saved on Photographic Lenses and Apparatus—goods exchanged; repairing done. Ralph J. Golsen, 1128 Argyle St., Chicago, Dept. P.

MOTION PICTURES AND SUPPLIES

SEND \$3.00 for the Cinema Hand Book. Everything pertaining to motion picture making, taking, projecting studio laboratory work. 572-page book, pocket size, only \$3.00 postpaid. Also the new complete courses of the New York Institute of Photography. Motion Picture Photography, postpaid, \$6.00. Motion Picture Projection, postpaid, \$6.00. Motion Picture Directing, postpaid, \$3.00. Screen Acting, postpaid, \$3.00. Photoplay Writing, postpaid, \$3.00. The most elaborate works ever written on this subject. Bass Special Offer: The five books at \$17.50 postpaid. Free Cinema catalog. Bass Camera Company, Motion Picture Division, 109 N. Dearborn, Chicago.

AMERICA'S Greatest Fortunes have been made in the Moving Picture Business. Small investment needed. We furnish complete theatre equipment. Easy payments. Openings everywhere. Catalog free. Monarch Theatre Supply Co., Dept. F, 724 So. Wabash Ave., Chicago, Ill.

BUY direct from Manufacturers—New or rebuilt Moving Picture Machines for Homes, Schools, Lodges, Churches, Traveling Shows and Theatres. Mazda—Arc or Gas complete outfits—Film and Supplies. Dept. X, Monarch Theatre Supply Co., Memphis, Tenn.

FREE to Writers—A wonderful little book of money-making hints, suggestions, ideas; the A B C of successful stories and play writing. Absolutely Free. Just address Authors Press, Dept. 13, Auburn, New York.

WE buy used portable suitcase and professional moving-picture machines. Highest prices paid. What have you for sale? Monarch Theatre Supply Co., 724 So. Wabash Ave., Chicago, Ill.

CLEARANCE Sale—500 reels high-grade film. Two to six reel subjects. Famous movie stars. Special \$3.50 per reel only while they last. Stock up now. List free. Monarch Theatre Supply Co., Union and Fourth, Memphis, Tenn.

FILMS for Toy and Professional Machines. All famous movie stars. \$3.00 per reel and up. Machine bargains also. Write for big list free. Monarch Theatre Supply Co., Dept. P. M., 724 So. Wabash Ave., Chicago, Ill.

\$35.00 PROFFIT nightly. Small capital starts you. No experience needed. Our machines are used and endorsed by government institutions. Catalog free. Atlas Moving Picture Company, 482 Morton Bldg., Chicago.

FILMS For Sale—\$2.50 per Reel up. Address Queen Feature Service, Birmingham, Ala.

NEW suit case. Movie films, 3 reel; projectors, \$40. Movie camera, 200 foot; fastest lens, \$80, pan and tilt tripod \$25. Bargains in Radio Apparatus. Ray, 320 Fifth Ave., New York, N. Y.

MAKE money writing photoplays; details free to beginners. No correspondence course. Producers League, 230 Wainwright, St. Louis.

SEND stamp for 1923 catalogue of best miniature projectors \$30. Professional \$250. Suit Case \$185. Films Cheap. Address Werner Movie Sales, High Ridge, Mo.

HIG Money Nightly—Get my installment figures Complete Moving Picture Outfit before buying. Ralph J. Golsen, 1128 Argyle St., Chicago.

SEND stamp for catalog illustrating wonderful 1923 Kinograph Grand Home Movie Projector. Bargains in films. Address Werner Brothers, High Ridge, Missouri.

ALEXANDER Publicity Motion Pictures are rented to 50 lines of business. They are short and snappy. They combine all the features of good advertising: known circulation, undivided attention, low price, front page position, skillful artistry, constant change of copy. 35 states now served. More hustling district managers and salesmen wanted. Service sold repeatedly to same advertisers. \$25,000 per year is the present known limit of earnings. A postal or wire will bring the details to high-grade men. Alexander Film Company, 1151 Main, Spokane, Wash.

COMEDY scenarios for one reels—we pay cash. Enclose return postage. Alexander Film Co., Spokane, Wash.

SCENERY TO RENT

SETTINGS for Opera, Plays, Minstrels, Plush Drops. Address Amelia Grain, Philadelphia.

FOR BOYS

BOYS build three foot model airplane at small cost. Write Aero Shop, 3050 Hurbit Ave., Detroit, Mich.

COMPLETE moving picture machines, \$1.50 up. Also Radio sets. Particulars, Nite Mail Order & Supply Co., 609 27th St., Denver, Colo.

BOYS! You who like gripping, thrilling stories of achievement will want to read "Victories of the Engineer," a book that tells in a way you can understand it how the great feats in railroad engineering, building great bridges, ships, dams, canals, harbors, tunnels, mining, etc., have been accomplished. By A. Williams. 487 pp. 250 illus. Price, \$2.00 postpaid. Popular Mechanics Book Dept., 6 N. Michigan Ave., Chicago.

MOUTH-ORGAN Instructor, 25c. Play in one hour. G. Elsen, Bowling Green, Ohio.

OUTDOOR Winter Sports—How to Make Devices For. Plain instructions and clear drawings for building motor-driven sleds, snow speedsters, air-propelled sleds and ice boats, ski sleds and gliders, skis and ski running, ice yachts, coasting toboggans, etc. Price, 25c postpaid. Popular Mechanics Book Dept., 6 N. Michigan Ave., Chicago.

EDUCATIONAL AND INSTRUCTION

STUDY Bacteriology—become a laboratory expert. Course interesting, can be mastered in few months at home or in school. Good paying positions open. Degree granted our graduates. School 13 years old. Send for Announcement. American College of Bacteriology, 2923 S. Michigan Ave., Chicago, Ill.

SHOW card writing, a pleasant, profitable profession easily and quickly learned by our new, simple, graphic block system. Artistic ability not necessary. We teach you how. Distance no object. Full particulars and booklet free. Wilson Methods, Limited, Dept. M, 61 East Richmond, Toronto, Canada.

LINCOLN-JEFFERSON University, Home study in Academic, College, Theological, Law, Music, Pharmacy, Business and Graduate Schools, leading to degrees. Box W, 61 W. Randolph St., Chicago.

HIG money in writing photoplays, stories, poems, songs. Send today for free copy Writer's Bulletin, full of helpful advice how to write, where to sell. Edward's, Publisher, 603 Butler Building, Cincinnati.

INVENTORS—Write for our illustrated guide book and Evidence of Conception Blank. Send model or sketch and description for free opinion of its patentable nature. Highest references. Prompt attention. Reasonable terms. Victor J. Evans & Co., 147 Ninth, Washington, D. C.

DOUBLE Entry Bookkeeping mastered in 60 hours with 8 keys; guaranteed; diplomas. Our graduates lead in bookkeeping, auditing, accountancy, balance sheets, financial statements. International Bookkeeping Institute, Dept. 8, Springfield, Mo.

ARTIFICIAL Marble, sanitary flooring instructions, ornamental casting, concrete plaster, papier-mache decorations, garden furniture, statuary, Rubber-moulds. Electro-chemicals, particulars and 200 illustrations free. Chris Mahler, Box 122, Huntington, N. Y.

WANTED: Information exchanged about commercial uses for air compressors. Address Engineering Dept., Brunner Mfg. Co., Utica, N. Y.

BOOKKEEPING in a week. Dukes, 1837-9 Walton Ave., New York.

HAVE a business of your own; the most fascinating, best paying business-profession in the world, a foot correctionist; easy terms for training you at home in a few weeks, a new protected system that has enabled men and women to rise in one step to greater earnings than they ever thought possible; no capital required or goods to buy, no agency or soliciting. Address, Stephenson Laboratory, 1 Back Bay, Boston, Mass.

BECOME a Laboratory Expert—Learn Interesting, Profitable Profession of Bacteriology, Microbiology. Extension and Residential Courses. Diplomas—degrees granted. Help secure position. 46-piece urinalysis outfit free to students. Send today for free 34-page Prospectus. Physicians & Surgeons College of Microbiology, 955 Belden Ave., Chicago.

ROFF'S Calculator and Short Cut Arithmetic shows the answer as quickly as a watch shows the time to all problems likely to occur in office, store, shop, bank, farm or factory. Price, pocket size, paper, 35 cents, cloth 50 cents. Leatherette \$1. Desk size, cloth \$1.50 postpaid. Popular Mechanics Book Dept., 6 N. Michigan Ave., Chicago.

WORLD-ROMIC System—Masterkey to All Languages. Primera, 16 languages, \$1.94 each language; Arabic, Chinese, Danish, Dutch, English, Scotch English, French, German, Italian, Japanese, Punjabi, Polish, Portuguese, Russian, Spanish, Swedish. Pronunciation Tables, 22 languages, 30c each language. Languages Publishing Company, 8 West 40th St., New York.

SLIDE Rule. Save 75% of the time used to multiply, divide, figure percentage, proportion, etc., 25 lessons, instruction by mail. Rule with course. Write us for information. Buffalo Engineering Institute, Buffalo, N. Y. Licensed by the New York State Dept. of Education.

USED books or educational matter of all kinds bought, sold, exchanged. Free bargain price list 1,000 items. Students' Exchange, 47 West 42d St., New York, N. Y.

WRITE articles, stories, news, in spare time for newspapers and magazines. Big pay. Copyright book free. Press Syndicate, 552, St. Louis, Mo.

ENGINEER teaches Arithmetic, Algebra, Geometry, Trigonometry, Drafting, Surveying. Mondell, 50 East 42nd, N. Y.

CARTOONISTS—Improve your style by following the work of the greatest cartoonists found in the bound volumes of Cartoons magazine. Eight volumes, each covering six months, Jan.-June, 1917, to July.-Dec., 1920, inclusive, 1,200 cartoons, 900 pages to a volume, 7 by 9 1/2 in., 3 in. thick. New books; durable and attractive binding. Sold separately at \$2 per vol. postpaid. Supply very limited. Send at once. Popular Mechanics Book Dept., 6 N. Michigan Ave., Chicago.

HARMONICA Instructor, 25c. Play in one hour. G. Elsen, Bowling Green, Ohio.

LEARN to test Gold, Silver, Platinum. Instructions \$2.00. Davis, 1637 Roosevelt Rd., Chicago.

"WHAT to Invent For Profit" free. Patent News, N. Washington, D. C.

RADIO OUTFITS AND SUPPLIES

CRYSTALS—Keystone famous diamond mounts, supersensitive, loud tones only. Money refunded if not satisfied. 25c postpaid. The Keystone Products Co., 148 Gardenia Ave., Royal Oak, Mich.

LOUD-SPEAKER, complete with special powerful unit—no extras to buy—\$12.50 prepaid. Standard Spira cabinet type, compact, powerful, beautifully finished, with absolutely no distortion or tininess—clear, natural tone. Money back guarantee. Catalog free. Doanell Company, Box 74, Ann Arbor, Mich.

RADIO Crystals, 10 Varieties, tested, \$1.00. Address Harlow Radio, 2121 Seventh Ave., New York.

BUY direct from the Manufacturer and build your own Concert type Radio Receiver. We furnish all parts with cabinets and panels ready to assemble with complete instructions, for one, two and three tube sets. \$29.00 and up. Send 4c for Catalog and literature. Nevel Manufacturing Co., Station B, Kansas City, Mo.

CRYSTAL Set—Receives fifteen to twenty-five miles. \$7.50; with aerial, insulators, switch, etc., \$9.00; with 2,400-ohm double ear phones, complete ready to set up and listen in, \$14.00; each set thoroughly tested, fine finish, Hamar Co., Ludlow, Ky.

A VACUUM Tube Hospital. We repair vacuum tubes and guarantee them to work. Dealers, agents wanted. George P. Porcell Co., Inc., West Somerville, Mass.

VERMICA variable condenser for sharp tuning. Capacity .0005 mfd. Special screw adjustment gives perfect control. Brings in signals louder and clearer. Suitable for either panel or board mounting. Will make your radio set more attractive and efficient. \$1.75 postpaid. "A Better Condenser for Less Money." Discounts to dealers. C. S. Chorpeck, Mfr., 3125 Davlin Court, Chicago.

RADIO for the Amateur—Building, installing, Operating Stations for Radio Communications treated simply in "Practical Amateur Wireless Stations," a 136-page book compiled by Editor of Wireless Age. 115 illus. and diag. Size 4x9 in. Price 75c postpaid. Popular Mechanics Book Dept., 6 N. Michigan Ave., Chicago.

RADIO Books—Send for our specially selected list of 20 leading volumes among the reliable radio publications and also our complete book catalog. They are sent free upon request. Popular Mechanics Book Dept., 6 N. Michigan Ave., Chicago.

AUDION Sets, complete with Detector tube, Eveready "A" & "B" batteries and Frost Phones, \$35.00. Two Step Amplifiers with tubes, \$50.00. Patented Radium-Jewell crystal receivers, with Murock Phones and antenna complete, \$20.00. Money Back if not satisfied. Maker to user only. Trio Radio Laboratories, 9916 E. 14th St., Oakland, Calif.

SAVE Money. Construct your own wireless station. Photos and diagrams tell you how. Only ten cents. Address today! King Radio Corporation, 122 Fifth Ave., New York, N. Y.

TELEGRAPHY

TELEGRAPHY—Morse and Wireless—taught at home in half usual time and at trifling cost. Omigraph Automatic Transmitter will send, on Sounder or Buzzer, unlimited messages, any speed, just as expert operator would. Adopted by U. S. Govt. and used by leading Universities, Colleges, Technical and Telegraph Schools throughout U. S. Catalog free. Omigraph Mfg. Co., 18 Hudson St., New York.

TELEGRAPHY (both Morse and Wireless) and Railway Accounting taught quickly. Big salaries. Great opportunities. Oldest and largest school; established 46 years. All expenses low—can earn large part. Catalog free. Dodge's Institute, 11 St., Valparaiso, Ind.

BUSINESS OPPORTUNITIES

DO More! Be More! Have More! The Independence Money-Making Plans show how. If you want to make more money, send \$1 at once for these amazingly successful business plans in 8 small volumes fully illustrated. They contain 157 practical ways to add to your income. Stop playing for others. Build profitable business of your own. Start right at home during your spare time. Begin small. Grow big. These plans show how. Don't delay. No risk. Satisfaction guaranteed or your dollar back. American Business Builders, Dept. 880, 1133 Broadway, New York. (Mention this magazine and receive—free of charge—Dr. Marden's new booklet, "Go Into Business for Yourself.")

PATENTS. Protect your rights. Before disclosing invention write for booklet and blank form Evidence of Conception to be signed, witnessed and returned with rough sketch or model of your idea, upon receipt of which I will promptly give opinion of patentable nature and instructions, no charge for preliminary advice. Highest references. Prompt, personal attention. Clarence B. O'Brien, Registered Patent Lawyer, Southern Building, Washington, D. C.

ARE you making enough money? Pitkin will say you better. Establish your own business in your own town. For details, write J. M. Pitkin & Co., 314 Commercial Bldg., Newark, N. Y.

\$125 TO \$2,000 is sufficient to establish you in a cash business. No bad debts. Free information. Dept. M, Paul Kaye, 140 Broadway, N. Y.

608 WAYS to make money—2,716 Formulas "Encyclopedia Business Opportunities," 3 volumes, \$1. Ideal Book Shop, 5501-VK, North Rober, Chicago.

SILVERING Mirrors! My exclusive French Tartaric method opens enormously profitable business. Booklet free. H. Barstow, 511 23d Street, Oakland, Calif.

500 FORMULAS, Resilvering Mirrors—Renewing Dry Batteries—10 Luminous Paints, 25c. Ideal Book Shop, 5501-BK North Rober, Chicago.

EARN good income in your spare time, mailing circulars; instructions 10c. Box 5904, Bridsburg, Philadelphia, Pa.

ADVERTISE. Country town newspapers. List free. Pennell Company, Covington, Ky.

BECOME a Landscape Architect. Dignified, exclusive profession not overrun with competition. Crowded with opportunities for money-making and big fees. \$3,000 to \$10,000 incomes attained by experts. Easy to master through our correspondence methods. Established 1916. Get information today. American Landscape School, 56-K, Newark, N. Y.

\$75.00 TO \$150.00 a week made by operating 10 Lucky Photo Venders—the new 5c play trade booster. You simply lease machines to dealers. We show you how. Little capital starts profitable business. Exhibit Supply Company, 509 S. Dearborn St., Chicago.

PROSPEROUS Real Estate business of your own or position worth \$3,500! Our graduates have choice. Training at home prepares you in short time. We help you make good. Bulletin free. Penn Realty School, 1909 Ellsworth, Philadelphia.

EXCEPTIONAL Opportunity for Sales Manager capable of handling state distribution. Marvellous new Adding Machine. Retail \$15. Work equals \$350 machine. Tremendous possibilities. Unlimited profits. Write quick for details. Lightning Calculator Co., Dept. B, Grand Rapids, Mich.

RESPONSIBLE Corporation wants general sales managers to open branch office, manage salesmen. \$500 to \$5,000 necessary; expenses allowed to Baltimore if you qualify. Address Manager, 693 N. Eutaw St., Baltimore, Md.

MARBLE mixing instructions, covering wood or cement flooring 1/2 inch thick, fireproof, waterproof, low cost, sanitary, all colors. Particulars, 200 illustrations free. Chris Mahler, Box 122, Huntington, N. Y.

MAKE money with your camera. Booklet free. Write Lancaster, 115B North Main, Los Angeles, Calif.

CHEMICAL Expert will furnish Formulas and Trade Secrets. All lines. Lists Free. W. L. Cummings, Ph.D., 228 Gaither Ave., Syracuse, N. Y.

AMBITIOUS Men, write today for attractive proposition, selling subscriptions to America's most popular automobile and sportsman's magazine. Quick sales. Big profits. Pleasant work. Digest Pub. Co., 9503 Butler Bldg., Cincinnati, Ohio.

GET into the specialty manufacturing business. Amazing profits. We will send you free book explaining our system. Write immediately. A wonderful opportunity awaits you. National Scientific Laboratories, 211 North Monroe, Richmond, Va.

WANTED—Ambitious men to start profitable local or mail order business at home, quickly, inexpensively, without previous experience. Others made \$15 day. Write immediately. "Krafft," Box 599-P, San Francisco, Calif.

OPEN Clothes, Hat Cleaning and Pressing Establishment. Easy cleaning methods makes clothes, hats, etc. look like new. Wonderful opportunity. Particulars free. Address Byron, 27, Sts. I., New York.

"SUBMER" Magazine, Alliance, Ohio, prints big profit schemes; one subscriber making \$25,000 from three; another \$10,000 from one. Try your luck. Year, only \$1.00; three months, 25c.

MAKE Money at Home making toys. We show you how. Send \$1 for complete working drawings and designs. DeKalb Designing Co., Dept. 6, Decatur, Ga.

GO Into Business for yourself—Repairing, Retrimming of automobiles easily learned at home. Very profitable. Indispensable to all automobile people. Auto-finisher, Shilobyan, Wis.

GOOD money easily earned at home, spare time silvering mirrors; no capital. Free instructive book tells how. Patterson & Co., Brooksville, Ky.

LEARN the collection business. Good income, quick results. Interesting booklet "Skillful Collecting," free. National Collectors Assn., Long St., Newark, O.

MAKE Money at Home Making Toys and Novelties. Particulars free. New Specialty Co., 138 E. 31st St., New York.

EARN \$8 to \$15 per day on \$1.50 start. Write J. W. Clark, 738 Chelsea St., Memphis, Tenn.

PREPARE—Sell Your Own Products—Formulas, trade secrets. Interesting catalog free. B. Thaxly Co., Washington, D. C.

"THE Mail Order Man's Monthly" will help you make money. Copy 10c. Box 843, Cincinnati, Ohio.

DOLLARS yearly in your backyard. No Mushroom dope. Particulars free. Metz, 313 East 89th, New York, N. Y.

WANTED—State Contracts Kitchen Specialties. Mail Complete Detailed Offers. United Supply House, Lyons, Iowa.

FORMULAS by expert chemists. Free booklet, Quaker City Laboratories, 182 E. Alhambra St., Philadelphia, Pa.

AMBITIOUS People \$8.00 day easy made. Plan 19c. Peters, 12 Harrison Avenue, Gardiner, Maine.

\$10 DAILY easy. A complete business \$1.00. Helms Company, Hoboken, N. J.

FREE—Formula Catalog. S. & H. Laboratories, Boylston Building, Chicago.

"HOW to Sell Patents" free. Patent News-H., Washington, D. C.

START a clean, legitimate business at home. Big profits. Quick returns. Particulars free. John LaTour Co., Newark, N. J.

PUBLISH your own Magazine. Sample and instructions for quarter. LeBeuf, Fairview Station, Detroit, Mich.

START a cleaning, pressing, dyeing shop. Splendid field, big profits. Plans free. International System, Dept. 19, Excelsior Springs, Mo.

MAKE big money manufacturing marble, onyx, agate tile; more beautiful than genuine at cost of about 10c sq. ft. Marble face brick, any color, \$15.00 thousand; sell \$75.00. Experience unnecessary. Money-back guarantee with all expenses incurred if you cannot make products listed by following my instructions. Send for sample and list. B. F. Spencer, Elsinore, Calif.

STUDY Bacteriology—become a laboratory expert. Course interesting, can be mastered in few months at home or in school. Good paying positions open. Degree granted our graduates. School 13 years old. Send for Announcement, American College of Bacteriology, 2323 S. Michigan Ave., Chicago, Ill.

ENTER a new business. Earn \$3,000 to \$6,000 yearly in professional fees making and fitting a foot specialty, openings everywhere, with all the trade you can attend to; easily learned by anyone at home in a few weeks, at small expense; no further capital required, no goods to buy, job hunting, soliciting or agency. Address Stephenson Laboratory, 11 Back Bay, Boston, Mass.

MAIL Order Business is your opportunity. Brenner's Famous Handbooks teach how to start small, grow big. Sell merchandise, service, ideas; enormous profits. Spare time to begin. Get complete set, 11 books, \$3.00, and be posted. Brenner, 335 Walnut, Philadelphia. Descriptive Catalog and big batch interesting mail order information, 25c. None free.

\$100,000 CORPORATION wants capable man; open office; manage sales for High Class New Device. Every Home a Prospect. Big money-making possibilities for the right man. Opening in every city. Cost \$2.00, retails \$5.00, \$500 to \$2,000 necessary to finance exclusive agency. Scott Corporation, 82 W. Washington, Desk G, Chicago.

PATENTS Procured—Trade Marks Registered—A comprehensive, experienced, prompt service for the protection and development of your ideas. Preliminary advice gladly furnished without charge. Booklet of information and form for disclosing idea free on request. Richard B. Owen, 30 Owen Building, Washington, D. C. or 2276-R Woolworth Bldg., New York.

\$1,000 TO \$6,000 Yearly. Want it? Others are making it. Send check or money order today for our invaluable books "How to Sell Real Estate," \$3.00—and "How to Conduct Real Estate and Insurance Business," \$1.50. Absolute satisfaction guaranteed. Free catalogs, Realty Book Co., Dept. 52, Cleveland, Ohio.

ATTENTION!! Go into business for yourself. Establish and operate New System real estate, business brokerage and insurance Agency in your community. Office at home; earn \$5,000 year. Representatives wanted everywhere; send stamp for booklet. Hayes Realty Association, Cincinnati, Ohio.

If you have about \$1,000 and capable of organizing sales force, to sell article needed by every merchant, wholesaler and retailer, which should net you \$10,000 profits first year, write Sales Director, 825 Reaper Block, Chicago.

I HAVE over 100 stores paying \$5 monthly maintenance. You can do the same in your City. Month's practice qualifies. Only one person in each City chosen. Address Midnight Alarm System, 6111 Mack Ave., Detroit.

CONVERT each spare moment into cash. My dignified methods requiring no merchandise nor peddling, will enable you to increase your income, tremendously, without study, capital, experience or delay. Stokoy, Box 798, Dallas, Texas.

MAKE \$50 weekly plating, refinishing, oxidizing on nickel, silver, copper, brass, iron, steel. Write for particulars. Lancaster-Metalcrafts, 28 West 22nd St., New York.

MANUFACTURE These Biggest Selling Specialties in all lines. It's easy with Miller's Guaranteed Formulas and simple-detailed Manufacturer's Instructions. No Machinery Required. Investment Small. Stamp brings valuable information and literature relative to Magic Windshield Cloths, Carbo-Cide, Amazon Rubber Repair, Launderite Washing Compound, Bluing Paddies, Mexican Yucca Soap, Concentrated Vanilla, Beverage and Food Flavors, Coconut Creme Custard and all latest Food Products. Not the cheap trashy recipes offered by others—but Guaranteed Manufacturer's Formulas. 26 years supplying the Best. Miller, Chemist, Tampa, Florida.

SALESMEN—Agents! Unusual opportunity! \$50 to \$125 weekly. Semi-automatic double vacuum washers, easily attached to tub. No cranks or posts; air pressure and suction. Superior to power machines in many ways. Easily carried; sells on sight. Guaranteed success. Selling plans, advertising free. Extremely liberal terms. Write Burlington Mfg. Co., Dept. 2, Syracuse, N. Y.

WE Start You in Business, furnishing everything; men and women, \$30.00 to \$100.00 weekly operating our "New System Specialty Candy Factories" anywhere. Opportunity lifetime; booklet free. W. Hilber, Bay-Date, Drawer 3, East Orange, N. J.

BE Independent. We teach by mail how to manufacture unexcelled Toilet Preparations. Earn while you learn. Results guaranteed. Particulars Free. School of Cosmetics, Box K, Omaha, Neb.

I MADE \$30 a Week Home. French Breadmaking. 15 years' experience; Free Booklet tells. Ashbrook, 67, Marengo, O.

"WHAT To Invent for Profit" free. Patent News-C., Washington, D. C.

CHEMISTRY

YOUR Chemical Problem solved and working formula furnished. Five dollars. Write me. W. Stedman Richards, Consulting Chemist, Box 2402, Boston, Mass.

FOR accurate chemical analysis, sample matching, and reliable formulas at reasonable rates, write Somers Laboratories, 160 N. Wells, Chicago, Illinois.

CHEMICAL analysis honestly and correctly done by L. E. Tenney, Culton, N. Y.

MANUFACTURING Processes, Formulas, Technical Information. Consulting Chemist, Little Falls, N. J.

ASTRONOMY

STAR study becomes fascinating recreation with guaranteed Radium Star Map. Shines at night, \$8.50 postpaid. Sample card free. Address E. Stoddell, 225 N. Grove, Oak Park, Ill.

FORMULAS AND TRADE SECRETS

500 FORMULAS 25c; Luminous Paint—Resilvering Mirrors—Renewing Dry Batteries—Mechanics Soap—Gas Tonic—Carbon Remover—Puncture Plugger. 25c each. Entire collection 50c; Ideal Book Shop, 5561FK North Robey, Chicago.

FORMULA catalog free. C. A. Lutz, Apartment 464, York, Pa.

550 RARE formulas for 25c (min.). We can furnish any formula wanted for 50c. Catalog Free. Allen's Enterprises, 1227 Milwaukee Av., Chicago, Ill.

FORMULAS of the better sort. Write for our free catalog. National Scientific Laboratories, 211 North Monroe, Richmond, Va.

1,000,000 FORMULAS, recipes, trade secrets—1816 pages, \$2.00. Hillside Laboratories, 7021-A So. Winchester, Chicago.

3,000 ENGLISH Formulas (300 pages), \$1.00. Greenback posted. Wilkes, Publishers, Stockton, Rugby, England.

10,000 SELECTED scientific, chemical, technological and practical recipes and processes including hundreds of so called trade secrets for every business alphabetically arranged in one large volume of 800 pages. Price, \$4 postpaid. Peculiar Mechanics Book Dept., 6 N. Michigan Ave., Chicago.

1,000,000 FORMULAS, 1016 pages, \$2. 500 Formulas Free if you order quick. Ideal Book Shop, 5561-MK North Robey, Chicago.

5,000 FORMULAS, \$1.25. See our advertisement on page 72. Wells & Edwards, Book-sellers.

800 MONEYMAKING Formulas, Plans, etc.; Andco, 4049-GK, North Whipple, Chicago.

FREE—Formula Catalog, S. & H. Laboratories, Boylston Building, Chicago.

HONEST-to-Goodness Reliable, Hygrade Formulas, Rare Processes in all lines, 26 years supplying the Best. Miller Chemist, 501 DeLeon, Tampa, Florida.

AGENTS WANTED

WE want men and women who are desirous of making \$25.00 to \$200.00 per week clear profit from the start in a permanent business of their own. Mitchell's Magic Marvel Washing Compound washes clothes spotlessly clean in ten to fifteen minutes. One hundred other uses in every home. Nothing else like it. Nature's mightiest cleanser. Contains no lye, lime, acid or wax. Free Samples make sales easy. Enormous repeat orders—300% profit. Exclusive territory. We guarantee sale of every package. Two other "sight sellers" and sure repeaters give our agents the fastest selling line in the country. No capital or experience required. Baker, Ohio, made \$600 last month. You can do as well. Send for Free Sample and proof. L. Mitchell & Co., Desk 76, 1382-1314 E. 51st, Chicago, Ill.

NO Dull Times—Selling Food. The greatest, surest and safest business in the world today is selling Federal Pure Food Products, and here is your opportunity to get into this business. You can make \$3,000, \$5,000, \$10,000 or more per year—the only limit is your ability to take care of the business. We print your name and address as distributor on every package, thus making sure that you will get the thousands of dollars' worth of repeat orders which will be sent to you. No Dull Times, for the People Must Eat, and our food products are the fastest selling, surest and quickest repeat order getters in the world. Sell on sight in every home where food is used—Repeat orders immediately and every week thereafter. A Real Big Business All Your Own. Every new customer adds a great deal to your weekly income. Your business, once established, has a market value just like a store and can be easily sold. The greatest money-making opportunity of your lifetime because you risk absolutely nothing, as we guarantee your sales, and we will not let you fail. Remember! Guaranteed! Best products, biggest sellers, surest repeat orders. No capital or experience is required. We furnish capital and everything necessary for you to become a Federal Distributor. Exclusive territory will be given honest men or women who will write at once asking us to send our "Success Guaranteed" proposition. Address, Federal Pure Food Company, Dept. 15, Chicago, Ill. Largest inventors of and packers of Pure Food specialties in the world. Reference, any bank, Dun or Bradstreet rating agency, Express or Railway Company in America.

"HEAT Without Coal." New kerosene burner cooks, heats, bakes, cheaper, better, cleaner than coal or wood. Coal bills cut one-half. Fits any stove or furnace. Fuel shortage makes every home buy. Amazing big profits. Demonstrating burner free. Selling experience unnecessary. Even Heat Generator Co., 5123 W. 25th, Cicero Station, Dept. 10, Chicago.

TAILORING Salesmen: You can earn \$50.00 to \$150.00 a week selling our virgin wool line of tailored to order suits and overcoats retailing at \$29.50. None higher. All one price. Regular \$50.00 values. We have a large assortment of rich dependable fabrics. Beautiful patterns and weaves. Satisfaction guaranteed. You collect your profits in advance. We ship C. O. D. to customer for balance. No investment required. We furnish 6x9 swatch line complete with agency supplies. Protected territory for hustlers. Substantial income derived from repeat business after first season. Experience not essential. Write before your territory has been spoken for. Address, J. B. Simmon, Inc., Dept. 288, 831 W. Adams Street, Chicago, Ill.

300% PROFIT—Sells like Wildfire. Klean-Rite Magic Washing Compound. Washes Clothes Without Rubbing. Sells for 25c. You can make 15c. Sales guaranteed. "Distributing Samples Free." Premium Plan gets business. Exclusive territory. Write quick for proof and free sample. Bestever Products Co., 1941-K10, Irving Park, Chicago.

AGENTS—Men or women, \$6 to \$9 a day, taking orders for Liberty Balmcoats. Made to order in our own factory. Guaranteed. We deliver and collect; pay you daily. Full or spare time. No capital needed. Be sure and write today. Liberty Mfg. Co., 480 Liberty Bldg., Dayton, Ohio.

AGENTS, Salesmen, Demonstrators, you will have the devil's own time trying to find a better seller than "Zippo." If there was such a thing we'd have it. 150% profit on 50c "Go Getter" repeat article that sells on ten second demonstration. Works While You Watch It. Demonstrates value, while others waste time making claims. New Discovery! Greatest Scientific Triumph of the age. It's the berries. Haven't room to tell our story here. Write immediately. Karam-Smith Co., 1244 Clark St., Fort Wayne, Ind.

AGENTS—Here's a sure winner. We pay \$3 an hour for your spare time taking orders for "Zanol" Pure Food Flavors. Miss Edith Haur made \$54 in one week. Write for sample case. Makes beautiful display. Shows 18 articles of best and fastest sellers of Flavors, Soaps, Perfumes, Toilet Articles, etc. Every woman buys. Big repeaters. Have steady income. Customer must be satisfied or money back. Send for sample case today. American Products Co., 7965 American Building, Cincinnati, Ohio.

AGENTS—Earn \$25 to \$100 weekly introducing Ho-Ro-Co. toilet goods, extracts, and household necessities. Men or women wanted for full or spare time. Ho-Ro-Co. Tonic and Medicated Skin and Scalp Soap are great profit makers. Repeat orders easy and sure. Over 100 other fast sellers. Free sample case offer; free samples and advertising matter. Write today. Ho-Ro-Co. Mfg. Co., 188 Locust St., St. Louis, Mo.

SALES Agents. Men or women. \$210 a month. Steady employment. Take orders for Jennings New Guaranteed Hosiery for men, women, children. Written guarantee with each pair to wear and give satisfaction or new hose free. All styles. Finest silk hose. Low priced. Write for complete line of samples. Big money for spare time. Jennings Mfg. Co., Dept. 368, Dayton, O.

TERRITORY Salesmen: First popular price Fire Extinguisher ever made. Retail \$5. Others cost \$15. Every home, office or factory can be sold. One man sold 12,000 in Dayton. Peck cleaning up in Detroit, \$90 a week. No capital. No experience. Territory going fast. Write Thurston Mfg. Co., 178 Fox St., Dayton, Ohio.

AGENTS: It's a "Whirlwind." Get in on the greatest Repeat Order Proposition. In three months' time orders for Universal Products will come in by themselves. Let us prove it. Exclusive territory. All repeat orders turned over to you. Write today. Universal-Victor Company, Desk B, 1460 East Jefferson Ave., Detroit, Mich.

WHY work for others? Make and sell your own goods. We show you how. Enormous profits. Write quick for free book explaining everything. National Scientific Laboratories, 211 North Monroe, Richmond, Va.

PORTRAIT agents earn big money selling our Photo medallions. Photo medallion clocks. Religious medallions. Photo pocket mirrors. Photo buttons. Photo jewelry, and Fraternal Photo medallions. Send for free catalogue. Satisfaction guaranteed. Four-day service. Address Gibson Photo Jewelry Co., Apartment 7, 698 Gravesend Ave., Brooklyn, N. Y.

AGENTS, \$8 a day. Take orders for Blue Ribbon Cutlery Set. Stainless steel. Aluminum handle. Guaranteed. We deliver and collect. Pay you daily. Big demand. Easy to take orders. No capital needed. Write for sample outfit. Parker Mfg. Co., 378 Aul St., Dayton, Ohio.

YOU can be your own boss with our Key Check outfit. Good for \$5 a day stamping names on pocket key checks, fobs, etc. Sample check with your name and address, 20 cents. Please Die Works, Dept. M, Winchester, N. H.

AGENTS—\$50 a week taking orders for guaranteed hosiery for men, women and children. Must wear 12 months or replaced free. All styles and finest line of silk hose. Write for sample outfit. Thomas Mfg. Co., Class 262, Dayton, Ohio.

SELL the latest nationally approved cooking utensil, the Squire Broiler. Sells on sight. Convenient to carry and show. \$30 profit weekly easy for live agents. Get full details from A. A. Squire Mfg. Corp., 289 Madison Ave., New York.

MONEY—Money—Money! Make it selling Hanslick, the new and unbeatable hand-cleanser—the original powdered hand soap! Removes grease, grime, ink, paint, etc., without injuring skin. Spreads like wildfire. Cheaper than all others. Sells in cans (or bulk with dispensers) to garages, autoists, auto supply companies, mechanics, factory and office folks, to housewives, hardware stores. Huge quantities used weekly by mercantile houses. Big repeat business assured. Exclusive agencies, crews working for you, fast sales, splendid profits, permanent business for hustlers. Live ones can clean up \$500 a month. Send 10c (coin or stamp) for liberal sample can. Complete sales plan goes with it. Write quick to Solar Products Co., 124 W. Lake St., Chicago, Ill.

AGENTS Wanted. Additional Territory Open to District sales managers capable of earning from \$5,000 to \$10,000 a year selling men's, ladies' and children's hosiery. Men with seasoned selling experience and executive ability. If you are manager of house to house salesmen and can develop them so they are able to earn big money in their territories and being a top-notch yourself accustomed to real selling; do not put off; but now, get your application on file; the time is ripe to start for the fall season. Write us for full particulars. H. & S. Hosiery Mills, Reading, Pa.

WANTED—Tailoring Sales Agent—Make big money from very start—\$60.00 to \$75.00 weekly. Largest made-to-measure tailoring house, furnishing an equipment of five hundred woolsens, wants you to take orders. Satisfaction guaranteed. Biggest merchants in many towns have started with our line. If you want to establish yourself permanently in business and make big money write for full particulars, giving your experience as salesman or tailor's sales agent. H. F. Foster, Sales Manager, Lock Box 483, Chicago.

AGENTS—If you are making less than \$300 a month our proposition on Sentinel Burglar Alarms for windows and doors will interest you. Many agents earn \$20 daily. Brand new inventions. No wires, batteries or nails. Instantly attached to any door or window. Handsomely nickel plated. Sell on sight. No competition. Provides cheap burglar insurance. Big money makers. Write today for extremely liberal terms to agents. Sentinel Alarm Co., 140 S. Dearborn St., Chicago, Ill.

FREE Sample "Rain Shield Wiper." Retail \$1.00—Costs You 25 Cents (80% Profit.) Every Autoist Buys Quickly. No Cloth. No Paste. No Mechanical Attachment. (1) Rub keeps Windshields clear 48 Hours against Rain, Snow Storms. Invention Just Out. Prevents Accidents. (Williams makes \$12 Hour.) Experience Unnecessary. Wonderful Pocket Side-line. Write Quick for Your Free Sample. Nu-Life (1) Corporation, Hartford, Conn.

AGENTS—\$6 to \$12 a day. Take orders for Aluminum handle Cutlery Set. Brand new. We deliver and collect. Pay you daily. Sample to workers. The Jennings Mfg. Co., Dept. 1768, Dayton, Ohio.

AGENTS, look!—Radio Polishing Cloth Improved; works without polish; Long lasting, wonderful seller, sure repeater; big, steady profits; special inducement; sample free; write quick. Shillings Chemical Works, 1789 Ogden Ave., Chicago.

SAHARA: No Water Hand Soap, for automobilists, to wash hands after roadside repairs, without water. Agents wanted. Sample and details free. G. P. Taggart, Sales Manager, Station "A," Cincinnati, Ohio.

AGENTS—Beautiful Complete New Line Combination Toilet Article Sets—Magnificent Display Boxes—sells instantly now until Xmas. Tremendous Profits—Exclusive Territory. Foster Reid Factories, Y-2001 Mango, Chicago.

AGENTS with Ford cars, boost your gasoline mileage and your income using and selling Cyclo "Dynamic" hot-spout. Greatest hill-climber known. Cyclo Manifold Co., South High, Akron, Ohio.

NEW Invention—Money-maker for agents. Universal necessity that has not been "worked to death" by mail order houses. Selling outfit \$3.75. Secure territory today. Moulton Umbrella Company, Wilmington, O.

AGENTS—8,000,000 Foods need our \$20 "Greater Grip." Guaranteed 5,000-mile Fabric Fan Belt. Address Teuscher & Son, St. Louis, Mo.

BEST Seller: Jem Rubber Repair for tires and tubes; supercedes vulcanization at saving of over 80%; put it on cold, vulcanizes itself in two minutes, guaranteed to last life of tire or tube; sells to every auto owner and accessory dealer. Get particulars how to make big money and free sample. Amazon Rubber Co., Philadelphia, Pa., Dept. 510.

AUTO-Stop-Signals. Agents wanted, Every County. Easy sales—Big Profits. Money back Guaranteed. Exclusive Rights. First applicant. Retail \$1.00—Samples, \$1.25. Manufacturer, 701 Benar Bldg., Pittsburgh, Pa.

100% PROFIT—Free Goods—No Investment. High grade guaranteed aluminum utensil specialties and cutlery. 10 to 15 dollars per day easily made. Perfection Aluminum Mfg. Co., Desk A., Lemont, Ill.

MAN or Lady in every town to distribute our 7 Piece Aluminum Handled Cutlery Set. Whole or spare time. Experience not necessary. Sells on sight. High Quality Guaranteed, \$10.00 per day to right people. Perfection Aluminum Mfg. Co., Desk A., Lemont, Ill.

AGENTS—Jolly Molly dresses are quick sellers—good repeaters. Every woman wants one or more. Complete line now ready. No capital required—no experience necessary. Commissions advanced. Domestic Products Co., 523 Davis Bldg., Dayton, Ohio.

\$1,000 BEFORE Christmas—you can make it; no experience necessary. Rapid selling \$1.60 household necessity, wonderful gift. You sell, we deliver, pay daily. Address Eastern Kreenware Co., Franklinville, N. Y.

AGENTS. Fifty-five Fast Sellers needed in every home. \$5 to \$15 a day easily made. B. & G. Rubber Co., 618 Penn Ave., Pittsburgh, Pa., Dept. 181.

"MAKE And Sell Your Own Goods"—Tremendous Profits; No machinery; No experience; We show you how; Write quick for Free Book. Clover Laboratories, 3501 CK North Robey, Chicago.

LIGHTNING—Strange Battery Compound startles the world. Better than sulphuric acid. Charges discharged batteries instantly. Gallon free to agents. Lightning Co., St. Paul, Minn.

\$50,000 PROFITS in Portraits. Canvassing spiel, samples Free and finance you. 24-hour service, prints, portraits, frames. Friedman's Studio, Dept. 8, 673 Madison, Chicago.

WANTED—Agents. Protect-O-Mats, with name imbed, proven big seller; exceptional opportunity; territory going fast. Write Jackson & Co., 249 West 81th, New York.

POLISHING Cloth—easy seller, big money. Hundred other tippop specialties. Get this proposition. Address Newton & Co., 82 Main Street, Newark, N. Y.

EVERYBODY uses extracts. Sell Duo Double Strength Extracts. Complete line household necessities. Big repeaters. Write today. Duo Co., Dept. E1, Attica, N. Y.

AGENTS—Big Profits. 50c seller, office-household necessity. Sample 25c. Act quick. Address, A'ax Co., Steger, Ill.

AGENTS—Best seller; Jem Rubber Repair for tires and tubes; supercedes vulcanization at saving of over 80%; put it on cold, vulcanizes itself in two minutes, and is guaranteed to last the life of the tire or tube. Sells to every auto owner and accessory dealer. For particulars how to make big money and free sample, address Amazon Rubber Co., Amazon Bldg., Philadelphia, Pa., Dept. 505.

WHY work for others? Make and sell your own goods. We show you how. Enormous profits. Write quick for free book explaining everything. National Scientific Laboratories, 211 North Monroe, Richmond, Va.

AGENTS Wanted (in U. S. only). Make your Christmas Money. Sell our exclusive line of engraved Xmas Cards. The very best in design, quality and price. Big commission allowed. No money needed. Write for free samples and particulars at once, as no answers will be considered if received later than November 30th. Knight & Co., Box 276, Riccarton, N. J.

AGENTS—\$85.00 weekly is a small income if you sell the Eradium (Luminous) Candles. Every Catholic will buy for \$2.00. Costs 84c. Your profit 110%. Demonstrating Case free. All homes can use Luminous Switch Plates, Balls and House Numbers. Quick easy sales that bring big money. The Pioneer Corporation, 6101 Yale Ave., Chicago.

LATEST! Newest! Biggest seller of the year. Over 350% profit. Mending Tissue. Repairs all kinds of cloth, umbrellas, gloves, etc., better and quicker than needle and thread. Every home needs this. Have others work for you. Sell to stores in dozen and gross lots. Sample free. Circle Sales Co., Moline, Ill.

PATENTS. Protect your rights. Before disclosing invention write for booklet and blank form. Evidence of Conception to be signed, witnessed and returned with rough sketch or model of your idea, upon receipt of which I will promptly give opinion of patentable nature and instructions. No charge for preliminary advice. Highest references. Prompt, personal attention. Clarence B. O'Brien, Registered Patent Lawyer, Southern Building, Washington, D. C.

AGENTS: Wonderful Sellers—Men's Diagonal Gas Mask Raincoats "Goodyear Brand" costs you, dozen lots up, \$1.80 each. Women's, \$2.00; Children's, \$1.65. Rubberized Aprons, \$3.00 per dozen, and Wonder 3 in 1 Bag, \$3.25 per dozen. Order samples now. Biggest season coming. Profits unlimited. Chester, 202 East 12th St., New York, N. Y.

AGENTS—Sell our Airtcraft felt rug. Made of all new bright stock. Colors, red, green, blue, tan, etc. If you are looking for something to double your money on, send for our sample 28x58, \$1.50 prepaid, and we will show you how. E. Condon, 77 Bedford St., Boston, Mass.

\$195 EARNED by Schleicher in first twelve hours. Self-selling proposition establishes new money-making records. Automatic hot or cold running water bath equipment, without plumbing or waterworks, only \$7.50. Exclusive territory. Investigate. Send no money. Terms. Write today. Allen Mfg. Co., 678 Allen Bldg., Toledo.

SPECIAL offer to Agents in limited number cities and towns to sell well-known guaranteed Electric Drill; sells remarkably low price, \$25.00; Agents net \$8.00 each. Present agents averaging over \$100.00 weekly. Only few vacancies left; write at once. Consolidated Instrument Company, 41 East 62nd Street, New York.

MEN with Ford cars to sell the Peter Prim Tire Pump, the only engine-driven air pump for Fords. Pumps 60 lbs. air pressure in 90 seconds. No competition—low price—liberal commissions. Send for circular. George Clagett Manufacturing Co., 631 Pennsylvania Avenue, Washington, D. C.

LIVE agents, either sex, positively a new article, every housewife buys "Ideal" non-linting Dish Towels on sight; easy sales, big profits. Send 20c for sample towel and credit coupon if you mean business and want a real leader. Utility Manufacturing Co., Norwich, Conn.

\$75.00 WEEKLY Commissions. Coin money (45) newest household, automobile specialties—(just out). Every home, garage, automobilist, accessory store instantly buys (1) to (100)—No money. No experience needed. Exclusive territory going fast. Write quick for free samples, Factory (A), Box 694, Hartford, Conn.

LARGE manufacturer wants agents to sell guaranteed made to measure raincoats, Gaberlines and Reversible top and raincoat combined. Make \$75 to \$100 weekly. Profit in advance. We deliver and collect. Outfit free. Standard Raincoat Co., 103 West 21st Street, New York, N. Y.

PORTRAIT Agents, who want good work and prompt service and who desire to purchase their frames at factory prices, should write us at once for catalog and price list. W. G. Hannan Co., Dept. A-5, 57 E. 18th St., Chicago, Ill.

TAILORING Agents: You can make more money with a one-price line than with any other. Ours is a better one-price line. It offers All-Wool Tailor-Made Suits, regular \$50.00 values, at only \$29.75, including a good profit for you. You get your profit in advance with every order. We supply everything. Can use a few more good men. Write at once. Address, Park Tailoring Company, Dept. 551, Chicago, Ill.

AGENTS! A sale in every home for our beautiful dress goods, silks and general yard goods. Quick sales! Big profits! Large book of nearly 1000 handsome fabric samples furnished to agents. Write today. National Importing & Mfg. Co., Dept. 6X, 573 Broadway, New York, N. Y.

WHY work for others? Make and sell your own goods. We show you how. Enormous profits. Write quick for free book explaining everything. National Scientific Laboratories, 211 North Monroe, Richmond, Va.

MAKE \$25 to \$50 Week representing Clows' Famous Philadelphia Hosiery, direct from mill—for men, women, children. Every pair guaranteed. Prices that win. Free book "How to Start" tells the story. George Clows Company, Desk 31, Philadelphia, Pa.

OUR Ex-Cel Luminous Crucifix shines brilliantly in the dark. Churches, hospitals and individuals are only waiting for a demonstration before buying. Agents make handsome profits. W. G. Hannan Co., Dept. B, 57 E. 18th St., Chicago.

MARVELOUS Scientific Discovery. "Marvel" pearls that are exact reproductions of real pearls. Women wild for them. Write quick. W. J. Trythall, Importers' Representative, Nashwank, Minn.

TAILORING Salesmen: Make \$75.00 a week selling our strictly All-Wool Made-to-Measure Suits at \$26.50. You collect profits in advance and keep them. We supply finest Selling Outfit in America. Many exclusive money-making features. Tailoring, raincoat and side-line men, part or full time, get in touch with us immediately. Goodwear Chicago, Inc., Dept. 161, Chicago, Ill.

AGENTS: Get your money on the spot, \$16 daily demonstrating Sereolas. No waiting for commission or salary checks. No delivering. No collecting. Big season just starting. Write or wire. Perry Ludlow Co., 8-1962, Dayton, Ohio.

AGENTS: Reversible raincoat. Two coats in one. One side dress coat, other side, storm overcoat. Guaranteed waterproof or money back. Not sold in stores. Big commission. Sample furnished. Parker Mfg. Co., Coat 578, Dayton, O.

BIG Money and Fast Sales. Every owner buys Gold Initials for his auto. You charge \$1.50; make \$1.35. Ten orders a day easy. Write for particulars and free samples. American Monogram Co., Dept. 40, East Orange, N. J.

AGENTS wanted, Act as Jobbers. Advertised products. Hand Cleaner, no water or soap required. Auto polishes, etc. Manufactured under formula Chief Chemist, Lackawanna Railroad. Particulars free. Scientific Mfg. Co., 39 Church St., New York.

CLARKE made \$18 an hour selling vest-pocket windshield cleaner needed by every autoist, motorman, engineer; one rub keeps glass clear 24 hours; 60,000 sold; amazing proposition free. Security Mfg. Co., Dept. 627, Toledo, Ohio.

BIGGEST commission ever paid agents selling standard household articles. Five exclusive specials. Entire first payment agent's. No collections, deliveries, investment. Baxter's patented "Tupay" bond insures satisfaction. Agent's kit free. National Factories, Tribune Bldg., New York.

WILLIAMS No Water Hand Soap, in tubes, has taken auto owners by storm; washes dirtiest hands perfectly clean without water. Easy demonstration makes quick sale; 150% profit. Address W. B. P. Williams, Montclair, N. J.

LIVE Agents make \$10 Day selling Kuzka Strainer and Splash Preventor for every water faucet. Takes on sight. Widely advertised and known. Get details today. A. B. Seed Filter Company, 78 Franklin, New York.

SALES Representative wanted every county to give all or spare time. Position worth \$1,200 to \$3,000 yearly. No previous experience or capital necessary. Write for full particulars. A. A. Silver-Chamberlin Co., Clayton, N. J.

ONE reliable agent in every city to sell Penkala, the handiest and most efficient Everpointed Pencil, awarded Gold Medal 1915. Big Christmas seller. Sample 50c, worth double. Muller-Service Co., 419 Pine, San Francisco.

ANY man handy with paint brush or light tools can start new mechanical business on nearly nothing; needed everywhere; nearly all profit; experience not required. John Braceland, 1457 So. Ninth, Philadelphia, Pa.

FREE—Formula Catalog. S. & H. Laboratories, Boylston Building, Chicago.

THE Agents' and Salesmen's Guide, tells where to buy almost everything. The most wonderful list of business opportunities ever published. Copy, 25c. Wilson Publishing Co., 1400 Broadway, New York.

EXCLUSIVE territory for our wonderful fuel economizer going fast. Saves third your coal. Fuel shortage creates large sale. Sample outfit, 50c. Engineer, 157 West 72nd St., New York, N. Y.

RADIOPHONE—special—complete machine under \$9.00. Big first payment yours. No investment, collections, deliveries; exclusive territories, sales outfit free. Patented "Tupay" card winner. National Specials, 154 Nassau, New York.

MEN'S Shirts. Easy to sell. Big demand everywhere. Make \$15.00 daily. Undersell stores. Complete line. Exclusive patterns. Free samples. Chicago Shirt Co., 9 So. Clinton, Factory 205, Chicago.

AGENTS—Make two dollars an hour, 35c profit on every 35c sale. Sells on sight. Sample free. Empire Company Branch, 7201, Atlantic Avenue, Ventnor Sta., Atlantic City, N. J.

STRETCHING Kuff Buttons are sensational sellers; automatically opens and closes when cuffs are raised or lowered. Great convenience. Big money maker. Flexo Mfg. Co., Sheboygan, Wis.

PORTRAIT Agents—Earn big money selling our Photo Medallions. Everybody buys. You charge \$3.00; make \$2.40 each sale. \$10 daily easy. Big variety designs, 4-day service. Perry Photo Novelty Corporation, Section 16, 360 Bowery, New York.

START your own little mail order business anywhere. Home employment evenings. Everything furnished. Send stamp for instructive Booklet. Address Charles Pier, 74 Cortlandt Street, New York.

MAKE \$50 weekly plating, refinishing, oxidizing on nickel, silver, copper, brass, iron, steel. Write for particulars. Lancaster-Metalcrafts, 28 West 22nd St., New York, N. Y.

\$60 WEEKLY refinishing, staining, gilding of furniture, automobile, picture frames; making varnishes, stains, polishes. Forbes-Jampel Chemical Co., 210 East 22nd Street, New York, N. Y.

GET our Big Money proposition and Free Samples on Easy Applied Transfer Letters and be convinced. Auto Monogram Supply, 16 Green St., Newark, N. J.

MONEY-BACK guarantee makes Premier Sharpener fastest seller. Hundreds getting rich. You can. Write Premier Mfg. Co., 813 E. Grand Blvd., Detroit, Mich.

A BUSINESS of Your Own—Make sparkling glass name plates, numbers, checkerboards, medallions, signs; big illustrated book free. E. Palmer, 511, Wooster, O.

AGENTS—A demonstration sells our Marvel Can Opener, and doubles your money. Clinch your success with our proposition. Staples Mfg. Co., Mt. Vernon, Ind.

AGENTS: Big profits. Best and cheapest window letters made. Easily applied. Dime brings five samples. Particulars free. Stalbrico Co., 1115 Second Ave., New York.

THE Sims Shoe Ventilator will relieve your sweaty, tender, sore feet. Agents wanted. Particulars, W. B. Sims, 315 Mason St., Portland, Ore.

AGENTS, mail-order men, beginners. Something new. Valuable, inside information, free. Nite Mail Order & Supply Co., 609 27th St., Denver, Colo.

EARN \$10 daily silvering mirrors, plating and refinishing metalware, autos, chandeliers, bedsteads, headlights. Outfits furnished. E. Deele Laboratories, 1133 Broadway, New York.

GALLAGHER made \$336.00 in one week selling guaranteed Collection Systems, used by all business men. Sayers Mfg., 2815 Sheffield Ave., Chicago, Ill.

TOBACCO Conqueror Tablets quickly overcome tobacco habit, or money back. Harmless; inexpensive. Details free. Peerless Pharmaceutical Co., 108 Syracuse, N. Y.

AGENTS: Big Money Monogramming By Transfer Method. Catalogue Showing Over 50 Styles and Particulars Free. Motorists' Accessories Co., Mansfield, Ohio.

AGENTS sell Ford Door Pockets. Every Ford owner a prospect. Write for particulars. Haddon Bin Label Co., Haddon Heights, N. J.

AGENTS—\$20 daily distributing bamboo self-tilting greatest fountain pens. Just out. Sample free. Spors Co., Le Sueur Center, Minn.

"IDEAL" Auto Top Dressing. Big Seller. "Guaranteed." Address, John Byrne, Irvington, N. J.

AGENTS—Send for sample "Fretnot"—the washday wonder. Be convinced you can do a whirlwind business. You can clear at least \$20 to \$100 weekly, according to spare or whole time. You don't have to talk; if she doesn't buy at sight, leave sample; she will be looking for you long before you are able to make the rounds again. Samples furnished free. Premiums for your customers. Exclusive territory guaranteed to agents who can produce. Credits given. Don't call. P. M. Motter & Sons, 20 E. Jackson Blvd., Chicago.

AGENTS—\$60 to \$200 a week. Free samples gold and silver sign letters for office windows, store fronts and glass signs of all kinds. Anyone can put them on. No experience necessary. Big demand everywhere. Over 500% profit. Fred Foley, Binghamton, N. Y., made \$185.00 first month. Albert Gibbons, Kansas City, made \$212.00 in ten days. Liberal offer to general agents. Write today for sample of our high-grade window letters. Address, Metal-lic Letter Co., 431-C North Clark St., Chicago, Ill.

AGENTS Wanted—Something New—Fire Fighter sells easily. Makes a spectacular demonstration; car owners, homes, factories, stores, practically buy on sight. Our men make \$10.00 to \$50.00 a day; exclusive territory. If you wish to establish a business of your own with unlimited possibilities for making big money, write us today. Py-Fyer Co., 1103 Py-Fyer Bldg., Dayton, Ohio.

START in a permanent business of your own selling guaranteed Hosiery and Underwear direct from mills. No capital or experience is needed; many representatives make \$3,000 to \$5,000 per year. Become our district manager—get others working for you. Write for details to Malloch Knitting Mills, 5211 Grant St., Grand Rapids, Mich.

\$5 TO \$15 Daily Easy—Introducing New Style Guaranteed Hosiery. Must wear or replaced free. No capital or experience required. Just show samples, write orders. Your pay in advance. We deliver and collect. Elegant outfit furnished all colors and grades including silks—wool and heathers. Mac-O-Chee Mills Co., Desk 1011, Cincinnati, O.

AGENTS Wanted (In U. S. only). Make your Christmas Money. Sell our exclusive line of engraved Xmas Cards. The very best in design, quality and price. Big commission allowed. No money needed. Write for free samples and particulars at once, as no answers will be considered if received later than November 30th. Knight & Co., Box 276, Riverton, N. J.

AT Last—World's Greatest Adding Machine. Almost human. Retail \$15; week equals \$300 machine. \$300 monthly easily made, demonstrating to stores, offices, garages, factories. Simple, easy; adds, subtracts, multiplies, divides, automatically. Speedy, accurate, durable, handsome. Five year guarantee. Tremendous demand; amazing profits. Liberal trial offer. Protected territory. Write quick. Lightning Calculator Corp., Dept. F, Grand Rapids, Mich.

EVERY Raincoat Agent should get our proposition at once. If you have never sold raincoats and waterproofed overcoats now is the time to start. Any man able to talk is able to sell raincoats. Write for our "profit sharing, collective buying, superior quality" offer. Associated Raincoat Agents, Inc., 448-A North Wells, Chicago.

\$100,000.00 CONCERN wants agents to take orders for Caloridine Gas Mask Raincoats. Biggest selling coat in America today. Wonderful value. Big profit—in advance. Two sales means big day's wages. Only sample of cloth necessary—furnished free. We deliver and collect. Write today for exclusive territory and selling outfit. Dept. 611, Lewis Raincoat Company, Cleveland, Ohio.

BIG Money Makers. Large factory offers you big profits on 150 fast sellers. Toilet gift sets, flavoring extracts, remedies, soaps being you \$8.00 to \$25.00 daily. Howe of Illinois makes \$4.00 an hour. Sample outfit free to workers. Lincoln Chemical Works, Dept. 155, 2956 No. Leavitt, Chicago.

BIG Profits Selling New \$3.50 Automatic Adding Machine. Absolutely accurate. Fully guaranteed. Quick sales. Ten daily easy. No competition. Pocket size. Business people everywhere positive customers. Thousands being sold. Tremendous demand. Here's high-grade money-maker. Bassett Co., 1458-L, Hollywood Ave., Chicago.

\$1,680 MADE by Wings in six weeks selling Never Fail Razor Sharpeners. Purdy made \$40.50 first day. Other inexperienced men cleaning up big money. Applewhite, L. e., six orders in thirty minutes. Hurry—investigate—exclusive territory. Write today. Never Fail Co., 153 Allen Bldg., Toledo, O.

\$5 TO \$15 Daily Easy—Introducing New Style Guaranteed Hosiery. Must wear or replaced free. No capital or experience required. Just show samples, write order. Your pay in advance. We deliver and collect. Elegant outfit furnished all colors and grades, including silks—wool and heathers. Mac-O-Chee Mills Co., Desk 1011, Cincinnati, O.

AGENTS—\$15 a day—Easy, quick Sales—Free Auto—Big weekly Bonus—\$1.50 premium Free to every customer. Simply show our Beautiful, 7 piece, Solid Aluminum Handle Cutlery Set. Appeals instantly. We deliver and collect. Pay daily. New Era Mfg. Co., 803 Madison St., Dept. 21-E, Chicago.

PATENTS—Write for our free illustrated guide book and Evidence of Concealment Blank. Send sketch or model for our opinion of its patentable nature free. Highest references. Prompt attention. Reasonable terms. Victor J. Evans & Co., 163 Ninth, Washington, D. C.

"\$10 A DAY and More." our new book shows clearly how you may gain sure success and large profits selling Guaranteed Hosiery and Underwear, factory to family. It is Free. Write today. C. & D. Company, 41-B Grand Rapids, Mich.

GREAT Profits Assured capable men joining immediately national selling organization for Everflo Self-Filling Ink-Pencil pen. Writes with ink instead of lead. Send for Profit Proposition. Everflo Pen Co., Dept. 54, Grand Rapids, Mich.

SPIRAL Curtain Rods, broom protectors, Ironing Sheet Clips, factory prices. Other fast sellers. Address Hunt Mfg. Co., Box 1652-P, Paterson, N. J.

OUR Agents make \$12 to \$20 every day and are getting it with new invention that sells to everybody. Low price. Pocket sample. Write Edward Suren Company, 25 N. Dearborn St., Chicago.

AGENTS—Make big money the year 'round selling latest New York fashions, so smart looking and low priced no woman can resist buying. Address Strump & Co., Dept. 16, 29 West 34th Street, New York City, N. Y.

PORTRAIT Agents—Sample Rolls, Sample Cases and Samples of all kinds furnished to the portrait trade. Write for catalog Chicago Sample Roll Co., Dept. P, 57 East 18th St., Chicago.

AGENTS—Enormous Profits, Permanent Repeat Business, exclusive territory, selling highest quality products at low prices. Coconut Oil Shampoo retails 50¢ bottle, costs \$1 dozen. Soaps, Perfumes, Extracts, etc. P. Verdina Company, 18 East 18th, New York.

MEN and Women Make Big Money from start selling exclusively Dr. Blair's famous toilet preparations for every member of the family. Complete line. Business permanent. Remarkable selling outfit. Write quick. A. B. Blair Laboratories, Lynchburg, Va.

JACO Sanitary Straps sell on sight to everyone using combs. Three dozen \$3.69 delivered; easily sell for \$9.00. \$5.40 Profit sure every day. Get particulars quick. Jay Company, 111 Jay Building, Washington, N. J.

BIG Agent's and Mail Order Magazine of Opportunities and Information, including "Simply" Guide; Three Months 25¢. Harvey Teeple, Decatur, Ind.

MYSTERIOUS Fibre Novelties, when dropped into water, turn into fish, flowers, animals. Sample dozen with prices 15¢. Helmsmann, 7242 Pingree, Chicago.

AGENTS—\$10-\$100 weekly easy. Big variety Sanitary Brushes. High quality, low prices. Big commissions. Newray Brush Co., Hartford, Conn.

YOU can make \$10 to \$20 daily selling Rex India Fibre Brooms. Outlast three ordinary brooms. 100% Profit. Write Rex Fibre Products Company, 145-C New Jersey Ave., Brooklyn, N. Y.

EARN big money fast applying gold initials to autos. Every owner buys—\$1.35 profit on \$1.50 sale—particulars and samples free. Write quick. Lithogram Co., Dept. 17, East Orange, N. J.

SELL "Amens" Shirts; best-looking, biggest value. Manufacturer to wearer. Every order nets profit \$1.50-\$2.25. Write for winning sales plan. Menxin Shirt Co., 2663-A, Third Ave., New York.

AGENTS—New patented curtain rod, necessary in every home; big profits; 4 to 10 sales at every house. Write for free sample. Home Curtain Rod Co., Providence, R. I.

AGENTS make 500% profit handling Auto Monograms, New Pictures, Window Letters, Transfer Plans, Novelty Signs. Catalog Free. Write Hinton Co., Star City, Ind.

AGENTS—Stamping names on Pocket Key Protectors; sample Check with your name and address, 25¢. Stamping Outlets, Emblem Checks, Check Folders, Name Plates. Hart Mfg. Co., Desk 2, 303 Degraw St., Brooklyn, N. Y.

AGENTS—New Invention. Harpel's Tetruse Brush Set and Fibre Broom. It sweeps, washes and dries upstairs windows, scrubs and mops floors and does five other things. Big profits; easy seller. Free trial offer. Harper Brush Works, Dept. 72, Fairfield, Iowa.

AGENTS—Enormous profits selling Genuine Gold Leaf sign letters. Guaranteed not to fade. Establish a permanent business or travel. Anybody can do it. Free samples. Guarantee Sign Service, A 436 South California Ave., Chicago.

AGENTS—Crew men, novelty men. Gloo-Pen, a 50¢ monogram fountain pen; everybody buys on demonstration. Write for big profit plan. Gloo-Pen Co., 56-PP Pine St., New York.

AGENTS—Genuine Gold Letters anyone can put on Store Windows. Guaranteed to not tarnish. Large profits. Enormous demand. Free samples. Write today. Genuine Gold Letter Co., 439-A North Clark, Chicago.

HOUSEHOLD and office necessity, endorsed by "Good Housekeeping." An article of daily use. Large profits. Everett & Barron Co., Providence, R. I.

AGENTS—Sell Patented Cigar Lighters and Cigar-Case Moisteners. Big Profits. Start making money at once. Write for circulars, cuts and sales plan. Drake Mfg. Co., Dept. M, Milwaukee, Wis.

AMBITIOUS Men, write today for attractive proposition, selling subscriptions to America's most popular automobile and sportsman's magazine. Quick sales. Big profits. Pleasant work. Digest Pub. Co., 905 Butler Bldg., Cincinnati, O.

\$200 WEEKLY. Free samples. Sell gold sign letters to stores, offices. No experience. Big future guaranteed. Can travel. Exclusive territory. Become our general agent. Acme Letter Co., 2500D Congress, Chicago.

MAKE 600% Profit. Free Samples. Lowest priced Gold window letters for stores, offices. Anybody can do it. Large demand. Exclusive territory. Big future. Sidellina. Acme Letter Co., 2500-D, Congress, Chicago.

GOLD sign letters for stores and office windows. Photo pillow tops, portraits, frames, sheet pictures, medallions, waterproof aprons, novelties. Samples, catalogue free. Thirty days' credit. James C. Bailey Co., Desk J-11, Chicago, Ill.

AGENTS make a dollar an hour. Sell Mendota, a patent patch for instantly mending leaks in all utensils. Sample package free. Collette Mfg. Co., Dept. 404-B, Amsterdam, N. Y.

AGENTS. \$25.00 a week for spare time. Suits \$13.45, pants \$3.45 up. Money-back guarantee. Guaranteed Quality. Line well known. Samples free. Write Chicago Tailors Association, Dept. 106, Chicago.

GREATEST Sensation! Eleven-piece soap and toilet set, selling like blazes for \$1.75 with \$1 dressmaker's shears free to each customer; other unique plans. E. M. Davis Company, Dept. 506, Chicago.

AGENTS—Six new fast-selling necessities; big demand; unique selling plan; makes dollar an hour; credit given; samples free. Consolidated Portrait Co., Desk E, Chicago.

CALIFORNIA Rosebuds selling like hot cakes. Agents coinng money; new stuff. Big profits. Catalog free. Mission, 2421-PM, Smith, Detroit.

MOST Wonderful Seller, 96¢ profit every dollar. No stock to carry. License unnecessary. Sample free. Mission, 2421-PM, Smith, Detroit.

CABBAGE Cutter, 5 knives, slices 20 vegetables, finer than aluminum, never dulls, 20,000 users Cincinnati alone, endorsed by Good Housekeeping Institute. Agent's Sample 45¢. Meyer Co., Orland Ave., Cincinnati, Ohio.

AGENTS—Cheer Invention! Inkspoon makes every pen a fountain pen. Fast office seller; big profit, demand increasing everywhere. Exclusive territory offered. Sample free. H. Martz Company, Tribune Bldg., New York, N. Y.

EASY, pleasant work for Mechanic, Shop Men, Clerks, during spare hours; will add many dollars to their salaries. Also want persons who can give full time. Big wages assured. Novelty Cutlery Co., 87 Bar St., Canton, O.

MAKE big money selling our stamped 21-jewel watches. Case gold filled, stamped; warranted 25 years. Sales easily made. Sample, \$6.75. Osken & Co., 3926 N. Kimball Ave., Dept. 460, Chicago.

AGENTS—Men, women, to sell Pure Silk Hosiery direct to wearer. Commissions paid daily. Full commission on all repeat orders. We deliver and collect. Write Norwalk Hosiery Mills, Norwalk, Conn.

SELL Necessities. Everybody needs and buys the "Business Guide." Hyland cleared \$800.00 in July. Send for sample. It's free. Nichols Co., Box 4-B, Naperville, Ill.

100% PROFIT selling our felt rugs to homes, hotels, offices, etc. Everybody buys. We are manufacturers, not jobbers. Prices defy competition. \$75 week easy. Newark Felt Rug Company, 56-C Bergen Street, Newark, N. J.

PORTRAIT Agents: Our goods will make you big profits. Delivery guaranteed. Rejects credited. Prompt shipments. Send for latest catalog and prices. Adams J. Kroll & Co., 692 Blue Island Ave., Chicago, Ill.

AGENTS: Big profits. Genuine Gold Leaf Window Letters anyone can put up. Scripts and 57 varieties. Chicago Agency Co., 842 Altgeld St., Chicago.

BEST Proposition on Earth. Kitchen Specialty Every Woman Wants. Nothing like it in existence. 200% profit. Best Novelty Mfg. Co., Dept. C, 160 N. Wells, Chicago.

We start you without a dollar. Soaps, Extracts, Perfumes, Toilet Goods. Experience unnecessary. Canadian Co., Dept. 201, St. Louis.

SELFOLITE—Agents, Streetmen—Selfolite lights any fire while user sleeps, or any time. Performs surprising stunts. Newly patented. Sample 25c, postpaid; money back. Particulars. Kaytwo Mfg. Co., C195 Station A, Boston, Mass.

SOMETHING New! Men and Women make \$500 a month. Write for particulars. The K Products Co., 5075 Burns Ave., Detroit, Mich.

AGENTS—Make 100%. Toilet articles, Perfumes, Extracts, Household necessities. Sample Case Free. LaDerra Co., Dept. A, Main and Walnut, St. Louis, Mo.

LARGE Shirt Manufacturer wants Agents to sell complete line of shirts direct to wearer. Exclusive patterns. Big values. Free samples. Madison Mills, 563 Broadway, New York, N. Y.

WANTED—District Purchasing Agents, \$250 per month. Steady employment and exclusive territory. Write now. Experience unnecessary. National Instrument Company, 4793 North Hamilton, Chicago, Ill.

I AM making \$20 daily. You can too—with my plan and instructions. Price \$1.60. Scott, Box 301, Globe, Ariz.

SALESMEN, Act Quick. Ten patented auto necessities. Spark plugs, visors, windshield cleaners, hose clamps, etc. Generous commissions. Jubilee Mfg. Co., 23 Sen. C, Omaha, Neb.

AGENTS: Big Returns, fast office sellers; particulars and samples free. One Dip Pen Co., 2 Daily Record, Baltimore, Md.

FIFTY "Ideal" Sidelines for Mail Dealers and Agents. 500% profit. K. Home, 187 Warren, Chicago.

RUMMAGE sales make \$50.00 daily. We start you. Representatives wanted everywhere. Permanent business. "Crosby Co.," 609 Division St., Chicago.

GOLD Leaf Sign Letters; make and sell; profits exceed 1,000%; immense demand; particulars free. Johnston Co., Quincy, Ill.

HOUSEHOLD necessity; cost 12c, sells 50c; sample 25c. Steitz, 1545 Minnesota, Camden, N. J.

"ROMAN'S-Three-Games." Agent's samples and prices, 10c. Roman Arndt, Detroit, Mich.

WHY work for others? Make and sell your own goods. We show you how. Enormous profits. Write quick for free book explaining everything. National Scientific Laboratories, 211 North Monroe, Richmond, Va.

CABBAGE Cutter, 5 knives, slices 20 vegetables finer than aluminum, never dulls. 20,000 users Cincinnati alone, endorsed by Good House-keeping Institute. Agent's sample, 18c. Meyer Co., Orland Ave., Cincinnati, Ohio.

AGENTS, Sell Wolverine Laundry Soap, 15¢ other household necessities. Big line, Big profits. Quick repeaters. Free instruction. Exclusive territory. Write quick. Wolverine Soap Co., Dept. K, Grand Rapids, Mich.

KEROSENE Burners for cooking and heating stoves and furnaces. The Holland Sunburnt burner. The best burner—the best Agent's terms. Write for terms and territory. Holland Brass Works, 618 West Monroe, Chicago, Ill.

GOODYEAR Raincoat Free. We will send a handsome Rainproofed, All Weather Coat to one person in each locality who will show and recommend it to friends. Write today to The Goodyear Mfg. Co., 1749-C Goodyear Bldg., Kansas City, Mo.

SELL "Shyn-Rite." World's greatest polish. Fast seller. Sure Repeater. Big profits. Exclusive territory. Free Sample. Learn what "Shyn-Rite" actually does—then you will sell it. Heaton Products Co., 1274 Cushman Ave., Chicago.

27,000 RECORDS guaranteed with one Everplay Phonograph Needle; new—different; cannot injure records; \$10.00 daily cash. Free sample to workers. Everplay, McCaughey Bldg., Desk 116, Chicago.

PORTRAIT Agents: Our goods will make you big profits. Delivery guaranteed. Rejects credited. Prompt shipments. Send for latest catalog and prices. Adams J. Kroll & Co., 692 Blue Island Ave., Chicago, Ill.

MEN and Women wanted everywhere to sell "Clean-O" Washing Compound direct to homes. 300% profit. Easy to sell. DeHaven Manufacturing Co., 344 Garfield Avenue, Chicago.

AGENTS—Very latest toilet articles, perfumes and novelties. Fast sellers. Sure repeaters. Big profits. Free sample case. Lee-Jackson Co., Avondale 5, Cincinnati, Ohio.

A **WONDERFUL** Seller! Any man, woman, boy or girl can make big wages. Some agents make from \$8.00 to \$20.00 per day. Crimp Grip Clothes Line Fasteners are a simple, time-saving device for holding a rope—also used for many other purposes. It pays for itself quickly in time saved on wash days. No knots—it fastens and releases quickly. Every home a prospect. Every housewife who uses Crimp Grips—and there are thousands of them—is a booster. There is but one Crimp Grip. Write for particulars, or send 50¢ for one pair and a mounted sample, with full particulars to agents. Crimp Grip Company, Belvidere, Illinois.

GOOD income, spare time, refinishing chandeliers, brass beds, automobiles, etc., by new method; producing amazing results; every household possible customer; experience unnecessary; simple plan of manufacturing at home starts you in big money-making business. Write for free samples, showing finishes, etc. Gunmetal Finish Co., Ave. H, Decatur, Ill.

WATCH Your Step. Don't spend a Penny for Formulas or information to "Make and sell your own goods" till you've received my Valuable Literature and many Lists of Guaranteed Reliable Specialties in all lines. 26 years supplying the best. Miller Chemist, 803 DeLeon, Tampa, Florida.

CENTRAL Indiana Manufacturers now marketing an entirely new auto accessory that makes night driving safe, eliminating glare from approaching headlights. Want general sales managers to open branch office, handle exclusive territory and manage salesmen. Some investment necessary. Profit possibilities practically unlimited. Ray Auto Filter Co., Marion, Ind.

\$8.00 To \$20.00 per day. A wonderful seller. Any man, woman, boy or girl can make big wages Selling Crimp Grip Clothes Line Fasteners. It is a perfect rope holder and can be used for many purposes. Crimp Grips are a simple, time-saving device. They last a life time and will not rust; it holds the line tight, and saves time on wash days. Every buyer is a booster. Send 50¢ for Mounted Sample and one pair of Crimp Grip Clothes Line Fasteners. Write for particulars. Crimp Grip Company, Belvidere, Illinois.

AGENTS: Men and women, in spare or full time, make big money selling household necessity. Every home a prospect. Quick sales, big profit. Territory open. Write for particulars. Judd & Leland Manufacturing Company, Box 21, Clinton Springs, N. Y.

AGENTS, Sign Market Directory Free. Showing where to buy over 1000 different items in the sign line. Address Attractive Sign Works P, Cicero P. O., Chicago.

"**POLMET**" Polishing Cloth cleans all metals. Retail 25c. Sample free. Gale & Co., Inc., 15 Edinboro St., Boston.

SELLS Like Hot Cakes: big profits; new ironing wax pad and asbestos rest; clamps board; perfumes clothes; outfit 10c. Yankee Mfg. Co., 380 Atlantic Ave., Brooklyn, N. Y.

AGENTS—Big profits. Gold Sign letters easily applied. samples free. Liberal offer to General Agents. Dept. C, Interstate Sign, 2620 No. Halsted St., Chicago.

SOMETHING new! Sixmonth, 200% profit. Retail 25¢ to houses and offices. Gale & Co., Inc., 15 Edinboro St., Boston.

MAN wanted in every town. Nov. 715 Baltimore Bldg., Chicago.

"**HOW** to Sell Patents" free. Patent News-O, Washington, D. C.

MAKE \$50 Daily. Something new! 400% profit. All business, professional men need it. Sells \$5. Costs \$1. Brooks, Texas, sold 29 first day, profit \$80. Big weekly repeater. Sells quickly. Experience unnecessary. Write today for territory wanted. Sample outfit free. Federal Association, 71-K Aerial St., Hartford, Conn.

MEN—Women. Make \$9 daily representing established hosiery corporation. Introduce guaranteed silk hosiery to friends and others. We deliver and collect. Details Free. Empire Hosiery Corporation, 1829 Broadway, New York.

\$100-\$150 EARNED weekly selling ladies', men's, children's and household furnishings from illustrated catalogue. Send for details. Libby Mfg. Co., 177 Blackstone St., Boston, Mass.

500% PROFIT: Household, Store and Office necessity. Free sample. Address Chapman Co., 839 Dwight Bldg., Kansas City, Mo.

AGENTS make \$12.00 daily introducing Lubricant Carbon Remover. Particulars free. Address A. C. Sullivan, Fairport, N. Y.

AGENTS—Drop dead ones. We have a live 25¢ seller. Universal Milk Bottle Cover. Every housewife wants it. Makes every milk bottle a sanitary, air and water tight piteber. Cannot spill. Samples 25¢. Write now. E. Z. Art Needle Co., 515 N. Dearborn, Chicago.

300% PROFIT. Snow Dust washes clothes without rubbing. Women wild about it. Going big everywhere. Free samples. Exclusive territories. Norman C. Conrad, Washburn, Ind.

If you need good live agents—fellows who can get the business—ask me how others are doing it. I'll gladly render the necessary assistance. J. Roy McClellan, Mgr. Classified Advertising, Popular Mechanics Magazine, Chicago.

HIGH-GRADE SALESMEN WANTED

EVERY man wears shoes; we want salesmen everywhere to take orders for our special made men's shoes, direct to wearer; good commission, experience unnecessary. Write Decatur Shoe Co., Brockton, Mass.

TWO Oklahoma side line salesmen are averaging \$15.00 daily—with Rose Special Fountain Pen, selling to dealers. Try R. D. N. Rose Co., Tulsa, Okla.

SALESMEN—Sideline men calling on Hardware, Garage and Auto Accessory Trades. Big Commissions. Pocket Samples. Everbet Manufacturing Company, Maywood, Ill.

Q-U-I-C-K—Your big opportunity! 100% profit. Cataract Auto Washer Co., Topeka, Kansas, Dept. P.

SALESMEN calling on Garage and Tire trade, sideline or full time. Wonderful product. Address Radcliffe Co., St. Paul, Minn.

WERE you ever offered a grocery store? You can handle Sugar, Flour, Canned Goods, Dried Fruit, Coffee and entire line of groceries, as well as Paints, Roofing, Aluminum Ware and Automobile Oils, with no rent to pay; no money invested. Take large orders from samples. Goods are guaranteed and proven quality. Selling experience not necessary. Steady, profitable work for "workers." Address Hitchcock-Hill Co., Dept. 206, Chicago, Ill. Reference: Any Bank or Express Co.

HIGH-GRADE Specialty. Salesmen Wanted—Something New—Fire Fighter sells easily. Makes a spectacular demonstration; car owners, homes, factories, stores, practically buy on sight. Our men make \$10.00 to \$50.00 a day; exclusive territory. If you wish to establish a business of your own with unlimited possibilities for making big money, write us today. Fyr-Fyter Co., 1150 Fyr-Fyter Bldg., Dayton, Ohio.

SALESMEN'S Rights. Shows why no license is required. Gives legal facts and advice which will enable you to avoid trouble from local or state authorities. Money back if you do not think this book worth \$25.00 to you. Mailed on receipt of \$1.00. Address R. S. Hill, 38-G, W. Kinzie St., Chicago.

MINUTES pay dollars demonstrating world's greatest specialty. Wonderful new three-pound Adding Machine. Retail \$15. Work equals \$300.00 machine. Adds, subtracts, multiplies, divides, automatically. Speedy, accurate, durable, handsome. Five-year Guarantee. Tremendous demand everywhere. Amazing profits, main or side-line. Experience unnecessary. Write quick for liberal trial offer and protected territory. Lightning Calculator Co., Dept. G, Grand Rapids, Mich.

AGENTS—\$60-\$200 a week. Free samples. Gold sign letters anyone can put on store windows. Liberal offer to general agents. Metallic Letter Co., 431-F N. Clark St., Chicago.

EASY to sell Groceries, Paints, Automobile Oils, Roofing, Stock Food to consumers from samples, no capital or experience necessary; steady, profitable work. Commissions advanced. Satisfaction guaranteed. 59 years in business. Write for full particulars. Lowerin & Bros. Co., Wholesale Grocers, 1775 S. State Street, Chicago, Ill.

MAKE \$5,000 every year—\$2,000 in spare time. You share profits besides. Show "Weather Menarch" Raincoats and Waterproof Overcoats. Ask about "Dead Coat" (No. 999). Get sample raincoat free. Associated Raincoat Agents, Inc. 416-A North Wells, Chicago.

TERRITORIAL and local salesmen. Climax Oil Burners hottest residence furnace burners made. Scientific principles prevent smoke and soot; slide-line success, big demand. E. L. Miller Mfg. Co., 2224 West Third, Kansas City.

AMBITIOUS Men, write today for attractive proposition, selling subscriptions to America's most popular Automobile and sportsman's magazine. Quick sales. Big profits. Pleasant work. Digest Pub. Co., 9505 Butler Bldg., Cincinnati, O.

SALESMAN: If you want \$6,000 this year, write me. Strong line for retail stores. Nationally advertised. Liberal weekly advance to producers. W. Morgan, Mgr., 1929 Euclid, Cleveland, Ohio, Dept. 280.

SALESMAN fond of automobiles and machinery who likes to talk about them, to solve their difficulties, and to make them run smooth under all conditions, can make a connection worth \$3,000 to \$10,000 in an automotive accessory line which will keep him happy and contented. Prefer man without salesmanship experience to good salesman who doesn't like machinery problems. Permanent and will be as big as the man himself. Write what you've done and what you'd like to do. Bridgers Company, A St., Florence, S. C.

ADVERTISING and Novelty Salesmen of ability, experience and large earning capacity can connect with manufacturer leather and advertising specialties in ready demand among banks and big business concerns. Fine contract, commission basis, \$150 on single order not unusual. Selling aid extended. Write us fully about your experience. David H. Zell, Inc., Dept. F, 532 Broadway, New York.

SALES District Managers Wanted for Dominant Mc-All Polish, the new wonder that is being adopted everywhere. If you have small capital, we can make you a remarkable offer, one that will put dollars in your pockets while you are making cents now. Exclusive territory granted. Dominant Products Co., 163 South St., New York City.

SALESMEN Sell Tailoring—one of the most profitable of all lines. Our better one-price line of Guaranteed All-Wool Suits at \$29.75 sells on sight. Every order pays you a good profit in advance. Experience not necessary. We supply everything. This is a rare opportunity. Get the facts—today. Park Tailoring Company, Dept. 350, Chicago.

CLOTHING Salesmen Wanted at once to sell High Grade Virgin Wool Custom Tailored suits and overcoats direct to wearer at \$28.00. Satisfaction guaranteed, big commissions; experience not necessary; exclusive territory to men who qualify. House of Campbell, 456 S. State, Chicago, Ill.

ONLY one policy a day means \$150 per month profit; same on renewals. Policy pays \$5,000 death; \$25 weekly benefit for injury or sickness. Premium \$10 yearly. Full or spare time. Easy seller. Write quick for territory. Underwriters, Dept. K-35, Newark, N. J.

57 MILES per gallon made with new patented gasoline vaporizer. Write for particulars. Vaporizer Co., Pulwassa, S. Dak.

SALESMEN—Sell "Zim's Peerless"—the "hundred" collection system. Exclusive collecting features makes sales easy. Merchants buy "Zim's Peerless"—cast other system aside. It's the seller, boys! Switch today. Creditors' Association, 312-E McKnight Bldg., Minneapolis, Minn.

SALESMEN, Local or Traveling, make \$75 a week selling our advertising novelties. Largest assortment on the market. Calendars, Pencils, yardsticks, whistles, etc. Liberal terms. Entire year proposition. Pershing Mfg. Company, South Bend, Ind.

SALESMAN—Create profitable business. Easy selling household necessity. Cool situation makes exclusive distributorship doubly profitable. Free training and selling helps assure workers big success. Write or wire. Crown, Richmond, Ind.

SOMETHING New, a necessity. All business and professional men need it. Sells \$7.50, costs you \$1.40. Big repeater. Write for sample. Merchants Assn., Minneapolis, Minn.

SALESMEN make good side money selling small acetylene torch to garages and shops. Easy to sell. St. Paul Welding & Mfg. Co., St. Paul, Minn.

SALESMAN wanted with car. \$100 weekly. Sell new tires, tubes to car owners. Guaranteed in writing. Experience unnecessary. No investment. Manager, 1434 Wabasha, Chicago.

SALESMEN, Act Quick. Ten patented auto necessities. Spark plugs, visors, windshield cleaners, hose clamps, etc. Generous commissions. Jubilee Mfg. Co., 22 8th, C. Omaha, Neb.

NEED Investment Salesmen! "Advance" Advertising, nationally used system, attracts "producers"; eliminates canvassing; closes sales. Address Hazen Plan, Buffalo, N. Y.

MAKE \$50 Daily. Something New! 400% Profit. All Business. Professional Men Need It. Sells \$5. Costs \$1. Brooks, Texas, sold 20 first day, profit \$80. Big weekly repeater. Sells quickly. Experience unnecessary. Write today for territory wanted. Sample outfit free. Federal Association, 71-D Asylum St., Hartford, Conn.

DISTRIBUTORS, here's your chance! Want it? Nifty Clever Little "Cataract" Washer; cleanses autos quickly. Attaches to Garden Hose. All Brass—can't rust. Won't wear finest varnish. Everybody your customer. Three Styles—No. 1, \$2.50; No. 2, \$1.75; No. 3, \$1.35. Alluring profits. Quick shipments. Cataract Auto Washer Co., Topeka, Kan.

HELP WANTED

DISTRICT Managers—Big Profits. Men capable of organizing and managing crews of lady solicitors can easily clear \$50 to \$100 per week with the B. & G. Protector, the original and best protector on the market. Every woman between fifteen and fifty needs and buys it. Two grades. B. & G. Rubber Co., Dept. 189, 618 Penn Ave., Pittsburgh, Pa.

SALESMEN. Independence awaits the Lico Wires who grasp this opportunity. Warehouses, terminals, steamship companies, factories, hotels, cafes, etc., desperately need our scientific, positive, but simple method of extermination of rats and mice; grateful clients and long contracts await you; best exclusive territories going fast. Commission only. Write to-day. The Rath Laboratory, Inc., 115 Broad St., New York.

AGENTS: Cost \$5.00, your profit \$89.50, transferring monograms on autos, trunks, bags, furniture, etc. No experience, no license. Write for free samples. Transfer Monograms Co., Inc., 10 Orchard St., Dept. 151, Newark, N. J.

BE a Finger Print Expert—Opportunities opening everywhere. Write National System, 186 East 79th, New York.

CREW Managers—Xmas Tag and Seal Packages. 25 Pieces in each 10c package. \$4.00 hundred postpaid. Cash with order. Your profit \$3.00 hundred if you pay Boys and Girls 75c for selling 25. Send \$1.00 for 25 packages and silent salesman display sheet. Orleans Parcel Post Co., 808 Water St., Orleans, Vt.

\$5 TO \$15 Daily Easy—Introducing New Style Guaranteed History. Must wear or replaced free. No capital or experience required. Just show samples, write orders. Your pay in advance. We deliver and collect. Elegant outfit furnished all colors and grades including silks—wool and heathers. Mac-O-Chae Mills Co. Desk 19511, Cincinnati, O.

SALESMEN—Become Independent. Own your business; experience unnecessary; selling our \$7,500 Accidental Death, \$50 Accident, \$25 Sick Weekly Benefits; \$12.50 yearly; other amounts proportional. Guaranteed steady income from renewals. \$250,000 deposited Insurance Department. Registration Dept. A, Newark, N. J.

GOVERNMENT Clerical Positions open to Men, Women, Girls 18, over; Postoffice, Railway Mail, Departmental. Other Positions. Good salary. Experience unnecessary. Examination soon. Full particulars free. Write Columbia School Civil Service, 411 Pope Bldg., Washington, D. C.

FIREMEN, Brakemen, Baggage-men, Sleeping Car Train Porters (colored). \$149-\$200. Experience unnecessary. 810 Railway Bureau, East St. Louis, Ill.

AMBITIOUS Men, write today for attractive proposition, selling subscriptions to America's most popular Automobile and sportsman's magazine. Quick Sales. Big profits. Pleasant work. Digest Pub. Co., 9505 Butler Bldg., Cincinnati, O.

SIGN Letter Agents and Painters: 500% Profit. Gold and Silver Sign Letters for Stores and Office Windows. Anyone can put on. Big demand. Free samples. Metallic Letter Co., 431D N. Clark St., Chicago.

ALL men, women, boys, girls, 17 to 40, willing to accept Government Positions, \$117-\$199, traveling or stationary. Write Mr. Gzment, 101, St. Louis, immediately.

STORIES, poems, plays, etc., are wanted for publication. Good ideas bring big money. Submit manuscripts or write Literary Bureau, 522, Hannibal, Mo.

MEN wanted to qualify for Firemen, Brakemen. Transportation furnished. Write W. Rogers, St. Louis.

MEN—Boys over 17. Become U. S. Government Railway Mail Clerks. Big opportunity. Commence \$135 month. Quick, sure raise to \$195. Pleasant work traveling constantly. Every second week off—with pay. No layoffs. Common education sufficient. Pull unnecessary. Write immediately for free list Government positions open. Franklin Institute, Dept. K-5, Rochester, N. Y.

UNITED States Government Wants Men. Excellent positions at attractive salaries. Railway Mail Clerk Examination open. Let our expert (former United States Civil Service Examiner) prepare you for this and other fine positions. Write today for free catalog PM. Patterson Civil Service School, Rochester, N. Y.

150,000 SALES of a \$12.50 household appliance in New England have paid salesmen \$25 to \$150 weekly. We want District Managers of exclusive territory elsewhere to sell direct or obtain sub-agents. The Reeves Company, 64 Broad Street, Milford, Conn.

HAVING sold 150,000 of a household appliance in New England we now offer direct salesmen and district managers in other territory equal opportunity to earn from \$2,500 to \$5,000 yearly. The Reeves Company, 65 Broad Street, Milford, Conn.

BE a Railway Traffic Inspector! \$110 to \$250 monthly; expenses paid after 3 months' spare-time study. Splendid opportunities. Position guaranteed or money refunded. Write for free booklet CM-46. Stand. Business Training Inst., Buffalo, N. Y.

MEN—We want a man in every shop to sell our hand cleanser to fellow-employees. New. Different. Not a soap nor paste. Demand growing rapidly. Big profits. Write Foot Orange Chemical Co., Albany, N. Y.

START your own little Mail Order business anywhere. Home employment evenings. Everything furnished. Instruction, samples, novelties. Stamp brings instructive booklet. Address Calvin Pier, 74 Co. Landt Street, New York.

YOU are wanted. Commence \$135 month. Government Railway Mail Clerks. Steady. Common education sufficient. Write immediately for list positions open. Franklin Institute, Dept. K-21, Rochester, N. Y.

\$60 WEEKLY refinishing, staining, gliding of furniture, automobile, picture frames; making varnishes, stains, polishes. Forbes-Jampel Chemical Co., 210 East 22nd St., New York, N. Y.

EARN \$10 daily silvering mirrors, plating and refinishing metalware, autos, chandeliers, bedsteads, headlights. Outlets furnished. E. Deets Laboratories, 1133 Broadway, New York, N. Y.

MEN. Women, over 18, desiring Government positions, \$1400 up, write immediately for full information. Chicago Civil Service College, A-41 Keener Building, Chicago.

WANTED: Railway Mail Clerks—\$1,600 to \$2,300. Exams everywhere. Write today for full information. Patterson, Civil Service Expert, Box 4625, Rochester, N. Y.

OUR genuine gold window sign letters are an excellent money-making proposition for handy men. Slann Sign System, St. Antoine St., Detroit, Mich.

\$92-\$195 MONTH. Men, Women over 17. Steady, U. S. Government positions. List free. Write immediately. Franklin Institute, Dept. K-21, Rochester, N. Y.

WRITE Articles, stories, news, in spare time for newspapers and magazines. Big pay. Copyright book free. Press Syndicate, 553, St. Louis, Mo.

\$135 MONTH commence. Steady Government Railway Mail Clerks. List positions free. Write immediately. Franklin Institute, Dept., K-21, Rochester, N. Y.

SILVERING mirrors, French plate taught. Easy to learn. Immense profits. Plans free. Wear Mirror Works, Excelsior Springs, Mo.

YOU are wanted. Government jobs, \$95 month. Write for list. Franklin Institute, Dept. K-21, Rochester, N. Y.

MAKE money writing Photo-plays; details free to beginners. No correspondence course. Producers' League, 230 Wainwright, St. Louis.

START Silvering Mirrors, Auto Headlights, Tableware, etc. Plans free. Clarence Speinkle, Dept. 28, Marion, Ind.

HOME work in spare time. Full particulars 10 cents. Helmar Company, N. J.

LOCOMOTIVE Firemen, beginners, \$150, later \$250 monthly, for railroads nearest their homes, everywhere in United States and Canada. Address Railway Association, Desk M-1, Brooklyn, N. Y.

INVENTORS desiring to secure patents should write for our book, "How to Get Your Patent," tells our terms and methods, send sketch for our opinion of its patentable nature. Randolph & Co., Patent Attorneys, 620 F, Washington, D. C.

FOR ADVERTISERS

THOUSANDS maintain New York addresses. Why? How to increase your advertising results. Free. D. C. Way, 35 New St., New York.

BLOTTERS will advertise your business or product. Samples for stamp. Labarre Company, Pittsboro, Pa.

ADVERTISE in 24 Big Sunday Newspapers, 25 words \$15.00. Catalog listing 1,000 leading Dailies, Weeklies, Magazines, 4c stamps. Union Advertising, Baltimore Blag., Chicago.

INTERNATIONAL Opportunity: a live, inspiring, intensely interesting magazine! Six months 25c. International circulation! Ads. 1c word. 2279 First Ave., New York.

ADVERTISE Your ad in 100 magazines for 4c per word. Sample copy 10c. Harley Snell, 1021 State Ave., Cincinnati, Ohio.

YOUR 25-word advertisement in 100 magazines \$1.00; Riley-Zaur, 1517 South 48th Court, Cicero, Ill.

COMMERCIAL Engraving and Printing—the most practical and complete book on engraving, printing and allied subjects ever published. Over 800 pages and 1,500 illustrations presenting over 3,500 distinct ideas on 35 separate subjects. Cloth. Price \$15.00 prepaid. We highly recommend this book. Popular Mechanics Book Dept., 6 N. Michigan Ave., Chicago.

INCH Display Advertisement 161 Magazines Thrice \$15. Year \$50. Page \$100. Wood's Popular Services, Atlantic City, N. J.

ADVERTISING? We write, illustrate and print it. Jacobus Advertising Service, Irvington, N. J.

ADVERTISERS! Great results by advertising in West Virginia Advertiser. Classified 3c. Order today! E. J. Evans, Box 428, Kenova, W. Va.

SIGNS AND ADVERTISING

THE creating of a good impression is one of the most profitable forms of advertising, and a very good way to create such result is by the judicious use of Morgan Signs, Morgan Aluminum and Bronze Cast Signs and Memorial Tablets are Everlasting, Economical and Artistic. Circular upon request. Morgan Sign Co., Dept. K, 442 W. 27th St., New York City.

INFORMATION

RELIABLE information furnished on any subject or money refunded, 75c. Co-operative Service, Times Plaza, Box N44, Brooklyn, N. Y.

BUSINESS SERVICE

INCORPORATE. Our lawyers do the work, saving you time, annoyance and money in incorporating under the most liberal laws of Arizona. Laws and forms free. Southwestern Securities & Investment Co., Box D188, Phoenix, Ariz.

MAILING LISTS

ADVERTISERS get our lists. Jacobus Advertising Service, Irvington, N. J.

NORTH DAKOTA Lists—New list 8,000 prominent actual farmers, \$15.00, or \$2.00 thousand; 4,000 Dodge owners, \$8.00; 4,000 Chevrolet owners, \$8.00; 50,000 Ford owners, \$90.00 or \$2.00 thousand. All lists up-to-date, typewritten. Business Service Company, Bismarck, N. D.

ON request the Trade Circular Addressing Co., 164 W. Adams St., Chicago, will send their general price list showing 3,000 classified mailing lists, including Radio lists.

TYPEWRITERS AND SUPPLIES

SIMPLEX Typewriters \$1-\$5. Remingtons, \$12.50. Dimeo, Miantonomi Court, Providence, R. I.

TYPEWRITERS, all makes, largest stock, lowest prices, all rebuilt, refinished and guaranteed five years, shipped with privilege of one month's free trial. Underwoods, Monarchs, Remingtons, Olivets, \$15.00 up. Send for our lists and agents' proposition before purchasing. Typewriter Exchange, 2316 University Ave., New York City.

TYPEWRITERS. All Makes. Save one-half. Thoroughly Rebuilt in our factory by the famous "Young Process." Fully guaranteed. Free trial. We handle all standard makes. Cash or sold on easy terms. Write for Catalog. Young Typewriter Co., Dept. 414, Chicago, Ill.

UNDERWOOD Typewriters at far less than manufacturers' price; rebuilt, all worn parts replaced, guaranteed good as new. Cash, installment payments. Write for Catalog 1518. Shipman-Ward Mfg. Co., estab. 1892, Montrose and Ravenswood Ave., Chicago, Ill.

REBUILT Typewriters—all makes—\$10.00 and up. Our prices are 20 to 30 percent lower than installment houses. Every machine fully guaranteed. Send for free catalogue. Accurate Typewriter Exchange, 26 No. Wells Street, Chicago.

TYPEWRITERS, all standard makes, \$10 up. Fully guaranteed. Free trial. Write for illustrated Bargain List. Northwestern Typewriter Exchange, 320 West Goethe St., Chicago.

RIBBONS, 33c. Visible Makes. Typewriter Supply, 7927-29 Colfax Ave., Chicago.

DUPLICATORS AND DEVICES

"MODERN" Duplicators save Time, Labor, and Money. Gets Business, Reproduces Typewritten or Pencil Letters, Drawings, Lessons, Music, Menus, Bills, Notices, Specifications, Maps or anything in one or more colors. Prints Two per minute. Special Sale On 30 Days Free Trial, \$2.25 up. Booklet Free. J. E. Durkin-Reeves Co., Pittsburgh, Pa.

NEOSTYLE Mimeograph No. 5, \$25.00; Underwood Revolving Mimeograph, \$20.00. Joseph Berg, Hendrum, Minn.

YOU can make 50 to 100 copies of a letter, notice, etc., at a cost of three cents on a Hoyer Quality Duplicator. Write for free trial offer. The Hoyer Duplicator Co., 162 No. Wells St., Chicago, Ill.

ADDING MACHINES

FREE Trial. Marvelous new Adding Machine. Adds, Subtracts, Multiplies, Divides, automatically. Work equals \$75.00 machine. Price only \$15.00. Speedy, durable, handsome. Five-year guarantee. Used by largest corporations. Write today for catalog and free trial offer. Lightning Calculator Co., Dept. E, Grand Rapids, Mich.

NEW \$3.50 Automatic Adding Machine. Adds, Subtracts, Multiplies. Absolutely accurate. Capacity 999,999.99. Fully guaranteed. 75,000 pleased users. Makes adding easy, positive, quick. Eliminates mistakes. Saves Time. Postpaid, \$3.75. Bassett Co., 1438-K, Hollywood Ave., Chicago.

PRINTING, ENGRAVING AND MULTIGRAPHING

REDUCED prices for better printing. 1,000 Bond letter-heads, \$3.99; 1,000 good envelopes, \$4.25; 1,000 four-page folders, 3 1/2 x 4 1/2 inches, \$12.00. Catalogues, circulars, booklets our specialty. All printing at reduced prices. Samples free. Fantus, 325 S. Dearborn St., Chicago.

150 NOTEHEADS, 100 white envelopes printed and mailed \$1.00. Samples printing free. Address Sunco, Mohawk, N. Y.

12 CHRISTMAS Cards. Steel Engraved design—appropriate for anyone—with greeting and name Process Engraved in Old English or script. Postpaid \$1.25. Send check or Money Order. Universal Process Engraving Co., 202 So. State Street, Chicago.

BETTER Printing prepaid, for less money. Samples for stamp. Write today. Model Company, Manchester, Iowa.

2,000 LETTERHEADS or Envelopes \$6.25, prepaid. 3rd zone. Samples Free. Quality Printshop, Marietta, Ohio.

SOMETHING New—Patented Book Form Seal Grain Card Case and 100 paneled business or calling cards, 65 cents. Agents wanted. Sample case 15 cents. Anderson Co., Crivitz, Wis.

PRE-USED Printing Presses. Type and supplies. List for stamp. Popular Bargains, Richland, Pa.

IMITATION Typewritten letters. Multigraphing, Mimeographing, Printing, Cal System, Fairview Station, Detroit.

GOLD lettered advertising-pencils for you; buy direct, save entire middleman's profit. Samples free (no agents). Address, S. Mustal & Co., 423 Walnut St., Yonkers, N. Y.

HAMMERMILL Bond Letterheads, Envelopes, Billheads, Statements, Cards, Tags, Labels, 150, \$1.00; 250, \$1.50; 500, \$2.50. Race Printing Company, Hudson, N. Y.

TRY our attractive two-color letterheads on 20-lb. watermarked bond, 2,500, \$9.50; 5,000, \$19.50. E. Fowler, Clintonville, Conn.

100 PERSONAL or Business Cards with Leatherette Case, \$1.00 prepaid. Free samples. Address, Lincoln Novelty Co., Rochester, N. Y.

1,000 PRINTED Envelopes or Letterheads, \$3.00. Sent prepaid. Samples free. Specialty Print, 1604 E. 25th Ave., Denver, Colorado.

MAIL beginner's special: 100 letter-heads, 100 envelopes, 100 returns, \$1.50 for all. Work guaranteed. Spalding's Printery, West Newton, Mass.

1,000 HAMMERMILL Letterheads or Envelopes, \$3.75. Multigraphing: 1,000, \$4.50; 5,000, \$18.00. Samples free. A. T. Shafer, Frederick, Md.

PERSONAL Stationery printed, \$1. 100 noteheads and 100 envelopes, postpaid. Art Printing Co., Dept. M, Ashland, Ohio.

1,960 IMITATION typewritten letters, \$4.00. Best multigraphing; prompt service. Samples. Carlsons, 6112 Kimbark Ave., Chicago, Ill.

200 PRINTED envelopes, size 6 1/2, \$1.00. Letterheads and cards, same price. R. Wise, 156 Atlantic, Iowa.

1,000 LETTERHEADS, \$3.00; 1,000 envelopes, \$3.50. Quick printing service. Samples. Deluxe Printing Co., Elmhurst, Ill.

PRINTING Outfits—Presses, type supplies, type galleys. Send stamp for catalogue. Model Press, York, Penna.

225 BOND letterheads, envelopes, bill-heads, cards, \$1.25 each. Combination, \$1.00. Economic Press, Leonia, N. J.

1,000 LETTERHEADS or envelopes, watermarked bond, \$3.75. The Automatic Print Shop, Newcastle, Ind.

GUMMED Labels!!! Rubber Stamps!!! Interesting Samples Free!!! Edward Harrison, "Attractive Printing," Baltimore.

BOOK, catalogue and commercial printing; reasonable prices. Printery, Bremen, Ohio.

500 BUSINESS Cards, \$1.00. Commercial Service, 153 Mason, Worcester, Mass.

WE print anything. Circulars, stationery, Catalogs, Samples. Commercial Press, Batavia, Ohio.

EMBOSSED business, personal stationery, Samples, stamp, Daniels Company, Pittston, Pa.

RAZORS AND BLADES

SAFETY Razor Blade Sharpener. Price \$2.00. Money refunded if not satisfied. Address Foster, 4342 No. Robey St., Chicago, Illinois.

BLADES resharpened, 3c; any make. Guaranteed service. Standard Safety Razor Corporation, Pittsburgh, Pa.

BLADES, resharpened, one edge 2c; double 3c. New York Edge Co., Glen Cove, N. Y.

FOR SMOKERS

PURE Red Leaf Tobacco, quality guaranteed. Best chewing, 4 lbs. \$1.25, 10 lbs. \$3.10. Mild smoking, 4 lbs. \$1.00, 10 lbs. \$2.10, delivered. O. D. Collier, Agent, Martin, Tenn. "Collier is absolutely honest and reliable." Martin Bank, Raymer, Cashier.

CIGARS. Advertised brands by box; lowest prices. Postage prepaid. Write for list. Quality Cigar Co., 6909 Westworth, Chicago.

GUNS, CUTLERY, SPORTING GOODS, ETC.

INSTRUCTIONS for Rebluing Guns to look new, fifty cents. No tools required. Satisfaction guaranteed. R. D. Gibbons, Calera, Ala.

"WING Shooting Made Easy"—Booklet for ten cents. Don't be a rotten shot. Shooting seasons now open. Make good bags. Ducks, quail, any game. Read testimonials we send. Address, Willbur Gun Sight, 116 West 39th Street, New York City, N. Y.

BE Strong, be healthy. Peerless five-lime exerciser will do it. Free illustrated booklet. For sale by all live Sporting Goods dealers. Peerless Exerciser Co., 381-B Pearl St., Brooklyn, N. Y.

MAUSER, Luger, Mannlicher Arms, Catalog, ten cents in stamps. Pacific Arms Corporation, San Francisco, Cal.

BOATS AND LAUNCHES

16' BOWBOAT easily made. Construction blueprint 30c. Weesho-U Co., West Market, Detroit, Mich.

"HOW to make your boat leakproof." Send for booklets. L. W. Ferdinand & Co., 152 Kneeland St., Boston, Mass.

ANTIQUES AND WAR RELICS

SEND 5c for my best list, coins, Indian relics, antique firearms. F. E. Ellis, Webster Groves, Mo.

GENUINE Indian Baskets and Wampum. Wholesale catalog. Gilham, Kelseyville, Cal.

FOR Dens; relics collected from Europe's battlefields. Catalogue and war photos, 10c. Lieut. Welsh, 2117 Regent Place, Brooklyn, N. Y.

FOR MEN

ARE You Old at Forty? See our advertisement on page 160 of this issue. The Electro Thermal Company, Steubenville, Ohio.

FOR THE HOME

SAVE Coal, make inexpensive dustless ashtray. Blue-print, 5c. William Quenore, Camden, N. J.

PHONOGRAPHS AND RECORDS

BUILD your own phonographs. We can supply you with motors, tone arms and all accessories at wholesale prices. Write for catalogue AX. Pheasant Sound Phonograph Co., 201 East 113th Street, New York, N. Y.

BUILD Your Own Phonograph, Big saving. Pleasant, instructive work. Complete instructions, blue-prints, etc., absolutely free. Write today. Associated Phonograph Co., Dept. A1-19, Cincinnati, Ohio.

BUILD Your Phonograph. Quality phonoparts. Famous Serenade Motors. Also original Perfection Motors. Electric Motors, tonearms, reproducers, amplifiers, case material, accessories. Free blueprints and building instructions. Big saving. Wonderful results. Prompt delivery. Catalog mailed for ten cents. Hoosier Manufacturing & Supply Co., 312 Baldwin Block, Indianapolis, Ind.

BUILD a genuine Choraleon phonograph and save over half. Big profit building and selling. We furnish motors, tone-arms, full instructions and all necessary parts. Send for catalog and free blueprint offer. Choraleon Phonograph and Radio Co., 1122 11th St., Elkhart, Ind.

BUILD your own Phonograph. Our motors, tone arms, are best and lower priced. Write for catalog today. American Phonograph Co., 3513 North Crawford, Chicago.

FOR quality, service and economy, use Superior phonograph builders' equipment. Catalogue, Superior Phonoparts Co., Erie, Pa.

SCIENTIFIC Phono Parts that give wonderful results. Write immediately for catalogue and new prices. Bellona Company, N. Tonawanda, N. Y.

MUSIC AND MUSICAL INSTRUMENTS

LEARN Tenor Banjo with the aid of Banjo Diagram Method, twelve lessons, containing cuts, charts, instructions, etc. Going big. Send five dollars, complete course, Banjo Diagram Institute, Watertown, Wis.

WRITE Songs. Big money and reputation. Write for information. J. Gordon Pub. Co., 291 N. Hoyne Ave., Chicago.

SONG Writers—Have you poems? I have wonderful proposition. Ray Hibbeler, D110, 3010 Dickens Ave., Chicago.

JOIN our Sheet Music Club and receive latest popular music of all publishers, \$1.00 Year Plan. Write today for details. Sheet Music Club, Suite 703, 1545 Broadway, New York.

VIOLINS—Deep, Mellow, Soulful—on credit. Easy terms for wonderful instrument. Get details today. Gustav F. Henning, 2121 Gaylord St., Denver, Colo.

CORNETISTS—Trumpetists—Saxophonists—Clarinetists. Send for "Free Printers." Name instrument. Virtuoso School, Buffalo, New York.

"MUSIC Composed" to words. Bauer Bros. (formerly of Sousa's Band), Oshkosh, Wis.

I WANT song poems. Casper Nathan, Garrick Theatre Building, Chicago.

DIAMONDS, WATCHES AND JEWELRY

CHRISTMAS is coming! Importer, by extra fortunate purchase offers genuine, indestructible Japanese pearl necklaces at greatly reduced prices, 18 inch and 24 inch graduated, or evenly matched pearls, rich and lustrous, \$10.50 and \$12.50 respectively. Opera length, 70 inch "De Luxe" necklaces, composed of perfectly matched, richly colored pearls, \$30.00; cannot be duplicated at twice this price. All in handsome gift boxes, sent by insured parcel post. Send Draft, certified, or cashier's check, or Postoffice, or express money orders—other remittances not accepted. Order Now, while the supply is good and the prices low. Address, J. Bennett, 1933 Lawrence Avenue, Chicago.

PATENT ATTORNEYS

PATENTS—"How to Obtain a Patent" is the name of a book which every inventor should have. It will be sent free upon request, and will tell you what you want to know about patents. It contains the whole story. It describes the different parts of the application and explains in simple language the prosecution before the Patent Office. It tells about joint applications, reissues, agreements, assignments, licenses, interferences, infringements, process patents, design patents, trade-marks, and prints and labels. If you are interested in patents either as an inventor, manufacturer or owner of a patent you will enjoy reading this book which was written by a lawyer who has had twenty-five years' experience in patent matters. If you have an invention and will send us a sketch, model or photograph of it we will promptly make a search of the Patent Office records and advise you whether or not, in our opinion, your invention is patentable, our charge for the service being \$5.00. We feel that our experience of twenty-five years has fitted us to render prompt and efficient service which will merit your confidence. Write today. Talbert & Talbert, 463 Talbot Building, Washington, D. C.

U. S. AND Foreign Patents Procured, Validity Reports, Infringement Suits, Exporting. Over forty years actual experience. If you have a new invention which you wish to patent, you can write to us fully and freely for advice in regard to the best way of obtaining protection, how to proceed, etc. Fred G. Dieterich & Co., Patents & Patent Causes, 650 Ouray Building, opposite U. S. Patent Office, Washington, D. C.

PATENTS Secured. Prompt service. Avoid dangerous delays. Send for our "Record of Invention" form and Free Book telling How to obtain a Patent. Send sketch or model for examination. Preliminary advice without charge. Highest references. Write today. J. L. Jackson & Co., 214 Ouray Bldg., Washington, D. C.

PATENTS promptly procured. Personal, careful and efficient service. Highest references. Moderate fees. Send sketch or model for actual search and advice. George F. Kimmel, Master of Patent Law, 51-N, Loan and Trust Bldg., Washington, D. C.

INVENTORS. Send sketch or model of invention for advice. Write for Evidence of Disclosure form and Book on Patents, free. Prompt service. Merton-Roberts & Company, 181 Mather Building, Washington, D. C.

AMASA HARTWELL BALCOM, Master of Patent Law, 806 Munsey Bldg., Washington, D. C. Patents, Trade Marks and Copyrights. Correspondence solicited.

BEFORE or after filing an application for patent on your invention it will pay you to read over my "Inventor's Adviser No. 3," which may be obtained free of charge. M. Labiner, Registered Patent Attorney, No. 2 Park Row, New York City.

PATENTS. Booklet free. Highest references. Best results. Promptness assured. Send model or drawing for preliminary examination. Watson E. Coleman, Patent Lawyer, 624 F Street, Washington, D. C.

HERBERT JENNER, Patent Attorney and Mechanical Expert, 624 F St., Washington, D. C. I report if patent obtainable and exact cost. Send for circular.

PATENTS. Protect your rights. Before disclosing invention write for booklet and blank form Evidence of Conception to be signed, witnessed and returned with rough sketch or model of your idea, upon receipt of which I will promptly give opinion of patentable nature and instructions. No charge for preliminary advice. Highest references. Prompt, personal attention. Clarence R. O'Brien, Registered Patent Lawyer, Southern Building, Washington, D. C.

ROBB, Robb & Hill offer a strictly professional service to manufacturers and inventors in patenting inventions and registering trade-marks, a service which is the result of 20 years' experience. Write for free booklet and names of prominent manufacturers and inventors represented by us. Send sketch for preliminary advice, 811 McArthur Bldg., Washington, D. C.; 1348 Hunn Bldg., Cleveland, Ohio.

PATENTS—Before disclosing an invention, the inventor should write for our blank form "Record of Invention." This should be signed, witnessed and returned to us together with model or sketch and description of the invention and we will give our opinion as to its patentable nature free. Our Three Books mailed Free to inventors. Our Illustrated Guide Book, "How to Obtain a Patent," contains full instructions regarding Patents, Trademarks, Foreign Patents. Our Methods, Terms, and 100 Mechanical Movements Illustrated and described. Articles on Patent Practice and Procedure and Law Points for inventors. Our Trademark Book shows the value and necessity of trademark protection and gives information regarding unfair competition. We have direct agencies in all the principal foreign countries and secure foreign patents in the shortest possible time and at the lowest cost. Write for our illustrated guide book on Foreign Patents, sent free to any address. "List of Patent Buyers" sent Free, containing unsolicited letters from manufacturers and others who are constantly writing us regarding the purchase or leasing of meritorious patents. We endeavor to assist our clients in the commercial development of their inventions. Owing to the growth of our business we have established for the benefit of our clients Branch Offices in New York City at 1407 Woolworth Bldg., Philadelphia at 714 Liberty Bldg., Pittsburgh, Pa., at 514 Empire Bldg., Chicago, Ill., at 1114 Tacoma Bldg., and San Francisco, Calif., at 1010 Hobart Bldg., Victor J. Evans & Co., Main Office 181 Ninth, Washington, D. C.

PATENTS Procured—Trade Marks Registered. A comprehensive, experienced, prompt service for the protection and development of your ideas. Preliminary advice gladly furnished without charge. Booklet of information and form for disclosing idea free on request. Richard B. Owen, 30 Owen Bldg., Washington, D. C., or 2276-R Woolworth Bldg., New York.

PATENTS—Trademarks. Thirty-five years experience. Send model or sketch for opinion as to patentability. Free "Inventor's Guide." Highest references and personal attention assure best results. Franklin H. Hough, 522 Washington Loan & Trust Bldg., Washington, D. C.

PATENTS, Trade-marks—30 years of confidential service; expert advice, prompt action, reasonable fees. Send for Free Book No. 61, Edgar Tate & Co., 245 Broadway, New York; 635 F St., N. W., Washington, D. C.

INVENTORS! Write to U. S. Patent Office for free copy of "Information Concerning Patents," then engage a competent Patent Lawyer to protect your ideas. Ralph Burch, Patent Lawyer, Jenifer Bldg., Washington.

"**INVENTORS' Guide**," free on request; gives very valuable information and advice. Write Frank Ledermann, 15 Park Row, New York, N. Y.

INVENTIONS Patented; Trade-marks Registered; reasonable charges; prompt service; plain advice; request detailed information. Jaynes & Jaynes, 709 Kellogg, Washington, D. C.

EXACT expenses quoted in advance. Moderate charges. No extras. Applications satisfactorily prepared or money returned. Submit data. Lynwood B. James, 891 McGill Bldg., Washington, D. C. Established 1918.

PATENTS and Trade-marks obtained. Prompt service. Write for our new book on patents. Established in 1889. D. Swift & Co., 369 7th St., Washington, D. C.

PATENTS—Prompt, personal efficient service by an attorney-at-law, skilled in all branches of Patent Practice. Over 18 years actual experience; full information upon request. B. P. Fishburne, 331 McGill Bldg., Washington, D. C.

PATENTS, Trade Marks, Designs and Copyrights. Registered firm of attorneys-at-law. Careful, prompt, personal service assured. Moderate fees. Full information free upon request. Gross & Collins, 606 Ouray Bldg., Washington, D. C.

PATENT application filed on partial payment plan. Trade-marks, copyrights, etc. Milo B. Stevens & Co., 635 F St., Washington, 352 Monadnock Bk., Chicago. Estab. 1861.

INVENTORS—Send for form "Evidence of Conception" to be signed and witnessed. Form, fee schedule, information, free. Lancaster and Allwine, 221 Ouray Bldg., Washington, D. C.

MONROE MILLER, Ouray Building, Washington, D. C., patent attorney, mechanical and electrical expert. Best quality of work and results. Moderate charges.

INVENTORS aided. Ideas developed and patented. Practice in all courts and departments. C. E. Richardson, 27 Albee Bldg., Washington, D. C.

PATENT-COST Divided, six payments. "Patent-Values" Booklet (free). Steeling Buck, Near Patent Office, Washington, D. C.

WOODWARD, New Book. Submit your ideas. H. L. Woodward, 714 9th St., Washington, D. C.

PATENTS. My fees in installments. Advice book free. Frank Fuller, Washington, D. C.

FOR INVENTORS

PATENTS—"How to Obtain a Patent" is the name of a book which every inventor should have. It will be sent free upon request, and will tell you what you want to know about patents. It contains the whole story. It describes the different parts of the application and explains in simple language the prosecution before the Patent Office. It tells about joint applications, reissues, agreements, assignments, licenses, interferences, infringements, process patents, design patents, trade-marks and prints and labels. If you are interested in patents either as an inventor, manufacturer or owner of a patent you will enjoy reading this book which was written by a lawyer who has had twenty-five years' experience in patent matters. If you have an invention and will send us a sketch, model or photograph of it we will promptly make a search of the Patent Office records and advise you whether or not, in our opinion, your invention is patentable, our charge for the service being \$5.00. We feel that our experience of twenty-five years has fitted us to render prompt and efficient service which will merit your confidence. Write today. Talbert & Talbert, 501 Talbert Building, Washington, D. C.

PATENTS Secured. Prompt service. Avoid dangerous delays. Send for our "Record of Invention" form and Free Book telling how to obtain a Patent. Send sketch or model for examination. Preliminary advice without charge. Highest references. Write today. J. L. Jackson & Co., 242 Ouray Bldg., Washington, D. C.

RARE opportunity to dispose of your patent. Order my tried and proven Copyrighted method, \$5.00. (Reference, First National Bank), William Hammond Lester (Patented since 1893—now retiring), B. G. Square, Westminster, Md.

INVENTORS. Send sketch or model of invention for advice. Write for Evidence of Disclosure form and Book on Patents. Free. Prompt service. Merton-Roberts & Company, 182 Mather Building, Washington, D. C.

UNPATENTED ideas can be sold. I tell you how and help you make the sale. Particulars free. Write W. T. Greene, 106 The Atlantic, Washington, D. C.

GET your own patents. Application blanks, complete instructions \$1. Cutting Sons, Campbell, Cal.

PATENTS. Write for free illustrated guide book. Send model or sketch and description for free opinion of its patentable nature. Highest references. Prompt attention. Reasonable terms. Victor J. Evans & Co., 157 Ninth, Washington, D. C.

900 MECHANICAL Movements and 50 Perpetual Motions illustrated and explained in my book. Inventor's Universal Educator, 5th Edition—Tells how to procure and sell patents, Government and other costs. Covers the matter from A to Z—160 pages—Elegantly bound. Contains noted decisions of U. S. Supreme and State Courts on Patent cases. Mechanical Movements greatly assist inventors—suggest new ideas that might prove of great aid in perfecting inventions. Tells how to select an Attorney. Has valuable information regarding Patent Sharks, Selling Agents and promoters. Price, \$2. Postage free everywhere. Fred G. Dieterich, 621 Ouray Bldg., Washington, D. C.

HAVE You an Invention? If so, write for our free book, "How to Get Your Patent," tells our terms and methods. Send model or sketch for our opinion of its patentable nature. Randolph & Co., Dept. 144, Washington, D. C.

PATENTS. If you have an invention which you wish to patent you can write fully and freely to Munz & Co. for advice in regard to the best way of obtaining protection. Please send sketches or a model of your invention and a description of the device, explaining its operation. All communications are strictly confidential. Our vast practice, extending over a period of seventy-seven years, enables us in many cases to advise in regard to patentability without expense to the client. Our Handbook on Patents is sent free on request. This explains our methods, terms, etc., in regard to Patents, Trade Marks, Foreign Patents, etc. "Scientific American" contains Patent Office Notes, Decisions of interest to inventors, and particulars of recently patented inventions. Munz & Co., Solicitors of Patents, 623 Woolworth Bldg., New York; Scientific American Bldg., Washington, D. C.; 891 A Tower Bldg., Chicago, Ill.; 611 Hanna Bldg., Cleveland, Ohio; Hobart Bldg., San Francisco, Calif.

MODEL Making and experimental work; Modern Shop; expert workmen. Manufacturing, Lamson Model and Experimental Works, 625 W. Jackson, Chicago.

INVENTIONS developed to practical manufacturing basis. Research and model work strictly confidential. Light manufacturing. Reliance, 138 West Broadway, New York.

PATENTS. Protect your rights. Before disclosing invention write for booklet and blank form Evidence of Conception to be signed, witnessed and returned with rough sketch or model of your idea, upon receipt of which I will promptly give opinion of patentable nature and instructions. No charge for preliminary advice. Highest references. Prompt, personal attention. Clarence B. O'Brien, Registered Patent Lawyer, Southern Building, Washington, D. C.

PATENTS Procured—Trade Marks Registered—A comprehensive, experienced, prompt service for the protection and development of your ideas. Preliminary advice gladly furnished without charge. Booklet of information and form for disclosing idea free on request. Richard B. Owen, 30 Owen Building, Washington, D. C., or 2276-R Woolworth Bldg., New York.

SEND sketch or search report. Get my latest book on patents. H. L. Woodward, 714 9th St., Washington, D. C.

"**INVENTOR'S Guide**," free on request; gives very valuable information and advice. Write Frank Ledermann, 15 Park Row, New York, N. Y.

WILL buy good Patent. What have you? Gordon, 4456 Evans Avenue, St. Louis.

PATENTS FOR SALE

FREIGHT Bill Stamp and Labeling Labeling Machine; automatic, simple, efficient, economical; necessary commercial, express and railroad accessory. Ready for production. Sales possibilities unlimited. For particulars and demonstration, H. H. McFadden, 118 Ralph St., Toledo, O.

FOR Sale—Patent No. 1,891,110; Price, \$5,000. A. H. Heaney, 524 Lawry St., Stillwater, Okla.

NOTICE—My household invention, absolutely new; alone in its most useful line. R. E. Brinson, 2019 Caspian Ave., Atlantic City, N. J.

DIRIGIBLE Headlight—13,656-1; Safety Device for Elevators—13,451-2; Coal Hoist—12,891-1; Post and Brush Puller—13,509-2. Talbert & Talbert, Talbert Bldg., Washington, D. C.

BASEBALL game; action; simple; best yet. Royalty or will sell outright. Address, H. Kaufman, 267 Cedar St., New Haven, Conn.

PRACTICAL Plush Clothes Line, family washings, rugs, beddings, etc. Outright. Get details, Wm. F. Cushing, 932 Court Circle, Los Angeles, Calif.

PATENT—Safety Egg Case Catch. Can be fastened on 30 doz. heavy or light cases. Also for parcel post shipment. Henry Appel, Plainview, Minn.

TEA Pot Lid Fasteners, U. S. A. and British Patents. Ladder Safety Devices, two British Patents; half interest for financing. Downes, 44 Oxley Street, Wolverhampton, England.

FOR sale, or will let on Royalty basis. Patent on very novel toy. No experiment. Proven success. Matthews & Company, Cambridge, Md.

NEW Improved Stove Scraper for sale, cash or royalty. M. L. Stout, 249 E. 49th St., Portland, Ore.

CLINCHER Tire Remover and Replacer. Patent No. 1,414,908. For Sale or Royalty. F. E. Wafer, 1314 Kenwood Ave., Chicago.

FOR Sale, outright; only Auto Piston Fitting Tool made. Address T. S. Watson, Box 1129, Burkburnett, Texas.

AUTOMATIC Direction Signal, patented. Partnership, Outright or royalty. Fred Voigt, 2503 Oceanview Ave., Los Angeles, Calif.

PATENT for sale. Nutcracker. Cash or royalty. Clyde Smith, Springbranch, Texas.

RENEWABLE Electric Fuse. Two forms "Drop Out" links. New method of fastening metal to fibre, less breakage. Outright or royalty. A. Peterson, 6234 Aberdeen St., Chicago, Ill.

SELL, Outright. Patented Collapsible Hand-truck Shopping Bag and Go-cart. Handiest thing out for Groceries and Parcels. Emery & Fleischauer, 956 W. Pingree, Detroit.

FOR Sale, two inventions: Gate Fastener and Detachable Shovel Handle; something new; good sellers; cheap to manufacture. Cecil Ruppe, Youghal, Colo.

PATENT for Sale—Men's sleeve holders which hold the sleeve exactly and securely in the adjusted length without in the least interfering with the blood circulation of arms. Entirely different from all others! Big demand—every man and boy a prospective customer. Will sell on sight. Get details by writing to S. Abe, P. O. Box 1840, Station C., Los Angeles, Calif.

MILLIONS spent annually for ideas! Hundreds now wanted! Patent yours and profit! Write today for free books—tell how to protect yourself, how to invent, ideas wanted, how we help you sell, etc. American Industries, Inc., 509 Patent Dept., Washington, D. C.

PATENT for Sale. Mechanical device to manufacture stone coils. Patented April 26, 1922, in Washington, D. C. No. 556664. Will sell outright. Jos. Morjesky, 139 E. 4th St., New York, N. Y.

FOR Sale. New household necessity. Shoe Tree, Stretcher and Polisher. Patented United States and Canada. Address P. F. Woods, 133 W. Ferry St., Buffalo, N. Y.

PATENT Duplex Flash Light Attachment. Red and green signals, two white lights. For auto and machinery trouble. Outright or royalty. Copies, John Hanstman, 2714 E. 27, Kansas City, Mo.

MONKEY wrench grips like a vise. Simple, serviceable. Sell royalty or outright. Address Harry L. Smith, Box 116F, Route Five, Fort Worth, Tex.

PATENT Frying Pan Attachment, saving gas and gasoline. Outright or royalty. For copies address T. Lander, 3951 Scarritt Ave., Kansas City, Mo.

NEW water-power device, develops power without dam. Would like to interest manufacturer in royalty deal. Eli Kunkel, Hamona, Calif.

PATENT for Sale—worth investigation. Foot-power grinder, something new. John Kotynek, 1248 S. 15 St., Omaha, Neb.

SHINGLING gage, outright or royalty; worth investigating, greatest carpenters' timesaver invented. J. J. Engbrecht, Box 850, Powell, Wyo.

PATENT for Sale—Oil cup for oiling loose pulleys. C. Kay, 5075 Burns Ave., Detroit, Mich.

NEW book on patents. H. L. Woodward, 713 9th St., Washington, D. C. Submit your ideas.

POCKET Check Protector Patent. Bargain. Fred Roeha, 1957 Warren, Chicago.

FOR Sale—An Extension Fly Swatter. Agnes Youngs, Livertmore, Iowa.

LACEY Patent Sense. See page 158.

FOR Sale—Hippolitus Automatic Adjustable Window Screen. Special new features. For details write Joseph Hippolitus, 26 No. 7th Ave., Mt. Vernon, N. Y.

WILL Sell Patent. Continuous Flow Hose Reel. Bonanza Commercially. Address Geo. A. Sanford, Escalator Springs, Mo.

PATENTS For Sale: To sell, buy or obtain patents write Patent News—P, Washington, D. C.

YOU have a worth-while patent, haven't you? Why don't you tell our two million readers about it? Most of them are especially interested in patents and new inventions. Ask me to tell you how other inventors successfully sold their patents. J. Roy McClellan, Manager, Classified Advertising, Popular Mechanics Magazine, Chicago, Ill.

MODELS AND MODEL SUPPLIES

PUNCH Press work, tool and die making, model and special machine work wanted. Completely equipped with new machinery of the latest type. Prompt delivery, reasonable prices guaranteed. Quality Hardware & Machine Co., Dept. A, 6154-56 N. Clark St., Chicago.

INVENTORS—Write for our free illustrated guide book and Evidence of Conception Blank. Highest references. Prompt attention. Reasonable Terms. Victor J. Evans & Co., 163 Ninth, Washington, D. C.

PATENTS. Protect your rights. Before disclosing invention write for booklet and blank form Evidence of Conception to be signed, witnessed and returned with rough sketch or model of your idea, upon receipt of which I will promptly give opinion of patentable nature and instructions. No charge for preliminary advice. Highest references. Prompt, personal attention. Clarence B. O'Brien, Registered Patent Lawyer, Southern Building, Washington, D. C.

MODEL Steam Engines, Boilers, Boats, Model Ship and Naval Fittings, Model Makers' supplies. Send 25c for new, enlarged illustrated catalogue and handbook. Bathe Mfg. Co., Dept. D, 5214 Woodland Ave., Philadelphia, Pa.

WE make working models for inventors and do experimental work and carry a complete stock of brass gears and model supplies. Send for catalogue. The Pierce Model Works, Tinley Park, Ill.

PRACTICAL model steam engines, boilers, blue-lamps, pumps, fittings. Send 15c in stamps for new catalogue. Model Machine Shop Co., 415-17 East 71 St., New York City.

MODEL Making and experimental work; Modern Shop expert workmen, Manufacturing, Lamson Model and Experimental Works, 625 W. Jackson, Chicago.

FOR MANUFACTURERS

WANTED—Metal Stamping and Model work taken on contract basis. We are ideally located and equipped to develop patents. Meyers Company, Box 263, Bedford, Ind.

INVENTORS and Manufacturers: Have your invention designed for commercial use; we make Drawings to Scale, Blue Prints, Models, Dies, Tools, Fixtures and Automatic Machinery for economical Manufacturing, Automatic Cost-Controlled Dispensing Machines, designed and constructed. John Frick, Mechanical Engineer, 1105 Arch St., Philadelphia, Pa.

MODEL making and experimental work; Modern Shop expert workmen, Manufacturing, Lamson Model and Experimental Works, 625 W. Jackson, Chicago.

MANUFACTURING

IF you want dies and metal stampings, write us. Lyons Machine Works, Lyons, Ia.

PATTERNS, wood and metal. Models, tools and dies. Brass, bronze, aluminum and iron castings. Screw machine work, production work of all kinds. Write Modern Machine & Pattern Co., Terre Haute, Ind.

PUNCHES and Dies made by us are cleverly designed to save you money and labor. Stampings of anything possible. Werner Rother Co., 50 Arthur St., Lawrence, Mass.

WIRE Goods, all kinds made to order. Coolcy Mfg. Co., 524-526 N. Western Ave., Chicago.

SPECIAL Devices and Machinery developed and built at reasonable rates. Jigs and fixtures designed and built for interchangeable and economical manufacturing. Punches and dies made for all kinds of metal stamping. Machine work to order. Simplex Tool Company, Woonsocket, R. I.

FOR reasonable prices on models, dies, stampings, manufacturing and experimenting. Reinforced Switch & Mfg. Co., 409 E. North Ave., Pittsburgh, Pa.

LET us be your factory! Write today. Logan Machine Company, 222 South Clinton St., Chicago, Illinois.

GEARS, tools, metal specialties and bronze bearings. Weldon Machine Works, 2940 Herndon St., Chicago.

MODEL making and experimental work; Modern Shop, expert workmen, Manufacturing, Lamson Model and Experimental Works, 625 W. Jackson, Chicago.

MACHINERY, TOOLS AND SUPPLIES

ELECTRIC Drill, 1/2-inch capacity universal motor, light, compact, powerful; sent on approval. Price \$55.00. With drill press \$75.00. Write The Electro Magnetic Tool Co., St. Louis, Mo.

WANTED: Information about new air compressors. Write for free manual, Engineers Dept., Brunner Mfg. Co., Utica, N. Y.

POWER Presses, second hand, all makes, styles and sizes. Send for latest stock list. F. H. Crawford, 299 Broadway, New York. Telephone Worth 3216.

7" BENCH Lathes \$20.00; 1/2 H. P. four cycle Gasoline Engines \$35.00. Star Specialty Works, 1742 W. Park Ave., Chicago.

CONCRETE Building Block Machines and Molds. Catalogue free. Concrete Machine Co., 303 South Third St., St. Louis, Mo.

LIGHT Power Transmission Machinery, Bearings, Hangers, Pulleys, Reducing Gears. Send for Catalog. Winfield H. Smith, Buffalo, N. Y.

OXY-ACETYLENE Welding machine. Good condition. C. B. Fred, Abilene, Kans.

ENGINES, MOTORS AND DYNAMOS

AUTOMOBILE Owners, Garagemen, Mechanics, Repairmen, send for free copy of our current issue. It contains helpful, instructive information on overhauling, ignition troubles, wiring, carburetors, storage batteries, etc. Over 140 pages, illustrated. Send for free copy today. Automobile Digest, 507 Butler Bldg., Cincinnati.

ALTERNATING and direct current motor bargains. New and rebuilt. All guaranteed for one year. Special prices. Get our price list before buying. Motors exchanged and repaired. Hyre Electric Co., 633-33M South Dearborn St., Chicago.

TWO Cylinder Airplane Motor, 12-15 H.P. Complete with practice prop. and fuel tank. \$50. Write D. R. Hanstrom, Clarissa, Minn.

MIDGET Gasoline Motor, one-half horse power at 1800 r. p. m. Ideal power plant for the small job usually done by hand. Exceptionally smooth running and efficient. Write for circular. Motor complete with battery and coil equipment, \$38.00. With latest Bosch Magneto, direct connected, \$50.00. L. & D. Tool Works, Hartford, Conn.

1/2 H. P. WESTINGHOUSE Motors, new, 32 volt, direct current, 1700 r. p. m., \$25.00. We buy and sell motors and generators of every size, kind and description. R. Scheinert Company, 123 N. Third St., Philadelphia, Pa.

SMALL Gasoline, Steam Engines, Dynamos, Motors, Storage Batteries, etc., new and secondhand. Bargain Bulletin 133 free. Dynamic Manufacturing Co., First National Bank Bldg., Chicago.

ELECTRICAL

STORAGE batteries for \$3.00. Build them yourself by our new method. Complete Instructions One Dollar. Address Yates Bros., 3463 W. Washington St., Los Angeles, Calif.

LARGEST stock of flashlights in the world at your disposal via Uncle Sam's mail. Simon Supply, 207 North Seventh, St. Louis, Mo.

ELECTRICITY For 10c Per Hour. Motor Auto Generator. Operates on any make automobile. Produces electricity for Moving Picture Machines, Theatres, Schools, Churches, Homes, Etc. Write for free particulars. Monarch Theatre Supply Co., Dept. AG 124 South Wabash Ave., Chicago.

ELECTRIC motors and supplies, including sockets, wire conduit, cleats, joans, sockets, switches. New revised wholesale prices. Illustrated Catalog free. Hyre Electric Co., 633-GH, South Dearborn St., Chicago.

ELECTRICAL Experimenters—Here is the book you have been waiting for—"How to Make Things Electrical," 256 articles, 127 pages, 353 illustrations. Size 4½x7, cloth binding. Price \$2.50 postpaid. Popular Mechanics Book Dept., 6 N. Michigan Ave., Chicago.

FOR MECHANICS

PATENTS—Write for our free illustrated guide book and Evidence of Conception Blank. Send model for sketch and description of the invention for our opinion of its patentable nature free. Highest references. Prompt attention. Reasonable terms. Victor J. Evans & Co., 184 Ninth, Washington, D. C.

SHOP Notes Volume 17 contains 702 practical articles such as Half-ton Traveling Crane, Boring Machine, Toggle Press, Gas-Fired Forge, Oil-Gas Generator, Movable Table for Drill Press, etc., 224 pp., 496 illus., 50 cents postpaid. Popular Mechanics Book Dept., 6 N. Michigan Ave., Chicago.

ALUMINUM Solder that will stand the test. Sample 25c. Formula \$2.50. John Brackman, 3916 Monroe, Chicago.

PATENTS. Protect your rights. Before disclosing invention write for booklet and blank form Evidence of Conception to be signed, witnessed and returned with rough sketch or model of your idea, upon receipt of which I will promptly give opinion of patentable nature and instructions. No charge for preliminary advice. Highest references. Prompt, personal attention. Clarence B. O'Brien, registered Patent Lawyer, Southern Building, Washington, D. C.

MECHANICS. Mark your tools by Kent's Simple Etching Process. Particulars free. Ed. Kent, 297 Fell St., San Francisco, Calif.

BLACKSMITHS

BLACKSMITHS. Listen: Any Handy man can make more money doing hard jobs easy. Forging and welding solid, with Toy's Modern Methods of Blacksmithing. Hardening and tempering to a standard with colored tempering charts. All for one dollar. Samples Free. W. M. Toy, Sedro, O.

SURVEYING INSTRUMENTS

NEW and used surveying instruments direct from factory. Satisfaction guaranteed or money refunded. Wisler, 610 Broadway, St. Louis.

FOR THE SHOP

SHOP Notes for 1922—Bench Lathes, Electric Soldering Outfit, Job Crane, Pump Troubles, Road Roller, Bench Grinder, Bench Miller, are among the 655 articles in this new volume, 224 pp., 50 cents postpaid. Popular Mechanics Book Dept., 6 N. Michigan Ave., Chicago.

REAL ESTATE AND FARM LANDS

LAND Opportunity! \$10 to \$50 down starts you on 20, 40, or 80 acres near thriving city in Lower Michigan. Balance long time. Write today for free illustrated booklet giving full information. Swigart Land Co., 1-1239, First National Bank Building, Chicago.

STROUT'S Farm Catalog: 1200 Bargains! Just out! Equipped farms, \$200 to \$50,000; big woodlots; self-sustaining homes. The pick of 35 states. Copy free. Address Strout Farm Agency, 150-P Nassau St., New York City, N. Y.

FLORIDA Oranges are most profitable as well as most delicious. Grow your own in a land of sunshine, away from winter blizzards and coal bills. Money you'll not miss will buy you land for a grove in a high rolling, lake-jeweled land of many golden groves. If you mean business, write today for Book of Facts and Photos. Lake County Land Owners' Association, 95 Arbor Avenue, Fruitland Park, Fla.

FOR Sale—Three full sections in McKenzie County and two sections in Billings County, North Dakota. Each section contains land suitable for crops, balance for cattle. Each section has valuable deposits of lignite which some day will alone be worth many times the present value of the land. This part of the state is developing very rapidly, with good schools within easy access. As owner cannot use this land himself will sell one or more sections at a price which almost anyone can afford to pay. Address, W., care Popular Mechanics, 6 North Michigan Ave., Chicago.

I WANT Farms for cash buyers; will deal with owners only. R. A. McNowa, 312 Wilkinson Bldg., Omaha, Neb.

SPECIAL "get-together-on Florida" farm home offer limited to 50 men. Choice of a lifetime. \$5 a month buys 10-acre farm tract in midst of beautiful lake region, where the fine oranges grow. Only \$19 an acre; limit 40 acres to a buyer. Bankers and business men say this land should bring \$100 to \$150 an acre when paved roads completed. Near Tampa. Don't wait, write. Tampa Bay Land Company, 1019 Citizens Bank Building, Tampa, Fla. Old, strong, reliable company.

SELL your property quickly for cash, no matter where located. Don't pay big commissions. Particulars free. Real Estate Salesmen Co., Desk B, Lincoln, Neb.

\$5.00 DOWN; \$5.00 monthly; Five acres fruit; poultry, for farm. Riverfront; Ozarks; \$100; hunting, fishing, trapping. Address Harvey Hubbard, 1975 North Fifth, Kansas City, Kan.

ATTENTION! "Get Acquainted." Cash for your property. Farm, Hotel or Retail Store, no matter where located; confidential service. Hayes' Business Agency, Cincinnati, Ohio.

FORTUNE awaits you in Lower Rio Grande Valley, Texas, where Grape fruits nets \$3000 per acre. Full particulars on application. Live agents wanted. Rio Delta Citrus Syndicate, 8 S. Dearborn, Chicago, Ill.

FOR SALE—MISCELLANEOUS

ADDRESSOGRAPHIS. Letter Folders, Multigraphs, Envelope Sealers, Duplicators, less than half price. Guaranteed. Pruitt Co., 112-B N. La Salle, Chicago.

WANTED—MISCELLANEOUS

CASH for Gold, Platinum, Silver, Diamonds, Liberty Bonds, War Thrift, Unused Postage Stamps, False Teeth, Magnetite Points, Jobs, any valuables. Mail in today. Cash sent, return mail. Goods returned in ten days if you're not satisfied. Ohio Smelting Co., 306 Hippodrome Bldg., Cleveland, Ohio.

MAIL us your discarded jewelry, Gold Crowns and Bridges, Watches, Diamonds, Silver, Platinum, War Savings Stamps and Old False Teeth. Money sent at once. Goods Ret. If offer is refused. United States Smelting Works, (Old Reliable) Dept. T, Chicago.

CASH for Old Platinum, Magnetite points, False teeth, gold, silver—Inquiry Solicited. Yonover, 1637-P Roosevelt Rd., Chicago.

CONSULTING ENGINEERS

YOUR ideas and inventions scientifically worked out, working models prepared and guaranteed. Consulting Engineer, 5 West 121st Street, New York, N. Y.

DRAWING INSTRUMENTS AND DRAFTING SUPPLIES

NO. 5 Mechanical Drawing Outfit, \$11.50 postpaid. This outfit, designed for student or draftsman, is complete in every respect enabling you to do excellent work. It includes: Imported Instrument Set; Drawing Board; 2 Transparent Celluloid Triangles and Irregular Curve; 24 inch Mahogany Maple Lined T Square; 4 inch Brass Protractor; 12 inch Triangular Boxwood Scale Rule; 2 bottles Waterproof Drawing Ink; Eraser; Drawing Pencil; Six Sheets Drawing Paper; Thumb Tacks. Money back guarantee. Kolar Stationery Co., Dept. B, 3117 W. 22nd St., Chicago.

BELGIAN HARES, GUINEA PIGS, ETC.

RAISE guinea pigs. Pay better than poultry or rabbits; easy to raise; little space required. We guarantee market. Particulars and booklet how to raise free. Cavies Distributing Co., 3192 Grand Ave., Kansas City, Mo.

DOGS, BIRDS, POULTRY, PETS

CATCH fur-beavers alive. Blueprint entitled "Eleven Good Box Traps" 50c. Weesho-Geo, West Market, Detroit, Mich.

FOR Sale—Coon, opossum, skunk and squirrel dogs; fox cat and rabbit hounds sent on trial. Catalog free. Address Mt. Yonah Farm Kennels, Cleveland, Ga.

WHITE Angora cats, males \$10.00, females \$7.50. Joseph Berg, Hammond, Minn.

DOG Owner's Text Book Free; expert advice on proper care, training and feeding. Free with 3 months' trial subscription to America's popular dog and hunting magazine. Send 25c today (cash or stamp). Sportsman's Digest, 545 Butler Bldg., Cincinnati, O.

COONHOUNDS and combination fur hunters. Free trial before you buy. Large new illustrated catalog 10c. Southern Farm Coonhound Kennels, Selmer, Tenn.

EXCELLENT Coon and combination hounds. Must please. Trial Stamp. Address Frank Reichenbach, Apple Creek, Ohio.

FOR Redbone Coonhound pups, write S. E. Keener, R. A., Terre Haute, Ind.

FOR Sale—Fox hounds, Coon and Opossum hounds. J. R. Thomas, Danville, Miss.

SILVERBLACK Foxes, \$300. Skunks, Boublet d'inc, Arthur Schumacher, Lockland, O.

FOR Sale—Bongles, all ages. Harold Evans, Moores Hill, Indiana.

WOLFPOUNDS for sale. Ben Ammon, Hammond, Neb.

BRED Squabs, Book free. E. Rice, Melrose Highlands, 77 Massachusetts.

PERSONAL

TOBACCO Habit Quickly Cured. Any form, 25c (over). Adolph Long, 1-9815 Taylor, Chicago.

ASTROLOGY Reveals. 2000-word trial reading, 25c; two questions free. State birthdate. Address Prof. Audrey, Dept. D, Box 834, Washington, D. C.

COMPLETE Life Reading, 35c. Give birthdate. Jay Wambush, Goshen, Ind.

YOUR Horoscope covering full year for 35c. Includes an extensive reading, valuable daily guide, large pictorial chart and special forecasts for each month. Scientific, complete. Try it! Money back if dissatisfied. Give birthdate. Address, H. Daniels, Flatbush Sta., Box 82, Brooklyn, N. Y.

ASTROLOGY Reveals: 2,000 word trial reading 25c. Two questions free. State Birthdate. Prof. Audrey, Box 834, Section P-M, Washington, D. C.

BALDNESS, thinning hair Try Kotalka. Watch mirror. Often astonishing growth when all else fails. Proof box mailed free. Kotalka Offices, BE-187, Station X, New York.

FREE—Stop using tobacco. We will give free information how to conquer habit easily and permanently. Results guaranteed. Anti-Tobacco League, Box K, Omaha, Neb.

Additional Classified Ads Page 50

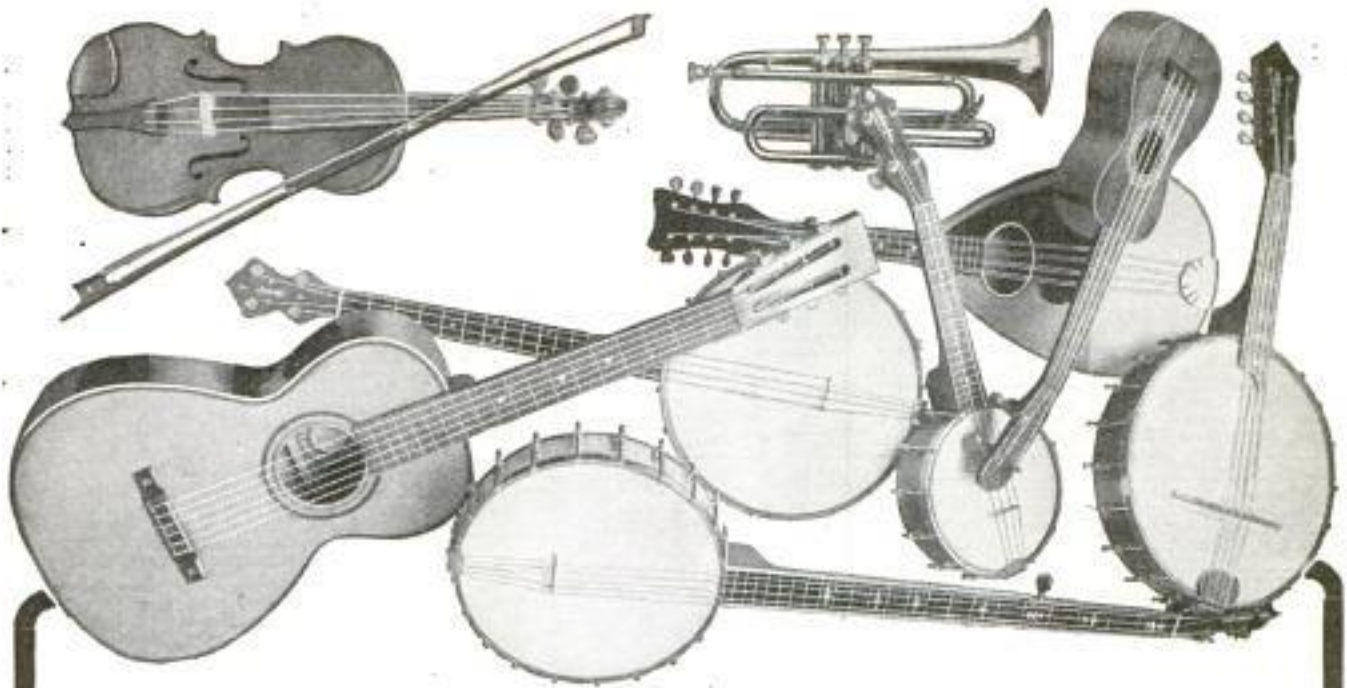

YOUR CHOICE \$ FREE 20

*Violin, Mandolin, Guitar,
Ukulele, Hawaiian Guitar,
Banjo, Banjo Mandolin,
Tenor Banjo, Cornet or
Banjo Ukulele.*

Actually given away, absolutely free, to pupils in each locality. Last year we gave away thousands of high-grade musical instruments on this sensational offer, now repeated for YOUR benefit.

We have the most wonderful new system of teaching NOTE music by mail. Take your choice of any of these magnificent instruments absolutely free and learn to play by this easy to learn method. Can have you playing standard note music in 4 lessons. A very small charge for lessons—just a few cents a week—your only expense. Your success guaranteed. Pay nothing if you fail to learn; you take no risk. Complete outfit free with every instrument. Don't wait a minute, but mail the coupon NOW.

To Advertise Our Copyrighted Course

Our plan is, \$2.00 monthly for lessons. No charge for instrument. Ukulele and banjo ukulele given free with 20 lessons at 50c a lesson. Tenor banjo, banjo and Hawaiian Guitar given free with 32 lessons at 50c a lesson; Violin, mandolin, guitar and banjo mandolin given free with 56 lessons, 43¼c a lesson. Lessons are mailed one each week. Fill out the coupon and enclose \$2.00 or, we will send instrument and complete outfit subject to examination at express office C. O. D. \$2.00 for first month's lessons, and you will get an instrument you will be proud to own. At end of one week if you are not delighted with instrument and lessons, send outfit back and we will refund your money.

Do not delay, but mail the coupon today, before it is too late. Be sure to state whether you want a free Violin, Mandolin, Guitar, Ukulele, Hawaiian Guitar, Banjo, Banjo Mandolin, Tenor Banjo. We guarantee any one of these instruments positively worth \$20 or more. For cornet, piano, organ and further information, write for booklet.

SLINGERLAND'S CORRESPONDENCE SCHOOL OF MUSIC
Dept. 4, 1815 Orchard St., Chicago, Illinois

FREE INSTRUMENT COUPON

Slingerland's Correspondence School of Music
Department 4, 1815 Orchard Street,
Chicago, Illinois

Please send me one.....free.
(Name of Instrument)

- Plan No. 1. I am enclosing \$2.00 for first month's lessons.
 Plan No. 2. Send outfit and lesson C. O. D. \$2.00; but if I am not satisfied at end of one week's trial, I will return outfit and my \$2.00 is to be returned to me or, I will pay \$2.00 monthly until lessons are paid for.

Name.....

St..... R. F. D.....

City.....State.....

Continued from Page 48

FREE Booklet, Health and Strength at home. Peerless Exerciser Co., 381-8 Pearl St., Brooklyn, N. Y.

RESTORINE clear as water restores your gray hair to its original color in a few days. Stops dandruff and falling hair. No dye, non-injurious, leaves hair soft and lustrous. Send 10c for full size package. Pay balance 50c when satisfied only. State original color of hair. The O'Neil Laboratories, Sta. G, Oakland, Calif.

BE Wise! Be Cheerful! Be Prosperous! New way plan brings wonderful results. Valuable pointers and your personality revealed for 10c and birthdate. Thomson-Heywood, Dept. 485, Chronicle Bldg., San Francisco, Calif.

STUDY Human Nature, know people, make more money. Send 10 cents for "Personal Power," a little book that points the way. Progress League, 31-A I. Union Square, New York.

YOU can make more money! Get our scientific horoscope with chart showing what you are best fitted for. Send 25c, birthdate. Astrolite Company, Dept. 983, Sharpsburg, Pa.

TOBACCO or Snuff Habit cured or no pay. \$1.00 if cured. Remedy sent on trial. Superba Co., TP, Baltimore, Md.

PLEASANT root, easily, inexpensively, overcomes any tobacco habit. Send address. Franklin Stokes, Mohawk, Fla.

MISCELLANEOUS

INCORPORATING a company? Save expenses and taxes by organizing on the popular, Common Law plan under a pure Declaration of Trust. Anyone, anywhere, can fill in Demaree Standard Forms, issue shares and begin doing business at once. Insist upon Demaree Forms, the original nationally-accepted forms, approved and used by well known attorneys. Send for large, free pamphlet (C-53) containing much information that you will need. C. S. Demaree, Legal Blank Printer, 708 Walnut, Kansas City, Mo.

CHRISTMAS is coming! Importer by extra fortunate purchase offers genuine Japanese indestructible pearl necklaces at greatly reduced prices. 18 inch and 24 inch graduated or evenly matched pearls, rich and lustrous, \$10.50 and \$12.50 respectively. "Opera length" (70 inches) "De Luxe" necklaces, composed of large, perfectly matched, richly colored pearls, \$30.00—cannot be duplicated for twice this price. All in handsome gift boxes, sent by insured parcel post immediately on receipt of your order. Send draft, certified, or cashier's check, postoffice or express money order—other remittances not accepted. Order now while supply is good and prices low. Address J. Bennett, 1090 Lawrence Ave., Chicago.

CASH for Old Platinum, Magneto points, False teeth, gold, silver;—Inquiry Solicited. Yonover, 1437-M Roosevelt Rd., Chicago.

WANTED: Distributors and royalty manufacturers; combined hat-holder and coat hanger for autos, etc. Also overtire device. Geo. T. Robinson, Calhoun, Ky.

INFORMATION. Positively anything you need know, scientific, technical, business, medical, legal, formulas, addresses, miscellaneous. Where buy, sell. 10c silver per question answered; none higher. Satisfaction guaranteed or money returned. Address General Information, Ann Arbor, Mich.

VIBRATION and Color: What do they mean to you? Interesting literature free. Robert Knox, Box 728, San Francisco, Calif.

HOLIDAY Greetings. Write today for particulars. Harper Syndicate, Columbus, Ohio.

5 MASTER Keys. Work like magic in emergencies or prove whether your home is burglar-proof. Test and open thousands of locks. Send \$1 today. Novel key chain free. Master Key Co., 3 Manhattan Block, Milwaukee, Wis.

CUTS anybody can make. Simple, cheap process. \$1. Specimens, particulars. 2c stamp. M. Day, Windfall, Ind.

ARTIFICIAL Eyes. \$3. Booklet free. Denver Optic, 559 Barclay, Denver, Colo.

OVERCOME coal shortage. Guaranteed coal saving process halves heating costs, consumes soot, keeps fires clean. Send any address if you enclose dime for expenses. Ewart's Specialties, Merritt, B. C., Canada.

N. O. P. Metal Polish, cleans and polishes all metals. Produces a lasting and waterproof luster. Seven-inch tube postpaid, twenty-five cents. Norwood Oil Products Company, Norwood, Ohio.

STOP! that repair bill—lower your cost of operation and be familiar with your auto by having in your vest pocket for emergency reference a copy of a new, compact little book entitled "Causes and Remedies for Ills and Ails of an Automobile." Price \$1 postpaid. Popular Mechanics Book Dept., 6 N. Michigan Ave., Chicago.

ARIZONA Incorporation completed day papers are filed, without nominal or par value shares. Least cost. Greatest advantages. Operate anywhere. Forms Free. Stoddard Incorporating Company, 8-B, Phoenix, Ariz.

JUST Out—Build your own clock for a quarter. Send us twenty cents for instructions. H. & M. Specialty Co., Box 68, Brighton, Mass.

LOCKSMITHS: Send \$1.00 for valuable chart for cutting tumbler padlock keys. Globe System, 278 Washington St., Newark, N. J.

MAKE Big money Opening Safes and Setting Combinations. Wayne Strong, Box 1430, Los Angeles, Cal.

ART Metal Workers—You will find our book "Metal Work and Etching" a complete manual on making book ends, desk sets, pad corners, paper knives, letter openers, stationery racks, rocking blotters, desk calendars, arts and crafts jewelry, etc., 96 pp. illus. Price 50 cents postpaid. Popular Mechanics Book Dept., 6 N. Michigan Ave., Chicago.

NEW KIND OF HEAT BURNS 95% AIR

Gives Three Times the Heat of Coal or Wood



Here's a new way to get as much or as little heat as you want—at the simple turn of a little valve

A St. Louis inventor has discovered a wonderful new kind of heat that burns 95% air and yet gives three times the heat of coal or wood. What this means to the householder in these days of mounting coal prices can readily be seen. Besides the expense-saving there are also big labor-saving features. With this invention in the home there are no more fires to build, bank or watch—no more dirty, heavy coal to carry and lift—no more clouds of ashes to breathe or back-breaking scuttles to empty—no more heating problems—no more suffering from lack of quick fires in uncertain Fall and Spring—no more worries about coal shortages, poor quality or high prices.

No worry about heat when you can get 3 times the heat of coal by just turning a valve. No coal, wood, ashes

This new kind of heat therefore has really ended the days of woman's

back-breaking servitude to a hot, mussy stove or furnace! The wonderful invention of Mr. B. M. Oliver of St. Louis, in one minute, turns any coal or wood burner into a modern, up-to-date gas stove.

Mr. Oliver calls his invention the Oliver Improved Oil-Gas Burner, because it uses 95% air and only 5% coal oil (ordinary kerosene)—the cheapest fuel there is, turning them into an actual gas that burns with an intensely hot, clean flame. It is cleanly also, and saves its cost in cleaning bills alone.

This invention can absolutely be depended upon to heat rooms in coldest Winter weather—it gives 3 times the heat of coal. But you needn't worry about the high price of coal. Install this amazing new kind of heat and you can snap your fingers at coal shortages, poor quality or high prices.

The Oliver Improved Oil-Gas Burner is made in sixteen different models to fit any kind of cook stove, heating stove or furnace. It doesn't change your stove and simply sets in firebox. It is easily slipped in, in one minute—is absolutely safe and lasts a lifetime.

Just turn the valve and you have heat—as much or as little as you need. Physicians recommend the Oliver as a sure safeguard against colds, influenza, etc.

Now, once and for all time you can do away with household dirt and drudgery. End ashes, dirt, smoke, odor, chopping, shoveling, carrying dirty, heavy coal and wood. Mr. Oliver will be glad to send you immediately **FREE ATTRACTIVE BOOKLET, "New Kind of Heat,"** telling all about this amazing new invention. Shows exactly how it works, how it is different from all other burners and tells how you can use it in your stove, 30 days, FREE. The famous Oliver Iron-Clad, Money-Back Guarantee protects you.

If you write at once you will be in time to receive Mr. Oliver's very low, introductory price offer and 30-day Free Trial. Get your Oliver installed immediately, before cold weather sets in.

OLIVER OIL-GAS BURNER & MACHINE CO.
Oldest and Largest Manufacturers of Oil-Gas Burners in the World
2014-K Oliver Building, ST. LOUIS, MO.

Mr. Oliver is anxious to obtain agents interested in filling the tremendous demands all over the country for his new invention. Oliver agents earn as high as \$500 a month—\$25 a day after time is okay. Exclusive territory. Big, all-season seller. Write for Special Offer.



The ideal thing for this winter when coal prices are high and you want to save work, time and expense

Do YOU Do Any of These Embarrassing Things?



The man in this picture has reason to be ill at ease. He has attended an informal dinner in conventional full dress. The Book of Etiquette would have told him how to interpret the word "informal" on the invitation—and would have revealed to him important things to know regarding an informal social function. The Book of Etiquette tells you what to wear on all occasions.



His friend has just introduced him to the young woman. Instead of waiting for her to offer her hand and make the acknowledgment, he has extended his hand first and mumbled confusedly something about being "Glad to meet you." By telling you how to make and acknowledge introductions, the Book of Etiquette prevents a great many embarrassing blunders.



She has just signed her name in the hotel register, and glanced at the names above. She sees, in these other signatures, that she has made a mistake—that she has registered incorrectly. Mistakes such as these can often be very embarrassing indeed. The Book of Etiquette prevents them, as it covers the whole subject of hotel etiquette completely and authoritatively.



Without realizing his mistake, the man in this picture has followed the head waiter, preceding the young woman. It is the wrong order of precedence and he discovers it to his embarrassment only when he notices the entrance of another couple. The Book of Etiquette tells you about the mistakes that might be made, when entering the theatre, the street car, the drawing room. And it tells you how to avoid these humiliating blunders.



Every one knows that table manners are an index to breeding. The man in this picture has taken olives with a fork, and has just realized his error, as the others have taken them with their fingers. Too bad he didn't refer to his Book of Etiquette! It tells all about table manners—how to eat corn on the cob, lettuce, asparagus, frozen pudding.



The gentleman at the right does not know how to dance. Instead of doing what he should, under the circumstances, he is making himself conspicuous by standing alone while the others dance. The Book of Etiquette would have told him how to avoid this embarrassment—and would have told him also the complete etiquette of the dance and of dancing. It is a most fascinating chapter.

The Book of Etiquette Sent for FREE Examination

If you do not already own the famous two-volume set of the Book of Etiquette, send for a set at once that you may examine it at our expense. Don't be without it another week. It solves many little problems that may be puzzling you, tells you the right thing to do, say, write and wear on all occasions.

It costs you nothing to examine the Book of Etiquette. You are not obligated to keep the set if you are not delighted with it. You be the judge—just mail the coupon and let us send you the Book of Etiquette for free examination. But do it NOW!

NELSON DOUBLEDAY, Inc., Dept. 2311, Garden City, N. Y.

NELSON DOUBLEDAY, Inc., Dept. 2311, Garden City, N. Y.

I accept your free examination offer. You may send me the two-volume set of the Book of Etiquette free for 5 days. During that time I will examine the books, read some of the chapters, examine the illustrations. I understand that all phases of etiquette are covered—wedding etiquette; the etiquette of dress, of speech, of manners, dance, party, tea etiquette, etc. Within the 5 day free period I will either return the books or keep them as my own and send you only \$3.50 in full payment. I need not keep the set unless I am delighted with it.

Name.....

Address.....

City..... State.....

Check in this square if you want these books with the beautiful full-leather binding at \$5.00, with 5 days' examination privilege. (Orders outside the U. S. are payable \$3.50 cash with order.)



\$1000.00

For a Single Drawing!

THINK OF IT! Leading illustrators and commercial artists frequently are paid \$1,000, and more, for single illustrations or designs,—and their work is eagerly sought.

Millions are paid yearly for commercial art, by thousands of advertisers, periodicals, publishers, and others. Good commercial art is vital to modern business, and artists who can produce it earn extraordinary incomes.

If you like to draw, develop your artistic talent. The present opportunities open to capable commercial artists have never been excelled. Both men and women who have developed their art ability through proper training readily earn \$50, \$75, \$100 a week and up.

Success Won by Federal Students

proves that the Federal Course is a result-getter. Daily we learn of it. A young telegraph operator obtains a \$40 a week position as Commercial Designer. A girl student earns over \$400 before completing her Course; another girl earns over \$1,000 making posters. A young man, Federal trained, accepts a highly paid position as head designer for a manufacturing firm. Still another makes 7 times his tuition while still a student—and there are scores of other instances given in our Free Book, "Your Future."

The List of Federal Authors

includes nationally known artists, illustrators, and others,—men who have won true success. You can now profit by their advice and experience, for each has contributed an exclusive original lesson to the Federal Course.

Think of having the help of such men as Charles E. Chambers, a leading magazine and story illustrator; Franklin Booth, called the "Painter with the Pen"; Harold Gross, Designer for the Gorham Co.; D. J. Lavin, formerly head of the Chicago Tribune Art Dept.; Edw. V. Brewer, who has done many illustrations for "Cream of Wheat"; Malack Price, an authority on posters; Charles Livingston Bull, the well-known animal painter, and others.

Send Today for "YOUR FUTURE"

This beautifully illustrated 56-page book in colors describes the fascinating Federal home-study method, easy to learn and apply, and endorsed by leading illustrating companies, designers and commercial artists as America's Foremost Course in Commercial Designing.

It shows remarkable work by Federal Students, and tells of opportunities in this field that will open your eyes. Every ambitious young man and woman should read this book. It's free for the asking to anyone 16 years old or more and in earnest—send the coupon below TODAY!

COUPON

FEDERAL SCHOOL OF COMMERCIAL DESIGNING, 682 Federal Schools Building, MINNEAPOLIS, MINN.

Gentlemen: Please send me "Your Future" without obligating me in any way.

Name Age

(Write your address plainly in margin.)

Draftsman's Complete Outfit

FREE



Everything Used by Expert Draftsmen Given You Absolutely FREE

Outfit includes "professional" complete set of fine drawing instruments with double set of compasses and dividers all in velvet lined case. Drawing board, T square, two triangles, protractor, universal curve, triangular, standard scale, water-proof ink, pens, pencils and all accessories—furnished you free in this expert's complete outfit.

Draftsmen Make \$225.00 to \$500.00 a Month

There is a tremendous demand for trained draftsmen. Now is the time to start. Draftsmen get good pay from the start and can work up to \$500 a month *and more*. Draftsmen are needed everywhere. Once you are trained you can choose your own business and work in any part of the country you please. Coyne training makes everything easy for you, Coyne student, L.T. Dubendorf, writes: "Immediately after completing Coyne course I went to work for Armour & Co. Work was easy for me. Five months later I accepted a position in New York at a large increase in salary."

MONEY BACK GUARANTEE

We guarantee that the training of the Coyne Course will place you in a good position as an expert draftsman or we will refund your money.



B. W. Cooke

President

COYNE

HOME STUDY DEPT.

TRADE & ENGINEERING SCHOOLS

Recognized Producer of Successful Men
552-598 So. Throop St., Dept. 1778, Chicago, Ill.

Easy to Learn at Home from Great School Known all over the World

The Coyne Home Study course guarantees to train you. Remember, the Coyne Trade and Engineering Schools are recognized by educators all over the world. Students come from all over the *world* to get Coyne training. Why? Because of the Coyne school's long established, tremendous reputation for successful teaching by its great staff of experts. Coyne is not a "one man" school, but a great educational institution, 22 years old, an acknowledged leader and originator. Coyne originated the "Learn by Doing" method now endorsed by educators everywhere. Coyne has graduated thousands of successful, prosperous men all over the world. You can't make a mistake if you write for the Coyne free book. Coyne students say every minute of the course was enjoyable. Some students took *good positions three months before their course was finished.*

Send for FREE Book

Mail this coupon for our interesting book, "Drafting, the Foundation of Industry," sent you free. It explains all about the Coyne home study method and shows you how to become a draftsman in the quickest and easiest way. You want to know all about this great institution. Don't put it off. Send for this book now. It's absolutely free, no obligation. It contains the most valuable information you will ever get in your life. Send the coupon now.

Check Coupon Below and Mail Now!

Coyne Trade and Engineering Schools,
Department 1778, 552-598 So. Throop St., Chicago, Ill.
Dear Sirs:—Please send me, absolutely free, without obligation, your book, "Drafting, the Foundation of Industry," also full information about the Course in Drafting. (Check which course you prefer.)

Name

Address

City.....State.....



Become a RAILWAY MAIL CLERK

**Earn \$1600 to \$2300 a Year in a Position Where There
Are NO STRIKES—NO LAYOFFS—NO LOCK OUTS**

HERE is an opportunity to get a good position in the government service—with good money right from the start and a position that is PERMANENT. Once you receive an appointment with the U. S. Civil Service you can be sure of your position and sure of your pay. There are no strikes, no layoffs, no hard times, no discharges for personal, religious or political reasons.

The salaries in the Civil Service begin at \$1600 to \$2300 a year. Increases are rapid. Many positions pay from \$2,000 to \$19,000 a year. And besides the fine salaries and the certainty of getting your money month in and month out, you enjoy other advantages in the government service. Hours are easy—eight or less a day. You get a vacation every year with full pay. There are positions in your home town, in Washington, at the Panama Canal, or travel if you like.

The Railway Mail Service offers unusually good positions. Splendid salaries are paid in this department—you travel on the fast trains and see the country. Besides the Railway Mail Service, there are other attractive branches to choose from—Postal Carriers, Rural Carriers, Postal Clerks, Customs House Internal Revenue Men, Postmasters, etc.

Why be satisfied with low-pay jobs—work for Uncle Sam—the steadiest, most dependable boss in the world.

Civil Service Needs Men NOW

If you are an American, 18 years old or more, and have an ordinary fourth grade education, you are eligible to a government Civil Service position. It is easy to pass the Civil Service Examination, provided you are prepared to answer the kind of questions asked.

You can quickly and easily get all the necessary coaching under the Patterson Civil Service School. It requires just a portion of your spare time at home. You receive the personal assistance of Mr. Arthur R. Patterson, who for eight years was a Civil Service Examiner. In fact, he is so sure of your success that he guarantees to coach you until you get a position.

Send for FREE BOOK

Send for the big FREE book that tells you all about the fine positions open. Mail the coupon or a postcard today—don't delay a minute. Get all the facts at once. There is no cost, no obligation.

PATTERSON CIVIL SERVICE SCHOOL

Dept. 811 Wisner Building Rochester, N. Y.

Patterson
Civil Service
School
Dept. 811,
Wisner Bldg.,
Rochester, N. Y.

Please send me your big free book and tell me how I can secure a position with the U. S. Government paying me \$1600 to \$2300 a year. This doesn't cost me a penny.

Name.....
Address.....
City.....
State.....

Big Pay for Automobile Men

High prices are paid for men who really know automobiles. Be a specialist. The trained man soon gets into business for himself. Write us at once. Let us show you the way to earn real money!

Largest Best Equipped Plant

The Y. M. C. A. schools are the largest and best equipped in the East. You will study in the heart of the world's industrial center. Hundreds of positions are open to you as soon as you finish your course.

You will be able to live in the Y. M. C. A. building—with full privilege of the gymnasium and swimming pool. The Y. M. C. A. is not a commercial institution. Its purpose is to serve you.

Y. M. C. A. SCHOOLS, Dept. 1778,

1115 Bedford Avenue, Brooklyn : Greater New York
318 W. 57th Street, Manhattan : Greater New York

Write for FREE Booklet

Let us help you. Write today for our free booklet. Learn how you too can earn big pay.

Y. M. C. A., Dept. 1778,
1115 Bedford Ave., Brooklyn, Greater New York
318 W. 57th St., Manhattan, Greater New York
(Use either address)

Please send me your free booklet and show me how I can make big money.

Name.....
Address.....

Conquer the TOBACCO OR SNUFF HABIT

quickly with simple, harmless preparation. No matter whether you smoke cigars, cigarettes, pipe, chew or use snuff, this preparation is guaranteed to quickly free you of the tobacco habit. NO CURE, NO PAY. Costs only \$1 if it cures—nothing if it fails. Full treatment sent on approval. Write today.

DR. C. M. SIMPSON CO.

242 W. 44th Street, Cleveland, Ohio

Clear-Tone
FOR
PIMPLES

Your skin can be quickly cleared of Pimples, Blackheads, Acne Eruptions on the face or body, Enlarged Pores, Oily or Shiny Skin. \$1,000.00 Cold Cash says I can clear your skin of the above blemishes.

FREE

WRITE TODAY for my FREE Booklet—"A Clear-Tone Skin"—telling how I cured myself after being afflicted for fifteen years.

E. S. GIVENS, 129 Chemical Bldg., Kansas City, Mo.

Which of these Instruments Would YOU Like to Play?

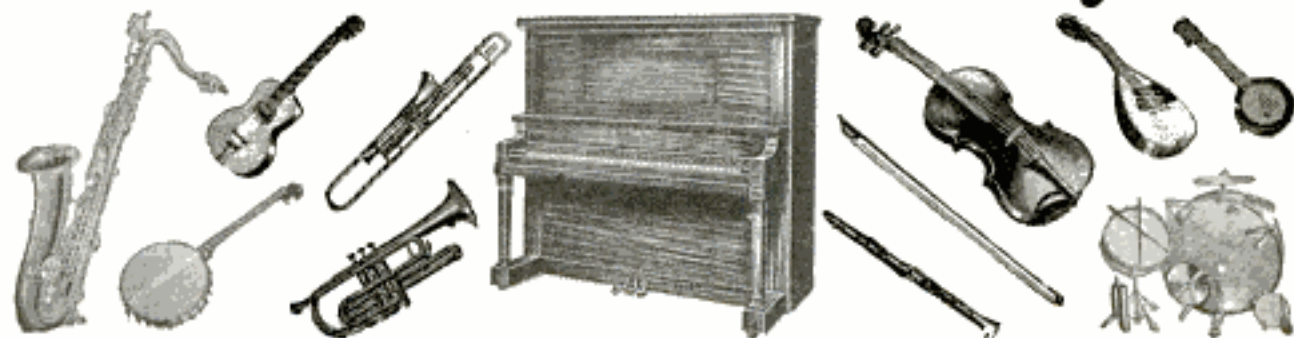

Amazing Free Test Shows If You Have Musical Ability

SURELY there is a favorite musical instrument you would like to play. Surely you will be glad to take advantage of this interesting free offer.

The test comprises just a few simple questions devised by a famous musical instructor. They may show that you have been depriving yourself of pleasures which nature has particularly fitted you to enjoy. You may have never played a note in your life. You may never have attempted to sing in public. Yet you may have natural talent that would make it easy for you to excel in music. Your hidden abilities will be quickly disclosed to you by the free test.

Free Book Tells About Amazing New Way to Learn Music at Home

This free test is contained in our remarkable book, "Music Lessons in Your Own Home." The book also tells you all about a wonderful new easy method of learning to play actual selections, instead of long, dreary exercises. Almost at the start, you can surprise your friends by playing for them. You obtain this skill in your spare time—just a few minutes each day—in your own home.

The new method is simple and fascinating. And you read REAL music, too. No numbers, or "trick" charts. You read the same kind of notes that are used by Paderewski, Kubelik, Sousa, Geraldine Farrar, Galli-Curci, Scotti, and McCormack.

Automatic Finger Control

is a remarkable feature in our new teaching method and is an exclusive invention offered only

Learn at Home Without a Teacher

Piano	Hawaiian
Organ	Steel Guitar
Violin	Harp
Drums and Traps	Cornet
Banjo	Piccolo
Tenor Banjo	Trombone
Mandolin	Saxophone
Clarinet	Harmony and
Flute	Composition
Cello	Voice and
Guitar	Speech
Ukulele	Culture
	Sight Singing

What Others Have Done

I regret that I did not know of you 10 years ago. I learned more in 15 minutes one night than I learned in the past year studying books on Harmony.

FRED A. HEICHEL,
Box 83, Rosiclare, Ill.

Three months ago I didn't know one note from another. Now I can play almost anything.

H. E. DANTZ,
304 Glenside Avenue,
W. S. Pittsburgh, Pa.

to the pupils of the U.S. School of Music. It develops the proper muscles used in playing any instrument, gives the fingers perfect control and quickly makes you skilful.

No Cost—No Obligation

Send for the valuable book today. This remarkable offer is absolutely FREE. It costs you nothing, it places you under no obligation, but it may show that you have musical ability.

Over a QUARTER-OF-A-MILLION people have learned to play their own favorite instruments by our new method. Many of them did not dream they possessed the slightest musical ability until the test revealed it. Many are now earning big incomes as music teachers, band or orchestra leaders, church organists, vaudeville artists, etc.

Mail the Coupon Now

So many thousands of requests will pour in to us for the free test book that we cannot promise to hold our offer open indefinitely. This offer may be withdrawn at any time without notice. It costs you nothing to accept our offer. Mail the coupon now—while it is before you.

Please write name and address plainly. **U. S. SCHOOL OF MUSIC, 711 Brunswick Building, New York.**

The Largest School of Music in the World

Please write name and address plainly so that there will be no difficulty in booklet reaching you.

U. S. School of Music,
711 Brunswick Bldg., New York.

Please send me absolutely FREE, and without obligation, your wonderful book, "Music Lessons in Your Own Home," which shows how to test my own natural musical ability. I name below the instrument I am particularly interested in.

Name.....
Please Write Plainly

Address.....

City..... State.....

Instrument.....

QUICK SUCCESS
in Automotive Electricity

Become a highly paid specialist—learn quickly and easily about Automotive Electricity. Men trained in this branch are scarce and, therefore, well-paid. Thousands of big paying positions awaiting AMBU trained men.

Own a Fine Business

Great chance to start your own business—little money needed—we train you in spare time at home. Thousands of similarly trained men are drawing big salaries or running their own successful business. You can complete our course successfully even if you now know nothing of automobiles or electricity.

Salaries Up to \$6,000
Earnings Up to \$25,000

Big Corporations pay men who have the equivalent of AMBU training, up to \$6,000 per year. Millions of autos are operated, their owners are ready to patronize AMBU trained men to get expert service in Starting, Lighting, Ignition and Battery. AMBU trained men can earn up to \$25,000 yearly operating such service stations. You can do as well.

Young Dick Blake Earns \$2,600 in Own Business in Six Months

Without previous training or special experience, young Blake earned \$2,600 first six months through AMBU training. We can help you to quick success also—you don't risk a penny. Write for our "Money Back Guarantee Bond" and "Success Book"—free.

MAIL THIS NOW—
get into the Big-money Class—Success Book tells you how.

AMBU ENGINEERING INSTITUTE
C. J. BUCKWALTER, President
111-2632 Prairie Ave. CHICAGO, ILL.

AMBU ENGINEERING INSTITUTE,
111-2632 Prairie Ave., Chicago.

Send FREE your Success Book and complete information. I want to learn how to train for Bigger Money in spare time.

Write Name and Address in Space Below. Tear Off on Dotted Line.

Name.....

Address.....

City..... State.....

Are you now in auto business Yes No



New friends, new pleasures, new and interesting experiences, invitations galore—dinners, dances, week-end parties, outings,—are some of the good things playing a Gibson brings into your life.

Gibson
Instruments

are easily learned in spare time without previous knowledge of music. A few weeks of pleasant, interesting study and you'll be able to play. And there's no other joy in life quite equal to hearing music you make on your own instruments.

\$5.00 Monthly buys a Gibson. The ultimate in construction, finish, tone quality and volume. Built like a violin. **Guaranteed for life.** Non-Gibson instruments exchanged.

Make \$25 to \$200 weekly selling, playing, teaching. Own a high class, exclusive business. We furnish stock, advertise, help sell, carry accounts. Gibsons easily sold on confidential credit plan.

Send for FREE catalog, FREE music and information about Mandolin, Mandol, Mando-cello, Mando-bass, Guitar, Harp-guitar, Mandolin-banjo, Tenor-banjo, Cello-banjo, Guitar-banjo. If interested in Agency, check here.....Teacher?..... Cap, check and mail this ad today.

Gibson Mandolin-Guitar Co.
1371 Parsons St. Foreign Dept.
Kalamazoo, Mich. 25 Broad St., N. Y. City

I Make Strong Men



That is my business. I make no other claims. But what I promise, I fulfill. I will increase your arm one full inch in 30 days and your chest in proportion. In three months I will make you a finished strong man. Are you interested? Read my book "Physical Perfection." It tells you how. All I ask is 10 cents to cover postage and wrapping. Don't put it off. Send today.

Arthur L. Hyson
110 Langdon Bldg. New York City

Don't Wear a Truss

Brooks' Appliance, the modern scientific invention, the wonderful new discovery that relieves rupture, will be sent on trial. No obnoxious springs or pads.



MR. C. E. BROOKS

Brooks' Rupture Appliance

Has automatic Air Cushions. Binds and draws the broken parts together as you would a broken limb. No salves. No lies. Durable, cheap. Sent on trial to prove it. Protected by U. S. patents. Catalog and measure blanks mailed free. Send name and address today.

BROOKS APPLIANCE CO., 1266 State St., Marshall, Mich.

Down goes the price!

BOXING \$1.97
Jiu-Jitsu
Wrestling Was \$5.00



Think of it! For only \$1.97 you can now have the famous Marshall Stillman Course—the same identical \$5.00 course by which Marshall Stillman has taught boxing, jiu-jitsu and wrestling to over 30,000 men! You can have it on 10-day trial. Send no money with order.

Over 80 complete lessons—six volumes, hundreds of pages, and over 200 illustrations—all for \$1.97, or less than 3 cents a lesson!

He teaches you right in your own home. You learn all the fundamentals of boxing and the blows and guards used by the top-notchers—the Benny Leonard Triple, the Jack Dempsey Triple, the Fitzsimmons Shift, etc. All the secrets of the ring, all the fine points of feinting, ducking, clinching, breaking ground, judging distance and timing—including three lively rounds of *Shadow Boxing* to develop speed and confidence. In short, you will become a good boxer in quick time—able to box rings around that "fellow who thinks he knows it all"—and for only \$1.97.

In *Jiu-Jitsu* you will learn how to disarm an opponent, how to break a stranglehold, etc., and, in *Wrestling*, the Gutch Toe Hold, Stecher Scissor Hold, the Head-lock, etc.

With the course you get a Free History of 69 Famous Boxers, with their pictures and "inside" stories about them.

SEND NO MONEY. Simply fill in and mail the coupon. When you have the course in your hands, deposit \$1.97 (plus the actual postage) with the postman. Then examine the course for 10 days—try it out thoroughly. We're sure you'll go on with it—and there'll be nothing more to pay. But if, for any reason, you are not entirely satisfied, return the course, and get your money back at once. Mail the coupon now to Marshall Stillman Association, Dept. 1222-L, 42nd Street and Madison Avenue, New York.

Marshall Stillman Association
 Dept. 1222-L, 42nd St. and Madison Ave., New York.

You may send me on approval the Marshall Stillman Course. I will deposit \$1.97 (plus the actual postage) with the postman, with the understanding that if, after 10 days, I wish to return the course I may do so and my deposit will be instantly refunded. If I keep the course, there is to be nothing further to pay.

Name.....
 Address.....

NOTE: Canadian and foreign orders must be accompanied by cash (\$1.97 U. S. funds) subject to money back if not entirely satisfactory.

You Can Play the Hawaiian Guitar

Just Like the Hawaiians!

Because Our Native Hawaiian Instructors Will Help You

OUR STUDENTS SAY

Koster School,
 214 So. Franklin St.,
 Chicago, Ill.
 First Hawaiian Conservatory of
 Music, Inc.

I shall certainly be very glad to recommend your course whenever the chance is mine to do so. Mr. W. K. Johnson has not played me yet, and if he does not please in a day or so, will write him. Am sending a letter to Miss Helen Slavik today which I think may help to secure her enrollment, and I shall be glad at any time to write a personal letter to anyone whom you may suggest.

Your former student,
 W. L. Walker.

San Quentin, Calif.
 First Hawaiian Conservatory of Music,
 903 Woolworth Building, N. Y. City.

Dear Sirs—

Lessons 18 and 19 came last evening and I was pleased to see that they are beginning to get hard, or at least a little bit more to learn in them. I have a great deal of spare time to put in on the guitar and I enjoy it. Your course is the simplest and most interesting I have ever tried to learn. I am getting along fine and can play every lesson up to the last one and I can readily see that when I have finished with all of the lessons I will be able to play most anything and play it good. I am, in appreciation,

Yours truly, J. E. FERGUSON.

P. S. If at any time you wish to use my name as a reference for your course you may do so, as I think that any one who takes it up will derive a great benefit from it and cheer about it.

Our improved method of teaching is so **simple, plain and easy** that you begin on a piece with your first lesson. **In half an hour you can play it.** Thousands of successful students prove this to be true.

ONLY 4 MOTIONS We have reduced the necessary motions you learn to only four, and you acquire these in a very few minutes. Then it is only a matter of a little practice to acquire the weird, fascinating, tremolos, staccatos, slurs and other effects that make this instrument so delightful. **The Hawaiian Guitar plays any kind of music, both the melody and the accompaniment.**

FREE Just think of it. 52 lessons on this wonderful guitar. You get a beautiful large sized **Genuine Hawaiian Guitar absolutely free as soon as you enroll for the lessons.** All the necessary picks, the steel playing bar and 52 pieces of music are included **without cost to you.**

Special Arrangements for Lessons if You Have Your Own Guitar
This Makes A Splendid Christmas Gift!

Play Any Music

In half an hour after you get the free Hawaiian Guitar and the first lesson, **you can play Hawaiian Melodies.**

In a very short time after a little practice **you can play any kind of music** as well as Hawaiian, both the melody and accompaniment.

[TEAR OUT COUPON]



Your favorite instrument given away FREE with first lesson. SPECIAL COURSES UNDER FAMOUS TEACHERS. Learn to play VIOLIN, BANJO or UKULELE.

First Hawaiian Conservatory of Music, Inc.
 233 Broadway (Woolworth Bldg.), New York City

Please send me full information about your 52 easy lessons and FREE GUITAR OFFER.

NAME.....

ADDRESS.....

TOWN..... STATE.....

Print name and address clearly. P.M. 11



Let Me Put You in Business as an Exterminating Engineer

Earn \$60 to over \$300 a week in this enormous untouched field. No competition—a tremendous demand—and no capital required.

THE secret of making big money is to get into something new where there is no competition—and yet a big enough demand. Do you appreciate what a rich field for profit Exterminating Engineering offers you? Do you know that over \$300,000,000 loss is occasioned every year from pests and vermin that infest offices, ships, warehouses, hotels and private homes? That is why individuals and commercial houses gladly pay enormous fees to Exterminating Engineers—specialists who know how to get rid of these destructive and annoying pests quickly and effectively.

How I Quickly Establish You In a Profitable Business

In a few short weeks I teach you the successful and exclusive methods with which I have revolutionized the exterminating science. I give you the secret formulae and supply you with materials which will enable you to give an **iron-clad guarantee** of satisfaction to your customers. My methods—totally different from any others—have never been known to fail; yet they are extremely simple once you know them.

As soon as you are experienced—it takes but a few short weeks—I start you in business as my local representative in your district. Here I refer all local inquiries and contracts to you, bring you new customers and lend dignity to your profession by an extensive national advertising campaign which explains the services rendered to health and sanitation by the exterminating engineers who have been trained under our supervision.

Send for FREE BOOK

Never has there been such an unusual opportunity to earn big money so easily! Send for my Free Book which describes the wonderful opportunities in this brand new field—opportunities which pay from \$3,000 to over \$15,000 a year. Mail the coupon for Free Book **today**.

Exterminating Engineers of America
Dept. 111, 43 West 16th St., New York City

EXTERMINATING ENGINEERS OF AMERICA
Dept. 111, 43 West 16th Street, New York City

Please send me without obligation, your free book, "A Profitable Business Overnight," which tells how I can make \$60 to over \$300 a week as an Exterminating Engineer.

Name

Address

Electricity

Taught by Practical Men

If you expect to become an **electrical expert in four months** this is not the ad you are looking for. Being an **electrical engineer** is a real job and cannot be learned over night. Haphazard methods of instruction may get you by for a time, but will not give you the **solid foundation** that opens the road to the biggest positions. You cannot learn **everything about electricity in a few months**. Steinmetz is still learning; and Marconi adds to his knowledge daily.

I am in business to teach men who are earnest in their desire to get ahead and want the **real electrical foundation**. I can give you the training, but how fast you get ahead, or how much you earn, depends on you. I give you a thorough teaching in **Electrical Engineering Principles and Applications**; you learn how and why to apply them.

You can get this training without losing a day or a dollar from your present work. **Learn at home in your spare time**. Hundreds of Burgess trained men have proven this and are earning bigger salaries. Burgess Home Study Methods are **approved by Electrical Engineers**. If you are earnest to **succeed in any branch of Electricity** write us today.



You cannot reach the top unless you start right. Let me show you how I teach men, so they **keep on going**. Write me today for the Burgess catalog on "Electricity," telling you of opportunities open, and how we teach by the Burgess Method. Take the surer road to success; write Burgess.

Yorke Burgess, Consulting Engineer.
BURGESS ELECTRICAL SCHOOL
744 E. 42nd St., Dept. 10, Chicago, Ill.



Be a Diamond Expert

Do you know that of two diamonds of equal size one may be worth a hundred times as much as the other? Who can distinguish them but an expert? My short easy course will make you a diamond expert!

\$5,000 to \$15,000 a Year!

FREE! Genuine up-to-date Jewelry houses everywhere need expert diamond men who can distinguish if you name their own salary! I will show you how to make this money! enroll at once! Booklet "Pay in Diamond Knowledge" sent free! Send for it!
CODINGTON SCHOOL OF DIAMONDS, Dept. 111
442 N. Wells St. Chicago, Illinois



New Way to learn Violin, Mandolin, Mandolin Banjo.

Play for Money in 2 Months! Marvellous new way to be a Musician. I give you my instructions on PHONOGRAPH RECORDS. Nothing ever like it. First lesson will convince you that you will be able to play these. Play real pieces in a few days. In 90 days play as professional and make big money. Any photograph will do. My records and instructions do the work!

INSTRUMENT GIVEN ABSOLUTELY FREE

Let me give you a fine Violin, Mandolin or Mandolin Banjo FREE. Write today for my special offer and full description of my wonderful new method of teaching these instruments. A post-card will do. No obligation. My name known to whole music world of America and Europe. Write me today.

F. M. SCHNEIDER, Director, Schneider School of Music
238 Vermont St., Blue Island, Ill. (A suburb of Chicago)

Get Rid of Pimples My Method is Guaranteed

You can easily clear your skin of pimples, blackheads, and other unsightly blemishes. I will prove it to you at my own risk. I will show you just how you can clear your complexion as easily as washing your face. Just write me what skin eruptions you have, where they appear and how long you have had them. Your letter will receive confidential, personal attention and I will send you, in a plain wrapper, a full size bottle of my special remedy for your pimples. Use it on your skin like you would use water. Then watch the pimples disappear.

Send No Money

The regular price of my pimple remedy is \$3.00. But you do not need to send any money. Just write me today. When the postman delivers the package to you, pay him **ONLY \$1.45** (plus a few cents postage) for this remarkable \$3.00 preparation. All I ask is that you follow the simple and easy directions. A Million Dollar Bank backs up my guarantee of satisfaction or your money back. You take no risk. Act today and banish pimples.

M. Sullivan, Dept. 5, 269 So. 9th St., Philadelphia, Pa.



Easy to Learn the Automobile and Tractor Business

Men Wanted

We can place a large number of capable men NOW. Concerns everywhere look to GREER College for reliable mechanics. All sorts of opportunities to have a business of your own.

Made His Pile

"I am ready to retire. I've made my pile. I'm ready for a man to step in and take my business" writes Edw. Hager of Colfax, Ill. He came to GREER College a greenhorn, as far as the auto business is concerned.

Makes \$5,200 a Year

"I am making \$5,200 a year as Service Manager. I give GREER credit for a very large part of my success."—says O. T. Hylton who came from Mason Co., W. Va.

COME! Be a money-maker! Anybody can plod along—at plodder's pay. Join the men, young and old, who are here fitting themselves for independence.

The Greer Shop Method of Instruction enables the average man to master all the principles of Motor Mechanics in a few short weeks. And the man with GREER training is a **master mechanic**—a Certified Automotive Engineer. That's why GREER graduates are successful—why they get the pick of waiting positions or start their own businesses and become financially independent. GREER Graduates are paid **\$50 to \$125 a week**. Many make up to \$10,000 a year as owners of garages and repair shops.

GREER College of Automotive Engineering

Most complete equipment. Brand new building used exclusively by GREER College. Numerous Master Mechanic Instructors insure personal, individual training. Small classes. All practical shop work on real autos, trucks, tractors; all types of motors, ignition and starting systems.

Personal Service:

We have calls for more men than we can supply. Capable graduates are assured positions immediately on completion of their training. Write for definite information.

Here is the Complete GREER Course:

Truck, Tractor and Automobile Repairing and Overhauling.	Electric Lighting and Starting Systems.
Automobile Driving.	Machine Shop Practice.
Roadside Repairs.	Acetylene Welding and Cutting.
Primary Ignition.	Storage Batteries.
Vulcanizing and Tire Repairing.	Salesmanship.

FREE BOOK

—just off the press, newest and most interesting. "How to Succeed in the Automobile Business" is a book you'll find a real guide to a better job at bigger pay. Use the Coupon and mail today.

Erwin Greer, President

GREER COLLEGE OF AUTOMOTIVE ENGINEERING

2061 Greer Bldg.
CHICAGO, ILL.

Write at Once: GREER College is more than an "automobile school," remember. We specialize in quick training for men of all ages who have had no previous experience.

MAIL THIS

Greer College of Automotive Engineering,
2061 Greer Bldg., Chicago, Ill.

Send me your Free Book, "How to Succeed in the Automobile Business" and Special Tuition Offer.

Name.....

Address.....



**I
Have a
GUARANTEED
POSITION
FOR YOU**

**Send this
"FIRST CHANCE"
COUPON**

\$1000 Guarantees This Offer

What I tell you here is backed up with a \$1000 Bank Deposit. If I fail to put you in a position—or do not make good on any obligation, \$1000 stands ready to make good. I can make this guarantee because I know from experience that you can succeed. I know I can help you become a trained Finger Print Expert. By just using your spare time you can step into a position now!

**You Can Be a Big
Finger Print Expert**

I have seen the Finger Print Profession grow from a baby to a young giant. I have seen men from every rank come into the Finger Print Profession with no special qualifications. They have become famous. They figure in big cases—where men's lives depend on the soundness of the Expert's knowledge. Out of my long experience I can show you how to succeed. And I'll guarantee you a position in any part of the country.

IMPORTANT—INTERESTING

Untold opportunities to earn money, fame and the rich rewards of success await the trained Finger Print Expert. Of all professions, none needs men more than the Finger Print profession. Just a handful of trained men are trying to serve the thousands of cases where trained Finger Print Experts must be relied upon. This is not opinion. It's fact backed up with a Guaranteed Position offer and a \$1000 Bank Guarantee.

I Guarantee You a Position

An opportunity to step into a guaranteed position will not last long. So I advise you to write me at once. Do this so you can be sure of securing a position—and all of my other Free Offers. The cost is so low and the terms are so easy that this is within the reach of any man. Conditions are changing rapidly though, so it is dangerous to delay or wait. You do so at your own risk.

**FREE Secret Service Reports and
Secret Service Instruction**

Because men are needed now I can offer all who act at once a complete course in Secret Service and actual copies of Secret Service Reports. These are both offered Free with my regular course in Finger Prints. This helps train you to get the "inside dope" of big mysteries. But heed this final warning and Act Now! Send the Position Coupon now. Full information will come to you free. Get ready for your big chance—and send the coupon now!

E. A. SHOOK, President

**U. S. SCHOOL OF FINGER PRINTS
Dept. 438 7003 N. Clark St. Chicago**

POSITION OFFER COUPON

**E. A. SHOOK, Pres., U. S. School of Finger Prints
Dept. 438, 7003 North Clark Street, Chicago**

Dear Sir: Without obligation tell me about your Guaranteed Position offer and how to become a Finger Print Expert.

Name _____

Address _____

City _____ Age _____

Please Mention Popular Mechanics

**No Better
Holiday Present
for \$3.00**

than a year's subscription to

**Popular
Mechanics
Magazine**

Containing 3600 Pictures
and 3600 Articles

Much of it Interests Everybody
Most of it Interests Anybody
All of it Interests Somebody

A Christmas card containing name of the donor will be mailed by the Publisher without additional charge.

Order through your Newsdealer or
address the Publisher

POPULAR MECHANICS CO.
6 N. Michigan Avenue Chicago, Ill.

Use the coupon below

Popular Mechanics Co.

6 N. Michigan Ave., Chicago, Ill.

For the enclosed \$3.00 send your magazine for one year to

Name

St. and No.

City and State

Send card containing the following name

Can You Guess This Man's Age?

See if You Can Tell Within 25 Years; The Author Couldn't; But He Stuck With Hobart Bradstreet Until He Revealed His Method of Staying Young

By WILLIAM R. DURGIN

I USED to pride myself on guessing people's ages. That was before I met Hobart Bradstreet, whose age I missed by a quarter-century. But before I tell you how old he really is, let me say this:

My meeting-up with Bradstreet I count the luckiest day of my life. For while we often hear how our minds and bodies are about 50% efficient—and at times feel it to be the truth—he knows why. Furthermore, he knows how to overcome it—in five minutes—and he showed me how.

This man offers no such bromides as setting-up exercises, deep-breathing, or any of those things you know at the outset you'll never do. He uses a principle that is the foundation of all chiropractic, naprapathy, mechano-therapy, and even osteopathy. Only he does not touch a hand to you; it isn't necessary.

The reader will grant Bradstreet's method of staying young worth knowing and using, when told that its originator (whose photograph reproduced here was taken a month ago) is sixty-five years old!

And here is the secret: he keeps his spine a half-inch longer than it ordinarily would measure.

Any man or woman who thinks just one-half inch elongation of the spinal column doesn't make a difference should try it! It is easy enough. I'll tell you how. First, though, you may be curious to learn why a full-length spine puts one in an entirely new class physically. The spinal column is a series of tiny bones, between which are pads or cushions of cartilage. Nothing in the ordinary activities of us humans stretches the spine. So it "settles" day by day, until those once soft and resilient pads become thin as a safety-razor blade—and just about as hard. One's spine (the most wonderfully designed shock-absorber known) is then an unyielding column that transmits every shock straight to the base of the brain.

Do you wonder folks have backaches and headaches? That one's nerves pound toward the end of a hard day? Or that a nervous system may periodically go to pieces? For every nerve in one's body connects with the spine, which is a sort of central switchboard. When the "insulation," or cartilage, wears-down and flattens-out, the nerves are exposed, or even impinged—and there is trouble on the line.

Now, for proof that subluxation of the spine causes most of the ills and ailments which spell "age" in men or women. Flex your spine—"shake it out"—and they will disappear. You'll feel the difference in ten minutes. At least, I did. It's no trick to secure complete spinal laxation as Bradstreet does it. But like everything else, one must know how. No amount of violent exercise will do it; not even chopping wood. As for walking, or golfing, your spine settles down a bit firmer with each step.

Mr. Bradstreet has evolved from his 25-year experience with spinal mechanics a simple, boiled-down formula of just five movements. Neither takes more than one minute, so it means but five minutes a day. But those movements! I never experienced such compound exhilaration before. I was a good subject for the test, for I went into it with a dull headache. At the end of the second movement I thought I could actually feel my blood circulating. The third movement in this remarkable SPINE-MOTION series brought an amazing feeling of exhilaration. One motion seemed to open and shut my backbone like a jack-knife.

I asked about constipation. He gave me another motion—a peculiar, writhing and twisting movement—and fifteen minutes later came a complete evacuation!

Hobart Bradstreet frankly gives the full credit for his conspicuous success to these simple secrets of SPINE-MOTION. He has traveled about for years, conditioning those whose means permitted a specialist at their beck and call. I met him at the Roycroft Inn, at East Aurora. Incidentally, the late Elbert Hubbard and he were great pals; he was often the "Fra's"



HOBART BRADSTREET, THE MAN WHO DECLINES TO GROW OLD

guest in times past. But Bradstreet, young as he looks and feels, thinks he has chased around the country long enough. He has been prevailed upon to put his SPINE-MOTION method in form that makes it now generally available.

I know what these remarkable mechanics of the spine have done for me. I have checked up at least twenty-five other cases. With all sincerity I say nothing in the whole realm of medicine or specialism can quicker re-make, rejuvenate and restore one. I wish you could see Bradstreet himself. He is arrogantly healthy; he doesn't seem to have any nerves. Yet he puffs incessantly at a black cigar that would floor some men, drinks two cups of coffee at every meal, and I don't believe he averages seven hours sleep. It shows what a sound nerve-mechanism will do. He says a man's power can and should be unabated up to the age of 60, in every sense, and I have had some astonishing testimony on that score.

Would you like to try this remarkable method of "coming back?" Or, if young, and apparently normal in your action and feelings, do you want to see your energies just about doubled? It is easy. No "apparatus" is required. Just Bradstreet's few, simple instructions, made doubly clear by his photographic poses of the five positions. Results come amazingly quick. In less than a week you'll have new health, new appetite, new desire, and new capacities; you'll feel years lifted off mind and body. This miracle-man's method can be tested without risk. If you feel enormously benefited, everything is yours to keep and you have paid for it all the enormous sum of \$3.00! Knowing something of the fees this man has been accustomed to receiving, I hope his naming \$3.00 to the general public will have full appreciation.

The \$3.00 which pays for everything is not sent in advance unless you prefer. Just pay the postman who brings it. Requests will be answered in turn. Try how it feels to have a full-length spine, and you'll henceforth pity men and women whose nerves are in a vise!

HOBART BRADSTREET, Suite 412,
630 S. Wabash Ave., Chicago, Ill.

I will try your SPINE-MOTION without risk if you will provide necessary instruction. I will pay postman just \$3.00 for everything, on arrival. This deposit to be returned in full if I send back the material in 5 days.

Name.....

Address.....

"Most Interesting Position with Unlimited Opportunities"

Says Glen
O. Trego,
Waterloo,
Iowa

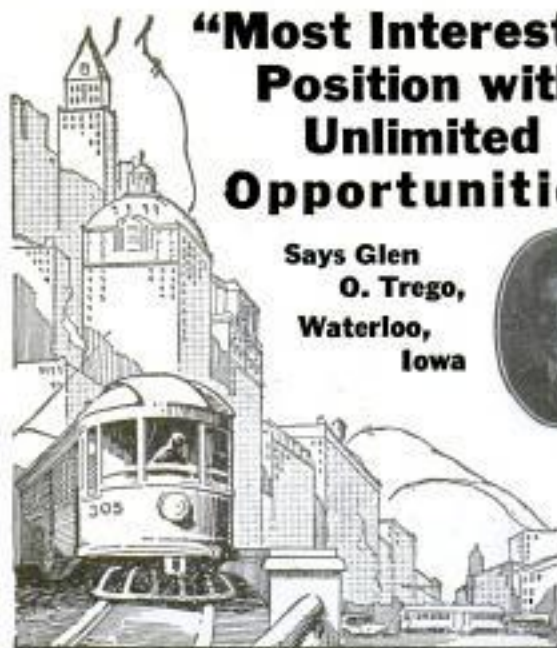

BE A RAILWAY TRAFFIC INSPECTOR

Earn Up to \$250 Per Mo.

Position GUARANTEED

Hundreds of openings for trained Railway Traffic Inspectors. Any average man can qualify. Steady, pleasant, outdoor work; travel or remain near home. Something new every day.

Splendid Opportunities

Start at \$110 per month, expenses paid, after 3 mos. spare-time study at home. Advancement rapid with experience. Earn up to \$250.00 and \$300.00 per month. Many splendid opportunities thru contact with big railway officials.

Read what G. O. Trego Says:

"Having completed your course in traffic inspection about nine months ago and received a position within a few days thereafter, I now feel it my duty to express my gratitude to you for the help which was extended me after I began work. And that was far more than I expected."

"I find railway traffic inspection to be the most interesting position with unlimited opportunities that any man could look for. I find that being a railway traffic inspector does not only enable a man to receive higher positions in railways, but it also verses one so he is more capable of conducting any kind of business which may be chosen for the future."

"I must admit that the price paid for the course of traffic inspection is the best investment I made."

YOU TAKE NO RISK

If position is not obtained for you, enrollment fee is refunded without question. You have nothing to lose! Send coupon for full details and booklet No. D-726.

STANDARD BUSINESS TRAINING INST.
BUFFALO, N. Y.

Standard Business Training Inst.,
Buffalo, N. Y.

Send me, entirely free, Booklet No. D-726, giving full particulars about course in Railway Traffic Inspection.

Name.....

Street.....

City.....

STOP USING A TRUSS

Do Away With Steel And Rubber Bands

FREE TRIAL



Inner surface is made adhesive to secure the PLAPAO-PAD firmly to the body, keeping the PLAPAO continually applied and the pad from slipping. No straps, buckles or springs attached. Soft as velvet—easy to apply.

It's the Non-Slip- ping, yet Non-Rigid Pad and What is Within It That Counts

FREE to 5,000 Truss Sufferers

To the extent of 5,000 sufferers who may apply I will send, ABSOLUTELY FREE, a sufficient quantity of the Plapao to positively convince them that this is the only logical, common-sense way of treating rupture. Plapao is a highly astringent medication placed within the Plapao-Pad and being absorbed through the skin, creates a wonderful feeling of relief and at the same time tends to strengthen the weakened muscles and thus permanently close the rupture opening. The process of recovery is natural, so you'll have no use for a truss—you can throw it away forever! Old and young have testified under oath that the Plapao-Pads cured their rupture—many of them long-standing, aggravated cases—without delay from work. Patent allowed in U. S. and foreign countries. Awarded Gold Medal at Rome and Grand Prix at Paris.

Send No Money—for a sufficient quantity of the Plapao is sent without charge to enable you to give it a thorough test; you pay nothing for this trial now or ever. Write for it and full information today. Address: Plapao Laboratories, Block 1427 St. Louis, Mo.

Deafness



Perfect hearing is now being restored in every condition of deafness or defective hearing from causes such as

Relaxed or Sunken Drums, Roaring or Hissing Sounds, Perforated, Partially Destroyed Drums, etc.

Wilson Common Sense Ear Drums

"Little Wireless Phones for the Ears"—require no medicine but effectively replace what is lacking or defective in the natural drums. They are simple devices, which the wearer easily fits into the ears where they are invisible. Soft, safe and comfortable to wear at all times.

Write today for our 168 page FREE book on DEAFNESS, giving you full particulars and plenty of testimonials.

WILSON EAR DRUM CO., Incorporated
195 Inter-Southern Building LOUISVILLE, KY.

Bowlegged Men

Your legs will appear straight when you wear

Straightleg Garters

Combination hose-supporter and pantleg straightener—Quickly adjusted to fit various degrees of bow-legs; as easy to put on and comfortable to wear as any ordinary garter—no harness or padded forms; just an ingenious special garter for bowlegged men—improves appearance wonderfully. Wearers are enthusiastic. You will be too. Write for free booklet, mailed in plain envelope.

S-L GARTER COMPANY
608 Davies Bldg. DAYTON, OHIO

FREE

The Book Which Is Guiding Thousands To Startling Salary Raises Through ELECTRICITY

"Give us trained men," is the great cry of large and small employers of men in the electrical industry throughout America. "Salary no object, give us men who know electricity."

There never has been such a demand for men at big pay. Millions upon millions of dollars are being spent in the electrical field. How about you? Are you making any effort to take advantage of this great wave of prosperity? You are unfair and unjust to yourself unless you get ready for one of the thousands of big positions waiting.

Get in the Game **EARN \$3500 to \$5000** Per Year
Be an Expert **And More**



The greatest, the most valuable free book ever offered by any school. 56 pages, 50 pictures, hundreds of vital facts. It is FREE.

RETURN COUPON BELOW

The World Technical Institute Offers You What No Other School Can Offer—

- (1) Complete, practical, simplified instruction in every phase of electricity, including:
- (2) Power plant management, maintenance, installation.
- (3) Wiring, armature winding, batteries, motors, generators.
- (4) Illumination, signs, motion picture operating.
- (5) Ac and dc machinery of every description, repairs.
- (6) Contracting, merchandising, telephony, telegraphy.
- (7) Train lighting, farm lighting, welding, meters, instruments.
- (8) Automobile ignition, lighting and starting.
- (9) Complete instruction in wireless.
- (10) Real working outfit, presented free.
- (11) A real employment service.
- (12) Information which will enable you to become an expert draftsman.
- (13) Reviews of your work by an electrical engineer.
- (14) Personal instruction by an electrical engineer.
- (15) Money-back guarantee bond.
- (16) Consulting service until you are earning \$100 per week.
- (17) All the advantages of our Keysheet System.
- (18) Information which will enable you to procure a license in any state or town where required.
- (19) Instruction which will help you to begin earning money in a few weeks after you enroll.
- (20) A diploma which means that you have completed the most practical course of training in existence.
(All explained in the Free Book.)

You must decide upon your future NOW. You cannot afford to hesitate another day. As to whether you are going to be a big success or a big failure in life is SQUARELY UP TO YOU.

As-In-Practice Training at Home

Waste no time in getting into the big-pay class. The World Technical Institute's improved methods of training men of all ages makes your success and progress absolutely sure. You cannot secure this as-in-practice training from any other school in America.

No Matter About Your Age, Experience Or Previous Education

If you can read, write, add, subtract, multiply and divide we can make of you an expert. We will help you to earn more money than you have ever dreamed you could earn. Our course of training outclasses all others in simplicity, accuracy, modernity, thoroughness.

Free Tools, Instruments, Material

You will be supplied with a real working outfit, consisting of over eighteen standard articles. Superior to the working outfit of any other school.

Free Employment Service

We render a real employment service to students who wish to avail themselves of the same. We give real time and energy to placing students in satisfactory positions.

Money-Back Guarantee

You run no risk whatever in enrolling with us. The risk is all ours. We give you a Bond which guarantees satisfaction.

MAIL FREE COUPON NOW

Our great free electrical book, and all particulars in regard to the most remarkable offers ever made by any school will be mailed to you free and post-paid upon receipt of coupon.

WORLD TECHNICAL INSTITUTE

Fuller Bldg., Jersey City, N. J.

FREE COUPON

WORLD TECHNICAL INSTITUTE,
Fuller Bldg., Jersey City, N. J.

Gentlemen:—Send to me postpaid, and without obligation, your valuable illustrated book entitled, "Electricity Taught by a Master Teacher," also full particulars in regard to your course and the remarkable offers you are making to students.

Name.....

Address.....

Why Good Dancers Are Popular

Perfect dancers are the life of any party. That's why they are invited everywhere and are always surrounded by a gay set. Everyone admires and wants to dance with the person who knows the latest steps. There is no need of being a wallflower!

Arthur Murray, America's foremost dancing teacher, has perfected a wonderful new method by which you can learn any of the latest dance steps in a few minutes—and all of the dances in a short time.

Even if you don't know one step from another—through Arthur Murray's method you can quickly and easily master any dance without a partner and without music, right in your own home—or the lessons won't cost you one cent. More than 60,000 have learned this new easy way. Your own success is *guaranteed*.



Proof You Can Learn at Home in One Evening

To show you how easily anyone can learn to dance at home without music or partner, Arthur Murray has consented to send, for a limited time only, his

16 Lesson Course Only \$1.00

Don't send any money now—just the coupon. When the postman hands you the 16-lesson course just deposit \$1.00 with him, plus a few cents postage, in full payment.

Keep the course for 5 days; and if within 5 days you are not perfectly satisfied in every way, return it and Mr. Murray will return your dollar promptly without question. Learn in private—surprise your friends. Act **Now** and be a good dancer soon.

ARTHUR MURRAY, Studio 470, 100 Fifth Ave., New York

ARTHUR MURRAY, Studio 470, 100 Fifth Ave., New York

To prove that you can teach me to dance in one evening at home, you may send the 16-lesson *new* course in plain cover, and when the postman hands it to me I will deposit \$1.00 with him (plus the few cents postage) in full payment. If within five days I decide to return the course, I may do so, and you will refund my money promptly and without question.

Name.....

Address.....

City..... State.....

If apt to be out when postman calls, send one dollar and we will pay postage.
(Price outside U. S. \$1.10 cash with order.)

Our BUREAU OF INFORMATION will answer all questions regarding articles in this magazine. Address Popular Mechanics Magazine, Chicago.

WANTED

Railway Mail Clerks \$1600 to \$2300 Year

**MEN—BOYS OVER 16
SHOULD WRITE IMMEDIATELY**

**Steady work. No layoffs. Paid Vacations
Common education sufficient.
Send coupon today—SURE**

LEARN BY DOING

Every phase of all branches of

ELECTRICITY

Taught by Actual Practice

In America's foremost and oldest institution for trade training.

**No Books Used
Individual Instruction
Start Any Day**

A SPECIAL and SEPARATE Course in Ignition, Auto Lighting and STARTER Systems. Write for FREE 64-page catalog.

THE
NEW YORK ELECTRICAL SCHOOL
44 West 17th Street, NEW YORK CITY

DRAW CARTOONS

and COMIC STRIPS **IT WILL PAY YOU TO LEARN**

Let a former staff cartoonist of the N. Y. World, N. Y. American, Lib. and Judge, train you for success by

CORRESPONDENCE

Send 6c stamps for illustrated BOOKLET, comic strip folder and particulars.

Box 328 The Carl Anderson School Madison, Wis.

RADIO Easily Learned

Be a Radio Expert.

Make big money. Win success in this new uncrowded field. Trained men needed, \$1,800 to \$6,000 a year easily earned. I will train you quickly, at home in your spare time, to construct, install, operate, repair, maintain and sell radio outfits. Short course, low cost, easy terms, money back guarantee. Write for "Radio Facts" FREE.

Engineer Mohaupt, American Electrical Association
Dept. 111, 4813 Ravenswood Ave., Chicago

LEARN TO GET DOLLARS OUT OF WATCHES.

WATCH-REPAIRING, ENGRAVING, JEWELRY REPAIRING.

WRITE NOW.

ENICAR TRADE SCHOOL
830 W. MONUMENT SQUARE, RACINE, WIS.

RAILWAY MAIL CLERKS

FRANKLIN INSTITUTE, Dept. J177, Rochester, N. Y.

Sirs: Send me without charge, (1) sample Railway Mail Clerk Examination questions; (2) Schedule showing places in all coming U. S. Government examinations; (3) list of many government jobs now obtainable.

Name.....
Address.....

Why We Pay Jackson \$10,000 a Year— for looking out the window

The secret that makes Arthur C. Jackson
one of the most valuable men in
our company

By George C. Kendricks
Treas. The Kendricks, Hadley Co., Inc.

A FEW weeks ago, one of our assistant bookkeepers came to me, with an anxious look on his face and asked for a raise. I didn't give it to him and told him why. He was very much peeved.

"Look at Jackson," he argued, "I think he gets away with murder. Keeps looking out the window half the time, yet you pay him \$10,000 a year. But I can't get even a \$10 raise on a \$35 a week salary. Just goes to prove that getting ahead in business is purely a matter of luck or"

"Jim," I cut in, "don't take it so hard. You're young and over-ambitious. I know you mean well but you don't seem to realize that the biggest salaries go to men with the best IDEAS—not to those who merely work hardest."

"But—"

"No buts about it," I told him, "I can get thousands of men like you for less money too! You just mentioned Jackson. Well, I honestly wish we had twenty men like Jackson. We'd pay each of them \$10,000 and have them all look out the windows. And our business would increase at least twenty times! You think Jackson gets away with murder? You're wrong. Do you know who developed the Bonus Plan that nearly doubled our sales last year? Jackson! Do you know who worked up that Sales Promotion System that lined up every dealer in the Central West? Jackson! He evidently snatched these wonderful ideas from the window. And about that new Perpetual Inventory System we're working on now—whose idea do you suppose that is? Jackson's of course!

"You're right—Jackson doesn't do much work. But he can think up big ideas—and that counts! Anybody with a little intelligence can follow instructions—but very, very few can create real money-making ideas. If we lose Jackson we lose one of our biggest assets; if you go—well, we can get 500 more ambitious young men like you in twenty-four hours. Isn't that so?"

"Jackson wasn't born a business wonder! On the contrary he was far lower down the scale at your age than you are now! At 26 years of age he was only a departmental clerk in a big mail-order house. Then he switched to this concern. I remember when he came. Honestly, he looked anything but a successful young business man. I put him just where you are today. Only he was 28 years old at the time. For three years he plugged along, just like thousands of other men.

"Then one day he seemed to wake up. He was no longer timid, or backward in any way. He was no longer shy, and he spoke like a man who was sure of himself! At first I thought someone must have died and left him a million—else how on earth could he become so self-confident and assertive almost overnight? But I was mistaken.

"Jackson had discovered the wonderful secret that opens up untold avenues to success. He knew just what to say and how to say it. He seemed to lift out of the air almost unheard ideas—wonderful ideas about increasing this business! Natur-



ally we had to promote him. And we kept on promoting him and raising his pay every few months. Today at 33, he earns \$10,000 a year and is worth every cent of it! To tell you the truth, we don't know when he will end—if he merely requested a raise of \$50 a week, we'd have to give it to him—and the same would be true of you if you could come across with such ideas.

"And just think only five years ago he was just a mediocre clerk—just a cog in the wheel like countless other men and women. Often have I tried to coax the secret out of Jackson but it was only recently he let me in on it.

"In a very few words it's merely developing your will power to swing the inactive nine-tenths of your brain into action. That sounds like deep stuff—but it's very simple. It's a proven fact that most of us go through life using only one-tenth of our brain power. And the only way you can acquire 100% brain power is through your Will. It's just as easy to develop your will power as it is to develop the muscles on arms and legs. You begin to reap the fruits of your labor right away. You're able to control the undesirable ideas and put across the valuable ones; you're able to remember better, to think clearer—and to actually do the right thing at the right time. According to Jackson the whole secret is contained in a wonderful book called 'Power of Will.' I advise you to read it. It made Jackson the big business man he is today. I'm sure it will do the same for you.

"This remarkable book is written in simple language as entertaining as it is instructive and profitable. It will give you the power to create big ideas and show how to drive them home with great force. It will teach you how to make quick and accurate decisions and carry them thru all obstacles with an ease that will amaze you.

"I strongly advise you to get in touch with the Publisher of that astonishing book. It will make you more valuable to us and to yourself. It tells you far better and in greater detail than I can, the amazing secrets that make some men succeed where others fail. You can't lose anything because you can examine the book five days free before you decide to keep it. I'm willing to wager that one week from today you'll be worth \$75 a week instead of only \$35, and if you read the book as carefully as I want you to we'll be more than glad to pay you even more!" Pelton Publishing Co., 13-T Wilcox Block, Meriden, Conn.

Pelton Publishing Co.,
13-T Wilcox Block, Meriden, Conn.

Gentlemen:

You may send me "Power of Will" at your risk. I agree to remit \$3.00 or return the book to you in five days.

Name.....

Address.....

Come to Detroit

The big factories are in full production. Some are producing more than their normal output. The Auto, Truck and Tractor business is the most active business there is today. Garages, Tire and Battery shops have been making money. They are again making big money.

Learn the Automobile Business

Training is needed badly, but to succeed in the biggest way Michigan State Automobile School Training is absolutely essential. M. S. A. S. training is not one man's idea, it is the result of years of keen co-operation with the big factories here in the "Heart" of the Automobile Industry. The biggest, best and most successful men in every branch of the industry have helped in outlining our course. The factories loan equipment, send us the heads of the departments for practical lectures and assist us in every way.

Make \$125 to \$500 or More Monthly

In a Fine Job or in Business for Yourself

With Detroit training at the M. S. A. S. graduates are successful—we have trained more than 18,000 men who are located in all parts of the world, either holding big pay jobs or in business for themselves. Thorough training in our excellently equipped school fits our graduates for success. Men leave our school to go right into business and make money from the start—it's the M. S. A. S. thorough training that makes the successes. There's really no limit to the money that can be made.

11,750,000 Motor Vehicles Now in Use

As many cars were produced in the first six months of this year as in all of 1921. This will be the biggest year in the history of the industry. 11,750,000 cars now in use and only 50,000 garages. Think what this means—an average of 235 cars for each garage. You can easily see the urgent need for more garages. Think of the eleven million batteries to be repaired or replaced, sixty million tires to be repaired or new ones sold. Can you think of a better business to get into? Thousands of repair shops are needed now, thousands of trained men to run them. Now is the time to get started.

\$220,000,000 This Year for Roads

Beginning July 1, 1922, the Government will spend through the Agricultural Department in one year over 220 millions of dollars for good roads. These roads will be built in every state for National Parks and forests' road ways, besides thousands of miles will be added to present roads. This means more touring, more buslines, more heavy trucking between cities, and best of all, thousands of more trained M. S. A. S. graduates with new garages.

Quality Instruction—Complete Equipment

Our school is thoroughly equipped—we have about \$250,000 in equipment just for students to study and work on; there is nothing slighted in the entire course that could help the student. In fact, our policy is to give the best course in the land and to hold our tuition within the reach of all. Anything that is worth having is surely worth paying reasonably for and at the M. S. A. S. you get the biggest money's worth to be had.

Start Any Time

You start the day you arrive, if you wish. The welfare department arranges for fine rooms and board. You have nothing to worry about—just get right down to business. The instructions are very practical and easily understood—no previous automotive experience is necessary. Now is the time to get started.

Jump on the Train and Come NOW

Hundreds of men have not waited, but after reading our advertisement have jumped right on the train and come to Detroit. The factories say you will make no mistake by coming to the M. S. A. S. The tuition is reasonable and board and room moderate in price. There never was such an opportunity as now. If you prefer, just fill in the coupon and mail it at once. It will bring you Catalog, "Auto News" and complete information FREE.

Michigan State

"The Detroit Auto School"

311 Auto Building 3729 Woodward Ave.

FACTORY LETTERS

HUDSON MOTOR CAR COMPANY
DETROIT, MICH., U. S. A.

This school is thought very highly of by the automobile men of Detroit. You will make no mistake by entering for a course.



Detroit, Mich., U.S.A.

Do not believe you would make any mistake in attending this school if you wish to become thoroughly experienced in the automobile business.



BUICK MOTOR COMPANY

We believe the Michigan State Auto School, located at Detroit, would best meet your requirements, as its course in technical training is most thorough and complete in every detail.

THE STUDEBAKER CORPORATION
OF AMERICA

We do not know a better automobile school that we could recommend to you than the Michigan State.

MAXWELL MOTOR SALES CORPORATION
AUTOMOBILES
DETROIT, MICH.

We heartily recommend the Michigan State Auto School of this city.



Money Back Guarantee

We guarantee that a graduate of our Automobile and Tractor Course will be qualified to fill a position as assembler, demonstrator, tester, repair man, auto electrician, chauffeur, tractor operator, or farm lighting expert, or we will refund his tuition fee.

the Auto Center

Study and

Learn Now—it is the thoroughly trained men who make the big successes in the auto, truck and tractor business. M. S. A. S. training will make you independent the rest of your life. You will secure in a few weeks of pleasant, practical study and training what hard times or adverse conditions can never take from you. **Trained heads and hands always get first call on big money and in business.**

Original and Only Factory Endorsed School

The M. S. A. S. is the original and only factory endorsed school. Ours is the only factory outlined course. The manufacturers and their service managers assisted us in outlining our course. They know it is right. They say you will make no mistake in attending the M. S. A. S. They heartily endorse our school and employ our graduates. Write to any automobile factory, business house or bank in Detroit and ask them about us.

Learn in Detroit the Auto Center

What is more logical than to learn autos where autos are made, in Detroit the auto center? 73% of the world's automobiles are made in Detroit, 94% in Detroit and vicinity. You make weekly trips to Packard, Hudson, Cadillac, Paige, Lincoln, Maxwell, Chalmers, Studebaker, Ford, etc. You meet the factory executives, service managers, etc. Study factory methods and service. Nowhere else can you do this. This is only one of the many advantages of learning at the M. S. A. S. in Detroit the Auto Center. When you go back to your home town it will mean more business if you can tell your customers that you trained in the M. S. A. S. in Detroit the heart of the auto industry.

Factory Trained Instructors

Many of our instructors had early training in the big factories—they practically grew up in the business. Those who did not, have gone into the factory methods in co-operation with the factory heads and give you the result of this intense research and training.

Complete Auto, Truck and Tractor Course

Our complete course includes training in the construction, operation, upkeep and repair of automobiles, trucks, tractors, farm lighting plants and stationary engines of every kind. Basically the instructions are alike, but we teach how to apply the knowledge to all motor vehicles. We have a large general garage for actual garage practice. We own a farm with all types of tractors for operation and upkeep practice. The course includes thorough training in automotive electrics with actual practice in overhauling, rebuilding all types of starting, lighting and ignition systems. You get everything from A to Z. We educate the head and train the hand in a thorough, complete way. Approved by the automobile industry.

Radio—Construction, Installation, Operation, Repair

Radio is here to stay. It is estimated that there are between 3 and 5 million receiving sets now in use. This fall 2 or 3 million more will be installed and will need service. There is big money in this work.

We are now equipped to teach a thorough course in addition to the regular Complete Automobile Course without additional charge. This we can do because of the thorough and complete electrical course already a part of the M. S. A. S. training. There is big money to be made in installation and repair. Prepare now for this work.

Tire Repairing

We have a separate course in this branch of the auto business—the best equipment and instructors train you. Our graduates are very successful.

Battery Repair

This important branch of the industry is also taught in a separate and complete course which equips our graduates to go immediately into this big profit business.

Welfare Department Gets Rooms

Our Welfare Department is every student's friend. The day you arrive, it locates you in a nice room and directs you to good table board. It helps you with personal matters, tells you where your church is located, helps you get the best care and attention. The M. S. A. S. Welfare Department is known around the world.

Mail the coupon for catalog and Auto News—all FREE—or, better still, just jump on the train and come right to the school.

Automobile School

"Endorsed by all Leading Manufacturers"

Detroit, Mich., U. S. A.

GOOD POSITIONS FOR YOU

We can get positions in the factories and garages for our graduates. In fact, we have more calls than we can supply men for. Detroit is booming and I want to share this permanent prosperity with you.

Arthur G. Zeller,
President



A. G. Zeller
Pres.

GRADUATES' LETTERS

Samuel Thomas, Pa. "I graduated and got a job immediately. Became foreman of the Dodge and Liberty Garage at a salary of \$200 a month, which job I still hold."

H. S. Bradley, Ohio. "From a job as shipping clerk at \$12.00 a week to a garage owner making \$500 a month."

J. B. Nelson, N. Y., took our course when 17 years old, now has five men working for him.

E. R. Greve, Cal. "Last year's business bought us a nice little home here, and we have started buying another for this year."

Geo. H. Purvis, Mich. "Am now experimental electrician with the Packard Motor Car Company. I give your school all the credit."

John Grahek, Minn. "I am now in business for myself. My earnings average \$500 to \$400 a month. Before I went to your school I hardly made enough for my family to live on."

SEND THIS COUPON TODAY!

Michigan State Auto School

311 Auto Bldg., Detroit, Mich.

Gentlemen: Send me your Catalog and Auto News FREE.

Name

Street or R. F. D.

Town

State

Do You Like to Draw?

Here Is a Simple, Easy Way
to Draw a Comic Face

TRY IT

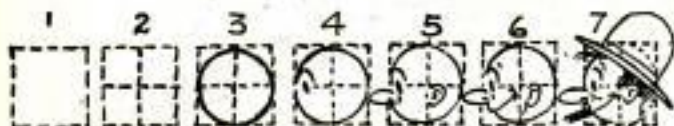

Make a square with pencil, then add to it with pencil as shown in the small squares above. Erase all pencil guide lines after the drawing is completed.

We will not give you any "grand prize," if you draw this picture. Nor will we claim to make you "rich in a week." But if you are anxious to develop your talent with a **successful cartoonist**, so you can **make money**, send a copy of this picture with six cents in stamps for portfolio of cartoons and sample lesson plate, and let us explain more in detail. Some of the **most successful cartoonists** are former students of this school. It is not hard to learn to draw **originals** when you are shown how in a practical way.



THE W. L. EVANS SCHOOL OF CARTOONING
"The School That Has the Reputation"
821 Leader Bldg. CLEVELAND, OHIO

Learn to Write

I Teach by Mail

I CAN make a good penman of you at your home during spare time, no matter where you live or how poorly you now write. My simplified system has shown thousands of others the way to good penmanship during the past twenty years — it can and will do the same for YOU!

Beautifully Illustrated Book
"How to Become a Good Penman" **FREE!**

It contains general information, with testimonials and beautiful specimens of penmanship showing what others have accomplished by the Tamblin System. (Your name elegantly written on a card if you enclose stamp for postage.) WRITE TODAY. Address

F. W. TAMBLIN
418 Ridge Bldg., Kansas City, Mo., U. S. A.

F. W. Tamblin

High School Course in Two Years

This simplified, complete High School Course — specially prepared for home study by leading professors — meets all requirements for entrance to college and the leading professions.

30 Other Courses Whether you need High School training or specialized instruction in any trade or profession the American School can help you. Check and mail coupon for Free Bulletin.

American School
Drexel Ave. and 58th Street
Dept. H874A
Chicago

American School, Dept. H874A, Drexel Ave. and 58th St., Chicago
Send me full information on the subject checked and how you will help me win success.

- | | |
|------------------------------|-----------------------------|
|Architect |Lawyer |
|Building Contractor |Machine Shop Practice |
|Automobile Engineer |Photoplay Writer |
|Automobile Repairman |Mechanical Engineer |
|Civil Engineer |Shop Superintendent |
|Structural Engineer |Employment Manager |
|Business Manager |Steam Engineer |
|Cert. Public Accountant |Foremanship |
|Accountant and Auditor |Sanitary Engineer |
|Bookkeeper |Surveyor (and Mapping) |
|Draftsman and Designer |Telephone Engineer |
|Electrical Engineer |Telegraph Engineer |
|Electric Light & Power |High School Graduate |
|General Education |Fire Insurance Expert |
|Vocational Guidance |Wireless Radio |
|Business Law |Undecided |

Name

Address

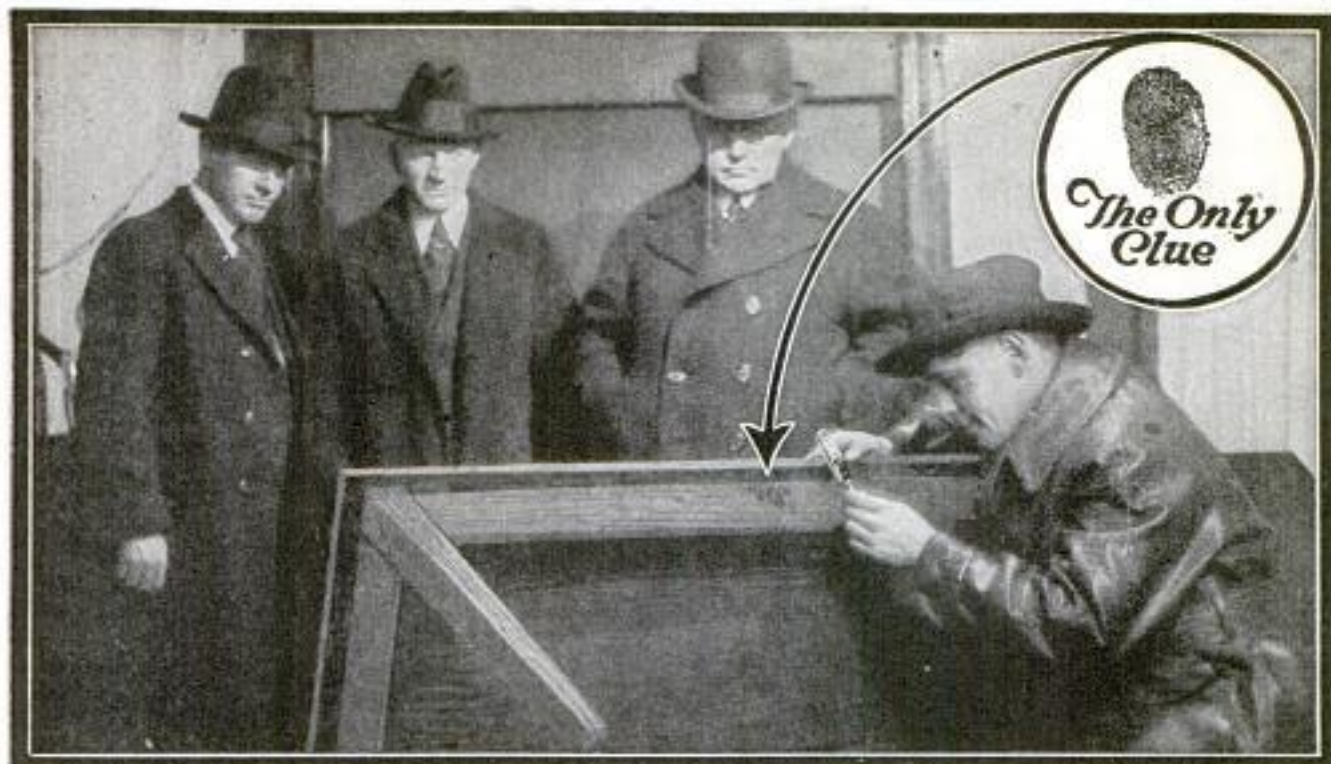

\$500 REWARD for TWO HOURS WORK

WARREN BIGELOW, the Finger Print Detective, was making his usual review in the morning newspapers. He had just finished reading the press reports of the daring robbery of the offices of the T—O—Company when the telephone on his desk rang. Central Office was calling, asking him to come immediately to the scene of the robbery.

Although he drove his high powered roadster rapidly and arrived very shortly at his destination, he had plenty of time to consider the main features of the case as reported by the press. The job had undoubtedly been done by skilled cracksmen and robbers of uncommon nerve. Sixty-five hundred dollars in currency—the company pay-roll—were gone. Not a single, apparent clew had been found by the police.

Finger Print Expert Solves Mystery

On his arrival, Bigelow was greeted by Nick Austin, Chief of Detectives, who had gone over the ground thoroughly.

"Hello, Warren. Here's a job that has us stumped. I hope you can unravel it for us."

By this time, the district officers and the operatives from Central Office had almost given up the investigation. After hours of fruitless efforts, their work was at a standstill. They were completely baffled.

With lively interest and a feeling of relief they stepped back to await the results of the Finger Print Detective's findings. They were plainly awed at his quiet, assured manner. The adroit old Chief himself was manifestly impressed at the quick, sure way in which Bigelow made his investigation.

Almost immediately Bigelow turned his attention to a heavy table which had been tipped up on its side. Examination of the glossy mahogany showed an excellent set of finger prints. The thief might just as well have left his calling card.

To make a long story short his prints were photographed and taken to Central Office, where they were matched with those of "Big Joe" Moran, a safe blower well known to the police. Moran was subsequently caught and convicted on Bigelow's testimony and finger-print proof. Most of the money was recovered. In the meantime the T—O—Company had offered a \$500.00 reward, which was given to Bigelow—his pay for two hours' work.

Learn At Home in Spare Time

Could you imagine more fascinating work than this? Often life and death depend upon decisions of finger-print evidence—and big rewards go to the Expert. Thousands of trained men are now needed in this great field. The finger print work of governments, corporations, police departments, detective agencies and individuals has created a new profession. Many experts regularly earn from \$3,000 to \$10,000 a year in this fascinating game. And now you can easily learn the secrets of this new Science in your spare time—at home. Any man with common school education and average ability can become a Finger Print Detective in a surprisingly short time.

Free Course in Secret Service

For a limited time we are making a special offer of a **Professional Finger Print Outfit, absolutely Free, and Free Course in Secret Service Intelligence.** Mastery of these two kindred professions will open a brilliant career for you.

Write quickly for fully illustrated free book on Finger Prints which explains this wonderful training in detail. Don't wait until this offer has expired—mail the coupon now. You may never

see this announcement again! You assume no obligation—you have everything to gain and nothing to lose. Address

UNIVERSITY OF APPLIED SCIENCE

Dept. 9358, 1920 Sunnyside Avenue, Chicago, Illinois

UNIVERSITY of APPLIED SCIENCE, Dept. 9358 1920 Sunnyside Av., Chicago

Gentlemen: Without any obligation whatever send me your new, fully illustrated, FREE book on Finger Prints and your offer of a FREE course in Secret Service Intelligence and the Free Professional Finger Print Outfit.

Name.....

Address.....

Age.....



Personal Instruction by Mail That Builds Up Your Ability

There are six points that distinguish the correspondence instruction service of the United Y. M. C. A. Schools.

Among these are the close personal service given to every student, from the choosing of a course to the last lesson; frequent letter-writing from a competent instructor that ties up the practical, reasonably-priced instruction to the actual needs of the student; free counsel on all of the student's problems.

"It is a mystery," writes one of our students, "how you can make a student feel as if the whole school is run for his personal benefit."

Such service accounts for the volumes of similar letters received from enthusiastic students. This same whole-hearted interest and our quarter-century of experience in aiding men, through their spare hours, to realize their Bigger Selves, is also at your command.

More than 30,000 have enrolled in the past two years. Mark and mail the coupon below for a copy of our new catalog and for our friendly counsel on how you can solve your problems and realize your ambition.

SOME OF OUR 300 CORRESPONDENCE COURSES

Accountancy	Business Courses	Office Management
Advertising	Business Administration	Practical Speaking
Banking	Business English	Salesmanship
Better Letters	Business Finance	Secretarial
Bookkeeping	Business Law	Show Card Writing
Business Arithmetic	Complete Letter-Writing	Stenography
	Technical and Other Courses	Traffic Management
Agricultural Courses	Foreign Languages	Plan Reading
Applied Psychology	Foremanship	Plumbing
Architecture	Highway Engineering	Poultry Husbandry
Automobile Courses	High School Courses	Radio Engineering
Building Construction	Illustrating	Radio Telegraphy
Civil Engineering Courses	Insurance Courses	Steam Engineering Courses
Drafting Courses	Mathematical Courses	Structural Drafting
Electrical Courses	Mechanical Engineering	Surveying
English Courses	Own-Your-Home Course	Use of the Slide Rule
Factory Management		Vocational Guidance

Are you an ex-service man?



Correspondence Instruction

375 Lexington Avenue
Dept. 74-N New York City

Without obligating me, please advise regarding the course in

Name.....

Full Address..... (Please write plainly.)

Please Mention Popular Mechanics

Does your English Help or Hurt you?

Every time you speak or write you show just what you are. Mistakes in English reveal you as a person who lacks education and refinement. Lack of language power prevents you from presenting your thoughts in the strongest possible way. No matter what you do, real command of English will help you to your goal. Stop making mistakes in spelling, punctuation, pronunciation. Increase your vocabulary.

WONDERFUL INVENTION

Only 15 minutes a day with Sherwin Cody's New Invention—and you can actually SEE your English improve. It teaches by HABIT—makes it easier to do the RIGHT way. Wonderful self-correcting lessons include Expression, Spelling, Punctuation, Grammar, Reading and Conversation.

BOOK FREE Lack of language power may cost you thousands of dollars every year. See what Mr. Cody can do for you. It costs nothing to find out. Mail a postal card or letter this very minute for free book "How to Speak and Write Masterly English." It will prove a revelation to you. **WRITE NOW.** Address Sherwin Cody School of English, 511 Searle Building, Rochester, N. Y.



MUSIC LESSONS FREE

IN YOUR OWN HOME
You can read Music like this quickly
Piano, Organ, Violin, Mandolin, Guitar, Banjo, etc.
Beginners or advanced players. One lesson weekly. Illustrations make everything plain. Only expense about 2c per day to cover cost of postage and music used. Write for **FREE** booklet which explains everything in full.
AMERICAN SCHOOL OF MUSIC, 51 Lakeside Building, CHICAGO

BE AN ARTIST

Comics, Cartoons, Commercial, Newspaper and Magazine Illustrating, Pastel-Crayon Portraits and Fashions. Our simple method quickly develops your talent in spare time. By Mail or Local Classes. Write for terms and list of successful Students.
ASSOCIATED ART STUDIOS 87-B Flatiron Building, NEW YORK

TELEGRAPHY

(Morse and Wireless) and RAILWAY ACCOUNTING taught thoroughly. Big salaries; great opportunities. Largest school, endorsed by Telegraph, Railway, Radio, and Government officials. Expenses low—opportunities to earn large portion. Catalog free.
DODGE'S INSTITUTE, Dyke Street, Valparaiso, Ind.

Big Opportunities In HOTEL WORK

Good Pay—Fine Living

Hotel work offers trained men and women **unusual opportunities.** Business growing; 80,000 employees needed each year. Enjoy comfortable living quarters; good meals; many chances to save money.

How to Get Started

Prepare in spare time at home with help of Hotel Operation and Management Course, endorsed by leading hotel experts. Completely fits you for good position and points the way to managerial work. Easy to understand; quickly mastered.

Don't Wait. Start NOW!

Send for free Booklet giving full information. You take no risk!

Standard Business Training Institute
Buffalo, N. Y.

Standard Business Training Inst., Buffalo, N. Y.

Send me free booklet No. 1093 giving full information about Hotel Operation and Management Course.

Name.....

Street.....

City.....



Repair Any Auto or Auto Truck

Examine These NEW AUTO BOOKS FREE

Be an expert auto repair man. You can have the skill that makes every complicated trouble as easy to fix as taking out a spark plug. Learn every detail of all makes of cars and trucks. Know exactly how to find what's wrong and how to make all repairs quickly. These great new Auto Books show you how.

Make Money Repairing Autos

Over 9 million cars are in operation and thousands of men are needed to keep them in good going condition. There are more jobs open than there are good men to fill them. Never before have expert auto repair men been in such great demand and made so much money. Now is your great money-earning opportunity in the auto repair business. Every mechanic, every chauffeur, every car owner needs this great New Library of Automobile Engineering.

Tells About
Explosion Motors,
Welding, Motor Con-
struction and Repair,
Carburetors and Set-
tings, Valves, Cooling,
Lubrication, Fly-
Wheels, Clutch Trans-
mission, Final Drive,
Steering Frames, Tires,
Vulcanizing, Ignition,
Starting and Lighting
Systems, Shop Kinks,
Public Garage Design,
Equipment and Opera-
tion, Electrics, Stor-
age Batteries—Care
and Repair, Steam Cars,
Motorcycles, Commer-
cial Trucks, Glossary,
More than 100 blue
prints Wir'g Diagrams.

75c a Week If You Decide to Buy

Let us send you the complete six-volume set of Automobile Engineering for one week's examination. Read the simple directions for repairing every automobile trouble. Six thick volumes 5½x 8¾ inches, flexibly bound and stamped in gold, 2,650 pages, 2,100 illustrations, wiring diagrams, etc. Everything in plain, every-day language simple to understand. If you decide to keep them, send only \$2.80 in seven days, and \$3 a month thereafter until the special introductory price of \$21.80 has been paid. The regular price is \$45.00, so you save \$23.20 by acting at once.

Send No Money

Don't send a penny! Your name and address in the coupon brings the six books to you at once for seven days' trial.

Mail Coupon NOW

American Technical Society

Dept. A-198 Chicago, U. S. A.



Starting and
Lighting



Welding

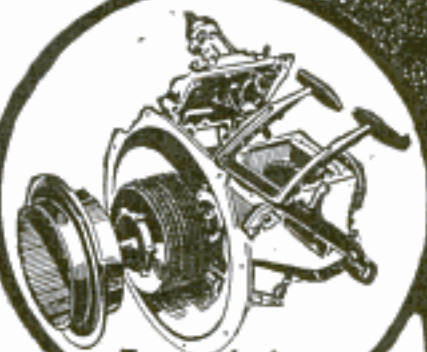

Transmission

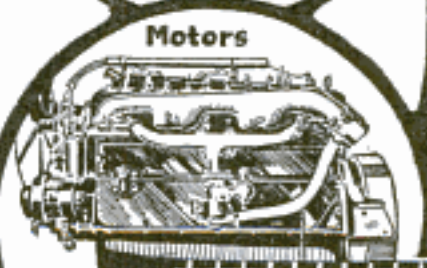

Motors

**AMERICAN TECHNICAL
SOCIETY**

Dept. A-198, Chicago, U. S. A.

Please send me the six-volume set of Automobile Engineering for seven days' examination, shipping charges collect. If I decide to buy, I will send \$2.80 within seven days and balance at \$3.00 a month until \$21.80 has been paid. Then you will send me a receipt showing that the set of books are mine and fully paid for. If I think I can get along without the books, I will return them, after 7 days, at your expense.

Name.....

Address.....

Employed by.....



He Earns \$10,000 a Year

This executive is one of the officers of a big corporation; he earns \$10,000 a year, and is still in his early thirties.

"He has a mighty good business head"—that's how the directors speak of him. "He's keen at a business problem, quick to pick out the essential points, sure in his decisions"—that's why the President is for him. "When he recommends a policy," declares the General Manager, "I know it's sound from a legal standpoint."

A big salary—\$10,000 a year—but this man has an asset that is vitally important in the management of big affairs—he is a law-trained man.

His Chance is Yours!

Why let the really big opportunities slip away from you—simply for lack of training?

Right in your own home, under the LaSalle Problem Method, you can study the same cases you would read at the resident universities, master the fundamental principles of law set forth by some of the most eminent authorities in the profession, develop under their direction a sound understanding of business relationships, a power for keen and logical thinking, a facility for analyzing business problems that in later years will make you the man the directors pick for the bigger job.

Read these statements, testifying to the thoroughness and income-value of LaSalle training:

"The Problem Method increased my salary nearly 150%."

"Passed bar examination with second highest honors in a class of seventy-one."

"Salary doubled in six months."

"Passed bar examination, third in a class of twenty-three, the youngest man who ever passed the examination in this state."

Send today for full particulars regarding LaSalle home-study training, together with details of our convenient-payment plan; also your free copy of that inspiring book, "Ten Years' Promotion in One." Mail the coupon NOW.

LASALLE EXTENSION UNIVERSITY
The Largest Business Training Institution in the World
Dept. 1164-LR Chicago, Illinois

Please send me catalog and full information regarding the course and service I have marked with an X below. Also a copy of your book, "Ten Years' Promotion in One."

LAW, Degree of LL. B.

LaSalle is the largest business training institution in the world. It offers training for every important business need. If more interested in any of these courses, check here:

- | | |
|--|--|
| <input type="checkbox"/> Business Management | <input type="checkbox"/> Banking and Finance |
| <input type="checkbox"/> Modern Salesmanship | <input type="checkbox"/> Modern Foremanship and Production Methods |
| <input type="checkbox"/> Higher Accountancy | <input type="checkbox"/> Personnel and Employment Management |
| <input type="checkbox"/> Traffic Management | <input type="checkbox"/> Expert Bookkeeping |
| <input type="checkbox"/> Railway Accounting and Station Management | <input type="checkbox"/> Business English |
| <input type="checkbox"/> Commercial Law | <input type="checkbox"/> Commercial Spanish |
| <input type="checkbox"/> Industrial Management Efficiency | <input type="checkbox"/> Effective Speaking |
| <input type="checkbox"/> Modern Business Correspondence and Practice | <input type="checkbox"/> C. P. A. Coaching |

Name.....
Present Position.....
Address.....

Please Mention Popular Mechanics

Play PIANO By Ear

No matter how little you know about music, if you can just remember a tune, I teach you to play Jazz, Ragtime, Popular Songs BY EAR, easily, quickly. Why spend years studying tiresome scales and finger exercises when, in 30 days you can

Be a Master of JAZZ and RAGTIME

and play any tune you can remember, by ear—without notes. Original method, wonderful, easy. No do-re-mi, no scales—just a few simple rules, a little practice—the results are amazing. Names and letters from hundreds of enthusiastic pupils and interesting book SENT FREE. Simply write me your name, address, age—and state if you have ever taken piano lessons; if so, how many. Write TODAY.

RONALD G. WRIGHT, Director,
Niagara School of Music,
Department 479, Niagara Falls, N. Y.

Send for this Free Book

5,000 FORMULAS

The 530 double-column pages in Youman's Household Guide contain nothing but formulas and processes for every phase of human effort. Many recipes hitherto unpublished. Any one of the five thousand easily worth more than the price you pay for ALL. To be without this book is costing you \$333. Prices, postpaid, Cloth \$2.00. **\$1.25** Heavy paper.....

WELLS & EDWARDS, BOOKSELLERS, Dept. A
852 George Street, CHICAGO

Send for free circular and 40 page Book Catalog

BE AN EXPERT Penman

I TEACH BY MAIL. You can become an expert penman right in your own home by my method. Small Cost. All that is required is some of your Spare Time. Write for my book, "HOW TO BECOME AN EXPERT PENMAN." It contains specimens and tells how others became expert writers by the TEVIS METHOD. Your name written on a card if you enclose stamp. FREE BOOK. Write today. **T. M. TEVIS, BOX 25K, CHILLICOTHE, MO.**

HARMONY

In 12 Easy Lessons

Get the most out of music. Equally valuable for Players, Teachers or Music Lovers. New easy System gives you real knowledge of Harmony in shortest time. **Easy, Quick, Sure!** Short-cut System used by professional Arrangers and Composers. Results guaranteed. Write for proof and limited offer—free!

DELAMATER HARMONY SYSTEM
DEPT. "M" 8337 PRAIRIE AVE., CHICAGO

BUILDING TRADES HAND BOOK

409 Pages
263 Illustrations

I.C.S. BUILDING TRADES' HANDBOOK

A reference book for every man connected with the building trades. Contents:—Blue Prints, Weights and Measures, Formulae, Mensuration, Geometric Drawing, Structural Design, Materials of Masonry Construction (stone, brick, terra cotta, lime, cements, sand, mortar, concrete), Carpentry and Joinery, Roofing, Plumbing, Heating, Estimating, etc.

409 pages, 263 illustrations. Only \$1. Money back if desired. Address
International Correspondence Schools, Box 5685-C Scranton, Pa.

\$1

Learn Electricity

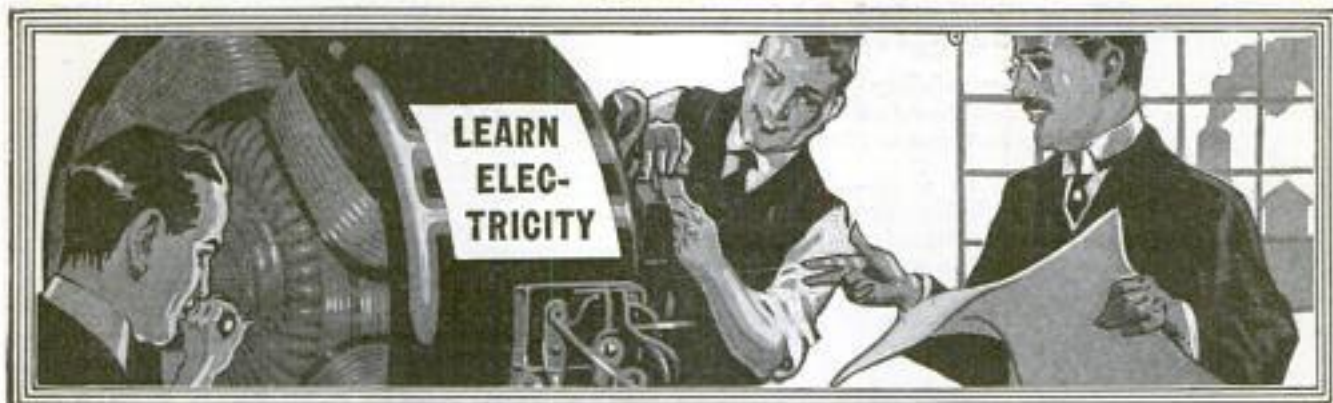

LEARN IN THE GREAT SHOPS OF EARN
 IN 3½ MONTHS **COYNE!** \$150 to \$400
 A MONTH

THE whole world of electricity is open to the Coyne trained man. He is trained completely. He can make big money as power Plant Operator, Superintendent, Telephone man, Construction worker, auto truck or tractor electrician, battery man, radio expert, or he can go into business for himself as electrical contractor, dealer, auto ignition or battery expert and make from \$3,000 to \$20,000 a year. Hundreds of our graduates today are making big money and you can do the same if you grasp this opportunity—act now.

Earn \$150 to \$400 per Month

No books or useless theory. You are trained on \$100,000 worth of electrical equipment. Everything from door bells to power plants. You work on motors, generators, house-wiring, autos, batteries, radio, switchboards, power plants—everything to make you an expert ready to step right into a position paying from \$45 to \$100 a week. Learn electricity in the electrical center of the world. Send the coupon today for free catalog.

Big New Home

The increasing popularity of Coyne and a tremendous influx of new students simply forced us to move into larger and more spacious quarters. Here, in the big, new home, you will find added electrical equipment—new and larger departments—a more complete electrical training—a school thoroughly equipped to train you for a big paying position.

Send Coupon NOW!

Don't delay a minute—send that coupon in **right now** for our big free catalog and full particulars of this wonderful offer;—Act Now.—Make up your mind to come to Coyne to learn electricity. Send coupon today.

B. W. COOKE, Pres.

Coyne Trade & Engineering School
 1300-1310 W. Harrison St. Dept. IX Chicago, Illinois

Radio Course FREE

We include the following free with your regular course:

- (1) A complete course in auto, truck and tractor electricity and storage batteries. Greatest outlay of auto electrical and battery equipment in the country.
- (2) Course in Radio—the marvel of the age. Constructing, installing and operating. You can build your own wireless telephone set.
- (3) A life scholarship in the Coyne School. You can stay as long as you wish and return for further training at any time in the future. The aim of the Coyne School is to turn out men completely trained in all branches of electricity—capable of succeeding in the highest paid positions.

Earn While You Learn

We help students to secure jobs to earn a good part of their expenses while studying.

B. W. COOKE, President

COYNE TRADE & ENGINEERING SCHOOL
 1300-1310 W. Harrison St., Dept. IX, Chicago, Ill.

Dear Sir:—Please send me free your big catalog and full particulars of your special offer of 3 extra courses.

Name

Address

LEARN CARTOONING

the Right Way



1. *Have your ability trained by the school that has developed many famous cartoonists.*

If you like to draw—if you find pleasure in picking up a pencil and paper and trying to make sketches or cartoons, don't regard it merely as a hobby. Have your ability developed and earn a good income as a cartoonist.



2. *Hundreds of nationally known cartoonists, such as Branner of the Chicago Tribune; Blosser, who draws "Freckles and His Friends"; Gene Byrnes, creator of "Reg'lar Fellers"; Thiele of the Sioux City Tribune; Fung, of the Seattle Times and others equally well known, took the Landon Course at home, in their spare time, and fitted themselves for their present positions at salaries ranging from \$50 to \$200 and more per week.*



3. *Have YOUR talent developed by the same method*

What the above mentioned boys did you can do, with the same training. The Landon method of teaching makes cartooning easy to learn. By means of an extensive series of Big picture charts all the necessary details of ORIGINAL drawing are explained step by step, in a clear and simple manner.



4. *FACTS that determine the superiority of the Landon School:*

1. Landon School Students are securing the best cartooning positions which open up everywhere.
2. The picture chart method of instruction was originated and is used exclusively by the Landon School.
3. From the very beginning, the Landon Course teaches ORIGINAL drawing. No copy work.
4. Individual attention and criticism of student's work. Personal coaching whenever necessary.
5. Specialized instruction on how to originate cartoon ideas. This is an exclusive feature of the Landon Course.
6. Practical assistance in securing positions for students and help in marketing their work.
7. The price is within reach of everyone who is ambitious to succeed. Easy payments can be arranged.



Write today for full information about the Landon Course, and sample chart by means of which you can test your own ability. Find out what the possibilities are for YOU in this interesting profession. Please state your age.

The Landon School

1138 National Bldg.

Cleveland, Ohio

\$1,500 to \$6,000 a Year

Dental Laboratory Work

Be a mechanical dentist—a high class, agreeable occupation for men or women. Course is inexpensive. Takes only short time to complete. Experience or entrance requirements unnecessary. No license required. McCarrie graduates make big successes and are in great demand everywhere. Largest and best equipped school laboratory and clinic in America; individual practical instruction, modern up-to-date methods. Write for trial sketching offer. Find out how easy it is to do yourself for this highly paid and dignified profession. Learn the McCarrie way. It pays.

Write for Book No. 28

McCARRIE

SCHOOL OF MECHANICAL DENTISTRY

34 and 36 W. LAKE STREET, CHICAGO, ILL.

HOW TO PAINT SIGNS AND SHO' CARDS

Our book gives a complete course of instructions, enabling any one to learn to paint good signs. WHY NOT MAKE YOUR OWN either for your business or for others?

CONTENTS: Alphabets, Composition, Color Combinations. How to Mix Paints, Show Cards, Window Signs, Banners, Board and Wall Signs, Ready Made Letters, Gilding, Commercial Art and Tricks of the Trade—Contains 100 alphabets and designs. Cloth bound, size 7 x 5 inches, price \$1.10 postpaid.

J. S. Ogilvie Pub. Co., 577 Rose St., New York

WANTED

U. S. GOV'T. CLERKS NEEDED

All men, women, boys, girls, 17 to 60, willing to accept Gov't. Positions, \$117-\$190, stationary or traveling, write immediately—TO-DAY.

Mr. Ozment, Dept. 111 St. Louis

LEARN ENGINEERING

Course, 3 months to 2 years practical-technical training under experts. Not a Trade School, but a practical-technical college teaching electricity, steam, gas, auto-electric, wireless, drafting. Extensive laboratory and shop equipment. Degrees awarded. Day and night sessions. Enroll today.

FINLAY ENGINEERING COLLEGE

1001 Indiana Avenue Kansas City, Mo.

STATEMENT OF THE OWNERSHIP, MANAGEMENT, CIRCULATION, ETC., REQUIRED BY THE ACT OF CONGRESS OF AUGUST 24, 1912 of Popular Mechanics Magazine, published Monthly at Chicago, Ill., for October 1, 1922.

State of Illinois, County of Cook, ss: Before me, a Notary Public in and for the state and county aforesaid, personally appeared H. H. Winsdor, who having been duly sworn, according to law deposes and says that he is the editor and business manager of the Popular Mechanics Magazine and that the following is, to the best of his knowledge and belief, a true statement of the ownership, management, etc., of the aforesaid publication for the date shown in the above caption, required by the Act of August 24, 1912, embodied in section 463, Postal Laws and Regulations, printed on the reverse of this form, to wit: 1. That the names and addresses of the publisher, editor, managing editor, and business manager are: Publisher, Popular Mechanics Co., 4 No. Michigan Ave., Chicago, Ill. Editor, H. H. Winsdor, 6 No. Michigan Ave., Chicago, Ill. Managing Editor, J. L. Peabody, 4 No. Michigan Ave., Chicago, Ill. Business Manager, H. H. Winsdor, 4 No. Michigan Ave., Chicago, Ill. 2. That the owners are (Give names and addresses of individual owners, or, if a corporation give its name and the names and addresses of stockholders owning or holding 1 per cent or more of the total amount of stock; H. H. Winsdor, 6 No. Michigan Ave., Chicago, Ill., L. B. Winsdor, 6 No. Michigan Ave., Chicago, Ill., First Trust and Savings Bank, Trustee for H. H. Winsdor, Jr., Chicago, Ill. 3. That the known bondholders, mortgagees, and other security holders owning or holding 1 per cent or more of total amount of bonds, mortgages or other securities are (If there are none so state). None. 4. That the two paragraphs next above, giving the names of the owners, stockholders and security holders, if any, contain not only the list of stockholders and security holders as they appear upon the books of the company, but also, in cases where the stockholder or security holder appears upon the books of the company as trustee or in any other fiduciary relation, the name of the person or corporation for whom such trustee is acting, is given; also that the said two paragraphs contain statements embracing affiant's full knowledge and belief as to the correctness and conditions under which stockholders and security holders who do not appear upon the books of the company as trustees, hold stock and securities in a capacity other than that of a bona fide owner; and this affiant has no reason to believe that any other person, association, or corporation has any interest direct or indirect in the said stock, bonds or other securities (less than as so stated by him). H. H. WINDSOR, Editor. Sworn to and subscribed before me, this 23d day of September, 1922. J. GRAHAM, Notary Public. (My commission expires June 17, 1924.)



If He Had Passed It Up

He Would Still be a Laborer at \$2 a Day. No Money, Nothing Ahead but Hard Work, Longer Hours—and Regrets. But He Didn't Pass It Up

He decided to learn Mechanical Drawing. He buckled down to work with the Columbia School of Drafting. When he had a quiet half hour to spend he spent it—as a wise man spends money—to get full returns.

MADE \$275 EXTRA IN 3 DAYS. He recently received \$275 for one drawing that only took him three days to draw.

NOW HOW ABOUT YOU? Are you working up hill or down? Count the money in your pay envelope next pay day. You'll find the answer there.

MAKE \$35 TO \$100.00 A WEEK. We will train you to be an expert Draftsman in your spare time at home by mail. There's lots of room for you if you act now.

PROMOTION IS QUICK. WE'LL QUALIFY YOU for a high-salaried position in the drafting field and keep you in touch with openings for Draftsmen in the big machine shops, industrial plants and United States Government departments. Men who start as

Draftsmen are often advanced to Chief Draftsmen, Chief Engineers, Production Managers and so on.

GET THE RIGHT TRAINING. Mr. Claffin, the founder and director, stands personally in back of the Columbia School of Drafting. You spend no time in long-winded theories—useless and expensive to you. You start on actual drawing work the day you receive your first lesson.

YOU NEED NO PREVIOUS TRAINING. The course is easy to understand and easy to follow. Many students are qualified even before they complete the course.

SUCCESS CALLS MEN OF ACTION ONLY. If you are a man of action clip the coupon now and show that you are a man of action. Keep right on top of this opportunity to make real money. Don't go looking for a pair of scissors. Tear the coupon off and mail it right now. We have a special offer for those who reply promptly. Get started now.

What We Give You

PRACTICAL PROBLEMS. You are carefully coached in practical Drafting work.

WE HELP YOU GET A JOB. We help you get a position as a practical Draftsman as soon as you are qualified.

PERSONAL INSTRUCTION AND SUPERVISION THROUGHOUT THE COURSE. You receive the personal instruction and help of Roy C. Claffin, president of the Columbia School of Drafting and a practical Draftsman of many years' experience.

DRAFTSMAN'S EQUIPMENT. We furnish you with a full set of Drawing Equipment and Drafting Instruments as shown in the picture below when you enroll. You keep both sets on completing the course.

CONSULTATION PRIVILEGES. You are free to write us at any time for advice and suggestions regarding your success.

DIPLOMA. The diploma we give you on completing the course attests to your proficiency as a Draftsman. It is an "entering wedge" to success.

FREE SUBSCRIPTION TO DRAFTSMAN'S PUBLICATION "THE COMPASS." You are given free a subscription to our helpful, inspiring publication, "The Compass."



**Drafting
Outfit
Free**

FREE We give you free with our course this professional Drafting outfit. It is yours to keep when you complete the course.

U. S. Civil Service Commission Needs DRAFTSMEN

The following are a few of the many positions open in Government Departments from time to time. The salaries are starting salaries, subject to increase. Practically all of them carry a bonus of \$240 a year additional.

Architectural Designer \$4,000
Chief Draftsman (Aeronautical) Naval Aircraft Factory, per day ... 15.04
Aeronautical Draftsman—Field Service of Navy Department, \$5.20 per day to \$12 per day.

FREE BOOK

Send in this coupon today. Immediately on receipt of it we will send you our book, "Your Future in Drafting," which tells you all about our new method of teaching Mechanical Drawing and gives full details of our special offer to those who reply promptly.

THE COLUMBIA SCHOOL OF DRAFTING

Roy C. Claffin, *President*

Dept. 1864, 14th and T Sts., N. W., Washington, D. C.

Free Book Coupon

COLUMBIA SCHOOL OF DRAFTING,
 Dept. 1864, 14th and T Sts., N. W., Washington, D. C.

Enter my name for a free subscription to "The Compass" and also send me without charge your illustrated book on Drafting, telling me how I can secure your complete Home Study Course and your help in securing a position as Draftsman.

Name

Address

City State



MEN write

I Pay Your and guaran

Eleven Million Automobiles!

In every place in the U.S. you can see this scene—cars waiting for the mechanic—11,000,000 cars in the U. S.—millions of jobs for young men. Start in with the easiest job of all—a chauffeur.

Pick the Job You Like

Chauffeurs	\$90 to \$150
Truck Driver	\$125
Tire Vulcanizers	\$100 to \$200
Welders	\$140 to \$200
Battery Men	\$150 to \$200
Auto Mechanics	\$6 to \$10 a day
Auto Electrician	\$225
Tractor Engineer	\$10 day
Garage Mgr.	\$150 to \$400
Demonstrator and Salesman	\$150 to \$500

I say a chauffeur gets \$90 to \$150 a month. I know, I pay my own driver \$125 a month and board and lodging, so that he has a pretty nice job and saves good money. He has a lot of fun driving around and making tours and seeing the world. He is treated right; he gets as good food as I do and as soft a bed to sleep in. I think on the whole he has a better job than mine because he hasn't a worry on earth. Well, the chauffeur job is the easiest and most simple job of all, the first step on the ladder.

If you want to be independent and do the work you like and get real money now is the time to start. You haven't any idea of the possibilities in the auto business. Let me tell you what I can do for you.

LEARN A TRADE

Now is the time for you to learn a trade. I teach men to be successful auto mechanics. Can you make a tire? Can you weld a broken crank case? Can you build a battery? Can you repair an automobile? Can you go anywhere in the U. S. and get a job in a garage, repair shop, auto agency, tire shop, welding concern? Can you get a job as a driver or chauffeur?

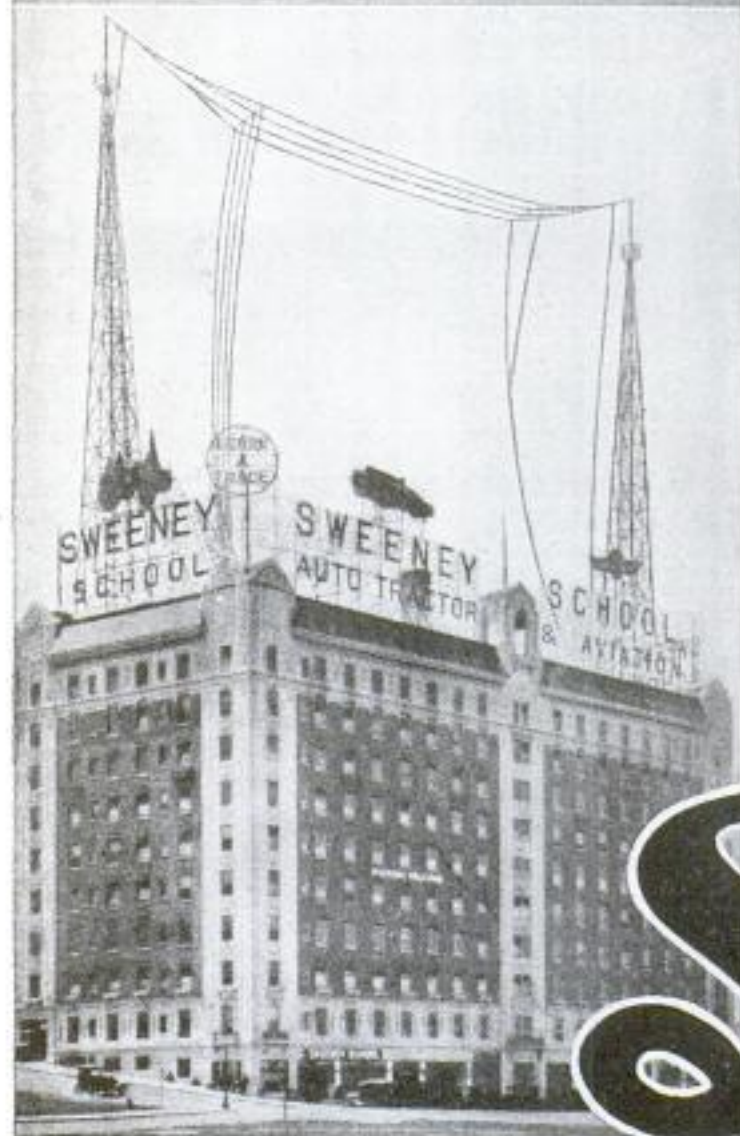

LEARN A Swee SCHOOL OF AUTO 1130 SWEENEY BLDG.

WANTED

today to Sweeney

Ry. Fare to K.C. tee You a Real Job You Must Apply Now

If you are ready for PROFITABLE EMPLOYMENT after eight weeks' training, write me today. Do not delay—for this opportunity may not occur again. For when these jobs are filled, I cannot offer such employment agreement any longer.

For fifteen years I have trained young men mechanically inclined. This is the first time I have been able to GUARANTEE A JOB. And I can only guarantee a certain number. But you can be one of those who take training UNDER MY GUARANTEE OF EMPLOYMENT IF YOU ACT NOW. Please do not apply unless you are willing to take eight weeks' course of training.

FREE The first step is to send me the coupon or write a postcard for my 72-page illustrated catalog. It tells all about this Million Dollar Trade School. How thousands of men just like you, without any special knowledge, but simply a liking for mechanics, MADE A LIFETIME SUCCESS as a result of this simple training.

I don't care how old you are. I don't care how small your education, for I teach with TOOLS, NOT BOOKS. I need 5000 salesmen and representatives to handle Sweeney batteries and radio supplies. I want managers for branch offices. I will hire you if you are in earnest and will qualify. And if you are willing to go to work. I WILL PAY YOUR RAILWAY FARE to Kansas City. Write me NOW! No colored students accepted.

You cannot get the SWEENEY SYSTEM OF PRACTICAL EXPERIENCE anywhere else—the system that trains men in eight weeks for big paying jobs.

E. J. SWEENEY,
President

TRADE
Sweeney
TRACTOR-AVIATION
KANSAS CITY, MO

W. H. B. Great Sweeney
Broadcasting.
Free Radio Course to all who answer this ad. \$20,000 Radio Station. Largest and finest radio outfit in the world for Sweeney students.

**This FREE Book
Tells You
Every-
thing**

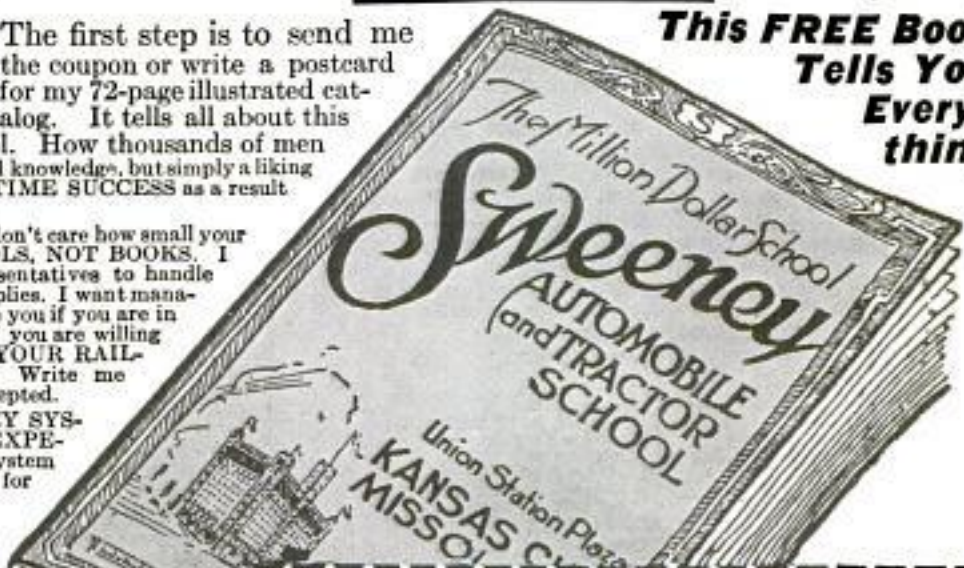

EMORY J. SWEENEY, President
1130 Sweeney Bldg., Kansas City, Mo.

Send me your offer of a guaranteed position, your big free catalog and full details of the Sweeney eight weeks' course leading to an immediate money-making opportunity.

Name.....

Address.....



"I'm making real money now"

"SEE that coupon? Remember the day you urged me to send it to Scranton? It was the best thing I ever did. Mr. Carter called me in today. Said he'd been watching my work for some time—ever since he learned I was studying with the International Correspondence Schools.

"Then he asked me if I thought I could take over Bill Stevens' job. I told him I was sure that I could—that I had had that goal in view ever since I started my I. C. S. course.

"I start tomorrow, Mary, at an increase of \$60 a month. It's wonderful how spare-time study helps a man to get ahead."

FOR thirty years, the I. C. S. has been helping men to win promotion, to earn more money, to get ahead in business and in life.

You, too, can have the position you want in the work you like best. Yes, you can.

All we ask is the chance to prove it. Without cost, without obligation, just mark and mail this coupon.

TEAR OUT HERE

INTERNATIONAL CORRESPONDENCE SCHOOLS Box 5684-C, Scranton, Penna.

Without cost or obligation, please tell me how I can qualify for the position or in the subject before which I have marked an X:

BUSINESS TRAINING DEPARTMENT

- | | |
|---|---|
| <input type="checkbox"/> Business Management | <input type="checkbox"/> Salesmanship |
| <input type="checkbox"/> Industrial Management | <input type="checkbox"/> Advertising |
| <input type="checkbox"/> Personnel Organization | <input type="checkbox"/> Better Letters |
| <input type="checkbox"/> Traffic Management | <input type="checkbox"/> Foreign Trade |
| <input type="checkbox"/> Business Law | <input type="checkbox"/> Stenography and Typing |
| <input type="checkbox"/> Banking and Banking Law | <input type="checkbox"/> Business English |
| <input type="checkbox"/> Accountancy (including C.P.A.) | <input type="checkbox"/> Civil Service |
| <input type="checkbox"/> Nicholson Cost Accounting | <input type="checkbox"/> Railway Mail Clerk |
| <input type="checkbox"/> Bookkeeping | <input type="checkbox"/> Common School Subjects |
| <input type="checkbox"/> Private Secretary | <input type="checkbox"/> High School Subjects |
| <input type="checkbox"/> Business Spanish <input type="checkbox"/> French | <input type="checkbox"/> Illustrating <input type="checkbox"/> Cartooning |

TECHNICAL AND INDUSTRIAL DEPARTMENT

- | | |
|--|--|
| <input type="checkbox"/> Electrical Engineering | <input type="checkbox"/> Architect |
| <input type="checkbox"/> Electric Lighting | <input type="checkbox"/> Blue Print Reading |
| <input type="checkbox"/> Mechanical Engineer | <input type="checkbox"/> Contractor and Builder |
| <input type="checkbox"/> Mechanical Draftsman | <input type="checkbox"/> Architectural Draftsman |
| <input type="checkbox"/> Machine Shop Practice | <input type="checkbox"/> Concrete Builder |
| <input type="checkbox"/> Railroad Positions | <input type="checkbox"/> Structural Engineer |
| <input type="checkbox"/> Gas Engine Operating | <input type="checkbox"/> Plumbing and Heating |
| <input type="checkbox"/> Civil Engineer | <input type="checkbox"/> Chemistry <input type="checkbox"/> Pharmacy |
| <input type="checkbox"/> Surveying and Mapping | <input type="checkbox"/> Automobile Work |
| <input type="checkbox"/> Metallurgy | <input type="checkbox"/> Navigation |
| <input type="checkbox"/> Steam Engineering | <input type="checkbox"/> Agriculture and Poultry |
| <input type="checkbox"/> Radio <input type="checkbox"/> Airplane Engines | <input type="checkbox"/> Mathematics |

Name.....
Street.....
Address.....
City..... State.....

Occupation.....
Persons residing in Canada should send this coupon to the International Correspondence Schools Canadian, Limited, Montreal, Canada.

Please Mention Popular Mechanics

Earn \$35-\$125 a Wk



Your Opportunity in MECHANICAL DENTISTRY

Ambitious men of all ages can rise above small salaried positions into this profession of unlimited possibilities.

Taught by actual practice—day or evening. Three months' course. Modern laboratories. No previous knowledge or experience required. No charge for tools or equipment. The men we train are in demand. Established 30 years. Catalog free.

Address your inquiry to Dept. 2

BODEE DENTAL INSTITUTE

NEW YORK, 136 W. 52d St.—PHILA., 15th & Walnut Sts.
BUFFALO, 1226 Main St.—BROOKLYN, 15 Flatbush Ave.

PLAY PIANO BY EAR in 4 Weeks!

Young and old can now learn to play piano by ear without notes or music by our brand new quick and easy 10 lesson method. Send now for

FREE Sample Lesson!

and play real chords at once. The World's simplest, easiest method. Nothing else like it. No musical experience necessary, play piano as easy as you hum or whistle a tune. Be a ragtime artist. Send for FREE sample lesson now before edition is gone. Don't delay.

DAVID PIANO COURSE 502 CUTLER-HAMMER BLDG.
CHICAGO, ILLINOIS

HIGHER EDUCATION

HOME
STUDY

Courses in English, Spanish, Mathematics, Chemistry, Drawing, Education, Business and in 35 other subjects are given by correspondence. Begin anytime.

The University of Chicago

31st Year

Division Chicago, Ill.

\$15.00 TENOR BANJO FREE

YOU CAN PLAY THE TENOR BANJO Just Like the Experts

Because PROF. BARKER will help you

Our method of teaching is so simple, plain and easy that you begin on a piece with your first lesson. In half an hour you can play it! We have reduced the necessary motions you learn to only five—and you acquire these in a few minutes. Then it is only a matter of practice to acquire the weird, fascinating tremolos, staccatos, slurs and other effects that make this instrument so delightful. The TENOR BANJO plays any kind of music—melody or accompaniment.

FREE Our complete course of 52 lessons includes FREE a beautiful TENOR BANJO, all necessary playing equipment and 52 pieces of Music.

Special arrangement for lessons if you have your own TENOR BANJO.

Your favorite instrument given away FREE with first lesson. Special courses under Famous Teachers. Learn to play Violin, Hawaiian Guitar, or Ukulele.
This Makes a Splendid Christmas Gift.



First Hawaiian Conservatory of Music, Inc.
223 Broadway (Woolworth Bldg.) New York
Please send me full information about your 52 easy lessons and FREE TENOR BANJO OFFER.

Name.....
Address.....
Town..... State..... P. M. 11

An Architect, A Painter and A Sculptress Joined in Designing This Exquisite Lamp

The lines, proportions and coloring of most of the lamps you see in these days of commercialism are the work of designing departments of large factories. They are the fruits of a deep knowledge of what makes a "popular seller." But some people, the **Decorative Arts League** committee felt sure, would like a lamp designed purely with an eye to good taste, a lamp of artistic proportions and harmonious tones, a lamp embodying grace, symmetry and beauty rather than the long experience of the "salesman-designer" of what seems most in demand in retail stores. Hence this exquisite little lamp you see pictured, "Aurora" as it has been named by an artist, because of the purity of its Greek lines and tones.

A Labor of Love

For the delicate work of designing a lamp that should be a real work of art instead of a mere unit in a factory's production, and yet should be a practical and useful article of home-furnishing, the League enlisted the enthusiastic cooperation of a group of talented artists—one a famous architect skilled in the practical requirements of interior decorating, one a painter and genius in color-effects, and one a brilliant sculptress, a student of the great Rodin in Paris.

They caught the spirit of the League's idea and the designing of a lamp that would raise the artistic standards of home-lighting became to them a true labor of love. Model after model was made, studied and abandoned, until at last a design emerged with which not one of the three could find a fault.

Every Detail Perfect

One style of ornamentation after another was tried out, only to yield in the end to the perfect simplicity of the classic Greek lines. Even such a small detail as the exact contour of the base was worked over and over again until it should blend in one continuous "stream" with the lines of the slender shaft. The graceful curves of the shaft itself, simple as they seem in the finished model, were the results of dozens of trials. The shape, the exact size, and the soft coloring of the shade were the product of many experiments.

The result is a masterpiece of Greek simplicity and balance. Not a thing could be added or taken away without marring the general effect—not the sixty-fourth of an inch difference in any moulding or curve but would be harmful. And yet with all the attention to artistic effect the practical knowledge of an experienced interior decorator has kept "Aurora" in perfect harmony with the actual requirements of the home. It blends with any style of furnishing, it adapts itself to boudoir or foyer-hall, to library or living room. And wherever you place it "Aurora" will add taste and refinement besides furnishing, with its tilttable shade, a thoroughly practical and mellow light wherever required.



"AURORA"
\$3.50

In the exclusive Fifth Avenue type of shops, where lamps that are also works of art are shown, the equal of this fascinating little "Aurora" if found, would cost you from \$15 to \$30—perhaps more. Yet the price of this lamp is but

\$3.50—Think of it!

Only the **Decorative Arts League** could bring out such a lamp at such a price. And only as a means of widening its circle of usefulness could even the League make such an offer. But with each purchase of this beautiful little lamp goes a "Corresponding Membership" in the League. This costs you nothing and entails no obligations of any kind. It simply means that your name is registered on the League's books as one interested in things of real beauty and art for home decoration, so that as artists who work with the League create new ideas they can be offered to you direct without dependence on dealers.

Send No Money

No matter how many other lamps you have in your house, you will always find a place just suited for this dainty, charming, little "Aurora" 16 inches high, shade 10 $\frac{1}{4}$ inches in diameter, base and cap cast in solid Metallium, shaft of seamless brass, choice of two color schemes—rich statuary bronze with brass-bound parchment shade of a neutral brown tone, or ivory white with golden yellow shade. Inside of shades is tinted old rose to give a mellow light. Shade holder permits adjustment to any angle; push-button socket, six feet of lamp cord and 2-piece attachment plug.

You will rarely if ever, get such a value again. Send no money—simply sign and mail the coupon, then pay the postman \$3.50 plus the amount of parcel-post stamps on the package. Shipping weight only 5 lbs., so postage even to furthest point is insignificant. If you should not find the lamp all we say of it, or all you expected of it, send it back in five days and your money will be refunded in full. Clip the coupon now, and mail to

Decorative Arts League, 175 Fifth Avenue, New York, N. Y.
Decorative Arts League (175 Fifth Avenue,
New York, N. Y.)

You may send me, at the member's special price, an "Aurora" Lamp, and I will pay the postman \$3.50 plus the postage when delivered. If not satisfactory I can return the lamp within five days of receipt and you are to refund my money in full.

You may enter my name as a "Corresponding Member" of the **Decorative Arts League**, it being distinctly understood that such membership is to cost me nothing, either now or later, and is to entail no obligation of any kind. It simply registers me as one interested in hearing of really artistic new things for home decorations.

Check finish desired—Statuary Bronze or Ivory White.

Signed

Address

City.....State.....

How do you buy Your Radio Batteries?

DO YOU SAY to a jeweller, "I want a watch!"—or do you ask for a specific watch that does well what watches must do well? And so with batteries for radio.

Most of the noises attributed to static and other causes are *battery* noises. They are caused by irregular current discharge—"fluctuating" voltage.

Have you ever noticed how electric lights *flicker* in some localities—enough to make reading impossible?

Just so, ordinary batteries send out *fluctuating* currents, which make *hearing flicker!*

Radiobats "A" and "B" give absolutely *steady* voltage. They eliminate "interference" because they never produce it. They cut out "static" because *they* don't produce sounds *like* static.

George Gaynor Hyde, one of the foremost consulting engineers in Radio reports, ".....total absence of any noises such as are common to the usual type of "B" batteries. In fact when the antenna wire was removed from the set, it was almost impossible to tell whether the remaining apparatus was working or not."

With Radiobats "A" and "B" one adjustment lasts *all* evening; screeches and screams become splendid harmony; hisses become the most enjoyable music; grating, rasping gasps become clear, melodious human voices.

Send for our intensely instructive booklet—free—and send us the name and address of your dealer, so that he may give you the finest radio demonstration you have ever heard. Send for it now.

MULTIPLE STORAGE BATTERY CORPORATION
350 Madison Avenue, New York

**A⁺
and
B** **RADIOBATS**
The Permanent Radio Power-UNIT



Popular Mechanics Magazine

REGISTERED IN U. S. PATENT OFFICE

WRITTEN SO YOU CAN UNDERSTAND IT

Vol. 38

NOVEMBER, 1922

No. 5

266

New "King of the White Water"

BEFORE an audience of 10,000 persons at Seattle, Wash., recently, famous log rollers from various parts of the United States and Canada met in competition to determine who should have the right to call himself "King of the White Water," champion log burler of the world. A. F. Speigel, Washington lumberjack, former world's champion, went down to defeat before Matt Dillon, woodsman of Hoquiam, Wash., following a spirited battle lasting 43 minutes—the longest contest of its kind on record.

Log-rolling contests originated in the woods of the eastern part of the United

States and Canada. Long before the advent of the steam sawmill, burling contests were held in Maine, Wisconsin, Michigan, and the famed North Woods of Quebec and Ontario. There was hardly a lumbering district that did not have a champion who could "ride the whitest water and cuff a log from day-break to dark." In more recent years log-rolling contests have moved to the Pacific coast along with the main lumber industry.

The recent contest, in which the world's championship changed hands, was held in the Lake Washington Ship Canal.



Matt Dillon, New World's Champion Log Roller, at Left, at the Start of His Record 43-Minute Battle—the Longest Contest of Its Kind on Record—Which Won Him the Lumberjacks' Coveted Title of "King of the White Water"

L. W. Pedrose

1453 W. 54th Street
Seattle, Wash.

Pike poles and other balancing aids were barred. The log used for the contest was of fir, 13 feet long and 18 inches in diameter, turned on a lathe to assure perfect cylindrical form. Contestants wore bath-

ing suits and caked shoes. The contest was a test of strength, agility, and headwork. A purse of \$200 rewarded the winner, who in addition enjoys the title of champion log roller of the world.

Spectator
COLOR AND SHAPE GLASSES TO MATCH HAIRDRESS

Claiming that health and beauty permit neither light lines above the eyes



Above: Eyeglasses Conforming to Lines of Hat and with Upper Portion of Rims Darkened. Left: Eyeglasses of Crescent Design and with Shaded Rims

COPYRIGHT, FRANK G. MURPHY

nor dark lines below them, and that therefore eyeglasses of a single color are impracticable, an optician has designed glasses with the top rim in dark hues and the lower rim in various light shades. Carrying the idea of beauty a step farther, he has also made the upper rim with different contours to conform to the wearer's eyebrows, hairdress, or hat.

It is estimated that motor-driven vehicles in the United States have a combined power equivalent to more than 300,000,000 horses, while the total number of horses and mules in the country is less than one-tenth that figure.

268
CENTRAL-STATION DRILLS TRAIN FIREMEN

The city of San Antonio, Tex., has been getting some highly gratifying results from the intensive training given the city firemen at the central station. This station has special towers for drill in climbing and rescue work. A permanent net is provided to guard against accidents. Members of the various companies have their definite days for this drill work and gain nimbleness in climb-

284
DEEP BRAZILIAN MINE NEEDS PRECOOLING OF AIR

Miners working nearly one and a quarter miles below the earth's surface in Brazil, South America, find the temperature of the surrounding rocks to be 118° F. To overcome this impossible working temperature, a system of pre-cooling the air with large fans has been installed. The effectiveness of this system is now being studied by the U. S. Bureau of Mines with a view of adopting a similar practice in some of the deeper mines in this country.

229
TEAPOT HEATED BY CHARCOAL COMMON SIGHT IN CHINA

Teapots heated by charcoal are common sights in China, where the affable host invariably serves a cup of tea to the visitor, even at business houses. The curious-appearing utensils are "two stories" in height—the upper being for tea and the lower for the charcoal burner—and are made of brass. These articles have been in use in that country for several centuries, and some contend that the elaborately finished percolators used for making coffee and tea in modern homes, are in fact modifications of the ancient Chinese teapot.



*Dr. Frank G. Murphy
Mason City, Iowa.*

*Cont. Roy C. Bennett
1208 N. 57th St.
Philadelphia, Pa.*

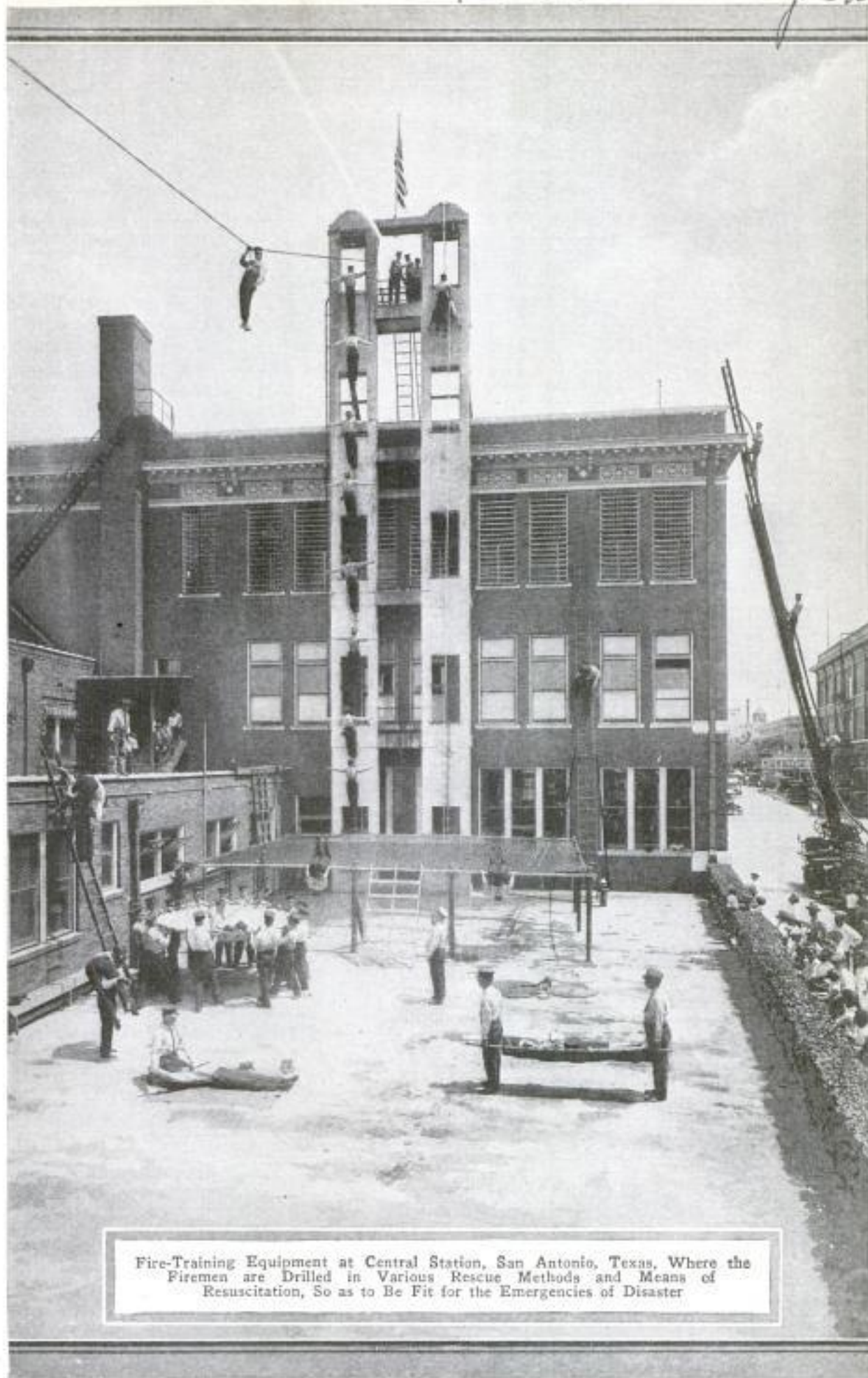

Fire-Training Equipment at Central Station, San Antonio, Texas, Where the Firemen are Drilled in Various Rescue Methods and Means of Resuscitation, So as to Be Fit for the Emergencies of Disaster

PUSH-BUTTON IN LONDON

Fresh-Air Supply Controlled at County Council—No

BY HENRY

stories above ground, and two stories below it. The latter are used for storage and for the housing of one of the most up-to-date ventilating systems that has ever been installed. The building is situated along one bank of the river Thames and the whole of the site is covered with a concrete raft, five feet thick, surrounded by deep retaining walls.

The most interesting portion of the building is the council chamber, which accommodates 200 members. Octagonal in shape, it is 55 feet high, and is lined with beautifully finished marble and oak paneling, in the same style as the committee rooms, lobbies, and main staircase.

Very elaborate means have been furnished for the heating and ventilation of the whole of the building, but especially with regard to the council chamber, which is supplied with filtered air, conditioned at a constant temperature of 65 degrees by means of apparatus controlled by thermostats. Louver air inlets are located at the roof level of the front and rear walls of the council chamber, and after passing down glazed brick shafts, the air enters the conditioning chamber below the ground level through inlets controlled by dampers. Thence the air passes to the humidifier where it is thoroughly cleansed and saturated. Automatically controlled batteries warm the air in winter to a constant temperature of 65 degrees. In hot weather the air is cooled by blocks of ice which are melted rapidly by spraying them with water. After being conditioned the air is propelled by electric fans through mains to a maze of distributing pipes below the chamber floor. That it is indeed a maze is caused by the fact that an air-supply pipe leads to every one of the 200 members' seats.

Here becomes apparent the most striking novelty of the whole ventilating system. At each seat is a desk, at the back of which is an outlet register pointed up-

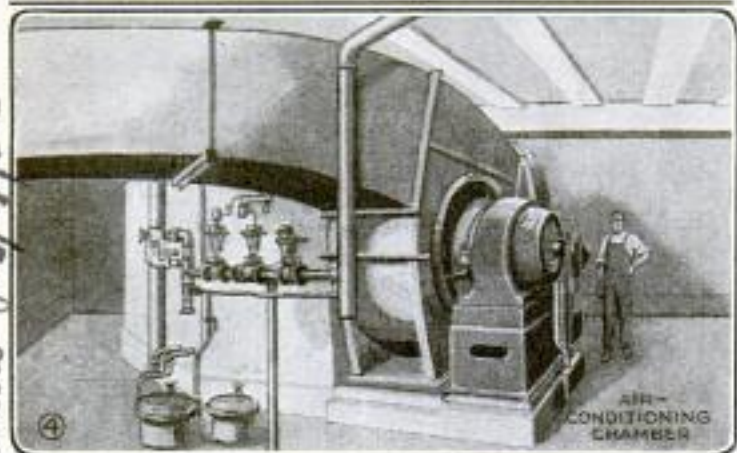
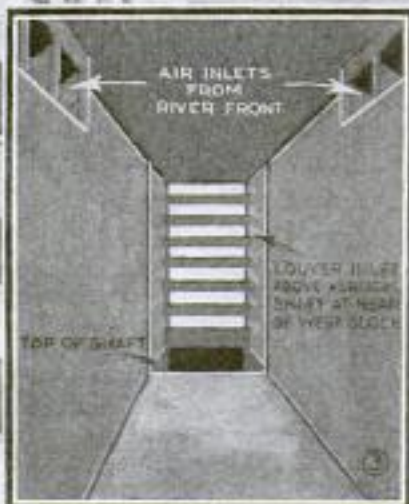
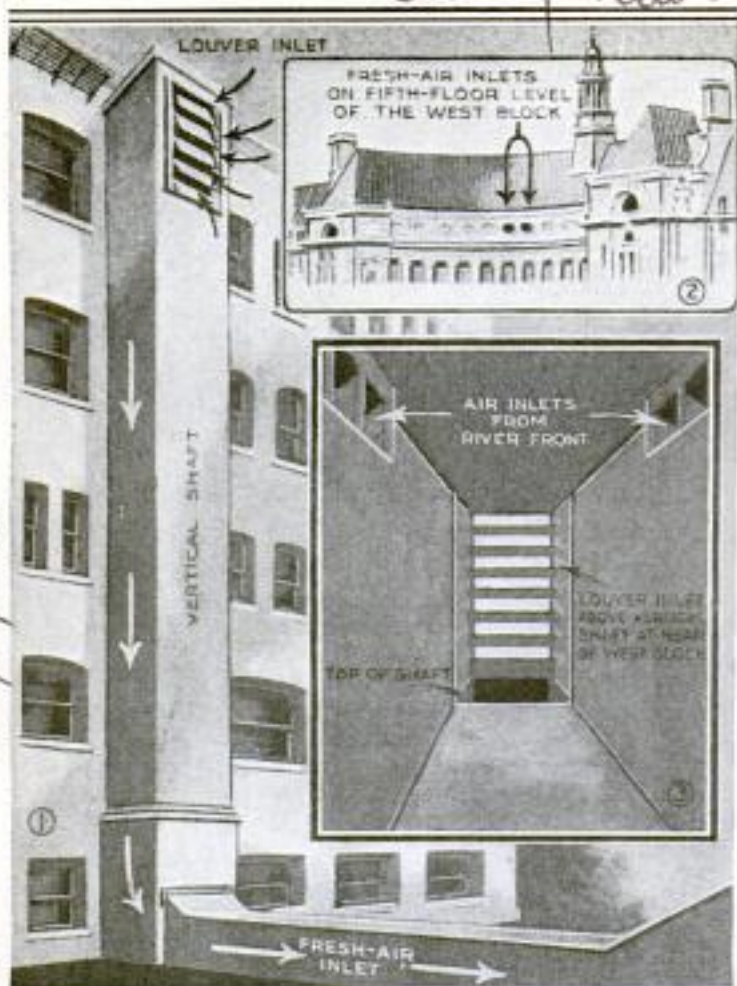

COPYRIGHT, ILLUSTRATED LONDON NEWS

View 1 Shows One of the Glazed-Brick Shafts on the Rear Wall of the Council Chamber; 2, the Air Inlet on the Front Wall of the Chamber, and 3, Air Corridor Connecting Front and Rear Inlets. View 4 Shows Large Fan in the Conditioning Chamber

ONE of the largest structures in London, England, is the new County Hall that was formally opened on July 17, 1922, although the cornerstone of the building had been laid as long as 10 years previously. That so long a time was required to complete the building was the result of delays caused by the war.

This new home for the London County Council, and its rapidly growing staff, is 750 feet long, with an average width of more than 300 feet, and comprises seven

The London Electrical Review Agency. The Illustrated London News 8/12/22. The London Electrical Review 8/4/22

VENTILATION BUILDING

Seats by Members of London Conflicting Air Currents

S. WHITE

ward, and another register below the desk pointed horizontally in such a manner that air issuing from it strikes the occupant of the seat like the breeze from a fan. On the horizontal register is a sliding button that controls a valve in such a manner that the occupant of the seat can switch the air either to the vertical register that carries it upward without affecting him individually, or to the horizontal one that directs the air to himself without affecting his neighbor. Additional fans remove the vitiated air from the floor level, and from the roof of the chamber.

Some idea of the capacity of this ventilating system may be gathered from the fact that, without creating any appreciable draft, the air is replaced in the chamber at the rate of over 1,000,000 cubic feet an hour.

In ordinary English summer weather, the refrigeration by means of melting ice, mentioned above, can be dispensed with. Instead, by the evaporation of some 20 or 30 gallons of water an hour, the temperature inside the chamber can be kept at from 10 to 20 degrees below the outdoor shade reading.

In every respect the work on the building has been carried out in accordance with the highest standards of material and workmanship. The total area of the site is about 6½ acres, and including reclamation work, the total cost of the building will be nearly 20,000,000 dollars.

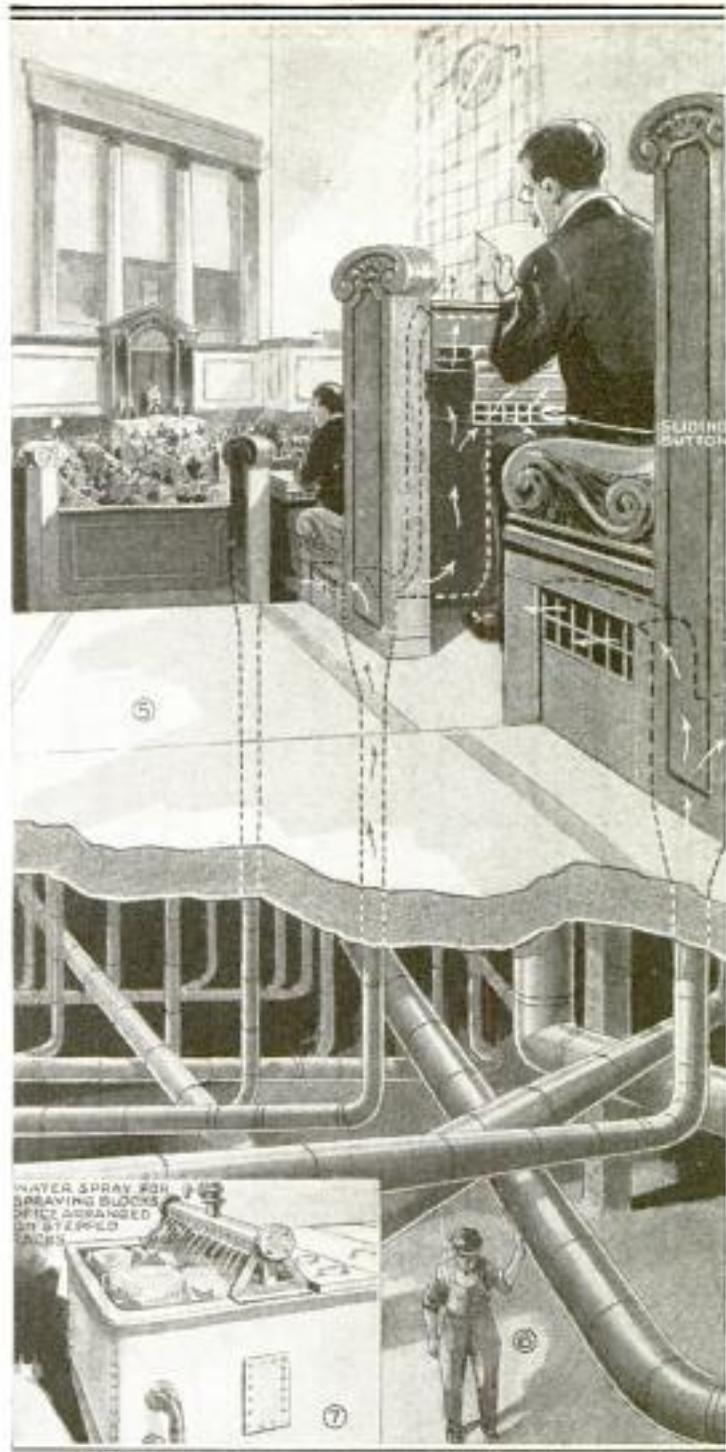

COPYRIGHT, ILLUSTRATED LONDON NEWS

View 5 Shows the Registers at Each Seat, and Button on Desk Register with Which Air is Directed Either Vertically or toward the Occupant of the Seat; 6, the Maze of Pipes under the Chamber Floor, and 7, Part of the Ice Tank for Cooling the Air

MAKING CROSS-COUNTRY TRIP ON ROLLER SKATES

328

Trying for a record in long-distance skating, an American married couple are roller-skating from Philadelphia to the Pacific coast, with the intention of also making a return trip regardless of road conditions and other obstacles. The skaters, who are now in the West, manage to make expenses by doing trick and

fancy skating at local theaters. They sleep outdoors in camp sacks when the weather permits. To make a perfect record, both refuse to accept offers of "lifts" from automobilists.

☐ The United States uses yearly 2,000,000 tons of newsprint which, if cut into a ribbon of the width of the average daily newspaper, would have a total length of 40,000,000 miles.

Cont. Henry H. Esraharn
536 Second Ave. E.
Twin Falls, Idaho.

C. H. Thomas, Kenneth Square, Pa.
 Kadel + Herbert, 153 E. 42nd St
 PRIVATE RADIO STATION WELL EQUIPPED
 204 ————— By H. A. LANE New York.

Owner. Horace P. Osale Parkersburg, Pa.

ELABORATE equipment is contained in a private radio station at Parkes-

burg, Pa., which has three licenses, "3 Z O," "3 X W," and "3 O I," these covering any combination of wave lengths not reserved by the navy. A number of transmitters, including a spark set of 325 meters, a radiophone set with a wave length of 3,660 meters, an open-arc set operating on 2,500 meters, and a 50-watt vacuum-tube, self-rectifying set working on 360 meters, are installed in this station. Four generators of 100, 600, 1,000, and 4,000 volts, furnish the direct current for the outfit, the receiving apparatus of which is inclosed in zinc-lined rooms, while the cabinets and lamp closets are constructed of the best bakelite.

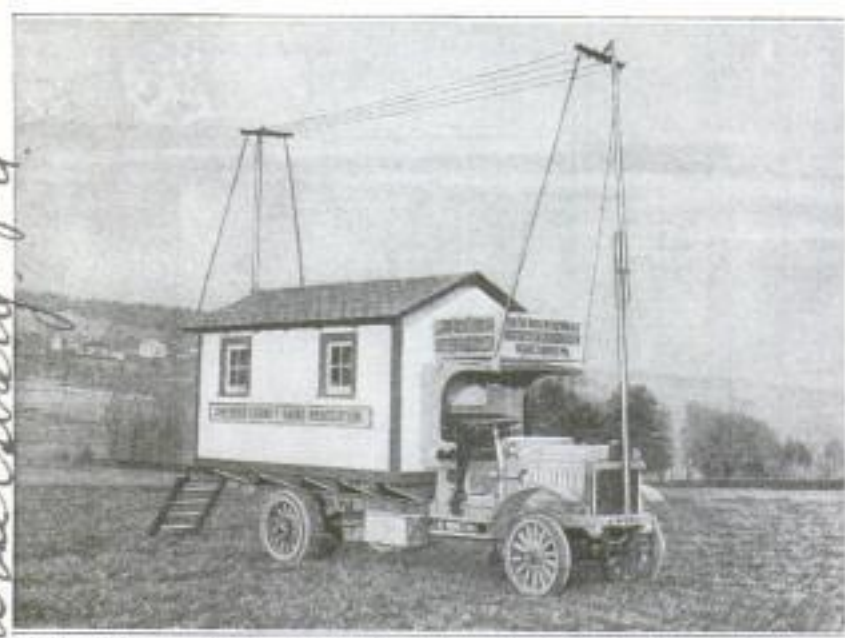

Mobile Wireless Station Which Contains a Complete Equipment for Transmitting and Receiving Radio Messages or Music

The antenna is erected 185 feet in the air and is 350 feet in length, messages and music being received from New Mexico, Maine, and the coast of Wales, which are relayed to other smaller stations or broadcast through a gigantic megaphone for a distance of seven miles. In connection with

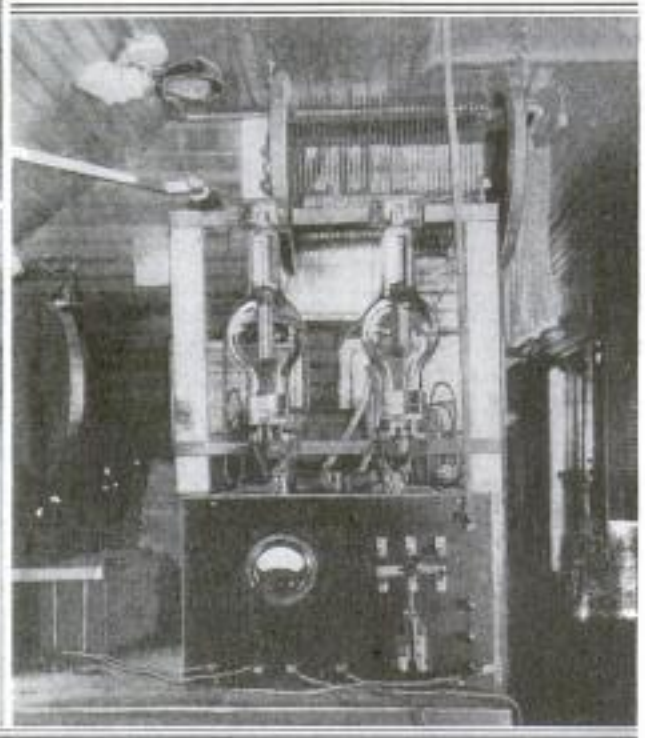
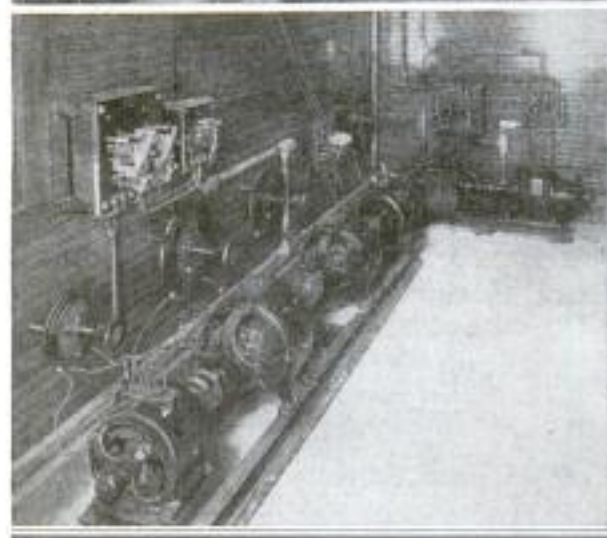

Upper Left: A Corner of the Elaborately Equipped Radio Station at Parkersburg, Pennsylvania, Showing Some of the Many Cabinets and Storage Batteries. Lower Left: Generator Room with the Direct-Current Machines and Controlling Rheostats. Right: Two of the Huge Amplifier Bulbs and Accompanying Apparatus

this station, a complete broadcasting and receiving set has been mounted on a motor-truck chassis and is inclosed in a miniature house which has windows in the sides, a door at the rear, and is

equipped with adjustable aerial masts. The mobile equipment tours the suburban districts in an effort to arouse the people to a greater interest in the wonders of radio.

270

HONDURAS NOW BUILDING MOTOR HIGHWAYS

It is announced that a new motor highway across Honduras, from the Atlantic to the Pacific, will be completed within the next three months. Work is also in progress on several other roads for motor traffic on the Atlantic coast and in the interior. There are no railways except along the Atlantic seaboard, and traffic in the country is now changing from antiquated oxcarts to motor trucks and automobiles.

The Engineer 8/11/22
BLISTERED PAINT REMOVED BY COMPRESSED AIR

Removing old or blistered paint with the aid of an air blast, instead of by the usual gasoline-torch burning method, is possible with an appliance which can be attached to any compressed-air outfit. A special scraper, having an air slot about 2 inches above its cutting edge, is inserted under the loose scales of the old paint, whereupon the powerful blast literally blows them off. As this procedure leaves a smooth surface, more efficient workmanship is assured, since the fresh coat of paint can be applied evenly.



Blistered-Paint Remover Which is Operated by Means of Compressed Air, Showing the Special Scraper Attached to the Air Hose

Machinery
26 EAR-CORN CLEANER REMOVES SHUCKS AND SILK

Ear corn may be efficiently cleaned of shucks and silk by an appliance that has six long toothed rollers which are driven

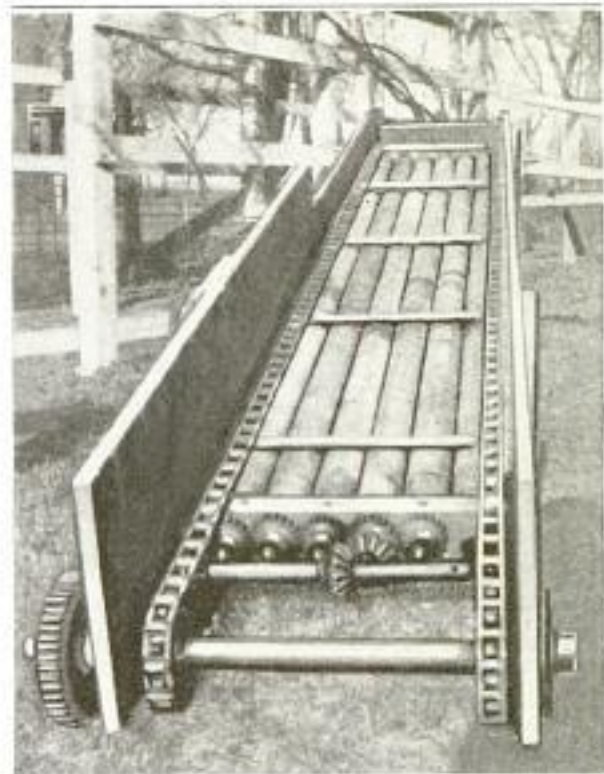

Ear-Corn Cleaner That Removes the Shucks and Silk, Showing the Endless Conveyor and the Rollers Which are Fitted with Teeth

by the same mechanism that operates an endless conveyor. As the conveyor carries the corn over the revolving rollers, the teeth of these tear the shucks and silk from the ears, while any loose grains fall between the rollers onto a screen, from which they can be sacked.

269
"RECREATION ENGINEER" ADDED TO FOREST SERVICE

"Recreation engineer" is the title given to a new official working under the direction of the U. S. Forest Service, for the development of public camp grounds and summer-home sites in the national forests of the West. It is estimated that 5,500,000 tourists visit the national reservations yearly.

Mr. Roman's 606 E. 7th Road St. Louis, Mo. - Wilmington, Del. - Poughkeepsie, N.Y. - Philadelphia Pa. - 12150 Allegheny St.

Mr. Compressed Air Scraper Co. Lancaster, Pa.

Dr. E. J. La Roche Philadelphia Pa. 12150 Allegheny St.

Engineering News-Record Copy 8/17/22

Designed by -
Welch & Ruppel

Electrical World

8/12/22

661

140 & Dearborn

POPULAR MECHANICS

109

BALCONY AND FIRE ESCAPE ATTRACTIVELY COMBINED

Chicago

A balcony and first-story gravity-type fire escape are attractively combined in a new design which conceals the fire escape



Ornamental Balcony Which has been Designed to Conceal a Gravity-Type Fire Escape, Showing a Man About to Descend



Here the Fire Escape is Shown Lowered by the Weight in the Front End, and a Man is Seen Descending It

when not in use. This type is not new, but contrary to the usual escape of this kind the weights are concealed in the front edge of the balcony, while steel sheeting is bolted under the steps, to match the decorated undersheeting of the rest of the balcony. There is nothing to be seen from the street which would lead one to believe that this attractive balcony also had a fire escape.

279

LOW-MELTING-POINT ALLOY FOR DIAMOND SETTING

A manufacturer of diamond-pointed tools used for cutting for many industrial purposes, has developed an alloy metal that melts at about 300° F., cools quickly, and becomes as hard as steel. This low degree of heat cannot harm the diamond, which is held firmly as the alloy contracts in cooling. The superiority over setting diamonds in steel which melts at about 3,500° F., with the danger of injury to the diamond and the tendency to form blowholes, is apparent.

988

FATAL ELECTRICAL SHOCK FROM PECULIAR CAUSE

Standing with her bare feet on a wet floor, a scrubwoman touched the glass bulb of an ordinary electric lamp and was instantly killed. Doctors stated that death was caused by electrocution. Horrified by the unusual occurrence, her employers called in an electrical expert to make a thorough examination. Upon closely scrutinizing the lamp bulb, the investigator discovered a thin streak of lime on the glass, extending from the base of the lamp to within a few inches of the tip. Voltmeter tests plainly indicated a heavy leakage of current through the lime. Further experiments illustrated the danger in conductive deposits upon the surfaces of electric lamps, when extending from the "live" base, this hazard increasing in proportion to the humidity of the surrounding atmosphere and the effectiveness of the contact made with the

"ground," or floor, which would complete the circuit through the body.

977

FLASHLIGHT RAZOR PERMITS SHAVING IN THE DARK

A new combination of flashlight and safety razor will enable all those who are in the habit of shaving themselves to shave when the lights are out, or to shave with more comfort where the light is poor. The handle of the razor is a flashlight and throws a brilliant glow on the face.



From Telegram 129 S. 24th St. New York City
Maker

Mfr. H. Messau, Printing Crafts Bldg
33 to 34th St, Eighth Ave. New York City

Cmt. Harry F. Osborn
65 Hudson St.
South Isles Falls, N.Y.

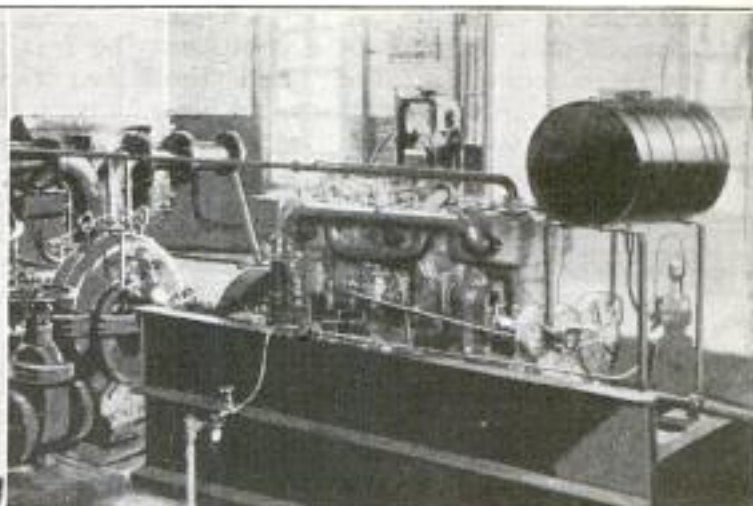
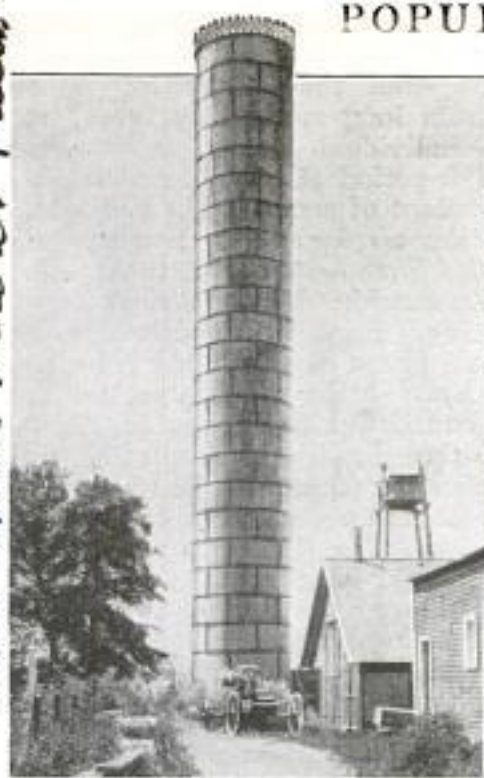

Above: Installation of an Automobile Engine Connected to Pump in the Water-Supply Station of an Eastern Village, Which is Saving Money for the Taxpayers with This Unusual Drive. Left: The 75-Foot Standpipe Which Accumulates the Excess Water Pumped, and Serves as a Reservoir When the Pumps Are Idle

VILLAGE WATER-SUPPLY PLANT RUN BY AUTOMOBILE ENGINE

An eastern village has adapted a well-known automobile engine to the operation of its water-supply system. The engine is direct-connected to a centrifugal pump which takes the water from the filter reservoir, and forces it some distance into a standpipe located on a hill. The motor, which will develop 120 horsepower, normally operates at 70 horsepower in pumping about 1,200 gallons per minute. This gasoline engine has replaced a steam-driven unit at considerable

saving to the taxpayers, and is said to represent a more economical installation than electric-motor-driven pumps.

FIRST AMERICAN-CONSTRUCTED SIX-PASSENGER BIPLANE

The first six-passenger cabin biplane built in America was only recently completed. It is equipped with the latest type 12-cylinder Liberty motor which can be started by cranking from within the cabin, and will attain a speed of 100 to 125 miles per hour. The plane has a wing spread of 43 feet 7 inches, measures

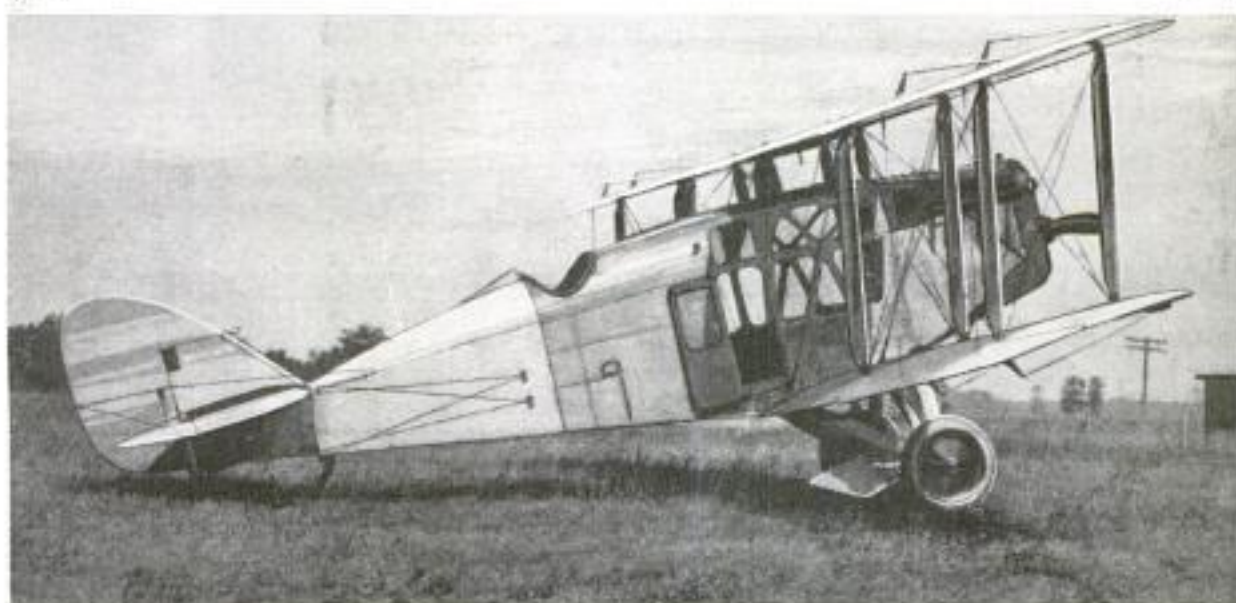

This First Six-Passenger Cabin Biplane Built in America Is of Interest Because of Its Equipment and Its Possible Adoption for Commercial Use on a Proposed Air Route

Designed by: Jno. L. Porter
+ G. S. Woodson, Wabash, Ind.

29 feet from propeller to tail, and weighs 3,500 pounds without load. It is equipped for wireless communication, and the cabin, with side-door entrance, is designed for the comfort of the passengers and for protection from the wind and elements.

MULTIPLE MANOMETER RECORDS AIRPLANE PRESSURES

A multiple manometer specially designed to record the air pressures at 30

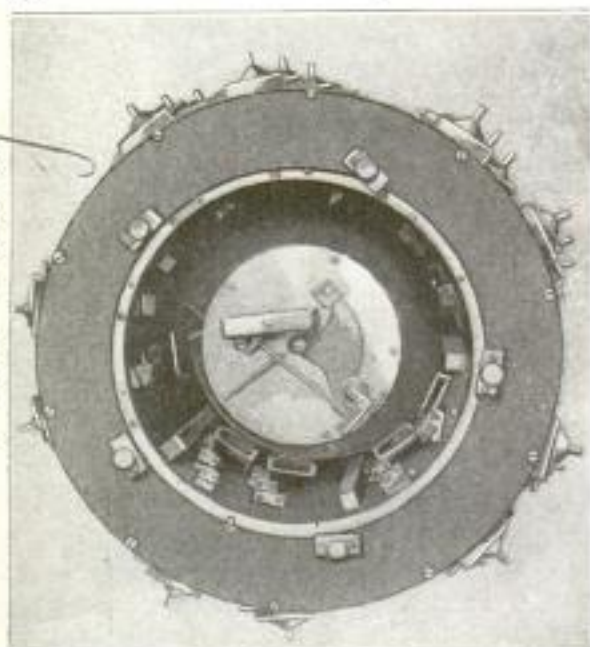

Top View of Multiple Recorder, with Film Drum Removed, for Measuring Air Pressures on the Surfaces of an Airplane

different points on an airplane in 30 seconds has recently been developed by the National Advisory Committee of Aeronautics. Its particular application is in measuring the magnitude and distribution of pressures over the horizontal tail surfaces of a machine in flight, regarding which there have heretofore been no real data.

Realizing that the instrument should be free from long connecting tubes, and that the individual manometers should have a high period of vibration as well as be independent of acceleration and vibrations in the airplane, the designers arranged the manometers in three rows around the outside of a cylindrical aluminum casting. Each manometer consists of a small brass case divided into two sections by a brass diaphragm, with a pressure connection to either side. Movement of the diaphragm rotates a tiny mirror delicately mounted. At the bottom of the cylinder an electric bulb throws a horizontal beam of light through a fine slit, which light is reflected by 10 prisms on the inside of the cylinder, up to 30 small prisms which throw it against the mirrors, and these in turn reflect the light upon a photographic film placed upon a drum in the center of the cylinder. A rotating shutter causes the light to reach each of the 30 mirrors in succession, as the film drum is moved into correct position by a tenth of a revolution after each exposure.

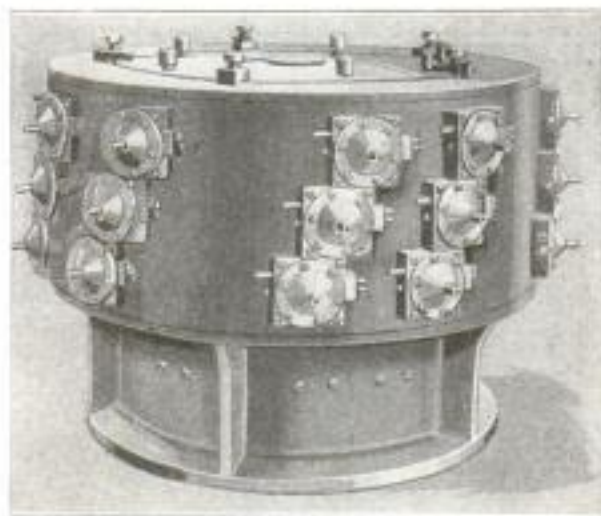

Outside View of Multiple Manometer: Note the Three Rows of Manometers Arranged around the Outside of the Aluminum Cylinder

"ONE-NIGHT STANDS" PLAYED BY PORTABLE THEATER

"One-night stands," on a "circuit" composed of the different playgrounds of the city, are the "bookings" obtained for a portable theater in Elmira, N. Y. The miniature playhouse, designed for community service, has, when closed, an outward appearance of a small house on wheels, with doors at either end. One side of the structure can be lowered by a lever arrangement, to provide a stage 16 feet wide by 15 feet deep, around which

a curtain may be stretched and which easily accommodates a cast of 15 to 25 persons. The outfit, which can be efficiently handled by one man, is fully equipped with footlights, border lights, motion-picture screen, piano, and other necessities of the theater. Since the introduction of the innovation, thousands of spectators have crowded the parks nightly, to witness the performance of plays by children.

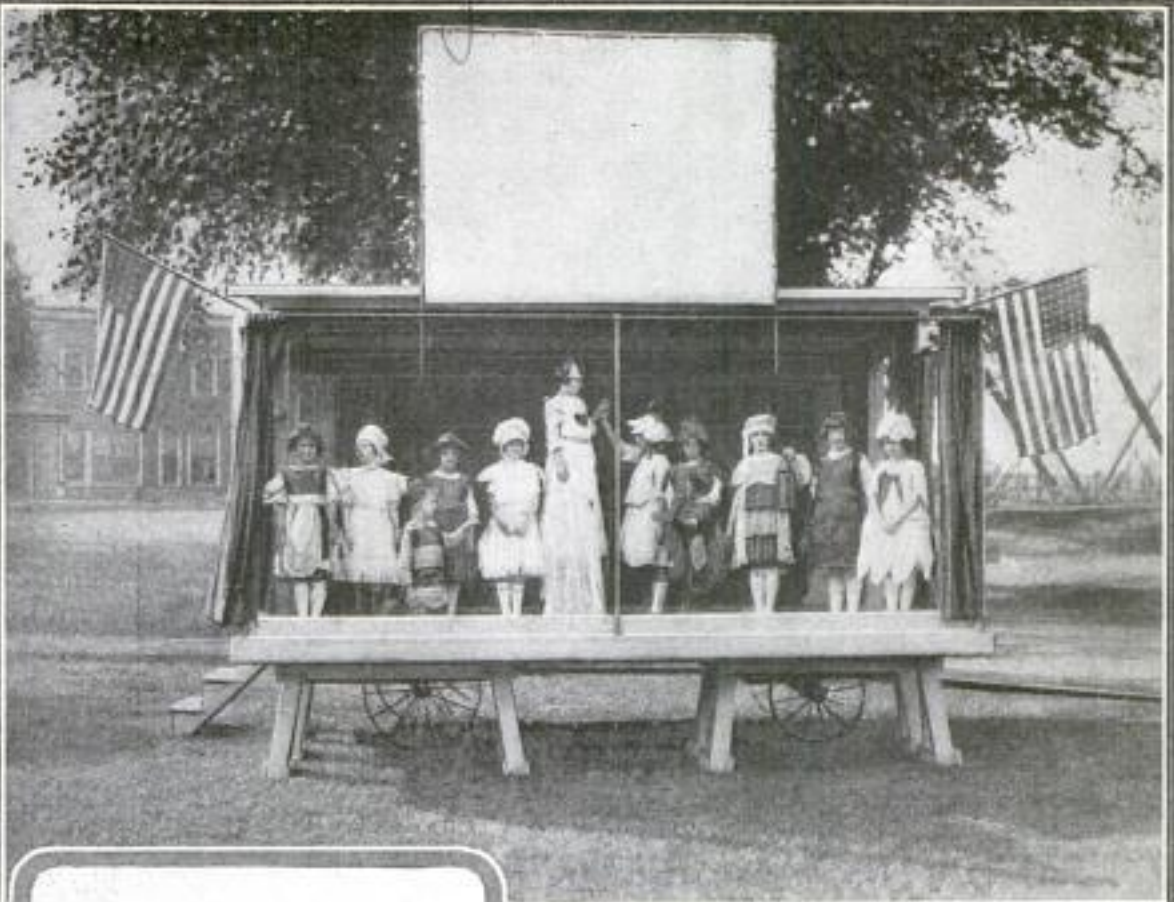

Above is Seen the Portable Theater of Elmira, New York, with Curtain Drawn Back and Cast Assembled at One of the Performances. Note the Picture Screen

At the Right is Shown the Manner of Lowering One Side of the Outfit by Means of a Lever Arrangement, the Lowered Side Forming the Stage

Below, at the Left, the Theater is Shown with the Curtain Drawn around the Stage, While the Players Make Up and Don Their Costumes

At the Lower Right is Seen the Theater Entirely Closed Up and Ready to be Hauled to Another Playground

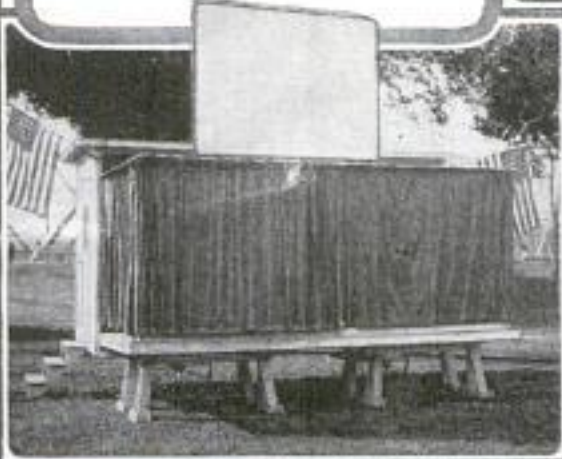
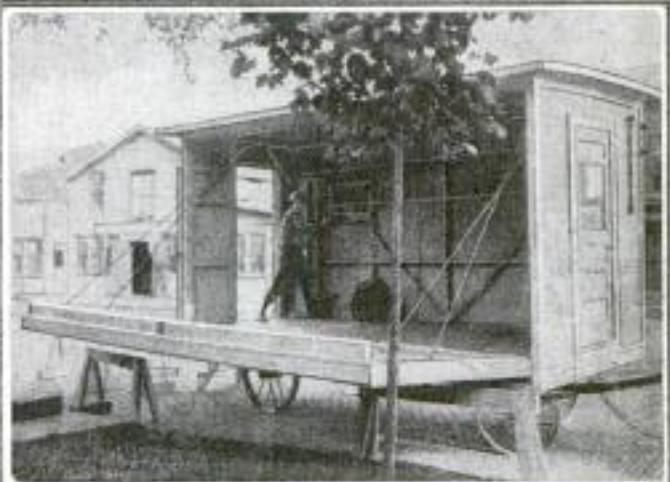

Built by Elum. Cooper Corporation Elmira, N.Y.

23 ⁷
**COPPER PIPES AS CONDUCTORS
 FOR ELECTRIC FURNACES**

An improvement in electric-furnace practice, for the making of refined steel

and alloy metals, is the substitution of copper pipes for the ordinary type of solid or built-up copper busbars used to conduct the electric current to the electrodes of the furnace.

At a plant where this has been done, the construction has not only been simplified, but there has been an increase in efficiency of the Heroult type of furnace used for melting and refining monel metal. The hollow circular section has an electrical advantage in conducting alternating current, and, in addition, the pipes are used to circulate water to cool the electrode holders. The cooling effect on the copper conductors is especially important where they have to be carried over a hot furnace, and in this case only one-third as much copper was required as when using busbars of older types.

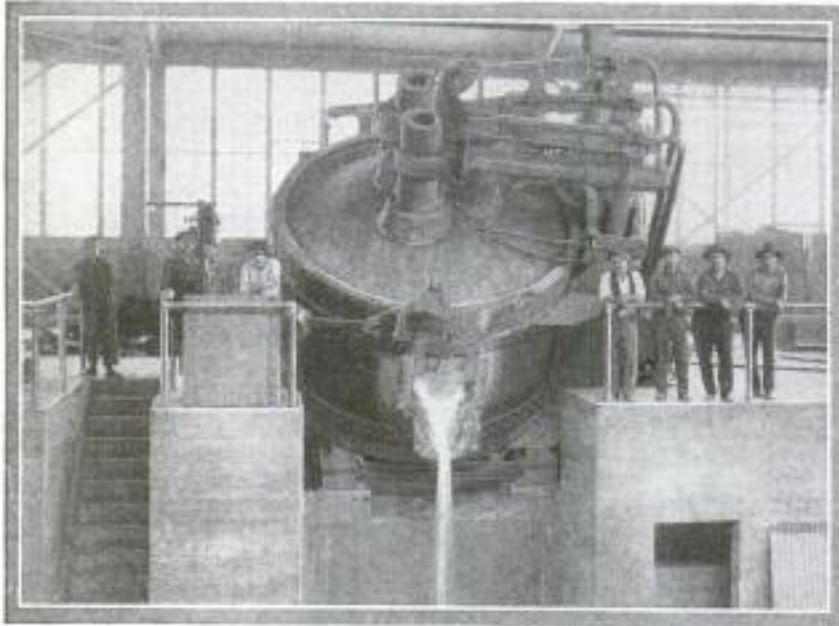

A Seven-Ton Electric Furnace, of the Heroult Type, Shown Tilted to the Pouring Position: This Furnace is Fitted with Copper-Pipe Conductors and is Used for Refining Monel Metal

22 ²²
KIDDIES PLAY ALL DAY IN REAL TROLLEY CARS

"Play as You Enter" is the welcome sign on the sides of the "Jollytown" trolley

has set aside several cars for the children to play in. The cars are complete in every detail except that the power is turned off and they are anchored to the ground, to prevent the more venturesome kiddies from attempting to explore the busy down-town districts in them.

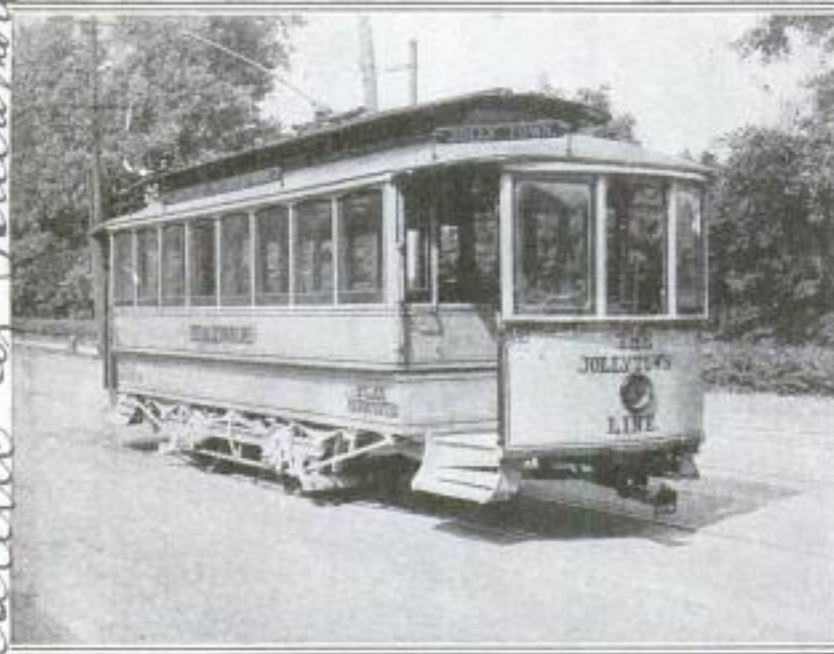

One of the Extremely Popular "Play Cars" Which have been Set Aside for the Kiddies to Play In, Showing the Welcome Signs and the Completeness in Detail of the Cars, Even to the Trolley

ley cars in Baltimore, near one of the city parks, where the traction company

of the "play cars" as the crews take them along fancied routes.

Owned by United Railway & Electric Co. Baltimore, Md.

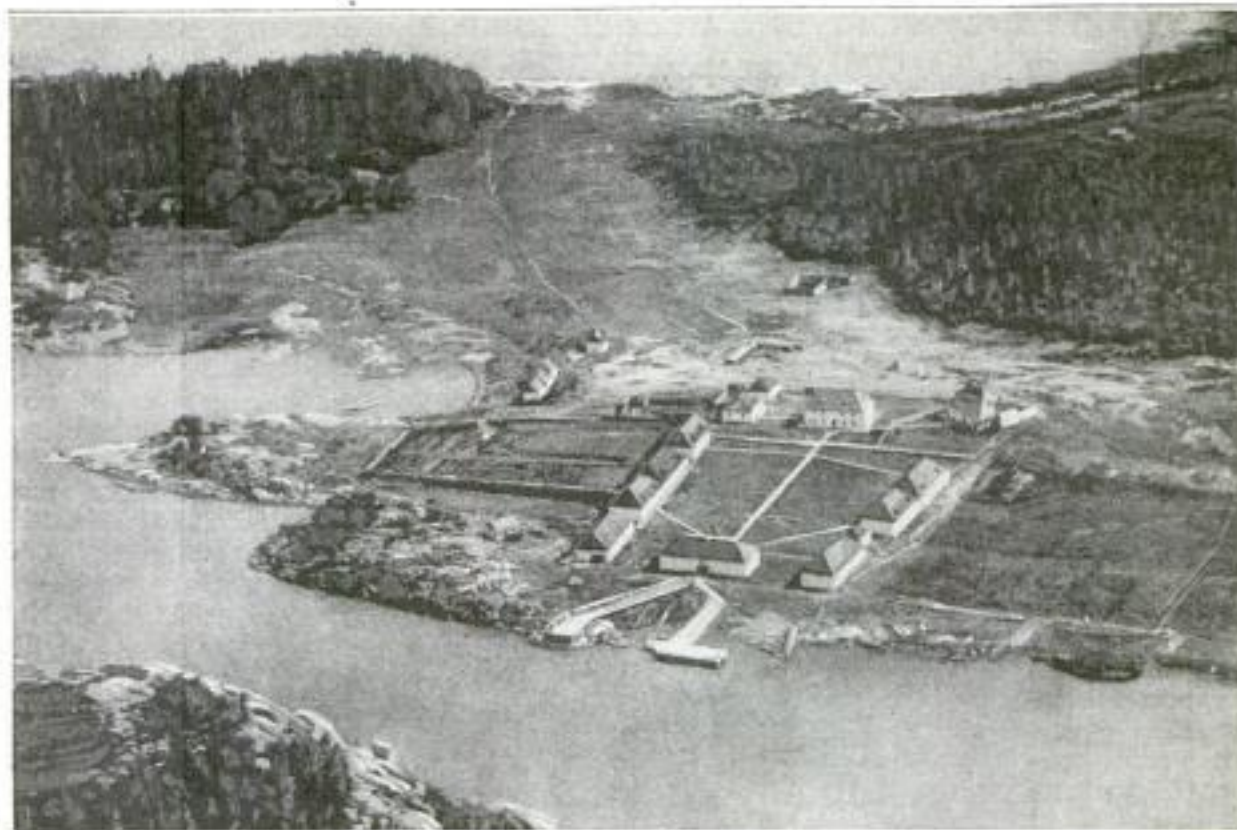

A View of Norway House, a Famous Trading Post of the Hudson's Bay Company in the Early Days of the Canadian Northwest, as It Appears Today after being Converted into an Airplane-Service Station by the Dominion Government

FAMOUS TRADING POST NOW AIRPLANE STATION

The advance of civilization in the wilds of Canada is strikingly shown by the establishment of an official air-service station at Norway House, one of the famous posts of the Hudson's Bay Company at the northernmost tip of Lake Winnipeg. The forest-patrol work that is being done from this station is of the greatest value in protecting millions of dollars' worth of the choicest timber from fire. The old trading post has taken on new life and importance since the coming of the bird-men.

Norway House was for over 100 years one of the great transfer points of the Hudson's Bay Company. It is situated on the shore of Playgreen Lake, a body of water formed by the expansion of the Nelson River just after it has left Lake Winnipeg on its way to Hudson Bay. It is roughly in the center of a large triangle, of which the angles are York Factory on Hudson Bay, Winnipeg (Fort Garry), and Edmonton. It is, in round figures, 500 miles from Hudson Bay, 300 miles from Fort Garry, and 550 miles from Edmonton. From Norway House the Nelson and Hayes rivers run northeasterly to Hudson Bay, the great Saskatchewan River gives access across the northern

line of prairies to the foothills of the Rocky Mountains, and Lake Winnipeg and the Red River make a highway to Fort Garry and the Pembina country.

The old post was thus at the main crossroads of the whole of middle Canada, and the wealth and commerce of this wonderful region passed annually through its gates. In the days when the goods for the Hudson's Bay Company's trade came in through York Factory, at the mouth of the Nelson River, it was not the custom to send the fleets of York boats (big freight skiffs, 40 feet long) from York Factory clear through to Edmonton. Instead, the vessels from the sea went as far as Norway House, where they met the fleets from Edmonton and Fort Garry. The traders from the South and West turned over their bales of furs to the men from the seacoast and returned to the Saskatchewan and Assiniboine trading posts with manufactured goods from Great Britain.

At such times all trails seemed to lead to Norway House, and now, when the big planes are skimming over the unbroken leagues of dark forests, their pilots are always eager for a glimpse of the familiar outlines of the old fort buildings.

Hudson Bay Company
Lake Winnipeg, Canada

Littell McChung, Florence, Ala.

WILSON DAM

World's Largest River Barrier Is Main Engineering Feature
of 1,000,000-Horsepower Muscle Shoals Power
Project on the Tennessee River

154

BY R. C. FOLGER

THERE has recently been considerable agitation to resume construction of the Wilson Dam, across the lower reaches of Muscle Shoals of the Tennessee River in Alabama, and it is felt in many quarters that, unless Congress accepts one of the offers now pending, the work should continue with government forces or under its supervision, until final disposition is made of the properties.

When completed, Wilson Dam will represent the largest river barrier ever built, making possible the world's greatest power-generating plant at an estimated total cost of over \$40,000,000. With 1,200,000 cubic yards of masonry, the dam will be nearly three times the size of Roosevelt Dam in Arizona, twice as large as the Keokuk Dam across the Mississippi, and will exceed the world-famed Assuan Dam in Egypt by almost 100,000 cubic yards.

Slightly more than 100 feet wide at the base, it will rise to a height of 100 feet, and will be 4,500 feet long. The water impounded by the dam will form a pond 1 to 3 miles wide and 15 miles long, submerging the much-talked-about Muscle Shoals, and will necessitate the clearing of 10,000 acres of timber land. There will be two electrically operated lock chambers at the north end of the dam, each having a lift of slightly more than 45 feet. The power house, forming an integral part of the south end of the dam, will be 1,184 feet long and house 18 gen-

erating units with a total capacity of 625,000 horsepower, which will require a high dam at the headwaters of the river in eastern Tennessee, to create an immense storage reservoir from which to regulate the flow of water through the river. Plans for the complete development of the power possibilities, providing for another dam at a site 15 miles above the Wilson Dam, will add 250,000 horsepower, and

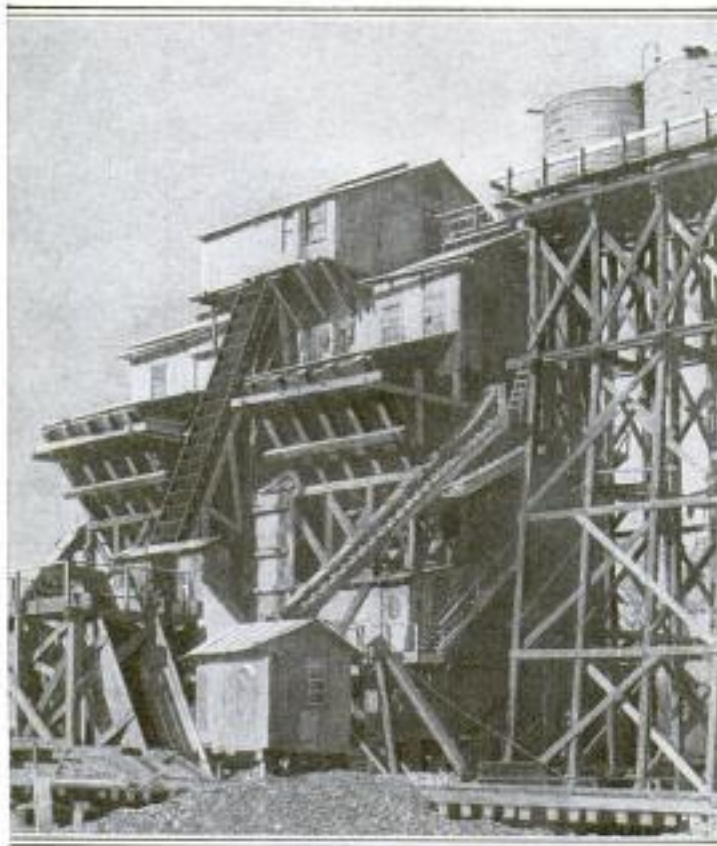

This Large Crushing and Screening Plant, for the Preparation of Stone Aggregate Used in Concrete for the Wilson Dam, is Conveniently Located on an Island in the Middle of the Tennessee River

other smaller dams still farther upstream will bring the total up to 1,000,000 horsepower. A 25,000-horsepower steam plant supplies power for all the construction machinery, and will later serve as an auxiliary to the water-power stations.

An interesting feature of the plans is the beautiful concrete bridge, spanning the entire length of the dam, that will mark the intersection of the Robert E. Lee and Jackson highways, and form a connecting link in

both of these great transcontinental roads. The economic significance of the project lies not only in the abundance of cheap power it will afford, but in its situation in the midst of one of the richest ore belts in the world, which will permit the manufactured products from the iron ores of Alabama and Tennessee, the phosphate and dolomite deposits of Tennessee, and the potash shales of Georgia to be transported over one of the longest inland watercourses in the world.

Begun during the late war for the purpose of supplying nitrates used in the

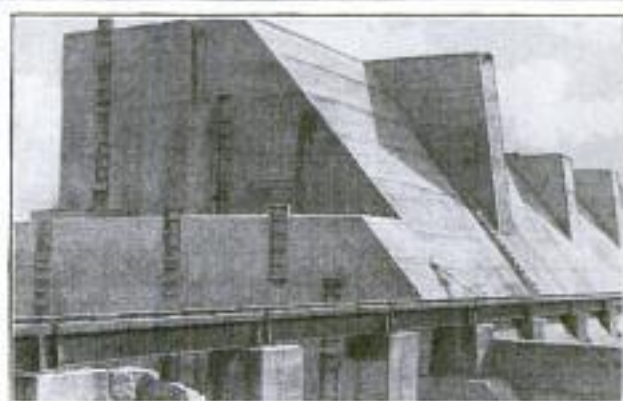
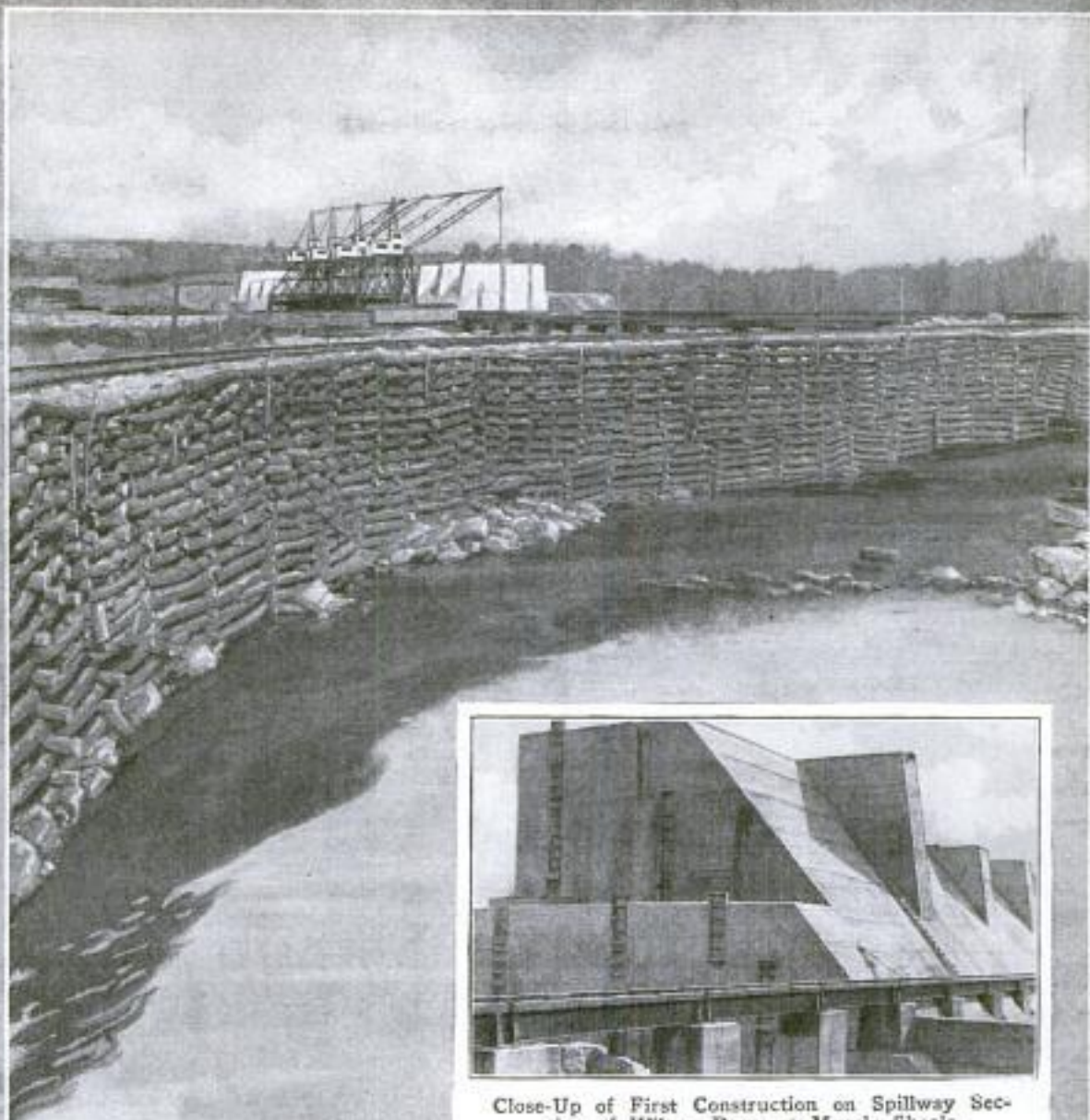

Close-Up of First Construction on Spillway Section of Wilson Dam, at Muscle Shoals Power Development

Building Spillway Section of Wilson Dam, across Jackson Island in the Middle of the Tennessee River



Bluffs on South Bank: Arrow Indicates Where the Lee and Jackson Highways will Cross Dam

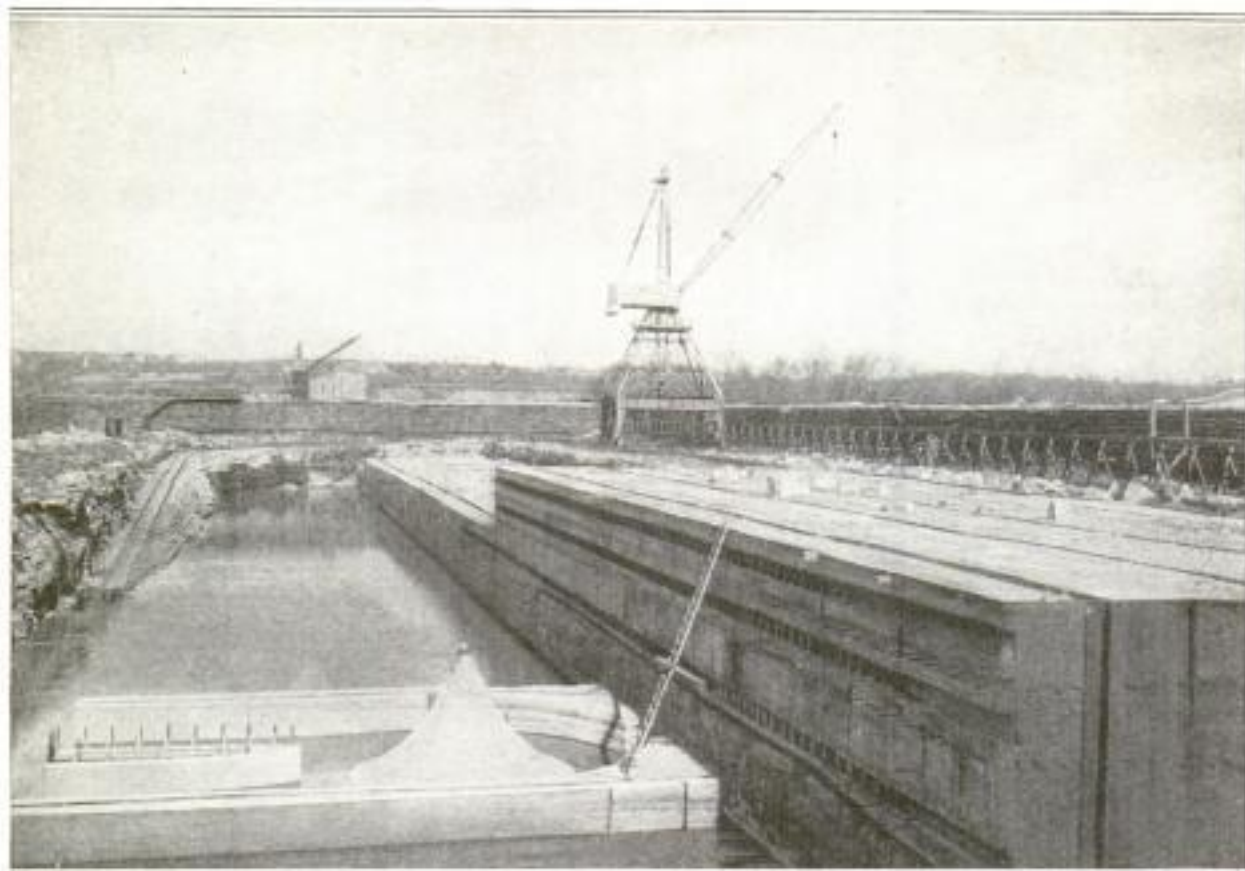

View Showing the 12-Acre Cofferdam, the Concrete and Limestone Foundation of the Power House, and, in the Foreground, One of the Water-Turbine Foundations for the Muscle Shoals Power Project

manufacture of high explosives, this enormous enterprise will be available for the future service of the country in time

of necessity, and its strategic inland location greatly enhances its value from the standpoint of national defense.

Auto Access

MOTOR CARS NOW HEATED BY HOT WATER

Heating the interiors of motor cars with hot-water radiators connected in the

circulating system of the engine, is the principle of a lately developed arrangement. The heaters are made in seamless-steel cylinder-footrail types, or in rectangular shapes, which are placed flush

with the floor in any part of the car. An intake valve, which may be controlled from the dashboard, regulates the flow of water to the heater and consequently its temperature. The innovation can be easily installed in any machine; there is no operating cost, merely an extra gallon and a half of water being required in the circulating system, and no odor of any kind is possible, as is not infrequently the case with heaters that make use of the hot exhaust gases from the engine.

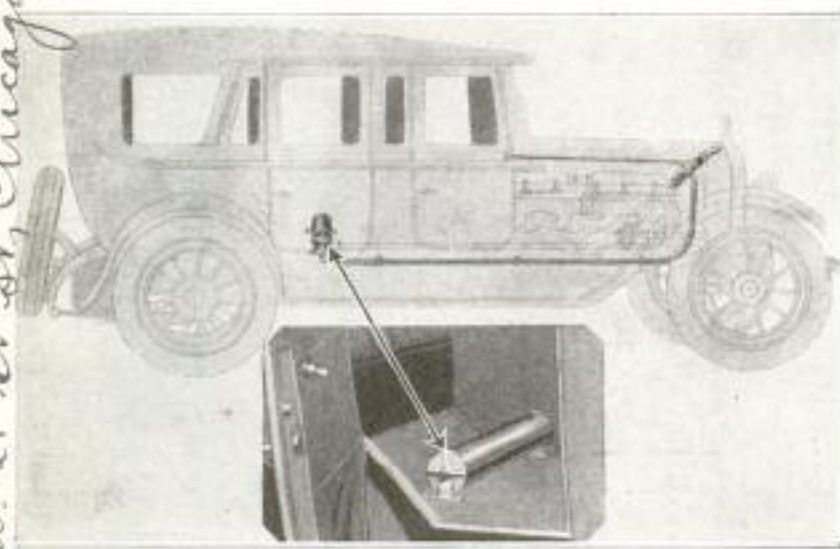

At the Top Is a Phantom View of a Motor Car with the Hot-Water-Heater System Installed, While at the Bottom a Close-Up of the Radiator is Seen

*American Water Heater Corp.
2838 W. 21st St. Chicago 169*

**COLLEGE NEAR ARCTIC CIRCLE
OPENED BY ALASKA**

Seventy miles from the Arctic circle, at Fairbanks, Alaska, has been opened a college with courses in mining, agriculture, home economics, civil and electrical engineering, general science, and commercial work. The college, probably the farthest north of any in the world, was founded with an appropriation of \$60,000 from the territorial legislature, while the Federal government will aid in supporting the institution by an annual subvention of \$50,000. About 100 students are registered.

**RADIATOR ATTACHMENT BLOWS
WHISTLE WHEN OVERHEATED**

A new automobile-radiator attachment helps to keep the water cool, and also acts as an alarm when the water becomes overheated. Attached to the radiator cap, a small closed cylinder, with a hollow wall that acts as a cooling chamber, contains a flat piston that is raised by the air pressure resulting from the overheated water. The top of the small cylinder is

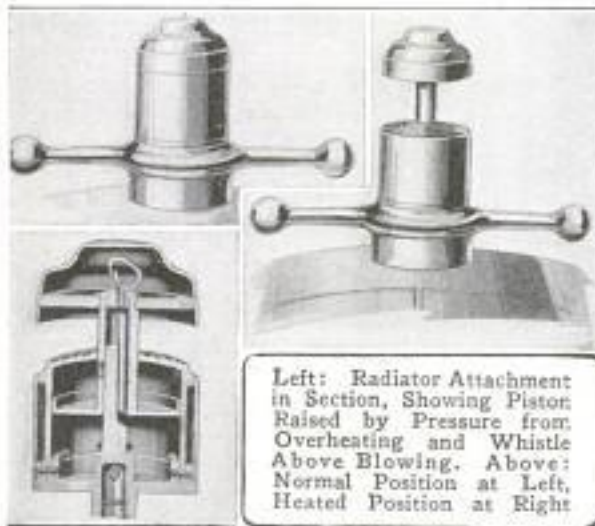

Left: Radiator Attachment in Section, Showing Piston Raised by Pressure from Overheating and Whistle Above Blowing. Above: Normal Position at Left, Heated Position at Right

convex and bright red in color. Normally, this is covered by a cap connected to the piston rod which passes through the top of the cylinder. On top of the piston rod and under the cap is a whistle. As the pressure enters the cylinder through ports below the piston, this is raised high enough to expose the red danger signal; then as the pressure increases, the whistle is blown, and finally, when the water actually boils, the piston is raised high enough to allow the steam to escape through a port located in the hollow piston rod.

*Alert Alarm Co.
609 N. La Salle
Chicago.*

**HANDY DEVICE FOR TURNING
LEAVES OF SHEET MUSIC**

For turning the leaves of sheet music quickly when on the stand, a device has been placed on the market in England



Device for Turning Over the Leaves of Sheet Music on a Piano or Other Music Stand: It is Operated with the Fingers and Thumb in the Manner Shown

that is somewhat similar to several in this country, though said to be exceptionally simple. This leaf turner is operated by pressure of the fingers of one hand aided by holding the thumb against a small lug by the side of the lever.

**RUBBER AND FRICTION TAPE
COMBINED IN ONE ROLL**

Electrical workers, when wrapping a newly made joint, can apply both rubber and friction tape from the same roll and at the same time, if a recently introduced insulating tape is used. The product comes in the usual half-pound rolls, 3/4 inch in width, averages approximately 85 feet to the pound, and is covered with tinfoil. Advantages of the use of the article are, that the workman saves time by applying both kinds of tape at one operation, plenty of insulating rubber is assured on every joint, and only one kind of tape need be carried in stock.



Combination Roll of Rubber and Friction Tape Which Enables Electrical Workers to Apply Both at Once

*From A. S. Hurler's Rubber Co. Atlanta, Ga.
269 Delafield Ave.
Atlanta, Ga.*

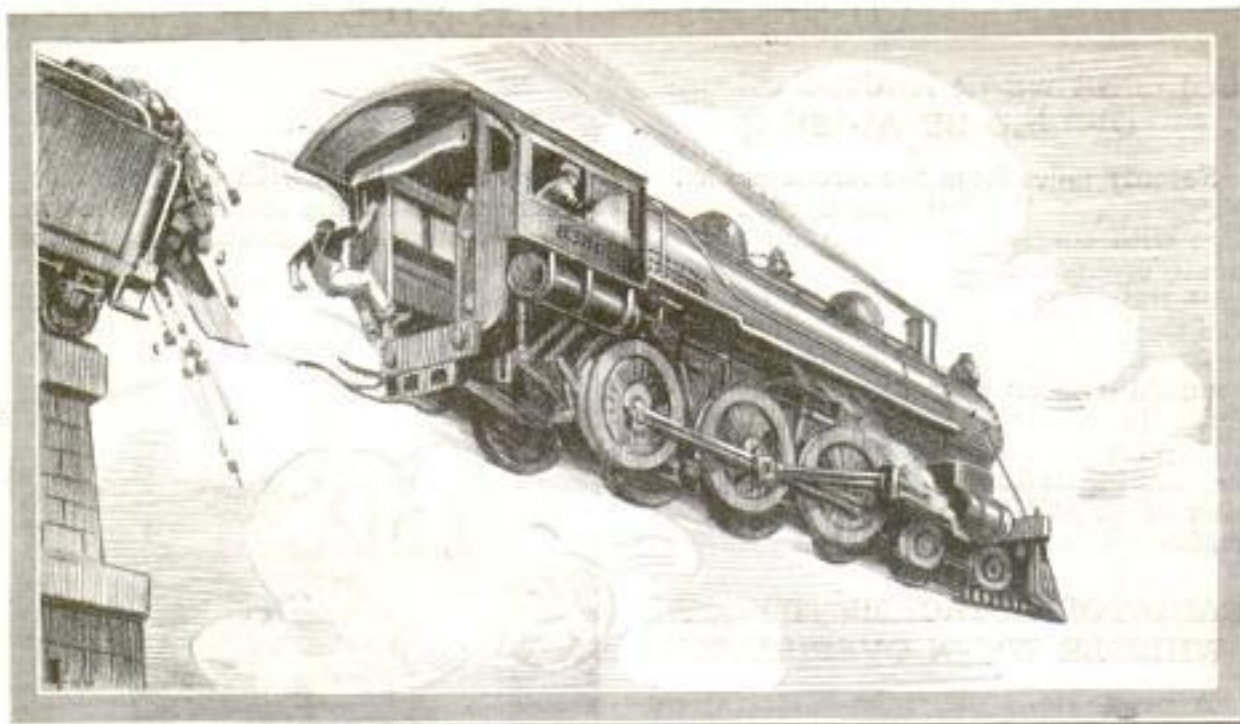

9744

HOW FAR CAN A LOCOMOTIVE JUMP ?

By FRANCIS W. WILSON

LOOK over a locomotive as it stands puffing in a train shed, and you regard its impressive bulk with a certain degree of awe. You cannot imagine this huge steel monster jumping at all. You would say that it couldn't jump. Imagine its solid supporting track removed, and you would predict that gravity would claim its own, regardless of the speed at which it might be traveling.

Stand close to the track as the same locomotive rushes past at 60 miles an hour, and you get another, and quite different impression—that of irresistible force, propelled at a speed which would hurl it across a sheer open space like a shell fired from a powerful gun. And then you change your opinion. Yes, you conclude, that, vast though its weight and clumsy its proportions, it might leap across a measurable span with rather a flat trajectory.

Your last impression is correct. A mathematician could tell you with reasonable accuracy just what might be expected if a locomotive of known weight, traveling at a given speed, arrived at a trackless open space. But more impressive are the known performances.

The bridge engineer of a certain railway showed me, some years ago, a photograph of a locomotive taken just after it had leaped across a 28-foot opening. The big drivewheels rested securely on the

cross-ties after jumping the span left vacant by an opened drawbridge.

The locomotive had been at the head of a fast freight previous to the accident. It was down-grade to the bridge, and the draw was open. It was impossible to stop. The train plunged ahead, and the locomotive reached the opposite side of the channel and alighted right side up and undamaged. The tender fell into the opening, and cars piled up in a heap between the two abutments.

I asked for a copy of the photograph, but was politely refused. Railroads do not care to advertise their accidents—naturally.

Of a different kind but equally strange was a mishap which occurred on an eastern railway. A long freight was coming off a steep grade when something caught the truck of a car near the center of the train. Almost instantly this car fell to one side and tumbled down the embankment. At the same time the car following was wrenched free and thrown clear, on the opposite side of the track. Then, as if to put the finishing touch on this odd performance, the rest of the train eased down and coupled onto the forepart of the train.

An engineer in the maintenance-of-way department of a mid-west railway told me the following story, which I afterward verified, for it was difficult to believe.

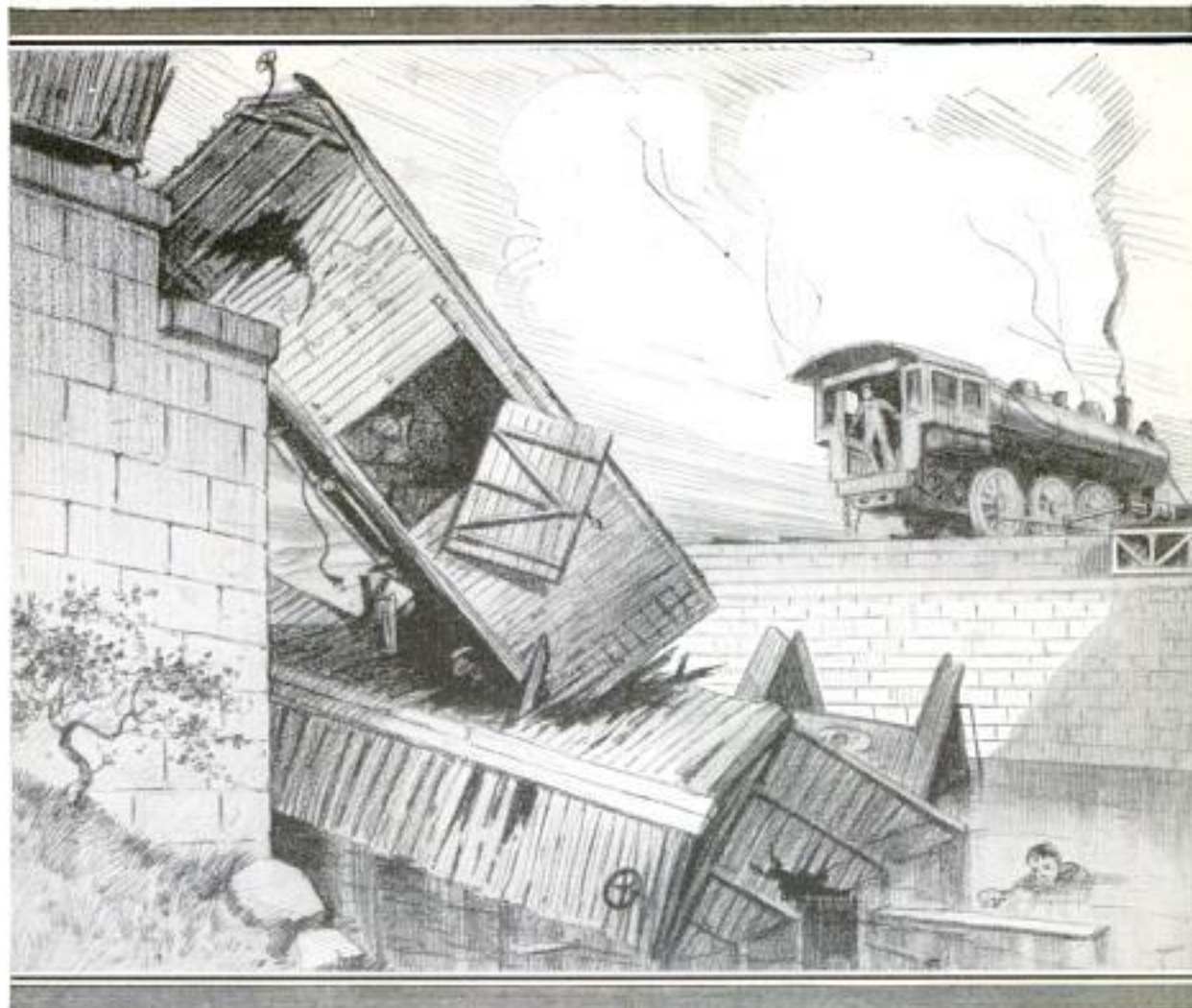

"The locomotive reached the opposite side of the channel and alighted right side up and undamaged. The cars piled up in a heap between the two abutments."

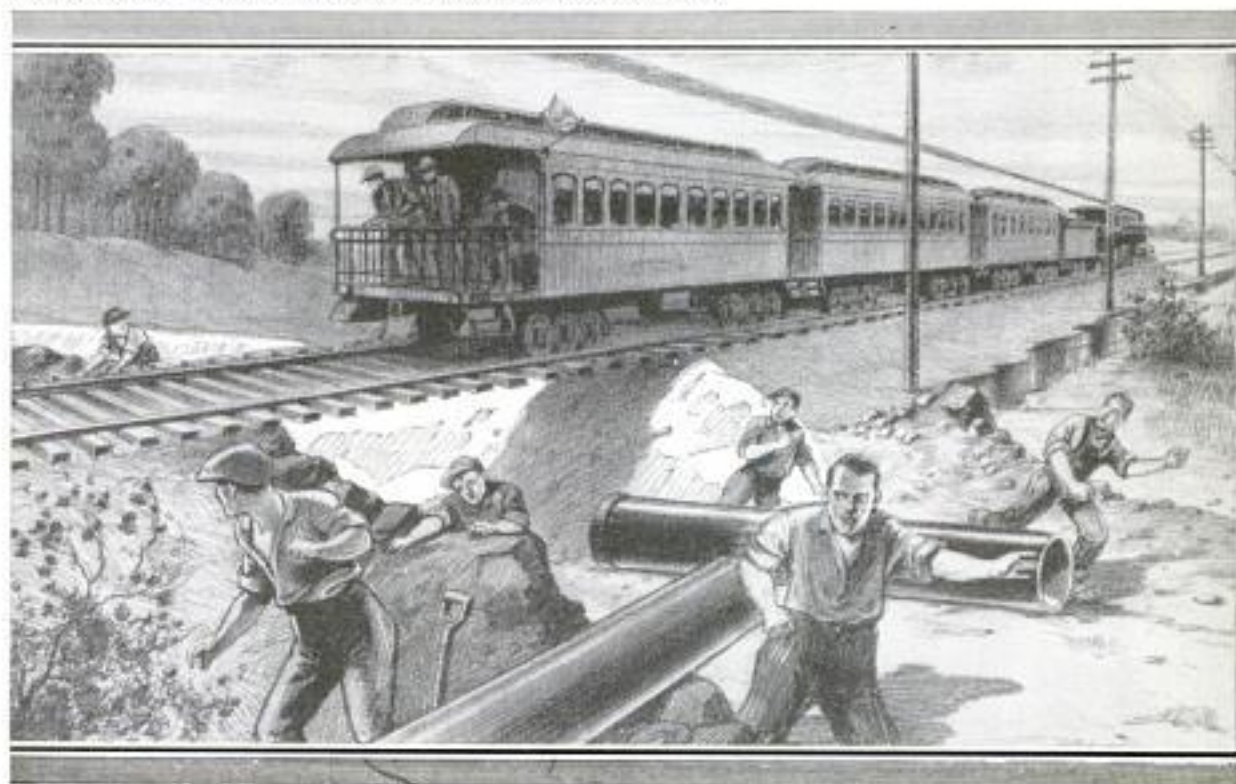

"At this stage 15 feet of steel rails spanned the opening. From them the cross-ties hung by the spikes. Underneath the ties there was nothing but air. There came the rumble of an approaching train. The red flag had blown down."

A small stone culvert was to be replaced by an iron pipe. There was a sufficient interval between regular trains to complete the work. Red flags were posted at the prescribed distances in both directions. A gang of workmen excavated the small fill over the culvert and removed the stone.

At this stage of the work, 15 feet of the steel rails only spanned the opening. From them the crossties hung by the spikes. Underneath the ties, for a height of some 6 feet, there was nothing but air.

There came the distant rumble of an approaching train. It was a "special,"

and the red flag having blown over, it came rushing on at full speed.

One and all, the workmen dropped their tools and ran headlong into the open field. The foreman ran, too, not venturing to look back, and expecting every second to hear the seemingly inevitable crash.

Finally, at a safe distance, he turned to look.

The special was fast disappearing from sight. It had crossed 15 feet of unsupported rails and continued on its way!

Not only had the locomotive jumped the space, but, to the amazement of all, three cars behind it had safely negotiated the hazardous crossing.

VANCOUVER THEATER BEATS HIGH COST OF GROUND

Ingenious use has been made of a very narrow street frontage by the builders of the new Capitol Theater at Vancouver, B. C., occupied by a motion-picture concern. Frontage on the street in this section, which is the center of the fashionable shopping district, is very high-priced, but a street at the back is a very quiet one, still given over to boarding houses and residences.

A site that was large enough for the new theater was easily obtained there, and the much-to-be-desired access from the busy main street was assured by the purchase of a narrow strip of ground only sufficient for the lofty entrance and lobby. It was necessary, however, to avoid interference with the traffic along the lane which traverses the block, and this difficulty was solved by a combination of sloping walks and stairs, which raise the approach sufficiently, by the time the lane is reached, to leave plenty of headroom underneath for any traffic likely to make use of it.

The effect obtained by this simple arrangement is very satisfactory, for as one steps inside the doors, a vista of fairyland opens out, the decorator having been given a free hand to make the most of the long corridor leading to the theater building proper. To the ordinary sights and sounds of a busy street this quiet and beautiful passage forms a pleasing contrast, and the sense of distance, so rarely obtained in city buildings, is magnified by a succession of arches and the great height of the ceiling. The effect is intensified by the clever disposition of mirrors, and by the series of beautiful candelabra which hang from the ceiling and from brackets on the walls. A short stairway of marble, the full width of the corridor, leads to the entrance of the foyer itself, which, owing to the peculiar construction, is considerably higher than would otherwise have been necessary and gives direct access to the balcony. Other stairways lead to the main auditorium floor.



From Left to Right are Shown: The Frontage of the Theater on the Back Street Where Property Is Cheap; the Front Entrance to the Theater on the Busy Main Street Where Property Is Expensive, and Part of the Approach That Spans an Intersecting Alley without Interference with the Traffic.

Emb. J. B. Holdcroft, 1485 Fort St. Victoria, B.C. Canada.

90/9

353

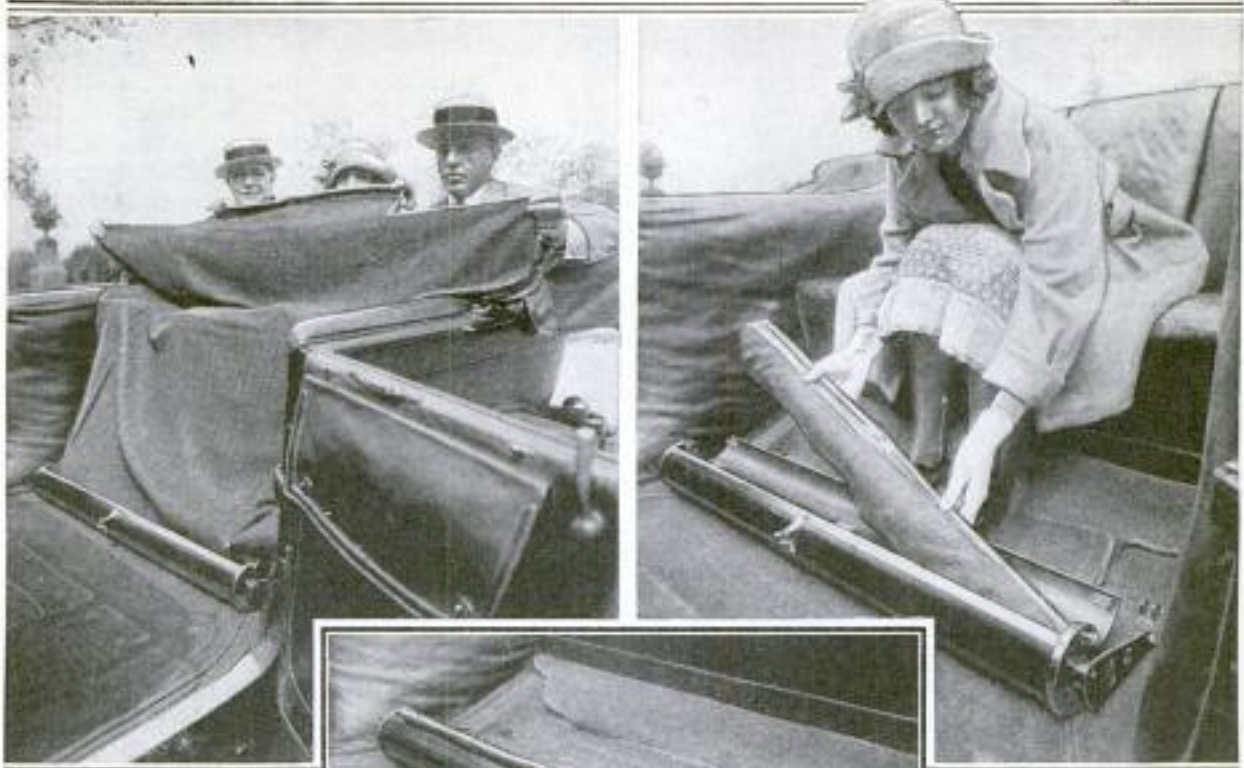

In the Illustration Above, the Robe is Shown Extended. Notice the Extra Width of the Top Section, Which Allows Ample Covering for the Passengers. These Strips Fold In When the Robe is to be Run Back into the Footrest

Above: Placing the Robe in the Footrest from Which It can be Run Back and Forth by Means of a Spring Roller. Left: The Footrest as It Looks When the Robe is Not in Use. A Brass Strip on Top Prevents Scratching

AUTOMOBILE ROBE ROLLS INTO CYLINDRICAL FOOTREST

An automobile robe, recently invented, is attached to a spring roller fastened inside a cylindrical footrest. When not wanted, the robe is easily run back into its container which is shaped like the ordinary footrest and differs only in the larger diameter of the cylinder and in its japanned finish. A heavy brass strip along the top prevents scratching. When drawn out, the top section of the robe unfolds at the sides, allowing ample covering. The cylinder, if desired, can be padlocked to prevent theft of the robe.

BLASTS OF COMPRESSED AIR REPLACE LOOM SHUTTLE

In a new type of loom the shuttle is dispensed with, and its work is done by means of compressed air. A filling-measuring device composed of chains, provided with filling pullers, works in connection with sprockets which are rotated with the loom parts. The filling, wound on large cones, passes through guide eyes in the line of travel of the filling pullers,

and sufficient filling is pulled off to make one pick. Then, by means of a cam on the sprocket wheel, the filling is released, and a blast of air from tubes located on the loom lay blows the filling between the warp shed.

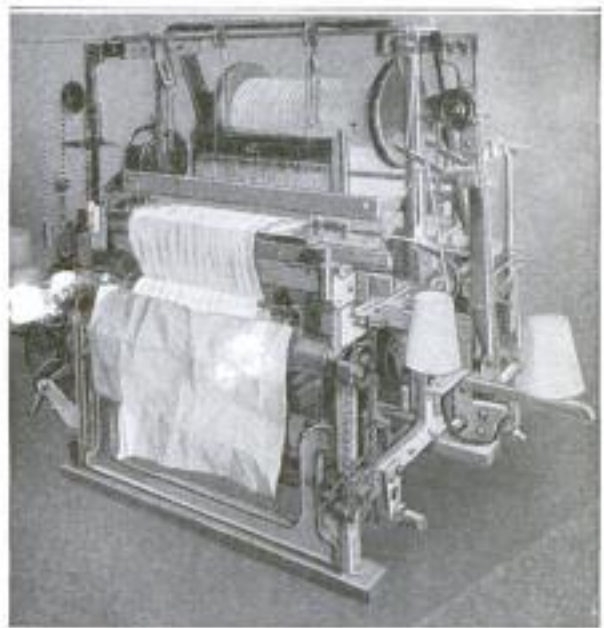

In This New Type of Loom, Blasts of Compressed Air from Tubes on the Lay Replace the Shuttle

Inv. John C. Brooks
425 Grand St.
Paterson N.J.

201 SMALL DRILL AND MARKER FOR GARDEN USE



Two Sizes of Garden-Seed Drill, and Three Views of Small Hopper



A foreign implement manufacturer is offering to horticulturists a small drill and marker intended to serve them as the larger seed drill serves the grain farmer. On top is a seed hopper with an opening in the bottom through which the seed is fed out by a revolving shaft having the supporting and marker wheels on its extremities. An adjustable slide regulates the quantity of seed fed into the small trench made by a projection from the body. The trench is afterward covered by means of a hand scraper. The seeder is made in two sizes, one for home gardens, and a larger one for market gardeners. The object is to speed up the planting and secure an even distribution of the seeds.

MOTOR FOR LOW WATER HEAD WITH SWIFT CURRENT



Side View of Motor for Use with Low Water Heads and Swift Currents: The End of the Water Flume Is at Extreme Right

of pairs of buckets, shaped so that the open sides of the buckets face each other in one pair, and in the next pair, are turned away from each other. The rapidly running stream of water strikes the first pair with the full force of its momentum, and is conducted without obstruction

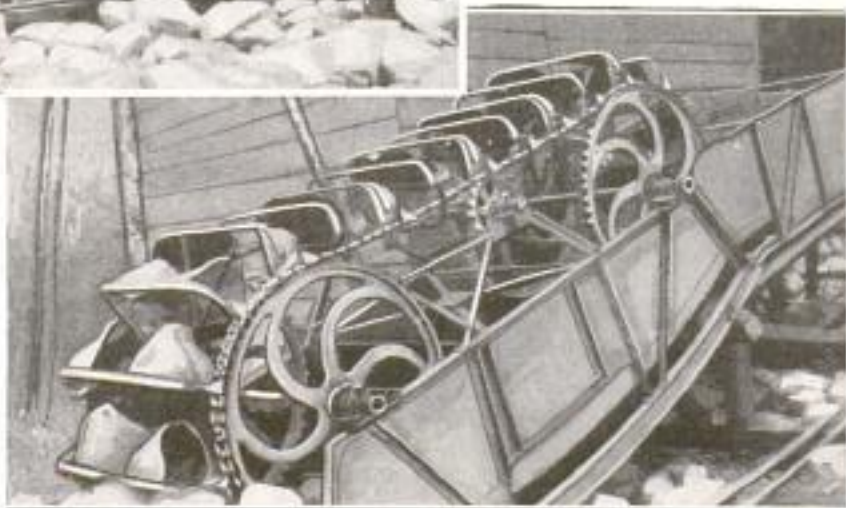

Front View of the Motor, Showing How the Open Sides of Alternate Pairs of Buckets are Turned in Opposite Directions

A hydraulic motor, specially adapted for use where the water head is low but the current swift, has been constructed in British Columbia. Mounted in bearings on the sides of a water-tight metal extension of the flume that conducts the water to the motor are two large sprocket wheels driven by a chain. Later-

tion to the next pair, and so on alternately to the end of the machine.

Ans. John S. Johnson, P. O. Vancouver,
 Collingwood B.C., Canada

Emb. Henry Copeland, 106
 Swift St. Vancouver,
 Canada

355

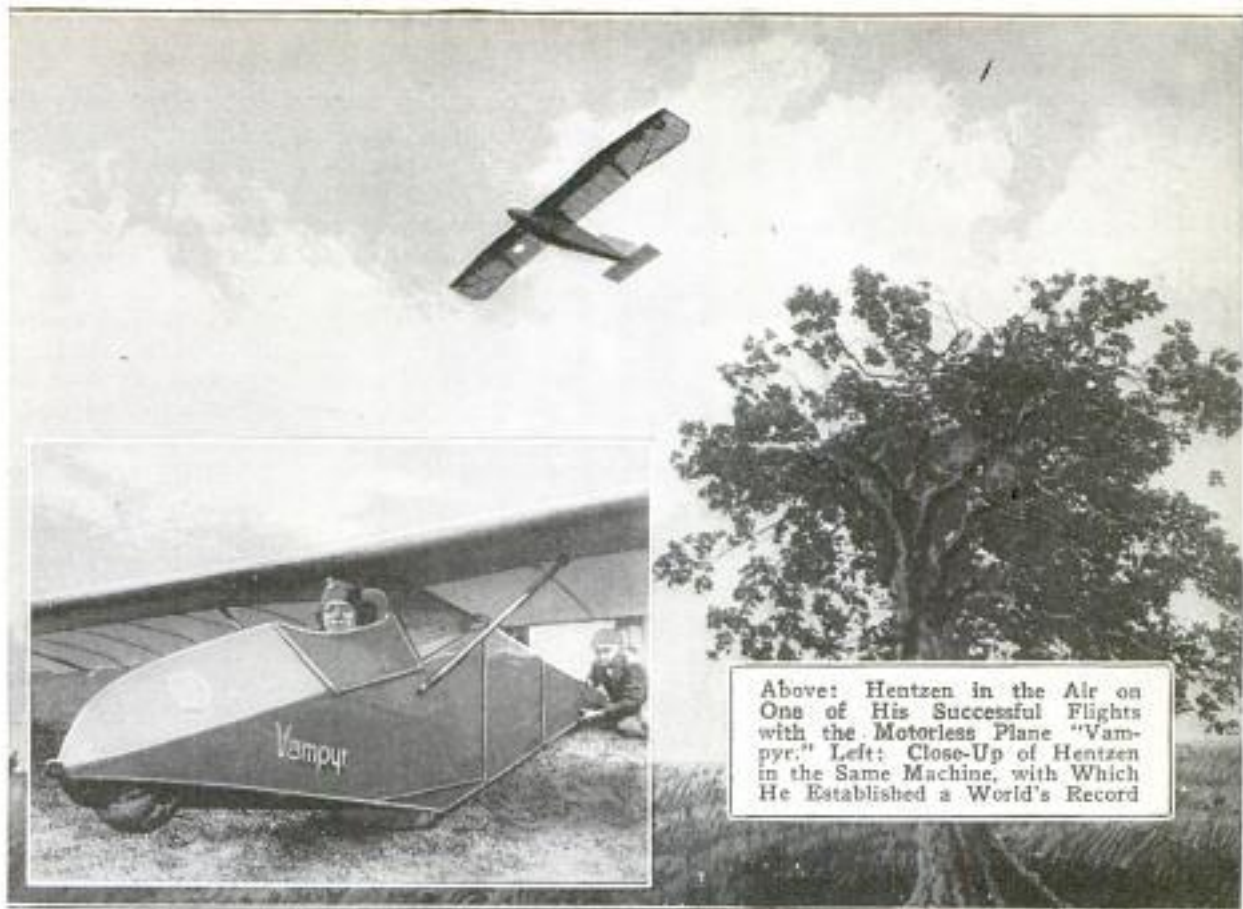

Above: Hentzen in the Air on One of His Successful Flights with the Motorless Plane "Vampyr." Left: Close-Up of Hentzen in the Same Machine, with Which He Established a World's Record

Aeroplanes

GLIDERS AND SOARING FLIGHT

434

BY R. C. FOLGER

THE world's duration record for gliders—or sailplanes as they are more properly called—was established on August 24 at the German soaring and gliding meet held in the Rhoen hills, when pilot Hentzen, flying the sailplane "Vampyr," cruised about for 3 hours 7 minutes and landed some 1,000 feet above his starting point in apparent defiance of the law of gravitation. This performance equals Wilbur Wright's first public flights in Europe in December, 1908, when he made all previous flights appear insignificant by remaining in the air for 2 hours 20 minutes with his motor-driven machine.

However, the recent achievements in motorless flight, among the most notable of which is that of the Dutch airplane expert Fokker, who stayed aloft with a passenger for nearly 15 minutes, should not be looked upon as anything that will have a tendency to displace or even to any great extent supplement the motor-driven planes, but only as a means of making heavier-than-air machines more efficient. Although some see the possibility of sailplanes taking off from the cliffs of Dover and with a favorable wind flying across the English Channel to the shores of France, the ability of the gliders to

keep in the air is so dependent upon suitable wind conditions as to minimize the practical value of soaring in most countries. Without intending to detract from the laurels of the daring and skilled men who are doing so much to advance the art of flying, there can be little doubt the Rhoen hills and the propitious air currents arising from the valleys of the Gersfeld flying field contributed largely to their success.

A study of the conquest of the air takes us back many centuries, and we find the ambition of man to fly manifesting itself in strange man-driven machines with which they threw themselves into the air from the top of a prominent hill or from a tower, usually with disastrous results to the individual. So it was almost down to the present day, when the real era of gliding began as men became convinced that they must learn to fly as well as build the machines. Of this there is evidence in the experiments of the great pioneers like Lilienthal, culminating in the glider trials of the Wright brothers, preliminary to their later successful work with power-driven planes. In this connection it is interesting to note that as far back as 1911, Orville Wright remained aloft in his glider for 9 minutes 54 seconds at their

private field at Kitty Hawk. The recent revival of interest in gliders and soaring flight has led to a more careful consideration of the flight of birds, by which students of flying have always been guided, and especially of those birds that are the best at soaring, like the sea gull, the buzzard, and the albatross. One of these magnificent soarers will sail through the air for a long time with wings motionless and with no apparent exertion, making use of what is often called the "internal energy" in the air. They will cant their wings to take advantage of the little puffs of wind that often carry them sharply upward, only to lose elevation a little later as the puff dies out or they lose momentum. Again flying directly into wind they are forced upward by the moving air. Sometimes, in finding a spiral current of air rising from the surface of the ground or from the sea, they will be carried almost vertically out of sight. Endowed by nature with an instinct for locating and making use of these varying puffs of wind and air currents, these birds are also equipped to utilize them efficiently, and they are provided with enough energy to propel them-

of sailplanes, it is certain he will never be able to equal the soaring birds, and then he will always be liable to sudden and unexpected descents in planes without some motive power. Some suggest that it is possible that pedal planes or planes of small power will eventually be the solution of this difficulty.

Getting them into the air is another drawback of the gliders or soaring planes. In all the trials of recent days even, it is necessary to start them off from the top of a hill, where they are projected into the air by means of some catapult device or by a number of men running rapidly down the hill and towing them by a cord until the plane has acquired enough velocity to leave the ground, much in the same manner as a kite is sent into the air. After the cord is cut, the plane continues to glide downward under the force of gravity until it gains sufficient speed to produce an upward impulse from the air impact against the properly set wings and horizontal rudder, to offset that force and maintain the plane in equilibrium. The plane may then soar around and even rise above its starting point, depending upon the efficiency of its design, the skill of the pilot, the velocity of the wind, the character of the air currents, and the height from which it started.

In most of the trials in France and Germany, this year, a catapult or huge slingshot was used to start the gliders. The glider that Hentzen flew was given its initial momentum by the use of a long rubber

band. In most of the trials in France and Germany, this year, a catapult or huge slingshot was used to start the gliders. The glider that Hentzen flew was given its initial momentum by the use of a long rubber

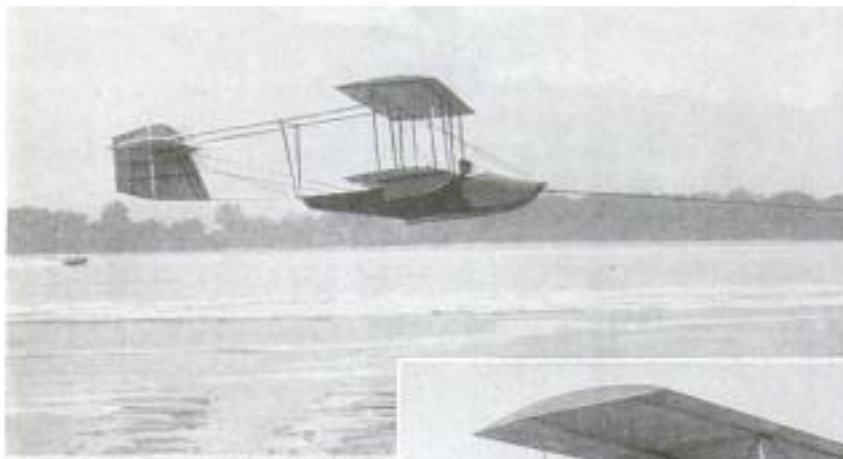
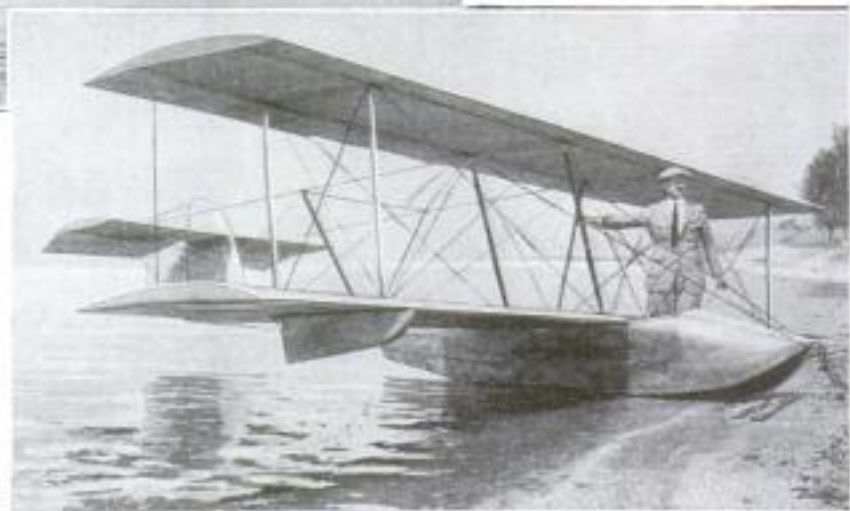
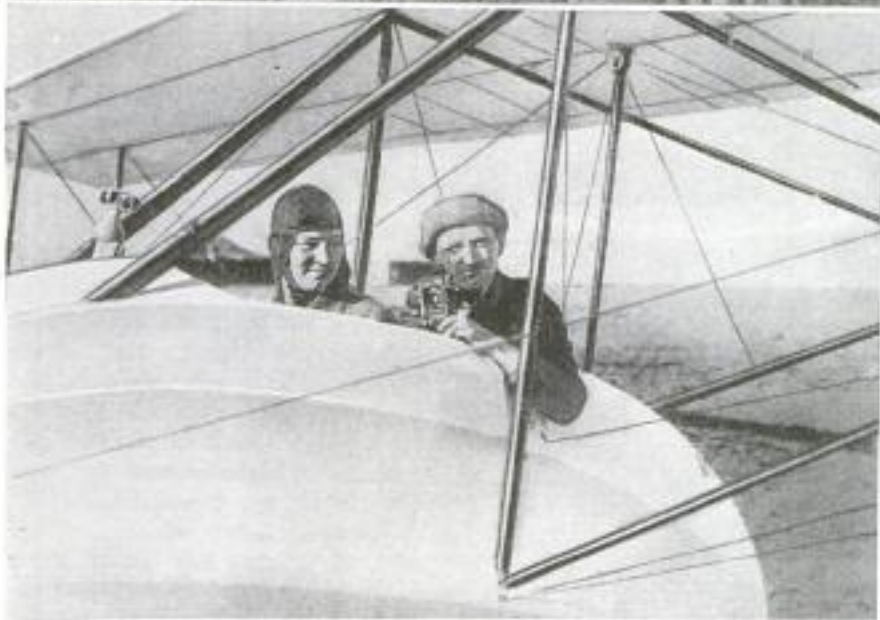
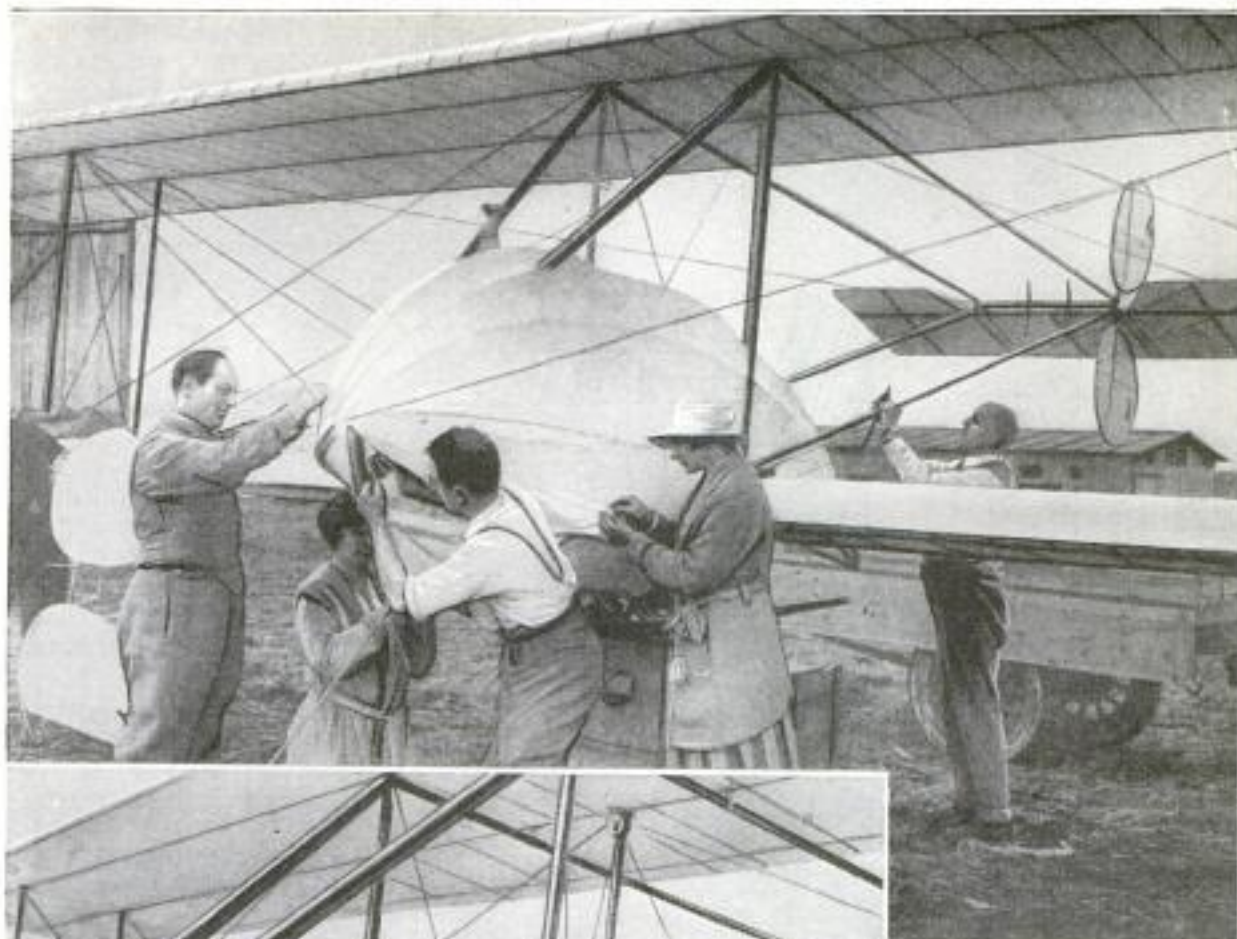

PHOTO COPYRIGHT, UNDERWOOD & UNDERWOOD
Hydro-Sailplane in Flight over Water: Note the Towline Leading to the Motorboat. It is Suggested That a Powered Airplane may Tow Several Sailplanes.

selves through the air to prevent a fall when they happen into an air pocket or when they approach the surface of the earth. With all the knowledge that man may gain of the air currents and with all his increased skill in the design and operation



Glenn H. Curtiss and the Hydro-Sailplane Which He Built at a Cost of Less than \$1,000: It is Made of Light Metal, and Weighs 140 Pounds



German Women Assisting Fokker When It became Necessary for Him to Renew the Covering on His Bi-plane Glider, Which Carried Two Persons

The Dutch Expert Fokker Seated in the Glider with Which He Made a Record Flight by Carrying a Passenger: His Assistant with the Camera Was the First to Take Photographs from a Motorless Plane

cord attached to the front of the craft by means of a large hook turned downward and open below. The plane was held steady while six men pulled the rubber cord, and when the command "start" was given, they ran against the wind, releasing the plane, which immediately rose. None of the sailplanes are heavy—varying from 80 pounds to 300 and 400 pounds—and therefore do not require much of a pull, especially when they are in the air, although they are difficult to handle on account of their awkward shape and frail structure.

costing less than \$1,000, which has been tested over Hempstead Bay, New York. In a number of attempts, in which the plane was started by towing it behind a fast motorboat, failure to rise was attributed to the dead calm that prevailed. Finally a slight breeze arose and, after being towed about a quarter of a mile at 35 miles per hour, the plane rose 12 feet above the water and remained in the air for 49 seconds after the towline was cut. Mr. Curtiss has visions of a flock of small hydro-sailplanes being towed behind the flying boat of the future.

It is of interest to Americans that the only entrants from this country in the glider contests in France and Germany this summer, were three students at the Massachusetts Institute of Technology, headed by Edmund Allen. Before leaving for France, they completed the most successful glider trials held in America

since those of the Wright brothers, 11 years ago. Handicapped in a number of ways, these young men took a plane of their own design abroad, where unfortunate accidents prevented them from bettering the very creditable showing they made in competition with the most expert fliers of the world.

HEROIC RESCUE ATTEMPT BY ARGONAUT MINERS

DESPERATE crews of "hard-rock" men and "muckers" battled in shifts for 22 days, in a futile attempt to reach comrades imprisoned nearly a mile below the surface of the earth in the Argonaut mine, at Jackson, Calif. On August 27, fire on the 3,000-foot level trapped 47 men. Rescue parties were immediately sent down but found the flames raging so fiercely that the lower levels, in which the miners were caught, could not be reached. Experienced miners grimly shook their heads.

A plan was hastily conceived, of drilling from the shaft of an adjacent mine so as to connect with the Argonaut, at a

point below the fire. Thus began the fight for human lives. To drive a tunnel from the adjacent Kennedy mine, at the 3,600 or 3,900-foot level, meant a drive of more than 300 feet through hard rock and muck. Day after day passed. The grief-stricken families of the entombed men waited anxiously while the half-stripped and sweating miners dug, blasted, and tore their way through the intervening mass of stone and mud. Finally, on September 18, a tunnel connecting the 3,600-foot level of the Kennedy mine with the 4,200-foot level of the Argonaut property was completed.

First-aid parties again advanced into

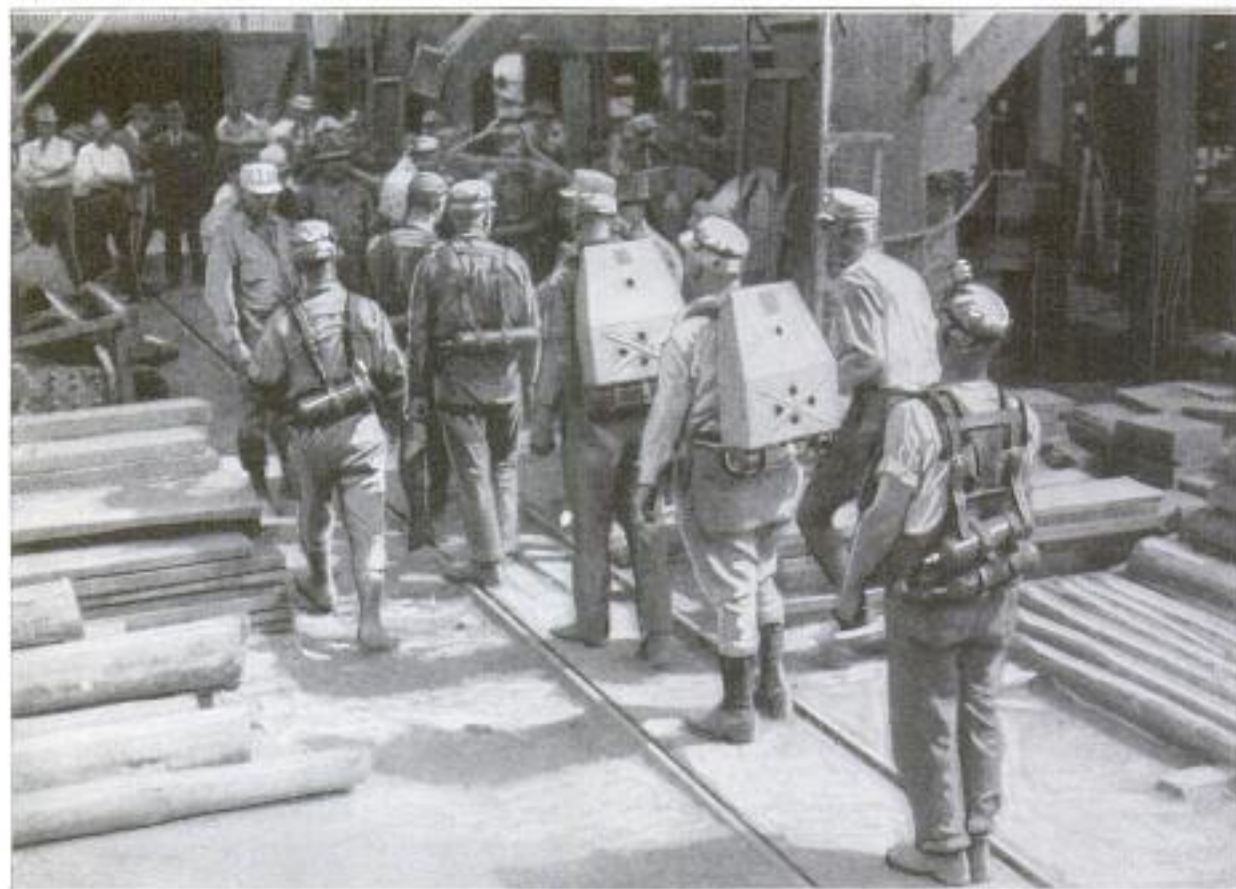

COPYRIGHT, INTERNATIONAL NEWSREEL CORP.

First-Aid Party at the Mouth of the Kennedy Shaft Preparing to Make the Descent to the Tunnel Connecting with the 4,200-Foot Level of the Argonaut Mine, for the Purpose of Exploring the Different Levels of the Ill-Fated Mine to Determine the Condition of the 47 Men Who were Trapped There by Fire. All of Them were Found Dead in the 4,350-Foot Level behind a Double Bulkhead Erected by Them

the ill-fated mine, this time below the impassable barricade caused by the fire, and, after hours of searching among the gas-filled levels, discovered a hurriedly

dead. The deadly carbon-monoxide gas had suffocated them. Although the efforts of the would-be rescuers terminated in failure, their devotion to their fellows

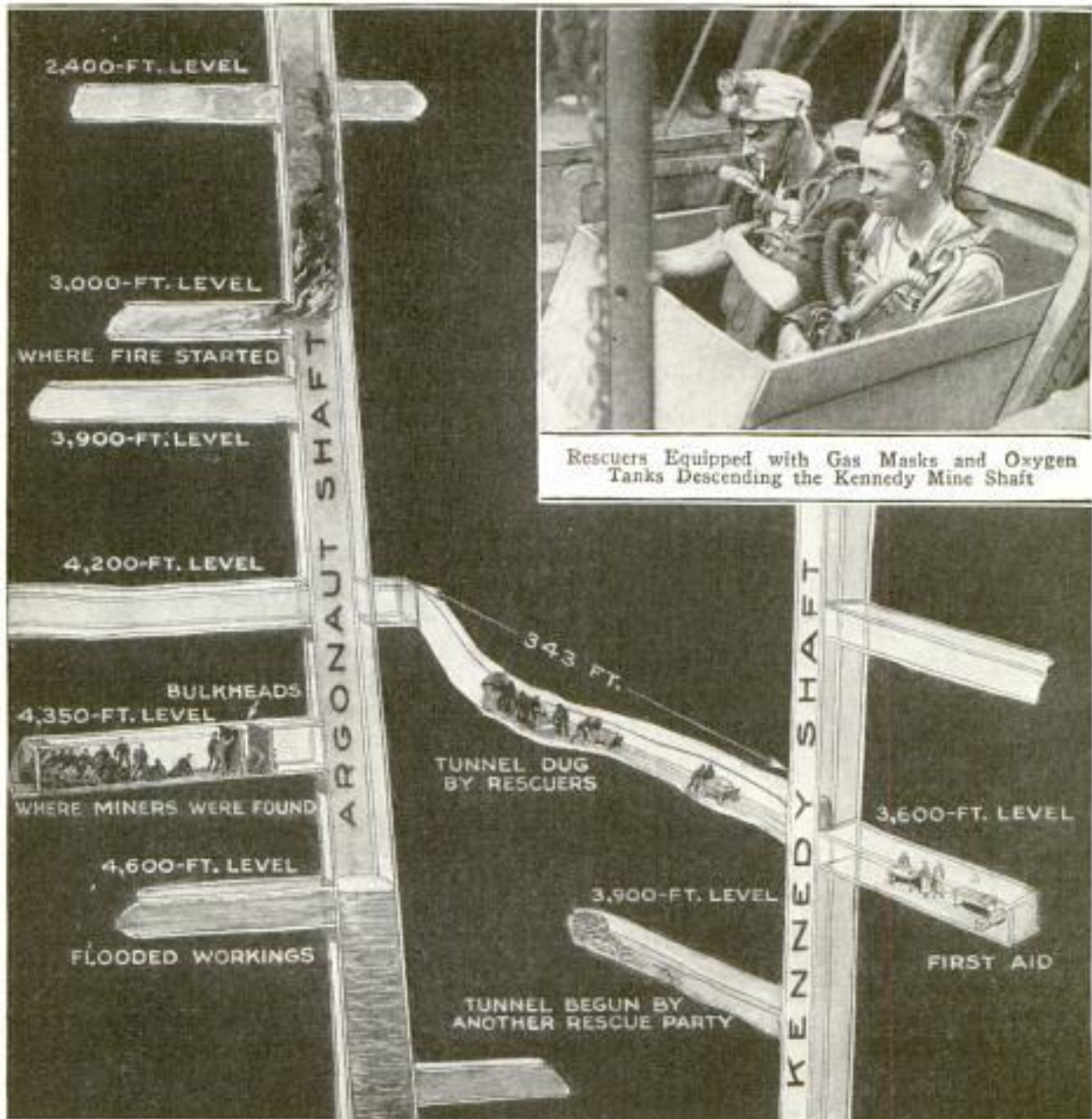

Rescuers Equipped with Gas Masks and Oxygen Tanks Descending the Kennedy Mine Shaft

Diagram of the Argonaut and Kennedy Mines, Showing Their Relative Locations: In the Argonaut is Seen the Place in Which the Fire Started on August 27 and below Which the 47 Men were Trapped. The Imprisoned Miners are Shown Building Bulkheads to Keep Out the Deadly Gas. The Rescuers are Seen Digging the Tunnel from the Kennedy Shaft in Which a First-Aid Station had been Established

erected bulkhead. This was quickly torn down. The apprehensive searchers proceeded a short distance farther and encountered a second bulkhead, the cracks in which had been stuffed with clothing torn from the trapped miners, thus giving pitiful evidence of the attempt to keep out the suffocating fumes.

This last barrier was likewise battered down and the first-aid party soon stumbled over the miners, huddled together—

and their stubborn persistence in their task remain as glorious. Mine accidents seem to occur periodically, and the toll of death sometimes reaches greater proportions than at the Argonaut; but in the display of pure heroism it called forth, no earlier disaster has ever surpassed it.

The country mourns the fate of the 47 miners, but thrills with pride at the recollection of their comrades who expended every human effort in the attempt at rescue.

NEW CONTROL IN MOTOR CARS OPERATES PNEUMATICALLY

Dispensing with the present emergency brake and gear-shift levers in any motor



The Motor-Car Control, Mounted on the Transmission Case, is Operated by the Lever with the Spherical Head at the Side of the Steering Wheel

car, the clutch, brakes, and gear shifts are controlled by means of pneumatic pressure of from 40 to 65 pounds, obtained from the motor, in a device of recent invention. The apparatus is mounted on the transmission case in place of its cover, and is operated by means of a small pivoted lever which, when moved backward 45° from the perpendicular, applies the brakes and disengages the clutch. When perpendicular,

the lever is neutral, and in this position, by turning a spherical head on top of it and handy to the driver, the transmission gears can be shifted as desired, and as indicated by pointers. To start the car in the selected speed, the lever is pushed forward to an angle of 45°. Reverse is obtained by pressing the lever down against a spring. With the new control it is impossible to strip gears, or to engage the clutch when the brakes are set. The service brake can be set independently of the emergency brake.

JUAREZ-MEXICO CITY AUTO ROUTE BEING PROMOTED

From Ciudad Juarez to Mexico City, following the right of way of the Mexican Central Railroad, is the route of a proposed automobile highway. The El Paso Automobile Club, promoter of the plan, hopes to obtain the needed funds by enlisting the aid of cities along the route, and also is confident of procuring the necessary grant from the Mexican government.

LIVE RATTLESNAKE INCLUDED IN WINDOW DISPLAY

Considerable attention was attracted, recently, to a drug company's window, in which a live rattlesnake was displayed as part of an advertisement for a snakebite remedy. To obtain as realistic an effect as possible, the cage in which the reptile was confined was provided with a painted background representing a typical desert scene. In addition, the window contained enlarged illustrations taken from an article entitled "Rattlesnake Etiquette," which appeared in the August issue of this magazine.



Window Display of Drug Company, Showing the Live Rattlesnake Confined in a Cage at the Center of the Window; The Background of the Cage was Painted to Represent a Typical Desert Scene

monarch Drug Co.; San Diego, Calif.

Rev 1067 d m d n Taylor, 96 The Auto Safety Control July 6, 63 7. main St. Wichita, Kans 143

Letter rec'd 1/20/5 7 Auto rec'd

Road

Commerce Reports 4/19/22

Copyrighted material

BULGING waste-paper baskets of discarded newspapers in office buildings, stores, and homes, may become a national asset. The Forest Products Laboratory of Madison, Wis., has announced the discovery of a simple process for de-inking newspapers. Old newspapers are turned back into a pulp, and by the introduction of bentonite, a new American clay, the ink, which rises to the surface when loosened by alkalies, is carried off. The pulp is then put through the old well-known process and again made into newsprint.

The same paper can be de-inked several times, there being but a slight deterioration at each process. It requires the installation of no expensive machinery. Bentonite is a highly colloidal clay which exists in large deposits in the intermountain regions of the United States, particularly in Montana and Wyoming. One ton of clay is used to clean 10 tons of paper, and the prices of the clay and the paper make the process a profitable one.

After a series of experiments extending over a year at the Federal laboratory, the process was introduced in a commercial way in some of the large Minnesota paper mills with entire success. It requires about an hour to do the washing. Over 1,500 tons of old newspapers have been de-inked in these plants.

The United States consumes some 2,000,000 tons of newsprint annually, most of which could not heretofore be salvaged for reprinting because no satisfactory de-inking process had been discovered. It has required upward of 5,000,000 cords of wood to meet the annual print-paper demand. It is the belief

of laboratory officials that the discovery will materially check this wasting of the timber supply. For this reason, the new process becomes a commercial revelation of great importance in national economy.



Lumps of Bentonite, Which Swells to Several Times Its Actual Size When Soaked in Water, Becoming a Soft Creamy Mass Like Corn-Meal Mush

Like many another remarkable discovery, this was made while experimenting on something else. When this mineral clay bentonite, creamy-white and smooth in appearance, was first discovered, it was believed that it would be a remarkable substance to use in making the enamel of book paper. One day the engineer at the laboratory placed some of the clay in the vat of murky old-newspaper pulp that was being run through the beater. At once the sooty particles began to float off through the waste-pipe sieves. That was the beginning of 13 months of experiments in laboratory and commercial plants, with the result that business men pronounce the discovery a success.

Bentonite is defined by the United States Geological Survey as a transported, stratified, volcanic ash that has been altered shortly after deposition. It is very fine-grained and has the property of swelling in contact with water to several times its original volume into a jellylike mass, which on further dilution forms colloidal solutions and will remain in suspension indefinitely in mixtures as dilute as 1 part of bentonite to 50 parts of water. Like any natural prod-



In the Center can be Seen the Large Vat Used in the De-inking Process and in Which Newspapers are Placed and Reduced to a Pulp; Then, to the Washing Solution in the Vat, is Added the Bentonite Which Removes the Ink from the Pulp

uct, different deposits differ considerably, and the finest-grained, or most colloidal, occur in Wyoming, although samples from many deposits in the state proved to be low in colloidal content. Samples freshly taken from the quarries are of a

Thermopolis Wyoming
1st National Research Laboratories

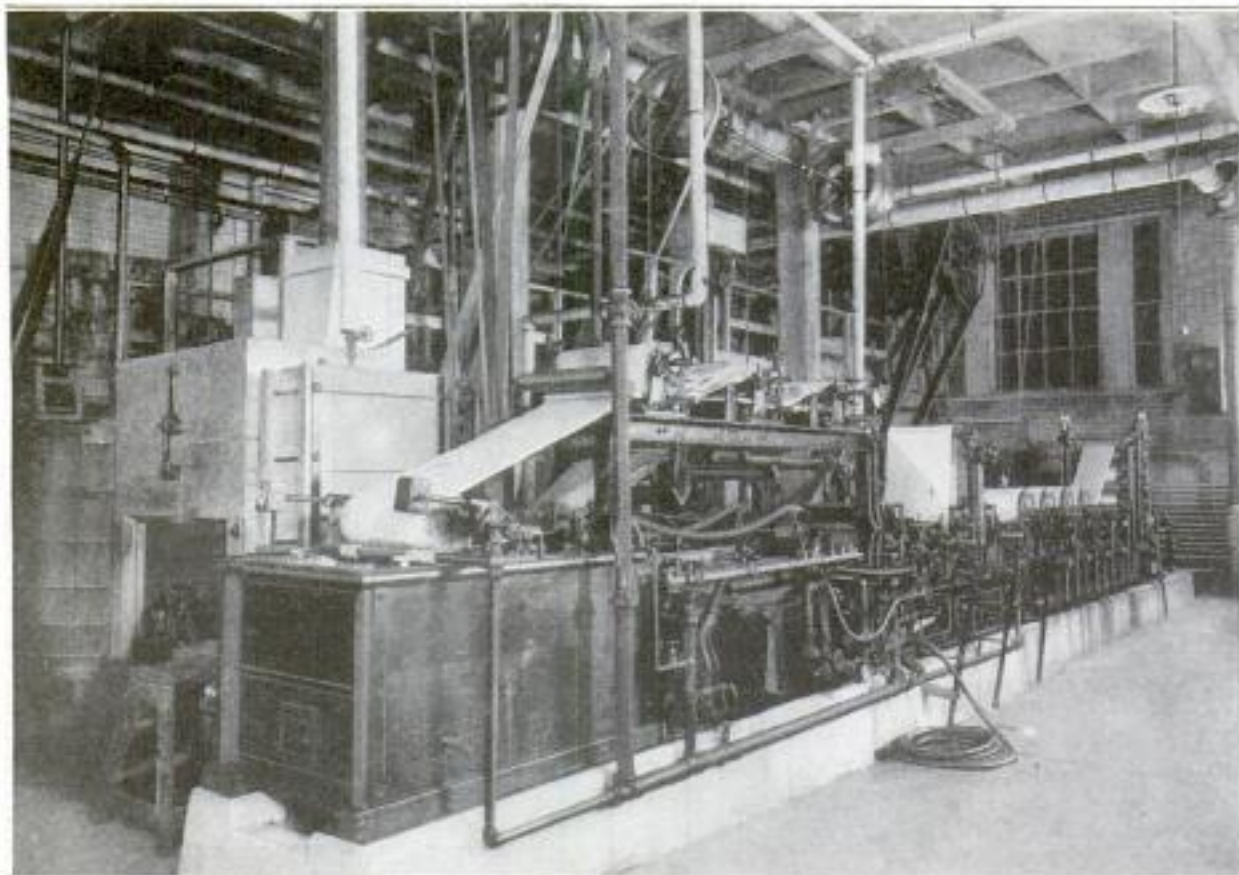

Paper Mill at the Forest Products Laboratory in Madison, Wisconsin, in Which Paper of White Texture is being Manufactured from the Pulp of Old Newsprint Paper Treated by the Bentonite De-Inking Process

greenish-yellow color, but on exposure to the air become light cream. It is a mineral akin to kaolin, although generally yielding on analysis more silica, less alumina, and more magnesia, and has

been found to be an excellent filler for paper. It is its physical properties, however, that render it of most value in de-inking paper, and of these, fineness is of most importance.

LAST FERRY ELIMINATED ON YELLOWSTONE TRAIL

The elimination of the last ferry on the transcontinental Yellowstone Trail is being accomplished by the erection of a steel bridge over the Columbia River be-

tween the towns of Kennewick and Pasco, in Washington. The former method of crossing the river, with its invariable and irritating delays, together with a universal

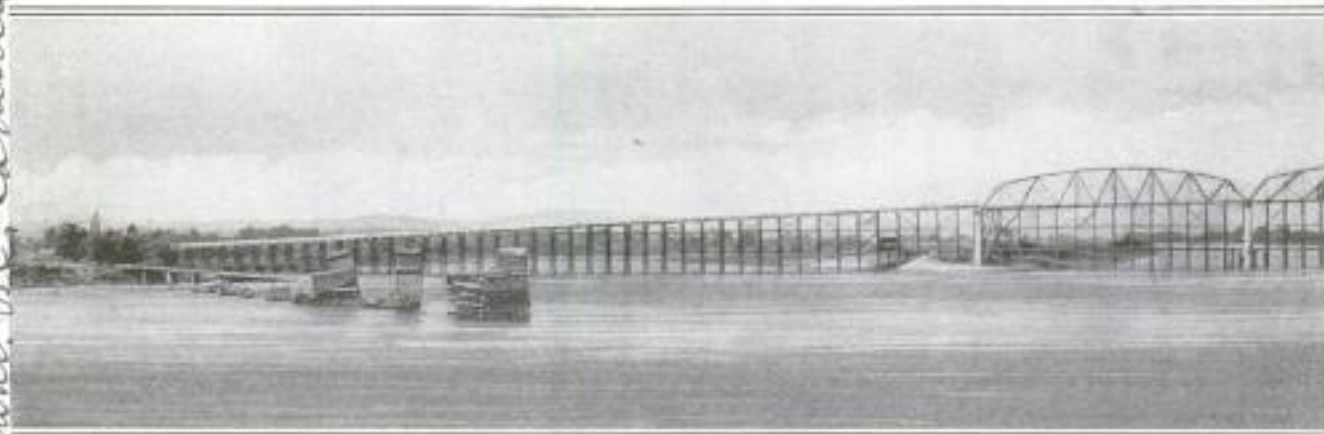

Partly Finished Steel Bridge over the Columbia River between the Towns of Kennewick and Pasco, in Washington, the being Planned for the Formal Opening. This Bridge Has a Clearance, above the Water, Approximately 30 Feet in Depth at the Channel Piers, the Bot

*Emt. Henry C. Copeland \$50
212 Union Bldg.
Vancouver, B.C., Canada*

desire for progress, caused the long-suffering citizens in that vicinity to demand a bridge. Subscriptions to the amount of \$500,000 were successfully solicited from interested persons along the trail between Seattle and Spokane, and construction started just one month after the necessary funds were raised in 1921. The completed structure, with the approaches, will be a half mile long, will have a 20-foot roadway, a center opening of 430 feet from pier to pier, and a clearance at high water of 50 feet.

7978
TUNER FOR RADIO RECEIVING
LIGHT AND COMPACT

That it weighs only 2 pounds and tunes to wave lengths of 100 to 600 meters, are merits claimed for a small and compact instrument which was given a practical test by the navy during the late war. Much of its efficiency is due to the minimum of space required. It is also said that the peculiar design of this tuner prevents, to a great extent, the interference by "strays" and static. "Fool-proof"



Radio Tuner Which Is of Light Construction, Thus Making It Adaptable for Portable Receiving Sets

features are incorporated which make it desirable for portable sets, Boy Scout outfits, or for simplified sets such as used by farmers in receiving the government market reports.

210
TRAFFIC SIGNALS OPERATED
FROM SIDEWALK

Electrically operated signals which are controlled from the sidewalk are the



COPYRIGHT, INTERNATIONAL NEWSREEL CORP.
 Electrically Operated Traffic Signal Which is Controlled from the Curb by Means of Switches

latest improvements for the traffic police of Chicago. The signal is located near the curb and mounted on an iron post, at the base of which is placed the control mechanism. When on duty, the traffic officer stands at the edge of the sidewalk and by manipulating the different switches, flashes the "stop" and "go" signs as occasion demands, thus directing the flow of traffic.

250

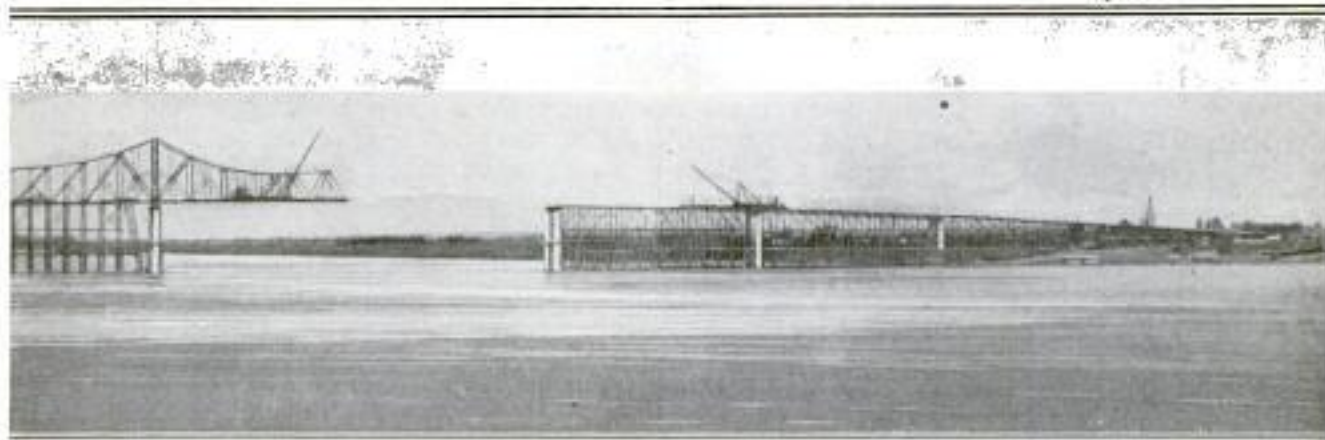

Completion of Which will Eliminate the Last Ferry on the Transcontinental Yellowstone Trail: Elaborate Ceremonies are of 50 Feet, Thus Doing Away with the Necessity of Having a Drawspan. The River Is toms of Which are Sunk 20 Feet below the Bed of the Stream

TWO MAY SIT SIDE BY SIDE ON NEW MOTORCYCLE

341

Two persons may sit side by side on a new motorcycle having separate "saddles" and double sets of



Motorcycle Which Accommodates Two Persons Seated Side by Side, Showing the Odd, but Comfortable Footrest and Double Handlebars

handlebars, the latter being attached to the frame at a point just behind the front fork. Individual footrests are likewise provided. Thus, while comfort in riding is assured the transcontinental tourists, or casual "joy riders," the narrow width of the outfit, in comparison with that of the usual sidecar and third wheel, permits the owner to economize space in the garage.

DRAWING ROOMS EN SUITE ON TRAINS TO COAST

Steel sleeping cars, containing seven drawing rooms, and so arranged with sliding doors that they can be used en suite, are now being built for the Santa Fe Railroad, and will soon be placed in operation between Chicago and the Pacific coast. There are to be 18 of the newly designed cars. Each room is to have an upper and a lower berth, a day lounge and bed, and lavatory and toilet equipment. The new sleepers will be part



This Diagram of the Steel Sleeping Cars Soon to be Placed in the Transcontinental Service of the Santa Fe Railroad Shows How the Rooms are to be Arranged. Notice the Sliding Doors between the Drawing Rooms

of \$3,500,000 worth of steel equipment planned for the regular daily passenger service of this company.

ACROSS U. S. IN RECORD TIME ON ONE-STOP FLIGHT

380

On September 5, Lieutenant Doolittle, army flier, landed in San Diego, Calif., about 22½ hours after he left Jacksonville, Fla. Stopping only once, at San Antonio, Tex., for fuel and oil, he averaged better than 100 miles per hour during the 21 hours 19 minutes that he was in the air. The 400-horsepower Liberty motor which drove his DeHaviland plane, consumed 399 gallons of gasoline and never missed a stroke on the 2,165-mile flight. In the early hours of his trip the lightning flashes of a thunderstorm he encountered, served to illuminate landmarks along the route. The only other incident was an attack of drowsiness while he passed over the monotonous plains of the Southwest.

USE PHONOGRAPH SOUND BOX AS RADIO AMPLIFIER

351

Sound boxes of phonographs may be used as radio amplifiers, by the attachment of a simple "adapter" to the tone arm of the machine, after first removing the reproducer. The appliance is constructed of a non-magnetic alloy. When the adapter has been fitted to the tone arm, one receiver is placed inside—the other being short-circuited—and tightly clamped there by means of a setscrew. In thus bringing the total volume of sound out through one receiver, instead of the sound waves opposing each other, as is the case when two receivers are used, the result is a clear and mellow reproduction of music or voices.



Westphal Mfr. Laboratory 653
 Railway Exchange Bldg. Chicago

Atchison Joseph + Santa Fe Ry.
 179 W. Jackson, Chicago 74

Morbrum Co., 1410 W. Wrightwood Ave., Chicago
TYPEWRITING BY RADIO

Typewritten Messages Sent from Airplane to Earth—Secret Radiograms Safeguarded by New Adaptation of the Printing Telegraph Machine—Business Methods Also Benefited by Invention

87

BY H. A. LANE

ANOTHER chapter has been added to the wonderful story of radio. So many and so remarkable have been the adaptations of this method of communication, that the interested observer of the world's progress scarcely has the time to familiarize himself with one mode before another appears. The latest achievement is the sending of typewritten messages through space. This feat has been accomplished through the efforts of radio experts working in conjunction with the Navy Department, who have thoroughly demonstrated its practicability for scout

able kind; that is, as far as the keyboard is concerned. The usual radio equipment



Printing Telegraph Apparatus of the Page-Form Type Which Performs the Double Function of a Sending or a Receiving Machine

and battleplanes in time of war. Also, radio typewriting represents added efficiency for business methods.

To the casual onlooker, the sending apparatus of the outfit resembles the ordinary commercial typewriter of the port-



Central-Station Sending Machine of the Printing Telegraph Outfit, on Which the Messages are Typed in Page Form

is carried on the plane, and in addition to this, the keyboard mechanism of the typewriter is installed in such a manner as to control the modulation circuit of the electron-tube transmitter. Thus, when a letter is struck on the keyboard, an impulse is sent out and received at a station on the ground. The receiving station, of course, has similar equipment to that on the plane. When any particular letter or number is depressed on the keyboard of the sending apparatus, a certain radioactive energy is released from the antenna of the plane and travels through the air. This is the common nature of radio.

Before any station can intercept these impulses, however, and decipher them, it is necessary to possess the same delicate

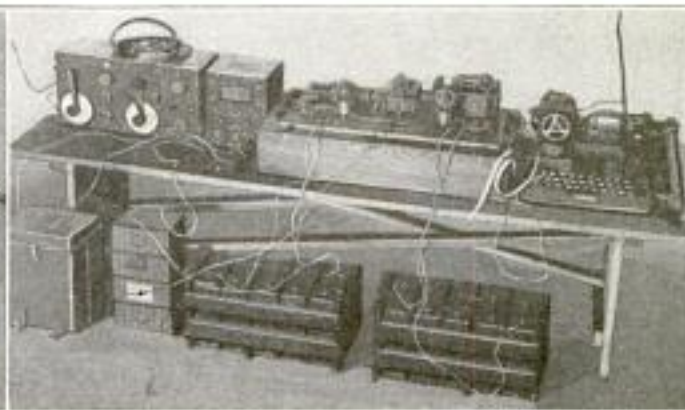

OFFICIAL PHOTOGRAPHS, U. S. NAVY

At the Left is Seen a Keyboard Transmitter of the Radio-Typewriting Apparatus Which is Carried on Airplanes, While on the Right is Shown the Wireless Equipment That is Installed in the Ground Station

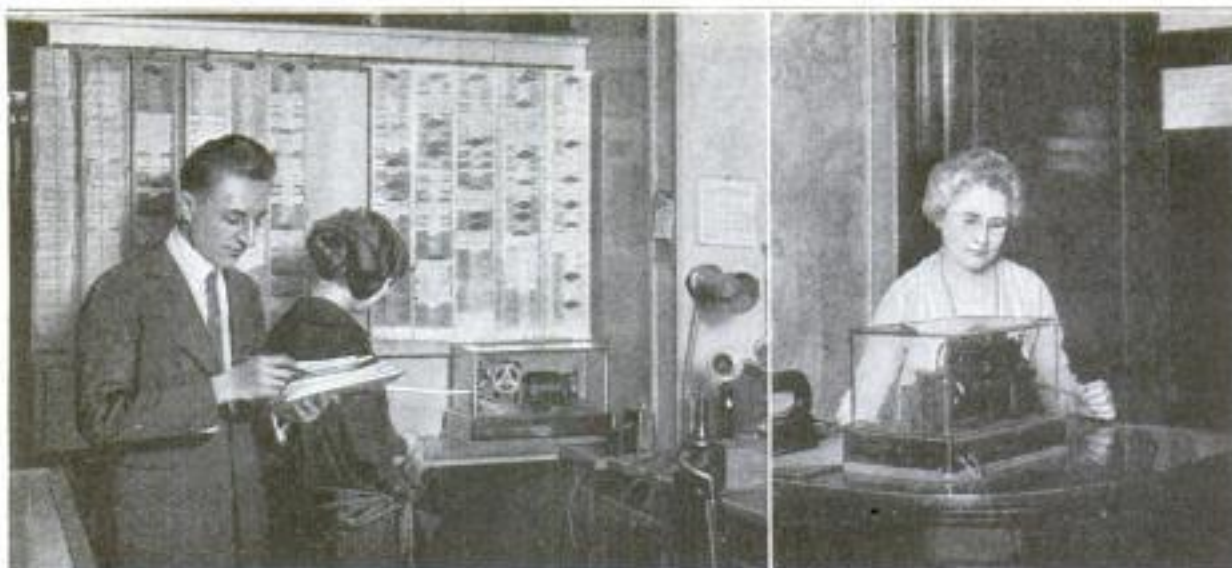

On the Left is Seen a Printing Telegraph Machine, Installed at the Mail Clerk's Desk in a Hotel, While at the Right is Shown a Similar Machine Mounted on the Desk of the Room Clerk, by Means of Which She may be Informed, for Instance, That a Certain Room has Just been Vacated and Needs Clean Linen

and complicated apparatus that is used on the plane. Thus the messages are secret. As a further precaution, the keys on the sending machine may be arranged in different sequences, so as to emit different impulses, the change of letters being previously understood, of course, by the station to which the messages are being sent. Any change in the sending keyboard would have to be duplicated in the receiving instrument.



Telephone Operator in a Hotel, Transmitting Messages to Various Stations through the Medium of the Printing Telegraph Machine

The value of this invention in the transmission of secret orders and reports,

during the maneuvers of an army or fleet in war time, is thus clearly apparent; no less is its efficiency in the commercial world. Hotels, department stores, police and fire departments, in short, any organization that directs a large force of employes from a common center, may be benefited by another adaptation of this machine, which operates similar to the telegraph except that the messages are printed on a tape instead of appearing in code. It is, in reality, a printing telegraph. Hotels operating under this latter system, have an efficient method of catering to the interests of the guests by giving rapid service, of which the following supposition might serve as an instance.

A room occupant notifies the switchboard operator of his intention to leave hurriedly. The guest requests that his laundry, baggage, and mail be taken care of, and that a taxicab be ordered to take him to the railroad station. The telephone attendant immediately sends a message via the printing telegraph machine. This message is received simultaneously by the laundry, baggage, and mail clerks, the cashier, taxicab stand, and the captain of the bellboys. The hurrying traveler descends to the desk to pay his bill, and is extremely gratified to find everything in readiness for rapid departure.

In the meantime, the hotel management, as stated above, also derives benefits from this system in another way than merely by having pleased the late guest. The original message from the switchboard operator's machine is received by the floor clerk, whose duty it is to see that the vacant room is quickly made ready,

with clean linen, etc., for the accommodation of the next guest, who may even at that moment be impatiently waiting downstairs in the lobby for a room. Thus is the efficiency of the modern hotel increased.

Although these first machines were constructed so as to print the messages on a narrow tape, one of a later type prints on a full-sized sheet of paper, or letterhead. The advantages of this are numerous. All messages sent out from a central source appear at the receiving stations in suitable form for filing purposes. If the message is desired in duplicate or triplicate form, carbon copies may be made as with the ordinary typewriter. This page-printing machine has been chosen by the Police Department of Chicago. One sending apparatus, installed at central headquarters, delivers simultaneous instructions to 40 outlying stations, thus doing away with numerous telephone conversations, with their attendant risk of misinterpretation. Irritating and everyday errors are consequently eliminated, and by the elimination of mistakes,



COPYRIGHT, UNDERWOOD & UNDERWOOD
 Sending Machine of the Printing Telegraph Outfit at Central Headquarters of the Chicago Police Department, with Which Page-Form Type-written Messages are Sent to 40 Outlying Stations

activities of all kinds are naturally accelerated.

Although the radio typewriter and other adaptations of the printing telegraph machine are still undergoing development, it is reasonable to assume that this method of communication will add to a nation's prosperity in times of peace and safeguard it in time of war. At any rate, the invention stands as a noteworthy addition to the practical application of wireless.

283

ADJUSTABLE BANJO BRIDGE AND CLOTHING GUARD

Two banjo accessories, a clothing guard and an adjustable bridge, are now available. The former consists of an elastic pad which fits over the brackets and nuts

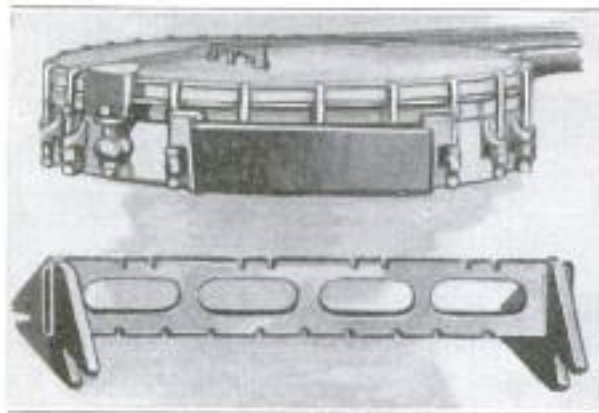

At the Top is Shown the Clothing Guard for Banjos, While at the Bottom is Seen the Adjustable Bridge with Many Notches

of the instrument, thus preventing any wear and tear on the garments. The latter may be adjusted to different heights and has notches of various depths, on both sides, by means of which all members of the banjo "family" can be accommodated.

386

GULLS DROP CLAMS ON ROOFS TO BREAK THE SHELLS

Sea gulls congregating near Port Angeles, Wash., are fond of eating clams. The shells, however, proved difficult to open until, either through accident or ingenuity, the gulls carried the clams to a considerable height and dropped them on pavements or roofs, thus breaking the shells and getting a goodly meal. The roof of one building near the water's edge has been so badly damaged, it is said, that it is leaking. On another, wire netting has been put over the skylights to prevent their destruction.

A. W. Cover
 Long Island City
 N.Y.

Cont. Emma Horton
 205 Northwestern
 Bank Bldg.
 Portland, Oregon

101
101
24
H. H. Stronach Electric & Mfg. Co., E. Pittsburgh, Pa.
NEW NAVY AIRSHIP-MOORING MAST
BY ERNEST JONES
East Pittsburgh, Pa. Washington, D.C.
8-25-17
W.

THE mooring of the gigantic airship of today when arriving in port or departing, is not radically dissimilar to the docking of large ocean liners. For the pull and push of panting tugs there are substituted a mooring mast, winches, and a small crew of men. There is no river traffic, low tide, or the want of a pilot, to delay arrival at the scheduled hour.

The ship of the air gracefully approaches the mooring tower—or mast, to be technical—from the leeward and lets go her main hauling line. This is then connected by the ground crew to a line from a hauling winch by means of a coupling, and the ship is gradually pulled toward the head of the mast by electric power.

After the hauling in has begun, and when the bow of the ship is near the circle of snatch-block anchorages, two guy lines are dropped and connected to corresponding lines from auxiliary winches. These lines are led to snatch blocks which lie at 60° each side of the direction of the wind, and thence, by such lead blocks as may be necessary, to the auxiliary winches. These latter are operated until a mark on each line appears at the corresponding snatch block, when the auxiliary winches are stopped, the lines being simply held, and the main hauling line continues to draw the ship forward and down until the cone on the ship's nose enters the receiving member, mounted on a gimbal at the top of the mast, where ultimately it is locked in place, and the ship rides to the structure of the mast alone.

The passengers, baggage, and freight may then pass over a gangplank laid down from the corridor in the keel, through the underside of the nose, to the main platform of the tower. From another platform, a few feet below this, an elevator operates.

In leaving, the ship is trimmed sufficiently light to rise as soon as it is released from the mast, the releasing hook is opened, the ship rises, and the mast is again ready to receive.

Just completed at Lakehurst, N. J., the mooring mast of the United States Navy airship station is the tallest in the world, and the first to be erected without guy wires. It consists essentially of a triangular steel tower, somewhat similar to that of a radio station, in the center of a circle of 48 snatch-block anchorages at equal intervals of 7½°. The radius of this circle is 500 feet. Additional anchor-

ages for snatch blocks or fair-lead sheaves are located about the base, to make it possible to lead two lines from any of the two guy-line snatch blocks, 120° apart, to the two auxiliary winches in such a direction as to feed properly.

At the base of the tower is a building for housing 4 officers and 20 men, with an office, elevator entrance, and the winches for the lines used in bringing the ship to the mast, together with the pumps for water, fuel, and oil.

The elevator runs in an interior rectangular framework to a platform 136 feet above the ground. Twelve feet above this is the main operating platform, reached by stairs; and at 160 feet is the gimbal of the main swinging tube.

Up the tower, lead the pipe lines: one for water, delivering 18,000 pounds in an hour; fuel is pumped at 1,500 gallons an hour; a 12-inch pipe, with fabric tube to the ship, supplies 300,000 cubic feet of hydrogen or helium gas. An electric system is provided for night arrivals and departures; and there are, of course, telephones.

On the uppermost platform is the gear for receiving and securing the ship, together with the connections for the water, gasoline, oil, and gas piping which couple to the ship's lines.

This receiving gear consists, in short, of a revolving steel cup on bearings, mounted on gimbals, with a spring device to take up shock at the moment of securing the cone of the ship in the cup, and a locking device.

366
TWO CITIES EXCHANGE POWER AS EMERGENCY MEASURE

The electric generating systems of Tacoma and Seattle, in Washington, have been "tied" together to safeguard each city against lack of power during unusually high demands or emergency conditions of any kind. Each municipality generates power at approximately 50,000 volts. The maximum amount of current to be exchanged is 15,000 kilovolt-amperes, and a water-cooled transformer of this capacity is used to tie the two systems together. The scheme is simple in operation. One side of the transformer is provided with a number of taps, through the medium of which any desired amount of the current, or all of it, can be interchanged from one set of lines to the other. The amount of the power interchanged is controlled by an induction regulator operated by two push buttons.

Lakehurst, N. J.

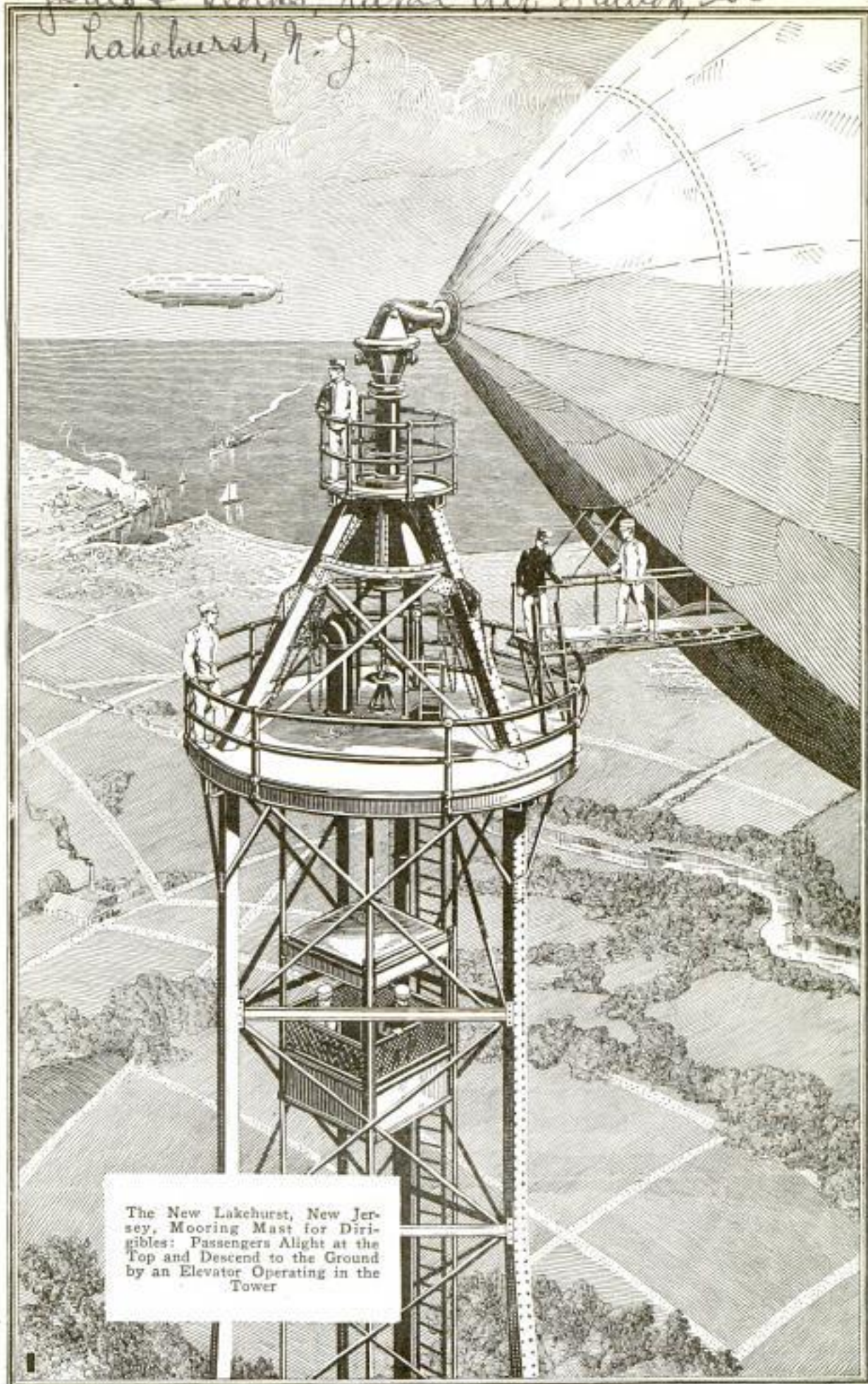

The New Lakehurst, New Jersey, Mooring Mast for Dirigibles: Passengers Alight at the Top and Descend to the Ground by an Elevator Operating in the Tower

Tuckahoe, N.Y.

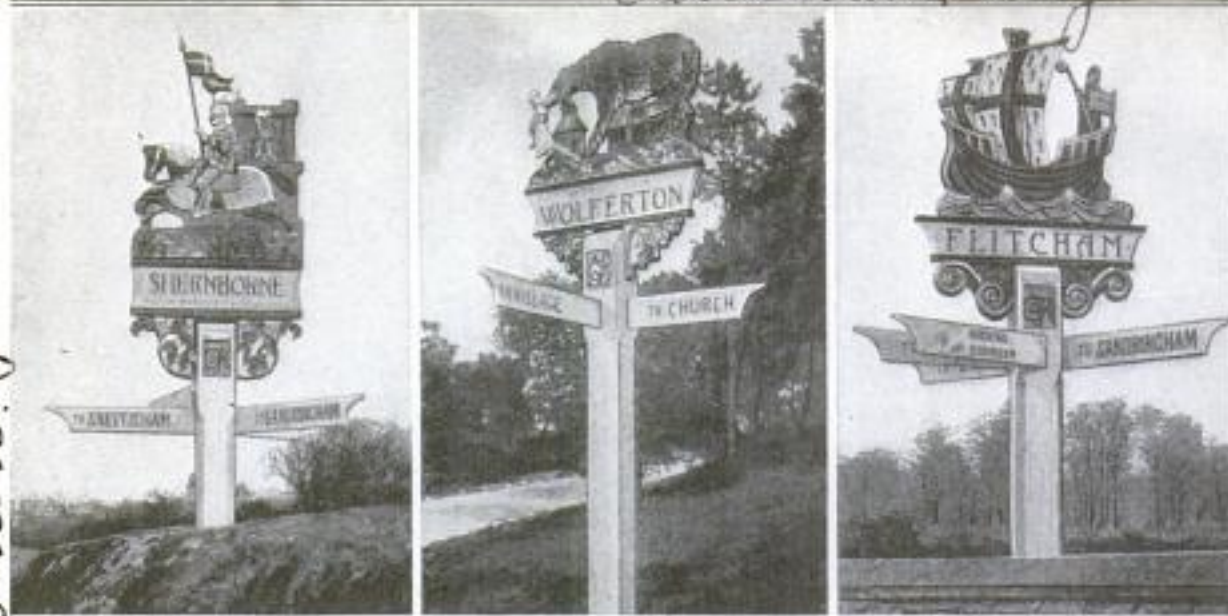

Some Ornamental Signposts Erected in England: The Carvings are Inspired by Local Associations. From Left to Right They Represent, Famous Knight and Dame; Local Legend, and an Event in Early Church History

USING BIRCH WOOD FOR FUEL COMMON IN SWEDEN

Coal strikes would have little effect upon domestic heating in Sweden, for the most common fuel in that country is birch wood. The logs are usually cut up in



These Stacks Consist of Birch Wood, a Common Fuel in Sweden. They are Left to Dry for Several Months Before the Wood is Used

winter, when the pieces are piled in large stacks to dry until the next fall. The fireplaces are so constructed as to store the heat, and practically none of it is wasted.

HISTORICAL CARVINGS ADORN SIGNPOSTS IN ENGLAND

That road signs can be made ornamental as well as useful is evident from the examples of some that have been erected on King George's Sandringham estate, in the county of Norfolk, England. Above

the ordinary direction signs are mounted very elaborate and decorative designs depicting historical personages and events connected with the locality. Skillfully carved and solidly built, these artistic creations may represent an armored knight mounted on his prancing steed, some legend associated with the name of a neighboring town, or an event of early church history. They are unusually large for signposts, and very conspicuous.

TALKING-MACHINE NEEDLE SIX FEET IN LENGTH

Measuring 6 feet in length, 7 inches in diameter, and weighing 10 pounds, the largest talking-machine needle in the world occasions great interest wherever it is placed on exhibition. The huge innovation, constructed entirely of steel in two telescoping parts, is more than 100 times the size of the ordinary needle used for playing records, and was manufactured by an Indiana concern solely for window-display purposes.



The White Mfg. Co. isoshea chad.

The White Mfg. Co. isoshea chad. Copyrighted material

Cont. Robt. M. Hillenpiper, Stockholm, Sweden. Stryllegatan 39, Stockholm

New York City

ODD-APPEARING VEHICLE OPERATED LIKE BICYCLE

How to transport himself and family of five children at the same time, was the problem encountered by a European father of limited means, in the solving of which considerable ingenuity was displayed. Taking the wheels, gears, pedals, and chains from two bicycles, he constructed a strong frame, axles, and steering apparatus. Four wicker baskets, having a combined seating capacity of six persons, were then mounted on the vehicle, and now, with his eldest boy aiding in the pedaling, the father and five youngsters jointly partake of pleasure trips.



Odd-Appearing Vehicle in Which the Entire Family may be Transported, Showing the Clever Pedal Arrangement and the Wicker Baskets Used for Seats

144

AIRPLANE LANDING GEAR DROPPED IN FLIGHT

A recent invention permits the conventional landing gear with rubber-tired wheels to be dropped from a plane in flight, the subsequent landing being effected with a pair of skids mounted beneath the plane. The object is to eliminate the weight and wind resistance of the usual landing gear and to make possible landings in a short space and on rough ground. Landing on water

is safer with skids than with the wheels because of the lowered center of gravity, which reduces the tendency to turn the machine over on its end. The arrangement of shock absorbers, some of which are double-acting, interposed between the skids and the body of the plane, is one of the most important features. In this design the propeller blades must be horizontal when making a landing.



Above: Dropping the Wheel Landing Gear from a Plane in Flight. Left: Airplane Equipped with Combination of Regular Wheel Gear for Leaving the Ground, and Skids for Landing. Right: Making a Landing on Skids, Which can be Done in a Distance of About 50 Feet

Lawrence O. Sperry
Lawrence Sperry Aircraft Corp
71 Armistead Ave. L. I., New York.

Brown by: Jns. B. Broadwell

696
241

ALPHARETTA, Ga.
POPULAR MECHANICS
RECORD STALK OF COTTON
HAS 700 BOLLS

A cotton stalk, bearing 700 bolls and standing 5 feet 6 inches in height, was grown recently on a plantation in Georgia.



As far as is known, this is a record number of cotton bolls to be grown on one stalk. The extraordinary growth, which is of the double-jointed variety that produces two bolls to the joint instead of one, has been placed in a glass case at the capitol in Atlanta, where

it will remain as a permanent exhibit for the benefit of sight-seers.

SHEET-STEEL TIRE PLATES
FOR MENDING RIM CUTS

A tire plate for mending rim cuts, made of the best sheet steel, is stamped to fit the tire and flanged to hook over the edge of the rim.

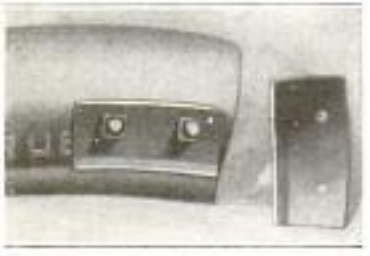

The plate is about 2 3/4 inches long, and is drilled with two holes for small flat-head bolts with self-locking washers that go inside the tire.

A belt punch is used for making holes in the tire that correspond to those in the plate. If the rim cut is long, two or more of the plates are placed side by side. They are made to fit both clincher and straight tires.

CAUTION USERS OF HARD-
334 COAL SUBSTITUTES

Persons intending to use soft coal, wood, kerosene, or other fuels as a substitute for anthracite, are warned that extra precautions are necessary for their safe usage, in a bulletin issued by the Na-

N.Y. Times 9/9/22

tional Board of Underwriters. Smoke-pipes and flues, states the bulletin, should be thoroughly cleaned before the furnace is started. Oil stoves should not be moved while lighted, and at all times should be kept away from inflammable household furnishings such as curtains. Office managers are advised to give special attention to their sprinkling systems so that they will not freeze from insufficient heat.

NEW MACHINE FACILITATES
9896 TIME-STUDY WORK

A recently marketed machine times and makes permanent records of time-study observations.



A strip of paper, positively driven, is moved at a uniform speed that can be adjusted to suit conditions. A pen, suitably mounted to trace a line on the paper, is caused to move back

and forth across the strip by two finger keys at the option of the observer, who presses one or the other of these keys at the completion of each element of the cycle. The machine is small, weighs only 9 1/2 pounds, and is driven by a clockwork motor, so it can be easily carried about. It is more accurate than a stop watch.

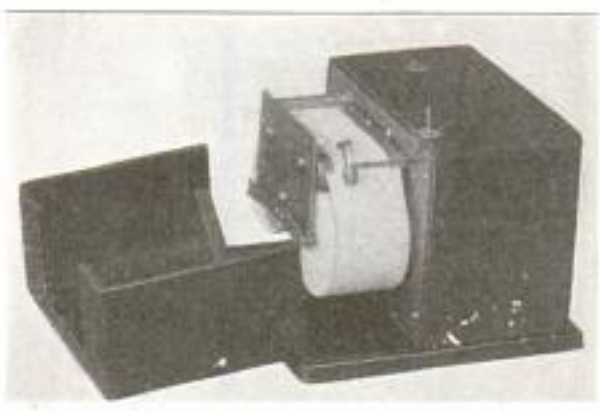

This Time-Study Machine is Controlled by Two Finger Keys, and the Operator can Observe the Worker

observations as low as .001 minute having been recorded, and the 24 steps obtainable provide for a record of all the data usually required.

Wm. H. Williams
1613 Chestnut St.
Philadelphia, Pa.

J.P. Jennings 40 Brewer St. Jacksonville, Fla.
J.P. Jennings 40 Brewer St. Jacksonville, Fla.
J.P. Jennings 40 Brewer St. Jacksonville, Fla.

294 Pichett-Thomson Research Laboratory
 St. Pauls Hospital, Endell St London, W.C. 697
 England.

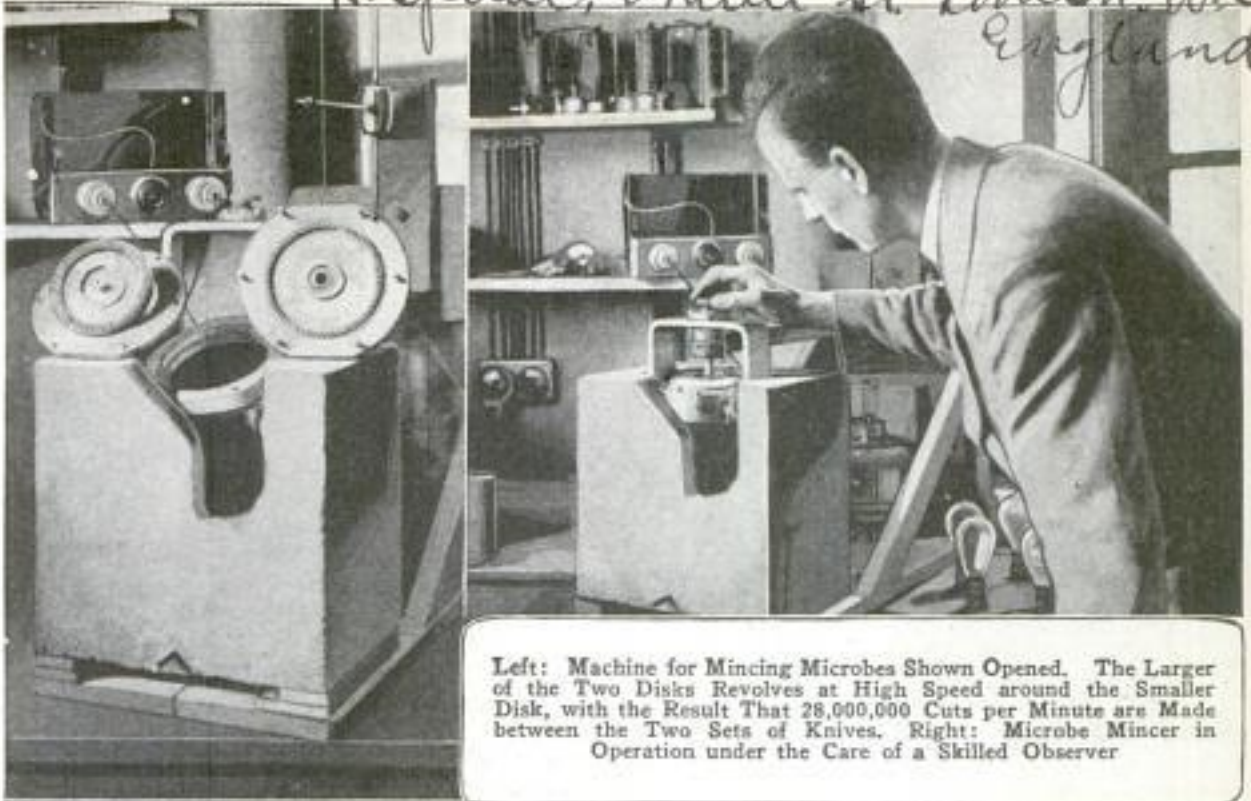

Left: Machine for Mincing Microbes Shown Opened. The Larger of the Two Disks Revolves at High Speed around the Smaller Disk, with the Result That 28,000,000 Cuts per Minute are Made between the Two Sets of Knives. Right: Microbe Mincer in Operation under the Care of a Skilled Observer

MACHINE MINCES MICROBES

294 **USED FOR VACCINE**

An interesting little machine is used for mincing microbes in the laboratory of a London hospital. This electrically driven machine consists of two disks, of which the smaller or stationary one has 70 small steel knives and the larger or rotating disk has 80 cutting edges. The microbes, suspended in an alkaline solution, are forced against the cutting edges at a speed of 60 miles per hour, and during the 20 minutes they usually remain in the machine receive 560,000,000 cuts. But while some microbes are properly cut by this machine, others are so tough that they come through it whole and sound. A machine is therefore being constructed with 450 cutting edges, which will whirl the microbes at the rate of 120 miles an hour, giving 500,000,000 cuts per minute.

The object is to remove the poisons from the germs so that a larger quantity can be administered to the dose of vaccine, giving greater protection against the particular disease.

AUXILIARY COIL SPRINGS

132 **FOR MOTOR TRUCKS**

Auxiliary coil springs for motor trucks are the latest improvement introduced for the purpose of reducing the jarring when driving over rough roads with solid tires. The rear ends of the ordinary leaf springs of the car, instead of being shackled to the frame, are fastened to a crossbar on which are placed two coil springs. The frame of the machine rests upon the top of these coils, which are limited in movement, except as to up and down, by a hinged arm affixed to the crossbar.

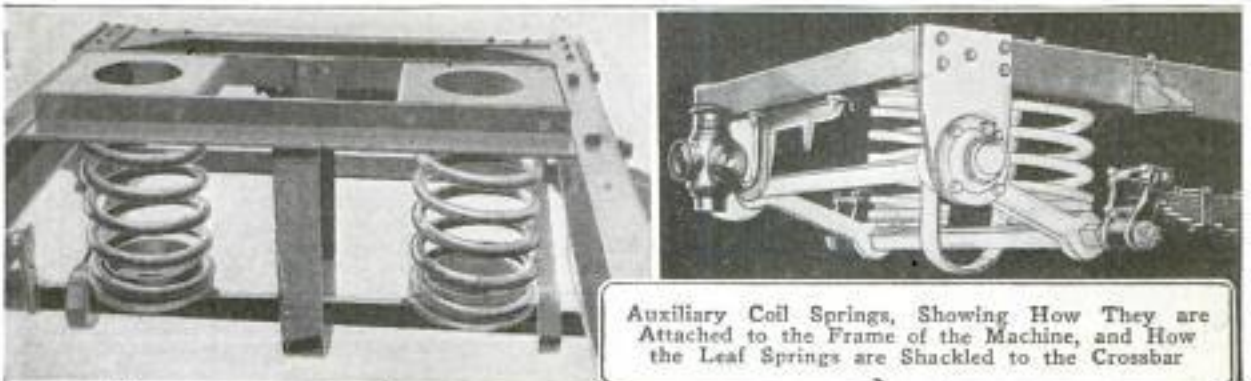

Auxiliary Coil Springs, Showing How They are Attached to the Frame of the Machine, and How the Leaf Springs are Shackled to the Crossbar

Traylor Engineering & Mfg. Co.
 Cornwells Heights Pa.

346 A. N. Mirzoeff, 269 Lelaire Ave.
EXPOSITION BUILDINGS AT RIO DE JANEIRO
Plainfield, N. J.

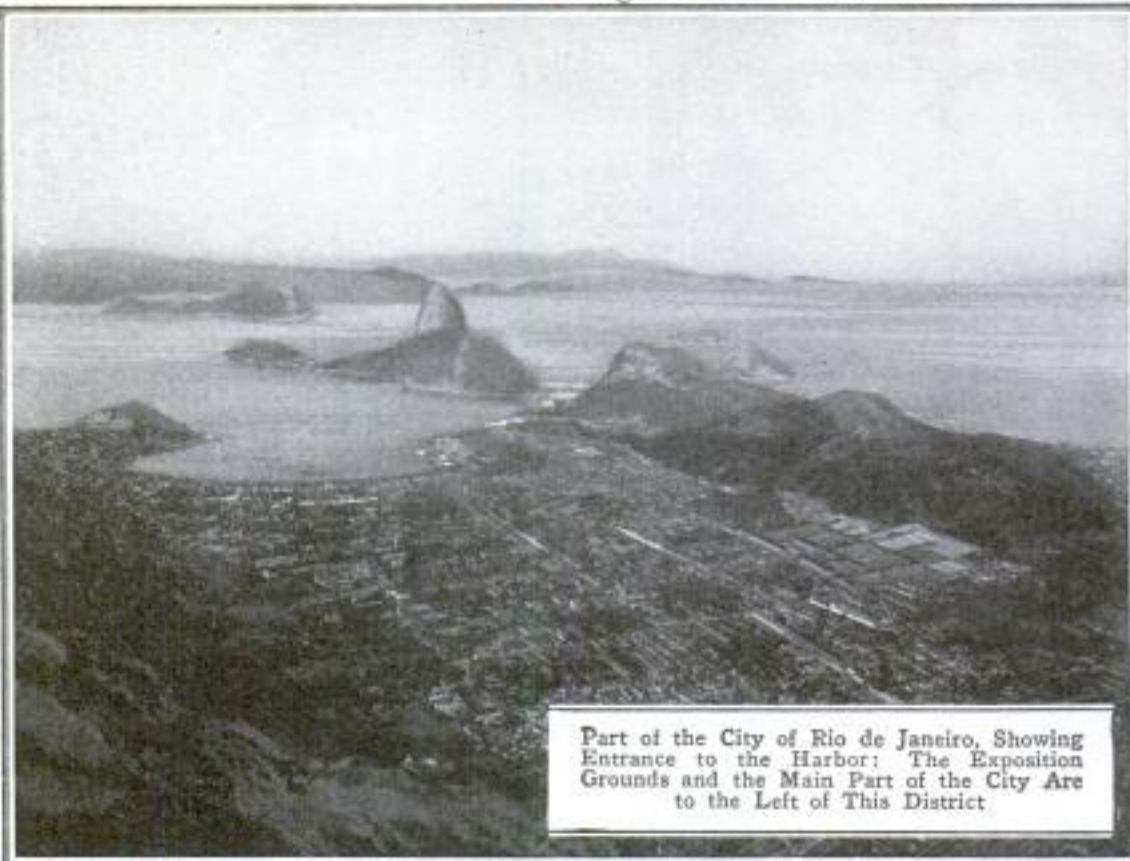

Part of the City of Rio de Janeiro, Showing Entrance to the Harbor: The Exposition Grounds and the Main Part of the City Are to the Left of This District

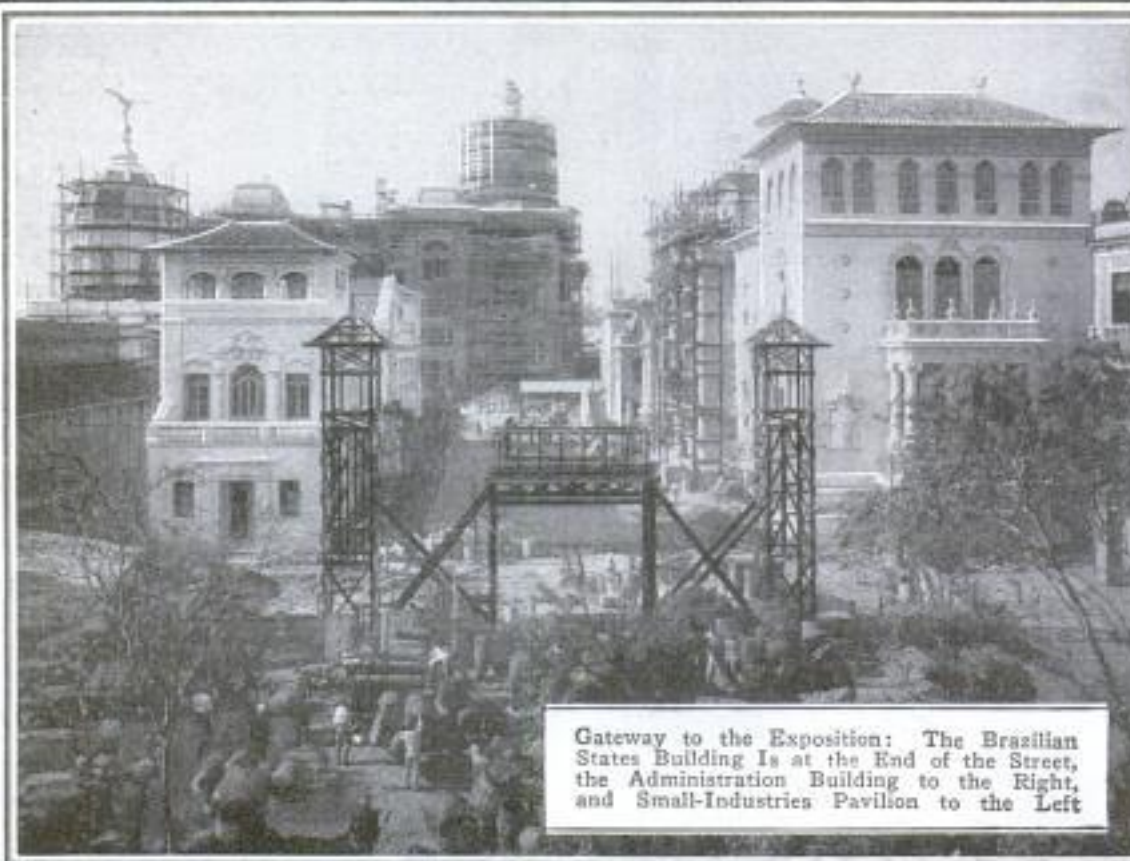

Gateway to the Exposition: The Brazilian States Building Is at the End of the Street, the Administration Building to the Right, and Small-Industries Pavilion to the Left

FOR BRAZILIAN CENTENNIAL CELEBRATION

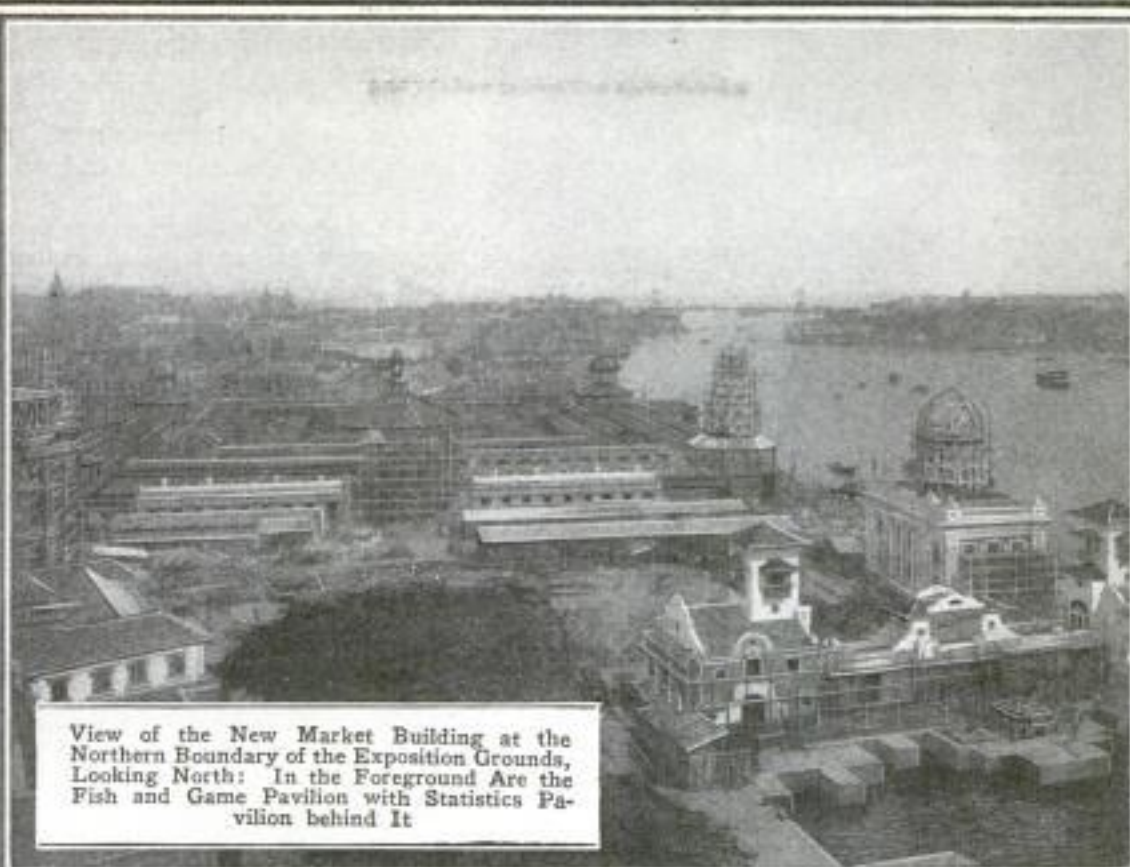

View of the New Market Building at the Northern Boundary of the Exposition Grounds, Looking North: In the Foreground Are the Fish and Game Pavilion with Statistics Pavilion behind It

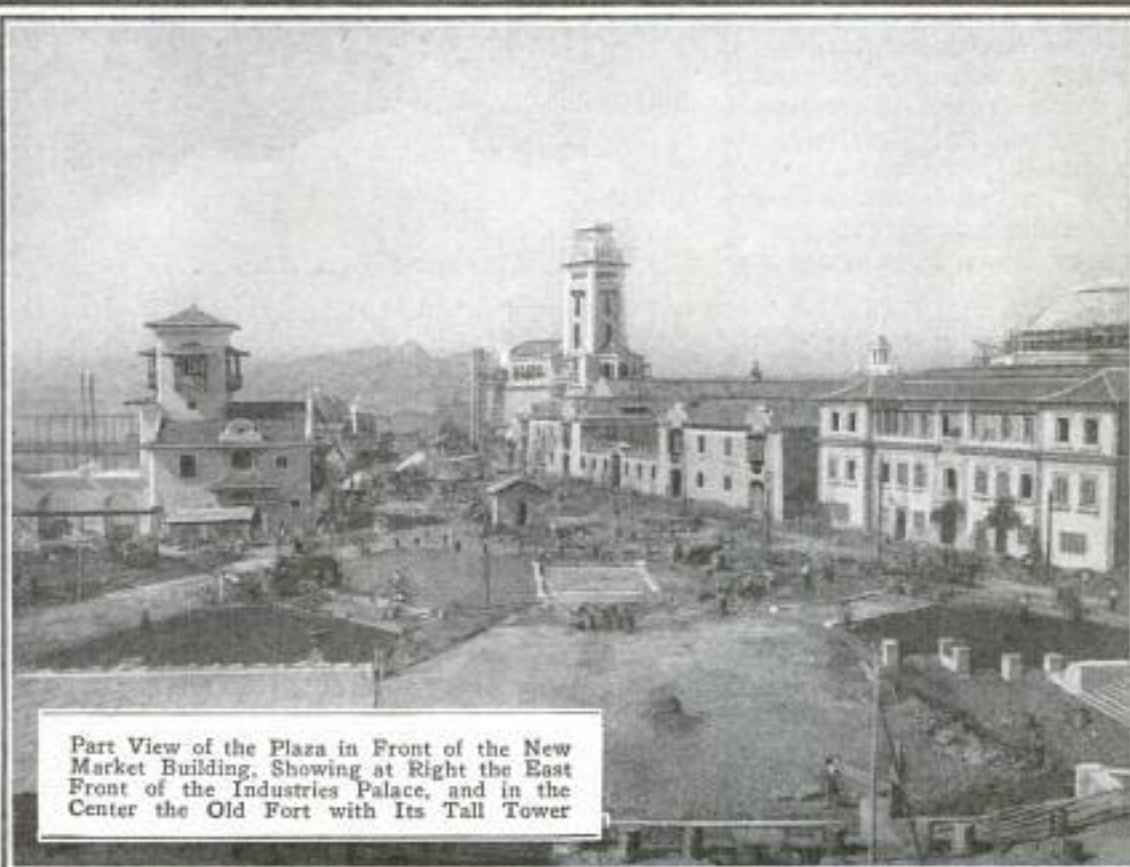

Part View of the Plaza in Front of the New Market Building, Showing at Right the East Front of the Industries Palace, and in the Center the Old Fort with Its Tall Tower



Above: The Inventor of the New Method of Testing the Accuracy of Optical Lenses is Here Seen with the Instrument He has Perfected. Right: Another View of the Instrument, Showing the Means of Holding a Pair of Spectacles

proximately accurate and more or less liable to human error. This instrument uses the light passing through the lens to measure its power, as a resultant of the combination of surfaces to which it is ground, and takes into account the refractive index of the glass of which it is made. As it combines the advantages of the other methods, none of which is complete in itself, and eliminates the defects peculiar to each, it is seen as the means of standardizing the testing of lenses for eyeglasses, the benefits of which will accrue to the millions of persons who are dependent almost entirely upon these aids to vision.

INSTRUMENT MEASURES LENSES BY LIGHT WAVES

By means of a new instrument perfected by an American scientist after a number of years of labor and experimentation, it is now possible to determine whether the lenses of eyeglasses and other optical devices have been accurately ground according to the prescribed formula. Heretofore the means for testing optical lenses have been only ap-



HIGH-SPEED BENCH SAW CUTS HARD OR SOFT METALS

Easily portable, a bench saw has been designed specially to save metal, saws,

and time. The machine is equipped with a small circular saw, only $\frac{1}{32}$ inch thick, covered by a guard and driven through worm gearing by a $\frac{1}{8}$ -horsepower inclosed motor that can be connected to any lamp socket. The saw can be driven at a very high speed for cutting soft metals, such as brass or copper, and at a much lower speed for hard metals, such as cold-rolled steel or drill rod. Attached to the saw support is a plierlike adjustable work holder that grips the metal while it is being cut. The saw cuts very rapidly, and, on account of its thinness, makes a clean cut with small waste of material. The saws can be interchanged for cutting the different metals.



Portable Bench Saw, Weighing 40 Pounds, for Hard or Soft Material, That can be Run from Any Lamp Socket

Triangle 31, Metal Products Corp.
Hartmouth St. Rochester, N.Y.

COMMENT AND REVIEW

[These pages were printed September 26, 1922.]

IN these days nations have become so large, and so attached to their home land, they no longer emigrate in a body, as history tells us was done by the Israelites, Aztecs, and others. Even the tremendous influx which this country experienced during the past 100 years, coming from almost every nation of the world, had begun to subside before legislation put limitations in force. The flow of emigration toward Australia, Africa, and South America, which are the remaining great unsettled continents, is relatively slow, and at a rate in no way comparable to the thousands which poured into the Dakotas, and west thereof, during the 80's.

A Place in the Sun

Writing in the *Yale Review*, Henry Pratt Fairchild makes the statement that the world's population in the 114 years ended 1914 more than doubled, going from 700 million to 1,649 million; while in the five years from 1906 to 1911 it increased at the rate of doubling every 60 years.

The startling result of such increase for 10,000 years is inconceivable. Mr. Fairchild says that after filling the standing room of the earth's surface by allowing each person one and one-half square feet to stand on (a little crowded for overweights) there would still be 60,750,000,000,000,000,000,000,000,000 individuals left over, with not even "standing room only," or to confine the figures to the United States, the rate of increase from 1906 to 1911 would give us, at the end of this century (1999), a population about one-third larger, on a territory one-fourth smaller than China today. And we think of China in terms of "teeming" humanity!

Against this appalling future Mr. Fairchild offers consolation in the words, "There is no more pernicious proverb than that history repeats itself. That is the one thing that history never does." (Disraeli also frequently said the same.)

Another surprising statement he makes is, that emigration does not reduce population, and that land aggression, hostile or peaceful, fails to solve the problems of overpopulation. "We could draw off a million Chinese a year," he says, "for 50 years, and at the end of the period China would have just as large a population as if not a soul had emigrated." The prospect is that in future the efforts and inducements held out to attract emigrants to the United States, Canada, Brazil, Argentina, and Australia will be lessened, and legislative restriction may be expected. Mass movements of population from one country to another will not long be permitted.



WHEN the war broke out our supply of coal-tar dyes, medicinals, and chemicals in great variety was suddenly reduced, and later, of course, was entirely cut off. We had depended on Germany so long and to so large an extent, that for a time our manufacturers were greatly crippled. The home production of these essentials had been so poorly supported and encouraged, we found ourselves in a surprising state of impotent dependence.

Encourage American Dyes

Our manufacturers of chemicals then set to work to produce these necessities here, but they were confronted at the very beginning with hundreds of American patents which the Germans had taken out for the sole purpose of blocking manufacture here. Later, when we entered the war, these owned-in-Germany patents were taken over by the alien-property custodian under act of Congress, and still later he was authorized to sell them at public auction, as no Government agency existed which had authority to acquire them. Therefore, a corporation was formed, which was as nearly as possible a quasi-public one, and this organization—The Chemical Foundation, Inc.—became the holding company for these patents.

The Chemical Foundation is controlled by five trustees, none of whom owns any of its stock or is himself a manufacturer. While limited dividends are permitted under its charter, it has paid no dividends; its president receives neither salary nor expenses, and all moneys received above expenses and dividends must be devoted to the advancement of chemical science and education in this country. It has authority to license manufacturers under the patents it acquired, but cannot give an exclusive license. Any American citizen could procure the same license, on precisely similar terms, with assurance of security and encouragement from the

Government. American manufacturers took licenses under these patents and invested more than \$100,000,000 in new plants.

Considering the short time in which they have been experimenting and operating, the results are highly encouraging. Many dyes and chemicals are already produced here which are equal to what formerly came from Germany; others are admittedly inferior, but it must be considered that Americans have only begun, and have made really wonderful progress in their three years, as contrasted to the more than half a century of similar manufacture in Germany.

Naturally, in their attempt to regain their former world-wide markets in all other lines, the Germans resent our entrance into an industry which they led and practically controlled, and hence they seek to recover their lost patents here. In furtherance of this effort, a bill is before Congress to restore to them the American patents they formerly controlled. To do so would be a repudiation of its recent promises by the Government; would throttle a most important and essential industry, and would cause an irreparable loss to the country at large, and personally to those who have put their millions into the new chemical enterprises here.

Great Britain, France, Italy, and Japan have already passed laws creating a complete embargo against the importation of such dyestuffs as are made in their respective countries; and Great Britain has gone farther, and is subsidizing the industry to enable its manufacturers to compete with Germany in the markets of the world. What is known as a "selective embargo" on dyestuffs is now before Congress. It would seem we too should promptly institute such a protective embargo here, and not restore the patents taken over by the Chemical Foundation.



THE Government has its coast guards, and sentinels to prevent and fight forest fires; and some states already have a mounted state constabulary. It is rapidly becoming evident that, at least all the more densely populated states, will have to have their state police.

*State
Mounted
Police*

Time was when a traveler was as safe from attack on a country highway as in a courthouse, but this is so no longer. The more miles of good roads a state provides, the more automobiles it has, and the easier it becomes for bandits to make their holdup in store, house, or highway, and escape in a stolen car. Where the theft occurs in a town or city, its police cannot go very far afield in pursuit of the robbers, and the small towns and country communities have only a limited force.

A state mounted force, a good proportion on motorcycles, properly distributed, could be put in action very quickly as a dragnet, making escape much more difficult than under present conditions. As the chances of escape became more difficult and unlikely, crime would automatically largely decrease.



"SAWING a Woman in Half" is the well-known title of an illusion which has created a furore wherever presented. It was conceived by Horace Goldin, who is receiving larger royalties from other magicians who are presenting the mystery, than has ever been paid in the history of magic. The apparatus used in the act was also invented by Mr. Goldin and built in that famous workshop of secrets maintained by Thurston in Long Island. Like all other great successes, there sprang up rivals, which were stopped by injunctions in Illinois, Pennsylvania, and Ohio.

*Magicians'
Rights
Recognized*

Then a moving-picture producer, more enterprising than just, succeeded in getting possession of the secret of the mystery. A film was made showing the regulation stage performance, and following this was a complete exposé, fully illustrated, showing exactly how the mystery was accomplished.

Mr. Goldin sought to obtain an injunction against the manufacturer and the showing of the film, but was refused in a lower court. On appeal to the Supreme Court of New York State, the judges, five in number, unanimously decided in Mr. Goldin's favor and reversed the ruling of the lower court.

It is unnecessary to recite in detail the evidence and arguments on both sides. The evidence proved conclusively that Mr. Goldin was the originator of the

mystery, but the interesting feature is that the court recognized the mystery as a tangible property that can no more be appropriated or stolen than a horse.

The decision, coming from so high a tribunal, establishes a precedent of untold importance to magicians, who will now feel warranted in spending money—as Mr. Goldin did several thousands—in inventing and constructing the apparatus necessary to produce what is known as a major mystery, and rely on legal protection of their rights. The outcome will doubtless be of the greatest encouragement to the profession to produce new and wonderful features of entertainment which the amusement-loving public will appreciate and enjoy.

The Society of American Magicians and Harry Houdini, its president, are to be congratulated on this legal victory which means so much to all of them.



TWENTY years ago when gliders were being flown by such scientists as Lilienthal, Canute, Picher, and the Wrights, they were the subject of jest and scorn in the daily press. Only a few years later they were being made and flown by boys as a new and startling amusement. This experimental work, however, established the foundation for what became, with the aid of the gas engine, the present airplane. Of late, considerable interest in the glider has been revived by remarkable achievements, especially in Germany. Some have even dared to predict the powerless plane as a practical vehicle of the air.

*Gliders
a
Fad*

While it is true some wonderful flights have been recorded during the past year, the glider promises to be very limited in its operations, and of little dependable use except as a landing plane from passenger express planes; to improve the airplane by further discoveries of the gliding ability of birds, and as an amusement. Some people are misled by the endurance of certain birds to remain aloft apparently motionless for a long time, into the belief that gliders can duplicate bird flight; but did anyone ever see a bird rise from the ground or water by merely spreading its wings and facing the wind? Or an eagle step off from some lofty tree or mountain crag and only spread its wings? The bird takes its start with wing propulsion, and largely, if not entirely, makes its ascent by the exercise of wing power, even though the wing motion is too slight to be detected by an observer on the ground, hundreds or thousands of feet below. The glider is a vassal of the wind and can no more go in any direction desired, at any moment, than a stuffed bird.

Its use therefore can only be quite limited, and certainly very much less than many have been given to expect and hope.



EVER since the invention of the pistol 400 years ago, its sole purpose and that of its successor, the revolver, was to kill human beings. Outside of legally authorized war, they have undoubtedly caused the accidental or murderous death of a thousand for every life saved by their justifiable use. The possession of such arms should be limited to military and police forces. For the hunter, the farmer, the explorer, and for target practice, the larger firearm affords quite sufficient service and protection. The concealed weapon is very seldom of value to any but the lawbreaker. The chief of one of the largest city police forces in this country says that more than 90 per cent of the sales of revolvers at the present time are to the criminal classes.

*Abolish
the
Revolver*

The revolver is really the weapon of the coward; without it the thug and holdup man would immediately lose his nerve in most cases, and would soon abandon his profession. Holdups in offices are of daily occurrence because one or two dash in and cover the occupants with "guns," but if these same bandits tried to accomplish their purpose with rifles, crowbars, or clubs, the results would be vastly different.

Some cities have tried to limit and control the sale of small firearms, but the effort is practically a failure because evasion is so easy, and then there is always the mail-order dealer sending goods in plain packages to fictitious names. If the bandit is afraid to purchase from regular dealers or pawnbrokers in town, he has the shipment mailed to some small suburb, a few miles out, where both he and the nature of the goods he receives are unknown and excite no comment.

350 N. Clark

A Chicago business man, John R. Thompson, a year ago advertised a reward of \$1,000 to anyone who would send him one really good reason (outside of military or police) why the manufacture of revolvers in this country should be allowed to exist. He has yet to receive a single convincing reason.

The alarming increase in crime and murder made possible by the possession of revolvers, has become such a national menace that nothing short of a Federal law prohibiting their importation, manufacture, sale, or possession (outside of museums, and military or police) can abate the evil. All possessors of revolvers should be required to turn them over to Government officials, and a heavy fine, or fine and imprisonment to fit the case, should then become effective. Criminals, fearing the strong arm of Government and finding it less easy to evade penalties, would be less inclined to carry arms, and as fast as arrested would lose what they had. We have too many laws now, but this is one more that would produce widespread and immediate good results, without depriving anyone of a necessary personal right.

Many publishers, recognizing the assistance which their columns were giving the criminal class by advertising revolvers to be sent by mail, are now voluntarily refusing to accept such advertising, although in many cases perfectly reputable firms were included in the ban. This magazine adopted such a policy months ago. Our Government should itself manufacture what few concealable firearms it permits to be used, and prevent all others from doing so, and from importing.

H. H. WINDSOR

STUMPS ARE QUICKLY BURNED

9929 WITH AIR-BLAST OUTFIT

Stumps can be quickly burned with the use of an incinerating outfit consisting of a blower driven by a gasoline engine, and a sheet-iron jacket which is placed over the stump to be destroyed. After the apparatus is in position, a fire is started at the base of the stump, and is steadily fanned with the engine-driven

a blower with sufficient capacity to supply several jackets with blasts may be utilized, thus making it possible to burn a number of stumps at one time.

RECREATION AND CAMP SITES GIVEN STATE OF MICHIGAN

3/5 Eleven park sites, ten of which have lake or river frontage, have been presented to the state of Michigan to help offset the congestion at the few remaining open parks and bathing beaches, resulting, it seems, from increased automobile travel. The new parks are all in the lake district around Detroit and consist of 627 acres of natural wood and lake country. Only one is without water, and that is a rugged stretch noted for its beautiful scenery. The purpose of the donation, as stated by the Dodge Brothers, is to provide a memorial to the late John F. and Horace E. Dodge, for whom the parks are to be

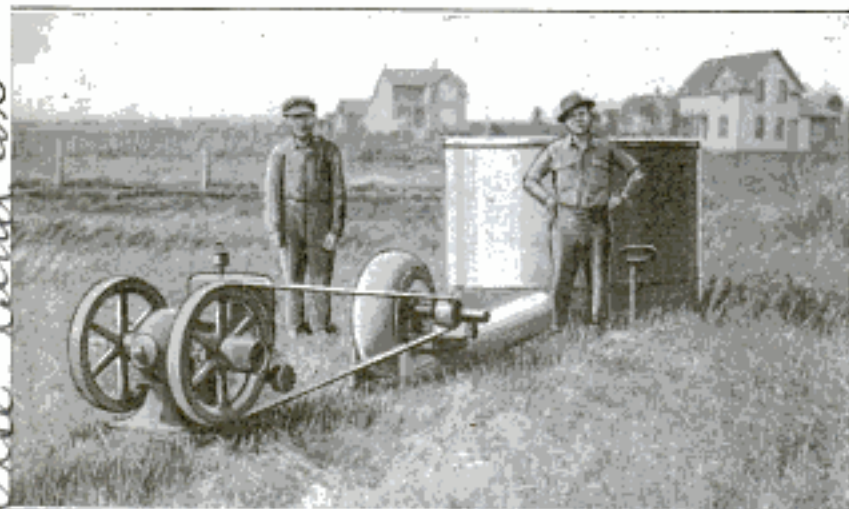

Air-Blast Outfit Which has been Successfully Used to Incinerate Stumps. Showing, from Left to Right, the Gasoline Engine Belted to the Blower Fan, and the Large Cylindrical Sheet-Iron Jacket

air blast until the wood is entirely reduced to ashes. The apparatus is safe, simple, labor-saving, inexpensive to operate, and does a neat job, and if desired,

named, and to give motorists places where they may have their picnics, games, and bathing without encroaching on private property.

Detroit, Mich.

Ans. Lawrence A. Wise Birchwood, Wis. Wise Land Co.

9906 Photos from: Atlantic Photo-Co.
Berlin, S. W. 11, Koniggratzer Strasse
Germany

POPULAR MECHANICS

705

PORTABLE SPRINKLERS WITH POWER-DRIVEN PUMPS

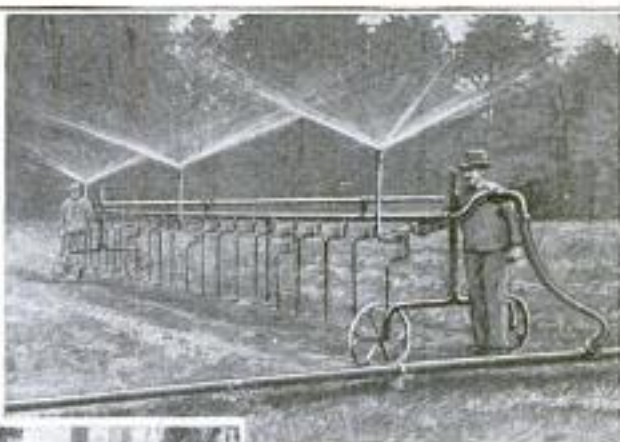
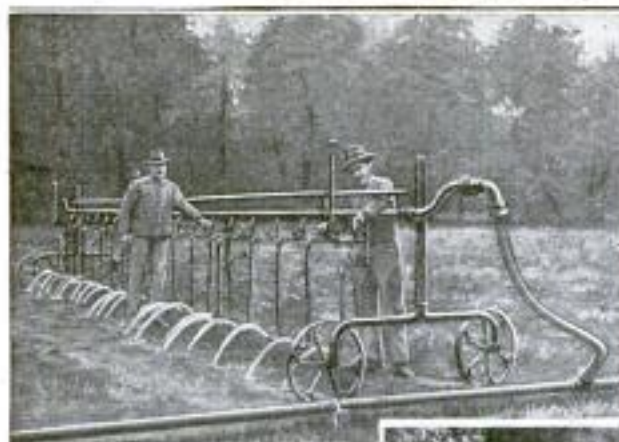

Large Portable Field Sprinkler with Its Suspended Discharge Nozzles in Use Throwing Streams of Water in Parallel Lines

9906

Large portable field sprinklers operated by gasoline engines and pumps, are in use in Germany, especially where intensive cultivation is applied. Each sprinkler, mounted on a pair of wheels at each end, consists of a long horizontal system of piping in connection with three vertical spraying nozzles above it, and with about 20 smaller sus-

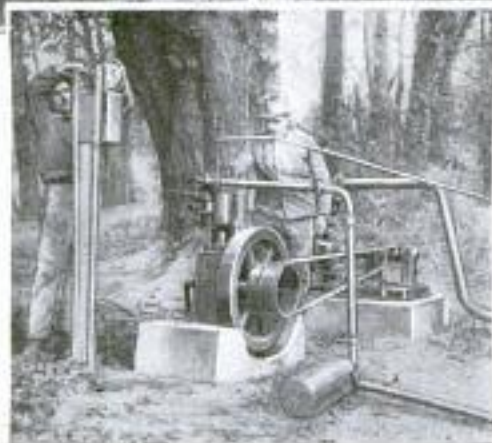

Gasoline-Engine-Driven Pump Which Furnishes Water under Pressure by a Hose Connection to the Sprinkler

Portable Sprinkler with the Upright Spraying Nozzles in Use, Showing How They Cover a Wide Area of Ground Evenly

ended pipes with discharge nozzles just above the ground level. The spraying nozzles cover evenly a wide area, and the hanging nozzles drop streams of water in parallel lines. The sprinkler can be operated at some distance from the source of water supply, where the pump is located, and which has a hose connection to the sprinkler.

240

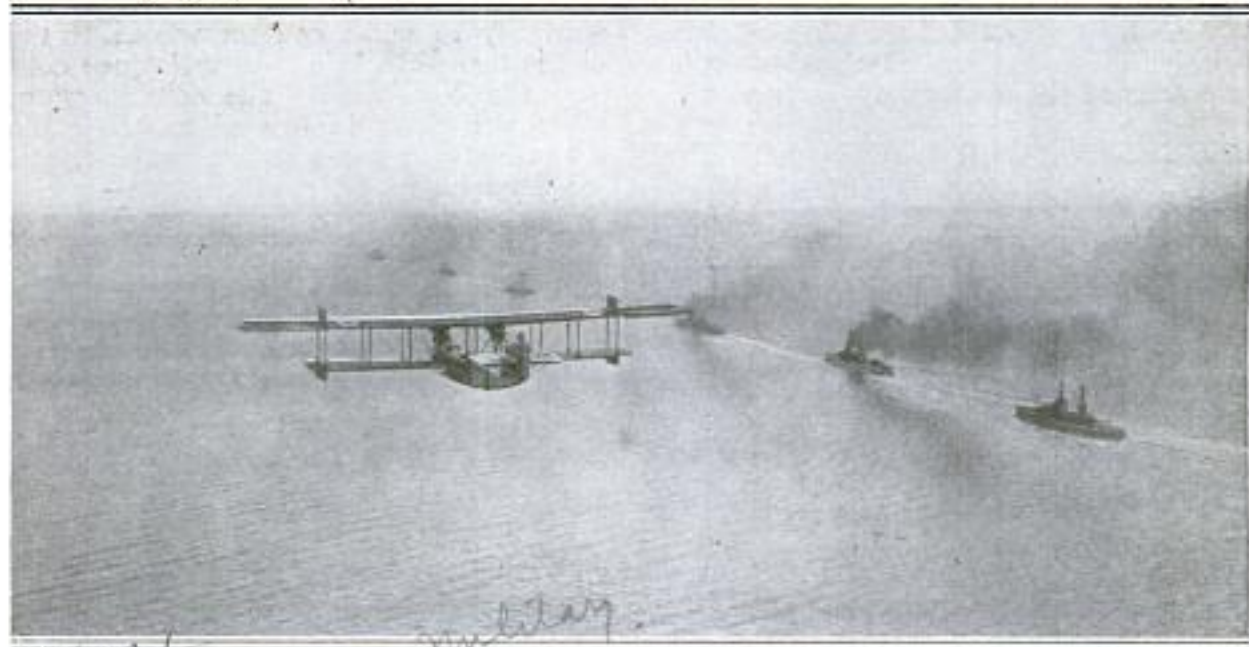

SEAPLANES ARE NOW ESSENTIAL IN NAVAL MANEUVERS

DURING recent maneuvers of the U. S. Navy, large seaplanes have accompanied the fleets and kept in constant touch, by radio, with the battleships. This type of plane is now an indispensable factor in naval operations, acting as a scout, and also directing the maneuvers.

The George B. Flynn Co
31 Claire St.
Lowell, Mass.

248

SMOKESTACK THAT SPECIALLY ATTRACTS LIGHTNING

Attempts are being made to ascertain what causes the attraction of lightning

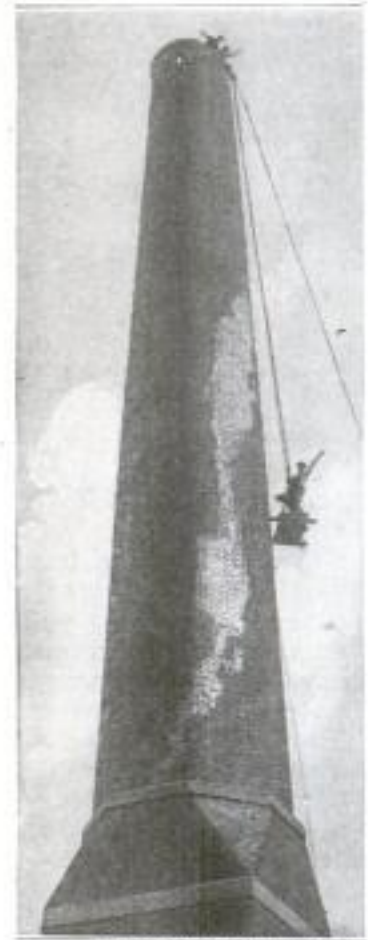

COPYRIGHT, UNDERWOOD & UNDERWOOD

to a smokestack 150 feet high that is located at the intersection of Elston and Webster avenues, Chicago. In the immediate vicinity there are some 22 other smokestacks of about the same height, and not one of them has been struck this year, whereas this particular one has been struck three times. The first time 50 feet of the top of the stack was demolished; the second time about the same length

was split, and the third time the lightning spiraled down the full length of the stack and reached the fire box of the furnace.

BATTERED, BENT, AND BROKEN CAR MAKES RECORD

Battered, bent, and broken, an American small car of a well-known make recently established an unparalleled record for consistent performance under the most adverse circumstances. This car, the property of the American relief, was driven across the great sand steppes of southern Russia and was the first machine to accomplish the passage of these wastes. However, even this car paid a severe penalty for the feat. After the long and dangerous trip, the tiny "Car of Juggernaut" came literally "limping" back with the appearance and sound, according to eyewitnesses, of a large tin can on wheels. Somewhere on the history-making tour, a front spring had been broken, the main bearings had disappeared, the

clutch band had parted, the grease had left the crankcase, and the tires were punctured. The versatile driver had used string, rope, wire, and sundry other materials to bind and bandage the damaged parts, had made main bearings from an old lead pipe, filled the crankcase with lard and the tires with sand, but the unconquerable "flivver" came triumphantly "home" under the power of its own grinding and "knocking" engine.

SLIDE-RULE DEVICE SOLVES TRIGONOMETRIC FORMULAS

A new instrument combines the ordinary slide rule in semicircular form, with a supplementary half from which can be read the values and solutions of trigonometric functions and formulas, and which also serves as a protractor. It is made of celluloid of substantial thickness with a transparent runner arm, and its pocket-fitting shape makes it convenient for field or office use.

RHEOSTAT AND JACK SWITCH COMBINED FOR RADIO

A new combined rheostat and jack switch for radio sets serves a double purpose and eliminates the use of a filament-control jack. The rheostat, which is operated by turning a dial on the panel, consists of two small resistance coils, connected by a tiny wiperlike brush. At the extreme rear end of the dial shaft is a cam which causes the jack switch automatically to make contact whenever the dial is turned to bring the resistance coils into the circuit. By the combining of these two parts in one piece, the radio enthusiast can use a smaller cabinet and panel for his outfit, and consequently less

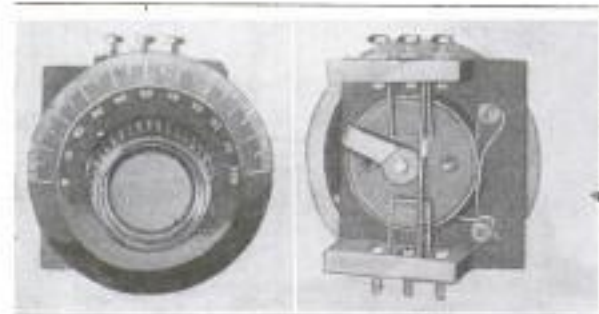

Left: Combined Rheostat and Jack Switch as It Appears from the Front of the Panel. Right: Rear of Appliance, Showing Contacts

wiring with less possibility of loose connections, so that a saving in space and cost, as well as added efficiency, are obtained.

Motor Age 9/7/22

Price \$1.75
Chicago St. Elgin, Ill.
W. K. Mcclure, 207

196 Curb George F. Paul
900 Ellsworth Bldg,
Chicago



Scene at New Laredo on the Mexican Side of the Rio Grande, during the Flood This Summer, When the River Covered the Streets near the International Bridge under Two Feet of Water

196 TEXAS PLANS FLOOD CONTROL ON THE RIO GRANDE

THE Rio Grande, which forms the international boundary between Texas and Mexico, impresses the average traveler as a passive stream content to follow its sinuous course among the sand bars to the



Flood Damage Done to Offices of Custom, Immigration, and Health Departments Located at American End of International Bridge across the Rio Grande

Gulf of Mexico. During the dry season there are spots in its bed with barely enough water to refresh a team of horses, and yet Texans living along its banks in the summer of 1922 saw it rise in a few hours to a swollen torrent.

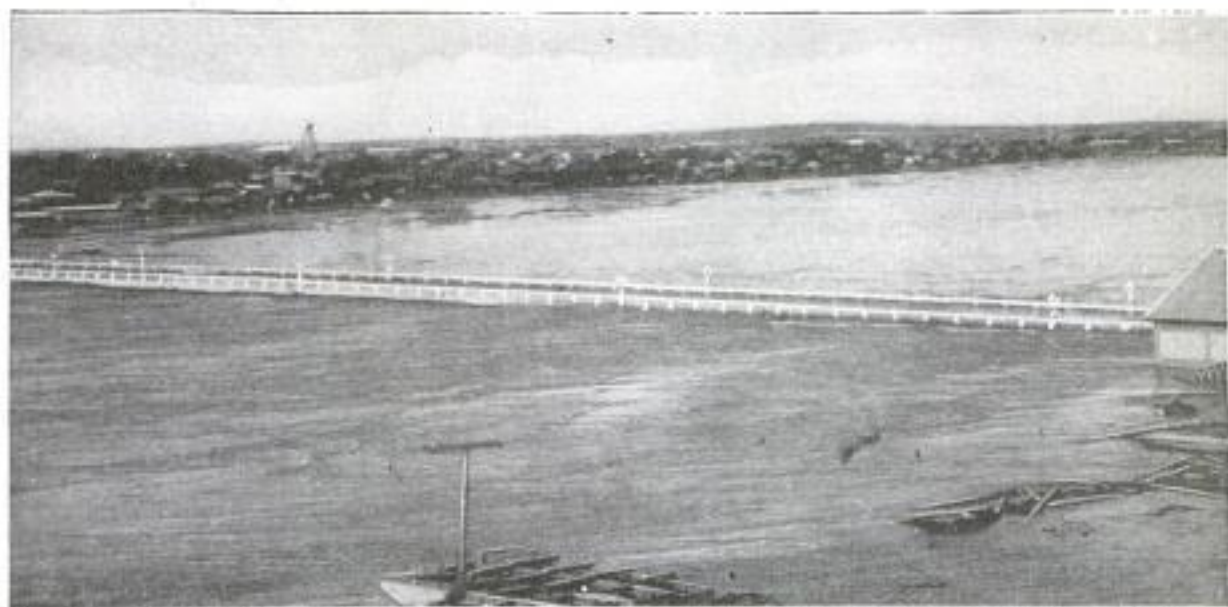

The International Bridge at Laredo, Texas, 40 Feet above the Normal Level of the Rio Grande, as It Looked at One Stage of the Recent Flood

Because of these experiences, the state of Texas is now planning to avert future floods, with their attendant loss of life and property, and remove the menace to important railroad centers. The new international bridge, at Laredo, had hardly been completed when the river suddenly rose in the recent flood to a height of 51 feet above its normal level, submerging the bridge under several feet of water

and entirely destroying the Laredo approach. For the first time, one block of streets beyond the bridge on the American side and several blocks on the Mexican side were covered with water, and the Immigration, Public Health, and Custom departments at the end of the bridge inundated. This flood was the worst since the one of 1919, when a high-water mark of 34 feet was recorded.

104
**PERAMBULATING INCINERATORS
 IN CALIFORNIA VINEYARDS**

Far from ruining the grape industry, as was at first feared by those interested,

advanced method now used in the vineyards for the production of the best possible crop, both in quality and quantity.

After the grape crop is harvested the vines are cut off close to the ground, to

grow up again the following year. Formerly the stalks were burned on the fields, but now it has been learned that the burning of grape stalks on the ground is injurious to next year's crop. To get rid of the old grape stalks, the growers now use wheeled incinerators in which the stalks are burned as the odd vehicle is drawn through the vineyards by teams of mules. The draft gear is lengthened, to keep the animals away



This Incinerator is Towed about Vineyards for Burning Grape Stalks and Weeds, So That the Ashes are Not Deposited in the Soil to the Detriment of the Following Year's Crop

prohibition has actually boosted the business. One way in which the increased prosperity has expressed itself is the ad-

from the heat of the fire in the incinerators, and the ashes are hauled away in the same vehicle.

114
FOREST-SERVICE MEN HONORED BY MEMORIAL

Commemorating the brave men who lost their lives fighting forest fires in Idaho and Montana in 1910, the United States Forest Service recently caused a monument to be erected in the first-named state. The memorial is located in the heart of the St. Joe National Forest, and consists of natural stones cemented together and forming a rectangular inclosure, with a column rising at one side. On the column is a tablet bearing the names of four men and designating another simply as "un-identified." Beneath the names is the inscription:

"Died Fighting Forest Fires. August 20, 1910."



Monument of Natural Stones, Erected as a Memorial in Honor of Forest-Service Men Who Lost Their Lives While Fighting Forest Fires in Idaho and Montana in 1910

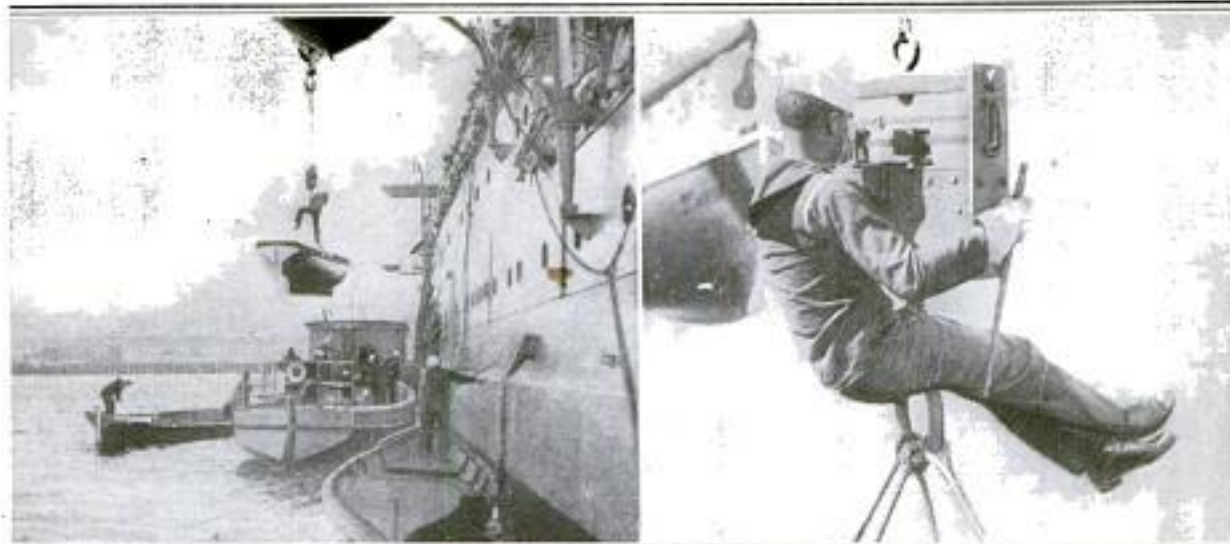

Left: Weighing In the Boat Representing the Battleship "California," Winner of the Recent Pacific-Fleet Boat Race, to Ascertain That It Had the Required Poundage of 1,650. Right: Close-Up of the Scale Used in Weighing the Boats, and the Sailor Who Acted as Official Weighmaster for the Event

PACIFIC-FLEET BOAT RACE

202 CLOSELY RUN

One of the most interesting events in the annals of Pacific-coast sportdom—the championship boat race of the Pacific fleet—was held on Lake Washington, Seattle, the last week in August, and was participated in by carefully trained boat crews from 11 warships, including the 1921 champions from the dreadnaught "Mississippi." The race was run over the usual two-mile course and was won by the "California's" crew. More than 50,000 persons witnessed the contest.

Every boat entered in the race had to comply with U. S. Navy standards. Testing the entrants was a matter of precision, and each boat had to meet a weight as well as displacement test. Each boat had to weigh 1,650 pounds; if too light, ballast was added to make up the weight. The crews, although constantly in the pink of condition, due to the nature of their vocation, spent several weeks in intensive training in preparation for the race. The thoroughness of this training may be judged from the fact that at the end of the two-mile race, four boats, entered by the "New Mexico," "Tennessee," "Mississippi," and "California," were grouped less than 9 feet apart, the close finish arousing great excitement among the spectators.

■ A 15-acre orange grove within the city limits of Anaheim, Calif., has been purchased at a cost of \$45,000 by the Chamber of Commerce as a site for the annual Valencia Orange Show, held in May, each year.

BODY OF MOTOR CAR BUILT TO IMITATE CHURCH

Constructing an imitation church on the chassis of a small motor car of well-known make, was the method adopted by a New York minister literally to take his sermons to the people. The odd-appearing vehicle, in which he intends to tour the country, has windows in front, doors at the sides, a steeple on top, and a pulpit at the rear, from which he preaches to the various gatherings.



Imitation Church and Its Pastor, Shown Ready for the Beginning of the Country-Wide Tour of Preaching

Rev. Stanford Clarke
 New York City

J. W. H. Cooley,
Sales Mgr. Western Electric Co

710 POPULAR MECHANICS

84 Marion St., Seattle, Wash.

"FOOL-PROOF" TIRE FILLER PREVENTS ACCIDENTS

193

"Fool-proof" methods have superseded the old way of filling automobile tires,

which was a precarious task when the air-supply pressure was not known. The new way includes the installation, on the air line, of a gauge containing a movable indicator, in addition to the usual "hand."



This indicator is first set at the point on the gauge which the motorist desires his tire pressure to be. When this pressure is reached, the gauge shuts off the supply.

NEAT MATCH HOLDER FASTENS TO WINDSHIELD BY VACUUM

For the convenience of motorists a match holder has been devised which, by means of two rubber vacuum cups, can be fastened to the windshield, side-door window, dash, or any other part of the car that is flat and smooth. It is only necessary to moisten the edges of the cups and push them tightly against the surface, to which they adhere tightly.

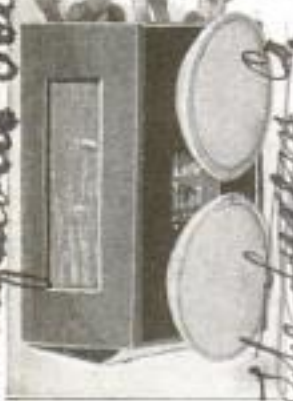

APPLES ARE MONOGRAMMED IN WESTERN ORCHARD

Monograms were stenciled, this fall, on the entire crop of an apple orchard in the western part of the state of Washington. The name or the coat of arms of the consignees, for the most part large hotels, was put on in blue ink while the apples were still green. After they had ripened, the ink was washed off, leaving the design in pale greenish-yellow.

QUARTER-IN-SLOT MACHINES FOR RADIO SERVICE

256

Evidence of the popular trend of radio is the announcement of a manufacturer of wireless apparatus, of contracts for 25,000 receiving sets to operate on the deposit of a quarter. Most of the outfits are for hotels and hospitals, where a guest or patient can drop in a coin, as in a chewing-gum or peanut-vending machine, and hear concerts, market reports, weather forecasts, baseball scores, and news of the day for the next 12 hours.

SPARK PLUG SELF-CLEANING BY CAUSING AIR SUCTION



A new self-cleaning spark plug, similar to any standard plug with the addition of an automatic air-intake valve, is said to have proved very satisfactory. The small intake valve connected to its iron shell admits air, during the suction stroke of the piston, around the central electrode and its insulation, thus both cleaning and cooling them. It has the further advantage of admitting air instantly at the beginning of the suction stroke of the piston, thus preventing excessive low

pressure, which has a tendency to suck oil into the combustion chamber.

REINFORCEMENT FOR BRIDGE ASSEMBLED ON BARGES

Engineers in charge of the construction of the new Belle Isle bridge, at Detroit, had the reinforcing steel for the concrete arches assembled on barges. Two steel barges were sunk under the timber framework upon which the reinforcement had been built up, and when pumped out, caused the whole section, with part of the framing, to lift clear of the temporary supports. The barges with their load were then towed into position at the bridge, and the section of reinforcing steel was lowered into place on the piers by letting water into the hold of the barges.

The Cooley Tire Inflator Co. Chicago
Chicago
Chicago
Chicago

Stamped on ink blue ink with rubber stencil.

Sold by J. St. Robertson Wichita Falls Texas
(Mrs. F. S. Williams)
Wichita Falls Texas

Emb. F. W. Pickle 502 1/2 12th St. N.E. Seattle, Wash.

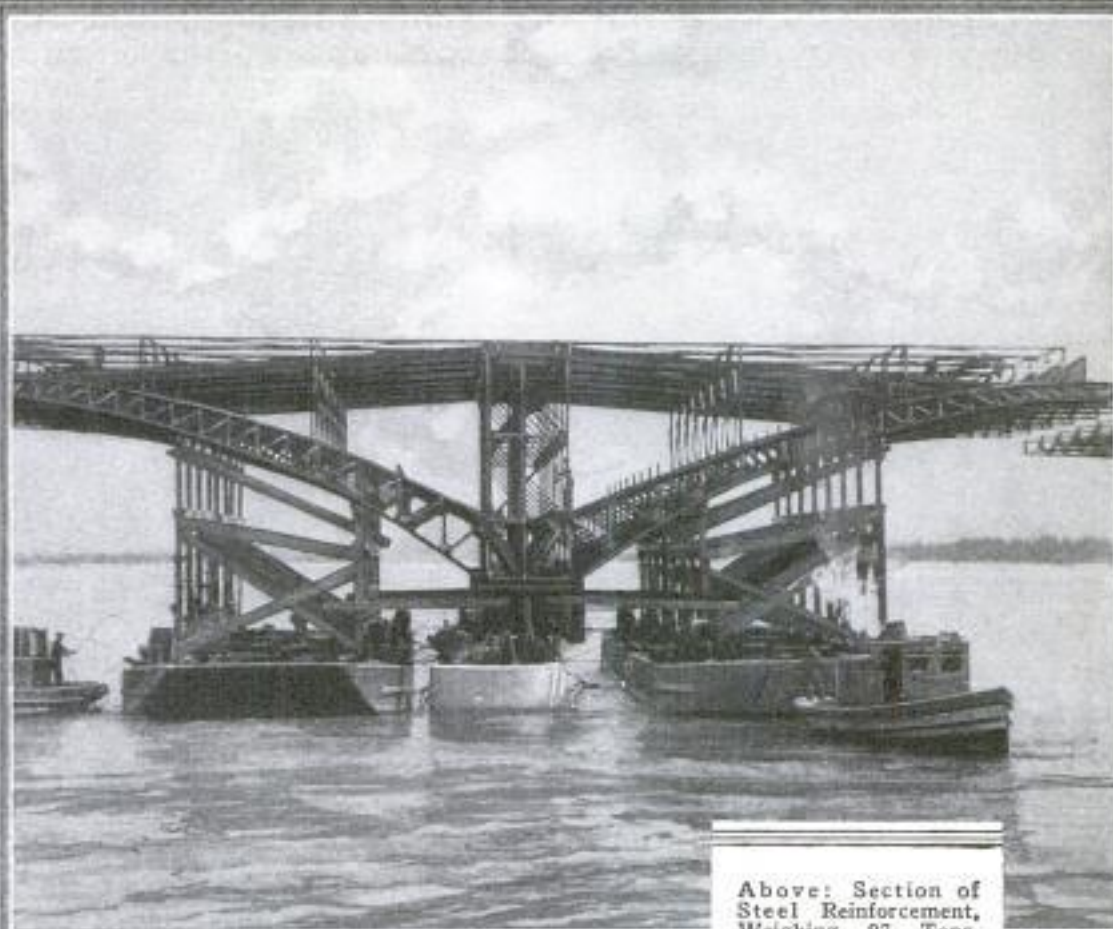

Above: Section of Steel Reinforcement, Weighing 97 Tons, for Concrete Bridge, at Belle Isle, Detroit, being Placed on Bridge Piers. Below: Section of Reinforcing Steel, Assembled on Barges, Ready to be Towed to the Bridge



W. R. Mc diver, Elgin Radio Supply Co.

712

POPULAR MECHANICS

Elgin
RADIO VARIABLE CONDENSER
OF COMPACT DESIGN

A new variable condenser for radio equipment possesses many good features, chief of which are compactness of design

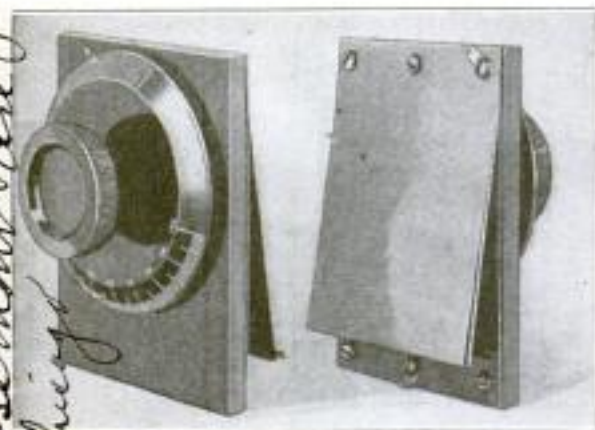

Front and Rear Views of Radio Variable Condenser, Showing Movable Plate Raised by Action of Dial Shaft Extending through the Panel

shaft through the panel. With this condenser, close tuning is made easier than with the rotary type, as three turns of the dial are necessary to vary the apparatus from its minimum to maximum capacity. In addition, the rigid construction causes the condenser to remain in adjustment regardless of any accidental knocks or jars.

195
DE-LUXE TAXICAB FITTED UP
LIKE A PARLOR CAR

A sensation in motor cabs is one that has appeared fitted up like a parlor car, and with the beautiful finish and luxurious appointments of an expensive private limousine. The unusually large body has wide plate-glass windows which extend to the top, and may be lowered into the sides in warm weather, affording a wide range of vision. Extra-wide doors extend to the running board which is only 16 inches above the ground, to permit easy entrance and exit. The rear seat is an overstuffed lounge, while the others are large wicker chairs held to the floor by rubber vacuum cups, which the passenger can release when desiring to move the chair. The driver's compartment provides space for hand luggage. Cut-glass dome lights and flower holders, a vacuum water carafe, ash receivers, mirrors, and a folding table are among the other attractive features of this unusual commercial car.

and cheapness in price. The appliance is constructed with a movable, but not rotary, plate, which is adjusted by the usual dial on the

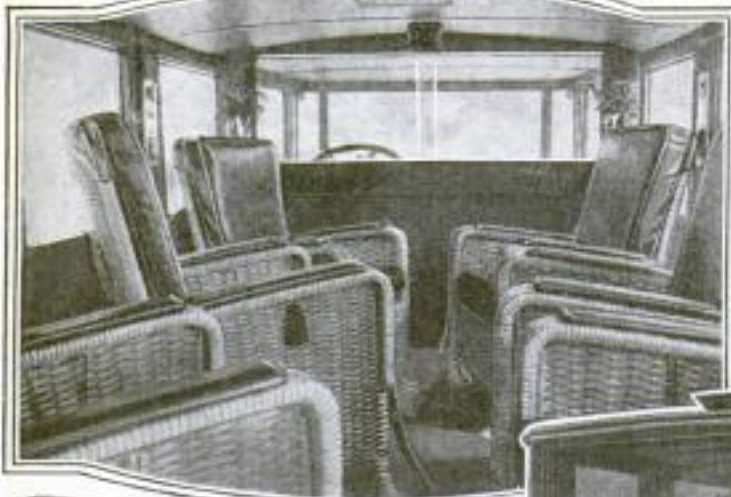

Roomy Interior of Parlor Taxicab, Showing Comfortable Wicker Chairs and Large Windows

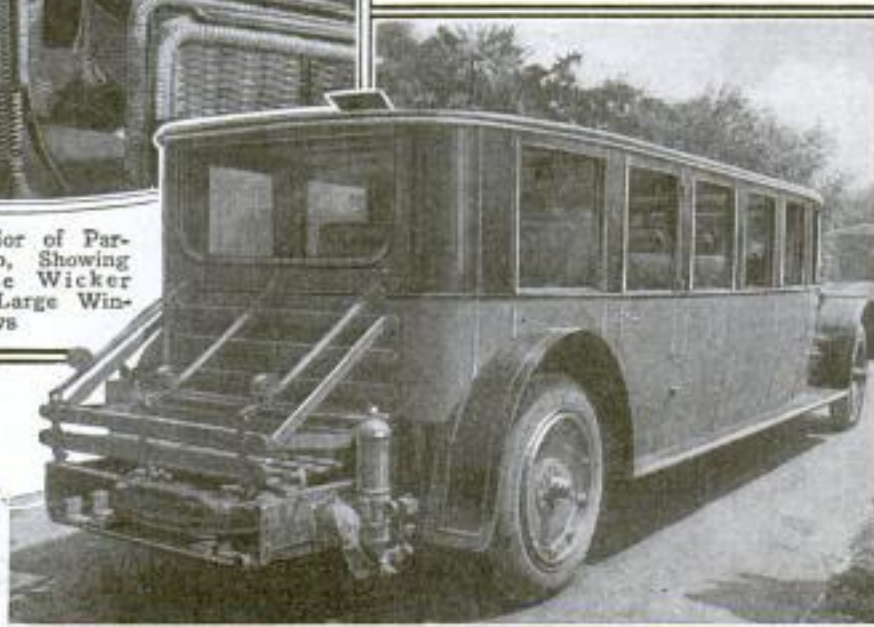

Left: Note Rubber Vacuum Cups Which Hold Chair Legs to the Floor. Right: Rear View, Showing Substantial Tire and Luggage Rack, and Large Air-Cushioned Shock Absorbers

Hogew Motor Co, Oakland, Calif.

Rosemont Radio Supply Co. Chicago

Copyrighted material

8222

BULL
M
Add
MI
U:
M

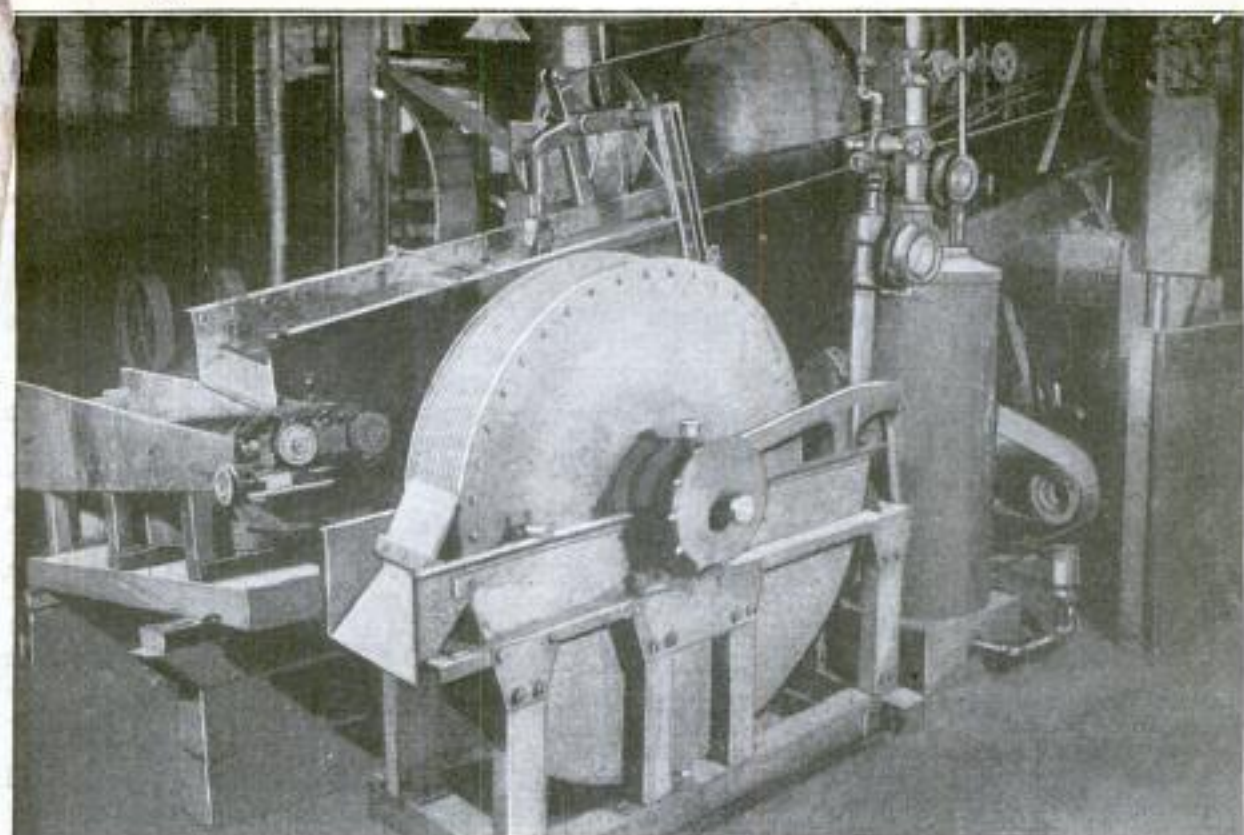

Equipment for Fine Grinding and Magnetic Concentration of Iron Ore: The Drum Filter is Shown in the Foreground; in the Center Is the Long Trough, or Classifier, at the End of Which is Shown the Magnetic Log Washer, While at the Top, in the Rear, can be Seen Part of the Pulverizing Ball Mill

TAPPING NEW IRON RESOURCES

BY EARL CHRISTMAS, *628 Grand Ave. St. Paul, Minn.*

UP AT Babbitt, Minn., an experiment of great importance is being worked out these days. If it succeeds, the life of the iron-mining industry in the Lake Superior district, instead of being limited to a score of years, may be doubled or tripled. Billions of tons of low-grade ore, hitherto regarded worthless, may be converted into iron. Under present mining methods, an ore cannot be mined profitably in this territory unless it contains about 50 per cent iron, and ores with a smaller iron content must be concentrated before shipment if they are to be utilized.

Magnetic concentration of the ore through a new process developed at the mines-experiment station of the University of Minnesota may be the solution of this problem. The process is being put into operation on a large scale

at Babbitt, at the eastern end of the famous Mesabi range, and represents the first big attempt of the kind to utilize the lower-grade ores.

Magnetic concentrators had been used before with materials of rather coarse nature, and with considerably richer ores. The mines-experiment station went farther and developed a device, known as

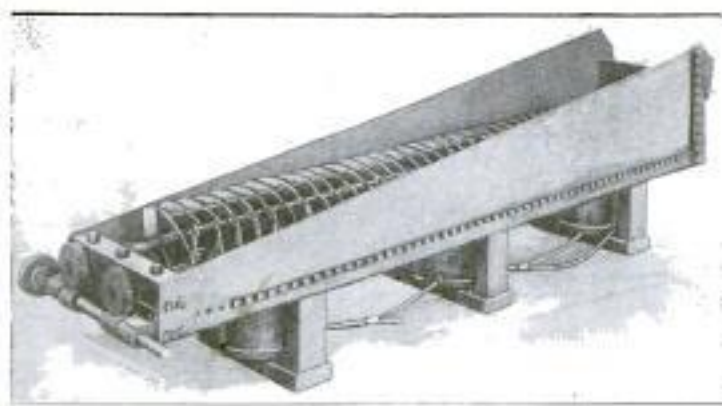

Magnetic Log Washer Which Makes Possible the Use of Billions of Tons of Hitherto Worthless Iron Ore, Showing How the Electromagnets are Placed beneath the Washer

the magnetic log washer, which separates the iron from the rock in pulverized form. This supplied a missing link, as it were, and apparently has made possible the utilization of great stores of ores considered unprofitable.

Worked out on a small scale at the university, the process was tested by mining experts in a mill built for the purpose in Duluth. As a result of the tests, a plant costing \$3,000,000 is just being completed at Bah-

8222

bitt, the first unit in a large mill planned there. If this first unit proves the process is a success under actual conditions in the field, then many more units will follow.

Nor is this the only reason mining men are watching Babbitt with so much interest these days. Minnesota has great stores of hematite that cannot be utilized

be made magnetic by heating. Then, the ore may be treated by the process of magnetic concentration.

In the plant at Babbitt, large crushers will reduce the rock to pieces about 2 inches thick. It then passes through a device known as the "magnetic clobber," which excludes part of the nonmagnetic material. The magnetic clobber, operating with these coarser materials, has been in use for some time in other districts.

The process of crushing, cobbing, and discarding worthless materials continues until the ore is reduced to pieces about 1/4 inch in size. Then it is pulverized in ball mills. The ore next goes to the magnetic washer, the final step in the process of separation. In this boxlike apparatus, magnets attract the magnetic materials to the bottom and

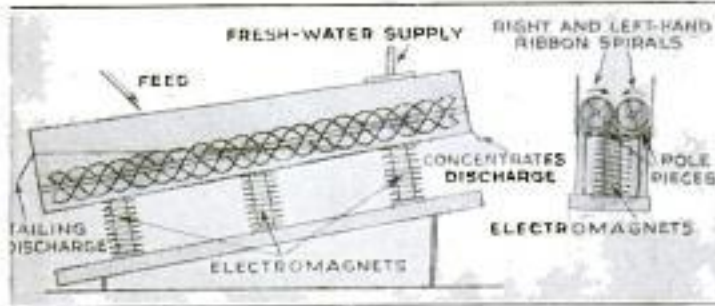
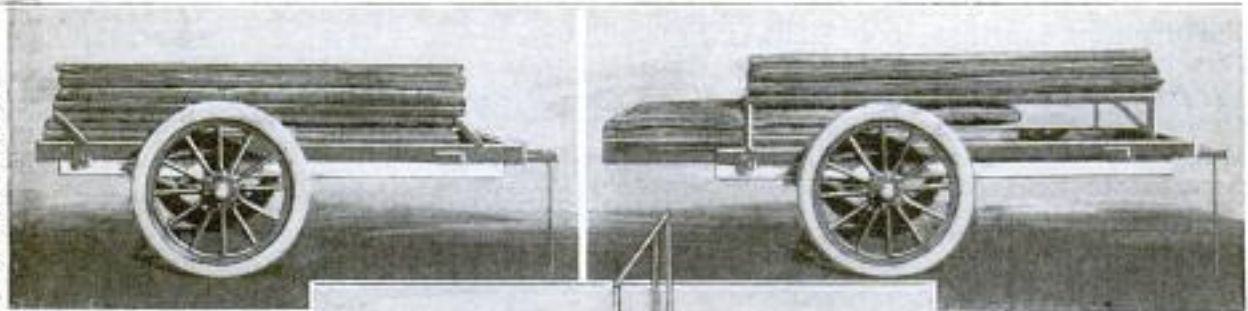

Diagram Illustrating the Principles upon Which the Magnetic Log Washer Operates, and Showing How the Magnetic Materials are Retained and the Nonmagnetic Washed Out

under present mining methods. Now, hematite is very similar to magnetite in composition, except that hematite has a slightly larger percentage of oxygen. Hematite is not magnetic, however. But engineers have shown that hematite may

hold them there, while water, running through the washer, carries away the waste rock at one end of the log washer. The concentrate, containing about 64 per cent iron, is delivered at the other end.

AUTO TRAILER FOR TOURISTS MAKES CAMPING EASY



Two-Wheeled Automobile Trailer with Its Two Double and Two Single Beds Packed Ready for Traveling

In Preparing to Camp, the Two Bottom Beds are First Pulled Out, Allowing the Upper Beds to Drop Down

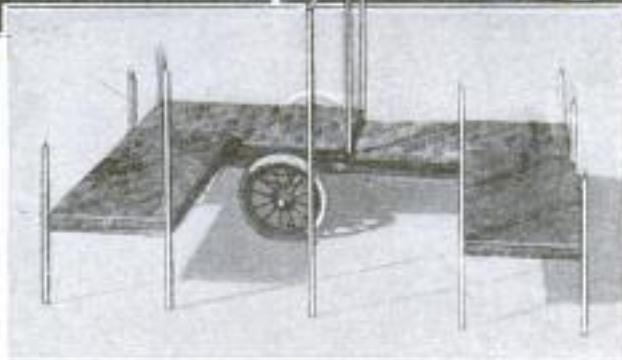

The Beds are Shown Ready for Use, with the Head of Each Single Bed Bolted to the Side of a Double Bed. The Ridgepoles between Them Support the Tent

Camping is made easy for the automobile tourist by the use of a trailer specially designed for that purpose. Mounted on two rubber-tired wheels, the frame of the trailer is 7 feet long by 3 feet 10 inches wide and carries, piled one above the other when traveling, two double and two single beds. When camping, these are

pulled out and arranged side by side in such a manner, that, in connection with steel supporting poles, a canvas tent can be thrown over the whole. When traveling, this tent is carried on the trailer beneath the beds, and in front of them is a box for a camp stove and cooking utensils.

Chas. E. Hancock, Liberal Kans. d.w.

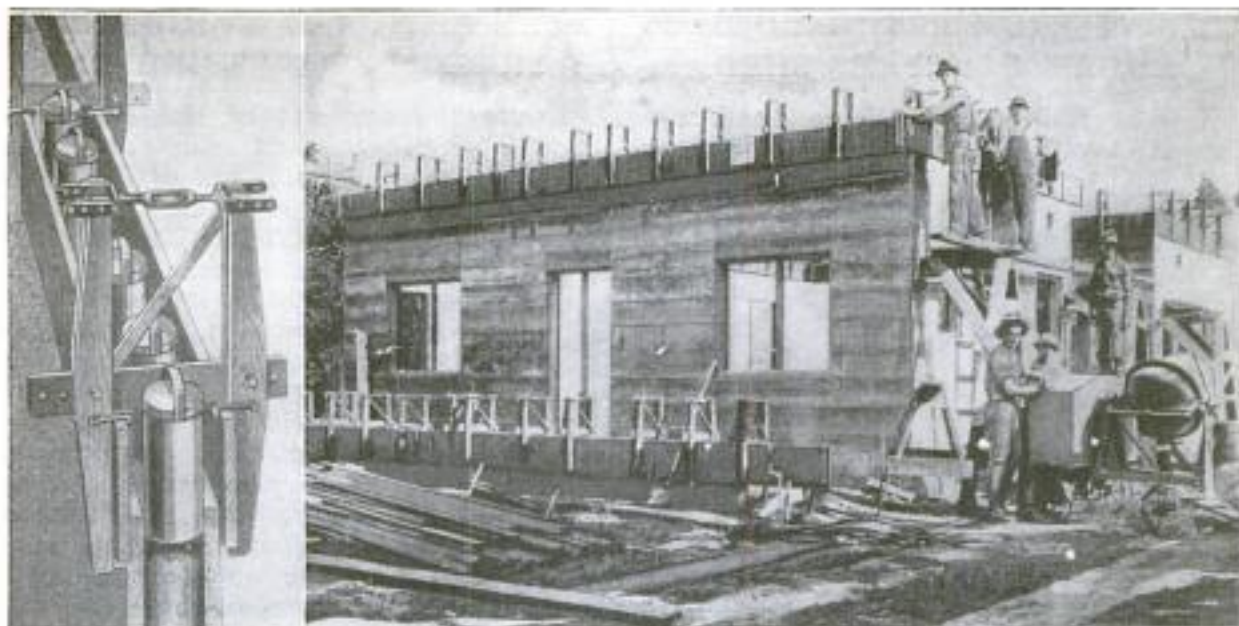

Forms for Pouring Hollow-Concrete Walls, Which are Built in Courses: At Top of the Finished Part of the Walls, the Forms are Seen Mounted and Ready for Pouring the Next Course; at Left Is an Enlarged View, Showing One Frame and Several Core Members

**FORM FOR POURING CONCRETE
 HOLLOW WALLS IN COURSES**

Simple and inexpensive in construction, a form for hollow-concrete walls that is very readily placed in and removed from its operative position has been recently patented. The form is composed of frame members, a series of which are mounted along a finished course of the wall so as to provide means for supporting sideboards extending upward and making a form for pouring the next course. Each frame member consists of a pair of uprights with transverse braces between them that are adjustable so that the sideboards can be supported in suitable position for any thickness of wall. Equally spaced between the sideboards are placed cylindrical core members to form a hollow-wall construction. They are supported in the cored holes of the finished course, and extend upward so as to continue these holes.

**STORM KING MOUNTAIN ROAD
 READY FOR AUTO TRAFFIC**

A splendid highway skirting the Storm King Mountain on the west bank of the Hudson River is now ready for auto traffic. The road, which necessitated six years of blasting through the rocky ledges of the mountain, shortens the route from Newburgh to New York by about 16 miles. The main section, which lies between West Point and Cornwall, is considered to be one of the most beautiful stretches along the Hudson.

*N. Y. Times 9/3/22
 P. 12. Sect. 1.*

**PHOTOGRAPHIC STATUETTES
 MADE VERY REALISTIC**

Recently introduced into this country from Europe is a very interesting method of making photographic statuettes.

The subject is photographed in the usual way. The paper print is then cut out, following the exact outline of the figure. This is pasted onto a mahogany board, $\frac{3}{16}$ inch thick, which is cut away to match the photograph. When mounted on a small pedestal, this picture stands out in relief so that it looks like an actual statuette. At a distance it is hard to tell the difference.



Individual "traffic maps," distributed to the 1,500 pupils of the Southside High School in Fort Wayne, Ind., guided them through the building during the first days of the fall term.

*Chicago
 William Louis Roehne,
 Michigan + Monroe*

*J. B. Holdcroft,
1485 Ford St.*

*Engineering News-Record
8/10/22*

*716
Victoria B.C., Canada*

POPULAR MECHANICS

**CEMENT FROM RETURNED BAGS
BUILDS CONCRETE SHED**

**PLAN NATIONAL ENGINEERING
MUSEUM AT WASHINGTON**

9858 The possibilities that lie in small savings are again demonstrated by a western

289 Under the auspices of the American Society of Mechanical Engineers, the

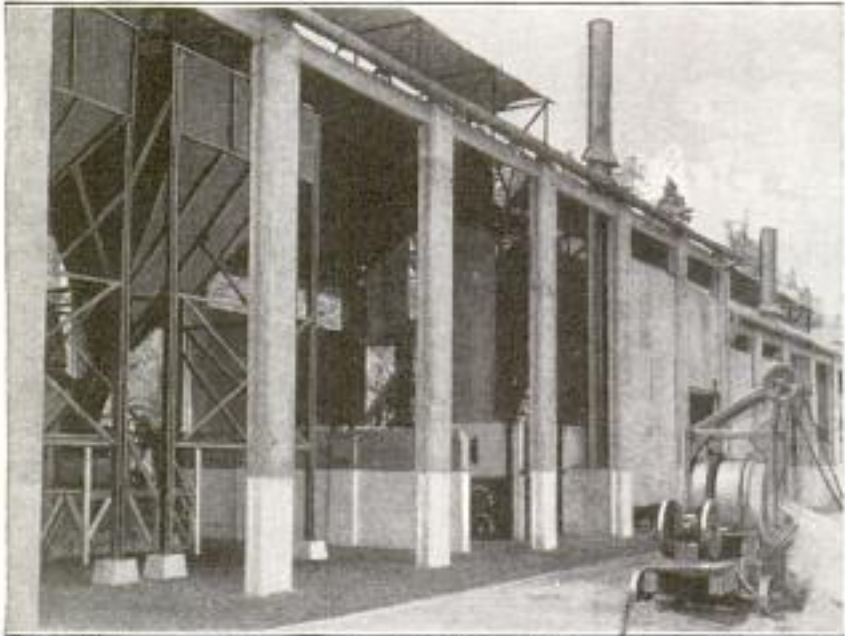

This Building was Constructed of Reinforced Concrete, the Cement for Which was Entirely Obtained from Empty Sacks Returned to the Mill of a Western Cement-Manufacturing Company

coöperation of engineering societies, alumni associations, engineering schools, and others, is sought in support of a project for the establishment of an engineering museum in connection with the National Museum at Washington. The plan has the support of the Smithsonian Institution. With adequate coöperation, it is expected that there will be established at the national capital an engineering shrine worthy of the profession, and of great educational value. All societies or organizations interested can obtain further information by addressing Joint Committee on the National

cement manufacturer. At his plant a concrete building has been erected, using only cement recovered from returned empty bags. A special machine beat the cement out of the sacks, and enough cement was accumulated in this way, in a comparatively short time, to complete the structure. Large users of cement would do well to consider this, and save for themselves not only the cement reclaimed, but also the extra freight on this cement if returned with the bags.

Engineering Museum, A. S. M. E., 29 West 39th St., New York City.

**EXTRA WATER MAY BE HEATED
IN UTENSIL COVER**

Practical economy in the kitchen is aided by the production of a cooking utensil which includes a hollow cover having a water capacity of 3 quarts. With this appliance, the housewife may boil the meat, vegetables, etc., for the meal and at the same time heat enough

**SINGLE INSTRUMENT IS BOTH
SPEED AND FLOW METER**

Fitted on the instrument board of an automobile, an ingenious instrument which shows the driver the fuel consumption in miles per gallon, is attracting much attention in England. The instrument has the appearance of an ordinary speedometer, but is a combination of this instrument with a flow meter. It shows the miles per hour in the same manner as a speedometer, while by means of a small moving hand on the dial, actuated by the flow meter, it also shows the miles per gallon. Thus the fuel consumption can be tested for all speeds and all adjustments of ignition and carburetor, and the most economical conditions can be ascertained.



At the Right is Seen the Economical Cooking Utensil, While at the Left is the Removed Cover Which Holds Three Quarts of Water, That is Heated While Food is Boiled in the Pot

water in the cover to make the tea or coffee, or even to use in washing the dishes.

*myr. Inoha g m. b. H.
Nurnberg, OB avaria
Germany*

*water address
3-2
Chas. Fulton
Newington England
Director*

Copyrighted material

Ad no. es. W. S. Midley, New Holland, Ohio.



Clod Crusher and Leveler Chained to a Harrow Which is Hauled by the Small Tractor over a Plowed Field: It Crushes the Clods and Leaves the Soil Perfectly Level and Smooth. Three of the Bent Plates Are Sufficient for Most Kinds of Soil, But More can be Added

260
CLOD CRUSHER AND LEVELER IMPROVED MOTORCYCLE STAND
OPERATES WITH A HARROW 8829 SIMPLE AND EASY TO USE

Trailed by a disk harrow which is hauled by a small tractor, a combined clod crusher and leveler, recently constructed in Ohio, consists of a flat rectangular frame to which are attached three or more parallel metal plates partly bent down at an angle of about 45°. Following the harrow over a plowed field, these plates break up the clods, and level the soil much more smoothly than can be done by the harrow alone.

205
RUBBER Mallet FOR AUTO USE
SAVES TIRE AND RIM

A large manufacturer of rubber goods is introducing a mallet with a rubber head, intended to eliminate the injuries to tires and rims that result from careless or misdirected blows from a metal hammer, when changing tires. The tool ought to save many bruised fingers, and will undoubtedly be appreciated by car owners and repairmen.

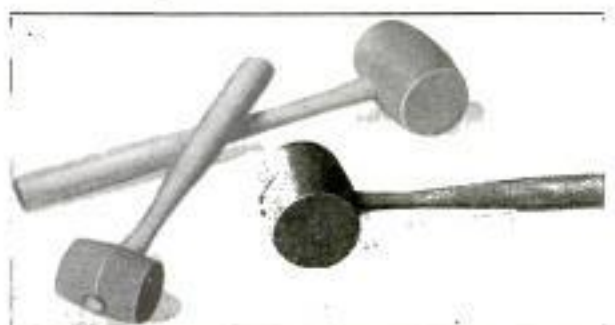

These Rubber-Headed Mallets, for Use in Changing Automobile Tires, do Not Injure Tires or Rims

The B. F. Woodruff Co., Akron, Ohio.

With a new motorcycle stand the lower base is arc-shaped so that, instead of being lifted up and over the brace, the machine need only be pushed backward, whereupon it automatically raises itself and settles into position. The base of the improved stand is held by two arms that join together near the wheel hub.

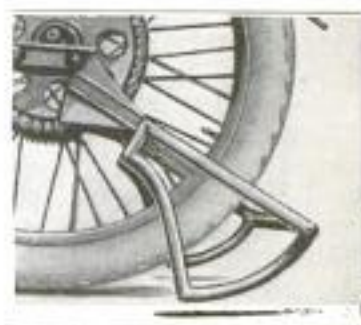

217
ROOFING MATERIALS TESTED
FOR HEAT RADIATION

Recent investigations of roofing materials in relation to their heat-radiating qualities, have been conducted by the U. S. Bureau of Standards. Nearly all material of this kind now available, either has both sides covered with asbestos, or both sides coated with aluminum paint. According to the experiments of the bureau, however, the best radiation results are obtained when only the outside of the roof is covered with asbestos or white paint, and the inside with aluminum paint. Thus it is claimed that tents and other similar inclosures, when exposed to the rays of the sun, can be made more comfortable in hot weather by preparing the roofs in that manner.

Bureau of Standards, Dept. of Commerce, 8/15/22

R. P. Valtier, 2910 Prairie Avenue Chicago

J. H. B. 64 P. 6.



Thirty-Eight Years of Cooperation have Made Possible This Gathering of North Dakota Farmers at the Farm of One of the Members of the Group Who Are Successful Breeders of Dairy Cattle

COOPERATIVE CATTLE BREEDING IN NORTH DAKOTA

BY ALLEN P. CHILD, Box 76, Station 6,
Kansas City, Mo.

MANY years ago an Indian stood watching one of the pioneer settlers of North Dakota as he plowed a field. After the farmer had completed a few

By retaining the prairie-grass pastures of the district around New Salem, 17 men, by their cooperative efforts, have established an enviable record in the raising



A Family from a Herd of Plains-Bred Cows Accustomed to Taking Their Living by Grazing on the Native Grass of the Prairie, of Which Eight Acres are Required to Support One Cow

furrows, the Indian stopped him, and bending over, turned back a piece of the freshly plowed sod, remarking simply, "Wrong side up." In a certain sense the Indian was correct, for hundreds of North Dakota farmers have found that wealth comes to those who plow not, but who maintain large herds of dairy cattle.

ing of pure-bred dairy cattle. In 1906, one man bought a carload of such cattle for sale among his neighbors, and no individual took more than one head. In 1921, this same group owned 251 pure-bred cows. Together they bought 10 silos and let a contract to a local concrete contractor for the foundations. Later they invested in eight milking machines. For 20 years they have maintained a mutual fire-insurance company. Their threshing is done in nine-men rings, and the silage cutting in five-men rings, the machines being jointly owned, manned, and operated. Four members who are neighbors use a section of pasture land together without cross fences, and have done so for 10 years. And so the effect



An Indian's Laconic Remark Led to the Foundation of North Dakota's Most Prosperous Dairying District, Where the Farmers Gave Up Plowing the Soil and Now Maintain Large Herds on the Prairie-Grass Pasture.

*Dr. Walter E. Loucke,
1023 Orange Grove Ave.*

South Pasadena, Calif.

of cooperating in securing pure-bred cattle has led them to apply the same principle in manifold ways to obtain the very most out of their farms.

A superintendent is employed who tests the cows of the members regularly, and helps them to keep feed-cost records. The members advertise their cattle as a unit, and show at fairs as a unit. Whenever a pure-bred animal is sold, five per cent of the sale price is put into the joint treasury to be used for promotion purposes.

9695

DESIGN KNOCKDOWN DECKING FOR SHIPPING AUTOS

Because of the great waste of lumber used for decking automobiles for shipment, a collapsible decking that can be used over and over has been patented. The supporting frame is made of castings and steel tubing, and castings are provided for bolting the frame to the car floor. The autos are supported on the hubs or axles, and rest on replaceable wooden blocks. When in position, they are securely held by lugs that fasten to

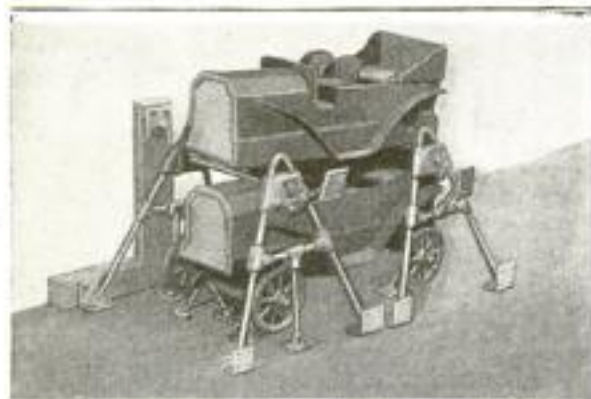

This Auto Decking, of Steel Tubing and Castings, Holds the Cars Securely and can be Folded and Returned to the Factory When Cars have been Delivered

the floor or the frame. When the cars reach their destination, the frames are removed, folded up, and returned to the factory.

224

OLD-FASHIONED WINDMILL STILL IN OPERATION

A relic of primitive flour-milling methods is a large windmill standing conspicuously on an island in Lake Vänern, Sweden. The main shaft, driven by the wings, is cut from one piece of wood and is 14 inches square. This drives, through wooden gears, a vertical shaft, also of wood, on which are mounted the millstones for grinding the grain. In these

days of power-driven rolling mills, such survivals of the kind of flour mill that



Old Windmill on an Island in Lake Vänern, Sweden: The Mill is Built Entirely of Wood, Including Its Driving Shafts and Gears

was once universal are interesting if not very useful.

SALESMAN OPENS OFFICE

281 IN LARGE OIL TANK

Having his office in an oil tank of the type he is selling, is the scheme employed by a California tank salesman to interest buyers. A hinged strip cut from one of the plates serves as an entrance, while an opened intake cap is used as a window. The office occupies a corner lot in a residential district.



Appropriate Office of an Oil-Tank Salesman in a California Town

Emb. W. A. Schrader, 5016 Van Ness Ave. Los Angeles, Calif.

Emb. Robert M. Lillespæl, Stockholm-Löteborg Cable

Sibyllegatan 39, Stockholm, Sweden

Wm. & Mrs. Adam
Ruger, 439 St. Luke St.

720
228 Philadelphia, Pa. POPULAR MECHANICS

**BRACKETLESS BANJO HEADS
ADJUSTED WITH ONE KEY**

A recent improvement in banjos, mandolins, and similar instruments does away with the old method of tightening the

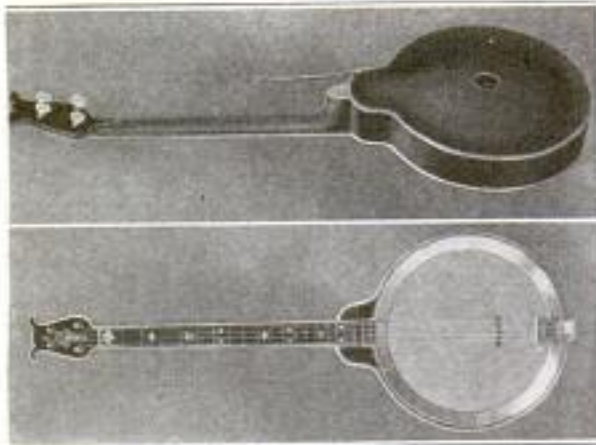

Banjo with Bracketless Head That is Adjusted Always Evenly, by Means of a Key Inserted in a Lock in the Center of the Back, as Seen Above

head by means of brackets, a method that often led to unequal tightening of the head, one side being perhaps too tight and the other side too loose. This is impossible in the new method, which adjusts the tension on the head suitably by the action of a key that is inserted in a lock at the center of the back of the banjo. With this key the adjustment is made in a second, and cannot be otherwise than perfectly uniform.

**CHIMNEY MOVED TO NEW SITE
EIGHT FEET DISTANT**

A brick chimney, 88 feet high and weighing 120 tons, stood on the site selected for a new building at Portland, Me., and it was a question of either building around the chimney, tearing it down and rebuilding it, or else moving it bodily. The latter plan was adopted, and

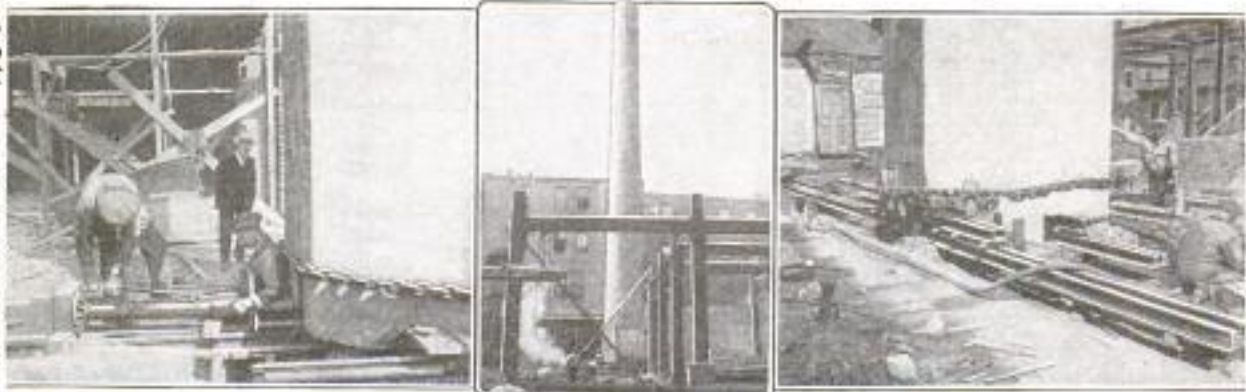

Left: Showing How One Man Operated a Jack to Move a 120-Ton Brick Chimney. Center: The Chimney before being Moved to the New Foundation. Right: Note Steel Rails Which Served as a Track

a concrete bed was laid for the track, on which steel rollers carried the stack to its new base, about 8 feet away. The actual moving was done by one man with a jack, and was accomplished in three hours, although several weeks were consumed in preparation and in securing the stack to its new foundation.

**CULTIVATION OF DAISIES
A PAYING ENTERPRISE**

218 The common white daisy which, when growing wild, is so irrepressible that it is regarded as a pest by the average farmer, has been converted by Luther Burbank, the plant wizard, into a nosegay popular with city dwellers. Burbank developed from the common stock a large beautiful blossom, called the "Maximum" daisy, and an agriculturist in Alabama conceived the idea of cultivating this plant, and selling the cut flowers to city florists. The enterprise has turned out to be quite profitable, and thousands of blooms were first sold in southern cities.



Field under Cultivation with the "Maximum" Daisy, Developed from the Common White Daisy by Luther Burbank: The Blooms are Shipped to City Florists

Recently blooms were sent to New York, where they arrived in good condition.

Contractor - W. S. Singley
Portland Maine

Dear Park, Ala.
Reader - L. K.

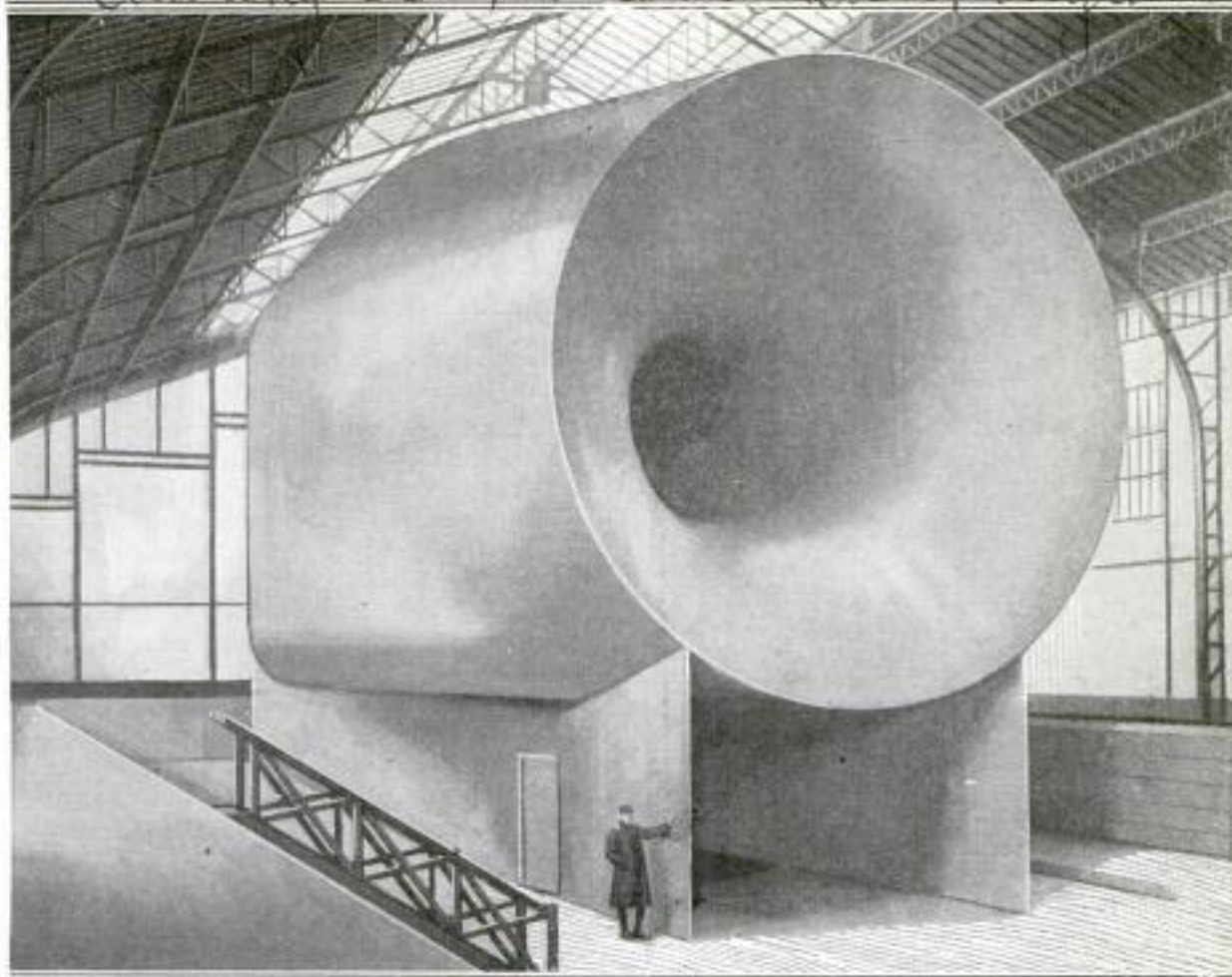

Intake End of Large French Wind Tunnel, Used for Testing Airplane Models: Note the Size of the Tunnel in Comparison with the Man Standing near the Base. It Is Nearly 100 Feet in Length and is Constructed of Reinforced Concrete

LARGE FRENCH WIND TUNNEL TESTS AIRPLANE MODELS

The French air service has built a large air tunnel to be used as a test chamber for miniature airplanes and models of parts of airplane structure. It is constructed of reinforced concrete and has an outlet resembling a huge phonograph horn, the mouth of which is 26 feet in diameter, while the tunnel is 10 feet inside diameter and nearly 100 feet long. The air current is created by an electric motor-driven fan of 1,000 horsepower, and can be maintained at a velocity of 185 miles per hour in the test chamber. The unusual dimensions of the tunnel and the high velocity of the air stream are the features of this installation, which is otherwise of standard type.

Red, white, and blue-blossomed clematis have been trained by a Washington woman so that, when in full bloom, the effect is an accurate reproduction of the American flag.

NONSINKABLE BATHING SUIT FOR TIMID SWIMMERS

Timid persons who lack a full measure of self-confidence while bathing, may now reinforce themselves in this respect by wearing non-sinkable suits. The garments are made of wool, knitted in the usual way, and have rubber tubes sewed on the inner side, which are inflated with air before the wearer enters the water. The tubes are incorporated in such a manner as to be hardly noticeable, and the outfit can be worn as an ordinary bathing suit when the air is released from the interior.



Knickerbocker Knitting
Mills, 1389 W. 6th St.
Cleveland, Ohio

*Manchester Guardian
Commercial 7/20/22*

CONSTRUCT MAMMOTH BARREL AS REFRESHMENT STAND

Built in the form of a huge barrel, a refreshment stand attracts considerable



Refreshment Stand Which was Built in the Shape of a Mammoth Barrel, Showing the Display Windows, Door, and Appropriate Name

attention from the motorists passing along the highway near which it is located. The odd-appearing structure is 20 feet in height, 14 feet in width, and consists of two stories or floors. The ground floor contains the display shelves, ice box, etc., while the upper portion is used as a storehouse for stocks of the goods on sale below.

time transported more than 49,000,000 letters, totaling 1,224,500 pounds. This outstanding record is attributed mainly to the experienced pilots who are now familiar with their routes, although it is felt that the abandoning of metal monoplanes, in which a number of fatalities occurred last year, has been a factor.

181
CARBON DIOXIDE SOFTENS BOILER SCALE

Investigations undertaken at the Mellon Institute of Industrial Research indicate that carbon dioxide is a solvent for the hard scale formed in boilers by some waters, and that it is an easy matter for the power-plant engineer to determine whether scale is susceptible to this treatment by a simple laboratory experiment. A few pieces of scale chipped from inside of the boiler can be placed in a stout bottle or other closed container, so as to be just covered with water, and carbon dioxide admitted from ordinary carbonating equipment, such as used in soda fountains. It should then be left under a pressure of 30 to 50 pounds per square inch, and the results observed at the end of four or five days.

127
PEG FOR STRINGS OF BANJOS AND OTHER INSTRUMENTS

For holding and tuning the strings of any instrument, but especially of the banjo, a transmission peg that prevents the strings from getting out of tune has recently been patented. The peg is screwed to the face of the head of the instrument, and is operated by turning a small handle, the spindle of which is geared to the peg. It takes three turns of this handle to make one turn of the peg, thus making possible very delicate adjustments.

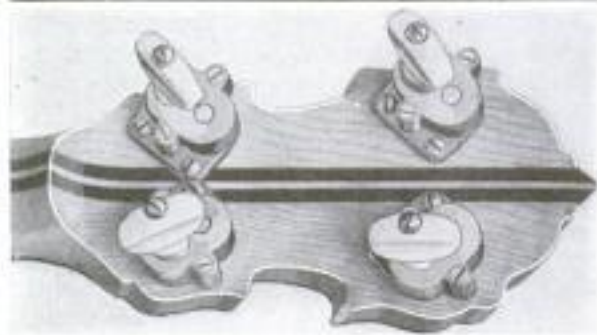

Transmission Peg for Banjos and Other Stringed Instruments: To Get a Higher or Lower Pitch on a String, the Small Handle is Turned Suitably

*William Page
225 E. 24th St.
New York City*

*Owner - W. L. Folgate, Mendocino, Calif.
Los Angeles, Calif.*

196
AIR-MAIL SERVICE GOES YEAR WITHOUT FATAL ACCIDENT

Not a single fatal accident in the air-mail service of the Post Office Department, is the record for the year ended July 16, which proves more conclusively than any other test the reliability and efficiency of the airplane. Flying daily in every kind of weather, the mail planes covered 1,750,000 miles on the New York to San Francisco route, and during that

Ariatic 7/31/22

SPECTACULAR REPAIR TASK OF LINE FOREMAN

Spectacular in the extreme, describes the task recently performed by a line foreman in repairing a high-tension transmission cable strung across the Straits of Carquinez, in California. These cables carry 110,000 volts and are 135 feet above the water, but despite this great height, a sailing vessel with an unusually high mast, drew down a lightninglike arc from one of the conductors and practically ruined it. To repair the



COPYRIGHT, UNDERWOOD & UNDERWOOD

Little Car in Which "Pete" Lindsay, the Fearless Line Foreman, Coolly Trolleyed Out upon the Damaged High-Tension Transmission Cable to Make the Necessary Repairs

trouble required the trolleying out upon the burned and weakened cable in a small car and working, literally, in mid-air. It being obvious that the undertaking was a precarious one, a volunteer was asked for. The foreman of the line crew immediately responded and, with groups of awed fellow workmen and spectators anxiously watching him, coolly pulled the little car out upon the swaying cable and repaired the damage.

67

CONCRETE-SURFACE CRUSHER FOR ROAD REPAIR

For use in concrete-road repair work a surface-crushing machine has been patented in Great Britain. Mounted on wheels, a strong steel frame supports a battery of eight drop hammers in front of it. These are operated in pairs by rotating cams driven by heavy flywheel pulleys and belts, in connection with a motor at the rear of the machine. With the drop hammers in operation, the machine is moved slowly along the road, and its concrete surface is broken up wherever necessary in repair work. At the end of each hammer is a chisel-shaped cutting tool, which can be removed.

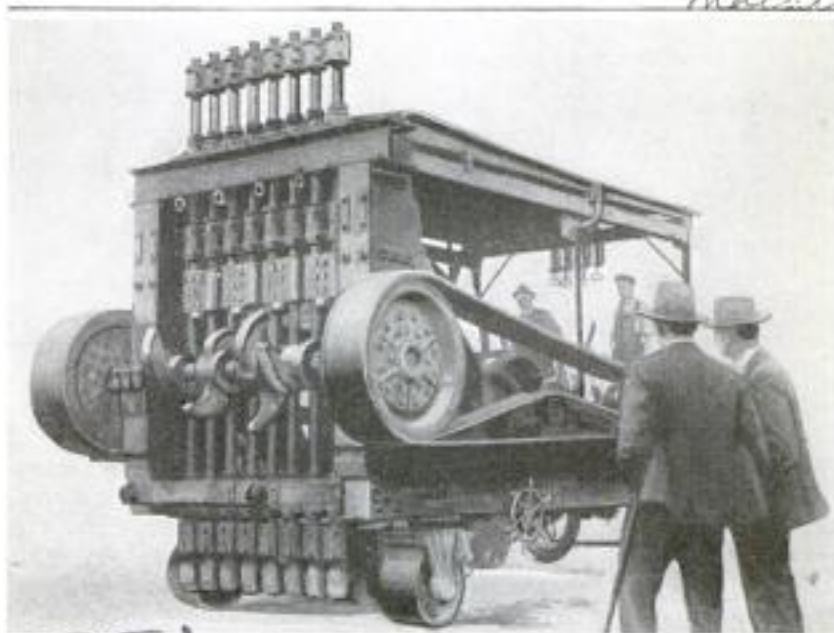

Concrete-Surface Crusher for Use in Road-Repair Work: The Eight Drop Hammers are Driven in Pairs by a Motor in the Rear Part of the Machine. On the Bottom End of Each Hammer is a Chisel-Shaped Cutting Tool Which can be Removed and Replaced

I.F.S.
no information as to
inventor or maker

13 7 724
Akron. Selle Co, Akron, Ohio

POPULAR MECHANICS

Built by above. To order for owner.

Auto
Touring



"Bungalow" on Motor-Truck Chassis That was Constructed for a Wealthy Ohio Man, and in Which He is Now Making a 2,000-Mile Tour of the Eastern States, Accompanied by Three Guests

128
**LARGE PIPE ON BICYCLE
ADVERTISES SHOP**

A new adaptation of old-world trade symbols is seen in the appearance of a large pipe mounted on the delivery bicycle of a pipe shop. The pipe is about 5 feet long, with its bowl resting upon



The Pipe on the Delivery Bicycle Shown Above Advertises the Shop, and in Addition Is Useful for Carrying Supplies

the rear axle and its stem over the handlebars. It has not only proved an effective means of advertisement but is found useful as well, as the bowl can be filled with smokers' supplies when the regular wire basket is overloaded.

13 7
**"BUNGALOW" ON MOTOR TRUCK
HOUSES FOUR TOURISTS**

Luxuriousness in motor travel has been exemplified in the building of a veritable "bungalow on wheels," which is now being driven on a 2,000-mile tour of eastern

mountains and lakes. The body, which contains a completely outfitted kitchen, living room, and bedroom, is constructed on a special chassis, being 27 feet long, 10 1/2 feet high, and weighing 12,000 pounds. In the kitchen is running water in an aluminum sink; four bunks with full-length windows opposite each are in the bedroom, while the living room has cushioned seats, a collapsible table, a phonograph, and a radio set with a loud speaker.

59
**COTTON REPLACED BY HEMP
IN IMPROVED CORD TIRE**

For the cotton generally used in cord tires, Bahama hemp is substituted in an improved pneumatic tire recently patented. This should naturally make the tire stronger. Other improvements consist of an inside rubber lining, which, in conjunction with a rubber interlocking device where the tire engages the wheel rim, make an inner tube unnecessary, as the tire casing is air-tight. Inside the lining, above the tread and the full width of it, is a layer of asbestos cement which is flexible and has a tendency to keep the tube cool.



Wm. F. A. Reasoner
+ W. F. Flintner
Royal High Flyer Tires Co

Emb. F. Richter, 403 Hammi St.
Houston Texas

Lake Park Ave. Chicago

3829

145

AUTOISTS TRAVEL 6,000 MILES ACROSS EMPTY CONTINENT

Not long ago an expedition of three motor cars completed a successful 6,000-mile trip across central Australia, from Adelaide on the south coast to Port Darwin on the north and back, in 67 days. Experienced travelers and scientists in the party were amazed to find thousands of acres of fertile and well-watered soil and vast grazing plains in this unsettled country. They passed through miles of country without sign of man or beast, and saw great stretches of land with many rivers available for irrigation purposes, the development of which is dependent upon the building of a north and south transcontinental railroad and the introduction of settlers.

146

LINEMEN BALKED BY TREE CUT THROUGH FOLIAGE

Unable to secure permission to fell a magnificent maple which stood directly in the way, and considering it inadvisable to attempt going above, below, or around it, telephone linemen working near Bloomington, Ill., finally conceived the idea of cutting through the foliage. With the owner's consent enough of the smaller branches and foliage was removed to form a circular opening near the center of the tree. While the "operation," it is claimed, will have no effect on the vitality of the tree, it has given it a most unusual appearance.



The Opening Shown in the Maple Tree Above was Made by Telephone Linemen Working near Bloomington, Illinois, after Vain Attempts to Secure Permission to Fell It

Carl E. Pierson
Bloomington, Ill.

MOVING-PICTURE PROJECTOR FOR SCHOOLS AND HOMES

A moving-picture projector that can be used by anybody anywhere, making possible the projection of moving pictures under all conditions, is



Pedal-Driven Moving-Picture Projector Which Generates Its Own Electricity: The Large Pulley Drives the Dynamo and Film Reel

in use in France. The lantern and film reels of the projector are supported above an upright triangular frame, at right angles to which is a second triangular frame supporting a seat and a large pulley driven by pedals. The frames are made of polished oak and are very rigid. Behind the large pulley is a dynamo which supplies current for a high-powered incandescent lamp. By means of belts the pedaled pulley operates the dynamo, the projector, and the film reels all simultaneously. Films used in moving-picture theaters, or special educational films, can be thrown on a screen about 5 feet wide, large enough for most schools or homes.

When you want anything and do not know where to get it, write Bureau of Information, Popular Mechanics, Chicago.

Mr. Beaumont, 30 rue des Alouettes, Paris, France.

161
726

Mail Equipment Shops
Post Office Dept.
POPULAR MECHANICS
Washington, D.C.

IMPROVED DEVICE SPEEDS UP HANDLING OF MAIL

A new machine designed by the staff of the mail-equipment shops of the Post

Office Department, will greatly facilitate the work and effect a saving of about

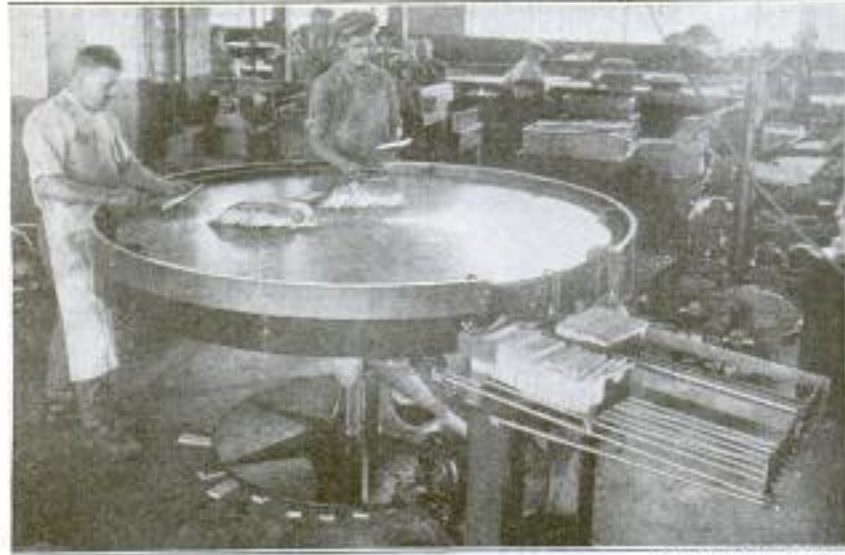

\$2,000 over each of the older units which it will supersede for systematically arranging letters preparatory to cancellation. This so-called "pick-up" or "facing" table is operated by a 1/2 or 1-horsepower motor, and has a stationary circular top with a revolving under platform surrounded by two circular slots which provide facilities for both large and small envelopes. Eight men can stand around the table and deposit letters in the slots, which revolve eight times a minute and stack the envelopes into packages.

This "Pick-Up" Table will be Used in the Larger Post Offices to Speed Up Cancellation of Letters. Eight Men Sorting Out the Large and Small Envelopes can Work around It

9824

Col. Francis Dickie Heriot
Ray, B.C., Canada

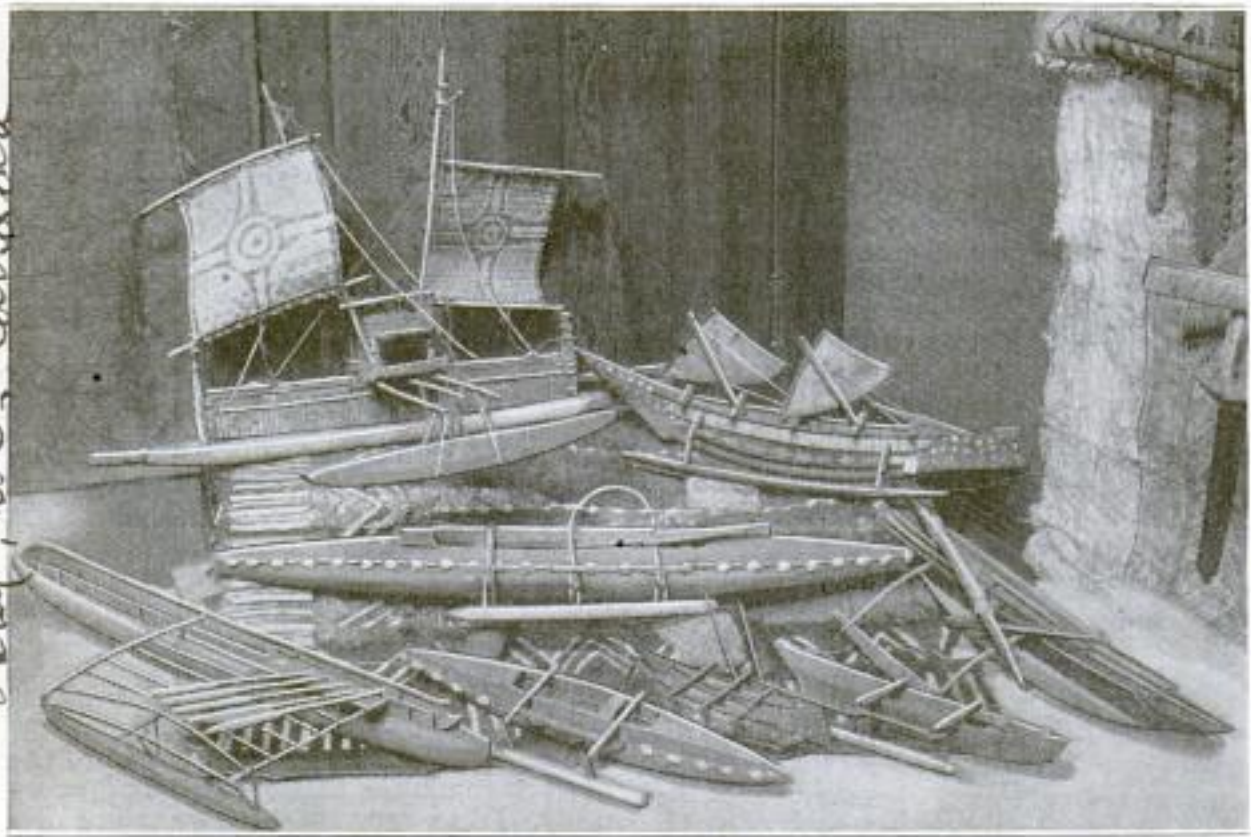

MODELS OF VARIOUS BOATS USED BY SOUTH SEA ISLANDERS

THE result of 25 years' effort by a resident of Canada is a curious collection of models of the many varied types of boats used by South Sea islanders. Among the models, all of which were made by natives, are a New Guinea war canoe with its fighting bridge, on which archers stand, between its sails; double canoes from Tongareva Island; canoes decorated with seashells from Savage Islands, and examples of nearly every kind of craft from the New Hebrides, from Samoa, and from many other islands of the Pacific. There is also, at the extreme right, a model of the pearl-fishing canoes, used by the natives of Ceylon, and so similar to the South Sea islanders' craft as to offer an interesting comparison.

address 166 d.w. Eugene F. O'Neill
 POPULAR MECHANICS
 % Lester Dargent, 524-10th St NW Minn.
 Washington, D.C.



One of the New "Listening Counters" Which have been Recently Introduced for Use in Music Stores and at Which the Prospective Buyer may Sit and Hear the Phonograph Records, Thus Enabling the Store Proprietor to Economize Space by Doing Away with the Customary Booths

166
**PHONOGRAPH RECORDS CHOSEN
 BY USE OF EAR TUBES**

"Listening counters" are innovations for music stores, to economize space by doing away with the booths in which the prospective customers play phonograph records before making their selections. The counters have a series of compartments, each containing a talking machine, the tone arms of these being connected to rubber tubes which the buyers place to their ears, thus enabling them to hear the melody without interference from the adjoining machines. 97

**NEW PAINT-SPRAYING MACHINE
 LIGHT AND COMPACT**

A portable paint-spraying outfit, recently placed on the market, is distinguished by its compactness and lightness, weighing, with its carrying case, only about 28 pounds, so that a workman can take it along to any job where there are facilities for running it. Its air compressor is driven by an electric motor which consumes about as much current as a 40-watt lamp. The compression cylinders,

which are arranged one at either end of the motor, have fins like those of an air-cooled engine.



Universal Sprayer Co.,
 90 W. Broadway
 New York City

Mess. Oscilloscope Syndicate, Ltd
 47 Victoria St. Westminster
 London, S.W., England
 POPULAR MECHANICS

728

9767

OSCILLOSCOPE ALLOWS STUDY OF HIGH-SPEED MACHINES

High-speed machinery can be studied at .01 of its actual velocity with the aid

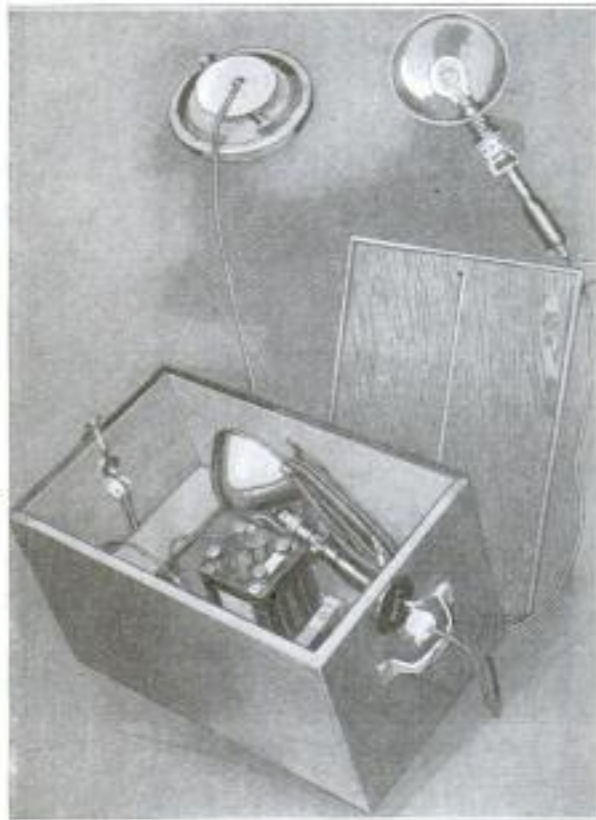

Electrical Oscilloscope Which Enables High-Speed Machinery to be Studied at a Rate of Only One-Hundredth of Its Actual Velocity

of an oscilloscope which is now being produced in portable units by an English company. The outfit consists of a small storage battery, two specially designed electric lamps and reflectors, and a spe-

cial switch, or contact breaker. Extension cords are provided for the lamps and contact so that they can be moved freely about while connected to the battery. In operation, the machine to be studied is placed in a darkened inclosure, and to its shaft a cam, or wheel, is geared at a 100-to-101 ratio, or 1 per cent slower than the machine shaft. The contact is then fastened to the cam, and at every revolution switches on the brilliant lamps for just an instant. The observer, of course, only sees the machine while it is illuminated, but if the shaft is turned fast enough, these illuminations, appearing .01 of a revolution apart each time, blend together. Thus the observer can see the entire revolution of the machine shaft at only .01 of its original speed, giving ample time to perceive any defects or peculiarities which would lower the efficiency of the machine.

ELECTRIC BLOWER FAN USED TO CURE HAY

Curing stacks of hay with an electric blower fan outfit, is the method employed by an English farmer-scientist, which enables him to treat his large crops without having to depend upon the sun's assistance. The grass is stacked as quickly as it can be hauled to the selected spot, the stacks being built in the usual manner but having in their centers an air chamber to which the fan is connected. The excessive heating, due to the action of the fermentation bacteria, is kept within safe limits by intermittent blowing, thermometers being used to observe the temperatures of the different stacks.

Berbert Kennedy & Co., Ltd.

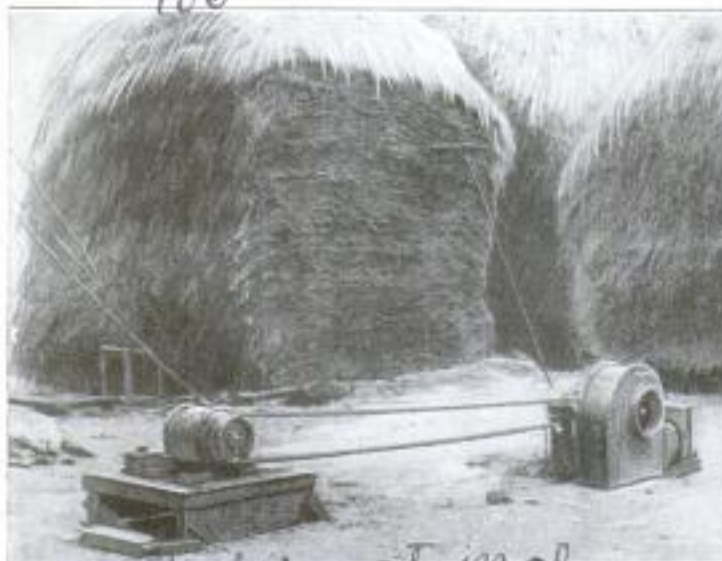

Left: Haystacks being Cured by an Air Blast from a Powerful Blower Fan Driven by an Electric Motor, Right: Taking the Temperature of a Haystack with a Thermometer Fastened to the End of a Stiff Wire

International

Seneca Falls, N.Y.



Above: Stream of Water from a Hose Held by Three Men, Thrown by a Rotary Pump Attached to a Tractor and Driven from the Tractor Engine. Below: Close-Up, Showing the Small Rotary Pump, Totally Inclosed and Weighing but 225 Pounds, Which Has a Capacity of 220 Gallons of Water per Minute at 100 Pounds' Pressure per Square Inch, Throwing a Stream from a $1\frac{1}{8}$ -Inch Nozzle 100 Feet in the Air

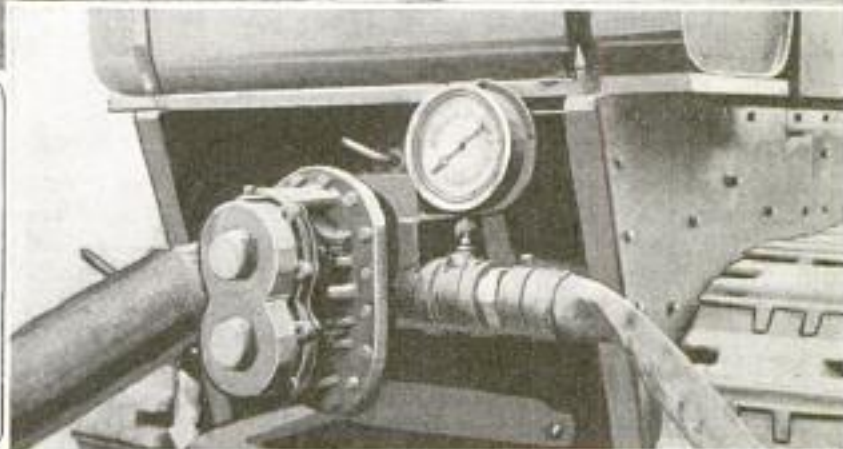

263 ROTARY PUMP HAS MANY USES APPLIED TO TRACTOR

A rotary pump, specially built with reference to its adaptation to tractors, offers interesting possibilities of practical value. The pump is designed with all working parts inclosed, so that the load is taken by driving gears with no metal contact between the blades, and with a positive jaw clutch for disconnecting from the power. It has a capacity of 220 gallons of water per minute at 100 pounds' pressure, and will throw a $1\frac{1}{8}$ -inch stream 100 feet in the air, requiring 26 horsepower. It will be useful in forest-patrol, municipal fire service, irrigation, and for contractors' work.

136

APPLAUSE FROM AN AUDIENCE ARTIFICIALLY STIMULATED

Any hesitation of an audience to start applause, and to continue it with increasing volume when once started, is dispelled by a very simple means of stimulating applause now in use in a theater in Ha-

vana, Cuba. Each member of the audience is furnished with a piece of hardwood, about 2 inches by 3 inches in size and $\frac{1}{4}$ inch thick, together with a small wooden mallet. With these in their hands the temptation is strong to use them, and the custom has been for the applauders to keep time with the music.

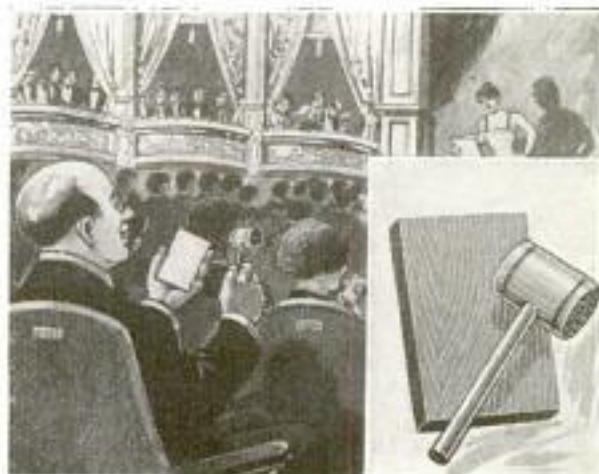

Applause Stimulator Seen in Operation in the Hands of the Member of the Audience in the Foreground. The Device, as Shown in the Inset, Consists of a Small Piece of Hardwood and a Mallet

Russell Raymond Doozhes
General Delivery, Miami, Fla.

Ele

Use
Art

Mr.

142
730

Model Adjustable Display
Flower Co., 519 North 23rd
POPULAR MECHANICS
Brooklyn, N.Y.
FLOWER-DISPLAY HOLDER
142 FITS ANY-SIZE POT



Flower-Display Holder, Showing the Stand and Pot Holder; Also How Potted Plants may be Exhibited

Flowerpots of any size may be placed in an adjustable display holder for use in florists' shops, at weddings and receptions, for window trimming, and the like. The holder permits the potted plant to be exhibited at various angles, or in an upright position, or even to be whirled around on the stand without danger of being thrown out. The fixtures, being made of brass, are practically indestructible, and are so constructed that the metal framework can be easily wrapped or draped if a further decorative effect is desired. When watered, the "drip" is caught in a small basin at the base of the holder, whence it may be drained away by the removal of a cork from the underside of the small catch basin.

189 AUTO SPEEDWAY BUILT UNDER DIFFICULTIES

The construction of the new speedway at Kansas City, Mo., presented unusual difficulties, owing to the fact that the city and vicinity are hilly, making it impossible to locate the speedway, which was to cover 192 acres, on a level site, and to the brief time limit imposed by the scheduled opening for the first race. Added to this, water was encountered five feet below the surface over most of the area. A large hill had to be cut away, and a ravine, through which ran a creek, was converted

These tunnels, of steel and concrete, form a bridge 125 feet long and 90 feet wide, and are tiled to reduce the seepage of the water which collects in sumps, from which it is emptied by automatic pumps with a capacity of 480 gallons per minute. The oval track is a mile and a quarter in circumference, 50 feet wide, and is banked from 7° on the stretches to 40° on the curves, where it reaches a height of 25 feet. The track is built entirely of yellow pine, 4,000,000 feet being required,

Cmd. A. Franklin Munderoff 1108
Ashew Ave., Kansas City, Mo.



Bridging a Ravine Where a Concrete Structure will Carry the Speedway Tracks for a Distance of 125 Feet and Form One of the Tunnels Leading to the Infield

into one of the tunnels from the outside, underneath the tracks to the infield, the creek being diverted for this purpose.

and is calculated to be the fastest in the world, with a safe speed of 120 miles per hour. The grand stand and bleachers, of steel construction and each with a seating capacity of 17,000, are located on opposite sides of the track, and each was completed in 7 days by a force of 500 men working on one shift. A 40-foot safety zone with 8-inch creosoted-oak posts protects the spectators. A 1-mile dirt track is within the speedway for horse racing, and the infield provides parking space for about 5,000 automobiles from which the racing can be viewed, while 17,000 more can be parked outside the speedway track but within the inclosure.



Above: Excavation for One of the Main Tunnels under the Track to the Infield. Center: Plan of



Large Automobile Speedway. Below: Large Steel Grand Stand Erected in Seven Days



Lobbie 'Mech'nes, Ltd, 57 Bothwell
 St., Glasgow Scotland
 POPULAR MECHANICS

732
 5012

INSTRUMENT INDICATES PITCH OF PROPELLER

An English dealer is advertising a small portable device for measuring the pitch of screw propellers, according to the fol-

lowing method: First, radii are drawn on the blade at 2-foot intervals from the center of the boss; then the bubble of the level is centered in its tube, keeping the shifting arm at the bottom of the index plate, while the two feet of the instrument are held against the boss or nut of the propeller; next the instrument is transferred to the blade of the propeller so that the feet will rest on the first radial line, and the arm shifted, without interfering with the level, until the bubble is centered. The pitch can then be read at the point where the top of the arm crosses the arc marked

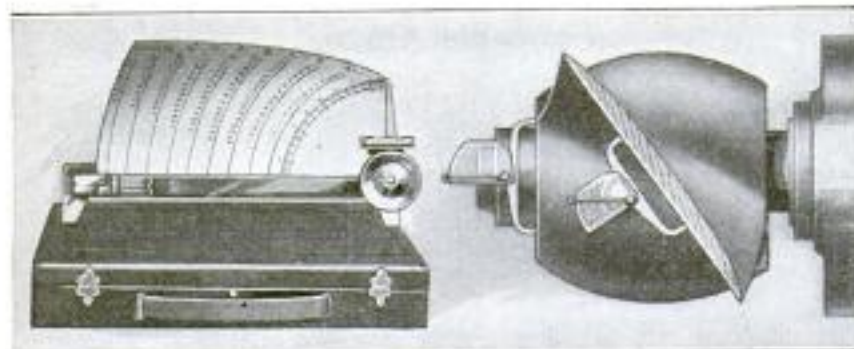

Left: Close-Up of Instrument for Measuring Pitch of Screw Propeller. Right: Instrument Shown in the Two Positions Required to Measure Pitch

lowing method: First, radii are drawn on the blade at 2-foot intervals from the center of the boss; then the bubble of the

"2 feet" on the index plate. The pitch at the other radial lines is found in a similar manner.

STORM WRECKS LUMBER BARGE, CARGO STREWN ON BEACH

Wreckage similar to that usually left in the path of a tornado, was strewn along a mile of beach at the mouth of the Umpqua River, in Oregon, recently, when the large lumber barge "Wash-tucna" was driven onto a sand spit by a severe storm. The high winds and waves that proved so disastrous to the heavily loaded craft, dashed the lumber around with such force that it was rendered commercially worthless. Some 800,000 feet of the product still remain in the hold of the barge, and plans are being considered to bring this safely ashore.



Splintered and Broken Cargo Washed Up on the Beach When the Heavily Loaded Lumber Barge "Wash-tucna" was Wrecked off the Oregon Coast Recently

Cont. H. E. Thomas
 911 Clunckley av. Portland, Ore.

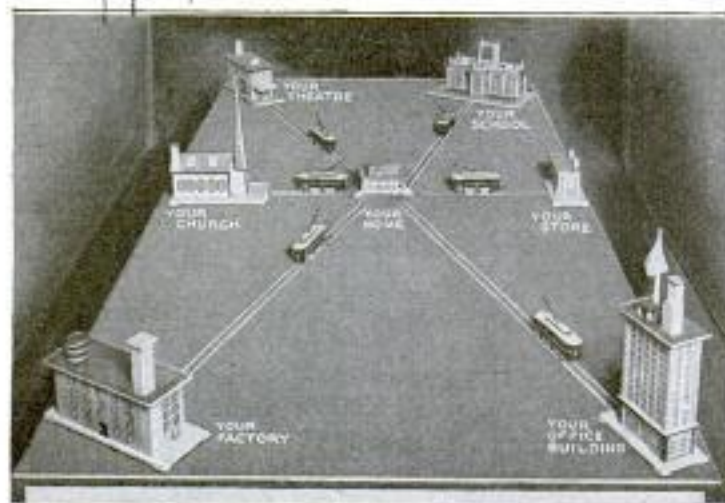

This Exhibition, Demonstrating the Benefits of Street Railways, was Displayed at a Better-Homes Show in Baltimore

BENEFIT OF STREET CARS SHOWN IN BALTIMORE BY MODEL RAILWAY

The benefit of street railways was demonstrated in an interesting manner at a better-homes show recently held in Baltimore. A model home was built in the center of an oblong platform, and railway lines with small cars running on them were shown radiating in six directions to other miniature houses representing an office building, a factory, a theater, church, school, and store. The table was built by a local traction company.

Cont. R. S. Burroughs, 3809 Park
 Heights Ave. Baltimore, Md.

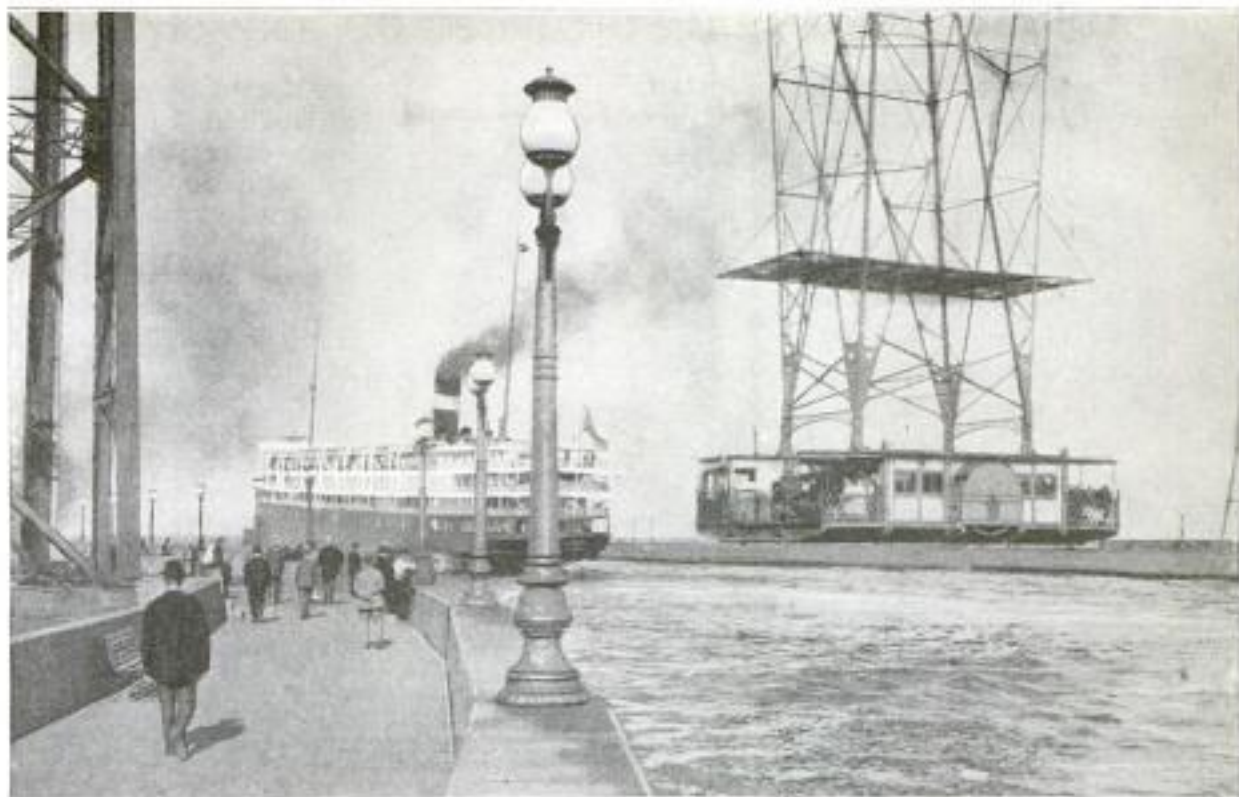

Famous Aerial Bridge at Duluth, Minnesota, Which It is Contemplated to Replace with a Tunnel: It Spans a Ship Canal across Minnesota Point. The Bridge Is 400 Feet Long, and the Traveling Carriage Suspended from Supports (Unseen in the View) That Are 186 Feet above the Water

9892
TUNNEL PLANNED TO REPLACE AERIAL BRIDGE AT DULUTH

Construction of a tunnel to replace the well-known aerial bridge at Duluth, Minn., is under consideration by the city council. The bridge is getting old and becoming unsafe. Not long ago the traveling carriage failed to work, and remained fixed over the channel right in the course of an approaching steamship, causing a panic. The bridge spans a ship canal across Minnesota Point, where there is heavy automobile traffic, particularly in the summer. The proposed tunnel would provide street-car service, and would also facilitate the automobile traffic, which is now handled so slowly by the aerial bridge.

9834
ACCURATE METHOD OF TIMING AIRPLANE SPEED

The essential feature of a new method of timing the speed of an airplane over a measured distance, is a transit instrument consisting of a telescopic line of sight with cross hairs, and having vertical and horizontal adjustability. The outer horizontal circle carries a movable arm that can be clamped and is designed to make electrical contact with a collar on the spindle, thereby energizing a magnet

which controls the starting of a stop watch. In making the observation, two instruments are used, each set up at right angles to opposite ends of the measured

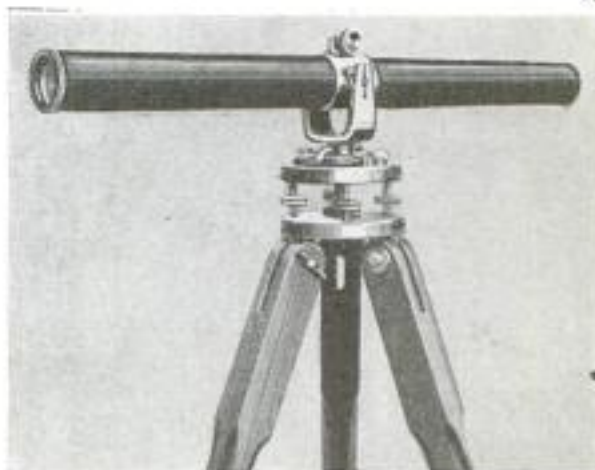

Transit Instrument, Two of Which are Used in Connection with Stop Watch and Electric Circuit for Timing Airplane Speed

course, the first one being adjusted to start the watch as the plane crosses the line of sight and the second to stop the watch as the plane passes its line of sight

CA preparation in liquid form, which when applied to a "run" in silk hose prevents further raveling until the fabric can be mended is now on the market.

Cml. Ralph H. Heacock,
 22 E. Haddon av. Oaklyn. N.J.

mfr. Laddering, Ltd. 26 Thackeray St. / Kensington W. 8. England
 mended
 2 rods.

ADJUSTABLE MOLD FOR TIRES OF ANY SIZE

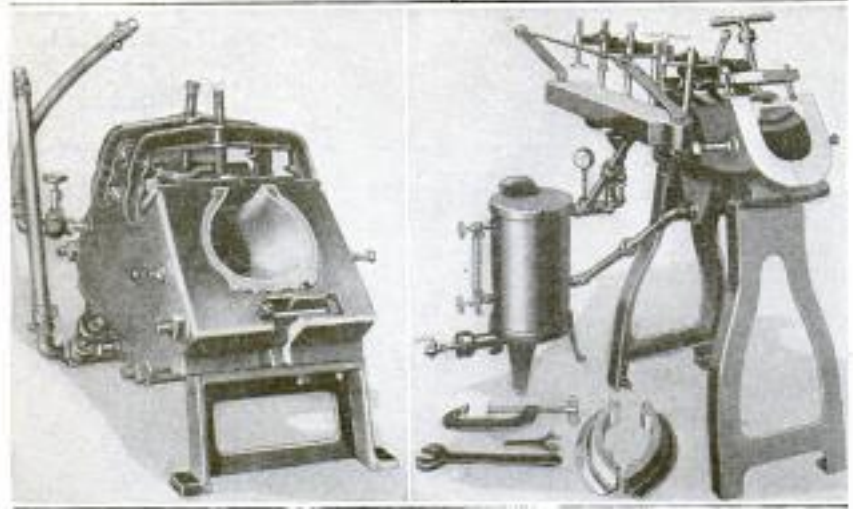

Left: Single-Cavity Mold Which Is Adjustable to Accommodate Truck Tires Ranging from Five to Nine Inches. Right: Single-Cavity Mold That can be Adjusted to Fit All Sizes of Passenger-Car Tires

Adjustability to within a fraction of an inch, both laterally and perpendicularly, so that all sizes of cord or fabric tires can be perfectly fitted, is the outstanding feature of a new vulcanizing mold. The mold is constructed in halves, held together by bolts, and can be made to fit any standard tire by the use of spacers between the halves for the larger tires, and reducing shells for the smaller. The equipment saves first cost, fuel, and space.

9957

AUTOMOBILE MOTORS USED IN PUMPING OUTFITS

In specially constructed frames, mounted on wheels, standard motor-car power plants, including radiators and hoods, have been installed in connection with

are provided. Two sizes are in use, one with a light automobile engine and a centrifugal pump that delivers 450 gallons of water per minute with a 12-foot suction lift. The larger outfit has a powerful truck motor, and a centrifugal pump with a capacity of 900 gallons per minute. Two of the smaller units have been in use for about five months, operating continuously from 8 to 10 hours a day.

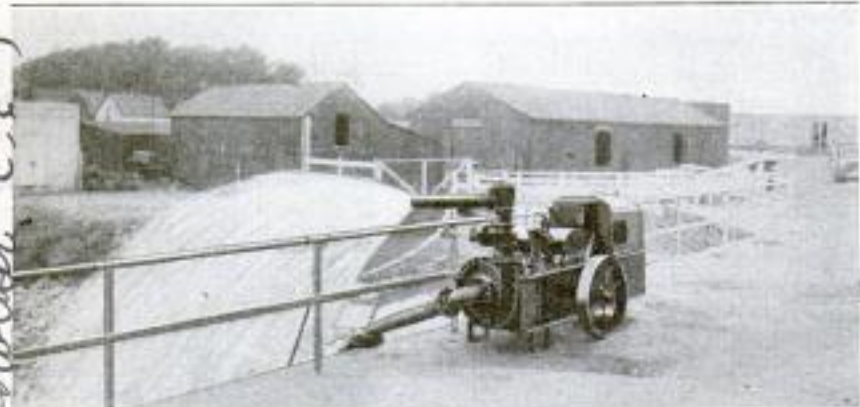

The Smaller of Two Sizes of Portable Pumping Outfits Seen at Work at the West Side Station of the Denver Municipal Water Plant

portable pumping outfits in use by the Denver municipal water plant. The motors are at one end of the framed carriage, and their shafts are direct-connected with flexible couplings to the shafts of centrifugal pumps mounted at the other end. Priming pumps and other accessories

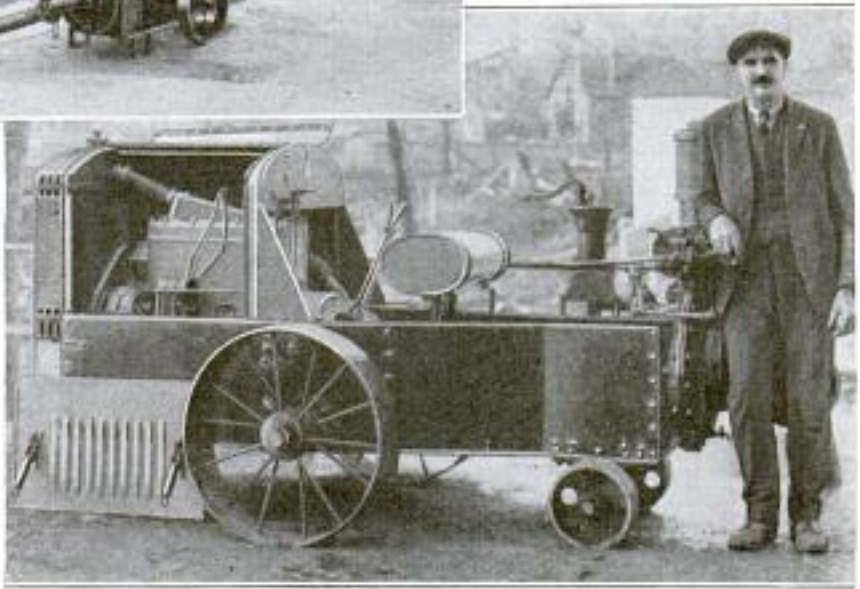

The Larger Size Portable Pumping Outfit, Showing Its Powerful Motor at One End That Drives the Centrifugal Pump at the Other End, with a Capacity of 900 Gallons per Minute: By the Side of It Is the Priming Pump

The Denver Municipal Water Plant
Denver, Colo. Burdette, Lowell, C. E. J.

133 Auto Palace Sales Co.

POPULAR MECHANICS

1551 Alce St., Oakland Calif

135

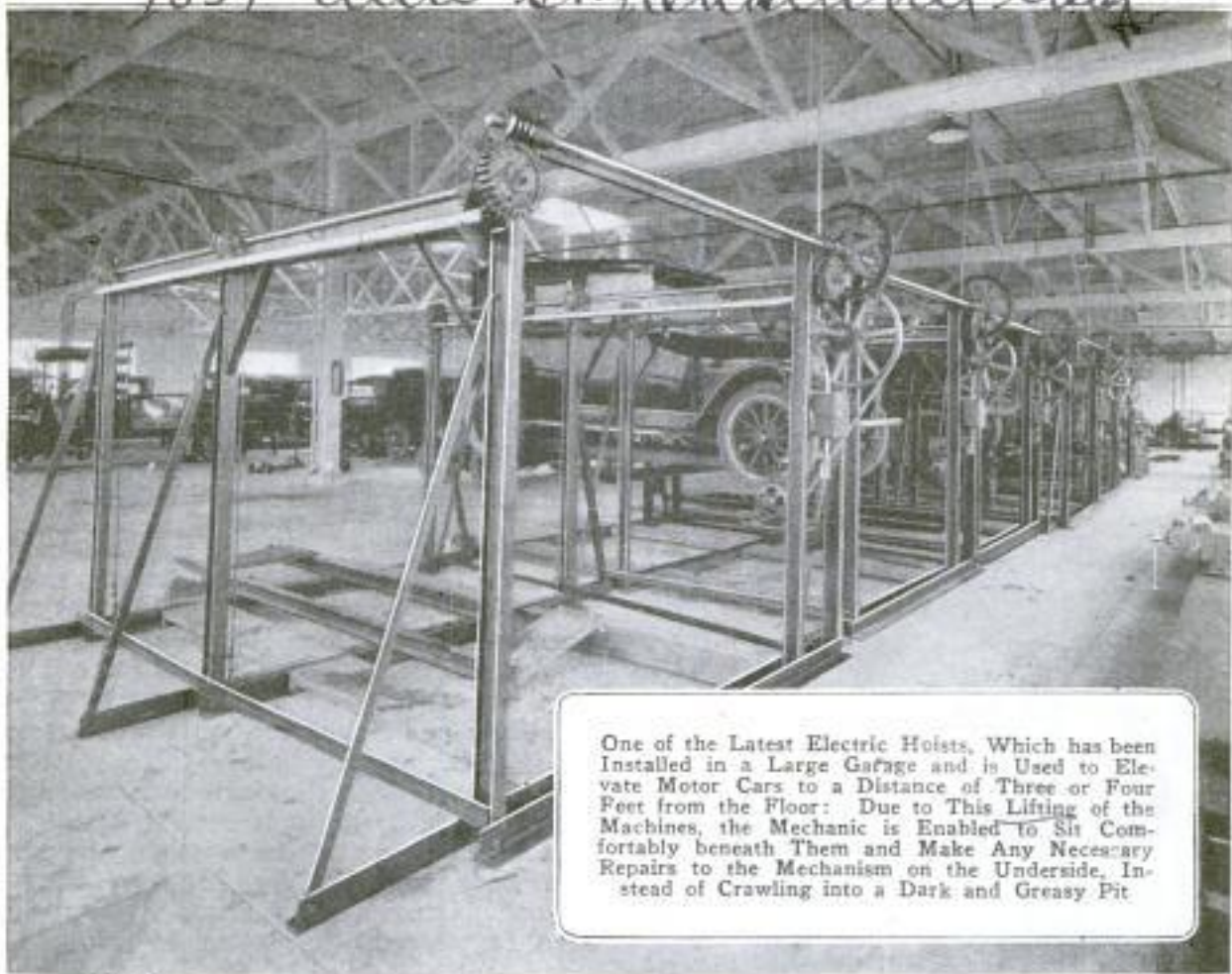

One of the Latest Electric Hoists, Which has been Installed in a Large Garage and is Used to Elevate Motor Cars to a Distance of Three or Four Feet from the Floor: Due to This Lifting of the Machines, the Mechanic is Enabled to Sit Comfortably beneath Them and Make Any Necessary Repairs to the Mechanism on the Underside, Instead of Crawling into a Dark and Greasy Pit

¹³³
MOTOR CARS HOISTED IN AIR FOR UNDERSIDE REPAIRS

Repair work on the underside of motor cars has been made easy by the introduction of an electric hoist which raises the machine 3 or 4 feet from the floor. The lifting appliance is a structural-steel framework of I-beams and angle irons. The car is run upon a base and then elevated by means of a cable drum driven by an electric motor, until the desired height is attained. The installation of this apparatus does away with the necessity of crawling into a dirty pit under the machine and speeds up the repair work, thus proving a time and money saver for the garage man as well as the car owner.

AMUSING SIGNS ON WINDOWS OF RIVAL REPAIR SHOPS

"We Weld & Repair Anything but the Break of Day," reads the sign displayed on the window of a repair shop in Phoenix, Ariz., by which the owner of the shop, evidently worried because of the success of a competitor in the same block, hoped to hold his share of business. Not

in the least nonplused, his rival, a short time later, decorated his window with this



Signs Displayed by Rival Repair Men in Phoenix, Arizona: The Shops Are in the Same Block

announcement: "We Weld and Repair Anything but a Broken Heart."

Phoenix Sheet Metal Works, 320 W. Washington
 Mat M Welding Co. 436 W. Washington
 Phoenix, Ariz.

The Wonder Products Co
 519 N. Monroe
 9999 S. Spokane Wash.
 POPULAR MECHANICS

GARDEN-HOSE ROLLER CLAMP
 REPLACES CLUMSY REEL

Garden hose can be quickly and easily rolled up into loops of any desired size by the use of a simple appliance pro-



Garden-Hose Roller Clamp, of Which an Enlarged View is Shown, can Also be Seen at the End of the Hose, Making the First Loop

duced by a northwestern manufacturer. The contrivance is a spring clamp that fits over and firmly holds the first two loops of the hose, after which the remainder can be rapidly rolled in a neat coil without using a clumsy reel.

19 FLEXIBLE SHAFT COUPLINGS OF SIMPLE CONSTRUCTION

A flexible shaft coupling of exceptional simplicity, and of positive action, now being manufactured, consists of two rings, one with a tongue and the other with a groove that fit together. In its



Tongued-and-Grooved Flexible Shaft Coupling in Its Simplest Form: Larger Sizes Have Hubs That are Keyed to the Shaft Ends

simplest form, these rings are drilled transversely with holes that are in line with the tongue and groove, and pass

through the ends of the shafts that are to be coupled. In these holes hardened pins are inserted, and the power is transmitted through them from one shaft to the other. Thus any parallel misalignment is taken care of by the tongue sliding in the groove, and any angular misalignment by the articulation around the driving pins. In couplings for larger shafts, hubs are keyed to the shaft ends, and the hardened pins are driven transversely into them instead of through the shaft.

34

ARGENTINE CORNCRIBS BUILT AS SELF-FEEDERS FOR HOGS

Corncrubs, made with a few poles and woven-wire fencing, are commonly used in the hog-producing parts of Argentina. Corn and alfalfa are the two feeds depended on for fattening the animals. The crubs are usually placed in the center of an alfalfa field. The fodder is allowed to get a good growth before the hogs are turned in. When they are admitted, the fence of the corncrub is turned up for a foot or two around the bottom, and the pigs very soon "make hogs of themselves." Only a very small amount of corn is wasted, the value of which is



One of the Corncrubs Constructed of Woven-Wire Fencing and Placed in Alfalfa Fields as Self-Feeders for Hogs

counterbalanced many times over by the economical method of feeding.

For relief of the increasingly heavy cross-river traffic, a new bridge is to be built in London, England. It will be known as St. Paul's bridge, because it will span the Thames from a point just opposite the cathedral. It is to have a roadway width of 80 feet.

of Mr. E. M. Bartlett
 Indianapolis, Ind.

Sold by: C. H. Breakey, Inc. 4236 Broadway
 General Agent
 Indianapolis, Ind.
 Mas. H. S. Bollock,
 Carabobo, 393,
 Flores, Buenos Aires
 Republic

103
 Refer all
 Inquiries to
 emb. H. Colin Campbell
 7301 N. Oak Park Ave.
 POPULAR MECHANICS
 Oak Park, Ill.
 737

ROTARY CEMENT KILNS CLEANED WITH SHOTGUN

Everyone knows that in an active volcano a crust of lava forms around the circumference of the crater. In the making of cement, a similar crust, or "ring" as it is called, forms in the long cylindrical kilns. The heat is so intense that the ground stone and other raw materials fuse into a solid mass. This "burning" is the most expensive and most important of the nearly 100 processes required to convert the raw materials into modern Portland cement, and calls for about 200 pounds of coal for every 376-pound barrel of cement made.

As this ring gradually grows thicker, and sometimes as long as 8 feet, it must be occasionally removed. When it has formed far from the working end of the kiln, it has been found more economical to shoot it away with balls fired from a shotgun than by shutting down the kiln and jamming or wedging it out.

At first the shells were charged with duck shot, but these were not strong enough. More recently one-ounce lead balls, similar to those used in a "deer load," are employed. A long-barrel, 12-

gauge repeating shotgun is the most commonly used. Once a wedge is cut from

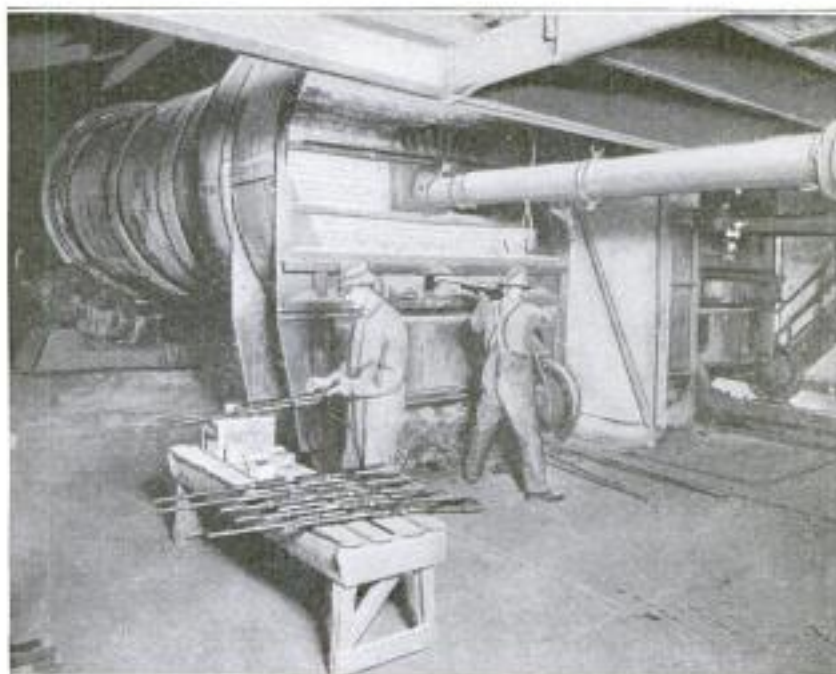

Using Shotguns to Clean the Crust, or "Ring," Out of a Cylindrical Cement Kiln, Showing the Workmen Standing outside the Kiln and Firing Heavy Deer Shot Until a Wedge is Cut through the Ring

the ring and the kiln is again made to rotate, the remainder of the ring breaks down.

When the shotgun method is not used, it is necessary to shut down the kiln, allow it to cool sufficiently to permit men to enter, and then jam or wedge it out by hand. This requires anywhere from one to two or three days, and entails an operating loss of about \$1,000. With the shotgun process, the ring can be removed in from one to two hours, and requires about \$50 worth of shot, proving the economy of the method.

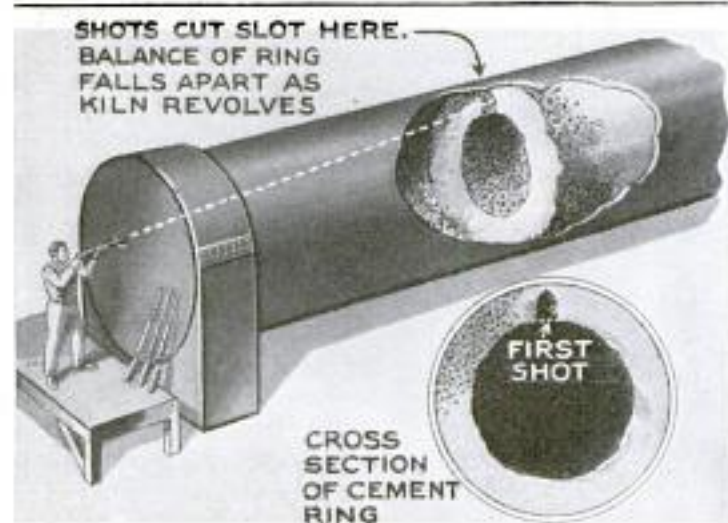

Phantom View of the Cement-Kiln Crust, Which can be Removed at a Far Less Expense with Shotguns than by the Old Method of Cutting It Out by Hand

LARGE RADIO STATIONS IN CENTRAL AMERICA

One of the most important radio developments to be reported in recent months is the placing of orders by a large fruit company and a tropical radio concern, for the erection of three 2,000-mile range wireless stations in Central America. Managua, capital of Nicaragua, will have one station, another will be constructed at Tegucigalpa, capital of Honduras, while the third will be located at Almirante, Panama.

The Financial World
 8/26/23 Copyrighted material

70 Wide World Photos.
 New York
 POPULAR MECHANICS

738
 9986

SWISS CHEESE IS EXAMINED WITH X-RAY MACHINE

Examining Swiss cheese with the aid of an X-ray machine is the method now in use at the Department of Agriculture,

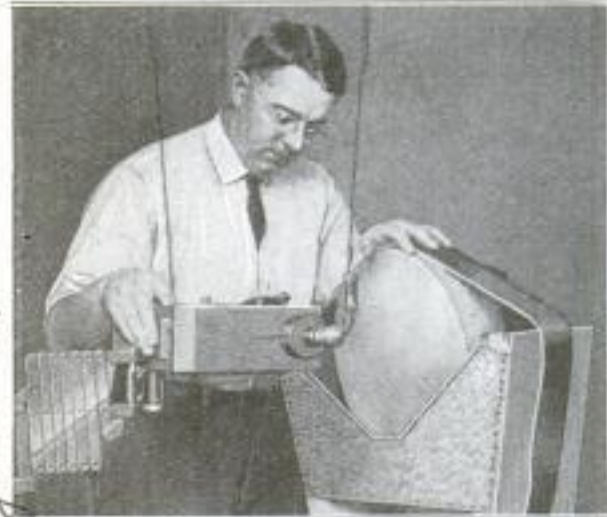

X-Ray Machine for Examining Swiss Cheese, Showing How the Product is Placed in a Special Holder While Its Interior is Illuminated

and one which is said to be an entirely new departure in this line. The cheese is first placed in a special holder, or frame, after which the dairy specialist employed by the government can quickly determine, with his electrical apparatus, the presence of any defect in the interior of the product.

AUXILIARY AUTOMOBILE TANK IS USED AS A FOOTREST

An auxiliary tank for automobiles, which may be used for gasoline, water, or oil, or may have partitions dividing it into compartments for all three, has been patented by an English inventor. It is triangular in shape, and is placed in the



Auxiliary Gasoline, Oil, or Water Tank for Automobiles: Placed under the Floor Rug behind the Front Seat, It Forms a Footrest for the Rear-Seat Passengers

tonneau at the back of the front seat, and under the floor rug, where it forms a comfortable footrest for passengers in the rear seat, thus serving another useful purpose.

STRONG BOXES SAFEGUARDED BY LOUD-SOUNDING ALARM

Protection against any tampering with a small safe or strong box is afforded by means of a loud-sounding alarm inside the box that starts the moment the box is moved even a fraction of an inch, and that cannot be stopped until the box is opened. Beneath a false bottom inside the box is an electric buzzer, to which is connected a small hammer that pounds rapidly on the side of the box. The buzzer is operated by a dry battery, the current from which is switched on by a contact device that is closed automatically by the slightest movement of the box. This is caused by the action of a small rod that protrudes from the bottom of the box holding up the contact

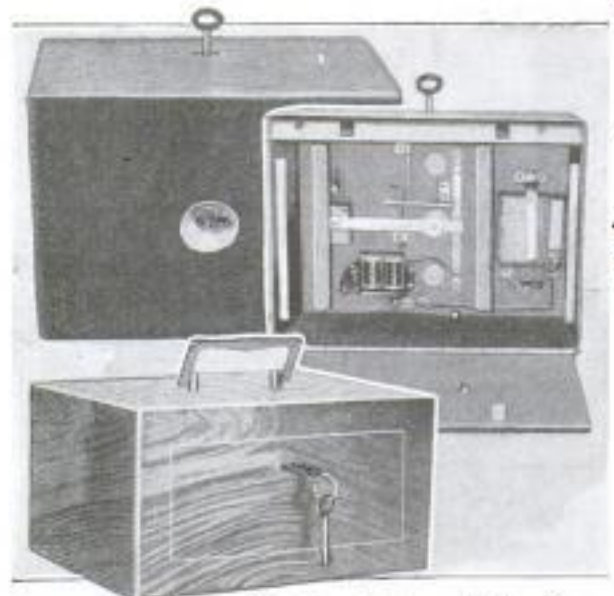

Strong Box Shown Closed, and Immediately Above, Opened with Its False Bottom Removed, Exposing the Electric Alarm; This Operates by Any Movement of the Small Rod Seen, at Left, Protruding from the Bottom of the Box

maker as long as its end is resting on any flat support such as a table or shelf. The slightest movement of this rod closes the electric circuit. The only way to break the circuit is by means of a switch inside the locked box.

Widening the Panama Canal at Gaillard Cut, by shortening La Pita Point, is being done to reduce the possibility of slides, and to give a clear view to pilots of meeting ships.

Streatham Engineering Co. London, S.W. 2, England.
 47 Streatham Hill
 9986

The Modern Hawkers, 226
 N. Michigan Ave., Chicago 9d.

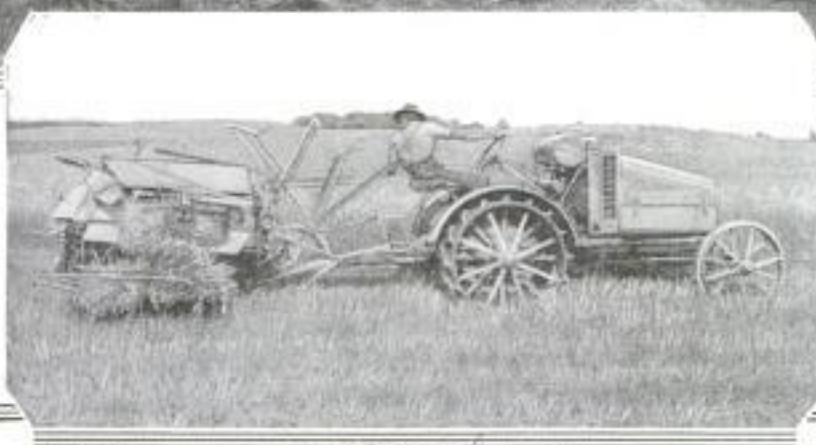

Above: New Grain Binder Which Cuts a 10-Foot Swath and Easily Harvests 35 Acres a Day. Below: Close-Up of Binder and the Tractor by Which It is Pulled and from Which It Derives the Power to Drive the Cutting and Binding Mechanisms. One Man Operates the Combination

155
 NEW GRAIN BINDER CUTS
 35 ACRES A DAY

A grain binder that enables one man to cut nearly twice as much as with any earlier type is a recent development in the implement field. This new binder, which cuts a 10-foot swath, differs from all others in that the power for driving the mechanism does not come from the main wheel, but from the tractor which pulls it. Independent of slippage of the binder wheels, this steady supply of power enables the binder to be run at a more uniform rate of speed and makes it possible to cut the wide swath, as well as permitting operations in soft ground and where the grain lies low. It reduces the hazards facing the farmer at harvest time.

WHEAT CUT, THRESHED, GROUND,
 AND COOKED AT ONE TIME

32

By adding a small gristmill and an oil stove to the equipment usual in connection with the machinery required for harvesting and threshing wheat simultaneously, the crew was furnished with hot baked biscuits at the end of one trip around the large field, made from wheat harvested during the previous round. The wheat was ground in an old family gristmill, a relic of pioneer days, and the baking was done in an oil stove, set up on a near-by road and shielded from the wind by an umbrella. This unusual performance took place last July on John Rueschhoff's farm near Grinnell, Kan. Two women attended to the baking.



Left: Combined Harvester-Thresher at Work. Above: Baking Biscuits Made from the Wheat Just Harvested, and Ground in a Small Gristmill. Right: Harvester Crew Eating the Hot Biscuits



Cont. J. W. Collins, 3409 Penn
 Kansas City, Mo.

IDLE SHIPYARD ADAPTED TO UNDO OWN WORK

BY D. R. LANE

1624 Capistrano St
Berkeley, Calif.

RECENT experience in scrapping naval vessels on the Pacific coast brings to light the fact that shipyards—intended primarily for building vessels—can be adapted to the reverse operation to an extent well worth while from the viewpoint of owners who otherwise would see them standing idle for lack of orders.

At one yard where construction facilities thus were used for demolition, there was developed a plan for beaching the broken hulks on the sloping foot of

ess of demolition was exactly the opposite of that of construction. The vessels were laid up alongside what had been the shipyard's fitting-out wharf, wreckers stripped them of woodwork, and riggers and fitters removed as units the fixtures which could be sold entire. Then torch men cut the ships down, course by course. When the hulk was so shallow that it could not be safely left floating, it was towed over the foot of the launching ways, tackle was rigged from deadmen

up the ways over sheaves shackled to the hulk, and the cranes hauled up on the tackle. Advantage being taken of the tide, little difficulty was experienced in floating the hulks well up over the foot of the ways and then skidding them up the incline the rest of the distance. Beaching in this manner enabled the wreckers to get all the material from the hulk, instead of losing the last few hundred tons, as is usual with ships beached on mud-flats, and saved the cost of a drydock, which would have been out of all proportion to the profits of the enterprise.

In the wrecking work, large engines were

broken up with explosives; small ones were cut out with the torch. Explosives were also used to start balky bolts, half a stick of dynamite doing the work cheaper and quicker than an hour's sledgeing. The propeller hubs were started off the tailshafts by the same method. As these were taper-fitted and pressed on by hydraulic rams, considerable difficulty had been anticipated, but a moderate charge of explosive loosened each one nicely.

Explosives came into play again in the close spaces of the lower part of the hull where the steelwork had been coated with cement. It was cheaper to crack the cement, or even to break a few inches of steel framing, with explosives than to chip out the steel with the torch.

The city gas was used for cutting torches, partly because of its cheapness, but mostly because tests showed that faster work could be done with it than with any other fuel available. A high-

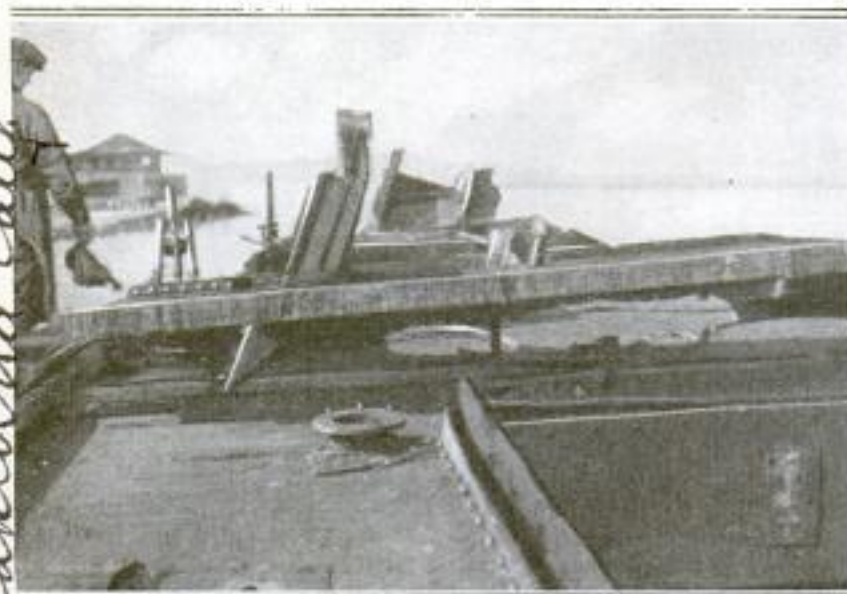

Former Cruiser "Minneapolis," Showing the Protective Deck, Which Was Four Inches in Thickness and Composed of Three Plates, Blind-Riveted Together, after Cutting by Gas Torches

the launching ways, to avoid renting a drydock for the final stages of the work; ordinary city gas was substituted successfully for acetylene or hydrogen in oxygen-cutting torches, and explosives were used in a variety of ways believed new to ship breaking.

The vessels broken up at this yard were the "Marblehead" and "Minneapolis," of 2,089 and 7,375 tons, respectively. The cruiser "Brooklyn," 9,215 tons, was largely cut up at a junking yard near by, but the hulk was brought to the shipbuilding plant in question to be beached and broken up. While none of the three ships would be considered a large vessel, by modern naval standards, the methods employed in breaking them were chosen with an eye to efficiency and economy, and the work was arranged in such a manner that the experience gained might serve as a foundation for operations on the larger craft soon to be sold for scrapping. In general, the proc-



Above: Operator at Work Cutting Up One of the Eight-Inch Guns of the Old Cruiser "Brooklyn," with Torches Using City Gas Instead of Acetylene or Hydrogen. Guns of Scrapped Naval Vessels are Always Disabled before Sale. Below: Cutting Up the Inner Shell of One of the "Brooklyn's" Gun Turrets. Several Pieces of Eight-Inch Armor Plate, Taken from This Turret, can be Seen under the Gun at the Left. The "Brooklyn" Was One of the Ships That Took Part in the Defeat of Admiral Cervera's Fleet off Santiago, Cuba, in the Spanish-American War, and has Long Been Obsolete Like the Other Ships of the Famous American Squadron, Many of Which have Served as Targets for the Guns of Newer Men-of-War



Another View of the "Minneapolis," Showing the Deck After the First Course of Steel Plating had been Removed for Part of the Distance around the Ship; This Illustrates the Effectiveness of the Gas Torches in Reducing the Heavy Armor Plate of Battleships to Salable Junk

pressure main was already in the yard, installed to feed its rivet-heating furnaces during the war, and this was simply coupled to the fuel side of the cutting-pipe system. The city-gas-oxygen flames cut up the entire protective deck of the "Minneapolis," built of three laminations of heat-treated steel, without a fragment being thrown, according to those in charge of the work.

Definite figures on the cost of demolishing these vessels have not been made public, but enough is known to warrant the statement that the steel and other ferrous materials removed nearly or quite repaid the investment and the cost of scrapping, leaving the proceeds of the brass and bronze scrap wholly or nearly clear profit, which result would likely be the same with larger ships.

149



Top: Showing How Inserts are Placed between the Leaves of the Spring and Pivoted on the Oiler. Bottom: Ordinary Leaf Springs Containing Steel Inserts and Oiler

AUTOMOBILE SPRINGS OILED IN EFFECTIVE MANNER

Lubricating the springs of a motor car can be accomplished in a rapid and efficient manner by the installation of a special oiler and steel inserts. These inserts are placed between the leaves of the spring and have $\frac{1}{4}$ -inch slots cut through their centers, running lengthwise of each leaf to within 1 inch of the ends. When oil is forced, by means of a "pressure gun," down through the oiler, the lubricant passes out along the inserts, flowing in the slots until every portion of the leaf has been reached.

Center - Fed Spring Insert Sales Co
Coal Exchange Bldg. Withers - Barre, Vt.

**LIGHTWEIGHT CONCRETE HAS
 SLAG IN PLACE OF GRAVEL**

245

Experiments conducted in France with concrete made with slag have proved that, other things being equal, slag concrete is rarely weaker, and generally a little stronger, than ordinary gravel concrete, and that its weight is from 30 to 40 per cent less. The ratio of strength to weight is at its maximum when the proportion of sand is from one-fourth to one-fifth that of the slag used as aggregate. In practical applications this reduction of dead weight is specially advantageous in such structures as arch and suspension bridges.

199
**SWEET-PEA TRELLISES SERVE
 AS CLOTHESLINE POSTS**

Wanting a bit of garden to brighten his home and finding it necessary to stretch a clothesline in the only place available, a resident of Fargo, N. D., built the necessary posts so as to serve at the same time as sweet-pea trellises. This he

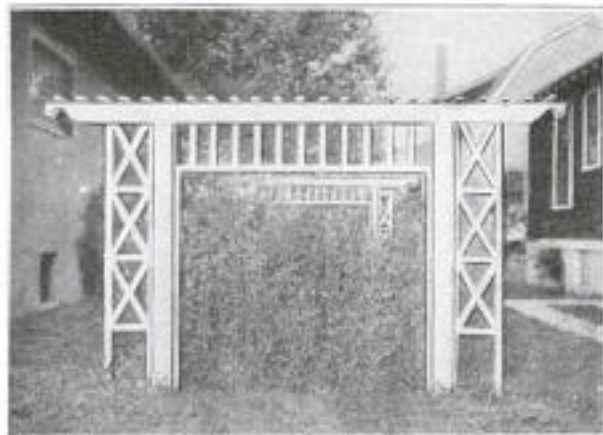

The Sweet-Pea Trellises Pictured Above were Built to Serve Also as Clothesline Poles

did by stretching wire netting between uprights of 6-by-6-inch timbers, using lighter lumber for the crosspieces and finishing the design with 2-inch lattice. This combination of the ornamental and useful makes a quite pleasing impression.

C. L. Meller, 1010 4th Ave. S.
 Fargo, N. D.

**SUPPORTING JACKS FOR AUTOS
 ADD TO LIFE OF TIRES**

7488

It is well known that the life of auto tires is considerably lengthened if they are relieved from the weight of the car while standing on the damp and oily floor of the garage. This can be done readily by a simple lifting jack that is

Beard Auto Lift Co.
 Auburn, Ind.

now on the market. It is made entirely of steel, and a set of four, one for each wheel, weighs only 25 pounds. In the

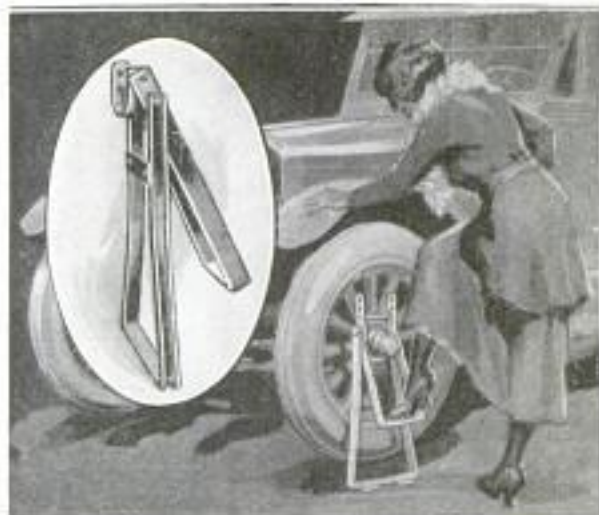

Steel Supporting Jack for Relieving Tires from the Weight of the Car: Inset Shows Enlarged View of the Jack, Which is Adjustable for Any-Size Wheel

supporting frame is pivoted a lever, at one end of which is a sling that is placed under the wheel hub, which is then lifted by pressing on the other end of the lever with the hand or foot.

17
**COMPOSITION SHINGLE SERVES
 AS TILE OR FLAT PATTERN**

A western manufacturer is introducing a shingle made from prepared roofing that can be used to represent a Spanish tile roof or laid flat according to a geometric design. The advantage lies with the dealer who can supply the demands for two kinds of roof from a single stock.



Roof Covered with New Composition Shingles, Which can be Laid Flat in a Geometric Pattern, or So as to Resemble Tile

The Paraffine Co., Inc.
 San Francisco, Calif.

Carl F. H. Hollingsworth, 213 Trinity Bldg

744

POPULAR MECHANICS

168 Marlborough St. Boston Mass

RARE COPY OF BIBLE DONATED

9884

TO AMERICAN LIBRARY

The only known copy of the first Protestant Bible printed in Latin has recently come into the possession of the

and Senators Most Highly Esteemed and Always Highly to be Honored by Me, Their Student and Disciple." Another feature is the title page and summary of contents, this being one of the first books to be so provided.

The printing of this edition was done in 1527, at Cologne, by Peter Quentel, who shortly before had printed an edition of the New Testament for Tyndale. The text is in black letter, with numerous woodcuts by Anthony of Worms, some of which had been used in the Grenville edition of Tyndale's English New Testament, published in 1526. These woodcuts are excellent examples of wood-block engraving; four of them, used as initial pieces at the head of each page in the four Gospels, being of especial interest. The four Evangelists are here represented as follows: Mark with a lion; Luke with a bull; John with an eagle; and Matthew with an angel dipping his stylus in the inspiring sunlight. The volume is a sample of skillful printing and painstaking work in the letterpress, for it is as bold, black, and clear as work done by the printers of today. The binding is still strong, and the vel-

610 Broadway, New York City



Title Page of Bible Recently Presented to Cambridge, Massachusetts, Public Library: Note Coat of Arms of City of Cologne

Public Library at Cambridge, Mass., the gift of an anonymous benefactor. It is valued at \$100,000 by the library authorities, which seems reasonable in view of some book transactions. Henry E. Huntington, owner of one of the finest collections of rare books in the world outside the British Museum, once paid \$50,000 for a copy of the Gutenberg Bible, of which 20 copies are known to be in existence. Book collectors value books according to their rarity, condition, some special feature such as an autographed copy, first edition, or some peculiarity for which the book may be notable. This Latin Bible, which was compiled by one John Rudelius, a noted scholar and graduate of the University of Frankfort, Germany, is not only a first edition, but it is in as perfect condition as a book of its age could well be. It was dedicated "to the Most Wise and Learned Fathers of the City of Frankfort, and to the Consuls



Page from Latin Bible, with Cut Representing the Evangelist St. John with the Apocalyptic Figure of an Eagle

9884

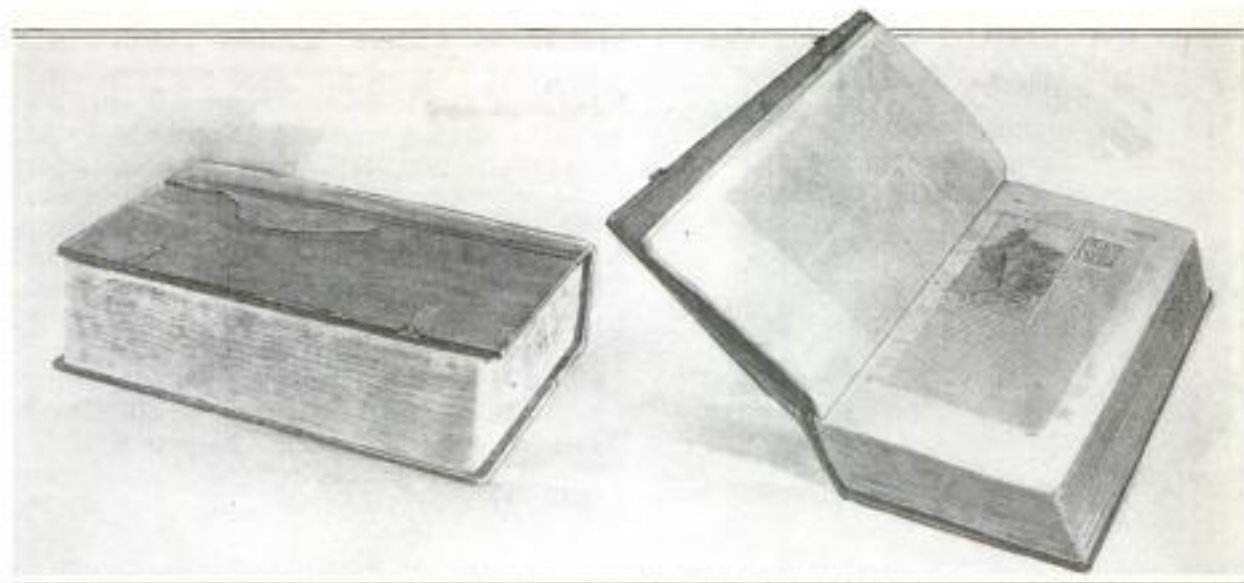

This Bible, Valued at \$100,000, Is the Only Copy of Its Edition Known to Exist. It is Shown Opened at the First Chapter of Genesis, the Figure Representing the Creation of the World

lum cover, though stained and yellow with age, is perfectly sound. The dog-eared condition of the margins, title page, and front pages, shows that it has been much handled and read, giving to it the appearance of the deckle edge, affected in many present-day books.

9829
**MAPPING VEGETATION WITH
 A PANTOGRAPH**

The millions of acres of cattle and sheep ranges within our national forests, are under the management of the U. S. Forest Service, and one of its duties is to calculate the "carrying capacity" of each range; that is, the number of cattle that can be grazed on it without exhausting the range. For this purpose, intensive field studies are constantly being made in the western forests, many of which have already been completely covered by a thorough range survey.

One of the means by which the live-stock capacity of the range is found is the establishment of sample lots at regular intervals and in all different grass and weed-forage types. With the aid of a special pantograph, a detailed map is made of the area covered by the different kinds of vegetation on the plot. Two men operate the instrument. One manipulates the free-moving arm and with its pointer circles the base of each individual bunch of grass or weed stems. The areas thus circumscribed are reproduced on a small

The size of the original edition is unknown, but editions were never large in those days, amounting at most to only a few hundred copies. Another edition of this Latin Bible, printed in 1528, has disappeared from view, and it is safe to assume there is no other copy in existence.

scale by a pencil on a map board, and the resulting sketch shows a series of irregular patches, which represent the area covered by the forage plants, as compared with the total ground area of the plot. Large numbers of these plots are thus mapped each year, and the total percentage of increase or decrease in vegeta-



PHOTO BY U. S. FOREST SERVICE

Pantograph and Quadrant in Use for Charting Vegetation on a Representative Plot, from Which the Forest Service Determines the Grazing Capacity of the Range

tion, due to grazing, is calculated. These data and the known forage values of the grasses are then used to determine how many cattle or sheep can be run on the area without injury to the range.

Cont. W. d. Hutchinson, 930 7th St., N. W.,
 Washington, D. C.

N.Y. Series 9/7/22

RJ

TIDE GAUGE ON RIVER BRIDGE HELPFUL TO NAVIGATORS

66

Recently installed upon the pier of a bridge across the Potomac River is a tide gauge which is operated by the rise and



International
Tide Gauge on a Bridge across the Potomac River Shows at Any Time the Number of Feet of Clearance between the River and the Bridge

fall of the tide. On its dial a pointer, like the hand of a clock, indicates at any time the number of feet of clearance between the river surface and the bridge. This is of great assistance to tugboat captains, who can see at a glance whether it is possible for their boats to pass safely under the bridge or not.

PLANS BEING MADE TO BUILD TWO 70,000-TON SHIPS

255

If Congress passes the ship-subsidy bill, it is stated authoritatively that an American company proposes to build two electrically driven ships, each of 70,000 tons gross, for service in the Atlantic passenger trade. These ships would, therefore, surpass the largest ship afloat, the White Star liner "Majestic," by more than 13,000 gross tons. As they are planned to be 1,000 feet long, they would also be 44 feet longer than the "Majestic." They would have accommodations for more than 3,000 passengers, and it is understood that they are to be propelled by electric motors supplied with current by generators driven by turbines or Diesel engines. The company will be wholly American, and the work will be done in yards in this country. The company, it is said, would also buy some of the U. S. Shipping Board's largest ships.

9648

POLES RAISED FROM GROUND COMPLETELY ASSEMBLED

Poles and towers for carrying the wires of the company that supplies electric light and power in Salt Lake City have the crossarms and insulators attached to them before they are raised from the ground. It is, of course, much easier to do this assembly work on the ground, and there is also the saving of the time expended in hoisting the materials to a workman after the pole is erected. It is just as easy to hoist the poles with the crossarms on as with them off.

1000
1000
1000
1000

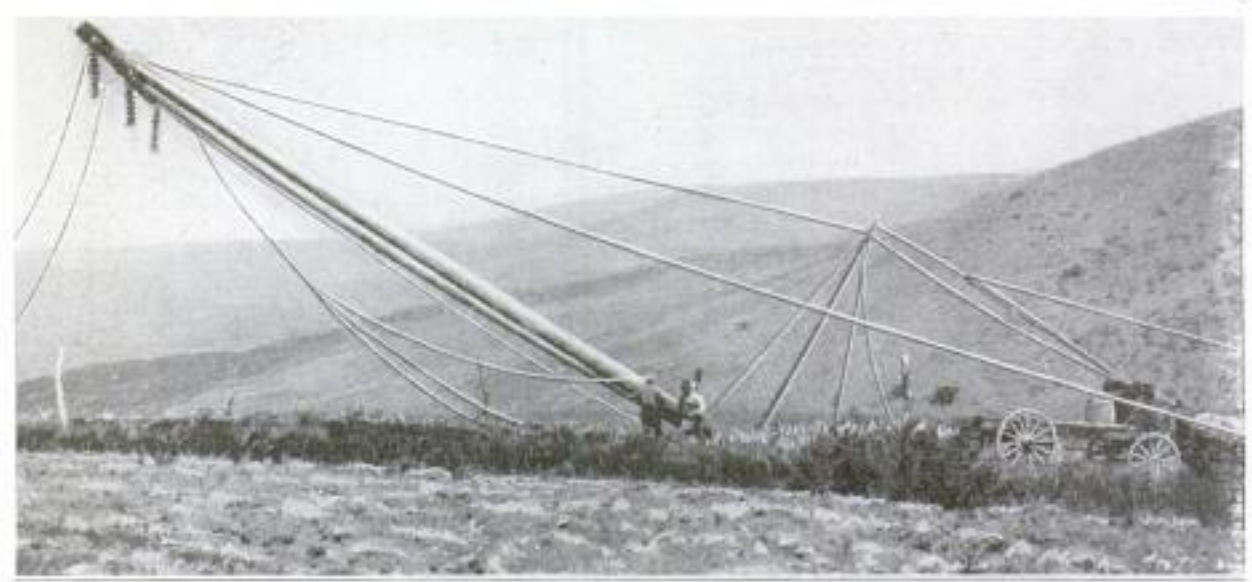

Raising a Tower for Supporting Electric Wires, the Insulators Being Already in Place, and Thus Avoiding the Necessity of Hoisting and Installing Anything but the Wires Themselves After the Tower has been Erected

Utah Power + Light Co., Salt Lake City - Utah.



Corporal André Peugeot, the First French Victim of the World War: At the Spot Where He was Killed by German Uhlans, 30 Hours before the Official Declaration of War, the Monument Seen to the Right was Erected to His Memory and Recently Dedicated



MONUMENT TO FIRST FRENCH VICTIM OF THE LATE WAR

Corporal André Peugeot has been immortalized by having been the first French victim of the World War. He was killed by a band of Uhlans at Junchery, near the fortified town of Belfort, just across the French frontier, on Aug. 2, 1914, 30 hours before the official declaration of war by Germany. At the spot where he met his fate, there was recently dedicated to his memory, with elaborate ceremony, a monument of stately proportions and impressive design.

AUTOMOBILE GRADIENT METER MOUNTED ON THE DASH

Another new instrument for the automobile dash is a gradient meter, manufactured in England, that indicates on a dial the percentage of any incline up or down which the car may be traveling. The graduations for rise or fall are divided from 1 in 4 to 1 in 30, showing grades, therefore, from about 3 to 25 per cent. The pointer is operated by the action of a pendulumlike weight, which



is immersed in oil in order to prevent it from being oscillated when the car is traveling over rough roads.

PORTABLE LOCK MORTISER USED ON DOOR JAMBS

To make unnecessary the common practice of cutting mortises for locks in door jambs by hand, a portable lock mortiser has been constructed that will do the work better and in far less time. It will cut any mortise of from 5/8 to 1 3/8 inch in width, up to 4 3/4 inches in depth, and 6 inches in length. The machine is readily attachable to the door jamb by means of self-centering clamps, and the only adjustment necessary—that of regulating the length of the mortise—is done by simply sliding a small sleeve up or down a vertical rod.

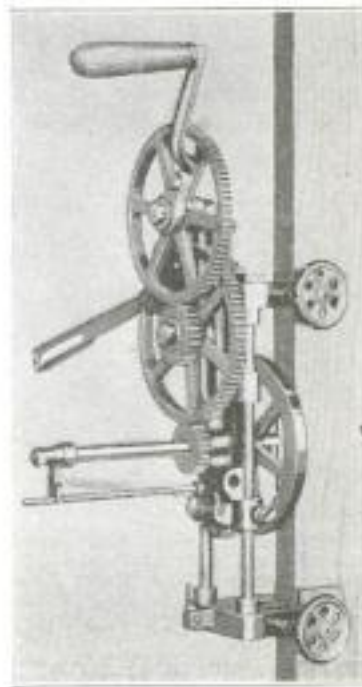

Japley & Co.

*Belvedere Works
Totton, Southampton, England.*

*Pittsburgh Instrument & Machine Co. Pittsburgh, Pa.
40 Water St. 1026 Reedsdale*

Flour Wheel Drive
Auto Co., Clintonville

748

9979

**GASOLINE RAILROAD TRAINS
CUT OPERATING COSTS**

Cutting the operating costs of short-line railroads or electric lines, and at the same time maintaining reliable transportation service, is possible with the use of equipment produced by a Wisconsin company. The innovation consists of a two-car unit of the open type, having ad-

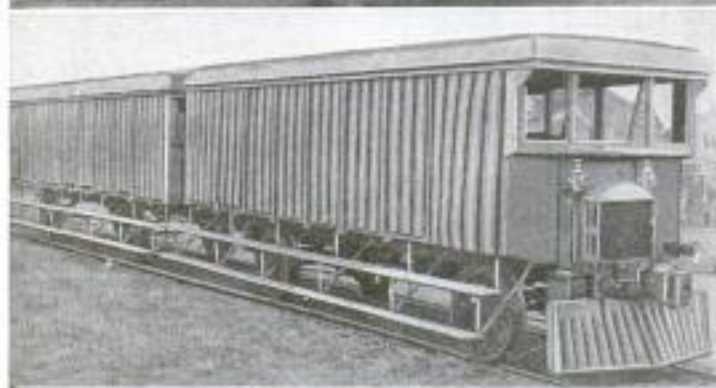
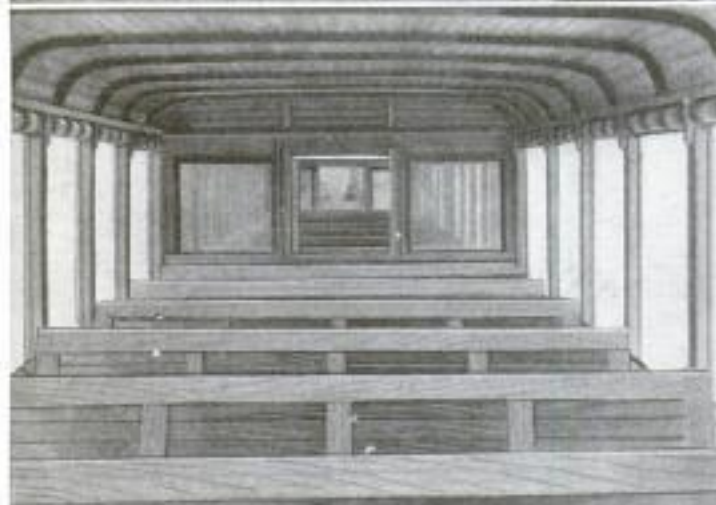
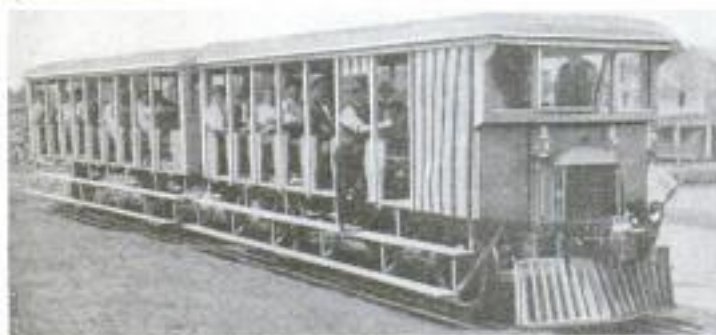

Top: Gasoline-Operated Railroad Train of Two Cars, Showing the Open Construction and Running Boards on the Sides. Center: Interior of the Train, Showing the Seating Arrangement and Adjustable Curtains Rolled Up. Bottom: Adjustable Curtains Pulled Down as a Protection against Bad Weather

justable curtains along the sides for protection against the weather. The forward car, which contains the gasoline engine, seats 35 persons, while that at the rear can accommodate 50 passengers. The outfit is equipped with air brakes, electric

POPULAR MECHANICS

starter and horn, standard couplers, locomotive cowcatcher, rail-sanding apparatus, and a high-speed reverse gear, all of which make it a highly efficient train.

**UTILIZE WASTE TO INCREASE
SUGAR YIELD OF BEETS**

In line with the movement for greater efficiency and the reduction of waste, a Utah beet-sugar concern has followed four years of experimentation with the installation of equipment for recovering sugar from the molasses heretofore discarded by the plant. The molasses is chemically treated and filtered, after which it is subjected to an evaporation process, followed by boiling to the point of crystallization. In the later stages, the process and equipment are identical with those of a standard sugar-beet factory and it is therefore possible to produce the additional sugar at a relatively small investment and with low operating costs. With a somewhat makeshift layout, 35 per cent of the waste molasses is recovered as sugar of good grade, and it is believed that as high as 50 per cent can be converted with a better plant. Aside from small quantities mixed with ensilage and some used as fertilizer, the molasses has been dumped into a near-by stream or spread over the ground to dry, so the new process will result in the saving of thousands of dollars to the sugar-beet industry. An added benefit is that the working season of the plants will practically be doubled, and the help employed longer.

**WATERMELONS GROWN
UNDER HAY, STRAW,
OR CANVAS**

Growing watermelons under cover of loosely applied hay, straw, and sometimes canvas, has produced in the Northwest irrigated regions, this summer, a superior fruit that is equal, it is claimed, to that of Texas fields. It is now believed that such covering, however slight, helps to keep in the ground warmth accumulated during the day, which, ordinarily, would be dissipated by the night air.

Emb. F. W. Fickle, Jr.
5021-12th St. N.E.
Seattle, Wash.

Emb. F. W. Fickle, Jr. of the Tribune
of Salt Lake City, Utah

Capt. Felix J. Kocou
4511 Clifton Ave
Cincinnati, Ohio

BOAT CLEARS RIVER CHANNEL

TELEPHONE-DIRECTORY HANGER

9951 AND ALSO BUILDS LEVEES

8709 SIMPLE AND CONVENIENT

For clearing the channel of snags and obstructions and for building levees on either bank, a novel kind of dredge is used by U. S. engineers on the Ohio River, below Cincinnati. The boat—called the "Scioto"—is a modification of an ordinary dredge, the boom of the crane being used for hoisting snags from the river bed, and swinging them onto the banks, where they are suitably disposed of. At the stern is a long derrick that carries a pipe from the vessel to a rotating cutter at the end of the derrick. When in operation, the boat is anchored at any point where the channel has to be cleared, the cutter is lowered to the river bottom, and is driven by power from the vessel. This has the effect of cutting up the material sufficiently to allow it to be sucked through the pipe into a receptacle in the interior of the vessel. From this pipes extend laterally to the shore, which may be as long as 300 feet, and these pipes deliver the material suitably for disposing of it, if desired, in the form of a dike or levee. When this operation is completed at one point, the vessel is moved a distance of 4 feet, anchored, and the operation repeated. Thus the process continues for any required distance.

Having the telephone book near the instrument is a great convenience, and a simple holder has been constructed which can be easily and quickly attached. The book is opened at the middle, the light polished-metal holder inserted, and the whole hung on a hook or nail by the ring at its end.

Those wishing further information on anything described in the editorial pages can obtain it by addressing Bureau of Information, Popular Mechanics Magazine.

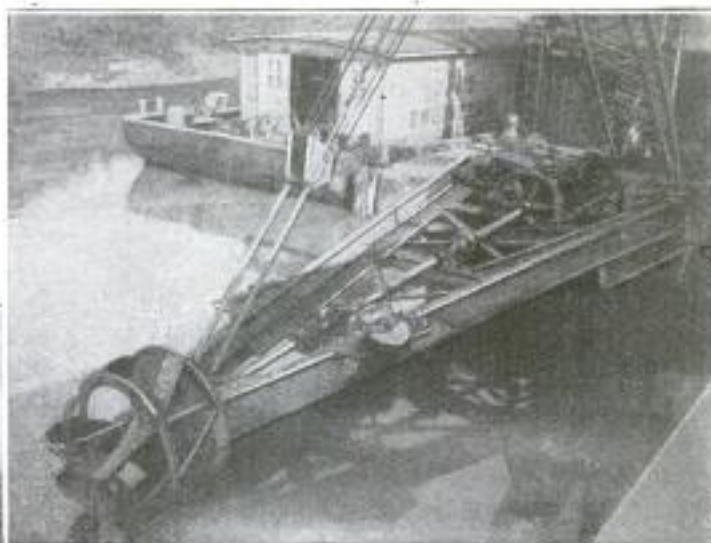

Dredge That Clears a River Channel and Builds Dikes or Levees on Shore: At Left and Above Are Two Views of the Derrick That Projects from the Stern of the Boat, and Has a Rotary Cutter at the End of It. At Right are Shown the Pipes That Connect the Vessel with the Shore

The Collyth Laboratories, 565 W. Washington St. Chicago

157

COMBINE SUBWAY, SURFACE, AND "L"-SYSTEMS

By GEORGE F. PAUL, 900 Ellsworth Bldg Chicago.

THE city of Cincinnati is busy at the present time in trying to free itself

from traffic congestion in the main parts of its business district. To handle the thousands of passengers that pour into this district every workday morning, and then late in the afternoon make a frantic scramble to reach their homes in the distant suburbs, a rapid-transit railway is being built.

It will be a combination subway, surface line, and elevated system, the plan being varied to suit the different conditions encountered. The system, when completed, will be a belt line, with all the latter's decided advantages. In 1916, the city voted \$6,000,000 for this plan, when this sum was thought sufficient to build the entire system,

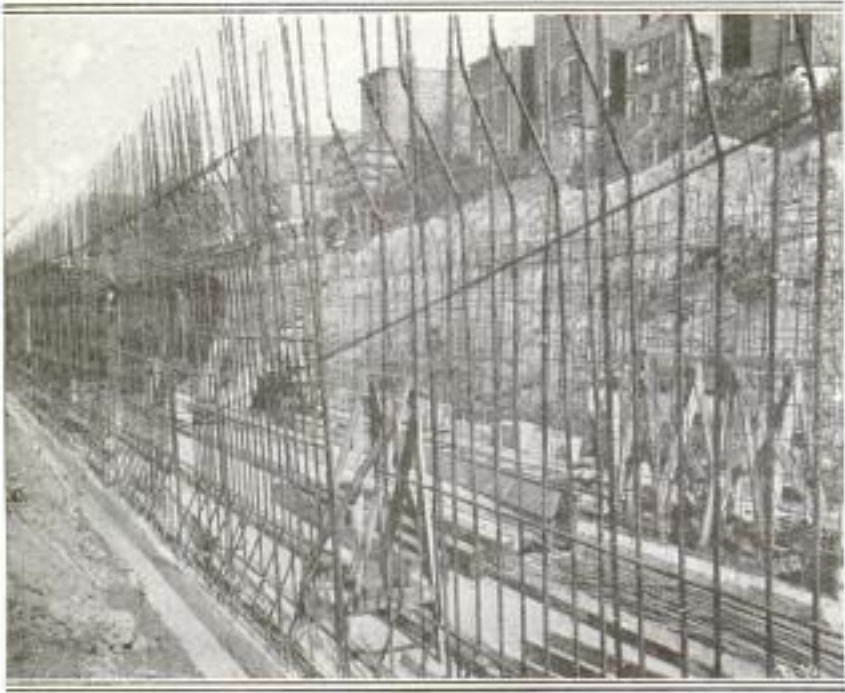

Above: Vertical Reinforcing Bars That Form Part of the Side Walls of the New Cincinnati Subway Tunnels. Below: Excavation for Subway, Showing Bottom Concrete in Place, and Side Wall, as Well as Some of the Arched Forms



View of One of Cincinnati's Subway Tunnels, Showing the Completed Concrete Work before Backfilling: Note the Small Track on the Roof of the Tunnel, Which Carried the Concrete Cars from the Mixer to the Forms

but with soaring labor and material costs, much more will be required to complete it. However, the work has been pushed in spite of many obstacles, and at present about two miles of subway has been completed, $4\frac{1}{2}$ miles of open work is constructed, and the line will probably be operated at first from Oakley to Race and Canal streets.

In one respect at least those urging this combination line have been fortunate: They have been able to obtain from the State of Ohio the right of way for a considerable distance along the old bed of the Miami and Erie Canal. This has meant a great saving in excavation costs and has speeded up the work materially.

Whenever a Cincinnati business man who lives in the suburbs to the north of the river wants to reach the heart of the city, which is in the vicinity of Fountain Square, it is necessary for him to cross practi-

cally the whole city. To the east of Mill Creek, on a slight elevation, stands this business district. At a varying distance from the river rise the bluffs that are so common throughout the Ohio and Mississippi valleys. A rolling country stretches

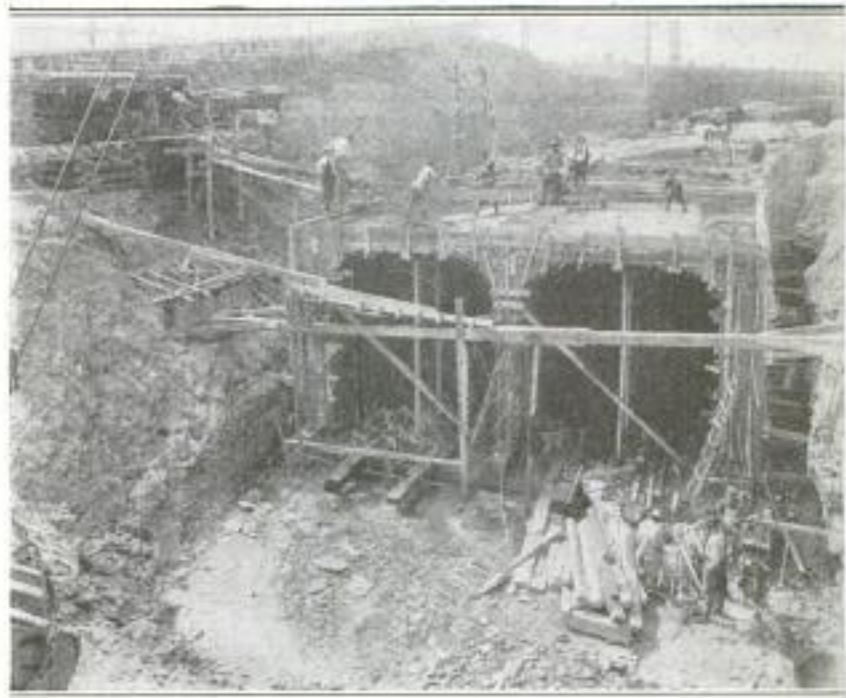

Subway Tunnel under Construction, Showing How, in Many Places, the Concrete was Run through a Chute into the Forms, Direct from a Movable Mixer

away from the brow of the bluffs. The number of streets tapping the business district from these bluffs is strictly limited, and with street-car lines on practically all of them and the number of automobiles steadily increasing, traffic is so slowed down that the worker in the business district spends entirely too much of his time in getting to and from his work.

The belt line is intended to help handle the cars of the interurban lines. It is planned to run the interurban cars to the heart of the city over the new tracks until such a time as the other traffic makes this impossible. A combination interurban and loop station on Canal Street will prove one of the main points on the new system.

There are to be no grade crossings on this new line. This means that far greater

speed will be possible and far greater safety will be assured. The line will be double-track, standard-gauge, with power from a third rail. With 4-car trains spaced 1 minute 9 seconds apart, it is estimated that more than 100,000 passengers can be handled an hour. Each car is to be 70 feet long. Reinforced-concrete construction has been used in building the double-tube structure for the subway portion. In order to admit freight cars, if necessary, the tubes have been built with a clearance of 14 feet 9 inches over the top of the rail. Reinforced concrete has also been chosen for building the elevated portion of the line. Block systems, ventilating openings, emergency exits, and other late safety appliances and measures, have been adopted to make it an up-to-date system.

NAIL-STRAIGHTENING DEVICE EASY TO OPERATE

194.

For straightening badly bent nails or spikes rapidly and easily, a small, simple machine is in use in Germany. A verti-



Nail-Straightening Device Shown Above with a Bent Nail in Place Ready to be Straightened by Swinging Back the Vertical Lever, as Shown Below

cal hand lever is pivoted to one end of a stand which has at the other end a slotted device, into which the bent nail can be dropped when a second small hand

lever connected with it is raised. Hinged to the vertical hand lever is a rod that passes through this slotted portion of the stand, and has connected to it a lug that holds the head of the nail. In operation, the vertical hand lever is pressed forward, the nail is dropped in, and the second small lever is pressed down upon the nail. Then the vertical lever is swung back, drawing out the nail straightened.

TEXTILE INDUSTRY TRYING TO SPIN KAPOK FIBER

Kapok fiber, that buoyant material now used so extensively in the manufacture of mattresses, pillows, cushions, and life preservers, is being made the subject of exhaustive experiments by the textile industry. The object is to find a means whereby this peculiar substance can be spun into thread. So delicate is this fiber, which is short and brittle, that it is broken into tiny particles as light as dust, at the slightest tension. Nevertheless, the possibility of spinning this valuable product, which comes from South America and Java, is the goal toward which many manufacturers and laboratory workers the world over are expending ceaseless effort.

N.M. Jones 9/5/28

Posts, poles, and ties cut from blight-infected chestnut trees are as durable in service as similar timbers cut from healthy trees, according to the U. S. Forest Service, although it is advised that these timbers be cut as soon as possible from the trees infected with fungous decay.

ADOBE BUILDINGS LONG IN RUINS REMODELED

IT HAS become a popular practice with artistically inclined Californians to purchase the old ruined adobe buildings at Carmel and Monterey, and convert them into modern studios and residences. The remodeling is done so as to make them architecturally as attractive as possible, and in connection with some of them are historic associations that make them additionally interesting.

Specimens of such buildings are shown in the accompanying illustrations. At the top is a view of an adobe building at Carmel that had been in ruins for about 100 years, and was remodeled into a charming and strictly modern tea room.

Below this is an old adobe house at Monterey that was purchased by an artist, who converted it into a studio, framing into it the large window at the gable end, that gave him all the light necessary for his work.

Next below is a view of an old adobe building, at Monterey, in its unimproved condition, giving an idea of the work that has to be done in remodeling it, reflooring it, and installing it with plumbing.

Below this, taken from another point of view, is the same building after it was remodeled, showing the wonderful results possible with such unpromising material. The walls are about three feet thick, and the work that had to be done on them was far from easy.

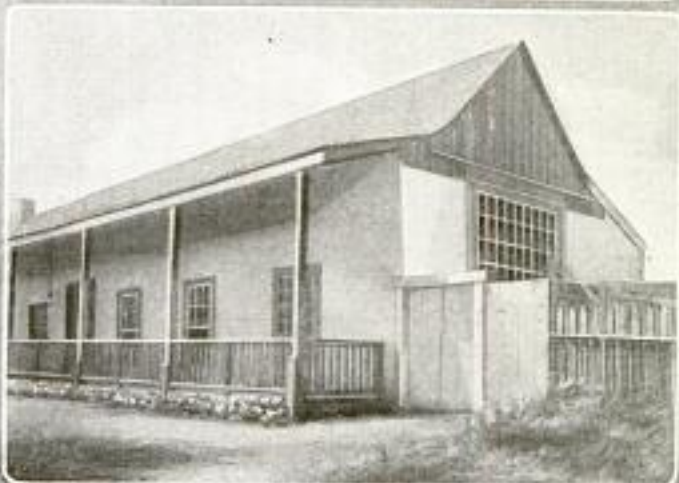

RIVER MADE TO PURSUE PRESCRIBED COURSE.

By J. B. HOLDCROFT,

1985 Fort St. Victoria, B.C., Canada

THE Capilano River near Vancouver, B. C., formerly had the habit of wan-

effective nature would have to be adopted. Previous attempts to put in abutments



Wreck of Highway Bridge, above the Railway Bridge, Caused by the River during One of Its Flood Periods

dering over flats about a mile wide, for some distance near its mouth, flowing in one place one year and in another the next. The construction of a railroad bridge at this point made it necessary to reduce the width of the river bed from 900 feet and confine it to a channel barely 200 feet wide.

Soon the river began wearing away the west bank, however, seeking a course it had undoubtedly followed before, which action was particularly destructive



View of River during the Dry Season, Showing the Railway Bridge in the Background and One of the Jetties with the Sand Bar Which It Caused to Form in the River Bed



Railway Bridge with Two 100-Foot Openings Bottling Up the River Which Was Formerly Nearly a Mile Wide at Its Mouth

in periods of high water, and it became apparent that protective measures of an

fight had to be renewed on the opposite bank. Before it was stopped, the current

the current of the river could not move, had proved futile in the case of a highway bridge higher up. So, just above the bridge on the threatened bank, a simple little structure of logs and wire was extended 18 feet into the stream. This caused an eddy and checked the current enough so that entrained sand, stone, and floating débris were dropped out, and the formation of a bar begun on the river bottom. Then other

jetties were similarly built at 400-foot intervals along the bank, and the growing bar extended to reinforce all of that section. Later, by adding a few feet to the length of each jetty, the bar was made wider and stronger, but this was no sooner accomplished than the river turned, and the



General View of Highway Bridge, Showing How the River Turned from One Side to the Other in Sweeping Out Both Approaches with Its Swift Current: Note Temporary Truss over the Most Easterly Span, and the Temporary Structure at Each Approach

had washed the rock filling from the wooden abutment pier, and later the central pier. This was stopped and the piers repaired by letting down into the water in front of them, woven-wire fencing covered with branches. Finally, to protect the east bank, a mattress of wire fencing

34

ADVANTAGES OF NEW BOOSTER IN GAS-BURNING PLANTS

In plants using gas for heat treating, forging, and other work, the gas pressure, as delivered by the gas mains, will vary from time to time as the demand for gas is made, either in the plant itself or by outside influences, changing, thereby, the ratio of air and gas and causing a corresponding change in the combustion conditions. This causes waste of a great amount of gas. To overcome this waste, and in other ways improve the efficiency of the installation, a gas booster has been developed which assures a uniform volume and a nonpulsating gas pressure, and thus permits the proper adjustment of burners.

An excess of air supplied to the burners produces an oxidizing flame, which, in addition to wasting gas, causes scaling in heat treating and forging work, while insufficient air wastes gas by incomplete combustion. Neither of these conditions gives the maximum amount of heat for the amount of gas used. Experienced engineers have found that the best method of burning artificial gas is to increase or boost the pressure to about 7 pounds per square inch, and entrain the necessary air from the surrounding atmosphere at the point of application through an injector. This method, applied in the device here in question, relieves the op-

erator of all adjustments of air and gas, and results in uniform heating and a constant combustion condition. It also eliminates air piping throughout the plant,

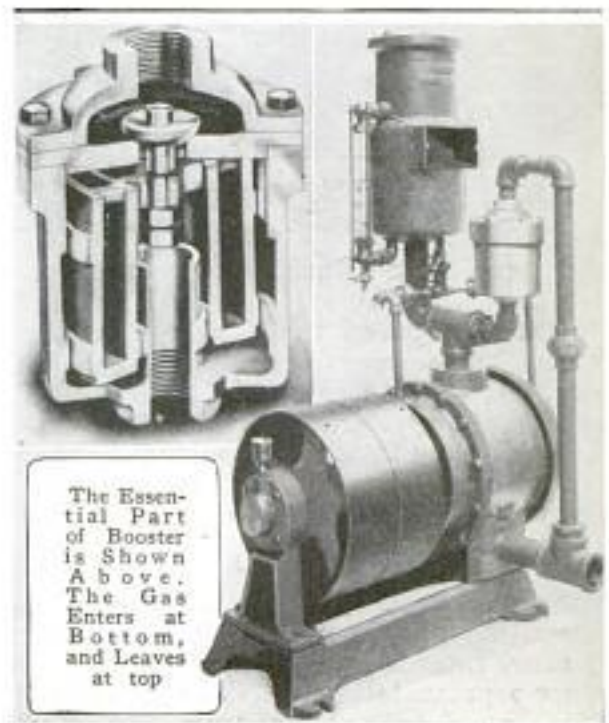

The Essential Part of Booster is Shown Above. The Gas Enters at Bottom, and Leaves at top

and moreover, as the gas is under pressure, a much greater volume can pass through existing lines than could be had with the low pressure supplied by the main.

Beach-Oruso Co.,
Hudson Terminal Bldg
New York City

W. B. Emig
Copyrighted material

Cml. Francis Lichie
 Herald Bay, B.C.
 756

Sumatra
**SUBSTITUTE FOR SCARECROWS
 DEvised BY SUMATRANS**

165 Farmers on the North American Continent who spend considerable money gunning for crop-destroying birds, when scarecrows have failed to perform their



Substitute for Scarecrows in Sumatra: The Native on the Platform Strikes the Bamboo Poles, Setting in Motion Bells and Rattles That Scare Away Birds

office, can get a valuable tip from the native farmers of Sumatra.

At the edge of the field to be protected, the farmer erects a strong high pole. At the top of this is built a small, well-braced platform, with a railing. To the railing are fastened two or more bamboo rods. From the rods strong cords are carried in all directions to upright flexible stakes, which are set around the boundaries of the field in such a way that an almost netlike stretch of lines covers the growing crop. To the cords, at short intervals, are attached grotesque paper representations of the spirit of the forest, previously placated with many offerings of fowls and pigs. In addition, though not intended in any way to imply doubt of the efficacy of the spirit, are hung little bells made of wood, which give off clicking sounds. At other places on the string are placed wooden rattles.

Just as the day is dawning, a member of the farmer's family, generally a small boy or girl, goes to the contrivance, climbs to the platform, and stays there till the last bird has disappeared at evening. During the daylight hours, the watcher is constantly on the alert, and whenever birds come near the field, the boy or girl strikes the bamboo poles, thus setting in motion the paper images, the wooden bells, and rattles, which latter are peculiarly discordant. The method never fails to protect the fields.

140
**TOLL OF ACCIDENTAL DEATHS
 REACHES HIGH MARK**

Seventy-six thousand persons died during 1920 from accidents which could have been avoided, according to statistics presented at the Eleventh Annual Safety Congress by the National Safety Council. Falling accidents of various kinds accounted for the largest percentage of deaths. Other causes in order of importance were: railroad accidents, drownings, deaths from gassing, firearms, mine accidents, machinery, street cars, other vehicles, and conflagrations. Twice as many men as women were killed, although the latter suffered greatly from domestic hazards. Children under 15 years of age figured in one-third of all automobile fatalities.

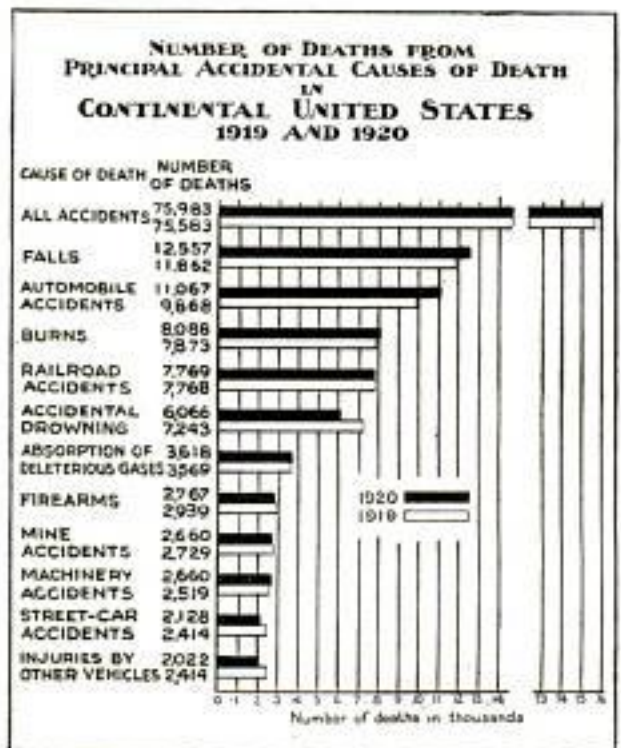

This Chart Presents a Comparison of the Number Killed in Accidents from Various Causes: The Black Lines Indicate the Toll of 1920, While 1919 is Represented by the White

168 2. Kuchigara Ave
 Copyrighted Chicago

9935



International AMATEUR BEDOUINS ON THE WARPATH

WHAT appears to be a Bedouin sheik leading his band of desert rovers across the sands of an African waste, is only the members of a moving-picture producing company out on "location." The scene is from a spot less than 75 miles from Los Angeles, California, where the Mojave Desert with an approximate area of 25,000 square miles, affords the necessary environment and atmosphere for the filming of photoplays, the scenes of which are laid in Egypt, Arabia, or other lands of northern Africa.

9632

CONCRETE PIERS REPLACED BY UNUSUAL METHOD

An unusual method was employed in the replacement of concrete piers under a viaduct on the Columbia River highway near Portland, Ore., which had been damaged the preceding winter by heavy drifts of snow. The customary wooden forms were built



beneath the viaduct floor, holes cut in this, and the concrete poured down into the forms from the roadway above. In addition to replacing the old supports, new piers to the same number were added, to prevent a possible recurrence of the trouble.



Top: Concrete Mixer, on the Viaduct, from Which Workmen are Taking the Mixture in Wheelbarrows to the Forms. Lower Left: Underside View, Showing the New Piers. Lower Right: Workmen Building Wooden Forms in Which the Concrete for the Additional Piers was Poured

*Cont H. E. Thomas, 911 Hunchley Ave
Portland, Oregon*

215 **CONCRETE WALLS DESTROYED PNEUMATICALLY**

Pneumatic Hammers, used by street railway, telephone, telegraph, and other companies as paving breakers, were recently employed in demolishing the reinforced-concrete walls of a vault in a factory in Cleveland, Ohio. The work was expedited by having two men handle each breaker, and in this manner a 24-inch wall, 20 by 23 feet in area, was completely demolished, reinforcing rods and all, in three days. The concrete was broken up into pieces small enough for one man to handle easily, and for the reinforcing rods a cutting tool was used in the pneumatic hammers. The side walls of the vault were 12 inches thick, 10 feet high, and 51 feet long. Only 7 days were required to remove them completely, and the work was done more cheaply than by hand methods.



Part of a Reinforced-Concrete Wall being Destroyed by Pneumatic Hammers, Each Operated by Two Men to Make the Work Speedy: The Reinforcing Rods Still Standing were Broken Up Later with Cutting Tools

36 **IMPROVED TESTER TELLS WORKABILITY OF METAL**

A machine has just been developed that will determine by actual test the

tation ball and micrometer screw, a micrometer thickness indicator which shows the thickness of the sheet or wire under test. A tester of this kind will save many dollars by eliminating improper material before much money has been spent in fabrication.

Pittsburgh Instrument Machine Co. 40 Water St. Pittsburgh Pa.

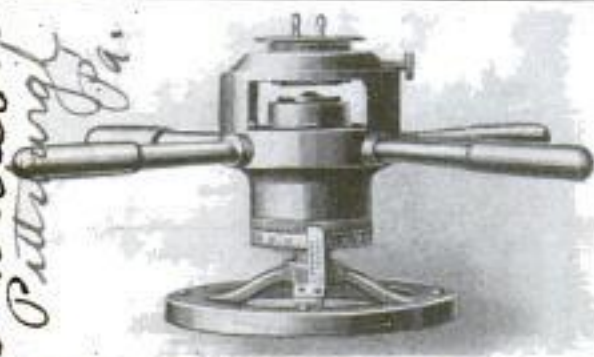

This Machine Determines by Test the Drawing, Stamping, Folding, and Compressive Qualities of Sheet Metal and Wire

drawing, stamping, folding, and compressive qualities of sheet metal. The machine is of rugged design and intended for use in the shop as well as the laboratory. By means of a special die and holder it is possible to test wire or rods of any material, up to No. 4 wire gauge. The machine combines with the regular inden-

Utilization of the Humber River, Newfoundland, in the production of electric power can be done so economically that it is estimated 186,500 kilowatts can be obtained as the result of an expenditure of only about \$97 per kilowatt.

BRASS	COPPER	COLD-ROLLED DRAW STEEL	ALUMINUM	GERMAN SILVER	TINNED SHEET
.535	.485	.405	.370	.360	.350
BRASS	COPPER	COLD ROLLED DRAW STEEL	ALUMINUM	GERMAN SILVER	TINNED SHEET
.300	.310	.300	.215	.275	.280

Specimens of Metal Tested by New Machine Which Indicates by Depth and Roughness of Dome, and Character of Fracture, the Workability of the Metal



Above: First of the 80 Houses being Moved from Jennings to Cadillac. Right: Backing the Trailer under the Jacked-Up House

90



HEAVY MOTOR-TRUCK TRAILER MOVES 80 HOUSES 11 MILES

Some 80 frame houses that formed the little village of Jennings, in Michigan, are being moved to Cadillac, 11 miles away. A large trailer for use with a powerful 6-ton motor truck has been specially built for the purpose. The trailer, constructed with a heavy steel frame, has a capacity of 40 tons. The plaster was removed from the first house to lighten the load, but the truck and trailer handled it so easily that this was not considered necessary with the other houses. The transportation is taking place at the rate of several houses a week.

89

PHILADELPHIA'S PUBLIC BEACH IS LARGEST IN COUNTRY

Just completed and thrown open to the public, Philadelphia's municipal bathing beach is reported to be the largest in this country. The two bathhouses, located on an artificial lake in League Island Park, have a combined capacity of 6,000. Provision for 3,500 is made in the men's bathhouse, while 2,500 can be taken care of in the women's quarters.

Both houses are equipped with steel lockers, special care being taken in the women's building to group the lockers so as to assure privacy. The dimensions of each building are 51 by 222 feet.

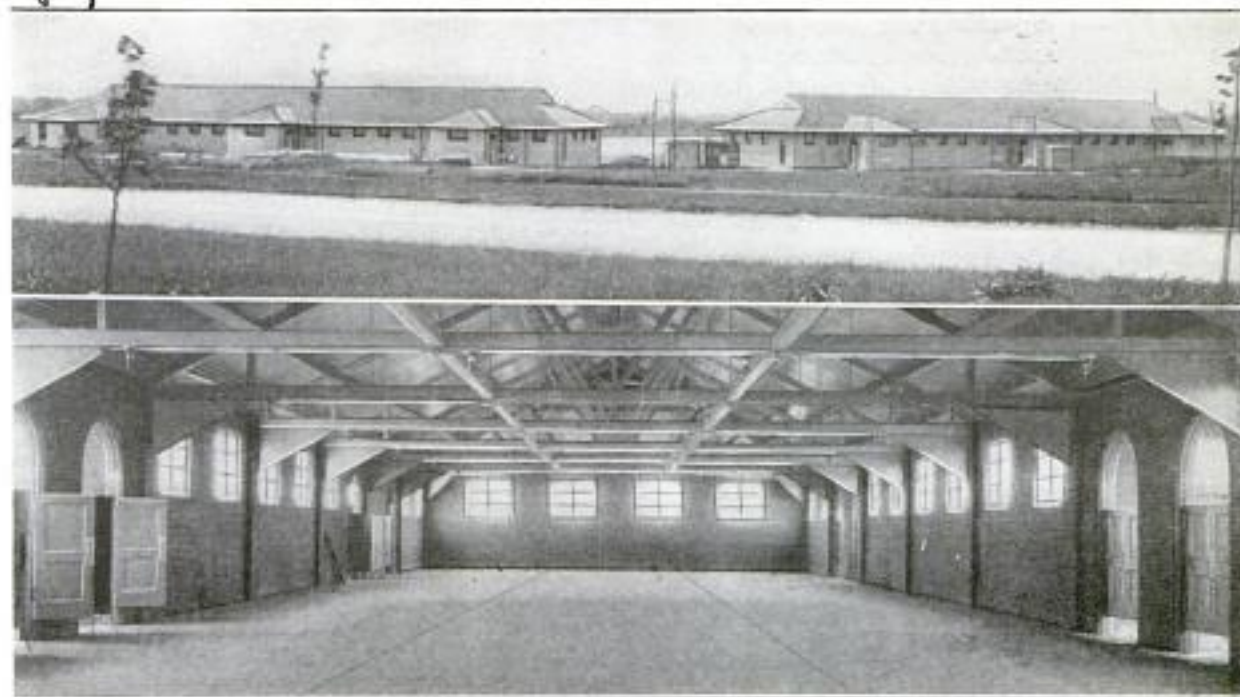

The Two Bathhouses, Pictured Above, were Recently Opened by the City of Philadelphia. They can Accommodate 6,000 Persons. Below is Shown the Interior of the Men's Quarters before the Installation of Lockers

Cmt. John H. McCarren,
 1026 Walnut St Philadelphia, Pa

100

ELECTRIC LIGHT ON MACHINE AIDS DEAF TYPIST

Handicapped by deafness, a typist overcomes this affliction to a great extent, when writing on his machine, by having

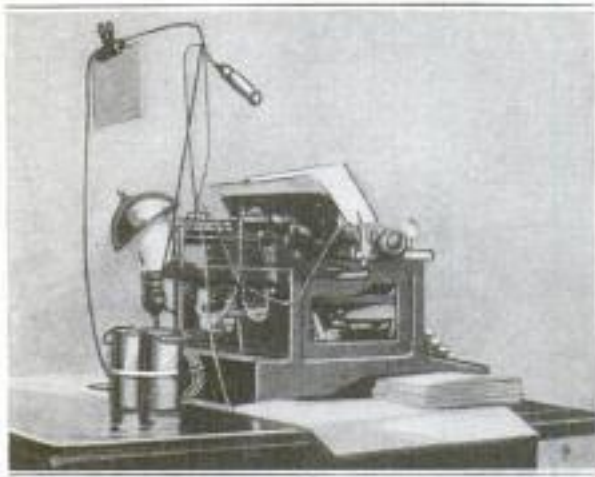

Typewriter of a Deaf Man Which Includes a Small Electric Lamp So Wired That It Lights When the End of a Line is Reached

installed on it an electric light in addition to the usual tabulator bell. Current is obtained from flashlight batteries, which are so wired that when the typewriter carriage reaches the tabulator stop, contact is made, and a red lamp suspended in front of the writer is illuminated.

PROVING-GROUND FIRE CAR HAS COMPLETE OUTFIT

Protection against the fire hazard at the Indian Head, Md., naval proving grounds, is adequately furnished by the equipment of an efficient fire car. An ordinary railroad flat car is used, this being towed over the network of tracks, with

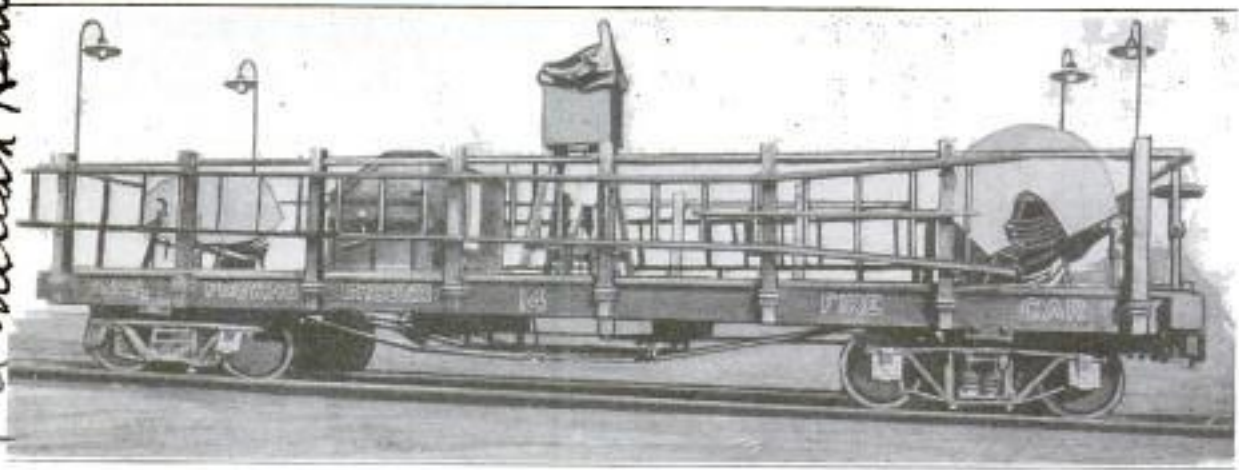

Fire-Fighting Equipment Mounted on a Railroad Flat Car at a Government Proving Ground, Showing the Large Electric Lamps and Hose Reels at Each End, While the Tool Box and Searchlight are Seen in the Center

which the hundreds of buildings are interconnected, by an electric trolley. The equipment includes hose reels, a searchlight and four electric lights—one at each corner of the car for night illumination—extension ladders, and a large tool box containing nozzles, axes, rope, and other miscellaneous fire-fighting aids.

IMPROVED INSTRUMENT EASILY TESTS PAPER FINISH

Refinements in design have lately been accomplished in connection with an instrument for testing the finish on paper that enable this work to be done quickly and accurately by a comparatively inexperienced operator. As in the older instrument, it depends upon the principle that obliquely reflected light is polarized much the same as from a glass surface, but the sensibility and accuracy have been considerably increased. Aside from its use in the paper industry, it can be



Instrument Used to Determine the Finish on Paper, Furniture, Automobiles, and the Like, by Analyzing the Reflected Light

applied to measuring the finish on furniture, automobiles, and the like.

Central Scientific Co., 460 S. Ohio St. Chicago

9586
 Capt. P. J. Seales, Naval Proving Grounds, Indian Head, Md.

158 Cmt. Edward Is. Maxwell
 P.O. Box 105
 POPULAR MECHANICS
 Norfolk Va.

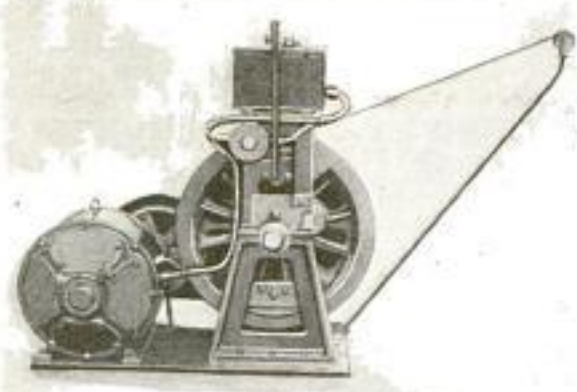

Coast and Geodetic Survey Vessel "Pioneer," One of Two Converted Mine Sweepers, Each of Which is Equipped with a Motor-Driven Deep-Sea Sounding Machine: Above is Shown One of These Machines. The Motor, at Left, is Gearing to the Drum, on Which 5,000 Fathoms of Wire can be Wound, and, with the Sounding Lead, Lifted at the Rate of 50 or 60 Fathoms a Minute

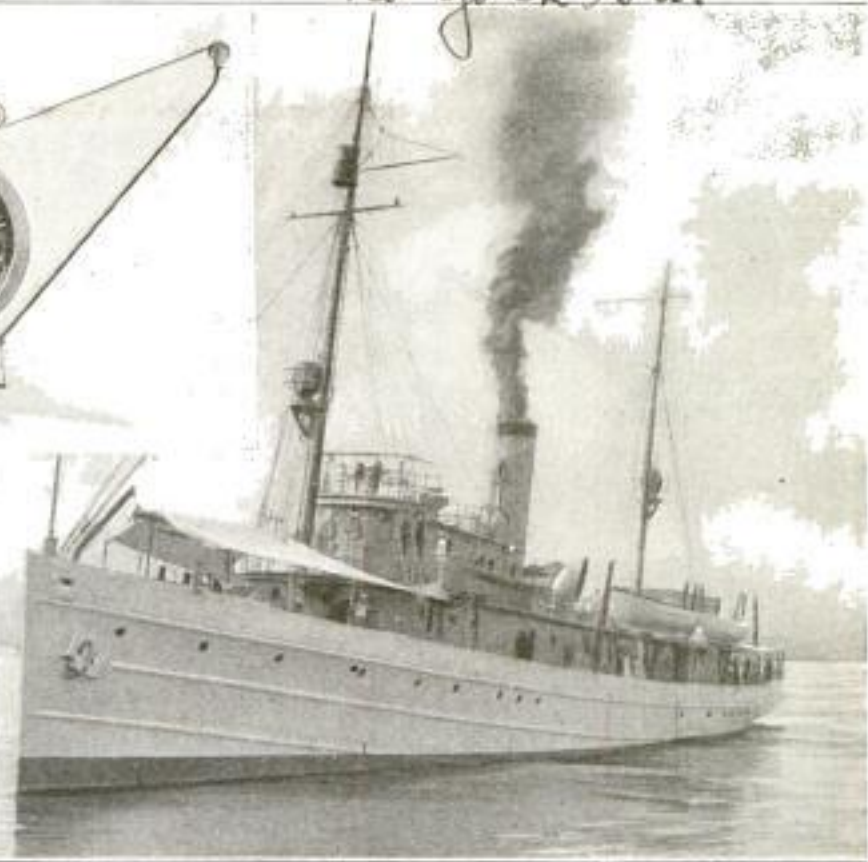

DEEP-SEA SOUNDING MACHINE THAT IS MOTOR-DRIVEN

158 In connection with the Coast and Geodetic Survey, the two newest vessels, the converted mine sweepers, renamed "Pioneer" and "Discoverer," have been equipped with a motor-driven deep-sea sounding machine in place of the customary steam-driven apparatus of this kind. A 2-horsepower electric motor is used to drive the drum, upon which 5,000 fathoms of fine steel wire can be wound. A 50-pound sounding lead is used, and with 1,000 fathoms of wire out, this weight can be raised at the rate of 50 or 60 fathoms a minute. The advantages claimed for the machine are simplicity and the ease with which it is operated.

ONE HUNDRED FEET OF FILM FINISHED AT SAME TIME

The developing, rinsing, fixing, and washing operations necessary in photography, have been facilitated by the introduction of a new film holder. This appliance consists of four racks placed on top of each other and held in position by a rod passing through their centers. The racks have evenly spaced bars, mounted vertically and extending diagonally across them from one corner to

the other. The films are wound around the bars with the sensitized side away from the metal, thus preventing any effacement of the coated part. Perforations in the racks permit the liquid being used to flow freely so that it will reach every part of the film, of which 25 feet may be wound on each set of bars.

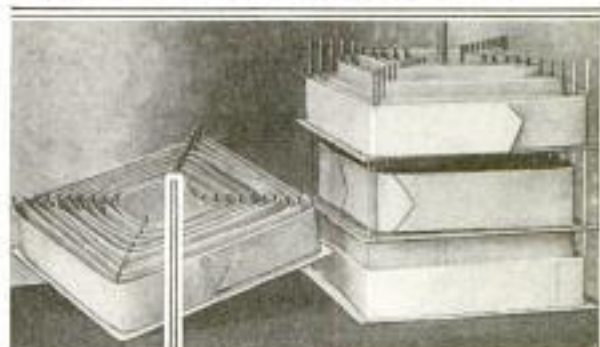

Top: Four Racks Wound with Film and Ready to be Placed in the Developing or Other Solutions. Bottom: Four Bare Racks, Showing the Spacing of the Bars, the Perforations in the Bases, and the Long Center-Rod Support

Chr. José E. R. Serra,
 Ponce, Porto Rico

LEVEL INDICATOR ADAPTABLE FOR VARIOUS LIQUIDS

93

In the type of gauge which indicates the depth of a fluid contained in a tank by means of a counterbalancing column of mercury, an improvement has been made which permits the use of the same gauge in connection with liquids of various specific gravities.

The improvement consists of a chart attached to the gauge, which has upon it a number of scales, marked at the top with certain specific gravities, and along their length graduated in

feet. For use, the proper scale, according to the specific gravity of the fluid, is lined up with the gauge glass, and the height of the mercury column will then indicate the depth of the fluid in the tank, in feet, or, with the tank area known, the quantity in cubic feet. Provision is also made for the attachment of an electric minimum and maximum-depth alarm. A check valve, located at the top of the instrument, serves to prevent the mercury from being blown out of the gauge glass,



(Edw. W. E. Lawson of Horbaro Co.)

in case the instrument should, for some reason or other, be subjected to an over-pressure.

MOTORCYCLE LOCK CONNECTED TO ITS SUPPORTING STAND

As a safeguard against theft, a motorcycle lock that is automatic in its action makes it impossible to move the machine under its own power or even to tow it away. The lock forms part of a supporting stand that can be attached to any motorcycle. It contains a pivoted locking bolt, which, when the motorcycle is raised on its stand, automatically snaps into locking position and cannot be released without the use of a key. To make it possible to raise the supporting stand from below the wheel, the key is inserted



ed and turned, moving the locking bolt out of engagement.

ed and turned, moving the locking bolt out of engagement.

CA huge airplane fitted with essential office equipment and a radiotelephone room, is being built for a wealthy Londoner, who will conduct business while traveling twice as fast as an express train.

9913

NOVEL MANNER OF BUILDING AN IRRIGATION DAM

By O. JOHNSON

King Victoria St. Otago, New Zealand

FOR the irrigation of 400 acres of arable land in the valley of the mountainous region near the town of Cromwell, in the province of Otago, New Zealand, the Kawarau River has been dammed in a very novel manner. The river, at the spot where the dam was to be built, is very narrow and rapid, with steep rocky banks. It was not possible to build the dam in the usual way, and instead two large columns of reinforced concrete, one on either side of the river, were built. One was 16 feet square and

46 feet high, and the other 13 feet square and 36 feet high. At the base, these columns were notched out in the way an axman cuts the trunk of a tree in felling it in a certain direction. Charges of dynamite were exploded under them, one after the other, and they fell end to end across the stream. Behind them a backing of stone hewn from the rock banks was built up, and mixed with concrete, until the level of the water was raised above the intake of a raceway, cut out of the solid rock and in places lined with

Cromwell Development Co Otago, New Zealand



One of the Columns is Seen Here Just as It Falls into the River, being Broken at the Notched Point by a Charge of Dynamite. The Standing Column Shows Where the Notch was Cut

concrete walls, This raceway is three-fourths of a mile long, and will carry the water to a point from which the whole of the flat can be irrigated by gravity flow. The flood-gates and spillways in connection with this part of the work are completed, and there is now being built a power house containing turbines that will generate 700 horsepower for driving centrifugal pumps.



View of the Part of the Raceway Where It Enters the Power House, the Top of Which is Seen in the Immediate Foreground

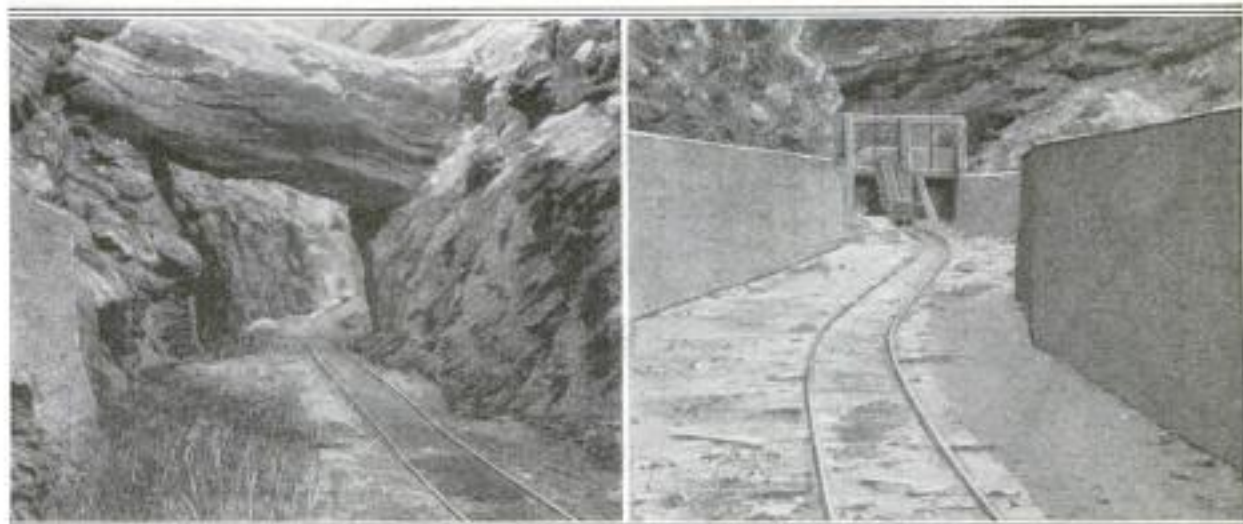

Left: View Showing the Rough and Rocky Nature of the Country, Which Presented Many Dangers in the Way of Rock Slides. The Huge Stone Lying across the Cutting is Provided at One End with a Concrete Support. Right: Inside View of the Raceway near the Intake, Showing the Gates

The Auto Cooker Co.

764 97 ~~Blondale~~ ~~Park~~ ~~POPULAR~~
Rochester, N.Y.

**AUTO EXHAUST-PIPE COOKER
HAS THREE LARGE PANS**

9815

Three large pans, allowing a diversified menu for a good-sized party of tourists, are contained in a new auto cooker which is heated by the exhaust. The cooker is



In the illustration above, the cooker, which is heated by the exhaust pipe, is shown disassembled. Notice the large size of the pans. On the right, the cooker is shown in its regular position just under the radiator cover.



made especially for a popular lightweight car, and is clamped in place under the hood. It is not necessary to heat either the food or any kind of radiator first.

The Bucyrus Co.

MECHANICS South Milwaukee
Wis.

**ENDLESS-TREAD TRACTION RIG
FOR STANDARD SHOVELS**

Heavy excavating machinery, mounted on endless treads instead of wheels, has demonstrated its superiority to such an extent that a keenly felt want is met by the recent production of traction attachments of this type to replace the trucks and wheels of the older machines. In this way owners of shovels, still serviceable from other viewpoints, can realize the advantages of the newer equipment at a relatively slight expense.

Propelling can be accomplished by either endless tread or both working together, either forward or backward, at a speed of about 1½ miles per hour, and is sufficient to enable the shovel to climb a 15 to 20-per-cent grade.

The recognized advantages of this type of traction are, that the operating field of the shovel is not confined to rails, which have to be laid, taken up, and relaid many times, and always give trouble in wet and cold weather; that it can be turned and does not have to face the blasting; that there are no supporting jacks to release and set, and no delays in operation from this source, and that the shovel is always in position to work most effectively. Furthermore, in an emergency such as a slide, the shovel can move itself out of danger, and there is no need of blocking under rails when working in soft ground.

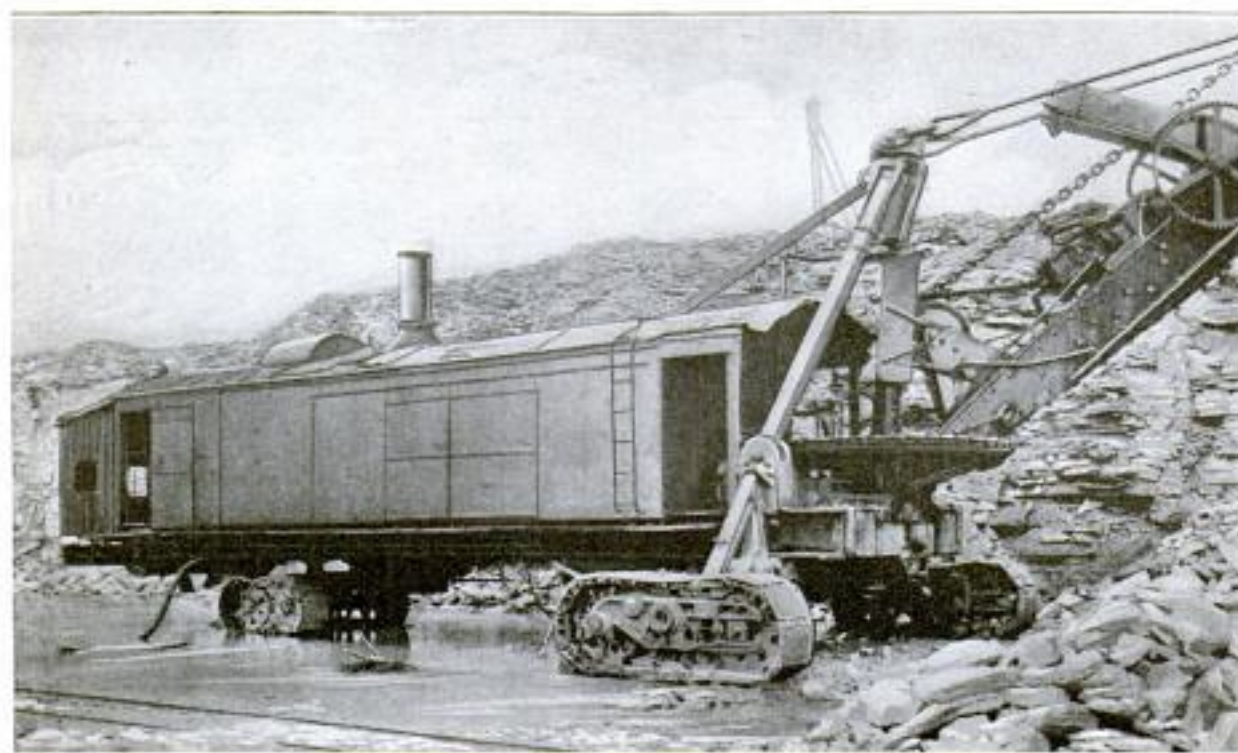

Heavy Steam Shovel in Which the Standard Trucks and Wheels for Rail Service have been Replaced with Endless-Tread Traction Attachments, at Relatively Small Cost

9900. Mr. Frederick B. La Forge,
 Bureau of Chemistry, Department of
 Agriculture, Washington D.C. 765
CORNCOB SEEN AS SOURCE OF NEW INDUSTRY

Six years of persistent research at the Bureau of Chemistry of the Department of Agriculture, has resulted in establishing the fact that a number of interesting and useful by-products can be derived from the humble corncob. Chief among these is a colorless oily liquid called furfural. One of its attractive possibilities is as a fuel for automobile engines and similar motors, where experiments indicate it can be used by the addition of a more volatile liquid, without modification of engine or carburetor design. This work has shown that another use of furfural would be as a cheap and satisfactory substitute for formaldehyde, as used in combination with carbo-lic acid in making a synthetic compound which is used for the manufacture of phonograph records, varnishes, pipe stems, parts for electrical appliances, buttons, and the like. Other valuable by-products from the corncob are adhesives, and a cob pulp which is suitable as a substitute for wood flour in the manufacture

of dynamite, or as a fiber in the manufacture of paper pulp and artificial silk. The equipment used and the methods of processing to obtain the fundamental derivatives are relatively simple. The corncobs are placed in a closed container and cooked for two hours in the presence of steam at about 135 pounds' pressure. The resulting liquid is then freed

from the pulp and distilled, so that, in condensing, the furfural is separated from the water. Following small-scale



Stills and Condensers of the Development Unit Used by the Bureau of Chemistry, Department of Agriculture, in the Extraction of By-Products from Corncobs

production by the government development unit at Arlington, Va., the department has made a survey of the regions where corn is extensively grown, to ascertain where factories could be located to support a production involving 100 tons of cobs per day, within a radius where transportation charges to the plant would be reasonable.

172
COMBINATION FOUNTAIN PEN AND REFILLABLE PENCIL

A self-filling fountain pen and refillable lead pencil, having all the good qual-



Combination Fountain Pen and Refillable Pencil, with Removable Cap Which Fits on Either End

ities of both, have been combined in one article. The barrel of the pen has the ink capacity of an ordinary fountain pen of the same size and is filled in a similar manner, while the pencil part contains a reservoir of seven standard-size leads.

When you want anything and do not know where to get it, write Bureau of Information, Popular Mechanics, Chicago.

cl no. to Wm. Chas
 1321 N. La Salle, Chicago



A Beautiful Rosebush Climbs the Foliage of This Tree in Santa Rosa, California. Running Nearly to the Top, More than 20 Feet above the House, the Bush is Said to Be One of the Tallest Known



Magazines Formerly Thrown Away by Departing Hotel Guests are Now Collected by a Society of Women in Portland, Oregon, and Distributed to Poor Families

In the Public Parks of Fargo, North Dakota, City-Library Magazines are Placed for Reference in Specially Made Boxes Nailed to the Trees

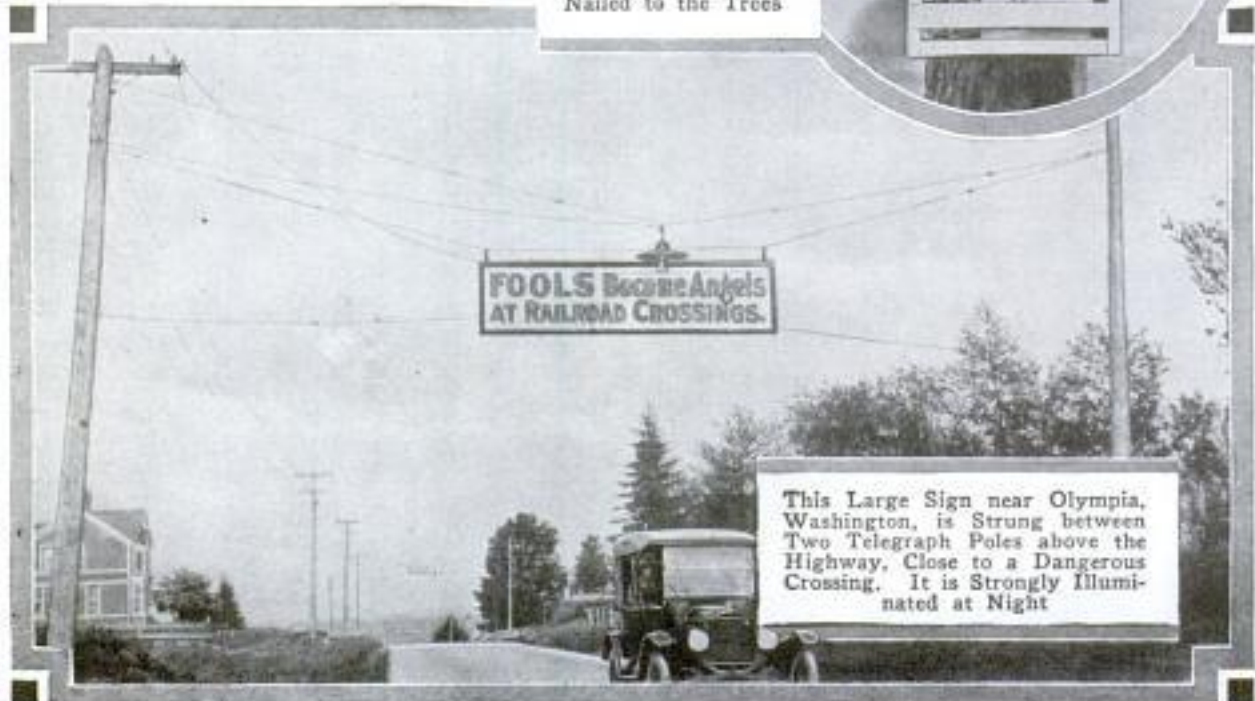
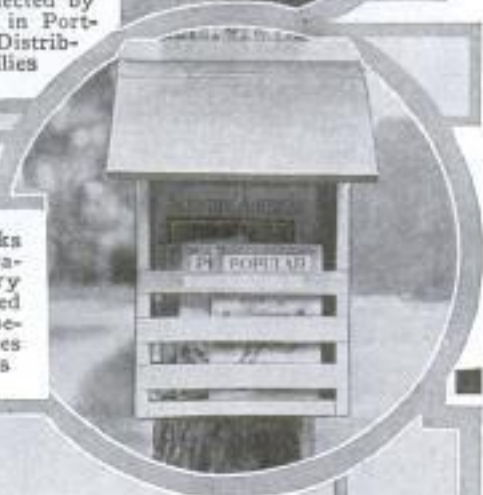

This Large Sign near Olympia, Washington, is Strung between Two Telegraph Poles above the Highway, Close to a Dangerous Crossing. It is Strongly Illuminated at Night

AND ENJOYMENT OF VISITORS AND RESIDENTS



More than 200 Young Children were "Checked" for a Two-Weeks' Vacation at a Summer Camp near Oakhurst, New Jersey, by a Charitable Day Nursery of the New York Tenement District.



The "Bandit Squad" of the Philadelphia Police Force Now Use High-Speed Motorcycles and Sidecars, and Carry Repeating Guns.



This Revolving Cross on the Steeple of a Church of Wilkensburg, Pennsylvania, Emits Flashes That Are Visible for Miles.

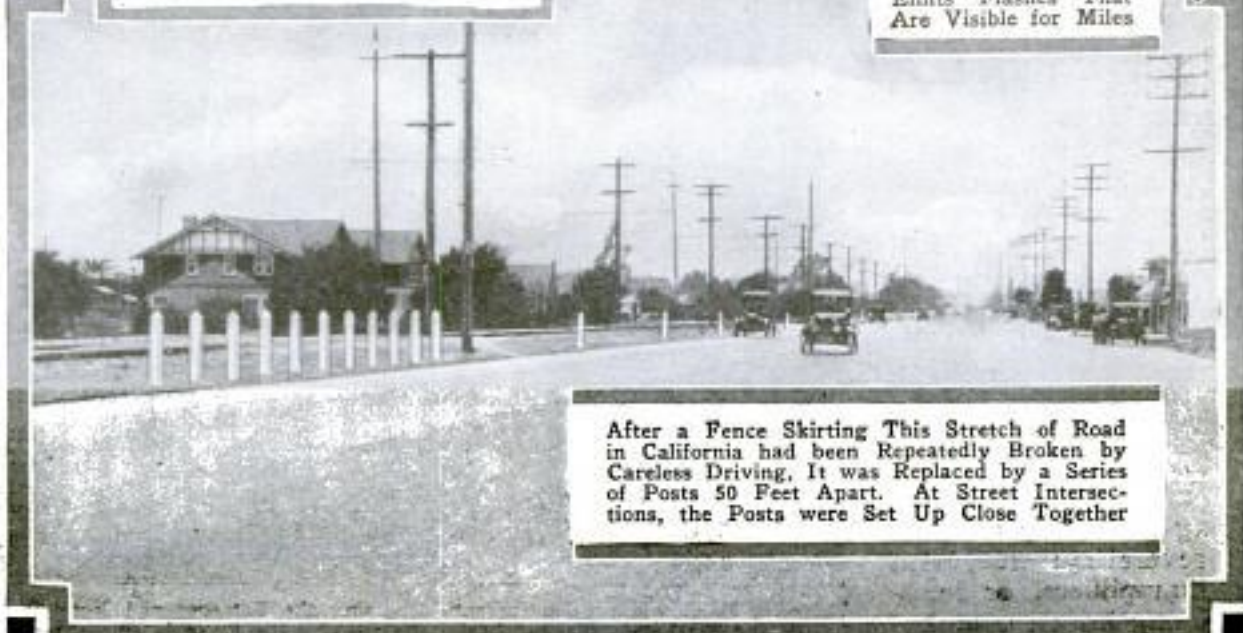

After a Fence Skirting This Stretch of Road in California had been Repeatedly Broken by Careless Driving, It was Replaced by a Series of Posts 50 Feet Apart. At Street Intersections, the Posts were Set Up Close Together.

768
 9760

METHOD TO PROTECT ROOTS OF IMPERILED TREE



When recent road-improvement work in New York City threatened the life of a beautiful large elm tree, special methods were adopted to protect the tree without interfering with the road work. Where the great roots crossed the excavation for the foundations of the new retaining wall, the earth was carefully scraped away from them, and they were wrapped in jackets of straw to preserve their moisture. Wooden sheeting was then driven vertically on each side of the roots to be protected. The channels formed between the rows of sheeting were filled with earth, and the concrete for the foundations was poured in the remaining spaces. Old steel rails, set on piers, were placed over the roots to protect them from excessive pressure.

☐ A native Paraguayan herb named "ka-a he-e," possesses sweetening properties that are said to be from 150 to 200 times greater than those of sugar cane, in addition to which the herb is soluble in water and does not ferment, these merits obviously being of value commercially.

*Sugar, 153 Waverly Ave New York
 May, 1922*

BY COURTESY OF THE AMERICAN FORESTRY ASSOCIATION
 Earth-Filled Channels were Formed to Protect the Roots of This Tree Where They Crossed the Excavation for the Foundation

BAND WITHOUT INSTRUMENTS IN STUDENT PARADE

Mystifying the onlookers, a recent student parade at the University of Wisconsin, at Madison, furnished excellent band music in spite of a "conspicuous absence" of any instruments. The answer to the puzzling phenomenon was radio. The drum major carried, instead of the usual baton, a pole with antenna wires which extended over the heads of the marchers to a similar pole borne at the rear. The receiving set and batteries were placed on a litter and carried along under the antenna by several students, with two amplifiers, or loud-speaking horns, complet-

ing the outfit, which certainly presented an unusual appearance.



Parading Band without Instruments, Showing the Batteries and Receiving Set on the Litter, the Amplifying Horns, and the Portable Antenna

*Emb. M. K. Brewery, 525 S. Warren St.
 Madison, Wis.*

Chas. Milton d. Dodd
1512 Beattie St
St. Joseph, Mo.

**RAT-EXTERMINATION PROBLEM
TURNED INTO SPORT**

Rat extermination, periodically made the object of nation-wide campaigns, has recently been presented in a light which tends to give these activities a sporting

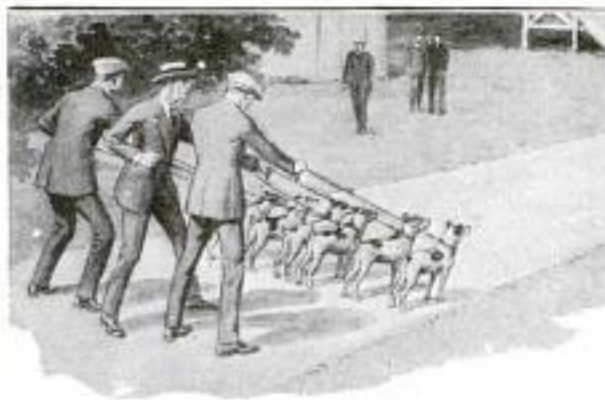

observed by experts who witnessed the test, that the plane flew just as well as with gasoline, that there was less vibra-



Rat-Extermination Contest. Showing the Dogs being Held in Leash at the Left of the Long Runway, While at the Extreme Right, the Rodent is being Dropped from a Cage into the Wire Inclosure

aspect. The innovation originated in St. Joseph, Mo., where a number of dog fanciers arranged a contest to determine the respective speed and rat-catching ability of their fox terriers. The method employed was to build a semicircular inclosure of wire netting, 25 feet in diameter, 4 feet in height, and with a 10-foot opening at one side. Leading away from this opening was a runway, or race track, for the dogs, about 500 feet in length, at the end of which the eager animals were held in leash. Over the center of the inclosure, a rat was suspended in a cage which could be opened by pulling on a string. At a given signal, the rat was dropped to the ground, and simultaneously the fox terriers were released, the latter immediately making a dash for the luckless rodent. Three heats were run to each race, the first dog crossing the line at the entrance of the inclosure receiving a credit of six points; the second dog, four; third dog, two, and the one catching the rat, two. Great sport for all parties concerned—except the rats!

**USE PETROLEUM AS FUEL
FOR AIRPLANE MOTOR**

What appears to some as an epoch-making event in the development of airplane and automobile motive power, is the recent successful trip near Copenhagen, Denmark, of an airplane using petroleum as engine fuel. Interest in this centers around the carburetor of the so-called dry type, an invention of a Dane, and which was attached to the 150-horsepower engine of the plane, although designed for only 80 horsepower. It was

tion and no soot formed, nor was there any self-ignition in the engine, which ran 100 less revolutions than normally. Petroleum costs a third as much as gasoline and has more heat units per gallon.

**METAL CAMP-FIRE STAKE HAS
THREE ADJUSTABLE RACKS**

Three adjustable racks, which may be turned, raised, or lowered according to the direction of the wind and the height of the flames, are attached to a metal stake designed for camp-fire cooking. One



Stake for Cooking over the Camp Fire: The Brackets on the Stake may be Turned, Raised, or Lowered of the racks is intended for roasting, another holds a frying pan, while a coffee-pot may be hung from the third.

Names and addresses of manufacturers of articles described in this magazine will be furnished free by our Information Bureau.

Secretary, National Dog Raising Association.

Aerial Age 9/1922

The Campfire Mfg. Co. 1035
St. Louis, Mo.

SOME NOVEL AND LITTLE-KNOWN ACCESSORIES



These Garment Hangers Have Two Hooks, and are Suspended from a Special Wall Bracket, Which is Easily Installed in Any Closet



Radio-Receiving Outfit Which has been Inclosed in a Highly Polished Case So That It Is an Ornament to Any Home: After the Luncheon or Dinner, the Apparatus is Brought Out and the Guests, or the Family Only, may Listen to the Broadcasting



Electric Lamp of Great Flexibility That Enables It to be Used on a Table or Desk, or Attached as a Wall Bracket

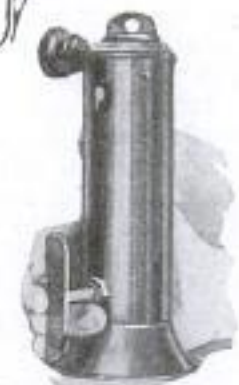

With This Shaving Accessory, Lather Ready for Application to the Face is Ejected by Pressing the Handle

Collapsible Vase, in Which Long or Short-Stemmed Flowers may be Displayed to the Best Advantage

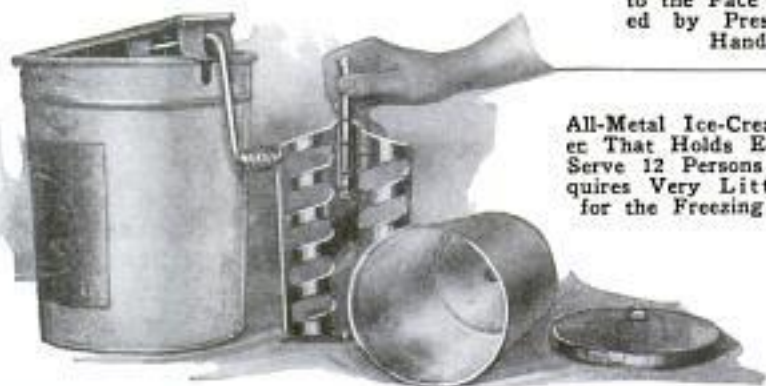

All-Metal Ice-Cream Freezer That Holds Enough to Serve 12 Persons and Requires Very Little Time for the Freezing Process

INTENDED FOR THE HOME AND ITS MEMBERS



Electric Frying Pan Constructed of Heavy Spun Steel for the Preparing of Eggs, Chops, and the Like, at the Table



Strainer Funnel Having Adjustable Screens Which can be Easily Interchanged



An Electrical Appliance with Two Attachments for the Accommodation of a Coffee Percolator and Toaster, or Other Electric Outfits: By Means of an Ordinary Extension Cord and Plug, It can be Connected to Any Light Socket



Belt Buckle Which may be Easily Taken Apart for Slight Adjustments of the Belt, as Shown to the Left

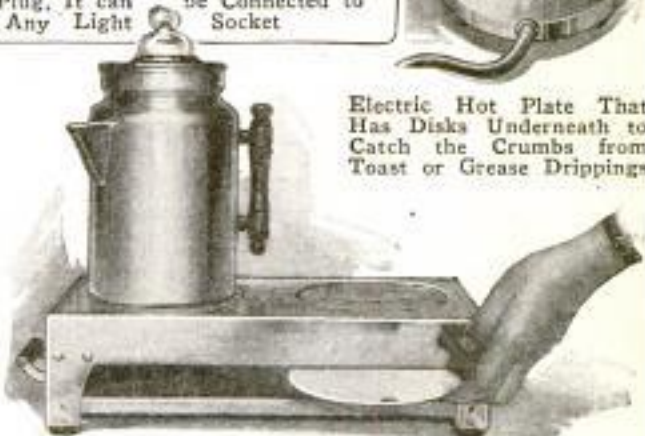

Electric Hot Plate That Has Disks Underneath to Catch the Crumbs from Toast or Grease Drippings



Window Brush Which Has a Small Water-Filled Compartment That Washes and Rinses at the Same Time

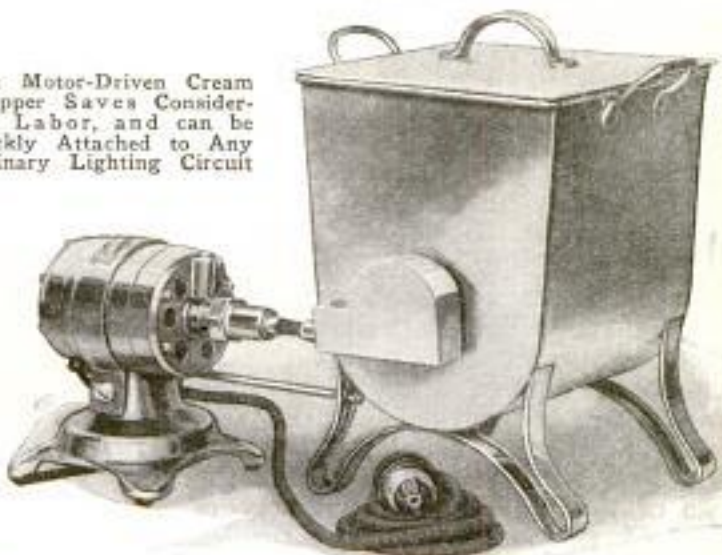

This Motor-Driven Cream Whipper Saves Considerable Labor, and can be Quickly Attached to Any Ordinary Lighting Circuit

Tw
M
Rad
El
L
Ic
Co
El
M
Du
H
St
E
Be
El
Co
Win
a

Chas. E. Sargent
 709 20th St.
 Rock Island, Ill.

Tasker's Engineering Co., Sheffield, England.
MECHANICS

BOILER FEED-WATER PURIFIER
REDUCES SCALE TROUBLES

A new device for overcoming the troubles arising from impure water in boilers precipitates the scale-forming materials before the water enters the boiler. A

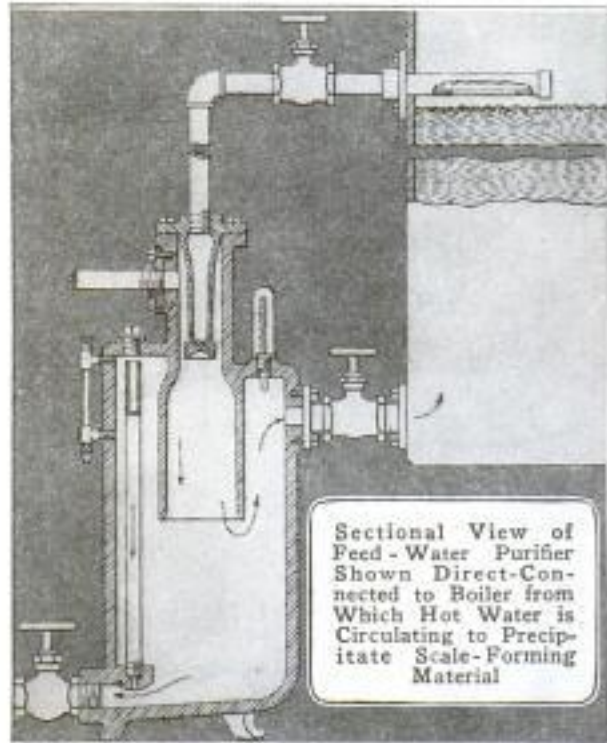

Sectional View of Feed-Water Purifier Shown Direct-Connected to Boiler from Which Hot Water is Circulating to Precipitate Scale-Forming Material

pipe, entering the boiler slightly above normal low water, has a slot underneath, through which water can pass out and into the purifier by way of an injector nozzle and downwardly opening bell. Raw water entering near the top of the heater, in passing down around the nozzle and through the bell, is heated sufficiently to deposit the foreign matter at the bottom, where a suitable blow-off is located. At a connection between the body of the purifier and the boiler, water enters the boiler below low-water level. The purifier is equipped with a gauge glass and thermometer.

CITY PROVIDED WITH MUSIC
BY BOY SCOUTS' RADIO

Installation of radio apparatus in a city-park band stand, from which music received from various parts of the West was amplified for the audience, was the venture originated by Boy Scouts in Twin Falls, Ida. The radio concerts proved such an immediate success, that those of the ordinary band variety were abolished, the enterprising youths being given full rein, as well as financial assistance, in their endeavor.

Emb. Henry H. Graham
 563 20th Ave. E.
 Twin Falls, Idaho

LARGEST ARMOR-GRINDING MACHINE IN THE WORLD

What is said to be the largest grinding machine ever made has been produced in Sheffield, England, for grinding the edges of naval armor plates. An unusual feature of the machine is that it does this grinding with the flat face of the wheel instead of with the periphery. The grinding disk is 54 inches in diameter, made of cast steel, and is divided by arms into sections filled with a grinding material, such as carborundum. Making 200 revolutions per minute it takes 120 horsepower to drive it. The total weight of the machine is 60 tons.

POLYPHASE MOTOR PREVENTED FROM SINGLE-PHASING

Polyphase motors in electric circuits are subjected to serious damage through "burning out," when a fuse on one phase "blows," thus permitting the heavily loaded motor to run on but a single phase of the current. Numerous protective appliances, such as circuit breakers, overload relays, etc., have been designed to overcome this trouble, but owing to the unstable character and surges of alternating current, these do not always operate satisfactorily. The introduction of a renewable fuse, which has a small heat coil incorporated in it, seems to have effectually solved the problem, however. These fuses are placed in a polyphase circuit in the usual manner, but the heat coil in each is connected across one of the other fuses. Therefore, if one phase receives a surge of current and blows its particular fuse, the current ordinarily flowing through this fuse immediately passes into the heat coil of a fuse in another phase. The heat resulting from the coil melts the second fuse, thereby killing the line and stopping the motor.

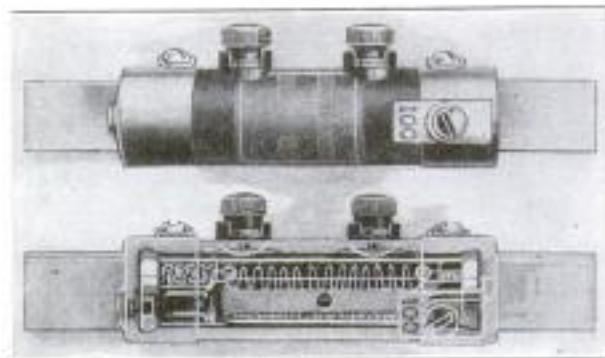

Top: Renewable Fuse, Showing the Terminals of the Heat Coil. Bottom: Phantom View of Fuse, Showing Location of Heat Coil

Edison Co. Chicago
Commonwealth
U. W. Marsh, Jr.
72 W. Adams, Chicago
Ing. to >

Federal Electric Co.
 72 W. Adams, Chicago

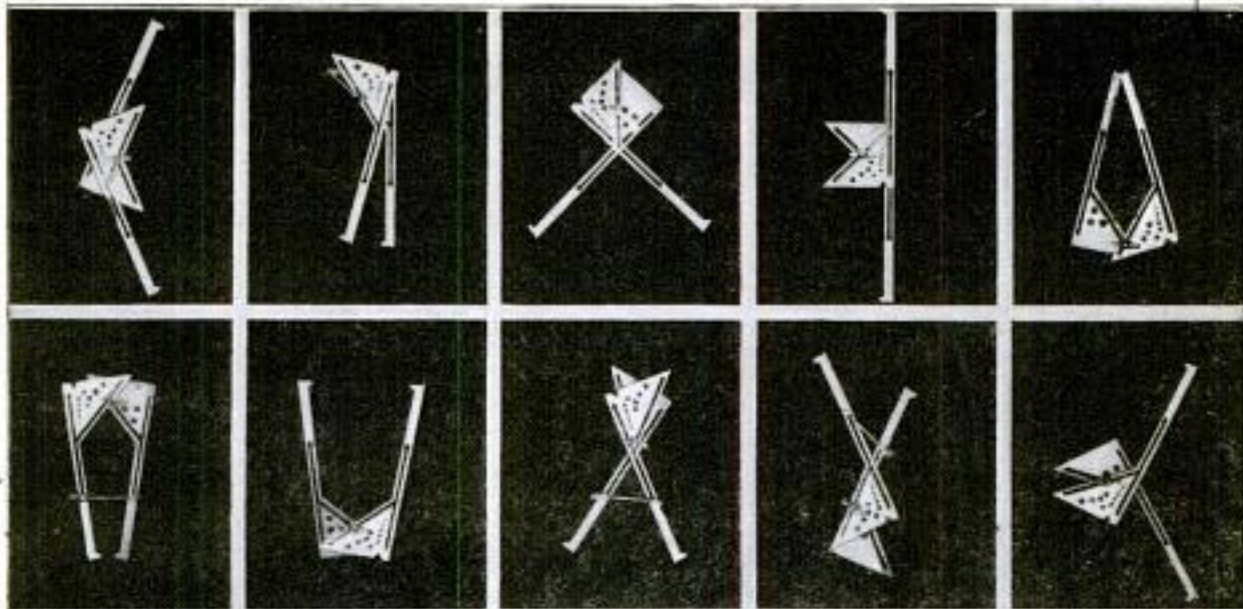

Reading from Left to Right, 10 Adjustments of the Measuring Instrument Are: Above, Bevel Protractor; Patternmaker's Caliper; Try Square; Inside Caliper or Straightedge, and Taper Gauge. Below: Two Forms of Outside Calipers; Inside Calipers; Extension Dividers, and Bevel Gauge

**ADJUSTABLE INSTRUMENT HAS
 NUMEROUS APPLICATIONS**

For the use of mechanics in general, an instrument that is adjustable for making measurements of a very varied nature has been recently patented. It can be adjusted for use as outside or inside calipers, as dividers, as a bevel gauge or protractor, as a straightedge, as a right angle, or 45° square, and it has a set of holes to act as wire and tool gauges. When in use as inside or outside calipers, it has a screw attachment for making very fine adjustments.

**39
 DOOR-LOCK STRIKE PLATE
 IS EASILY ADJUSTABLE**



An adjustable door-lock strike plate is made with an outer and inner plate so that the latter can be raised or lowered when required, to take care of any settlement that may occur in the door frame. To adjust this inner plate, in which are the openings for the latch and lock bolt, all that is necessary is to loosen the two screws that hold the outer plate, and after adjustment to retighten them.

**HEATER VAPORIZES THE HEAVY
 PARTICLES OF GASOLINE**

It is claimed the drawbacks of other heating devices have been overcome in a new design to completely vaporize low-test gasoline. The idea is not to heat the gas already vaporized by the carburetor, which heating would lower the efficiency of the engine, but only to apply heat to vaporize the particles of gasoline that are permitted to drop into a chamber surrounded by exhaust gases. This vapor forms a relatively cool mixture with that from the carburetor, and enters the engine without fouling the spark plugs, or diluting the crankcase oil, giving a reported increase in efficiency of 20 to 25 per cent. It does not require a new carburetor.



[An American manufacturing company has inaugurated a departure in the transporting of rubber latex, or liquid, by mixing this product with a chemical to keep it from coagulating, and then carrying it from the Malay Peninsula to this country in tank steamers.

Bohde Mfg. Co. 2621 Vine St. Milwaukee Wis. Copyrighted material

W. S. Engineering Co. Mobile, Ala.

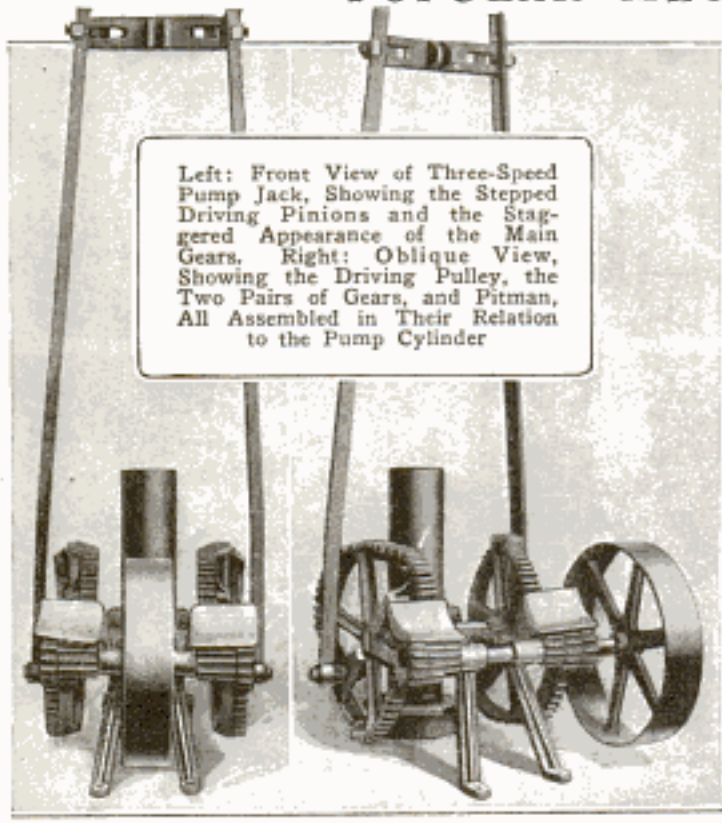

Left: Front View of Three-Speed Pump Jack, Showing the Stepped Driving Pinions and the Staggered Appearance of the Main Gears. Right: Oblique View, Showing the Driving Pulley, the Two Pairs of Gears, and Pitman, All Assembled in Their Relation to the Pump Cylinder

THREE-SPEED AUTOMATIC PUMP JACK

An ingenious pair of gears forms the interesting part of a new pump jack. The smaller gear, or driving pinion, is made with three different diameters, giving it a stepped appearance, each step being the same width as the larger or driven gear, which is of varying diameter and presents a staggered appearance, in order to correspond properly with the different steps on the pinion, at designated points in the pump cycle. The idea of this speed changing is to balance the work done in the different parts of the pump strokes, which has a tendency to reduce the power required to drive the pump. The changes are automatic and gradual, thereby giving a very smooth motion and eliminating undue strain on the pump.

SAFE PLAYGROUND APPARATUS 9811 MAKES EXERCISE A JOY

A new piece of playground apparatus, now on the market, combines the features of a tricycle and a merry-go-round. It can be operated by two or more persons, who push with their feet and pull with their arms. There are no gears, chains, or traps to become entangled in, and the centrifugal action of the swing tends to

hold the child more securely in its seat. A steel band, encircling the swing, adds strength and safeguards bystanders from stepping between the seats while the swing is in motion.

9970 CHANGES IN LIBERTY MOTOR RECTIFY FORMER DEFECTS

Changes in the Liberty motor have been made by naval experts that have resulted in making possible long-distance airplane flights without even so much as the changing of a spark plug. As is well known, the original Liberty motor had several faults, the most serious of which was the failure of the timing gears. This was first remedied by redesign. Additional grooves and holes in the pistons prevented oil from getting into the combustion chamber, and causing spark-plug trouble. The ignition system was greatly improved by substituting a 12-volt for the original 8-volt system. With these changes flights have been made of 25 hours' duration.

Aeromarine engine

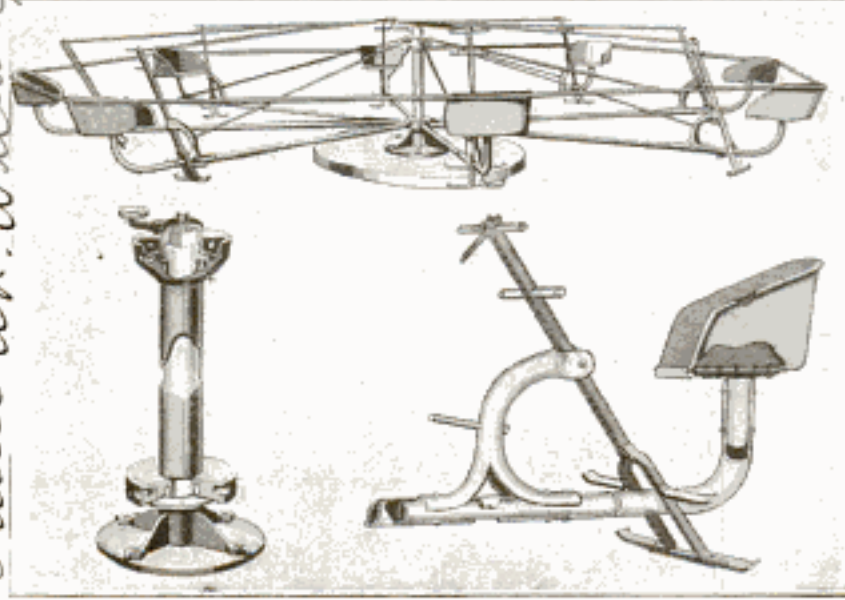

Above: Moving Part of Playground Apparatus, Showing Arrangement of Seats. Lower Left: Pedestal Support. Lower Right: Close-Up of One of the Seats, Showing Propelling Mechanism

*Williams Seamless Circle Spring Co.
 1102 Patton Ave. Wichita, Kan.*

*N.Y. Times
 P. E., 7/8/22*

177

PENINSULA OF SOUTH AFRICA ENCIRCLED BY A DRIVEWAY

For several years work has been in progress upon a roadway to encircle the entire peninsula at the southern extremity of South Africa, upon which Cape-town is situated. The roadway is now completed, and at the opening ceremonies, last May, it was claimed to be the finest marine drive in the world, surpassing even the famous Corniche Road, at Mentone, in the south of France. The road is 125 miles long, and for most of its length is hewn in the rocky sides of the mountains that tower over the entire seacoast of the cape.

102

SMALL POUCH FOR MAILING SOUVENIR CARDS

Made in the form of the regular U. S. mail pouch, a miniature bag for the inclosure of photographs or souvenir cards has been put on the market. A tag for the addresses of the sender and recipient



Small Bag, Constructed after the Pattern of a Government Mail Pouch, for Use in Sending Souvenir Post Cards

is attached, and the pouch is mailed at the regular rate of postage. A note or letter may, therefore, be inclosed with the pictures.

998 7

PUREST ICE MANUFACTURED ECONOMICALLY

At a famous sanitarium in the Swiss Alps, a simple method is in use for the economical production of pure ice. The ice plant consists of a structure having four upright posts, about 10 feet long, arranged in a square with 4-foot sides. Cross timbers at the top form a skeleton roof. A 1-inch steam pipe connecting with the boiler room, rises up one of the posts and terminates in a nozzle near

the top of the structure. Steam from the nozzle is projected against the underside

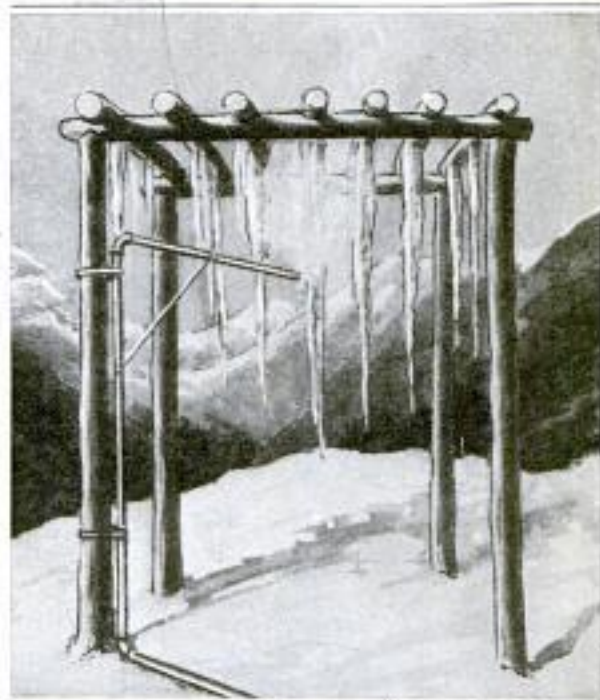

Simple Arrangement Used to Obtain Pure Ice at Low Cost in the Swiss Alps

of the roof timbers, where it condenses and forms into icicles, which are later broken off and stored.

3

CONVENIENT BATHROOM SEAT FOLDS INTO WALL

Convenience and economy of space are aptly illustrated in a recently introduced bathroom seat, which can be folded into the wall when not in use. The seat is the door of a small cabinet that can be fitted between two of the wall studs in any ordinary house, thus not taking up any valuable room when folded.

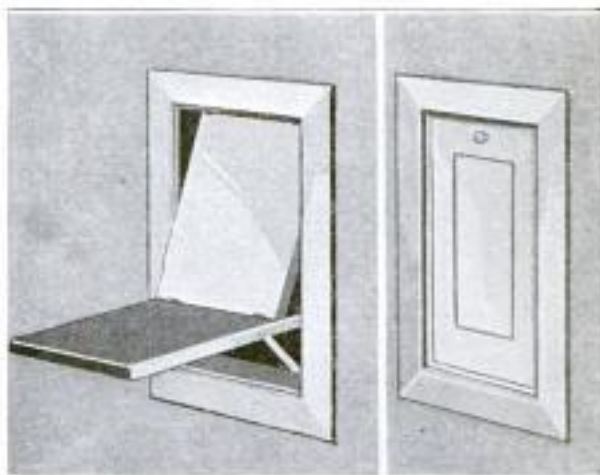

Left: Bathroom Seat Shown Pulled Out of the Wall Ready for Use. Right: Seat Folded Back into Cabinet

Murphy Door Seat Co
23 W. Monroe
Chicago

Bloom Bros.,
Minneapolis, Minn.

CHILDREN'S PICTURE-STORY DEPARTMENT



Of All Nests, a Humming Bird's Is the Hardest to Find, Both on Account of Its Smallness and the Cunning Way in Which It is Hidden. Here Is One That was Not Only Found but was Also Photographed—Mother Bird and All

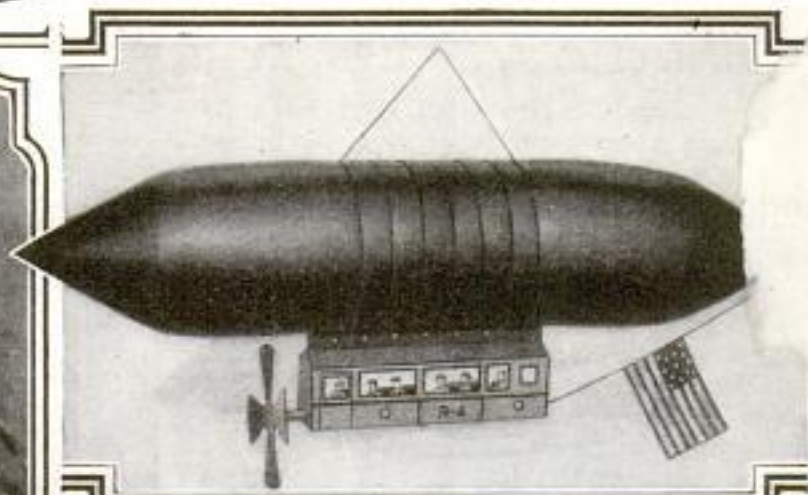

This Toy Dirigible Balloon Comes to the Home Folded Up and Packed in a Flat Envelope. Instructions Come with It, Explaining How to Convert the Folded Parts into a Car with Propeller and Connections to the Gas Bag After It is Inflated, When It Measures 24 Inches in Length and 5 Inches in Diameter



Here Are Two Gophers—Usually the Shyest of Animals—Apparently Posing of Their Free Will for the Photographer. The Picture was Taken in British Columbia



These Orphan Lambs Have Certainly an Excellent Foster Mother, with No Danger of Running Short of Nourishment—Quite the Contrary. This Unusual Family Scene was Photographed in a Little Out-of-the-Way Town in the Province of Quebec, Canada

OF MODERN ACTIVITIES AND INTERESTS



Florence Froude, of San Bernardino, California, Only 6½ Years Old, Looks Sturdy and Certainly does Not Belie Her Appearance, for, Swimming with Her Hands Tied behind Her, She Towed the Boatload of Heavyweights, Shown at Left, a Distance of 50 Feet



The Bank Shown Below Is Wireless in the Radio Sense of the Term. When a Coin is Placed in the Proper Position, It will Not Go into the Bank Until Told To



When Wound Up, This Mechanical Duck Acts Just like a Real, Live One. It Walks About 25 Feet, and When Placed in the Water, Swims for 10 to 15 Minutes

The Circus Elephant in the Foreground is Named "Billy Sunday," but His Namesake would Scarcely Approve His Behavior, for Here He is Caught in the Act of Doing the "Shimmy." The Picture Clearly Indicates That He Enjoys It as Much as if He Were Human

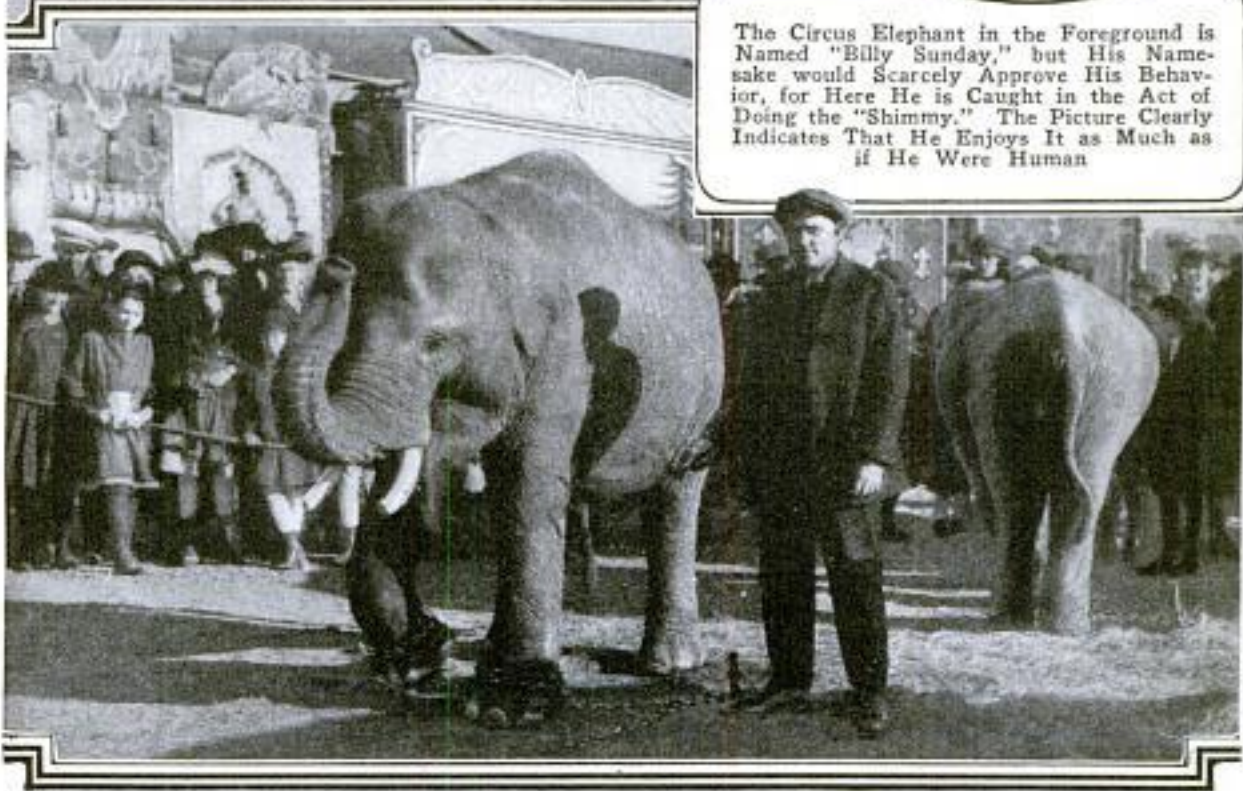

Sold by
 Central Scientific
 Supply Co. POPULAR
 460 E. Ohio
 SIMPLE AND EFFECTIVE PUMP
 CREATES HIGH VACUUM

Chicago
 With a new air pump of simple construction, it is possible to obtain a so nearly perfect vacuum that the pressure of the remaining air is only .001 millimeter, the normal open-air pressure being about 760 millimeters.

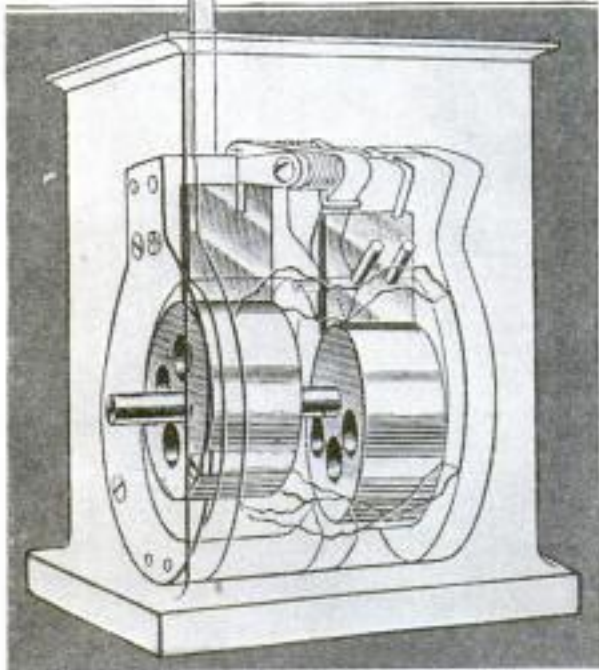

BY COURTESY OF LA NATURE
 High-Vacuum Pump for Laboratory Use, or in Places Where Small Volumes of Air are Handled, Shown in Phantom View

meters. It is designed for use in laboratories and other places where the quantity of air to be handled is comparatively small. A solid eccentric cylinder, balanced by being perforated on one side, rotates in a cylindrical shell provided with two openings. One opening leads to the chamber to be exhausted, while the other communicates with the atmosphere through a suitable valve. By means of a

9422

READY-MADE RADIO AERIAL NOW ON THE MARKET

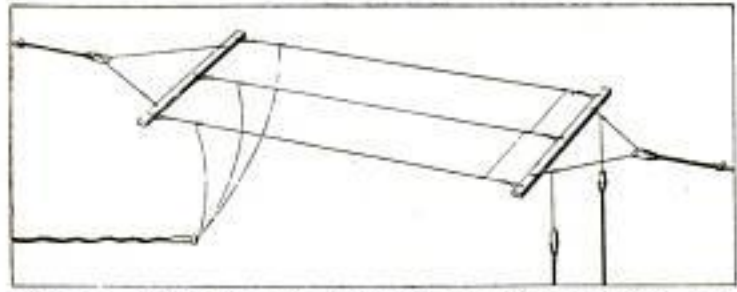

Wireless Aerial That Is Complete in Every Detail, and Which can be Erected in 10 Minutes, Shown Stretched Ready for Operation

Harmon Radio Equipment Co
 7 Princeton Ave, St. Louis, Mo

The Lawrence Sperry
 Aircraft Co. of Inc
 Farmingdale, L.I. N.Y.

MECHANICS

spring and lever, a valve, sliding in a slot in the outer cylinder, is kept in constant contact with the rotor, and by this means, the latter and the outer cylinder always touch at two points, thereby dividing the pump chamber into two parts of varying capacity. The pump consists of two similar units mounted upon the same shaft, one serving as the preliminary to the other. The whole is mounted in an iron box, on the outside of which are pulleys from the common shaft for connecting to a motor of only one-tenth horsepower.

FLIGHT OF AIRPLANE SHOWN BY GYROSCOPE INSTRUMENT

Handling an airplane in clouds or in a fog is uncertain because the earth, otherwise the means of checking direction and balance, is invisible. The compass is not steady enough, but a new instrument is used to assist the pilot. A Venturi tube, placed in the air stream of the propeller, produces air pressure to drive a small gyroscope, to which it is attached by tubing, at 8,000 revolutions per minute. The gyroscope, on a lateral axis, is suspended in a frame hung in a fore-and-aft axis, movement about which is restrained by a spring. A turning or tilting motion of the plane influences the action of the gyroscope so that it is indicated on the face of the instrument.



La Nature 4/1/22



How to Make Concrete Tile

By HJALMER LINDQUIST

FLOORING, wall facing, garden walks, etc., are some of the common constructions in which concrete tiles are used. These tiles are not at all difficult to make, and the results of their use are well worth the time expended.

When only a few tiles are wanted, the forms can be made from two pieces of board, tacked flat to a wide plank, with other pieces tacked between them at right angles, to divide the individual tiles. The nails with which the boards

of tiles are to be made, it will, of course, pay to have good forms ready beforehand so that the work can be done quickly.

The forms are filled with a wet concrete mixture of 3 parts sand and 1 part cement. Some kind of reinforcing wire should be placed in the center of each tile to strengthen it; a coarse wire mesh will serve the purpose. The form is half-filled with concrete, the reinforcing put in, and the rest of the cement applied until the

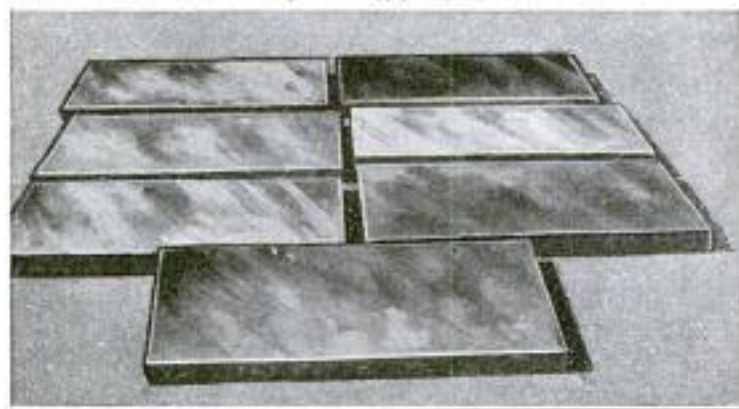
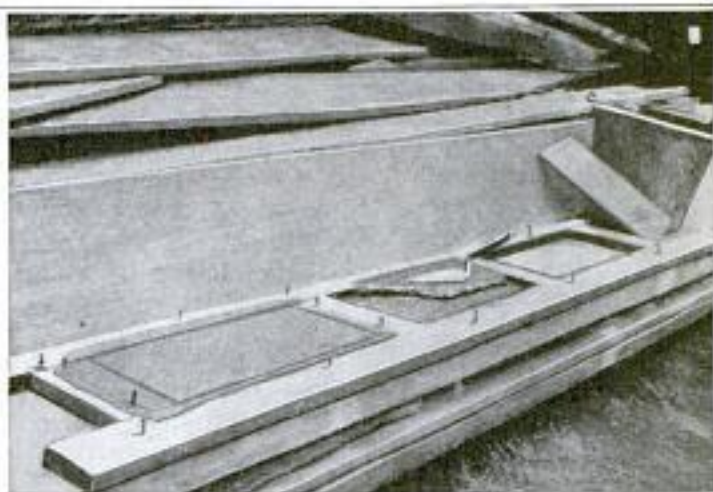

Upper Left: Coating the Tile Surface with Neat Cement. Upper Right: Simple Forms for the Production of the Tile. Lower Left: A Group of Finished Concrete Tiles

are fastened are only partly driven in, so that they can be easily pulled when the tiles have set. These forms should be squared, and the lumber from which they are made should have straight, smooth edges. If a considerable number

top edge of the form, next to the tile, with the point of a trowel, will help give the tiles a better appearance when they are dry.

When finished, the tiles should be allowed to dry, before they are taken from

the forms, preferably in the shade, as rapid setting is not advisable. They should then be soaked in water for about two days to harden them. After being removed from the water, they are allowed to dry overnight, and the top surfaces are coated with a neat cement, which is a mixture of cement and water, a little thicker than cream. Whipping the cement while mixing it seems to give a slight gloss to the work. A little of the neat cement mixture is spread over the tile surface and shaken into contact and smoothness by rubbing the bottom of the piece over a thin layer of sand sprinkled on a smooth surface. When the top coating has set for a day, the tiles should be placed in water for a day or two, then allowed to dry for a day before coloring.

Coloring of the tiles is effected by inexpensive chemical solutions. A saturated solution of copper sulphate, or bluestone, gives a bluish-green color,

while a solution made from sulphate of iron or copperas produces a rust-red. By using a solution of either of these salts as a mordant, any of the dry cement colors can be used. The dry cement color is mixed with water to the desired shade, and then about $\frac{1}{25}$ part, liquid measure, of either copperas or bluestone solution is stirred in. A syringe should be used in applying the colors; with this the colors can easily be varied and blended together on the surface of the work.

The tiles should be set in soft mortar, on a solid base, and the appearance of the work is often improved by spacing the tiles about $\frac{1}{2}$ in. apart and filling this space with colored mortar. To color the mortar, the dry colors can be mixed with it directly. The tiles shown in the illustration are about 7 by 14 in. and $\frac{3}{4}$ in. thick. Other sizes, of course, can be made in the same manner.

Gas Burner for Heating Furnaces

The high cost of gas-furnace burners led a householder to devise a burner that

is very easily made, and at the same time cheap and efficient. The burner consists simply of a flat-iron bracket fastened to a 2-in. pipe by a machine screw at each end. The burner tips screw into holes in the bracket, so that they can be adjusted individually to the proper distance from the small holes that serve as outlets for the gas.—John H. Schalek, Pittsburgh, Pa.

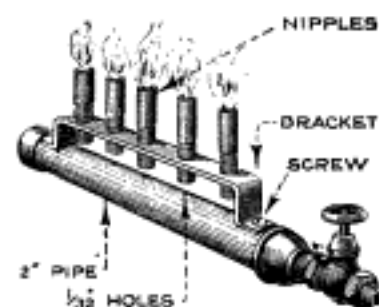

Strength of Douglas Fir and Southern Pine

There is little difference between the strength of the southern pines and that of Douglas fir from the Pacific Northwest, as government tests show. True long-leaf yellow pine averages heavier, stronger, and tougher than Douglas fir. True short-leaf pine averages heavier and tougher than fir, but is about equal to it in strength when used as a beam or post. Loblolly pine, though averaging heavier than the fir, is somewhat weaker. The difference in strength between any of these pines and Douglas fir, however, is

not so great but that low-density pieces of the one species are weaker than the average for the other species.

As far as strength is concerned, the choice between any of two lots of southern pine and Douglas fir will depend upon the grade and density of each lot. The mountain type of Douglas fir averages considerably weaker than the Pacific-coast type.

Runner for a Plowshare

A shoe or runner, such as that shown in the drawing, will save a lot of time

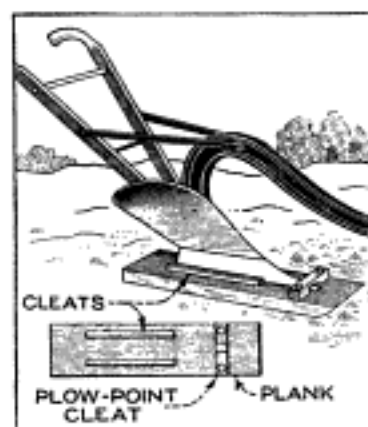

and energy when the plow is being taken to and from the field. A thick plank of oak, or other hardwood, is provided with a cleat in which a notch is cut; this is fastened to the forward end of the shoe and the point of the plow inserted into the notch. Cleats nailed on either side of the share serve to prevent it from slipping off to one side. The front end of the shoe is beveled or rounded off, so that it will ride over any obstruction in its path.—F. H. Hanford, Detroit, Mich.

Antique Color for New Parchment

New parchment can be given the appearance of great age by soaking it in a 5-per-cent solution of potassium permanganate and then washing in clean water. The solution acts very quickly, and care must be taken that the parchment is not allowed to remain in it too long, or the color will be too dark. If the parchment should be a little greasy, wash it with soap and water, and rinse before placing in the permanganate solution. If the parchment is to be pasted to anything, as, for example, the covers of a book, fasten it to a board with thumb-tacks and allow it to dry slowly.—Jean L. Martin, Paris, France.

Removing Bushings from Blind Holes

Although it is easy to install a bushing in a blind hole, its removal is an entirely different matter. The shopman

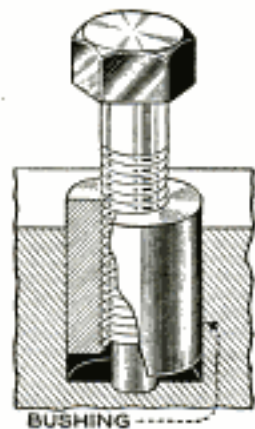

is frequently called upon to remove such a bushing, and the method described may help when he meets with an obstinate case. The bushing hole is first tapped, using a bottoming tap, and running it down to the bottom of the hole; this will thread all but a very small length of the bushing. An ordinary bolt with the same size thread as the tap is turned down or filed so that a portion of the end is smaller than the bore of the bushing. By screwing this bolt into the threads cut on the inside of the bushing, the end of the bolt strikes the back of the hole and the bushing is forced out. If the bolt screws into the end of the thread before the bushing is entirely out, the bolt may be removed and a small block placed below; this will usually give enough additional purchase to finish the job.

Fuse-Wire Gaskets for Tight Joints

Cutting gaskets from sheet lead, as usually performed, is wasteful, and it is also difficult to cut them uniformly without special tools. In addition to this, if the surfaces to be jointed are not true at all points, great pressure will be required to make the joint tight. On a small ice

machine, 40-ampere fuse wire was used instead of sheet lead, with entirely satisfactory results. A step was cut in the cover of the machine, as shown, and the wire laid in this step and cut so that the ends just met. A groove was then cut

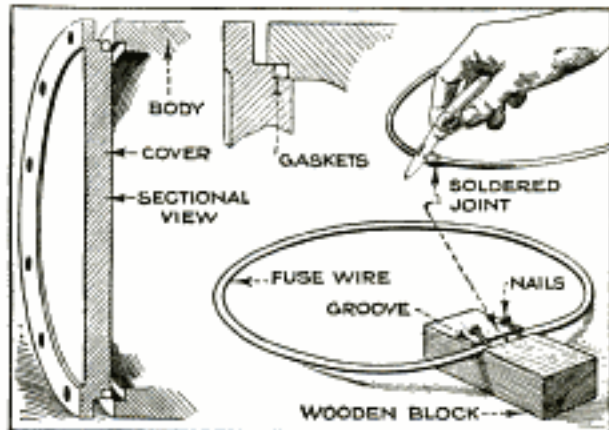

Fuse Wire Used Instead of Sheet-Lead Gaskets, in Ice-Machine Cylinder Heads: The Method of Jointing the Ends of the Wire is Shown at the Lower Right

in a small block of wood, and the ends of the fuse wire held together, in the groove, with small nails. Soldering paste was applied and the ends soldered, after which the joint was trimmed smooth with a pocketknife. With the lead ring in place, very little pressure was needed to make a gas-tight joint, as the wire squeezed out against all four sides of the joint.

Adjustable V-Blocks from Pipe Fittings

One of the handiest sets of V-blocks for use on the drill press or milling machine can be made with a minimum of machinework, from standard pipe fittings. These blocks are adjustable for height, which makes them particularly serviceable when the work is to be supported at points having different diameters.

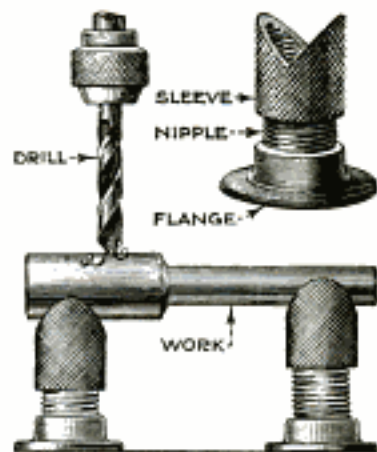

The base of each block is made from a pipe flange, which needs no machining whatever. The standard is a short nipple screwed tightly into the flange. The "V" proper is made from a threaded sleeve or coupling, having a knurled outer surface. The 90° "V" can be cut out with a saw and finished by filing.

Supporting Long Bars in a Speed Lathe

Speed lathes are not, as a rule, equipped with any means for supporting long bars, and, as it is impossible to run these at any

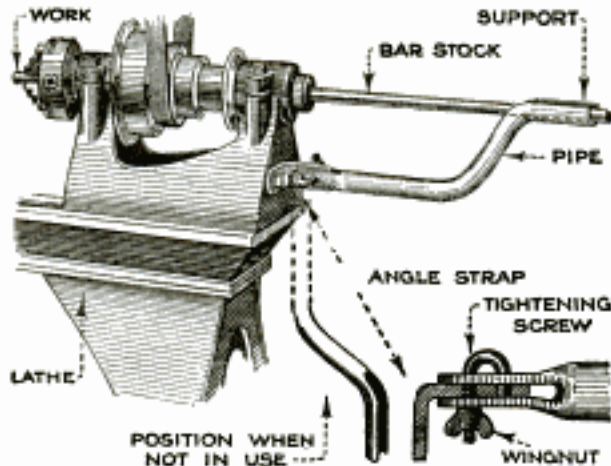

A Support for the Speed Lathe Makes It Possible to Work from the Bar without Cutting the Stock into Short Lengths

speed without support of some kind, the general practice is to cut the long stock into short lengths. In this manner a pile of short ends, which have no more than junk value, soon accumulates. This type of lathe is not always used for bar work, so the support illustrated has the advantage of being readily dropped out of the way, yet remaining a part of the machine.

A piece of iron, bent to form a right-angled bracket, is bolted to the end of the machine, and a piece of pipe is slotted at one end to fit over the bracket. The pipe is then bent at a convenient distance, and the top bend is ground or cut away to allow the bars to pass through. The two parts of the support are connected by a U-bolt, as shown, the long end of which is threaded for a wingnut, so that the device can be swung up into position or released in a few seconds, the only necessary operation being the tightening or releasing of the hook-bolt.

Finding Unusual Armature Trouble

The armature of an automobile generator had been rewound, and it tested perfectly until assembled in the frame; then it refused to develop full voltage, and, when run as a motor, it turned with a strong torque even when the field coils were disconnected. Ordinarily this would immediately suggest a wrong brush position, but the brushes on this machine were fixed and nonadjustable. The only remaining possibility was that the armature-coil ends were all brought the wrong

distance around the commutator before being connected. Before this accusation could be brought against the armature winder, who had otherwise done a good job, it was necessary to prove the fact by a test. The test used was simply to touch two brushes to the commutator, the proper angular distance apart, and find with a compass the axis on which the armature iron was magnetized. If the armature had been properly wound, the armature poles should have come out about midway between the field poles; as they came out far from this position, it proved that the leads were all connected to the wrong bars.

Compressor for Cage-Valve Springs

Usually it is a difficult and slow job to compress the springs and remove the keys in the cage-type valves used on a

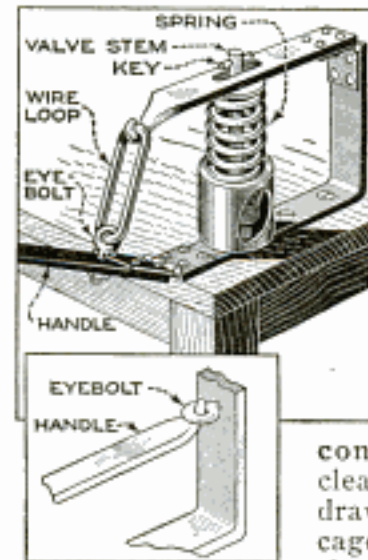

number of automobiles, but the easily made device illustrated makes it possible to do this very quickly. The compressor is made of $\frac{1}{4}$ -in. flat-iron stock, and is bolted to the workbench, its

construction being clearly shown in the drawing. The valve cages are placed as shown, and the handle

pushed downward, the valve stem and key extending through a slot cut in the top member. With this rig, the keys can be removed and replaced almost as fast as the cages can be placed in position.

In the insert a type of construction is shown in which the handle has a hooked end that is placed in eyebolts spaced at intervals along the upright member; this device will take valves of any size. However, a simpler method would be to bore $\frac{3}{8}$ -in. holes in the upright through which the hook could be inserted. This construction may also be used in place of the lower hinge, which requires more work in assembling than the eye-bolt method, although it possesses the advantage of having all parts connected, so that no individual parts can be lost or mislaid—a decided advantage in most shops.—D. C. Stephenson, Augusta, Kan.

Using Old Blueprint Paper

Having some blueprint paper that had become "stale" in the roll, that is, darkened without having been exposed to the light, and receiving a small order for prints that amounted to less than the cost of a new roll, I decided to make an attempt to use the old paper on hand. The print was exposed in bright sunlight, but, instead of using cold water, the exposed print was washed in hot water, the result being a perfectly legible blueprint. —Edwin J. Bachman, Fullerton, Pa.

Lapping Wristpin Centers

After a large number of air-compressor wristpins had been made up and hardened in the usual way, it was discovered that the steel used was different from that customarily used for this work. The

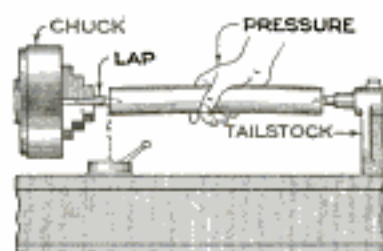
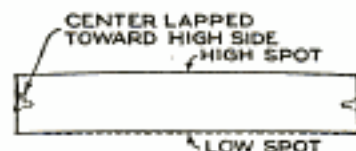

heat-treating process had caused the work to warp so badly that most of the pins would not clean up in the finish-grinding operation, and to save the pieces the centers were lapped with a copper lap which was charged with emery. The high spot in the center of the pin was marked with chalk and pressure exerted in an opposite direction when the piece was placed on a speed lathe in the manner illustrated. The lap was first turned up to a 60° angle and then smeared with medium emery and oil. When, after continued lapping, the lap had worn out of shape it was again brought to shape by using a file and center gauge. The amount the centers were lapped depended upon the amount of warp, most of the pins cleaning up with a lapping of .01 in. off center.

Keyseating Fixture for Use on the Shaper Head

Keyseating operations in small shops are usually assigned to the shaper, but to do the work in this manner is objectionable because of the chattering of the gooseneck tool and the breaking away of the front edge of the keyseat. All these and other difficulties can be overcome and

heavier cuts taken by the use of the cutter bar shown in the drawing. The bar is fastened to the clapper box in place of the regular toolholder, and a locknut is provided to hold the bar in the proper position. The tool bit is held in the slot

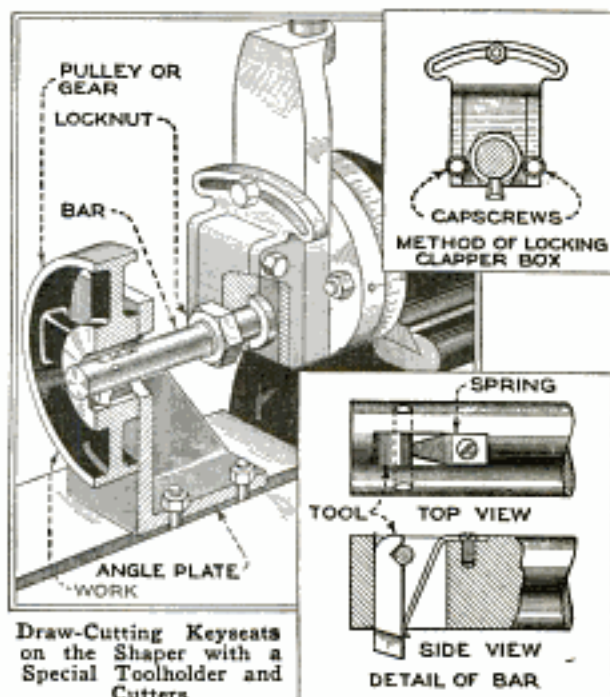

Draw-Cutting Keyseats on the Shaper with a Special Toolholder and Cutters

of the bar by a tool-steel pin. The upper end of the tool bit is ground off to a radius that allows it to swing in an arc and lift on the return stroke. A flat spring, fastened to the top of the bar, holds the tool in the cutting position, but allows it to lift on the noncutting stroke of the ram. Although a single tool of this description will not answer for all sizes of work, it is simple to make, and a variety can be kept on hand, or made up as required.

To use a draw-cut tool bar, the clapper box must be tightly held; so holes are drilled and tapped in the outer flanges of the box, and capscrews and washers are used to clamp it and prevent lifting.

The work is mounted on an angle plate in alignment with a hole of sufficient diameter to permit passage of the bar. Greater accuracy and heavier cuts are possible with the draw-cut method, and all causes of chatter and vibration are overcome. Also, the ability to work to the layout line, which is not broken away, is another advantage of such a tool.

In fitting up the cutter for the draw-cut bar, grind it to make a neat sliding fit in the bar slot, and also grind a notch in the tool bit, to allow it to move in an arc without any lost motion on the pin.

Attachment Makes Drilling Machine from Horizontal Miller

Drilling, reaming, and other operations usually done on a drill press, can be done

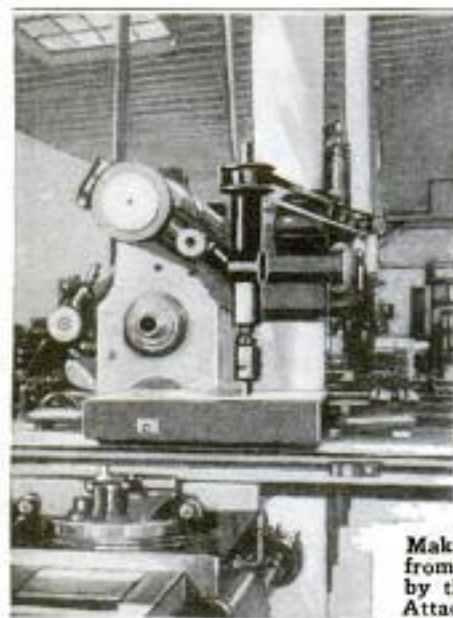

Making a Drilling Machine from the Horizontal Miller by the Addition of a Simple Attachment: Power is Provided by a Separate Motor

on a milling machine by the use of an attachment similar to the one illustrated. The attachment is a simple casting with an arm cast at an angle to the perpendicular section, the arm being machined to fit into the overarm of the miller. The vertical part of the device is cast hollow and bored for spindle bushings; to the upper end of the spindle a pulley is attached. The power to drive the drill is provided by a separate motor through a quarter-turn belt.—J. H. Rouse, San Francisco, Calif.

Corrosion of Oil Tanks

Investigations carried out on behalf of insurance associations have shown that steel oil tanks, buried in cinders, show greater corrosion than when buried in other materials, probably because of electrolytic action between the steel and carbon in the cinders.

The best coverings, in the order of merit, are: oily sand, sand, gravel, clay, loam, and cinders. It was also shown that ground or tide water do not stimulate corrosion to any great extent. Steel tanks, buried under favorable conditions, should last more than 30 years. In damp ground this time will be reduced to between 15 and 20 years.

Tanks should be coated with red lead and asphalt and buried 3 ft. or more below the surface; ground and tide water should be avoided as far as possible.

Emergency Repair for Stripped Thread on an Auto Axle

A trouble that is frequently met with in rear-axle shafts of some types of automobiles, is the stripping of the threaded end and consequent failure of the nut, which holds the wheel in place, to grip on the axle. An emergency repair that will hold until a new shaft can be obtained, is effected by drilling a $\frac{1}{4}$ -in. hole about 1 in. deep into the center of the axle, parallel with its axis. A tapered punch is driven into the drilled hole to expand the stripped end. It is only necessary to expand the end of the shaft a small fraction of an inch, after which a new thread can be cut. For the purpose of recutting the thread, in the absence of a regular die, the castellated nut can be run up on the axle in an inverted position. The nut, in most cases, is case-hardened, and a serviceable thread will result, especially if portions of the original thread remain as a guide for the improvised threading die.



Locking a Fan-Pulley Pin

An expedient by which the fan pulley of a standard light automobile can be securely locked on the crankshaft, is indicated in the drawing. The pin, as commonly used, frequently works loose and drops out; this is prevented by splitting the outer end of the pin with a hacksaw. The ends are bent apart and the pin is driven into the hole. After the end of the pin has passed the rim of the fan pulley, the ends expand in such a manner that they must be compressed with a pair of pliers before the pin can be removed.

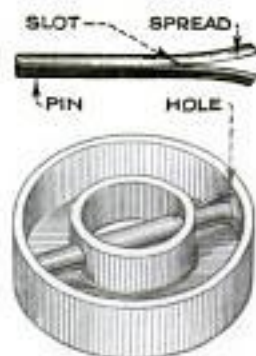

Dressing and Cleaning Leather Belts

In service, a belt gradually loses a portion of its lubricating material, so that, unless this is renewed at suitable intervals, the durability of the belt is impaired. A good grease or dressing gives the belt sufficient flexibility, and at the same time causes it to cling to the pulley, but does

not subsequently stiffen or injure it in any way. Among the best belt dressings are mixtures of cod and neat's-foot oils, with tallow, and wool grease free from mineral acid.

Clean the belt well, especially on the pulley side, by washing it with warm water and a good neutral soap, such as castile or white toilet soap, and, if necessary, scrape it on the pulley side to remove any dressing and dirt that may be caked there. Caking of dressings is injurious to the belt and also causes it to run unevenly. Wash rapidly and under no circumstances permit the belt to become wet, as it will then stretch and slip, and cemented joints may become loosened. Apply the dressing, which may be either liquid or solid at ordinary temperature, to the outside of the belt, while it

is at rest, and allow it to soak overnight. It should be applied very evenly and rubbed in with cotton waste, felt, or similar material. If absolutely necessary, a very light dressing may be applied to the pulley side of the belt, using cotton waste or felt lightly coated with the dressing. Even distribution and penetration should be aimed at. Resin, or greases containing it, weaken the belt and shorten its period of service. The use of too much dressing causes undue stretching and loss of grip. Belts should never feel greasy or look greasier than when they were installed. Because a little belt dressing is good for belts, it does not follow that more is better; just as little as possible should be used, but enough to make the belt flexible, and cause it to cling to the pulleys.

How to Make a Motorcycle Trailer

By J. R. KOONTZ

THE painter, carpenter, paperhanger, mason, or other tradesman doing a jobbing business, or the farmer, will find a trailer for a sidecar motorcycle a practical addition to his equipment.

The trailer shown in the illustrations is mounted on a pair of wheels taken from an old hay-rake, and runs on a

ladders, lumber, or other long articles. The sideboards are fastened to the bed with bolts, in the same manner as on an ordinary farm wagon. When finished, the box is balanced on the axle so that the weight will be uniformly distributed. The axle may be bolted to the center of the box by drilling holes

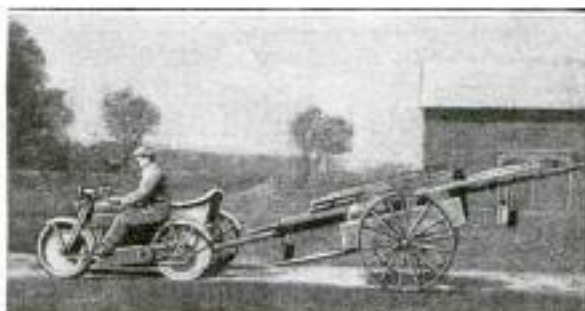

An Easily Made Trailer for Attachment to a Motorcycle and Sidecar: The Pictures at the Center and Left Show the Use of Such an Outfit for Hauling Painting Equipment. Right: The Same Equipment Used for Hauling Supplies to the Farm

pipe axle, although one of solid steel could be used. The axle should be long enough so that the wheels will track with a regular wagon, 56 in. center to center, or with the motorcycle and sidecar. The box bed of the trailer is 4½ ft. long by 3 ft. wide, and 8 or 10 in. deep. Make it with loose end gates so that they can be removed in case it is necessary to haul

through the metal and wood, or fastened, as in the drawing, by using brackets or straps, forged from flat iron, and collars to prevent sideplay; all should be provided with setscrews.

The trailer hitch is made either of angle iron or wood; the latter will perhaps be the easier to get, and for this purpose, a piece of 2 by 4-in. hardwood will

answer; it must be long enough to reach from the axle and project about 30 in. beyond the front of the box. An iron

solid, helps to equalize the draft, and distributes the pull without undue strain on the motorcycle or sidecar.

The hitch must be placed on the left-hand side of the trailer, so that the latter will track with the motorcycle and sidecar, and should be attached to the sidecar frame as closely as possible to the main frame of the motorcycle, so that the pull will be nearly behind the latter; otherwise too great a strain would be placed on the frame of the sidecar.

If something of neater appearance is desired, two old motorcycle wheels, mounted on suitable axle spindles, can be used instead of the iron wheels; this will reduce the noise and allow the trailer to run much more smoothly.

In the winter months, when the ground is covered with snow or ice, the wheels can be removed from the trailer and a pair of runners substituted.

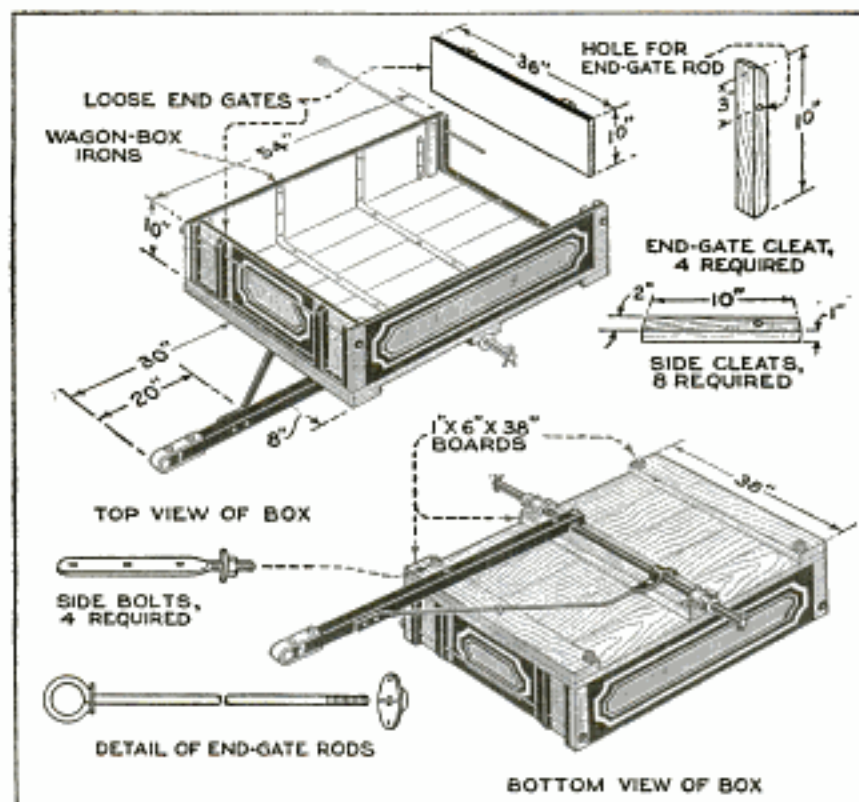

Detail Drawings, Showing the Simplicity of Construction of the Motorcycle Trailer: Such a Trailer can be Easily Built in the Farm Shop

brace is also required, and this should be bent so that it will meet the hitch about 20 in. from the end, and extend back at

Making Invisible Molding Joints

Amateur craftsmen who have had occasion to use odd pieces of molding know some of the difficulties of making

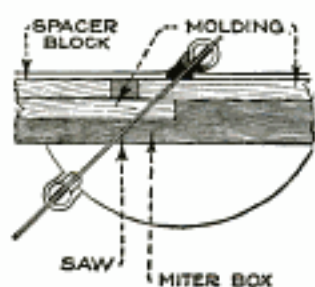

good joints. The method illustrated makes a joint that is practically invisible, and is very easily followed. The pieces to be cut are both placed in the miter box and the ends that are to be fitted together have their angles formed by a single cut of the saw; as both pieces are cut exactly alike, a perfect joint will result. A spacer block, of the same thickness as the molding, is necessary to fill up the space between the side of the miter box and the second piece of molding.—L. H. Georger, Buffalo, N. Y.

Simplifying a Difficult Soldering Job

When soldering the joints on the brine tank of a small refrigerating machine, trouble was experienced in making the solder take hold on the galvanized sheet iron used in the construction. After a number of futile attempts with different fluxes, each resulting in a gaping, leaking seam, the method illustrated was used with success.

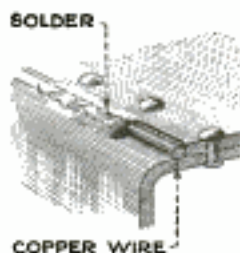

The sheet metal was fairly heavy, so some No. 18 copper wire was skinned of its insulation, brightened with sandpaper, covered with soldering paste, and laid along the edge of the seam. Undiluted muriatic acid was applied to the adjacent galvanized metal, and, with a hot iron, the solder was wiped on smoothly; it flowed easily over both metals, and a perfect joint was made.

Improved Small Generator Brushes

Where carbon brushes are used, the generators on some makes of automobiles often fail to charge the storage battery as they should, on account of poor contact. To overcome this trouble, drill a hole through the brushes from face to top, and insert a bunch of very fine copper wires that will fill the hole as tightly as possible, then trim them off flush with the face of the brush. This will increase the output considerably. The copper cores should be staggered so that they will bear on the commutator in different places.—O. G. Crooks, Newcastle, Pa.

Caliper Attachment for Scale

By attaching a caliper leg to a 12-in. scale a tool is obtained that can be used to test whether or not a long hole has been bored straight. Every mechanic knows that a slight taper in a long hole is easily overlooked when calipers are used to measure the diameter, and also,

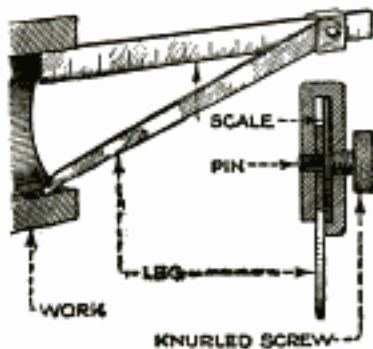

unless the bore is large enough to admit the hand, it is sometimes impossible to gauge the bottom end of a blind hole at all. A 12-in. power-hack saw blade, ground

to shape, makes an excellent caliper leg, and can be attached to a scale of the same length in the manner illustrated by the drawing. Bend a piece of $\frac{1}{8}$ -in. flat steel, and drill one side for a tight-fitting pin, which projects inside and serves as a pivot for the saw-blade leg. A hole is drilled and tapped on the opposite side for a knurled screw with which the attachment is clamped to the scale.

The caliper is set to the proper dimension by means of another scale, and as the leg is opened the holder is pushed forward to keep the caliper point in line with the end of the scale. In use, the tool is pushed into the bore, with the scale held firmly against one side of the hole. Any variation in size can then be felt immediately as the caliper is moved forward. In addition to being handy for long holes of medium diameter, the tool is also useful for larger holes of short length which must be perfectly straight.

Dipping Tank for Brick and Tile

In the laying of face brick and some forms of ornamental tile, it is necessary that the materials be soaked in water or

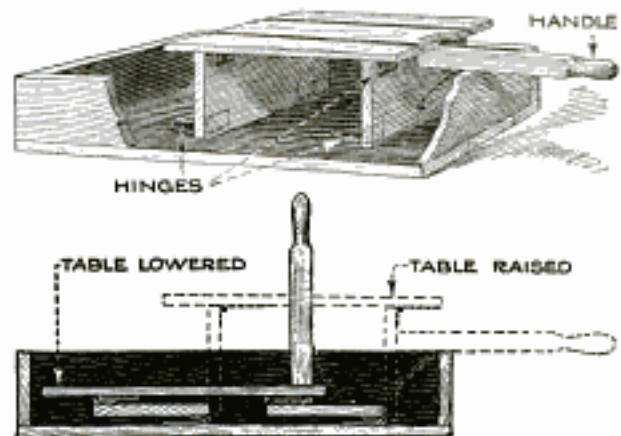

Tile Setters and Bricklayers Who must Soak Certain Kinds of Materials in Water or Other Solutions, will Find the Dipping Vat Illustrated Very Convenient

other fluid so that the cement will adhere to them. In such cases, the dipping tank illustrated is a most convenient accessory. The tile or brick is placed on a horizontal platform, which is hinged to two parallel supports, the latter being fastened to the bottom of the tank with hinges. A handle is attached to one of the endpieces, for raising or lowering the material into the solution. This enables the worker to do the work rapidly without placing his hands in the bath.

Underground Garbage-Can Receiver

A convenient and inexpensive garbage-can container is easily made from a section of glazed sewer tile, as shown in the drawing. This arrangement conceals the garbage receptacle under the surface of the ground. A section of tile, large enough to receive the can, is set into a pit dug in the ground so that the shoulder end is just flush with the surface.



A mixture of sand and cement is poured into the bottom, to a depth of several inches, so that the container can be easily kept clean. A wooden cover, which fits neatly into the shoulder of the tile, is provided to keep flies and animals from the refuse.

A Multiple Fuse Block

A multiple fuse block is a very handy thing to have in the workshop or experimental laboratory, because, when a

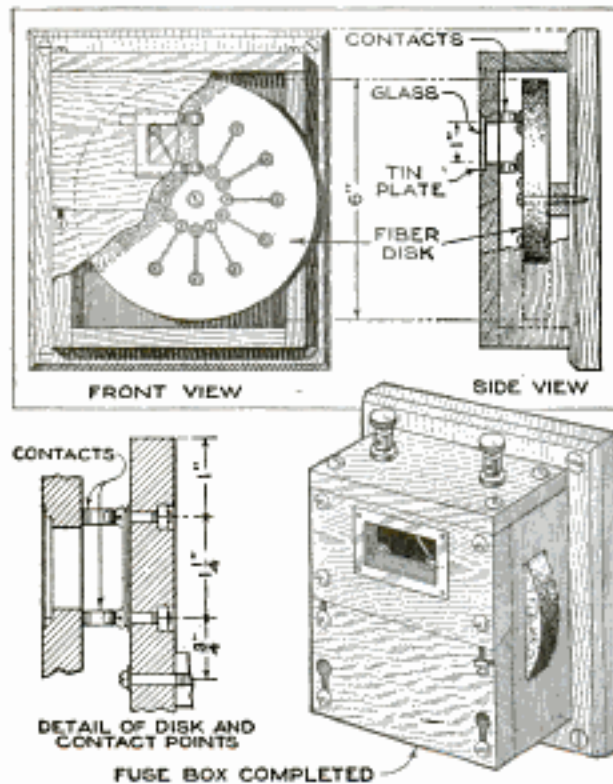

A Fuse Block That Enables a New Fuse to be Put into an Electrical Circuit, to Take the Place of One That has Blown, by the Mere Turn of a Fiber Disk

fuse is blown, a new one can be brought into the circuit by the mere turn of a disk.

Cut out a 6-in. disk from $\frac{1}{2}$ -in. fiber and drill 12 equally spaced holes on a circle 2 in. from the center. Then drill 12 more holes, on a 4-in. circle, in such a manner that the holes in the outer circle will be in a radial line with those on the inner one. Obtain 24 small brass machine screws, $\frac{3}{8}$ in. long, with brass nuts and washers to fit. Counterbore the holes on one side of the disk to a depth of $\frac{1}{4}$ in., with a drill slightly smaller in diameter than the width of the nuts across their corners, and drive the nuts into the counterbores with a flat-ended stick. If the nuts do not fit tightly, small wooden plugs should be driven in around them to hold them in place. Place a washer on each machine screw, and screw them into the nuts from the opposite side of the disk.

Build a case, as shown, a slot being cut in one side so that the edge of the disk will protrude, and mount the disk as indicated. The screw used as a bearing should be fairly large, in order to

present a large wearing surface; a washer should be placed under the screw head and the screw tightened just enough to make the disk turn stiffly. The cover for the case should be made in two pieces. The upper part is permanently fastened to the case, while the lower section is fastened in such a manner that, by slightly loosening the screws, it can be quickly removed. The object of making half of the cover removable is to make possible reloading of the fuses on the disk. A slot is made in the upper part of the case, and recessed so that the small light of glass used will come flush with the surface; a piece of tin or brass, cut to the shape shown, is fastened over the glass with brads to hold the glass in place. Two brass fingers are cut and shaped as in the drawing; these are mounted on the inside of the upper half of the cover, in such a manner that they will coincide and make contact with the two brass screws of one fuse wire. Wires are led from these fingers to binding posts on the top of the case or any other convenient position.

To load the fuse disk, remove the lower cover, loosen the machine screws, and place lengths of standard fuse wire under the screw heads; then tighten the screws. After loading the disk, the cover is replaced, and the disk is turned by its protruding edge until a fuse wire appears immediately behind the glass window. The fuse that appears through the window is the one in the circuit, and if it blows out, it is a simple matter to turn the disk until another fuse is in place.—I. B. Jackson, Lafayette, Ind.

Bottle Cap Prevents Bolt from Turning

While a man was repairing some of the body irons of a wagon, he found that the holes had become enlarged so that it was hardly possible to prevent the bolts from turning while tightening the nuts. In order to prevent this, the simple method illustrated was successfully used. Square holes were punched through the centers of crown bottle caps; the bolts were driven through the punched holes and the nuts tightened, drawing the corrugated edges of the caps into the wood, and thus anchoring the heads of the bolts securely.

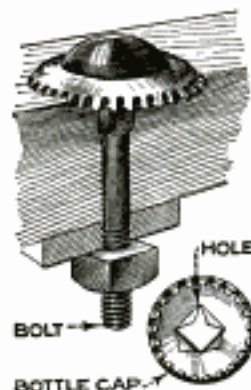

Forms for Concrete Gateposts

The drawings illustrate two designs of concrete gateposts that can be made from easily constructed forms; the latter are put together on the job, and may be used repeatedly.

The style illustrated in Fig. 1 is about the simplest it is possible to build, but the severity of a plain post is relieved by the grooves, which are formed by cleats nailed to the four faces of the form. For either of these types, a footing is sunk $3\frac{1}{2}$ ft. below grade, using alternate layers of field stone and concrete, mixed in the proportion of 1 part cement, 2 parts sand, and 4 parts crushed stone or gravel. Very heavy iron rods are imbedded in the footing with their ends projecting above the ground to serve as an anchorage for the posts. The face forms are made of $\frac{7}{8}$ -in. pine or spruce, and are crossed at intervals by $\frac{1}{2}$ -in. cleats of dressed pine. The front and back faces of the forms should lap the sides, and, when finished, the inside surfaces of all four pieces should be painted with dropblack, which, when dry, is coated with shellac. When set up, the forms should be held together by bolt

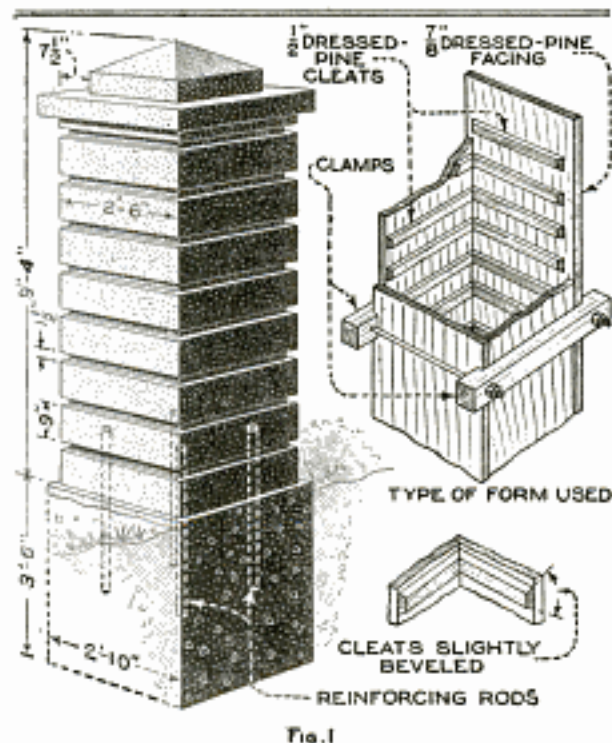

Simplest Type of Gatepost and Form: Note the Reinforcing Rods Extending into the Footing

clamps, spaced vertically at intervals of about 2 ft. The pyramidal tops of the posts are trowel-finished.

In general, the construction of the type illustrated in Fig. 2 is the same as the

other except that it is paneled. If a light is desired, center the pipe or conduit, and allow plenty of the thread to project above the form, for attaching the lighting fixture, before the concrete mixture is poured. In all cases, the forms should be plumb, securely braced, and tight, so that no cement will run out with

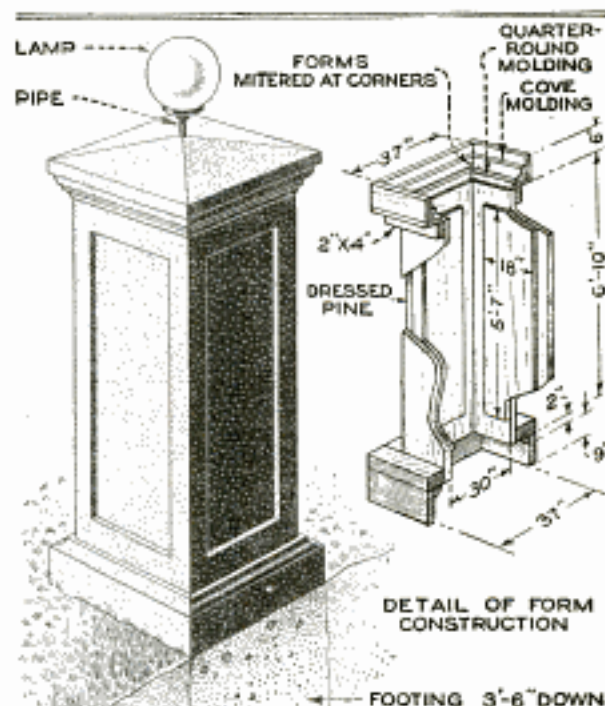

Fig. 2

Form Construction for Paneled Type of Gatepost: The Pipe or Conduit for a Lamp may be Cast in Place and the Top Finished with the Trowel

the water and leave unsightly voids on the outside surfaces.

The cement mixture used for both posts should consist of about 1 part cement, 2 parts sand, and 3 parts of fine aggregate, either in the form of crushed stone or gravel. By using white cement, white sand, and white stone or gravel, a practically pure-white effect is obtained instead of the usually objectionable tone of gray or brown. The concrete should be poured into the forms a little at a time, and should be thoroughly rammed so that it will come into contact with all parts of the mold and fill all corners completely. For convenience in removing the forms, the edges of the cleats and panels should be beveled slightly. The bevel shown on the cleats in Fig. 1 is exaggerated so as to illustrate it better.

☛ To fit sheet metal over rivets, hammer the metal over the rivets with a short piece of iron pipe of a diameter suited to the rivets used.

Hanging Hinged Window Frame from Inside

When a window is to be hung so that it will swing outward, the hinges being

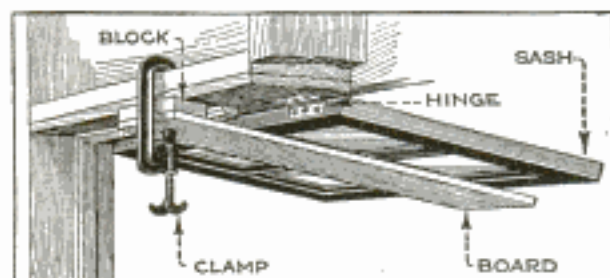

The Difficult Job of Hanging Windows to Swing Outward can be Easily Accomplished Single-Handed by Using the Method Illustrated

on the upper edge of the frame, and the work cannot be reached from the outside by ladder or otherwise, it is a difficult matter to attach the hinges properly. A method of doing this consists in first screwing the hinges to the window sash, after which the position of the holes is carefully transferred onto the upper part of the frame, and holes drilled for the screws. Then take a 1 by 6-in. plank, a little longer than the sash, and clamp this to the upper part of the window opening so that the board projects outward with a slight downward angle. This form of window is often hung in rough construction, or buildings that have not been finished inside, in which case it is an easy matter to get the clamp over the framing. If the inside is finished, the plank can be temporarily nailed in place. Next lift the window sash onto the plank and balance it there, and ease off on the clamp or lower the plank if necessary, until the hinges will lift into place and register with the drilled holes. One man can hang windows of this kind by this method.

Preventing Steel Straightedge from Slipping

A surveyor in the field found that he had been provided with a large drawing board, straightedges, and triangle, but that none of the boards was smooth enough to use a T-square with, even had there been one at hand. It was therefore necessary to use a steel straightedge, but it was found that strips of adhesive tape, applied to the underside, would not provide sufficient friction to prevent the instrument from sliding down the inclined drawing board. It was also discovered, however, that the adhesive tape was the only thing that would stick to the steel, and, in order to obtain

the necessary friction, strips of ordinary table oilcloth were glued to the adhesive tape with liquid glue. Under ordinary conditions glue will not adhere to steel for any length of time, so that it is necessary, in cases of this kind, to apply the adhesive strips first and then glue the oilcloth, with the coated, or smooth, side out, to the tape.—H. E. Balfour, Ottawa, Canada.

Surveyor's Tape Made of Rope

In surveying a piece of land where extreme accuracy is not a requisite, one man can do the job when the tape shown in the drawing is used.

Take a 100-ft. length of window-sash cord, and serve the ends of it around a couple of pins so that the bodies of the pins will be exactly 100 ft. apart. Measure off 10 ft. from one pin and wrap with colored thread, red preferably, as being easiest to see on the ground; continue this for the length of the cord so that it is divided into ten 10-ft. sections. Divide the 10-ft. sections at each end into ten equal sections of 1 ft. each.

To measure distances of less than 100 ft. it is necessary to set the tape on the nearest 10-ft. mark, and measure in feet at the end of the cord, guessing the inches, just as with the steel tape, except

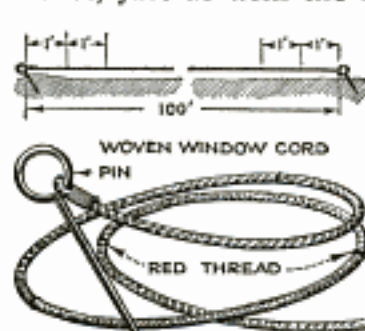

that one sets on a 10-ft. section instead of a 1-ft. division. It is impractical to mark the inches on the cord with anything except ink, which does

not show well when the tape is wet. In starting the measurement, push the pin into the ground, inclining it a little in the same direction as the measure is to be taken, and carry the other end out 100 ft.; stick in the second pin, inclining it in the same direction as the other and pull the first one loose. If the line to be run is a long one, it is well to set up the range pole at 100 ft. from the instrument, so as to have something to aline with. Reverse the end of the tape and continue until the desired distance is reached, measuring the final distance in the manner described above.

To get exactly on the line, pull the tape across it as nearly at right angles to the traverse as possible, and at sufficient

height to see it with the instrument, placing the middle of one of the 10-ft. sections at one end across where the line should run, as nearly as can be judged with the eye; then go back to the instrument and read the position on the tape at which the stake should be placed.—B. F. Leeper, Chickasaw, Ala.

Level for Tapered Masonry

Anyone acquainted with the operation of laying brick masonry is more or less familiar with the makeshifts used by the masons in fixing up their levels for tapered walls or chimneys. Usually a strip of wood that will give the proper taper for the work at hand is nailed to the edge of the level, and often there are no facilities in the field for cutting such a strip with any degree of accuracy. The drawing shows a very simple and practical attachment which forms a permanent part of the level, and can be fitted with very little trouble to any standard instrument. A strip of aluminum, or other light metal, is hinged

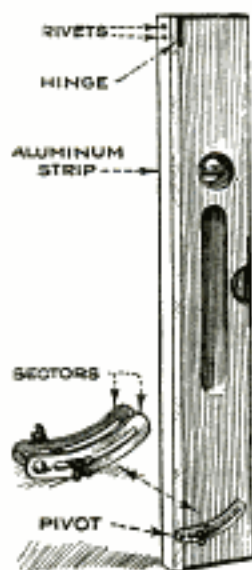

to the upper end of the level, and at the other end is pivoted to a pair of slotted sectors, clamped against the side of the instrument with a thumbscrew. It will be seen at once how easy it is to set the attachment for any taper. There are many reasons why this attachment is a decided improvement, the chief among them being that time is saved; economy is another consideration, as a good level is soon ruined by constant nailing.

A Kink for Draftsmen

Those who have had little experience in detailing machine parts where very irregular curves are a part of their make-up, will find the following hint helpful. Place the article to be drawn on a sheet of paper on a flat surface with a light suspended directly above the center line of the object. A shadow will be cast by the light which can be pointed off easily with a pencil at intervals of about $\frac{1}{4}$ in. This idea is particularly effective when rapid work is required.

A Quick-Acting Jack

The jack shown in the drawing is particularly useful in a garage or service station because of the time saved in jacking

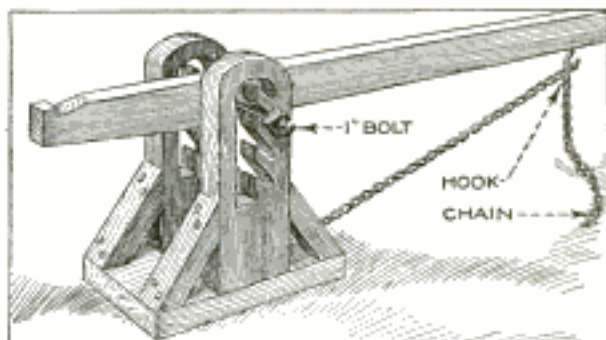

A Jack for Service Station or Garage, Which Makes the Raising of the Front or Rear of a Car a Matter of Seconds

up the front or rear of a car. The details of construction will be apparent at a glance. The long wooden lever is adjustable to different heights by altering the position of its pivot in the notches. A chain and hook are provided for holding the load when raised from the floor.—Theodore E. Landry, Baton Rouge, La.

Fastening Drawplates on Patterns

When locating and fastening drawplates on deep-lift patterns, the usual practice is to allow them to extend beyond the flat, or cope, face of the pattern. When rammed up on a bottom board, these extending drawplates prevent the molder from laying the pattern flat on the mold or bottom board; this trouble is often overcome by cutting holes in the bottom board to take the projections, or by removing the plates. A better way of attaching drawplates to the

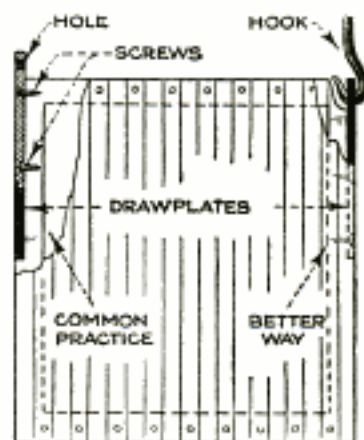

patterns is shown in the drawing, this arrangement making it unnecessary to remove the plates or cut holes in the bottom boards. The end of the plate is brought flush with the cope face, and a recess is gouged out of the pattern just back of the eye, to allow the hooks to be placed in the holes.—M. E. Duggan, Kenosha, Wis.

Vulcanizing Inner Tubes

A method of repairing inner tubes is shown in the drawing that is worth adopt-

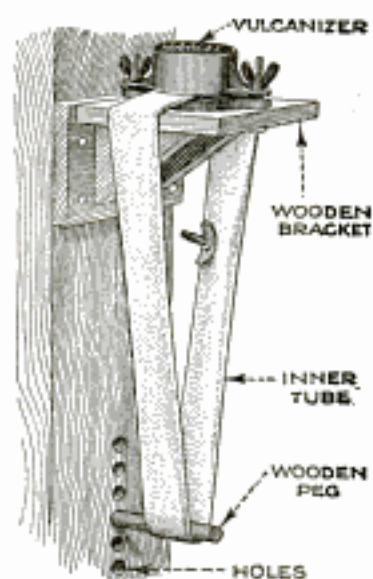

ing because of the speed with which the work can be roughened, the patch applied, and vulcanization completed. The base of the vulcanizer is screwed or bolted to a wooden bracket at a convenient height. Under the bracket a series of holes is drilled so that any tube can be stretched taut by inserting a wooden peg in one of the holes. With the puncture placed uppermost on the bracket and the tube stretched taut, the roughing of the work and the other operations can be done easily, leaving both hands free.

Improved Swill Trough for Swine

"Swilling" hogs in troughs is not a very pleasant task, as the animals climb into the trough and make it inconvenient

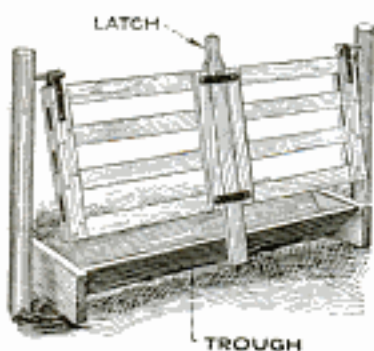

to empty the feed from buckets. A swineherd has adopted the original idea shown in the drawing, which does away with the annoyance. A gate, made like an ordinary gate, but fitted with a vertical latch, is suspended between two posts directly above the trough. The hinges, which consist simply of pins and iron straps, are placed at the upper corners so that the gate is free to swing either backward or forward at the bottom. When feeding time comes, the gate is pushed forward and the latch dropped; this holds the gate in place and keeps the hogs from the trough until it has been filled from the other side, when the latch is withdrawn, allowing the gate to swing free.

Asbestos Dams for Babbitting

Clay and putty are the materials commonly used for damming the ends of a bearing which is being babbitted. Finely ground magnesia or asbestos are better, however, as they will not dry out or soften under heat like clay or putty. The material is brought to the proper consistency by mixing it with heavy cylinder oil; it can be used several times.

Centering Round Stock

Easily formed from a piece of sheet brass, the little device shown in the drawing has been satisfactorily used for

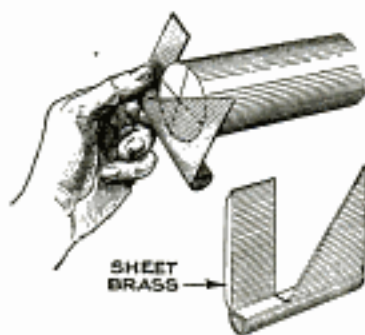

locating the center on cylindrical work that is to be turned, drilled, or otherwise machined. In use, the device is placed on the end of the piece to be centered, the perpendicular part being held closely against the work, and a line is scribed with a sharp point along the 45° edge. Then the device is turned about one-fourth of the way around the work and another line scribed. The intersection of the lines will be the center of the work. However, as a check for accuracy, three or more lines should be scribed across the end.—C. D. Cheney, Lyndhurst, N. J.

Wrench for Plugs

The owner of a farm has a tractor on which removable plugs are used in the axle housing, gas tank, and other parts.

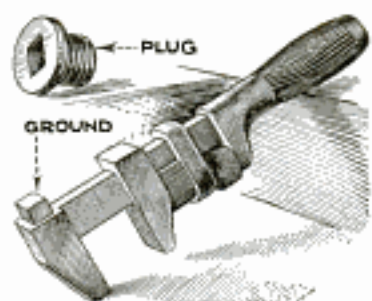

This type of plug has a square hole at the center, into which a square wrench or key must be inserted. To avoid the delay incident to searching

for the regular wrench, which was usually missing when most needed, an ordinary monkey wrench was adapted for the removal of the plugs, as shown, by grinding down the back of the stationary jaw to fit the square hole.

How to Make a Selenium Cell

BY THOMAS P. BENSON

EXISTING demands for a sensitive, reliable selenium cell that can be produced in quantities have not been met in any sense. The development of such a cell opens interesting possibilities to the experimenter and inventor.

There are many types of light-sensitive or photoelectric cells that make use of various substances, such as thallium, barium, or the alkaline metals; the construction of these, however, requires elaborate apparatus, while selenium cells are simple, and comparatively easy to make.

As to selenium itself, it is an element

mere connection of a stick of selenium into a circuit with a relay will not give results, as it must receive special treatment before it will actuate a relay.

A selenium cell consists essentially of two conductors, spaced a short distance apart, with a thin film of selenium forming a bridge between them. The Bildwell type of cell, described in this article and shown in the drawing, is the simplest form for the amateur to make. Two bare wires of copper, brass, or platinum are wound on a heat-resisting form of mica, slate, glass, or porcelain, the wires being

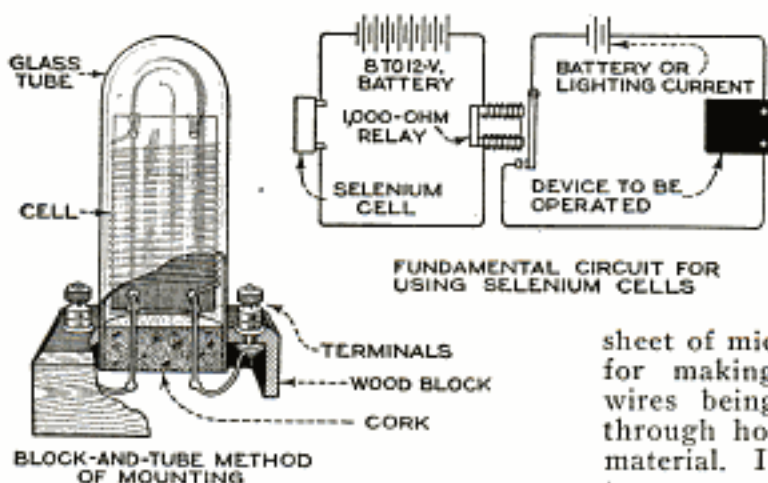
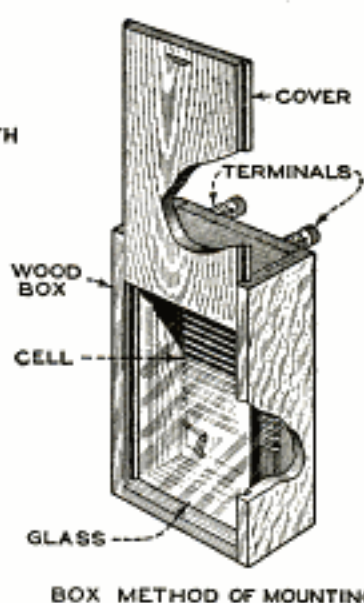
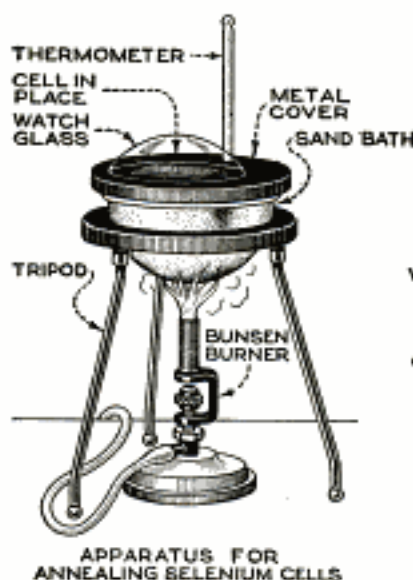
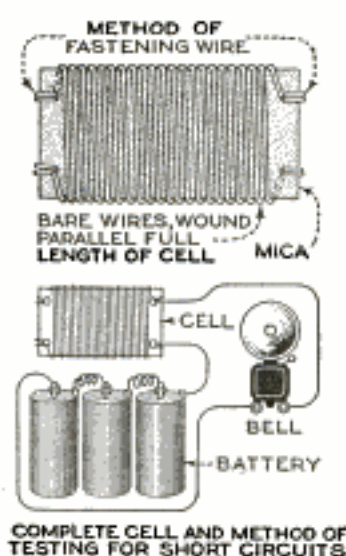

Method of Winding, Coating, Testing, and Mounting Selenium Cells of the Bildwell Type: This Is the Simplest Type to Construct, and will be Found Very Suitable for Experimental Work

spaced $\frac{1}{32}$ in. apart. The size of the wire used is of little importance, No. 26 or 28 being generally used for the purpose. A sheet of mica, 1 by 2 in., can well be used for making an experimental cell, the wires being fastened by looping them through holes punched in the insulating material. It should be kept in mind that two separate wires are used and that neither should come into contact with the other at any point. After the wires have been wound onto the mica, or whatever is used for the insulation, the cell at this stage is tested for short circuits by means of a battery and bell, as in the drawing. If the bell rings, the wires touch at some point and must be separated.

Having proved that no short circuit ex-

that resembles sulphur in its chemical reactions and occurs in three well-defined forms—amorphous, vitreous, and metallic. Only the metallic form is of value for selenium-cell construction. In this form it is an opaque, black, glossy mass, and a poor conductor of electricity in the dark. It is well to note, at this point, that the

*Selenium Emer & Amend, 3rd Ave
18th St. New York*

793
Copyrighted material
608-2002

ists in the winding, the cell is ready for the selenium to be applied. To do this properly, the following apparatus is necessary: a tripod, a Bunsen burner, a sand bath with cover, and a chemical thermometer reading to 225° C. (437° F.). A hole is drilled in the cover of the sand bath to admit the thermometer as in the drawing, which shows the assembly.

The selenium should be bought from a reliable chemical-supply house. Specifying "electrolytic selenium" will insure that chemically pure material is obtained, instead of the commercial grade, which is often sold for cell work, but is entirely unsuited to the purpose. The selenium comes in round sticks, about $\frac{1}{4}$ in. in diameter, and has the appearance of black sealing wax.

To apply the selenium to the cell, the apparatus is set up in the manner shown, and the cell is laid on the metal cover of the sand bath. Light the burner and heat the cell until a stick of the selenium will melt when the cell is touched with it. Then quickly coat the entire surface of the cell with a thin layer of selenium, smoothing out any lumps that may form with a strip of mica. To obtain a satisfactory coating, the temperature must be maintained at about 220° C. (428° F.), when the selenium is in a semifluid condition. At lower temperatures the selenium turns gray and hard and cannot be spread properly without raising the temperature. On the other hand, a temperature in excess of that given will cause the selenium to collect in balls, like mercury.

When a smooth, even surface has been obtained, remove the cell and allow it to cool, turning down the Bunsen burner until the temperature of the sand bath has dropped to about 120° C. (248° F.). The cell is then replaced on the sand bath and allowed to heat slowly. Within a short time the surface of the cell will take on a gray color, which is caused by the crystallization of the selenium. Increase the temperature slowly and watch carefully for the first sign of melting, which is indicated by the selenium turning black around the edges. At the first sign of melting, remove the cell quickly, turn down the burner a trifle, and replace the cell. Continue to watch it for signs of melting; should none appear, it is covered with a watch glass and left alone for three hours. Should the selenium show signs of melting a second time, the cell is again removed, allowed to recrystallize, and replaced on the sand bath after the flame has been turned still lower, the idea being to hold the tem-

perature just below the melting point of the material, for, should it melt during the process, it will be necessary to begin all over again. Care in this annealing operation will prevent a waste of much time.

When the three-hour annealing period is up, the flame is lowered by small degrees over a period of an hour, and then finally turned out entirely. The sand bath and cell are then covered with a heavy cloth and allowed to cool slowly.

When completely cooled, the cell is finished and ready for mounting and testing. Either of the methods of mounting shown in the drawing may be used. The box method is perhaps the simpler and easier; that with the cell inclosed in a glass tube is neater, protects the device from moisture and dust, and makes a better-looking piece of apparatus. To protect the cell from light when it is not in use, a cardboard tube should be slipped over the glass. The cell is now ready to be tested for its light-sensitive properties. It would be well first to connect the cell in circuit with a bell and battery, as already mentioned, and make sure that the wires have not come into contact during the application of the selenium. Should the bell ring, at this stage, the cell is useless and must be discarded.

Selenium cells should only be used with a high-resistance relay. Get a relay, wound to at least 500 ohms' resistance, and three or four flashlight batteries, which will give about 12 volts when connected in series. Connect the cell, batteries, and relay in series, as shown in the diagram, with a separate battery and bell connected to the relay-contact binding posts, to indicate when the relay closes. With the cell covered, or in darkness, adjust the relay so that the flow of current is not quite strong enough to close it. Now allow light to fall on the cell, when the relay should close sharply. Reduce the voltage slightly by cutting out one or more of the batteries, and re-adjust the relay until it will give quick action with the fewest number of batteries in the circuit. It will be found that selenium cells vary greatly in their resistance, and each one will require individual testing to determine the proper voltage to use.

The action of the selenium cell is more or less understood; in the dark it has a very high resistance and will permit but a small current to flow. On allowing light to fall on it, the resistance drops to from one-half to one-quarter of its "dark" value, and more current flows, thus closing the relay. The higher the resistance

of the relay used, the more satisfactory the results will be; a 1,000-ohm polarized relay is the best for the purpose.

It is not within the scope of this article to describe in detail the application of selenium cells. They may be used for any purpose where light is desired to be the controlling agent. Thus, they can be used as a sunrise alarm, the rising sun acting on the cell to control any desired apparatus. As a burglar alarm the intruder's flashlight serves to operate the apparatus; garage doors can be arranged to open automatically when the headlights of the car flash on the cell. There are many other applications for selenium cells that are interesting and instructive; for example, a secret lock on a door can

be made so that anyone familiar with the arrangement may open it by striking a match and holding it before the keyhole, thus affecting a cell mounted in line with the aperture and controlling an electric lock. The number of applications is limited only by the constructor's ingenuity, but a few precautions should be observed in the care and use of the cell.

Do not overheat it by passing too strong a current through it, and keep it protected from dust and moisture. When not in use, the selenium cell should be kept in the dark, because long exposure to light fatigues it, and it loses its sensitiveness temporarily. A daily exposure to light for a short period, however, seems to mature and improve it.

Electroplating Stainless Steel

It has been found that stainless steel is unaffected by many plating solutions that are successful when used with ordinary steels. Even the usual copper solution with which steel is coated as a preparation for other deposits, fails to make a successful job of plating the new metal. Direct nickelplating also fails with stainless steel. The most satisfactory coating for this metal has been found to be zinc deposited from a cyanide-of-zinc solution.

A Self-Closing Gate

Instead of the cumbersome chain and weight generally used to keep gates to the garden and poultry inclosure shut, the arrangement shown in the drawing may be used. It is neat in construction, and will always swing the gate shut when released. In making a gate of this type, the width of the top should be made about 6 in. less than the bottom, and either the post to which it is fastened

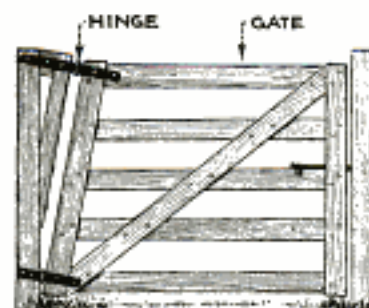

should be inclined at the same angle or an extra piece nailed to the post, parallel with the side of the gate. When the gate is hinged as shown, it will swing upward at the outer corner so that, when released, it will instantly shut. The hinges should always be put on at right angles to the sloping pieces.—H. F. Grinstead, Columbia, Mo.

An Improved Loom for Beadwork

Devotees to woven beadwork will be quick to appreciate the advantages provided by the adjustable loom illustrated.

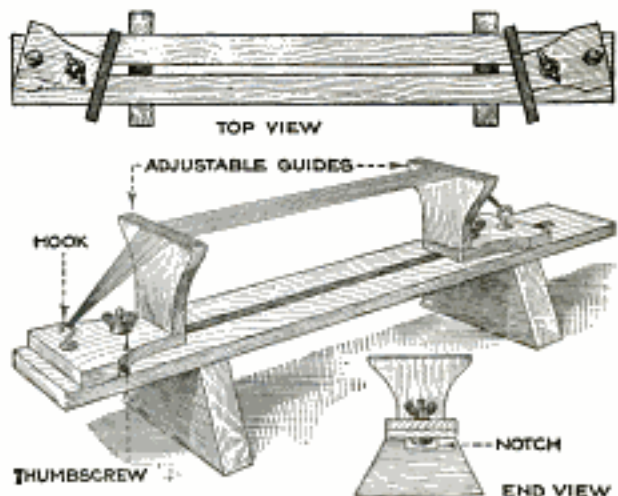

A Bead Loom with Adjustable Guides for the Advanced Worker: The Guides can be Moved Independently of Each Other

This loom does not differ in general appearance from the common type, except that the guides are adjustable. There is a slot through the center of the base which extends to within a short distance of each end and serves as a guide for the thumbscrews that clamp the guides to the base. The guides are made separate from the base and can be placed at any distance apart on the base or set at any angle. Two small brass hooks are provided on the guides, as shown, for drawing up the threads. The small notches in the top of the guides are placed $\frac{1}{16}$ in. apart, and every or every other one may be used, according to the kind of work being done.—Osler B. Walker, Columbus, Ohio.

Spring Clamp for Acetylene Welding

A large part of the jobbing welder's time is spent in the repairing of cast-iron articles of medium or light thickness, the ends and corners of such articles frequently becoming broken off. Before these broken pieces can be welded together, they must, of course, be lined up, and this operation takes more time than the actual welding itself, if the usual method of packing with various odds

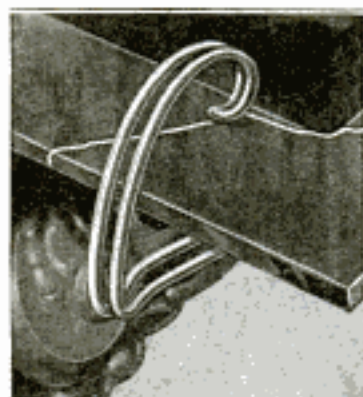

and ends is followed. A spring clamp that will hold the broken piece in position while it is "tack"-welded, can be made in a few minutes from a piece of steel wire. In the illustration such

a clamp is shown attached to the front of a stove casting, to hold a broken corner in place. The steel wire is not hardened, the natural spring of the metal being sufficient to hold the pieces; also, by leaving the wire soft, the ends that pass underneath and support the broken piece can be bent as desired to conform to the shape of the work. This clamp will hold any broken piece that is not too heavy, provided the top end is pushed over onto the main part of the work. By making the upper part of the clamp as shown, it can be used on work with beaded edges, shoulders, etc. The clamp is not left in place all the time the weld is being made; it is merely used to hold the parts in place for tack-welding at either end, after which it is removed.

Refinishing Brass Beds and Lighting Fixtures

Brass beds and lighting fixtures are given a coat of lacquer in order to protect the polished surface as long as possible, and prevent it from turning black. During the annual housecleaning period all such brass work is usually polished, with the result that the lacquer is rubbed off in spots, leaving unsightly patches that contrast sharply with the lacquered portions. Fixtures in a kitchen will turn black quicker than those elsewhere in the house, as smoke, steam, and grease cause the protecting varnish to fail. In order

to restore their original luster, it is necessary to remove all the old finish; this can be done by rubbing with a rag saturated with alcohol. Should the alcohol fail to remove the lacquer, it is an indication that the latter is made with a turpentine base, in which case turpentine instead of alcohol should be used. Next get a good metal polish, and go over all brass work thoroughly until it has the desired polish. Wipe off every trace of the polish, using clean rags so as not to leave any grease, which would prevent the lacquer from sticking. Then put on a coat of the lacquer and allow it to dry. Lacquer can be bought at most paint stores, but if it is unobtainable, it can be made after the following formula: Dissolve 3 oz. gum mastic in 1 pt. of turpentine by shaking. After dissolving the gum, strain the liquid through a piece of clean cheesecloth. As the density of the mastic varies somewhat, it may be necessary to add a little more than the quantity given; the idea is to make it thick enough to flow easily under a common varnish brush. If a more golden finish is wanted, add $\frac{1}{4}$ dr. of turmeric and also $\frac{1}{4}$ dr. of gamboge. Three coats of the lacquer should be applied, and each should be thoroughly dry before the next is put on. This varnish may be cleaned with a soft sponge and white soap and water.

For gas and electric fixtures in the kitchen there is nothing better than a coating of clear yellow spar varnish, containing Chinese wood-nut oil; such varnish, besides being flexible, will withstand the effects of steam and grease. It will last longer than the lacquer.

Cleaning Auto Oil-Feed Pipe

When the oil-feed pipe of an automobile engine becomes clogged, the usual cleaning method consists in blowing air under pressure through it, or passing a wire into it in an effort to clear the obstruction. In the course of time, however, the oil deposits a film of waxy or

gummy substance in the tube, and the methods described can only be depended upon to remove solid obstructions, leaving much of the

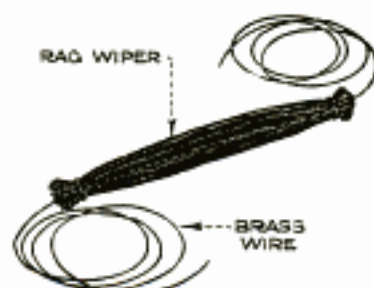

dirt sticking to the inner surface of the pipe. A better one is used by an autom-

bile-service station to clean the oil-feed pipes of its customers' cars thoroughly. A piece of brass wire is looped around the ends of a piece of rag; the wire is passed through the pipe, pulling the rag swab along with it, and as both ends of the wire project from the feed pipe, the swab can be worked back and forth until all foreign matter is removed.

Indicator for Shaper or Drill Press

Very often the lack of a simple indicating device has caused hours of extra work on a shaper or drill press, when shafts, or other round work, are being splined, key-seated, or otherwise machined. The indicating plate illustrated can be attached to the end of stock of any diameter that

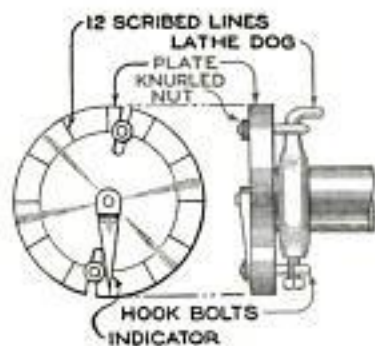

has a center hole, and will be found very convenient for accurately dividing it. The plate is 8 in. in diameter and $\frac{5}{8}$ in. thick, with a $\frac{5}{8}$ -in. reamed hole in the center. Twelve equally spaced radial lines are scribed on one side, and two slots are cut at opposite points on the circumference, as shown; hook bolts, fitted with knurled nuts, are used in these slots. Fitting snugly in the reamed hole in the center is a pin having one end pointed to fit the center in the work, and the other end tapered. An indicating piece is made from flat stock, one end being drilled to fit the tapered pin easily, and the other end pointed. To hold the plate in position, a lathe dog is tightened on the shaft, then the plate is held against the end of the work with the pin in the center hole. The hook bolts are placed over the dog, the knurled nuts tightened lightly, and the plate is swung around until the pointer coincides with one of the lines, when the nuts are drawn tight. If it is desired to work on the shaft at, say, six different positions, the shaft is loosened in the vise or V-blocks, and revolved until the pointer, which hangs in a vertical position, coincides in turn with every other line on the plate.

☛ Oxygen and acetylene tanks should never be handled by crane, either magnetic or mechanical.

Dragging Boulders with a Tractor

When moving large rocks from a field, attention should be paid to the manner in which the hitch is made. The chain



Pulling Heavy Boulders with a Tractor, Illustrating How the Hitch should be Made in Order to Enable the Tractor to Pull the Load Easily

or cable used should be fastened to the load as close to the ground as possible. Thus, when power is applied, the pull will be away from the ground rather than along it, or—worse—against it. In the illustration, the hitch is made in the proper manner, but the pull might be made even lighter by attaching the tractor end of the chain a little higher. Another important factor is the length of the chain. If possible, not more than 3 or 4 ft. of it should extend between the tractor and the rock. The closer the two are, the greater will be the angle of pull, and the less the draft necessary.

A Handy Siding Gauge

A gauge that will save a great deal of time in the application of siding to a building can be made

from three pieces of flat iron. It consists of three pieces of iron, with a rivet bolt and wing nut. The iron pieces are formed and the tool assembled as in the drawing.



With one end of the siding temporarily tacked to the studding or sheathing, the other end is accurately spaced by means of the gauge, applied as illustrated, and the nail driven home. Before the last blow is struck, the gauge may be slid along to the next point to be nailed.

Automobile-Control Pedals Operated by Hand

The controls of a light automobile, fitted for the use of a man who had lost both

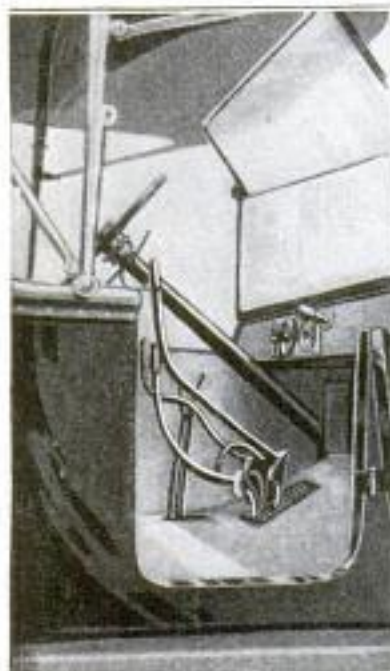

legs, are shown in the illustrations. Three le-

the levers being of such length that they are within easy reach of the driver. A fourth rod is welded at right angles to the brake pedal, and carried over to the clutch in such a manner that the clutch will be forced into neutral when the brake lever is pushed forward. Thus, the brake is applied and the gears disengaged with a single movement. The tops of the handles are fitted with leather grips such

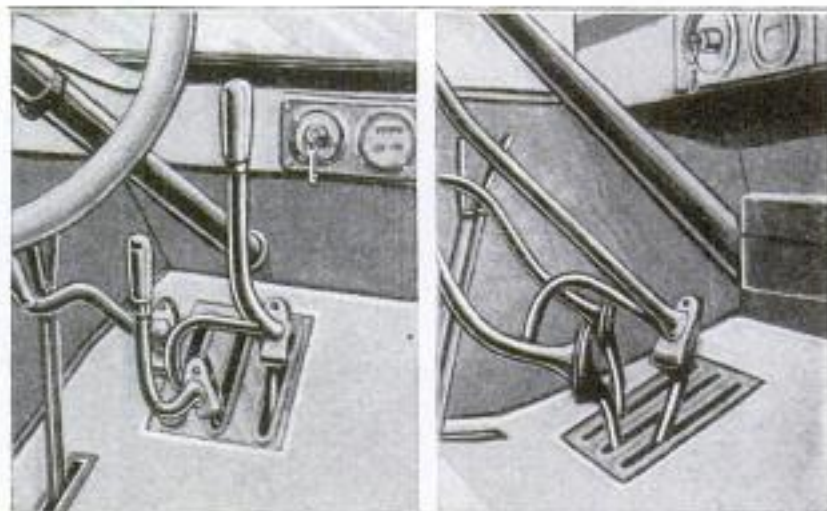

Extensions to Pedal Controls of an Auto That Enable a Cripple to Drive His Car. Left: General View of the Pedal Extensions. Center and Right: Method of Connecting the Brake and Clutch Levers So That the Clutch is Thrown into Neutral by a Forward Movement of the Brake Handle

vers are welded to the pedal pads of the clutch, reverse and brake pedals,

as used on the handlebars of a bicycle.—G. K. Bowman, Columbus, Ohio.

Testing Penetration of Wood Preservatives

The effectiveness of any wood-preservation treatment is measured very largely by the depth to which the preservative penetrates. The presence of creosote oil is indicated by the dark discoloration, and the degree of penetration may be readily found by taking a sample at a point free from checks and other imperfections and at a considerable distance from the end. This may be done with an ordinary $\frac{1}{2}$ -in. bit, or with an increment borer, which brings out a core of wood, showing in cross section the depth of penetration. The observation should be made at once, because the oil spreads rapidly over the cut surface. In order to prevent infection, the hole in the treated piece should be tightly closed with a creosoted plug.

Zinc chloride, on the other hand, is colorless, and the depth of penetration of this preservative must be found by chemical means. After cutting the stick in two, or obtaining a sample by means of the increment borer, the freshly cut surface is dipped for not over 10 seconds in

a 1-per-cent solution of potassium ferrocyanide, and the excess solution is removed by blotting paper. The sample is then dipped in a 1-per-cent solution of uranium acetate and dried. The treated portions will be whiter than the natural wood, and those untreated will have a dark-red or maroon color. This method does not give very sharp contrast on wood which is reddish in color, like red oak, but is otherwise very satisfactory.

Another method consists in spraying over the freshly cut surface a mixture of equal parts of a 1-per-cent potassium-ferricyanide solution, a 1-per-cent potassium-iodide solution, and a 5-per-cent solution of soluble starch. This mixture colors the treated portion a very dark blue but does not affect the untreated wood. Although the color fades in time, it may be brought back by spraying again.

Sodium fluoride is also a colorless preservative, but no satisfactory method for showing its presence in wood has been devised. Mercuric chloride, which is another colorless preservative, turns black when dipped in a solution of hydrogen sulphide.



Motor Wheel Serves as Home-Shop Power Plant

By L. B. ROBBINS

A POWER PLANT that will operate small drills, grinding wheels, lathes, and similar machines, in the home workshop, can be readily made from one of the popular motor wheels, in the manner shown in the illustrations. When the bicycle is laid up for the winter, the wheel can be taken off and used in the shop.

First, choose the location best suited for the installation; this should be an overhead beam or joist running at right angles to the bench. Set the machine to be operated on a bench, so that it will not interfere with other work, and then locate the motor wheel back of the center line of the machine, if possible, so that the belt will run at an angle. The motor wheel is suspended from the ceiling by a flat-iron hanger; this should be long enough so that, when it is fastened to the beam and the motor attached, there will be at least 15 in. between the top of the tank and the ceiling. This arrangement provides room for filling the tank with fuel. One of the hanger legs is a straight piece of iron, while the other is offset so that the bottom ends are 12 in. apart. Drill three holes in the top of the legs and one $\frac{1}{2}$ -in. hole an inch from the bottom of each; the latter is for the pivot bolt. Attach the legs to opposite sides of the overhead beam or joist with bolts or lagscrews, and make sure that the pivot holes are exactly in line with each other. Then drill a smaller hole in the straight leg, 15 or 16 in. above the

pivot hole, and bolt a diagonal iron brace to it and the beam—it may be found necessary to use two such braces, and one between the legs, as shown, to keep them rigid and perpendicular.

Place the end of the motor wheel that attaches to the bicycle between the legs, and pivot it to them with a bolt made

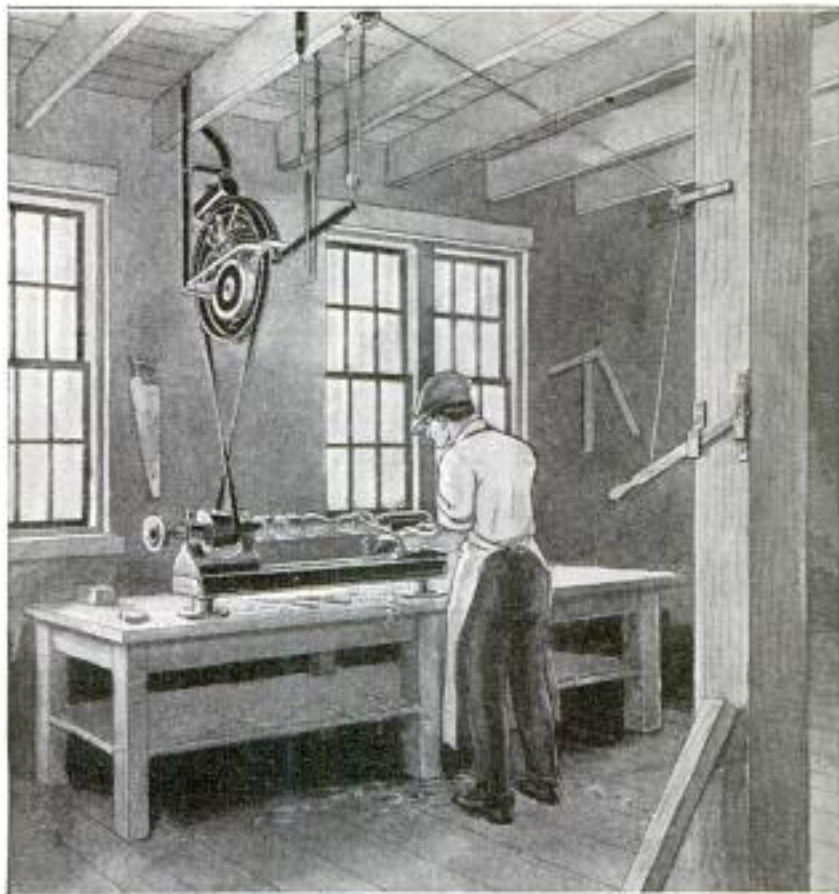

A Motor Wheel, Detached from the Bicycle When the Summer Is Over, and Installed above the Bench, Provides a Small Power Plant for Driving the Tools in the Home Workshop

from a piece of $\frac{1}{2}$ -in. round iron rod, threaded at both ends and provided with nuts and washers. Set a piece of pipe over the bolt to serve as a spacer; this should be long enough to keep the motor wheel bearing against the straight leg.

Drill two or three small holes in the rear end of the mudguard and bolt on the

adjusting lever shown in the drawing. This lever is made from a piece of heavy iron, twisted at one end and curved to fit the mudguard. Holes should be drilled in the iron to correspond with those drilled in the guard, in addition to a hole in the end for the pull wire.

Next, a guide is made from a piece of round rod, the ends of this being flattened, and bolted to the beam directly over the adjusting lever. With the motor wheel blocked horizontally, adjust the guide so that the bottom will be about 3 or 4 in. below the adjusting lever. Forge the sides of the guide together, so that they just allow the lever to slide easily between them without undue play.

and under the metal catch shown, the motor will be raised about 3 in. above the bottom of the guide.

Lastly, make a back frame of flat iron. This should be bolted to the bent leg of the hanger at the pivot hole, and to the end of the motor wheel below the adjusting lever. This is done by removing the bolt that binds the engine crankcase to the motor guard, slipping the iron against them, and bolting all three together with a longer bolt. Then bolt a properly bent piece of flat iron onto the middle of this back frame, at right angles to it, and bolt or rivet the end to the mudguard underneath the fuel tank; this forms a rigid frame and keeps the motor wheel vertical

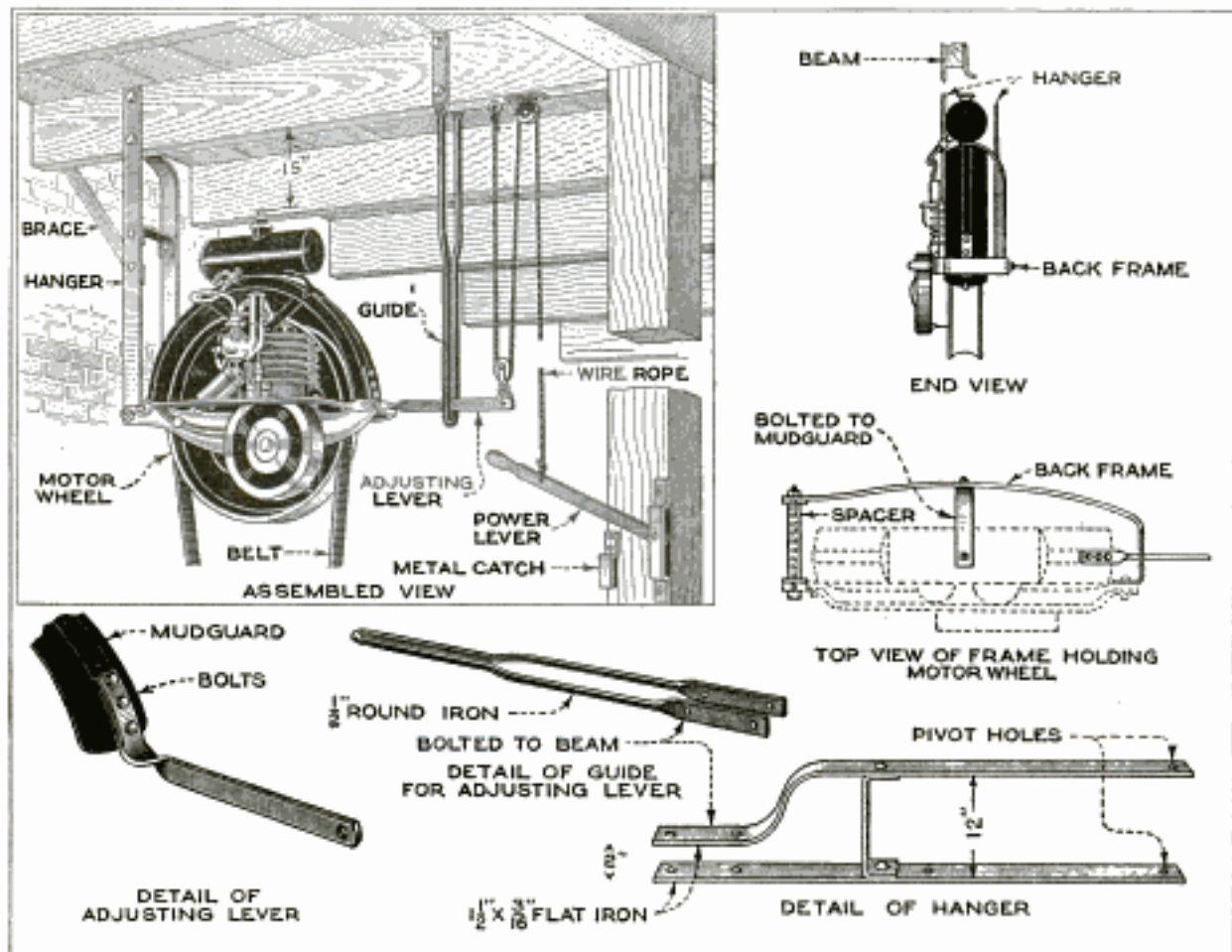

Insert: The Complete Assembly. Upper Right: End and Plan Views of Back Frame and Brace. Lower Left: Detail of Adjusting Lever. Center: Construction of Guide. Lower Right: Assembly of Hanger

Attach a pulley and a screweye to the overhead beam, and a pulley to the end of the adjusting lever. Then fasten a length of small wire rope to the screweye and reeve it through the pulleys as shown. Lead the end of this rope down to a pivoted lever that is fastened to a convenient post, or to the wall, and attach it so that, when the lever is up, the motor wheel will be lowered to the bottom of the guide; when the lever is down

and always in line with the machine below.

Place the control lever in a convenient position and remove the tire from the rim, to leave a pulley large enough for high-speed work. Belt the machine so that the belt is loose when the lever is raised; this allows the motor to run without operating the machine. As soon as the power lever is pulled down and caught under the catch, the belt will be tightened

and the machine will turn. In this way the engine can be kept running while the machine is stopped for any reason.

The engine is started by setting the controls and spinning the rim, and the speed can be regulated to suit the work in hand by means of the spark and throttle controls.

Starting a Saw Cut Smoothly

Everyone using a handsaw has, at one time or another, had trouble in getting the cut started in the wood, as the teeth catch in the edge and either stop the saw or mar the edge. A remedy for this is to file smaller teeth on the last two inches of the blade nearest the handle. This may be done by filing the point off the teeth so that a notch can be cut in each of the old teeth, thus making two teeth from each one. A few strokes with these small teeth will start the cut easily. If more convenient, the small teeth can be filed at the outer end of the saw.—Chas. N. Shaw, Jr., Oxford, Ga.

Joining Rag Strips for Weaving

Much of the time and labor required to sew the strips of rags together, which are to be woven into carpet or braided into rugs, can be saved by a simple and easily made device. A small piece of thin, flat steel is bent at right angles, the upper end pointed and sharpened, and a slot or eye cut in it, through which the strips may be inserted. Two holes are also drilled into the horizontal part for attaching to a

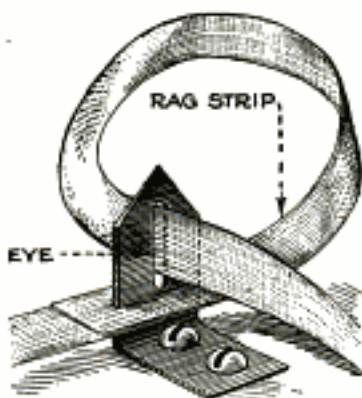
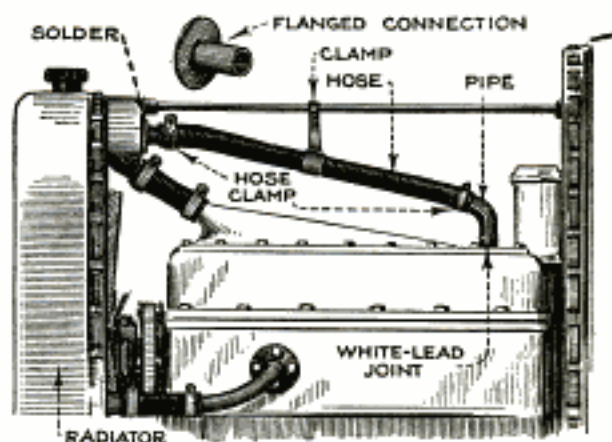

table or wooden block. In use, the strip to be joined is laid over the end of the other and both pushed down over the sharpened point; then the loose end of the former piece is brought through the eye, and pulled up close. When this has been done, the junction of the two strips is pulled up from below, the portion in the eye passing through the slit. After the strip has been pulled out of the eye and drawn up tightly, the resulting joint will be almost perfectly flat.

Auxiliary Piping Prevents Overheating

A means of preventing an automobile engine from overheating can be provided by adding an auxiliary outlet pipe in the



Preventing Overheating of Automobile Engine by Providing an Auxiliary Pipe: Thus the Water from the Rear Cylinders Passes Directly into the Radiator

manner suggested in the drawing. A hole is drilled and tapped near the rear of the cylinder-head casting to take a 1 or 1¼-in. pipe; this is bent as shown, and, after coating the threads with white lead, screwed into the hole. A hole is cut into the back of the upper header on the radiator, and a flanged connection of the type shown is soldered, or, better, brazed to it. The two connections are united by a section of rubber hose, which, if inclined to vibrate too much, can be supported from the radiator stay rod. The extra pipe allows the hot water from the rear cylinders of the engine to pass to the radiator without passing over the forward cylinders.

Repair for Broken Eyeglass Spring

Wearers of pince-nez or "nose glasses" often find that one or both of the small springs on the bridge of the nosepiece are broken, or have become so weak that the glasses slip off. Of course, the proper thing to do is to take the glasses to a jeweler or optician for repair, but, in an emergency, resort can be had to the method illustrated. One end of a small rubber band is slipped over one of the guards and wound around the bridge often enough to obtain the proper tension, when the opposite end is pulled over the guard on the opposite side.—Truman R. Hart, Ashtabula, Ohio.



Match-Box Holder and Lighter

Easily made from a piece of sheet metal, the match-box holder and cigar lighter

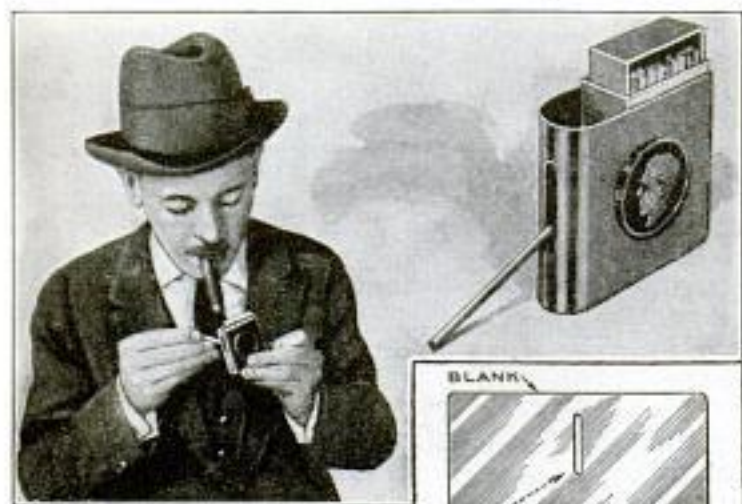

A Match-Box Holder and Cigar Lighter That Prevents the Small Boxes of Safety Matches from becoming Crushed in the Pocket, and Provides a Windshield That Makes It Possible to Get a "Light" Even in a High Wind

illustrated makes it possible to carry the small boxes of safety matches in the pocket without crushing, and provides a windshield for the flame so that it is easy to get a "light" even in a strong wind. The sheet-metal strip from which the device is formed is cut to the width of the match box, which is about $2\frac{1}{4}$ in. long. A slot is cut in the middle of the pattern, through which the match to be struck is inserted. Also, an ear, about $\frac{7}{8}$ in. long, is provided on what is to be the bottom. After the sheet-metal form has been cut, it is bent as shown, and the ear is turned up and soldered to the sides. The holder illustrated is embellished with a foreign coin.

A Two-Handled Cord Reel

A reel that will save much time in the winding of kite strings, fishlines, clotheslines, and other cords, can easily be made from a piece of board of the proper length. The ends are cut out to hold the cord and to prevent it from slipping off, and handles are fastened on opposite edges of the



board, near each end, as illustrated. After attaching the cord to the reel it may be wound up easily and rapidly.

Pulling Light Car Out of Mud

An owner of a light automobile has used a novel idea for extricating his car from bad mudholes. He raises the engine hood and passes one end of an ordinary clothesline through the footboard, tying it to the clutch pedal. The engine is then speeded up, the driver walks to the loose end of the rope, throws it over his shoulder, and pulls. This throws in the clutch and applies power to the rear wheels, which, together with the force of the pull and the lessened weight in the car, suffices to pull the car out in most cases. As soon as the pull on the rope is relaxed, the clutch will throw itself out, and the car stops. The emergency-brake lever should be kept in the neutral position during the operation; this allows the low-speed band to engage, but prevents the pedal from flying back into high and stalling the engine.

Keeping Insects from Light Bowls

A mercantile concern has a large number of inverted electric-light globes under a balcony that runs around the store. Formerly it was a regular weekly job for the porter to unscrew the globes and remove the accumulation of dead insects and other matter that collected in the bowls. Finally, shields of glass, cut circular to fit the open ends of the bowls, and with a hole in the center to slip over the light sockets, were used to cover the openings. This arrangement did not interfere with the illumination and kept out the dust and insects. Having successfully demonstrated its usefulness, the idea was applied to all the lamps in the store.—Chas. A. Goddard, Los Angeles, Calif.



Ⓢ A small hole drilled through the socket provided in stove lids for the lifter, will allow the light from the fire to shine through so that the location of the socket is easily found in the dark.

Making Varicolored Flash Papers for Stage Effects

Amateur plays are often produced in small communities where there is no electric-lighting current. If the play calls for fire scenes, lightning, artillery fire, explosions, etc., it is difficult to produce much of an effect without electric lights. For just such occasions, a set of varicolored flash papers will produce the effects desired. These papers can be prepared at home at small cost.

It is well, at this point, to call attention to the danger attending the use of these sheets, as well as of colored fires, etc., in close proximity to scenery, costumes, and other "props" that have not been fireproofed. Sheets of tissue paper, about 12 in. square, are used; these are cut in half for small, weak flashes, while, for longer ones, a whole sheet can be used. The tissue paper is soaked in aqua fortis, which should be bought ready-mixed from the druggist. The paper is thoroughly soaked, but is taken out of the solution as soon as possible, rinsed in running water, and hung up to dry. A wooden clothespin, or something of the sort, should be used to remove the paper from the acid, which should be prevented from contact with the fingers or clothing. When the papers thus treated have dried, they are pinned to a stick, held at arm's length and touched off with a match at one corner. They will burn with a brilliant white flash.

Colored flashes are made as follows: In all cases the paper is first treated as described above, and dried before immersion in the chemical solutions that produce the colors.

For red, dip the treated sheets in a solution of water and nitrate of strontium. Blue is obtained by soaking in copper-nitrate solution. Green can be produced from a solution of copper chloride, while a solution of calcium nitrate will produce another red. A beautiful violet flash is made from a solution of saltpeter and water.

Be sure to pin the paper to the end of a stick, which can be held at arm's length, or else fasten to a tin reflector before lighting.

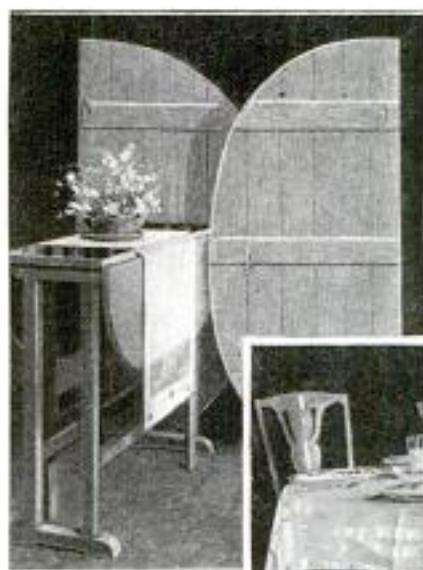

Dining Table Made from a Small Gate-Leg Table

Usually the extension dining table is a cumbersome affair for the small family dwelling in a modern apartment. The illustration shows a table that affords a real economy of space. A small gate-leg table was used, and provided with additional capacity for guests by using the two-piece auxiliary top shown. The thin boards used for making



Above: The Gate-Leg Table and the Two Parts of the Sectional Top. Below: The Sectional Top Hooked to the Small Table

the halves were screwed to wooden battens; hooks were provided for holding the sections together at the center and to the supporting table. The small table will serve for two or three persons, while eight can be seated when the sectional top is used.—Walter C. Harris, Brooklyn, New York.

How to Bleach Beeswax

Pure white wax, which is not only desirable for certain uses but brings a higher price on the market, is obtained from ordinary yellow beeswax. The yellow wax is sliced into thin chips and laid on cloth-covered frames or trays, supported a few inches above the ground, in the open. The flaked wax is turned over frequently, and occasionally sprinkled with clean soft water, if there is insufficient dew or rain to moisten it. The wax should be bleached in about four weeks, but if, on breaking the flakes, the wax still appears yellow on the inside, it is necessary to remelt it and expose a second time or even a third, until it is thoroughly bleached. The time required for proper bleaching depends largely upon the condition of the weather and the amount of sunshine that falls on the wax.

Shooting Gallery for Toy Pistols

Skill in shooting toy pistols, blowguns, and similar harmless weapons that use peas, marbles, or wooden darts for am-

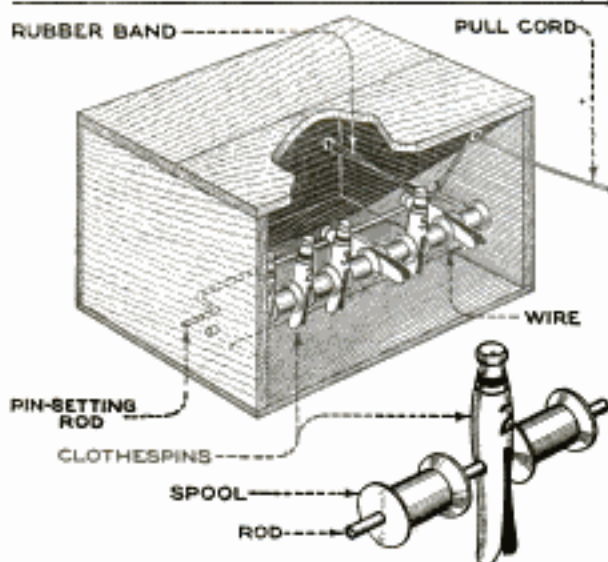

A Pistol Butt for Indoor Use, by Means of Which the Young Marksman can Improve His "Shot," with Harmless Weapons Such as Marbles, Peas, and Darts

munition, can be easily acquired by practicing on a target of the type shown in the drawing. Clothespins, spools, and some wire are about the only materials required. The clothespins, a spool between each pair, are placed on a stiff wire or small rod and fitted in a box, as shown. Back of the clothespins and a little above their lower ends is a second wire that holds them upright; this wire should be placed so that the pins will lean forward a little. When these targets are knocked over by an expert—or lucky—shot, they are caught by the pin-setting rod at the back; this rod is bent from a piece of stiff wire, and is held horizontally by a rubber band. When all the targets have been knocked over, or after each marksman's turn is over, the pins are reset by a pull on the cord tied to the pin-setting rod. If desired, the clothespins can be painted and designated by numbers.—Louis M. Steffen, Dayton, O.

How to Bake a Fish in Clay

A clay-baked fish is so simply prepared, compared with cooking it in camp, that it will be hailed with delight. The best kind of clay to use for the purpose is the gray clay generally found along streams, but in the absence of this, ordinary red clay will answer. The fish is cleaned and washed, stuffed if desired, and sewed up

in the ordinary way; the head of the fish may be left on. The clay is packed around the fish so that there will be a 2-in. thickness of it at all points, and it is then ready to be tucked into the fire. Previously, a hot hardwood fire has been kept going; ash is to be preferred because it produces hot coals that last a long time. It is generally a good idea to convert the evening campfire into a heap of coals for the purpose. The fish is placed at the bottom of the coals, covered, and left overnight. In the morning the coals are scraped away, and the hard-baked clay crust broken away with the camp hatchet, exposing the thoroughly cooked fish, savory and palatable to the last morsel. A 5 or 6-lb. fish makes an ideal bake.—Robert Page Lincoln, Minneapolis, Minn.

Swing Stand Used during the Winter

A familiar type of porch swing is suspended from a frame of steel tubing so that it can be moved to any location, either on the porch or lawn. During the winter months, when the swing is not in use, the steel frame can be used to provide additional space for the storage of clothing. This is accomplished by removing the swing from its stand and hanging the clothes—which are placed on hangers, of course—from the horizontal crosspiece.—Mrs. Elizabeth Bachman, Fullerton, Pa.

A Simple Wire Stretcher

A novel arrangement, that is simply installed on any wire line to facilitate lowering or raising, or to maintain a uniform tension, is shown in the drawing. It is made from a bent bar of round iron.

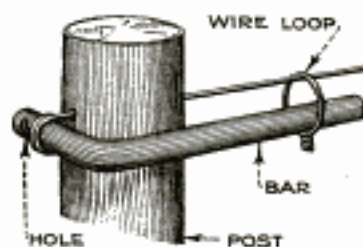

Such a device is being used, in one instance, to keep wire clotheslines taut, so that no props or other supports are necessary. The wire is led through a hole in the post and fastened through a hole drilled in the bent bar. Turning of the bar crank winds the wire around it and tightens the line. The crank is held in place and prevented from unwinding by a loose loop, or link, which is slipped over its end.

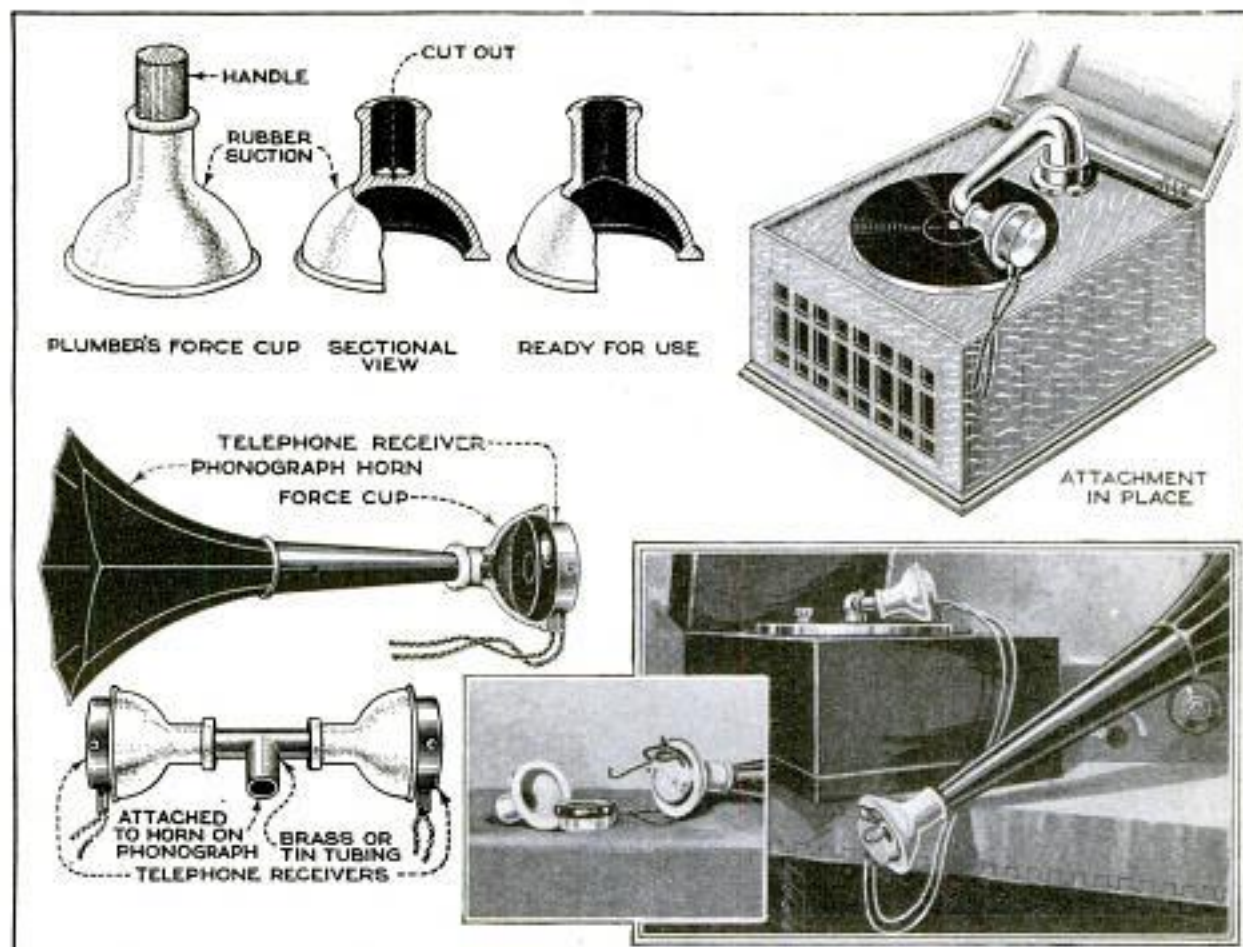

Simple Methods of Making a Loud Talker for the Radiophone-Receiving Set: One or Two Force Cups, with a Few Scraps of Tubing and a Discarded Phonograph Horn, Are the Only Materials Necessary

Making Loud Talkers for Radio-Receiving Sets

A variety of devices for amplifying the sounds received through the radiophones are on the market for the choice of the owner of a radio-receiving set—if he cares to pay the price. If his means are limited, the ideas illustrated may be applied at a cost of well under a dollar.

The only material required is one or more small force cups, such as can be bought from any plumber or hardware store. Usually these cups are mounted on a wooden handle, and this is removed, as the rubber cup is the only part used. Between the handle socket and the hemispherical cup there is a dividing wall of rubber that must be cut out, which makes the cup ready for use. One of the phone receivers is fitted inside the large end of the cup and the neck is slipped over the tone arm of a phonograph, after the soundbox or reproducer has been removed, or over the end of a horn as in the drawing. A larger volume is, of course, obtainable by using both receivers of a headset and mounting them on the ends of a tee.

Efficiency of Spark-Plug Points Improved by Sharpening

As the result of investigation as to the advantage obtained by varying the form of the electrodes through which a high-tension current was passed, it was found that the same voltage would bridge a gap from 25 to 50 per cent greater when the points were made very sharp, than when they were blunt. This knowledge was put into practice on a number of cars in which trouble was experienced due to persistent fouling of the plugs with oil and carbon. As a result of these tests, extending over a year, the invariable practice in one shop, when fitting new plugs, is to file the electrodes to a point, and make the gap the usual thickness, that of a worn dime. The practice has overcome the trouble with the plugs, and has made cylinders, which previously required weekly cleaning of the plugs, operate without a "miss" for months. It is necessary to set the points closer after a long period of operation, as the smaller points burn away quicker than the usual circular-section electrodes. It is most important to sharpen the positive electrode.

How to Make Artificial Pearls

BY R. R. HENDERSON

ARTIFICIAL-PEARL making would seem, at first glance, to be a process somewhat beyond the skill of the amateur, but, as a matter of fact, very good-looking "pearls" can be turned out in the home workshop. The art is not difficult, and can readily be acquired by practice.

For many years, artificial pearls were made by coating the outside of small glass beads with a luster paint. This method, however, had the disadvantage that constant wear caused the paint to chip off, leaving the glass bare. At the present time this method is used for the cheaper grade of goods only. The better and more expensive artificial pearls are now made by first blowing thin glass globules, with a hole in each end, from thin-walled glass tubing. Then, by a special process, the interior of the globule is coated with a luster solution.

First obtain a supply of thin-walled glass tubing of small diameter. The exact size of tubing and thickness of wall depend upon the size of pearls one wishes to make, but for most ordinary uses, tubing of $\frac{1}{8}$ -in. outside diameter and walls $\frac{1}{32}$ in. thick will serve.

Place one end of a piece of tubing in the flame of a Bunsen burner, as in Fig. 1, and rotate it slowly until the glass melts and runs together, closing the hole in the end of the tube. Remove the tube from the flame and let it cool slightly. Then again insert the tube in the flame, about 1 in. from the closed end, and rotate it slowly so as to heat it uniformly all around. When the glass becomes red-hot and soft, remove it quickly from the flame and blow in the open end, as in Fig. 2, until a bulb or globule of glass appears of the desired size. Be careful not to heat the glass until too soft or to blow too hard, or the bulb may accidentally be blown so thin as to burst it. Also, if the tubing is not uniformly heated all around, the hottest spot will swell out first, and a globule of imperfect roundness will be formed. A complete globule, blown near the end of the tube, is shown in Fig. 4. After blowing the first globule, let it cool a moment so as to set and become hard. Then heat a place on the tube beside the first globule, Fig. 4, and blow another; continue in this manner until as much as possible of the length of the tube has been used, as in Fig. 5. Now, with a small three-cornered file, make a scratch between each globule and break them apart. The small tips left on each end may be ground off by rubbing

on a piece of emery paper, and then polishing with wet chalk, or, preferably, they may be melted and closed in slightly to give a finer hole, by holding the globule in a pair of tweezers and rotating the end in a fine flame. Wash a quantity of the globules in a pint of water, to which a spoonful of washing soda has been added, stirring them around thoroughly; rinse them in three or four changes of clear water to remove every trace of the washing soda, then place them in a pan in an oven to dry. The globules should not be touched by the hands after washing.

Now prepare a very thin varnish by dissolving a small quantity of mastic in acetone. To this add a very little ordinary copal varnish. Then stir into this thin mixture a quantity of "fish silver." This material consists of the carefully dried, ground, and sifted white scales of fish; it may be obtained from dealers in artists' and decorators' supplies. The complete solution, already mixed up, may also be obtained, under the name of "pearl solution" or "essence d'Orient."

Construct a coating apparatus from a glass or enamel-ware jar, as shown in Fig. 6; this is so arranged that it may be rapidly rotated about an inclined axis, and should be equipped with some sort of cover. An ordinary preserve jar serves well. Place in the jar a small quantity of the fish-silver and varnish mixture, and about three times as great a bulk of the glass globules, close the cover, and rotate the jar rapidly. In a few minutes it will be found that the interior of every globule is coated with the luster mixture, and that all the excess liquid will be in the form of drops in the inside of the globules, capillary attraction, assisted by the rubbing of the globules together, which prevents the coating settling and adhering to the outside, having drawn the liquid to the inside. Now heat the jar gently with a gas flame or alcohol lamp, rotating it again rapidly, leaving the cover off. In a short time the excess liquid will have evaporated, leaving on the interior of the globules a hard coating of the luster material, and giving the effect of natural pearls. Care must be taken that the luster varnish is very thin, and that only a small quantity is used, to prevent the excess from sticking to the inside of the jar, or to the outside of the glass globules. If, by any chance, a little of the coating should stick to the outside of the globules, it may be removed by putting them

Essence for making Pearls: - Dyannig Maco
 Nelson Chemical Co. + Parts

Roos,
 Reed
 York
 Chicago
 Bowen burner-glass-making
 Central Scientific Supply Co
 406 E. Ohio

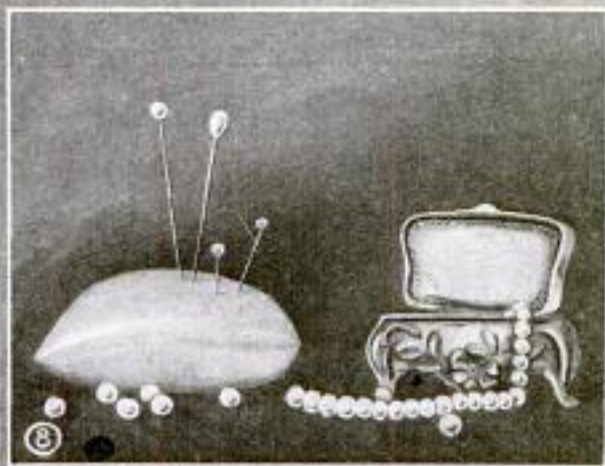
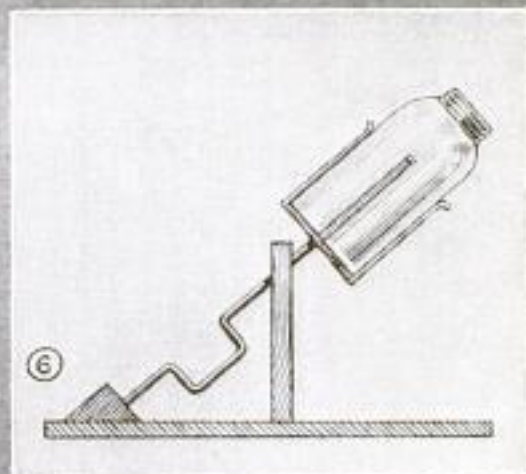
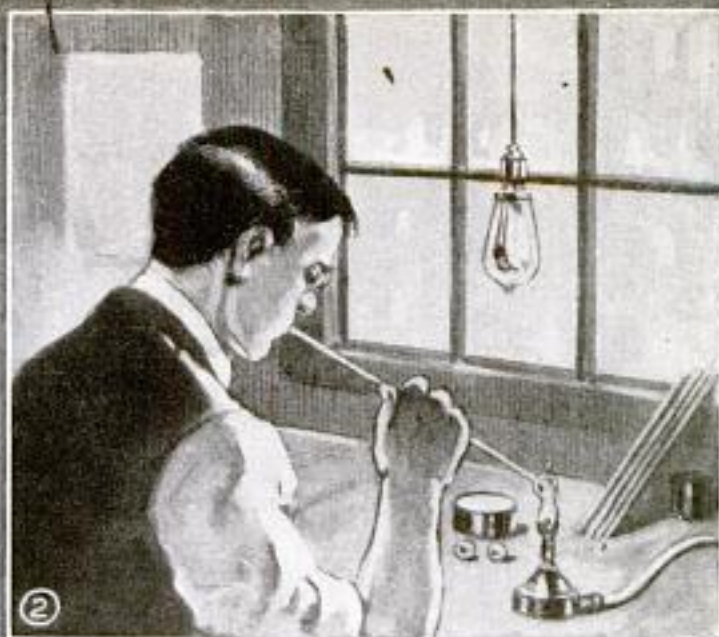

Fig. 1, Closing the End of the Tube; Fig. 2, Blowing the Globule; Fig. 3, a Hatpin Globule; Fig. 4, Preparing the Tube for the Second Bulb; Fig. 5, a Complete String of Bulbs; Fig. 6, the Coating Apparatus; Fig. 7, Emptying the Jar after Coating, and Fig. 8, Complete Hatpins, Stickpins, a Necklace, and Some Loose Pearls. This is an interesting hobby, and is well within the skill of the amateur.

back in the revolving jar, with an equal amount of sawdust which has been slightly moistened with acetone. If the jar is then rotated, the rubbing of the pearls against each other and the sawdust will clean them. They may be polished by rotating in the jar with fresh, clean, dry sawdust. It is best first to sift the sawdust, so that it will contain no grains small enough to get inside the pearls through the small holes. Use the sawdust that remains on the sieve.

Cork Prevents Double Exposures

After accidentally bumping the trigger of his box camera a few times and getting double exposures, the owner decided that some step must be taken to prevent this. The method consisted simply in the insertion of an ordinary cork into the opening in front of the lens. This arrangement not only makes the opening light-tight, but permits unlimited tripping of the trigger, and is also dustproof, thus protecting the lens and shutter mechanism. It should be borne in mind, however, that the cork must not be so long as to bear against the revolving shutter disk.



An Auxiliary Seat for the Auto

Upon occasion it is desirable, especially with a two-passenger car, to accommodate an extra passenger. One method providing this extra seat is that shown in the appended sketch. This consists of a hinged seat attached to one of the right-hand doors as shown, and provided with a hook and leg on the forward edge of the seat, for its support.

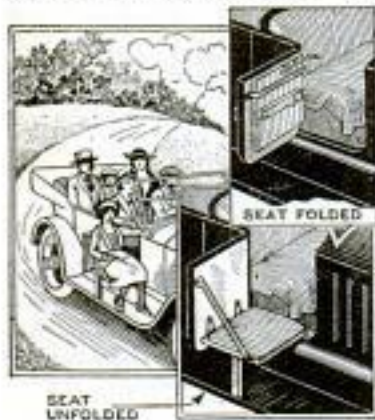

To prepare glass globules for hatpins, seal one end of a glass tube by rotating it in the flame and blow the globule directly from this sealed end; Fig. 3 shows a hatpin globule. When cut from the tube by a three-cornered file, this gives a globule with only one hole. It is coated in the same manner as the ordinary beads. Pins may be fixed in place by imbedding them in a small amount of light-colored melted sealing wax run into the bead around the pin.

This seat has the advantage that it can be folded snugly against the door when not in use.

For roadside tire repairs, or other troubles, this seat provides a handy place to work without stooping, and a shelf for the tools.

Socket Wrench for Connecting Rods

The socket wrench shown in the drawing was made for the purpose of tightening the bolts used to hold the caps of automobile connecting-rod bearings. The space between the cap body and the inner edge of the nut is generally so small that only a very thin socket wrench can be used. The result is that the wrenches are often broken. For the tool illustrated, a heavy wrench is used, one side being ground off. With this wrench the nut can be drawn up tightly without resort to a hammer and chisel.

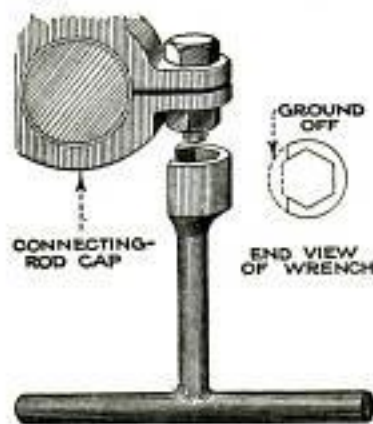

Thought Transference with Dice

A simple arithmetical trick, that is very impressive, consists in asking a member of the party to throw a pair of dice on a table, then telling him what he has "thrown." In order that the person performing the trick may not see the dice, he goes to another part of the room, where he remains until the conclusion of the trick. The performer then requests the person casting the dice to use the uppermost figure on one of the dice and multiply this by 2, then add 5 to the product,

multiply the sum by 5, and, finally, add the uppermost figure on the second dice. When he has done this, the performer tells the number of spots showing on each of the dice, although he has not seen them.

When the performer is told the number that has been obtained by the above process, it is only necessary for him to subtract 25 from it, and the remainder will be a two-figure number; one of these figures will be the number of spots showing on one of the dice, and the second will be that on the other. Thus, for example, assuming that the person tells the performer that his final number is 67, by subtracting 25 from it, 42 is obtained; then the performer knows that the figure on one of the dice is 4 and that on the other is 2. The operation from beginning to end is: $4 \times 2 = 8 + 5 = 13 \times 5 = 65 + 2 = 67 - 25 = 42$.—Raymond Dixie, New Haven, Conn.

Reading Lamp Made from Music Rack

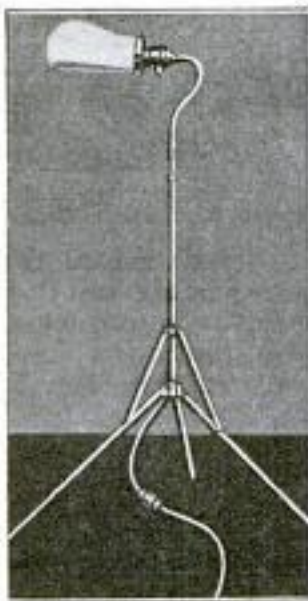

that can be adjusted for height and is readily portable.—L. Ringer, Cincinnati, Ohio.

A Camp-Site Incinerator

Proper sanitation is a first necessity in an auto-tourist's camp site. A small garbage incinerator can be built at little expense, and the aid it will render in keeping the place sanitary is well worth the small outlay of labor and materials. The inner lining should be of fire brick, while ordinary bricks, old or new, will serve for facing. Built like an old-

fashioned beehive, the incinerator has a fire grate about 18 in. from the bottom,

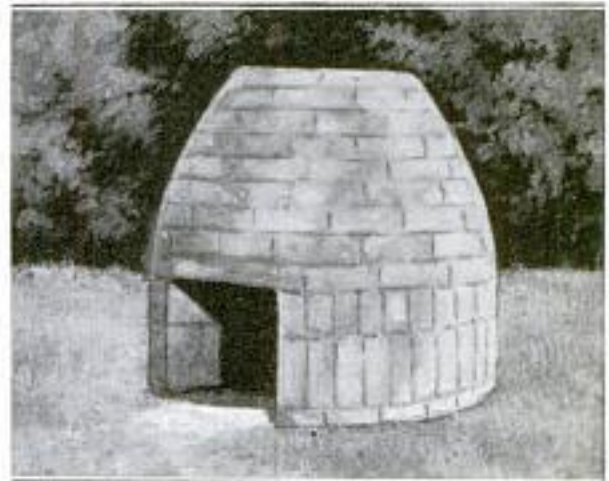

Incinerator for a Camp Site Used Mainly by Auto Tourists Helps to Keep the Camp Sanitary and Free of Refuse of All Kinds

with an opening at the top equal to about one-half its diameter at the bottom. After a wood fire has been started under the grate, the refuse is dumped through the top hole, and will be gradually consumed without further attention on the part of the caretaker. Further to facilitate the disposal of refuse, each tourist, as he enters the camp, should be provided with a wire basket in which he is requested to deposit the refuse from his tent.—C. L. Meller, Fargo, N. D.

Sewing Kit Made from a Cigar Box

An ordinary cigar box, preferably one used for holding 50 cigars, provides a good container for spools of thread, and other sewing materials, when fitted up as shown in the illustration. Two long aluminum knitting needles, such as can be obtained for a few cents, are fitted into holes drilled in the ends of the box. In the end at which the knitting needles are inserted, the holes are a loose, sliding fit, while at the opposite end they are a little smaller so that the needles will be held in place by friction. The spools turn freely on the rods, which need never be removed except when an empty spool is taken out to make room for a new one. The remaining space in the box can be used for pin-cushions, scissors, and other articles.



A Novel Photo-Print Washer

A great deal of time is saved by the user of the print washer illustrated, and the prints are thoroughly washed, as they do not come into contact with each other, and each is surrounded by circulating water. Ordinarily, the prints are removed from the hypo fixing solution, dumped into a pan or other vessel, and the water turned on; as the wet prints always stick together more

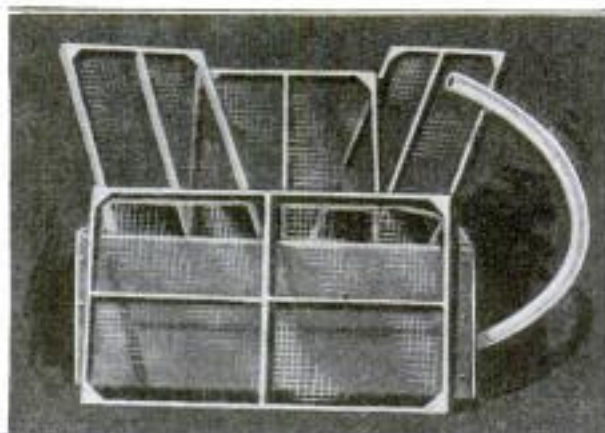

copper-screen wire, to prevent rusting, and the sides, ends, and partitions are made of narrow strips of galvanized iron, soldered together and to the wire screen. A small strip of wood is placed in the bottom of the box to keep the trays from the bottom, and allow a free circulation of water underneath. The hose that carries the water from the faucet to the washer enters the box at the bottom. In use, a strip of sheet metal is placed over the top and fas-

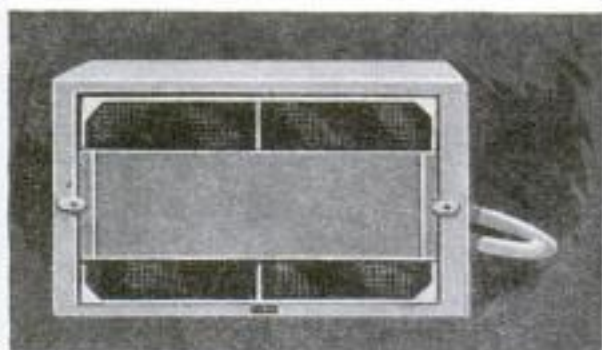
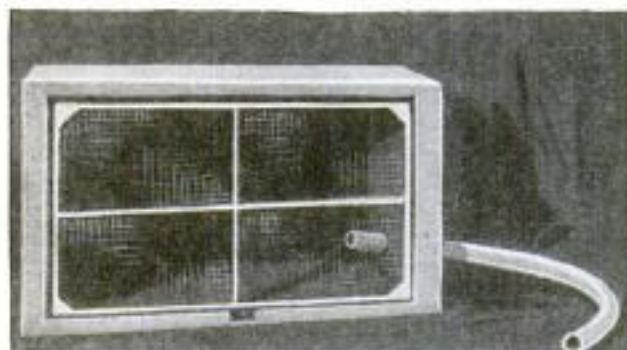

Above: The Wooden Container and Four Copper-Wire Trays, Each Divided into Four Compartments. Left: Top View of the Washer. Right: Strip of Sheet Metal Fastened at Each End over the Top of the Washer

or less, there is no assurance that all of the prints are thoroughly washed.

This print washer consists of a wooden box, which serves as a container for four trays, divided into four compartments, one for each print. The trays are made of

tened with buttons on each end of the box, to prevent the prints in the top tray from washing out. Double the number of prints can be washed by placing two, back to back, in each compartment.—John T. Daniel, San Francisco, Calif.

The Care of Leather-Bound Books

Bookbinding leathers have a tendency to dry out and finally break at the hinge, if the leather is not kept flexible by occasional greasing. For this purpose any high-grade vaseline, free from acids, may be used. The following method of greasing the leather is that used in a large library to preserve the sheep bindings of legal volumes:

The work should be done in a well-lighted, airy place, preferably in the summer, when the windows can be opened to let in the outside air. Place the book, back up, on a table having a smooth top, and coat the back with vaseline, rubbing it well into the grain of the leather with the hand. Next, treat the sides and edges, being careful not to get

any of the vaseline on the paper. Use small quantities of vaseline and rub it in well, with a firm, flexible stroke. The first application is usually absorbed rapidly. Next apply a second coat and rub the leather down well as before. The back and back edges require more vaseline than the sides and front edges. Then place the book on a shelf to dry, which takes from 24 to 48 hours, and finally rub off all surplus grease.

Merely dabbing on the vaseline with a cloth and rubbing it off does not suffice. Neither is one application, left to dry in by itself, satisfactory. Light rubbing with cloth pads will not do the work as well as rubbing with the bare hands. Also it is better to use small quantities of vaseline, and make several applications, according to the condition of the book.

Fusible Alloys for Setting Crystals

Radio-sensitive crystals, such as galena, silicon, and the like, should be imbedded in metal to obtain the best results, and this is done by using an alloy that melts at a point considerably below the boiling temperature of water. Heat destroys the sensitiveness of the best crystals, and for that reason lead cannot be used.

An alloy which melts at 197° F. is composed of lead, 3 parts; tin, 2 parts, and bismuth, 5 parts. The melting point of the metal can be still further reduced by adding 1 part of warm mercury to the molten alloy when it is removed from the fire. The addition of mercury will cause the alloy to remain liquid at 170° and become a firm solid only at 140°. The boiling point of water is generally taken as 212° F., although the higher the elevation above sea level the lower this temperature will be.

Making a Toy Catapult

A 10-cent rat trap of the type shown in the drawing can easily be made into a marble-throwing catapult, the range of the missile being regulated by an adjustable stop.

The trap is fastened to the edges of the ammunition box and the bait hook is removed. The stop is then bent from a strip of sheet metal and fastened to opposite edges of the trap as indicated. Two side arms that serve as braces for the stop are adjusted by means of a wire pin passing through holes in the stop and arms. The throwing arm should be made of 1/2 by 1/2-in. hardwood, about 10 in. long, although the length is best determined by trial. A small metal cup at the end of the arm provides a pocket for the ammunition. If desired, a trigger arrangement, similar to that shown, can be added to the device. Flour, tied in tissue paper, may be used to make a realistic bomb, as it gives off a smokelike puff when it strikes, and is harmless. The longest throw the device is capable of, will usually be attained when the stop is set at an angle of about 45 degrees.—J. H. Kindelberger, Cleveland, Ohio.

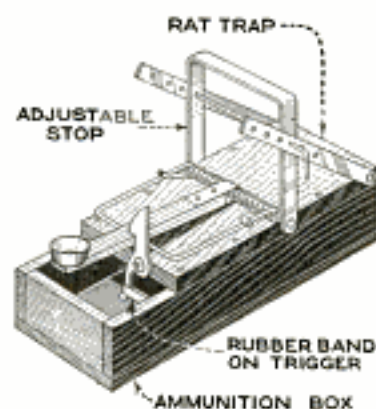

Straightening a Bent Auto Axle

When an automobile skidded into a partly obscured curb, one of the rear-axle shafts was badly bent. The wobble of the wheel was so pronounced that further driving was out of the question. This happened near the garage, and as the use of the car was necessary for delivery purposes, the method illustrated was used to straighten up the wheel.

A piece of plank, about 3 ft. long, had a hole cut in its center to clear the wheel hub. Driving the car into the doorway of the brick garage, a jack was placed between the upper end of the plank and the side of the doorway. The opposite wheel was blocked to prevent the car from being pushed sidewise, and pressure exerted on the jack straightened the axle. Repairs made in this manner should not be considered permanent.

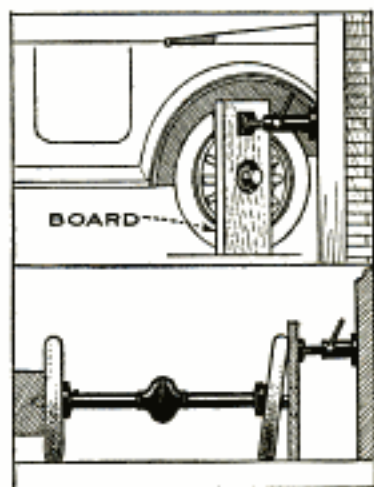

Windmill Controlled from the House

Having to go from the house to the windmill, some 30 rods away, in order to stop it when the tank is full, soon becomes quite a nuisance. To avoid this, and to control the operation of the pump from the house, the arrangement shown by the drawing was worked out.

A bell crank made from a piece of tire iron, was pivoted to one of the tower legs with a bolt. Wires fastened to the ends of the crank were led to the house and to the controlling mechanism of the windmill for throwing the pump out of gear. The pump can also be started by releasing the control wire.—Rufus E. Deering, Ottawa, Kan.

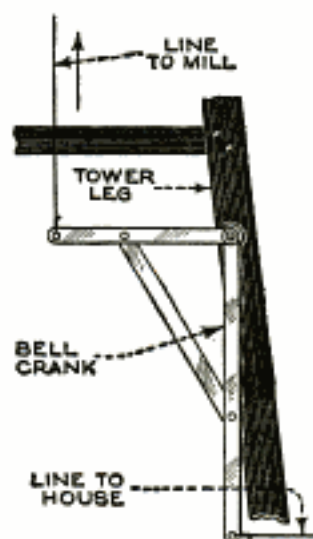

Wheatstone Bridge for Coil Winding

To wind electrical coils that must possess a certain resistance, or to wind a coil that will have the same resistance as another, are real problems to the experimenter unless he knows how to go about it. Almost every amateur is familiar with

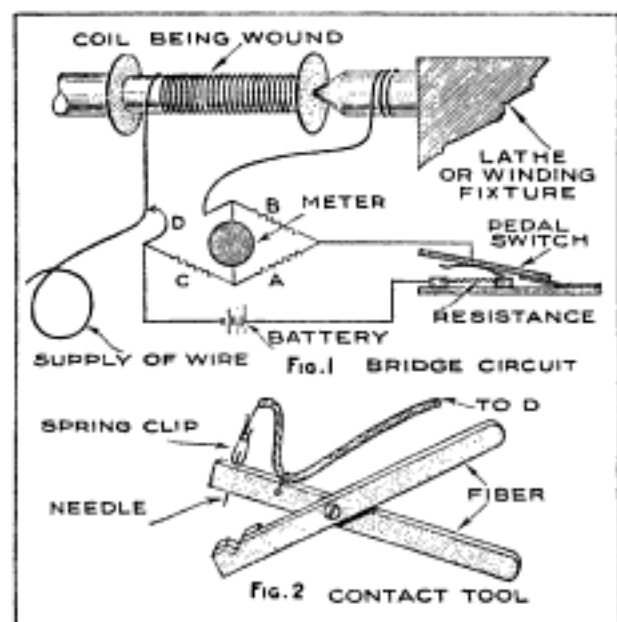

Winding a Coil of Wire to a Certain Resistance Is an Easy Task When the Wheatstone Bridge Illustrated is Used

the Wheatstone bridge, by name at least; this is usually represented by four resistances in a diamond-shaped figure, with a battery connected at two of the points of the diamond and a galvanometer across the other two. When there is no current passing through the meter, it shows that the four resistances are balanced, and in proportion; that is, A is to B as C is to D. The voltage of the battery and the markings on the instrument need not be known or correct, as the accuracy of the result does not depend on them. Fig. 1 shows a method of applying the bridge principle to a coil as it is being wound, so that one may know just where to cut off the wire to get the right resistance. The galvanometer should, of course, be as sensitive as possible; it is not difficult to make one from a compass and a coil or two, or an excellent galvanometer can be obtained by removing the resistance coil from any good moving-coil voltmeter, or by connecting direct to the meter so as to bypass the resistance. The resistances A, B, and C must be of known value, if the coil is to be made a definite number of ohms, but if any one of them is of known resistance, two more can be made equal to it, by using ordinary bridge

methods, so that only one known resistance is necessary at the start.

In the figure, the coil being wound forms side D of the bridge; the inner end, or that next the meter, is grounded on the dead center of the lathe or winding fixture, and a temporary contact is made with the last turn wound by piercing the insulation. The pedal switch shown serves two purposes: It connects the battery in the circuit after the contact is made at D, and, as the pedal is further depressed, shorts out a resistance. This resistance is in series with the battery, and should be high enough to protect the meter from the high current which will result if the four sides of the bridge are much out of balance. When the first contact of the pedal switch closes and it is seen that only a small deflection appears on the meter, then the pedal can be pressed farther down, shortening out the resistance and giving greater accuracy in balancing the coil resistance against resistances A, B, and C. Fig. 2 shows a simple and handy tool for making the contact at D. Two pieces of fiber or hardwood are pivoted together at the middle; one is notched, and through the other a sharp steel needle is driven which is connected to the wire leading to the bridge. By laying the magnet wire in the notch and gently closing the needle point against it, the point will pierce the insulation sufficiently to make contact, but without damage of any importance to the cotton or enamel insulation.

Spreader for Split Rims

Automobile owners and drivers generally have trouble in bringing the ends of a split rim together when a new tire



has been placed on it. Various tools are made for this work, but unfortunately, they are not usually carried on the car. The drawing shows a simple method of using the jack, which no motorist is without, and a short block of wood. Pressure exerted on the rim through the jack and block will force the ends together speedily and easily. A block may be placed under the jack, to protect the rim.—Harry G. Schultz, Teaneck, N. J.

Two Effective Card Tricks

The first trick involves the use of four cards, which are "fanned" out, to show a corresponding number of kings, the performer repeats the magical "abracadabra," and, presto! the same hand has changed to four aces when it is again displayed—a third pass, and only blank cards are shown. Six

cards are required for this trick, three of which are unprepared, the other three being "prepared." The three unprepared cards are the king, ace, and blank card shown in Fig. 1, the three other cards being prepared by pasting a part of the remaining three kings over a corner of the aces as shown in Fig. 2. In the presentation of this trick, the four kings are first displayed to the audience. The real king being on top, the cards are fanned as in Fig. 3, so as to show only the kings on the corners of the other three cards. Then, the performer picks up the ace of spades, which has been left face up on the table, and announces that he will place it directly behind the king of spades, which he does. He then lays the king of spades on the table. The cards are then closed up and turned over so that the cards are held at what is the top of the cards in

the first presentation of the four kings. Then, the cards are fanned out to show the four aces, as in Fig. 4. The index numbers in the corners of the aces should be erased or covered up, otherwise it will be impossible to show the blank cards.

The manipulator now states that by placing a blank card, which he picks up from the table, where the ace of spades is, the spots will disappear from all the cards. The ace of spades is placed on the table, the blank card taking its place. The cards are then closed and fanned out, the hand showing four blank cards, as in Fig. 5. In the second trick, an ace of diamonds is held in one hand and an

ace of spades in the other, but while held in full view of the audience, the cards change places. The prepared cards are made from two aces of diamonds, from which the corner index pips and letters have been erased. An ace of spades is also required, the center of which is cut from the rest of the card as indicated in Fig. 6, which shows the appearance of the

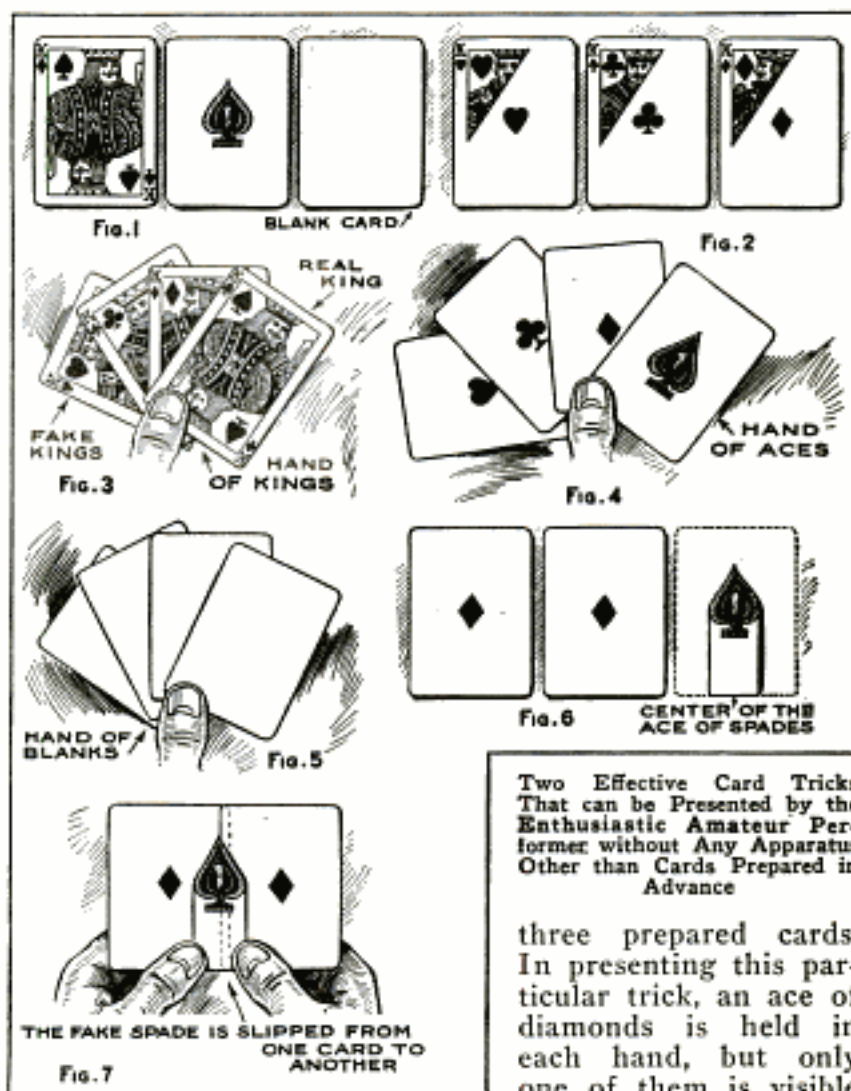

Two Effective Card Tricks That can be Presented by the Enthusiastic Amateur Performer without Any Apparatus Other than Cards Prepared in Advance

three prepared cards. In presenting this particular trick, an ace of diamonds is held in each hand, but only one of them is visible to the audience, the

other being concealed underneath the ace that has been cut from the card. The performer then announces his intention of making the cards change places. He turns the backs of the cards toward the audience, and, with the hands apart, begins moving the cards back and forth, bringing them a little closer to each other at each pass. Finally, when the edges touch, as in Fig. 7, the false center from the card is slipped over and onto the other card; this done, the cards are moved back and forth, gradually separating them, and their faces are again turned to the audience, when, to all appearance, the cards have changed their positions.



BUILDING A SIMPLE RADIO RECEIVER

By F. L. BRITTIN

THE form of receiver described in this article is a very popular one for reception from broadcasting stations; it gives excellent results for distances up to 250 miles and can be built at small cost. Under average conditions, telegraphic signals can be received within a radius of 1,500 miles, on wave lengths from 150 to 400 meters. The instruments are mounted on a $\frac{3}{16}$ -in. bakelite panel, fastened to a wooden base by two angle irons. The variable condenser used is of .001-mf. capacity and is of the panel-mounting, 43-plate type. The variocoupler may either be bought ready-wound, or the knock-down parts are wound and assembled. The stationary bakelite or cardboard tube is wound with 40 turns of No. 20 single cotton-covered magnet wire and six taps are taken off at approximately equal steps; these taps are led off to the contact points of the primary switch, as shown at the upper left. The secondary, or rotor, of the variocoupler is wound with 34 turns of No. 26 single cotton-covered wire, 17 turns on each half, and the leads are brought out, through the hollow shaft, to a pair of binding posts. The tube socket is mounted on the base, at the left of the variocoupler; in front of the socket, the 6-ohm battery-type rheostat is placed, and above it several holes are drilled through the bakelite for observing the brilliancy of the tube filament when in operation. The binding posts for the ear phones are located in the panel directly in front of the socket. The switch for the primary of the variocoupler is mounted on the panel, at the right of the socket, looking at it from the rear, and it should be noted that the switch lever is connected to the ground post. Above the primary switch is located the B-battery switch, which has the "off" point at the right; this switch is for the purpose of varying the B-battery

voltage on the plate of the detector tube. The grid condenser is placed on the panel above the variocoupler; this condenser is of standard type with a capacity of .0005 mf. The grid leak has a resistance of 2 megohms, and is of the ordinary type, obtainable from any dealer in radio supplies. Six binding posts are placed on the panel, one for the aerial, one for the ground, two for the A-battery, which is a 6-volt, 40 or 60-ampere-hour type, and the other two are for the ear phones. The B-battery is a positive-tapped 22½-volt unit of standard make. The taps are connected to the B-battery switch taps on the panel; the various voltages are plainly marked on the battery unit, and should be connected to the switch in the order shown.

Use No. 18 insulated fixture wire for the circuit and carefully solder every connection. Bare, tinned copper wire, with varnished cambric tubing or "spaghetti" slipped over it, can be used, but the fixture wire is cheaper and serves just as well. The detector tube used is a UV-200. The dials for the variable condenser and variocoupler are of standard make.

The proper aerial to use with this type of receiver is one wire, 125 to 150 ft. long, placed from 30 to 50 ft. above the ground. The phones should be wound for at least 2,000 ohms' resistance. If desired, the instruments can be placed in a cabinet, to make a neat and compact set, at the same time protecting the various parts from dust. Many operators prefer the variable condenser in series with the aerial with a receiver of this type, instead of across the secondary, as shown in the diagram, as closer tuning may be had for the radio-phone broadcasting stations. It is suggested that both ways be tried out, to find which best suits the aerial used, as under varying conditions the results will differ.

LIST OF MATERIALS

- | | |
|---|--|
| 1 variable condenser, .001-mf. capacity. | 1 wood base, $\frac{1}{2}$ by 6 by 14 in. |
| 1 grid condenser, .0005-mf. capacity. | 1 variocoupler. |
| 1 UV-200 detector tube. | 2 switch levers. |
| 1 tube socket. | 12 contact points. |
| 6 binding posts. | 1 22½-volt B-battery unit. |
| 2 angle irons. | 1 storage battery; 6 volt, 40 or 60 ampere-hour. |
| 1 battery rheostat. | 1 pair 2,000-ohm phones. |
| 1 bakelite panel, $\frac{3}{16}$ by 7 by 14 in. | |

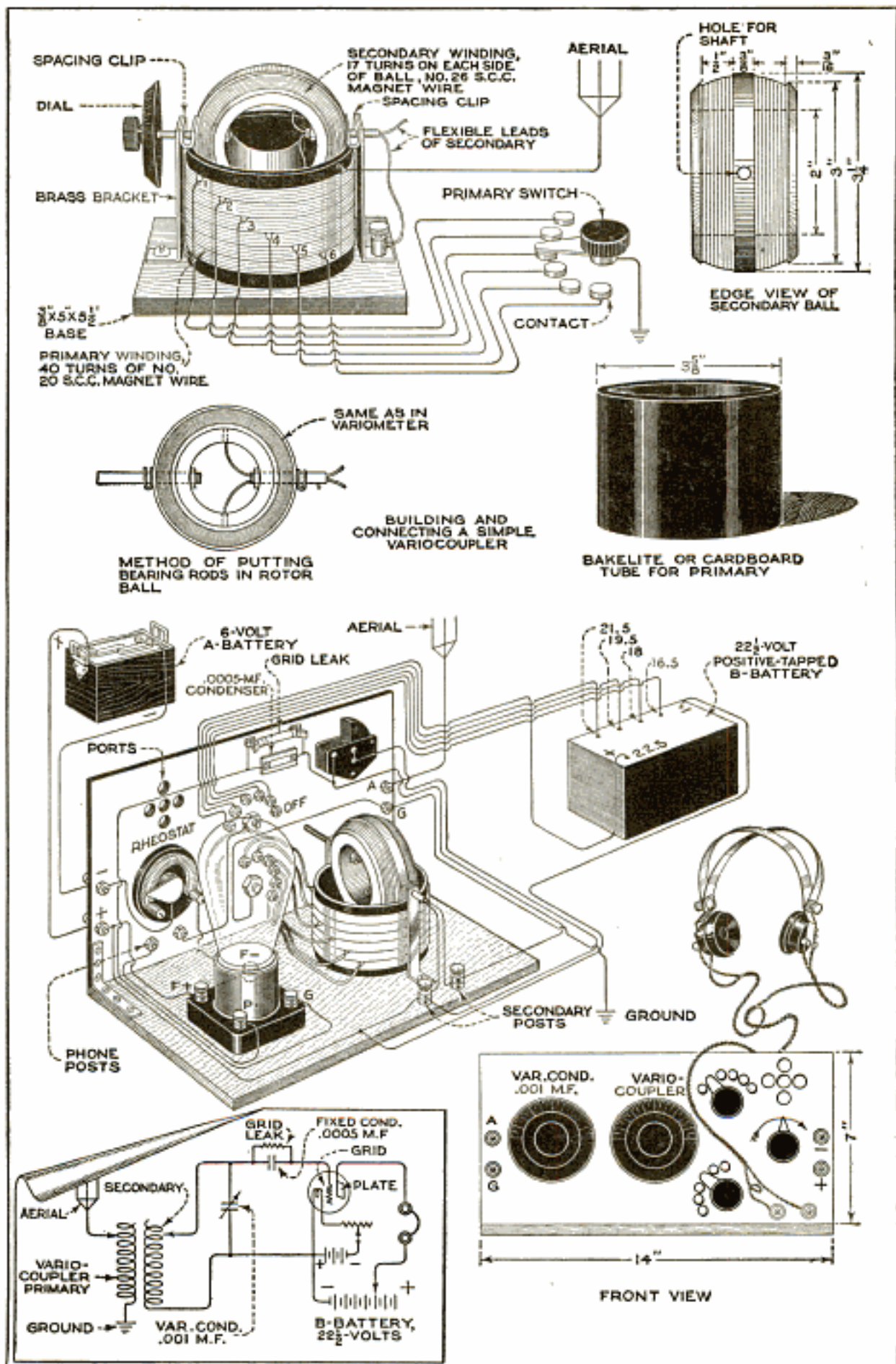

A Simple and Easily Made Receiver for Broadcasting-Station Work: It Has a Wave-Length Range of 150 to 400 Meters, and a Working Radius, for Telephone Work, of 250 Miles. Telegraph Stations can be Heard at a Distance of 1,500 Miles. Standard Instruments are Used Throughout

Block for Multiple Radiophones

When more than one set of phones are used with a radio set, they should be connected in series; it is also best to shunt

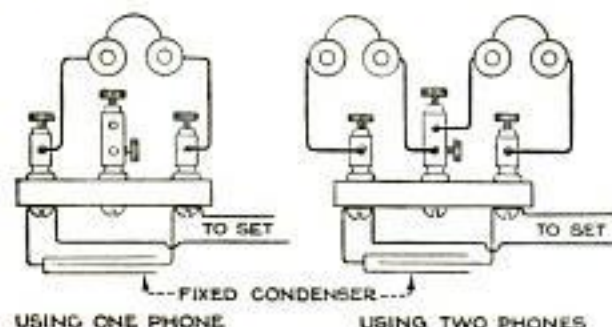

Block for Connecting One or Two Sets of Ear Phones to the Radio Set: The Efficiency of the Phones is Increased by Shunting a Small Fixed Condenser across the Phone Circuit, as Shown

a small fixed condenser across the circuit, as in the diagram.

The block illustrated for connecting the two sets of phones is fitted with three binding posts, which are mounted in a straight line. The central post is of the two-hole type and is left "blind," not being connected in the circuit. The two end binding posts are of the ordinary type and are connected in the circuit in the usual manner. The posts are spaced about $\frac{3}{4}$ in. apart, and the fixed condenser is connected across the two outside ones. When only a single pair of phones is used, the tips are fastened in the end posts, as shown at the left, but when two sets are used, the connections are made as at the right.—W. C. Michel, Jersey City, N. J.

A Bookshelf Accessory

If one or more books are removed from a bookshelf, those remaining have a tendency to fall over sidewise, not only giving the shelf a bad appearance but also allowing dust to accumulate between the volumes. These troubles can be overcome by using an expansion dummy book that will automatically fill the space occupied by the removed book. Such a dummy is made by simply placing a spiral spring between the covers of an old book. Strips of cloth are pasted between the covers at top and bottom to prevent the spring from falling out.—Harry H. Schneckloth, Omaha, Neb.

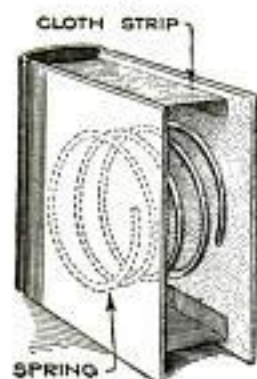

Restoring Tarnished Headlamp Reflectors

The reflectors of automobile spotlights and headlamps will frequently become tarnished, especially if the car is allowed to be exposed to the weather, dust, smoke, or fumes. A simple means of restoring the reflectors almost to their original brilliancy consists in cleansing them with alcohol and sulphuric acid. To a half pint of alcohol, a tablespoonful of sulphuric acid is added. The reflectors are thoroughly rinsed in this solution for 10 or 15 seconds, after which the surface is washed with alcohol alone, and later with clear water, then polished with a piece of soft linen. It is important that every trace of the sulphuric acid be removed from every part of the lamps, to prevent further corrosion.

A Simple Trousers Press

A device for keeping trousers freshly pressed is easily made from a few strips of light wood, tacked together in the

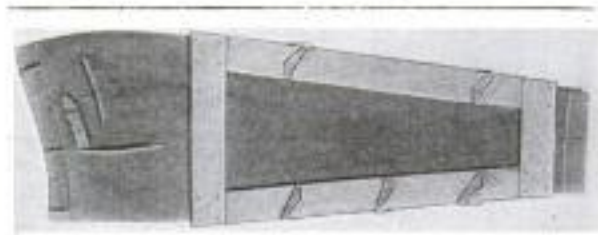

A Few Strips of Light Wood and Some Heavy-Wire Paper Clips, or Clothespins, Made into a Device for Keeping the Trousers Neatly Pressed

shape shown in the picture. Two such forms are made, one for each side of the folded garment, and these are held in place by means of large wire paper clips or spring clothespins. The press illustrated was made from the slats of an old venetian blind, but, of course, any light hardwood strips will serve.

Feather Dusters for Chick Brooder

A woman raising and selling poultry bought an incubator in order to increase the number of her chicks, but overlooked the need for a brooder. However, when the eggs began to hatch, she obtained a number of feather dusters, and suspended them from the rafters in the chicken house, so that the feathery ends barely touched the floor. The chicks, just hatched in the incubator, were turned loose among the dusters, finding in them an excellent substitute for a mother hen.—Littell McClung, Florence, Ala.

Identifying Golf Clubs

A good way to mark golf clubs is to coat the end of the handle with a thin layer of sealing wax, into which the owner's initial is impressed with a seal. This method is quite effective, and a short stick of the wax can be carried in the golf-ball pocket of the golf bag, in case the wax should require renewing.—Marion B. Cook, Bellport, N. Y.

A Handy Electric-Lamp Holder

A simple hook made from wire, and a hose clamp, can be attached to an ordinary electric-lamp socket so that the lamp can be hooked to any convenient projection. The drawing shows clearly how the device is made and attached. Such an arrangement will find many useful applications in the garage, shop, home, or office. If desired, the hook can be turned at right angles to the light.—George O. Reed, Detroit, Mich.

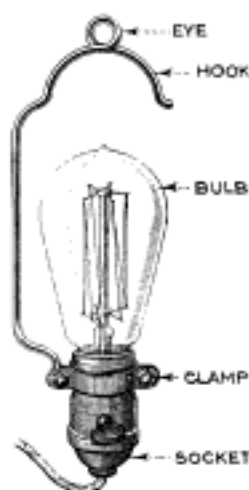

Fastening Barbed Wire to Iron Posts

Occasionally it is desired to attach plain or barbed-wire fencing to posts made of old iron pipe. The simplest way is to drill small holes through the post wherever the separate strands are to come and use wire ties. After the posts are set up, the ties, each about 1 ft. long, are run through the holes and wrapped around the wire on opposite sides of the post. Regular fence staples can be used if the holes are drilled at an angle, so that, when the staple is driven in, the ends will spread apart inside the pipe, and prevent the staple from being pulled out, accidentally, while permitting it to be removed easily, when desired.

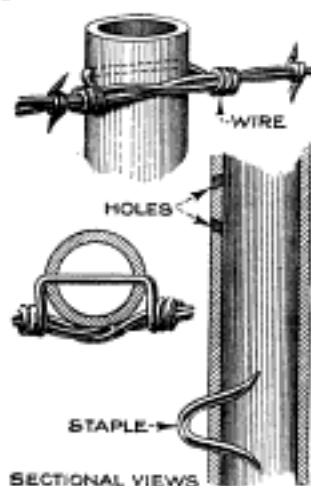

Priming the Auto Engine

An ordinary sight-feed oil cup, such as used on most types of stationary engines, affords a convenient means of holding a

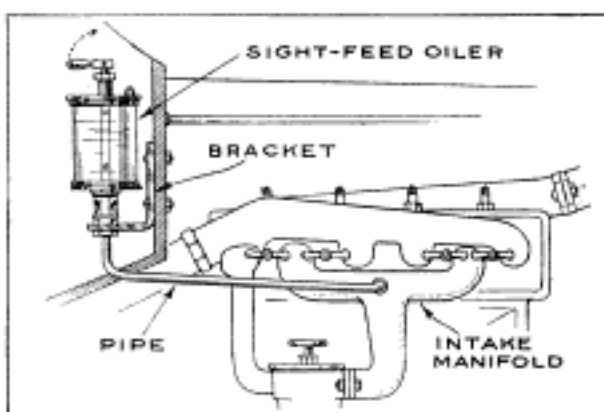

A Sight-Feed Oiler, Attached to the Dash of the Auto, Affords a Convenient Method of Priming the Engine in Cold Weather

quantity of special high-gravity fluid for priming an automobile engine. The oil cup can be mounted on the dash of the car, on a sheet-metal bracket, as indicated, the priming fluid being conducted to the intake manifold of the engine through suitable tubing.

By this method the engine can be primed from the driver's seat without the necessity of raising the hood to inject gasoline into the cylinders through the priming cups. The flow of fluid to the engine is controlled by raising or lowering the snap lever on top of the lubricator. The amount fed is adjusted by means of the nut on the needle valve.

Shoe Guard Prevents Soiling and Damage

Many good shoes have been ruined by acid, oil, paint, whitewash, and other materials, which, had the shoes been suitably protected, would not have injured them. The shoe cover illustrated is made from a piece of rubber, canvas, or other material, cut to shape and fitted with a cuff of the same material, to which the buckles from a pair of old arctics are fastened. A strap fastened to the projecting ears of the guard passes under the instep like a legging strap. The old buckles are at the back and allow the covers to be slipped on or removed quickly.

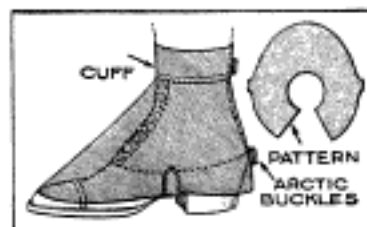

Trouble Lamp Used as Headlight

A simple expedient, when one or both headlights go out, is to attach the trouble lamp to the underside of one of the



An Extension Trouble Lamp Fastened to the Underside of One of the Headlights Makes Night Driving Safe, and Prevents Arrest for Driving without Lights

headlamps, preferably the right-hand one. Cord, wire, or rubber bands can be used for holding the extension lamp in such a position that the light will shine ahead. This idea makes it possible for the driver to avoid arrest in places where the laws against driving without lights are strictly enforced.

Enlarged Photographic Negatives

The making of numerous enlargements is a tedious and expensive undertaking, when a number of large prints are required from a small negative. The alternative is to make a copy negative from an enlargement, but by this method a considerable amount of the original negative's quality is lost. By the following process, however, large prints that are as good as the negative, can be obtained from small negatives with the rapidity and cheapness of contact printing.

First, an enlargement is made in the ordinary way, but instead of making it on paper a "slow" plate or a piece of commercial film is used; the film being preferable because it is more easily handled. One grade faster than the process plate or film is about right. The process grade is too "contrasty," but may be used when the original negative is lacking in this quality. The enlargement will, of course, be a positive, and should be made slightly flat and dense; in other words, slightly overexposed and carried to a rather full development. The positive is fixed and washed in the usual way. Next, a tray, somewhat larger than the positive, is filled with water. In the bottom a piece of glass, also larger than the positive, is placed. Then, working in the red light, a piece of unexposed film of the same grade as the positive is immersed in the water so that

no air bells form on it, and allowed to remain until it is quite limp. Care must be taken not to touch the face of the film, which should be uppermost, with the fingers at any time.

When the film has become quite limp, it is permitted to settle onto the glass at the bottom. The well-washed positive, still wet, is immersed with a sliding motion to prevent the formation of air bells, but face, or film side, down, and settled on top of the unexposed piece of film or plate, whichever is used, thus bringing the two film sides together. Another piece of glass is slid into the water and brought down on top of the positive, with the two films between. The water is then allowed to remain undisturbed for a moment, until it becomes quiet and no movement is visible. The exposure is made by burning a match about 2 ft. above the tray. If the positive is very dense, two or three matches may be required to get full exposure. The glass is then removed, the films separated and the exposed piece developed, fixed, and washed as usual.

The resulting negative, when properly made, is fully equal in quality to the original, and is not the makeshift usually obtained by copying. While it is possible to let the positive dry and then make a negative by contact in the printing frame, the underwater process produces much better results with the additional advantage of a saving in time.

Brush Hook Made from an Old Saw

A wood cutter uses the hook shown in the picture for cutting brush and small



branches, the end of an old crosscut saw being used for the blade. Finding that his ax was not the proper implement for cutting the brush, he cut a foot from the end of an old crosscut saw and bolted it to a hardwood handle. The back of the blade is sharpened to a cutting edge. This makes a splendid tool for the purpose.

PRIZE OFFERS AND ANNOUNCEMENTS

254 PAN-PACIFIC COMMERCIAL CONFERENCE TO BE HELD AT HONOLULU, HAWAII

At Honolulu, the capital of Hawaii, centrally situated in the Pacific Ocean, a great gathering of the most influential commercial and financial men from all lands bordering on the Pacific will meet each other daily during the two weeks from October 25 to November 8. At these meetings, held under the auspices of the Pan-Pacific Union, plans will be formulated for future interracial cooperation in matters of common interest. It is expected that more than a hundred delegates, representing government departments, chambers of commerce, or commercial organizations, will attend, including some from the U. S. departments of Commerce, Agriculture, the Navy, and the Interior. Delegates from similar government departments will attend from Canada, Australia, New Zealand, Japan, China, and other Pacific countries. It is expected that President Harding will sound the keynote of the conference in his message, which is to be read by the governor of Hawaii at the opening session.

183 PULITZER AND OTHER AIR-RACE COURSES MADE OVER WATER INSTEAD OF LAND

At the third annual aerial contests for the Pulitzer and other trophies, held at Detroit, October 7, 12, 13, and 14, several changes were made in the race courses. For the sake of safety the Pulitzer was changed to a water course. Starting at Selfridge Field, Mt. Clemens, Mich., the course has been made triangular, and 40 miles long, as in previous contests, but easterly over Lake St. Clair instead of westerly over land. Other courses that have been similarly changed are those for the Detroit News aerial-mail trophy, for the Aviation Country Club of Detroit trophy race, and for the Liberty Engine Builders' trophy race. Altogether there are five events at these contests, and \$10,000 in cash prizes, besides which \$30,000 worth of gold and silver trophies are awarded.

119 SOCIETY FORMED TO PROVIDE LEISURE FOR BUDDING AUTHORS AND ARTISTS

A new idea of great interest to artists and authors is the formation by a group of American and French artists of a society called "Bel Esprit." The originator of the idea, Ezra Pound, a Chicago poet, expresses it thus: "To give an artist leisure to work is actually to take part in his creation." It was with this object that the society was founded, and already one American poet, T. S. Eliot, has been rescued from his uncongenial work in a bank, and given leisure for the exercise of his genius. The society first finds the man, and then supports him in leisure, as long as is necessary to develop his talent, by the cooperation of subscribers, who are now being sought in both America and France. The society's address is: Bel Esprit Sanctuaire, 20 Rue Jacob, Paris, France.

84 ONE WEEK IN OCTOBER SET ASIDE FOR GOOD-HEALTH PROMOTION

An organized movement for better health that, according to Secretary of Labor James J. Davis, should have the support of every man, woman, and child in America, is being promoted by a large merchandizing group known as the "Good Health Week Promotion Bureau." A campaign being conducted by them will culminate in the week of October 23-30, which has been set aside as a period of national emphasis on health, especially as connected with ventilation, sanitation, and personal hygiene. By letters, exhibits, and lectures, comprehensive information will be given out on these health subjects in an authoritative but snappy manner, calculated to make the people ask questions. Self-interest in health is the end aimed at. The work is being conducted by the Executive Committee, Good Health Week Promotion Bureau, 209 Grand Ave., Milwaukee, Wis.

244 PRIZES ARE OFFERED FOR BEST DESIGNS OF THREE CLASSES OF CLOCK CASES

Designers and draftsmen are invited to compete for \$1,200 in prizes offered for the best clock-case designs. Three classes of mantel clocks are required, diagrams and particulars of which will be furnished, and for the three best designs in each class prizes of \$250, \$100, and \$50 will be awarded. The contest is open to everyone, and any number of designs may be submitted. The designs must be delivered not later than Oct. 23, 1922, to Clock Design Competition, Cloister Clock Corporation, Room 1340, 200 Fifth Ave., New York City.

183 ENGLISH PUBLISHERS OFFER A REWARD FOR A BOOK OF SELF-REVELATION

For a book of self-revelation an English publishing concern offers £250 advance royalties, and any added royalties that may accrue from the sale of the book after publication. It may be in the form of a diary, a journal, or a novel, and it may be long or short. The writer is to remain anonymous. Truth to life is the feature most desired. Typewritten manuscripts must be submitted not later than Dec. 15, 1922. Address, Messrs. A. M. Philpot, Ltd., 69 Great Russell St., London, W. C. 1, England.

286 U. S. CIVIL SERVICE EXAMINATIONS TO FILL VARIOUS VACANCIES

Competitive examinations for senior engineer, grade 2, and for senior architect, will be held in various cities and towns throughout the United States, and applications will be rated as received until further notice. The initial salaries are \$2,100 to \$2,700 a year, and appointees at salaries of \$2,500 or less may receive a bonus of \$20 a month.

Examinations will be held Dec. 6-7, 1922, for computer, Coast and Geodetic Survey, at a salary of \$1,400 a year for service at Washington, and \$2,000 a year for duty at Manila, P. I., in both cases with the added bonus of \$20 a month.

For junior engineer, junior physicist, and junior technologist, examinations will be held Nov. 22, 1922, for vacancies in the Bureau of Standards at salaries of \$1,200 to \$1,500 a year with the added bonus of \$20 a month.

Applicants for any of the above positions should write at once for Form 1312, stating the title of the examination desired. Address, Civil Service Commission, Washington, D. C., or the Secretary of the U. S. Civil Service Board in the applicant's vicinity.

86 MONTHLY PRIZES OFFERED FOR PHOTOS BY AMATEURS OR PROFESSIONALS

For the encouragement of pictorial photography prizes are offered monthly by the publishers of American Photography. Not more than three prints may be submitted monthly by any photographer, amateur or professional. Prints must be accompanied by data filled out on a form furnished by the publishers. There are two classes: senior, with prizes of \$10, \$5, and \$3 in value; junior, with prizes of \$5 and \$2. Address, American Photography, 428 Newbury St., Boston 17, Mass.

182 PRIZES FOR THE BEST PROFESSIONAL NAME FOR A YOUNG SCREEN ARTIST

With the object of securing an attractive professional name for the young screen artist, Helen Lynch, \$375 in prizes is offered in a "My Name Campaign," now being conducted by The People's Home Journal. Anybody may compete by writing the name on a postal card, signing it, and mailing it on or before Dec. 1, 1922. Any number of names may be sent in by the same person. Address, Motion Picture Editor, The People's Home Journal, 80 Lafayette St., New York City.

Detroit Aviation Society of the 4612 Woodward Ave. 57 Frank A. Bunker Co. culture

Washington, D. C.

119

84

Chicago Tribune 8/20/22

244

286

86

182

Prize

No. 301-57-38

GOLD MEDALS OFFERED FOR EXCELLENCE IN LITERATURE AND KINDRED ARTS

The National Literary Society, recently founded for the purpose of promoting American literature, elocution, and drama, will award annually a gold medal, properly engraved, to the highest competitor in each of the following nine contests: declaimer, reciter, orator, debater, poet, essayist, novelist, short-story writer, and playwright. The home office of the society is at Washington, D. C., but branches are being organized to cover the entire country, and these contests will be held first in each county seat, the fourth Wednesday of January; then county winners will compete in the largest city in each congressional district, the second Wednesday of February; winners in these contests will compete in the capital city of each state, the fourth Wednesday of February; and a final contest will be held in Washington, D. C., the second Wednesday of March, annually. The contests are open to any member of the society, and any white resident of the United States is eligible to become a member by the payment of an annual fee of \$1. Address, The National Literary Society, International Building, Washington, D. C.

CONTESTS PREVIOUSLY ANNOUNCED

Medals, Diplomas, and Money Awards: Announced August issue, 1921; awards offered by the Franklin Institute.

For Service to City of Philadelphia: Prize \$10,000; announced September issue, 1921; awarded each year by Edward Bok, former editor of The Ladies' Home Journal.

One Million Francs for Best Motor: Announced January issue, 1922; closes June 1, 1923; address, Aero Club of France, Paris.

Research Thesis by a Woman: Prize \$1,000; announced October issue, 1921; awarded annually; ad-

dress, Dr. Lilian Welsh, Goucher College, Baltimore, Maryland.

Annual Commercial Airplane Contest for "Italy's Great Trophy": announced July issue, 1922; address, Aero Club of Italy.

Ideas for New Occupations for Shut-Ins: Prizes, \$100, \$50, and \$25; announced July issue, 1922; closes Nov. 1, 1922; address, Prize Editor, Popular Mechanics Magazine, 6 North Michigan Ave., Chicago.

Fishing Contest: Prizes, seven "Model 94" Winchester hunting rifles; announced July issue, 1922; no definite closing date.

Best Novel by an American Author: Prize \$2,000; announced August issue, 1922; closes March 1, 1923; address, Harper & Brothers, New York City.

Designs for Chicago Tribune Building: Prizes, \$100,000; announced August issue, 1922.

Best Essay on a Historical Novel: Prize \$100; announced September issue, 1922; closes Dec. 1, 1922; address, Kenyon College, Gambier, Ohio.

Competition for American Composers: Prizes from \$1,000 to \$100; announced October issue, 1922; closes Dec. 15, 1922; address, Mrs. Edwin B. Garigues, Room 201, Bellevue-Stratford, Philadelphia, Pa.

Best Symphonic Composition: Prize \$1,000; announced October issue, 1922; closes Jan. 1, 1923; address, Balaban & Katz, 175 N. State St., Chicago, Illinois.

For Musical Compositions: 24 prizes; announced October issue, 1922; closes Dec. 1, 1922; address, The Etude Prize Contest, 1712 Chestnut St., Philadelphia, Pa.

¶A new variety of winter apple, originated by the Minnesota State Fruit-Breeding Farm, is not grown from seed as stated on page 203 of our August issue, but by budding and grafting. This apple is attracting considerable attention from orchardists.



AMERICA'S LARGEST CITIZEN TAKES AIRPLANE SPIN

IT is seldom that a private citizen would dare to make light of an intrepid airman, yet that is what giant Johan Aason was doing to Pilot Horchem shortly after their descent from a 1,500-foot height to which they climbed. In the course of the flight the pilot played a few tricks on the giant, and the giant showed some of his own tricks to the pilot. The flight was made under a wager that with the giant in the cockpit, the "Swallow" would never get off the ground. However, at the end of five minutes they had climbed to an altitude of 1,500 feet, a most remarkable feat for a ship the size of the "Swallow," considering the load.

IN accordance with the editorial policy of this magazine never to accept compensation in any form for what appears in our reading pages, and also to avoid all appearance of doing so, we are obliged to omit the name of the maker or the seller of any article described. This information, however, is kept on file and will be furnished free, by addressing Bureau of Information, Popular Mechanics Magazine, Chicago. [Editor.]

Sensational!

Revolutionary!

It had to come! Quill, wood, hard rubber—all have been used for pens. And now comes metal—so durable, so light, so superior in taking beautiful engraved designs.

In the WAHL PEN, the fine quality metal and Wahl precision are so exceptional, that the metal barrel can be made thinner than in other pens of the same size. This gives extra ink capacity. The tough, sturdy barrel and cap will not crack or split. This means long life.

WAHL PEN

The all-metal barrel cannot expand under body heat. The metal threads cannot jam or break; they hold the cap on air-tight, and keep the pen leak-proof.

Lay it alongside any other pen, and appearance alone will sell you the WAHL PEN. The chased or engine-turned designs are beautiful. They match those on EVERSHARP—its write-hand mate. In gold or silver, singly, or with EVERSHARP in velvet-lined boxes, they make the perfect GIFT. Sold everywhere.

Made in U. S. A. by THE WAHL COMPANY, CHICAGO
Canadian Factory, THE WAHL COMPANY, Ltd., Toronto

*Indestructible
all-metal barrel
holds more
ink*

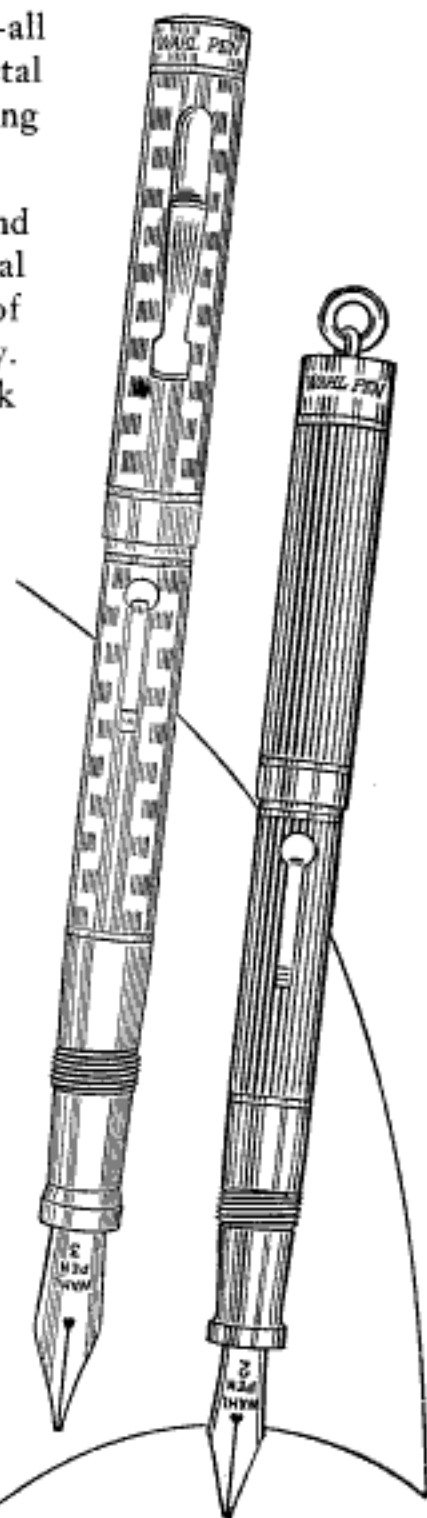



Dividend checks from the American Telephone and Telegraph Company are received quarterly by more than 200,000 telephone users.

Owned by those it serves

Less than fifty years ago an application was made for a patent which created the possibility of speech between distant points. It was the culmination of years of study, research and experiment. It suggested a new aid in commerce and domestic life; a new tie to bind the people together. But it was only a suggestion—a dream.

To make that dream come true required the creation of an organization unlike any other. It demanded a kind of scientific knowledge that was yet to be formulated, as well as a type of equipment still to be devised. And it necessitated the financial and moral support of many communities.

Out of this situation grew the Bell System, bringing not only a new public service, but a new democracy of public service ownership—a democracy that now has more than 200,000 stockholders—a partnership of the rank and file who use telephone service and the rank and file employed in that service. The American Telephone and Telegraph Company exists

to serve the people and is owned directly by the people—controlled not by one, but controlled by all.

Evolution is going on. Each year the ownership is more widespread. Each year the various processes of the service are performed more efficiently and economically. Each year new lines and extensions are constructed. The responsibility of the management is to provide the best possible telephone service at the lowest possible cost and to provide new facilities with the growth of demand. To do these things requires equipment, men and money.

The rates must furnish a net return sufficient to induce you to become a stockholder, or to retain your stock if you already are one; after paying wages sufficient to attract and retain capable men and women in the service. They must adequately support and extend the structure of communication.

These are considerations for the interest of all—public, stockholders, employees.



" BELL SYSTEM "
AMERICAN TELEPHONE AND TELEGRAPH COMPANY
AND ASSOCIATED COMPANIES

One Policy, One System, Universal Service, and all directed toward Better Service

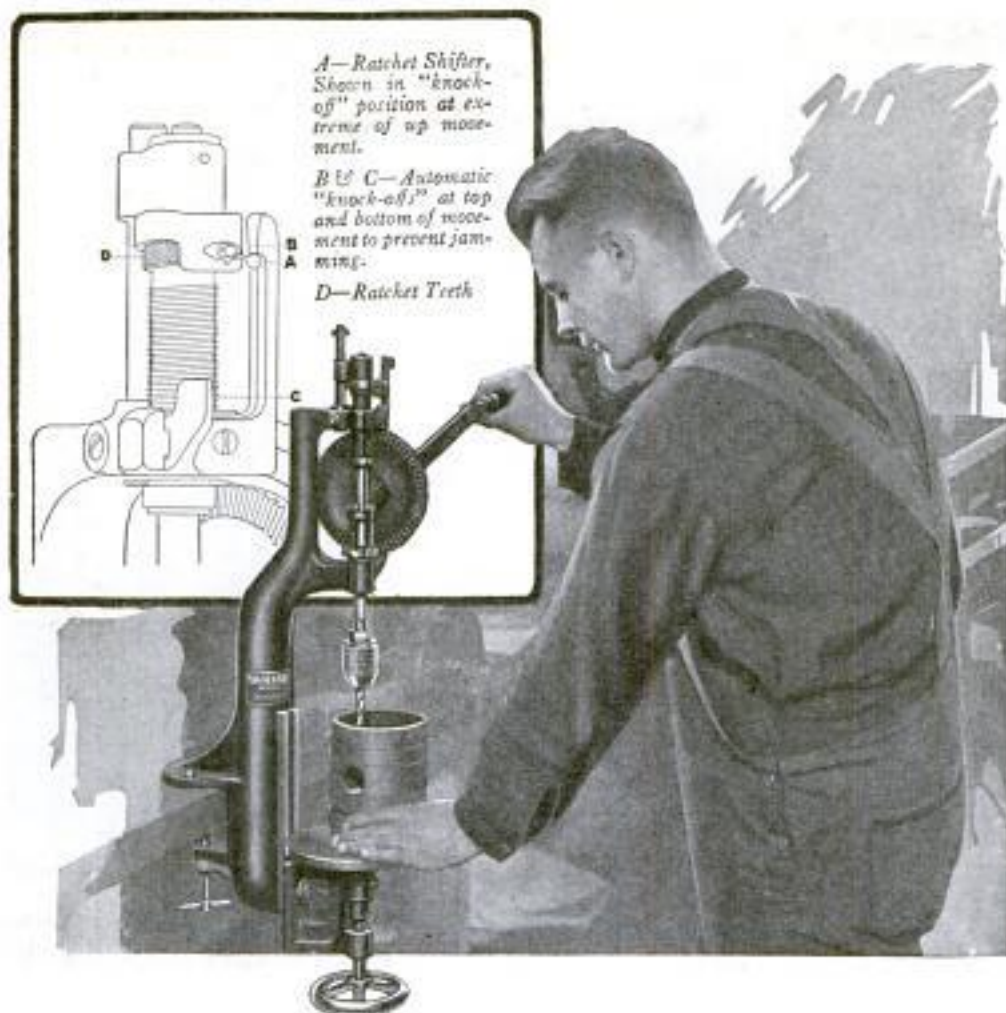

A—Ratchet Shifter, Shown in "knock-off" position at extreme of up movement.

B & C—Automatic "knock-offs" at top and bottom of movement to prevent jamming.

D—Ratchet Teeth

"I don't need three hands with the 'YANKEE' Bench Drill"

"No hand feeding with the 'Yankee' Bench Drill. The 'Yankee' friction and ratchet feed does away with that. Pressure is automatically regulated for all drills from the smallest up. Think of the drills I save!

"One hand steadies the work

on the table—the other turns the crank. That's all the attention I have to give it.

"Friction feed rapidly runs drill down to the work. Ratchet feed then goes into operation. Automatic throw-off prevents jamming."



TOOL Book FREE

Illustrates and describes all the ingenious "Yankee" Tools for saving time and labor. Write for it today!

No. 1005 (illustrated). Two speeds; 3-jaw chuck; holds drills up to $\frac{1}{2}$ in. diameter. Entire length, 28 in. Extends below top of bench 6 in.

No. 1003. One-speed; 3-jaw chuck; holds drills up to $\frac{1}{4}$ in. Entire length $18\frac{3}{4}$ in. Extends below top of bench $4\frac{1}{4}$ in.

Dealers everywhere sell "YANKEE" Tools

NORTH BROS. MFG. Co.

Philadelphia



"YANKEE" Vise No. 990

Designed for use on Bench Drills. Machined true on ends, bottom and sides. Swivel jaw for taper work. Jaws open 3 in.

"YANKEE" TOOLS

Make Better Mechanics

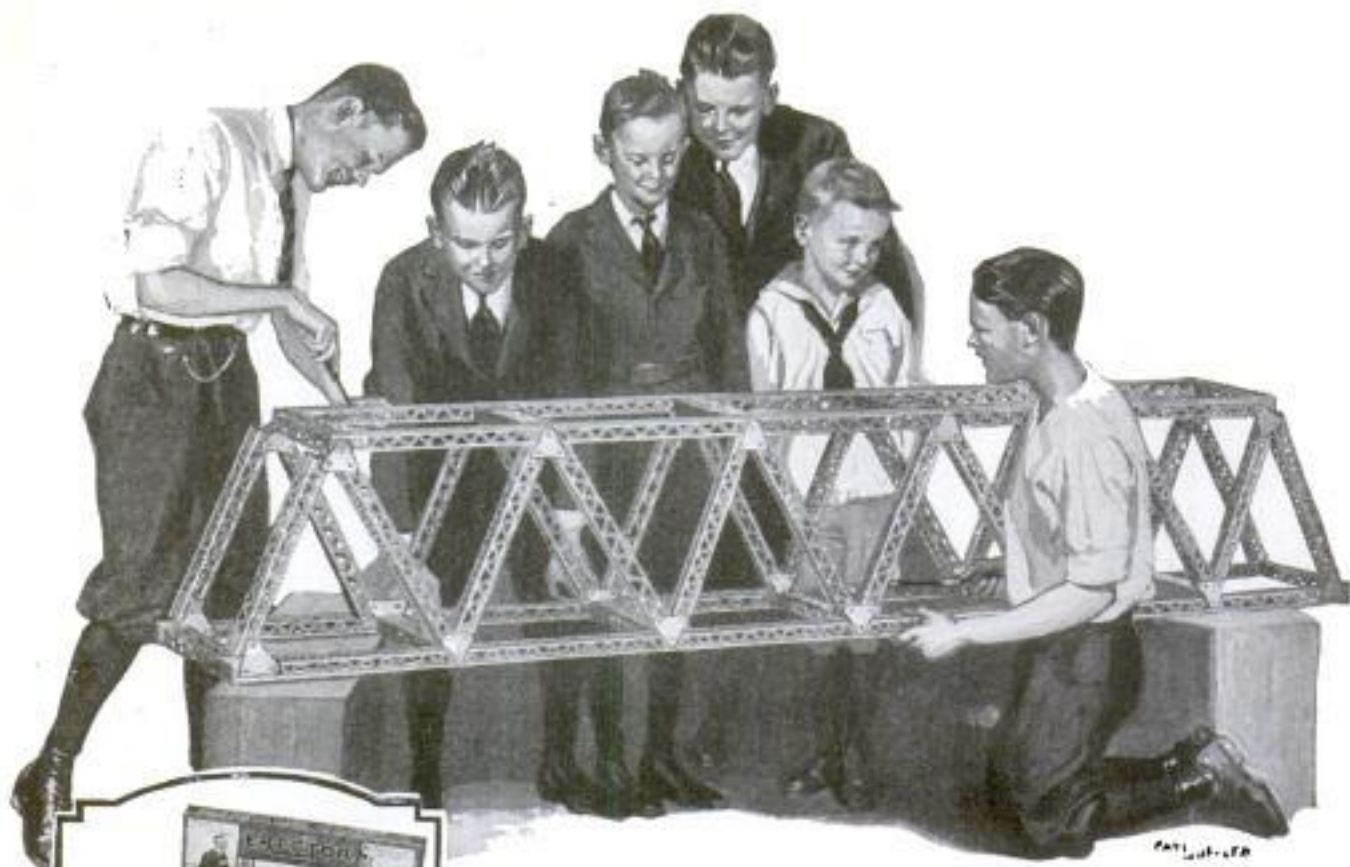

PAT. 1,111,111



ERECTOR

MAKE this the best Christmas you ever had in your life, get a \$5.00 Erector Set or any other Gilbert Toy for the kid brother, boy friend or son.

Boys today—men tomorrow!

THOUSANDS of young men from 20 to 30 years old, who are to-day making great strides in engineering, chemistry, and other sciences were Gilbert Toy boys just a few years ago. I have watched their progress with intense interest and I will tell you that I am mighty proud that my engineering toys have started them on the road to success. When I was a boy I loved to play with scientific things myself, but no one made the kind of toys that I wanted so I said that some day I would make for a new generation of boys, toys that I wanted when I was a kid.

That is why there are wonderful Gilbert Toys for all kinds of scientific fun, electrical sets, telegraph sets, signal engineering, weather bureau outfits, civil engineering, hydraulic and pneumatic engineering, light experiments, sound experiments, glass blowing, mineralogy, magnetism, as well as all kinds of magic outfits, and sets to perform tricks with coins, handkerchiefs and cards. There is a Gilbert Toy for every boy. They range in price from \$1.00 to \$30.00.

Erector is the leader. It is the most wonderful construction toy in the world. Boys can make wonderful machines, bridges, cranes, towers, in fact any engineering feat can be duplicated with a Gilbert Erector. The \$5.00 sets have a sturdy electric motor that will lift 200 pounds. That is the toy most boys pick for it is the most popular toy in the Gilbert line.

If you want to know more about Gilbert Toys, send 10c for the Gilbert 1923 Year Book. It not only contains wonderful articles on radio, magic, sports, chemistry and engineering that will delight the heart of any boy, but it is also a complete catalog of Gilbert Toys.

A. C. GILBERT, President

THE A. C. GILBERT COMPANY

104 Blatchley Avenue

New Haven, Conn.

In Canada

The A. C. Gilbert-Menzies Co. Limited, Toronto.

The A. C. Gilbert Co.,
104 Blatchley Avenue,
New Haven, Conn.

Enclosed is 10c. Send the
1923 Year Book to

Name

Street

City

State

GILBERT TOYS

21 Jewel Burlington

Just Out

Latest Designs in Watch Cases beautifully illustrated in our booklet. Send for FREE Copy.



Adjusted to the Second
Adjusted to Temperature
Adjusted to Isochronism
Adjusted to Positions
New Ideas in Thin Cases

21 Ruby and Sapphire Jewels
25 Year Gold Strata Case
Your Choice of Dials
(Including Montgomery R. R. Dial)

**Only \$1.00
Down**

Only One Dollar Down will buy this masterpiece of watch manufacture. The balance you are allowed to pay in small, easy, monthly payments. The Burlington — a 21-Jewel Watch — is sold to you at a price much lower than

that of other high-grade watches. Besides, you have the selection of the finest thin model designs and latest styles in watch cases. Don't delay! Write for the FREE Watch Book and our SPECIAL OFFER today.

Write While This Special Offer Lasts

Get the Burlington Watch Book by sending this coupon. Find out about this great special offer which is being made for only a limited time. You will know a great deal more about watch buying when you read this book. You will be able to "steer clear" of the over-priced watches which are no better. Remember, the Burlington is sent to you for only One Dollar down, balance in small monthly payments. Send the coupon for watch book and our special offer TODAY!

Burlington Watch Company

Dept. 1358, 19th Street and Marshall Blvd., Chicago
Canadian Address: 62 Albert Street, Winnipeg, Manitoba

Burlington Watch Company

Dept. 1358, 19th St. and Marshall Blvd., Chicago
Canadian Address: 62 Albert St., Winnipeg, Manitoba

Please send me (without obligations and prepaid) your free book on watches with full explanation of your \$1.00 down offer on the Burlington Watch.

Name _____

Address _____



HANES GUARANTEE:

We guarantee Hanes Underwear absolutely—every thread, stitch and button. We guarantee to return your money or give you a new garment if any seam breaks.



5

HANES features that will appeal to you

- 1 Hanes Staunch Elastic Shoulders are made with service-doubling lap seam. They fit right, with plenty of "give."
- 2 Hanes Tailored Collarettie won't gap or roll. Fits snugly around the neck and keeps the wind out.
- 3 Hanes Elastic Cuffs are made far stronger and better than the usual cuff. They fit the wrist firmly and won't flare or rip.
- 4 Hanes Closed Crotch is cut and stitched in a special way that really keeps it closed.
- 5 Hanes Elastic Ankles hold their shape through repeated washings. They never bunch over your shoes.

THESE big features alone are enough to give men folks a friendly feeling for this high-grade, popular-priced winter underwear. But there are other important Hanes features too—strain points that are strongly reinforced; flat, non-irritating seams that hold fast; buttons that actually stay put; buttonholes that keep their shape. *And all covered by the Hanes money-back guarantee.*

If you want underwear this winter that will give you perfect comfort and long wear—and at a very low price—buy Hanes.

The Hanes winter underwear line includes heavy-weight shirts and drawers and heavy union suits in two weights.

Hanes for Boys: Two weights—heavy and extra heavy. Sizes 2 to 16 years. Also knee length and short sleeves.

If your dealer can't supply you, write direct to us.

P. H. HANES KNITTING COMPANY
Winston-Salem, N. C.

ELASTIC KNIT
HANES
UNDERWEAR

Next summer wear Hanes full-cut athletic Union Suits!



Before you turn this page, write for our "Location Chart" that will tell you approximately how much profit you can make the Butter-Kist Way in your location. Fill in and mail the coupon. It may solve your problem of how to increase your profits. Send the coupon today.

**ADD FROM \$600 TO \$5000
A YEAR TO YOUR STORE
PROFITS!**

WHY worry about *lessened* profits from your store? Here's an easy way to *increase* your profits every month in the year!

Place a Butter-Kist Popcorn and Peanut Machine in your store in unoccupied space—sell these tasty treats to every customer. And the space required? That's easy! Any store has enough space because the machine takes up little room.

And the profits? Out of every dollars' worth of Butter-Kist Popcorn you sell, 70 cents is yours to keep!

It's so easy to make steady customers because everybody likes the delicious taste of Butter-Kist products. People will come back to you again and again for more. That's why you can sell dollar after dollar's worth, day in and day out. Just remember, Popcorn and Peanuts are big sellers everywhere.

Steady streams of customers every day tell why merchants all over America are averaging from \$600 to \$5000 every year with Butter-Kist Popcorn Machines. If others can do this—so can you.

HOLCOMB & HOKE MFG. CO.

World's Largest Manufacturers of Popcorn Machines and Peanut Toasters
2124 Van Buren St. Indianapolis



BUTTER-KIST Popcorn
"America's Oldest Treat"

HOLCOMB & HOKE MFG. CO.,
2124 Van Buren St., Indianapolis, Ind.

Please send me, without obligation on my part, your free Butter-Kist book, "America's New Industry." I also want the Location Chart which I will fill out and return to you.

Name _____
Address _____
City and State _____
Business _____

BUTTER-KIST POPCORN AND PEANUT MACHINES

Get Big OFFER!

New 1923 Model-Throttle Governed

The Standard By Which All
LOG SAWS Are Judged.



Saws
Faster Than
Any Other Log Saw.

Exclusive Features
of the Best Log Saw
Ever Built:

Saws Fastest
Easiest To Move
Most Powerful
350 Saw Cuts a
Minute
Saws Human Way
Saws Fast or Slow
as you wish
Clutch Control
4 H-P (and you need
all this power)

USES CHEAPEST FUEL—Kerosene, Gasoline, Distillate

Send today for New Special Offer on this Fastest Cutting, Most Powerful, Easiest Moved One-Man Log Saw. More OTTAWAS used than all others. Saw more wood with greater ease, using cheapest fuel. 4 H-P makes 350 saw cuts a minute; throttle governed. Learn how easy it is to own an OTTAWA and how others are making big money in spare time, selling wood during coal shortage.

Run Saw Fast or Slow. Now, with New 1923 Model, you can run saw fast or slow while cutting. Easy to change speed while the saw runs. Easy, now, to cut small as well as large logs. Quick and easy to operate new Speed Changer.

Saws the Human Way. The New 1923 Model OTTAWA has a Power Force Feed. Saws as 2 men would, only many times faster. The OTTAWA not only makes more cuts a minute, but cuts deeper into the log each stroke.

MECHANICALLY OPERATED VALVES

Now, inlet as well as exhaust valve opened mechanically—like automobiles and tractor motors—not used on other log saws. Makes engine easier to start, uses less fuel, develops more power. Exclusive feature 1923 model.

OTTAWA LOG SAW

Falls trees, saws limbs. This year, built in 2 sizes, 2 H-P and 4 H-P. Sold, only, direct from factory to you at Less Than Wholesale Prices. A great work-saver and money-maker. Use engine for belt work when not sawing. **CASH or EASY TERMS; 30 DAYS' TRIAL; 10-YEAR GUARANTEE.** Backed by the largest Engine and Log Saw Factory in the world—Builders of Better Log Saws.

SPECIAL CLUTCH—

Lever Controlled Friction Clutch enables you to start and stop saw while engine runs.

4-cycle frost-proof engine. When magneto equipped, no batteries ever needed. Mounted on wheels with swivel axles—easiest to move.

ORDER NOW! We will ship immediately from our Factory or from Branch House nearest you: St. Paul, Minn., Indianapolis, Ind., Dallas, Texas, Pueblo, Colorado, Albany, N. Y., Pittsburgh, Pa., Atlanta, Ga., San Francisco, Cal., Portland, Ore., Ottawa, Kan. Save one-half to one-third on freight; get outfit sooner—better shape. Send for Special Offer Today.



Saw
Wood

Beat Coal Shortage!

Make
Money

Get your OTTAWA Log Saw, now, and let it pay for itself as you use it. Now, with the whole country facing most serious coal shortage in history and coal higher than ever before the OTTAWA will be a blessing to many. If you act at once you can get your own fuel free. You can make Big Money on every cord you sell and keep your friends from suffering.

Latest Offer! Send at once for Big Special Offer and New Reduced Prices. Learn how to make Big Money—easy.

Free Book! Send today—a postcard with your name and address will do. Rush—the first to get a new 1923 OTTAWA Log Saw.

OTTAWA MFG. CO.,
1748-R Wood St., OTTAWA, KANS.

**FREE
WOOD-
SAWING
ENCYCLO-
PEDIA**



Cuts Down Trees
Level With Ground

EASIEST
TO CHANGE
TO LOG SAW
AND BACK AGAIN.

60% of Market Price

will buy

Diamonds here



\$42.65
3/4 - 1/16 Ct.
Perfectly Cut



\$275
1/2 - 3/8 Ct.
Blue White



\$69.00
2 Ct. Show Center



\$195
White Gold
Large Diamond

\$50.00
1/2 Ct.
White Gold



\$250
1/2 - 3/8 Ct.
Blue White

\$45.00
Colored Center



\$980
American
Movement

\$57.00
All Platinum
Wedding Ring



Why Pay Full Prices Costs Nothing to See

This famous 75-year old firm — the *Largest and Oldest Diamond Banking Institution* of its kind in the world — must sell the diamonds on which we loan money. This firm rated highest, at over \$1,000,000.00 capital, having made loans on diamonds, watches, other jewels in unpaid loans and other special advantage bargains that we must sell to get back our cash. Buy here where loan values the price basis, not market values. Send now for bargain list.

FREE—On Approval! The Buys of a Lifetime!

The diamond bargains pictured here are merely a few of the many unusual offers on our lists, all with full and complete descriptions. At our risk—we send you any bargain you wish for **Absolutely FREE Examination**. No obligation. Compare it carefully, have it valued any way you wish. If you decide not to buy, you are not out one penny.

As Low As \$60 Per Carat

Not all, but some. Yes, some even lower priced, but also diamonds of finest qualities at higher per carat charges. Get a diamond now around half its market price.

Send for Latest List of Diamond Loans

Unlike the ordinary catalog. Hundreds of Diamond Bargains described in full detail with exact weight, color, quality, etc. You know what you're buying before you buy. Besides it tells of **Guaranteed Loan Value**, unlimited exchange privilege at full price paid, and complete details of free examination offer.

Use Coupon NOW!

We'll send our latest Bargain list. It's free. No obligation. No expense to you. Write Now!

Jos. De Roy & Sons

1992 De Roy Building
Only Opposite Post Office,
Pittsburgh, Pa.

References by permission:—
Bank of Pittsburgh—N.
A. Marine Nat'l Bank
—Union Trust Co.,
Pittsburgh, Pa.
Your bank can
look us up in mer-
cantile agencies.

Jos.
DeRoy
& Sons
1992 DeRoy
Building
Only Opposite
Post Office
Pittsburgh, Pa.

Gentlemen: Please
send me free and pre-
paid, your latest bar-
gain list of diamonds,
watches and other jew-
elry. It is understood I
assume no obligation of
any kind.

Name _____

Address _____

Guaranteed Cash Loan!

Diamonds bought here are like insurance policies. You know what you can borrow before you decide to buy—**FREE OUR CASH BACK GUARANTEE!**



Choke off that "squawk"

AFTER all it is not always the bad vaudeville actors that "get the hook." Many owners have found an efficient hook to choke off the "squawk" of their radio sets and secure enjoyable music by adding Acme Audio Frequency Amplifying Transformers to the ordinary detector unit. Acme Transformers cost but five dollars, yet the results are almost marvelous. Not only do they amplify sound, but they bring it naturally—realistically. They are necessary to the proper operation of the Acme Clear Speaker which enables a whole roomful of people to enjoy the broadcasting concerts.

In order to get more than one broadcasting station and thereby pick out the concert you like best, you should also add an Acme Radio Frequency Transformer. This greatly increases the range of your set whether it be vacuum tube or crystal detector type. This wonderful little transformer sells for the same price as its twin brother the Acme Audio Frequency Amplifying Transformer. Your set is not complete without both these transformers and the Acme Clear Speaker.

The Acme Apparatus Company (pioneer transformer and radio engineers and manufacturers) also make detector units, the Acme phone, Acme C. W. and Spark Transmitters, etc. Write for interesting Transformer booklet if your own radio or electrical dealer cannot supply you. The Acme Apparatus Company, Cambridge, Mass., U. S. A., New York Sales Office, 1270 Broadway.

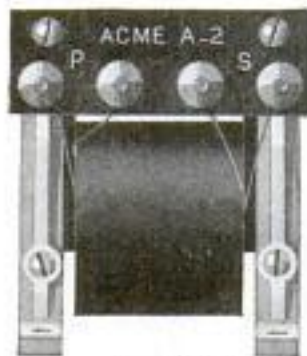

Type A-2 Acme Amplifying Transformer
Price \$5 (East of Rocky Mts.)

ACME

for amplification

Machine-Shop Men can now Cash In On Radio

Practical hints in free book tell just how to profit big from nation-wide craze. Big new money-making field opened to machinists everywhere.



Huge Demand for Radio Panels

Every real radio-fan insists today upon one certain material for panelling his outfit; and cutting that material to dimensions is as profitable and practical a job as any machine-shop can ever make money doing. The makers of that material, wanting reputable machine-shops to cash in on this proper preference of radio enthusiasts, have prepared a handy little book which gives the machinist all the particulars he wants to open up for him this immensely profitable new field. A copy is yours for the asking.

Wonderful Money-Maker for Machinists

This supremely demanded material comes in sheets 38x38 inches, is miles ahead of every other known substance for panelling and insulating radio installations, and can be readily machined by any decently-equipped machine-shop. The difficulty the machinist will have will be in taking care promptly of the orders that will be forced upon him; and that, though it sounds almost too good to be true, is absolutely a FACT. The free book tells all about it, giving every fact the machine-shop man wants to know; and there is not one cent to pay for a copy of it, if you are legitimately a machinist with a plant fit for ordinary work. Send for your copy today, ride the wave of radio development to your own profit, and understand that you commit yourself to nothing whatever by asking for a copy. Ask The Continental Fibre Company, Newark, Delaware.

1 Tune in with the phone—one Master-Baldwin as good as two ordinary phones.



2 When tuned in, attach speaker to phone like this—simplicity itself.



3 Now a whole roomful can hear—it clarifies the sounds—you hear perfectly.



New Radio Enjoyment —at an amazing, low price

NOW comes this new Speaker, the *Master-Baldwin "Throatype" Clarophone* which means new radio enjoyment. It enables a roomful of people to hear distinctly any broadcasting that your receiving set will catch.

New in design, it is more perfect in execution, because it combines the famous Baldwin Phone with a scientific throat-like speaker.

You know the Baldwin Phone, used wherever most exacting work is done. It has been selected by the United States Bureau of Standards as the standard radio phone.

The United States commandeered the Baldwin factory during the war to assure Baldwin Phones for War Vessels, and Army and Government stations.

A Clarifier—Not an Amplifier

Now this finest phone is combined with a new scientific speaker which enables you to hear distinctly every word or note—hear the overtones, even the harmonics. No rasping, buzzing, breaking or any noise for which your receiving set is not responsible.

Designed like the human throat, the speaker has the same tone chamber. And the top part is fashioned after the roof of the mouth. Both are shaped in non-resonant metal.

It has the rectangular mouth, following the principle that opera singers know and use. For getting full resonance they always square their mouths in singing—never round them.

Unequaled Low-Priced Offers

The Master-Baldwin "Throatype" Clarophone, Complete Described above, - - - **\$22.50**

The Master-Baldwin Phone - - - - - **\$ 9.00**

The genuine *Master-Baldwin Improved Phone*, manufactured by the Baldwin Radio Co., Salt Lake City, Utah.

The Master-Baldwin Head-Set - - - - **\$16.00**

The standard supersensitive head-set for those who want the double phone.

Master Radio Corporation

Dept. 4011, 631 So. Spring St., Los Angeles, California

The vocal chords are represented in the Baldwin Phone by a marvelous mica disk, unaffected by heat or cold or electric currents, which is actuated in both directions by an armature tone-arm superimposed in a magnetic field.

So the *Master-Baldwin "Throatype" Clarophone* follows accurately the most perfect model ever made. To hear one is to want one.

Why We Can Sell It For \$22.50

Because of its simple but scientific design the Clarophone lends itself to large quantity production which enables us to sell it for \$22.50—an amazing price.

And the *Master-Baldwin "Throatype" Clarophone* is the world's standard quality—remember the Government selection of Baldwin Phones.

Try It at Our Risk

We know that the Clarophone will please you. So we invite you to test it for ten days at our risk. If you are not pleased, your dealer will gladly refund your money.

Ask your dealer for the *Master-Baldwin "Throatype" Clarophone*.

If he hasn't it, order direct from us, enclosing \$22.50. We will ship immediately, charges prepaid, a complete Clarophone to you. (Reference: Citizens National Bank, Los Angeles, Calif.)

Try the Clarophone. Know the real pleasure it will give you.

The Master-Baldwin "Throatype" Clarophone

REG. U.S. PAT. OFF.

Master Radio Corporation,

Dept. 4011, 631 So. Spring St.
Los Angeles, California.

Enclosed is \$22.50 for one *Master-Baldwin "Throatype" Clarophone*, charges prepaid, insured. My money to be returned if I am not satisfied. I buy my radio equipment from

(DEALER'S NAME).....

(Address).....

(YOUR NAME).....

(Address).....

MAKE YOUR OWN RADIO SET

Prices Slashed!



Not one bit of experience is required to make your own high grade Radio Receiving Set. Our instructions are so simple that a boy of twelve can follow them easily.



VARIOMETER



VARIO COUPLER



VARIABLE CONDENSER



TRANSFORMER



VACUUM TUBE SOCKET



KNOB-DIAL



GRID LEAKS

Thousands of homes are enjoying daily RADIO PROGRAMS received on sets made the METRO way. You too, now have this same opportunity. You will take great pride in owning a set made by yourself, and the cost will be only a fraction of what you would have to pay for the highest type of Radio set.

Save 40%

Buy Direct From the Factory

No dealers. No jobbers. The large Metro factory ships radio parts direct to users at a clean saving to them of 40%. Note these prices.

	Regular Price	Special Price
Variometers	\$5.00	\$3.00
Vario Couplers	5.00	3.00
Transformers	5.00	3.00
23 Plate Condensers	3.60	2.25
43 Plate Condensers	4.50	2.75
Vacuum Tube Sockets	1.00	.65
Dials and Knobs	1.00	.65

Every part is made right in our own factory and is carefully tested and inspected by Radio experts. Every part is guaranteed to work perfectly.

FREE—illustrated photo diagrams and prints with complete working drawings and instructions for assembling your own Radio Set—**ABSOLUTELY FREE** with every order.

Order Today! This special bargain price offer is for a limited time only. Send full payment with order, or if you prefer, you may send a deposit and we will ship C. O. D. for the balance. Circular mailed on request.

Satisfaction Guaranteed or Money Back
Write Department 2

METRO ELECTRIC CO.
1422-1438 RANDOLPH ST. CHICAGO

HOMCHARGE YOUR RADIO BATTERY for a Nickel

ENJOYABLE Radio Concerts and Maximum Receiving Range are obtained only when your battery is fully charged. The

RADIO HOMCHARGER DE LUXE

charges your "A" or "B" battery over night. Silent and clean in operation—requires no watching—may be used right in your living room.

Connects to any lamp socket. Self-polarizing—fully automatic—cannot overcharge or injure the battery.

Entirely enclosed—approved by Underwriters. Unconditionally GUARANTEED. Lasts a lifetime.

Beautifully finished in Mahogany and Gold—the most efficient and handsome rectifier ever produced. Bulletin G37 proves it—send for your copy today—IT'S FREE. Sold by all good dealers or shipped prepaid for \$18.50, complete.

Dealers—Jobbers: The HOMCHARGER Merchandising Plan offers the best proposition in the entire radio field—send for details.

THE AUTOMATIC ELECTRICAL DEVICES CO.
129 West Third Street
Cincinnati, Ohio

Over 50,000 HOMCHARGERS in Use



"MAMMOTH" TUNING COIL

With Wood Mounting

\$1.50

A superior tuning coil for amateurs and others—8 inches in length and 4 inches in diameter—bound at both ends with polished aluminum bands. The "Mammoth" is made of heavy fibre tube, SHELLACKED (not paraffined) inside and out. Wound with high quality No. 22 enameled copper wire, shellacked in place, the ends being brought through the tube and securely fastened. The "Mammoth" is the ideal tuning coil for sets designed to receive telephone messages and music within 40-mile radius. Mounting is made of three-ply veneer—will not warp. Sent postpaid to any address at the special introductory price of \$1.50, currency or money order. Coil alone, \$1.00. Send today and take advantage of this special introductory offer. Agents and dealers wanted.

Oakwood Radio Co.

Dept. 10, Detroit, Mich.



BUILD YOUR RADIO

Save Money

Build Your Own At Home Complete Standard Parts for Long Distance Radio Outfits. We do all machine work; you do the hand work; we tell you how. Immediate delivery. Also complete Radio Sets—all sizes at bargain prices. Write now for our big bargain catalog.

Colonial Radio Equipment Co., 4759 Calumet Avenue, Dept. 19 Chicago, Ill.

Now four can listen to clear **RADIO MUSIC** No. 138 \$2.50

With the Frost-Radio Multiphone plug (shown to right) four Frost-Phones can be attached to Frost-Receiving Set.

Your local Radio dealer can supply you. See him Now!



Fits any standard jack. Packed in individual container.

HERBERT H. FROST 154 W. Lake St. Chicago, Ill.



They Fight Film— They who have pretty teeth

Note how many pretty teeth are seen everywhere today. Millions are using a new method of teeth cleaning. They remove the dingy film. The same results will come to you if you make this ten-day test.

Why teeth are cloudy

Your teeth are coated with a viscous film. It clings to teeth, gets between the teeth and stays. Film absorbs stains, then it often forms the basis of thin, dingy coats. Tartar is based on film.

Old brushing methods do not effectively combat it. So

most teeth are discolored more or less.

Thus film destroys tooth beauty. It also causes most tooth troubles. It holds food substance which ferments and forms acid. It holds the acid in contact with the teeth to cause decay.

Germs breed by millions in it. They, with tartar, are the chief cause of pyorrhea, now so alarmingly common.

Now a daily remover

Dental science, after long research, has found two ways to combat film. Authorities

have proved their efficiency. Now leading dentists, nearly all the world over, are urging their daily use.

A new-type tooth paste has been created to comply with modern requirements. These two film combatants are embodied in it. The name of that tooth paste is Pepsodent.

Its unique effects

Pepsodent, with every use, attacks the film on teeth.

It also multiplies the starch digestant in the saliva. That to digest the starch deposits which may cling to teeth and form acids.

It multiplies the alkalinity of the saliva. That is Nature's neutralizer for the acids which cause decay.

In these three ways it fights the enemies of teeth as nothing else has done.

One week will show

Watch these effects for a few days. Send the coupon for a 10-Day Tube. Note how clean the teeth feel after using. Mark the absence of the viscous film. See how teeth whiten as the film-coats disappear. Enjoy the refreshing after-effects.

Do this to learn what millions know—the way to whiter, cleaner, safer teeth. Cut out the coupon now.

Pepsodent PAT. OFF.
REG. U.S.

The New-Day Dentifrice

Endorsed by modern authorities and now advised by leading dentists almost the world over. Used by careful people of some forty races. All druggists supply the large tubes.

10-Day Tube Free 948

THE PEPSODENT COMPANY,
Dept. 359, 1104 S. Wabash Ave., Chicago, Ill.
Mail 10-Day Tube of Pepsodent to

.....
.....
.....

Only one tube to a family.

for Christmas— MECCANO

ENGINEERING FOR BOYS

The reason why you can build such wonderful models with Meccano is that every part is a real engineering piece—pulleys, gears, strips, girders, rods, couplings and cranks, all perfectly designed and accurately made.

ANYWHERE BETWEEN 5 AND 70 is the correct age to start Meccano. The youngest boy can begin to build the moment he gets his outfit home. A screw driver and spanner are the only tools necessary. Every outfit complete, nothing further to buy.

FULL INSTRUCTIONS. A big illustrated Book of Instructions goes with each outfit, making everything perfectly clear. No study needed.

3 BOOKS FREE TO BOYS →

1. **Meccano Products:** All about model building. 2. **Dick's Visit to Meccanoland:** A boy's fascinating experience at Meccano headquarters. 3. **Radio:** How to make a receiving set with Meccano to hear concerts, etc. All three books free if you send us addresses of three of your chums. Put No. 35 after your name for reference.

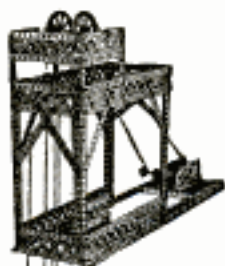

Pit
Head
Gear

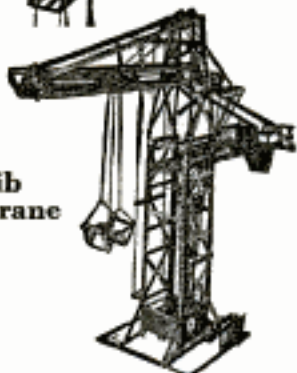

Jib
Crane

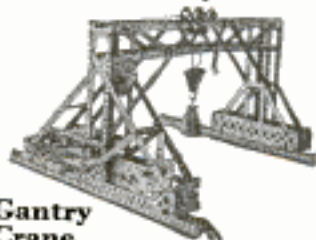

Gantry
Crane



He
didn't
buy
it;
he
BUILT
IT!



MECCANO COMPANY, Inc.

Division H
ELIZABETH, N. J.

In Canada:
MECCANO, Ltd.
11 Colborne St.
TORONTO

Grand \$1250 Prize Contest

Hundreds of
prizes. Get
Entry Blanks
from your
dealer, or
write us.

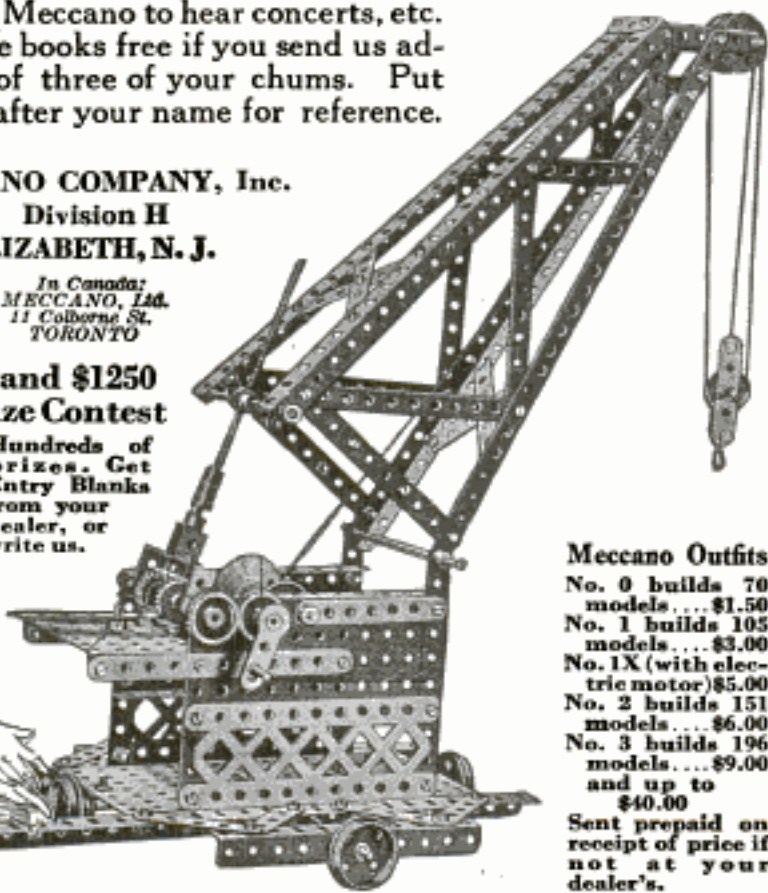

Meccano Outfits

No. 0 builds 70
models... \$1.50
No. 1 builds 105
models... \$3.00
No. 1X (with electric
motor) \$5.00
No. 2 builds 151
models... \$6.00
No. 3 builds 196
models... \$9.00
and up to
\$40.00

Sent prepaid on
receipt of price if
not at your
dealer's.



Your Choice, On Trial

THE Wurlitzer plan gives you any instrument with a complete musical outfit for a week's Free Trial in your own home. No obligation to buy. Return the instrument at our expense at the end of the week, if you decide not to keep it. Trial won't cost you a penny.

Monthly Payments

Payments are arranged in small monthly sums. A few cents a day will pay for your instrument and complete outfit. The Wurlitzer plan gives you all at direct cost. You get the outfit and instrument practically for the cost of the instrument alone.

Artistic quality of Wurlitzer instruments is known all over the world. Wurlitzer instruments have been used

by artists and in the finest orchestras and bands for years. The house of Wurlitzer has made the finest musical instruments for more than 200 years.

Complete Outfits

The new plan includes with the instrument everything that you need—velvet and plush lined carrying case with lock and key, all accessories and extra parts, self instructor, book of musical selections, etc.

A Wurlitzer Outfit

This shows the Wurlitzer Violin Outfit. Case is professional style, beautifully finished. Complete outfits like this are now furnished with all Wurlitzer instruments.

Every musical instrument known, including Pianos and Victrolas, is embraced in the Wurlitzer plan.

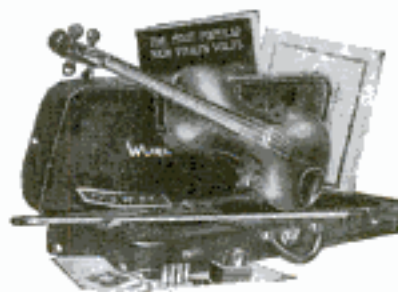

Send for New Catalog

Every known instrument illustrated and fully described in detail with prices, monthly payments and free trial blank. More information and pictures of instruments than in any other book published. (Also complete catalog of accessories, repairs, strings and all needs for replacements for any instrument made. Instant mail service.) Book is absolutely free. No obligation. Send the coupon now.

The Rudolph Wurlitzer Company

Cincinnati Chicago New York San Francisco

Copyright 1921, The Rudolph Wurlitzer Co.

THE RUDOLPH WURLITZER CO., Dept. 1778

117 E. 4th St., Cincinnati 120 W. 42nd St., New York
329 S. Wabash Av., Chicago 250 Stockton St., San Francisco

Send me your new catalog with illustrations in color and full description of the Wurlitzer Complete Outfits and details of the free trial and easy payment offer.

Name.....

Address.....

(State musical instrument in which you are especially interested)

**Automobile
Valve-Grinder
No. 288
Price, \$4.50**



This valve-grinder has both an adjustable spanner and a blade, as shown, so it can be used on different makes of car. It is simple and strong. This model has an enameled iron frame.



“Grind valves?” asks Mr. Punch

“A simple twist of the wrist does it, when you use this good tool.

“Valve-grinding used to be hard work even for experts,” says Mr. Punch, “but with this Goodell-Pratt Valve Grinder it’s a simple job. All you have to do is turn the handle; the tool itself does the rest. While you crank round and round, the valve is rotated back and forth with the proper motion. The weight of the tool supplies all the pressure needed.”

Ever use Goodell-Pratt Tools?

There’s one of them for almost every job, especially around your automobile. The list of 1500 Good Tools includes complete motor tool sets, valve lifters, scrapers, rim wrenches—all kinds of tools for tool users in every line of work.

And all Goodell-Pratt Tools are the kind good workmen insist on. They must live up to the reputation Goodell-Pratt 1500 Good Tools have so faithfully built up. If you are interested in “Tools for the Motorist,” write to us.

GOODELL-PRATT COMPANY

Toolsmiths

Greenfield, Mass., U. S. A.

GOODELL-PRATT
1500 GOOD TOOLS



Your Home Is Within Your Reach When You Buy From Us

NOW is the time to build your Harris Home!

And here is a mighty organization of thirty great departments ready to serve you. Managed by expert material buyers, designers and practical builders. We have vast stocks bought at huge quantity price savings which are now at your command. Our sole aim and purpose is

To help you get a home that will prove entirely satisfactory at a price that will mean a substantial saving in actual dollars of your money.

The combined efforts of these great departments in experimenting and testing materials and methods of construction have produced for you a **GUARANTEED** home, expert machine cut, bundled and marked—the last word in building economy.

Not One Penny in Advance

So sure are we of the super-excellence of our material and our **GUARANTEED** Ready-Cut System that we will ship you any **HARRIS HOME** without the payment of one cent down. Our Plan Book explains our liberal terms fully.

FREE Plan Book

The latest edition is waiting for you, contains our **FREE PLAN OFFER** and photographic reproductions, with floor plans and specifications of 100 beautiful homes. Mail coupon today.

Building Material of All Kinds

For over a quarter of a century, thrifty wise buyers have realized that here is the "open door" to real economy, whether it be a brand new home or material for improvements or repairs. Our big stocks of brand new building material, all purchased in tremendous quantities at savings that are passed along to you are ready for quick and complete shipments.

"PRESTO-UP" Patented Bolt-together Buildings!

The wonder buildings of the age. Guaranteed buildings, for quick industrial housing. Individual Homes, etc., extra strong, practical and suitable for all year 'round habitation in any climate. 50 different plans. They come to you in easily handled sections—painted and stained, ready to bolt together and move in.

Plumbing and Heating!

Hot water and heating systems, warm air heating plants, pipeless furnaces and plumbing material of every kind—the product of America's leading makers. Our mammoth plumbing stock offers unlimited possibilities for you to save money. Our heating plants are guaranteed to heat your home in any weather with big fuel economy. Mail the coupon for our Plumbing and Heating Book and get the benefit of our Expert Engineering Service.



Department NM-7

HARRIS BROTHERS CO.
1349-1525 W. 35th St., CHICAGO

HARRIS BROTHERS CO.
Dept. NM-7, Chicago

These books are **FREE** and sent post paid. Mark an "X" in the squares to indicate which ones you wish.

- | | |
|--|---|
| <input type="checkbox"/> Harris Home Book of Plans | <input type="checkbox"/> Book of "Presto-up" Houses and Garages |
| <input type="checkbox"/> Building Material Catalog | <input type="checkbox"/> Plumbing and Heating Book |

Name.....

Address.....

**FREE BOOK
of Plans**

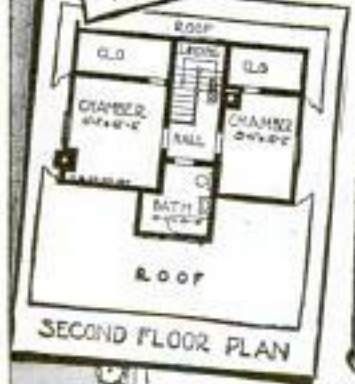
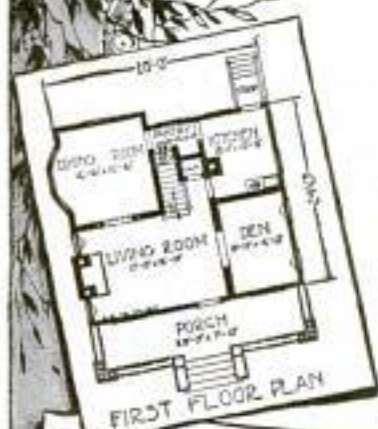

"Speaking of short cuts"

"Cutting cross corners to the job is one thing. Cutting cross corners on the job is another. Only one way to get ahead there and that's by turning out work that's right. Good tools help the most—that's why mine are Starrett."

Here's a new Starrett tool you'll be glad to own—the Starrett Black Enamelled Frame one-inch Micrometer Caliper. Starrett quality throughout. You can get it at any hardware store for \$6.25. With Ratchet Stop, \$6.75. Leather case \$1.00 extra.

Write for Catalog No. 22 A.P. and the Supplement describing the new Starrett Tools.

THE L. S. STARRETT CO.

The World's Greatest Toolmakers
Manufacturers of Hacksaws Unexcelled
 ATHOL, MASS.



New Starrett
 Black Enamelled Frame
 Micrometer Caliper, \$6.25
 (without Ratchet Stop).

No. 436

Use Starrett
 Tools



Radio

The Greatest Radio Offer of the Year—Absolutely Complete, \$49.50

This special receiving outfit will give as good results as any outfit of this improved type on the market. It is absolutely complete, there is nothing extra to buy. We include everything—you simply put up the aerial, connect the instruments, which is easy to do, and in less than half an hour you can be receiving signals, radio music, lectures, stock reports, market reports, or any other radio program sent out.

In making tests with this set in Chicago we regularly heard Detroit, Pittsburgh and other stations were often tuned in. Of course, atmospheric conditions affect the range of this or any other receiving set made.

Highest Development in Radio Receiving

This outfit will equal in results any outfit of this type regardless of price. It is especially made for us and has behind it the fifty year old guarantee of Montgomery Ward & Co.: "Satisfaction guaranteed or your money back." You take no risk whatever in ordering this set.

Long Distance Vacuum Tube Receiving Set

The complete outfit includes our special Combined Tuner and Detector; Special 2000 ohm Double Head Set; Radio Storage Battery; one Detector Tube, one "B" Battery; and complete antenna and connecting equipment including 150 feet bare copper wire and 25 feet insulated wire, porcelain tube; double throw switch; 2 antenna insulators; lightning protector; ground clamp, 2 screw eyes and 25 feet of wire for instrument connections.

Order this set at our risk. It will be packed carefully and shipped immediately from our nearest house. Shipping weight 40 pounds. 563Z599—Complete Outfit..... **\$49.50**

Order this outfit today and start at once enjoying in your home the most marvelous invention of the age.

Price of receiving Set without batteries, head piece, switch and aerial, shipping weight 8 pounds: 563Z598 — \$27.50. Send money order or check to the one of our five houses that is nearest to you.

MONTGOMERY WARD & CO., Dept. 6-R
Chicago Kansas City Saint Paul Fort Worth Portland, Ore.



RADIO CATALOG
FREE

This FREE catalog tells you the kind of Wireless Equipment to own, so that you receive in your own home all the latest news, music, Church services, lectures, —everything that is broadcasted.

Every home should have a wireless telephone outfit. We now offer complete outfits from \$12.95 up.

Everyone interested in radio should see our low prices on parts and accessories. Write for this book. Learn about the miracle invention of the age. Easy to install, simple to operate.

One copy of this booklet is yours FREE. Write for your copy.

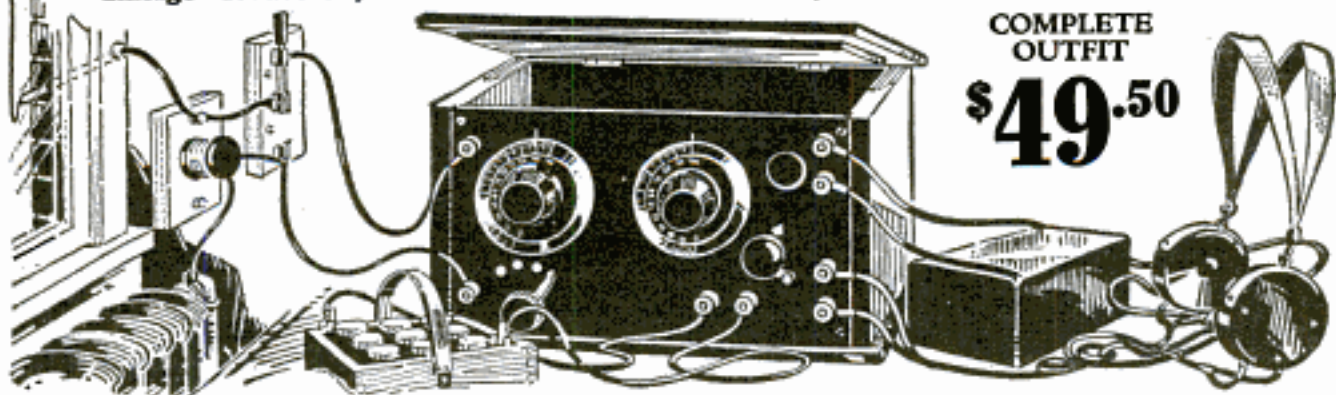

COMPLETE
OUTFIT
\$49.50

Montgomery Ward & Co.

The Oldest Mail Order House is Today the Most Progressive



Look! Only **\$3.50** a Month

See It First—No Money Down

Our determination to this year double our sales of the world famous

Santa Fe Special
and
Bunn Special Watches

prompts this matchless offer

While other watch dealers are raising their prices, asking you for larger monthly payments, and making payment terms harder for you to meet, we are offering you our new model Santa Fe Special, no advance in price, no money down, easier terms and smaller monthly payments. WE realize the war is over and in order to double our business we MUST give you pre-war inducements, better prices, easier terms and smaller payments.

Without one penny of advance payment let us place in your hands to see, to examine, to inspect, to admire, to approve, a real masterpiece in watch creation.

A watch which passes the most rigid inspection and measures up to the exacting requirements of the great Santa Fe Railway System, and other great American trunk lines.

Page Twelve of Our Watch Book Is of Special Interest to You!

Ask for our Watch Book free—then select the Watch you would like to see, either the famous Santa Fe Special or the 6 position Bunn Special, and let us explain our easy payment plan and send the watch express prepaid for you to examine. No money down.

SANTA FE WATCH CO.

Dept. B-6 Thomas Bldg., Topeka, Kans.

Please send prepaid and without obligation your Watch Book free, explaining your "No Money Down" offer on the Santa Fe Special Watch.

Name.....

Address.....

State.....

Remember —No money down—easy payments buys a master timepiece—a 21 Jewel guaranteed for a lifetime at about half the price you pay for a similar watch of other makes. No money down—a wonderful offer.

SANTA FE WATCH CO.
Dept. B-6 Thomas Bldg. Topeka, Kans.

They Wouldn't Be The Same—

GIVEN the same tools and material, two different workmen would make two kinds of a house. The house of one would be well finished—its interior, decorations and grounds a pleasant sight to behold—the small details given attention—a house well made, finished and complete.

The other would build, but not so cleverly—you know the difference in two people. You would see the amateurishness in his work. His house would not serve as well or last as long as the house of the first builder.

So it is with Machinists' Tools. There is a difference in the way they are made, in the hardening and finishing of the steel, a superiority in design, a higher accuracy, cleaner graduations, here and there a slight advantage, which, all combined, make a superior Machinists' Tool.

BROWN & SHARPE

MACHINISTS' TOOLS

represent the first builder's product. They were the first precision tools in America. Their superiority is shown by their fine finish, clean cut graduations, correct design, their world known accuracy and long life. Mechanical measurements the world over depend upon Brown & Sharpe Tools—they are the choice of every mechanic who has used them. Send for copy of our No. 28 Catalog, listing 2000 different tools.

BROWN & SHARPE MFG. CO.
PROVIDENCE, R. I., U. S. A.

Great Diamond Ring Bargain

Perfectly cut, genuine blue-white Diamond held aloft on six white gold prongs. Gentleman's 14K Green Gold, hand-carved mounting, trimmed with artistic scroll designs of White Gold.

Send No Money—Ring sent FREE for your approval. If entirely satisfied pay only \$10, then \$5 a month, for ten months until the total price of \$60 has been paid.

Free Gift Book shows thousands of other bargains in Diamonds, Watches and Jewelry. Send for copy No. 532-S.

\$ **5⁰⁰**
A Month



Buy
Today
10
Months
TO PAY

"THE HOUSE OF QUALITY"
L.W. SWEET INC.
1650-1660 BROADWAY, NEW YORK.

DIAMONDS • WATCHES

Genuine Diamonds Guaranteed.

CASH OR CREDIT

THE BEST CHRISTMAS GIFT OF ALL—A GENUINE DIAMOND. WHY PAY MORE THAN LOFTIS ASKS

We import Diamonds direct from European markets and sell direct to you by mail. Our immense BUYING POWER is a great saving to you.

SEND FOR FREE CATALOG

There are over 2,000 bargains in Diamonds, Watches, Wrist Watches, Pearls, Mesh Bags, Silverware, etc. Select as many articles as you wish and have all charged in one account. Catalog explains everything.

"Sylvia" Diamond Ring here shown, 18-k Solid White Gold, \$75. Wedding Ring, Platinum, \$25; solid gold, \$5 up. Wrist Watch, 18-k White Gold, 17 J., \$30; 14-k, 15 J., \$22.

17 JEWEL ELGIN—Open Face. Green Gold, engraved, guaranteed 25 years. 12 Size, gilt dial. Assorted patterns. Big value. \$35

Our Diamonds are magnificent blue white, perfect cut gems, set in Solid Gold and Platinum. *Liberty Bonds Accepted.*

LOFTIS

BROS. & CO. 1857

105 N. State St., Chicago, Ill.
Stores in Leading Cities

CREDIT TERMS on all articles: One-fifth down, balance divided into equal payments within eight months. *Send for Catalog.*

Only \$2 Down



Play Well in 4 Weeks

—Ten months to pay

Write for Free Catalog Folder telling all about the Masterbilt—the world's finest Saxophone outfit. Price now lowest ever quoted—5 days' trial—very easy monthly payments. No interest to pay—no extras. Outfit includes finest nickel-trimmed and richly lined Case, Instruction Book, Album of Popular Saxophone Solos, Music Lyre, Carrying Strap, Mouthpiece and three fine Reeds.

"Masterbilt" Saxophones

Used by leading Bands and Orchestras. Highest quality, built in perfect tune, assembled and tested by experts. All latest key improvements, light, quick action and beautiful finish. Write today for FREE Catalog Folder fully describing these handsome Masterbilt outfits.

The Saxophone Shop, 429 S. Wabash Ave., Chicago
Largest Exclusive Dealers in Saxophone Supplies in the World

1000 SHOT
ALL STEEL
MAGAZINE
AIR RIFLE

WE GIVE TO BOYS WITHOUT COST
Choice of six guns (on four easy plans) for selling our Magic Healing

HAMILTON
22 CAL.
HUNTING
RIFLE

Way-o-lena at 25c box. **We Trust You!** Order Seven Boxes Today On Postal Card—we send promptly, prepaid. *Easy to sell—used in every home.* Return money as instructed, choosing your gun according to one of the plans shown in our Big Premium List. Also 200 other Gifts or Big Cash Commission if you prefer. If you are prompt, a special Free Gift.

Waverly Co., 219 Towner Bldg., Monroeville, Pa.

TYPEWRITERS

We Save You 50%

FREE TRIAL—EASY TERMS

Your choice of all STANDARD MAKES: UNDERWOOD, ROYAL, SILENT L. C. SMITH, Self-starting REMINGTON, etc. Rebuilt by the Famous Young Process. Guaranteed good as new. Lowest cash prices. Time payments or rentals with special purchase privilege. Largest stock in U. S. Write for special prices and terms.

YOUNG TYPEWRITER CO., Dept. 458 CHICAGO

AGENTS: \$54 A WEEK

2 in 1 Reversible Raincoat



One side dress coat, other side storm coat, Tailored seams, sewed and strapped. Two coats for the price of one. Brand new. First season. Not sold in stores. We control the entire output. Take orders from men and women who object to paying present high prices.

Guaranteed Waterproof

or money back. Our men and women representatives having wonderful success. Right now is the big season. No experience or capital needed. You take the orders. We ship by parcel post and do all collecting. Commission paid same day you take orders. We are paying thousands of dollars to our agents taking orders for this new Reversible Coat. We have all of the latest and best styles of raincoats, for men, women and children. Our new, big swatch book, 48 pages, shows all new and distinct patterns. Write today for agency and sample coat and make some ready money this season.

Parker Mfg. Co., 578 Storm St., Dayton, O.



Agents

LARGE MANUFACTURER OF SHIRTS wants Agents to sell complete line of shirts direct to wearer. Exclusive patterns. Big values. No capital or experience required. Write for free samples.

MADISON SHIRT MILLS
507 Broadway New York, N. Y.



Dependable
Champions
For Every Engine Everywhere

Ask your dealer to sell you a full set

Hand Forged
Razor Steel
Blades, No. 57



A GENUINE \$2 KNIFE
FOR
\$1.18 POSTPAID

Direct at Factory Prices

This \$2 KNIFE \$1.18 Postpaid
Hand Forged Razor Steel Blades
Handy shaped Blade makes this knife best for mechanics, sportsmen and farmers; light but strong; re-sharpened easily. Stag handle. German silver finish; blades file tested, hand forged from razor steel and warranted.

Sample \$1.18 3 for \$3.00 Postpaid.

Send for our 100-page List and "HOW TO USE A RAZOR" **FREE**

MAHER & GROSH CO., 106 A St., Toledo, Ohio

W. L. DOUGLAS

\$5.00 \$6.00 \$7.00 & \$8.00 SHOES FOR MEN AND WOMEN



W. L. Douglas \$7.00 & \$8.00 shoes are absolutely the best shoe values for the money in this country. All W. L. Douglas shoes are made of the best and finest leathers, by skilled shoemakers, all working to make the best shoes for the price that money can buy. The quality is unsurpassed. The smart styles are the leaders in the fashion centers of America. Only by examining them can you appreciate their wonderful value. Shoes of equal quality cannot be bought elsewhere at anywhere near our prices.

W. L. Douglas shoes are put into all of our 110 stores at factory cost. We do not make one cent of profit until the shoes are sold to you.

WEAR W. L. DOUGLAS SHOES AND SAVE MONEY.

W. L. Douglas \$4.00 & \$4.50 shoes for boys, best in quality, best in style, best all around shoes for boys. It is worth dollars for you to remember that when you buy shoes at our stores **YOU PAY ONLY ONE PROFIT.**

No matter where you live, shoe dealers can supply you with W. L. Douglas shoes. They cost no more in San Francisco than they do in New York. Insist upon having W. L. Douglas shoes with the name and retail price stamped on the sole. Do not take a substitute and pay extra profits. Order direct from the factory and save money.

W. L. Douglas Write for Catalog Today
President W. L. Douglas Shoe Company
128 Spark St., Brockton, Mass.

We Pay \$6 a Day

taking orders for Aluminum Handle Cutlery Set. Brand new. Handles made of pure aluminum. Will not hold heat. Can't come apart. Written guarantee with each set. You take orders. We deliver and collect.



PAY YOU DAILY

No experience or capital needed. Big money for spare time. Write today for agency and sample. Prompt delivery.

Jennings Mfg. Co., Delight 826, Dayton, Ohio

VIOLINS

SPECIAL LOW PRICE SALE



We can save you money on standard makes and models best quality, guaranteed violins. Biggest offers ever made by us. SEND TODAY for list of bargains and information.

JENKINS MUSIC COMPANY
(63 years in business—12 stores.)
931 Jenkins Bldg. Kansas City, Mo.

SEND NO MONEY

Try this Portable Typewriter 10 Days FREE



Now you can buy famous, 9-pound National Typewriter direct from the factory, after 10 days' trial—absolutely free. You be the judge. Then we give you

10 MONTHS TO PAY

Same machine as used by thousands of doctors, lawyers, bankers, salesmen, students, writers and business men in 31 countries. Every feature of best, standard size machines. 28 keys.

\$4 characters. Brand new—not a rebuilt typewriter. Neat, compact carrying case free with every machine. Send today for our 10 Days' Free Trial offer and 10 Months' Easy Payment Plan.

NATIONAL TYPEWRITER CO.

Dept. 7-K.

Fond du Lac, Wis.

GREEN AUTOMATIC MACHINE



ADD TO YOUR INCOME

WITH LITTLE EFFORT
\$5 to \$10 A DAY MADE EASY WITH

New Improved Green Automatic Machine

Sharpens Razors and Straps all kinds of safety razor blades, in one operation, from four to six blades per minute. For both Quality and Quantity, this machine is in a class by itself. There is nothing like it on the market. Let us send you our descriptive literature explaining everything, including the "AMERICAN" Key Cutter—cuts square, angular or round slots.

AMERICAN SHARPENING MACHINE CO. (Inc.), Dept. 11, 134 W. Washington St., CHICAGO

"AMERICAN" Key Cutter



**Two
Dimes
a Day
Pays**

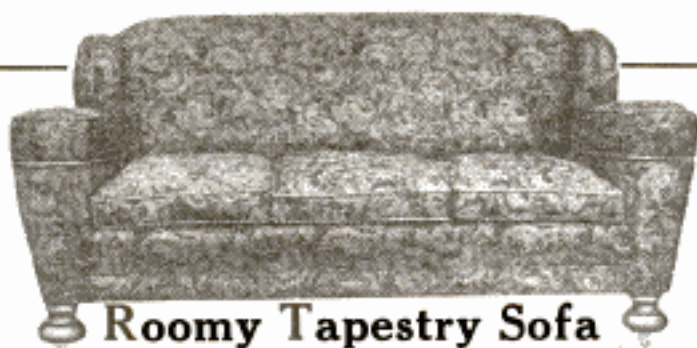

**One
to Four
Years'
Time**

Roomy Tapestry Sofa

Choice of flowered Tapestry or beautiful Velour. Chair and Rocker to match. Over a thousand other Furnishings offered on easy monthly payments in our big, helpful, 104-page Larkin Book of Better Homes. FREE for the asking.

LOWER FACTORY-TO-FAMILY PRICES

On these attractive Furnishings and on our famous Musical Instruments. One to four years to pay. Big savings at our bed-rock prices. Check below offer interested in.

- Furnishings
 Symphonic Pianos
 Symphonic Player Pianos
 Symphonola Phonographs

(Check offer interested in and mail ad Today for FREE Book. Give full name and address)

Desk FPM-1122

Larkin Co Inc.

BUFFALO, N. Y.
PEORIA and CHICAGO, ILL.

**Different from all others—the
NEW BENJAMIN**

AIR RIFLE

Made on a different principle from all other Air-Rifles. The Benjamin is really a strong air-pump used to compress the air in the air chamber to any degree of power desired. From one to six strokes of the pump give all the force necessary. Each additional stroke gives increased power. The Benjamin works on the same principle as all air-drills and air-hammers—with this difference:

You control the shooting force as you desire. Look at this block of hardwood. It shows how Benjamin power is regulated as you wish.

You can't have accidents with a Benjamin. It's safe, always, because you control the power. The Benjamin never loses shooting force, and has no springs to get out of order or shake your aim. Write us for an interesting folder about this wonderful air-gun.

For sale by all dealers. Price \$5.00.

**BENJAMIN
AIR-RIFLE & MFG. CO.
615 N. Broadway, St. Louis, Mo.**

Ask your dealer for demonstration.

Buchstein's Fibre Limb

is soothing to your stump—strong, cool, neat, light. Easy payments. Braces for all deformities.

**D. BUCHSTEIN CO.
113 8th St. S., MINNEAPOLIS, MINN.**

Send for Catalog Today

**WINDOW
SIGNS**

AGENTS \$60—\$200 a week. Free Samples **GOLD SIGN LETTERS** for store fronts and office windows. Anyone can put them on. No experience necessary. Big demand. LIBERAL OFFER TO GENERAL AGENTS.

METALLIC LETTER CO., 4338, N. Clark St., CHICAGO

**SELF-FILLING INK PENCIL
"INDEPENDENT"**

Meets all requirements. Self-filling, non-leakable, safety cap. Attached clip. Smooth writing gold style point.

Guaranteed Improved Fountain Pen. Eliminates fatigue. Promotes efficiency. Writes uniform. A business necessity.

\$2.00 by Mail

Your Name in Gold—25 Cents Extra

AGENTS WANTED
J. C. ULLRICH & CO., 161 Washington St., New York

**AGENTS-WE START YOU
WITHOUT A DOLLAR**

Soaps, Extracts, Perfumes, Toilet Goods. Extensive Line 100% profit. Experience unnecessary. Catalog Free.

Carnation Company, Dept. 360 St. Louis, Mo.

ADDING MACHINE \$15

Latest model. Equals work of \$350.00 machine. Adds, subtracts, multiplies, divides. Absolutely automatic. Infallibly accurate. A whirlwind in speed. Easy to understand; simple to operate. **Guaranteed in writing for 5 years.** Used by U. S. Gov't and largest Railroads. Only \$15.00. Worth its price for inventory alone. Write now for illustrated booklet and **free trial offer.**

LIGHTNING CALCULATOR CO., DEPT. W. GRAND RAPIDS, MICHIGAN

EASY FOR YOU TO OWN A FINE INSTRUMENT!

YEARS ago the famous King Brass Instruments were sold only for cash to famous musicians. But now due to our easy payment plan anyone can own one of these wonderful instruments.

SAVE MIDDLEMAN'S PROFITS

Simply order direct from the factory. You save middleman's profit—and you get a fine, new, sound-laboratory tested, acoustically perfect King Instrument. With it goes our guarantee plus free factory-service.

IT'S EASY TO OWN A KING

Rebuilt instruments, refinished to look like new, we sell for cash at low prices. New instruments on the easy payment plan. Thus it's "easy to own a King". Send for our latest complete catalog and list of special bargains.

THE H. N. WHITE COMPANY
5242 Superior Avenue Cleveland, Ohio



New Gum Vending Machine Makes You \$10 to \$20 a Day

Pays Rent for Store Owner

Install one in your store or any public place and get this easy profit. Requires no attention. Always works. Machine's profits pay the rent. Write us about rebuilt penny and nickel machines. Finished like new. In excellent running order. Pay their cost in 10 days. Price \$85.

Write or wire today for full particulars. \$25 down payment. Balance C. O. D. Mints \$30 per case—2,000 5 cent packages. Single boxes, 100 5 cent packages, \$2.50.

SILVER KING NOVELTY CO.
400 Williams Bldg. Indianapolis, Ind.



MONEY IN MUSHROOMS

NOW TIME TO START

BIG DEMAND. HIGH PRICES BEING PAID

An uncrowded occupation. Exceptional opportunities for live men and women. Raised at home. Only small space needed. Small expenditure will start you in a practical money-making enterprise. Big profits. Booklet telling all free. Write **Nat'l Spawn Co., Dept. 17, Brighton, Mass.**

30 DAY TRIAL

FINE STROP FREE

STERLING razors are hand forged from special cutlery steel, hollow ground, tempered and finished by experts. Thousands used by barbers and self shavers. We will send you a STERLING on 30 days trial. If satisfactory, costs \$1.67. If not, costs nothing. Barber's double swing horsehide strop FREE with each razor. Write today. Sterling Company, Dept. 209 Baltimore, Md.

Please Mention Popular Mechanics

\$2 Brings This Genuine DIAMOND PLATINUM RING



SEND ONLY \$2.00 and this hand carved and pierced ring of Solid Platinum set with a brilliant blue white perfect-cut first quality Diamond comes to you charges paid.

No Red Tape
No Delay

10 Days' Free Trial

Keep the ring 10 days. If not satisfactory or if you can duplicate this value anywhere for less than \$90.00 your deposit will be returned to you. After trial pay balance \$6.30 a month for 10

months. Price \$65.00.

FREE—Write today for Royal catalog of Diamonds, Watches and Jewelry. Thousands of gift suggestions shown in our \$2,000,000 stock. 10 months to pay on everything. Address Dept. 617.

ROYAL DIAMOND & WATCH CO. 35-37-39 Maiden Lane - New York

AGENTS: \$50 a Week

taking orders for New Kerosene Burner

Fits any stove, just shove into the fire box. Quickly lighted, turns off by valve—just like gas. Burns Kerosene (coal oil) cheapest and cleanest fuel known.



Clean
No Odor
Low Price

For Winter or Summer

Our agents report big success. The high price of coal makes this New Burner sell everywhere. Big money for spare time workers. Write quick for demonstrating sample.

Thomas Mfg. Co.

B-448

Dayton, Ohio

\$30⁰⁰ per Day PROFIT for You!

AGENTS WANTED AT ONCE to make as high as \$60.00 per day supplying tremendous demand for \$15.00 furnace controlling and fuel saving device which takes the place of \$75.00 equipment.

100 PER CENT PROFIT TO YOU ON EVERY SALE

The coal situation is desperate and thousands of these devices are already in use controlling every style of heating plant. Saves fuel; provides a warm house AUTOMATICALLY; uses the same chains as any draft plate; is not electrical; sells at once to 7 out of 10 people who see it work. FOR FULL DETAILS OF OUR BIG MONEY MAKING OPPORTUNITY WRITE

SAHLIN MFG. CO., 39 N. Ottawa Ave., Grand Rapids, Mich.



This is Best for RADIO PANELS

FOR the novice or professional there is positively no substance as completely satisfactory for Radio paneling as the famous Bakelite-Dilecto (XX Grade).

It's the smartest and most handsome material procurable, besides giving the absolute insulation necessary in Radio and eliminating vibration.

Sleek — Tough — Durable — Super-resistant

Bakelite-Dilecto is not something new, which has sprung up with the Radio "craze." It is a thoroughly established product. Used by the United States Navy and Signal Corps for *over eight years!* No higher recommendation needed.

Guaranteed highest in tensile and dielectric strength (proved constant 5.2). Resists heat, water and milder acids and solvents. Far superior to wood, marble or hard rubber. (A Laminated Phenolic Condensation Product.) Tough, yet readily machined.

Start your radio set RIGHT! Panel with B-D-X-X. Any dealer can get it for you, cut to size. Write us direct for dealers' names.

THE CONTINENTAL FIBRE COMPANY

Factory: Newark, Delaware

DEALERS: Demand for B-D-X-X, in sheets, rods, tubes, etc., grows heavier every day, stimulated by our aggressive advertising. Get in on the profits now. Ask for price lists and our interesting offer.

SERVICING FROM

NEW YORK CITY, 233 Broadway
ROCHESTER, N. Y., 85 Plymouth Ave.
CHICAGO 332 S. Michigan Ave.
PITTSBURGH, 301 Fifth Ave.
SAN FRANCISCO 75 Fremont St.
LOS ANGELES 411 S. Main St.
SEATTLE 91 Connecticut St.

bakelite-dilecto



BURROWES

Home Billiard & Pool Tables

Magnificently made in all sizes, at all prices. Game exactly same as standard table. Become expert at home. Use in any room, on any house table or on its own folding stand. Quickly leveled. Put up or down in a minute. Small amount down, easy payments. Ask your dealer or WRITE TODAY for Catalog.

E. T. BURROWES CO., 51 Free St., Portland, Maine

HUNTING COATS

Made of 8 oz. olive tan duck: lined, front opening pockets, corduroy collar, three flap pockets, double stitched, strong and serviceable. Sizes 36 to 46.

2.95

GET OUR LOW PRICES

Other outdoor clothing for general wear at similar low prices. Write for FREE big catalogue 112 and winter supplement.

RUSSELL'S, Inc.

ARMY—NAVY—CAMP—SPORTING GOODS

245 W. 42d Street

New York

DIAMONDS

One Year to Pay Prices Cut to the Limit

Genuine perfect cut Diamonds. Prices cut to the limit. Must make room for our Fall stock. At ridiculously low prices we offer you real genuine diamonds. Pay on our special monthly payment plan to meet your pocketbook. You won't miss the money and you can wear the diamond while you pay for it. All correspondence strictly confidential. Nearly 25 years experience as diamond merchants. Send for our easy payment plan today.

Free Ask for our new De Luxe catalog which contains hundreds of special bargains in all kinds of diamonds, watches and jewelry. THE KLEIN WAY — A YEAR TO PAY — WRITE TODAY FOR FREE CATALOG.

Klein & Co. 122 W. Madison St.
Dept. 8711 Chicago, Ill.
Nearly 1-4 century same location



\$400
A Month
payments will
buy this magnificent
hand engraved
"Lady Lorraine"
ring. 14Kt Solid Gold.
Large Steel-blue white
perfect cut diamond
of very brilliancy.
Was \$100.00.
Now \$68.00
Pay Only
\$14 Down

Use Your Credit
No Delay—No Red Tape

Agents---Here It Is



Something new. Wonderful invention. The Serenola does more than machines costing 10 times its price. Taking the country by storm. Orders taken for over a thousand a week. Big demand. Easily carried with you anywhere. Built in just like a suitcase. Fully guaranteed. Low price. Must satisfy customers or money back.

Easy to Take Orders

Biggest, best and most profitable proposition we have ever offered. Big money on every order. No capital needed.

No collecting. Pay you every day. Get started at once. Some of our representatives making from \$7 to \$21 a day. No competition. Territory given. Don't pass up this wonderful opportunity.

PERRY-LUDLOW CO., S. 448 DAYTON, O.

SAVE YOUR BODY

Conserve Your Health and Efficiency First

"I Would Not Part with it for \$10,000"

So writes an enthusiastic, grateful customer. "Worth more than a farm," says another. In like manner testify over 100,000 people who have worn it.

The Natural Body Brace

Overcomes WEAKNESS and ORGANIC AILMENTS of WOMEN AND MEN. Develops erect, graceful figure.

Brings restful relief, comfort, ability to do things, health and strength.

Wear It 30 Days Free at Our Expense

Does away with the strain and pain of standing and walking; replaces and supports misplaced internal organs; reduces enlarged abdomen; straightens and strengthens the back; corrects stooping shoulders; develops lungs, chest and bust; relieves backache, curvatures, nervousness, ruptures, constipation, after effects of flu. Comfortable and easy to wear.

Keep Yourself Fit Write today for illustrated booklet, measurement blank, etc., and read our very liberal proposition.

HOWARD C. RASH, Pres. Natural Body Brace Co.
223 Rash Building SALINA, KANSAS



For Boys and Girls Also

Taxidermy Book FREE.

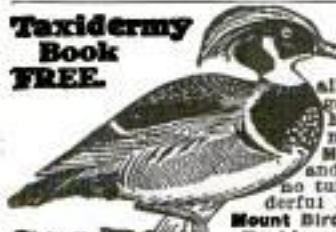

Write Today.

Stuff Beautiful Birds. Learn by mail to stuff and mount

all kinds of birds, animals, fish and game heads, make rugs, tax skins. Mount your own specimens and make money preserving for others. Men, women and boys learn easily and quickly. Success guaranteed or no tuition. Write today for our wonderful FREE book "How to Learn to Mount Birds and Animals. N.W. School of Taxidermy, 9778 Elwood Bldg., Omaha, Neb.

TYPEWRITERS

17¢ a Day soon pays for a genuine visible Underwood or L. C. Smith rebuilt Typewriter. Save \$20 to \$30 on famous Larkin Easy-Payment plan. Handsomely finished. 5 Year Guarantee. 30 Days Trial. Send for FREE Book TODAY.

Larkin Co. Inc. Desk TPM-1122
Buffalo, N. Y. Peoria and Chicago, Ill.



THE AJAX EYELET FASTENER

BINDS AND INSERTS AJAX EYELETS IN PAPER, CARDBOARD, LEATHER OR CLOTH

It Saves Time by Punching the Hole, Feeding the Eyelet and Clinching It in One Operation.

Drop the eyelets into the magazine and go right ahead. Order from your stationer or direct.



PRICE WITH 1500 AJAX EYELETS, \$10.00 DELIVERED IN U.S.A.

Write for our catalogue of office tools

MACHINE APPLIANCE CORPORATION

351-353 Jay St. Spec. Dept. Brooklyn, N. Y.

THIS WONDERFUL INVENTION



converts any cook stove into a gas stove. Oxo-Gas made from kerosene and air is cheaper, cleaner and more efficient than coal. Send for catalog illustrating Oxo-Gas appliances for all purposes where coal is used. We have openings for General Sales Managers and distributors. Only those who can finance themselves considered.

Gas appliances for all purposes where coal is used. We have openings for General Sales Managers and distributors. Only those who can finance themselves considered.

GLORIA LIGHT COMPANY

111-119 N. MAY ST.

CHICAGO, ILL.



PLUMBING & HEATING

Buy Direct—Save 50%

\$66.95 Complete Bathroom Outfit \$66.95

Send NOW for our FREE Catalog "A" of Wholesale prices

Satisfaction Guaranteed



LAMPLOUGH BEAUMONT COMPANY
39 So. Portland Ave. Brooklyn, N. Y.



This little Stevens certainly does shoot

Snuggle it up to your shoulder and draw a line on the target. Doesn't it feel good? But that's not all—it shoots just as good as it feels.

If you have the skill your Stevens will back you up. For a Stevens is always accurate.

Hold a Stevens barrel up to the light and take a peep through it. Smooth, isn't it? Not a flaw—that barrel is accurate.

When a Stevens rifle is drilled, the final cutting cuts away less than one-half of a thousandth of an inch. It's slow work—but a Stevens rifle shoots true.

And Stevens turns out these sturdy, accurate rifles at prices that you can afford.

Ask at your dealer's or write for the interesting catalog describing our complete line of rifles and shotguns.

J. STEVENS ARMS COMPANY

Department J-264 Chicopee Falls, Mass.

Owned and operated by the Savage Arms Corporation
Executive and Export Offices 59 Church St., New York

Retail price — including tax, \$9.85. Stevens "Favorite," 24 in. barrel take-down; .22 long rifle, .22 short, .25 Stevens and .32 long rim-fire. Other models ranging in price from \$5.40 to \$23.50.



Retail price — including tax, \$15.00. Stevens "Visible Loading." An accurate .22 caliber Repeater.

Please Mention Popular Mechanics

A NEW WAY TO GET YOUR CLOTHES ABSOLUTELY FREE

and Make Big Money during your spare time—something different, better, bigger, more liberal than any offer ever made. Lower prices—better clothes—bigger cash profits—express or postage paid on everything.

DOUBLE PAY

Free Clothes and Cash Profits Besides. You can easily earn \$30.00 cash, extra, every week during your spare time, taking orders for our made-to-measure clothes. We don't ask you to use your cash profits for your own clothes. That's not our way of doing business. Ours is a new and better plan.

Fifty-six stylish, real cloth samples—FREE covered fashion plates; inside wholesale prices—everything FREE. First drop as a line today and we will send complete outfit FREE.

SPENCER MEAD CO. Dept. L-245 Chicago



Nu-Way STRETCH

SUSPENDERS

A full year's wear or more guaranteed (75c and 50c), Men's Garters (50c) and Hose Supporters (all sizes, 25c). No rubber to rot from heat or sweat. Phosphor Bronze Rustless Springs give the stretch.

ASK YOUR DEALER. If he can't supply you, send direct, giving dealer's name. Accept no substitute. Get the genuine Nu-Way. Look for guarantee and name on buckle. Write for story of Nu-Way Spring Stretch.

NU-WAY STRETCH SUSPENDER COMPANY

Exclusive Manufacturers of Nu-Way and Electric Lines
Dept. C 411 Adrian, Mich.

Moore Push-Pins
Glass Heads—Steel Points

Moore Push-less Hangers
To hang up things

Ask your dealer to show them

Sold Everywhere **10¢** per packet

Moore Push-Pin Co.
Wayne Junction Philadelphia

Build This Phonograph Yourself

TREMENDOUS SAVING IN COST

Easy, fascinating work with our **SIMPLIFIED PLANS.** We furnish blue prints, diagrams, motor, cabinet pieces, ready-built horn, etc. You don't need to be a cabinet maker. A few hours assembling and you will have a fine instrument at one-quarter the regular retail price. **AGENTS MAKE MONEY** making and selling these instruments. Write today for full details and our **FREE OFFER.** Address:

MODERN PHONOGRAPH SUPPLY CO.
213 N. Morgan St. Dept. 702 CHICAGO, ILL.

VITALIC Bicycle Tires

TRADE MARK REGISTERED
Tougher Than Elephant Hide

TYPEWRITERS

\$50 buys a brand new Corona, the Personal Writing Machine. Fold it up, take it with you, typewrite anywhere! Write for free booklet No. 8.

Corona Typewriter Co., Inc.
GROTON, N. Y.

Save your Hearing



The Acousticon

**Does More Than Enable You to Hear—
It Preserves and Improves Your Natural Hearing**

If you do not use your ears, they quickly become helpless. Just so with the ears—They must be stirred to activity by increased sound or they lose all sensitiveness.

You can be the judge of hearing better and clearer by letting us loan you

**The 1923 ACOUSTICON
For 10 Days FREE TRIAL
No Deposit—No Expense**

One user writes "My hearing is so improved that I forget to use it at times!"

Remember, please, if you return the Acousticon, the trial costs you absolutely nothing—

But, don't let your hearing grow worse—Don't buy any hearing aid until you have first tried it—and don't neglect to try the Acousticon.

It will help you greatly and prove it without obligation. Send for your free trial today.

**DICTOGRAPH PRODUCTS CORPORATION
1307 Candler Bldg., 220 W. 42nd Street, New York City**

TOBACCO

Habit Cured or No Pay

Any form, cigars, cigarettes, pipe, chewing or snuff Guaranteed. Harmless. Complete treatment sent on trial. Costs \$1.00 if it cures. Nothing if it fails. **SUPERBA CO. E-41 BALTIMORE, MD.**

"BOW LEGS and KNOCK-KNEES" UNSIGHTLY

SEND FOR BOOKLET SHOWING PHOTOS OF MEN WITH AND WITHOUT THE PERFECT LEG FORMS

**PERFECT SALES CO.
140 N. Mayfield Ave., Dept. S, Chicago, Ill.**

SEND NO MONEY

**If You Can Tell it from a
GENUINE DIAMOND Send it back**

To prove our blue-white MEXICAN DIAMOND cannot be told from a GENUINE DIAMOND and has same DAZZLING RAINBOW FIRE, we will send a selected 1 carat gem in ladies Solitaire Ring, (Cat. price \$5.25) for Half Price to introduce, \$2.63, or in Gents Heavy Tooth Belcher Ring (Cat. Price \$6.50) for \$3.25. Our finest 12 Gold Filled mountings, GUARANTEED 20 YEARS, SEND NO MONEY. Just mail postcard or this ad. State Size. We will mail at once. When ring arrives deposit \$1.00 for Ladies ring or \$3.25 for Gents with postman. If not pleased return in 2 days for money back less handling charges. Write for Free catalog. Agents Wanted.

**MEXICAN DIAMOND IMPORTING CO., Dept. E.T. Las Cruces, N. Mex.
(Exclusive controllers Mexican Diamonds)**

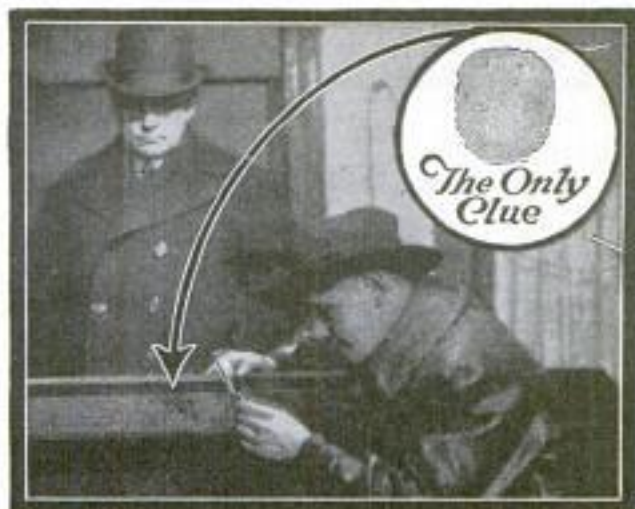

\$500 REWARD for TWO HOURS WORK

It was in answer to a request from the Chief of Police that Warren Biglow, the Finger Print Expert, arrived at the scene of the daring robbery of the T—O— Company offices. The job was undoubtedly the work of skilled cracksmen and robbers of uncommon nerve. \$6,500 in currency—the company payroll—was gone. Not a single apparent clue had been found by the police. Almost immediately after his arrival Biglow turned his attention to a heavy table which had been tipped up on its side. Examination of the glossy mahogany showed an excellent set of finger prints. The thief might just as well have left his calling card. To make a long story short, his prints were photographed and taken to Central Office, where they were matched with those of "Big Joe" Moran, a safe blower well known to the police. Moran was subsequently caught and convicted on Biglow's testimony and finger-print proof. Most of the money was recovered. In the meantime the T—O— Company had offered a \$500 reward, which was given to Biglow—his pay for two hour's work.

Be a Finger Print Expert—Learn at Home in Spare Time

Could you imagine more fascinating work than this? Often life and death depend upon the decisions of finger-print evidence—and big rewards go to the EXPERT. Thousands of trained men are now needed in this great field. The finger-print work of governments, corporations, police departments, detective agencies and individuals has created a new profession. Many experts regularly earn from \$500 to \$10,000 a year in this fascinating game. And now you can easily learn the secrets of this new science in your spare time—at home. Any man with common school education and average ability can become a Finger Print Expert in a surprisingly short time.

FREE Finger-Print Outfit and Large Illustrated Book!

For a limited time we are making a special offer of a complete Professional Finger Print outfit, absolutely free and also a Free Course in Secret Service Intelligence. Mastery of these two kindred professions will open a brilliant career for you. Write quickly for fully illustrated free book on Finger Prints which explains this wonderful training in detail. Don't wait until this offer has expired—mail the coupon now. You may never see this announcement again! Address

University of Applied Science

Dept. 1358, 1920 Sunnyside Ave., Chicago

University of Applied Science, Dept. 1358, 1920 Sunnyside Ave., Chicago

Gentlemen: Without any obligation whatever send me your new, fully illustrated, FREE book on Finger Prints and your offer of a free course in Secret Service Intelligence.

Name.....Age.....

Address.....

Town.....State.....

Please Mention Popular Mechanics

1/2 SAVED
BUY DIRECT
GET BIG BOOK



DO YOUR OWN PLUMBING & HEATING AT LOW COST

Send for our big instructive 256-page well-bound **HANDY-MAN Book-Catalog**. Every home-owner, contractor, farmer, mechanic, institution, etc., needs it. Shows over 10,000 fixtures and supplies in plumbing and heating at wholesale; how to save skilled labor, hard work and unnecessary material by our new

Cut-To-Fit Method

This wonderful encyclopedia on plumbing and heating helps you select and install the proper plumbing, water system, hot air, water or steam plant. Besides being our wholesale catalog, it has many practical plans, diagrams, sketches, elevations, handy kinks, etc., showing how to do the work this newer easy way. Any handy man with a few tools can do his own installing with the aid of this



Pipeless Furnace

Big Handy Man Book

We have spared no effort, and have gone to a **GREAT EXPENSE** to compile this valuable book, and to keep from sending it to uninterested persons, we request 25c, which will be refunded on your first order, or send for our free bulletin.

Write today and save.

HARDIN-LAVIN CO.
50 Years at 4547-4557 Cottage Grove Avenue, CHICAGO

\$500,000 Plants Behind Our Guarantee



Hot Water Boiler

WHITE FLAME

BURNERS make your old kerosene lamps and lanterns give a brilliant white light better than electricity or gas. Doubles your light. Saves oil. **NO MANTLE TO BREAK.** Guaranteed Safe and Reliable. Delights every user. Send now for complete sample postpaid 50 cents, stamps or coin. \$1.00 \$1.25. Money Back if Not Satisfactory. Live Representatives Wanted. Exclusive Territory. WHITE FLAME LIGHT CO., 65 Clark Bldg., Grand Rapids, Mich.



BURN Home Made GAS COAL STOVES

Change your coal or wood stove into a gas stove in 3 minutes. A Child can do it. Burn kerosene Vapor Gas—hotter than coal or wood and costs less. Safe and simple.

FREE TRIAL

Just turn a valve and get even heat instantly. No ashes, no dirt, no smoke, no wood to chop or carry. No fires to build and feed. No fuel wasted. Cooks and bakes better. No damage to stoves. Makes its own gas from common coal oil, cheapest, cleanest fuel. Guaranteed five years. Money back if not satisfied after 30 days trial.

Write for FREE folder with proof and **SPECIAL OFFER**

SIMPLEX UTILITIES MFG. CO.

1110 Simplex Bldg.

2537 S. State St., Chicago

NEW SINGLE PHASE A. C. MOTORS

1/4 H. P.—110 volt, 60 cycle, 1725 speed, complete with cord, plug and grooved pulley... \$13.00

General Electric

1/4 H. P., \$16.50
1/2 H. P., \$39.00



ONE YEAR GUARANTEE

EMERSON

1/4 H. P. \$58.00
1 H. P. 62.00
1 1/2 H. P. 75.00
2 H. P. 89.00

Include Pulley and Base—All Motors, 1/4 H. P. or larger, 110-220 Volt Rep. Ind. Type.

Satisfaction guaranteed or money refunded
Illustrated Catalog of Motors and Supplies FREE
HYRE ELECTRIC CO., 615-M So. Dearborn St., Chicago

"Lighting Fixtures" READY TO HANG

(Direct from Manufacturers) Completely wired, including glassware. New designs. Send for catalogue No 24. Send for **DEALERS'** proposition.

ERIE FIXTURE SUPPLY CO.
STA. A. ERIE, PA.



Beautiful HOUSES \$900 and BUNGALOWS

CAN BE BUILT FOR AND UP
This and many others in my new book, **Building Plans for Modern Homes**, will save you hundreds of dollars. One of the most complete and comprehensive books of plans ever published by any architect. New edition just off the press. Nearly 100 floor plans and photographs of bungalows, Colonial houses, etc., costing from \$200 up; gives sizes and cost to build.

Send postpaid for \$2.00

FREDERICK H. GOWING
ARCHITECT

181 Tremont St., BOSTON, MASS



Why Pay What Others Save?

No one can make better stoves, ranges and furnaces—than Kalamazoo. And no one can give you more for your money than manufacturers dealing direct with you from the factory.

Write for the Kalamazoo Catalog and just find out what wonderful bargains you can get this year in our new designs—blue and gray porcelain enamel ranges—beautiful heaters, etc. Also new pipeless furnaces \$52.95 and up. 400,000 pleased customers. Cash or easy payments. 30 days' trial—**money-back guarantee.** Ask for Catalog No. 473

A Kalamazoo
Trade Mark Registered
Direct to You

KALAMAZOO STOVE COMPANY
KALAMAZOO, MICH.



24-Hour Shipments

BIG MONEY MAKERS for AGENTS



SHOCK-PROOF LAMP, the new unbreakable mill type lamp, is fast replacing the old style. Stronger and gives many times the downward light. As to name imitations, it is **SHOCK PROOF**, stands up and sudden knocks as prevalent in GARAGES, FACTORIES, MILLS, SHIPYARDS, STAMPSHOPS, MINES—even in the HOMES. Lasts longer and is sold for less money. Big money-maker.



FREE Send for our AGENTS PLAN and Booklet, fully explains how easy it is to sell **SHOCK PROOF** lamps. Every GARAGE, FACTORY, MILL, RAILROAD YARD, STORE and HOME is looking for just this chance to get a better lamp for less money and it is a **BIG MONEY MAKER**. AGENTS everywhere are "cashin-in." This is YOUR opportunity. Don't let it get by. Grab it.

SEND FOR OUR AGENTS PLAN TODAY given to agents who qualify. Now is the time to get your share of **BIG MONEY** and **EXCLUSIVE TERRITORY**. GET THE AGENTS PLAN TODAY. IT COSTS YOU NOTHING.

MIDWEST LAMP CO., Dept. C, 141 W. Basile Ave., CHICAGO

BALBA bouquet perfume



Get Our Money-Making Agency Offer
Balba Sales Machines
Make \$200 to \$1000 Monthly

This new plan of selling high quality perfume has taken the country by storm. Men everywhere are jumping at the opportunity to get into this big money-making field. See page 171 of March Popular Mechanics.

Over 500 Cities Already Taken

Remember the first who qualify get the exclusive sales rights. We do the local newspaper and national advertising. Get full particulars NOW.

BALBA CORPORATION OF AMERICA, Inc.
Dept. 44, Adams and Jackson Sts.
TOLEDO, OHIO, U. S. A.



The BEST LIGHT

Positively the cheapest and strongest light on earth. Used in every country on the globe. Makes and burns its own gas. Casts no shadows. Clean and odorless. Absolutely safe. Over 200 styles, 100 to 2000 Candle Power. Fully Guaranteed. Write for catalog. AGENTS WANTED EVERYWHERE.

THE BEST LIGHT CO., 324 E. 5th St., CANTON, O.

Factory to Rider

Saves \$10 to \$25 on the **Ranger Bicycle** you select. You can have your choice of **44 Styles**, colors and sizes. Delivered free on approval, express prepaid, for **30 DAYS' FREE TRIAL**.

12 Months to Pay if desired. Possession and use at once on our liberal year to pay plan. Parents often advance first payment.

Tires best quality, at factory prices, express prepaid. Lamps, wheels and equipment, low prices. Send **No Money**, do business direct with makers.

Mead Cycle Company
Dept. H101 Chicago

Write today for free Ranger Catalog, factory prices and most favorable easy payment terms.



PHONOGRAPH OWNERS: GOOD NEWS!

No More Changing Needles! No More Scratched and Ruined Records! The Everplay Needle cannot injure your records like the steel needles. The playing point consists of a fine, soft, special alloy wire 6 inches long, coiled within the needle. It is extended as used by a turn of the little star head, each adjustment playing thirty to forty records. It exactly fits the record groove at all times, bringing out every note and vibration without the surface noise and scratch. Cleans and polishes the groove, saves \$25 to \$40 in steel needles and much more in wear of records. You be adjusted hard or soft. Without lighting. Guaranteed to play 27,000 records and the last as perfectly as the first. Adds to the appearance of your phonograph, and fits all reproducers just like an ordinary needle. Price \$1.00—10c extra if C. O. D.

Money back if not satisfied. **EVERPLAY Needle Co., Desk 117** Actual size Agents wanted everywhere **McClurg Building, Chicago, Ill.**

DEAFNESS IS MISERY

I know because I was Deaf and had **Head Noises** for over 30 years. My invisible Antiseptic Ear Drums restored my hearing and stopped Head Noises, and will do it for you. They are Tiny Megaphones. Cannot be seen when worn. Effective when Deafness is caused by Catarrh or by Perforated, Partially or Wholly Destroyed Natural Drums. Easy to put in, easy to take out. Are "Unseen comforts." Inexpensive. Write for Booklet and my sworn statement of how I recovered my hearing.

A. O. LEONARD, Suite 226, 70 5th Avenue, New York City



Ladies'
Ring
No. A4350

Genuine Diamond
Solid 14K Green Gold Ring
with White Gold Top.
Was \$50.00. Read new offer:
NOW \$38.75
A Year to Pay

Pay Nothing

An amazing new offer—wear this **GENUINE DIAMOND** for a week at our expense—absolutely no risk to you—deposit nothing—**READ EVERY WORD OF THIS OFFER:**

**Send No Money
Pay No C.O.D.**

Mail the Free Trial Coupon Below

Just send the coupon below—do not enclose a penny—and we will send you on approval at our expense your choice of these diamond rings. The ring illustrated above is the most beautiful hand engraved solid gold ladies' ring you ever saw, set with a fine, large, genuine blue-white diamond. **Pay nothing when it arrives.** Merely accept the ring and wear it for a week, at our expense. After a week decide. If you return the ring, that ends the matter. **You have risked nothing.** But if you keep the ring, send us only \$3.75 a month until you have paid the amazingly low price of \$38.75 for this regular \$50 value. The ring is an elaborate pierced model in solid 14K green gold with hand engraved white gold top. A striking new model. The diamond is a beauty—extra brilliant, blue white, perfectly cut—a remarkably big value.



Men's extra massive 14K solid gold fluted ring with 14K hand cut white gold top set with extra fine perfectly cut blue-white genuine diamond. Extra Big Value. Now \$38.75—\$3.75 a month. Send no money. Pay no C.O.D. A week's trial absolutely FREE. Mail coupon now.

Just mail the Free Trial coupon below. Be sure to enclose finger size. **SEND NO MONEY—pay nothing on arrival.**

Harold Lachman Co., Dept. 1778 204 S. Peoria St., Chicago

Send me absolutely free and prepaid, for a week's trial, the genuine diamond ring checked below. I am to pay nothing when it arrives. After one week I will either return the ring by registered mail and that ends the matter, or I will send you \$3.75 each month until \$38.75 has been paid. Title remains with you until fully paid. **I ENCLOSE MY FINGER SIZE.**

Ladies' Ring No. A4350

Men's Ring No. A4450

Name.....

Address.....

Age..... Occupation.....

Copyright 1922, Harold Lachman Co.

**\$1332.00 CASH
AND
AUTO
GIVEN**



This Offer Open to Men and Women!

A few choice places open for willing workers—men and women—as "Direct from the Factory" Representatives—to introduce our nationally advertised "Zanol" line of high class Food and Household Specialties. All or part time work. No experience and no capital needed. Workers making as high as \$80 to \$100 a week. Beginners \$5 to \$10 a day. Write for particulars and Ford Offer today.

American Products Co., 7224 American Bldg., Cincinnati, O.

Please Mention Popular Mechanics



SOUTH BEND LATHES

Screw Cutting Engine Lathes

STANDARD CHANGE GEAR

9"x 3' Lathe.....	\$ 176.00
11"x 4' Lathe.....	228.00
13"x 5' Lathe.....	304.00
15"x 6' Lathe.....	376.00
16"x 8' Lathe.....	452.00
18"x10' Lathe.....	656.00
21"x12' Lathe.....	933.00
24"x14' Lathe.....	1254.00

QUICK CHANGE GEAR

9"x 3' Lathe.....	\$ 216.00
11"x 4' Lathe.....	273.00
13"x 5' Lathe.....	354.00
15"x 6' Lathe.....	431.00
16"x 8' Lathe.....	512.00
18"x10' Lathe.....	721.00
21"x12' Lathe.....	1016.00
24"x14' Lathe.....	1353.00

Catalog No. 77 sent free to any address

SOUTH BEND LATHE WORKS

625 E. Madison St.

SOUTH BEND, IND.

How to Run a Lathe:—New 80-page book, Revised Edition No. 24, for 10 cents postpaid, silver or stamps.

An Easy Way to Make A Thousand and One Things

SAW a board, cut a groove, smooth a block, sand a joint, grind a tool, buff a piece of metal or do any of a thousand and one things easier, better and cheaper with the

Crane's Junior Bench Saw

Price \$28.75 WITHOUT MOTOR OR BASE

A high grade product of remarkable capacity, low in first cost and upkeep.

Size No Indication of Capacity

The Crane Junior Bench Saw is constructed to handle quantity work whether in brass, fibre, aluminum, steel or wood. Surprisingly simple, accurate and durable.

Dozens of jobs—cutting, ripping, planing, grooving, rabbeting and tenoning, can be done on this machine. Cuts pipe and rollers stock up to 1 1/2" thick. Special saws for type metal, brass, copper, aluminum, fibre, bakelite, etc. Cuts steel tubing, rods, thin sheets of iron, steel, wire, and carbon with elastic energy wheel. Special grooving saws for cutting tenons and rabbets. Carpenters, Contractors, cabinet makers, radio manufacturers, toy makers, printers, private shops, etc., are users of the Crane Junior Bench Saw.

OUR SPECIAL OFFER

For a limited time we offer the Crane Junior Bench Saw with rip guide, cut-off guide and 6" wood or 3" metal saw 1, c. b., Toledo, for \$28.75, cash with order. Special removable insert in table to permit use of 3-8" diao head, \$6.50 extra. Mounted on iron base with 1/4 hp, 110 volt, 60 cycle motor, belt, belt tightener, cord, plug and switch \$60.00, 1/3 hp. motor \$63.50. Prices with other motors quoted on request.

Specifications. All metal construction; height 7 in.; bronze bearings with grease cup; table top 10x12 in., planed smooth and true; flanged pulley 1 1/2" diameter for 1 1/4" belt. (Grooved pulley if desired.) Speed 3500 r.p.m., Power required 1/4 or 1/3 hp. Finish, dull black; wt. 40 lbs. Shipping wt. 50 lbs.

OUR GUARANTEE. Send for a Crane Junior Bench Saw and use it 10 days. If not satisfied, return at our expense and price will be refunded. Ask for prices and descriptive literature on other Boice machines and motors. Satisfaction guaranteed.

W. & J. Boice, Dept. P.M. 11
114 23rd St., Toledo, Ohio



Workmanship! A Keen Kutter knife hides no part of which its maker or owner need be ashamed. To be really knife-satisfied, carry a Keen Kutter.

Simmons Hardware Company

KEEN KUTTER

9 CORDS IN 10 HOURS



BY ONE MAN, It's KING OF THE WOODS. Saves money and backache. Send for FREE catalog No. B115 showing low price and latest improvements. First order gets agency. Folding Sawing Machine Co., 1005 East 75th St., Chicago, Ill.

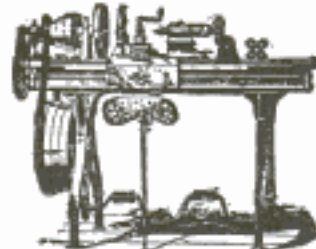

LATHES

9 to 18-inch Swing

List price \$165 and up according to size. When ready to buy send for Lathe Catalog and prices.

W. F. & John Barnes Co.

100 Ruby Street, ROCKFORD, ILL.

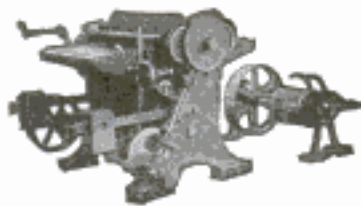

It is the well known quality of CRESCENT machines that justifies you in selecting one of them each time you have need for wood working machinery. The CRESCENT line is better than ever and will always give you satisfaction in every particular. Ask today for catalog of hand saws, saw tables, jointers, shapers, planers, borers, planes and matchers, swing saws, disk grinder, cut off table, hollow chisel mortiser, variety wood worker. Universal wood workers.

THE CRESCENT MACHINE CO., 93 Columbia Street, Leetonia, Ohio

6 Hour Constant Potential Battery Charging - Pays Big!

Charge auto and radio batteries perfectly in 6 to 8 hours with new HB Constant Potential Charger, instead of 3 to 4 days as formerly. Increases profits, draws trade, overcomes competition, saves current and rentals. HB users making \$1500 to \$3000 yearly. You can too! Small cash payment brings this money-maker, balance easy terms. Biggest season yet starting. Write for information. Ask about HB Air Compressors, Motor Grinders, etc. **HOBERT BROS. CO., Box M 11, Troy, Ohio.**

Small Down Payment - Increased Profits Carry Balance





UNSCRAMBLE that wire with Bernard's. The pliers that swallow wire, so you can grip it anywhere like a vise. Parallel jaws, outside cut and open throat. Why worry with old-style pliers? Hardware dealers.

MADE IN SEVEN SIZES

Send for illustrated Plier Booklet M



PARALLEL JAWS

**BERNARD
PLIERS**
Wm. SCHOLLHORN CO.
NEW HAVEN, CONN.



OUTSIDE CUTTER

For that tough job where soft solder won't work—you need

Briggs' Silver Solder

1 oz. Tube—5 ft. long, 3/4 in. wide, 3/1000 in. thick, in non-waste, metal box. **\$1.25**

J. BRIGGS & SONS CO., Mfrs.
67 Clifford St. Providence, R. I.



Dealers and Agents; Request Attractive Proposition

Adjusts Instantly to Any Length

Just slide it out. Gives exact inside or outside diameter. No fiddling. Accurate, strong, brass trimmed. Any length 2 to 8 feet. If not at dealer's, sent postpaid.

Master Rule Mfg. Co., Inc.
841-43 East 136th Street
NEW YORK CITY

Interlox
MASTER SLIDE RULE



The Midget "FIVE-IN-ONE" Slide Rule is a combination Mannheim, Log-Log, Add and Subtract, Polyphase and Binary Slide Rule. It will instantly add, subtract, multiply and divide any combination involving whole numbers, fractions, decimals and mixed numbers. Gives every possible root and power of every quantity. The graduations are printed on metal, coated with white celluloid and are green and waterproof. While it is the most versatile calculator ever invented, its operation is simple and easily understood. Diameter 4 inches. Price with 16-page Instruction Book, \$1.95. Leatherette carrying case 50c extra. Catalog free. Your money back if you are not satisfied.
GILSON SLIDE RULE CO., Niles, Mich.



TOOL CHESTS

for Machinists & Toolmakers
Every tool arranged in order. No up-to-date mechanic should be without one. A Gerstner Case costs no more than some tools, and will last a lifetime. Catalog free.

Gerstner & Sons

717 Columbia Street DAYTON, OHIO



"Red Devil" Rapid Boring Auger Bits are 33 1/4% easier boring, have 10% greater clearance, and bore with or against the grain of any wood. Style 2400—10/16 in., shown here, 75c.

Red Devil

REG. U. S. PAT. OFF.

Lock Washers Do Stop Vibration!



LOOSENING, rattling, wear and tear put to an end instantly and permanently!

Bolts and nuts on automobiles, trucks, tractors, stationary and marine engines, farm machinery, etc., **hold and stay tight!**

"Red Devil" Lock Washers are corrugated—have six points of contact, where others have only two. It requires 1/4 turns to loosen them; others loosen with a 3/4 turn. That means 66 2/3 per cent greater efficiency. Easy to apply.

In assorted sizes in handy bags as follows: 30 in a bag, 15c; 40 in a bag, 20c; 90 in a bag, 25c. At hardware stores, or if not in stock, send dealer's name and order direct.

"Red Devil" Mechanics' Tool Booklet Free.

"RED DEVIL" TOOLS—AMERICAN MADE
SMITH & HEMENWAY CO., Inc.
260 Broadway, New York, N. Y.

"Red Devil" Glass Cutters—the glaziers' standard tools of the world. "It's all in the wheel." Made in 40 styles. No. 024 shown here, 20c.



Please Mention Popular Mechanics

\$5.00 Makes This
Down

**Genuine
Diamond
Ring—
Yours**



Send no money. We'll send you this beautiful, SWEET Diamond Engagement Ring entirely FREE. Ring is 14K. solid gold with 18K. white gold prongs. If satisfied pay only \$5 upon receipt, then send balance, \$4 a month. Price of ring, \$45.



FREE Send for your copy of 98-page colored catalog, showing the greatest assortment of DIAMONDS, WATCHES AND JEWELRY—gifts for all occasions. Write to Dept. 62-S.
Capital, \$1,000,000

"THE HOUSE OF QUALITY"
CAPITAL \$1,000,000.

L.W. SWEET INC.
1650-1660 BROADWAY, NEW YORK



Little Giant Drill Press

Just the thing for small shop and experimental work. Mechanically right and well made. Sizes 0 to 3/4 in. drill. Weight 22 pounds. Price \$15.00.

Send for circular.

SYEPHER MANUFACTURING CO.
Dept. "D" Toledo, Ohio

ALL RADIO OPERATORS USE



25c

MOST WONDERFUL SOLDER EVER INVENTED Per Tube

SOLDERS WIRES
SOLDERS RADIO CONNECTIONS
SOLDERS POTS & PANS
SOLDERS ALL METALS

Put up in Paste Form in Collapsible Tube Ready for Instant Use.

Sold By All Up-to-Date Stores Or Sent By Us Post Paid

SOLDERALL CO., Dept. P
129 Sussex Avenue NEWARK, N. J.

The Monarch Junior Lathe is also made in a larger size, with 11 inches swing, at slightly higher price

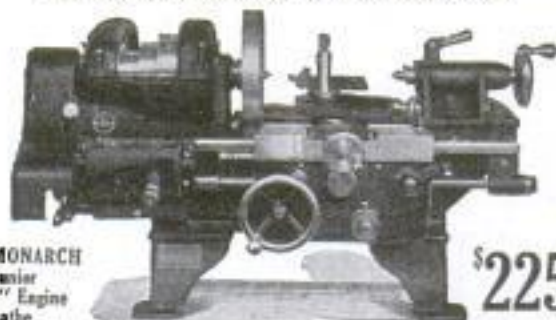

MONARCH
Junior
9" Engine
Lathe

\$225

Here's the Lathe You've Long Been Looking For

INVENTORS—EXPERIMENTERS—MECHANICS—AUTO REPAIRMEN—here's the lathe that will exactly answer your requirements for a small, compact and trouble-proof tool for your workshop.

The MONARCH Junior 9" Engine Lathe is fully equipped—has a 2 1/2 foot bed—semi-quick change gear—bench legs—and automatic safety devices. It will do any small work that any other lathe will do and do it with 1-1000 of an inch accuracy. Built with bed lengths up to 5 feet.

Write today for Free catalog of MONARCH Lathes which are built up to 30 inches swing

THE MONARCH MACHINE TOOL CO.
400 Oak Street Sidney, Ohio

MYERS WONDERFUL SEWING AWL

Tools in Handle



A complete repair shop in itself. Sews anything heavy or light, leather, shoes, harness, buggy tops, curtains, bolts, etc. \$1.00 Postpaid.
C. A. MYERS COMPANY, 6339 Woodlawn Ave., Chicago, Ill.

BURN YOUR NAME ON TOOLS WITH

ARKOGRAF

Protect your tools from theft. Write any name, engrave any design on metal with electricity like writing on paper with pen or pencil. Complete outfit \$3.50, prepaid anywhere. Interest-free descriptive circular free. Write today. Agents wanted. Arkograf Pen Company 1007 Yeon Building Portland, Oregon



MOTORCYCLE BARGAINS

Save 25% to 65%

on Slightly used and Rebuilt Motorcycles, Side Cars, Johnson Motor Wheels, Evans Power Cycles, Bicycles. Send for Free Bargain Bulletin and Money Saving Message, listing hundreds of Bargains in used, rebuilt and new machines, supplies, accessories, etc.

AMERICAN MOTOR CYCLE CO.
Dept. 7114 2047 W. Chicago Avenue, CHICAGO



MOTORCYCLES

RELIABLE STANDARD MAKES that you can DEPEND on.

Enjoy the glorious experience of going wherever you like—whenever you like. The price is within your means—35% to 50% less than others. These machines are slightly used, thoroughly overhauled or rebuilt.



Send for catalogue.
MYEROW BROS.
258 Columbus Ave., Boston, Mass.

Guaranteed Motors at a Bargain Price



1/6 HP.
\$10

THEY'RE RELIABLE REYNOLDS MOTORS

These are new, first-quality motors. Made and guaranteed by a big, responsible house. They cost us more than \$10 to make. All ready for assembly when orders were cancelled. You save more than half.

JUST THE THING FOR HOUSE, GARAGE, SHOP

Deliver full 1/6 H. P. with liberal overload capacity, 1750 R. P. M. Alternating current, 110 V. 60 Cy. (also 1/8 H. P. for 25, 30, 40, 50 Cy. or 220 V. at \$10 each). Suitable for washing-machine, ironer, dishwasher, compressor, bench lathe, blower, fan, drill press, scroll saw, etc.

MADE AND GUARANTEED BY WELL KNOWN HOUSE

Low price may not mean a bargain in a motor. A low grade, unreliable, short-lived motor is expensive at any price. But these are new, high grade, Reliable Reynolds Motors—a motor bargain at \$10—that you are not likely to meet again.

SOLD ON MONEY BACK GUARANTEE

New motor or free repairs if anything goes wrong within one year. Parts always obtainable. Net weight 20 pounds, shipping weight 26 pounds. Easy means of reversing direction of rotation. 10 ft. cord with attachment plug, 50c. Pulleys, 1 1/2 inch or 2 inch, 50c.

Send cash or order C. O. D. by express.

REYNOLDS 2610 W. Congress St.
ELECTRIC COMPANY CHICAGO, ILL.

MAKE YOUR FORD INTO THIS SPORT CAR \$ ONLY 6.40
Other type down to \$3.20. *Patented* size 28, *Pat-Fit* 22-size patterns and simple picture instructions show how. You can easily convert your Ford into this fast, snappy Sport Car as hundreds have done with a few dollars worth of material from the hardware store. No need to lay up the car. The "PAL" with central disc wheel pattern. Pressed Metal Streamline Rear only \$3.40 delivered. Built low, rides wonderfully easy. Order NOW while we can make good delivery. Send 5c coin for illustrated prospectus of "Sport Cars," "Jigs," "Taps and "Gases" by Webster, Koempel Co., 30 Koempel Bldg., Guttenberg, Iowa

Keen, Classy Up-to-the-Minute Taps and "Gases" Webster, Koempel Co., 30 Koempel Bldg., Guttenberg, Iowa

MAKE OVER \$800 MONTHLY



Owning and operating an Anderson Vulcanizing Station. We guarantee the Anderson as the best money-making vulcanizer made.

Write us for Terms and Prices.

ANDERSON STEAM VULCANIZER CO.
Pop-Williams Building Indianapolis, Ind.
An Anderson School is near you.



No. 1-J. G. Grinder

11¢ a Day

soon pays for this Grinder

CAN you afford to be without such a sturdy, accurate grinder when its cost per day is so trifling? Makes difficult jobs easy. Limits of .0001 are possible with this handy grinder. Perfect balance combined with correct cutting speed eliminates chatter-marks, taper, or bell-mouth. Pivots on its base and is adjustable to any angle. Easily portable for quick set-up on any machine, this DUMORE No. 1—J. G. Grinder is the ideal tool for garages, repair shops and small machine shops.

Write for interesting booklet, specifications and prices.

WISCONSIN ELECTRIC CO.
Dept. G-11 Racine, Wisconsin

DUMORE HIGH SPEED GRINDERS

TWO-YEAR GUARANTEED BATTERIES SAVE 50%



© 1921

SPECIMEN PRICES
Ford-Dart-Chev. \$18.80
Overland-Buick 21.85
Maxwell-Dodge 25.60
Save 50% Service on all cars

Famous "Royal" Batteries—highest quality made—now selling direct from factory to car owner. You save half. We give written 2-year guarantee—longest on any battery. Big responsible organization backs guarantee. Batteries for any car, tractor or gas engine. Save time. Order from this ad. Battery, fully charged, shipped immediately—by express C.O.D. You run no risk. Our location same for eight years. Reference: Nat'l Bank of the Republic, Dan or Brodstreet.

Free Booklet If you want description give address first, send for free booklet. Gives full details of this superior battery. Get this booklet before you buy any battery. Write today! Give your car model of your car.

K-E BATTERY CO., Dept. 141
646 N. Michigan Ave., Chicago

Largest Exclusive Mail Order Battery House in America
Members of Chicago Association of Commerce

WHITING-ADAMS BRUSHES

Demanded by Master Workmen. Advertiser by All Users as the Best. Methods of Construction Render Failure Impossible.

Send for Illustrated Literature

JOHN L. WHITING-J. J. ADAMS CO., Boston, U. S. A.
Brush Manufacturers for Over 113 Years and the Largest in the World



DELTA ELECTRIC BICYCLE LAMP

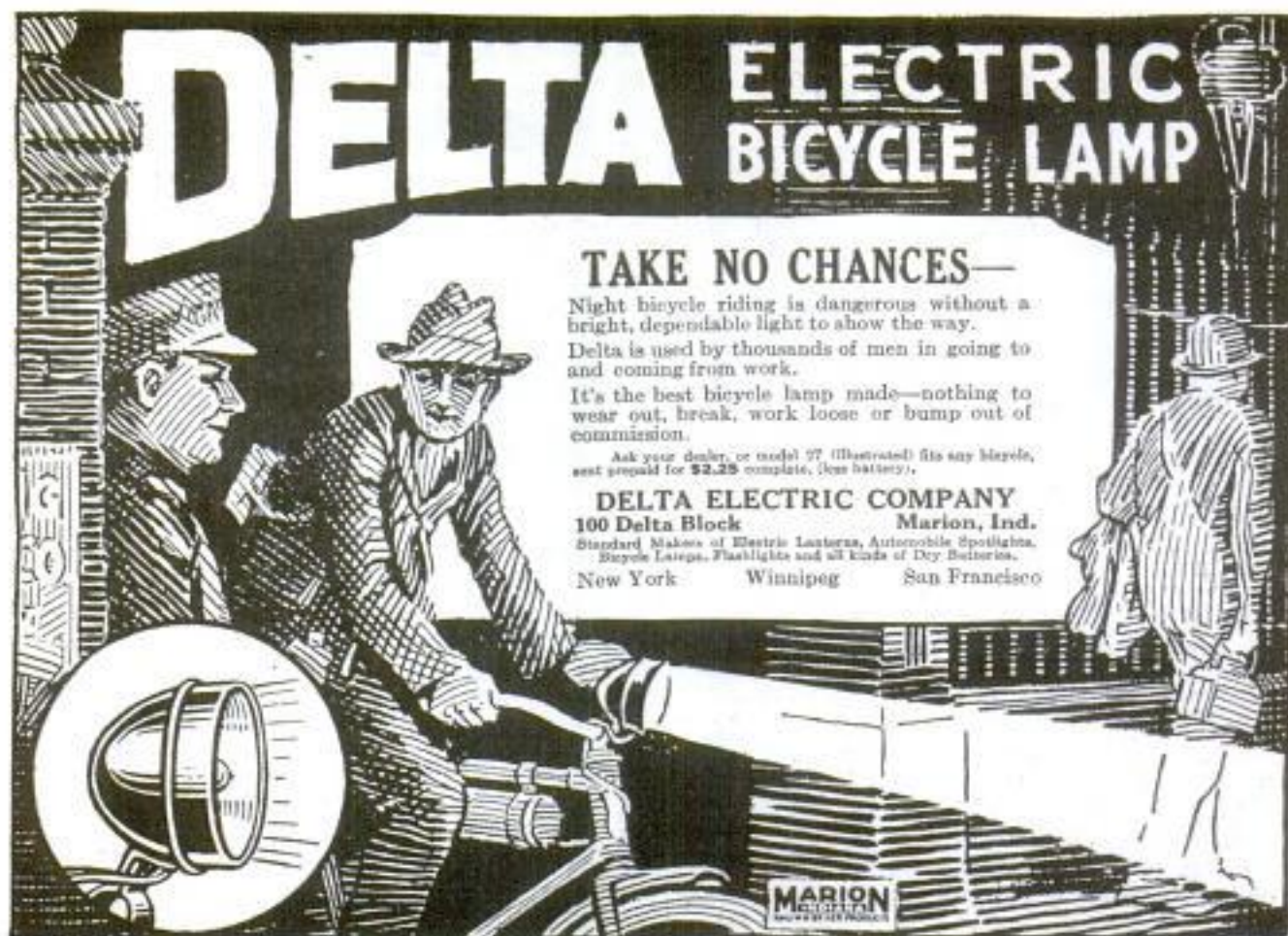

TAKE NO CHANCES—
Night bicycle riding is dangerous without a bright, dependable light to show the way. Delta is used by thousands of men in going to and coming from work. It's the best bicycle lamp made—nothing to wear out, break, work loose or bump out of commission.

Ask your dealer, or model 97 (illustrated) fits any bicycle, sent prepaid for \$2.25 complete, (less battery).

DELTA ELECTRIC COMPANY
100 Delta Block Marion, Ind.
Standard Makers of Electric Lanterns, Automobile Spotlights, Bicycle Lamps, Flashlights and all kinds of Dry Batteries.
New York Winnipeg San Francisco

MARION
MADE IN U.S.A.

FEDERAL BICYCLE TIRES



"Slim Has Been Along Here Because These Are His Bicycle Tracks. He Just Got a New Set of Federal Tires."

THE tread trail of Federal Bike Tires is "The Road Mark of Extra Service."

Sturdy, tough, wear-resisting and highly puncture-proof, they add greatly to the life, comfort and performance of your bike.

THE FEDERAL RUBBER CO.
of Illinois
Cudahy, Wisconsin

Traffic

Please Mention Popular Mechanics

The "Big Star" Quality Line

Delivered to You Free

For 30 days trial on approval. You can have your choice of 44 Styles, colors and sizes of the famous RANGER Bicycles. Express prepaid. Factory-to-Rider Prices save you \$10 to \$25 on your bicycle.

12 Months to Pay if desired. Many boys and girls easily save the small monthly payments. Parents often advance first payment.

Tires—best quality, at factory prices, express prepaid. Lamps, wheels and equipment, low prices. Send No Money, do business direct with makers.

Mead Cycle Company
Dept. H108 Chicago

Write today for free Ranger Catalog, factory prices and marvelous easy payment terms



CUSTOM TAILOR MADE To fit your individual car

Made in our custom shops after your order is received. We ship ordinarily in 2 or 3 **\$4.40 and up** Parcel days. Perfect fit guaranteed Post Paid

easily apply it yourself. We furnish instructions and all necessary tools, wets and fasteners. Our catalog No. 11, with samples, is free for the asking.

LIBERTY TOP & TIRE CO., Dept. E-7, Cincinnati, O.



The Duncan will cure Two or Three tires as many times per day, heavy duty mold. Will cure Two 2 1/2" or Three 4" or Two 4 1/2" Tires at one time and will make as perfect a cure with sand bag pressure as with air bag.

Earn \$600.00 a Month by Yourself with a DUNCAN Vulcanizing Plant

Includes every tool and vulcanizer for a high-grade repair business. Will handle the work of six men. Will cure either Cord or Fabric Tires in the same cavity, perfect to form and contour, without a reducing shell.

We teach you approved factory methods of tire repair, in your own home or in one of our many Schools FREE, when you purchase DUNCAN EQUIPMENT.

There is a big demand for high-grade shops and competent repairmen. We will start you in business for a small cash payment. Write today for all particulars of this really wonderful offer, and get started in this paying business for yourself.

F. M. DUNCAN COMPANY

314-49 East Ohio Street, Department P., Chicago, U. S. A.

SMOOTH-ON REPAIR BOOK

MOTORISTS

You Need This Free Book

Repairs such as leaky radiators, radiator edges, etc., can be made easily and quickly at a few cents' expense by using

SMOOTH-ON IRON CEMENT NO. 1

Write for FREE Book and learn how

Smooth-On is also unequalled for making household repairs. Sold by Hardware and General Stores in 6 oz., 1 lb. and 3 lb. tins. Also in larger sizes.

SMOOTH-ON MFG. CO.
Dept. 37-K Jersey City, N. J., U. S. A.

No Matter Where the Leak SMOOTH-ON Will Stop It.



Miracle No. 7

Motorist left car parked at curb and on returning found someone had backed into radiator, starting leak. Was advised to use liquid

RADIATOR NEVERLEAK

as it would save delay and costly repairs. Secured 75c can and poured contents into radiator. Leak completely and permanently stopped almost instantly. Radiator has not leaked since.

Carry Radiator Neverleak for emergency. **Guaranteed** not to clog or impair cooling system. At all dealer's or sent post-paid for 75c.



Buffalo Specialty Co.

The Liquid Veneer People
357 Ellicott Street
Buffalo, N. Y.

LAUGH AT THE WEATHER

with

"Wear Me"

Windshield Wings

10"x20" Beveled Plate Glass. Clamped not Bolted. Hardware Strong and Rustproof. No interference with Slide Curtains. Fully Guaranteed.

\$12.50 per set
Ford Special \$10.00 per set
"The Kind You Have Been Waiting For"



WEAR ME AUTO SPECIALTY CO.
"Wear Me" Auto Specialists
PITTSBURGH PA.

Order from your dealer or direct

AGENTS Wanted

Big Money

to Active Agents

WRITE FOR DETAILS

Converse Tire Co.
Malden (48) Mass.



Worn-Out Tires good for 3000 miles



Wonderful invention. Inside Tyres—Inner Armor for automobile tires. Old worn-out casings will give 3 to 5,000 miles more service. Positively prevent punctures and blowouts. Guaranteed to give double tire mileage, any tire—old or new. Applied without tools, just slip inside casing before replacing tube.

CAR OWNERS SAVE \$50 A YEAR

Will not heat or pinch. Use over and over again. Low priced. Over 100,000 satisfied customers. Write for special terms. Agents wanted.

AMERICAN ACCESSORIES CO., B-1576, Cincinnati, O.

Only \$45.00 For This Job Complete

Save exorbitant freight rates and one-half original cost by buying Ford Speedster Bodies knocked-down. Simple, complete instructions furnished, all parts cut to exact fit. Any one who assemble this job. Complete with hood, radiator shell, instrument board, upholstery, metal parts, wood parts, belts, screws, etc. Front radiator shell furnished made up. Designed low with lack of wind resistance. Price set up \$90, further particulars on request.

The Central Auto Supply Co., Eng. Dep. 120, Louisville, Ky.



World Batteries

for

RADIO OR AUTOMOBILE

SAVE YOU 50%

Buy direct from factory. Get highest quality—lowest prices and 100% battery service.

WRITTEN TWO-YEAR GUARANTEE

Batteries shipped immediately express C.O.D. Thousands of satisfied users. Mail your order today!

AUTOMOBILE PRICES	
6 Volt, 15 Plate	\$12.50
Ford, Durr, Chev.	
6 Volt, 18 Plate	14.50
Overland, Buick, 12 Volt, 7 Plate	18.00
Maxwell, Dodge	
Same 50% Saved on all cars. Give make car	

RADIO PRICES	
6 Volt, 40 Amps.	\$ 8.50
6 " 60 " "	10.00
6 " 80 " "	12.50
6 " 100 " "	14.50

World Battery Company 1219 S. Wabash Ave., Dept. P CHICAGO, ILL.



Big Profits in 6 Hour Constant Potential Battery Charging

New HB Constant Potential Outfit charges auto and radio batteries perfectly in 6 to 8 hours. Old systems take 2 to 4 days. Get in your own big money-making battery charging business now with this new HB Outfit. Make \$150 to \$300 every month. Easy payments, money-back guarantee, free trial. Send postal for information. Do it now. Coming season pays biggest profits. **HOBART BROS. CO., Box M 112, Troy, Ohio.**

Small Cash Investment - Increased Profits Carry Balance





Mends Most Everything

Crockery broken? Tool handle cracked? Clothing torn? A strip of Tirro, and presto, it's mended! Sticks to metal, china, glass—extra strong and waterproofed. Nothing just like it—a handy mender. 15c 25c 50c. Ask your druggist.

Mail This for Free Strip and Booklet, "1001 Uses" P M 11-22
BAUER & BLACK, 2590 S. Dearborn St., Chicago
 Name.....
 Address.....

FORDS RUN 34 MILES on Gallon of Gasoline



Wonderful new carburetor. Guaranteed to reduce gasoline bills from one-half to one-third and increase power of motors from 30 to 50%. Start easy in coldest weather.

Sent on 30 DAYS' TRIAL

Fits any car. Attach yourself. Fords make as high as 34 miles to gallon. Other cars show proportionate saving. Send make of car and take advantage of our special 30-day trial offer. Agents Wanted.

AIR FRICTION CARBURETOR CO.
 Dept. 3380 Dayton, Ohio

Men Who Like Good Tools Appreciate UNION TOOL CHESTS

They are strong, and keep tools free from harm and theft. Enable you to know where every tool is when you want it. They are arranged in a manner that every mechanic likes. Zinc covered and variety are illustrated and described in our booklet. Write for it. It's free.



UNION TOOL CHEST CO.
 22 Mill St. Rochester, N. Y.

Please Mention Popular Mechanics

GET FACTORY PRICES ON GALVANIZED ROOFING

EDWARDS "REO" Metal Shingles

Absolutely rust-proof — edges as well as ends. Not the space of a pin point exposed to weather. Also fire and lightning proof. Reduce insurance. Outlast building. Need no repairs — and all roofing expense. Easy to lay — one man can do the work — hammer and nails only tools needed. Lay over old shingles if desired. Patent interlocking device makes water tight seams — all nail heads covered — no rust or leaks possible.

Exclusive "Tightcote" Process

Put all Edwards Galvanized Roofing in a class by itself. Bend, twist, strike it with a hammer as much as you like — you can't loosen or scale off the galvanizing — due to our "TIGHTCOTE" process which practically makes zinc covering a part of the metal sheet. No other galvanized roofing can withstand this test.

FREE Roofing Book

Don't buy roofing until you get our big free book, describing Edwards famous "Tightcote"



Roofings, Sidings, and Ceilings, and our lowest factory prices. We sell you direct and save you in-between dealers' profits. Write for Roofing Book No. 160.

Low-Priced Garages

Lowest prices on Ready-Made Fire-Proof Steel Garages. Set up any place. Send postal for Garage Book showing styles.

THE EDWARDS MFG. CO.
 118-120 Pike St. CINCINNATI, O.



Corrugated



Brick Siding



FREE Samples & Roofing Book

SEND for the INTERNATIONAL CATALOG

Factory to Consumer direct—

FOR FORD, CHEVROLET and DODGE.



Our net price list of auto bodies and body supplies at Wholesale Prices. Save big money by buying Direct from Factory

PRICES FROM \$27.95 UP
 International Body Works 914 W. Ohio Street, Chicago, Ill. Dept. 7

HAWAIIAN IM. DIAMONDS



No. 8810 Special price \$2.98

The Greatest Discovery the World Has Ever Known Just to advertise these 10,000 diamonds we will send you one of these 14K gold rings, postage paid. When it arrives pay postage \$2.00 C.O.D. charges to cover rest, etc. Only 10,000 rings given away. Money refunded if you can tell it from a genuine diamond. Send now to:

KRAUTH & REED
 Dept. C Masonic Temple Chicago



No. 9011 Special price \$2.98

RADIO & AUTO Storage BATTERIES CHARGED

FROM A LAMP SOCKET At Home For a Few Cents, With An F-F BATTERY BOOSTER, which has FULL WAVE

Magnetic Rectifier for 100-125 volt 60 cycle A.C. Leave Battery just as it is in Your Car, Snap Charger Clips on Battery Terminals, Turn Switch, & Battery Will be Charged in the Morning. **AMMETER** Eliminates ALL GUESS WORK. A Complete Portable Automatic Charging Unit, with Infusible Carbon Rectifying Brushes, which Charge Uninterruptedly. No Skill is Required. A Fully Charged Battery Starts Car & Truck Quick, this lower expensive Replacement Storage Batteries must be bought, when kept Fully Charged. So It Costs Less to Buy a Booster than to buy a new one. Do Not Think Your Battery is dead, and wear out simply because it will not start Your Car. Buy a BOOSTER, Fit it with Life and Bear Charge 100% F-F Automatic Full Wave, BATTERY BOOSTERS SAVE YOU MONEY and Lasts Lifetime. **POPULAR PRICES:**
 Type 6 charges "A" 6 volt Battery at 6 amperes \$15
 Type 8 charges Radio "B" Batteries up to 120 volts \$18
 Type A-B charges both "A & B" Radio Batteries \$20
 Type 12 charges 12 volt Battery at 12 amperes \$18
 Type 16 charges 6 volt Battery at 16 amperes \$20
 Type 1612 charges 12 volt Battery at 7 amperes \$20

Charges Auto & Radio Batteries. Type 1600 is a Combination of Types 1600 & 1612 \$25
 The Larger Types are recommended for heavy Batteries, or where time is limited. Shipping Weights Complete with **AMMETER & BATTERY CLIPS** 11 to 15 pounds. Purchase from Your Dealer or Mail Check for Prompt Express Shipment. If for Parcel Post add Postage & Insurance Charges. Or Order us to forward TYPE desired C.O.D. For Dependable, Economical **GROUP CHARGING, WRITE for FREE Descriptive 12 Battery, 8 Ampere, FULL WAVE, Automatic ROTARY RECTIFIER Bulletin 24-A. ORDER Now or WRITE Immediately for FREE Descriptive BOOSTER Bulletin 24. THE FRANCE MFG. CO., CLEVELAND, OHIO, U. S. A. Canadian Representatives: Battery Service & Sales Co., Hamilton, Ontario, Canada**

Home School Club
MARVELOUS MOVIES
 Church Camp Office

The most beautiful and best constructed motion picture machine for the price in the world. Shows the same clear, crisp movies the big theatres exhibit. Child or grownup can easily operate the **Paramount** without any previous experience. Do not confuse this machine with toys at the same price. The **Paramount** is not a toy. It is a real, wonderful, guaranteed machine made of best materials by skilled workmen.

Just attach the electric plug to any electric current and turn the crank and your show is on. The entire outfit, complete, weighs only twelve (12) pounds.

Our Film Service Is Available
 Includes best movie stars

The **PARAMOUNT** Motion Picture Machine (Patents pending) Price . . . **\$35.00**
 (Sent anywhere—ready for use)

Inquire at your nearest dealer. If he cannot supply you write us mentioning dealer's name and we will send you our free catalogue.

Remember there is no substitute for the **PARAMOUNT**

PARAMOUNT MFG. CO.

Box 1371, Dept. M.

BOSTON, MASS., U. S. A.



Professional Construction
 Absolutely SAFE



"Health brought me Beauty"

"My friends had used Renulife Violet Ray successfully for neuritis, (my ailment), rheumatism, blood and nerve disorders.

"I was persuaded to try this new, scientific treatment—the relief from pain overjoyed me and in addition, my friends say I'm actually beautiful now."

Renulife Violet Ray

saturates the body with highly therapeutic electricity, reaches the source of the ailment and aids nature in bringing back health, vigor and energy.

If you are suffering from any ailment, or if you lack a fine clear complexion, write for full information. Renulife has proved a blessing to many. You owe it to yourself to try this modern treatment.

Renulife Electric Co.

1114 Newberry Bldg., Detroit
 (In Canada, Pitt St., E.
 Windsor, Ont.)



REGISTERED TRADE MARK
CHEMCRAFT
 THE CHEMICAL OUTFIT



There's Fun and Mystery in Chemistry!

Let **CHEMCRAFT** show you the wonders and fascinations of chemistry. It's fine fun to be an amateur chemist and perform wonderful and interesting chemical experiments with your own chemical laboratory. You can join the Chemcraft Chemist Club too, and start a local chapter under your own name. **CHEMCRAFT** outfits are scientifically correct; are educational for both boys and girls and a never-ending source of interest. They do not contain any explosive or poisonous chemicals. There are five different sizes; No. 0, 75c No. 1, \$1.50; No. 2, \$2.50; No. 3, \$5.00, and No. 4, \$10.00. They can be obtained wherever good toys are sold. Look for them in your local stores.

Run a Magical Show with **CHEMCRAFT-MAGIC**

This is an outfit containing everything required to conduct a first class performance of mystifying chemical tricks, with full directions telling how to arrange for and run the show. Contains a Magic Wand and many magical chemicals which produce startling, yet harmless results when used by the boy who knows how. Complete outfit is only \$3.00 at any store which sells good toys. (West of Denver, Colo., and in Canada, these prices are 10% more.)

Let us send you a free copy of the Chemcraft Chemist Club Magazine; a real boy's magazine, full of stories and new ideas. Just ask for it on a postal card—it will come to you Free!

THE PORTER CHEMICAL COMPANY

Porter Products Put Science at Your Service

103 Washington St., Hagerstown, Md.



Let DIAMONDS say Merry Xmas



642 AD—18" Pearls, Diamond Clasp. \$14.50



643AD—Premier diamond Ring. \$95.00



644AD—Engraved, Diamond \$37.50



645AD Hexagon diamond Ring. \$55.00



651 AD—Platinum Dia. Ring. \$118.50



649AD—Premier Cluster. 7 dia., \$73.50



653AD—W. G. Cluster. Dia., \$59.50



652AD—14 kt. Wh. Gold 15-jwl. Wrist Watch \$33.65



654AD—Blue, white. Dia. Rg., \$110.00



647AD—Belcher Dia. Ring. \$80.00

NO MONEY DOWN

THE startling Diamond values pictured can be yours without risking a single penny. Each item is ideally suited for a charming Christmas gift. Your selection sent on your simple request without a single penny down. If you don't agree that it is the biggest bargain you ever seen, return at our expense. If you keep it, pay at the rate of only a few cents a day.

YEARLY DIVIDEND

You are guaranteed 8 For Cent. yearly increase in value on all diamonds exchanged; also 5 For Cent bonus dividends.

J.M. LYON & CO.
2-4 MAIDEN LANE-NEW YORK
In Business Nearly 100 years

SEND FOR
MILLION
DOLLAR
BARGAIN BOOK
FREE

MILLION DOLLAR
BARGAIN BOOK FREE

Send for your copy today to Dept. 1778. See these bargains. Special Discount of 15% on all cash sales this month only.

Please Mention Popular Mechanics

NEW AUTO SWING

ONLY **\$1** Complete as illustrated

Automatic swinging—the new safe thrilling sport for children. Swings without effort—the weight of the hands swing the child. Let your boy or girl have the Auto Swing on

TEN DAY Free Trial



MONEY BACK GUARANTEE

If you and your children do not find Auto Swinging to be the most fun they have ever had for one dollar, send it back and we will refund you your dollar. You are the judge! Remember this is positively a

Limited Time Special INTRODUCTORY OFFER

And our method of placing this new invention for children in the greatest number of homes in the shortest time. Send us your name, address and One Dollar Bill or money order and we will immediately send you one Auto Swing with the privilege of Ten Day Free Trial and Money Back Guarantee. As a special inducement during this month

We Pay Postage \$1 in your first, last and only cost! For your kiddies sake mail the dollar and your name and address today!

AUTO SWING CO
Box 11 PM, NAPPANEE, IND. U.S.A.

NO JOKE TO BE DEAF

—Every Deaf Person Knows That I make myself hear, after being deaf for 25 years, with these Artificial Ear Drums. I wear them day and night. They are perfectly comfortable. No one sees them. Write me and I will tell you a true story, how I got deaf and how I make you hear.



Address
GEO. P. WAY, Artificial Ear Drum Co. (Inc.)
80 Adelaide St., Detroit, Mich.



Medicated Ear Drum
Pat. Nov. 2, 1906



SHOP WORK with a

CARNES ARTIFICIAL ARM

FOR nearly ten years a Carnes Artificial Arm has kept Mr. Pahhe Yarns of Lawrence, Kan., on the payroll as a draftsman and machinist at a good salary. Thousands of other mechanics, artisans, office workers, farmers and laborers owe their independence to this improved arm.

Life-Like in Action and Appearance

The Carnes Arm cannot be detected from the natural except by close inspection. Its user can dress himself, use knife, fork, pen, pencil and keys; pick up large or small objects, carry grips—in fact, do virtually everything that was possible before. He can bend the elbow of the Carnes Arm, bend and turn the wrist and open and close the fingers at will, even if the amputation is at the shoulder.

192-Page Book FREE. A book of 192 pages, profusely showing what can be done with this remarkable invention, will be sent free to any person interested. Send for it now.

CARNES ARTIFICIAL LIMB CO.,
208 Carnes Bldg., Kansas City, Mo.

This Man Gave Up a
FOR A FUTURE *with*



Public Service Career
OLD MASTER

EARL A. ZEISLOFT, late Director of Public Service, City of Akron, Ohio, also City Chief Engineer, Engineer of City Plan Commission, and member of Board of Control, retires from public life, and an assured niche of success, to cast his lot—his entire future—with "OLD MASTER" organization.

This act is a challenge to others with ambition; an example of courage. A successful administrator of public service, a man with vision, sees a greater future in "OLD MASTER" activities. This proposition should be worth your investigation.

**\$50.00 to \$150.00 Per Week
Working for Yourself**

Here is what Zeisloft with his broad vision of opportunity, foresees—As "Old Master" representative, Local Agent, District Distributor, holding the exclusive right to sell the wonderful "Old Master" 24-hour Auto Enamel, with which anyone can "Paint the car today—drive it tomorrow", you can rise from the wage earning class to independent business man, and in a short time make for yourself the salary stated above. This is a nation-wide public service to the auto owner and to men who would be independent and in business for themselves.



Be An "Old Master" Business Man

Investigate this proposition today. Don't delay. All around you business is plentiful. Autos must be repainted; protects the investment; adds value to the car. "Old Master" gives beautiful finish—like new; makes handsome, elegant appearance. Durable; protecting and lasting. And best yet, anyone can apply it—"Paint the car today—drive it tomorrow." Magical. Dries dust proof in two hours, is glass-hard in twelve hours. Put up, ready for use, including high grade brush. You simply sell—that will keep you busy; you will also employ others to sell for you.

5,000,000 Autos Waiting

that many and more, pleasure cars, delivery cars, trucks—needing new coat of enamel. You supply it. The buyer paints his own car with "Old Master" and is sure of results. Whole auto world is enthused.

Dollars for You in This Can

Every can of "Old Master" holds opportunity for the man who wants to succeed with a business of his own. "Old Master" salesmen are making big money quickly and building permanent business, fast. The thing to do is

Get Your Name in Today

Write. Get the facts. Learn of the three years' time perfecting the product, the nearly half century high standing of the firm, etc., and how we guarantee your ability.

Write or Send This Coupon

The Akron Paint Products Co., Akron, Ohio
Send me your proposition.

Name.....
Address.....

Auto Supplies
Knowing *HOW* to buy is merely knowing *WHERE*
This is Chicago's Great Wholesale House.
AUTO SUPPLIES AND MOTOR PARTS
WHOLESALE ONLY
Dealers send today for this big money-saving book
AXTELL AUTO ACCESSORIES COMPANY
1507 A South Michigan Avenue
CHICAGO

Big Money
Made by agents selling our wonderful Facial Soap, Perfumes, Toilet Articles, Spices, Extracts, etc. Free cake of soap and agents' terms mailed to any address.
LACASSIAN CO. Dept. 455 ST. LOUIS, MO.

TIRE Agents Wanted

An auto owner in each locality to use and introduce

Mellinger EXTRA-PLY and CORD Tires

Make big money part or full time. No capital or experience needed. Sample Sections furnished. **GUARANTEED**

8,000 and 10,000 Miles (No Sec-onds)

Hand made. Finest materials. Shipped prepaid on approval.

FREE Tires for Your Car to one user in each locality for taking a few orders. Be first to write quick for Special Agents Offer and Low Wholesale Prices.

MELLINGER TIRE & RUBBER CO.
910 North Oak Street Kansas City, Mo.



TOOTH No Bristle BRUSH

"ERASES THAT FILM"

For Tender Gums Protects Against Pyorrhea

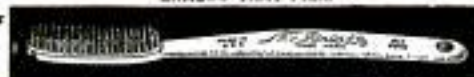

Made of Pure White Rubber. Will Clean Polish and Massage.

We guarantee this brush to outwear any bristle brush made. Clean—healthful—sanitary. Brush replaced if defective. At your dealer's or by mail postpaid 50c. Fine opportunity for agents.

THE NO BRISTLE BRUSH CO., 10 High St., BOSTON, MASS.

WORLD'S FAMOUS DANZIG

SPORTING and HUNTING

RIFLE \$14.95

With **OIGEE** Telescope and Shoulder Strap complete. Take-down model. Shoots standard cartridges.

Bolt action. **KRUPP STEEL**, checkered pistol grip, **WALNUT** stock, metal butt plate. Pocket pistols for target practice. **GENUINE GERMAN**

MAUSER, 9 shot 25 cal., \$12.95; 32 cal., \$13.95; **WORLD'S FAMOUS LUGER**, 30 cal., \$21.95. Hand ejector swing out cylinder, 32 cal., \$16.95; 38 cal., \$17.95. Guaranteed brand new, genuine imported.

\$8.45 Pay Postman on Delivery **SEND NO MONEY** Satisfaction Guaranteed or money promptly refunded

25 cal. **BLUE STEEL**—32 cal., \$10.45. Officers 3 safeties, 25 cal., \$10.50. **MILITARY TRENCH**—32 cal., 10 shot, extra magazine **FREE**, \$11.65.

UNIVERSAL SALES CO., 141 BROADWAY, Desk DD15, NEW YORK CITY



22 cal.

REGULAR VALUE \$35

22 cal. Cartridges,
Box of 100, \$1.00

THIS BIG $\frac{1}{4}$ H. P. MOTOR A Little While \$13.50 Longer at ... **13.50**

(No Telling When Prices Will Advance)

Steadily increasing cost of fuel, power, labor and material may force us to raise our price on this big, sturdy, 28-lb., 60 cycle split-phase A. C. Motor; but we'll hold the price down to this competition-defying level as long as we can.

A wonderful fan-cooled, squirrel-cage motor, tested for 50% overload before leaving factory, and guaranteed for 1 year.

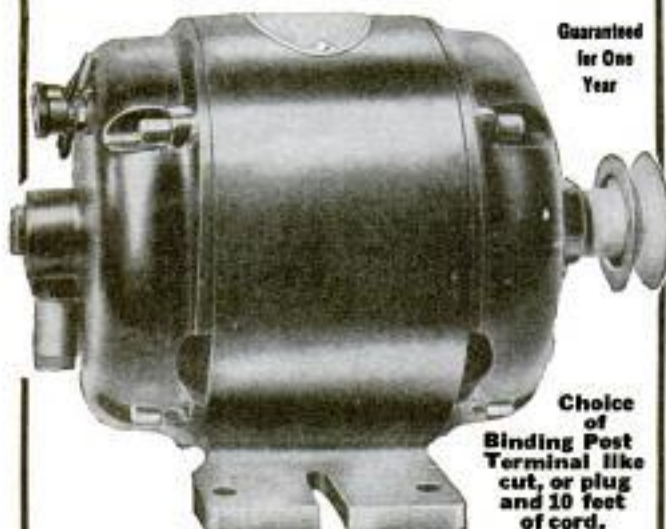

Guaranteed
for One
Year

Choice
of
Binding Post
Terminal like
cut, or plug
and 10 feet
of cord.

Its speed of 1740 r. p. m. fits it exactly for such service as drills, small lathes, fans, blowers, forges, household washing machines, cream separators and all forms of motor drive calling for $\frac{1}{4}$ h. p. and a capacity for temporary overload.

Prices F. O. B. Chicago

110 volt, 60 cycles single phase A. C.	\$13.50
220 volt, 60 cycles single phase A. C.	\$14.50
110 volt, 25 cycles single phase A. C.	\$15.50
32 or 110 volt direct current	\$16.00

Combined Grinder and Buffer \$25.00 Complete With Above Motor



Machine has handy on-and-off lever in front, with switch enclosed in and protected by base. Grinding wheel is 6 in. in diameter, with $\frac{1}{2}$ in. face; Buff $7 \times \frac{1}{2}$ in. unsewed. Motor is same as described above except that it is totally enclosed and dust proof.

Also ask for our line of Motors and Generators for RADIO Service.

Send Cash with Order, as these low prices permit of no booking, billing or collection expense. Our money-back plan and our guarantee fully protect you.

NORTHWESTERN ELECTRIC COMPANY
408 So. Hoyne Ave. Chicago

PARKS New Rapid Upright Hollow Chisel Mor- tising and Boring Machine

\$90

Do better work—quicker—with this Parks. Makes mortises of any size and kind, up to 6 in. deep. Adjustable bed plate tilting to angle of 45 degrees; can be raised and lowered to take work up to 12 in. thick. Takes hollow-chisel bits from $\frac{1}{4}$ to $\frac{3}{8}$ in. and boring bits with $\frac{1}{2}$ in. shank from $\frac{1}{8}$ to 2 in. Operates with 1 to $1\frac{1}{2}$ H.P. Frame construction is 2 in. angle steel, joints electric welded—the best you can get. 10-year guaranty, 30-day trial.



Send for catalog

THE PARKS BALL BEARING MACHINE CO.
1500-1540 Knowlton Street CINCINNATI, OHIO
Canadian Factory, 200 Notre Dame East, Montreal

57

PARKS

WOODWORKING MACHINES

Sleeper Radio Construction Sets THE SLEEPER RADIO CORPORATION 88 PARK PLACE, NEW YORK CITY

The **WONDERFUL**

ERICKSON PATENT LEG

Will not
chafe,
overheat,
nor draw
end of
stump.



ERICKSON ARTIFICIAL LIMB CO., 38 Wash. Av. N., Minneapolis, Minn.

Big ENGINE Sale

Prices Smashed Again!

Famous OTTAWA Engines back to 1914 priced New Improved Models. Better built for long, hard service. Direct-From-Factory Sales Plan saves you \$15 to \$150. Big surplus over rated H.P. Built in largest, most modern engine factory. Prices way down on all sizes.

2 H-P	\$38.50
2½ H-P	45.57
3½ H-P	59.50
4 H-P	75.95
5 H-P	97.50
7 H-P	115.15

OTTAWA 90 Days Trial 1922 MODEL ENGINES

stationary, portable or saw rig; gasoline or kerosene. Easy to start—easy to operate. Guaranteed for 10 years. Cash, or Easy Payments.
Write Today for book "How to Know Better Engines." Sent at once while Sale is on.

Ottawa Mfg. Co. 533-F King St. Ottawa, Kans.



PATENTS TRADE-MARKS AND COPYRIGHTS

OUR OFFER—Free Opinion as to Patentable Nature

Before disclosing an invention, the inventor should write for our blank form "Record of Invention." This should be signed and witnessed and if returned to us together with model or sketch and description of the invention, we will give our opinion as to its patentable nature.

Our Three Books Mailed FREE to Inventors

OUR ILLUSTRATED GUIDE BOOK

HOW TO OBTAIN A PATENT

Contains full instructions regarding Patents, Trade-Marks, Foreign Patents, Our Methods, Terms, and 100 Mechanical Movements illustrated and described; Articles on Patent Practice and Procedure, and Law Points for inventors.

OUR TRADE MARK BOOK

Shows the value and necessity of trade-mark protection and gives information regarding unfair competition.

OUR FOREIGN PATENT BOOK

We have direct agencies in all the principal foreign countries and secure foreign patents in the shortest possible time and at the lowest cost. Write for our illustrated Guide Book on Foreign Patents, sent free to any address.

LIST OF PATENT BUYERS SENT FREE

Containing unsolicited letters from manufacturers and others who are constantly writing us regarding the purchase or leasing of meritorious patents. We endeavor to assist our clients in the commercial development of their inventions.

Specialization—Our Staff

The field of invention is so vast that it is impossible for any one man to become an expert in all the different classes of invention. For this reason Victor J. Evans & Co. employ a number of patent lawyers and mechanical experts who have been selected for their special knowledge and ability in certain lines of invention. Each case is placed in charge of experts in the classes to which the invention relates.

THE VALUE OF YOUR PATENT

will depend much upon the skill and care with which your case is prepared and prosecuted in the United States Patent Office. That every case intrusted to us receives our best efforts, and that our work is done consistently, skillfully, and thoroughly is evidenced by the many unsolicited letters of commendation that we receive constantly from our clients. We will furnish upon request lists of clients from any State in the Union for whom we have secured patents.

Our New York, Philadelphia, Pittsburgh, Chicago and San Francisco Offices

Owing to the growth of our business we have established for the benefit of our clients Branch Offices in New York City, Philadelphia, Pa., Pittsburgh, Pa., Chicago, Ill., and San Francisco, Cal. These branch offices being located in these large commercial cities together with our Main Office located near the U. S. Patent Office, in Washington, enables us to more promptly handle the business of our clients, particularly as the branch offices are in constant touch with the Main Office and fully equipped to handle patent business in all its branches.

Highest References—Prompt Attention—Reasonable Terms

---FREE COUPON---

VICTOR J. EVANS & CO., Patent Attorneys

NEW YORK OFFICES
1007 Woolworth Building

CHICAGO OFFICES
1114 Tacoma Building

PHILADELPHIA OFFICES
714-715 Liberty Bldg.

PITTSBURGH OFFICES
514 Empire Building

SAN FRANCISCO OFFICES
Hobart Building

MAIN OFFICES: 765 9TH STREET, N.W., WASHINGTON, D. C.

Gentlemen: Please send me FREE OF CHARGE your books as described above.

Name..... Address.....



PATENTS

IF YOU HAVE AN INVENTION which you wish to patent you can write fully and freely to Munn & Co., for advice in regard to the best way of obtaining protection. Please send sketches or a model of your invention and a description of the device, explaining its operation.

All communications are strictly confidential. Our vast practice, extending over a period of seventy-seven years, enables us in many cases to advise in regard to patentability without any expense to the client. Our Hand-Book on Patents is sent free on request. This explains our methods, terms, etc., in regard to Patents, Trade Marks, Foreign Patents, etc.

If you are a reader of the **SCIENTIFIC AMERICAN**

you are probably aware of the fact that it has a special appeal to the inventor. Each issue contains a description of a large number of recently patented inventions. Pending patent legislation as well as the most recent rulings of the Patent Office and the courts are considered in its columns.

MUNN & CO.

SOLICITORS OF PATENTS

672 Woolworth Bldg., NEW YORK
 Scientific American Bldg., WASHINGTON, D. C.
 801 A Tower Bldg., - - CHICAGO, ILL.
 611 Hanna Bldg., - CLEVELAND, OHIO
 582 Market St. SAN FRANCISCO, CALIF.

Please Mention Popular Mechanics

PATENTS

C. L. PARKER
 Formerly Member Examining
 Corps, U. S. Patent Office
PATENT LAWYER
 MCGILL BLDG.
 WASHINGTON, D. C.

Patents, Trade Marks, Copyrights, Patent Litigation

Handbook for Inventors, "Protecting, Exploiting and Selling Inventions," sent free upon request.



PATENTS

Send us sketch or model for patentability opinion and exact cost of patent. Our book "How to Obtain a Patent," Sent Free on request. It tells how to apply for Patents, Trade Marks, Foreign Patents, Copyrights, etc.; gives information on Patent Procedure; tells what every inventor should know. Thousands of Inventors, who are our clients, are our references.

Chandlee & Chandlee, 25 Years Experience.
 435 7th St. Washington, D. C.

INVENTORS

who derive largest profits know and heed certain simple but vital facts before applying for

PATENTS



Our book Patent-Sense for Inventors and Manufacturers gives those facts; free. Write Lacey & Lacey, 646 F St., Washington, D.C.

ESTABLISHED 1869

PATENTS

TRADE-MARKS COPYRIGHTS

Send for our free book of patent information.

Beale & Park 802 F St., Washington, D. C.
 16 S. Broad St., Philadelphia, Pa.

PATENTS Secured

Prompt service. Avoid dangerous delays. Send for our "Record of Invention" form and Free Book telling How to Obtain a Patent. Send sketch or model for examination. Preliminary advice without charge. Highest references. Write TO-DAY, J. L. Jackson & Co., 327 Ouray Bldg., Washington, D. C.



GEARS ALL KINDS SMALL

The most accurate made and prices reasonable. We carry a complete line of gears in stock for immediate shipment. Can also quote on special gears of all kinds. Send us your inquiries.

WRITE FOR CATALOGUE.

CHICAGO STOCK GEAR WORKS
 105-109 S. Jefferson St., CHICAGO

NO MORE BALD HEADS



WHEN our VACUUM CAP is used a few minutes daily. We accept no pay until you have tried the Cap 60 days and are satisfied. The Vacuum Cap is an appliance that draws the blood to the Hair Roots and starts a new healthy crop of hair. It stops Dandruff, stops the hair from falling out.

Bought by Doctors and men who know that it is the only reasonable HAIR GROWER known to science. No Drugs Used. Write for application, blank testimonials, and booklet on "HAIR," sent sealed in plain envelope, FREE.

THE MODERN VACUUM CAP CO.

D559 BARCLAY, DENVER, COLO.

PATENTS

Booklet Free

Highest References

Promptness Assured

Best Results

Send drawing or model for preliminary examination

ALL BUSINESS GIVEN PROMPT AND PROPER ATTENTION

WATSON E. COLEMAN, Patent Lawyer, 624 F St., Washington, D. C.

Can You

think of a simple, practical idea that will fill one of the many requests we have on file for new inventions? It may mean a fortune for you. Thousands of things are needed right now. Your brains can help. Send today for our great new book—

"Inventions and Trade-Marks, Their Protection and Exploitation" and learn more about making money from ideas than you ever knew before. It tells many things that are wanted, too.

**A postal will do —
It is free**

We Help Our Clients

without charge, to get the dollars out of their ideas—having facilities none others possess. Advice free. Don't delay—get the book at once.

American Industries, Inc.
200 Patent Dept.
WASHINGTON, D. C.

Patents Advertised For Sale Free

in Invention and Manufacturing Supplement

Published for the man with an idea. Send for free sample copy. One year's subscription, 50c.

U.S. PATENTS



DON'T LOSE YOUR RIGHTS TO PATENT PROTECTION

Before disclosing your invention to anyone send for blank form "EVIDENCE OF CONCEPTION" to be signed and witnessed. A sample form together with printed instructions will show you just how to work up your evidence and establish the same before filing application for patent. As registered patent attorneys we represent hundreds of inventors all over the United States and Canada in the advancement of inventions. Our schedule of fees will be found reasonable. The form "Evidence of Conception," sample, instructions relating to obtaining of patents and schedule of fees sent upon request. Ask for them—a post card will do.

PATENTS AND TRADE MARKS



204 Ouray Bldg. Washington, D. C.
Originators of forms "Evidence of Conception."

PATENTS If You Have an Invention and Desire to Learn How to Secure a Patent

Send for our Guide Book, **HOW TO GET A PATENT**, sent Free on request. Tells our terms, methods, etc. Send model or sketch and description of your invention and we will give our opinion as to its patentable nature.

RANDOLPH & CO.
600 F St., N.W., Washington, D. C.

NAME.....

STREET.....

CITY..... STATE.....

DIAMONDS

ONLY \$2 AND 10 MONTHS TO PAY

Send only \$2.00 deposit as a guarantee of good faith and we will send your choice of the \$49.00 cluster diamond ring, or the \$50.00 beautiful solitaire diamond ring, or the \$12.00 wedding ring, or the \$25.00 wrist watch - Pay the balance in ten equal monthly payments. For the \$100.00 solitaire blue white diamond, send \$20.00 deposit. For the \$75.00 diamond, send \$15.00 deposit. Men's rings with same diamonds will be supplied at same price. Hundreds of similar bargains are described in our new catalog.

30 DAYS FREE TRIAL

Wear any article of your choice on trial for 30 days. If not satisfied send it back and we will return every cent you paid. Free examination at bank or express office before paying deposit, if desired. Written guarantee that if any other jeweler in the U. S. can sell you equal merchandise for less money, you can get your money back. On this guarantee you cannot lose.

14 Karat solid white gold rectangular wrist watch, 16 jeweled movement. Worth \$40.00. Full length indestructible pearls \$5.00.

Our prices are the same for credit as for cash. Order article of your choice by letter and give size wanted. Everyone a wonderful bargain. Rings A-B-C-D are 18 Karat white gold. Ring E 14 Karat yellow gold. Thousands of similar values in our beautiful catalog.

Write for our big catalog
\$1,000,000.00 and 43 yrs. experience back of our guarantee

B. GUTTER & SONS
Wholesale Jewelers & Diamond Importers
172 NASSAU ST., DIV. 373, NEW YORK

INVENTORS! Sell Your Patents Quickly!

Order the "Patent Salesman" at once! It tells you exactly how to sell your Patent. Only \$1.00 per copy. Address
SIMON, 4456 Evans Ave., St. Louis, Mo.

CLASS PINS

FREE CATALOG GIVE NAME OF SCHOOL OR CLUB AND NUMBER IN CLASS

Either pin illustrated made with any 3 letters and 2 figures, one or two colors enamel. Silver plate, 20¢ ea., \$2.00 doz. Sterling silver, 40¢ ea., \$4.00 doz. Write for catalog of sterling and solid gold pins and rings.

Bastian Bros. Co. 458 Bastion Bldg., Rochester, N.Y.

PATENTS

To the Man with an Idea

I offer a comprehensive, experienced, efficient service for his prompt, legal protection and the development of his proposition.

Send sketch, or model and description, for advice as to cost, search through prior United States patents, etc. Preliminary advice gladly furnished without charge.

My experience and familiarity with various arts frequently enable me to accurately advise clients as to probable patentability before they go to any expense.

Booklet of valuable information and form for properly disclosing your idea free on request. Write today.

Richard B. Owen, Patent Lawyer

9-303 Owen Building, Washington, D.C.
2276-E Woolworth Bldg., New York City

PATENTS

Protect your rights. Before disclosing invention write for booklet and blank form **EVIDENCE OF CONCEPTION** to be signed, witnessed and returned with rough sketch or model of your idea, upon receipt of which I will promptly give opinion of patentable nature and instructions. **NO CHARGE** for preliminary advice. Highest references. Prompt, personal attention.

CLARENCE O'BRIEN

Registered Patent Lawyer

798 Southern Building

Washington, D. C.

Are YOU Old at 40?

A very common cause of early old age is the disturbed condition of an important gland. Even big strong men are not exempt from this serious irregularity. Our plainly written, interesting educational

FREE BOOK—Why Many Men Are Old at Forty

may bring a priceless message to you. It tells of a simple sensible way by which thousands have corrected this prostate gland condition. It tells how sciatica, backache, pains in toes and heels, interrupted sleep, mental depression, frequent micturation, etc., are so often due to this gland. Sold for over five years upon a money-back-if-not-satisfied plan. Do not confuse it with massage, medication, violet rays, etc. No obligation. Physician's inquiries especially invited.

Thermalaids

The Electro Thermal Co. 2115 Main Street, Steubenville, Ohio



COAL

Help Save It Make Big Money

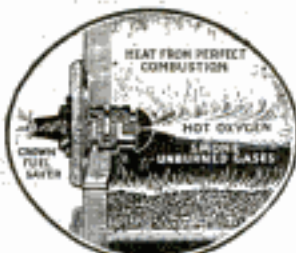

Capitalize the present urgent demand for economy. Coal Prices are high. Become distributor for the CROWN Fuel Saver which helps keep coal prices down by saving at least one-fifth the coal. This is a proved fact and a good selling argument.

Now is the psychological time to put yourself on a paying basis. Distributors for the CROWN receive FREE training and are backed by advertising and selling helps. Exclusive territory assigned.

This is a legitimate opportunity to establish a big profitable, permanent business. It will pay you to investigate. Write or wire.

CFSCO, 15 N. 10th St. Richmond, Indiana

NEW LAMP BURNS 94% AIR—FREE

A new oil lamp that gives an amazingly, brilliant, soft, white light, even better than gas or electricity, has been tested by the U. S. Government and 35 leading universities and found to be superior to 10 ordinary oil lamps. It burns without odor, smoke or noise—no pumping up, is simple, clean, safe. Burns 94% air and 6% common kerosene (coal-oil).

The inventor, H. E. Johnson, 609 W. Lake St., Chicago, is offering to send a lamp on 10 days' FREE trial, or even to give one FREE to the first user in each locality who will help him introduce it. Write him today for full particulars. Also ask him to explain how you can get the agency, and without experience or money make \$250 to \$500 per month.



FOIL BURGLARS

Most locks offer no protection. Test yours with this wonderful set of Master Keys. 5 keys in all, and each one different. Open and prove thousands of locks as worthless. Recommended by users in ten different nations. Novel key chain FREE.

Send only \$1 today.

MASTER KEY CO., 26-K Manhattan Block, Milwaukee, Wis.



FINE OLD VIOLINS

On Easy Payments
30 Days Free Trial

allowed, no matter where you live. If not more than pleased with our values return violin AT OUR EXPENSE—and no harm done. Ability to play the violin brings social and financial success. Get a violin with a rich, mellow tone and it will create in you a desire to master it.

Free! Magnificent
Album-Catalog

containing portraits of the world's greatest violinists since Paganini's time, a half-tone of "Stradivarius in His Workshop," and the romantic story of The King of Musical Instruments. A postal brings all to you FREE—no obligations.

CREMONA VIOLIN SHOP
Dept. F41 Chicago



"Will say I am highly pleased; find it does the work of \$100 machines. Have had several friends to see it; they were surprised that I got such a good machine for the money."

AMAZING
VALUE

"I had an opportunity to investigate the other makes of typewriters and have come to the conclusion there is more real value in your machine at the price."

"I am well pleased with the typewriter and my friends have expressed surprise that a machine of such value could be turned out for the price. My son at the State Normal School says it is the smoothest running machine he ever tried and in many respects superior."

"Am pleased with typewriter; will take another five machines."

Brand-
New:
From
Factory
To
You.



BIG SAVING—FREE TRIAL

This beautiful machine is the only brand-new (unused), standard, full-size typewriter with a 4-row, 42-key, 84-character Universal keyboard that you can buy for less than \$100. It comes direct from factory to you at practically the wholesale price of other high-grade typewriters—a remarkable saving. Use Annell on your work at our expense, put it to the test for ten days; then if it doesn't satisfy you in every way, return it to us and we will refund even the express charges. You take no risk. Could anything be fairer?

Easy Terms

While you are using the machine, small monthly payments scattered over a period of more than a year make it easy and convenient to own this full-size, brand-new (unused), 4-row, standard-keyboard typewriter.

Mechanical Marvel

Strength and simplicity are the outstanding qualities of this machine. It embodies the ideas and experience of mechanical geniuses who have been making typewriters for generations. Every essential operating convenience is possessed by Annell, including the 4-row, 42-key, 84-character Universal standard keyboard. It will last a business lifetime and is fully covered by an ironclad guarantee.

Send Coupon Today

for complete information about the greatest of all typewriter offers. Don't miss it. Act now.



NOT AN ORDER—MAIL TODAY

ANNELL' TYPEWRITER CO.
698 No. 230 East Ohio Street, Chicago.

Send me free catalog and complete information about your wonderful typewriter offer; this places me under no obligation.

Please Mention Popular Mechanics

GENUINE KEYSTONE MOVIEGRAPH

(PATENTED)

SHOWS BIG SIZE MOVING PICTURES

Safe for **\$9.89** Non-Inflammable Safety Films
the Home — Wm. S. Hart — Chaplin — Tom Mix
Machine and Four Reels Complete for **\$9.89**

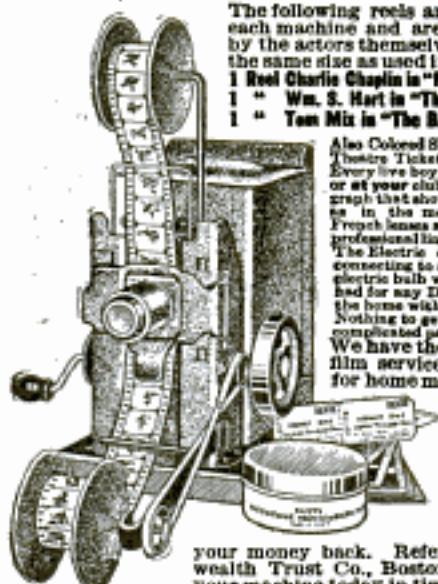

The following reels are included with each machine and are genuine, posed by the actors themselves. The film is the same size as used in the theatres.

- 1 Reel Charlie Chaplin in "Fun in the Bakeshop"
- 1 " Wm. S. Hart in "The New Sheriff"
- 1 " Tom Mix in "The Battle on Horseback"

Also Colored Slides, Drawing Slides, Theatre Tickets, etc., included. Every live boy should have at home or at your club a Keystone Moviegraph that shows pictures the same as in the movies with powerful French lenses and constructed along professional lines.

The Electric cord is included for connecting to any lamp socket your electric bulb will fit. Can also be had for any Dry Cell Batteries for the home without electric current. Nothing to get out of order. No complicated parts.

We have the largest comedy film service in the country for home machines. Size of machine all set up is 15"x9". Weight 3 lbs.

Send Money Order or check.

Guaranteed to give good big pictures or

your money back. Reference Commonwealth Trust Co., Boston, Mass. Order your machine today in time for Xmas.

WARREN MANUFACTURING CO.

Dept. M

115 E Brookline St., Box 240, Sta. A, BOSTON, MASS.

Price for Machine and Reels \$9.89 complete, prepaid. Genuine Keystone Moviegraph Patented 1919, 1920, 1921

Build Your Own PHONOGRAPH

IT'S EASY WITH OUR HELP

A few hours' interesting work saves over half and gives you a machine to suit your ideas. We furnish motors, tone arms, case material, blue prints and full instructions. Plays any record. Make fine profit building phonographs for your friends.

Write today for our **FREE** Blue print offer.

GET YOUR **RADIO SUPPLIES** FROM US

Choraleon Phonograph & Radio Co.
1122 1st St., Elkhart, Ind.



SAVE
OVER
HALF

MASCOT

\$100.00 Weekly Profit

Agents—Specialty Men—Premium Users
BIG MONEY—SELL

MASCOT The Portable Keyless Lock

Fits any door or window without tools (fits in vest pocket). Absolutely new. No competition. Force and jimmy proof. Our agents averaging 1,000 Mascots a month. Send \$3.00 for a trial order (50c seller). \$25.50 in quantities. Send cash or C. O. D. Satisfaction guaranteed.

Milbruck Products Corporation
404 4th Avenue Dept. K New York City



Isham Jones

Paul Biese

Joseph Smith

The Conn Saxophone "The World's Best"

The first American saxophone was built in the Conn factory. The best in the world are still built here. So say the great artists of the day who use Conn instruments exclusively.

Play a Tune in One Hour. You can do it with a Conn Saxophone, easiest of all to learn. Beautiful tone; exclusive features and improvements. Send For Free Book and details of Free Trial; Easy Payment Plan.

C. G. CONN LTD.
1131 Conn Bldg., Elkhart, Ind.



GET THIS
FREE BOOK



CONN

WORLD'S
LARGEST MANUFACTURERS
OF HIGH GRADE BAND AND
ORCHESTRA INSTRUMENTS



Lost Your Keys?

One way to avoid this inconvenience is to apply yourself with a **DEVIL'S COMBINATION MASTER KEY**, which by actual test has opened and tested THOUSANDS of locks, and may save you in an emergency. The most wonderful Combination of Master Keys in the world. By mail \$1.50.

B. URICH KEY CO.
232-3rd Street Milwaukee, Wis.
Largest Exclusive Key and Lock Shop in America



FREE



TRIAL

Let us send this fine Razor for 30 days free trial. When satisfied after using, send \$1.35 or return razor. Order Today. **JONES MFG. CO.** 160 N. Wells St. Dept. 1131 Chicago

FREE LIGHTING FIXTURE CATALOGUE



Our prices are 50% LOWER than elsewhere in the United States. We manufacture our own electric fixtures and eliminate the dealer's profits by selling **DIRECT FROM OUR FACTORY** to you. Special 8-room sets complete ready to hang as low as \$24.50. Write at once for latest catalogue.

UNITED LIGHTING FIXTURE CO.
280 Bowery Dept. 136 New York City



AGENTS FOR XMAS

Combination Toilet sets in fancy floral boxes. Cash in between now and the holidays with a line that sells on sight to men and women. Each article full Drug store size—You triple your money on our sets—besides they are the fastest sellers on earth.

9 ARTICLE TOILET SET—Costs you 55c—Retail value all Drug stores \$3.75—you sell for \$1.50 or more and triple your money. **DO NOT DELAY**—Each day's delay from now on means big money loss to you.

500 sets per week MEANS \$500.00 per week

You must act now. Decide today. Wire or write us for your territory. Sample of 9 article set including Display Case \$1.50 postpaid. At least write for full particulars—Hurry! before it's too late.

HARVARD LABORATORIES, Desk P, 338 W. 63rd St., Chicago

\$3 Brings you
DOWN a genuine

UNDERWOOD TYPEWRITER

Latest model—Shipman-Ward rebuilt like new. Shipped anywhere on ten days' free trial—only \$3 down. You can tell it from a brand new machine in looks, action or quality of work we'll refund every cent paid by you. Below factory price. Guaranteed five years. Unbeatable easy payment proposition.

Send for Our Free Book

A postal will bring you our big typewriter book in colors and gold—FREE. Every step in famous rebuilding process illustrated and explained. Let us show you how you can save real money. Write now—no obligation.

Shipman-Ward Mfg. Co.

Typewriter Emporium
2123 Shipman Bldg.
Monroeville and Ravens-
wood Avenues,
Chicago.



New 300 Candle Power Lamp



THE
DIAMOND
LIGHT

Make \$60 to \$100 a Week

Introducing this wonderful new lamp. Gives soft, brilliant light; restful to eyes; ideal illumination.

Burns Kerosene or Gasoline

Clean, odorless, economical. Burns 96% air, 4% fuel. Absolutely safe. Lights with match. 100 times brighter than wick lamps. Patented. Greatest improvement of age. Table lamps, hanging lamps, lanterns. Work all or spare time. You simply take orders. We deliver by Parcel Post and do collecting. Commissions paid same day you take orders. No experience necessary. Get started at once. Big season now on. Write today for catalog and special agents' offer.

THE AKRON LAMP CO.
111 Lamp Bldg. Akron, Ohio

How to Get Rid of Moles



A simple, safe home treatment—
15 years' success in my practice.
Moles (Also BIG Growths) Dry Up.

Ask for Free Booklet of Full Particulars

WM. DAVIS, M. D.

124-5 Grove Ave., Woodbridge, N. J.

30 DAYS FREE TRIAL \$10 Worth of Records FREE



Simply wonderful! The limit of value giving! Just think! A GENUINE DAVIS PHONOGRAPH on 30 Days' Free Trial, and on terms as low as

\$2 A MONTH

in case you decide to buy. Magnificent instruments in quartered oak or mahogany piano finished cases, equipped with the finest worm gear motors, rich toned machines— at less than half the standard price—and \$10 worth of records FREE.

Send No Money

Just a postal with your name and address. Only a limited number of machines shipped on this extra-liberal offer. Better act quickly. This is a life-time opportunity.

DAVIS, Dept. E41
6101 MAY ST., CHICAGO



**It Clamps
Everywhere
stands
anywhere**

\$5

The
LAMP
With the
CLAMP

Pat. U. S. A.
Canada and Foreign
Countries

Adjusto-Lite

A FARBWARE PRODUCT

Adjusto-Lite is the handy, economical light for home, office, store, studio—everywhere good light is needed. HANGS—CLAMPS—STANDS. The name says it—it's quickly adjustable. A turn of the reflector sends the light exactly where you want it. No glare—no eyestrain. And—economy.

Solid brass; handsome, durable and compact. Clamp is felt-lined—can't scratch. 5-yr. guarantee. Complete with 8-ft. cord and screw socket with 2-piece standard plug.

Get an Adjusto-Lite today. If your dealer doesn't carry it order direct.

S. W. FARBER

141 So. Fifth St. Brooklyn, N. Y.

Prices in U. S. A. and Canada: brass finish, \$5; bronze or nickel finish, \$5.50; West of Mississippi and Canadian Rockies and in Maritime Provinces, 25c per lamp additional.



Easy to Play—Easy to Pay



DAN RUSSO

Director of the Oriole Terrace Orchestra of Detroit, a Symposium of Superb Instrumentalists playing Brunswick Dance Records with Buescher Band Instruments and Saxophones.

It is the one instrument that everyone can play—and it wholly satisfies that craving everybody has to personally produce music. It is so perfected and simplified that it is the easiest of all musical instruments to master. You learn the scale in an hour's practice, play popular music in a few weeks, and take your place in orchestra or band within 90 days, if you so desire. Saxophone players are always in demand for dance orchestras.

BUESCHER

True-Tone Saxophone

Nothing can take the place of the Saxophone for home entertainment, church, lodge, school. It increases the pleasure you get out of life, increases your popularity and your opportunities.

Free Trial—Easy Payments

You may order any Buescher Saxophone, Cornet, Trumpet or Trombone or other Band or Orchestral Instrument without paying in advance, and try it six days in your own home without obligation. If perfectly satisfied, pay for it in easy payments to suit your convenience. Mention the instrument interested in and a complete catalog will be mailed free.

Free Saxophone Book

After nearly 300 years' supremacy, string instruments are almost entirely displaced by Saxophones in all nationally popular orchestras. Our Free Saxophone Book tells which Saxophone takes violin, cello and bass parts, and many other things you would like to know. Ask for your copy.

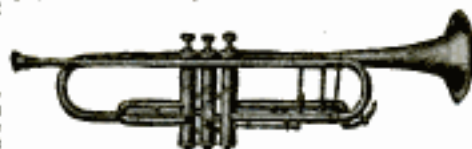

Buescher-Grand Trumpet

An entirely new model, featuring the Buescher improved taper, bore and new proportions. It will meet every demand, from the martial flourish to the tender love song. We guarantee it to be the best Trumpet you have ever heard.

BUESCHER BAND INSTRUMENT CO.
Makers of Everything in Band and Orchestra Instruments
2553 Buescher Block Elkhart, Ind.

75%

of all popular phonograph records are played with Buescher Instruments.

Burns Water in Autos

Amazing scientific invention. Uses water-gases with present carburetor. Oxygen disbursts carbon, hydrogen exploded for power. **ASTOUNDING, UNBELIEVABLE RESULTS.** Carbon deposit eliminated. No plug cleaning, no carbon cleaning, no valve grinding. **Mileage increased 1/3 to 1/2. FORD CAR MADE 52 MILES ON 1 GALLON.** Other cars equally good. A scientific device of genuine merit approved by highest engineering authorities. Sent on 30 days' trial. **Car owners, write for one today.** Give make of car and carburetor. Walter Critchlow, Inventor, Suite 205, 716 Madison, Chicago.



Smoke 6 Cigars On Approval

You should buy direct and cut your cigar bill in half—save retailer's and wholesaler's profits. **El Vandoma Cigars sold only on approval plan.**

GUARANTEED to be strictly long filler of superior quality—a mild Havana blend. You will thoroughly enjoy their rich, mellow taste. Packed in handsome useful **CEDAR CHESTS.** Just send your name and address on your business card or letterhead. **YOU MUST BE PLEASED**

50 El Vandoma Cigars (Aristocrat Size) 5 inches long price \$5.00 will be sent post paid. **SMOKE SIX—** if thoroughly satisfied mail us \$5.00; if not, return balance at our expense and you will owe nothing.

Some of our customers prefer to send check, money order or have them shipped C. O. D. If you pay cash and are not pleased, full amount of your remittance will be promptly refunded upon return of the Cigars.

YOU RISK NOTHING
Order a box today—**NOW**
ON THE APPROVAL PLAN

EL VANDOMA CIGAR COMPANY, Dept. 604
290 Washington St., Brooklyn, N. Y.
"El Vandoma—the best cigar in America for the price—bar none."

Please Mention Popular Mechanics



American Poultry Journal

OLDEST, LARGEST and BEST
4 MONTHS' TRIAL 25 cents

1 Yr. 75c. 2 YEARS \$1 5 Yrs. \$2

Averages over 100 pages per issue—tells how to feed, house and breed; how to secure high egg production; how to hatch and rear poultry successfully. Established 1874. Only 25 cents for 4 months. Stamps accepted.

American Poultry Journal, 14-523 Plymouth Ct., Chicago

PLANS FOR POULTRY HOUSES!

All styles 150 Illustrations; secret of getting winter eggs, and copy of "The Full Egg Basket." Send 25 cents. **INLAND POULTRY JOURNAL, Dept. 74, Indianapolis, Ind.**

SQUAB BOOK FREE

Squabs are selling at the highest prices ever known. Breed them and make money. Write at once for free book, prices, etc.

Plymouth Rock Squab Co., 634 Howard St., Melrose Highlands, Mass

Free Book

Tells How to Get Big Egg Yield And Save Feed



1000 Amazing Money-Making Secrets

Never before has such a valuable, dependable poultry book been given **Free.** Prof. Quisenberry explains his wonderful method of rearing, breeding and feeding for heavy egg production, now in use by over 46,000 successful poultry raisers. Tells how Chas. Kittinger averaged \$11.77 net profit per hen; M. S. Hume made \$2000. Revised edition ready. **Write quick.**

FREE Simply send name today. Post card will do, for this 96-page free book "Dollars and Sense in the Poultry Business." However if you send 25c we will also send you 25 colored celluloid leg bands to mark your best layers without using trap nests. *Mention breed of hens.*

96 PAGE FREE BOOK

AMERICAN POULTRY SCHOOL
Dept. 186 Kansas City, Mo.

1923 Indian Scout Motorcycle

\$2.50
ELECTRICALLY EQUIPPED \$285

Was \$400 a year ago

all Indian prices down to bed rock.

The Indian Scout is different from the average motorcycle. It's light, low, easily handled, economically operated.

60 to 75 miles per gallon—60 miles per hour.

Cheaper than carfare, and the greatest sport in the world. No garage, two small tires, all other upkeep correspondingly low.

See the nearest INDIAN Dealer or
Write Dept. 37 for information

HENDEE MANUFACTURING COMPANY

Largest Motorcycle Manufacturer
in the World

Springfield

Mass.

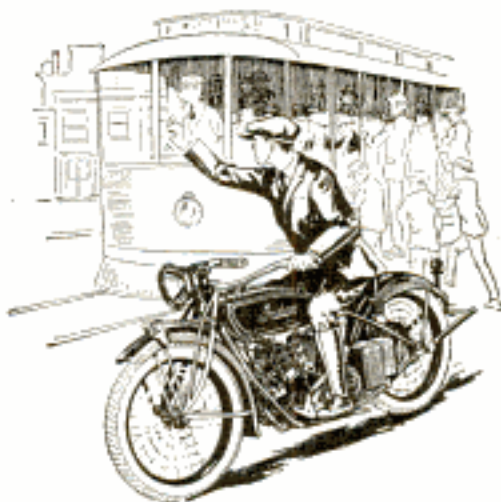

THE SHAW MOTOR ATTACHMENT Makes Your Bike a Motorcycle

A high grade 2½ H. P. Motor attachment quickly clamped to any bike frame. Speed 4 to 40 miles an hour. 90 to 125 miles per gallon of gas.

Special Low Price Now! Write today for Complete Description and Special Low Prices on SHAW Motor Attachments and the Shaw Complete Motorbicycle.

SHAW MFG. CO., Dept. 37, GALESBURG, KANS.



2 TIRES FOR \$9.95

FREE TUBE WITH EACH TIRE

Sensational Cut in Standard Tire Prices!

Two tires for less than the usual cost of one, and a free inner tube with each tire! No double brands or second tires. Our big volume means best tire values! Act now and cut your tire cost in two. Thousands of steady customers are getting 8,000 MILES

120 mileage out of these tires and you, too, can get

Note Special Price on Two Tires, Same Size

Size	1 Tire	2 Tires	Size	1 Tire	2 Tires
28 x 3	\$ 6.75	\$ 9.95	34 x 4	\$12.85	\$19.70
30 x 3	6.95	10.95	32 x 4 1/2	12.95	20.95
30 x 3 1/2	7.95	12.95	33 x 4 1/2	13.45	21.65
32 x 3 1/2	9.25	14.95	34 x 4 1/2	13.95	22.55
31 x 4	10.45	16.75	35 x 4 1/2	14.45	23.55
32 x 4	11.85	17.85	35 x 5	15.45	25.95
33 x 4	12.35	18.75	37 x 5	15.95	26.50

State whether straight side or clincher

SEND NO MONEY! Shipment C.O.D., express or parcel post. Express return same as our expense and your money will be promptly refunded. **DON'T DELAY! ORDER NOW!**

ALBANY TIRE & RUBBER COMPANY
1506 So. Michigan Ave. Dept. 164N Chicago, Illinois



VULCANIZES Cuts or punctures in Five Minutes

No tool-kit is complete without a Shaler 5-Minute Vulcanizer. It is a necessity and the greatest convenience ever offered to the motorist.

The Shaler 5-Minute Vulcanizer is easy to use—you need only a match. Always ready—never bothered by wind or storm. Cannot injure or burn the tube. No gasoline—no danger of fire.

Costs Only \$1.50

Get a Shaler 5-Minute Vulcanizer from your dealer. It will soon repay for itself by the saving of time, trouble and tire repair bills.

C. A. SHALER CO.

2010 Fourth Street

Waupun, Wis.



You Can't Beat It!

YOUR favorite sport—plus the thrills of motorcycling! An early morning jaunt to duck-marsh or hunting lodge, with your Harley-Davidson making miles seem short as city blocks. Why, man, you can't beat it!

And you can't beat the 1923 Harley-Davidson. Its 10 improvements are added touches of excellence to the greatest motorcycle ever produced.

Reduced prices, too, on 1923 models! Only \$285 for the famous Twin—the clean-cut, comfortable speed-mount that travels 50 miles on a dollar's worth of "gas," oil and tires.

See your dealer for free demonstration.
Write us for new illustrated literature.

Harley-Davidson Motor Co.
Milwaukee Wisconsin

Opportunity for dealers in unassigned territories. Address Desk A-2

Harley-Davidson
World's Champion Motorcycle



Every Boy's IDEAL Airplane

5 1/2 ft. Wing Spread
Weight 10 1/2 ounces

A New Idea in Model Airplanes for Boys!

The Simplest, Easiest to Make and Most Perfect Flying Toy Airplane Ever Made. Every Boy can Clip the Parts Together; No Tools Needed; and Have this Airplane in the air in Two Hours!

EVERY Boy can now have a lot of fun flying his own model Airplane without trouble building it. If you have hesitated to tackle the job of building your own Airplane, here's your chance to get one with all the difficult work done for you.

You need only clip the ready-formed parts of "Every Boy's" Airplane together, put on the covering and your plane is finished. All the hard work is eliminated. No staining and bending wood parts; no plans to follow; no nails, wire, glue or tools needed. This is a strong, sturdy Monoplane Type Airplane, made largely of aluminum and when finished will look like the picture above. Guaranteed to rise from the ground by its own power and fly in the air. Comes in a handy box with complete instructions for assembling and flying.

Costs only \$6.00—at your Dealer's or Direct from Factory
(In Denver and West of Denver—\$4.50)

Ask at your Toy Store for "EVERYBOY'S" IDEAL AIRPLANE, or we will fill your order direct upon receipt of price and guarantee satisfaction or money refunded.

Ideal Aeroplane & Supply Company
159 Wooster St., Cor. W. Houston St., New York City

Plans for IDEAL Models of Famous Planes

For Boys who want to completely build their own 2 ft. Model Aeroplanes, we have IDEAL Scale Drawings and Building and Flying Instructions for the following:

Curtis JN4D-2 Training Plane; DeLauvilland Battle Plane; NC-4 Naval Seaplane; Curtiss Military Transport; Blériot, Hispano or Taube Monoplane; also Cecil Peel Racer

IDEAL Catalogue of Plans, Parts and Supplies for Model Aeroplanes sent postpaid for 5c. The biggest and most complete catalogue published.

25c

EACH POSTPAID

2 1/2-H.P. SAW \$77.50

Try 30 Days.



FAST CUTTING

cost. Shipped direct from factory or 9 branch houses. FREE BOOK—write today.

Cuts fast; easy to operate. Steel saw-back with split bearings. 2 1/2 and 3 1/2 H.P. Saws ready to mount on skids or on wagon bed. Magnets built in at small additional cost.

F.O.B. Factory Ottawa, Kan.

3 1/2 H-P \$97.50

4 H-P \$104.50

5, 7, 10, 12 H-P at Proportionally Low Prices NOW.

OTTAWA MFG. CO., Dept. 171-B, Ottawa, Kan.



Ford
Chevrolet
Only \$4.85
Buick and \$5.85
Chandler

CARTER Oil Gauges

If your dealer can not supply you, send remittance, or order by parcel post C. O. D. Easy to screw gauge on instrument board, connect copper tube in place of lower petcock on Ford or Chevrolet. No oil passes thru gauge or tube.

Accurate—Durable—Guaranteed
Order before cold weather; you will need it. It will save its cost many times in oil and wear on the engine.

CARTER MOTOR ACCESSORIES, Inc.
340 Pearl Street Buffalo, N. Y.

Smashing Big Money Maker AGENTS!



Can Be Used With Shade or Without

Two Great Lights in One

Here's a high grade, dependable combination reading lamp and lantern that is fairly taking the country by storm! Everybody who sees one, wants one! Great for indoors (with shade). Great for outdoors—for barn, out-of-

100 Candle Power. A steady powerful white light many times brighter than gas or electricity. Stands by self or swings. Burns common gasoline; lights quickly (with wick—not torch); burns without flicker in strong winds. Always ready. No wicks to bother with, no smudging, no soot, no danger if tipped or dropped. Takes less space than ordinary wick lamp, gives light of twenty. Nickel brass and a beauty. The original—no lamp of its kind so good, so dependable, so satisfactory.

Every home, barn, auto, should have one of these great Combination Handy Lites. Satisfaction or money back. Write quick for low introductory price!

Enterprise Tool & Metal Works 126-128 So. Clinton Street, Chicago

Write Quick For Big Agent Profit Plan

Agents making money light and left on the Combination Handy Lite.

A big seller. Making profits on every sale. Use spreads like wildfire. Exclusive territories, crew working for you, permanent business for hustlers. Get started at once. Let us tell you how! Don't get behind us! Write quick for sales plan.

A FILE

Stop Forgetting

NOT A FILE



Make Your Mind an index from which you select facts, figures, names. Develop concentration, self-control; overcome bashfulness, forgetfulness. Write today for FREE memory and concentration test and illustrated booklet, "How to Remember."

PROF. HENRY DICKSON
Dept. 705-A Evanston, Ill.



5 Magic Keys

Work like magic in emergencies or prove whether your door or padlocks are burglar-proof. Open and test thousands of different locks. Recommended by users in ten different nations. Most wonderful and only keys of their kind. Send \$1 today. Novel key chain FREE with set. MASTER KEY CO., 25K Manhattan Block, Milwaukee, Wis.



YANKEE VIOLET RAYS

Guaranteed to Last a Lifetime With Ordinary Use.

Positively will give beneficial treatment for most ailments and increase blood circulation, stops disease destroying action and imparts a delightful stimulating effect on the whole body.

SEND NO MONEY

Just your name and address, we will send Home Ours! by mail, \$12.50 collect—4 days' free trial. Money back if not satisfactory.

YANKEE LABORATORIES, Inc.
113 Fourth Ave. Dept. 218 New York, N. Y.



The Versatile HAMMOND Folding Portable Typewriter

MULTIPLEX HAMMOND'S Instantly changeable type. Many styles, many languages. Just Turn the Knob to change.

Hammond Typewriter Corp., 569A East 69th Street
New York City, N. Y., U. S. A.

\$2.50

101 Universal Wrench

30-Point Carbon Steel Forging Nickel Plated Against Rust

A Tool Kit In Itself

The most practical implement ever developed for the hundred and one odd jobs that confront the handy man about the house, in the garage, on the farm.

A socket wrench adjustable up to the largest size spark plug.

A pipe wrench, a hammer, and a tire tool all in one.

A sturdy, well balanced tool that does the work of all for the price of one.

Workmanship and material guaranteed.

\$2.50—Postpaid any place in the United States. Profitable proposition and good territory for jobbers, dealers, and agents.

101 UNIVERSAL WRENCH CO.
Executive Offices, Bartow, Florida

Name

Street and Number

Town and State

Add \$5 a Day to Your Profits WITH A TORCH ACETYLENE TORCH NO. 13

For radiator repairing, general soldering, tube brazing, heating, battery repairing, etc. Produces instant hot flame, works rapidly. Furnished with 4 different tips and soldering copper, enabling you to do a wider range of work.

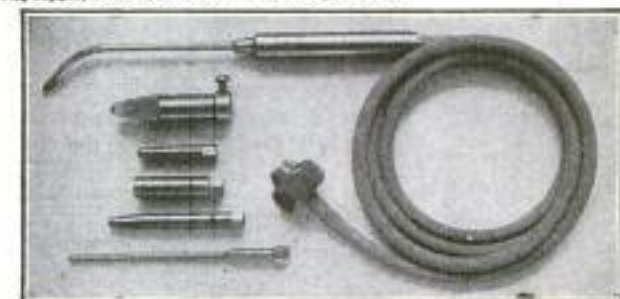

USES ACETYLENE GAS ONLY

A splendid use for discarded auto acetylene tanks. Many owners make the Torch No. 13 pay for itself in a single day. Torch with 4 different tips, soldering copper, 5 ft. tubing and connections for auto acetylene tank. \$7.50

ORDER TODAY FROM YOUR JOBBER, OR
St. Paul Welding & Mfg. Co., 177 W. 3rd St., St. Paul, Minn.

A Better Mortise Kester and Quicker

Make a smooth, clean-out job in any kind of wood: hard, soft, knotty, cross-grained or end wood; through dove pins or panel ends with perfect ease. A portable mortise with straight sides and uniform depth—made ten times faster than by ordinary method. Specially adapted for use on doors, sashes, screens, cabinet work, etc.

THE CHAMPION MORTISER easily makes 100 perfect mortises per day without the use of brace and bit or chisel. Quickly adjusted from round hole to 3/4 in. slot. Accurate and automatically regulated. Has 2 speeds for working in different woods. Simple to operate. Any workman can cut 100 mortises per day. Size 1-4 in., 3-8 in., 1-2 in., 5/8 in., and 3-4 in. bits; special sizes up to 1-4 in.

Fully guaranteed. You take no risk. Money back if not satisfied, after 10 days' trial. Price includes any two bits. Additional bits \$1.50 each.

Price \$35.00
Send today

Colgan Mach. & Supply Co.
Dept. P. M. 11, 801 Hayden Bldg., Columbus, Ohio

Price \$35.00

Send today

Colgan Mach. & Supply Co.
Dept. P. M. 11, 801 Hayden Bldg., Columbus, Ohio

THIS IS YOUR GOLDEN OPPORTUNITY WIN \$1,000 CASH



To Solve Puzzle Name Only Those Objects In Picture Beginning With Letter "C"

Are You A THINKER Or A TOILER?

Do you work with your brains or—only with your hands? Brain work pays biggest rewards! Think! Acquire wealth! \$1,000 if you give puzzle picture a little thought and make up the best or second best answer!

\$3,000 In 50 Free Prizes

Class "A" Gifts

If You Buy \$5 Pen

1st Prize.....	\$1,000.00
2nd Prize.....	1,000.00
3rd Prize.....	350.00
4th Prize.....	200.00
5th Prize.....	100.00
6th to 10th.....	20.00
11th to 15th.....	10.00
16th to 25th.....	7.50
26th to 50th.....	5.00

Class "B" Gifts

If No Pen Is Bought

1st Prize.....	\$25.00
2nd Prize.....	25.00
3rd Prize.....	10.00
4th Prize.....	7.00
5th Prize.....	5.00
6th to 10th.....	4.00
11th to 15th.....	3.00
16th to 25th.....	2.00
26th to 50th.....	1.00

ANSWER THIS PUZZLE PICTURE

Want to win \$1,000—QUICKLY? Look at the picture above. They're all plain, every day objects, aren't they? Make a list of the names of only those beginning with "C"—like cage, cat, child, etc., and send it in. Yours may be the best answer and win the biggest prize. Correct list by which judging will be done will be made up only of correct words included in all lists received. Thus you are insured honest and impartial treatment. Our policy guarantees A SQUARE DEAL FOR ALL!

How to Win \$1,000

Two \$1,000 cash prizes are offered for first and second best puzzle answers. So if your list of words is awarded first or second prize and you have "Qualified" for Class "A" by ordering only one Drew Jewelpoint Fountain Pen, at the special introductory price of \$5, you will win \$1,000. But if you have not ordered a pen you would win only \$25.

MEMO BOOKS FREE

Everyone sending in a puzzle answer that merits the consideration of the Judges will receive absolutely free our souvenir memo book with 1923 calendar. It's a handy little booklet for addresses, birthdays, etc., so send in a good list at once.

Advertising campaign for the beautiful Drew Jewelpoint fountain pens

The Drew Jewelpoint is made of the finest materials obtainable and is fully guaranteed. Illustration shows both Gent's style (actual size 6 3/4 inches long) and Lady's style (actual size 6 inches long). Barrel is of best grade black Para rubber, beautifully engraved and polished. Clip, bands, crown and ring, and patented self-filling lock-lever are all 14-K gold

filled. The pen is hand tempered 14-K gold, tipped with hard iridium and is carefully ground to a jewel-like smoothness. All in all a fountain pen you'll be proud to own, and the supreme gift for "Her" or "Him." Yet, now only \$5 prepaid. Three pen points—fine, medium or stub. When ordering be sure to state point and style wanted.

NOW ONLY \$5—PREPAID TO YOUR HOME

SQUARE DEAL RULES

1. Anyone living outside of St. Paul may take part in this puzzle game except employees of this company or their relatives.

2. Name only those objects visible in picture beginning with letter "C." Whichever list receives the most points will be awarded first prize, and so on down the list of 50 prizes. One point will be given for each correct word, and one deducted for each incorrect word or omission of a correct word. In case of tie, prize tied for will be awarded each trying contestant. The contest list by which judging will be done will be made up from lists received, and not from any so-called "master list." List winning first prize and names and addresses of all prize winners will be published at close of contest and mailed to all who have "Qualified" for Class "A."

3. Use only English words. An object may be named only once, but parts of objects may also be named. Either the singular or plural of a word may be used, but not both. Words of the same spelling but different meaning or pronunciation words will count only once. Compound, hyphenated and obsolete words are not permissible. Webster's International Dictionary will be the final authority.

4. Write "C" words on one side of paper only, numbering each word 1, 2, 3, 4, etc., and be sure to write your full name and address at top of each sheet. All answers must be mailed and postmarked not later than December 2, 1922. Contestants may "Qualify" for Class "A" up to midnight December 16, 1922.

5. Three prominent St. Paul people have consented to act as Judges: Dr. M. N. Moss; Jessie T. Collier, Public School Director; and P. M. Rogers, President Washburn National Bank. All who take part in contest agree to accept their decisions as final and conclusive.

6. Enlarged Picture Free On Request.

DREW PEN CO., Dept. 51, Tower Bldg., St. Paul, Minn.

The 140,000th Evinrude

—has just been shipped. Today these sturdy little motors are in general use throughout the world. In fact, the word "Evinrude" has come to mean outboard motor.

All of the 140,000 Evinrudes delivered are giving good service today, with the possible exception of some of the first few hundred built 12 years ago. Every year, refinements and improvements have been added, and the Evinrude has always been the outboard motor. Remember—the only genuine Evinrude is the Evinrude.

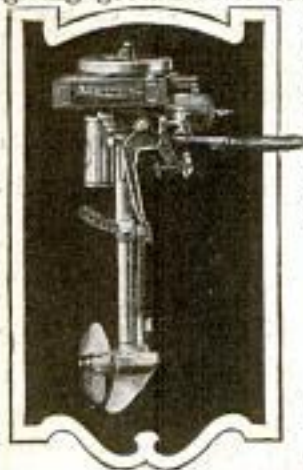

Two genuine Evinrude models are displayed at sporting goods and hardware dealers—the Standard and the Lightweight (weighs only 50 lbs.) See them or write for free catalog.

Evinrude Motor Co.
753 Evinrude Bldg.
Milwaukee Wisconsin

EVINRUDE Standard and Lightweight DETACHABLE MOTORS FOR WATERCRAFT

DISTRIBUTORS
69 Cortlandt St., New York, N. Y. 219 Broadway, Oakland, Calif.
780 Commonwealth Ave., Boston, Mass. 211 Morrison St., Portland, Ore.

AGENTS BIG MONEY SURE

Taking orders for fastest selling Ford accessories manufactured. **Browning, Ill., cleared \$20.40 first 3 hrs.** Be our General Agent. Sell to jobbers, dealers, car owners. Big profits. Strongly patented. No competition. Exclusive. Get into the big paying auto accessory business now. Write for samples today. Mr. Vixon, Suite 199, 716 Madison, Chicago.

STOP TOBACCO

If you cannot stop it, do you know why? Do you know its effect on efficiency? This subject discussed in common-sense manner in booklet written by one who conducted anti-cigarette clinic for L. A. Police Dept. for over a year. Treated thousands—all forms. Booklet free as long as they last. Write
Dr. T. H. Trinwith, Black Bldg., Los Angeles, Calif.

MYSTERIOUS CHARM

Gold-Plated and Aluminum

\$1.00
each

Write for free catalogue of Masonic publications, Jewelry and paraphernalia.

REDDING & COMPANY
200 Fifth Avenue Dept. P New York City



"Blake is the Man!"

"I told Hartley he was a 'comer'—and this confirms my judgment! Listen to this letter:—

Dear Sir:

You will no doubt be glad to know that James H. Blake, one of your employees of whose excellent work as a student we have been advising you each month, has completed his course and has been granted a diploma.

International Correspondence Schools

"That settles the manager question. The man who cares enough about his future to invest some of his spare time in training is the kind we want in this firm's responsible positions.

"That \$5,000 salary will mean a lot to Blake and his family. I'll send for him now! It's a pleasure to promote a man who *deserves it.*"

There is a job ahead of you that some man is going to be picked for. And your boss can't take chances. He is going to choose a trained man. Why don't you put yourself in line for that promotion?

One hour a day spent with the I. C. S. in your own home will bring you bigger money, more comforts, more pleasures, all that success means. Don't let another single priceless hour of spare-time go to waste! Without cost or obligation of any kind, let us prove that we can help you. Just mark and mail this coupon.

TEAR OUT HERE

INTERNATIONAL CORRESPONDENCE SCHOOLS

Box 5681-C, Scranton, Penna.

Without cost or obligation, please tell me how I can qualify for the position or in the subject before which I have marked an X:

BUSINESS TRAINING DEPARTMENT

- | | |
|---|---|
| <input type="checkbox"/> Business Management | <input type="checkbox"/> Salesmanship |
| <input type="checkbox"/> Industrial Management | <input type="checkbox"/> Advertising |
| <input type="checkbox"/> Personnel Organization | <input type="checkbox"/> Better Letters |
| <input type="checkbox"/> Traffic Management | <input type="checkbox"/> Foreign Trade |
| <input type="checkbox"/> Business Law | <input type="checkbox"/> Stenography and Typing |
| <input type="checkbox"/> Banking and Banking Law | <input type="checkbox"/> Business English |
| <input type="checkbox"/> Accountancy (including C.P.A.) | <input type="checkbox"/> Civil Service |
| <input type="checkbox"/> Nicholson Cost Accounting | <input type="checkbox"/> Railway Mail Clerk |
| <input type="checkbox"/> Bookkeeping | <input type="checkbox"/> Common School Subjects |
| <input type="checkbox"/> Private Secretary | <input type="checkbox"/> High School Subjects |
| <input type="checkbox"/> Business Spanish <input type="checkbox"/> French | <input type="checkbox"/> Illustrating <input type="checkbox"/> Cartooning |

TECHNICAL AND INDUSTRIAL DEPARTMENT

- | | |
|--|--|
| <input type="checkbox"/> Electrical Engineering | <input type="checkbox"/> Architect |
| <input type="checkbox"/> Electric Lighting | <input type="checkbox"/> Blue Print Reading |
| <input type="checkbox"/> Mechanical Engineer | <input type="checkbox"/> Contractor and Builder |
| <input type="checkbox"/> Mechanical Draftsman | <input type="checkbox"/> Architectural Draftsman |
| <input type="checkbox"/> Machine Shop Practice | <input type="checkbox"/> Concrete Builder |
| <input type="checkbox"/> Railroad Positions | <input type="checkbox"/> Structural Engineer |
| <input type="checkbox"/> Gas Engine Operating | <input type="checkbox"/> Plumbing and Heating |
| <input type="checkbox"/> Civil Engineer | <input type="checkbox"/> Chemistry <input type="checkbox"/> Pharmacy |
| <input type="checkbox"/> Surveying and Mapping | <input type="checkbox"/> Automobile Work |
| <input type="checkbox"/> Metallurgy | <input type="checkbox"/> Navigation |
| <input type="checkbox"/> Steam Engineering | <input type="checkbox"/> Agriculture and Poultry |
| <input type="checkbox"/> Radio <input type="checkbox"/> Airplane Engines | <input type="checkbox"/> Mathematics |

Name.....
Street.....
Address.....

G-26-22

City..... State.....

Occupation.....

Persons residing in Canada should send this coupon to the International Correspondence Schools Canadian, Limited, Montreal, Canada.



LUMINOUS PAINT

Make Your Watches, Clocks, Etc., Visible by Night

The very latest discovery in the scientific world, hitherto, practically unobtainable except at an exorbitant price, we have at last succeeded in producing this remarkable LUMINOUS PAINT, which, applied to the surface of any article, emits rays of white light, rendering it perfectly visible in the dark. THE DARKER THE NIGHT, THE MORE BRILLIANT IT SHINES. Quite simple to use. Anyone—you can do it. A little applied to the dial of your watch or clock will enable you to tell the time by night. You can coat the push buttons or switch plates of your electric lights, match boxes, and innumerable other articles; make your own Luminous Crucifixes, Luminous Rosaries, etc. Small bottle, price 25c, Larger sizes, 50c and \$1 postpaid.

Serpent's Eggs

Has contents 10 eggs. When lit with a match, each one gradually hatches itself into a make several feet long which curls and twists about in a most life-like manner. Price per box, 10c postpaid, \$3 for 25c.



Potmend

Mends Tins, Aceto-ware, bottles, pots, pans, beer cans, tin pipes, etc. Comes in powdered form. Just mix with water and apply. HARDENS LIKE IRON. Mends a big hole or a small crack. PRICE 15c, 3 for 40c, postpaid.

broken things, porcelain, hydro-bone, bicycle, crank-ty, woodensure, stable, etc. Comes in powdered form. Just mix with water and apply. HARDENS LIKE IRON. Mends a big hole or a small crack. PRICE 15c, 3 for 40c, postpaid.

Midget Bible

GREAT CURIOSITY
Smallest Bible in the World. Size of a postage stamp. 200 Pages. Said to bring good luck to the owner. A genuine work of art. Must be seen to be appreciated. Make good money selling them to friends, church acquaintances, etc. PRICE 15c each, 3 for 40c, 12 for \$1.35, 100 for \$7.50.



With a bunch of these bills, it is easy for each person of limited means to appear prosperous. By flashing a roll of these bills at the proper time and peeling off a genuine bill or two from the outside of the roll, the effect created will be found to be all that can be desired. Prices, postpaid: 15 Bills 10c, 50 Bills 25c, 125 for 50c, or \$3.50 thousand.

STAGE MONEY



With a bunch of these bills, it is easy for each person of limited means to appear prosperous. By flashing a roll of these bills at the proper time and peeling off a genuine bill or two from the outside of the roll, the effect created will be found to be all that can be desired. Prices, postpaid: 15 Bills 10c, 50 Bills 25c, 125 for 50c, or \$3.50 thousand.

WONDERFUL X-RAY TUBE

A wonderful little instrument producing optical illusions both surprising and startling. With it you can see what is apparently the bones of your fingers, the lead in a lead pencil, the interior opening in a pipe stem, and many other similar illusions. A mystery that no one has been able to satisfactorily explain. Price 10c, 3 for 25c, 1 dozen 75c. JOHNSON SMITH & CO.



Good Luck Ring

Quaint and Novel Design

A VERY striking and uncommon ring. Silver finish, skull and crossbone design, with two brilliant, flashing gems sparkling out of the eyes. Said by many to bring Good Luck to the wearer, hence its name, Good Luck Ring. Very unique ring that you will take a pride in wearing. ONLY 25 CENTS.

Address orders for all goods on this page to

JOHNSON SMITH & CO.

Dept. 935 3224 N. Halsted St. Chicago

Our large catalog (300 Pages) of all the newest and best novelties, unobtainable elsewhere, free with every order.

The Dying Pig



The most laughable novelty yet produced. Made of rubber, and you have only to blow it up and stand the pig on his feet, when he begins to squeal as he slowly collapses and finally lies down and dies in the most natural manner. You can blow him up as often as desired, and each time he will go through the same performance to the great amusement and delight of your friends. Price, 15 cents; 3 for 40 cents; one dozen \$1.35, mailed.

Popular Watch Charms



ONLY 15c

3 for 40c; \$1.35 doz.

Very pretty little curiosities and decidedly novel. Fitted with Magnifying Lenses that enlarge the pictures to a very surprising degree; in fact, it seems almost incredible that a clear picture could be possible in such a small compass, and how sharp and distinct they show up when you look through. Come in assorted views—Arcansas, views of Panama Canal, Lord's Prayer in type, etc.

Mystic Skeleton

A jointed figure of a skeleton 14 in. in height, will dance to music and perform various gyrations and movements while the operator may be some distance from it. 10c pd.



NEW BOOK ON ROPE SPLICING

Useful Knots, Hitches, Splices, etc.

A most practical handbook giving complete and simple directions for making all the most useful knots, hitches, rigging, splices, etc. Over 100 illustrations. All about wire-rope splicing, lashing, blocks, tackles, etc. 25 Heraldic Knots illustrated. Of great value to mechanics, riggers, carpenters, boatmen. Price 20c postpaid.

MAGIC FLUTE

Wonderfully Sweet Toned and Musical

The Magic Flute, or Human-stone, is a unique and novel musical instrument that is played with your mouth and mouth-castors. There is just a little knack in playing it which, when once acquired after a little practice will enable you to produce very sweet music that somewhat resembles a flute. There is no fingering, and once you have mastered it you can play all kinds of music with facility and ease. When played as an accompaniment to a piano or any other musical instrument, the effect is as charming as it is surprising.

Post Paid 25c

BLANK CARTRIDGE PISTOL

Protection against Burglars, Tramps, & Dogs

PRICES 50c. \$1.00



JOHNSON SMITH & CO., Dept. 935, 3224 N. Halsted St. Chicago

DANCING BEAUTIES

Get a Kinetograph and see the picture move. France's latest sensation. A great surprise. Is worth twice what they cost. Are made of solid brass, highly nickel-plated and very durable. Satisfactory or your money back. Price 50c. Don't show your girl. Price 50c.

JOHNSON SMITH & CO., Dept. 935, Chicago

BOYS!

BOYS!

BOYS!

THROW YOUR VOICE

Into a trunk, under the bed or anywhere. Lots of fun fooling the teacher, policeman or friends.

THE VENTRILLO
a little instrument, fits in the mouth out of sight, used with above for Bird Calls, etc. Anyone can use it.

Never Fails. A 32 page book on ventriloquism, the Ventrillo, ALL FOR 10 CENTS

1000 Silk Remnants

For patching Crazy Quilts, Sofa Cushions, Head Rests, Pin Pads, etc. Large pieces, all colors and shades. Sure to delight you. For 10 Cents stamps, we send a large package and Book of quilt designs. 3 packages, 25c. 1 pound makes a lovely large quilt. Price 75c postpaid. Our silk is the best.

JOHNSON SMITH & CO., Dept. 935, 3224 N. Halsted Chicago

LOOK 50c Look

Wonderful instrument. Greatest thing yet. Nine separate articles in one. Everybody delighted with it. Odd, curious and interesting. Lots of pleasure as well as very useful. It is a double Microscope for examining the wonders of nature. It is also an Opera Glass, a Stereoscope, a Burning Lens, a Reading Glass, a Telescope, a Compass, a Pocket Mirror, and a Laryngoscope—for examining eye, ear, nose and throat. It is worth all the cost to locate even one painful cinder in the eye. Folds flat and fits the pocket. Something great—you need one. Don't miss it! Sent by mail, with 300 page Novelty Catalog, ONLY 50c or 3 for \$1.25

Resurrection Plant

One of the most wonderful plants known. Possesses the strange power of turning in a few minutes from an apparently lifeless, dry herb to a beautiful living fernlike plant of a dark green color. Simply place the plant in saucer of water, it will open up and start to grow in 20 minutes. When taken out it will dry up and go to sleep until placed in water again. Fine house plant—summer or winter. 10 cents each or 3 for 25c. post paid.

BEAUTIFUL LIVING FERNLIKE PLANT of a dark green color. Simply place the plant in saucer of water, it will open up and start to grow in 20 minutes. When taken out it will dry up and go to sleep until placed in water again. Fine house plant—summer or winter. 10 cents each or 3 for 25c. post paid.

AGENTS WANTED
JOHNSON SMITH CO., Dept. 935, 3224 N. Halsted, Chicago

Swear Off Tobacco



Tobacco Tells on Nervous System



Tobacco Ruins Digestion

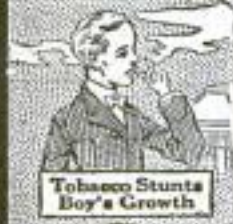

Tobacco Stunts Boy's Growth



Tobacco Robs Man of Vitality



Tobacco Steals from You the Pleasures, Comforts, Luxuries of Life

Tobacco Habit Banished Let Us Help You

Quick Results

Trying to quit the tobacco habit unaided is often a losing fight against heavy odds, and may mean a serious shock to your nervous system. So don't try it! Make the tobacco habit quit you. It will quit you if you will just take Tobacco Redeemer according to directions.

It doesn't make a particle of difference whether you've been a user of tobacco for a single month or 50 years, or how much you use, or in what form you use it. Whether you smoke cigars, cigarettes, pipe, chew plug or fine cut or use snuff—Tobacco Redeemer will positively remove all craving for tobacco in any form in a few days. Your tobacco craving will usually begin to decrease after the very first dose—there's no long waiting for results.

Tobacco Redeemer contains no habit-forming drugs of any kind and is marvelously quick, scientific and thoroughly reliable.

Not a Substitute

Tobacco Redeemer is in no sense a substitute for tobacco, but is a radical, efficient treatment. After finishing the treatment you have absolutely no desire to use tobacco again or to continue the use of the remedy. It helps to quiet the nerves, and will make you feel better in every way. If you really want to quit the tobacco habit—get rid of it so completely that when you see others using it, it will not awaken the slightest desire in you—you should at once begin a course of Tobacco Redeemer treatment for the habit.

Results Absolutely Guaranteed

A single trial will convince the most skeptical. Our legal, binding, money-back guarantee goes with each full treatment. If Tobacco Redeemer fails to banish the tobacco habit when taken according to the plain and easy directions, your money will be cheerfully refunded upon demand.

Let Us Send You Convincing Proof

If you are a slave of the tobacco habit and want to find a sure, quick way of quitting "for keeps" you owe it to yourself and to your family to mail the coupon below or send your name and address on a postal and receive our free booklet on the deadly effect of tobacco on the human system, and positive proof that Tobacco Redeemer will quickly free you from the habit.

Newell Pharmacal Company
Dept. 300 St. Louis, Mo.



Free Book Coupon

NEWELL PHARMACAL CO.,

Dept. 300

St. Louis, Mo.

Please send, without obligating me in any way, your free booklet regarding the tobacco habit and proof that Tobacco Redeemer will positively free me from the tobacco habit or my money will be refunded.

Name.....

Street and No.....

Town..... State.....

Free Book on Drafting!

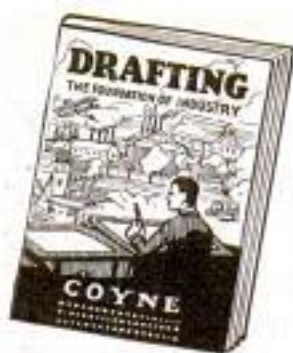

Tells you all the secrets of drafting—"The Foundation of Industry." Specimen plans and dozens of photographs show you how and where the draftsman works. How he designs and plans details of airplanes, engines, automobiles—machinery and structures of all kinds—before a wheel can turn or a brick can be laid.

Why draftsmen command high salaries and pleasant working conditions. The interesting story of how great inventors and executives win fame and fortune through knowledge of drafting. How you can enter this field where big pay and unlimited opportunities are yours for the taking.

Drafting Outfit FREE! How you can have a complete drafting outfit, the same as professional draftsmen use, **absolutely free!** Send for this big free book and the details of this wonderful offer. No charge—no obligation. Write today!

Coyne Trade & Engineering Schools

Dept. 9778, 552-598 S. Throop St., Chicago, Ill.

MECHANIC'S POCKET SECRETARY

Constructed of finest steel. Just push the button and out comes the article you require. Worth \$1.00. Postpaid

25c

See One To-day



25c

10 in 1—

Adjustable Pencil, pen, paper knife, ink eraser, pencil sharpener, nail file and cleaner, mechanic's marking point, fine compass with screw attachment, foot rule.

Universal Co., Box 508, Stamford, Conn.



Always on Time

"The Fifth Avenue" Illinois 19 Jewel Watch

Give you everything you can demand of a timepiece—accuracy, dependability and beauty. A fully adjusted movement in a thin model, 25 year Green Gold filled Case and an unobtainable record of service. Unconditional guarantee against everything except loss and that our price of \$45.00 can not be duplicated.

\$5.00 DOWN—\$5.00 A MONTH

No Red Tape—No Delay—No Risk

FREE: Deluxe illustrated catalog, Hundreds of Special Extra Values.

Write Dept. P.M.K. Est. 32 years

AMERICAN WATCH & DIAMOND CO.
6 MAIDEN LANE NEW YORK

SPECIAL CLUB PLAN OFFER—SAVE 30 TO 40%

Get together with your friends and obtain a snappy Fordspeed Body and pay only five dollars a week. Oh Boy, Oh Joy! no need of waiting till you save up the full amount of money. Send for our Special Club Offer, Now.

Ford-speed Bodies

8-16 Valve Heads, 1 & 6 Speed Transmissions



Crankshaft Counterbalances Wire and Disc Wheels

Every thing for Speed and Power

SPECIALS FOR THIS MONTH

	Price	Now	Drum Head, Light Nickel	Price	Now
Foot Accelerator	\$ 2.50	\$ 2.79	Trimmed with Brackets, or	\$10.00	\$ 6.25
24:1 Gears	12.50	6.59	Brass new Disc Magneto	55.00	14.50
3:1 Gears	12.50	6.59	Spiral Gear Magneto Drive	22.00	14.50
Speed and Power Camshaft	19.50	9.95	Underlining Parts	15.00	9.95

A limited number of each at above price. Order Now! Satisfaction or Money Back Guarantee. Terms—30% with order, balance upon delivery.

J. H. FORD SPEED & POWER EQUIPMENT MANUFACTURERS
250 West 54th St., New York City, N. Y.

Automobilists SAVE MONEY Do Your Own Repairing



Off-Set Ratchet Screw Driver

Will work in close places that are absolutely impossible and inaccessible with any other off-set screw driver of any kind.

It has a powerful 6 inch drop forged, case hardened, polished handle, two steel interchangeable, silled screw driver bits, made from the highest grade, oil tempered steel, that can be removed and replaced in one second.

For a short time to introduce this wonderful tool, we send you one post paid to any address on receipt of one dollar. If you are not satisfied we will return the dollar.

DUKEY SALES CO. Berwyn, Ill.



AGENTS Make Big Money

Selling D-REX-U Safety Signal to automobile owners; complies with safety laws; guaranteed. Write today for wholesale price to agents and get territory quick. Big Winter Seller. Address Comstock-Bolton Co., Dept. K, 1925 E. 15th St., Kansas City, Mo.



BRIGHTEST OIL LIGHT

Famous Vapelite burner used on old kerosene lamps. Generates large white gas flame. Saves oil. Smokeless, Unbreakable. Guaranteed Five Years. Sample 50c. Complete Home Outfit of three burners \$1.25. **AGENTS WANTED.**

THE VAPOLITE CO.

Dept. F. Toledo, Ohio

Ingersoll

Send for Free Catalog of Money Saving Bargains

Bargains in Sports, shot guns, fishing tackle and other sporting items await those who send for this big, beautifully illustrated free catalog. Many sensational low prices. Write now for your free copy. Paramount Trading Company Dept. 243 34 West 20th St., New York

Bargains in Sporting Goods

At Last! *The Perfect* Radio Loud Speaker *for the Home*

THERE is no other Loud Speaker like the DICTOGRAPH—made expressly for home use by the makers of world-famous Dictograph products—standard everywhere for the finest, most accurate and most sensitive sound-transmission and loud-speaking devices.

DICTOGRAPH Radio LOUD SPEAKER

Years of experience in producing the marvelously sensitive "Acousticon" for the Deaf, the Detective Dictograph and the Dictograph System of Loud-Speaking Telephones have made possible this wonderful Radio Loud Speaker that reproduces every sound—singing, speaking, instrumental music—in crystal-clear, natural tones, full volume, and FREE FROM DISTORTION AND NOISE. The price is only \$20—complete with 5 ft. flexible cord.

The Dictograph Radio Loud Speaker gives perfect results with any vacuum tube receiving set. No alterations; no extra batteries—you simply plug in and listen. Ask for FREE DEMONSTRATION of the Dictograph Radio Loud Speaker at any reliable radio shop. Get DICTOGRAPH quality and still save money.



DICTOGRAPH Radio HEAD SET The Best Head Set at any Price

The Dictograph Radio Head Set has established a standard of quality impossible to secure in any other head set. Its use on any receiving set, crystal detector or vacuum tube, improves reception immeasurably. 3000 ohms resistance. Price, \$12.00. The best Head Set in the world. Regularly furnished as Standard Equipment with the leading Receiving Sets made.

Dealers: Order through your jobber or write for names of authorized distributors.



Price
\$20

Complete with 5 ft. flexible cord

A beautiful instrument! Finely constructed, richly finished. Its handsome appearance harmonizes with any home. Highly burnished, French lacquered, eleven inch spun copper bell horn attached to die cast black enamel tone arm, finished with nickel trimmings. Cabinet 6x5 inches base, 4 inches high, of solid, ebony-finished hardwood, mounted upon rubber knobs. Furnished complete with 5 ft. flexible cord. No extra batteries required.

The DICTOGRAPH PRODUCTS CORPORATION, 220 West 42nd St., NEW YORK CITY (Branches in All Principal Cities)

I Need Branch Managers



LIGHTNING—WONDERFUL NEW ELECTROLYTE charges discharged batteries instantly. Eliminates old sulphuric acid method entirely. Dissolves sulphation. World has waited half a century for this invention. One gallon, retails \$10.50, free to agents. Lightning Battery Co., St. Paul, Minn.



S-C Loud Speaker Horn

Delivered at any door in U.S. for \$7.50

Largest Value on the Market
22 1/2" High; 8 3/4" Bell

Made of soft brass of remarkable tonal quality, on correct, tested acoustic principles. Takes any radio receiver in universal receptacle. Handsome gold bronze finish, lacquered. Counterweight prevents tipping.

In the same high quality with low prices: Variometers, Variocouplers, Variable Condensers, Amplifying Transformers and other Radio parts. Pink-a-Tone Sets, \$25. Ask for Bulletin R.

S-C Products Company
1264 Nicholas Bldg. Toledo, Ohio

MURDOCK RADIO PHONES

Have been
The Standard Radio Phones
for Over 18 Years

THERE are no other Phones so good at so low a price. Examine Murdock apparatus at your dealers. Send for descriptive circular of the complete Murdock line of instruments.

WM. J. MURDOCK CO.

349 Washington Ave.
1270 Broadway
509 Mission St.

Chelsea, Mass.
New York
San Francisco

2000 Ohm, \$5.00
Complete Set

3000 Ohm, \$5.50
Complete Set



NEW No. 16, 256-Page DUCK'S Radio Catalog

All Other Catalogs in One

Our new catalog is truly the wonder catalog. You can spend more than a dollar for other catalogs and yet you will not have the equal of this catalog. There are over 50 pages of diagrams and data on wireless. As a radio book alone it is priceless. The complete catalog of the Radio Corporation of America, with circuits and information for making powerful wireless telephone transmitters, the Remler, Murdock, Firth, and in fact all other catalogs are incorporated in this catalog, not to mention over 70 pages of our own goods.

Send 25c in coins carefully wrapped for this catalog today. Not sent otherwise.

The William B. Duck Company, 223-227 Superior St., Toledo, Ohio

 SIGNAL

Junior Detector Units

For the amateur and also the rapidly growing commercial field, we have developed an entirely new line of apparatus, in which is incorporated the very latest advancement of the science of Radio.

Each individual unit is primarily a separate and distinct device, complete in itself, yet by adding one to another any combination may be obtained, from the simple crystal detector through all the stages of radio frequency and audio frequency amplification.

Seasoned knowledge and experienced handicraft are built into these units—the product of a plant and an organization whose history in Radio dates back to the earliest days of "wireless."

Signal Crystal Detector, Type 110



Rear view showing perfection of detail in finish, formica back, nickel plated binding posts for connecting other units, etc.

The instrument illustrated is undoubtedly the best type of crystal set ever offered. Its special features include:

High grade 21-plate condenser.

Device for locking cat whisker into positive position after live spot is obtained. No jarring or vibration of the set can destroy this positive contact.

Range 150 to 600 meters, which may be increased to 12,000 meters by attaching loading coils.

Space forbids complete description. Send for our Booklet and Special Bulletins. For certainty of Radio results insist on SIGNAL parts and sets. For sale by dealers everywhere.

SIGNAL Electric Mfg. Co.

Factory and General Offices
1910 Broadway Menominee, Mich.

Atlanta
Boston
Cleveland
Chicago
Minneapolis
Montreal
New York
Pittsburgh
St. Louis
San Francisco
Toronto
You'll find our local address in your Telephone Directory.

COUPON FOR GUIDE TO RADIO SATISFACTION

Signal Electric Mfg. Co.
1910 Broadway, Menominee, Mich.

Please send, without obligation, your interesting book about SIGNAL parts and sets, to the name and address written in the margin of this page.

(1824A)

Please Mention Popular Mechanics

3000 OHM SETS \$3.98

PLUS 20 CTS. POSTAGE AND PACKING
Satisfaction Guaranteed or Money Back.



We mail phones the day your order arrives. Every pair tested, matched, and guaranteed as sensitive as \$8 to \$10 Sets. Circular Free.

Tower Mfg. Company
35 STATION ST. BROOKLINE, MASS.

FREE Radio Catalog



Describes and illustrates our large complete stock of Radio Equipment of all kinds. We can make immediate shipments of proven, reliable equipment. Protect yourself against disappointment by taking advantage of our experience and reliability.

Send \$5.00 for Genuine Cunningham or Radiotron Detector Tube. Free catalog sent on request.

JULIUS ANDRAE & SONS CO.
116 Michigan St. In business since 1860 Milwaukee, Wis.

BUILD THIS RECEIVER



Fully assembled \$25.00.
Unassembled, except cabinet, \$12.63. Brings in all big stations. We manufacture Regenerative and non-regenerative receivers, audion detectors, crystal detectors, radio and audio amplifiers. Blue prints 25 cents each. All six for \$1.25. Catalog 10 cents.

TRIBUNE AIRPHONE COMPANY
Dept. N Owego, N. Y.

Edison Radio Phones

Adjustable Diaphragm Clearance

We guarantee satisfaction, or your money refunded. The adjustment feature places ear phones on a par with the world's greatest makes. Our sales plan eliminates dealer's profits and losses from bad accounts, hence the low price. Better phones cannot be made. Immediate delivery. Double 3000 Ohm set, \$3.98; 1500 Ohm single set, \$1.50. Circular free!



Edison Phone Co. 6 Beach St. Dept. 48 Boston Mass.

WESTINGHOUSE BATTERIES

\$25.00 Radio Set Given



Send no
Money

Every girl or boy can enjoy the thrill of receiving all the news, music, etc. with this famous **Pink-a-tone Radio Set**. Guaranteed to receive up to 25 miles. Yours without a single penny. Write to Dept. 103 for our easy plan telling how to get this handsome and efficient outfit without expense.

National Service Co., 1834 Bway., N.Y.

Manufacturer to Consumer

Our 50 Standard Radio parts are engineered and designed right, and manufactured under minimum overhead. Our factory is now under full production and can supply your needs.



Mic-O-Phone Repetitor with modifying sounding board. Designed by experienced engineers. Will reproduce music and speech in any volume or sound desired, with purity of tone as clear as original. Heavy cast polished aluminum. Equipped with army and navy loud speaking receiver and 6 feet of cord. By parcel post, complete, \$20.00.

Compare our prices with others and see what a big saving there is for you to purchase direct from us.

Over 25 years' experience in the electrical field puts us in position to know the exact Radio needs, and our goods are purchased with increased satisfaction.

Our Prices Will Interest You

Send 10 cents in stamps for 40 of the latest diagrams for Radio Hookups.

WRITE FOR CATALOG

ALDINE RADIO & MFG. CO.

Aldine Square, Chicago, Ill.
Dept. F11



Mic-O-Phone Listener-In for Crystal or Tube Sets. A one-hand phone connected to this instrument and the whole family can listen in. Saves the cost of additional head phones. Made of heavy cast polished aluminum. Equipped for 6 persons. By parcel post, complete, \$5.00.



Mic-O-Phone Variometer, \$3.25



Mic-O-Phone Variocoupler, \$2.50

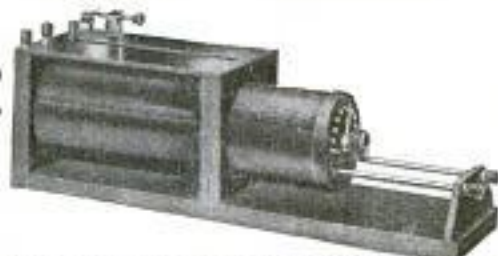

Mic-O-Phone Wave Coupler. Is acknowledged the most accurate tuning device on the market. Wave length 1000 meters. Top panel polished hard rubber. Complete, as shown with crystal detector, by parcel post, \$10.00.



RADIO
HEAD SETS, JACKS, PLUGS,
MICROPHONES

Manufacturers

American Electric
COMPANY

State and 64th Sts., Chicago, Ill.



Make Your Own **Radio**
Receiving Set

Get Baseball scores, enjoy the concerts, market reports, latest news, etc., as sent out by large broadcasting stations. This **NEW** copyright book, "EFFICIENT RADIO SETS," shows how to make **INEXPENSIVE** sets for receiving wireless broadcastings. Sent postpaid for 25c. Address **J. C. DORN, Pub., 725 S. Dearborn St., Dept. 116, Chicago, Ill.**

"Superior" Receiving Set, \$4.75



In Cabinet Complete as Shown

Guaranteed to bring in signals as loud or louder than any other crystal set made, regardless of price. We will prove this to your satisfaction or refund your money.

Parts for "SUPERIOR" set ready for assembling \$3.25
Vacuum Tube Detector Unit \$5.50. Unassembled \$3.90
Detector and Two Stage Amplifier \$22.50. Unassembled \$16.80
2000 Ohm Headset \$5.00; 3000 Ohm \$6.50;

1000 Ohm Phone \$1.75

Catalog FREE at your Dealer's or
STEINMETZ WIRELESS MFG. CO. 5706 Penn. Ave. Dept. K Pittsburgh, Pa.

MILLION POINT MINERAL

The World's Greatest Radio Crystal

is revolutionizing radio. It is supersensitive and is the only crystal which reproduces from every point on its surface. Doubles your radius and greatly increases the audibility. Send 50c and the name of your Radio Dealer for two M. P. M. crystals, concert tested and guaranteed. Dealers: Write-today-for complete information about M. P. M. and our attractive sales proposition.

M. P. M. SALES COMPANY

Dept. P

247 So. Central

Los Angeles, Cal.

Air-Way Radio

A Wonderful New Source of Home Pleasure and Profit

"Listen-in" at home with an "AIR-WAY" to the latest news of the world, music of wonderful artists, church services, lectures by famous men and women, weather reports, market quotations on stocks, bonds, cattle, sheep, hogs, grains and crops. Give your children entertainment—college extension courses, over the easily-installed wireless telephone. All these priceless advantages are broadcasted daily without a penny of cost to you. It is all within your range, no matter where you live, if your home is equipped with "AIR-WAY" Radio.

Complete Sets or Easily-Assembled Parts of Guaranteed Quality



AIR-WAY Model "B" Complete Receiving Set, Long-distance vacuum tube outfit—detector and one-stage amplification.

"AIR-WAY" Green Seal Radio equipment represents the highest quality and latest in radio development—assures certain satisfaction in operation and reception of radio messages. With an "AIR-WAY" outfit you are capable of "tuning-in" to your choice of broadcasting stations. Pick up anywhere, any time, during day or evening, miracles in the air. Anyone can operate it. As simple to use as a telephone. Costs less than a good phonograph—more valuable to you and your family than an automobile.

FREE RADIO BOOK

Illustrates and completely describes "AIR-WAY" Green Seal Guaranteed Radio Equipment. Tells you best parts to use in building your own set or how to buy a complete long-range outfit at an amazingly low price. You need this book to intelligently select the most perfect operating equipment for Radio Receiving. Send name and address for it, today. It's FREE.

Air-Way Electric Appliance Corporation
Dept. 104 Toledo, Ohio

Look for this Guarantee Tag attached to every Radio instrument you buy. The AIR-WAY Green Seal Guarantee Tag attached to a Radio instrument is the symbol of quality that is known and preferred by experienced Radio Buyers.

Air-Way GREEN SEAL GUARANTEE

Please Mention Popular Mechanics

"Just What They Have All Been Waiting For"

\$4⁵⁰

Postpaid Fully Guaranteed

Money back if not entirely satisfied.

A HIGH QUALITY HEAD SET

Its high quality and excellent features can not be estimated by its extremely low price. So very light that you can wear it an entire evening without tiring. This adds new comfort and ease to radio entertainment. Study these seven FEATHER-WEIGHT features.

Featherweight
DOUBLE HEAD SET

Double Head Set postpaid \$4.50 complete with 5 foot cord. Single Head Set with 4 foot cord, no head band, postpaid \$2.50. Send money order or any C.O.D. Order today. It's a wonderful value. We also supply dealers.

STANDARD RADIO COMPANY, 4393 Apple Street, Detroit, Mich.

DOUBLE HEAD PHONES



BOYS! A REAL RADIO SET ABSOLUTELY FREE

RUSH your name and address and we will tell you HOW you can get this RADIO SET ABSOLUTELY FREE.

RADIO SET comes to you complete, with single slide tuning coil, crystal detector and phone condenser. AND DOUBLE HEAD PHONES. No batteries required; no experience.

Write Today for Free Radio Plan
HOME SUPPLY CO.,
110 Nassau St., Dept. 151,
New York City

See your dealer for information about
RADISCO Radio Products
THE RADIO DISTRIBUTING CO.
Newark, N. J. U. S. A.



CATALOG No. 22 IS READY

Small Steam and Gasoline Engines, 1/2 H. P. up. Pumps, gears, model makers' supplies. Sent postpaid (2 dimes preferred) or 20c stamps.

Modern Engine & Supply Co.
334 Massachusett Bldg., Chicago



ANY BOY CAN BUILD THIS 20" CAT BOAT

with our complete Construction Set.

"Everything but the paint"

\$5⁰⁰

We have other boats, engines, boilers, etc.

Catalog Free

The H. E. Boucher Mfg. Co.
154 Lafayette St., New York



Baby Grand Lathes

FOR METAL OR WOOD
HIGHEST QUALITY—LOWEST PRICE

A precision machine tool at a price within the reach of everyone, everywhere.

A Practical Tool For Universal Use

A dependable, low priced lathe for use by those engaged in light manufacture, model making, experimenting, repairing, etc., as well as the requirements of the amateur, the inventor and the student.

Ideal For Use in the Home

Interesting, instructive and profitable employment for your spare time.

Develop Your Ideas in Private

Build your experimental models with your own hands.

Add \$5 to Your Income

In spare time make salable product, radio equipment, Xmas gifts, etc.

Lasts a Life Time

A sturdy machine built for real work.

**Write NOW
For Prices
and
Details**

- 6-in. Swing
- 12 in. or 18 in. Between Centers
- 20 in. or 26 in. Bed

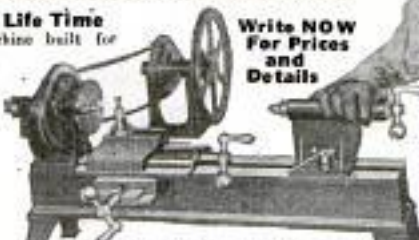

THE WATSON MFG. CO.
30 Post Street, Toledo, Ohio, U. S. A.

30 DAYS' FREE TRIAL TO FORD OWNERS SEND NO MONEY



MAKES FORD DRIVING STEADY

stabilizing devices. At the end of 30 days you send it back—or, send us \$3.75.

Special 30 Day Trial Offer. Our dealers are authorized to sell genuine Hastings Stabilizers at this price and on this 30 Day Free Trial basis. Get your Hastings Stabilizer now from your dealer or the

HASTINGS MANUFACTURING COMPANY
45 E. Mill St. Hastings, Michigan

What we say in print we back up. We will ship you, postpaid, one Hastings Ford Stabilizer. Pay nothing to the postman—not one cent. For 30 full days let the Hastings Stabilizer steer you steadily and safely over any road in any weather. Compare it with other end of 30 days you send



Does Your Camera Shutter Work?

Seneca, Kodak, Premo, Ansco or Ingento Shutters repaired and adjusted. Any style or size. Expert work done and guaranteed. Prompt Service. Reasonable Prices. Send your shutter in today.

Address Shutter Division
SENECA CAMERA MFG. COMPANY
Rochester, N. Y.

NOW ONLY \$2.48



A Real Phonograph

An actual, serviceable talking machine that plays all records up to and including 10 inches, except Edison. Powerful Spring Motor, Universal Tone Arm and Reproducer. Rascally portable. Weighs 4½ lbs.

THIS MACHINE FULLY GUARANTEED
Order today, add 32c for postage

A. W. POMEAN & CO. 1640 Germantown Ave. Philadelphia, Pa.

Price
\$1.00
Per Pair

Distributors
and Dealers
wanted.
Write for
Proposition



Don't Gamble—Take A Chance!

Save Shirts— Save Laundry

HERE'S a new idea in cuff buttons—the handiest thing you ever saw! The buttons are mounted on the ends of light, adjustable spring bands that lie between the folds of the cuffs and hold the cuffs securely, comfortably, unwrinkled and clean wherever you want them on wrist, forearm or upper arm. The spring bands are easily adjustable to fit any size cuff and wrist. The buttons open automatically when you draw up your sleeves and close automatically when you pull them down. Nothing to fasten or unfasten. Hands slip through cuffs without unfastening buttons.

Save on laundry bills and make your shirts last longer by wearing Chance Cuff Buttons. They hold the cuffs smooth and unwrinkled on the arm—away from the dirt when you're working, away from the splash when washing hands. The one cuff button you can't lose.

Chance CUFF BUTTONS ADJUSTABLE PATENTED



A slight pull draws them up on the forearm out of the way.

Ideal for Christmas

Made in attractive pearl and silver finish—a dollar a pair. Just the thing for Christmas presents. Ask your dealer—if he can't supply you, write us direct. Don't risk annoyance, discomfort and soiled shirts any longer—**take a Chance!**



Held, smooth and clean, above the elbow. Wonderfully comfortable.

Chance Sales Co.

27-29 No. 4th St.
Minneapolis, Minn.

Pin a Dollar Bill on This Coupon and Mail It Today

Chance Sales Co., 27-29 North 4th St., Minneapolis, P.M. 1
Gentlemen:—Please mail me..... pairs of Chance
Cuff Buttons for which I enclose \$.....

Name.....
Street No.....
Town..... State.....



52 PAGE FUR BOOK FREE TO TRAPPERS

Be Taylor Equipped—Save Money

Send for new BOOK of TRAPS. Bigger and better than ever this year—many entirely new trapping devices shown for the first time. Also trapping laws, trapping methods, traps and baits to use—lists every article the trapper uses at money-saving prices. BOOK of TRAPS; the MOST COMPLETE FUR BOOK ever compiled for FREE DISTRIBUTION. WRITE—

Taylor
BEST FOR FIFTY YEARS

in ST. LOUIS since 1871
Taylor Free Service Helps You

Send your name and address for Taylor Trapping Service. Most complete Fur Market reports, also shipping tags. Free to you. Write

F. C. TAYLOR FUR CO.
860 Fur Exchange Bldg. ST. LOUIS, MO.



RAISE BELGIAN HARES
New Zealand Stock — Flemish Giants — American Blues.
BIG PROFITS, WE PAY \$1.50 TO \$8 EACH.
Also Cavies, Minis, Bucks, Fox, Muskrat, Etc.
Easily raised anywhere. \$2.
Free Catalog and Contract.
Illustrated book "COMMON SENSE RABBIT RAISING," quarterly journal, and copy of America's leading small stock magazine, all for 10 cents. Address
Outdoor Enterprise Co., 1005 D. L. BLDG., KANSAS CITY, MO.

FOUKE

Trappers: **wants your name and address if you are going to trap or buy FURS**

Write Fouke today—prospects very good. For best results it's important to have constant up-to-the-minute market information. Fouke gives it. Get the jump on the other fellow. **SEND TO-DAY**

FOUKE FUR COMPANY
640 Fouke Building, St. Louis, Mo.
Put my name on your books for Fouke Market Reports and "The Trapper's Partner," the new book on how to trap and grade furs, game laws, low prices on all supplies—all FREE.

Name _____
Town _____
State _____ R. F. D. _____ Box _____

FREE

300 Candle Power Sunray Lantern

As a special introductory offer, a 300 Candle Power SUNRAY Lantern worth \$8.50 will be given absolutely Free with the first purchase of a SUNRAY Lamp. Lights up the yard or barn like a search-light. Brighter than sun light—burns 30 hours on a few cents worth of kerosene or gasoline. Lights with match or torch. No wicks to trim—no chimneys—no smoke—no smell. Find out about this great special offer.



Better Than Gas or Electricity

Whitest light ever produced. Nothing to wear—simple—absolutely safe—you can burn it upside down. Get rid of drudgery and poor light—see the SUNRAY—flood your home with light—save your eyes.



No Wicks to Trim
No Smoke
No Smell

15 Days' Trial

Absolute satisfaction guaranteed. If you don't like it, send it back. Our money-back guarantee protects you—no red tape.

Write Today Send for special introductory offer on FREE Lantern and agency proposition, also free literature on the cheapest and best way to light the home. Act Now!

KNIGHT LIGHT CO.
Dept. 1358 Chicago, Ill.

THE LETTEROGRAPH

FOR

Draftsmen and Students

Makes it possible for one not proficient in free-hand lettering, to do excellent work. As essential to the draftsman as the ruling pen or compass.



No. 1 OUTFIT—1 Letterograph (large or small) 2 Pens, Copies and Instructions (4 sizes of letters) **\$3.50**

No. 2 OUTFIT—2 Letterographs, 3 Pens, Copies and Instructions (6 sizes of letters) **\$6.50**

DURO METAL PRODUCTS COMPANY
360 E. Grand Avenue CHICAGO, ILL.

Improve Your Memory in One Evening

Thousands have done it through the Roth Memory Course in seven easy lessons. Be able to remember names, faces, numbers, rates, appointments, speeches, etc., on the instant. Exercise the course free for five days, then decide. Price \$2 if you keep it. Otherwise no obligation. Write today to Independent Corporation, Dept. R-4511, 15 West 37th St., New York City



Rabbit Book FREE

Illustrated. Facts about the easy, profitable home industry—growing domestic hares for meat, fur, fancy. Little space—cheap equipment. Big demand. We buy all you raise at \$7 to \$18 per pair. Turn your spare time into cash. Book free—write now.

STANDARD FOOD & FUR ASS'N
407B Broadway New York City

TRAPPERS!

make this
Your biggest year!

Ship all your furs to McCullough & Tumbach. Make this the most profitable year you've had. You know our policy:

A Square Deal to Every Shipper

We'll give you honest grading by fur experts. We'll pay top market prices the day we get your furs. No delay. And in the long run we'll make more money for you.

Ship early—ship often—ship every skin to us.

We Keep You Posted

Write for free shipping tags, price lists, and market reports. Write today.

McCullough & Tumbach
129 N. Main Street
St. Louis, Mo.



Get more for furs

Highest market prices—highest possible grading—quicker returns. No commission, spot cash. 20 years in business. Write for Rogers' Dependable Market Report and Price List.

ROGERS FUR CO.
471 N. Main St., St. Louis, Mo.



MOTORCYCLES

ONE YEAR TO PAY

Know the joy of owning—for business or pleasure—a HARLEY-DAVIDSON, EXCELSIOR, HENDERSON, INDIAN, CLEVELAND, or any other standard make; thoroughly rebuilt in our own factory.

Write for Free Catalog Bulletin and Easy Payment Plan
HAVERFORD CYCLE COMPANY

America's Largest Cycle House
Established 26 Years

503 Market St., Philadelphia, Pa. Dept. P. M.



How to Get Trapper's Supplies FREE

Send for Details!

Get all or large part of your Trapping Supplies FREE! Write today for big Premium List and Catalog of Trapper's Supplies. Fur Magazine FREE—"Trappers' Exchange," full of trapping secrets, hunting stories; advance Fur Market News, Game Laws—all FREE. Write today.

Biggs pays most for furs.

E. W. BIGGS & CO.
3287 Biggs Bldg.
Kansas City, Mo.



Don't Take A Chance With Your FURS

GET wise, fellows—make those extra dollars yourself. We need your furs. You need the money. We are right in the heart of the New York Fur Manufacturing Industry. They are right at our door ready to take your furs as they come in and pay the right prices.

Your check goes back by return mail and you get one hundred cents on the dollar. We pay right because we sell right. This means we get all your shipments and do the business. Ask the trapper who knows. Once a Struck & Bossak shipper and you're always one. Our trappers have no poor years. They know in advance that we give a square deal and every shipment brings good money.

Send us your name and address. Get our Price Bulletins, Shipping Tags and full particulars. Do it right now. This means real dollars to you, so don't put it off. Write today.



Struck & Bossak, Inc.
155 West 28th Street
New York, N. Y.

WANTED

Raw Fur Buyer...

We want a country raw fur buyer in every county of your state, to represent us this season. A big opportunity for those who qualify. Write at once for our proposition.

CHARLES S. PORTER, INC.
133 West 27th St., New York City

Please Mention Popular Mechanics

THESE PLIERS Free!



WITH your first order for anything in our big catalog, we will send you **absolutely free** these pliers—they are regular six inch combination, full nickel plated slip joint. Mail coupon at once as this offer is for a limited time only.

Big Bargain Book

Shows 1,001 automobile accessory bargains, radiators, batteries, headlights, tires, special bodies, etc.

Guaranteed Parts for Fords

We carry a complete stock of replacement parts for Fords—all **guaranteed** to fit perfectly and to be made of the best materials and workmanship. Look over a partial list of our bargains and be convinced that our prices are the lowest. Luggage Carriers \$1.10, 6 Volt Vibrating Horn \$1.15, Best Grade Fenders for Fords per set, \$9.95, 1-Cylinder Pump 65c, Nickel Plated Hub Cap 9c, Front Springs for Fords \$1.17, Piston Rings 12c, Set Brake Shoes 38c, Connecting Rods 88c.

Hundreds of other similar bargains.



1001 BARGAINS

Home Bargain Supply House,

1017 W. Jackson Blvd., Chicago, Illinois.

Gentlemen: Please send me by return mail your big free catalog, together with special order blank, which will entitle me to one pair of pliers as advertised in Popular Mechanics.

Name.....
Street.....
City.....

A SNAP for MEN! Big-4 Combination

All Wool Cap
2 Pair All Wool Sox
Pair Wool Gloves
all for

99c

Plus Postage

Sure! It's less than cost! Worth \$2.00 of any man's money—right now only 99 cts. So reach out and snap up this astounding bargain by return mail. Better order two or three sets—you can't buy 'em at this price when cold weather is here.

SEND NO MONEY NOW—pay on arrival. Order No. 831—money back if you're not pleased.



GORDON BATES CO.
Dept. 1156
Minneapolis, Minnesota

Order No. 831

SAVE 1/2 SHOE COST Bend to Fit Shoe

FLEXIBLE STEEL SOLE AND HEEL PLATES

make sole and heels outlast uppers. Corrugations prevent slipping. Weight 2 oz. Tacks with plates. Put on yourself. Not pair sole and heel plates! Men, Women and Boy's size. Agents, dealers, cobblers, write.

SHOE SHIELD CO.

Dept. 111 Augusta, Ky.



Can't Come Off



Can't Slip
By Mail
Postpaid

60c

"BAM-BEE-NO" Real Baseball on any table

Just out. Now green. Interest all. Miniature baseball. Including 10¢ Book of all plays known. Excitement, Fun, Thrills Galore! Send \$1.50 for complete outfit. Play 27 inches; if not all we return game and money will be refunded. Folder and testimonials free.

Dept. 6112 **THE BAMBEENO SALES CO.** Toledo, Ohio

FOR THIS STANDARD TIRE ANY SIZE

Guaranteed Six Months

Don't pay big prices for tires. Get these Standard adjusted tires at 1-3 the cost. And for a limited time, with each tire ordered we send another, same size for \$1. Amazing Bargain! These are Flak, Goodrich, Goodyear, and other Standard road and fabric tires. No sewed or double tread. Thousands of users get 10,000 and 12,000 miles. Remember we offer the extra tire for a short time only—just to introduce them. You will see nothing else when you have used a pair. You are absolutely protected by our guarantee to replace, at 1-3 the original price any tire that does not wear 6 months. Order now. See these wonderful bargains for yourself. We can't hold this remarkable offer open long. Send order—today!

Note These Smashing Prices

Size	1 Tire	2 Tires	3 Tires	4 Tires	
20x5	4.95	22x4 1/2	6.50	22x4 1/2	10.50
20x3 1/2	4.95	22x4 1/2	6.50	22x4 1/2	10.50
22x3 1/2	5.75	24x4 1/2	10.00	24x4 1/2	11.00
24x4	7.75	26x4 1/2	11.00	26x4 1/2	12.00
26x4	8.25	26x4 1/2	12.25	26x4 1/2	13.25
26x4	8.75	26x5	12.25	26x5	13.25
26x4	9.00	27x5	12.50	27x5	14.50

deduct 10% from above prices if cash is sent with order.

SEND NO MONEY Terms on arrival. Do send cash now and deduct 10% from above prices. In either case you can return tires if not satisfactory and your money will be promptly refunded. Simply state size of tire you want, whether straight side or clincher. Order now—while this amazing offer is open!

MOTORIST TIRE CO., 126 E. 33rd St., Chicago, Ill.

NOW ONLY \$7 A MONTH
STANDARD
Artist's Model
SAXOPHONE



Learn in an Hour
 The Saxophone is so easy to learn you can actually play tunes after an hour's instruction and practice! Most popular instrument in history of music. Favorite on stage, at dances, in the home—even in churches!

Make Extra Money
 Saxophone players make BIG MONEY! Nothing you can learn so quickly pays so well! And all doors are open to the fellow or girl who can contribute Saxophone music to the evening's fun. The world holds new pleasures for those who can play!

10 Months to Pay
 Standard Artists' Model. The choice of professionals and teachers everywhere because of its golden tone, perfect pitch and easy fingering and blowing. Now offered for only \$89.50, payable \$7 per month, only \$9.50 down! No interest, no extras! And you get FREE \$10 case, instruction book, extra reeds, pearl finger tips and leather strap. And we give you 6 days' FREE trial besides to prove that no Saxophone can equal this and to show you how quickly you can learn! Illustrated Catalog, order blanks, and complete information Free! Write today!
STANDARD MUSIC CO.
 Dept 422, P. O. Box 503, CHICAGO, ILL.

Great *New*



Invention for seekers of **Health Power Beauty**

Elco Health Generators at last are ready for you! If you want more health—greater power to enjoy the pleasures and delights about you, or if more beauty is your desire—write! Ask for the book on these inventions which has just been prepared. It will be sent to you without cost. It tells you how Elco Health Generators aid you in leaving the lethargy and hopelessness of bad health and weakness behind forever. Re-vitalize yourself. Bring back energy. Be wholly alive. Write today!

10 Days Free Trial—Write for Free Book!



These great new inventions generate Violet Ray, Vibration, Electricity and Ozone—**\$685** combined or separate—price as low as - -

They operate on the electric light in your home or on their own motive power at less than 50 cents per year. Elco Health Generators are positively the only instruments which can give you in one outfit Electricity, Violet Ray—Vibration and Ozone—the four greatest curative agents. Send the coupon below. Get the Free Book NOW!



For All These:

Paralysis	Catarrh
Pimples	Insomnia
Falling Hair	Skin Diseases
Headache	Hay Fever
Lumbago	Neuralgia
Nervousness	Deafness
Rheumatism	Pain
Sore Throat	Development
Asthma	Neuritis
Black Heads	Obesity

Mail Coupon for FREE Book!

Do not put this paper down without sending the coupon. Don't go on as you are with pains and with almost no life and energy. You owe it to yourself to be a better man or woman. You were put here to enjoy life—not just to drag through it. So do not rest another day until you have put your name on the coupon here. That will bring the whole story of these great new inventions. Do it today—now.



Lindstrom & Company

442-448 N. Wells Street, Dept. 1358, Chicago, Ill.

Please send me your free book, "Health—Power—Beauty" and full information of your 10-day Free Trial Offer.

Name _____

Address _____

Please Mention Popular Mechanics

The F-B Oil Saver for FORDS

Patent
 Pending



\$1.00

STOPS OIL PUMPING
STOPS SPARK PLUG FOULING
SAVES 50% LUBRICATING OIL
SAVES TIME—SAVES MONEY

Thousands are using them. Write today for one on 30-day trial, post-paid for \$1.00. Money back if not satisfied. No cost to install. Replaces breather cap on oil filling pipe.

Dealers Wanted

PENINSULAR CORPORATION, Penobscot Bldg., Detroit, Mich.

For \$1.00 enclosed send me an F-B Oil Saver on your money-back guarantee if not satisfactory.

Name _____

Street No. _____ City and State _____

Buy a Lucky "11" and Throw away the other seven

Socket Wrench



Does the work of seven ordinary wrenches. Fits Bolts, Nuts, Spark Plugs, Cones and Hub-Caps on Ford car. Handiest Ford Tool. Always ready. No adjusting. Made of best durable material. Guaranteed. No Ford owner can afford to be without one.

If unable to get from your dealer, send \$1.50 to

M. P. WESSLING, Dept. P, 79 W. Monroe St., CHICAGO, ILL.
DISTRIBUTORS WANTED

RADIO-SENSATION \$2³⁵ PERFECTED SET

Complete with Receiving Set, Ear Phone, and Galena Crystal—all ready to install

Not a toy, but a real Radio Outfit. So simple a child can use it. Too inexpensive to do without. Weighs only 3 ounces; no bigger than your hand. No adjustments. "tuning in" batteries. Enjoy it as you sit in your favorite chair or lie in bed.

GUARANTEED EQUAL TO ANY CRYSTAL SET

Receives clearly and distinctly from 5 to 15 miles—up to 25, under good conditions. No adjustments. Simple aerial, installed according to our plain instructions. Then attach head phones and "listen in." Wonderfully simple; simply wonderful—and all for \$2.35. Send for set today postpaid. Satisfaction guaranteed or money refunded.

HAMBURGER FACTORIES, Dept. A,
38 So. State St., Chicago

We Want Unusual Representatives and Local Sales Managers

Here is your opportunity to sell a line of merchandise that is practically without competition—the world famous "Dreadnaught" and "Wizard"—The Original Quicklit Gasoline and Kerosene Lamps, Lanterns and Lighting Systems. Discovery of "Thema" Metal makes possible new automatic cleaning device exclusive with these products. Here is the light that never fails—a better, brighter light—a safe light. You sell to dealers, consumers or through any legitimate trade channel. Chance to organize sales force and multiply your income. Men now making \$60 to \$130 a week. Write for details, now—territories going fast.

THE NAGEL-CHASE MANUFACTURING CO.
242 East Erie St., Chicago



This Palatial Florida Home

can be purchased at a very reasonable price. It is the finest estate in a community of 30,000 situated amid 5 acres of orange, grape fruit, sweet bay, palmetto and a large variety of semi-tropical trees and foliage. A water front of 400 feet, with entrance from a Boulevard, affording every modern convenience. House recently completed and never occupied. Has every modern improvement, large sun parlors, sleeping porches and 8 bath rooms. Inexhaustible supply of soft water, steam heat, high, light basement under entire house. Surf bathing all winter within 5 minutes walk.

For full details, photographs and price address

E. H. PECK,
S. OSGOOD PELL & COMPANY
17 West 44th Street New York City



WANTED

Railway Mail Clerks
\$1600 to \$2300 Year

MEN—BOYS OVER 16
SHOULD WRITE IMMEDIATELY

Steady work. No layoffs. Paid Vacations

Common education sufficient:
Send coupon today—SURE



FRANKLIN INSTITUTE, Dept. J176, Rochester, N. Y.
Sirs: Send me without charge, (1) Sample Railway Mail Clerk Examination questions; (2) Schedule showing places in all coming U. S. Government examinations; (3) list of many government jobs now obtainable.

Name:

Address:

"HANDY" AGENTS 300% PROFIT BIG SELLER



Just the article you have been looking for. Small—compact. Everybody who sees "THE HANDY" Coat and Hat Hanger buys—costs 3c, sells for 10c. Just stick it in any wood surface inside or out. Easily supports 35 lbs. Gross costs \$4.20, brings \$14.40; profit \$10.20. Wonderful proposition for demonstrators and canvassers. Money instantly refunded if you can't sell them. Fair enough? Send check or money order or shipped C.O.D.

THE HANDY COMPANY
203 Lafayette St., Dept. 10 New York City

Standard Typewriters Save \$25 to \$60.



\$3.00 Down—Balance \$5.00 Monthly
Underwoods, Royals, Remingtons—all makes. Rebuilt in our factory; practically good as new. Every machine guaranteed. Prices now lower than ever! Write for Special Bargain List and particulars on 5-day Free Trial. Write today!

WYNN TYPEWRITER EXCHANGE
13 Bellevue Bldg. Kansas City, Mo.

FREE TRIAL ~ Write Today!

What Kind of A Man Are YOU!



Are you 100% alive? Are you a strong, healthy, vigorous, clean-blooded, clear-brained specimen—overflowing with pep and vitality? Or are you a weak complaining misfit—an apology for a real man—afflicted with Catarrh, Constipation, Indigestion—crippled with Rheumatism, Rupture, Flat Chest, Weak Spine—wretched with Nervousness and other ailments? (See consultation coupon.)

No matter what your condition is, or what caused it, you can banish your ailments with STRONGFORTISM—The Modern Science of Health Promotion. I guarantee it.

Mark the subjects on the free consultation coupon on which you want special information and send with 10c (one dime) to help pay postage, etc., on my book, "Promotion and Conservation of Health, Strength and Mental Energy." It's a man-builder and a life saver. Send for my free book **Right Now TODAY.**

Strongfort
The Perfect Man

LIONEL STRONGFORT

Physical and Health Specialist

Dept. 1004

Newark, New Jersey

~~~~~ Cut out and Mail this Coupon ~~~~~  
FREE CONSULTATION COUPON

Mr. LIONEL STRONGFORT, Dept. 1004, Newark, N. J.—Please send me your book, "PROMOTION AND CONSERVATION OF HEALTH, STRENGTH AND MENTAL ENERGY," for postage on which I enclose a 10c piece (one dime). I have marked (X) before the subject in which I am interested.

- |                     |                 |                     |
|---------------------|-----------------|---------------------|
| .. Colds            | .. Increased    | .. Poor Memory      |
| .. Catarrh          | .. Height       | .. Rheumatism       |
| .. Asthma           | .. Pimples      | .. Falling Hair     |
| .. Hay Fever        | .. Blackheads   | .. Weak Eyes        |
| .. Obesity          | .. Insomnia     | .. Gastritis        |
| .. Headache         | .. Short Wind   | .. Heart Weakness   |
| .. Thinness         | .. Flat Feet    | .. Poor Circulation |
| .. Rupture          | .. Stomach      | .. Skin Disorders   |
| .. Lumbago          | .. Disorders    | .. Despondency      |
| .. Neuritis         | .. Constipation | .. Round Shoulders  |
| .. Neuralgia        | .. Billousness  | .. Lung Troubles    |
| .. Flat Chest       | .. Torpid Liver | .. Stoop Shoulders  |
| .. Deformity        | .. Indigestion  | .. Muscular         |
| .. (Describe)       | .. Nervousness  | .. Development      |
| .. Female Disorders |                 | .. Great Strength   |

Name .....

Age ..... Occupation .....

Street .....

City ..... State .....

# BULLDOG Pipeless Furnace

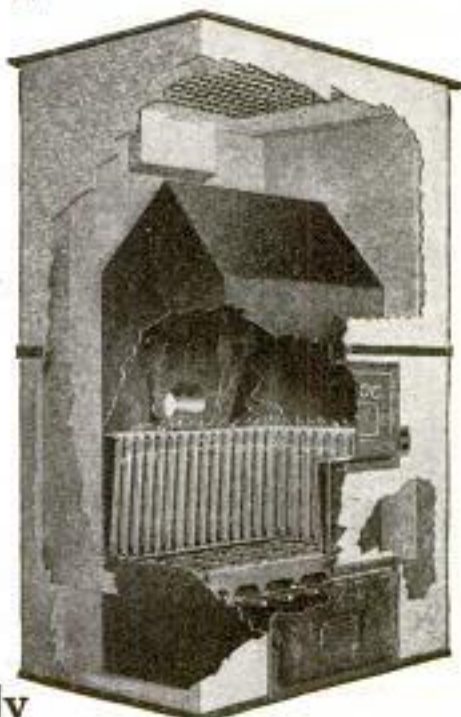

Only

**\$10**

**Puts the BULLDOG Pipeless Furnace in Your Home!**

**I**f you are even thinking of a furnace, write for our free catalog. The Bulldog is one furnace you must investigate. Heats without pipes! Comes completely erected. An extraordinary development in heating. Built on the foundation of common sense. Write for our catalog now before you forget.

## Two Hours to Install

You do it yourself with nothing but a hammer and a saw. Rectangular shape (one of the common sense principles) allows passage through any door. The man desiring a warm, cheerful home at the very minimum of installation and fuel expense cannot afford to consider the purchase of any furnace until he finds out about the Bulldog.

## Fits Any Floor Height

No matter what the depth of your basement or cellar may be—the Bulldog fits it. The adjustable casing (another common sense feature) takes care of this. When you read our catalog we think you will agree that this alone should be sufficient to influence you to choose the Bulldog. Mail this coupon **TODAY!**

**Babson Bros.**

19th and California Sts., Dept. 1358, Chicago

Without obligating me in any way, please send me your free catalog and \$10 down offer on the Bulldog Pipeless Furnace.

Name .....

Address .....

Please Mention Popular Mechanics

# MEN WANTED AT ONCE

## OUR REPRESENTATIVES MAKING BIG MONEY

### THE FUEL PROBLEM SOLVED — "HEAT WITHOUT COAL"

Coal shortage makes every home buy our new kerosene burner which cooks, heats, bakes, cheaper, better, cleaner than coal or wood.

#### COAL BILLS CUT ONE-HALF

Fits any stove or furnace. No experience necessary.

#### DEMONSTRATING BURNER FREE

The profit that you can make during the next sixty or ninety days showing and selling our kerosene (coal oil) burner for any stove or furnace is so startlingly great as to be almost unbelievable.

For FREE particulars, write

**EVEN HEAT GENERATOR CO.** 5123 West 25th Dept. 12 **CHICAGO, ILL.**  
Cicero Station



**SPECIFICATIONS**—Fine English Walnut Stock with checkered pistol grip, cheek-piece, sling swivels, tapering 24-inch Krupp steel barrel; silver bead front sight, two-leaf hunting rear sight, 100, 200, 300 yards, which can be used whether telescope is mounted or dismounted. Double set (half) trigger; flush magazine holding 5 cartridges; weight 7 lbs.; caliber 8 MM. only, using American or Imported cartridges. Price for limited time, 1009.....\$21.00  
Equipped with 6-power high-grade telescope, detachable and non-interfering with open sights, 1109. Price.....\$35.00  
Supply limited—Rush your order today. Charges prepaid when accompanied by Money Order, Check or Bank Draft. Examine merchandise carefully and if not as represented just return same and get your MONEY BACK at once. Bank References.

(C. O. D. Orders for Rifles must be accompanied with deposit of \$5.00)

Send for FREE Illustrated Catalog of Sporting Goods, Rifles, Shot Guns and Field Glasses at bargain prices.

**EDWARDS IMPORT TRADING CORP., 258 Broadway, New York**

The above is a Special Offer to Readers of "Popular Mechanics"—Prompt action is urged, as the same may be withdrawn without further notice.

## COMPLETE RECEIVING SET

including tube, batteries, headphone, antenna and ground wire—everything you need with full directions for installing.

A high class long distance regenerative set, built under the Armstrong license. U. S. Patent No. 1,113,149.

Sold direct on easy payments.

Send for illustrated folder.

## HAROLD WAKEM & CO.

835 Washington St.

Chicago, Ill.

## RADIO

\$15 Down  
\$10.00  
A Month



Sensitone Long Distance Receiving Set



### AGENTS

One agent in every county to introduce LYNER TYRES. Prevents 90% of punctures, guaranteed against blowouts. Double tire mileage. Installed very easily, no tools needed. Easy to sell, many repeat orders, splendid commissions. No capital necessary. Quick shipments. Factory prices. Sell in spare or full time. Protected territory. Write today. Now.

**PELLETIER MFG. CO.**  
115 So. Dearborn Chicago, Ill.

### ALONG LOOKED FOR INVENTION HAS IMPROVED the STRADIVARIUS VIOLIN

The Virzi "Tone Producer" installed in the violin or piano will render the tone free and clear as a bell, mellow, beautiful and brilliant—more than any other existing in the world. Try it and compare. It is recommended and used by Kreisler, Casals, Heifetz, Betti, Thibaud and other great artists. Write for booklet. If not satisfactory money refunded. We send inside J. & J. VIRZI BROS. No. 507 Fifth Ave., NEW YORK CITY  
Inventors, sole owners and distributors.



**\$2.50 HOT-BLAST BURNER \$2.50**  
Burns Like a Blow-Torch — No Compressed Air

For soldering, welding and other purposes. Has no equal for artificial, acetylene and Hydrogen gas.

**HENRY HEIL CHEMICAL COMPANY, 213 S. 4th St., St. Louis**

# FREE BOOK on Musical Instruments



Describes and illustrates every known musical instrument. Many of them shown in full colors. Over 3000 musical articles—a veritable musical encyclopedia!

Also tells how you may have any instrument for free trial in your own home.

Write today for this book. Sent you free, no obligation.

**Rudolph Wurlitzer Co., Dept. 9778**  
Cincinnati Chicago New York San Francisco

## 5 Master Keys

Work like magic in emergencies or prove whether your door or padlocks are burglar-proof. **Open and test thousands of different locks.** Recommended by users in ten different nations. Most wonderful and only keys of their kind. Send \$1 today. Novel key chain FREE with set.

**MASTER KEY CO.**

26 MANHATTAN BLOCK Milwaukee, Wis.



# Wipe Out Every Rat and Mouse

**AMAZING VIRUS QUICKLY KILLS  
THEM ALL—NOT A POISON—  
80,000 USERS**



Rats, Mice, Gophers,—in fact all Rodents can now be easily and quickly wiped out. Imperial Virus is the standard, time-tested method to do it. Kills Rodents only.

Harmless to humans, poultry pets, stock, etc. Greedily eaten on bait. Sets up burning fever. Pests die outside, hunting air and water. Indorsed by Farm Bureau Experts, and large, nationally known institutions.

### YOU CAN GET YOURS FREE

Send no money, just your name and address to Imperial Laboratories, Dept. 1769, Kansas City, Mo., and they will send you two regular \$1.00 bottles of Imperial Virus (double strength). Pay the postman only \$1.00 and a few cents postage when the package containing the two \$1.00 bottles arrives. Enough for yourself and neighbor. Special inducements to represent them. Your \$1.00 refunded on request if not pleased, any time within 30 days.



# High School Course in Two Years!

Lack of High School Training has kept thousands of men and women from attaining **business and social position.** Without this training you are absolutely barred from a successful business career, from leading professions, from well-paid civil service jobs, from teaching and college entrance. In fact, all preferred positions are closed to you without this vital training. You can't stand this heavy handicap nor do you have to. The American School can give you the valuable training you missed.

**Put Your Idle Hours to Work** You can complete our simplified High School Course within two years by spare-time study. Then you will be mentally equipped to handle a worthwhile position. This course, prepared by some of America's leading professors, will broaden your mind, give you a wider outlook and make you keen, alert and capable.

## Remove Your Handicap

Whether you need High School Training or specialized instruction in your chosen line—NOW is the time to remove your handicap. You must know the short cuts and efficiency methods. You must know the HOW and WHY. Over 50,000 students owe their success to training received from the practical, money-making Courses in the coupon below. Let us tell you about this training—about the Course you are interested in. Check and mail the coupon.

### American School

Dept. H874, Drexel Ave. and 58th St., Chicago

### American School

Dept. H874, Drexel Ave. and 58th St., Chicago

Send me full information on the subject checked and how you will help me win success.

- |                              |                             |
|------------------------------|-----------------------------|
| .....Architect               | .....Lawyer                 |
| .....Building Contractor     | .....Machine Shop Practices |
| .....Automobile Engineer     | .....Photoplay Writer       |
| .....Automobile Repairman    | .....Mechanical Engineer    |
| .....Civil Engineer          | .....Shop Superintendent    |
| .....Structural Engineer     | .....Employment Manager     |
| .....Business Manager        | .....Steam Engineer         |
| .....Cert. Public Accountant | .....Foremanship            |
| .....Accountant and Auditor  | .....Sanitary Engineer      |
| .....Bookkeeper              | .....Surveyor (& Mapping)   |
| .....Draftsman and Designer  | .....Telephone Engineer     |
| .....Electric Engineer       | .....Telegraph Engineer     |
| .....Electric Light & Power  | .....High School Graduate   |
| .....General Education       | .....Fire Insurance Expert  |
| .....Vocational Guidance     | .....Wireless Radio         |
| .....Business Law            | .....Undecided              |

Name.....

Address.....

Please Mention Popular Mechanics



## Ives Toys make happy boys

AN IVES Railroad System will make any boy smile. They range in price from \$1.75 to \$50.00. There are spring locomotives and monster electrics, a dazzling variety of bridges, tunnels, switches, passenger and freight stations, signals, passenger cars, freight cars, coal cars, tank cars, stock cars, flat cars, lumber cars and cabooses.

The Ives Trains can be operated either indoors or out. Boys can build a railroad to the edge of a pond, load freight on an Ives merchant ship and have an entire transportation scheme all with Ives equipment. No other manufacturer furnishes this complete outfit. Additions may be made from time to time as all equipment may be bought as separate units.

Send 10c right now for our dandy 1922 catalog in colors, showing Ives Trains and Boats.

THE IVES MANUFACTURING CORPORATION  
197 Holland Avenue Bridgeport, Conn.

### Special \$15 Combination

(West of Mississippi, \$16.50)

The Ives Electric Train Outfit 21 inches long, consisting of reversible locomotive with electric headlight, 3 cars with automatic couplers, 14 feet of track, station, tunnel, semaphore, danger signal and 6 telegraph poles. If your dealer will not supply you, send us the money and we will see that you are taken care of.



# Ives Trains

# ATKINS

## SILVER STEEL SAWS



## Write for These FREE Books

### Every Saw User Should Have Them

These three helpful books are full of time-saving and money-saving suggestions for saw users. They show you the best saw for every use, tell how to buy and care for saws of all kinds, and give useful facts on construction work.

### The Name "Atkins"

Has been identified with the manufacture of saws for three hundred years. On a saw this name means that the saw is made of the famous "Silver Steel," found only in Atkins saws. It means that the saw will run easier, cut faster, hold its edge longer, and save you time, labor and money in cutting wood or metal.

How to  
Care for  
Cross Cut  
and  
Hand Saws

### Before You Buy Any Saw—

It will pay you to learn all about the Atkins line. It includes a better saw for every wood and metal cutting purpose—a saw that will help you do your work better, quicker and easier—give you the greatest value and longest service for your money.

Act  
Now!

Get these books—now: "Saw Sense," "How to Care for Saws," "Hack Saw Chart." We'll send you any or all of them, FREE. Just write your name and address on the margin of this page, state which books you want and mail it to us TODAY, giving us your dealer's name. No matter what you want to know about saws, ask Atkins.

E. C. ATKINS & CO., Inc.  
Dept. P Indianapolis, Ind.

Makers of "Silver-Steel" Saws and Tools sold by Leading Hardware Dealers and Jobbers, Mill Supply Houses and Factory Branches all over the World.



# "WITTE Power-Lite"

All the POWER You Need  
All the LIGHT You Want

Low Cost Ready to Attach to Your Wiring



IN our new "Power Lite" outfit we provide a specially built, Throttling Governor Electric Light Engine, connected to a 700-watt generator and 15-cell battery, making a practical Power and Light Outfit for farm and suburban homes. Besides running generator to charge battery, engine will operate cream separator, washing machine, churn, feed grinder, air compressor, pump, wood-saw or lineshaft.

## SAVE \$50 TO \$100

You can operate engine on Kerosene, Distillate, Gasoline or Gas—run your machinery direct from engine—use battery for lights. Costs much less to install—more power. Plenty of light for house and barn—easy to operate. For particulars and prices, address,

**WITTE ENGINE WORKS,**  
174 Oakland Avenue, KANSAS CITY, MO.  
174 Empire Building, PITTSBURGH, PA.  
174 Fremont Street, SAN FRANCISCO, CAL.

## ARMY BLANKETS \$2.98

ARMY KNIT WOOL SHIRTS  
2 Pockets, reinforced elbows.  
Class B, now \$1.98. All merchandise sold with money back guarantee. Write for Bargain Catalog of Army & Navy Goods, Sent Free. All merchandise shipped parcel post free. Thousands of satisfied customers.

**NAVY & ARMY GOODS STORE**  
Cor. 13th & Pacific Ave., Tacoma, Wash.

ARMY HIG BOOTS: all sizes... \$4.45  
O. D. Wool Fibre Socks Sweaters Heavy weight. Now... 2.39  
Hi-Cut Shoes, 15 and 16 inch boots; all sizes; worth \$10.00 Now... 6.85  
NEW NAVY RAIN SUITS Wind and rain proof rubberized cloth. Worth \$7.00 Our Price... 2.95

ORDER BY MAIL—NOW  
And Save Time—Goods Sent Parcel Post Prepaid

## GREATEST WONDER

THE ONLY GENUINE INSTRUMENT!  
Latest European Invention.  
Become Popular. Play the JAZZY FLUTA!  
Wonderful tone. No lessons required. Great Entertainment for Parties.

15 POPULAR SONGS FREE  
SEND NO MONEY. Pay Postman on arrival.

B. B. ORIOL CO. 15 PARK ROW, N.Y.C.

PLAY IT WITHOUT LEARNING



## 300 Candle Power Light From Common Kerosene or Gasoline

A steady white light more brilliant than city gas or electricity at a fraction of the cost.

EQUIPPED WITH AUTOMATIC CLEANING NEEDLE  
Makes and burns its own gas. Safe, simple and easy to operate.

OUR AGENTS MAKE BIG MONEY  
selling our complete line of lamps, lanterns, lighting systems, tanks and Doud Kerosene Oil Gas Burners for Cooking and Heating.

Write for full particulars and FREE TRIAL OFFER.

**DOUD LIGHTING CO.**  
1429-1461 Congress St., Chicago



## The Famous YORK Saxophone

The Easiest Instrument to Play Sent to You ON FREE TRIAL



Yes, you can have the World famous York Saxophone shipped to you on 10 days' Free Trial. Play it at home for ten full days. Convince yourself of its superb quality and richness of tone. And then, if our instrument does not completely sell itself to you simply ship it back to us, and it won't cost you a penny.

### Take Your Choice

You can get any one of these fine band instruments made by the House of York on 10 days' Free Trial. Send the coupon below for beautifully illustrated literature and take your pick of the following:

Saxophones  
Clarinets  
Cornets

Drums  
Trombones  
Baritones

### Easy Payments

You can pay while learning to play. Make a small payment down and the balance in monthly installments. We send you everything you need—carrying case and all necessary attachments.

### Send Coupon Today

Fill out the Coupon now with your name and address and simply mention the instrument you are interested in and we will send illustrated literature and full details of our Trial Offer and Easy Payment Plan. This literature also tells you how to practice and how to learn to play. Send Coupon today.

**J. W. YORK & SONS**  
Dept. 2218  
Grand Rapids, Mich.

Mail This Coupon Today

**J. W. YORK & SONS,**  
Dept. 2218, Grand Rapids, Mich.

Gentlemen:—  
Kindly mail, without cost to me, your beautifully illustrated literature and details of your Free Trial and Easy Payment Offer.

NAME.....  
ADDRESS.....  
INSTRUMENT.....  
(Mention above the instrument most interested in)

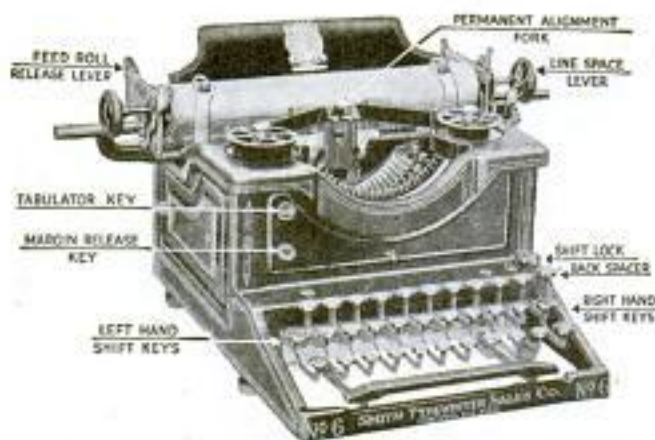

## TYPEWRITER SENSATION!

Free Trial—Use as You Pay

Send us only \$4.00 a month until the low total price of \$48.85 is paid, and the machine is yours.

This is absolutely the most generous typewriter offer ever made. Do not rent a machine when you can pay \$4.00 a month and own one. Cash price \$44.00, just a little less than half its original price.

## (STANDARD VISIBLE) SMITH Model No. 6

Perfect machines. Standard size. Keyboard of Universal arrangement, writing 84 characters. The entire line of writing completely visible at all times, has the tabulator, the two-color ribbon, the back spacer, in fact every late style feature and modern operating convenience. Comes to you with everything complete; tools, cover, operating book and instructions—nothing extra to buy. You cannot imagine the perfection of this beautiful reconstructed typewriter until you have seen it. We have sold thousands of these perfect late style machines and every one of these thousands of satisfied customers had this beautiful, strictly up-to-date machine on five days' free trial before deciding to buy it. We will send it to you F. O. B. Chicago for five days' free trial. It will sell itself, but if you are not satisfied that this is the greatest typewriter you ever saw, you can return it at our expense. You won't want to return it after you try it, for you cannot equal this wonderful value anywhere.

## SEND NO MONEY Put In Your Order Now

**\$4.85**  
AFTER TRIAL

When the typewriter arrives deposit with the express agent \$4.85 and take the machine for five days' trial. If you are convinced that it is the best typewriter you ever saw keep it and send us \$4.00 a month until our bargain price of \$48.85 is paid. If you don't want it, return it to the express agent, receive your \$4.85 and return the machine. We will pay the return express charges. This machine is guaranteed just as if you paid \$100.00 for it. It is standard. These typewriters are samples the manufacturer had at their branch offices throughout United States and have never been used except for demonstration purpose. Just like new but at extremely low price. **The supply at this price is limited, the price will probably be raised when next advertisement appears, so don't delay. Fill in the coupon to-day—the typewriter will be shipped promptly.** There is no red tape. We employ no solicitors—no collectors—no chattel mortgage. It is simply understood that we retain title to the machine until full \$48.85 is paid. You cannot lose. It is the greatest typewriter opportunity you will ever have. **Do not send us one cent. Get the coupon in the mails to-day—sure.**

SMITH TYPEWRITER SALES CO., 288, 218 N. Wells St., Chicago, Ill.

SMITH TYPEWRITER SALES CO., 288, 218 N. Wells St., Chicago, Ill.

Ship me the Standard Visible Smith Model No. 6, F. O. B. Chicago, as described in this advertisement. I will pay you \$4.00 monthly as rent until the \$44.00 balance of the Special \$48.85 sale price is paid. The title to remain in you until fully paid for. It is understood that I have five days in which to examine and try the typewriter. If I choose not to keep it I will carefully repack it and return it to the express agent. It is understood that you give the standard guarantee.

Name .....

Street Address .....

City ..... State .....

Occupation or Business .....



## Health-Vigor SUCCESS

## FREE BOOK

By means of Marvelous

## VIOLET RAYS

### Use it Yourself at Home

This wonderful FREE book describes the marvelous strange new force, simply tells how Violet Rays revitalizes every cell and works apparent miracles in overcoming pain and sickness. Pleasant to use in your home.

Physicians and plain home folks explain how Violet Rays has made them well, strong and happy. 60 pages, illustrated, actual photographs, scientific charts and diagrams. It's FREE

## QUICK RESULTS—No Medicine

Violet Rays work quickly, you feel results at once, it's scientific, goes after the cause. That's why results are quick and permanent. Dr. Duncan, Kewanee, Ill. writes, "Violet Rays is the finest thing I ever used . . . to relieve pain, treatments are so pleasant all my patients like it." Use it yourself at home, save Doctor's bills. See list of ailments Violet Rays treats successfully, and many others, not space to list. Success depends on health, this book shows the way.

## Beauty Aid Send For FREE BOOK

Brings natural, magnetic beauty of health, no dieting, exercise or drugs.

Explains how Nikola Tesla discovered Violet Rays, how it works, why it heals. Tells what doctors and plain folks accomplish in conquering pain, disease and nervous troubles with Violet Rays.

## Earn Cash

Men, women, without experience earn liberal profits in spare time showing Violet Rays to neighbors. Proves results first demonstration, sells on sight. Get attractive offer and wholesale prices now.

**REVEALS MARVELOUS SCIENTIFIC DISCOVERY** Shows charts of human body, explains where pains start, how to banish them. Offered FREE for a limited time only, to introduce Violet Rays. Send for FREE copy.

## Check Your Ailment Below for Free Advice

Here is a partial list of ailments successfully treated with Violet Rays:

|              |              |               |             |
|--------------|--------------|---------------|-------------|
| Catarrh      | Eye Disease  | Nervousness   | Sore Throat |
| Chilblains   | Falling Hair | Neuralgia     | Sprains     |
| Colds        | Hay Fever    | Neuritis      | Tonsillitis |
| Constipation | Headache     | Paralysis     | Whooping    |
| Deafness     | Goitre       | Piles         | Cough       |
| Eczema       | Insomnia     | Rheumatism    | Asthma      |
|              | Lumbago      | Skin Diseases |             |

## VI-REX ELECTRIC CO., 326 WEST MADISON ST. Dept. 221, CHICAGO

Please send me without cost or obligation your free book describing your VI-REX Violet Ray outfit, and details of your free trial offer.

Name .....

Address .....

City ..... State .....

Please Mention Popular Mechanics



**NEW WITTE**  
KEROSENE  
**LOG SAW**

**Runs Steadier  
Cuts Faster  
More Power  
EASIER To Handle  
Burns Kerosene  
or Gasoline**

Saws 'Em  
Down—  
Cuts 'Em  
Up—



**Our Big New Outfit**

**New Price**  
**\$99<sup>50</sup>**  
F.O.B. K.C.  
From Pittsburgh \$107.00

**Built for Men Who Need A Rapid-Cutting Money-Making Log Saw**

Portable and Easy to Operate. Use engine also to pump, grind, buzz wood, or do other belt work. Comes all set up ready to use.

**Only Log Saw Sold On LIFETIME GUARANTEE—Cash or Easy Terms**

**See What You Get**—Special 4-cycle Log Saw Engine—More power than needed—Less weight—Lever controlled clutch—Double arm swing motion and other valuable WITTE improvements. Users say: "Cut 30 cords hard maple in 8 hours"—"Downed 60 trees in 7 hours"—"Best on market"—"Runs smooth"—"Works fine". If that is the kind of a rig you want, write us. CATALOG FREE.

**WITTE ENGINE WORKS**  
1745 Oakland Avenue, KANSAS CITY, MO.  
1745 Empire Building, PITTSBURGH, PA.



## Are Your Hands Tied?

Are your hands tied by a lack of training? Are you bound down to a routine job because you have never learned to do any one thing well?

Don't give up! There is an easy, fascinating way for you to prepare yourself for a better job and a bigger salary. You can do it right at home in the spare time that now goes to waste.

No matter where you live, the International Correspondence Schools will come to you. No matter what your handicaps, or how small your means, we have a plan to meet your circumstances.

Don't let another priceless hour of spare time go to waste. Without cost or obligation, let us prove that we can help you to get a better job and a bigger salary. Just mark and mail this coupon.

----- TEAR OUT HERE -----  
INTERNATIONAL CORRESPONDENCE SCHOOLS  
Box 5682-G, Scranton, Penna.

Without cost or obligation, please tell me how I can qualify for the position or in the subject before which I have marked an X:

### BUSINESS TRAINING DEPARTMENT

- |                                                                           |                                                                           |
|---------------------------------------------------------------------------|---------------------------------------------------------------------------|
| <input type="checkbox"/> Business Management                              | <input type="checkbox"/> Salesmanship                                     |
| <input type="checkbox"/> Industrial Management                            | <input type="checkbox"/> Advertising                                      |
| <input type="checkbox"/> Personnel Organization                           | <input type="checkbox"/> Better Letters                                   |
| <input type="checkbox"/> Traffic Management                               | <input type="checkbox"/> Foreign Trade                                    |
| <input type="checkbox"/> Business Law                                     | <input type="checkbox"/> Stenography and Typing                           |
| <input type="checkbox"/> Banking and Banking Law                          | <input type="checkbox"/> Business English                                 |
| <input type="checkbox"/> Accountancy (including C.F.A.)                   | <input type="checkbox"/> Civil Service                                    |
| <input type="checkbox"/> Nicholson Cost Accounting                        | <input type="checkbox"/> Railway Mail Clerk                               |
| <input type="checkbox"/> Bookkeeping                                      | <input type="checkbox"/> Common School Subjects                           |
| <input type="checkbox"/> Private Secretary                                | <input type="checkbox"/> High School Subjects                             |
| <input type="checkbox"/> Business Spanish <input type="checkbox"/> French | <input type="checkbox"/> Illustrating <input type="checkbox"/> Cartooning |

### TECHNICAL AND INDUSTRIAL DEPARTMENT

- |                                                                          |                                                                      |
|--------------------------------------------------------------------------|----------------------------------------------------------------------|
| <input type="checkbox"/> Electrical Engineering                          | <input type="checkbox"/> Architect                                   |
| <input type="checkbox"/> Electric Lighting                               | <input type="checkbox"/> Blue Print Reading                          |
| <input type="checkbox"/> Mechanical Engineer                             | <input type="checkbox"/> Contractor and Builder                      |
| <input type="checkbox"/> Mechanical Draftsman                            | <input type="checkbox"/> Architectural Draftsman                     |
| <input type="checkbox"/> Machine Shop Practice                           | <input type="checkbox"/> Concrete Builder                            |
| <input type="checkbox"/> Railroad Positions                              | <input type="checkbox"/> Structural Engineer                         |
| <input type="checkbox"/> Gas Engine Operating                            | <input type="checkbox"/> Plumbing and Heating                        |
| <input type="checkbox"/> Civil Engineer                                  | <input type="checkbox"/> Chemistry <input type="checkbox"/> Pharmacy |
| <input type="checkbox"/> Surveying and Mapping                           | <input type="checkbox"/> Automobile Work                             |
| <input type="checkbox"/> Metallurgy                                      | <input type="checkbox"/> Navigation                                  |
| <input type="checkbox"/> Steam Engineering                               | <input type="checkbox"/> Agriculture and Poultry                     |
| <input type="checkbox"/> Radio <input type="checkbox"/> Airplane Engines | <input type="checkbox"/> Mathematics                                 |

Name.....  
Street.....  
Address.....

City..... State.....

Occupation.....

Persons residing in Canada should send this coupon to the International Correspondence Schools Canadian, Limited, Montreal, Canada.

Please Mention Popular Mechanics

**GET A RAZOR!**



This unique Razor-blade pocket knife is the handiest, safest general utility knife. Uses an old Gillette blade. Artists, writers, draftsmen, tailors, dressmakers, office men, women, school children all need RAZOR. Send 25c for yours today. Great money maker for agents.

**RAZOR NOVELTY CO.**  
504 Sherman St. Chicago

**Be A Floor Surfacing Contractor**



New uncrowded field. Contractors prefer to sublet floor surfacing to American Universal Contractors. Machine does work of 6 men. Works quickly, easily. We set you up in business of your own. furnish office forms, advertising, etc.

**Make \$5,000 to \$15,000 or More—Yearly**

Prepare for big building boom. Make new floors perfect, old floors like new. Every floor a prospect. Big money in old floors. No town too small. Beginners often pay for machines first month with profit besides. Get full information.

**THE AMERICAN FLOOR SURFACING MACHINE CO.**  
523 So. St. Clair St. Toledo, O., U. S. A.

**YOU'LL LIKE THESE "LYON" BODIES**  
For Fords, Chevrolets and Dodges



**SEND NOW**

For our completely illustrated body and accessory catalogue just off the press. Dealers will find a ready sale for our snappy, roomy, well built bodies. Buy direct from the factory.

**AUTO TIRE SALES CO., Dept. P2. Body Division**  
1346 S. Michigan Ave. Chicago



## \$70 to \$90 Daily

FLESSNER Brothers have hit their stride. Under date of Aug. 29, 1922, they say: "Did \$300 last week. Have averaged this amount during the past few weeks. Some days we take in \$70, \$80 and \$90." Others coining money too. Ira Shook's place regular magnet. On holidays receipts run high as \$375. My CRISPETTE machine does the trick! Makes those wonderfully delicious, toothsome confections that sell right and left.

### Big Money in Crispettes

Money—lots of it—for those who start the CRISPETTE business. Gibbs writes: "Sold \$50 first night." Master's letter says; "Sold \$40 in one hour." Erwin's boy (going to school) makes \$35 every Saturday afternoon.

### I Start You in Business

I furnish everything—secret formula, equipment, supplies, etc. Experience not necessary. It's a project you can handle. Amazing successes everywhere—cities, small towns, and so on. CRISPETTE habit grows and sticks wherever introduced.

### \$1,000 Month Easily Possible

You are successful from the very start. No slow building-up process. Business grows by leaps and bounds. Some men wholesale to stores, others do direct retail business. All reap wonderful financial harvest. Raw materials plentiful and cheap. Profits enormous. Do not do another thing until you have clipped and mailed coupon.

**LONG EAKINS CO.**  
1125 HIGH STREET  
SPRINGFIELD  
OHIO



**JUST MAIL THIS COUPON**

**LONG EAKINS CO.**

1125 High St., Springfield, Ohio

Please send me at once full details of the CRISPETTE business.

Name \_\_\_\_\_

Address \_\_\_\_\_

Please Mention Popular Mechanics

## Rejuvenate Your Energies



Attain the vigor and power you are entitled to.

**SHELTON VIOLET RAY**—this wonderful new scientific discovery—will give you the means of alleviating all your ailments by the simple application of soothing, satisfying electric waves.

Heretofore the **SHELTON VIOLET RAY** has been available only to the Medical Profession. Now, due to improved manufacturing facilities, the *Shelton Laboratory Model* can be yours at the exceptionally low price of \$17.50.

### SEND NO MONEY

On delivery, pay the postman *Only \$12.50*, and at the end of thirty days, when you have proven to your own satisfaction that the

**SHELTON VIOLET RAY** has improved your condition, send in the remaining \$5.00, making the total cost to you only \$17.50. Remember, YOU have to be satisfied.

Send today for the genuine **Violet Ray**—the **SHELTON Laboratory Model**.

**Shelton**  
Electric Laboratories  
16 East 42nd St., New York



DEALERS: Write for attractive proposition

## Factory Sale

AIR  
TIGHT

SCREW  
TOP



## Copper Oil Kettles

All made of 16, 18, 20 and 22 gauge best cold rolled heavy solid copper. Non-explosive. All solder outside. 5 inch air-tight screw cap. Absolutely guaranteed to be the best and strongest kettle made.

Goods shipped the day order is received. Packed in strong, plain boxes. Above are lowest factory cash prices. Send money order or draft with order.

Catalog of other excellent cut prices FREE, upon request. Price of copper going up. Order now before prices advance. Order at once.

**THE HOME MANUFACTURING COMPANY**  
Dept. N-51 2650 No. Halsted St., Chicago

Reference: Cosmopolitan Book, Chicago, Ill.

# Stylish Moleskin Cloth Coat

# 50¢ Down

\$20.00 Value  
—Special Price  
**\$13.85**

Send only 50c with coupon for this coat. Guaranteed rain proof, and is also suitable for stylish top coat. Made from moleskin cloth, a smooth, soft-finished material resembling chamois leather. Warm and comfortable in the coldest weather. Double-breasted belted style with stylish plaited pockets. Strap on sleeve. Yoke back with inverted plait, giving the coat plenty of fullness. Collar can be converted into military style, buttoning close up to neck. Backed with fancy plaid fast colored woven lining. All seams sewed, strapped and cemented. 45 inches long. Sizes 34 to 46. Rich Leather Brown Shade. Order by No. F-19. Terms, 50c with coupon, \$2.25 monthly. Total price, \$13.85.

**Plaid  
Backed**

**Rain  
Proof**

## 6 Months To Pay

Buy the Elmer Richards way. You can always be well dressed and pay in small monthly sums, so small you will never miss the expense. Money back if not satisfied. No charge for credit. Don't miss this bargain. Supply limited at this special bargain price.

### Elmer Richards Co. Dept 1778 West 35th St., Chicago

Enclose 50c. Send Moleskin Cloth Coat No. F-19. Size .....  
If I am not satisfied when I receive the coat I can return it and get my payment back with charges. Otherwise, I will pay advertised terms, 50c with coupon, \$2.25 monthly. Total price, \$13.85.

Name.....

Address.....

P. O. .... State.....

Write for our Monthly Bulletin of men's, women's and children's clothing and shoes. All your clothing needs supplied on small monthly payments.

**No C. O. D.  
Charges to Pay**





**"It's  
What You Get  
For Your Money  
That Counts"**

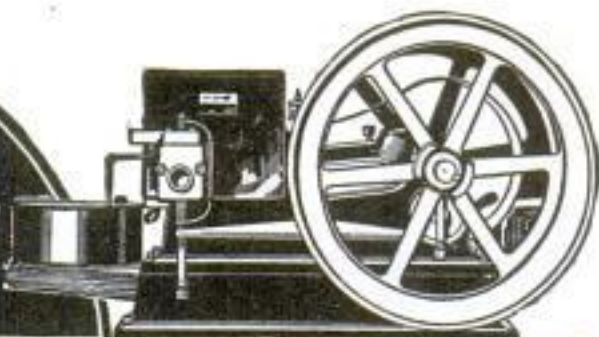

**2 H-P.** Chas. Beaulieu, Wis., says: "Good as the first day I had it."

**3 H-P.** M. W. Kopecky, Tex.: "Easy to start—stop—regulate."

**4 H-P.** Geo. A. Neeter, Va.: "Used it 7 years. Not a penny for repairs."

**6 H-P.** Wm. Mittelstadt, Iowa: Had several makes, but Witte is best."

**8 H-P.** Ralph Milliken, Calif.: "Engine gives splendid service."

**12 H-P.** A. B. Trest, Ala.: "Runs smooth as a sewing machine."

**16 H-P.** J. C. Clark, Va.: "I like the 16 H-P. fine."

**22 H-P.** J. F. Brown, Ark.: "Engine is just what you told me."

**30 H-P.** T. E. Walton, Miss.: "It is surely a fine puller."

**Engine Value Depends On EASY OPERATION,  
LOW FUEL COST and DURABILITY**

Records for 37 years show that WITTE Engines not only stand up, giving long service, but they have big surplus power, operate easy, cost less to operate, and sell for less. No matter what size engine or power outfit you need or where you live, I can supply you direct at a saving—make Immediate Shipment—Cash or Easy Terms, as you wish—in sizes 2 to 30 H-P.—most any style you want.

**WITTE Engines are sold on a Straight  
Lifetime Guarantee**

This guarantee applies to every size and style outfit I make—Stationary, Portable, Portable Buzz Saw, Log Saw, Tree Saw, Stationary Cutoff Saws, Power Stump Borers and my New "Power-Lite" Engine used on electric light plant. I furnish this new light plant complete, with engine, generator and batteries ready to attach to your wiring, at a big saving in price. Use it for both power and light. If you need power for any purpose—write to WITTE—get an engine you know is time-proven, reliable and durable. Read what users say.

**WITTE ENGINE WORKS, 1740 Oakland Avenue, KANSAS CITY, MO.  
1740 Empire Building, PITTSBURGH, PA.**

**Tell Me What  
You Want  
I Guarantee  
Safe Delivery  
Anywhere.  
CATALOG  
FREE**

**Ends Tire Troubles**

Wonderful patented invention doubles life of tires, old or new. Blowouts eliminated. Punctures forgotten. Thoroughly practical and selling like wildfire where introduced. Agents, big money. Write quick for sample. Car owners, give size. Doublewear, Suite 210, 716 Madison, Chicago.

**Ford Given**

**Solve This Puzzle—Win 5,000 Votes**

|   |    |    |    |
|---|----|----|----|
| 6 | 15 | 18 | 4  |
| 9 | 19 | 6  | 18 |
| 5 | 5  |    |    |

What words do these numbers make? The numbers in the squares represent letters of the alphabet. Figure 1 is A, 2 is B and so on. The ten figures spell three words. What are the words?

**Many Prizes and Cash Rewards**  
Get your share of these EASY-TO-WIN prizes. Besides the Ford Touring Car I am going to give Photographs, Bicycles, Gold Watches, Silverware, etc., and Cash Rewards to contestants in my contest for subscriptions. Prizes duplicated in case of tie. Full particulars sent as soon as your solution is received. Send your answer quick.  
Duane W. Gaylord, 537 S. Dearborn St., Dept. 98 Chicago



**THROW YOUR VOICE**

Under the table, down in the cellar, into a trunk or any old place. With our **VENTRILO** which fits into the mouth you can have lots of fun fooling your friends. Also full instructions in the art of Ventriloquism, and big book of jokes. Sent by mail for 10 cts. Stamps or coin.



**WONDERFUL  
WIRELESS  
TELEGRAPH**



Two instruments and 2 Codes in a box. Can Telegraph from room to room or house. Full instructions. By mail 12 cents.

**AERIAL AIRSHIP**

**UP IT GOES!**

Climbs in the air by its own power. The propeller spinning automatically at a lively rate.



floats around a room or outdoors. Lots of fun. By mail 10c.

**Invisible  
Ink**

Letters written with this ink look like blank paper. Can be brought out plainly by heating over lamp or stove. Bottle in wooden box, 10 cents.



**SKULL RING**



The eyes in this ring are either Emeralds or Rubies and would scare the timid. Either Roman Gold or Oxidized Silver. 25c by mail.

**All the Above by Mail for 50c. Stamps or Coin.  
UNIVERSAL DISTR., Dept. 704, STAMFORD, CONN.**



Mounted by our student  
W. T. Holcomb, Warren, Ohio



Mounted by our student  
J. C. Green, Sioux Falls, S. D.



Beautiful specimens  
mounted by our stu-  
dent Charles Weber

## Sportsmen Mount Your Own Trophies

**B**E A Taxidermist. Learn at home by mail to mount all kinds of specimens absolutely true to life. Save the trophies of wondrous beauty and value that you secure on your hunting and outing trips. Mount them yourself. Save Taxidermist bills, decorate your home, den or office with the choicest art in all the world. Instead of pictures of game for your dining room have actual mounted trophies. Nothing like it! Thousands now learning from our splendid mail lessons. You can learn, too. Here is a real wonderful opportunity. Do not neglect it. **Send the coupon today for free books and full particulars.** You positively learn to

## Mount Birds and Animals

You can learn to mount *game-heads, fishes, reptiles; to tan skins* and make magnificent *rugs and robes*. You enjoy every moment given to Taxidermy. You can learn **easily and quickly at home by mail**. Adapted to everyone, men, women and boys. Learned in spare time only. Enroll in our school and be a real Taxidermist. This is the one and original school, teaching the latest and easiest methods. Over 55,000 graduates. Among our students are the most famous sportsmen, out-door lovers, statesmen, lawyers, doctors, merchants, farmers and mechanics. If you ever hunt or fish, or if you are a bird or nature lover, **don't overlook this marvelous opportunity.**

## Learn for Pleasure and Profit

No other art is so interesting and fascinating. Men and women make Taxidermy a hobby. Nothing equals it for a delightful sparetime occupation. If you want to **make big profits** from your leisure time, taxidermy is just the thing. Our students easily earn from \$20 to \$35 a week from spare time alone, mounting trophies for sportsmen, and selling their own mounted game specimens. Professional taxidermists can earn \$3,000 to \$5,000 a year. You will be delighted with this marvelous art, so investigate now. Write for our free books, and see for yourself what a wonderful art Taxidermy really is.

### 55,000 Students Praise Our Schools and Lessons.

George Whitted, the great National League ball player (Philadelphia) says: "I am delighted with your course of lessons. I heartily recommend them."

W. A. Findlay, Edna, Texas, writes: "Have mounted over 100 specimens since taking your course. Would not take \$1,000 for them. I cannot endorse your school too highly."

Charles Weber of Cleveland says: "Your lessons are marvels of simplicity, any man or woman can learn taxidermy perfectly from your course." We have tens of thousands of such letters in our files.

## Mail Coupon Today

Send the coupon today, right now, before you forget it. The coupon will bring you, **absolutely free**, a magnificent taxidermy book, finely illustrated with photos of game specimens, also a copy of the **Taxidermy Magazine**. Remember these are **FREE**, no obligations whatever. Mail the coupon or a postal will do. These free books will show you marvels you never dreamed of in the new and easily learned art of taxidermy.

### The Northwestern School of Taxidermy 8778 Elwood Bldg., Omaha, Neb.

Our school is Patronized by Paul J. Rainey, the greatest living sportsman, by the Rockefellers, U. S. Govt., State Universities, Museums and Colleges.

Northwestern School of Taxidermy,  
8778 Elwood Bldg. Omaha, Neb.

Without obligation on my part send me copies of your **Free Taxidermy Book** and the **Taxidermy Magazine**, and full particulars about your course of lessons on taxidermy.

Name.....

Address.....



"Be Wise"

# Let Me Pay You \$12 for 15 Minutes of Your Time

## \$215 in One Day

"Ye gods—some seller! I made \$215 today!"

F. W. Bentley,  
of Philadelphia.

### Buys Car With Profits

"Have earned enough in one month to buy me a new auto."

S. W. Knappen, Cal.

### \$7 Profit per Hour

"I started out and made \$21.50 in about 3 hours. The Oliver does the work. It certainly is the real thing."

L. Zucker, Ohio.

### "Sells Like Beer in a Dry Town"

"Am sending today for 7 Olivers. This is one day's orders (\$85 profit). Selling like beer in a dry town."

W. H. Drew, Mich.

### Mr. T's 23th Order in Six Months

"Ship 52 Olivers: 10 No. 30; 6 No. 1; 12 No. 2; 24 No. 4." (Mr. T's profit on this order alone is \$711.)

G. T. Ottawa, Ont.

### Russel Earned \$3,300 in Five Months

"Have averaged \$660 profit a month for last six months."

A. M. Russel, Conn.

### Carnegay—\$1,000 a month

"Am making \$1000 per month. I have made big money before, but did not expect so much. Your Burner is just the thing."

J. Carnegay, S. D.

### Berger—\$258.50 per week

"Send following weekly hereafter: 10 No. 1; 8 No. 2; 4 No. 5."

R. Berger, Ont.

### \$11.75 in Ten Minutes

"I took order for a neighbor. \$11.75 profit in ten minutes."

Mrs. N. B., Hattiesburg, Miss.

### \$43 in One Evening

"I made \$43 last night selling Oliver Burners."

N. B. Chelan, Wash.



**B. M. OLIVER**

The man who built the Oldest and Largest Manufacturing Concern for Oil-Gas Burners in the World. Now he wants to show you how to make \$12 for 15 minutes of your time. Read what he has done for others right on this page.

## New Invention Is Sweeping Salesmen Into Big Profits

AGENTS find it no work at all to sell this amazing invention—the Oliver new Improved Oil-Gas Burner. They just show it—taking only one minute to connect it—then light it. And the sale is made! This new invention is its own salesman. It sells itself! About 15 minutes does it. The Oliver Oil-Gas Burner is the most timely thing that could be put out. It dispenses entirely with coal and wood when both are now high-priced. It burns the cheapest fuel—oil. It saves a woman work now in times when she is looking for just such things. Just as much or as little heat as wanted, off and on instantly by simply turning a valve. It makes an immediate hit with her. Because in the winter it gives her 3 times the heat of any other method. And in the summer she has heat for her cook stove or range whenever she wants it—but does not have to have a hot, roasting kitchen.

### The Secret of Big Money—Any Season of the Year

Of course, now that you know the facts you yourself can understand why this new invention is going over like wildfire! And you can understand why F. W. Bentley made \$215 in one day. Why J. Carnegay made \$1,000 in one month and why hundreds of other agents are cleaning up big too.

These men know the secret of big money. They know a good thing when they see it and they know that the time is ripe for this new Oliver Improved Oil-Gas Burner. They know that this age of high-priced coal and wood makes it necessary for some substitute. They see ships and locomotives being run by oil and big buildings being heated by

YES, \$12 for 15 minutes of your time. This wonderful invention practically sells itself. Just this little short-time demonstration puts the sale over for you. And you pocket the big profit. Read how easily others are drawing down enormous earnings.

No wonder this amazing new invention is bringing fortunes to agents. All over the whole country this new device is doing away with old-fashioned methods of heating with coal stoves, ranges and furnaces. Already over \$1,000,000 worth have been sold. You can readily understand why this new invention—the Oliver Perfected Oil-Gas Burner—is sweeping over the country like wildfire. It does away with all the expense of coal—making every stove a modern oil-gas burner. Saves money, time and drudgery. Three times the heat of any other method—right on tap when the housewife wants it. No hot kitchen for housewives in the summer when they don't want it. No wonder agents are riding in on the tide of big Oliver profits.

it. And they know that an invention that makes use of this cheap fuel for every home—and yet does it so as to give more heat than coal or wood—is the thing they want to tie up to.

### Big Profits Quickly Made

You too can use this secret of big money. You do not need to be a high-powered salesman. The Oliver's amazing features sell it for you. When people see it they know at once that it is the thing they want. You will realize that this is a proposition that will pay you as big money as it does others. We have a definite number of open territories which we are ready to dispose of to those who act quickly. Every territory allotted is filled with big-money opportunities. And this big money comes easily. Because not only does this invention practically sell itself on sight but when you have sold one this one will sell several others as soon as your customer's friends and neighbors see it. And thru our special plan you get credit and commissions for every sale in your territory.

You can also make big money just by using your spare time. Note how N. B. Chelan made \$43 in one evening.

### Coupon Brings Full Offer

If you want to make at least \$5,000 a year easily, mail this coupon now for our offer. We are not making any extravagant claims about this. We do not have to. We believe that your common sense will indicate a good proposition to you when you know about it. We want to give you the facts. Won't you write us? And by doing so quickly you will be allotted an exclusive territory with private selling rights.

The coupon will bring you the facts and will save you writing a letter. But mail the coupon at once.

### OLIVER OIL-GAS BURNER AND MACHINE CO.

2014-W Pine Street, St. Louis, Mo.

### Oliver Oil-Gas Burner and Machine Co.

2014-W Pine Street, St. Louis, Mo.

Please send me full facts about how I can make at least \$5,000 a year representing you in my territory. Also your plan if I wish to make big money in my spare time.

Name.....

Address.....



# Start the Joy Special On Your LIONEL Electric Railroad



Lionel Electric Warning Signal is all-steel construction with heavily nickeled gong. Bell rings when train passes over special section of track provided with it.



Lionel "Multivolt" Transformers operate all trains from any electric light socket at minimum cost. Approved by National Board of Fire Underwriters. Best for running every electrical toy.

**S**TART your Lionel Limited with a touch of your finger on the controller. Send her down the track, fast or slow, backward or forward, stopping at stations, slowing down for signals, ringing automatic crossing warnings—golly, what a pack of fun!

Lionel locomotive and car bodies are of all-steel construction, hand-enameled, and baked like automobile bodies. For twenty-two years Lionel products have been "Standard of the World" because of their perfect electrical and mechanical workmanship.

You can run Lionel trains from any electric light socket with Lionel "Multivolt" Transformers or from dry or storage batteries.

Lionel Electric Trains are made in America and sold by department, toy, sporting goods, hardware, and electric stores. Say "Lionel" to your dealer.

Send post card at once for the handsome 40-page Lionel Catalog. The complete line is shown in beautiful four-color illustrations—chock-full of outfits and all kinds of up-to-date railroad accessories.

**THE LIONEL CORPORATION**  
52-C East 21st Street New York City

# LIONEL ELECTRIC TOY TRAINS

*& Multivolt Transformers*

# Learn Electricity

In **3½**  
Months

Earn  
**\$150**  
to  
**\$400**  
per  
Month

In the Great Shops of

**COYNE**

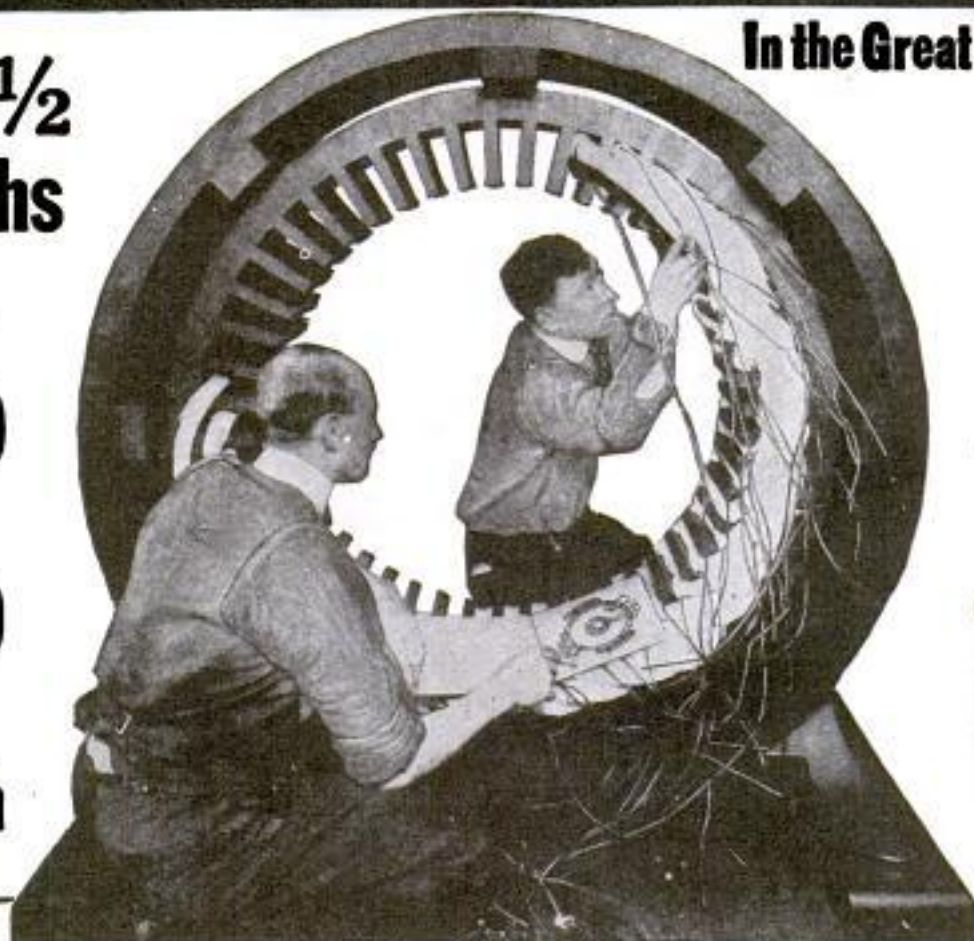

Student Winding Stator

**T**HE whole world of electricity is open to the Coyne trained man. He is trained completely. He can make big money as Power Plant Operator, Superintendent, Telephone man, Construction worker, auto, truck or tractor electrician, battery man, radio expert, or he can go into business himself as electrical contractor, dealer, auto ignition or battery expert and make from \$3,000 to \$20,000 a year. Hundreds of our graduates today are making big money and you can do the same if you grasp this opportunity—act now.

## Earn \$150 to \$400 per Month

No books or useless theory. You are trained on \$100,000 worth of electrical equipment. Everything from door bells to power plants. You work on motors, generators, house-wiring autos, batteries, radio, switchboards, power plants—everything to make you an expert ready to step right into a position paying from \$45 to \$100 a week. Learn electricity in the electrical center of the world. Send the coupon today for free catalog.

## Radio Course FREE

We include the following free with the regular course:

- (1) A complete course in auto, truck and tractor electricity and storage batteries. Greatest outlay of auto electrical and battery equipment.
- (2) Course in Radio—the marvel of the age. Constructing, installing and operating. You can build your own wireless telephone set.
- (3) A life scholarship in the Coyne School. You can stay as long as you wish and return for further training any time in the future.

**Earn While You Learn** We help students to secure jobs to earn a good part of their expense while studying.

**Send Coupon NOW!**

B. W. COOKE, President  
COYNE TRADE & ENGINEERING SCHOOL  
1300-1310 W. Harrison St., Dept. 5x, Chicago  
Dear Sir:—Please send me free your big catalog and full particulars of your special offer of 3 extra courses.

Name .....

Address .....

Don't delay a minute—send that coupon in right now for our big free catalog and full particulars of this wonderful offer.

**Act Now!**

B. W. Cooke, Pres.—Coyne Trade & Engineering School  
1300-1310 W. Harrison St. Dept. 5x Chicago, Ill.

## Big New Home

The increasing popularity of Coyne and a tremendous influx of new students simply forced us to move into larger and more spacious quarters. Here, in the big, new home, you will find added electrical equipment—new and larger departments—a more complete electrical training—a school thoroughly equipped to train you for a big paying position.







# Free Proof That Cooke Trained Men

## DO Earn **\$3,500 to \$10,000 A Year**

Let me send you Free, this big package of "Vital Facts" showing what "Cooke Trained Men" earn, the big opportunities Electricity offers and how you, too, can earn \$3,500 to \$10,000 a year. The coupon will bring it Free.

Electrical Experts—Trained Men are in big demand at the highest salaries ever known. The opportunities for advancement and a big success are unlimited—positively unlimited. The Electrical Industry faces a big shortage of trained men. It needs you and will pay you well.

### What's Your Future?

It's a shame for you to earn less than \$100.00 a week. You ought to earn more. You can do it too, when you are backed up with my training—the training that makes "Big Pay Men." Don't be content with an ordinary job paying anywhere from \$3 to \$10.00 a day, with no future to speak of. Strike right out—hold the job you've got and prepare for a better one—prepare for a "he man's job" in the \$3500 to \$10,000 a year class in the greatest profession in the world. I will show you the way.

#### Radio Course FREE

My new \$45.00 Radio Course, just completed given Free when you enroll for the Electrical Course. Two courses for the price of one. Two professions open to you.

## Be an Electrical Expert and Get This Big Pay Yourself

Today even the ordinary electrician, the screw driver kind, is making money—big money. But it's the trained man—the man who knows the whys and wherefores of Electricity—the Electrical Expert—who is picked out to boss the ordinary electricians—to boss the big jobs—the jobs that pay \$70.00 to \$200.00 a week. Fit yourself for one of these big jobs—*Begin Now.*

#### Age or Lack of Experience No Drawback

You don't have to be a College Man; you don't have to be a High School graduate. My Course in Electricity is the most simple, thorough, and successful in existence, and offers every man, regardless of age, education, or previous experience, the chance to become, in a very short time, an "Electrical Expert," able to make from \$70 to \$200 a week.

#### I Give You A Real Training

As Chief Engineer of the Chicago Engineering Works I know exactly the kind of training a man needs to get the best positions at the highest salaries. Hundreds of my students are now earning \$3,500 to \$10,000 a year. Many are now successful ELEC-TRICAL ENGINEERS.

#### Your Satisfaction Guaranteed.

So sure am I that you can learn Electricity—so sure am I that after studying with me, you too, can get into the "big money" class in Electrical work, that I will guarantee under bond to return every single penny paid me in tuition if, when you have finished my course you are not satisfied it was the best investment you ever made.

#### FREE—Electrical Working Outfit—FREE

I give each student a Splendid Outfit of Electrical tools. Materials and Measuring Instruments absolutely FREE. I also supply them with drawing Outfit, examination paper, and many other things that other schools don't furnish. You do PRACTICAL WORK—AT HOME. You start right in after the first few lessons to WORK AT YOUR PROFESSION in a practical way.

#### Get Started Now—Mail Coupon

I want to send you my package of "Vital Facts" including Electrical Book and Proof Lessons FREE. These cost you nothing and you'll enjoy them. Make the start today for a bright future in Electricity. Mail the coupon—NOW.

**L. L. Cook, Chief Engineer**  
**CHICAGO ENGINEERING WORKS**  
Dept. 518, 2150 Lawrence Ave.  
Chicago, Illinois.

**L. L. Cooke,**  
Chief  
Engineer  
**Chicago  
Engineering  
Works**

Dept. 518, 2150 Lawrence Ave., Chicago, Ill.

Dear Sir—Send at once the "Vital Facts" containing Sample Lessons, your Big Book, and full particulars of your Free Outfit and Home Study Course—all fully prepaid, without obligation on my part.

Name.....

Address.....

**The "Cooke" Trained Man is the "Big Pay" Man**



## This Beautiful Book on Wood Finishing FREE

**G**IVES complete instructions for finishing all wood—hard or soft—old or new. Explains just what materials to use and how to apply them. Tells how inexpensive soft woods may be finished so they are as beautiful and artistic as hard wood. This book is the work of experts—illustrated in color. Includes color card—gives covering capacities, etc.

### JOHNSON'S WOOD DYE

Use coupon below for a free copy of "*The Proper Treatment for Floors, Woodwork and Furniture.*" It is full of valuable ideas on Wood Finishing and Home Beautifying.

S. C. JOHNSON & SON, Dept. P. A. 11, Racine, Wis.

Please send me, free and postpaid, your instruction Book on Wood Finishing and Home Beautifying

NAME .....

ADDRESS .....

CITY & STATE .....

Dealer's Name .....

Johnson's Wood Dye is very easy to apply—dries in four hours and does not rub off or smudge. Penetrates deeply, bringing out the beauty of the grain. Made in fourteen popular shades, all of which can be easily lightened or darkened. Color card in book.

**S. C. JOHNSON & SON**

*The Wood Finishing Authorities*

Dept. P. A. 11

RACINE, WIS.

Canadian Factory—Brantford

**Bargains! Bargains! Bargains!**

**SAVE OVER HALF!**

**On A New Or Rebuilt Standard Typewriter!**

## Lowest Prices! Lowest Terms!

Here they are! The most astonishing bargains in standard typewriters you have ever heard of! New from the factory machines at less than factory prices. **SAVE OVER HALF!** Factory rebuilt machines, good as new, at a saving of **OVER HALF!**

You've been looking for a chance to buy a typewriter at a low price. Here's the time, the place, the offer! Today, everyone should own a typewriter. It is a universal necessity. You can't imagine what a convenience it is. But, cheer up! You can now have a sturdy, splendid, serviceable, standard typewriter at a price, and at terms that make it easy for you to satisfy your desire. Typewriters for the home, the office, the farm, for school teachers and pupils, and all at *record low prices.*



## Free 10-Day Trial! One Year To Pay!

Here is our startling offer! Mail the coupon below for our big **FREE** catalog and price offer, terms, etc. Select from the catalog the machine you want. Send us your request for a **FREE 10-DAY TRIAL**, accompanying your request with \$2 as an evidence of good faith. We will then ship you the machine you want. This request places you under *no obligations*. When you receive the machine, test it, use it, compare it for ten whole days. Then, when you are convinced that it is the *greatest typewriter bargain* you ever heard of, you keep it and pay a little each month to suit your convenience, with a year to complete payments. Just like renting a machine, only after a few months you have paid for it—it is *yours forever*, and you will not have missed the little monthly payments. If you are not *delighted*, return it *at our expense*, and we will return your \$2, the test won't have cost you anything.

We offer you **ONLY** standard machines. Either new from the factory at this special bargain price, or factory rebuilt, like new. In all factory rebuilt machines every weak or defective part is replaced, new rollers provided, new type where defective. Good for years of splendid service. Mind you, these new and rebuilt typewriters are up-to-date models with back spacers, red and black ribbon shift, visible reading and writing, tabulators, velvet action, and every modern convenience and improvement. You can't imagine how good they are unless you try a machine yourself. Hence our big **FREE 10-DAY TRIAL OFFER**. Send for the catalog, price list and special offer. This request does not obligate you in any way. Write today. We never had such bargains as we are listing today in our twelve years of selling new and rebuilt typewriters.



Use the  
coupon  
now

## Get Our Bargain Catalog Now!

Don't delay a single day. The very special bargain you want may be grabbed up while you are delaying. And **REMEMBER! SEND NO MONEY NOW!** Select your machine. Then send your order and \$2 and we will ship you the typewriter you want on **FREE 10-DAY TRIAL**, with no obligation on your part. **ACT AT ONCE!**

**Typewriter Distributing Syndicate**  
*Established 1910*  
Room 18, 1516 S. Wabash Ave.  
**CHICAGO ILLINOIS**

Typewriter Distributing Syndicate  
Room 18, 1516 S. Wabash Ave., Chicago

Please send me your catalog and bargain price list of new and rebuilt standard typewriters, also your **FREE 10-DAY TRIAL OFFER**, and your terms for deferred payments. This request places me under no obligations.

Name.....

Address.....

City and State.....

# MEN WANTED

write today to the

# SWEENEY SCHOOL



SEND FOR MY FREE BOOK

Now I will guarantee a real job to qualified Sweeney Graduates. Learn the Auto and Tractor Business. Learn a trade. Eight weeks' course leads to employment. Free railway fare to Kansas City. Wonderful offer to you from world famous Million-Dollar Trade School. **FREE RADIO COURSE.**

**Hundreds of Good Jobs paying \$50.00 a Week and More are open to Sweeney Trained Men. You need no previous experience. I train you in 8 weeks with tools, not books.**

Garages, repair shops, welding and vulcanizing shops, etc., have written the Sweeney School asking for competent mechanics. Sweeney Trained men are in demand everywhere—their practical training and experience in this great Million Dollar Trade School fits them to fill any position. I also can personally offer several thousand jobs for local branch managers. I will train you for this special work without extra cost. What I offer the mechanically inclined young man is the **COMPLETE COURSE**—personal instruction, the course that has made the Sweeney School famous the world over. This course includes Auto Mechanics, Welding, Vulcanizing, Battery Work, and I have also added a **FREE Course in RADIO** to those who answer this ad.

## Sweeney System of Practical Experience

The Great Million Dollar School, world famous, and the success of my thousands of graduates are due to the Sweeney System.

This is what you get here. I have taught 50,000 men to be expert repair men, chauffeurs, tractor engineers, etc. I am proud of the fact that I was selected by the U. S. Government to train 5,000 men for mechanical work in the service. I teach by using tools, not books. You learn as you do the real work with your hands.

**I PAY YOUR RAILWAY FARE**

I want you to come now—not to wait and postpone—I am making it easy for you—I will help you—the first step is to send for my free catalog.

**FREE RADIO COURSE**

The Sweeney Broadcasting Station—Call W. H. B.—is one of the finest in the world. Talks all over the U. S. Cost \$50,000 to erect. Sweeney Auto Students are taught Radio **FREE**. Build their own sets. It's easy and interesting and offers many profitable opportunities.



**Free Ry. Fare to Kansas City**



Young man, the only difference between a rut and the grave is that the grave is deeper. I say, get out of the rut. Do the work you like. Be independent. Learn a trade. Be a mechanic. Get into the auto business. You can earn big money. You can travel and see the world.

I have helped 50,000 men to success. This Million-Dollar trade school is the greatest success factory you ever saw. The way to learn is easy. You don't need any experience. I teach with tools, not books. You learn your trade by actually doing the work.

You have a right to make a success of your life. Make a start now. I'd like to show you what thousands of men just in your position have done as a result of the Sweeney system of practical instruction. It's a shame for you to stick in a rut or work at jobs you don't really like.

Learning is a real pleasure in the Sweeney School. World's finest equipment. Fine associates. Healthful surroundings. Entertainment after working hours. Instructors who take personal interest in you. Free radio course. Big radio broadcasting station.

I am now paying your railroad fare to Kansas City and giving a free radio course. No extras. No books. You are sure of getting a job when you graduate. I can't tell it all here, but send for my big catalog. Investigate this real opportunity.

## BIG FREE CATALOG AND SPECIAL OFFER

Get my big **FREE** 72-page catalog. It shows hundreds of actual photographs of men at work in my magnificent new school. Tells all about wages, profits, opportunities in auto and tractor business. Explains step by step how you learn. Interesting letters from graduates telling how they made good. Shows how men come from all over the world to this big school. Makes you want to join the crowd. Tells everything you want to know. I will gladly send you a copy beautifully illustrated. No colored students accepted.

EMORY J. SWEENEY, President.

**For Big Offer and Catalog Mail this Coupon**

Emory J. Sweeney, President,  
Dept. 983, Sweeney Bldg., Kansas City, Mo.  
Send me your offer of a Guaranteed position, your big Free Catalog and full details of the Sweeney eight weeks' course leading to an immediate money making opportunity.

Name.....  
Address.....

**LEARN A TRADE**  
**Sweeney**  
SCHOOL OF AUTO-TRACTOR AVIATION  
983 SWEENEY BLDG. KANSAS CITY