

October

25 Cents

POPULAR MECHANICS MAGAZINE

WRITTEN SO YOU CAN UNDERSTAND IT

REG'D TRADE MARK, GREAT BRITAIN, No. 410426

REG. U. S. PAT. OFF.



LANDING FROM
THE NON-STOP
AIR EXPRESS

See Page 511

It takes *only* 8 weeks to get a big job



Read what these men are doing in the Auto and Tractor Business. Here is your big chance to get "on easy street." Come to these great shops on the biggest FREE offer ever made.

O. H. Justus owns a big agency and repair shop at Parkersburg, W. Va. He says "that my schools give motor secrets that will put any man 'on easy street.'"

Big Firms Need Trained Men

The Auto and Tractor Business is on the boom. Thousands of trained men will be needed during the next few months. I get calls every day from Garages, Battery Stations, Auto Repair, Welding Shops and other successful concerns for Rahe men. When the big fellows need high grade men they know where to come for them. They want Rahe trained men.



Emanuel Rushfeldt, Alberta, says: "Earning \$10 a day and only 20 years old."

My Training Unusual

Scientific tool training—that's the secret. You do things here according to the latest engineering standards. Thousands of dollars have been spent in modern tools and equipment. That's why my men are at home in the biggest shops in the country. If you want to succeed the way Beimer and Justus and the rest have—qualify by the same method.

I'll Pay Your Railroad Fare and Board You

In order to fill the openings that now exist, I am making an offer no one has ever made before—**Free railroad fare, Free board.** But even that is not all. I'll tell you about the rest in my letter.



W. W. Peace gets \$250 a month and expenses operating a tractor in the oil fields.

Send for **FREE** Book

My big illustrated training book tells how others are succeeding. It tells many things you ought to know about Autos and Tractors. Write for it and my **short time** offer NOW. It soon expires.

Rahe *Auto & Tractor Schools*

CHICAGO
4445 Grand Blvd.

Dept. 896 CINCINNATI
Ninth and Walnut



Louis Beimer at 24 was made foreman over men many years older. That's not luck—*it's Rahe training.*



Rahe Auto & Tractor Schools,
Dept. 896, (address school nearest you)
Chicago, Ill., or Cincinnati, Ohio.

Without any obligation, send me your big free book, "More Money." Also information regarding special temporary offer.

Name.....
Street.....
City..... State.....

Is Your English a Handicap? This Test Will Tell You

THOUSANDS of people make little mistakes in their everyday English and don't know it. As a result of thousands of tests, Sherwin Cody found that the average person is only 61% efficient in the vital points of English. In a five-minute conversation, or in an average one-page letter, from five to fifty errors will appear. It is surprising how many experienced stenographers fail in spelling such common words as "business," "abbreviate," etc. It is astonishing how many business men use "who" for "whom," and mispronounce the simplest words. Few people know whether to use one or two "c's" or "m's" or "r's," whether to spell words with "ie" or "ei," and when to use commas in order to make their meaning absolutely clear. Make the test shown below, now. See where you stand on these 30 simple questions.



Sherwin Cody

Try This Test Now

Correct answers shown in panel at the right

1. Would You Write—

Between you and I	or	Between you and ME
I HOPE it would come	or	I WISH it would come
WHO shall I call	or	WHOM shall I call
It's just AS I said	or	It's just LIKE I said
How MANY are there	or	How MUCH are there
I WOULD like to go	or	I SHOULD like to go
The FIRST TWO lessons	or	The TWO FIRST lessons
He sat AMONG the three	or	He sat BETWEEN the three
The wind blows COLD	or	The wind blows COLDLY
You will FIND ONLY one	or	You will ONLY FIND one

2. How Do You Say—

evening	EV-en-ing	or	EVE-ning
ascertain	AS-er-tain	or	as-CER-tain
hospitable	HOS-pl-ta-ble	or	hos-PIT-able
abdomen	AB-do-men	or	ab-DO-men
mayoralty	MAY-or-al-ty	or	may-OR-al-ty
amenable	a-ME-na-ble	or	a-MEN-able
acclimate	AC-cl-i-mate	or	ac-CLI-mate
profound	PRO-found	or	pro-FOUND
beneficiary	ben-e-fi-shEE-ary	or	ben-e-FISH-ary
culinary	CUL-i-na-ry	or	CU-li-na-ry

3. Do You Spell It—

superCede	or	superSede	or	replEtition	or	replition
receIve	or	receIve	or	separAtate	or	seperate
reprEive	or	reprIeve	or	aComodate	or	aCCommodate
donkEYS	or	donkIES	or	trafficking	or	traffICK ng
factoRIES	or	factoRYs	or	aCSesible	or	aCCeSSible

Answers

1

Between you and me
I wish it would come
Whom shall I call
It's just as I said
How many are there
I should like to go
The first two lessons
He sat among the three
The wind blows cold
You will find only one

2

EVE-ning
AS-er-tain
HOS-pl-ta-ble
ab-DO-men
MAY-or-al-ty
a-ME-na-ble
ac-CLI-mate
pro-FOUND
ben-e-FISH-ary
CU-li-na-ry

3

supersede
receive
repeive
donkeys
factories
repetition
separate
accommodate
trafficking
accessible

New Invention Improves Your English in 15 Minutes a Day

Mr. Cody has specialized in English for the past twenty years. His wonderful self-correcting device is simple, fascinating, time-saving, and incomparably efficient. You can write the answers to 50 questions in 15 minutes and correct your work in 5 minutes more. You waste no time in going over the things you know. Your efforts are automatically concentrated on the mistakes you are in the habit of making, and through constantly being shown the right way you soon acquire the correct habit in place of the incorrect habit. There is no tedious copying. There is no heart-breaking drudgery.

FREE—Book on English

A polished and effective command of the English language not only gives you the stamp of education, but it wins friends and impresses favorably those with whom you come in contact. Many men and women spend years in high school and years in college largely to get the key to social and business success. And now a really efficient system of acquiring an unusual command of English is offered to you. Spare-time study—15 minutes a day—in your own home will give you power of language that will be worth more than you can realize.

Write for this new free book, "How to Speak and Write Masterly English." Merely mail the coupon or a letter, or even a postal card. You can never reach your greatest possibilities until you use correct English. Write to-day for the free booklet that tells about Mr. Cody's simple invention.

Mail this coupon or postal AT ONCE

SHERWIN CODY SCHOOL OF ENGLISH
510A Searle Building Rochester, N. Y.

Sherwin Cody School of English
510A Searle Building, Rochester, N. Y.

Please send me at once your Free Book, "How to Speak and Write Masterly English."

Name.....

Address.....

City.....

State.....



"A NEW HOUSE IN
SIX OR EIGHT JUMPS."

"A
ROOM
AT A
TIME,
SO
THE COST
WON'T
CLIMB."

Tide Water
Cypress
"The Wood Eternal"

"New Insides for Old Houses"

is one of the most valuable, and most appreciated, of all the forty-four books in the world-famous Cypress Pocket Library. And with good reason! It is volume 39 and contains 40 pages with 10 pictures, an Art Supplement in tint (showing the beauty of Cypress grain), Detailed *Working Drawings* on a sheet 24x36 inches, with *Full Specifications* for rebuilding the *Hall, Library, Dining Room* and *Living Room* with architectural correctness and artistic finish without resort to expensive hardwoods. (Cypress works easily and is wonderful under stains.) Each design is by an authority—on our special order. No "stock patterns." Write *today* for Vol. 39. We will send it promptly with our compliments. Study it. Your better acquaintance with Cypress, "the Wood Eternal," will be valuable to you in many ways in the future. It will save you repair bills. "If you build of Cypress you build but once."

SOUTHERN CYPRESS MANUFACTURERS' ASSOCIATION



1219 Poydras Building, New Orleans, Louisiana
or 1219 Graham Building, Jacksonville, Florida



Insist on **TRADE - MARKED CYPRESS** at your local lumber dealer's.
If he hasn't it please advise us promptly and we will see that you are supplied.

Popular Mechanics Magazine

6 N. Michigan Avenue, Chicago, U. S. A.

H. H. WINDSOR, Editor

London: Hachette & Co.,
16-17, King William Street, Charing Cross, W. C. 2

Paris: Hachette & Co.,
111 Rue Reaumur

Melbourne, Australia,
The Australasian News Co.

ISSUED MONTHLY

SUBSCRIPTION:

SINGLE COPY, 25 CENTS

In United States, and its possessions, Cuba, Mexico, and Canada, per year, postpaid . . . \$3.00

To all other countries in the Postal Union 3.50

All subscriptions are discontinued at expiration. Please examine the date printed on your wrapper.

Entered as Second Class Matter Sept. 15, 1903, at the Post Office at Chicago, Illinois, under Act of March 3rd, 1879.
Entered as Second Class Matter at the Post Office Department, Canada.

Published monthly by POPULAR MECHANICS CO.

Copyright, 1922, by H. H. Windsor.

Copyright in Australia.

Vol. 38

Contents for October, 1922

No. 4

Accident—Tree, Falling, Kills Horse and Misses Man	549	Carpenter's Tool Carrying Attachment	512
Airmen, Round-the-World, Halted in India	520	Cattle, Young, Automatic Weaning Device for	557
Airplane Aids Men in Fighting Forest Fires	494	Chain, Steel, Stretching of, Makes It Rigid as Bar	548
Airplane Express, Nonstop, Landing from, by R. C. Folger	510	Chairs and Rockers, Folding, Comfortable and Cool	534
Airplane Stresses, New Instrument Records	506	Chairs, Bent Wood Folding, of Extreme Compactness	543
Airplanes, Giant, to Carry 100 People 500 Miles	538	Chemical Container, New, Is Boon to Industry	524
Airplanes, Speediest, America Develops	510	Chiefs of Colonial Troops Visit French Capital	561
Airship Wreck, Peculiar, Lands Crew in Sea	509	Children's Picture Pages	612
Amphitheater Illuminated by Exterior Lights	551	Church, Beautiful, Erected at Small Cost	516
Armor, Curious Suit of, Used by Gilbert Islanders	538	Church, Brick, Built around Frame Structure	597
Auto Cycle, Four Wheeled, Propelled like Boat	538	City Site and Buildings Moved Two Miles	556
Automobile, American, Makes Attractive Hansom Cab	590	Civic Features	602
Automobile Device Holds Cars in Transit	604	Coal Mine Belt to Carry Output through Long Tunnel	544
Automobile Disk Wheels, Fan Attachment Cools	588	Concrete, Air Drills and Wedges Used to Break Up	591
Automobile Grease Gun Operated by Air	583	Concrete Mixer, Two Wheeled, Portable	558
Automobile Hood Attachment Prevents Rattling	608	Concrete, Reinforced, Made in Sheets, by Allen P. Child	564
Automobile Life Saving Fender Is Automatic	570	Concrete Road Paving, Moisture Tests Made on	601
Automobile Packing Case can be Used as Garage	534	Concrete Roads, Keeping from Cracking	603
Automobile Running Board, Space Under, Used for Luggage	549	Concrete Surfaces Made Nonslipping	617
Automobile Safety Bumpers Stop Car Automatically	535	Corn, Device for Stringing, Simple and Rapid	593
Automobile Stop Signal Entirely Automatic	539	Cylinder Grinder for Lathes and Millers	502
Automobile Testing Apparatus Gives Complete Road Performance Data, by H. G. Dacy	501	Dentistry—Lip Protector Aids Operator and Patient	521
Automobile Thief Signal Obscures License with Red Bars	598	Dentistry—Suction Valve for Plate Maintains Vacuum	531
Automobile, Transcontinental Wireless, Makes Fast Trip	598	Dog Clinic, Kennel Club Opens in New Jersey	574
Automobile Truck Brings Ready Cooked Meals to Homes	508	Drill Holder with Gauge for Rapid Measurement	611
Automobile Ventilator, Automatic, Creates No Draft	585	Drilling and Tapping Machine, Combined Multiple	546
Automobile Windshield, Rear Seat, on Automatic Rollers	556	Driveway Lamp, Small, Shields against Glare	558
Automobile Work, Yacht's Rigging Utilized in	579	Dynamometer, Traction, Gives New Soil Tillage Data	594
Automobiles, Old Model, Self-Thawing Oil Pump Drive for	551	Electric Iron, "Ironing Day" a Pleasure with	527
Balloon Race Ends in Doubt	544	Electric Power Stations, Output of, Pooled in England	543
Bathhouse, Hot Spring, for Salt Lake City, by George F. Paul	516	Elevator Doors, Interlocking Device for	592
Battery Cell Filler Prevents Overflow	532	Engine Piston, Novel, Keeps Oil from Combustion Space	610
Bicycle Handlebar, New Adjustable, Is Convenient	514	Engines, New Double Acting, of Modified Diesel Type	550
Birds Answer Dinner Bell at State Game Farm	595	Explosion—Gas Holder Explodes	509
Blowtorch, Improved, Uses Kerosene or Gasoline	609	Exposition, Brazilian, Spectacular Illumination at	496
Boat, Collapsible, Made to Carry Three	573	Fences, Wire, Stretched with Aid of Tractor	500
Boat—Oil Tanker, Wrecked, Salvaged by Docking It Sideways	582	Ferry, Passenger and Auto, on Detroit River	531
Boat Rudder, Propelling, for Small Crafts	555	Ferryboats, Electric Drive, Coming to the Fore	546
Boats—Destroyers, Maneuvers of, Necessary for the Formation of Smoke Screens	520	Fire Alarm System, Modern, for New York	570
Book Trimmer, Improved Continuous	536	Fire Truck, Electric, Has Four Wheel Drive	493
Bottle Crowner, Improved, Operated by Hand	508	Flour Port, Largest, Philadelphia may Become	499
Bridge Arches, Concrete, Built by New Method	539	Flying Boat, Small, Recently Turned Out in Germany	525
Bridge, Cantilever, to Span Hugli River in India	549	Forest, National, Playground for People in	586
Bridge, Concrete, Dedicated to Service Men	507	Furnace, Gas Fired Bench, Has Many Uses	527
Bridge Dedication, Indian Participates in	535	Garden Set Has Five Tools for One Handle	584
Bridge, New Brooklyn, Planned as Cables Shift	609	Gas Meter, New, Has Positive Blower Mechanism	607
Bridge Timbers, Long, Ingenious Rig for Hauling	523	Gas, Oil, and Air Delivered from House to House	533
Bridges, Small Suspension, Built in New Zealand	582	Gas Range with Efficient Method of Combustion	556
Buildings, Height Limit of, Increased in London	509	Gas Valve, New, Design of, Is Radical Departure	609
Bus, Upper Deck of, Has Unique Top Piece	523	Gasoline Tank Tube Prevents Explosions	611
Caravansary, Motorists', Is New Industry, by Lawrence Wm. Pedrose	582	Gasoline Tanks, Odd Appearing Protection for	614
		Glove Sizer Takes Place of Tape Measure	535
		Golf Balls, New, Machine for Testing Resiliency of	572
		Golf Chart Is Primer for Beginners	545
		Golf Stroke Counter Worn on Player's Wrist	524
		Golfers, Leather Device for, Prevents Overswing	599

[Continued on Page 4]

This One



49EQ-GFU-09ZC

erial

[Contents—Continued]

Grate Bars Protected by Aluminum Coating.....	574	Shoe Shining Footrest Swings Out of Way.....	530
Grinding Machines, Tool Holding Attachment for..	533	Sight—Length of Time to See a Thing.....	614
"Growler" Rope Winding as Heat Conductor.....	604	Ski Slide Design, Laws of Mechanics Applied in...	513
Hearing, New Analysis of, Discovered by Laboratory Experiments.....	656	Smokestack, Spiral, to Reduce Wind Stresses.....	561
Heater, Electric, Strapped to Side of Tank.....	538	Snowshoe, Metal, for Children.....	605
Heater, Rugged Electric, Has Many Applications...	594	Spark Plug Holder, New, Prevents Fouling.....	600
Heater, Wheelbarrow, Made for Repairing Roads....	535	Speed Recorder, Hand, Gives Readings at a Glance..	568
Highway Penetrates Famous Wilderness.....	577	Sprayer, Angular Nozzle, for Underside of Leaves..	607
Horseshoe Pitching Arena Has Twenty Courts.....	525	Squirrel Collection, Finest, Kept in Beautiful Home	569
Hospital, Reconstruction, to be Enlarged.....	540	Stereoscope, Small, to Aid Salesmen.....	563
Hotel Moved to New Site, 120 Feet Distant.....	547	Sugar Beet Harvester Works Automatically.....	543
House Built Single-Handed by Inexperienced Man..	598	Suitcase, Heavily Loaded, Shows Great Strength...	531
Household Devices.....	603	T-Square Guide, Convenient, for Draftsmen.....	583
Ice Cream Cone Holder Made of Pasteboard.....	558	Talking Machine, Human Throat Inspiration of....	557
Ice Cream Confections, Simple Device for Making..	594	Tape Tunnel of the Bureau of Standards.....	473
Ice Machine, Hand Operated, for Home Use.....	583	Teeth, Nonskid False, Uses Vacuum-Cup Idea.....	572
Ice Sled for Passengers and Freight.....	563	Telephone Inventor—Alexander Graham Bell, Death of.....	529
Lakes, Uncharted, Locating by Airplane.....	554	Tennis Courts Covered with Roofing.....	610
Lamp, Adjustable Floor, Aids Garage Shop.....	514	Theater "Crying Room" for Babies.....	557
Lamp Made of Cows' Horns Gives Mellow Glow....	604	Thread Chasers, Chamfer Grinding Fixture for....	534
Law, Illinois Zoning, Made Void by Court Decision	563	Tiering Machine Does Work of Numerous Kinds....	535
Lawn Mower Driver Shielded from Stray Golf Balls	593	Tombs, Egyptian, Work of Exploring, by F. N. Hollingsworth.....	595
Lightning Bugs "Flashes" on Photographic Plate..	540	Torpedo Boats, Small Speedy, Navy Acquires.....	497
Linotype Slug Adjuster Has Antifriction Roller....	609	Tower Climbing Is Part of Forester's Daily Routine	609
Logging Wheel, All Steel, for Tractor Use.....	578	Tractor Propelled by Feet for Use on Soft Ground..	521
Lumber, Speed Kiln Drying Process Improves....	548	Tractors, Farm, Emery Wheel Attachment on.....	565
Lunch Box, Cylindrical, Used as Extra Auto Seat..	608	Transformers, New Type, for Direct Current.....	598
Manhole Cover, New, Has Reversible Flange.....	594	Trap Gun, New, Gophers Commit Suicide with....	606
Measuring Device, Electric, for Minute Dimensions..	604	Travel, Modes of, Used in Central Australia.....	582
Memorial, George Washington Masonic National, by R. C. Folger.....	518	Truck with Elevating Body for Dumping.....	590
Memorials, Interesting, of Notable Historical Events and Personages.....	580	Type, New, Permits Sightless and Seeing to Correspond.....	520
Memorials to Mark Historic Delaware Crossing....	551	Valve, Drain and Relief, for Steam Cylinders.....	512
Message Clearing House at New York Terminal....	562	Ventilator Fan for Kitchen Easily Installed.....	576
Microscope, Monster, Used in Detecting Criminals..	534	Violin Finger Board, Corrugated, Aids Players....	569
Mixer Stirr Tank Contents with Vertical Motion....	598	Water Power Project, Huge, in Bavaria.....	575
Monument Records Origin of Poland China Hog....	599	Window Wedge, Inexpensive, Stops Rattling.....	543
Motor, Squirrel Cage Induction, New Form of....	614	Wireless Antenna, Longest, Oregon Lumber Camp Boasts.....	430
Motor Truck Turntable Speeds Road Construction..	547	Wireless Equipment, Portable, Set Up in Few Minutes.....	600
Motorcycle, Broad Tired, for Desert Travel.....	559	Wireless Fan Coils and Mountings.....	498
Motorcycle, Windshield and Spotlights Fitted on...	503	Wireless Loud Speaker, High Voltage, Needs No Batteries.....	500
Mountain Climbing, Risky Method of, in Switzerland	568	Wireless Receiving Set Clock Increases Efficiency..	611
Mountain—Mount Hood, Looping, by S. Gerismon..	559	Wireless Station, New Swedish, to be American Built	521
Mountain Pass Has New Road among Clouds.....	494	Wireless Umbrella, Durable, Has Detachable Parts..	494
Mufflers, Exhaust, Venturi Tube Principle in.....	583	Wreck—Railway Coaches Reduced to Kindling....	495
Music Roll Cabinet, Automatic.....	496	Wrench, Socket, Has Eleven Different Grips.....	527
Narcotics, Action of, on Life.....	656		
Orange Groves, Central Heating System for, by C. R. Baldwin.....	499		
Parade, "Keep the Forests Green".....	574		
Photograph Cabinet Made from Hollowed Log.....	590		
Phonograph Records Turned by Automatic Device..	507		
Photography—Pictures at the Rate of 92,000 per Second, by A. N. Mirzoeff.....	541		
Pictures and Mirrors, New Device for Hanging....	584		
Piles, Big Concrete, Divers Work in Cavities of....	554		
Pipe Filler, Combination, and Tobacco Case.....	517		
Pipes, Penstock, Utilized for Storage Purposes....	599		
Plants, Lime Secreting Sea, Aid in Reef Building..	608		
Platform, Improvised, Built to Drive Posts.....	562		
Plating, Chrome, Possible by New Process.....	611		
Poison Indicator, Luminous, Prevents Accidents....	603		
Port, New, to Make Atlantic Passages Shorter....	503		
Power Plant Design, New, Increases Efficiency....	526		
Power Plant, Large, Obtains Efficient Gas Burning	578		
Prize Offers.....	355		
Protector, Shirt and Waist, on Auto Trips.....	494		
Pump, Novel Wheel, for Draining Marshland.....	597		
Pumping Plant, Automatic, for Household Use....	540		
Radiological Work, New Protective Material for....	489		
Railroad Extension, Recent, in East Central Africa..	540		
Railroad, Narrow Gauge, Inclined Turntable for....	577		
Railroad—Trains, Floodlights on, by H. A. Lane....	514		
Reamer Holder to Produce Accurate Reaming.....	584		
Religion, Star Island Dedicated Exclusively to....	539		
Rivets, Mechanical Device Passes Automatically....	513		
Rock Crusher, Huge, Holds Full Wagonload.....	563		
Rock Drill Bit, Detachable, Indicates Economy....	600		
Rowboat, Open, Cruise of Great Lakes in.....	550		
Sand Drying Stove Resists Hard Usage.....	608		
Scale, Device Converts into Automatic Machine....	610		
School Wardrobe Changes into Blackboard.....	601		
Seaplane, U. S. Navy Is Developing for Land....	535		
Seasickness, Scientific Seesaw Study of.....	519		
Ship, Crumpled Bow, Saved from Sinking.....	505		
Ship, Disabled, Towed 2,000 Miles.....	504		
Ship—"Leviathan," Model of, Passes to Shipping Board.....	591		
Ship Rudder, Double, New Form of, being Tested in Germany.....	593		
		SHOP NOTES.....	
		Aluminum, How to Color Black.....	628
		Belts, Tight, How to Put on Pulleys.....	616
		Blueprints, Quick Method of Making.....	624
		Brass, Coppering for Laying Out.....	624
		Can, Oil Filling, for Auto Engines.....	633
		Chuckling Narrow Work.....	630
		Clamps, Magneto Magnets Used as.....	634
		Concrete Bases, Making for Steel Posts.....	632
		Corn Harvester, Simple.....	624
		Cutting-Off Tools, Improving.....	632
		Doubletrees, Brace for.....	628
		Draftsmen, Armrest for.....	625
		Drawing Table, Folding, Convenient.....	615
		Drill Bushing, Self Locking, for Slot Jig.....	623
		Drill Press Stop Collar, Neat.....	634
		Eaves Trough Made Removable.....	633
		Electric Wiring, Knot for, Protects Fixtures....	619
		Electric Wiring, Putting Rubber Sleeving on.....	623
		Electrical Grounds, Testing for, During Winding Operations.....	627
		Fence, Discarded Porch Railing Made into.....	620
		Finishing Tool, Double Faced.....	626
		Flooring Clamp, Simple.....	631
		Grease Gun, Device Aids in Filling.....	634
		Grinding Wheels, Angular, Fixture for Dressing..	625
		Ivory, Removing Stains from.....	620
		Keystats, Cutting in the Shaper.....	628
		Knife for Cutting Sheet Metal.....	617
		Lathe Tools, Gauge for Setting.....	619
		Locomotive Piston Heads, Renewing.....	616
		Magneto Testing, Driving Pulleys for.....	628
		Micrometer Attachment, Quick-Reading.....	617
		Money—Exchange, English, Table for Computing...	624
		Nails, Short, Holder for.....	619
		Oilstone, Handy Oil Dropper for.....	617
		Pinholes, Transferring in Shafts.....	618

DRAKE'S PRACTICAL MECHANICAL BOOKS

THEY WILL RAISE YOUR PAY—

ORDER ON 5-DAY TRIAL

The books listed below will perfect you in your chosen trade — pave the way to the big positions. Written in non-technical language—easy to read and understand. *Every book covers its subject completely. An entire course of instruction condensed into one volume.* Your choice sent postpaid — you benefit 5 days — money refunded in full if not entirely satisfactory. Order direct from this page.



Automobile Books

Automobile Ignition, by Manly	Leatherette	\$2.00
Automobile Starting and Lighting, by Manly	Leatherette	\$2.00
Brookes' Automobile Handbook	Leatherette	\$2.00
Ford Motor Car, Truck and Tractor, by Manly	Cloth	\$1.50
Starting and Lighting Troubles, Remedies and Repairs, by Manly	Leatherette	\$3.00
Automobile Battery, Care and Repair, by Manly	Leatherette	\$2.00
Automobile Catechism and Repair Manual	Leatherette	\$1.50
Tires and Vulcanizing, by Tufford	Cloth	\$2.00
Gas and Oil Engine Handbook	Cloth	\$1.50
Automobile Upkeep and Care, by Manly	Cloth	\$1.50
Motorcycle Handbook, by Manly	Cloth	\$1.50

Shop Practice Books

Sheet Metal Workers' Manual	Leatherette	\$2.00
Oxy-Acetylene Welding and Cutting	Leatherette	\$1.75
Sound Welds	Cloth	\$2.00
Slide Rule and Logarithmic Tables	Leatherette	\$2.00

Handbook for Millwrights	Cloth	\$2.00
Modern Blacksmithing	Cloth	\$1.25
Machine Shop Practice	Cloth	\$2.00
Mechanical Drawing and Machine Design	Cloth	\$2.00
Pattern Making	Cloth	\$1.50

Carpentry Books

Cloth Binding	
Modern Carpentry, 2 vols.	\$3.00
The Steel Square, 2 vols.	\$3.00
Wooden Boat and Shipbuilding	\$1.50
Modern Estimator	\$1.50
Timber Framing	\$2.00
Builder's Architectural Drawing	\$2.00
Concrete	\$1.50
Practical Bungalows	\$1.00
Low Cost Homes	\$1.00
Roof Framing	\$1.50
Stair Building and Hand Railing	\$1.50

Electrical Books

Practical Applied Electricity	\$2.00
Alternating Current	\$1.50
Electric Motor Control Systems	\$1.50
Wiring Diagrams and Descriptions	\$1.50
Electrical Tables and Data	\$1.50
Armature and Magnet Winding	\$1.50
Modern Electrical Construction	\$1.50
Modern Electric Illumination	\$1.50
Electricians' Operating and Testing	\$1.50
Motion Picture Operation	\$1.50
Drake's Electrical Dictionary	\$1.50
Electric Motors, D. & A.	\$1.50
Electrical Measurements and Meter Testing	\$1.50
Drake's Telephone Handbook	\$1.50
Modern American Telephony	\$2.00
Easy Electrical Experiments	Cloth \$1.25
Wireless Telegraph and Telephone Handbook	Cloth \$1.25
Telegraphy Self-Taught	Cloth \$1.25

Steam Engineering

Swingle's Handbook for Steam Engineers and Electricians	Leatherette	\$4.00
Examination Questions and Answers for Marine and Stationary Engineers	Leatherette	\$2.00

Steam Boilers	Leatherette	\$2.00
Swingle's Catechism of Steam, Gas and Electrical Engineering	Leatherette	\$1.50

Painting Books

Scene Painting and Bulletin Art	Cloth	\$4.00
A Show at Sho' Cards	Cloth	\$4.00
Sign Painting	Cloth	\$4.00
Strong's Book of Designs	Leatherette	\$4.00
Strong's Art of Show Card Writing	Cloth	\$4.00
Signist's Alphabets	Cloth	\$1.50
Modern Painter's Cyclopedia	Cloth	\$2.00
Automobile Painting	Cloth	\$1.50
Estimates, Costs and Profits, Painting and Decorating	Cloth	\$1.50
New Hardwood Finishing	Cloth	\$1.50
The Amateur Artist	Cloth	\$1.50
New Stencils	Cloth	\$1.25

Farm Books

Farm Mechanics	Cloth	\$1.25
Farm Buildings	Cloth	\$1.25
Farm Engines	Cloth	\$1.25
Traction Farming	Cloth	\$1.50

Business and Reference Books

Better Business Letters	Leatherette	\$1.50
Better Business English	Leatherette	\$1.50
Better Advertising	Leatherette	\$1.50
Finger Prints Simplified	Cloth	\$2.00
Practical Bricklaying	Cloth	\$1.25
Practical Instruction for Detectives	Cloth	\$1.00
Practical Plumbing	Cloth	\$1.50
Hot Water Heating	Cloth	\$1.50
Elementary Chemistry	Cloth	\$1.50
Courses in Civil Service	Cloth	\$1.50
Cyclopedia of Recipes	Cloth	\$1.50
American Star Speaker	Cloth	\$1.50

Modern Languages

By Prof. P. S. Allen, U. of Chicago	
French without a Teacher	Cloth \$1.25
Spanish without a Teacher	Cloth \$1.25
German without a Teacher	Cloth \$1.25
Everyday French	\$1.25
Everyday Spanish	\$1.25

ORDER DIRECT FROM THIS PAGE—ON OUR MONEY-BACK PLAN

The books listed above are only a few of the many in our catalogue, which you will receive promptly after filling out and mailing us the attached coupon. For quick action order direct from this page—cross name of each book wanted and send in with price quoted. We prepay postage and send the books on our money-back plan.

FREDERICK J. DRAKE & CO.

PUBLISHERS

1008 Michigan Ave., Chicago

Drake Books Are For Sale at All Book Stores

FREDERICK J. DRAKE & CO.
1008 Michigan Avenue
Chicago, Ill.

GENTLEMEN:—Please send me free, postage paid, your illustrated catalogue which lists and describes over 100 Practical Mechanical Books for Home Study.

My name is

and my address

Mail Coupon For Free Catalogue
Your Guide to Home Study

[Contents—Continued from Page 4]

Pipe Connections, Water Tight, for Concrete Tank..	627
Plane Bits, Grinding	631
Plating—Replating Worn Spots	630
Pounding Block, Strap Handle for	633
Rectifiers, Electrolytic, How to Make	629
Roofing Paper, Rolls of, Preventing from Crushing..	630
Saw, Drag, Made Handy for the Farm	631
Saw, Flooring, for Wiremen	632
Saw Oiler, Handy	619
Scaffold Dogs, Handy Type of	627
Screwdriver for Rapid Work	626
Shank, Emergency, for Farm Implements	626
T-Bolt, Split, Handy	616
Tractor, Radiator Guard for	618
Vises, Machine, Removable Jaws for	626
Water System, Settling Chamber for	618
Windlass, Ratchetless	625
Window Sash, Method of Mounting	631
Wire Gauge, Novel	617
Wood—Hardwood, Yellow Stain in	632
Workbench, Adjustable Rest for	634

AMATEUR MECHANICS

Automobile Dash Container Saves Spark Plugs	641
Automobile Horns, Double	641
Automobile, Lightweight, Testing Lubrication in	642
Automobile Running Boards, Sagging, Reinforcing ..	643
Automobile Starter Gears, Lengthening the Life of ..	640
Automobile Starting Gears, Cleaning	642
Automobile Tire Chains, Applying	645
Automobiles, Aid for Warming Up	651
Bathing Caps Made Ornamental	643
Birdhouse, Dishpan Cat Guard for	640
Boat—"Pushboat," How to Build	635
Bottles, Shaker Top for	638
Carburetor Needle Valves, Repairing	638
Closet Concealed by Open Door	640
Clothes Closet, Chain in, for Holding Hangers	642
Corn Cutter, Novel	637
Door Bell, Connecting to Lighting System	643
Easel for Show Cards and Photos	649
Fish, Crumbs as Lure for	637
Fishhook, Extracting from the Flesh	644
Fishing—Trolling Rig for Autumn Lake Trout	643
Fishing—Trout Line, Taking up	646
Garage Door, Device for Holding Open	646
Hoisting Gear for Farm or Shop	645
Lacquers, the Use of	646
Leather, Preventing Mildew on	639
Light Reflector, Novel, Inverted	639
Lock, Simple, for Drawer or Chest	644
Magazine Rack, Homemade	641
Mittens, Rubber, for Handling Brick	640
Oil, Dispensing System for	649
Poultry Roost, Miteless	646
Poultry, Self Feeder for	647
Rake, Improved, for Leaves	647
Scaffold, Adjustable Portable	652
Seesaw Built for One	639
Stamp, Consecutive Number, Made from Dater	640
Steam Boiler for Model Engines	643
Switch, Knife, Made from Snap Switch	645
Table Leaves, Extra, Storing	642
Tennis Nets, Keeping Taut	638
Tire Shoe, Blow Out, Long Lived	647
Typewriter Stand, Simple	642
Typewriters, Manifold Aid for Use on	639
Violin as Phonograph Reproducer	637
Washing Machine Driven by Engine in Detached Building	641
Water Barrel Regulator, Simple	638
Water "Scooter," Toy, How to Make	651
Window Screen, Cloth, Keeps Out Soot	638
Window Shade, Mounting of, Allows Top and Bottom Ventilation	644
Window Shades, Preventing from Tearing from Roller ..	637
Wireless Buzzer, High Tone, Homemade	654
Wireless Cage Antenna, New Type	652
Wireless Instrument Knobs, Storage Battery Plugs as ..	642
Wireless Receiver, Portable	649

BE AN ARTIST

Caricatures, Cartoons, Commercial, Newspaper and Magazine Illustrating, Pastel, Crayon Portraits and Fashions. Our simple method quickly develops your talent in spare time. By Mail or Local Classes. Write for terms and list of successful students. ASSOCIATED ART STUDIOS 87-B Flatiron Building, NEW YORK



Agents

**"Ye Gods,
—some seller!
I made \$215 to-day"**

—writes Bentley

The Oliver Oil-Gas Burner

does away with coal and wood. Burns 95% air—5% oil. Turns any range, furnace or stove into a gas stove. 16 different models. Burns kerosene (coal oil). Gives much or little heat by simply turning valve. Think of the appeal you can make in every community. Solves fuel problem. Cheaper than coal, wood or gas—absolutely safe. Does away with drudgery—no fires to make, no ashes, dirt, smoke, chopping, carrying coal and wood. Easy to install. Doesn't change stove. Protects health. Easy to demonstrate—slips in or out of stove in one minute. Show any woman what it will do right in her own home and sale is made. Big demand all year. Let the fuel shortage make you big money.

Big profit. Some Oliver agents earn as high as \$1000 per month. \$21 a day is easy.

Free Sample Case Offer
and book "New Kind of Heat"
Write for them now.

Oliver Oil-Gas Burner & Machine Co.
Oldest, largest Manufacturers Oil-Gas Burners in the world.
2048-V Oliver Building,
ST. LOUIS, MO.

Read what these Oliver agents say:

\$660 a month
"Have averaged \$660 profit a month for last six months."
A. H. Russell, Conn.

\$1000 in 4 weeks
"Am making \$1000 per month. I have made big money before, but did not expect so much. Your Burner is just the thing."
J. Carnegie, S. Dak.

Guys car with profit
"Have earned enough in one month to buy me a new auto."
S. W. Knappen, Col.

Sells like beer in a dry town
"Am sending to day for seven Oliver's. This is one day's orders (\$85 profit). Selling like beer in a dry town."
W. H. Drew, Mich.

\$43 in one evening
I made \$43 last night.
N. K. Cholan, Wash.



Learn to Write

I Teach by Mail

I CAN make a good penman of you at your home during spare time, no matter where you live or how poorly you now write. My simplified system has shown thousands of others the way to good penmanship during the past twenty years — it can and will do the same for YOU!

Beautifully Illustrated Book

"How to Become a Good Penman" FREE!

It contains general information, with testimonials and beautiful specimens of penmanship showing what others have accomplished by the Tamblin System. (Your name elegantly written on a card if you enclose stamp for postage.) **WRITE TODAY.** Address

F. W. TAMBLIN
418 Ridge Bldg., Kansas City, Mo., U. S. A.

F. W. Tamblin

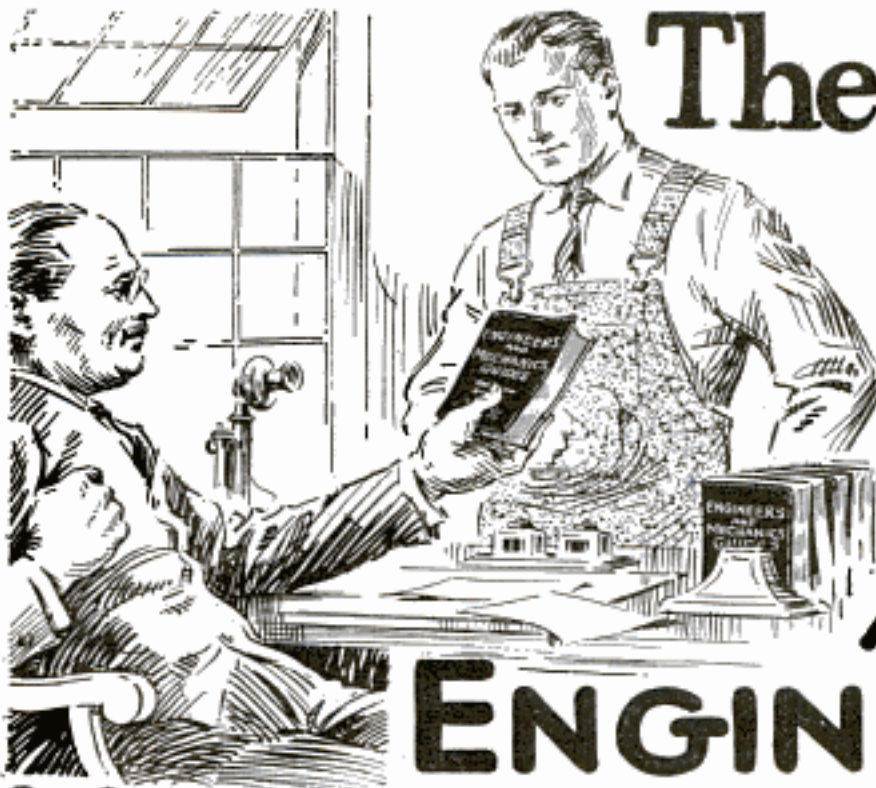

The CHIEF said—

"Tom, the way to **earn** more is to **learn** more. Audel's Engineers' Guide will help you. The biggest favor I can do you is to advise you to send for this Master Set. Remember—What you are tomorrow depends on what you think and do today."

AUDEL'S ENGINEERS and MECHANICS GUIDES

—the Master Set for the man on the job. Just completed. Contains latest practical information on every phase of Modern Engineering and Electrical Theory and Practice. Solves your problems. Answers your questions. Fits you for the **job higher up**. Points the way to better pay. Highly recommended by **Chief Engineers, Master Mechanics and Instructors**. Every engineer, mechanic and electrical worker that owns and uses this set will begin immediately to be a more valuable man.

"Gives fundamentals more clearly than any other set"—R. H. Wilson. "Should be in the house of every man on power house work"—Barney Meyer. "Gave me more common sense knowl-

edge than any other books"—Neil Crottean. "You certainly give a square deal; I'm delighted"—W. D. McGrew. "Congratulate you on such complete set at such low price"—W. H. Hailey.

THESE BOOKS TELL YOU ALL ABOUT—

Theory, Practice and Operation of ALL Steam Engines, Valve Motions—VALVE SETTING; complete information on ALL engines and pumps—CORLISS ENGINES and the Theory, Construction and Operation of all Steam Engines including UNIFLOW and POPPET VALVE ENGINES and LOCOMOTIVES—Locomotive-Motive Engines, Turbines; Rotary Engines—the Indicator—Lubrication—PRACTICAL MANAGEMENT. How to use Indicator—GAS, GASOLINE, OIL, SEMI- and FULL DIESEL ENGINES—Aeroplanes, and Aviation—HOW TO SELECT AN ENGINE, working instructions, drawings on STEAM ENGINE DESIGN including rules and formulae. Theory and Construction of ALL Steam Boilers; Heat-Combustion; Fuel and Flue Gas Analysis—CO₂ recorders—Characteristics

of Boilers—Materials—Construction of all types of Boilers. (THE LATEST PRACTICE.)—Boiler Construction—Mechanical Stokers—Oil Burners—Setting—Chimneys—Mechanical Drafts—HOW TO SELECT A BOILER—Complete instructions and drawings on BOILER DESIGN based on A. S. M. E. BOILER CODE—OPERATION, including installation, FIRING; care and repair of Steam Boilers—Pipes, Fittings and Pipe Fitting—Heating and Ventilation—Refrigeration—Cooling Towers—Condensers—Distilling Apparatus—Elevators—Cranes and Hoisting Machinery—Ropes and Cables—Splicing. Special Features in Volume No. 8—a compendium of practical electrical engineering, an aid for engineers and electricians in obtaining a license—57 chapters—ready reference index, covering entire field of Modern Electricity.

FREE EXAMINATION

We want these books to be their own salesmen! Look them over yourself free—without any obligation—just as if you borrowed them from a library or a friend. If you like them send us \$1—and then \$1 a month. If you don't like them send them back. Each book is pocket size, gilt edged, clearly printed on light weight paper with flexible binding.

POCKET SIZE 4750 PAGES 8754 ILLUSTRATIONS FLEXIBLE

\$1 Per Month



\$12 Complete

THEO. AUDEL & CO., 72 Fifth Ave., New York City
 For free examination, AUDEL'S MASTER SET FOR ENGINEERS AND MECHANICS, send \$1.00. If you prefer, you may send \$1.00 monthly until you are satisfied.
 Name _____
 Home Address _____
 Employed by _____
 Occupation _____
 Reference _____

Send
 Coupon or Postcard
 for Your
FREE
 Copy of
 Hartman's
 Wonderful
 Bargain
 Catalog

368
Pages
 of the
World's



Greatest Furniture Bargains

We are determined to add 100,000 new customers this season, and to secure them we have made the prices in our new Bargain Catalog so low that everyone who knows values will see that we offer **UNEQUALLED SAVINGS** on the world's best merchandise. Hartman is breaking all records.

But—**ONLY 100,000 EXTRA COPIES** of this big Bargain Catalog showing these bargain prices have been printed for new customers. All the rest go to our old customers. The 100,000 extra copies will soon be gone. Be first—send for your copy **NOW** and save 33 per cent on your home furnishings.

Full Year to Pay—A Little Every Month on practically everything you order from Hartman's. Just a small first payment, balance on easy monthly payments—and 30 days' **FREE** trial.

Amazing bargains in furniture, carpets, rugs, linoleum, stoves, ranges, silverware, watches, dishes, washing machines, sewing machines, aluminum ware, gas engines, cream separators—*everything for home and farm*. Send today—either the coupon or a post card.

"Let Hartman Feather YOUR Nest"

— Mail Catalog Coupon Today —

HARTMAN Furniture & Carpet Co.

Dept. 4880 Chicago, Illinois

Send free and postpaid your 368-page bargain catalog.

Name

Street Address

R. F. D. Box No.

Town..... State.....



\$1 Brings This
 Richly Upholstered
 7-piece Suite

This is one of Hartman's most sensational bargains shown in Hartman's great 368-page catalog—a splendid suite of solid oak Living Room or Library Furniture in the popular Mission Style with fumed finish. Only \$1.00 down, 30 days' **FREE** trial and over a year to pay. See pages 29-36 of catalog for descriptions of other suites in various patterns—so many to choose from that the assortment is amazing, priced from \$21.95 up. Send today.

HARTMAN Furniture & Carpet Co.

Dept. 4880

Copyright, 1923, by Hartman's, Chicago

CHICAGO, ILLINOIS

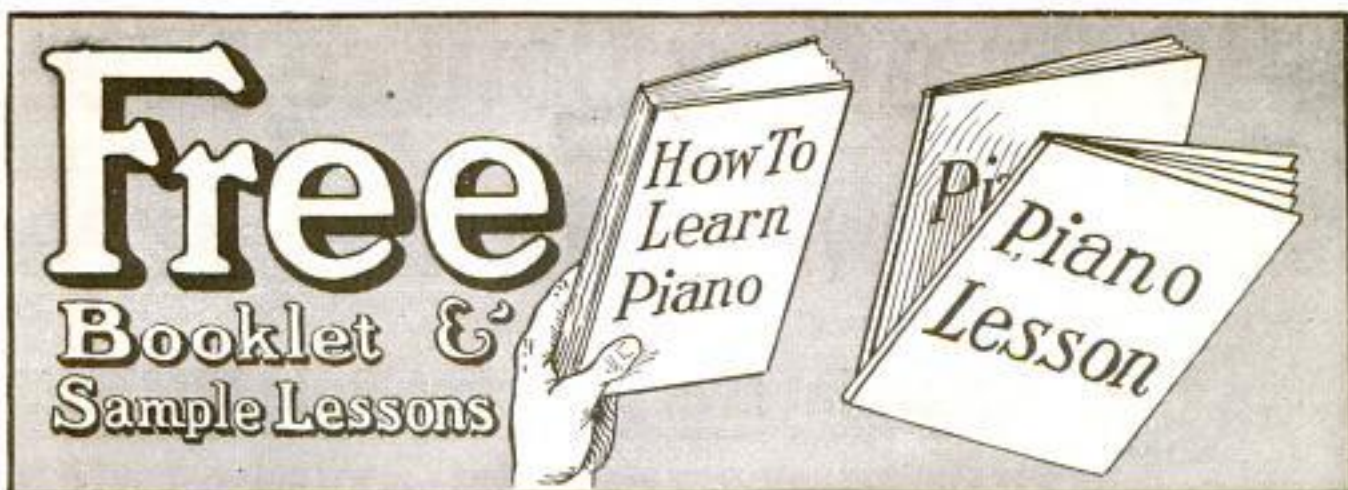

Stop Wondering How I Teach Piano; I'll Show You, FREE

YEAR after year you've seen my advertisement in all the leading publications, offering to teach you piano in *quarter* the usual time. Year after year my school has grown and grown until now I have far more students than were ever before taught by one man. In 1921 over a thousand students *graduated* from my Piano or Organ course and received their diplomas.

Yet when I first started giving piano and organ lessons by mail in 1891 my method was laughed at. Could my conservatory have grown as it has, obtained students in every state of the Union and in fact practically every civilized country of the world unless it produced very unusual and satisfying **RESULTS** for its students? See for yourself what it is that has brought my method so rapidly to the front. Write for free booklet and sample lessons.

Now, for the first time, you can obtain sample lessons without charge. In the past I have always been opposed to sending out free lessons, even to persons who were seriously interested in my course. But my friends have insisted that I give everybody a chance to see for themselves just how simple, interesting and **DIFFERENT** my lessons are, and I have consented to try the experiment *for a short time*. Simply mail the coupon below or write a postcard, and the 64-page booklet and sample lessons will go to you at once absolutely free and without obligation.

Within four lessons you will play an interesting piece on the piano or organ, not only in the original key, but in all other keys as well. Most students practice months before they acquire this ability. It is made possible by my patented invention the Colorotone. Another invention obtainable only from me is my hand-operated moving picture device, Quinn-dex. By means of Quinn-dex you actually see my fingers in motion on the piano, and can learn just how to train your own fingers.

When I say that I can teach you piano in *quarter* the usual time, do not think that this is too good to be true. Modern inventions and improved methods have accomplished just as great wonders in other branches of education. You at least owe it to yourself to *investigate*. Send coupon or postcard at once, before the offer of free sample lessons is withdrawn.



Quinn
Conservatory,
Studio PM 50,
598 Columbia Road,
Boston 25, Mass.

Please send me, without cost or obligation your free booklet, "How to Learn Piano or Organ," free sample lessons, and full particulars of your method.

Name.....

Address.....

\$80 Drafting Course Free

for best copy of sketch

\$25 Drawing Outfit Free

for next best copy of sketch

A Special Ivory Pocket Rule FREE!

for sending any copy of drawing shown at left hand side



Copy this sketch

YOU may enter this *Free Prize Drawing Contest* if you give your age when writing or sending your sketch. There are no conditions requiring you to buy anything. So, if you are interested in drawing, send in your sketch right away. Whether you obtain one of the big prizes or not, you are sure to be given *free* a 6-inch Ivory Pocket rule and a 6 x 9 book on "Successful Draftsmanship."

Chief Draftsman Dobe, of the Engineers' Equipment Company, offers these prizes to interest ambitious men who would like to better themselves at bigger salaries, doing work which brings big pay and at the same time leading more to advancement. There will be 72,000 open positions this year paying from \$3,000 to \$3,600 a year. The great building boom all over the country is causing this great demand, and industrial activity in the mechanical line makes it worth your while to give this opportunity your immediate attention.



\$250 to \$300 a Month

Positions paying \$250 to \$300 per month, which ought to be filled by skilled draftsmen are vacant everywhere. There are in every part of this country ambitious men, who with practical training and personal assistance, will be qualified to fill these positions.

Mr. Dobe is very much interested in finding these men and calling to their attention the great future in draftsmanship—how when a man enters into this profession, he is in an uncrowded field and how with surprisingly little effort he may rise to the salary of from \$3,000 to \$3,600 a year.

Ambitious boys and men, between the ages of 16 and 50, are wanted by great business concerns, and the man who is ready when opportunity calls him, gets the high grade positions and the highest pay.

No man can hope to share a part in the great coming prosperity in manufacturing and building, unless he is properly trained and able to do first class, practical work and is ready when he is called.

Mr. Dobe knows now is the time to get ready and he knows that few men realize this so well as he. So in order to interest men everywhere he is offering special prizes mentioned above.

If you send in what the judges decide to be the best drawing of the sketch above, you will be awarded a complete \$80 Practical Drafting Room Course, being trained by Mr. Dobe personally. This training is given by mail and he guarantees to train a limited number of students under this agreement to give practical drafting room training UNTIL placed in a permanent position at a salary of \$250 to \$300 per month.

To any student that Mr. Dobe accepts for his personal training, he will furnish a complete \$25 draftsman's working outfit absolutely free. This outfit consists of all instruments and tools required by any first class draftsman.

Considering that Mr. Dobe selects and limits the number of students for training, it is very important that you act promptly and send in your reply either with your sketch or without a sketch at once, asking for full particulars.

He will also send you a free book entitled "Successful Draftsmanship" in addition to all other information, telling you how you may learn drafting at home.

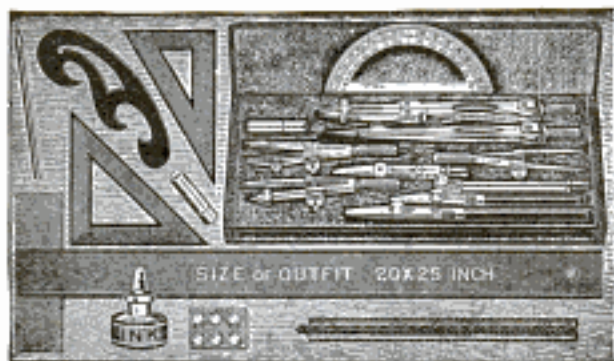

FREE — this \$25 Draftsman's Working Outfit

These are regular working instruments, the kind I use myself. I give them free to you if you enroll at once. Don't delay. *Send for full information TODAY!*

Chief Draftsman, Engineers' Equipment Co., 4001 Broadway, Div. 9357; Chicago, Ill.

Mail Your Drawing At Once—

and Get Ivory Pocket Ruler Absolutely FREE!

Ambitious men, interested in drafting, hurry! Don't wait! This is your opportunity in this great profession. Accept this offer which Mr. Dobe makes. Send in your sketch or request for FREE Book and Ivory Pocket Rule. Address:

BUILDING TRADES NEED TRAINED MEN!

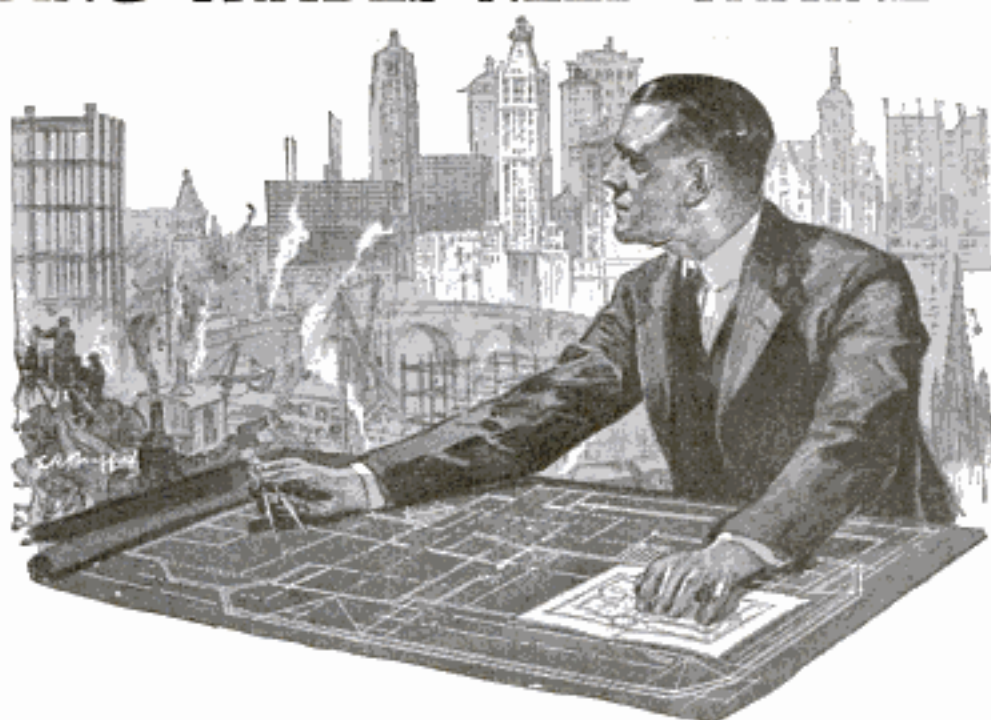

Thousands of good positions at good salaries

THE business tide has turned! And the building trades are leading the way back to prosperity! Government experts estimate that more than four billion dollars will be spent for construction this year.

"It will take us 12 years, working 25 per cent above normal," says John Ihlder, Manager of the Civic Development Department of the United States Chamber of Commerce, "to provide as adequately for our population as before the war."

Today the most vital need of this great building program is men—trained men—men who can step right in and do the skilled work that building construction requires.

There is a simple, easy, fascinating way by which you can prepare for a good position, at a good salary. You can do it right at home, in spare time, no matter where you live, through the International Correspondence Schools.

There is no question—no doubt about this. For thirty years the I. C. S. has been training men for advancement in the building trades and in many other business and technical subjects.

A recent investigation of 13,298 students enrolled in I. C. S. Building Trades Courses showed that 1291 had become Architects; 246 had become Designers; 494 had become Chief Draftsmen; 2827 had become Draftsmen; 1845 had become Contractors; 211 had become Assistant Foremen; 4030 had become Foremen; 2354 had become Superintendents.

IN every instance these students reported salaries or independent incomes far greater than when they took up their studies. Many have shown increases of 300% to 500%. Some have incomes as high as \$25,000 per year.

You, too, can have the position you want in the work you like best, an income that will give you

and your family the home, the comforts, the luxuries you would like them to have. No matter what your age, your present occupation, or your means, you can do it!

All we ask is the chance to prove it. That's fair, isn't it? Then mark and mail this coupon.

----- **TEAR OUT HERE** -----
INTERNATIONAL CORRESPONDENCE SCHOOLS
 Box 5671-C, Scranton, Penna.

Without cost or obligation, please tell me how I can qualify for the position or in the subject before which I have marked an X in the list below:

TECHNICAL AND INDUSTRIAL DEPARTMENT

- | | |
|--|---|
| <input type="checkbox"/> Architect | <input type="checkbox"/> Surveying and Mapping |
| <input type="checkbox"/> Architectural Draftsman | <input type="checkbox"/> Gas Engine Operating |
| <input type="checkbox"/> Blue Print Reading | <input type="checkbox"/> Automobile Work |
| <input type="checkbox"/> Building Foreman | <input type="checkbox"/> Airplane Engines |
| <input type="checkbox"/> Concrete Builder | <input type="checkbox"/> Plumber and Steam Fitter |
| <input type="checkbox"/> Contractor and Builder | <input type="checkbox"/> Plumbing Inspector |
| <input type="checkbox"/> Structural Draftsman | <input type="checkbox"/> Foreman Plumber |
| <input type="checkbox"/> Structural Engineer | <input type="checkbox"/> Heating and Ventilation |
| <input type="checkbox"/> Electrician | <input type="checkbox"/> Sheet Metal Worker |
| <input type="checkbox"/> Electrical Engineer | <input type="checkbox"/> Steam Engineer |
| <input type="checkbox"/> Electrical Contractor | <input type="checkbox"/> Railroad Positions |
| <input type="checkbox"/> Electric Wiring | <input type="checkbox"/> Chemistry |
| <input type="checkbox"/> Mechanical Engineer | <input type="checkbox"/> Pharmacy |
| <input type="checkbox"/> Mechanical Draftsman | <input type="checkbox"/> Metallurgy |
| <input type="checkbox"/> Machine Shop Practice | <input type="checkbox"/> Mining Engineer |
| <input type="checkbox"/> Toolmaker | <input type="checkbox"/> Navigation |
| <input type="checkbox"/> Civil Engineering | <input type="checkbox"/> Mathematics <input type="checkbox"/> Radio |

BUSINESS TRAINING DEPARTMENT

- | | |
|--|---|
| <input type="checkbox"/> Business Management | <input type="checkbox"/> Salesmanship |
| <input type="checkbox"/> Industrial Management | <input type="checkbox"/> Advertising |
| <input type="checkbox"/> Personnel Organization | <input type="checkbox"/> Better Letters |
| <input type="checkbox"/> Traffic Management | <input type="checkbox"/> Foreign Trade |
| <input type="checkbox"/> Business Law | <input type="checkbox"/> Show Card Lettering |
| <input type="checkbox"/> Banking and Banking Law | <input type="checkbox"/> Stenography and Typing |
| <input type="checkbox"/> Accountancy | <input type="checkbox"/> Teacher |
| (Including C.P.A.) | <input type="checkbox"/> Civil Service |
| <input type="checkbox"/> Nicholson Cost Accounting | <input type="checkbox"/> Railway Mail Clerk |
| <input type="checkbox"/> Bookkeeping | <input type="checkbox"/> Common School Subjects |
| <input type="checkbox"/> Business English | <input type="checkbox"/> High School Subjects |
| <input type="checkbox"/> Private Secretary | <input type="checkbox"/> Illustrating |
| <input type="checkbox"/> Business Spanish | <input type="checkbox"/> Cartooning |
| | <input type="checkbox"/> French |

Name.....

Street Address.....

City..... State.....

Occupation.....

Persons residing in Canada should send this coupon to the International Correspondence Schools Canadian, Limited, Montreal, Canada

BE A RAILWAY TRAFFIC INSPECTOR



**POSITION
GUARANTEED**

**Earn Up to \$250⁰⁰ per Month
EXPENSES PAID**

Many fine opportunities for trained Railway Traffic Inspectors. Steady, pleasant outdoor work; travel or remain near home.

Easy to Qualify

Prepare in three months' spare-time study at home. Position then **guaranteed** at not less than \$110 per month and expenses, with many chances for advancement thru contact with big railway officials.

"MY SALARY WAS RAISED"

Read what Mr. James M. Hurt, Jr., says about the work:

"After finishing your course in Traffic Inspection about three months ago, I was placed in a permanent position at \$110.00 per month. Several days ago my salary was raised to \$135.00 per month, and I have every reason to believe it will go higher soon if my work is satisfactory. Have come to the conclusion that there are very few classes of work in which the opportunities are as unlimited and at the same time, the work as pleasant as Traffic Inspection."

You Take No Risk

If position is not obtained for you, entire enrollment fee is refunded without question. You have nothing to lose.

Send coupon for details and booklet No. D-725

STANDARD BUSINESS TRAINING INST.

BUFFALO, N. Y.

COUPON

Standard Business Training Inst.,
Buffalo, N. Y.

Gentlemen:—

Send me by return mail, entirely free, full details about profession of Railway Traffic Inspection and booklet No. D-725.

Name.....

Street.....

Town and State.....

Date.....

\$1,500 to \$6,000 a Year

Dental Laboratory Work

Be a mechanical dentist—a high class, agreeable occupation for men or women. Course is inexpensive. Takes only short time to complete. Experience or entrance requirements unnecessary. No license required. McCarrie graduates make big successes and are in great demand everywhere. Largest and best equipped school laboratory and clinic in America; individual practical instruction, modern up-to-date methods. Write for trial scholarly offer. Find out how easy it is to fit yourself for this highly paid and dignified profession. Learn the McCarrie way. It pays.

Write for Book No. 27

McCARRIE
SCHOOL OF MECHANICAL DENTISTRY
34 and 36 W. LAKE STREET, CHICAGO, ILL.

LEARN JIU-JITSU

Know how to protect yourself and your loved ones against a bully or a ruffian. Muscle and weight are helpless before this marvelous science. Anyone can master it easily. Complete instructions in book entitled **JUDO (Improved Jiu-Jitsu)** by Sekizue Yokoyama, Professor of Jiu-Jitsu in the Kodokwan (leading athletic university in Japan). 200 pages. Illustrated with 90 actual photos. **Special Reduced Price Only \$2.00, Postpaid.** (Same edition originally sold for \$5.) Money cheerfully refunded within 5 days if not entirely satisfactory.

Will ship C. O. D. anywhere in U.S.A. if desired.

NISHODO BOOK COMPANY
512 Chamber of Commerce Bldg. Los Angeles, Cal.

Learn Photography at HOME

Make \$75.00 a Week on the Side

Establish yourself as a Photographic Expert quickly—during your spare time—under a leading photographer. I'll show you how to start your own business—or command a large salary. Send for my special offer—it's only temporary. Ask at once. A postal will do. H. R. VANT.

INTERNATIONAL STUDIOS, Inc.
Dept. 1197, 3601 Mich. Ave., Chicago, U.S.A.

BE A JAZZ MUSIC MASTER

PLAY BY EAR

Play popular song hits perfectly by ear. Hum the tune, play it by ear. No tedious ding-dong daily practice—just twenty brief, entertaining lessons which you can master in no time. Send for the Free book. It tells how to start if you want musical ability at which friends will marvel.

Niagara School of Music
Dept. 470, Niagara Falls, N.Y.

Send for this Free Book

Clear-Tone FOR PIMPLES

Your skin can be quickly cleared of Pimples, Blackheads, Acne Eruptions on the face or body, Enlarged Pores, Oily or Shiny Skin. **\$1,000.00 Cold Cash says I can clear your skin of the above blemishes. WRITE TODAY for my FREE Booklet—"A Clear-Tone Skin"—telling how I cured myself after being afflicted for fifteen years.**

FREE

E.S.GIVENS, 129 Chemical Bldg., Kansas City, Mo.

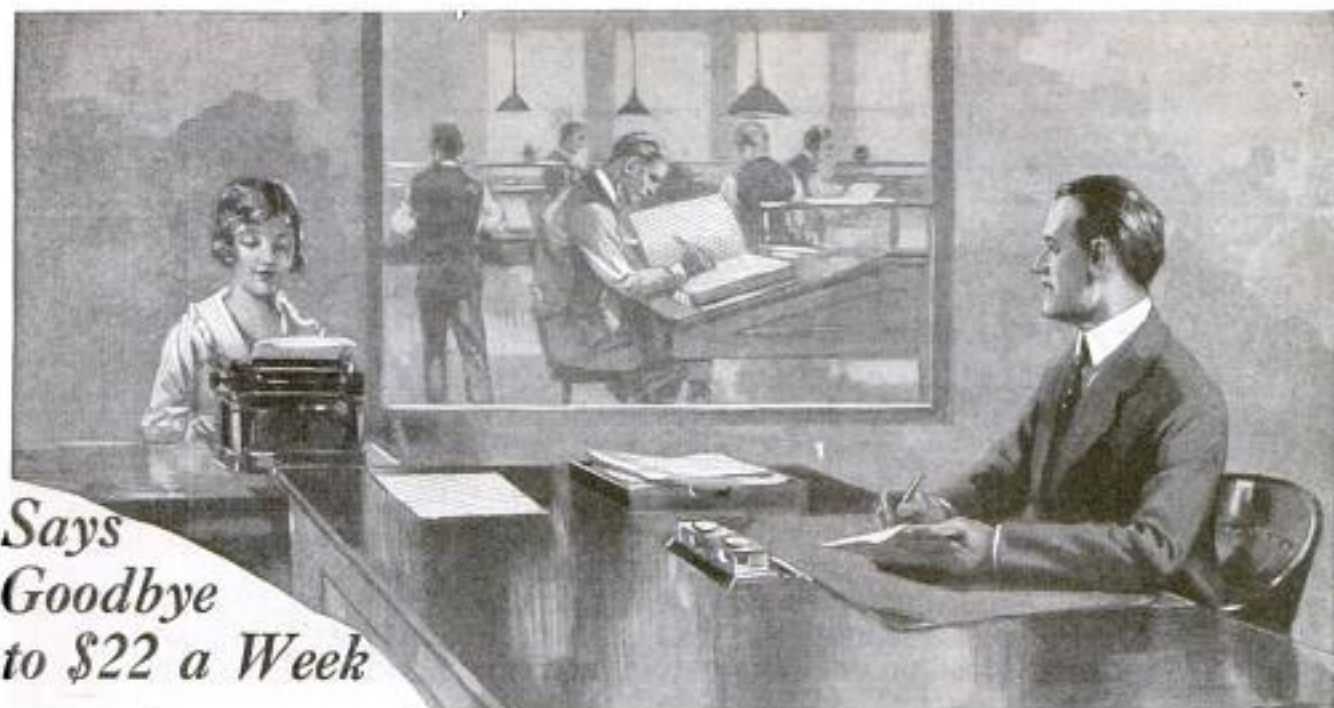

*Says
Goodbye
to \$22 a Week*

—At 27 Earns \$4,500 a Year

"Three years ago," writes A. J. Klick, "I was just an average young man of 24, possessing a fair education, liking a (so-called) good time, occupying a bookkeeper's high stool and receiving \$1,100 a year.

"A crisis in my affairs woke me up and I began the serious study of Higher Accountancy.

"Before the year was over, I was making progress financially. Interested in my work, advancing steadily, more confident of myself, by the time I had finished the course, I had an executive position and \$3,000 a year.

"Last year I became comptroller of a good-sized corporation. My work became a pleasure; salary increased to \$3,800.

"This year I accepted a similar position with a larger corporation, with broader responsibilities and an initial salary of \$4,500. The future years are full of promise."

Unusual Opportunities in Accounting

Klick is right. His future years are full of promise!

Never in the history of business has the need for trained accountants been so great or the rewards so attractive. The files of LaSalle Extension University contain literally thousands of letters reporting rapid advancement—incomes doubled, trebled and quadrupled as the result of a comparatively few months of home-study training. Where these men were getting \$1,500 or \$2,000 a short time ago, they are earning from \$3,000 to \$10,000 today, and they are on the up-grade.

Their chance is yours—if you will take it!

Train by the "Problem Method"

Why let the other fellow walk away with the better job when the training you need is readily within your reach?

Right in your own home you can master Higher Accounting just as well as they! By the LaSalle Problem Method, you will be trained under the direct supervision of William B. Castenholz, A. M., C. P. A., former Comptroller and Instructor, University of Illinois, assisted by a large staff of Certified Public Accountants, including members of the American Institute of Accountants. You will be guided step by step through every phase of modern accounting practice—Auditing, Cost Accounting, Business Law, Organization, Manage-

ment, Finance and Income Tax Procedure. You will handle practical accounting problems lifted bodily from business life. You will be given special preparation for the C. P. A. examinations.

Send for further information regarding the opportunities in accounting; read the enthusiastic testimony of men still in their twenties and early thirties who have broken away from the low-pay ranks and today are expert accountants—with incomes ranging from \$5,000 to \$10,000 a year. With this information we will send you particulars of our *convenient-payment plan*; also a copy of that inspiring book, "Ten Years' Promotion in One." "Get this book," said a prominent Chicago executive, "even if you have to pay five dollars for it." We will send it *free*.

Mark—Sign—Mail the coupon—NOW.

LaSalle Extension University

The Largest Business Training Institution in the World

Dept. 1064-HR

Chicago, Illinois

Please send me catalog and full information regarding the course and service I have marked with an X below. Also a copy of your book, "Ten Years' Promotion in One," all without obligation to me.

Higher Accountancy

Training for positions as Auditor, Comptroller, Certified Public Accountant, Cost Accountant, etc.

Other LaSalle Training Courses

LaSalle is the largest business training institution in the world. It offers training for every important business need. If more interested in any of these courses, check here:

- | | |
|--|--|
| <input type="checkbox"/> Business Management | <input type="checkbox"/> Banking and Finance |
| <input type="checkbox"/> Salesmanship | <input type="checkbox"/> Modern Foremanship and Production Methods |
| <input type="checkbox"/> Traffic Management | <input type="checkbox"/> Personnel and Employment Management |
| <input type="checkbox"/> Railway Accounting and Station Management | <input type="checkbox"/> Expert Bookkeeping |
| <input type="checkbox"/> Law—Degree of LL. B. | <input type="checkbox"/> Business English |
| <input type="checkbox"/> Commercial Law | <input type="checkbox"/> Commercial Spanish |
| <input type="checkbox"/> Industrial Management | <input type="checkbox"/> Effective Speaking |
| <input type="checkbox"/> Efficiency | <input type="checkbox"/> C. P. A. Coaching |
| <input type="checkbox"/> Modern Business Correspondence and Practice | |

Name

Present Position

Address

Building Contractor
\$5,000—\$10,000

Draftsman and Designer
\$2,500—\$4,000

Electrical Engineer
\$4,000—\$10,000

General Education In One Year

Employment Manager
\$4,000—\$10,000

Mechanical Engineer
\$4,000—\$10,000

Shop Superintendent
\$1,000—\$7,000

Architect
\$5,000—\$15,000

Automobile Engineer
\$4,000—\$10,000

Automobile Repairman
\$2,500—\$4,000

Civil Engineer
\$5,000—\$15,000

Structural Engineer
\$4,000—\$10,000

Business Manager
\$3,000—\$15,000

Certified Public Accountant
\$7,000—\$15,000

Radio and Wireless Expert
\$2,500—\$10,000

Accountant and Auditor
\$2,500—\$7,000

Which One?

*Not one of these jobs is beyond your reach
Which one do you want?*

The kind of a fellow who gets ahead today—and holds one of these high positions is the fellow with *training*. Nowadays employers can find men with training very easily—because colleges are graduating them pretty fast—so the fellow who had to leave school early is handicapped unless he gets training during his idle hours.

Today you can get it in your home town, every man can, regardless of how much time he spent in school. And you can make every hour of your practical experience pay big dividends as well. American School training was made for YOU and has brought success to thousands.

Big Raise in Salary

It is easy to get, if you go about it in the right way. You have often heard of others who doubled and trebled their salaries in a year's time. You wondered how they did it. Was it a pull? Don't you think it. When a man is hired he gets paid for exactly what he does, there is no sentiment in business. It's preparing for the future and knowing what to do at the right time that doubles and trebles salaries.

Why Don't You Try It?

Why don't you see what an American School course will do for you? Our experience in helping thousands of others will surely help you get to the top. If you really want to get ahead, get busy and—

Mail This Coupon Today

Send us your name and address on the coupon. Just write underneath, in the coupon what job you want to hold. We'll tell you how you can get just the training you need right in your own home.

You'll be under no obligation—and the information you will get will do you a great deal of good. Let us help you. We are at your service—and all you need to do is to send this coupon with your name and address. Do it now—for your own sake and the man you want to be.

American School Dept. G 774 Chicago, U. S. A.

Dept. G 774

I want this job—tell me how to get it.

Job.....

Name.....

Address.....

Lawyer
\$2,000—\$15,000

Steam Engineer
\$2,500—\$4,000

Foreman's Course
\$2,500—\$4,000

Photoplay Writer
\$2,000—\$10,000

Sanitary Engineer
\$2,500—\$5,000

Telephone Engineer
\$2,500—\$5,000

Telegraph Engineer
\$2,500—\$5,000

High School Graduate In Two Years

Vocational Guidance if You Are Undecided

Let These Guides

Solve Your Problems

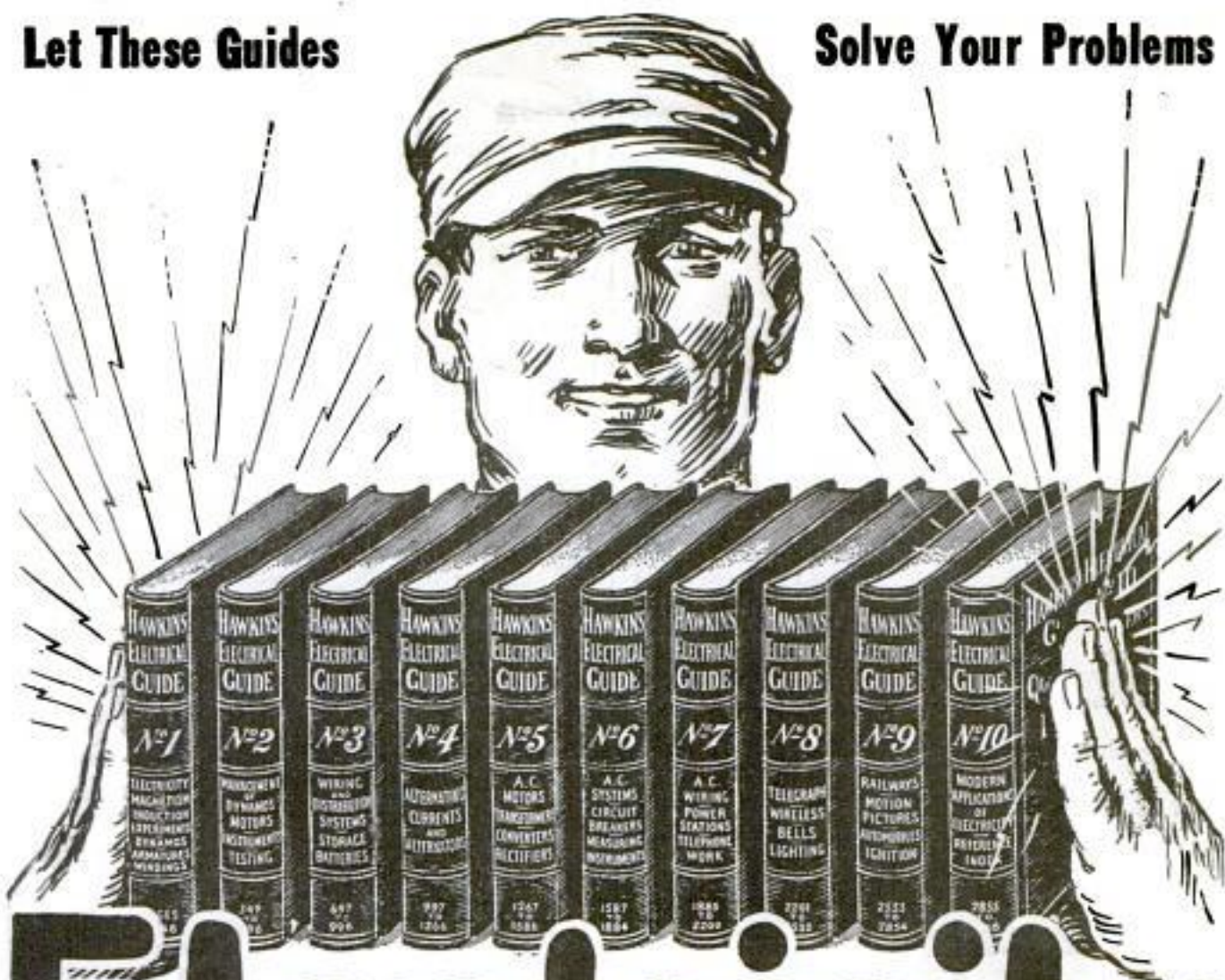

Electricity at your finger ends

HAWKINS ELECTRICAL GUIDES IN TEN VOLUMES
**3500 PAGES
4700 PICTURES**
**\$1 A VOLUME
\$1 A MONTH**
Send No Money--Send Only This Coupon

Know the facts in Electricity. They mean more money and better position for you. Hawkins Guides tell you all you need to know about Electricity. Every important electrical subject covered so you can understand it. Easy to study and apply. A complete, practical working course, in 10 volumes. Books are pocket size; flexible covers. Order a set today to look over.

LEARN ALL ABOUT

Magnetism—Induction—Experiments—Dynamios—Electric Machinery—Motors—Armatures—Armature Windings—Installing of Dynamios—Electrical Instrument Testing—Practical Management of Dynamios and Motors—Distribution Systems—Wiring—Wiring Diagrams—Sign Flashers—Storage Batteries—Principles of Alternating Currents and Alternators—Alternating Current Motors—Transformers—Converters—Rectifiers—Alternating Current Systems—Circuit Breakers—Measuring Instruments—Switchboards—Wiring—Power Stations—Installing—Telephone—Telegraph—Wireless—Bells—Lighting—Railways. Also many Modern Practical Applications of Electricity and Ready Reference Index of the ten numbers.

SHIPPED FREE

Not a cent to pay until you see the books. No obligation to buy unless you are satisfied. Send Coupon now—today—and get this great help library and see if it is not worth \$100 to you—you pay \$1.00 a month for ten months or return it.

**THEO. AUDEL & CO.,
72 Fifth Ave., New York City**

Please submit me for free examination, HAWKINS ELECTRICAL GUIDE, (Price \$1 a number). Ship at once prepaid, the 10 numbers. If satisfactory, I agree to send you \$1 within seven days and to further mail you \$1 each month until paid.

Name

Occupation

Employed by

Home Address

Reference

PM OCT. 22



"You're Right! Where'd you learn that?"

Any employer is ready to say it, to give you credit for thinking ahead of your job. The world is too full of men who just wait and wish to be pushed into more responsible positions.

Be prepared to say and to show that you are using spare hours to put more into your head. Prove to your employer that you are really determined to win more responsibility, better pay, and the privileges and comforts that come fairly to "the man who knows."

A student of ours writes: "A short time ago the Boss, needing a man for more responsible work, asked me if I was doing any studying in my spare hours. You can bet I was proud to answer, 'I am.'"

After a quarter-century of experience in aiding men, through spare hours to become their Bigger Selves, the United Y. M. C. A. Schools offer their tested service by mail, so that wherever you may be, whatever you may need or whatever your hours of employment are, you can now get this valuable aid.

The United Y. M. C. A. Schools system of teaching through the mails is unique. It gives "the most service for the least money."

Mark and mail the coupon for free copy of our new catalog and our friendly counsel on how you can realize your ambition.

SOME OF OUR 300 CORRESPONDENCE COURSES

- | Business Courses | | |
|---------------------|-------------------------|--------------------|
| Accountancy | Business Administration | Practical Speaking |
| Advertising | Business English | Salesmanship |
| Banking | Business Finance | Secretarial |
| Better Letters | Business Law | Show Card Writing |
| Bookkeeping | Complete Letter-Writing | Stenography |
| Business Arithmetic | Office Management | Traffic Management |

- | Technical and Other Courses | | |
|-----------------------------|----------------------|-----------------------|
| Agricultural Courses | Foremanship | Plumbing |
| Applied Psychology | Highway Engineering | Poultry Husbandry |
| Architecture | ing | Radio Engineering |
| Automobile Courses | High School Subjects | Radio Telegraphy |
| Building Construction | Illustrating | Radio Telephony for |
| tion | Insurance Courses | Amateurs |
| Civil Engineering | Mathematical | Steam Engineering |
| Courses | Courses | Courses |
| Drafting Courses | Mechanical Engi- | Structural Drafting |
| Electrical Courses | neering | Surveying |
| English Courses | Own-Your-Home | Use of the Slide Rule |
| Factory Management | Course | Vocational Courses |
| Foreign Languages | Plan Reading | |

Are you an ex-service man?



Correspondence Instruction

375 Lexington Avenue
Dept. 2-0 New York City

Without obligating me, please advise regarding the course in

Name.....

Full Address.....
(Please write plainly.)

SPANISH LEARNED EASILY AND QUICKLY!

Also FRENCH and ITALIAN

Another language will enable you to make more money—whether you are an employer or employee, professional man or woman, boy or girl.

A Few Spare Minutes Can Increase Your Income
Learning a new language by the Rosenthal Language Phone Method, is as easy as learning a new tune. Study when you are in the mood—in the comfort of your own home—on your own phonograph. Soon, you can talk, read and write Spanish, French or Italian.

ROSENTHAL LANGUAGE PHONE METHOD

makes rapid progress possible

Any number of people can learn at the same time—the whole family or groups of friends.

FREE 64-Page Book. It shows how easy, interesting, and profitable it is to learn a foreign language; and explains Dr. Rosenthal's world-famous method of quick study. Also details of **FREE Trial** offer. Send a postal—*to-day*.

FUNK & WAGNALLS COMPANY
549 Hess Building, 354 Fourth Ave., N. Y.



BE AN ARTIST

We can teach you **DRAWING** in your own home during your spare time.

Our 18 years of successful teaching prove our ability. 30 Courses in Commercial and Illustrative Drawing, Teachers Normal and Applied Art, Endorsed by high art authorities. Students trained by members of our Faculty are filling high-salaried positions. Artist's Outhit **FREE** to Enrolled Students. Write today for Art Year **FREE YOU!**

OUR HANDSOME ART YEAR BOOK

SCHOOL OF APPLIED ART
APPLIED ART BLDG. No. 2 BATTLE CREEK MICH.

HOW TO BECOME A PROFESSIONAL PHOTOGRAPHER

Earning \$35 to \$125 a Week

An interesting illustrated booklet (free) on choosing a vocation, the exceptional opportunities Photography offers you and how to avail yourself of these advantages.

Motion Picture—Commercial—Portraiture
Three to six months' Practical course. Modern equipment. Day or evening classes. Easy terms. Call or write for **Catalog No. 49.**
N. Y. INSTITUTE OF PHOTOGRAPHY
NEW YORK CHICAGO BROOKLYN
141 W. 36th St. 630 So. Wabash Ave. 505 State St.

Play Cornet?

Trombone, Baritone, etc.? You can't afford to be without "Lip Science." Marvelous secret manual for brass players. Easy playing in the entire register. Highest notes without effort. Results guaranteed. Send postal—get free information. Act now!

W. E. HITCHCOCK, Publisher
Dept. "M" 5337 Prairie Ave., Chicago

LEARN WATCHMAKING
and become independent. Good-paying positions secured. Easy to learn. Send for **FREE CATALOG.**
ST. LOUIS WATCHMAKING SCHOOL, Dept. 5, ST. LOUIS, MO

Learn Autos and Tractors

Wonderful opportunities constantly offered trained men; we train you thoroughly to start your own business or make good money as motor expert, driver, shop foreman, etc.

7,000 Graduates making good. Catalog Free
Cleveland Automobile School, 1814 E. 24th St., Cleveland, O.

It's a Crime to Slave for Low Pay — When It's So Easy To Earn Big Money

If You Are Making Small Pay, Then You Ought to Investigate This Simple Plan that Has Shown Thousands a Way to Magnificent Earnings

It is little short of an actual crime for a man to struggle along trying to make ends meet, when he can easily step into a position with better pay and unlimited opportunities for making money.

The sentence for a crime of this kind is "a lifetime of drudgery." Trying to make ends meet is a much harder task than making from three to ten times as much money as you are now making. For you can just as easily take advantage of the experience of countless others who, in one swift stroke, have jumped from small pay in blind-alley jobs to incomes of anywhere from \$5,000 to \$10,000 a year.

These Men Investigated and—

As an office worker in Detroit, Mr. B. H. Voss slaved away for \$125 a month. But he saw his one big opportunity—grasped it—and increased his pay to \$500 a month.

As a farmhand, George W. Kearns, of Oklahoma City, grasped the same opportunity. He writes, "Last week I cleared \$306, and this week \$218." And Mr. Kearns earned \$60 a month previously.

Mr. J. L. DeBonis, Chicago, now enjoying magnificent earnings. Before investigating, he was earning \$16 a week as a clerk.

When Charles Berry, of Winterset, Ia., decided that it was a crime to slave for low pay, he was earning \$18 a week. And then the very first month he earned \$1,000.

A whole book could be filled with stories equally amazing of men who have taken this new, quick road to big pay. Nor is there anything exceptional about these men. They were once in the same circumstances that you may be in now. They were discouraged, tired of working for small pay, and disgusted with their prospects. And then, as though by a touch of magic, they were earning salaries that they had never dared hope for.

For they have entered a new field—a field that they had never dreamed of as theirs—one that is not only the most interesting, but the best paying branch of all business—selling.

A Foolish Notion About Salesmen

The average man imagines that, in order to make good in selling, he must be a "born" salesman. Nothing could be further from the truth. There is no such thing as a "born"



salesman. Thousands of clerks, machinists, bookkeepers, factory hands, firemen and farmhands, to-day, are making big money in the selling field through the simple plan you are invited to investigate.

Secrets that Make Master Salesmen

No matter what your earnings may be, you can quickly learn the secrets of selling that have put thousands into the big-pay class. For the past fifteen years the National Salesmen's Training Association has successfully trained thousands for the selling field—and through its Free Employment Service helped thousands to secure good selling positions.

And through the National Demonstration Method you gain actual experience in overcoming sales problems of all descriptions while studying in your spare time at home. Then, through the N. S. T. A. System of Electives, you get specific instructions in how to sell the line or lines you want to handle. In other words, the proved selling plans of master salesmen in all lines are laid before you.

Book on "Modern Salesmanship" Free

Without cost or obligation, we will gladly mail you a copy of a very interesting book, "Modern Salesmanship." In addition to many interesting facts about salesmanship, it will also give you full information as to how you can become a highly paid salesman. No matter what you may think now, this book will prove to you that it's a crime to slave for low pay when magnificent earnings are within easy reach. There is no obligation, so just fill in the coupon and mail it to-day.

National Salesmen's Training Association
Dept. 12-R Chicago, Ill.

National Salesmen's Training Association,
Dept. 12-R, Chicago, Ill.

Send me FREE your book, "Modern Salesmanship," and proof that I can become a Master Salesman. Also send me list of lines with openings for salesmen.

Name.....

Address.....

Age..... Occupation.....



"\$60 More a Month!"

LAST night I came home with great news—a \$60 increase in salary! I took the money out of my pocket and asked Mary to count it. You should have seen her face light up when she found the extra \$60. I think she was even happier than I was, for it was the third increase in a year.

"Today I am manager of my department—earning more money than I ever thought it would be possible for me to make. I owe it all to the training I received from the International Correspondence Schools. That little coupon was the means of changing my whole life."

HOW much longer are you going to wait before taking the step that is bound to bring you more money? Isn't it better to start now than to wait for years and then realize what the delay has cost you?

One hour after supper each night spent with the I. C. S. in your own home will prepare you for the position you want in the work you like best.

Don't let another priceless hour go to waste! Without cost or obligation, let us prove that we can help you. Mark and mail this coupon.

----- TEAR OUT HERE -----
INTERNATIONAL CORRESPONDENCE SCHOOLS
Box 5471-C, Scranton, Penna.

Without cost or obligation, please tell me how I can qualify for the position or in the subject before which I have marked an X:

- | BUSINESS TRAINING DEPARTMENT | |
|---|---|
| <input type="checkbox"/> Business Management | <input type="checkbox"/> Salesmanship |
| <input type="checkbox"/> Industrial Management | <input type="checkbox"/> Advertising |
| <input type="checkbox"/> Personnel Organization | <input type="checkbox"/> Better Letters |
| <input type="checkbox"/> Traffic Management | <input type="checkbox"/> Foreign Trade |
| <input type="checkbox"/> Business Law | <input type="checkbox"/> Stenography and Typing |
| <input type="checkbox"/> Banking and Banking Law | <input type="checkbox"/> Business English |
| <input type="checkbox"/> Accountancy (including C.P.A.) | <input type="checkbox"/> Civil Service |
| <input type="checkbox"/> Nicholson Cost Accounting | <input type="checkbox"/> Railway Mail Clerk |
| <input type="checkbox"/> Bookkeeping | <input type="checkbox"/> Common School Subjects |
| <input type="checkbox"/> Private Secretary | <input type="checkbox"/> High School Subjects |
| <input type="checkbox"/> Business Spanish <input type="checkbox"/> French | <input type="checkbox"/> Illustrating <input type="checkbox"/> Cartooning |
| TECHNICAL AND INDUSTRIAL DEPARTMENT | |
| <input type="checkbox"/> Electrical Engineering | <input type="checkbox"/> Architect |
| <input type="checkbox"/> Electric Lighting | <input type="checkbox"/> Blue Print Reading |
| <input type="checkbox"/> Mechanical Engineer | <input type="checkbox"/> Contractor and Builder |
| <input type="checkbox"/> Mechanical Draftsman | <input type="checkbox"/> Architectural Draftsman |
| <input type="checkbox"/> Machine Shop Practice | <input type="checkbox"/> Concrete Builder |
| <input type="checkbox"/> Railroad Positions | <input type="checkbox"/> Structural Engineer |
| <input type="checkbox"/> Gas Engine Operating | <input type="checkbox"/> Plumbing and Heating |
| <input type="checkbox"/> Civil Engineer | <input type="checkbox"/> Chemistry <input type="checkbox"/> Pharmacy |
| <input type="checkbox"/> Surveying and Mapping | <input type="checkbox"/> Automobile Work |
| <input type="checkbox"/> Metallurgy | <input type="checkbox"/> Navigation |
| <input type="checkbox"/> Steam Engineering | <input type="checkbox"/> Agriculture and Poultry |
| <input type="checkbox"/> Radio <input type="checkbox"/> Airplane Engines | <input type="checkbox"/> Mathematics |

Name.....
Street..... 6.26.22
Address.....
City..... State.....

Occupation.....

Persons residing in Canada should send this coupon to the International Correspondence Schools Canadian, Limited, Montreal, Canada.

Please Mention Popular Mechanics

Learn to Dance!

at home
to music

FREE PROOF record teaches you to dance in one hour

All your friends dance. Why don't you? Surprise them with the latest steps. You can easily learn by yourself without embarrassment. It's not necessary to know the first thing about dancing.

Just slip these wonderful records on your phonograph—and do as they say. That's all there is to it.

I'll Prove It FREE

Convince yourself at my expense how remarkably easy my unusual method is. For a short time I will send my first lesson, including ten-inch record, free and prepaid. Try it out for 5 days and decide whether you wish to learn dancing the modern way. You may then enroll or return the record. I have set aside only a few hundred for this special offer. You must write at once.

WILLIAM CHANDLER PEAK

"The Man Who Makes Better Dancers"
Studio 34 4737 Broadway, Chicago, U. S. A.

WM. CHANDLER PEAK, M. S. The Originator of Dance Instruction by Mail. Nationally known—he is an outstanding figure in teaching dancing at home, having taught over 60,000 men and women of high social standing. He is Special Instructor in the oldest and most exclusive dancing association—The American Society of Teachers of Dancing, New York. Also, President of the new famous Peak School of Dancing, Inc., Established since 1880.

LEARN WATCH REPAIRING

Be a watchmaker—you can learn this profitable trade by correspondence in a few weeks in your own home by the DeSelms Chart System. After you complete the course you will know a watch from A to Z. You will know just what the matter is and how to repair one. When you graduate you will be a practical watchmaker and repairer and competent to fill any position. Positions for our graduates.

Ask for our Free Book. It explains our system and terms.

THE DeSELMS WATCH SCHOOL
23 Perry Street ATTICA, INDIANA



STAMMER

If you stammer attend no stammering school till you get my large FREE book entitled "STAMMERING, Its Origin and the Advanced Natural Method of Cure," bound in cloth and stamped in pure gold. Ask for special tuition rate and a FREE copy of "The Natural Speech Magazine." Largest, best equipped and most successful school in the world for the cure of stammering, stuttering, etc. No sing-song or time beat. Write today! The North-Western School, 2317 Grand Ave., Milwaukee, Wis.

Factory to Rider

Saves \$10 to \$25 on the Ranger Bicycle you select. You can have your choice of 44 Styles, colors and sizes. Delivered free on approval, express prepaid, for 30 DAYS' FREE TRIAL.

12 Months to Pay if desired. Possession and use at once on our liberal year to pay plan. Parents often advance first payment.

Best quality, at factory prices, express prepaid. Lamps, wheels and equipment, low prices. Send

Tires No Money, no business direct with makers.

Write today for free Ranger Catalog, factory prices and marvelous easy payment terms

Mead Cycle Company Dept. C 105 Chicago



BE AN EXPERT
Penman

I TEACH BY MAIL. You can become an expert penman right in your own home by my method. Small Cost. All that is required is some of your Spare Time. Write for my book, "HOW TO BECOME AN EXPERT PENMAN." It contains specimens and tells how others became expert writers by the TEVIS METHOD. Your name written on a card if you enclose stamp. FREE BOOK. Write today. T. M. TEVIS, BOX 25K, CHILLICOTHE, MO.

Copyrighted material

AUTO BOOKS

We've Cut the Price in Half

SAVE 23 DOLLARS

Earn increased hundreds. The biggest paying field in the world is the automotive industry. In it there is big pay and a steady job for every man who qualifies for a place. You can qualify with these books, they are the finest, most comprehensive automotive reference library ever compiled. It covers every phase of the industry. With these books within easy reach you can solve at once any problem that may confront you. Everyone who has purchased a set says they are the real

PAY RAISING BOOKS

They contain absolutely everything you want to know about the upkeep, care and repair of motor vehicles and tractors. Written in plain, easy to understand English; there are 2600 pages, 2300 pictures, diagrams and blue prints—bound in flexible morocco, gold stamped.

If you want to be the man in your shop who can solve any automotive problem—if you want to get ahead—if you want to make more money—if you want to succeed in the automobile or tractor game—send today for this library of reference books. They are yours for a week's

FREE EXAMINATION DON'T SEND MONEY

Just fill in the coupon and the entire library will be shipped you by express, collect, so that you may use them right in your own home or shop for seven whole days without any obligation. Put them to work—show them to your friends—ask them what they think of them, and if you are not absolutely satisfied that they are the greatest reference library in the world, send them back without cost of another penny to you—if you decide to keep them, send us \$2.80 within 7 days and balance \$3.00 month, until the special reduced price of \$21.80 is paid. Mail the coupon TODAY.

**American
Technical
Society**
Dept. A-197
Chicago, U.S.A.

FREE EXAMINATION COUPON

American Technical Society, Dept. A-197 Chicago, Ill.

Send me the 6 volume set of Automobile Engineering books for a week's free trial, by express collect. I will either return the books in one week at your expense or send you \$2.80 as first payment and \$3.00 every month until a total of \$21.80 is paid.

Name

Address

City.....State.....

Employed by

WANTED!

\$1,000 REWARD

CONVICT 6138, escaped from the State Penitentiary; Name, Charles Condray; Age, 37; Height, 5 ft. 8 in.; Weight, 141 pounds; Hair, light brown; Eyes, gray.

Easy enough to identify him from his photograph and this description, you may say—but, Condray took the name of "Brown", dyed his hair, darkened his skin, grew a mustache, put on weight and walked with a stoop.

Yet he was captured and identified so positively that he knew the game was up and returned to the penitentiary without extradition. A Finger Print Expert made this identification and secured the reward.

MORE TRAINED EXPERTS NEEDED NOW!

There is a big chance for you in this uncrowded, fascinating profession. State, City, and Private Bureaus being established and expanded constantly. Trained men in great demand. Many earn \$3000 to \$10,000 yearly.

LEARN AT HOME IN SPARE TIME

Common school education, common sense and ambition, the only requirements. Many of the country's greatest experts learned their profession in this great school. A few hours' spare time a week soon fits you for a fine position as a Finger Print Expert.

**UNIVERSITY OF
APPLIED SCIENCE**
1920 Sunnyside Avenue,
Dept. 1357, Chicago, Ill.

Gentlemen:—Without any obligation whatever, send me your new, fully illustrated FREE Book on Finger Prints and your offer of a FREE course in Secret Service Intelligence and the Free Professional Finger Print Outfit.

Name.....
Address.....
Present.....
Occupation..... Age.....

FREE! for a limited time. A professional Finger Print Outfit—a course in Secret Service Intelligence. Also a complete book on Finger Prints sent at once if you will mail this coupon. Write today.

**UNIVERSITY OF
APPLIED SCIENCE**
1920 Sunnyside Ave.
Dept. 1357
CHICAGO, ILL.



FONTAINE FOX

makes more
than

\$200 a day!



for six drawings a week—more than \$80,000 a year! Clare Briggs, Sid Smith, J. N. Darling, Fontaine Fox and many others get immense incomes from simple cartooning and illustrating ideas.

These men and more than 60 others of America's leading illustrators and cartoonists comprise the Federal Staff. They teach you those secrets and methods of their success that took them years to discover and perfect. If you have talent for drawing, capitalize your ability. Make it earn big money for you. Be successful by learning drawing from men who have achieved fame and fortune through drawing.

SEND FOR OUR FREE BOOKLET—"A Road to Bigger Things." It explains the Federal Method of instruction. Read of opportunities in the art world. Learn how you can qualify for a position paying big money. Your name, address and age, together with 6c in stamps to cover postage, will bring this book by return mail.

Federal Schools, Inc., 1003 Federal Schools Bldg., Minneapolis, Minnesota

WANTED—RAILWAY MAIL CLERKS

\$135 to \$190 a Month for Life

Every second week off with full pay—no "lay offs" because of strikes, poor business, etc.—sure pay—rapid advancement to higher positions. City and country residents stand same chance. Common sense education sufficient—no political influence. Examinations likely in every city very shortly.

CANDIDATES PREPARED FREE

Write for free schedule of full examination places. Every day's delay means so much less coaching—so write at once.

FRANKLIN INSTITUTE, Dept. H176, Rochester, N. Y.

Mail This Coupon

Write Plainly

Use It Before You Lose It

COUPON

FRANKLIN INSTITUTE, Dept. H176, Rochester, N. Y.

Kindly send me, without any obligation whatever on my part and entirely free of charge, (1) a full description of the position checked below; (2) Sample examination questions; (3) Free copy of copyrighted book "Government Positions and How to Get Them"; (4) A list of U. S. Government Jobs now open; (5) Schedule showing dates and places of all coming examinations.

.. Railway Mail Clerk (\$1600 to \$2300) .. Customs Positions (\$1100 to \$2000)
.. Postoffice Clerk (\$1400 to \$1800) .. Internal Revenue (\$1100 to \$2000)
.. Postoffice Carrier (\$1400 to \$1800) .. Rural Mail Carrier (\$1100 to \$2000)
.. Income Tax Auditors..... (\$2040 to \$3000)

Name.....
Address.....

If you were dying to-night

and I offered you something that would give you ten years more to live, would you take it? You'd grab it. Well, fellows, I've got it, but don't wait till you're dying or it won't do you a bit of good. It will then be too late. Right now is the time. To-morrow, or any day, some disease will get you and if you have not equipped yourself to fight it off, you're gone. I don't claim to cure disease. I am not a medical doctor, but I'll put you in such condition that the doctor will starve to death waiting for you to take sick. Can you imagine a mosquito trying to bite a brick wall? A fine chance.

A Re-built Man

I like to get the weak ones. I delight in getting hold of a man who has been turned down as hopeless by others. It's easy enough to finish a task that's more than half done. But give me the weak, sickly chap and watch him grow stronger. That's what I like. It's fun to me because I know I can do it and I like to give the other fellow the laugh. I don't just give you a veneer of muscle that looks good to others. I work on you both inside and out. I not only put big, massive arms and legs on you, but I build up those inner muscles that surround your vital organs. The kind that give you real pep and energy, the kind that fire you with ambition and the courage to tackle anything set before you.

All I Ask Is Ninety Days

Who says it takes years to get in shape? Show me the man who makes any such claims and I'll make him eat his words. I'll put one full inch on your arm in just 30 days. Yes, and two full inches on your chest in the same length of time. Meanwhile, I'm putting life and pep into your old back-bone. And from then on, just watch 'em grow. At the end of thirty days you won't know yourself. Your whole body will take on an entirely different appearance. But you've only started. Now comes the real work. I've only built my foundation. I want just 60 days more (90 in all) and you'll make those friends of yours who think they're strong look like something the cat dragged in.

A Real Man

When I'm through with you, you're a real man. The kind that can prove it. You will be able to do things that you had thought impossible. And the beauty of it is you keep on going. Your deep full chest breathes in rich pure air, stimulating your blood and making you just bubble over with vim and vitality. Your huge, square shoulders and your massive, muscular arms have that craving for the exercise of a regular man. You have the flash to your eye and the pep to your step that will make you admired and sought after in both the business and social world.

This is no idle prattle, fellows. If you doubt me, make me prove it. Go ahead. I like it. I have already done this for thousands of others and my records are unchallenged. What I have done for them, I will do for you. Come, then, for time flies and every day counts. Let this very day be the beginning of new life to you.

Send for my book

"MUSCULAR DEVELOPMENT"

It is chock full of large size photographs of both myself and my numerous pupils. Also contains a treatise on the human body and what can be done with it. This book is bound to interest you and thrill you. It will be an impetus—an inspiration to every red blooded man. I could easily collect a big price for a book of this kind just as others are now doing, but I want every man and boy who is interested to just send the attached coupon and the book is his **absolutely free**. All I ask you to cover is the price of wrapping and postage—10 cents. Remember this does not obligate you in any way. I want you to have it. So it's yours to keep. Now don't delay one minute—this may be the turning point in your life to-day. So tear off the coupon and mail at once while it is on your mind.

EARLE E. LIEDERMAN
Dept. 2010, 305 Broadway, New York

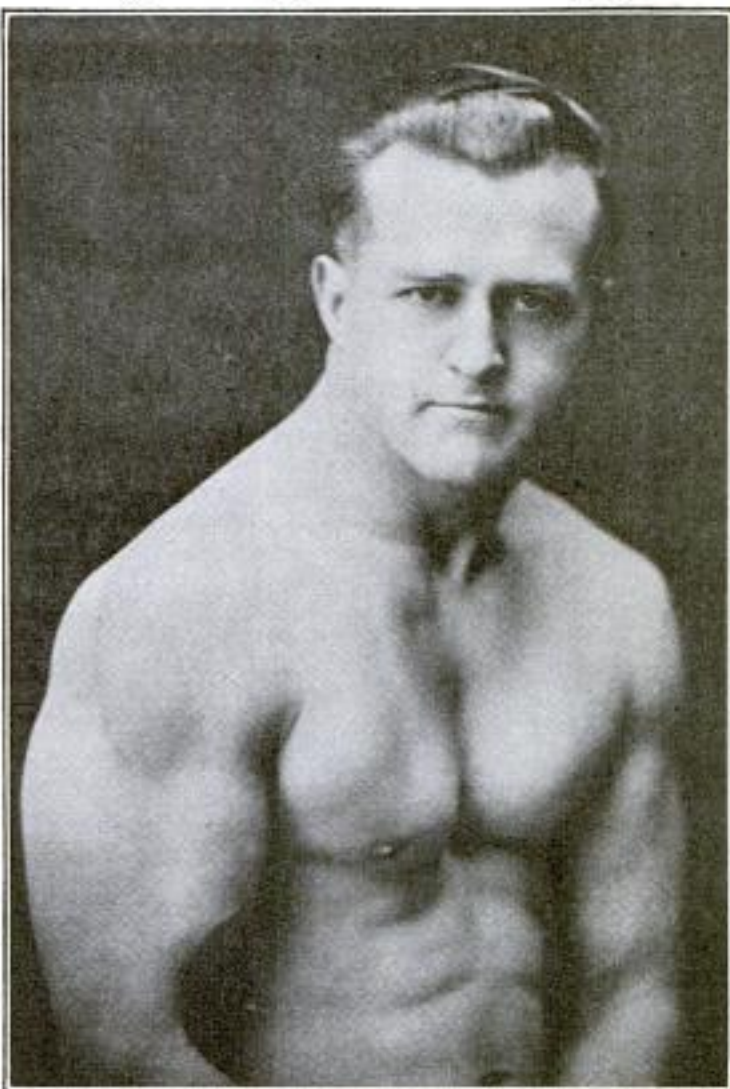

Latest photograph of Earle E. Liederman taken February, 1922

EARLE E. LIEDERMAN

Dept. 2010, 305 Broadway, N. Y. City

Dear Sir:—I enclose herewith 10 cents for which you are to send me, without any obligation on my part whatever, a copy of your latest book, "Muscular Development." (Please write or print plainly.)

Name.....

Address.....

City.....State.....

Men Wanted

\$150 to \$400 a Month

is actually being made by good mechanics—not just in a few cases but as a general rule. Hundreds of letters from our former students prove that "Iowa State" trained men are getting the big-paying jobs or making a success of their own business. The whole United States is a field of opportunity for you, once you learn motor mechanics right. Trained men are wanted everywhere.

Be a trained man—learn a trade—get out of the low-wage class and earn real money. We extend a real helping hand—we help you get ahead thru your own efforts—that's the greatest assistance that can be offered to any man—to help him **help himself**—that's the one big reason for this school's existence.

If you could read all the inspiring letters we get from former students—how quickly they spot trouble, how successfully they perform all kinds of repair jobs, what big money they're making—you'd be confident of your own chances for success. For instance, read this letter from Burke Grieme:—

"My \$23,000 garage and equipment is the result of my course in the Iowa State Auto & Tractor School. I had no gas engine experience, but I had the ambition to get ahead, so I took a seven weeks' course in the Iowa State Auto & Tractor School and went into business for myself. Today I own and conduct a big business."

Master Big Shop Standard Methods in 7 Weeks

Here you get a **thorough, standard, practical training** in the care, repair and operation of autos, trucks, tractors, stationary gas engines and aeroplane mechanics, all in one course—all for one small price. You work with tools and modern equipment—not books. Our test and trouble work alone is worth the price of the entire course. No education or experience required. No age limit. Life scholarships. **Y. M. C. A. Membership** and a night Business Course included—no extra charge.

Big free book—Tells all about the big opportunities of motor mechanics and our practical big shop standards of instruction. Write for it.

F. D. HENNESSY, President and Manager
IOWA STATE AUTO, TRACTOR & ELECTRICAL SCHOOL

739 Nebraska Street,
Sioux City,
Iowa

"The
Quality
School"



F. D. HENNESSY
739 Nebraska St.
Sioux City, Iowa

**Fill Out
and Mail
TODAY**

Name.....

Address.....

Please Mention Popular Mechanics



Learn by Mail to Play Your Favorite Instrument

Of all the arts, **music** has the widest popular appeal. You hear orchestras, bands, singers, instrumental soloists everywhere you go—at dances, in theaters, hotels, amusement parks, etc. There has never been such a great demand for musicians as now. Play any instrument and the way is open to you for earning big money.

The University Extension Conservatory now places at your disposal the teaching experience of some of the greatest Master Musicians of both America and Europe—lessons that are no less than marvelous in their simplicity and thoroughness, leading you from the first rudiments of music to a complete mastery of your favorite instrument. Endorsed by Paderewski. You are taught and coached every step of the way by the individual instruction of a specialist.

What Instrument Interests You?

Write, telling us the course you are interested in—Piano, Harmony, Voice, Public School Music, Violin, Cornet, Mandolin, Guitar, Banjo or Reed Organ—and we will send our Free Catalog together with proof of how others, both beginners and those more or less advanced in music, have made wonderful headway under our instruction methods.

University Extension Conservatory
682 Siegel-Myers Building, Chicago, Ill.

LAW

IN YOUR SPARE TIME
Learn law with only institution giving same course by correspondence as was given for years at resident classes of this college. **DEGREE OF LL. B. CONFERRED.** One year business law course prepares you for success in business. Law trained business men in demand. Three year university course covers preparation for bar examination. Money back guarantee if not satisfied. Low fee, easy terms, includes complete 1921 thirteen volume library, text material and all expenses. Write for **FREE BOOK.**
Hamilton College of Law 431 South Dearborn St., Dept. 67 Chicago

"BECOME A LIGHTNING TRICK CARTOONIST"

MAKE MONEY CHALK TALKING. SEND \$1.00 FOR SNAPPY PROGRAM OF TRICK DRAWINGS WITH INSTRUCTIONS BY A PROFESSIONAL CARTOONIST. SATISFACTION GUARANTEED. CIRCULAR FREE. BALDA ART SERVICE, 61, OSHKOSH, WIS.

STAMMERERS

For 25 years we have successfully corrected stammering by our simple and natural course of individual lessons. Attend no school until you have read our free booklet, "How To Stop Stammering."
SAMUEL A. ROBBINS, Director,
Boston Stammerers' Institute
246 Huntington Ave. Boston 17, Mass.



Wonderful, new device, guides your hand; corrects your writing in few days. Big improvement in three hours. No failures. Complete outline **FREE.** Write C. J. Ozment, D-34, St. Louis, Mo.

SPEED TYPEWRITING

Learn at Home

Write 80 to 100 words a minute. Big money for speed typists, trained by the Tulloss "New Way." Learn in spare time at home. 10 easy lessons. Costs little. Many Tulloss pupils make double former pay. Send for big catalog. Tells you all. Shows how to train for best positions. Write today.
THE TULLOSS SCHOOL 1841-T College Hill Springfield, Ohio

Easy to Get \$35 to \$100 a week Making Drawings like these

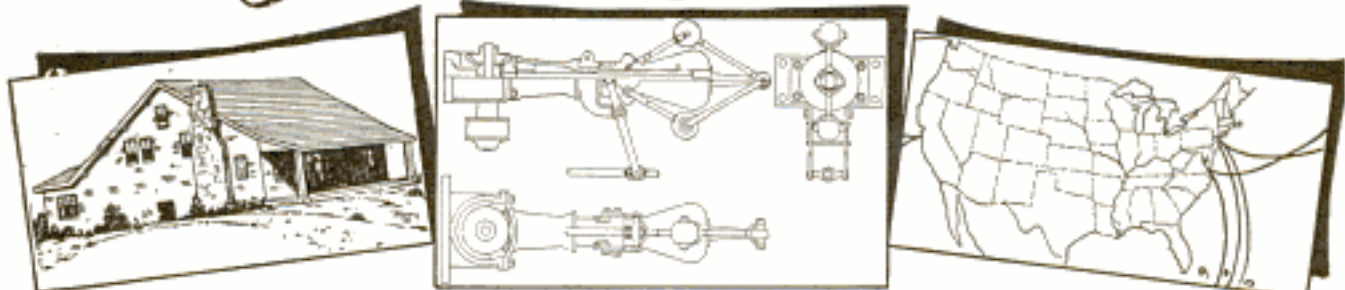

Drawing Outfit Furnished FREE

You need no artistic talent or "pull." In a few months with our help you can be alongside the best of them, earning enough money to live on and to lay some aside.—Here's how.

Learn Mechanical Drawing

That means Big Money for you, Shorter Hours, Quick Promotion. The real opportunities for success in Mechanical Drawing today are big as compared with other fields. Mechanical Drawing or Drafting is specialized knowledge. It is power to succeed.

Big Salaries

\$35 to \$55 a week is only a beginning. \$100 a week and up is within your grasp as a practical Mechanical Draftsman.

Quick Promotion

You can climb up and up to salary and position—from Draftsman to Chief Draftsman—to Chief Engineer—to Production Manager—and so on up. You can also make big money on the side in your spare time, in addition to your regular salary. Then when the opportunity comes, you can go into business for yourself, as many others have done.

Permanent Employment

You won't have to stand around looking for a job. Properly trained draftsmen are always in demand. Railroads, Manufacturing Plants, Electrical Works, Engineering and Construction Houses and United States Government Departments always need trained draftsmen. Even when men in other lines of work are without positions, the draftsman is usually on the job at good pay.

Get the Right Training

"Columbia" training is simple and sure, yet complete and practical. By Roy C. Clafin's improved "Columbia" method of practical Mechanical Drawing you can become a master Mechanical Draftsman in a few months of pleasant, easy home study, under Mr. Clafin's personal supervision. No troublesome, fancy theories—no difficult mathematics to master—just the plain, common-sense brass tacks of Drafting. And after that, if you want it, you receive free training in a specialized branch of drafting, through your choice of one of our post-graduate courses.

Drafting Outfit Free



FREE We give you free with our course this professional drawing outfit of sixteen pieces, and eleven piece set of highest grade drafting instruments in plush lined case. The entire outfit is yours to keep.

"Columbia" Draftsmen Are in Demand

The largest concerns in the country, including the United States Government, employ Columbia graduated draftsmen. Openings for draftsmen in Government Departments carry starting salaries ranging from \$5.20 to \$15.04 per day—and it is generally recognized that salaries outside of government service are still higher.

What You Get Free With Course

PRACTICAL PROBLEMS
You are carefully coached in practical drafting work.

WE HELP YOU GET A JOB
We help you get a position as soon as you are qualified.

**TRAINING AS A DRAFTING
SPECIALIST**

After completing the course in mechanical drawing we'll train you free in your choice of one of our special elective courses.

DRAFTSMEN'S EQUIPMENT
A full set of professional equipment as shown in the picture below.

CONSULTATION PRIVILEGES
You are free to write us any time for advice and suggestions.

DIPLOMA
A lithographed, engrossed diploma attesting to your proficiency as a draftsman.

FREE SUBSCRIPTION TO DRAFTSMAN'S PUBLI- CATION "THE COMPASS"

**U. S. Civil Service Com-
mission Calls for
Draftsmen**

A few of the many positions open in Government Departments.

Salaries are starting salaries, subject to increase. Practically all of them carry a bonus of \$240 a year additional.

Architectural Designer—\$4,000.

Chief Draftsman—Naval Aircraft Factory, \$15.04 per day.

Aeronautical Draftsman—Field Service of Navy Department, \$5.20 per day to \$12.00 per day.

FREE BOOK

Send in this coupon today. Immediately upon receipt of it we will send you our illustrated book, "Your Future in Drafting." It tells you all about our new method of teaching Mechanical Drawing and gives full details of our offer.

SPECIAL OFFER TO THOSE WHO REPLY PROMPTLY. GET STARTED NOW

COLUMBIA SCHOOL OF DRAFTING

ROY C. CLAFIN, Pres.
Dept. 1851, 14th and T Sts., N. W., WASHINGTON, D. C.

— SEND THIS FREE COUPON —

Columbia School of Drafting
Dept. 1851, 14th and T Sts., N. W.
Washington, D. C.

Without obligation to me, please enter my name for a subscription to "The Compass" and send me your illustrated book on Drafting, telling how I can secure your complete home study course and your help in securing a position as draftsman.

Name..... Age.....

Address.....

City..... State.....

SKILLED MEN GROW SCARCE

Labor Barometer Urges Training of Workers as Jobs Open.

DETROIT AHEAD IN PROSPERITY

Leads Every City Except New York in Recovery of Retail Sales.

G. M. C. OUTPUT OF '21 DOUBLED

Corporation Produces 115,000 Vehicles in Four Months; 40,000 in April.

MAXWELL FORCE INCREASED 2,500

Departments Being Run on 24-Hour Schedule.

Durant Plans Production of 14,000 in Second Quarter



STUDEBAKER



CADILLAC



HUDSON

Thousands of Trained Men Needed

Wonderful opportunities await thousands of men. Millions of automobiles need expert attention. Every street and road is filled with them. Government statistics show nearly twelve million automobiles in the United States which must be kept in running order; twelve million batteries needing attention; fifty million tires



to repair—and only fifty thousand garages to do this work. No wonder they need help! Why not be one of the trained men to handle these jobs and make the big pay? Come to Detroit—the automobile center of the world—and get your training at the Michigan State Automobile School—the school endorsed by the biggest auto factories in the world.



Learn the Automobile Business

—the world's greatest industry. Automobiles are a necessity and must be properly cared for. Trained men are needed everywhere. The M. S. A. S. gives you the necessary training in a thorough and practical manner. Located in Detroit, the Heart of the Auto Industry, it is surrounded by the biggest automobile factories in the world. Factory managers and executives give our students their fullest co-operation. They give practical and helpful lectures on every phase of the auto industry—an exclusive feature with the M. S. A. S., invaluable to our students.

Experienced Instructors

M. S. A. S. instructors are thoroughly trained men—every one a specialist in his line and enthusiastic about his work. They enjoy a close, personal contact and friendly co-operation with each student which helps to make your studies pleasant and your success assured.

Complete Equipment

Our mechanical equipment is unexcelled and represents an investment of nearly a quarter million dollars. Every department is thoroughly equipped for the complete instruction of our students. Automobile engineers enthusiastically approve the completeness of our instruction.



Make \$2,000 to \$10,000 Yearly— Have a Business of Your Own

Fit yourself to step into a good paying job anywhere or manage a business of your own. Thousands of our graduates are making big money in the automobile field. More than 18,000 M. S. A. S. trained men are making good because of the practical, down-to-earth training received here at the "Old Reliable Auto School." Men have come here from India, Australia and many European countries to learn the Automobile business. They come to the M. S. A. S. because of the thorough and practical training given here at the Factory Endorsed School in the heart of the auto industry.



What We Teach—Complete Automobile, Truck and Tractor Courses

Our course covers every branch of the automobile business. Nothing is omitted. Even closely related subjects are thoroughly covered. When you have finished our complete course you will be thoroughly familiar with construction, operation, up-keep and repair of automobiles, trucks, and tractors, farm lighting plants and stationary gas engines. Actual experience with these machines makes our teaching practical. Nothing left to guess-work. Our students also visit auto factories, meet executives and service men, and learn the vital things about automobiles which can only be taught right where the machines are made, in the greatest auto center of the world. In fact, the auto factories helped to outline our Course. That's why M. S. A. S. graduates make good everywhere.

Auto Electrics and Radio

Practical instruction on Auto Electrics enables students to handle every problem in ignition, starting, and lighting; teaches how to find and remedy all electrical troubles quickly. Actual experience given in overhauling, repairing and rebuilding every type of electrical and mechanical equipment. Complete instruction also given on Radio work—construction, installation and repairs, without extra charge.

Battery Repairing

Students may also take a complete course covering every phase of battery repair and building. This course offers unusual earning possibilities.

Tire Repairing

A separate course covers every kind of cord and fabric tire construction and repair. Many graduates make big money in the repair business.

Machine Shop

This special course gives students a complete training in all machine work. Actual Machine Shop experience combined with practical instruction includes the making of parts and all kinds of repair work.

Brazing and Welding

Course completely covers the modern method of repairing metals. Students are taught by doing actual work. Our graduates are able to handle all kinds of brazing and welding jobs.

Good Positions Await Our Graduates

Factories, garages and service stations continually call for M. S. A. S. trained men. These positions pay good salaries and offer excellent opportunities for advancement, or to build a business of your own. There are more opportunities for trained men in Detroit and elsewhere than we can fill. Let the M. S. A. S. fit you for the wonderful future of the automobile business.



Michigan State

"The School With a Heart and Helping Hand"

AUTO DEMAND NEARS RECORD

All Plants Behind in Output despite Frantic Effort to Speed Production.

STUDEBAKER CO. EXPANSION TO COST 15 MILLION

Immediate Expenditure of \$3,000,000 Voted for South Bend Improvements.

PACKARD HITS PEAK OF PEAKS

Output Three Times Oversold, States President Macaulay; 7,000 Men at Work.

5,400 MOTORS DAILY TO BE FORD OUTPUT

Opposes To Meet Demand for 94,750 Machines for June.



CHALMERS



PACKARD



FORD

Learn in Detroit—the Auto Center

Here you can visit the big factories and see just how automobiles are made. You get the benefit of factory co-operation and lectures by factory men. Here, in the heart of the auto industry, where 75% of the World's automobiles are made, you can study each different make of machine. That's why M. S. A. S. graduates make



good. They know construction, repair and up-keep of every make of car. Training counts these days and Detroit, the Auto Center, is the logical place to learn the automobile business right.



What Our Graduates Say

"Before taking your course was working in Silk Mills at \$18.00 per week. Am now making \$100.00 a week. Cleaned up \$2200.00 in six months repairing cars, selling accessories, etc. Time and money spent at M. S. A. S. was best investment I ever made." J. S. Stoeker, Pa.

"It is four years last month since I finished the two courses at your school. Have not had a single job I could not master. Have saved \$100 every month since I got home. I give M. S. A. S. credit for my success." J. I. Mayes, Kansas.

"Have been rushed since leaving the M. S. A. S. last November. Can surely give the M. S. A. S. credit for raising my pay from a pencil grinder at \$13.50 a week to \$42.50, which I am now getting." F. W. Johnson, Ohio.

"Since I left your school have found it takes M. S. A. S. training to get ahead in the world. Have worked with men who had fifteen years experience as mechanics, but my M. S. A. S. training put me up with them, and sometimes ahead of them. If I had it to do over again would be to M. S. A. S. ten years earlier." J. R. Navarre, West Va.

"Before entering your school was earning \$12.00 per week. I knew absolutely nothing about automobiles—didn't know the difference between carburetor and wheel base. Since I left your school have worked up through several positions, last one paying \$350 per month. Then decided to go into business myself. Present earnings is \$200 per month." H. S. Bradley, Ohio.

Start Any Time

No need to delay. Instructions begin day you enter. Our welfare department helps to arrange for board and room. No time wasted. Every minute counts. Start on the road to Success NOW!

Come Now! Don't Wait or Doubt!

If you want more money and a bigger success, become a trained man, capable of earning a trained man's salary. Write today for our free catalog telling how. Thousands of satisfied students are your best guarantee, or write any auto factory or bank in Detroit.

Be fair to yourself. Give yourself a chance. Get the facts. Don't hesitate. Start now! Get into a business with a future. Make use of every ability you possess. M. S. A. S. training will help you.



DO THIS—NOW

Fill out and mail attached coupon. Or, if you prefer, get on the train and come to Detroit. If you don't find everything exactly as represented, we will gladly refund your car fare. Don't put it off. Make a start today. Fill out and mail the coupon NOW!



Endorsed by Big Factories
Read these Letters

HUDSON MOTOR CAR COMPANY
DETROIT, MICH., U. S. A.

This school is thought very highly of by the automobile men of Detroit. You will make no mistake by entering for a course.



Detroit Mich. U.S.A.

Do not believe you would make any mistake in attending this school if you wish to become thoroughly experienced in the automobile business.



BUICK MOTOR COMPANY

We believe the Michigan State Auto School located at Detroit would best meet your requirements, as its course in technical training is most thorough and complete in every detail.

THE STUDEBAKER CORPORATION
OF AMERICA

We do not know a better automobile school that we could recommend to you than the Michigan State.

MONEY-BACK GUARANTEE

We guarantee that a graduate of our Automobile and Tractor Course will be qualified to fill all positions as assembler, demonstrator, tester, repair man, auto electrician, chauffeur, tractor operator, or farm lighting expert, or we will refund his tuition fee.

Automobile School

310 Auto Bldg.
3729 Woodward Ave. **Detroit, Mich.**

SEND THIS COUPON TODAY!

Michigan State Auto School
310 Auto Bldg., Detroit, Mich.

Gentlemen: Send me your FREE Catalog telling all about the opportunities in the Auto Business.

Name.....

Street or R. F. D.....

City..... State.....

LEARN CARTOONING the Right Way



1.

Have your ability trained by the school that has developed many famous cartoonists.

If you like to draw—if you find pleasure in picking up a pencil and paper and trying to make sketches or cartoons, don't regard it merely as a hobby. Have your ability developed and earn a good income as a cartoonist.



2.

Hundreds of nationally known cartoonists, such as Branner of the Chicago Tribune; Blosser, who draws "Freckles and His Friends"; Gene Byrnes, creator of "Reg'lar Fellers"; Thiele of the Sioux City Tribune; Fung, of the Seattle Times and others equally well known, took the Landon Course at home, in their spare time, and fitted themselves for their present positions at salaries ranging from \$50 to \$200 and more per week.



3.

Have YOUR talent developed by the same method

What the above mentioned boys did you can do, with the same training. The Landon method of teaching makes cartooning easy to learn. By means of an extensive series of Big picture charts all the necessary details of ORIGINAL drawing are explained step by step, in a clear and simple manner.



4.

FACTS that determine the superiority of the Landon School:

1. Landon School Students are securing the best cartooning positions which open up everywhere.
2. The picture chart method of instruction was originated and is used exclusively by the Landon School.
3. From the very beginning, the Landon Course teaches ORIGINAL drawing. No copy work.
4. Individual attention and criticism of student's work. Personal coaching whenever necessary.
5. Specialized instruction on how to originate cartoon ideas. This is an exclusive feature of the Landon Course.
6. Practical assistance in securing positions for students and help in marketing their work.
7. The price is within reach of everyone who is ambitious to succeed. Easy payments can be arranged.



5.

Write today for full information about the Landon Course, and sample chart by means of which you can test your own ability. Find out what the possibilities are for YOU in this interesting profession. Please state your age.

The Landon School

1138 National Bldg.

Cleveland, Ohio

Earn \$35-\$125 a Wk



Your Opportunity in MECHANICAL DENTISTRY

Ambitious men of all ages can rise above small salaried positions into this profession of unlimited possibilities.

Taught by actual practice—day or evening. Three months' course. Modern laboratories. No previous knowledge or experience required. No charge for tools or equipment. The men we train are in demand. Established 30 years. Catalog free.

Address your inquiry to Dept. 2

BODEE DENTAL INSTITUTE

NEW YORK, 136 W. 52d St.—PHILA., 15th & Walnut Sts.
BUFFALO, 1226 Main St.—BROOKLYN, 15 Flatbush Ave.



Why Miss Half the Fun in Life?

BE POPULAR—Learn to dance well! Arthur Murray, America's greatest dancing teacher, has invented a remarkable new easy method which enables anyone to learn all the newest dances at home—in a few hours—at very little cost!

No music or partner needed. Success positively guaranteed! "60,000 learned dancing by mail."

FREE DANCING LESSON—To prove you can learn easily and quickly, Arthur Murray will send you a lesson absolutely free. Also, the Secret of Leading, How to Gain Confidence and other dancing helps, in plain cover. For mailing, send 10c. Act now and be a good dancer soon.

Arthur Murray, Studio 421
100 Fifth Avenue New York

FORTUNES In a Single Year

—have been made by trained paint salesmen. Incomes of from \$4800 to \$12,000 yearly are common. Our course equips you with the necessary knowledge to make these large earnings. It is endorsed by leading paint companies. They want to secure men who have completed it. Write for free information of the course and our assurance of placing you with a reliable company after you have completed it.

Cleveland Paint Salesmen's Training School
416 Bangor Bldg., Cleveland, Ohio

TELEGRAPHY

(Morse and Wireless) and RAILWAY ACCOUNTING taught thoroughly. Big salaries, great opportunities. Oldest, largest school. Endorsed by Telegraph, Railway, Radio, and Government officials. Expenses low—opportunities to earn large portions. Catalog free. DODGE'S INSTITUTE, Dyke Street, Valparaiso, Ind.

HARMONY

In 12 Easy Lessons

Get the most out of music. Equally valuable for Players, Teachers or Music Lovers. New easy System gives you real knowledge of Harmony in shortest time. Easy, Quick, Sure! Short-cut System used by professional Arrangers and Composers. Results guaranteed. Write for proof and limited offer—free!

DELAMATER HARMONY SYSTEM
DEPT. "M" 5337 PRAIRIE AVE., CHICAGO

LEARN WATCH REPAIRING



You can learn by our modern and original system of instruction every part of the Watch Repairing Trade at home as good or better than at a shop. You can earn money while learning and secure a well paying position or start in business after completing our course of instruction. Good watch repairers are always in demand and earn from \$30 to \$70 per week. For particulars apply to the WISCONSIN SCHOOL OF WATCH REPAIRING 106 Mason St., MILWAUKEE, WIS.

He thought he could throw me—

Dear Tom: You know how Ted Brown has always been saying he could throw me with one hand tied behind him, if he wanted to. Well, yesterday, he grabbed hold of me and we had it out. Gee, I wish you'd been there. You know how much bigger Ted is than I. He thought he had me licked dead easy—

but

I wriggled around and got a hold on him that I'd learned from the Farmer Burns School of Wrestling. The next second — KERFLOP, and I had Mister Ted Brown on the ground, yelling for me to quit. It's a cinch to handle a fellow half as big again as you are if you know the secret holds. If I were you I'd write to Burns School for their free book about wrestling. So long—FRED.

Learn Wrestling Secrets from Worlds Champions Farmer Burns and Frank Gotch

Learn the marvelous holds, breaks, blocks and tricks that will enable you to handle big, strong men with ease. The renowned FARMER BURNS—"father of scientific wrestling"—and FRANK GOTCH the world's champion, have prepared a series of lessons in which they reveal the inside secrets of training that will make YOU, too, an expert wrestler. All the great secrets of self-defense and jui-jitsu illustrated by printed word and picture. The lessons teach you how to become a great athlete, and secret knowledge enabling you to throw boys and men larger and stronger than yourself.

Send for FREE Book

Our FREE ILLUSTRATED BOOK tells you all about the advantages in health, vigor and respect that being able to wrestle brings one. It tells you how to learn to become a skilled wrestler in your spare time. Brim full of interesting information about wrestling. Also lots of pictures. INVESTIGATE. Write today for this free book. No obligations. Tear out and mail coupon NOW!

Farmer Burns School 1777 Railway Exchange Bldg. Omaha, Neb.

Farmer Burns School
1777 Railway Exchange Bldg., Omaha, Neb.

Please send me at once without obligation your FREE illustrated booklet on Scientific Wrestling, Physical Culture, Self-Defense, and How to Win.

Name.....

Address.....

Age.....

"THERE'S MONEY IN IT"

AT HOME LEARN TELEGRAPHY AT HOME MORSE AND WIRELESS



TEACH YOURSELF

in half usual time, at trifling cost, with the wonderful Automatic Transmitter **THE OMNIGRAPH**. Sends unlimited Morse or Continental messages, at any speed, just as an expert operator would. Adopted by U. S. Government, and leading Universities, Colleges and Telegraph Schools. 3 styles. Catalog free.

OMNIGRAPH MFG. CO.

16-22 Hudson St., NEW YORK

ILLINOIS COLLEGE OF PHOTOGRAPHY

Established 1893. Photography and Photo-Engraving complete in six months. Salaries of \$35 to \$100 on graduating. College assists in locating positions. Tuition and living expense low. Address **LE GRAND A. FLACK, Pres.,** Box 4102, Effingham, Ill.



LEARN TO GET DOLLARS OUT OF WATCHES.
WATCH-REPAIRING, ENGRAVING, JEWELRY REPAIRING.

WRITE NOW.

ENICAR TRADE SCHOOL
530 W MONUMENT SQUARE, RACINE, WIS.

WANTED

Railway Mail Clerks
\$1600 to \$2300 Year

MEN—BOYS OVER 16
SHOULD WRITE IMMEDIATELY

Steady work. No layoffs. Paid Vacations

Common education sufficient:
Send coupon today—SURE



FRANKLIN INSTITUTE, Dept. H177, Rochester, N. Y.
Sirs: Send me without charge, (1) Sample Railway Mail Clerk Examination questions; (2) Schedule showing places in all coming U. S. Government examinations; (3) list of many government jobs now obtainable.

Name.....

Address.....



An Easy Way to Learn PHARMACY AT HOME

Graduate pharmacists are always in demand. The work is interesting and pleasant and salaries are good. Many young men open drug stores of their own and become independent.

There's an easy way to learn pharmacy right in your own home in spare time, without losing a day or a dollar from your present work.

The International Correspondence Schools course in Pharmacy supplies the knowledge which it will be necessary for you to have in order that you may pass your State Board Examination.

Just mark and mail the coupon printed below to the International Correspondence Schools, Box 5677-C, Scranton, Pa., and full particulars about the Pharmacy Course or any other work of your choice will come speeding to you by return mail.

INTERNATIONAL CORRESPONDENCE SCHOOLS Box 5677-C, Scranton, Penna.

Without cost or obligation, please send me full information about the subject before which I have marked an X in the list below:

TECHNICAL AND INDUSTRIAL DEPARTMENT

- | | |
|--|---|
| <input type="checkbox"/> PHARMACY | <input type="checkbox"/> Civil Engineer |
| <input type="checkbox"/> Chemistry | <input type="checkbox"/> Surveying and Mapping |
| <input type="checkbox"/> Automobile Work | <input type="checkbox"/> Mine Foreman or Engineer |
| <input type="checkbox"/> Navigation | <input type="checkbox"/> Steam Engineer |
| <input type="checkbox"/> Agriculture and Poultry | <input type="checkbox"/> Gas Engine Operating |
| <input type="checkbox"/> Mathematics | <input type="checkbox"/> Wireless <input type="checkbox"/> Airplane Engines |
| <input type="checkbox"/> Electrical Engineering | <input type="checkbox"/> Architect |
| <input type="checkbox"/> Electrician | <input type="checkbox"/> Contractor and Builder |
| <input type="checkbox"/> Mechanical Engineer | <input type="checkbox"/> Architectural Draftsman |
| <input type="checkbox"/> Mechanical Draftsman | <input type="checkbox"/> Concrete Builder |
| <input type="checkbox"/> Machine Shop Practice | <input type="checkbox"/> Structural Engineer |
| <input type="checkbox"/> Railroad Positions | <input type="checkbox"/> Plumbing and Heating |

BUSINESS TRAINING DEPARTMENT

- | | |
|---|---|
| <input type="checkbox"/> Business Management | <input type="checkbox"/> Salesmanship |
| <input type="checkbox"/> Industrial Management | <input type="checkbox"/> Advertising |
| <input type="checkbox"/> Personnel Organization | <input type="checkbox"/> Better Letters |
| <input type="checkbox"/> Traffic Management | <input type="checkbox"/> Foreign Trade |
| <input type="checkbox"/> Business Law | <input type="checkbox"/> Stenography and Typing |
| <input type="checkbox"/> Banking and Banking Law | <input type="checkbox"/> Business English |
| <input type="checkbox"/> Accountancy (including C.P.A.) | <input type="checkbox"/> Civil Service |
| <input type="checkbox"/> Nicholson Cost Accounting | <input type="checkbox"/> Railway Mail Clerk |
| <input type="checkbox"/> Bookkeeping | <input type="checkbox"/> Common School Subjects |
| <input type="checkbox"/> Private Secretary | <input type="checkbox"/> High School Subjects |
| <input type="checkbox"/> Business Spanish <input type="checkbox"/> French | <input type="checkbox"/> Illustrating <input type="checkbox"/> Cartooning |

Name.....
Street.....
Address.....

City..... State.....

Occupation.....

Persons residing in Canada should send this coupon to the International Correspondence Schools Canadian, Limited, Montreal, Canada.

Please Mention Popular Mechanics

WE TEACH COMMERCIAL ART

Meyer Both Company, the largest commercial art organization in the field, offers you a different and practical training. If you like to draw, develop your talent. Study this practical course—taught by this widely known institution, with twenty-two years success—which each year produces and sells to advertisers in the United States and Canada over ten thousand commercial drawings. Who else could give you so wide an experience? Commercial art is a business necessity—a highly paid, intensely interesting profession, equally open to men and women. Home study instruction. Get facts before you enroll in any school. Write for our illustrated book, "YOUR OPPORTUNITY"—for one-half the cost of mailing—four cents in stamps.

MEYER BOTH COLLEGE OF COMMERCIAL ART
Michigan Ave. at 20th St., Dept. 16 CHICAGO, ILL.

NOTE—To Art and Engraving Firms: Secure practical artists among our graduates. Write us.

ELECTRICAL ENGINEERING men with training are in demand. For more than a quarter of a century this school has been training men of ambition and limited time, for the electrical industries. Condensed course in Electrical Engineering enables graduates to secure good positions and promotions. Theoretical and practical Electricity, Mathematics, Steam and Gas Engines, Mechanical Drawing. Students construct dynamos, install wiring and test electrical machinery. Course with diploma, complete.



Thoroughly equipped fireproof dormitories, dining hall, laboratories, shops. Over 3000 men trained.

Write for catalog. 30th year begins Sept. 27, 1922.

BLISS ELECTRICAL SCHOOL

404 TAKOMA AVENUE, WASHINGTON, D. C.

5,000 FORMULAS



The 530 double-column pages in Youman's Household Guide contain nothing but formulas and processes for every phase of human effort. Many recipes hitherto unpublished. Any one of the five thousand easily worth more than the price you pay for ALL. To be without this book is costing you \$\$\$\$.

Prices, postpaid, Cloth \$2.00. Heavy paper \$1.25

WELLS & EDWARDS, BOOKSELLERS, Dept. A
852 George Street, CHICAGO

Send for free circular and 40 page Book Catalog

PLAY PIANO BY EAR in 4 Weeks!

Young and old can now learn to play piano by ear without notes or music by our brand new quick and easy 10 lesson method. Send now for

FREE Sample Lesson!

and play real chords at once. The World's simplest, easiest method. Nothing else like it. No musical experience necessary, play piano as easy as you hum or whistle a tune. Be a ragtime artist. Send for FREE sample lesson now before edition is gone. Don't delay.

DAVID PIANO COURSE 501 CUTLER-HAMMER BLDG.
CHICAGO, ILLINOIS

Learn Watchwork, Jewellerywork and Engraving. A fine trade commanding a good salary, and your services are always in demand. Address HOROLOGICAL, Dept. P. Bradley Institute, Peoria, Ill., for our latest catalog.



SHORTHAND IN ONE MONTH

Boyd—the Wonderful, New, Easy System. Writers hold World's record. 100 to 150 words a minute in 30 days guaranteed. New Principles—dictation first week. Best for Court Reporting and Secretaries. Also Typewriting, Bookkeeping and Commercial Law. Send today for Catalog and Money-Back Guarantee.

CHICAGO HOME STUDY SCHOOLS, 802 Reaper Block, Chicago, Ill.

Copyrighted material

You Can Play the Hawaiian Guitar Just Like the Hawaiians!

Because Our Native Hawaiian Instructors Will Help You

OUR STUDENTS SAY

Keanter School,
214 So. Franklin St.,
Chicago, Ill.

First Hawaiian Conservatory of
Music, Inc.

I shall certainly be very glad to recommend your course whenever the chance is mine to do so. Mr. W. R. Johnson has not phoned me yet, and if he does not phone in a day or so, will write him. Am sending a letter to Miss Helen Slavik today which I think may help to secure her enrollment, and I shall be glad at any time to write a personal letter to anyone whom you may suggest.

Your former student,
W. L. Walker.

San Quentin, Calif.

First Hawaiian Conservatory of Music,
902 Woolworth Building, N. Y. City.

Dear Sirs—

Lessons 15 and 19 came last evening and I was pleased to see that they are beginning to get hard, or at least a little bit more to learn in them. I have a great deal of spare time to put in on the guitar and I enjoy it. Your course is the simplest and most interesting I have ever tried to learn. I am getting along fine and can play every lesson up to the last one and I can readily see that when I have finished with all of the lessons I will be able to play most anything and play it good. I am, in appreciation,

Yours truly, J. E. FERGUSON.

P. S. If at any time you wish to see my name as a reference for your course you may do so, as I think that any one who takes it up will derive a great benefit from it and never regret it.

Our improved method of teaching is so **simple, plain and easy** that you begin on a piece with your first lesson. **In half an hour you can play it.** Thousands of successful students prove this to be true.

ONLY 4 MOTIONS We have reduced the necessary motions you learn to only four, and you acquire these in a very few minutes. Then it is only a matter of a little practice to acquire the weird, fascinating, tremolos, staccatos, slurs and other effects that make this instrument so delightful. **The Hawaiian Guitar plays any kind of music, both the melody and the accompaniment.**

FREE Just think of it. 52 lessons on this wonderful guitar. You get a beautiful large sized **Genuine Hawaiian Guitar absolutely free as soon as you enroll for the lessons.** All the necessary picks, the steel playing bar and 52 pieces of music are included **without cost to you.**

Special Arrangements for Lessons if You Have Your Own Guitar

Play Any Music

In half an hour after you get the free Hawaiian Guitar and the first lesson, **you can play Hawaiian Melodies.**

In a very short time after a little practice you can play any kind of music as well as Hawaiian, both the melody and accompaniment.

[TEAR OUT COUPON]



Your favorite instrument given away FREE with first lesson. SPECIAL COURSES UNDER FAMOUS TEACHERS. Learn to play VIOLIN, BANJO or UKULELE.

First Hawaiian Conservatory of Music, Inc.
233 Broadway (Woolworth Bldg.), New York City
Please send me full information about your 52 easy lessons and FREE GUITAR OFFER.

NAME.....

ADDRESS.....

TOWN..... STATE.....
Print name and address clearly. P.M. 10

HIGHER EDUCATION

HOME STUDY

Courses in English, Spanish, Mathematics, Chemistry, Drawing, Education, Business and in 35 other subjects are given by correspondence. Begin anytime.

The University of Chicago

31st Year

Division 4, Chicago, Ill.

Taxidermy Book FREE.



Stuff Beautiful Birds. Learn by mail to stuff and mount

all kinds of birds, animals, fish and game heads, make rugs, tax skins. Mount your own specimens and make money preserving for others. Men, women and boys learn easily and quickly. Success guaranteed or no tuition. Write today for our wonderful FREE book "How to Learn to Mount Birds and Animals. N.W. School of Taxidermy, 9777 Elwood Bldg., Omaha, Neb.

Cheapest Way to Go

to work or school and recreation is on a **Ranger** bicycle. You can have your choice of 44 Styles, colors and sizes. **30 DAYS' FREE TRIAL.** Express prepaid. **Factory-to-Rider** Prices save you \$10 to \$25. **12 Months to Pay** if desired. Saved time and care easily meets the small payments. Parents often advance first payment.

Best quality, at factory prices. Lamps, wheels and equipment, low prices. Send No Money, do business direct with makers.

Mead Cycle Company
Dept. C18 Chicago



Write today for free Ranger Catalog, factory prices and marvelous easy payment terms.

AVIATION Information FREE

Send us your name and address for full information regarding the Aviation and Airplane business. Find out about the many great opportunities now open and how we prepare you at home, during spare time, to quality. Our new book "Opportunities in the Airplane Industry" also sent free if you answer at once.

AMERICAN SCHOOL OF AVIATION
Dept. 1197 3601 Michigan Ave. CHICAGO

\$60,000 REWARD

This huge sum was recently offered when a Canadian millionaire was kidnapped. His abductor was located hundreds of miles away in a lumber camp—and a **finger print conclusively proved his guilt.**

BIG MONEY—FAME AND TRAVEL

Are within your grasp if you study finger prints. For the man who is looking for "something better" this science offers untold possibilities. Finger print experts earn good salaries—collect big rewards for work that is always fascinating. We will show you how to fit yourself for one of these positions—through an easy home study course. The Dunlap School of Finger Prints is known all over the world, and its graduates are successful finger print experts in detective agencies, banks and Municipal, State and Federal Governments.

SPECIAL FREE OFFER

Included with the course, we furnish Free a professional finger print outfit and complete Secret Service Library, featuring advanced work in crime detection. Here is your **BIG CHANCE**—clinch it by returning the coupon for the largest book on finger prints ever issued. Mail it TODAY.

DUNLAP SCHOOL OF FINGER PRINTS
Dept. 22 1029 So. Wabash Ave. Chicago, Illinois



ALEXANDER DUNLAP
President and Founder

Dunlap School of Finger Prints
Dept. 22, 1029 S. Wabash Ave.
Chicago, Illinois

Dear Mr. Dunlap— You may send me **FREE** your illustrated **BOOK** and full information about Finger Print Course and Finger Print outfit given free. This does not obligate me in any way.

Name.....

Address.....

Town.....



More Money For You in **RADIO**

THE amazing expansion of Radio has opened up thousands of wonderful new positions on land and sea. Big salaries, fascinating, easy work, short hours, and a wonderful future are offered to ambitious men who get into Radio now.

Take advantage of these wonderful opportunities to step into a big paying position in this great new field. Radio offers you an opportunity to travel and see the world, with all expenses paid, and a fine salary besides. Or you can stay at home and work up to a position paying up to \$10,000 a year.

Easy to Learn Radio

Hundreds of men are already earning handsome incomes in this wonder science. If you want to get into a profession where opportunities are unlimited make Radio your career—become a Certified Radio-trician.

Thousands of Certified Radio-tricians are wanted to design Radio sets; to make new Radio improvements; to manufacture Radio equipment and to install it; to maintain and operate great Broadcasting stations and home Radio sets; to repair and sell Radio apparatus; to go into business for themselves; to operate aboard ship and at land stations.

You can easily and quickly qualify in your spare time at home through the help of the National Radio Institute. Prominent Radio experts will help you. Four wonderful instruments are furnished free. The same plan that has already helped hundreds of our graduates to real success and real money in Radio is open to you.

Big Book Free

No other field today offers such great opportunities as Radio. Take your choice of the many wonderful openings everywhere. Prepare now to step into the most interesting and best paid profession today. Read about the opportunities open now—the different kinds of work—the salaries paid. Write today for the free 32-page book, that tells how America's first and biggest Radio school can make you a Certified Radio-trician in your spare time. Mail the coupon or write a letter NOW.

NATIONAL RADIO INSTITUTE

1345 Pennsylvania Ave., N. W.

Dept. 1212

WASHINGTON, D. C.

National Radio Institute, Dept. 1212
1345 Pennsylvania Ave., N. W.
Washington, D. C.

Send me your free book "How to Learn Radio at Home" which tells all about the opportunities in Radio, how spare time study at home will qualify me quickly as a Certified Radio-trician so I can get one of these splendid positions, and how your free Employment Service helps me to secure the job I want.

Name.....Age.....

Street.....

City.....State.....

\$100 a Week FOR DRAWING

How would you like to make \$100 a week as a commercial artist? If you like to draw, you are indeed fortunate—well-trained artists are always at a premium. They readily earn \$75, \$100, \$150 a week, and even more, and beginners with practical ability soon command \$50 a week.

Learn Quickly at Home In Your Spare Time

Develop your talent—put your natural ability to its best use. The Federal "Master" Course, endorsed by high authorities, teaches you by mail in your spare time. No experience needed, each step is clearly explained. You receive individual personal criticisms on all your lessons.

Send for "Your Future", a splendid book showing work of Federal Students, telling all about this remarkable course, and pointing out opportunities that will surprise you. If you are in earnest and 16 years old or more, write today for this free book, kindly stating your age.



Federal School of Commercial Designing

681 Federal Schools Bldg.
Minneapolis
Minn.

Keystone Institute "The Service School"

A fully equipped school with expert instructors, organized to give intensive instruction in

2-Year Courses
Electrical Engineering
Mechanical Engineering
Accounting and Business Administration
16 weeks' course in Automotive Engineering

Day and Night Classes. Graduates are sought by large and small industrial establishments and are filling important positions in all sections of the country. Write for information on subject that interests you to Keystone Institute. Address The Vice President, 133 North 4th Street, Reading, Penna.

"STAMMERING Its Cause and Cure"

You can be quickly cured if you stammer. Send 10 cents, coin or stamps, for 288 page cloth bound book on Stammering and Stuttering. It tells how I cured myself after Stammering and Stuttering for 20 years. BENJAMIN N. BOGUE
742 Bogue Building, 1147 N. Ill. St. Indianapolis

LEARN WATCHMAKING AND ENGRAVING



Earn while learning. Most practical watch school. Individual instructions. Graduates in great demand. Book free. Chicago School of Watchmaking, Dept. 20, 4840 Lincoln Ave., Chicago

MUSIC LESSONS FREE

IN YOUR OWN HOME
You can read music like this quickly
Piano, Organ, Violin, Mandolin, Guitar, Banjo, etc.
Beginners or advanced players. One lesson weekly. Illustrations make everything plain. Only expense about 2c per day to cover cost of postage and music used. Write for FREE booklet which explains everything in full.
AMERICAN SCHOOL OF MUSIC, 51 Lakeside Building, CHICAGO



Are You Climbing To Bigger Pay? —Or Are You Watching Others Climb?

Any number of routine men at the *foot* of the ascent—and all of them wondering how they can get up higher!

Out of the crowd, now and then, a man makes a start—he begins to climb.

"A mighty stiff grade"—that's the way the first big step appears to the man who is standing still. He has no confidence.

"Mighty good sport"—that's the way the event strikes the man who is *climbing*. The thing that perplexes *him* is why in the world he didn't get into action *sooner*.

The power that carries him up the grade to a bigger job?—Confidence in his own ability.

And the thing that *gives* him confidence—the only thing that *can* give a man real and dependable confidence?—*Specialized training!*

* * * *

During the last fourteen years more than 350,000 ambitious men, enrolled with LaSalle Extension University, have broken away from the crowd and are on their way to bigger jobs and splendid incomes.

When Charles S. Jones took up home-study training in Higher Accountancy under the LaSalle Problem Method, he was earning only \$100 a month. Three years later, on the letterhead of Henry & Jones, Certified Accountants, El Paso, Texas, he writes as follows:

"My income is a trifle in excess of \$8,000 and I am just beginning to grow. I have recently enrolled for your full Law course and expect to complete my business education with LaSalle."

James C. Pitton, of Tacoma, Washington, writes:

"I have your course in Business Management to thank for the position I now hold. When I took up your work I was barely making a living. Today I sit in the manager's chair of one of the largest financial institutions in the United States and Canada. My earnings this year will be in the neighborhood of \$10,000 and I have the greatest opportunity that any man could wish for in the way of promotion to bigger things."

During only three months' time as many as 1089 LaSalle members wrote to the University telling of the raises they had received as a result of home-study training under the Problem Method. The ma-

majority of these men had not yet completed their courses, *yet the average increase per man was 56%.*

To the man unacquainted with the LaSalle Problem Method, results so prompt and definite seem extraordinary. As a matter of fact, *anything else* would be extraordinary—for the Problem Method represents just the difference between *reading* how to do a thing and *actually doing it for oneself*. In other words the LaSalle member masters the *principles* of business by solving *actual business problems*—under the direction of some of the ablest men in their respective fields in America.

Which do you see ahead of *you* in the next twelve months—the cliff, or the path that will take you to the top?

If you are determined to climb, you should find out at once about the LaSalle Problem Method and how it can direct you to a bigger job. The coupon will bring you full information, together with particulars of our convenient-payment plan; also your free copy of that inspiring book—"Ten Years' Promotion in One."

Break away from the men who are holding you back—the men who would make you think that "you haven't a chance." Find out today what YOU must do to command big money. Mail the coupon NOW.

LaSalle Extension University

The Largest Business Training
Institution in the World

Dept. 1064 R Chicago, Ill.

Please send me catalog and full information regarding the course and service I have marked with an X below. Also a copy of your book, "Ten Years' Promotion in One," all without obligation to me.

- | | |
|--|--|
| <input type="checkbox"/> Business Management | <input type="checkbox"/> Modern Business Correspondence and Practice |
| <input type="checkbox"/> Salesmanship | <input type="checkbox"/> Modern Foremanship and Production Methods |
| <input type="checkbox"/> Higher Accountancy | <input type="checkbox"/> Personnel and Employment Management |
| <input type="checkbox"/> Traffic Management | <input type="checkbox"/> Expert Bookkeeping |
| <input type="checkbox"/> Railway Accounting and Station Management | <input type="checkbox"/> Business English |
| <input type="checkbox"/> Law—Degree of LL.B. | <input type="checkbox"/> Commercial Spanish |
| <input type="checkbox"/> Commercial Law | <input type="checkbox"/> Effective Speaking |
| <input type="checkbox"/> Industrial Management | <input type="checkbox"/> C. P. A. Coaching |
| <input type="checkbox"/> Efficiency | |
| <input type="checkbox"/> Banking and Finance | |



Name.....

Present Position.....

Address.....

Be a Certificated Electrical Expert



Your Future is in Electricity

EARN \$3500 to \$10000 a Year

Trained "Electrical Experts" are in great demand at the highest salaries, and the opportunities for advancement and a big success in this line are the greatest ever known.

"Electrical Experts" earn \$70 to \$200 a week. Fit yourself for one of these big paying positions.

Learn at Home to Earn \$12.00 to \$30.00 a Day

Today even the ordinary Electrician—the "screw driver" kind—is making money—big money. But it's the trained man—the man who knows the whys and wherefores of Electricity—the "Electrical Expert"—who is picked out to "boss" ordinary Electricians—to boss Big Jobs—the jobs that pay. You too, can learn to fill one of these jobs—spare-time only, is needed. Be an "Electrical Expert"—Earn \$70 to \$200 a week.

Age or Lack of Experience No Drawback

You don't have to be a College Man; you don't have to be a High School graduate. If you can read and write English, my course will make you a big success. It is the most simple, thorough, and successful Electrical Course in ex-

istence, and offers every man, regardless of age, education, or previous experience, the chance to become, in a very short time, an "Electrical Expert," able to make from \$70 to \$200 a week.

Some Features of My Course That Make SUCCESS Certain

1. Practical Money-Making Instruction—no useless, high-sounding theory.
2. Free Electrical Outfit—Finest outfit ever sent out for home experiment, and practical use.
3. Free Employment Service. (Helps you get a good job.)
4. Free Consulting Service. (No chance to get stuck on anything, while studying or afterward.)
5. Free Engineering Magazine.
6. Free use of my Electrical Laboratory.
7. Extra Courses Free—Radio—Electrical Drafting.
8. Spare time work—Special earn-while-you-learn lessons.
9. All supplies furnished free of cost.
10. Cash Refund Guarantee Bond.

These features are all explained in my big Free Book.

not satisfied it was the best investment you ever made.

I Give You A Real Training

As Chief Engineer of the Chicago Engineering Works, I know exactly the kind of training a man needs to get the best positions at the highest salaries. Hundreds of my students are now earning \$3,500 to \$10,000 a year. Many are successful ELECTRICAL CONTRACTORS.

Your Satisfaction Guaranteed

So sure am I that you can learn Electricity—so sure am I that after studying with me, you too can get into the "big money" class in electrical work, that I will guarantee under bond to return every single penny paid me in tuition if, when you have finished my course you are

FREE Electrical Working Outfit FREE

I give each student a Splendid Outfit of Electrical Tools, Materials and Measuring Instruments absolutely FREE. I also furnish them with all supplies including examination paper, and many other things that other schools don't furnish. You do PRACTICAL work—AT HOME with this Outfit. You start right in after the first few lessons to WORK AT YOUR PROFESSION in a practical way.

Get Started Now—Mail Coupon

I want to send you the "Vital Facts" of the Electrical Industry including my Electrical Book, Proof Lessons and a sample of my guarantee bond all FREE. These cost you nothing and you'll enjoy them. Make the start today for a bright future in Electricity. Send in the coupon—NOW.

L. L. COOKE, Chief Engineer
CHICAGO ENGINEERING WORKS
Dept. 17 1150 Lawrence Ave. Chicago, Ill.

L. L. Cooke, Chief Engineer
Chicago Engineering Works, Dept. 17
2150 Lawrence Ave., Chicago, Ill.

Dear Sir:—Send at once the "Vital Facts" containing Sample Lessons, your Big Book, and full particulars of your Free Outfit and Home Study Course—all fully prepaid, without obligation on my part.

Name.....

Address.....

The "Cooke" Trained Man is the "Big Pay" Man

CLASSIFIED ADVERTISEMENTS

WORLD'S BEST WANT AD MEDIUM

Advertisements in this section, 25 cents per word, each insertion, minimum 10 words, payable in advance. To be inserted under proper classification in November issue, copy should be in our office Sept. 25th.

AUTOMOBILE SUPPLIES

AUTO Top Roof Covers easy to put on. You drive 100 yards and save \$15 to \$40. Ford Roadster \$5.20, Touring Cars \$6.95 and \$9.95. Chevrolet, Dodge or Maxwell \$13.95. All other cars \$16.50, with plate glass lights. Regular Side Curtains \$5.95 up. Special Winter Side Curtains that open with doors \$11.90 up. Seat Covers \$3.15 up. Radiator and Hood Covers \$1.45 up. Winter Tops \$66 up. California Summer and Winter Tops \$150. All goods same quality as car manufacturers use and guaranteed to fit. Printed instructions given how to apply. Send for samples. Prices delivered at your door. Equipment Co., 30 Canal, Cincinnati, Ohio.

BUILD Your Own Camp Trailer. A million people are going motor camping this year. You can now have an outfit of your own at very minimum cost. For complete instructions, bill of material including price list of parts, send \$1.00. (Money order or stamps). Keuka Industries, Dept. "C", Hammondsport, New York.

BARGAINS — Radiators — Sport Bodies. Chevrolet 490 \$17.95. Dodge and Maxwell Radiators \$22.95. Others at Bargain prices. Wabash Radiator Co., 1117 Wabash Ave., Chicago.

TOP recovering, including back curtain, \$4.50. Seats \$4.50. One-man top complete \$16.25. Guaranteed quality. Castle Syndicate, Detroit, Mich.

PENETRATING OIL. Rust and Springs. Concentrated form. Enough for one gallon \$1. Herald, 902-13 Ave., Seattle, Wash.

"GIDZ" eliminates carbon; result increased mileage. "Som-Clas" saves labor. Sure fire winners for agency. No competition. Giddings Products, Galesburg, Ill.

AIR compressors, ball bearing, automatic. \$28 cash. Balance terms. Motors, battery chargers, buffers on same easy payments. Write postal to Hobart, Troy, Ohio.

NEW Invention for Automobile. You have often said, "I would give \$5 if I could wash my hands," after changing a tire or cleaning a spark plug. Trik Holder (Retail Price \$1.50) complete with Trik Soap and towels, is bolted to license bracket or any convenient place on any automobile and is sent anywhere in United States postage prepaid \$1.00. Canada \$1.25. Extra Trik Soap refills 25c. No-Water-Needed. You rub it on—wipe it off—your hands are smooth and clean. We also have an agents' proposition. The Alline Company, 6523 Euclid Ave., Cleveland, Ohio.

AUTOMOBILE Parts. Save 10 to 80% and get what you want when you want it. Satisfaction guaranteed or money refunded. We are shipping parts and accessories to all parts of the world. If you need gears, shafts, bearings, springs, piston rings and pins, bushings, bolts, connecting rods, radiators, complete transmissions, rear axle assemblies, etc., write us advising year, make and model of car and parts wanted, or send in old parts for duplication. Send forty cents for repair kit for repairing inner tubes. Auto Tire & Parts Co., 501 Broadway, Cape Girardeau, Missouri.

BUY Direct and Save Money. Valves, Gears, engine bearings, piston rings, piston pins and bushings for all makes of passenger cars and trucks. All parts guaranteed. Write for Dealers Proposition. Auto Replacement Parts Co., 3941 Washington Blvd., Chicago, Ill.

CRAFT Filters Reclaim Used Crankcase oil. Absolute regeneration. Make your own filter at no cost. Blueprint and complete instructions \$1.00. Descriptive circulars free. Saturn Specialty Co., 257 N. First St., San Jose, Calif.

PROTECT your rights—Write for "Record of Invention" and booklet about Patents. Prompt personal service. Advice without charge. J. Reaney Kelly, 612 G Columbian Building, Washington, D. C.

AIR Compressors—Genuine Brunner Compressors, new, on very attractive terms; send post card. Brunner Mfg. Co., Dept. A, Utica, N. Y.

STEAM Automobile Owners, inclose stamp for "list," serviceable supplies, boilers, burners, vaporizers, superheaters, engines, gauges, automatics, fittings, accessories. "Doc" Paine, Denver, Colo.

AUTOMOBILE Repairshop Shortcuts—Over 1,500 time and labor saving kinks from more than 1,000 of the best Repairshops in the U. S. 256 PP. 1,500 figs. Price \$3.50 postpaid. Popular Mechanics Book Dept., 6 N. Michigan Ave., Chicago.

AIR Compressor, \$28.00. With tank, \$51. With motor, \$70.75; suitable for private or public garage, tire shop, painting or cleaning. Motors, 1/3 H.P., \$19.75. Battery charging outfit, home or garage size, \$14. Send for our large 100-page catalog describing all kinds of Air Compressors, Vulcanizers, Garage and Battery outfits. Equipment Co., 21 Canal, Cincinnati, Ohio.

AUTOMOBILE parts, guaranteed new, for all cars. Save money: get our wholesale prices on gears, shafts and bearings. State make of car, model and parts wanted. Parts shipped immediately from stock. We refund your money, including transportation charges, if not satisfied. Mechanics Gear Co., 3708 No. Halsted St., Chicago.

PROTECTION from the wind, dust, rain and snow. Use "Wear Me" windshield wings and motor with pleasure. Fully guaranteed. Money back if not satisfied after ten days' use. Regular set, \$12.50; Ford special, \$16.00. Wear Me Auto Specialty Company, No. 1602 Broadway, Pittsburgh, Pa. See "Ad." page 113.

AUTO Owner Tire Agent wanted each locality to use and take orders for hand-made Mellinger extra ply and cord tires; guaranteed by bond for 8,900 and 10,000 miles (no seconds); shipped prepaid on approval; get your tires free; no capital or experience required; make \$100 to \$300 weekly. Write for wholesale prices and sample section, Mellinger Tire Co., 929-K Oak, Kansas City, Mo.

VULCANIZING and Repairing is a paying business. Forty million tires need repairing every day. Make big profits in tire repair. Easy to learn. Instructions free. No hard times. Always busy. Get into this moneymaking business quick! Plants \$200 up. Write for free catalog. Equipment Co., 1 Canal, Cincinnati, Ohio.

AUTOMOBILE Owners, Garagemen, Mechanics, Repairmen, send for free copy of our current issue. It contains helpful, instructive information on overhauling, ignition troubles, wiring, carburetors, storage batteries, etc. Over 140 pages, illustrated. Send for free copy today. Automobile Digest, 505 Butler Bldg., Cincinnati.

AUTO Parts—Save 25-90%. New gears, axles, bearings, springs, radiators, magnetos—4,000 models. Bankrupt supplies, retopping outfits. Brightman Auto Exchange, 321 Windsor Ave., Hartford, Conn. Largest in the East.

BATTERY charging pays big profits, \$20 starts your business. Profits pay balance. Write us. Hobbartson, Troy, Ohio.

AUTOMOBILES

90% SAVED buying garage equipment direct from manufacturers. Magneto testers, chargers, gear pullers. Write for complete list and low prices. Besser Mfg. Co., Webb City, Mo.

PATENTS. Protect your rights. Before disclosing invention write for booklet and blank form Evidence of Conception, to be signed, witnessed and returned with rough sketch or model of your idea, upon receipt of which I will promptly give opinion of patentable nature and instructions. No charge for preliminary advice. Highest references. Prompt, personal attention. Clarence B. O'Brien, Registered Patent Lawyer, Southern Building, Washington, D. C.

35 MILES on Gallon of Gas. Send ten cents, self-addressed stamped envelope, names of five friends, and receive complete instructions for obtaining this mileage on Ford; other automobiles in proportion. John Blum, Fourteen-nineteen W. Susquehanna Ave., Philadelphia.

DYKE'S Automobile Encyclopedia contains the greatest array of automobile facts ever published in one volume. Several separate books containing the same information would cost in the neighborhood of \$21.00. New, enlarged edition, 968 pp. 3362 illus. Cloth \$6.46—American Morocco \$7.96 postpaid. Popular Mechanics Book Dept., 6 N. Michigan Ave., Chicago.

START!! Auto Toy Building—new invention. Write Schires, 19 S. La Salle St., Room 1229, Chicago.

AUTOMOBILE Repairman's Helper. In Two Vols. An excellent new work that gives every operation required to adjust or repair the troubles likely to be found in all standard cars. Vol. 1—Repairshop Practice—Passenger Cars—Trucks. 335 pp. 417 figs. Price \$3. Vol. 2—General Shop Practice—Passenger Cars—Parts and Accessories. 528 pp. 428 figs. Price \$3. Popular Mechanics Book Dept., 6 N. Michigan Ave., Chicago.

AUTOMOBILE Mechanics, Owners, Garagemen, Repairmen, send for free copy America's Popular Motor Magazine. Contains helpful, instructive information on overhauling, ignition wiring, carburetors, batteries, etc. Automobile Digest, 505 Butler Bldg., Cincinnati.

PATENTS—Write for our free illustrated Guide Book and Evidence of Conception Blank. Send model or sketch and description of your invention and we will give our opinion of its patentable nature. Highest references. Prompt service. Reasonable terms. Victor J. Evans & Co., 185 Ninth, Washington, D. C.

FOR FORD OWNERS

FORD owners send ten cents to cover cost of mailing, and we will send you for free trial one Jules oil circulator for Ford cars, guaranteed to stop oil pumping, spark-plug fouling, and double your oil mileage. Use it thirty days. If satisfactory send us \$1.90. If not return it to us. Electric Machine Corporation, Indianapolis, Ind.

FORD one-man touring tops—extra quality \$25.00 each. Only six on hand. Superior Co., 313 Halsey St., Newark, N. J.

FOR Ford Owners: Learn how to time your intake and exhaust valves properly. You can quiet your motor, secure a remarkable increase in power, and save oil and gasoline by our method of adjusting valves in such a way as to take up play caused by wear at six points. Write for free circular which tells how. Address: Dept. W, Steel Products Mfg. Co., Racine, Wisconsin.

MR. Ford Owner, what's it worth to you to have an engine-driven tire pump always with you? Attaches to crank-shaft and transforms your car into a traveling air station. Pumps 60 lbs. air pressure in 90 seconds. Costs less than \$10.00 delivered. Buy one yourself and if you have some selling time, ask us for terms to agents. Make big money according to the time you work. Absolutely new, and greatest accessory for Ford Car. Send for free circulars. George Clagett Manufacturing Co., No. 631 Pennsylvania Avenue, Washington, D. C.

FORD Car Repair Book sent free. This complete, well-illustrated, valuable book explains in a simple way the Causes and Cures of Overheating; Repairing Ford Timer; Curing Piston Ring Troubles; Carburetor Adjustments and Repairs; Connecting Rods; Transmission Troubles; Care and Repair of Rear Axle; Stopping Axle Grease Leaks; also covers practically every other phase of Ford Car Repairing. Send 25c coin for three months' trial subscription and get the valuable repair book free. Ford Owner and Dealer Magazine, 522 Montgomery Bldg., Milwaukee, Wis.

COMBINATION Carbon burner and trouble locator. Makes Fords run better. See when your plugs are getting spark through glass tubes. Price only \$2.00. Address, Star Accessories, Harrisburg, Texas.

NEW Ford accessory; something good; sell direct to car owners, or side line. Repeater. Sample 35c. Mfgd. by Peter N. Swanson, Kewanee, Ill.

FORD Owner—Cylinders oil up? Plugs quit firing? Stop it! Send \$1.00 for information. Address H. Cofer, 30 Second Avenue, Long Branch, N. J.

CYCLE "Dynamic" hot-spot controls gas temperature automatically without dampers. Powerful and efficient. Cycle Manifold Co., South High St., Akron, Ohio.

VELVET Grip stops Ford's chattering and jumping. Price \$1.00. Money-back guarantee. S. A. Smith, 3429 Market St., Youngstown, Ohio.

FORD \$20 Simplex Starter Guaranteed. American-Simplex Co., Anderson, Ind.

SPEEDSTER Fans: Don't fail to see "Red-I-Kut" ad. Page 128.

REPAIR your own Ford Car, Truck, Tractor. New 229-page book describing proper and most efficient way to repair products of Ford factories by former director Ford Motor Co. Service School. This information otherwise unavailable outside of Ford plant. For owners, repairmen and dealers. Price \$2 postpaid. Popular Mechanics Book Dept., 6 N. Michigan Ave., Chicago.

MOTORCYCLES, BICYCLES AND SUPPLIES

LARGEST stock of new and used motorcycle parts and accessories in the world at your disposal via Uncle Sam's mail. Write for quotations. Motorcycle Parts Mfg. Co., 2930-36 Wabash Ave., Chicago, Ill.

FOR Sale—Two Smith Motors with Buckboards. A-1 condition. \$100 each. O. C. Schulz, Riverside, Ill.

ENGINES \$4.00. Frames \$1.00. Motorcycles \$14.00. Plugs 25c. Grips 30c. Knights, 1512 Locust, St. Louis, Mo.

SEND for our Bargain Bulletin and Money-Saving Message. It will save you money on Motorcycles, Side Cars, Motor Wheels, Repair Parts and Accessories. Some used parts at less than half. Cleveland and Henderson Motorcycles our specialty. See our ad on page 138. American Motor Cycle Co., 2943-5-7 W. Chicago Ave., Chicago.

NEW 1923 Indian Scout \$250. New Briggs-Stratton Flyer \$125. Good used Motorcycles cheap. Best Bicycle buy in America \$30. Seiber-Hofhelms, Buffalo, N. Y.

BICYCLES, men's, girls' \$10.00; Tandems, new tires, spokes and rims, \$25. McDougald, 390 N. Wells, Chicago.

MOTORCYCLE cylinders reground, fitted with new piston and rings, \$6.00. Guaranteed. Muncie Piston Co., Muncie, Ind.

BEFORE buying get our list. See ad Page 159, Wisconsin Cycle Sales Co.

INDIAN Powerplus, \$65.00. Johnson Motorbike, \$60.00. Box 135, Windham, Ohio.

USED parts for all motorcycles cheap. State wants. Schuck Cycle Co., 1922 Westlake, Seattle, Wash.

'19 INDIAN 3 Speed \$85.00. '20 Indian 3 Speed \$100.00. '21 Indian 3 Speed \$150.00. Howard A. French Company, Baltimore, Md.; Washington, D.C.

SEND for big list of slightly used motorcycles on our easy payment plan. Howard Cycle Co., 152 N. Broad St., Trenton, N. J.

DON'T buy a Bicycle Motor Attachment until you get our catalogue and prices. Shaw Mfg. Co., Dept. 27, Galesburg, Kan.

NEW motorcycles have been reduced 10%. Our prices have been reduced 35%. Send for big bargain list of rebuilt motorcycles. Western Supplies Co., 359 Hayutin Bldg., Denver, Colo.

AVIATION

BUILD your own aeroplane; materials cut to fit, ready to assemble, on terms. "A" Angeles, East Seattle, Wash.

REAL aeronautical bargains—turnbuckles, 20c; aero cloth, 30c; shock absorber, 5c; Gnome motors, \$150.00; tubing, 5c per foot; airplane sheet steel, 5c per lb.; tape, 3c; spark-plugs, 25c; high tension wires with terminals, 20c; wheels, 20x4, \$6.00; brass screws, 40c per gross; plywood, 20c; aircraft nuts, 1/4c. Many other bargains. Sale sheet, 2c. Heath Airplane Co., Chicago.

MEN wanted! Airplane Experts earn \$2,000 to \$10,000 a year. I will qualify you for one of these big jobs. Write, L. R. Coombs, Chief Engineer, Central Airplane Works, 3254 Lincoln Ave., Chicago.

PROPELLERS for aeroplane propulsion, 5 ft. diameter, \$12; other sizes in proportion. Motorcycle Sleigh blue prints, 75c. Ford prints, \$1.00. Address Crawford Motor & Aeroplane Manufacturing, Long Beach, Calif.

FOR Sale—H. D. Motorcycle engine, A-1 condition, suitable for Aero-Sled; cheap. H. M. Sensesch, R. No. 3, Lititz, Pa.

LEARN to fly with America's oldest aircraft company. Six hours' flying worked in with three months' shop training at \$190.00, makes our course the most complete ever offered, and an opportunity long waited for. Enroll at once. Heath Airplane Co., Chicago, Ill.

REMARKABLY fast and efficient Aero-drive Sled Blueprint 50c. Aircraft Supplies Bulletin for stamp. Ostergaard Aircraft, 1269 North Narragansett, Chicago.

AIRPLANE parts, propellers, air-drives, motors and material. Circular for stamp. Chicago Airplane Co., 2110 Washington Blvd., Chicago.

INVENTORS desiring patents should write for our Free Illustrated Guide Book and Evidence of Conception Blank. Send model or sketch for our opinion of its patentable nature. Highest references. Prompt service. Reasonable terms. Victor J. Evans & Co., 187 Ninth, Washington, D. C.

BIGGEST, best catalogue Model Aeroplanes, Parts and Supplies; 5c postpaid. Ideal Aeroplane Co., 67 1/2 West Houston, New York.

HEATH propellers represent the most efficient method of aerial drive. Each propeller individually designed for the particular work to be done, as laid out by America's oldest aeronautical engineers. Propeller catalog, 4c. Heath Airplane Co., Chicago.

WELDING

WELDING Encyclopedia—A complete instruction book on all welding processes; oxy-acetylene, electric arc, electric resistance and thermit. Welding of all weldable metals fully discussed. 326 pp. 375 ill. The accumulated experience of the welding brains of America is yours for \$5. Money-back if not satisfied. Popular Mechanics Book Dept., 6 N. Michigan Ave., Chicago.

BOOKS AND PERIODICALS

TWO books containing 70 plans and ideas to make money. Both \$1.00. A. Centerwall, 1817 Pennsylvania Ave., Dallas, Texas.

FREE Sample. Copy of "Popular Educator" on Health, Science, Psychology, Character-Analysis. Success. 624 Vancouver Block, Vancouver, B. C.

SOVEREIGN Pubs., 40 Broadway, Buffalo, Great "35 Course Master Key." Leather, \$5.00. "Mahatma Blind Mind Reading" \$1.00.

BOOKS. All kinds. Lists. Higene's, A2441 Post Street, San Francisco, Calif.

WE can furnish any book in print at retail price. No charge for service. We pay the postage. Tell us your wants; we will send details and price by return mail. The Dacrow Corporation, 347B Fifth Avenue, New York.

USED books, educational nature, bought, sold, exchanged. Free bargain price list of 1,000 items. Students' Exchange, 47 West 42d St., New York.

"MIND-READING"—Any distance; wonderful; 30c. "Hypnotism" controls others—25 easy lessons, \$1.00. Science Institute, FM102, 1014 Belmont, Chicago.

OUR new catalogue listing over five hundred carefully selected practical books under eighty different subject groupings will be sent free upon request. Popular Mechanics Book Dept., 6 N. Michigan Ave., Chicago.

RADIO books cheap. Catalogue free. Zenith Book Co., St. Paul, Minnesota.

1,000,000 INDUSTRIAL Facts, Calculations, Receipts, Processes and Trade Secrets for every business are contained in the 1016 page Book "Moore's Universal Assistant and Complete Mechanic." 500 Engravings. Cloth. Price \$2 postpaid. Popular Mechanics Book Dept., 6 N. Michigan Ave., Chicago.

VIBRATIONS—Lights—Colors—Radio—Cold—Lights—Illustrated. Write Ernest Stevens Laboratories, Department Mechanics, San Francisco, California.

BOYS' toy-maker book, 64 pages, illustrated, 10c. Amateur Electrician, 64 pages, illustrated, 10c. Radio Sets, how to build, illustrated, 25c. Western Puzzle Works, St. Paul, Minn.

BIG money in writing photoplays, stories, poems, songs. Send today for free copy America's leading writer's magazine, full of helpful advice on writing and selling. Writer's Digest, 708 Butler Building, Cincinnati.

"MAGIC." Edward M. Massey. Just published. 36 entirely new and original effects, clearly described. Illustrated with 25 full-page plates and 11 smaller illustrations. Attractively bound. Elaborate gold stamping 8"x5 1/2". \$3.00 postpaid. Spon & Chamberlain, 120 P. M. Liberty Street, New York, N. Y.

PLANS for Poultry Houses. All styles. 150 illustrations; secret of getting winter eggs, and copy of "The Full Egg Basket." Send 25 cents. Inland Poultry Journal, Dept. 74, Indianapolis, Ind.

INDUSTRIAL Alcohol, Wright's book everybody wants. Full directions for making with drawings of necessary apparatus. \$2.50 postpaid. Spon & Chamberlain, 120 P. M. Liberty Street, New York, N. Y.

INSTRUCTION Book (for shop use) on vulcanizing auto tire, boots and shoes, \$1 bill. Equipment Co., 3 Canal, Cincinnati, O.

PICTURES AND POSTCARDS

10,500 MEMBERS, 119 countries, belong to Parisian Club; exchange postcards, stamps, letters. Particulars free. Norou, 162 Sawyer, New Bedford, Mass.

GET foreign postcards, curios, interesting letters, etc. Membership 50c (stamp). Delacavefer, 282-M d'Entraignes, Tours, France.

JOIN Live Postcard club; Sample paper, list, catalog, 10c. Harvey Teeple, Decatur, Ind.

NOVELTIES, CURIOS, ETC.

EDUCATING and profitable, join the national curio club. Men, women, boys and girls from Alaska to Mexico and from coast to coast, are exchanging curios and antiques. Butler, California, wants to exchange shells for birds' eggs. Rogers of Alaska, collecting every specie of tree bark. Miss Banks, of Florida, collecting flowers of all kinds. Baker, of Iowa, wants mineral specimens. Membership one dollar coin or currency. Box 953, Casper, Wyoming.

IMPORTED and Domestic Novelties. Newest articles. Lowest prices. Agents wanted everywhere. 100% Profit. P. J. Loesch, Importer, 1416 Broadway, New York City.

SNEEZE Powder, greatest funmaker on earth. Bottle 10c. C. Fenner, 2401 Jefferson, Louisville, Ky.

LATEST imported Oriental novelty. Chinese back scratcher. Sensational—25c. Holco, Annawan, Ill.

GAMES AND ENTERTAINMENTS

HIGH-GRADE Stage and Parlor Magic—Crystal gazing, Card tricks, Mind-reading, Spiritualistic effects. Book, Sensational Escapes. Large illustrated catalog for stamp. Deal direct with the largest. Heaney Magic Company, Berlin, Wis.

FUN, Jokers' Goods, Trick Pencils, Small Bombs, Cachoo Powder, Sooner Dogs, Trick Matches, Shooting Cigars and Cigarettes, 100 others. Send 2c for Illustrated Catalogue. Grandfield, 1238 Theriot Ave., W. F., New York.

VENTRILOQUISM taught almost anyone at home. Small cost. Send 2c stamp today for particulars and proof. George W. Smith, Room M-291, 125 N. Jefferson Ave., Peoria, Illinois.

GET Dollar Dazzler Book: real snappy rhymes. "Bath-she-ba," pictures! Dramatic, humorous, Elegant Song Supplement (or book only, 50c). New York Trend, 1752 E. 17th St., Brooklyn.

REDUCED Prices! Tricks, Jokes, Puzzles. Imported Novelties. Catalog and "Ten Pocket Tricks," 6c. Send today! Lyle Douglas, Station A, Dallas, Texas.

HOUDINI'S Paper Magic—by Houdini. All who are looking for "something different" for instructive amusement will welcome this book on tricks with paper, puzzles, paper-folding, etc. Price \$2.50 postpaid. Popular Mechanics Book Dept., 6 N. Michigan Ave., Chicago.

250 **MAGIC Tricks**, only 10c. Andon, 4049-TK, North Whipple, Chicago.

MAGIC—Tricks, Books and Supplies. For Amateurs as well as the great professionals. Anyone can learn through our instructions. Feature Acts in Mind Reading, Spiritualism, Rope Ties, etc. Large Illustrated Professional Catalog, 10c. Chicago Magic Co., Dept. B, 140 S. Dearborn St., Chicago, Ill.

TRICKS, Puzzles, jokes, magical apparatus, plays, stage supplies, mind-reading acts, and sensational escapes. 100-page illustrated professional catalogue, 10c. Oaks Magical Co., Dept. 548, Oshkosh, Wis.

67 **TRICKS**, 400 Jokes, Riddles, Toasts, Fortune Telling Secrets, Funny Readings and big catalog, 10c. Ideal Book Shop, 5501NC, North Robey, Chicago.

MAGIC TRICKS, BOOKS AND JOKER'S NOVELTIES

MYSTERIOUS Spirit Pad.—Writing appears and disappears; questions asked and answered. New! Just from Europe! Price, 30c. Real money charm—he who wears one never goes broke, 25c; 375 Magic Tricks, 35c; complete 120 page illustrated catalogue of books, superior grade of magic tricks and jokers' novelties, 10 cents; money refund with first order. Chelsea Trick & Mystery Company, Station R, Box 24, New York, N. Y.

FREE—68-page Illustrated Magic Catalogue from factory. C. Pentz, Minneapolis, Minn.

\$7,000 STOCK magical goods. Catalogues 15c. Address, Gilmaglio, Morgan Park, Ill.

STAMP COLLECTING

FINE collection 210 different stamps, high-grade stock, including Togo, Cameroons, Caroline Islands, Morocco, Marshall Islands, German, China, Samoa, Iceland, Siam, Shanghai, etc. Price 25 cents to approval applicants. Address J. A. McHiney, 21 Oak Ridge Ave., Summit, N. J.

150 **DIFFERENT** Argentine and Uruguayan stamps, cataloguing over \$40, mailed for \$5 Bill. Will exchange medium and rare stamps with collectors in all countries. Base Scott. James Collins, 318 Branden, Quilmes, Argentine Republic.

IRISH Republic Surcharges, 4 var. mint, 17c postpaid. New U. S. Price List free. Send for a selection of Midwest Approvals today. Address, Midwest Stamp Company, Kemper Building, Kansas City, Mo.

100 **DIFFERENT** Stamps and Perforation Gauge, 10 Cents. Sonnee Stamp Co., 675 Ivy Street, St. Paul, Minn.

1,500 **DIFFERENT**, \$5.00; 1,000, \$2.50; 500, \$1.00; 300, 45c. Fred Oaken, 630 79th Street, Brooklyn, N. Y.

100 **DIFFERENT** U. S. Stamps, 60c. Address M. Mogensen, 414 North 14th, Omaha, Neb.

150 **STAMPS** Liberia, Sudan, etc., 10c. Fred Takagi, Box 543, Redwood, Calif.

STAMPS on approval, 1/4 cent up. Free premium. Herbert Keigwin, Middletown, N. Y.

FREE Packet Hinges to approval applicants. Oklahoma Stamp Company, Ardmore, (3) Okla.

FREE Stamps with 60% approvals. Send reference. H. O. Buchholz, Norwood, Ohio.

LARGE Russian Rosenoff Postage Stamp Free. Nielsen, 1923 Melrose, Chicago.

25 **NORTH**, South Americans, etc., 2c. Harland Bargett, Lima, Ohio.

START a Stamp Collection—45 different stamps from 65 different foreign countries, including Africa, Asia, Australia, Europe, West Indies, etc. Our pamphlet which tells "How to make a collection properly," and price list of albums, packets and sets, all for only 16 cents. Queen City Stamp Co., Room 36, 604 Race St., Cincinnati, O.

FREE! Sectional Loose Leaf Postage Stamp Album at the rate of 8 pages each month given with subscription to our monthly Journal. Send two-cent stamp for prospectus. United Stamp Co., 140 S. Dearborn St., Chicago, Ill.

BUY from Old Dominion Approvals. Enlarge your collection with attractive, hard-to-get stamps of selected quality. Valuable premium to serious collectors furnishing reference. Hugh Argenbright, Staunton, Va.

FREE, U. S. \$2.00 postage (initialed), to applicants for net approvals. Reference necessary. The Stamp Shoppe, 1413 G Street, N. W., Washington, D. C.

FRENCH Colonies Free—Beautiful Picture set, including Native Chiefs, Tigers, Pictorials, 2c Postage. Empire Stamp Company, Toronto, Canada.

500 **MIXED** U. S., old and new, 10c; 100 different Foreign, 10c; 1,000 hinges, 10c; Stamp Album, 15c. Weatherby, Medina, Ohio.

25,000 **DIFFERENT** stamps at wholesale. Large, Fine selection (no junk), cataloguing \$5.00, for \$1.00. Frank Hook, 4715 Lincoln, Detroit, Mich.

FREE! 20 different foreign 2c postage, 18 fine unused 10c. Approval sheets 50% discount. Austin, 526 North Temple, Indianapolis, Ind.

COINS, medals, paper money, antique firearms, swords, historical newspapers, stamp collections, antiques, curios. Catalogue free. Nagy, 33-A South 18th Street, Philadelphia.

STAMPS, 100 different for ten cents with fine approvals at 50% discount. J. A. Coldsmith, Box 313, Kansas City, Mo.

FREE, 25 U. S. stamps with 60% approvals to reliable parties. 100 different U. S. 25c. C. Seidenberg, Merton, Wis.

FREE "Leader" Pkt. to approval applicants sending 2c stamp. Earl Stamp Co., 1811, 26th Ave., North, Minneapolis, Minn.

FRENCH Colonies Free—Beautiful Picture set, including Native Chiefs, Tigers, Pictorials, 2c Postage. Empire Stamp Company, Toronto, Canada.

AUSTRIAN Battle Scenes, complete set; also 500 different stamps for 60c. Jacob Fischer, 1539 North Lawler, Chicago.

ZAMBESIA, Abyssinia, Herzegovina, Holkar, Ukraina Stamps, Monagorie Packet, 250 Hinges, 10c. Liberty, 3974 Arsenal, St. Louis, Mo.

GUATEMALA stamps, 10 different; catalog value 31c, my price 10c. Nickles, 122 Florida Ave., Washington, D. C.

Big Variety Packet Foreign Stamps free for 2c postage. Gray Stamp Co., Station E., Toronto, Canada.

SAVE Old Stamps. Cole's Approvals will Satisfy. W. Jay Cole, 3919 Wallace St., Chicago.

FREE Set of Stamps to approval applicants sending 2c. Address, Richard P. Lauprecht, Valparaiso, Ind.

FREE! World's smallest stamp, Approvals. Postage 2c. Cannon, 918 East Tenth, Davenport, Iowa.

100 **DIFFERENT** 3c. Co-Operative Stamp Co., 710 Pelham, St. Paul, Minn.

1,000 **MIXED** Newfoundland, etc., 25c. Eisen, 3918 13th Ave., Brooklyn, N. Y.

100 **DIFFERENT**, many rare unused, 5c. Elvin Stanton, Niantic, Conn.

FREE—Rare Stamp to approval applicants. Albert Behuke, Davenport, Iowa.

FRENCH Colonies Free—Beautiful Picture set, including Native Chiefs, Tigers, Pictorials, 2c Postage. Empire Stamp Company, Toronto, Canada.

BEST one cent approvals in America. F. P. Hand, 1117 S. 60th St., Philadelphia, Pa.

105 **CHINA**, etc., stamp dictionary, list, 2c. Albums (500 illustrations), 3c. Bullard, Sta. A, Boston.

FREE—New Europe, 20 diff., to applicants for my 1/2, 3/4, 1, and 2c approvals; also the higher-priced stamps at 50% disc. Send reference and receive extra premium. Chas. T. Egner, 1335 Pike St., Philadelphia, Pa.

KANGAROO set and 55 other different foreign stamps, hinges, pocket album and lists for 10c to approval applicants. Address, Moseley, 1994 Tower Grove, St. Louis, Mo.

200 **DIFFERENT** stamps, 15c. Lists free. Michael, 5602 Prairie, Chicago.

LIKE Triangular Stamps? To introduce our Sudden Service Approvals we'll send triangular Fiume, set China ships, large \$1.00 United States revenue, also packet 50 foreign, millimetre scale, perforation gauge, ruler and bargain lists for only 3c! Fennell Stamp Company, Dept. F, Fullerton Bldg., St. Louis, Mo.

STAMPS, 50 Varieties, Africa, Brazil, Peru, Cuba, Mexico, etc., 10c. 50 different U. S., 25c; 1,000 mixed, 40c; 1,000 hinges, 10c. List free. C. Stegman, 5948 Coto Brillante, St. Louis, Mo.

STAMPS sent on approval at 70% discount. Reference required. Emory Renoll, Hanover, Pa.

200 **STAMPS** and Bargain Stamp Magazine, 15c. Harvey Teeple, Decatur, Ind.

STAMPS—50 different Jamaica, Venezuela, etc., only 7c; 100 all diff., 10c; 1000 all diff., \$2.50; 100 diff., U. S., 25c; 1000 Hinges, 10c; 50 per cent approvals with every order. List free. I buy stamps. Write L. B. Dover, Dept. A, Longmont, Colo.

125-**GENUINE** Foreign Stamps—Mexico War Issues, Venezuela, Salvador and India Service, Guatemala, China, etc., only 10c. Finest approval sheets, 50 to 60%. Agents Wanted. Big 72-p. Lists Free. We Buy Stamps. Estab. 29 yrs. Hussman Stamp Co., Dept. 51, St. Louis, Mo.

FOREIGN Stamp Collection Sent Free. Cornish Company, Schenectady, N. Y.

24 **VARIETIES** Cuban stamps, 10 cents. List of 6,000 low-priced stamps free. Address Chambers Stamp Co., 111P, Nassau St., New York City, N. Y.

20 **UNUSED** stamps free. All different. Postage, 2c. Fisk Stamps, Toledo, Ohio.

PACKET of 23 stamps, no two countries alike. Packet hinges, set of \$1 and \$2 U. S. Rev., all for 5c. Mention paper. Miami Stamp Co., Toledo, Ohio.

STAMPS, 20 unused, all different, free. Postage 2c. Mention paper. Quaker Stamp Co., Toledo, O.

FREE 10 different Scandinavian, millimetre scale, gauge, book, lists, etc., to all sending 10c for 57 different Siam, Ceylon, Guatemala, etc. 200 different, 25c; 300 different, 60c; 100 different U. S., 25c. Hawkeye Stamp Co., Cedar Rapids, Ia.

RARE COINS

MONEY of the Great War. Issued by the various countries, in paper and metal. All are curious and interesting. Will send you a fine specimen and my large 50-page Illustrated Coin Catalog for only 10c—"just to get acquainted." Send now. B. Max Mehl, Numismatist, Mehl Bldg., Dept. P, Fort Worth, Texas. Largest Rare Coin Establishment in the United States.

OLD coins, large fall selling catalogue of coins for sale, free. Catalogue quoting prices paid for coins, ten cents. William Hestlein, 101B Tremont St., Boston, Mass.

COMBINATION. California Gold 1/4, 27c. \$100 Ohio Bill, 15c. Nickel 3c, White Cent, 15c. Price Lists, 3c. 60c Lot, 50c. Al. E. Bonaill, Richmond, Ind.

40 **OLD** coins, all different, \$1.00. 100 old coins, all different, \$5.00. Claud Denney, Box 315, Dallas, Texas.

COIN catalog sent to collectors on application. F. Stolteben, 2319 Osgood St., Chicago.

EGYPTIAN coin 10c; coin guide 10c; Durso, 25 Mulberry, N. Y. City.

1 **LARGE** cent, over 100 years old, 25c; hundreds of other bargains. Address Fred Greenclay, Box 297, Altam, Ill.

CALIFORNIA gold, 1/4 size, 27c. 3/4 size, 52c. 3c piece and catalogue, 10c. Address Norman Shultz, Colorado Springs, Colo.

WILL pay fifty dollars cash for Nickel of 1913 with Liberty Head. Watch your change. We pay cash premiums for all rare coins. Send 4c for Coin Circular. Numismatic Bank, Dept. H., Fort Worth, Texas.

FOR BOYS

BOYS build three foot model airplane at small cost. Write Aero Shop, 3050 Hurbit Ave., Detroit, Mich.

110 **VOLT** Motor \$2.00. "Built Like a Big Motor." Annis Motor Co., 308 S. 17th, Columbus, Ohio.

BOYS!—You who like gripping, thrilling stories of achievement, will want to read "Victories of the Engineer," a book that tells in a way you can understand it how the great feats in railroad engineering, building great bridges, ships, dams, canals, harbors, tunnels, mining, etc., have been accomplished. By A. Williams. 487 pp. 259 illus. Price \$2.00 postpaid. Popular Mechanics Book Dept., 6 N. Michigan Ave., Chicago.

MOUTH-ORGAN Instructor, 25c. Play in one hour. G. Elsen, Bowling Green, Ohio.

SCENERY TO RENT

SETTINGS for Opera, Plays, Minstrels, Plush Drops. Address Amelia Grain, Philadelphia.

CAMERAS AND PHOTO SUPPLIES

SPECIAL Trial Offer: Any size Kodak film developed for 5c; prints 2c each. Overnight service. Expert work. Roanoke Photo Finishing Co., 209 Bell Ave., Roanoke, Va.

FILM developed and six prints 20c. Quality Finishing. Young Photo Service, 16E Alden Ave., Albany, N. Y.

GLOSSY Prints three cents. Rolls Developed seven cents. MacFarlanes Studio, 4150 Hamilton, Cincinnati, Ohio.

If you want first class work on films, prints and enlargements it will pay you to compare our work with others. We also have a complete line of photo supplies and give valuable household premiums to agents. Do not fail to write for our great offer. Dixie Photo Service, Dept. B, 129 E. Third St., Cincinnati, Ohio.

JUST Published—Our new complete 128-page catalog and bargain book of new and used cameras and supplies. Our goods are guaranteed finest quality obtainable. We have thousands of satisfied customers. Write at once for this bargain bulletin, just hot from the press. Address Central Camera Co., 124 S. Wabash Ave., Dept. E-62, Chicago, Ill.

SOMETHING new. Kodak enlargements, oil painted. Everybody is going wild over them. Send your favorite film; will enlarge to 10x12 and Oil paint for \$1.50. Be sure to state colors. Address Cassen's Art Studio, Box 183, Litchfield, Ill.

KODAK Finishing; send for prices. Special this month. 5x8 enlargement 25c. Kodafin, 387 Bellevue Place, Milwaukee, Wis.

SAMPLE Enlargement, dime, and negative (returned). Roll developed and six prints, 25c silver. Brown Studio, Lake Elmo, Minn.

DEVELOPING, printing, enlarging. Wholesale prices. Price list free. Photocraft, Box 69, Ann Arbor, Mich.

TWO Dollars with photo brings crayon portrait fourteen by seventeen. Floyd Miller, Arenxville, Ill.

KODAK Prints 3c. Postcards 5c. developing 5c. Aline Photo Co., Dept. P, 1832 Kinney, Cincinnati, Ohio.

HAVE You a Camera? Write for Free sample of our big magazine, showing how to make better pictures and earn money. American Photography, 790 Camera House, Boston, 17, Mass.

ESTABLISH yourself—at home—as an Expert Photographer and train with B. Vant, director International Studios, 343-B—3601 Michigan Ave., Chicago.

KODAKS, Cameras, Lenses, Photo Supplies, Radio outfits. Ask for bargain list. Hyatt's Supply Co., 417 N. Broadway, St. Louis, Mo.

MOTION PICTURES

SEND \$3.00 for the Cinema Hand Book. Everything pertaining to motion-picture making, taking projecting studio laboratory work. 572-page book, pocket size, only \$3.00 postpaid. Also the new complete courses of the New York Institute of Photography. Motion Picture Photography, postpaid, \$6.00. Motion Picture Projection, postpaid, \$6.00. Motion Picture Directing, postpaid, \$3.00. Screen Acting, postpaid, \$3.00. Photoplay Writing, postpaid, \$3.00. The most elaborate works ever written on this subject. Bass Special Offer: The five books at \$17.50 postpaid. Free Cinema catalog. Bass Camera Company, Motion Picture Division, 189 N. Dearborn, Chicago.

\$\$\$ FOR Ideas. Photoplay plots accepted any form; revised, criticized, copyrighted, marketed. Advice free. Universal Scenario Corporation, 917 Western Mutual Life Bldg., Los Angeles.

MACHINES, Films, Supplies, Bargain lists. National Equipment Co., Duluth, Minn.

\$85.00 PROFIT nightly. Small capital starts you. No experience needed. Our machines are used and endorsed by government institutions. Catalog free. Atlas Moving Picture Company, 482 Morton Bldg., Chicago.

MOVIE Cameras \$55. Panorama and Tilt Tripods \$25. New Home Projector \$39. New suit case Projector \$40. Films \$3 reel. Radio Apparatus Bargains. Ray, 329 5th Ave., New York, N. Y.

BARGAIN—Projector, motor driven, arc lighting, two lenses. Stereopticon projection, rewind screen, \$45.00. Guy Faber, 4901 W. Fulton St., Chicago.

SEND stamp for catalog illustrating wonderful 1923 Kinograph Grand Home Movie Projector. Bargains in films. Address Werner Brothers, High Ridge, Missouri.

WE buy used portable suitcase and professional moving-picture machines. Highest prices paid. What have you for sale? Monarch Theatre Supply Co., 724 So. Wabash Ave., Chicago, Ill.

AMERICA'S Greatest Fortunes have been made in the Moving Picture Business. Small investment needed. We furnish complete theatre equipment. Easy payments. Openings everywhere. Catalog free. Monarch Theatre Supply Co., Dept. F, 724 So. Wabash Ave., Chicago, Ill.

FREE to Writers—A wonderful little book of money-making hints, suggestions, ideas; the A B C of successful story and play writing. Absolutely Free. Just address Authors Press, Dept. 12, Auburn, New York.

CLEARANCE Sale—500 reels high-grade film. Two to six reel subjects Famous Movie stars. Special \$3.50 per reel only while they last. Stock up now. List free. Monarch Theatre Supply Co., Union and Fourth, Memphis, Tenn.

BUY direct from Manufacturers—New or rebuilt Moving Picture Machines for Homes, Schools, Lodges, Churches, Traveling Shows and Theatres. Mazda—Arc or Gas complete outfits—Film and Supplies. Dept. X, Monarch Theatre Supply Co., Memphis, Tenn.

FILMS for Toy and Professional Machines. All famous movie stars. \$3.00 per reel and up. Machine bargains also. Write for big list free. Monarch Theatre Supply Co., Dept. P. M., 724 S. Wabash Ave., Chicago, Ill.

FILMS For Sale—\$2.50 per Reel up. Address Queen Feature Service, Birmingham, Ala.

MAKE money writing photoplays; details free to beginners. No correspondence course. Producers League, 230 Wainwright, St. Louis.

EDUCATIONAL AND INSTRUCTION

BECOME a Laboratory Expert—Learn Interesting, Profitable Profession of Bacteriology, Microbiology. Extension and Residential Courses. Diplomas—degrees granted. Help secure position. 46-piece urinalysis outfit free to students. Send today for free 34-page Prospectus. Physicians & Surgeons College of Microbiology, 955 Belden Ave., Chicago.

SHOW card writing, a pleasant, profitable profession easily and quickly learnt by our new simple graphic block system. Artistic ability not necessary. We teach you how. Distance no object. Full particulars and booklet free. Wilson Methods, Limited, Dept. M., 64 East Richmond, Toronto, Canada.

WORLD-ROMIC system. Masterkey to All Languages. Primers, 15 languages, \$1.94 each language: Arabic, Chinese, Danish, Dutch, English, French, German, Italian, Japanese, Panjabi, Polish, Portuguese, Russian, Spanish, Swedish. Pronunciation-Tables, 86 languages, 29c each language. Languages Publishing Company, 8 West 40th Street, New York.

THERE is a Winning Way to Larger Life, and you can make it Yours. A postal brings convincing facts. Robert Knox, Box 728, San Francisco, Calif.

BECOME Shorthand Expert. New training system; prepares successful writers. Easy, practical home study. Earn while learning. Write "Business Methods," 404 Willoughby Building, Chicago.

ALL kinds of educational books or subjects bought, sold or exchanged; Low prices; Complete catalogue mailed free. J. J. Henderson, 154 Ridge Ave., Yonkers, N. Y.

CARTOONISTS—Improve your style by following the work of the greatest cartoonists found in the bound volumes of Cartoons magazine. Eight volumes, each covering six months, Jan.-June, 1917, to July-Dec., 1920, inclusive. 1,200 cartoons, 900 pages to a volume, 7 by 9½ in., 3 in. thick. New books; durable and attractive binding. Sold separately at \$2 per vol. postpaid. Supply very limited. Send at once. Popular Mechanics Book Dept., 6 N. Michigan Ave., Chicago.

USED books, educational nature, bought, sold, exchanged. Free bargain price list of 1,000 items. Students' Exchange, 47 West 42nd St., New York.

AUCTIONEERS make \$100 day. Free catalogue. Largest Auction School in world. \$10 course \$2. Carpenter Hall Bld., Kansas City, Mo.

"WHAT to Invent For Profit" free. Patent News, N. Washington, D. C.

ROPP'S Calculator and Short-Cut Arithmetic shows the answer as quickly as a watch shows the time to all problems likely to occur in office, store, shop, bank, farm or factory. Price, pocket size, paper 35 cents, cloth 50 cents, leatherette \$1. Desk size, cloth \$1.50 postpaid. Popular Mechanics Book Dept., 6 N. Michigan Ave., Chicago.

HARMONICA, Violin, Piano, Ukulele, or Mandolin instructors, 25c. G. Elsen, Bowling Green, Ohio.

BIG Money in writing photoplays, stories, poems, songs. Send today for Free copy America's leading writer's magazine, full of helpful advice on writing and selling. Writer's Digest, 603 Butler Building, Cincinnati.

BOOKKEEPING in a week. Dukas, 1857-9 Walton Ave., New York.

HAVE a business of your own; the most fascinating, best paying business-profession in the World, a foot correctionist; easy terms for training you at home in a few weeks, a new protected system that has enabled men and women to rise in one step to greater earnings than they ever thought possible; no capital required or goods to buy, no agency or soliciting. Address, Stephenson Laboratory, 1 Back Bay, Boston, Mass.

WANTED: Information exchanged about commercial uses for air compressors. Address Engineering Dept., Brunner Mfg. Co., Utica, N. Y.

WRITE articles, stories, news, in spare time for newspapers and magazines. Big pay. Copyright book free. Press Syndicate, 552, St. Louis, Mo.

ARTIFICIAL Marble, sanitary flooring instructions, ornamental casting, concrete plaster, papier-mache decorations, garden furniture, statuary, Rubber-moulds, Electro-metallurgy, particulars and 200 illustrations free. Chris Mahler, Box 122, Huntington, N. Y.

INVENTORS—Write for our illustrated guide book and Evidence of Conception Blank. Send model or sketch and description for free opinion of its patentable nature. Highest references. Prompt attention. Reasonable terms. Victor J. Evans & Co., 167 Ninth, Washington, D. C.

DOUBLE Entry Bookkeeping mastered in 60 hours with 8 keys; guaranteed; diplomas. Our graduates lead in bookkeeping, auditing, accountancy, balance sheets, financial statements. International Bookkeeping Institute, Dept. 3, Springfield, Mo.

STUDY Bacteriology—become a laboratory expert. Course interesting, can be mastered in few months at home or in school. Good paying positions open. Degree granted our graduates. School 13 years old. Send for Announcement. American College of Bacteriology, 2923 S. Michigan Ave., Chicago, Ill.

AMBITIOUS writers—send today for free copy America's leading magazine for writers of photoplays, stories, poems, songs; instructive, helpful. Writers Digest, 708 Butler Bldg., Cincinnati.

TELEGRAPHY

TELEGRAPHY—Morse and Wireless—taught at home in half usual time and at trifling cost. Omnigraph Automatic Transmitter will send, on Sounder or Buzzer, unlimited messages, any speed, just as expert operator would. Adopted by U. S. Govt. and used by leading Universities, Colleges, Technical and Telegraph Schools throughout U. S. Catalog free. Omnigraph Mfg. Co., 18 Hudson St., New York.

TELEGRAPHY (both Morse and Wireless) and Railway Accounting taught quickly. Big salaries. Great opportunities. Oldest and largest school; established 46 years. All expenses low—can earn large part. Catalog free. Dodge's Institute, H St., Valparaiso, Ind.

WIRELESS

BUILD your own electrolytic storage battery charger. Plates and complete instructions \$1.00. Descriptive circular free. Peerless Electrical Parts Co., 105 Harris, Rochester, N. Y.

RADIO Spot. Latest puzzle, 25 cents (no stamps). Address Nifty Novelty Co., Newark, N. J., Manufacturers of radio parts.

RADIO OUTFITS AND SUPPLIES

ORDER Direct, save dealer's profit. Double head sets, weight ten and half ounces, 2000 ohms, \$1.50, plus 15c postage, insurance, etc. Every pair tested, matched, guaranteed. Applebaum, 650 Book Bldg., Detroit, Mich.

WRITE for catalog showing complete line of Elmo Shielded Radio Apparatus, tuners, detectors, amplifiers, transformers and sockets. Electric Machine Corporation, Indianapolis, Ind.

SUPER sensitive Crystals, pair 25c. Catalogue free. Nelson Mfg. Co., Dallas, Texas.

TRIO Radio Receiving Sets, complete with double standard phones, aerial and full instructions. Will receive news, music, reports, etc., within 50-mile area, telegraph code within 150 miles. Bakelite panel 6x7 mounted with nickelplated parts. Cabinet 1/2-inch Mexican birch, lock-cornered, Walnut finish. Bus-bar wiring, all soldered connections. No batteries or tubes to burn out. Costs nothing to keep up. No experience needed to install or operate it. Maker to user only. Price, complete, \$15 C. O. D. We pay postage in U. S. A. Trio Radio Laboratories, 9916-9922 E. 14th St., Oakland, Calif.

RADIO for the Amateur—Building, Installing, Operating Stations for Radio Communication treated simply in "Practical Amateur Wireless Stations," a 134-page book compiled by Editor of Wireless Age, 115 Illa. and diag. Size 6x9 in. Price 75c ppd. Popular Mechanics Book Dept., 6 N. Michigan Ave., Chicago.

MANUFACTURER to Consumer. Don't miss this bargain. A complete Radio Receiving Set with Murdock phones and antenna ready to work on Receipt of \$8.50. Send 2c stamp for Catalog on big line of Radio parts. Ajax Co., 7802 Stony Island Ave., Chicago, Ill.

MAKE Variable Condensers for 15 cents each. No tools needed. Full instructions for 25c (coin). Bond, Box 93, Union, N. J.

RADIO Books—Send for our specially selected list of 20 leading volumes among the reliable radio publications and also our complete book catalog. They are sent free upon request. Popular Mechanics Book Dept., 6 N. Michigan Ave., Chicago.

ROTORS, Variometers, Variocouplers. Discounts to dealers. E. U. Mack, Mfr., Florence, S. C.

WESTINGHOUSE and other Standard Radio Sets and Parts. Liberal commissions paid for interesting others which enable you easily to earn your set and make money. Write for price list and proposition. Wheeler-Thomas Radio Co., Dept. 29, Holland, N. Y.

BUSINESS OPPORTUNITIES

FOR Sale—Shop and County rights of Patent Combination Auto Lunch Box and Table. Material costs less than \$2.50 per unit. One man can make four units per day. Will sell for from Ten Dollars to Fifteen Dollars per unit. Only one right sold in any town or county. Shop rights \$35.00, County rights \$75.00. One unit sent with each right sold. Address with remittance, Henry Harrell, Care of Washington Trust Co., Spokane, Washington.

CLOTHING store of your own without investment. Everything men and boys wear. Merchandise that repeats. Permanent business of big profits. Spare time at first if preferred. Write for full particulars and proof of what you can do. Deal with million-dollar concern. Write today. Wright & Company, Dept. 9357 Congress, Throop and Harrison Streets, Chicago.

ENTER a business, manufacture, appoint agents, and distribute your own products. Any chemical formula or process furnished, for one to ten dollars and up, according to amount of research necessary. Mechanical engineering, models developed and perfected. Write your needs. Chester W. Johnson Co., 168 Dartmouth St., Boston, Mass.

MARKET Charts. Learn to understand the movements of stocks and grain. Read the swings in advance; big help to traders and investors. Write for folder today. R. M. Marshall, Box 174, Dept. A, Topeka, Kans.

MAKE Thousands of Dollars selling Fired-Process Oriental Pearl Necklaces; amazing new discovery supercedes all other pearls. Sell like wildfire. Address, McCallister, Importer, Phelan Bldg., San Francisco, Calif.

MAKE money at home making toys—we show you how. Send 50c (no stamps) for complete working drawings and instructions. DeKaib Designing Co., Dept. 6, Decatur, Ga.

MFG. RUBBER GOODS, splendid profits. We lease equipment, and sell outputs. Only small capital necessary. I. X. L., Main and Jeff., Peoria, Ill.

MAKE Money at home making toys and novelties. Particulars free. New Specialty Co., 417 E. 71st St., New York.

MAKE Money with your camera. Booklet free. Lancaster, 409B Wright-Callender Building, Los Angeles, Calif.

BIG Money, unlimited possibilities; Formula, Trade Secret Business. Particulars. Co-Operative Service Bureau, Kokomo, Indiana.

PATENTS. Protect your rights. Before disclosing invention write for booklet and blank form. Evidence of conception, to be signed, witnessed and returned with rough sketch or model of your idea, upon receipt of which I will promptly give opinion of patentable nature and instructions. No charge for preliminary advice. Highest references. Prompt, personal attention. Clarence B. O'Brien, Registered Patent Lawyer, Southern Building, Washington, D. C.

FOR Sale—An effervescent natural spring in Colorado, a short distance from Denver, 150 acres of land with the spring, also a high-grade bottling works on the property. Company is doing a large business at the present time. Reason for selling, other interests. B. G. Earl & Co., 56 E. Randolph St., Chicago.

ROYAL North West Mounted Policeman retiring from service in five weeks, has purchased valuable Patent Vaporiser for all makes combustion engines. Thousands sold in Canada. One shipment New Zealand 100 gross—I want man with capital to join me, equal terms, 300% profit. Canadian Vaporiser Co., 114 Jarvis St., Toronto, Canada.

PATENTS Procured—Trade Marks Registered—A comprehensive, experienced, prompt service for the protection and development of your ideas. Preliminary advice gladly furnished without charge. Booklet of information and form for disclosing idea free on request. Richard B. Owen, 30 Owen Building, Washington, D. C., or 2276-R, Woolworth Bldg., New York.

ATTENTION! Go into business for yourself. Establish and operate New Systems real estate; business brokerage and Insurance Agency in your community. Office at home; earn \$5,000 year. Representatives wanted everywhere; send stamp for booklet. Hayes Realty Association, Cincinnati, Ohio.

CAPITALIZE the Radio Craze. Sell instructions by mail for Home-Made Receiving Sets. You will receive hundreds of replies as I have. Complete Plan, Instruction Book, Sources of Supply, Ads for \$1. Fable, Box 748, Springfield, Ill.

AMBITIOUS men wanted to refinish and plate brass beds, chandeliers, autos, accessories, etc., by improved methods. Large income assured without capital or experience. Write for samples and particulars. Lancaster-Metalcrafts, 28 W. 22nd St., New York.

I MADE \$30 a Week Home. French Breadmaking. 15 years' experience; Free Booklet tells. Ashbrook, 67, Marengo, O.

REPRESENTATIVES wanted to handle our complete line of copyrighted blueprints, showing home construction of Radio Receiving Outfits. Write for price list and discounts. Temple Radio Engineering Service, Suite 27, 2764 Second Blvd., Detroit, Mich.

CONVERT each spare moment into cash. My dignified methods, requiring no merchandise nor peddling, will enable you to increase your income, tremendously, without study, capital, experience or delay. Stekey, Box 798, Dallas, Texas.

WANTED—Right man with \$3,000 cash and up, by manufacturing company, to establish and conduct permanent distributing business. \$300 a month and expenses, and share of profits. Superintendent, 625 Lumber Exchange, Chicago.

OPEN clothes, hat cleaning and pressing establishment. Easy cleaning methods makes clothes, hats, etc., look like new. Wonderful opportunity. Particulars free. Address Byron 27, Sta. I, New York.

PROTECT your rights—Write for "Record of Invention" and booklet about Patents. Prompt personal service. Advice without charge. J. Reaney Kelly, 612-G, Columbian Building, Washington, D. C.

MAKE large profits placing our Target Practice Machine in stores on percentage basis. Only small capital required. Particulars free. Target Machine Company, 157 East 7th St., New York.

USED books, educational nature, bought, sold, exchanged. Free bargain price list of 1,000 items. Students' Exchange, 47 West 32nd St., New York.

MANUFACTURE Extracts, and other necessities, 200% profit; we tell you how. Write White Manufacturing Drug Co., Box 323, Cincinnati, O.

LEARN Plating, Automobile Painting, Etc. Big Profits, Demand, Plans Free. Write today. Borick, 427 Carroll St., Akron, Ohio.

START Anywhere profitable branch manufacturing business. New, uncrowded field. Capital or experience unnecessary. Details free. Box 425, Chicago.

GENERAL Agents—High-class auto novelty. Handsome Profits. Address Cataract Auto Washer Co., Dept. P, Topeka, Kans.

WANTED—State Contracts Kitchen Specialties. Mail Complete Detailed Offers. United Supply House, Lyons, Iowa.

NEW, reliable, tested formulas by expert chemists. Quaker City Laboratories, 132 E. Albanus St., Philadelphia, Pa.

FORMULAS By Experts, different, dependable. Interesting Catalog free. B. Thaxby Company, Washington, D. C.

MAKE Big Money Opening Safes and Setting Combinations. Wayne Strong, Box 1430, Los Angeles, Cal.

"WHAT To Invent for Profit" free. Patent News-C, Washington, D. C.

"HOW to Sell Patents" free. Patent News-H, Washington, D. C.

FREE—Formula Catalog. S. & H. Laboratories, Bogston Building, Chicago.

I HAVE over 100 stores paying \$5 monthly maintenance. You can do the same in your City. Month's practice qualifies. Only one person in each City chosen. Address Midnight Alarm System, 6411 Mack Ave., Detroit.

AMBITIOUS people: \$8.00 day easy made. Plan Free. Peters, 12 Harrison Avenue, Gardiner, Maine.

AMBITIOUS Men, write today for attractive proposition, selling subscriptions to America's most popular automobile and sportsman's magazine. Quick sales. Big profits. Pleasant work. Digest Pub. Co., 9505 Butler Bldg., Cincinnati, Ohio.

GET into the specialty manufacturing business. Amazing profits. We will send you free book explaining our system. Write immediately. A wonderful opportunity awaits you. Thos. Steel, President, 624 M'n, Richmond, Va.

ENTER a new business. Earn \$3,000 to \$6,000 yearly in professional fees making and fitting a foot specialty, openings everywhere, with all the trade you can attend to; easily learned by anyone at home in a few weeks, at small expense; no further capital required, no goods to buy, job hunting, soliciting or agency. Address Stephenson Laboratory, 11 Back Bay, Boston, Mass.

RESPONSIBLE Corporation wants general sales managers to open branch office, manage salesmen. \$500 to \$5,000 necessary; expenses allowed to Baltimore if you qualify. Address Manager, 603 N. Eutaw St., Baltimore, Md.

MAIL Order Business is your opportunity. Brenner's Famous Handbooks teach how to start small, grow big. Sell merchandise, service, ideas; enormous profits. Spare time to begin. Get complete set, 11 books, \$3.00, and be posted. Brenner, 335 Walnut, Philadelphia. Descriptive Catalog and big batch interesting mail order information, 25c. None free.

EXCEPTIONAL Opportunity for Sales Manager capable of handling state distribution. Marvelous new Adding Machine. Retail \$15. Work equals \$350 machine. Tremendous possibilities. Unlimited profits. Write quick for details. Lightning Calculator Co., Dept. B, Grand Rapids, Mich.

\$100,000 CORPORATION wants capable man; open office; manage sales for High Class New Device. Every Home a Prospect. Big money-making possibilities for the right man. Opening in every city. Cost \$2.00, retails \$5.00. \$500 to \$2,000 necessary to finance exclusive agency. Scott Corporation, 82 W. Washington, Desk G, Chicago.

WE Start You in Business, furnishing everything; men and women, \$30.00 to \$100.00 weekly operating our "New System Specialty Candy Factories" anywhere. Opportunity lifetime; booklet free. W. Hillier Bagdale, Drawer 4, East Orange, N. J.

"SCHEMER Magazine," Alliance Ohio, prints big profit schemes; one subscriber making \$25,000 from three; another \$10,000 from one. Try your luck. Year, only \$1.00; three months, 25c.

CHEMICAL Expert will furnish Formulas and Trade Secrets. All lines. Lists Free. W. L. Cummings, Ph.D., 228 Gordon Ave., Syracuse, N. Y.

DOLLARS yearly in your backyard. No Mushroom dope. Particulars free. Metz, 313 East 89th, New York, N. Y.

\$3,000 TO \$6,000 Yearly. Want it? Others are making it. Send check or money order today for our invaluable books "How to Sell Real Estate," \$3.00—and "How to Conduct Real Estate and Insurance Business," \$1.50. Absolute satisfaction guaranteed. Free catalogs. Realty Book Co., Dept. 52, Cleveland, Ohio.

BE Independent. We teach by mail how to manufacture unexcelled Toilet Preparations. Earn while you learn. Results guaranteed. Particulars Free. School of Cosmetics, Box K, Omaha, Nebr.

LEARN the collection business. Good income, quick results. Interesting booklet, "Skillful Collecting," free. National Collectors Assn., Long St., Newark, O.

START a Paying Business of Your Own. Be a business man. Any location. 8,000 new Tire Vulcanizing and Repair Stations needed. Business always good. Are you ambitious? \$200 will start you. Write at once. Wonderful opportunity. Equipment Co., 11 Canal, Cincinnati, Ohio.

MARBLE mixing instructions, covering wood or cement flooring 1/2 inch thick, fireproof, waterproof, low cost, sanitary, all colors. Particulars, 200 illustrations free. Chris Mahler, Box 122, Huntington, N. Y.

SILVERING Mirrors! My exclusive French Tartaric method opens enormously profitable business. Booklet free. H. Barstow, 514 23d Street, Oakland, Calif.

GOOD money easily earned at home, spare time silvering mirrors; no capital. Free instructive book tells how. Patterson & Co., Brooksville, Ky.

IF you have about \$1,000 and capable of organizing sales force, to sell article needed by every merchant, wholesaler and retailer, which should net you \$10,000 profits first year, write Sales Director, 826 Reaper Block, Chicago.

CHEMISTRY

YOUR problem solved for five dollars. Write me. W. Steadman Richards, Consulting Chemist, Box 2402, Boston, Mass.

FORMULAS AND TRADE SECRETS

500 FORMULAS, 20c. Luminous paint—Resilient Mirrors—Renewing dry batteries—Mechanics' Soap—Gas Tonic—Carbon remover, Puncture Plugger, 20c each. Entire collection, 50c. Ideal Book Shop, 5501PG, North Robey, Chicago.

HIGH-GRADE Formulas, Douglas Chemists, 8 St. Louis Ave., Chicago.

NEW! Silk Photos! Have succeeded with my experiments to sensitize and print pictures on silk. You too can do it. Will mail you my formula for only \$1.25. F. Irsa, 105 Division St., Elizabeth, N. J.

550 RARE formulas for 25c (coin). We can furnish any formula wanted for 50c. Catalog Free. Allen's Enterprises, 1227 Milwaukee Ave., Chicago, Ill.

CONSULTING Chemist will prepare any formula quickly \$2.50. Satisfaction guaranteed. Write me your wants. Edward Mease, 852 14th St., Des Moines, Iowa.

1,000,000 FORMULAS, recipes, trade secrets—1016 pages, \$2.00. Hillside Laboratories, 7021-A So. Winchester, Chicago.

5,000 FORMULAS \$1.25. See our advertisement on page 28. Wells & Edwards, Booksellers.

FREE—Formula Catalog, S. & H. Laboratories, Boylston Building, Chicago.

10,000 SELECTED scientific, chemical, technological and practical recipes and processes including hundreds of so called trade secrets for every business alphabetically arranged in one large volume of 800 pages. Price \$4, postpaid. Popular Mechanics Book Dept., 6 N. Michigan Ave., Chicago.

FORMULAS of the better sort. Write for our free catalog. Thos. Steel, President, 624 Main, Richmond, Va.

3,000 FORMULAS, Money-makers, 400 pages, \$1. Restovall Laboratories, 4049-BK, North Whipple, Chicago.

MONEYMAKING Formulas— Catalogue free. Clover Laboratories, 5501C, North Robey, Chicago.

FORMULAS; guaranteed, Catalog free. Restovall Laboratories, 4049-K, North Whipple, Chicago.

1,000,000 FORMULAS, Trade Secrets, Processes, \$2.00. Jay-Hersheberger, Kokomo, Ind.

1,000,000 FORMULAS, Trade Secrets, 1016 pages, \$2.00. Ideal Book Shop, 5501M, North Robey, Chicago.

500 SUCCESSFUL money-making formulas and trade secrets for 50c. Postpaid. Rudolph Bjerggaard, Rollag, Minn.

AGENTS WANTED

NO Dull Times Selling Food. The greatest, surest and safest business in the world today is selling Federal Pure Food Products, and here is your opportunity to get into this business. You can make \$3,000, \$5,000, \$10,000 or more per year—the only limit is your ability to take care of the business. We print your name and address as distributor on every package, thus making sure that you will get the thousands of dollars' worth of repeat orders which will be sent to you. No Dull Times, for the People Must Eat, and our food products are the fastest selling, surest and quickest repeat order getters in the world. Sell on sight in every home where food is used.

—Repeat orders immediately and every week thereafter. A Real Big Business All Your Own. Every new customer adds a great deal to your weekly income. Your business once established, has a market value just like a store and can be easily sold. The greatest money-making opportunity of your lifetime because you risk absolutely nothing, as we guarantee your sales, and we will not let you fail. Remember! Guaranteed! Best products, biggest sellers, surest repeat orders. No capital or experience is required. We furnish capital and everything necessary for you to become a Federal Distributor. Exclusive territory will be given honest men or women who will write at once asking us to send our "Success Guaranteed" proposition. Address, Federal Pure Food Company, Dept. 15, Chicago, Ill. Largest inventors of and packers of Pure Food specialties in the world. Reference, any bank, Dun or Bradstreet rating agency, Express or Railway Company in America.

WE want men and women who are desirous of making \$25.00 to \$200.00 per week clear profit from the start in a permanent business of their own. Mitchell's Magic Marvel Washing Compound washes clothes spotlessly clean in ten to fifteen minutes. One hundred other uses in every home. Nothing else like it. Nature's mightiest cleanser. Contains no lye, lime, acid or wax. Free Samples make sales easy. Enormous repeat orders—300% profit. Exclusive territory. We guarantee sale of every package. Two other "sight sellers" and sure repeaters give our agents the fastest selling line in the country. No capital or experience required. Baker, Ohio, made \$600 last month. You can do as well. Send for Free Sample and proof. L. Mitchell & Co., Desk 76, 1302-1314 E. 61st, Chicago, Ill.

AGENTS—we pay \$6 a day taking orders for Liberty Raincoats. Brand new line. Latest styles. Made in our own factory. Guaranteed. Big opportunity for men and women. Some of our representatives make \$12 a day. No capital or experience necessary. You take orders. We deliver and collect. Pay you daily. If you want a big paying business, your money every day, and a steady income, write us today. Liberty Mfg. Co., 280 Liberty Bldg., Dayton, Ohio.

MONEY—Money—Money! Make it selling Hanslick, the new and unbeatable hand-cleaner—the original powdered hand soap! Removes grease, grime, ink, paint, etc., without injuring skin. Spreads like wildfire. Cheaper than all others. Sells in cans (or bulk with dispensers) to garages, autoists, auto supply companies, mechanics, factory and office folks, to housewives, hardware stores. Huge quantities used weekly by mercantile houses. Big repeat business assured. Exclusive agencies, crews working for you, fast sales, splendid profits, permanent business for hustlers. Live ones can clean up \$500 a month. Send 10c (coin or stamps) for liberal sample can. Complete sales plan goes with it. Write quick to Solar Products Co., 124 W. Lake St., Chicago, Ill.

TAILORING Agents Wanted—Make \$50 to \$100 and more per week, selling our wonderful virgin wool one-price line. Suits and overcoats sell for \$29.50. None higher. Retail stores ask at least \$50 for the same quality. You collect your profits in advance. We ship C. O. D. to customer for balance. We furnish beautiful 6x9 swatch outfit and powerful co-operation. Several hundred successful salesmen are now earning \$50 to \$100 a week and more. The low price and wonderful quality wins enthusiastic customers and repeat business. That's what counts. Hustlers write at once. Mention territory wanted. Sales Manager, J. B. Simpson, Inc., Dept. 260, 831-843 W. Adams St., Chicago, Ill.

AGENTS Wanted. Additional Territory Open to District sales managers capable of earning from \$5,000 to \$10,000 a year selling men's, ladies' and children's hosiery. Men with seasoned selling experience and executive ability. If you are manager of house to house salesmen and can develop them so they are able to earn big money in their territories and being a top-notch yourself accustomed to real selling; do not put off; but now, get your application on file; the time is ripe to start for the fall season. Write us for full particulars. H. & S. Hosiery Mills, Reading, Pa.

REGAL Keyless Spare Tire Lock—newest, greatest auto invention. Quick, easy seller. Tremendous money maker for agents. Baffles thieves. Cannot be picked—forced—sawed—filed or nipped. Opens only by secret combination. Simple for owner—he just moves combination till letters on discs spell secret word and presto! it opens. Safer than a safe. Every motorist buys. Low price. Unlimited guarantee. Nothing like it. Novel features and safety attract customers. Sell motorists and dealers—make \$2.66 per sale. Write quick. Regal Keyless Lock Co., 1808 N. Clark St., Dept. 10, Chicago.

AGENTS, Salesmen, Demonstrators, you will have the devil's own time trying to find a better seller than "Zippo." If there was such a thing we'd have it. 150% profit on 50c "Go Getter" repeat article that sells on ten second demonstration. Works While You Watch It. Demonstrates value, while others waste time making claims. New Discovery! Greatest Scientific Triumph of the age. It's the berries. Haven't room to tell our story here. Write immediately. Karam-Smith Co., 1244 Clark St., Fort Wayne, Ind.

TAILORING Agents: You can make more money with a one-price line than with any other. Ours is a better one-price line. It offers All-Wool Tailor-Made Suits, regular \$50.00 values, at only \$29.75, including a good profit for you. You get your profit in advance with every order. We supply everything. Can use a few more good men. Write at once. Address, Park Tailoring Company, Dept. 416, Chicago, Ill.

PATENTS. Protect your rights. Before disclosing invention write for booklet and blank form Evidence of Conception to be signed, witnessed and returned with rough sketch or model of your idea, upon receipt of which I will promptly give opinion of patentable nature and instructions. No charge for preliminary advice. Highest references. Prompt, personal attention. Clarence B. O'Brien, Registered Patent Lawyer, Southern Building, Washington, D. C.

ACT Quick—\$100 weekly. Sells like wild-fire. Klean-Rite. New magic washing compound. No rubbing. Women crazy about it. 200% profit. Premium plan gets business. Distributing samples free. Bestever Products Co., 1941-K10 Irving Park, Chicago.

AGENTS—\$8 a day taking orders for In-syde Tyres. Positively prevent punctures and blowouts. Guaranteed double tire mileage. Old worn out casings will give 3 to 5 thousand miles more service. No tools needed. Just slip inside casing before replacing tube. Will not heat or pinch. Katz made over \$500 first month. Biggest thing on the market. Low priced. Write for territory. American Accessories Co., B-1073, Cincinnati, Ohio.

AGENTS—Earn \$50 to \$100 a Week Selling Kilglare Shields to Auto Owners. Protect eyes from blinding sun and glaring lights. Every auto owner wants one. Exclusive territory to the right men. Agent's sample 25c, retails \$1.00. Write for full particulars or send 30c for sample, postage prepaid and particulars. Territory allotments going fast. Anyone can attach it to windshield. Kilglare Shield Corporation, Luceum Building, Duluth, Minn.

AGENTS—Chinese baskets are a fine holiday seller; made of split bamboo, come nested 5 to a set; size of largest basket 12 in. wide by 4½ in. deep, decorated with silk tassels, jade rings, beads and real Chinese money. Sample set of 5 baskets sent parcel post for \$3.50; special discount to live agents. Stamp for particulars. Young, 235 Gough St., San Francisco, Calif.

AGENTS. Biggest money taking orders for newest style written guaranteed hosiery. Complete line, men, women, children, including silks. No competition. Not sold in stores. Written guarantee with each pair. You display samples and write order. We deliver and collect. Pay you daily in advance. No experience necessary. Spare time satisfactory. Write for samples. Jennings Mfg. Co., Dept. 848, Dayton, Ohio.

AGENTS—\$85.00 weekly is a small income if you sell the Eradium (Luminous) Crucifix. Every Catholic will buy for \$2.00. Costs 84c. Your profit 140%. Demonstrating Case free. All homes can use Luminous Switch Plates, Bulbs and House Numbers. Quick easy sales that bring big money. The Pioneer Corporation, 6301 Yale Ave., Chicago.

AGENTS: It's a "Whirlwind". Get in on the greatest Repeat Order Proposition. In three months' time orders for Universal Products will come in by themselves. Let us prove it. Exclusive territory. All repeat orders turned over to you. Write today. Universal-Victor Company, Desk B, 1460 E. Jefferson Ave., Detroit, Mich.

AGENTS—Sell our Artkraft felt rugs. Made of all new bright stock. Colors, red, green, blue, tan, etc. If you are looking for something to double your money on, send for our sample 28x58, \$1.50 prepaid, and we will show you how. E. Condon, 77 Bedford St., Boston, Mass.

AGENTS—Steady income, large manufacturer of Soaps, Perfumes, Toilet Articles and Pure Food Products, etc., wishes representative in each locality. Manufacturer direct to consumer. Big Profits. Honest goods. Whole or spare time. Cash or Credit. Send at once for particulars. American Products Co., 7747 American Building, Cincinnati, Ohio.

AGENTS—\$15 a day—Easy, quick Sales—Free Auto—Big weekly Bonus—\$1.50 premium Free to every customer. Simply show our Beautiful, 7 piece, Solid Aluminum Handle Cutlery Set. Appeals instantly. We deliver and collect. Pay daily. New Era Mfg. Co., 803 Madison St., Dept. 21-D, Chicago.

\$1,080 MADE BY WINGS in six weeks selling Never Fail Razor Sharpener. Purdy made \$40.50 first day. Other inexperienced men cleaning up big money. Applewhite, La., six orders in thirty minutes. Hurry—investigate—exclusive territory. Write today. Never Fail Co., 153 Allen Bldg., Toledo, O.

AGENTS—New Invention. Harper's Ten-Use Brush Set and Fibre Broom. It sweeps, washes and dries upstairs windows, scrubs and mops floors and does five other things. Big profits; easy seller. Free trial offer. Harper Brush Works, Dept. 72, Fairfield, Iowa.

27,000 RECORDS guaranteed with one Everplay Phonograph Needle. New; different. Cannot injure records. \$10 daily easy. Free sample to workers. Everplay, Dept. 4, McClurg Bldg., Chicago.

GOODYEAR Raincoat Free. We will send a handsome Raincoated, All-Weather Coat to one person in each locality who will show and recommend it to friends. Write today to The Goodyear Mfg. Co., 1748C, Goodyear Bldg., Kansas City, Mo.

EASY, pleasant work for Mechanics, Shop Men, Clerks, during spare hours; will add many dollars to their salaries. Also want persons who can give full time. Big wages assured. Novelty Cutlery Co., 67 Bar St., Canton, O.

AGENTS: Enormous Profits, Permanent Repeat Business, exclusive territory, selling highest quality products at low prices. Coconut Oil Shampoo retails 50c bottle, costs \$1 dozen. Soaps, Perfumes, Extracts, etc. P. Verdina Company, 16 East 13th, New York.

MEN and Women Make Big Money from start selling exclusively Dr. Blair's famous toilet preparations for every member of the family. Complete line. Business permanent. Remarkable selling outfit. Write quick. A. B. Blair Laboratories, Lynchburg, Va.

AGENTS—Jolly Molly dresses are quick sellers—good repeaters. Every woman wants one or more. Complete line now ready. No capital required—no experience necessary. Commissions advanced. Domestic Products Co., 523 Davies Bldg., Dayton, Ohio.

JACO Sanitary Straps sell on sight to everyone using combs. Three dozen \$3.00 delivered; easily sell for \$9.00. \$5.40 Profit sure every day. Get particulars quick. Jay Company, 111 Jay Building, Washington, N. J.

PATENTED Kwick-Change Price Tickets, Signs. Give any price quotation instantly. U. S. Corporation using them for advertising. Send one dollar for introductory sample of fees and territory. Somerville Brothers, Locust Street, Pasadena, California.

OUR Agents make \$12 to \$20 every day and are getting it with new invention that sells to everybody. Low price. Pocket sample. Write Suren Churchill Company, 25 N. Dearborn St., Chicago.

AGENTS—Genuine Gold Letters anyone can put on Store Windows. Guaranteed to not tarnish. Large profits. Enormous demand. Free samples. Write today. Genuine Gold Letter Co., 429-A North Clark, Chicago.

AGENTS 100% profit. Sells on sight, 25c patented. New. No competition. Exclusive territory. Sample, prepaid, 15c stamps, or write for information. Van Noorden Sales Company, 3855 S. Flower St., Los Angeles, Calif.

CABBAGE Cutter, 5 knives, slices 20 vegetables, finer than aluminum, never dulls, 20,000 users Cincinnati alone, endorsed by Good Housekeeping Institute. Agent's Sample 48c. Meyer Co., Oriand Ave., Cincinnati, Ohio.

AGENTS—Men, women, to sell Pure Silk Hosiery direct to wearer. Commissions paid daily. Full commission on all repeat orders. We deliver and collect. Write Norwalk Hosiery Mills, Norwalk, Conn.

AGENTS. Patented specialty needed in every home. Inexpensive. A money saver. No competition. Four sales in five calls. Tremendous profit. Exclusive territory. Spengler-Leomis Co., 1360 Garland Bldg., Chicago.

SHI-NOFF: Takes shine off clothes. Sells big. Office and household canvassers' proposition. 50c brings facts and self-proving sample. Address, Shineoff Corporation, 21 West 42nd St., New York, N. Y.

AGENTS Make sixty dollars per week selling new Sallie May "Dressup" Aprons. Write and learn how to obtain samples without cost. Miss Apron Co., 109 Searle Bldg., Rochester, N. Y.

AGENTS. Sell Wolverine Laundry Soap, 150 other household necessities. Big line. Big Profits. Quick repeaters. Free instruction. Exclusive territory. Write quick. Wolverine Soap Co., Dept. K, Grand Rapids, Mich.

BIG money selling Beecher's pocketknives with patented blade for trimming ingrowing toenails; 75c up. Catalogue free. Beecher Knife Co., Dept. P, 111 West 42nd Street, New York City.

AGENTS: We pay \$9 a day taking orders for 300 candle power coal-oil lantern. Get orders from farmers, dairymen, hucksters, gardeners, contractors. Auto furnished to travel in. Write for particulars. Thomas Mfg. Co., Class 2962, Dayton, Ohio.

\$5 TO \$15 Daily Easy—Your pay in advance introducing new style guarantee of hosiery. Must wear or replaced free. No capital or experience required. Just show samples, write orders. We deliver and collect. Elegant outfit furnished. All colors and grades, including silks and leathers. Mac-O-Chee Mills Company, Desk 110, Cincinnati, Ohio.

AGENTS—To sell our pocket cutlery, with name, lodge emblem, etc., under the handle; also our photo knives with sales-board. Lackawanna Cutlery Co., Ltd., Nicholson, Pa.

MEN with Ford cars make easy money, and lots of it, selling our Peter Prim Tire Pump, the only engine-driven power pump for Fords at reasonable price. Pumps 60 lbs. air pressure in 90 seconds, without work or bother. Tremendous demand—no competition—sells on sight. Liberal commissions. Send today for circular. George Clagett Manufacturing Co., 631 Pennsylvania Avenue, Washington, D. C.

TAILORING Salesmen: Make \$75.00 a week selling our strictly All-Wool Made-to-Measure Suits at \$26.50. You collect profits in advance and keep them. We supply finest Selling Outfit in America. Many exclusive money-making features. Tailoring, raincoat and side-line men, part or full time, get in touch with us immediately. Goodwear Chicago, Inc., Dept. 161, Chicago, Ill.

AGENTS Wanted—Something New—Fire Fighter sells easily. Makes a spectacular demonstration; car owners, homes, factories, stores, practically buy on sight. Our men make \$10.00 to \$50.00 a day; exclusive territory. If you wish to establish a business of your own with unlimited possibilities for making big money, write us today. Fyr-Fyter Co., 1003 Fyr-Fyter Bldg., Dayton, Ohio.

AGENTS—New 2-in-1 Reversible Double-duty Raincoat. One side rich tan dress coat, other side storm overcoat. Two coats for the price of one. Saves \$20. Positively guaranteed waterproof or money back. Commission paid same day you take orders. No capital required. Sample furnished. Great seller. Real money for agents. Parker Mfg. Co., 478 Roe St., Dayton, Ohio.

AGENTS—Make \$7 to \$14 a day. Brand new Aluminum handle Cutlery Set. You take orders, we deliver and collect. Pay you daily. Full or spare time. No experience necessary. No capital. We need 1500 Sales agents, men or women, to cover every county in the U. S. Demand enormous. Write quick. Jennings Mfg. Co., Dept. 1868, Dayton, Ohio.

\$100,000.00 CONCERN wants agents to take orders for Gabardine Gas Mask Raincoats. Biggest selling coat in America today. Wonderful value. Big profit—in advance. Two sales means big day's wages. Only sample of cloth necessary—furnished free. We deliver and collect. Write today for exclusive territory and selling outfit. Dept. 611, Lewis Raincoat Company, Cleveland, Ohio.

START in a permanent business of your own selling guaranteed Hosiery and Underwear direct from mills. No capital or experience is needed; many representatives make \$3,000 to \$5,000 per year. Become our district manager—get others working for you. Write for details to Malloch Knitting Mills, 5210 Grant St., Grand Rapids, Mich.

\$5 TO \$15 Daily Easy—Your pay in advance, introducing New Style Guaranteed Hosiery. Must wear or replaced free. No capital or experience required. Just show samples, write orders. We deliver and collect. Elegant outfit furnished. All colors and grades, including silks and leathers. Mac-O-Chee Mills Company, Desk 10610, Cincinnati, Ohio.

WE pay \$7 a day taking orders for Stainless Steel Cutlery Set. Guaranteed. Aluminum handle. We deliver direct to your customer and pay you every day. Big demand. No capital or experience needed. Big money for spare time. Complete outfit to workers. Parker Mfg. Co., 278 Aul St., Dayton, Ohio.

AGENTS. Good salary and commission for selling "Ratskyll," our new Rat and Mouse Exterminator. Ready for use, no bait required, non-poisonous. Harmless to man, poultry, cat, dog and other animals. Rodents die outside premises. No odor. Exclusive territory, no competition. Empire Specialties Co., 1549 N. Wells, Dept. 301, Chicago, Ill.

AGENTS: Wonderful sellers—Men's Diagonal Gas Mask Raincoats "Goodyear Brand," costs you, dozen lots up, \$1.80 each; Women's \$2.00; Children's \$1.65—Hubberized Aprons, \$3.00 per dozen—and Wonder 3-in-1 Bag, \$3.25 per dozen. Order samples now. Biggest season coming. Profits unlimited. Chester, 202 East 12th St., New York.

GOOD income, spare time, refinishing chandeliers, brass beds, automobiles, etc., by new method; producing amazing results; every household possible customer; experience unnecessary; simple plan of manufacturing at home starts you in big money-making business. Write for free samples, showing finishes, etc. Gunmetal Finish Co., Ave. H, Decatur, Ill.

TERRITORY Salesmen—First popular price Fire Extinguisher ever made. Every home, garage and office can be sold. \$90 a week can be made. No capital or experience necessary. You take orders, we deliver and collect—pay you daily. Write for territory. Thurston Mfg. Co., 278 Poe St., Dayton, Ohio.

MAKE \$50 Daily. Something new! 400% Profit. All business, professional men need it. Sells \$5. Costs \$1. Brooks, Texas, sold 20 first day, profit \$80. Big weekly repeater. Sells quickly. Experience unnecessary. Write today for territory wanted. Sample outfit free. Federal Association, 71-K Asylum St., Hartford, Conn.

AGENTS wanted by large raincoat manufacturer to take orders for our guaranteed made to measure Raincoats, Gabardines. \$75 to \$150 weekly easily earned; commission in advance. We deliver and collect. Write at once for further details and free outfit. Universal Raincoat Co., 607 Broadway, New York.

SELL Minutemen for tires and tubes—cost 2c repair; surpasses vulcanizing, saves 500%. Every auto and accessory dealer buys. Profits amazing. Shaw made \$21 first day. Hart \$155 first week. Particulars and free sample. The Colonial Rubber Co., Dept. 85, Philadelphia, Pa.

SALESMEN, Act Quick. Ten patented auto necessities. Spark plugs, visors, windshield cleaners, hose clamps, etc. Generous commissions. Jubilee Mfg. Co., 13 Sta. C, Omaha, Neb.

WORLD'S fastest agent's seller. 300% Profit. Needed in every home and store. Establish permanent business. Premier Mfg. Co., 813 E. Grand Blvd., Detroit, Mich.

WONDERFUL composition applied on wet windshield prevents rain or snow blurring. Cake form. Agents coin money. Sample 25 cents. Marvel Wax Company, Sheboygan, Wis.

AGENTS earn \$10.00-\$15.00 daily selling our attractive novelties and toilet articles. Wonderful proposition. Write for samples. Lee-Jackson Company, Avondale 5, Cincinnati, Ohio.

WANTED—Agents. Protect-O-Mats with name inlaid; proven big seller; exceptional opportunity; territory going fast. Write Jackson & Co., 249 West 34th, New York.

AGENTS: Exclusive rights. New portable talking machine \$15.00. Equal to \$35.00. Big discount. No competition. P. Appelbaum, 335 N. Orianna St., Philadelphia, Pa.

WONDERFUL Fast Seller—New adjustable valve-grinding tool. Fits any car. Sample 35c. Simon Brothers, 207 North Seventh, St. Louis. Act quickly for Territory.

SELL guaranteed coal-saving device. Save half coal. Expensive coal makes tremendous demand. 100% profit. A. A. Dalot, 204 N. 5th St., Philadelphia, Pa.

EARN \$10 daily silvering mirrors, plating and refinishing metalware, autos, chandeliers, bedsteads, headlights. Outfits furnished. E. Decie Laboratories, 1133 Broadway, New York.

HOUSEHOLD and office necessity, endorsed by "Good Housekeeping." An article of daily use. Large profits. Everett & Barron Co., Providence, R. I.

GENEROUS exclusive territory for Paste Soap, not house to house. Connecticut Can Co., Park St. at New Park Ave., Hartford, Conn.

AGENTS—Johnson cleared \$137.00 last week selling Jiffy Chang Signs. Every merchant buys. Fastest seller made. Costs 25c, sells \$1.00. Sample prepaid—25c. Peoples Portrait, Dept. E, 566 W. Randolph, Chicago.

A-1 SELLERS—Pillow Cases, Scarfs; beautiful; three samples \$1.00. Address Manufacturer: Art Embroidery Works, West New York, New Jersey.

THE Agent's Guide—Tells where to buy almost everything. Copy 25c. Wilson Publishing Co., 1400 Broadway, New York

AGENTS wanted to sell latest nifty pocket pencil sharpener. Sample mailed 25 cents. Voigt Novelty, Mt. Vernon, Ill.

AGENTS, \$54 a week; travel by auto, install New Stove Converter in country homes. Wonderful invention. Cook and bake all year without coal or wood. No gas or electricity needed. We furnish the auto. Sample free. Thomas Mfg. Co., Class 2562, Dayton, Ohio.

MAN or Lady in every town to distribute our 7 Piece Aluminum Handled Cutlery Set. Whole or spare time. Experience not necessary. Sells on sight. High Quality Guaranteed. \$10.00 per day to right people. Perfection Aluminum Mfg. Co., Desk A, Lemont, Ill.

DISTRICT Managers, Crew managers, salesmen and saleswomen. Quick for exclusive territory. 240 foods, household necessities, sell on sight. Big profits. Hard made \$62.05 in 3 1/2 hours. Get our free sample case offer. Dept. 1, E. C. Harley Company, Dayton, Ohio.

STATE and County Distributors. We have it. \$85 to \$100 weekly; new patented auto device for Ford cars; big demand; fast seller; act quick. State and County Distributors Wanted. Write Bigelow-Bruno Co., Dept. A, 537 S. Dearborn St., Chicago.

ELECTRIC Heating Pad, 110 volt, retailing at \$3. First time offered at a price that makes every home a prospect. Exclusive territory now. Sample \$3, postpaid. Credited on first order. Address Advance Products Co., 7710 St. Clair Ave., Cleveland, O.

SCOTT-BLACK'S New patented 10c household necessity sells at sight. No competition. Send 60c for 1 doz. packs. Sells for \$1.20. Money back for unsold goods. Write quick for territory. Scott-Black Co., Inc., 304 W. 54th St., New York City.

AGENTS! A sale in every home for our beautiful dress goods, silks and general yard goods. Quick sales! Big profits! Large book of nearly 1000 handsome fabric samples furnished to agents. Write today. National Importing & Mfg. Co., Dept. 6X, 573 Broadway, New York, N. Y.

AGENTS: Men and women, in spare or full time, make big money selling household necessity. Every home a prospect. Quick sales, big profit. Territory open. Write for particulars. Judd & Leland Manufacturing Company, Box 21, Clifton Springs, N. Y.

AGENTS—Either sex. Big commissions daily. World's fastest selling book. Wonderful sales plan. No delivering. Free outfit, including strong canvass. Special proposition for competent Crew Managers. Give experience. Science Publishing Company, 1141 Rand-McNally Building, Chicago.

AMBITIOUS men wanted to refinish and plate brass beds, chandeliers, autos, accessories, etc., by improved methods. Large income assured without capital or experience. Write for samples and particulars. Lancaster-Metalcrafts, 28 W. 22d St., New York.

WANTED General Agents—Or Managers of Good Live Crews, to sell our Super-Bag. This bag sells on sight with a good profit. For particulars write to Presto Bag Co., 81 S. Howard St., Akron, Ohio.

LIGHTNING—Wonderful new Electrolyte—charges discharged batteries instantly. Eliminates old Sulphuric Acid method entirely. World has waited half a century for this invention. One gallon retails \$10.00, free to agents. Lightning Co., St. Paul, Minn.

AGENTS, both sexes. Milk Bottle Opener and Sealer. Can be attached to any bottle in second. Patent pending; a live one. Free sample. Send 10c for mailing. B. D. Bottle Works, 417 N. Clark, Chicago.

GOLD Sign letters for stores and office windows. Photo pillow tops, portraits, frames, sheet pictures, medallions, waterproof aprons, novelties. Samples, catalogue free. Thirty days' credit. James C. Bailey Co., Desk J-10, Chicago, Ill.

PORTRAIT Agents—\$50,000 is what "Picture Man Friedman" made canvassing. Free circular "Profits in Portraits" tells how. 24-hour service prints, finished portraits, frames. Samples free. "Picture Man Friedman," Dept. 8, 673 Madison, Chicago.

SELL "Shyn-Rite," world's greatest polish. Fast seller. Sure repeater. Big profits. Exclusive territory. Free sample. Learn what "Shyn-Rite" actually does—then you will sell it. Heaton Products Co., 1274 Clybourn Ave., Chicago.

SAMPLE Free—New household article. Sells 25c—profit 17c. ABC Company, Box 1715-P, Washington, D. C.

NEW Office Article. Minute Demonstration Means Sure Sale. 100% Repeater. Odiorne, 117 South Fourth, Philadelphia, Pennsylvania.

AGENTS: 200%. New line Perfumes, etc. Write National Soap, 20 E. Lake, Dept. 6, Chicago.

40c CORN Sheller. Big Seller. Star Supply Company, Lima, Ohio.

AGENTS Wanted. Make big money selling Earl's wonderful Cutwell Imported Pencil Sharpener. Nothing like it. Sells on sight. Send 25c for samples, full particulars. B. G. Earl, 54 E. Randolph Street, Chicago.

MAKE big money selling our stamped 21-jewel watches. Case gold filled, stamped; warranted 25 years. Sales easily made. Sample, \$6.75. Oskin & Co., 3920 N. Kimball Ave., Dept. 400, Chicago.

RADIOPHONE. Complete, under \$9.00. Big commissions; entire first payment agent's. No investment, collections, deliveries. Our patented "Topsy" plan produces phenomenal sales. Exclusive territory open. Frank Baxter, Tribune Building, New York, N. Y.

100% PROFIT—Free Goods—No Investment. High grade guaranteed aluminum utensil specialties and cutlery. 10 to 15 dollars per day easily made. Perfection Aluminum Mfg. Co., Desk A, Lemont, Ill.

CITY and county, household necessity. guaranteed five years; fast seller, retails \$1.00; public needs 25 million. Sample prepaid 50c. S. S. Mfg. Co., 1619 Kimball Bldg., Chicago, Ill.

MEN'S shirts. Easy to sell. Big demand everywhere. Make \$15.00 daily. Undersell stores. Complete line. Free samples to workers. Chicago Shirt Co., 9 So. Clinton, Factory 205, Chicago.

PROTECT your rights—write for "Record of Invention" and booklet about Patents. Prompt personal service. Advice without charge. J. Reaney Kelly, 612-G Columbian Building, Washington, D. C.

RADIO a New Field. Big money selling Radio parts. We manufacture over 50 Radio parts. Send for catalog. Ajax Co., 7802 Stony Island Ave., Chicago, Ill.

MANUFACTURER with reputation among agents for "putting over" biggest money-makers in household articles wants agents full or spare time. Flo-Mar Manufacturing Co., 2530 Drake Ave., Chicago.

AGENTS: Get into a good repeat proposition. Sell our high-grade flavoring extracts. Build up steady income. Liberal terms. Acme Extract Co., 520 West Broadway, New York.

300% PROFIT. Snow Dust washes clothes without rubbing. Women wild about it. Going big everywhere. Free samples. Exclusive territory. Norman C. Conrad, Washash, Ind.

PEOPLE Must Eat—Big profits introducing Mother Hubbard Foods. Goods worth \$150 free. Sales guaranteed. Send for free outfit. Inthout Company, 558G Congress, Chicago.

\$100 WEEKLY. 350% profit. New, easy seller. Big repeater. Free samples get customers. Crew manager's harvest. Hansen Mfg. Co., A-220 W. Ontario St., Chicago.

GUARANTEED metal outfit makes articles costing 1c sells 10-15c like wildfire. Price, \$7.50. Sample, 25c. New Jersey Specialty Co., 16 Bergen St., Jersey City, N. J.

\$150.00 WEEKLY Making Modern Automobile Specialties. Repainting, Retrimming of cars easily learnt at home—indispensable to all automobile people, etc. Autofinishco, Sheboygan, Wis.

MEN'S Belts. Price sells them, quality gets reorders. Gold mine for agents. Send 25 cents for sample. Grith Belt Co., Box 634, Akron, O.

AGENTS—Big Profits. Selling Wunrub Polish, for Furniture, Woodwork, Automobiles, etc. Cleans and polishes. Write for Big Free Offer. Fritch's Laboratories, 6431 Magnolia, Chicago.

SALESMEN, agents, district managers, attractive permanent proposition representing manufacturer of electrical appliances and flashing signs. Write N. Y. Electric Sales Co., 199 Broadway, New York.

AGENTS—Biggest money-making agencies in America (2 propositions). Exclusive territory. Sample, particulars free. Thayer Consolidated Factories, Armitage and Mangos, Chicago, Ill.

REAL Estate and Business Exchange office in your home, earn \$5,000 year. Complete instruction, outfit, send \$3.75. Realty Publishing Company, Cincinnati, Ohio.

FASTEST Selling Ford Necessity just out. Seward's profit one day \$74.00. Territory going fast. Write quick. Super, 421 National, Milwaukee, Wis.

SOMETHING New! Men and Women make \$500 a month. Write for particulars. The K Products Co., 5073 Burns Ave., Detroit, Mich.

AGENTS—Make \$20 daily introducing finest silk hosiery. We deliver, collect. Commission paid daily. Experience, capital not necessary. Mylady's Hosiery, 414 Madison Ave., New York.

FREE—Valuable information for beginners, mail-order men, agents; 300% profit. Nite Mail Order & Supply Co., 699 27th St., Denver, Colo.

800 PERCENT Profit. Agents applying Goldfoil window letters. Samples free. Lowest prices. Luckysign Letter Co., 515 Evergreen Ave., Brooklyn, N. Y.

AGENTS—Signs of all kinds. Big money-making line. Prices right. Address Attracto Sign Works, F. Cicero P. O., Chicago.

I AM making \$20 daily. You can too—with my plan and instructions. Price \$1.00. Scott, Box 391, Globe, Ariz.

DEAL Direct—8-11 Repeaters, foods, toilet preparations, etc. Big commission, cash or credit. Fletcher Production Company, 415 E. 69th, Chicago.

START little Mail Order business anywhere. Home employment evenings. Everything furnished. Stamp brings instruction. Bruce Pier, 74 Cortland Street, New York.

AGENTS—make \$75 weekly selling our famous silk knitted neckties. Pennsylvania Hosiery Mills, 20 South 17th Street, Philadelphia, Pa.

AGENTS: Choice opportunity offered selling imported Jewish New Year Name Cards. 1922 d-signs. Forman Printery, Deot. J. Plantaville, Conn.

AGENTS to sell Kerosene Burners for all purposes. Big Profits. Economy Mfg. Co., 616 W. Monroe St., Chicago.

GOLD Leaf Sign Letters: make and sell; profits exceed 1,000%; immense demand; particulars free. Johnston Co., Quincy, Ill.

NOVELTY from Alaska. 200% profit. Full package free postpaid. Voltine Company, 1258 East 61st Street, Cleveland, Ohio.

AGENT Seekers—5,000 Live Agents' names and addresses, typed \$3 a thousand. Hough Co., Meriden, Conn.

SAMPLE "Cutwell" Aluminum Pocket Pencil Sharpener 25c postpaid. Agents wanted. Roman Arndt, 3131 Meldrum, Detroit, Mich.

AGENTS. Sell lightning needle threads. \$10 daily. Costs 5c, sells 25c. Address Maher Co., Dover, N. J.

FREE—Twenty big money making opportunities free. Address Lawrence Products Company, Beaver Dam, Wis.

FREE—Formula Catalog. S. & H. Laboratories, Boylston Building, Chicago.

"HOW to Sell Patents" free. Patent News-O, Washington, D. C.

AGENTS Wanted (in U. S. only). Make your Christmas Money. Sell our exclusive line of engraved Xmas Cards. The very best in design, quality and price. Big commission allowed. No money needed. Write for free samples and particulars at once, as no answers will be considered if received later than November 30th. Knight & Co., Box 276, Riverton, N. J.

GREATEST Sensation! Eleven-piece soap and toilet set, selling like blazes for \$1.75 with \$1 dressmaker's shears free to each customer; other unique plans. E. M. Davis Company, Dept. 508, Chicago.

GREAT Profits Assured capable men joining immediately national selling organization for Everflo Self-filling ink-pen-cil pen. Writes with ink instead of lead. Send for Profit Proposition. Everflo Pen Co., Dept. 56, Grand Rapids, Mich.

EVERY Raincoat Agent should get our proposition at once. If you have never sold raincoats and waterproofed overcoats now is the time to start. Any man able to talk is able to sell raincoats. Write for our "profit sharing, collective buying, superior quality" offer. Associated Raincoat Agents, Inc., 448-A North Wells, Chicago.

AGENTS: Wonderful opportunity in Japanese Novelty. Write P. Ponna, U. S. Wholesaler, New Richmond, Wis.

YOU can make \$10 to \$20 daily selling Rex India Fibre Brooms. Outlast three ordinary brooms. 100% Profit. Write Rex Fibre Products Company, 145-C New Jersey Ave., Brooklyn, N. Y.

AGENTS. \$25.00 a week for spare time. Suits \$13.45, pants \$3.45 up. Money-back guarantee. Guaranteed Quality. Line well known. Samples free. Write Chicago Tailors Association, Dept. 106, Chicago.

AGENTS—Crew men, novelty men. Gloo-Pen, a 50c mucilage fountain pen; everybody buys on demonstration. Write for big profit plan. Gloo-Pen Co., 56-FF Pine St., New York.

SELLS Like Hot Cakes; big profits; new ironing wax pad and asbestos rest; clamps board; perfumes clothes; outfit 10c. Yankee Mfg. Co., 380 Atlantic Ave., Brooklyn, N. Y.

"POLMET" Polishing Cloth cleans all metals. Retail 25c. Sample free. Gale & Co., Inc., 15 Edinboro St., Boston.

CLARKE made \$18 an hour selling vest-pocket windshield cleaner needed by every autoist, motorman, engineer; one rub keeps glass clear 24 hours; 60,000 sold; amazing proposition free. Security Mfg. Co., Dept. 627, Toledo, Ohio.

100% PROFIT selling our felt rugs to homes, hotels, offices, etc. Everybody buys. We are manufacturers, not jobbers. Prices defy competition. \$75 week easy. Newark Felt Rug Company, 56-C Bergen Street, Newark, N. J.

AGENTS: Big profits, no competition. Make \$5 to \$15 daily selling our beautiful Scripture Text Calendars. Agents now selling from 10,000 to 50,000 yearly. Write now. Address Messenger Publ. Co., Dept. 116, 314 W. Superior St., Chicago, Ill.

AGENTS—Six new fast-selling necessities; big demand; unique selling plan; makes dollar an hour; credit given; samples free. Consolidated Portrait Co., Desk E, Chicago.

WANTED—District Purchasing Agents. \$250 per month. Steady employment and exclusive territory. Write now. Experience unnecessary. National Instrument Company, 4705 North Hamilton, Chicago, Ill.

SPIRAL Curtain Rods, broom protectors, Ironing Sheet Clips, factory prices. Other fast sellers. Address Hunt Mfg. Co., Box 1652P, Paterson, N. J.

AGENTS and distributors wanted to sell our Radio-Gaslighters. 25 cent sellers. 300% clear profit. Universal demand. Write for proof. Ignition Products Company, Inc., 12E Union Square, New York.

WHY work for others? Make and sell your own goods. We show you how. Enormous profits. Write quick for free book explaining everything. Thos. Steel, President, 624 Main, Richmond, Va.

"\$10 A DAY and More." our new book, shows clearly how you may gain sure success and large profits selling Guaranteed Hosiery and Underwear, factory to family. It is free. Write today. C. & D. Company, 41-E Grand Rapids, Mich.

AMBITIOUS Men, write today for attractive proposition, selling subscriptions to America's most popular automobile and sportsman's magazine. Quick sales. Big profits. Pleasant work. Digest Pub. Co., 9505 Butler Bldg., Cincinnati, O.

EARN big money fast applying gold initials to autos. Every owner buys—\$1.35 profit on \$1.50 sale—particulars and samples free. Write quick. Lithogram Co., Dept. 17, East Orange, N. J.

LARGE Shirt Manufacturer wants Agents to sell complete line of shirts direct to wearer. Exclusive patterns. Big values. Free samples. Madison Mills, 543 Broadway, New York, N. Y.

WHY work for others? Make and sell your own goods. We show you how. Enormous profits. Write quick for free book explaining everything. Thos. Steel, President, 624 Main, Richmond, Va.

A BUSINESS of Your Own—Make sparkling glass name plates, numbers, checkboards, medallions, signs; big illustrated book free. E. Palmer, 511, Wooster, O.

AGENTS—Make 100%. Toilet articles, Perfumes, Extracts, Household necessities. Sample Case Free. LaDerma Co., Dept. A, Main and Walnut, St. Louis, Mo.

WANTED—Agents and Salesmen to handle Europe's Famous Wonder Glass, the newly imported Prism "Binoculet." For theatre, hunting, yachting, races, touring, aviation, etc. This is the smallest and of its size the most powerful Glass in the world. Can be carried in vest pocket or ladies' bag. Retail at \$25.00. Confidential wholesale price to agents \$12.50. Sent with privilege of examination, if satisfied pay expressman, otherwise return at our expense. George Mayerle Optical Co., General Importers, established 1894, 960 Market St., San Francisco, Calif. (Order before the new tariff doubles prices.)

WHY Buy Your Goods. Use Miller's Guaranteed Manufacturer's Reliable Formulas for Manufacturing Agent-Specialty Salesman's Big Selling Specialties—all lines. Free Descriptive Literature Concerning Non-Thermic Ice Cloths, Grape-Ola, and Flavors for all beverages, New Food Specialties, Launderite and New Laundry products. All latest Automobile Specialties including 666 Polish and Amazon Rubber Repair and many other meritorious sellers which can be manufactured in your home, store or office without machinery. Make your start now. Stamp brings Valuable Information. Miller, Chemist, Tampa, Fla.

A WONDERFUL Seller! Any man, woman, boy or girl can make big wages. Some agents make from \$3.00 to \$20.00 per day. Crimp Grip Clothes Line fasteners are a simple, time-saving device for holding a rope—also used for many other purposes. It pays for itself quickly in time saved on wash days. No knots—it fastens and releases quickly. Every home a prospect. Every housewife who uses Crimp Grips—and there are thousands of them—is a booster. There is but one Crimp Grip. Write for particulars, or send 50c for one pair and a mounted sample, with full particulars to agents. Crimp Grip Company, Belvidere, Illinois.

AGENTS, \$60 to \$200 a week. Free samples gold and silver sign letters for office windows, store fronts and glass signs of all kinds. Anyone can put them on. No experience necessary. Big demand everywhere. Over 500% profit. Fred Foley, Binghamton, N. Y., made \$485.00 first month. Albert Gibbons, Kansas City, made \$212.00 in ten days. Liberal offer to general agents. Write today for sample of our high-grade window letters. Address, Metallic Letter Co., 431-C North Clark St., Chicago, Ill.

"IDEAL" Sideline. "Sureshot" Selling Method Free. K. Home, 1957 Warren, Chicago.

WHY work for others? Make and sell your own goods. We show you how. Enormous profits. Write quick for free book explaining everything. Thos. Steel, President, 624 Main, Richmond, Va.

GET our Big Money proposition and Free Samples on Easy Applied Transfer Letters and be convinced. Auto Monogram Supply, 16 Green St., Newark, N. J.

BIG earnings and steady repeat business assured agents selling to women and homes, finest, most complete line toilet preparations and specialties. Sure Success Plan. Get details today. Colonial Chemical Company, 631-N, Penn Avenue, Pittsburgh, Pa.

SELL "Amens" Shirts; best-looking, biggest value. Manufacturer to wearer. Every order nets profit \$1.50-\$2.25. Write for winning sales plan. Menzin Shirt Co., 3863-A, Third Ave., New York.

AGENTS—A demonstration sells our Marvel Can Opener, and doubles your money. Cinch your success with our proposition. Staples Mfg. Co., Mt. Vernon, Ind.

AT Last—World's Greatest Adding Machine. Almost human. Retail \$15; work equals \$300 machine. \$500 monthly easily made, demonstrating to stores, offices, garages, factories. Simple, easy; adds, subtracts, multiplies, divides, automatically. Speedy, accurate, durable handsome. Five year guarantee. Tremendous demand; amazing profits. Liberal trial offer. Protected territory. Write quick. Lightning Calculator Corp., Dept. F, Grand Rapids, Mich.

WE Start You Without a Dollar. Soaps, Extracts, Perfumes, Toilet Goods. Experience unnecessary. Carnation Co., Dept. 281, St. Louis.

LIVE Representatives Wanted: Agents, crew managers, salesmen, distributors, side line men and house to house canvassers who desire a splendid opportunity to make big money with "Fearless Miners." This is a product that every housewife wants. Now on sale at all State Street Department Stores, Chicago, also handled by dealers and jobbers of consequence. Agents working alone are now making \$12.00 to \$20.00 per day. Crew managers are earning at the rate of \$10,000 annually by having a small crew working from house to house. If you have the ability and experience and are looking for something good, write for our Agents' Free Sample Proposition. It is a Big Money Maker. The Ernest Reich Company, 337 W. Madison St., Chicago, Illinois.

1000 AGENTS wanted to sell "Cleano" Washing Compound direct to homes. 300% profit. Easy to sell. DeHaven Manufacturing Co., 344 Garfield Avenue, Chicago.

"SUPERIOR" Wind Deflectors a necessity for all automobiles. Agents write. Service Sales Corporation, Shelby, Ohio.

TUTTHILL Brand Honey is finest grade. Good repeater. Salesmen—male and female in Chicago and suburbs wanted. Orders can also be gotten in evenings. Apply 17 W. Illinois St., Chicago.

ANY man handy with paint brush or light tools can start new mechanical business on nearly nothing; needed everywhere; nearly all profit; experience not required. John Braceland, 1457 So. Ninth, Philadelphia, Pa.

\$8.00 TO \$20.00 per day. A wonderful seller. Any man, woman, boy or girl can make big wages selling Crimp Grip Clothes Line Fasteners. It is a perfect rope holder and can be used for many purposes. Crimp Grips are a simple, time-saving device. They last a life time and will not rust; it holds the line tight, and saves time on wash days. Every buyer is a booster. Send 50c for Mounted Sample and one pair of Crimp Grip Clothes Line Fasteners. Write for particulars. Crimp Grip Company, Belvidere, Illinois.

PORTRAIT Agents—Earn big money selling our Photo Medallions. Everybody buys. You charge \$3.00; make \$2.40 each sale. \$10 daily easy. Big variety designs. 4-day service. Perry Photo Novelty Corporation, Section 16, 860 Bowery, New York.

EVERYBODY uses extracts. Sell Duo Double Strength Extracts. Complete line household necessities. Big repeaters. Write today. Duo Co., Dept. E1, Attira, N. Y.

LARGE manufacturer wants agents to sell guaranteed made to measure raincoats, Gaberdines and Reversible top and raincoat combined. Make \$75 to \$100 weekly. Profit in advance. We deliver and collect. Outfit free. Standard Raincoat Co., 163 West 21st Street, New York, N. Y.

AGENTS—Sell Skimit Kitchen Cream Separator; nationally advertised; sells on sight; attractive terms; big profits; retails \$1. Skimit Mfg. Co., Oskaloosa, Ia.

AGENTS—Send for sample "Fretnot"— the washday wonder. Be convinced you can do a whirlwind business. You can clear at least \$20 to \$100 weekly, according to spare or whole time. You don't have to talk; if she doesn't buy at sight, leave sample; she will be looking for you long before you are able to make the rounds again. Samples furnished free. Premiums for your customers. Exclusive territory guaranteed to agents who can produce. Credits given. Don't call. P. M. Motter & Sons, 20 E. Jackson Blvd., Chicago.

CENTRAL Indiana Manufacturers now marketing an entirely new auto accessory that makes night driving safe, eliminating glare from approaching headlights. Want general sales managers to open branch office, handle exclusive territory and manage salesmen. Some investment necessary. Profit possibilities practically unlimited. Ray Auto Filter Co., Marion, Ind.

MOST Wonderful Seller. 96c profit every dollar. No stock to carry. License unnecessary. Sample free. Mission. 2421-MP, Smith, Detroit.

BIG Money Makers. Large factory offers you big profits on 150 fast sellers. Toilet gift sets, flavoring extracts, remedies, soaps bring you \$8.00 to \$25.00 daily. Howe of Illinois makes \$4.00 an hour. Sample outfit free to workers. Lincoln Chemical Works, Dept. 155, 2956 No. Leavitt, Chicago.

AGENTS—Enormous profits selling Genuine Gold Leaf sign letters. Guaranteed not to fade. Establish a permanent business or travel. Anybody can do it. Free samples. Guarantee Sign Service, A 430 South California Ave., Chicago.

AGENTS—Earn \$50 to \$100 a week selling Marquette Tire Tool. Simple demonstration sells it. Removes tires in a jiffy. Every owner wants it. Thousands in use. Exclusive territory going fast. Agent's sample \$1.25, retails at \$3.50. Write for full particulars or send \$1.25 for sample and particulars. Marquette Mfg. Co., Dept. A, 218 S. Wabasha Ave., St. Paul, Minn.

CALIFORNIA Rosebuds selling like hot cakes. Agents coining money; new stuff. Big profits. Catalog free. Mission, 2421-PM, Smith, Detroit.

MOTOR Ignition Amplifier—A Wonder Invention! Gives new power to an old motor and more power to the new. Sell to garages, accessory dealers and users. Quick action, big money and satisfaction. Write for prices and literature. Motor Ignition Corporation, Mfgs., Albany, N. Y.

SALES Representative wanted every county to give all or spare time. Position worth \$1,200 to \$3,000 yearly. No previous experience or capital necessary. Write for full particulars. A. A. Silver-Chamberlin Co., Clayton, N. J.

GALLAGHER made \$336.00 in one week selling guaranteed Collection Systems, used by all business men. Sayers Mfg., 2815 Sheffield Ave., Chicago, Ill.

AGENTS—Big Profits, Gold Sign letters easily applied, samples free. Liberal offer to General Agents. Dept. C, Interstate Sign, 2620 No. Halsted St., Chicago.

WANTED—Tailoring Sales Agent— Make big money from very start—\$60.00 to \$75.00 weekly. Largest made-to-measure tailoring house, furnishing an equipment of five hundred woolsens, wants you to take orders. Satisfaction guaranteed. Biggest merchants in many towns have started with our line. If you want to establish yourself permanently in business and make big money write for full particulars, giving your experience as salesman or tailor's sales agent. H. F. Foster, Sales Manager, Lock Box 483, Chicago.

AMERICO Booster auxiliary water carburetor makes autos burn water. Eliminates carbon. Low cost; liberal profits; details free. Americo Co., Dept. 178, Cincinnati, Ohio.

SELL Necessities. Everybody needs and buys the "Business Guide." Bryant cleared \$800.00 in July. Send for sample. It's free. Nichols Co., Box 4-B, Naperville, Ill.

WHY work for others? Make and sell your own goods. We show you how. Enormous profits. Write quick for free book explaining everything. Thos. Steel, President, 624 Main, Richmond, Va.

AGENTS: Big Returns, fast office sellers; particulars and samples free. One Dip Pen Co., 2 Daily Record, Baltimore, Md.

AGENTS make 500% profit handling Auto Monograms, New Pictures, Window Letters, Transfer Flags, Novelty Signs. Catalog Free. Write Hinton Co., Star City, Ind.

PORTRAIT Agents, who want good work and prompt service and who desire to purchase their frames at factory prices, should write us at once for catalog and price list. W. G. Hannan Co., Dept. A-8, 57 E. 18th St., Chicago, Ill.

AGENTS—New patented curtain rod, necessity in every home; big profit; 4 to 10 sales at every house. Write for free sample. Home Curtain Rod Co., Providence, R. I.

AGENTS—Clever Invention! Inkspoon makes every pen a fountain pen. Fast office seller; big profit, demand increasing everywhere. Exclusive territory offered. Sample free. H. Marul Company, Tribune Bldg., New York, N. Y.

AGENTS: Big Money Monogramming By Transfer Method. Catalogue Showing Over 50 Styles and Particulars Free. Motorist's Accessories Co., Mansfield, Ohio.

\$200 WEEKLY. Free samples. Sell gold sign letters to stores, offices. No experience. Big future guaranteed. Can travel. Exclusive territory. Become our general agent. Acme Letter Co., 2800D Congress, Chicago.

MAKE \$25 to \$50 Week representing Clows' Famous Philadelphia Hosiery, direct from mill—for men, women, children. Every pair guaranteed. Prices that win. Free book "How to Start" tells the story. George Clows Company, Desk 31, Philadelphia, Pa.

AGENTS—Sell Patented Cigar Lighters and Cigar-Case Moisteners. Big Profits. Start making money at once. Write for circulars, cuts and sales plan. Drake Mfg. Co., Dept. M., Milwaukee, Wis.

MAKE \$31.00 Profit With Only \$1.50 Selling Pure Gold Leaf Monograms for Automobiles, Trunks, Bags—Window and Wagon Letters. Applied instantly. No experience necessary. No. 1 Outfit brings you \$32.50—cost only \$1.50—you make \$31.00 profit. Get colored catalog. Full particulars—free samples (36 designs). "Hurry." Nulife Auto Aid, Hartford, Conn.

LIVE Agents make \$10 Day selling Eureka Strainer and Splash Preventor for every water faucet. Takes on sight. Widely advertised and known. Get details today. A. B. Seed Filter Company, 73 Franklin, New York.

MAKE 600% Profit, Free Samples, Lowest priced Gold window letters for stores, offices. Anybody can do it. Large demand. Exclusive territory. Big future. Sideline. Acme Letter Co., 2800-D, Congress, Chicago.

SELFOLITE—Agents, Streetmen—Selfolite lights any fire while you sleep, or any time. Performs surprising stunts. Newly patented. Sample 25c, postpaid; money back. Particulars. Kaytwo Mfg. Co., C195 Station A, Boston, Mass.

BEST Proposition on Earth. Kitchen Specialty Every Woman Wants. Nothing like it in existence. 200% profit. Best Novelty Mfg. Co., Dept. C, 160 N. Wells, Chicago.

AGENTS—If you are making less than \$300 a month our proposition on Sentinel Burglar Alarms for windows and doors will interest you. Many agents earn \$20 daily. Brand new inventions. No wires, batteries or nails. Instantly attached to any door or window. Handsomely nickel plated. Sell on sight. No competition. Provides cheap burglar insurance. Big money makers. Write today for extremely liberal terms to agents. Sentinel Alarm Co., 140 S. Dearborn St., Chicago, Ill.

MAKE \$2 an Hour. Article that removes iron rust, grass, medicine, fruit, mildew stains. Cleans Panama and Straw Hats. Bleaches clothes. Sells Every home. Write for free demonstrating outfit and start taking orders at once. Christy, 81A Union, Newark, N. Y.

AGENTS make a dollar an hour. Sell Mendets, a patent patch for instantly mending leaks in all utensils. Sample package free. Collette Mfg. Co., Dept. 404-B, Amsterdam, N. Y.

BIG money and Fast Sales. Every owner buys Gold Initials for his auto. You charge \$1.50; make \$1.35. Ten orders a day easy. Write for particulars and free samples. American Monogram Co., Dept. 40, East Orange, N. J.

OUR Ex-Cel Luminous Crucifix shines brilliantly in the dark. Churches, hospitals and individuals are only waiting for a demonstration before buying. Agents make handsome profits. W. G. Hannan Co., Dept. B, 57 E. 18th St., Chicago.

AGENTS—Stamping names on Pocket Key Protectors; sample Check with your name and address, 25c. Stamping Outfits, Emblem Checks, Check Fobs, Name Plates. Hart Mfg. Co., Desk 2, 303 Degraw St., Brooklyn, N. Y.

YOU can be your own boss with our Key Check outfit. Good for \$5 a day stamping names on pocket key checks, fobs, etc. Sample check with your name and address, 25 cents. Pescoe Die Works, Dept. M, Winchester, N. H.

AGENTS: Big profits. Best and cheapest window letters made. Easily applied. Dime brings five samples. Particulars free. Stalbrite Co., 1115 Second Ave., New York.

PATENTS—Write for our free illustrated guide book and Evidence of Conception Blank. Send sketch or model for our opinion of its patentable nature free. Highest references. Prompt attention. Reasonable terms. Victor J. Evans & Co., 163 Ninth, Washington, D. C.

AGENTS—Best seller: Jem Rubber Repair for tires and tubes; supercedes vulcanization at saving of over 300%; put it on cold, vulcanizes itself in two minutes, and is guaranteed to last the life of the tire or tube. Sells to every auto owner and accessory dealer. For particulars how to make big money and free sample, address Amazon Rubber Co., Amazon Bldg., Philadelphia, Pa., Dept. 545.

HIGH-GRADE SALESMEN WANTED

HERE is an opportunity for capable men with sales experience and good references to connect with one of the largest advertising specialty houses in the world. Our line, nationally known, consists of high-grade art and commercial calendars, collifoid, leather, metal and paper specialties. Leads and comprehensive sales help furnished. Every bank and reliable business house is a prospective customer. Liberal commissions with weekly remittances. See our rating in Dun or Bradstreet and if interested write fully. American Art Works, Coshocton, Ohio.

WE are looking for district sales managers to help carry forward the largest and most aggressive business of its kind in the country. It's film advertising. Live actors, not cartoons. Compelling motion-picture sales stories build business for our advertisers and renewal commissions for our salesmen. Ample territory and helpful cooperation for able men. A postal card inquiry brings you the complete story. Alexander Film Company, 1151 Main Ave., Spokane, Wash.

SIX million Ford Owners are red-hot prospects for the Bellable Ford Oil Gauge, best on the market. Active salesman has unlimited opportunity to make big income. Sells easy, discount unusually high. Write Milwaukee Device Co., 410 Loan & Trust Bldg., Milwaukee, Wis.

SALESMEN—Sell "Zim's Peerless"—the "bumdinger" collection system. Exclusive collecting features makes sales easy. Merchants buy "Zim's Peerless"—cast other systems aside. It's the seller, boys. Sells \$7.50. Creditors' Association, 312 E. McKnight Bldg., Minneapolis, Minn.

SALESMAN: If you want \$6,000 this year, write me. Strong line for retail stores. Nationally advertised. Liberal weekly advance to producers. W. Morgan, Mgr., 1929 Euclid, Cleveland, Ohio, Dept. 290.

SALESMEN—Wonderful new patented device for Ford cars. Sold on money-back guarantee. Exclusive or side line. Real money-maker. Protected territory. Auto Sun Products Company, Dept. C, Cincinnati, Ohio.

OLD established manufacturer wants reliable salesmen for line of auto belts, timers, brake lining, piston rings, plugs and other necessities. J. C. Mehan, 1301 Michigan Blvd., Chicago, Ill.

\$20.00 TO \$30.00 a Day for Salesmen Selling our Auto Accessories to Dealers and Consumers. Send \$1.00 for several Good Sellers. David Simon, 4927 Fountain Avenue, St. Louis, Mo.

SALESMEN, Act Quick. Ten patented auto necessities. Spark plugs, visors, windshield cleaners, hose clamps, etc. Generous commissions. Jubilee Mfg. Co., 12 Sta. C, Omaha, Neb.

SALESMAN wanted with car. \$100 weekly. Sell new tires, tubes to car owners. Guaranteed in writing. Experience unnecessary. No investment. Manager, 1434 Wabash, Chicago.

SALESMEN: Newly Patented Powder Puffs; No Lady will be without it; fortune selling it. Walters Specialty Co., 1217 N. Paulina St., Dept. 3, Chicago.

WANTED—Salesmen for Metal Polish. Silver Polish, cake soap, shaving soap, etc. Good commissions, exclusive territory, opportunity for advancement. The Skat Co., Hartford, Conn.

EARN money selling men's shoes direct to wearer, full or spare time. Liberal commission. Write immediately. Senate Shoe Company, Bridgeport, Conn.

WE want a man to represent us. Our suits, overcoats, blankets, work pants, raincoats are made in our own factory from wools made in our own mill and sold direct to consumer at prices that defy all competition. Fabrics and tailoring are the finest. If you have a clean record, stand well in your community and can give your entire-time to our work, we will show you how you can make up to \$150.00 per week. No experience or capital required. For full particulars address G. H. Linder, General Manager, Taylor-Wellis Co., C-2740 North Paulina, Chicago.

HIGH-GRADE Specialty Salesmen Wanted—Something New—Fire Fighter sells easily. Makes a spectacular demonstration; car owners, homes, factories, stores, practically buy on sight. Our men make \$10.00 to \$50.00 a day; exclusive territory. If you wish to establish a business of your own with unlimited possibilities for making big money, write us today. Fry-Fyter Co., 1650 Fry-Fyter Bldg., Dayton, Ohio.

WERE you ever offered a grocery store? You can handle Sugar, Flour, Canned Goods, Dried Fruit, Coffee and entire line of groceries, as well as Paints, Roofing, Aluminum Ware and Automobile Oils, with no rent to pay; no money invested. Take large orders from samples. Goods are guaranteed and proven quality. Selling experience not necessary. Steady, profitable work for "workers." Address Hitchcock-Hill Co., Dept. 290, Chicago, Ill. Reference: Any Bank or Express Co.

SALESMEN: We desire energetic men of ability, high moral standing and pleasing personality; accustomed to earning from \$5,000 to \$10,000 yearly; experience in this particular line not necessary, but success in previous undertakings absolutely essential; to men who can measure up to our standards, an exceptional proposition will be made. When replying state fully past connections and references. Address Room 1280, 100 Broadway, New York City.

SALESMEN Sell Tailoring—one of the most profitable of all lines. Our better one-price line of Guaranteed All-Wool Suits at \$29.75 sells on sight. Every order pays you a good profit in advance. Experience not necessary. We supply everything. This is a rare opportunity. Get the facts—today. Park Tailoring Company, Dept. 411, Chicago.

SALESMEN'S Rights: Shows why no license is required. Gives legal facts and advice which will enable you to avoid trouble from local or state authorities. Money back if you do not think this book worth \$25.00 to you. Mailed on receipt of \$1.00. Address H. S. Hill, 38-G, W. Kinzie St., Chicago.

MAKE \$50 Daily. Something New! 400% Profit. All business. Professional Men Need It. Sells \$5. Costs \$1. Brooks, Texas, sold 20 first day, profit \$80. Big weekly repeater. Sells quickly. Experience unnecessary. Write today for territory wanted. Sample outfit free. Federal Association, 71-D Asylum St., Hartford, Conn.

ONLY one policy a day means \$150 per month profit; same on renewals. Policy pays \$5,000 death; \$25 weekly benefit for injury or sickness. Premium \$10 yearly. Full or spare time. Easy seller. Write quick for territory. Underwriters, Dept. K-34, Newark, N. J.

SALESMEN Wanted: Have you ever wanted to sell? If you are an auto mechanic and feel you could sell, write us. We pay liberal commissions and bonus on a rapid selling, big profit maker. Address The Unigarto Co., Fort Wayne, Ind.

AGENTS—Everywhere—We Want 10,000 men to sell the "Safety First" Rain Pad. Indispensable to every motorist. Quick demonstrator, lightning seller. Thousands satisfied users. Big profits for you. Good territory open. International Specialties Co., Polson Bldg., Seattle, Wash.

MAKE \$5,000 every year—\$2,000 in spare time. You share profits besides. Show "Weather Monarch" Raincoats and Waterproofed Overcoats. Ask about "Duol Coat" (No. 999). Get sample raincoat free. Associated Raincoat Agents, Inc. 446-A North Wells, Chicago.

TERRITORIAL and local salesmen. Climax Oil Burners hottest residence furnace burners made. Scientific principles prevent smoke and soot; side-line success, big demand. E. L. Miller Mfg. Co., 2224 West Third, Kansas City.

SALESMEN, Local or Traveling, make \$75 a week selling our advertising novelties. Largest assortment on the market. Calendars, Pencils, yardsticks, whistles, etc. Liberal terms. Entire year proposition. Pershing Mfg. Company, South Bend, Ind.

SALESMEN Investigate—Wonderful new check protector. Retail for \$10, costs you \$4. Equals protection of \$50 machine. Big seller to business and professional men. B. Lewis, 1821 Berceau Ave., Chicago.

SALESMEN—Profitable agency for household utility. Coal shortage creates unusually big market. Men of energy and ability backed by strong advertising. Free training. Exclusive territory assigned. Write Crown, Richmond, Ind.

SALESMEN—Your opportunity to earn \$60 weekly taking orders for the best repeating hand-made cigars in America, direct to smoker. Santa Clara Co., 290 Washington St., Brooklyn, N. Y.

SALESMEN, with cars, new proposition: sell publicity service to banks and merchants; no advances; straight commission; possible earnings \$5,000 upward yearly. Hamilton Service Corporation, 1819 Broadway, New York.

DISTRICT managers to appoint salesmen; exclusive rights, sanitary brushes; dusters, mops. Big profits. Newway Brush Co., Hartford, Conn.

SALESMEN—Ammo Salve sixty cents; Piles, infections. Commission. Ammann McMahon, Peotone, Ill.

AMBITIOUS Men, write today for attractive proposition, selling subscriptions to America's most popular Automobile and sportsman's magazine. Quick sales. Big profits. Pleasant work. Digest Pub. Co., 9545 Butler Bldg., Cincinnati, O.

SALESMEN make good side money selling small acetylene torch to garages and shops. Easy to sell. St. Paul Welding & Mfg. Co., St. Paul, Minn.

SALESMEN Can make \$5.00 a day selling our Calendars, Pencils, Signs, Advertising Novelties, Yardsticks, Whistles, etc. Liberal terms. Sells entire year. Fine side line. Local and traveling agencies. Model Calendar Co., Dept. 226, South Bend, Ind.

A BUSINESS of your own. Aggressive, ambitious men who seek new and larger business opportunities and expect to scratch and hustle to build real prosperity. Such men can secure factory sales connection and exclusive wholesale distribution on high-grade automobile necessities becoming well-known through national advertising. More than sales job; an opportunity to build permanent and profitable business with "Money back" merchandise that sells and repeats. Must have references, financial standing, evidence of past success and business promotion experiences outlined. Waste no time on postal cards or letters that do not state particulars requested. Correspondence with new, wide-awake specialty distributors solicited. Write Robert Bowes Company, Indianapolis, Ind.

ADVERTISING and Novelty Salesmen of ability, experience and large earning capacity can connect with manufacturer leather and advertising specialties in ready demand among banks and big business concerns. Fine contract, commission basis. \$150 on single order not unusual. Selling aid extended. Write us fully about your experience. David H. Zell, Inc., Dept. F, 582 Broadway, New York.

SOMETHING New—a necessity—Zim's Peerless Collection System. Salesmen making big money. Exclusive collecting features aid salesmen. Creditors' Association, 312-E McKnight Bldg., Minneapolis, Minn.

MINUTES pay dollars demonstrating world's greatest specialty. Wonderful new three-pound Adding Machine. Retail \$15. Work equals \$300.00 machine. Adds, subtracts, multiplies, divides, automatically. Speedy, accurate, durable, handsome. Five-year Guarantee. Tremendous demand everywhere. Amazing profits, main or side-line. Experience unnecessary. Write quick for liberal trial offer and protected territory. Lightning Calculator Co., Dept. G, Grand Rapids, Mich.

AGENTS—\$60-\$200 a week. Free samples. Gold sign letters anyone can put on store windows. Liberal offer to general agents. Metallic Letter Co., 431-E N. Clark St., Chicago.

57 MILES per gallon made with new patented gasoline Vaporizer. Write for particulars. Vaporizer Co., Pukwana, S. Dak.

CALIFORNIA Rosebuds selling like hot cakes. Agents coining money. Absolutely new. Big profits. Catalog free. Mission, 2421-SP, Smith, Detroit.

EASY to sell Groceries, Paints, Automobile Oils, Roofing, Stock Food to consumers from samples, no capital or experience necessary; steady, profitable work. Commissions advanced. Satisfaction guaranteed. 50 years in business. Write for full particulars. Lovern & Brown Co., Wholesale Grocers, 1775 S. State Street, Chicago, Ill.

BEST Seller: Jem Rubber Repair for tires and tubes; supersedes vulcanization at saving of over 800%; put it on cold, vulcanizes itself in two minutes, guaranteed to last life of tire or tube; sells to every auto owner and accessory dealer. Get particulars how to make big money and free sample. Amazon Rubber Co., Philadelphia, Pa., Dept. 516.

HELP WANTED

DISTRICT Managers—Big profits. Men capable of organizing and managing crews of lady solicitors can easily clear \$100 to \$300 per week with the B. & G. Protector, the original and best Protector on the market. Every woman needs and buys it. Two grades, B. & G. Rubber Co., 618 Penn Avenue, Dept. 178, Pittsburgh, Pa.

TIME Tells, but don't waste too much finding out. Are you looking for a better line? One that will stand the time test? That is exactly what we have to offer. Necessities—fifty-five of them needed in every home. And they are so much better and such real value that they practically sell themselves. Regardless of your natural ability any sincere salesman can make profits much larger than he is accustomed to. Get Right: Write Now. B. & G. Rubber Mfg. Co., 618 Penn. Ave., Pittsburgh, Pa., Dept. 177.

HAVING sold 150,000 of a household appliance in New England we now offer direct salesmen and district managers in other territory equal opportunity to earn from \$2,500 to \$5,000 yearly. The Reeves Company, 65 Broad Street, Milford, Conn.

START Silvering Mirrors, Auto Headlights, Tableware, etc. Plans free. Clarence Sprinkle, Dept. 28, Marion, Ind.

GOVERNMENT Clerical Positions open to Men, Women, Girls 18, over; Postoffice, Railway Mail, Departmental, Other Positions. Good salary. Experience unnecessary. Examination soon. Full particulars free. Write Columbia School Civil Service, 411 Pope Bldg., Washington, D. C.

AGENTS: Cost \$5.00, your profit \$80.50, transferring monograms on autos, trunks, bags, furniture, etc. No experience, no license. Write for free samples. Transfer Monogram Co., Inc., 10 Orchard St., Dept. 151, Newark, N. J.

EARN \$10 daily silvering mirrors, plating and refinishing metalware, autos, chandeliers, bedsteads, headlights. Outfits furnished. E. Decio Laboratories, 1183 Broadway, New York.

START a pressing, cleaning and dyeing shop, excellent field, splend'd profits. We tell you how. Write for booklet, Ben-Vende System, Dept. C, Charlotte, N. C.

NEW Managers—Xmas Tag and Seal Packages. 39 Pieces in each 16c package. \$4.00 hundred postpaid. Cash with order. Your profit \$3.00 hundred if you pay Boys and Girls 75c for selling 25. Send \$1.00 for 25 packages and silent salesman display sheet. Orleans Parcel Post Co., 808 Water St., Orleans, Va.

\$5 TO \$15 Daily Easy—Your pay in advance, introducing new style guaranteed hose. Must wear or replaced free. No capital or experience required. Just show samples, write orders. We deliver and collect. Elegant outfit furnished. All colors and grades, including silks and heathers. Mac-O-Chee Mills Company, Desk 16510, Cincinnati, Ohio.

U. S. GOVERNMENT continually needs men—women over 17. Steady positions, \$92 to \$190 month. No strike or layoffs. Easy pleasant office or outside work. Quick, steady raise. Paid vacation. Common education sufficient. "Pull" unnecessary. Write immediately for free list positions now open to you. Franklin Institute, Dept. J-3, Rochester, N. Y.

SALESMEN—distributors—agents—establish a permanent business selling patented necessity to grocers; sells readily. Write at once for exclusive distributor proposition. Address Gilbert & Co., 10 West 18th St., New York.

ORGANIZERS, National and local everywhere. Commission \$5,000 up. Loyal Order of Buffalos already established. State agents, nationality, experience. I. P. Snyder, Sup. Sec., 399 South Sixth St., Newark, N. J.

U. S. GOVERNMENT wants help. Men—women, over 17. \$92—\$190 month. Steady. Common education sufficient. List positions free. Write immediately. Franklin Institute, Dept. J-21, Rochester, N. Y.

ALL men, women, boys, girls, 17 to 60, willing to accept Government Positions, \$117—\$190, traveling or stationary. Write Mr. Ozment, 101, St. Louis, immediately.

DISTRICT Representatives for quick selling Household Specialties. Opportunity build permanent, profitable business. Lafayette North, Fourth St., Philadelphia, Pa. Write for address nearest branch.

MEN, Women, over 18, desiring Government positions, \$1400 up, write immediately for full information. Chicago Civil Service College, A-41 Kessler Building, Chicago.

WANTED—men—women, over 17. U. S. Government Jobs. Steady. \$100 month. List positions open—free. Franklin Institute, Dept. J-21, Rochester, N. Y.

START little Mail Order business anywhere. Home employment evenings. Everything furnished. Stamp brings instruction. Bailey Pier, 74 Cortlandt Street, New York.

GOVERNMENT Railway Mail Clerks—commence \$135 month. List positions free. Write immediately. Franklin Institute, Dept. J-21, Rochester, N. Y.

MEN and Women to mail circulars at home. Sample articles and instructions 25c. Morris, 2395 N. Gratz, Philadelphia.

WANTED—Men—Boys. \$35 week. Become Automobile experts. Sample lessons free. Franklin Institute, Dept. J-401, Rochester, N. Y.

WANTED—Railway Mail Clerks. \$135 month. List positions open—free. Franklin Institute, Dept. J-21, Rochester, N. Y.

SALESMEN—Become Independent. Own your business; experience unnecessary; selling our \$7,500 Accidental Death, \$50 Accident, \$25 Sick Weekly Benefits; \$12.50 yearly; other amounts proportionate. Guaranteed steady income from renewals. \$250,000 deposited Insurance Department. Registration Dept. A, Newark, N. J.

SILVERING mirrors, French plate taught. Easy to learn. Immense profits. Plans free. Wear Mirror Works, Excelsior Springs, Mo.

UNITED States Government Wants Men. Excellent positions at attractive salaries. Railway Mail Clerk Examination soon. Let our expert (former United States Civil Service Examiner) prepare you for this and other fine positions. Write today for free catalog PM, Patterson Civil Service School, Rochester, N. Y.

BE a Railway Traffic Inspector! \$110 to \$250 monthly; expenses paid after 3 months' spare-time study. Splendid opportunities. Position guaranteed or money refunded. Write for free booklet CM-46, Stand. Business Training Inst., Buffalo, N. Y.

STORIES, poems, plays, etc., are wanted for publication. Good ideas bring big money. Submit manuscripts or write Literary Bureau, 522, Hannibal, Mo.

\$100 MADE in one week by young man in small town without capital or experience in local advertising business. Why can't you do likewise? Free book tells how. S. Meyer, 211 Seventh St., Louisville, Ky.

AMBITIOUS Men, write today for attractive proposition, selling subscriptions to America's most popular Automobile and sportsman's magazine. Quick sales. Big profits. Pleasant work. Digest Pub. Co., 9505 Butler Bldg., Cincinnati, O.

MEN wanted to qualify for Firemen. Brakemen. Transportation furnished. Write W. Bogges, St. Louis.

WANTED: Railway Mail Clerks—\$1,600 to \$2,300. Exams everywhere. Write today for full information, Patterson, Civil Service Expert, Box 4025, Rochester, N. Y.

SIGN Letter Agents and Painters: 500% Profit. Gold and Silver Sign Letters for Stores and Office Windows. Anyone can put on. Big demand. Free Samples. Metallic Letter Co., 431D N. Clark St., Chicago.

WRITE Articles, stories, news, in spare time for newspapers and magazines. Big pay. Copyright book free. Press Syndicate, 553, St. Louis, Mo.

MAKE money writing Photo-plays; details free to beginners. No correspondence course. Producers' League, 230 Wainwright, St. Louis.

INVENTORS desiring to secure patents should write for our book, "How to Get Your Patent," tells our terms and methods. Send sketch for our opinion of its patentable nature. Randolph & Co., Patent Attorneys, 620 P. Washington, D. C.

OUR genuine gold window sign letters are an excellent money-making proposition for handy men. Slans Sign System, St. Antoine St., Detroit, Mich.

SITUATIONS WANTED

INVENTOR, wants position; send stamped envelope. Pilewski, Blairstown, N. J.

FOR ADVERTISERS

ADVERTISERS! Great results by advertising in Evans Magazine. Classified 3c. Order today! E. J. Evans, Box 428, Kenova, W. Va.

THOUSANDS maintain New York addresses. Why? How to increase your advertising results. Free. D. C. Way, 55 New St., New York.

CLASSIFIED advertising brings many inquiries—big profits. Agents; salesmen; business; for sale. Catalogue of leading publications. Send stamps. Dept. One, Climax Advertising Agency, Clinton, Iowa.

INTERNATIONAL Opportunity: A live, inspiring, intensely interesting magazine! Six months 25c. International circulation! Ads: 1c word. Address 2279 First Ave., New York.

COMMERCIAL Engraving and Printing—the most practical and complete book on engraving, printing and allied subjects ever published. Over 800 pages and 1500 illustrations presenting over 3500 distinct ideas on 35 separate subjects. Cloth. Price \$15.00 prepaid. We highly recommend this book. Popular Mechanics Book Dept., 6 N. Michigan Ave., Chicago.

24 WORDS 37 biggest Sunday papers, \$18.96. Proof guaranteed. Kline, Kline Bldg., Kent, Ohio.

CONSULT Us Before Advertising. Jacobus Advertising Service, Irvington, N. J.

ADVERTISE in 24 Big Sunday Newspapers, 25 words \$15.00. Catalog listing 1,000 leading Dailies, Weeklies, Magazines, 4c stamps. Union Advertising, Baltimore Bldg., Chicago.

INCH Display Advertisement 161 Magazines Thrice \$15. Year \$50. Page \$100. Wood's Popular Services, Atlantic City, N. J.

BLOTTERS will advertise your business or product. Samples for stamp. Labarre Company, Pittston, Pa.

SIGNS AND ADVERTISING

THE creating of a good impression is one of the most profitable forms of advertising, and a very good way to create such result is by the judicious use of Morgan Signs. Morgan Aluminum and Bronze Cast Signs and Memorial Tablets are Everlasting, Economical and Artistic. Circular upon request. Morgan Sign Co., Dept. K, 402 W. 27th St., New York City.

INFORMATION

RELIABLE information furnished on any subject or money refunded, 75c. Co-operative Service, Times Plaza, Box C64, Brooklyn, N. Y.

MAILING LISTS

FRESH list 1,000 mail-order buyers \$1.50. Benner Co., Webb City, Mo.

BRAND new list, never used before. Mostly Mid-Western territory. \$2.00 per 500 names. Address M. B. J., Room 925, Popular Mechanics Magazine, Chicago.

TYPEWRITERS AND SUPPLIES

TYPEWRITERS, All Makes. Save one-half. Thoroughly Rebuilt in our factory by the famous "Young Process." Fully guaranteed. Free trial. We handle all standard makes. Cash or sold on easy terms. Write for Catalog. Young Typewriter Co., Dept. 412, Chicago, Ill.

UNDERWOOD Typewriters at far less than manufacturers' price; rebuilt, all worn parts replaced, guaranteed good as new. Cash, installment payments. Write for Catalog 1517. Shipman-Ward Mfg. Co., estab. 1892. Montrose and Ravenswood Ave., Chicago, Ill.

ALL Makes, rebuilt, refinished and guaranteed. Olivets, Underwoods, Monarch, Hemmingsons, others. \$15.00 up. This month's special, Monarch No. 3 only \$28.00 while they last. Send for lists and agents' proposition. Typewriter Exchange, 2316 University, New York City.

TYPEWRITERS, all standard makes, \$10 up. Fully guaranteed. Free trial. Write for Illustrated Bargain List. Northwestern Typewriter Exchange, 320 West Goethe St., Chicago.

DUPLICATORS AND DEVICES

"MODERN" Duplicators save Time, Labor, and Money. Gets Business. Reproduces Typewritten or Panned Letters, Drawings, Lessons, Music, Menus, Bills, Notices, Specifications, Maps or anything in one or more colors. Prints Two per minute. Special Sale On. 30 Days Free Trial. \$2.25 up. Booklet Free. J. E. Durkin-Reeves Co., Pittsburgh, Pa.

YOU can make 50 to 100 copies of a letter, notice, etc., on three cents' worth of Hoyer Quality Compound. Write for free catalog and samples. The Hoyer Duplicator Co., 162 N. Wells St., Chicago.

ADDING MACHINES

FREE Trial. Marvelous new Adding Machine. Adds, Subtracts, Multiplies, Divides, automatically. Work equals \$350.00 machine. Price only \$15.00. Speedy, durable, handsome. Five-year guarantee. Used by largest corporations. Write today for catalog and free trial offer. Lightning Calculator Co., Dept. E, Grand Rapids, Mich.

OPTICAL GOODS

POWERFUL Army field glasses, cheap. G. Walker, Box 633, Cincinnati.

PRINTING, ENGRAVING AND MULTI-GRAPHING

TYPE, Border, Ornaments, Quads, Spaces, Leads, Slugs, Metal Rule, Etc. Large and small fonts or by weight in any quantity at lowest prices. Material guaranteed. Send for catalogue. Washington Monotype Composition Co., 905 to 909 E Street, N. W., Washington, D. C.

100 BOND noteheads beautifully printed in 2 colors and 100 envelopes, 4 lines, \$1.25. D5 CP. Print, Box 133, Kankakee, Ill.

100 BUSINESS Cards, your name and address on a Rubber Stamp, one stamp pad, postpaid, \$1.00. Wm. Sirdevan, Coates Bldg., Ravenna, O.

5,000 5 1/2 x 8 1/2 CIRCULARS, \$8.50; **5 1/2 x 6 1/2**, \$6.50; **Envelope Slips**, \$4.50. Samples—Bargain List Free. Good's Printery, Harrisonburg, Va.

BETTER Printing prepaid, for less money. Samples for stamp. Write today. Model Company, Manchester, Iowa.

225 EACH Bond Letterheads, Envelopes, Billheads, Cards, \$1.25. Combination \$3.00. Economic Press, Leola, N. J.

ALL Printing Prices Smashed. 5,000 Letterheads or Envelopes \$13.85. Samples, Quality Printshop, Marietta, Ohio.

500 TWO-COLOR Letterheads \$2.65. Samples free. "Adverpress," Station C-3, Milwaukee.

WE print anything. Circulars, stationery, Catalogs, Samples. Commercial Press, Batavia, Ohio.

REDUCED prices for better printing. 1,000 Bond letter-heads, \$5.00; 1,000 good envelopes, \$4.25; 1,000 four-page folders, 3 1/2 x 6 1/2 inches, \$12.00. Catalogs, circulars, booklets our specialty. All printing at reduced prices. Samples free. Fantus, 525 S. Dearborn St., Chicago.

PRINTING Outfits—Presses, type supplies, type galleys. Send stamp for catalogue. Model Press, York, Penna.

250 LETTERHEADS, 250 white envelopes, printed and mailed, \$3.00. Samples printing free. Address Sumco, Mohawk, N. Y.

PRE-USED Printing Presses. Type and supplies. List for stamp. Popular Barcafes, Richmond, Pa.

EMBOSSED business, personal stationery. Samples, stamp. Daniels Company, Pittston, Pa.

FOR MEN

ARE You Old at Forty? See our advertisement on page 140 of this issue. The Electro Thermal Company, Steubenville, Ohio.

RAZORS AND BLADES

BLADES—Imported—three dozen \$1. Blade Sharpener \$3. Vest-Pocket Safety Razor 50c. Finest Silver Steel Straight Razors 5/8" Gold Shell, \$3. Agents Wanted everywhere. P. J. Leach, 1416 Broadway, N. Y. City.

SAFETY Razor Blade Sharpener. Money refunded if not satisfied. Address, Foster, 4342 N. Robey St., Chicago, Ill.

FREE—Half dozen new blades, any make, with 4 dozen resharpened, 3c each. Send Ad. Standard Safety Razor, Pittsburgh.

BLADES, resharpened, one edge 2c; double 3c. New York Edge Co., Glen Cove, N. Y.

FOR SMOKERS

HOMESPUN Smoking Tobacco, Mild and Mellow—10 lbs. \$1.50; 20 lbs. \$2.75; delivery guaranteed. We furnish free recipe for preparing Smoking Tobacco Exchange, Sedalia, Ky.

SMOKE Real tobacco, Sample 10c. Folder free. Direct to smoker, East Mailing Co., Paducah, Ky.

PURE Red Leaf Tobacco, quality guaranteed. Best chewing, 4 lbs. \$1.25, 10 lbs. \$3.10. Mild smoking, 4 lbs. \$1.00, 10 lbs. \$2.10. S. J. Collier, O. D. Collier, Agent, Martin, Tenn. "Collier is absolutely honest and reliable." Martin Bank, Raymer, Cashier.

BOATS AND LAUNCHES

16' ROWBOAT easily made. Construction blueprint, 30c. Wee-Sho-U Co., West Market, Detroit, Mich.

"HOW to make your boat leakproof." Send for booklets. L. W. Ferdinand & Co., 152 Kneeland St., Boston, Mass.

GUNS, CUTLERY, SPORTING GOODS, ETC.

DUCK-HUNTER: Freeman's improved extension adds 4 more shots to your Remington Automatic Shot Gun. Put on or taken off in 1 minute and does not alter gun. Order direct. W. A. Freeman, 3612 Bales Ave., Kansas City, Mo. Price \$6.25.

HUNTING-KNIFE Blades, hand forged and hand ground, nickel silver guards, 5 inch 50 cents, 6 inch 60 cents, 7 inch 70 cents. Phil F. Uncapher, Bradford, Pa.

MAUSER Luger, Mannlicher Arms. Catalog, ten cents in stamps. Pacific Arms Corporation, San Francisco, Cal.

ANTIQUES AND WAR RELICS

FOR Dens—Relics Collected from Europe's Battlefields. Catalogue and War Photographs 10c. Will also buy relics. Lieut. Welsh, 2117 Regent Place, Brooklyn, N. Y.

SEND 5c for my best list, coins, Indian relics, antique firearms. F. E. Ellis, Webster Groves, Mo.

GENUINE Indian Baskets and Wampum. Wholesale catalog. Gilham, Kelseyville, Cal.

FURS

FURS, Coats, Scarfs, Muffs, Chokers, etc., made from your raw or tanned furs. Remodeling and Repairing. Enormous savings. Write for Free Catalog today. Tells everything. Arthur Felber Fur Co., Dept. PMS, 25 N. Dearborn St., Chicago Ill.

WEARING APPAREL

SWEATERS, Pure virgin wool, knit to fit. Sold direct. Write for catalogue. Bullard Knitting Mills, Duluth, Minn.

MEN, buy your hats direct from factory. Send for catalogue. Model Hat Mfg. Co., East Orange, N. J.

PHONOGRAPHS AND RECORDS

BUILD Your Own Phonograph and save half. Use genuine "Perfection" motors, tonearms, cabinets, etc. Protected by registered trade-mark. Lowest prices. Catalog free. Federal Supply Company, Indianapolis, Ind.

BUILD a genuine Choraleon phonograph and save over half. Big profit building and selling. We furnish motors, tone-arms, full instructions and all necessary parts. Send for catalog and free blueprint offer. Choraleon Phonograph Co., 1022 11th St., Elkhart, Ind.

SCIENTIFIC Photo Parts that give wonderful results. Write immediately for catalog and new prices. Belltona Company, N. Tonawanda, N. Y.

BEST quality phonograph parts, assuring finest results at big saving. Catalogue for stamp. Superior Phonoparts Co., Erie, Pa.

BUILD your phonograph. Quality Phonoparts. Highest quality spring and electric Motors, Tone Arms, Reproducers, Amplifiers, Case Material and Accessories. Free Blue Prints and Building Instructions. Big saving. Wonderful results. New catalog mailed for ten cents. Hoosier Manufacturing & Supply Co., Phonograph Supply Department, 313 Baldwin Block, Indianapolis, Ind.

MUSIC AND MUSICAL INSTRUMENTS

JOIN our Sheet Music Club and receive latest popular music of all publishers. \$1.00 Year Plan. Write today for details. Sheet Music Club, Suite 703, 1545 Broadway, New York.

SONG Writers—Have you poems? I have wonderful proposition. Ray Hibbelet, D110, 4040 Dickens Ave., Chicago.

I WANT song poems. Casper Nathan, Garrick Theatre Building, Chicago.

CORNETISTS—Trombonists—Saxophonists—Clarinetists. Send for "Free Pointers." Name instrument, Virtuoso School, Buffalo, New York.

WRITE Songs. Big money and reputation. Write for information. J. Gordon Pub. Co., 201 N. Hoyne Ave., Chicago.

VIOLINS—Deep, Mellow, Soulful—on credit. Easy terms for wonderful instrument. Get details today. Gustav F. Hennig, 2424 Gaylord St., Denver, Colo.

"MUSIC Composed" to words. Bauer Bros. (formerly of Sousa's Band), Oshkosh, Wis.

PATENT ATTORNEYS

PATENTS—Before disclosing an invention, the inventor should write for our blank form "Record of Invention." This should be signed, witnessed and returned to us together with model or sketch and description of the invention and we will give our opinion as to its patentable nature free. Our Three Books mailed free to inventors. Our Illustrated Guide Book, "How to Obtain a Patent," contains full instructions regarding Patents, Trademarks, Foreign Patents. Our Methods, Terms, and 100 Mechanical Movements illustrated and described. Articles on Patent Practice and Procedure and Law Points for inventors. Our Trademark Book shows the value and necessity of trademark protection and gives information regarding unfair competition. We have direct agencies in all the principal foreign countries and secure foreign patents in the shortest possible time and at the lowest cost. Write for our illustrated guide book on Foreign Patents, sent free to any address. "List of Patent Buyers" sent free, containing unsolicited letters from manufacturers and others who are constantly writing us regarding the purchase or leasing of meritorious patents. We endeavor to assist our clients in the commercial development of their inventions. "Specialization—Our Staff." The field of invention is so vast that it is impossible for any one man to become an expert in all the different classes of invention. For this reason Victor J. Evans & Co. employ a number of patent lawyers and mechanical experts who have been selected for their special knowledge and ability in certain lines of invention. Each case is placed in charge of experts in the classes to which the invention relates. The Value of Your Patent will depend much upon the skill and care with which your case is prepared and prosecuted in the United States Patent Office. That every case entrusted to us receives our best efforts and that our work is done conscientiously, skillfully and thoroughly, is evidenced by the many unsolicited letters of commendation that we receive constantly from our clients. We will furnish upon request lists of clients from any state in the Union for whom we have secured patents. Owing to the growth of our business we have established for the benefit of our clients Branch Offices in New York City at 1007 Woolworth Bldg., Philadelphia at 714 Liberty Bldg., Pittsburgh, Pa., at 514 Empire Bldg., Chicago, Ill., at 1114 Tacoma Bldg., and San Francisco, Calif., at 1010 Hobart Bldg. These branch offices being located in these large commercial cities, together with our Main Offices located near the U. S. Patent Office in Washington, D. C., enables us to more promptly handle the business of our clients, particularly as the branch offices are in constant touch with the Main Office and are fully equipped to handle patent business in all its branches. Victor J. Evans & Co., Main Offices 181 Ninth, Washington, D. C.

INVENTORS: Send sketch or model of invention for opinion concerning patentable nature and exact cost of patent. Book, "How to Obtain a Patent," sent free. Tells what every inventor should know. Established twenty-eight years. Highest references. Prompt service, reasonable charges. Address Chandlee & Chandlee, 438 Seventh, Washington, D. C.

PATENTS—"How to Obtain a Patent" is the name of a book which every inventor should have. It will be sent free upon request, and will tell you what you want to know about patents. It contains the whole story. It describes the different parts of the application and explains in simple language the prosecution before the Patent Office. It tells about joint applications, releases, agreements, assignments, licenses, interferences, infringements, process patents, design patents, trade-marks, and prints and labels. If you are interested in patents either as an inventor, manufacturer or owner of a patent you will enjoy reading this book which was written by a lawyer who has had twenty-five years' experience in patent matters. If you have an invention and will send us a sketch, model or photograph of it we will promptly make a search of the Patent Office records and advise you whether or not, in our opinion, your invention is patentable, our charge for the service being \$5.00. We feel that our experience of twenty-five years has fitted us to render prompt and efficient service which will merit your confidence. Write today. Talbert & Talbert, 464 Talbert Building, Washington, D. C.

INVENTORS. Send sketch or model of invention for advice. Write for Evidence of Disclosure form and Book on Patents. Free. Prompt Service. Merton-Roberts & Company, 181 Mather Building, Washington, D. C.

PATENTS Secured. Prompt service. Avoid dangerous delays. Send for our "Record of Invention" form and Free Book telling How to obtain a Patent. Send sketch or model for examination. Preliminary advice without charge. Highest References. Write Today. J. L. Jackson & Co., 244 Ouray Bldg., Washington, D. C.

PATENTS. Protect your rights. Before disclosing invention write for booklet and blank form Evidence of Conception to be signed, witnessed and returned with rough sketch or model of your idea, upon receipt of which I will promptly give opinion of patentable nature and instructions. No charge for preliminary advice. Highest references. Prompt, personal attention. Clarence B. O'Brien, Registered Patent Lawyer, Southern Building, Washington, D. C.

PATENTS Procured—Trade Marks Registered—A comprehensive, experienced, prompt service for the protection and development of your ideas. Preliminary advice gladly furnished without charge. Booklet of information and form for disclosing idea free on request. Richard B. Owen, 30 Owen Building, Washington, D. C., or 2276-R Woolworth Bldg., New York.

MILLIONS spent annually for ideas! Hundreds now wanted! Patent yours and profit! Write today for free books—tell how to protect yourself, how to invent, ideas wanted, how we help you sell, etc. Address, 500 Patent Dept., American Industries, Inc., Washington, D. C.

PATENTS—Trademarks. Thirty-five years' experience. Send model or sketch for opinion as to patentability. Free "Inventors Guide." Highest references and personal attention assure best results. Franklin H. Hoagh, 522 Washington Loan & Trust Bldg., Washington, D. C.

PATENTS promptly procured. Personal, careful and efficient service. Highest references. Moderate fees. Send sketch or model for actual search and advice. George P. Kimmel, Master of Patent Law, 54-M, Loan and Trust Bldg., Washington, D. C.

PATENTS—Prompt, personal, efficient service by an attorney-at-law, skilled in all branches of Patent Practice. Over 18 years' actual experience; full information upon request. B. P. Fishburne, 331 McGill Bldg., Washington, D. C.

PATENTS. Trade Marks, Designs and Copyrights, Registered firm of attorneys-at-law. Careful, Prompt personal service assured. Moderate fees. Full information free upon request. Cross & Collings, 606 Ouray Buildings, Washington, D. C.

EXACT expenses quoted in advance. Moderate charges. No extras. Applications satisfactorily prepared or money returned. Submit data. Lynwood B. James, 891 McGill Bldg., Washington, D. C. Established 1913.

PROTECT your rights—Write for "Record of Invention" and booklet about Patents. Prompt personal service. Advice without charge. J. Reaney Kelly, 612-G Columbian Building, Washington, D. C.

PATENTS and Trade-marks obtained. Prompt service. Write for our new book on patents. Established in 1889. D. Swift & Co., 269 7th St., Washington, D. C.

PATENT application filed on partial payment plan. Trade-marks, copyrights, etc. Jillo R. Stevens & Co., 485 F St., Washington; 352 Monadnock Bldg., Chicago. Estab. 1864.

INVENTORS—Send for form "Evidence of Conception," to be signed and witnessed. Form, fee schedule, information free. Lancaster & Allwine, 221 Ouray Building, Washington, D. C.

INVENTORS aided. Ideas developed and patented. Experimental machinery built. Practice in all courts. Richardson & Rogers, 7 Albee Building, Washington, D. C.

MONROE MILLER, Ouray Building, Washington, D. C., patent attorney, mechanical and electrical expert. Best quality of work and results. Moderate charges.

PATENT-COST Divided, six payments "Patent-Values" Booklet (free). Sterling Buck, Near Patent Office, Washington, D. C.

WOODWARD New Book. Submit your ideas. H. L. Woodward, 714 9th St., Washington, D. C.

ALUMINUM tube for grazing cattle on alfalfa with safety. S. M. Craddock, Roosevelt, Okla.

PATENTS. My fees in installments. Advice book free. Frank Fuller, Washington, D. C.

PATENTS. Trademarks. Moderate fees. Easy payments. Eugene E. Stevens, Jr., Washington, D. C.

INVENTORS! Write to U. S. Patent Office for free copy of "Information Concerning Patents," then engage a competent Patent Lawyer to protect your ideas. Ralph Burch, Patent Lawyer, Jenifer Bldg., Washington.

"**INVENTORS' Guide**," free on request; gives very valuable information and advice. Write Frank Ledermann, 15 Park Row, New York, N. Y.

PATENTS. Booklet free. Highest references. Best results. Promptness assured. Send model or drawing for preliminary examination. Watson E. Coleman, Patent Lawyer, 624 F Street, Washington, D. C.

ROBB. Robb & Hill offer a strictly professional service to manufacturers and inventors in patenting inventions and registering trade-marks, a service which is the result of 20 years' experience. Write for free booklet and names of prominent manufacturers and inventors represented by us. Send sketch for preliminary advice, 811 McLachlen Bldg., Washington, D. C.; 1348 Hanna Bldg., Cleveland, Ohio.

PATENTS—Herbert Jenner, patent attorney and mechanical expert, 622 F St., Washington, D. C. I report if a patent can be had and its exact cost. Send for circular.

FOR INVENTORS

PATENTS—"How to Obtain a Patent" is the name of a book which every inventor should have. It will be sent free upon request, and will tell you what you want to know about patents. It contains the whole story. It describes the different parts of the application and explains in simple language the prosecution before the Patent Office. It tells about joint applications, releases, agreements, assignments, licenses, interferences, infringements, process patents, design patents, trade-marks, and prints and labels. If you are interested in patents either as an inventor, manufacturer or owner of a patent you will enjoy reading this book which was written by a lawyer who has had twenty-five years' experience in patent matters. If you have an invention and will send us a sketch, model or photograph of it we will promptly make a search of the Patent Office records and advise you whether or not, in our opinion, your invention is patentable, our charge for the service being \$5.00. We feel that our experience of twenty-five years has fitted us to render prompt and efficient service which will merit your confidence. Write today. Talbert & Talbert, 464 Talbert Building, Washington, D. C.

PATENTS. If you have an invention which you wish to patent you can write fully and freely to Munn & Co. for advice in regard to the best way of obtaining protection. Please send sketches or a model of your invention and a description of the device, explaining its operation. All communications are strictly confidential. Our vast practice, extending over a period of seventy-seven years, enables us in many cases to advise in regard to patentability without expense to the client. Our Handbook on Patents is sent free on request. This explains our methods, terms, etc., in regard to Patents, Trade Marks, Foreign Patents, etc. "Scientific American" contains Patent Office Notes. Decisions of interest to inventors, and particulars of recently patented inventions. Munn & Co., Solicitors of Patents, 623 Woolworth Bldg., New York; Scientific American Bldg., Washington, D. C.; 801 A Tower Bldg., Chicago, Ill.; 811 Hanna Bldg., Cleveland, Ohio; Hobart Bldg., San Francisco, Calif.

AT Last! The book you always wanted. Contains valuable information relative to inventing, inventions in demand, selling inventions, why inventions fail, developing ideas, ascertaining the value of a proposed patent, selling an invention before patenting, financing a patent, how to obtain your own patent, advice regarding fakers, etc. Eleven chapters of knowledge that is absolutely essential to the inexperienced inventor. Price \$1.00. Scholtz & Co., Durand, Mich.

PATENTS. Protect your rights. Before disclosing invention write for booklet and blank form Evidence of Conception to be signed, witnessed and returned with rough sketch or model of your idea, upon receipt of which I will promptly give opinion of patentable nature and instructions. No charge for preliminary advice. Highest references. Prompt, personal attention. Clarence B. O'Brien, Registered Patent Lawyer, Southern Building, Washington, D. C.

PATENTS Procured—Trade Marks Registered. A comprehensive, experienced, prompt service for the protection and development of your ideas. Preliminary advice gladly furnished without charge. Booklet of information and form for disclosing idea free on request. Richard B. Owen, 30 Owen Building, Washington, D. C., or 2276-R, Woolworth Bldg., New York.

No inventor makes money without full knowledge manufacturing costs and methods, securing capital, licensing and royalty contracts, profits, etc. New manuscript "Making Your Patent Pay" discloses indispensable information, unobtainable elsewhere, \$2.50. Written especially for you. Send for literature. W. Bullock, M. E., 29 W. 39th St., New York.

PROTECT your rights—Write for "Record of Invention" and booklet about Patents. Prompt personal service. Advice without charge. J. Reaney Kelly, 612-G, Columbian Building, Washington, D. C.

INVENTORS. Before patenting your invention consult us. Advice on patentability, searches, drawings, reports, and outline of commercial possibilities. Dept. 32, Engineering Board, Box 467, Middletown, Conn.

YOU can market your invention without losing control of it if you know how! Write Murray Sherman and Associates, 500 Fifth Avenue, New York.

SEND sketch for search report. Get my latest book on patents. H. L. Woodward, 711 9th St., Washington, D. C.

I SELL Patents. Established 1908. Address, Charles A. Scott, 773PM Garson Avenue, Rochester, N. Y.

WANTED Patents. No Charge For Selling. American Business Service, 3915-25th Street, Detroit, Mich.

BICYCLE Sprockets, chains for experimental work. McDougal, 300 N. Wells St., Chicago.

PATENTS Secured. Prompt service. Avoid dangerous delays. Send for our "Record of Invention" form and Free Book telling How to obtain a Patent. Send sketch or model for examination. Preliminary advice without charge. Highest References. Write today. J. L. Jackson & Co., 242 Ouray Bldg., Washington, D. C.

INVENTORS. Send sketch or model of invention for advice. Write for Evidence of Disclosure form and Book on Patents. Free. Prompt Service. Merton-Roberts & Company, 182 Mather Building, Washington, D. C.

UNPATENTED ideas can be sold. I tell you how and help you make the sale. Particulars free. Write W. T. Greene, 106 The Atlantic, Washington, D. C.

INVENTIONS developed to practical manufacturing basis. Research and model work strictly confidential. Light manufacturing. Reliance, 138 West Broadway, New York.

900 MECHANICAL Movements and 50 Perpetual Motions Illustrated and explained in my book, Inventor's Universal Educator, 5th Edition—Tells how to procure and sell patents, Government and other costs. Covers the matter from A to Z—150 pages—Elegantly bound. Contains noted decisions of U. S. Supreme and State Courts on Patent cases. Mechanical Movements greatly assist inventors—suggest new ideas that might prove of great aid in perfecting inventions. Tells how to select an Attorney. Has valuable information regarding Patent Sharks, Selling Agents and promoters. Price, \$2. Postage free everywhere. Fred G. Dieterich, 621 Ouray Bldg., Washington, D. C.

GET your own patents. Application blanks, complete instructions \$1. Cutting Sons, Campbell, Cal.

PATENTS. Write for free illustrated guide book. Send model or sketch and description for free opinion of its patentable nature. Highest references. Prompt attention. Reasonable terms. Victor J. Evans & Co., 157 Ninth, Washington, D. C.

"INVENTOR'S Guide," free on request; gives very valuable information and advice. Write Frank Ledermann, 15 Park Row, New York, N. Y.

HAVE You an Invention? If so, write for our free book, "How to Get Your Patent," tells our terms and methods. Send model or sketch for our opinion of its patentable nature. Randolph & Co., Dept. 144, Washington, D. C.

MODEL Making and experimental work; Modern Shop; expert workmen. Manufacturing. Lamson Model and Experimental Works, 625 W. Jackson, Chicago.

PATENTS FOR SALE

FOR Sale or Royalty—U. S. Patent issued June 29, 1922, Pneumatic Tire Protector; goes together in sections. The above invention has recently been Patented and is possessed of great merit; it is superior to anything heretofore designed for this purpose, but is unquestionably one of the best inventions of its kind ever produced. Clarence Taylor, 15 Cross St., Newport, R. I.

AUTOMOBILE Switch—patent No. 1,381,409. Prevents car thefts. Secret Combination lock, provides mechanism operated without keys or other extraneous parts. Combination changeable at will. Simple, durable, inexpensive to manufacture. Many important features. Must be fully described to be appreciated. Outright or royalty. For detailed information, address John A. Freeze, Sayreville, N. J.

OUTRIGHT or royalty, Patent No. 1,419,245. Chair attachment for beds. Shiftably secures Collapsible Chair to corner post of bed, allowing chair to be set up in operative position at side of bed; collapsed for moving beneath bed when not in use. Novel! Worth thoroughly investigating. John A. Freeze, Sayreville, N. J.

FOR Sale—Patent on a Train Order Support. This device is badly needed by every railroad in the Country and should be used at every station. Therefore, the patent should prove extremely valuable. For further particulars, terms, etc., address L. H. Stearn, Shafter, Nevada.

FOR Sale outright: Patent issued May 2, 1922; Pin for holding Curtains. It is one of the simplest and most practical devices yet introduced for holding up the headings of Curtains, particularly lace and silk Curtains. Clarence Taylor, 15 Cross St., Newport, R. I.

WHAT Offers for American and Canadian Patents (outright or Royalty) on best Anti-Skid Chain, for automobiles? Experts say this chain has all others skinned to death; a sure money maker. Address Robert Golphin, Box 256, Brownburg, P. Q., Canada.

PATENT 1,373,882, on Hand Parting Device, to let on royalty basis. Excellent advertising premium or 10c Store article. A stamping job. Computing Cheese Cutter Co., Anderson, Ind.

SELF-CLEANING Lawn Rake. Patented in U. S., Canada, England. Automatic. Cleans on back stroke. Simple! Needed in every household. Investigate! Stanley Scarvie, Decorah, Iowa.

SELL Outright. Patented Collapsible Hand-truck Shopping Bag and Go-cart. Handiest thing out for Groceries and Parcels. Emery & Fleischauer, 956 W. Pingree, Detroit.

PATENTS for Sale. Photo Ring, No. 1,362,995. Sole and Heel Frames, 1,410,061. Collapsible Shipping Containers, No. 1,424,099. Nannie K. Hunt, Adolphus, Ky.

FOR Sale, Cash or Royalty—Lamp Socket Construction, Patents 1,336,395 and 1,361,842. Electrical Switch, Patent 1,411,131. Address, Box 1273, Los Angeles, Calif.

SALE or Royalty: Practical Music-turning device. For Pianos and Orchestras. Ornamental. Efficient. Address McCormick, 29 September Road, Liverpool, England.

ONE man's bolting up device. Blueprints sent on request. Leon D. Van Winkle, 1502 Walnut St., Everett, Wash.

PATENT For Sale—A new invention: Shoe Lace Fastener. Address G. J. Gaither, General Delivery, Washington, D. C.

PATENT: An improved oil can. For terms, inquire of W. B. Svetlik, Cadott, Wis.

DIRIGIBLE Headlight—13,656-1. Talbert & Talbert, Talbert Bldg., Washington, D. C.

NEW Legless Ironing Board Patent for Sale. Box 84, Oskaloosa, Iowa.

PATENT No. 1,424,039, folding shoe horn, can be carried in pocket. Splendid as advertising novelty with ad on blade. Manufactured at cost of 3c each. Outright for cash. Harry E. Peck, 426 Park Ave., Waverly, N. Y.

PATENTS, Trade-marks—30 years of confidential service; expert advice, prompt action, reasonable fees. Send for Free Book No. 61. Edgar Tate & Co., 245 Broadway, New York; 635 F St. N. W., Washington, D. C.

PUNCTURE Proof Resilient Tire for sale; just Patented; Outright or Royalty; Full Particulars. Vincent O. Woodruff, 130 Atlantic St., Bridgeton, N. J.

INVENTIONS Patented; trade-marks registered; reasonable charges; prompt service; plain advice; request detailed information. Jaynes & Jaynes, 709 Kellogg, Washington, D. C.

OUTRIGHT or royalty: Thief-proof receptacle for milk bottles, etc. Unusual features. A winner! Schulze, 2209 S. Front, Philadelphia, Pa.

PATENT for Sale. Write today for full description. Mrs. Cora Parker, R. 1, Box 116, Corsicana, Texas.

WILL Sell Patent. Continuous Flow Hose Reel. Bonanza Commercially. Address Geo. A. Sanford, Excelsior Springs, Mo.

PATENT for Sale. The economical and convenient Automobile. James Kawasami, 125 (E.) Lafayette St., Stockton, Calif.

NEW book on patents. H. L. Woodward, 718 7th St., Washington, D. C. Submit your ideas.

PATENTS For Sale: To sell, buy or obtain patents write Patent News—P. Washington, D. C.

SANITARY detachable toothed comb. Patented. E. St. Clair, 515 Chene, Detroit.

LACEY Patent Sense. See page 142.

YOU have a worth-while patent, haven't you? Why don't you tell our two million readers about it? Most of them are specially interested in patents and new inventions. Ask me to tell you how other inventors successfully sold their patents. J. Roy McClellan, Manager, Classified Advertising, Popular Mechanics Magazine, Chicago, Ill.

PATENT, Trade-mark and Copyright specialist. Prompt, personal efficient service. Advice on request. M. E. Jones, Lawyer, 509B 7th St., Washington, D. C.

POCKET Check Protector Patent. Bargain. Fred Bothe, 1957 Warren, Chicago.

MODELS AND MODEL SUPPLIES

SMALL, Light weight Gasoline Engines, send stamp for circular. Address Weiss Mfg. Co., 327 Washington St., Brooklyn, N. Y.

PATENTS. Protect your rights. Before disclosing invention write for booklet and blank form Evidence of Conception to be signed, witnessed and returned with rough sketch or model of your idea, upon receipt of which I will promptly give opinion of patentable nature and instructions. No charge for preliminary advice. Highest references. Prompt, personal attention. Clarence B. O'Brien, Registered Patent Lawyer, Southern Building, Washington, D. C.

PRACTICAL model steam engines, boilers, blow-lamps, pumps, fittings. Send 10c in stamps for new catalogue. Model Machine Shop Co., 415-17 East 71 St., New York City.

MODELS and experimental work; also first-class pattern work. Years of experience. Geo. C. Donald Pattern Works, 929 Lawrence St., Denver, Colo.

MODELS and Patterns made. Light manufacturing. Address H. W. Hathorn, Mason City, Iowa.

PUNCH Press work, tool and die making, model and special machine work wanted. Completely equipped with new machinery of the latest type. Prompt delivery, reasonable prices guaranteed. Quality Hardware & Machine Co., Dept. A, 6154-56 N. Clark St., Chicago.

WE make working models for inventors and do experimental work and carry a complete stock of brass gears and model supplies. Send for catalogue. The Pierce Model Works, Tinley Park, Ill.

INVENTORS—Write for our free illustrated guide book and Evidence of Conception Blank. Highest references. Prompt attention. Reasonable Terms. Victor J. Evans & Co., 145 Ninth, Washington, D. C.

MODEL Making and experimental work; Modern Shop expert workmen. Manufacturing. Lamson Model and Experimental Works, 625 W. Jackson, Chicago.

FOR MANUFACTURERS

THE Jiffy Shower, made of seamless brass tubing, nickel-plated and highly polished. Retail for \$3.00. Will sell rights. Patent pending. Wm. C. Feller, 208 Brownsville Road, Mt. Oliver Branch, Pittsburgh, Pa.

MANUFACTURERS, Attention—Royalty only—no exclusive rights—now on market. "Lawn Mower Sharpener"—cost to manufacture 25c. Sells at \$2.00. Lock Box 375, St. Charles, Ill.

MANUFACTURERS and Inventors. For developing your invention, designing and constructing Automatic Machinery, Labor-saving Devices for all purposes, Coin-Controlled Beverage and Food-Dispensing Machines. Consult John Frick, Mechanical Engineer, 1105 Arch St., Philadelphia, Pa.

WANTED—Metal Stamping and Model work taken on contract basis. We are ideally located and equipped to develop patents. Meyers Company, Box 263, Bedford, Ind.

MANUFACTURING

LONG established manufacturer of auto accessories which are daily sold by practically all wholesale and retail accessory houses will consider manufacturing and distributing new products capable of equally wide sale through same channels. Patented articles preferred. Address "Accessory Manufacturer," 1400 North American Bldg., Chicago, Ill.

WE design and build special machinery, make models; dies, stamping tools, do general machine work and light manufacturing. Marshall Mfg. Co., Kansas City, Mo.

GEARS, tools and metal specialties. Weldon Machine Works, 2940 Herndon St., Chicago.

SPECIAL Devices and Machinery developed and built at reasonable rates. Jigs and fixtures designed and built for interchangeable and economical manufacturing. Punches and dies made for all kinds of metal stamping. Machine work to order. Simplex Tool Company, Woonsocket, R. I.

WE are equipped to manufacture all kinds of wire and light metal goods. Stampings, Dies and Tools. Punch press work. Patented articles wanted. Safety Wire Gas Globe Company, Columbus, Ohio.

USE our factory. Half million dollars invested in special and automatic machinery. Wire and metal products in quantity our specialty. Send sample your product for quotation. The Autoyre Company, Oakville, Conn.

LET us be your factory! Write today. Logan Machine Company, 222 South Clinton Street, Chicago, Illinois.

IF you want dies and metal stampings, write us. Lyons Machine Works, Lyons, Ia.

WIRE Goods, all kinds made to order. Cooley Mfg. Co., 524-530 N. Western Ave., Chicago.

MACHINERY, TOOL AND SUPPLIES

ONE 75 K. W. Crocker-Wheeler Generator—Direct connected to steam engine; One 75 K. W. Crocker-Wheeler generator; direct connected to 3 Cylinder Nash gas engine; One 45 K. W. Crocker-Wheeler generator, connected to Otto gas engine; all 220 d. c.; now running in our plant; for sale at bargain, as we are installing Edison Power. B. Heller & Co., Calumet Ave., Chicago.

CONCRETE Building Block Machines and Molds. Catalogue free. Concrete Machine Co., 363 South Third St., St. Louis, Mo.

WANTED: Information about new air compressors. Write for free manual. Engineers Dept., Brunner Mfg. Co., Utica, N. Y.

LIGHT Power Transmission Machinery, Bearings, Hangers, Pulleys, Reducing Gears. Send for Catalog, Winfield H. Smith, Buffalo, N. Y.

CONSULTING ENGINEERS

YOUR Ideas and Inventions scientifically worked out, working models prepared and guaranteed. Consulting Engineer, 5 West 121st Street, New York, N. Y.

ENGINES, MOTORS, AND DYNAMOS

AUTOMOBILE Owners, Garagemen, Mechanics, Repairmen, send for free copy of our current issue. It contains helpful, instructive information on overhauling, ignition troubles, wiring, carburetors, storage batteries, etc. Over 140 pages, illustrated. Send for free copy today. Automobile Digest, 507 Butler Bldg., Cincinnati.

ALTERNATING and direct current motor bargains. New and rebuilt. All guaranteed for one year. Special prices. Get our price list before buying. Motors exchanged and repaired. Hyre Electric Co., 633-8M South Dearborn St., Chicago.

ELECTRICAL

ELECTRICAL Experimenters—Here is the book you have been waiting for—"How to Make Things Electrical." 256 articles, 427 pages, 353 illustrations. Size 4 1/2 x 7, cloth binding. Price \$2.50 postpaid. Popular Mechanics Book Dept., 6 N. Michigan Ave., Chicago.

ELECTRIC motors and supplies, including sockets, wire conduit, cleats, levers, roseettes, switches. New revised wholesale prices. Illustrated Catalog free. Hyre Electric Co., 633-8M, South Dearborn St., Chicago.

ELECTRICITY For 10c Per Hour. Motoco Auto Generator. Operates on any make automobile. Produces electricity for Moving Picture Machines, Theatres, Schools, Churches, Homes, Etc. Write for free particulars. Monarch Theatre Supply Co., Dept. AG 724 South Wabash Ave., Chicago.

FOR MECHANICS

ALUMINUM Solder that will stand the test. Sample 25c. Formula \$2.50. John Brackman, 3916 Monroe, Chicago.

MECHANICS to try Swenson's old file "renewer." Information \$1. Fred Swenson, 324, Nampa, Idaho.

PATENTS—Write for our free illustrated guide book and Evidence of Conception Blank. Send model for sketch and description of the invention for our opinion of its patentable nature free. Highest references. Prompt attention. Reasonable terms. Victor J. Evans & Co., 184 Ninth, Washington, D. C.

PATENTS. Protect your rights. Before disclosing invention write for booklet and blank form Evidence of Conception to be signed, witnessed and returned with rough sketch or model of your idea, upon receipt of which I will promptly give opinion of patentable nature and instructions. No charge for preliminary advice. Highest references. Prompt, personal attention. Clarence B. O'Brien, Registered Patent Lawyer, Southern Building, Washington, D. C.

PLUMBERS and Heating Men thinking of going into business for themselves soon, can hasten that time by sending at once to Niebuhr Plumbing Business School, Desk PM, La Crosse, Wis., for interesting information regarding financing, estimating, accounting, etc., and free booklet "Making Plumbing Profits." Home Study. No obligation.

SOLUTION of right triangles. Deytall formulas. Relieving tool formulas. Others. Concise. Neatly bound. Shop agents wanted. 50c P. O. Money Order. J. J. Dunn, 5 Topliff St., Dorchester 22, Mass.

SHOP Notes Volume 17 contains 762 practical articles such as Half-ton Traveling Crane, Boring Machine, Toggle Press, Gas-Fired Forge, Oil-Gas Generator, Movable Table for Drill Press, etc., 224 pp. 496 Ills. 50 cents postpaid. Popular Mechanics Books Dept., 6 N. Michigan Ave., Chicago.

BLACKSMITHS

BLACKSMITHS, Listen: Any Handy man can make more money doing hard jobs easy. Forging and welding solid, with Toy's Modern Methods of Blacksmithing. Hardening and tempering to a standard with colored tempering charts. All for one dollar. Samples Free. W. M. Toy, Sidney, O.

SURVEYING INSTRUMENTS

NEW and used surveying instruments direct from factory. Satisfaction guaranteed or money refunded. Wissler, 619 Broadway, St. Louis.

FOR SALE—MISCELLANEOUS

FOR Sale—Roof Sixteen Valve Head. Arthur Fjone, Riceville, Iowa.

MECHANICAL Drawing Outfit for sale. Cheap. National Instrument Company, 4704 North Hamilton, Chicago.

\$17.50 GENUINE Carl Zeiss Field. Marine and Aviation Glasses, eight power, adjustable focus and eye pieces; cost \$38.00 with carrying case. Sent C. O. D. subject to examination. Money refunded. We have other Glasses, Binoculars and merchandise. Wolf's Curiosity Shop, 20 S. 2nd St., Philadelphia, Pa.

FOR THE SHOP

SHOP Notes for 1922—Bench Lathe, Electric Soldering Outfit, Job Crane, Pump Troubles, Road Roller, Bench Grinder, Bench Miller, are among the 655 articles in this new volume. 224 pp. 50 cents postpaid. Popular Mechanics Book Dept., 6 N. Michigan Ave., Chicago.

REAL ESTATE AND FARM LANDS

GOOD Farm Lands, 20, 40, 80-acre tracts near bustling city in Lower Michigan. Only \$10 to \$50 down; balance on long time. Learn how we help you get a farm home and business of your own. Write today for Free booklet giving full information. Swigart Land Co., P-1259 First National Bank Building, Chicago.

\$800 SECURES Farm—\$2350 Income; 4 horses, 8 cows, 3 acres potatoes, 2 acres corn, acre vegetables; hay, poultry, hogs, tools, furniture included; 100 acres; 2-story 7-room house, barn, poultry house, \$3000 takes all, only \$800 needed. Page 26 Free Catalog. Strout Farm Agency, 150-P, Nassau St., New York City.

\$5 DOWN, \$5 monthly; 20 acres unimproved fruit, stock, poultry, woodland; \$100; Ozarks. Fishing, hunting, trapping. Address Alfred Zimmerman, 1800 N. Fifth, Kansas City, Kansas.

WANT to hear from party having farm for sale. Give particulars and lowest price. John J. Black, 11th St., Chippewa Falls, Wis.

CASH for your Farm or Business, any location. Write Calaway, Box 782, Cincinnati, O.

ATTENTION! "Get Acquainted." Cash for your property. Farm, Hotel or Retail Store, no matter where located; confidential service. Hayes' Business Agency, Cincinnati, Ohio.

FOR Sale—Three full sections in McKenzie County and two sections in Billings County, North Dakota. Each section contains land suitable for crops, balance for cattle. Each section has valuable deposits of lignite which some day will alone be worth many times the present value of the land. This part of the state is developing very rapidly, with good schools within easy access. As owner cannot use this land himself will sell one or more sections at a price which almost anyone can afford to pay. Address, W., care Popular Mechanics, 6 North Michigan Ave., Chicago.

FLORIDA Oranges are most profitable as well as most delicious. Grow your own in a land of sunshine, away from winter blizzards and coal bills. Money you'll not miss will buy you land for a grove in a high, rolling, lake-jewelled land of many golden groves. If you mean business, write today for Book of Facts and Photos, Lake County Land Owners' Association, 93 Arbor Avenue, Fruitland Park, Fla.

I WANT Farms for cash buyers; will deal with owners only. R. A. McNow, 312 Wilkinson Bldg., Omaha, Neb.

SELL your property quickly for cash, no matter where located. Don't pay big commissions. Particulars free. Real Estate Salesmen Co., Desk B, Lincoln, Neb.

WANTED—MISCELLANEOUS

CASH for Gold, Platinum, Silver, Diamonds, Liberty Bonds, War Thrift, Unused Postage Stamps, False Teeth, Magneto Points, Jobs, any valuables. Mail in today. Cash sent, return mail. Goods returned in ten days if you're not satisfied. Ohio Smelting Co., 306 Hippodrome Bldg., Cleveland, Ohio.

USED books, educational nature, bought, sold, exchanged. Free bargain price list of 1000 items. Students' Exchange, 47 West 42d St., New York.

MAIL us your discarded jewelry, Gold Crowns and Bridges, Watches, Diamonds, Silver, Platinum, War Savings Stamps and Old False Teeth. Money sent at once. Goods Ret. if offer is refused. United States Smelting Works, (Old Reliable) Dept. T1, Chicago.

DOGS, BIRDS, POULTRY AND PETS

BROKEN Rabbit Hounds and Beagles \$25.00 up. Airedales, Collies, Fox-terriers, white Eskimos, 50 others, American Kennel, Ivyland, Pa.

HIGH-CLASS Coon Hounds; a few Still-Trailing coon and Varmit dogs; Rabbit hounds. Address Stephens Kennels, Marshall, Ark.

COON, fox, deer, rabbit hounds, thoroughly trained; guaranteed. Nothing cheap. D. Ward, 3145 Fortin, New Orleans, La.

SILVERBLACK Foxes \$300.00. Skunks, Coonhounds. Booklet dime. Arthur Schumacher, Lockland, O.

FOR Sale—Coon, opossum, skunk and squirrel dogs; fox, cat and rabbit hounds, sent on trial. Catalog free. Address Mt. Yonah Farm Kennels, Cleveland, Ga.

Become An Automotive Electrician

\$75 to \$100 a Week

GET into the highest paying branch of the continually expanding automobile industry. 78% of all automobile repair work is electrical. Yet not one out of fifteen garage men know enough about automotive electricity to cash in on this field. No matter what you now know about automobiles, this is your big chance to quickly qualify for this uncrowded, big money field. \$75 to \$100 a week is gladly paid to men who know how to repair batteries, ignition, lighting and starting systems, magnetic gear shifts, signalling systems and other electrical units.



PREPARE—AT HOME OR IN CHICAGO

Enjoy the thousand pleasures and broadening educational advantages of America's great western metropolis, while you learn a business that will put you far ahead in the Automotive Field.

Visit the immense stockyards. See the great mile long Municipal Pier, the interesting exhibits in the new Field Museum, the old Masters in the Art Institute. Attend the theatres—spend Sundays at your favorite sport. There is no place like Chicago. It is the playground and the Educational Center of the West. Come to Chicago and have the happiest and most profitable visit of your life while you learn Automotive Electricity in America's most practical and thorough school.

PROOF

Earns \$75 to \$100 a Week

I have earned \$75 to \$100 a week ever since I left school.
N. Blotzer, Chicago.

Doubles Salary in Two Weeks

Before I went to Ambu my salary was \$50.00 a week. In two weeks I was raised twice to \$100.00. Now doing even better in my own business.
Wm. Bass, Louisiana.

Ambu Course Gets 70% Increase

Earning 70% more than ever before. The course at Ambu did it.
S. E. Kilgore Batavia.

Big Dividends in New York

Went to work in largest service station in New York the day after nine men were let out. My course at Ambu is paying big dividends.
Lewis D. Jones, New York.

Ambu Men in Demand

Believe me, they sure grab you off when you say you've been thru Ambu.
J. L. Bailey, Rockford.

Ambu: Then Double Earning

My earning capacity has been more than doubled since my training with Ambu.
H. M. Bernhardt, Greenock, Pa.

\$1000 a Month

I'm starting my own business as my boss has been taking in over \$1,000 clear profit every month.
Wyrons J. Elford

Forced to Open Service Station

After graduating, I just did spare time work. But my reputation spread so fast that I had to open a service station of my own.
Ernest Cameron.

Gets 50% More Than Before

With wages going down all over the country, my electrical repair business is booming. Thanks to Ambu. My earnings are 50% more than ever before.
Eugene A. Chaput, Holyoke.

Increased Income 4 Times

Have my own shop. Earning four times what I did before I went to Ambu.
Willard W. Ludlow.

NEW EASY WAY TO LEARN In Chicago or at Home

The automobile business is here to stay. The last few years have been only a start. Tremendous additional expansion is on the way. And the highest paid and uncrowded branch of this enormous field needs you. There are plenty of auto mechanics to take up a bearing, tighten a bolt, grind out carbon. But, suppose your starter won't start, your battery won't charge, your lights won't light. Just try to get his aid. They're a Chinese puzzle to the average mechanic. You'll visit from 5 to 10 garages before you find an Automotive Electrician. In a short time you too can become a highly-paid Automotive Electrician who knows his work and his worth—not a dabbler or a guesser. The special method developed by the Ambu Engineering Institute does not saturate you in theories and rules—it shows how to do things and why to do them. Things ordinarily considered complicated are now made amazingly easy.

FREE BOOK ABOUT AUTOMOTIVE ELECTRICITY

12,000,000 cars in America are equipped with electrical units constantly getting out of order and defying the ingenuity of the ordinary garage men. The specialist is the man who makes money today. The Automotive Electrician is a specialist and the demand is far ahead of the supply.

Mail the coupon for FREE book about this big money field. If you want to learn at home the special Ambu Method has made it practical and thorough. If you want to learn at our school in Chicago, a staff of experts (the same men who developed our Home-Study method) will take you in hand. ANY man with a common school education can now become an Automotive Electrician in eight short weeks. The facts about this field are so interesting and can mean so much to you that you should inquire about them right away. A special limited time offer is open now—so mail the coupon at once.

This 32-page book tells all about the field of Automotive Electricity and how hundreds of men have broken out of the rut and entered this field with good money and a future. Already 10% of them own their own businesses. Mail this coupon at once for full facts and special limited time offer.



Ambu Engineering Institute,
Dept. 110, 2632 Prairie Ave.,
Chicago, Illinois.

Please send me FREE booklet and complete information on Automotive Electricity. Tell me of the rich rewards which await me in this uncrowded field. I am interested in your

- Residence Course.
 Home Study Course.

Name
Occupation
Address City

AMBU ENGINEERING INSTITUTE
Dept. 110, 2632 Prairie Avenue
Chicago, Illinois

Continued from Page 48

TRY Arkansas Kennels, Russellville, Arkansas, this season, for trained tree and running dogs.

RABBIT Hounds, Foxhounds, Coon, Opossum, Skunk, Squirrel, Groundhog dogs, Setters, Pointers. Circular 10c. Brown's Kennels, York, Pa.

1,000 **RINGNECK** Pheasants and Pheasant Eggs for sale. All other game birds and eggs and animals, Charles C. Garland, Oldtown, Maine.

BREED Squabs, Book free. E. Rice, Melrose Highlands, 77 Massachusetts.

RAISE Silver Black Foxes. Breeding stock your own terms. Write for particulars. Todd & Moore, St. Stephen, N. B.

BELGIAN HARES, GUINEA PIGS, ETC.

RAISE guinea pigs. Pay better than poultry or rabbits; easy to raise; little space required. We guarantee market. Particulars and booklet how to raise free. Cavies Distributing Co., 3102 Grand Ave., Kansas City, Mo.

PERSONAL

RESTORINE clear as water restores your gray hair to its original color in a few days. Stops dandruff and falling hair. No dye, non-injurious, leaves hair soft and lustrous. Send 10c for full size package. Pay balance 50c when satisfied only. State original color of hair. The O'Neil Laboratories, Sta. G, Oakland, Calif.

STUDY Human Nature, know people, make more money. Send 10 cents for "Personal Power," a little book that points the way. Progress League, 31-A L Union Square, New York.

ASTROLOGY Reveals, 2,000 word trial reading 25c; two questions free. State birth date. Prof. Audrey, Desk E, Departmental Bank Bldg., Washington, D. C.

FEET sweat, smell bad? Send for "St. John's Neufoot," guaranteed, \$1.00 postpaid. St. John Remedy Co., Box 312, Battle Creek, Mich.

HOROSCOPE showing character, talents, suitable occupation, congenial life partner, etc. Scientific, accurate. Send 25c, birthdate. The Astrolite Company, Sharpsburg, Pa.

HOROSCOPE—Complete—25c. Give birthdate. Hull, 14 West 101st, New York.

TOBACCO, liquor and morphine habits can be overcome with the aid of Hill's Chloride of Gold Preparations. Liquor remedy can be given secretly. Particulars free. Ohio Chemical Works, Dept. 9, Charleston, S. C.

BE Wise! Be Cheerful! Be Prosperous! New way plan brings wonderful results. Valuable pointers and your personality revealed for 10c and birthdate. Thomson-Heywood, Dept. 985, Chronicle Bldg., San Francisco, Calif.

YOUR Horoscope covering full year for 35c. Includes an extensive reading, valuable daily guide, large pictorial chart and special forecasts for each month. Scientific, complete. Try it! Money back if dissatisfied. Give birthdate. Address, H. Daniels, Flatbush Sta., Box 32, Brooklyn, N. Y.

TOBACCO or Snuff Habit cured or no pay. \$1.00 if cured. Remedy sent on trial. Superba Co., TP., Baltimore, Md.

ASTRONOMY

STAR study becomes fascinating recreation with guaranteed Radium Star Map. Shines at night. \$8.50 postpaid. Sample card free. Address E. Sundell, 225 N. Grove, Oak Park, Ill.

MISCELLANEOUS

LOCKSMITHS: Send \$1.00 for valuable chart for cutting tumbler padlock keys. Globe System, 278 Washington St., Newark, N. J.

INFORMATION. Positively anything you need know, scientific, medical, personal, formulas, addresses, miscellaneous. Where buy, sell. Ten cents per question answered, none higher. Send questions without money. Pay only if satisfied. General Information, Ann Arbor, Mich.

INCORPORATING a company? Save expenses and taxes by organizing on the popular, Common Law plan under a pure Declaration of Trust. Anyone, anywhere, can fill in Demaree Standard Forms, issue shares and begin doing business at once. Insist upon Demaree Forms, the original, nationally-accepted forms, approved and used by well known attorneys. Send for large, free pamphlet (C-53) containing much information that you will need. C. S. Demaree, Legal Blank Printer, 708 Walnut, Kansas City, Mo.

ART Metal Workers—You will find our book "Metal Work and Etching" a complete manual on making book ends, desk sets, pad corners, paper knives, letter openers, stationery racks, rocking blotters, desk calendars, arts and crafts jewelry, etc., 96 pp. illus. Price 50 cents postpaid. Popular Mechanics Book Dept., 6 N. Michigan Ave., Chicago.

STOP! that repair bill—lower your cost of operation and be familiar with your auto by having in your vest pocket for emergency reference a copy of a new, compact little book entitled "Causes and Remedies for Ills and Ails of an Automobile." Price \$1 postpaid. Popular Mechanics Book Dept., 6 N. Michigan Ave., Chicago.

ARIZONA Incorporation completed day papers are filed, without nominal or par value shares. Least cost. Greatest advantages. Operate anywhere. Forms Free. Standard Incorporating Company, S-R, Phoenix, Ariz.

CUTS anybody can make. Simple, cheap process. \$1. Specimens, particulars. 2c stamp. M. Day, Windfall, Ind.

ARTIFICIAL Eyes, \$3. Booklet free. Denver Optic, 559 Barclay, Denver, Colo.

NEW KIND OF HEAT!

Does Away With Dirty Coal and Wood

No more fires to build, bank or watch—no more dirty heavy coal to carry and lift—no more clouds of ashes to breathe or back-breaking scuttles to empty—no more heating problems—no more cold rooms in Winter—no more suffering from lack of quick fires in uncertain Fall and Spring—no more worries about coal shortages, poor quality or high prices since this Wonderful New Invention.

3 Times the Heat of Coal—at Turn of Valve

Here is the amazing new kind of heat that has ended forever the days of woman's back-breaking servitude to a hot mussy, stove or furnace! The wonderful invention of Mr. B. M. Oliver of St. Louis, in one minute, turns any coal or wood burner into a modern, up-to-date gas stove.

Cheaper Than Coal and Wood

Mr. Oliver calls his invention the Oliver Improved Oil-Gas Burner, because it uses 95% air and only 5% coal oil (ordinary kerosene)—the cheapest fuel there is, turning them into an actual gas that burns with an intensely hot, clean flame. Saves its cost in cleaning bills alone.

Fits All Stoves—Any Kind or Size

Mr. Oliver's wonderful invention is made in sixteen different models to fit any kind of cook stove, heating stove or furnace. Doesn't change your stove. Simply sets in firebox. Easily slipped in, in one minute. Absolutely safe. It lasts a lifetime. Saves your stove.



16 models—one for every heater, range or furnace

Hotter than Coal

You can absolutely depend upon your Oliver to heat your rooms in coldest Winter weather—it gives 3 times the heat of coal. And you needn't worry about the high price of coal. Install this amazing new kind of heat and you can snap your fingers at coal shortages, poor quality or high prices.

AGENTS Oliver agents earn as high as \$50 a month—\$25 a day spare time, as easy. Exclusive territory. Big, all-season seller. Write for Special Offer.

Your Oliver burns the cheapest and most reliable fuel there is, kerosene. Just turn the valve and you have heat—as much or as little as you need. Physicians recommend the Oliver as a sure safeguard against colds, influenza, etc.

Use It 30 Days—FREE

Now, once and for all time do away with household dirt and drudgery. End ashes, dirt, smoke, odor, chopping, shoveling, carrying, dirty, heavy coal and wood. Send immediately for the **FREE AT-TRACTIVE BOOKLET, "New Kind of Heat,"** telling all about this amazing new invention. Shows exactly how it works, how it is different from all other burners and tells how you can use it in your stove. 30 days, FREE. The famous Oliver Iron-Clad Money-Back Guarantee protects you.

Send for Big Offer

If you write at once you will be in time to receive Mr. Oliver's very low, introductory price offer and 30-day Free Trial. Get your Oliver installed immediately, before cold weather sets in.

OLIVER OIL-GAS BURNER & MACHINE CO.

Oldest and Largest Manufacturers of Oil-Gas Burners in the World
2014-J OLIVER BUILDING, ST. LOUIS, MO.



No worry about heat when you call get 3 times the heat of coal by just turning a valve. No coal, wood, ashes.



\$225⁰⁰ to \$500⁰⁰ per Month!

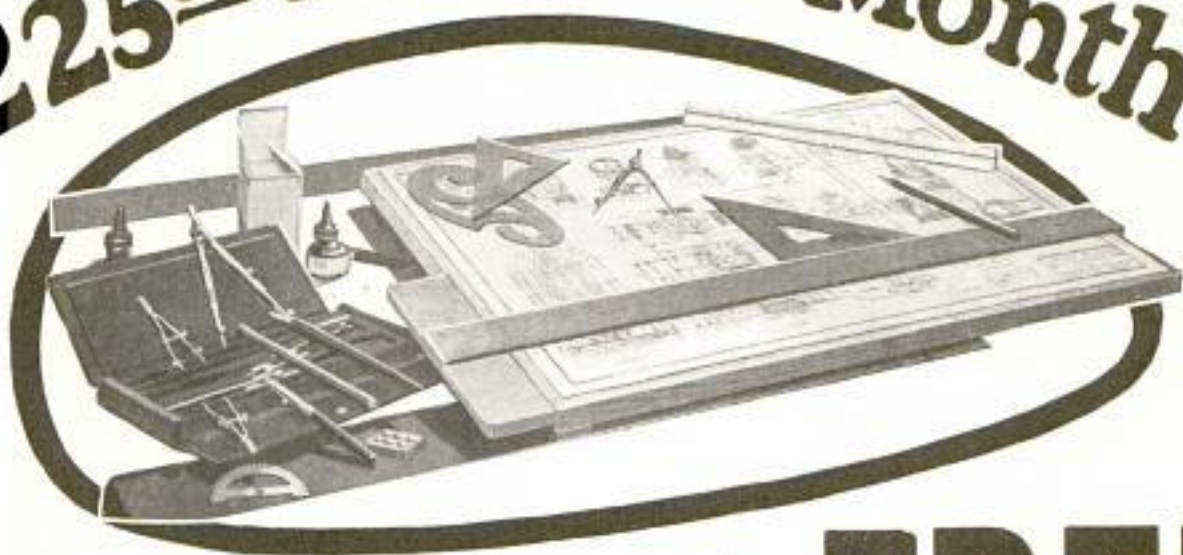

Expert Draftsman's Complete Outfit

FREE

There is a tremendous demand for trained draftsmen. Easy, pleasant work and big pay, with limitless opportunities. Before a building can be put up—before a machine can be made—or before a bridge can be built, **draftsmen** must draw the plans. In machine shops—in manufacturing plants—in fact wherever there is industry **trained draftsmen are needed**. The pay is **big** and because the work brings you in direct touch with the captains of industry the draftsman has an unusual opportunity for advancement. Read these facts:

Now is the time to start. Draftsmen get good pay from the beginning and can work up to \$500 a month and more. Draftsmen are needed everywhere. Once you are trained you can choose your own business and work in any part of the country you please. Coyne training makes everything easy for you. Coyne student, L. T. Dubendorf, writes: "Immediately after completing Coyne course I went to work for Armour & Co. Work was easy for me. Five months later I accepted a position in New York at a large increase in salary."

Complete Outfit FREE

Gives you practical Drafting Training

Outfit includes complete set of fine "professional" drawing instruments with double set of compasses and dividers all in velvet lined case. Drawing board, T square, two triangles, protractor, universal curve, triangular, standard scale, water-proof ink, pens, pencils and all accessories. Coyne methods are practical.

MONEY BACK GUARANTEE

We guarantee that the training of the Coyne Course will place you in a good position as an expert draftsman or we will refund your money.



B. W. COOKE

PRESIDENT

COYNE

TRADE AND ENGINEERING SCHOOL

Recognized Producer of Successful Men

552-598 So. Throop St., Dept. 1777, Chicago, Ill.

Easy to Learn at Home

The Practical Teaching Methods of the Great Coyne Schools Brought to Your Home

The Coyne Home Study Course guarantees to train you until you are permanently located in a job. Remember, the Coyne Trade and Engineering Schools are recognized by educators all over the world. Students come from all over the world to get Coyne training. Why? Because of the Coyne school's long established, tremendous reputation for successful teaching by its great staff of experts. Coyne is not a "one man" school, but a great educational institution, 23 years old, an acknowledged leader and originator. Coyne originated the "Learn by Doing" method now endorsed by educators everywhere. Coyne has graduated thousands of successful, prosperous men all over the world. Heretofore the valuable Coyne training could be had only at our residence school. **But now, you can enjoy the advantages and the special Coyne training under the personal direction of our experts right in your own home, at a fraction of the cost of the residence school.** You can't make a mistake if you write for the Coyne free book. Coyne students say every minute of the course was enjoyable. Some students took good positions three months before their course was finished. Here is your opportunity.

FREE Book

Send Now for Your Copy and FREE Outfit Offer

Mail this coupon for our interesting illustrated book, "Drafting, the Foundation of Industry," sent you free. It explains all about the Coyne home study method and shows you how to become a draftsman in the quickest and easiest way. You want to know all about this great institution. Don't put it off. Read for this book now. Get the free drafting outfit offer. It's absolutely free, no obligation. The book contains the most valuable information you will ever get in your life. **Send the coupon now.**

Coyne Trade and Engineering Schools

Dept. 1777

552-598 So. Throop St. Chicago, Ill.

Dear Sirs:—Please send me, absolutely free, without obligation, your book, "Drafting, the Foundation of Industry," also full information about the Course in Drafting and your Special Free Outfit offer. (Check which course you prefer.)

Check Coupon and Mail NOW!

Home Study Course School Course

Name.....

Address.....

City..... State.....



"I'm as Good a Man as Jim!"

"They made him manager today, at a fine increase in salary. He's the fourth man in the office to be promoted since January. And all were picked for the same reason—they had studied in spare time with the International Correspondence Schools and learned to do some one thing better than the rest of us.

"I've thought it all out, Grace. I'm as good a man as any one of them. All I need is special training—and I'm going to get it. If the I. C. S. can raise other men's salaries it can raise mine. If it can bring a better home with more comforts to Jim and his family it can do it for us. See this coupon? It means my start toward a better job and I'm going to mail it to Scranton tonight!"

Thousands of men now know the joy of happy, prosperous homes because they let the International Correspondence Schools prepare them in spare hours for bigger work and better pay. You will find them in offices, shops, stores, mills, mines, factories, on railroads—everywhere.

Why don't you study some one thing and get ready for a real job, at a salary that will give your wife and children the things you would like them to have?

You can do it! Pick the position you want in the work you like best and the I. C. S. will prepare you for it right in your own home, in your spare time—you need not lose a day or a dollar from your present occupation.

Yes, you can do it! More than two million have done it in the last thirty years. More than 150,000 are doing it right now. Join them without another day's delay. Mark and mail this coupon!

TEAR OUT HERE

INTERNATIONAL CORRESPONDENCE SCHOOLS
Box 5676-C, Scranton, Penna.

Without cost or obligation, please tell me how I can qualify for the position or in the subject before which I have marked an X:

BUSINESS TRAINING DEPARTMENT

- | | |
|---|---|
| <input type="checkbox"/> Business Management | <input type="checkbox"/> Salesmanship |
| <input type="checkbox"/> Industrial Management | <input type="checkbox"/> Advertising |
| <input type="checkbox"/> Personnel Organization | <input type="checkbox"/> Better Letters |
| <input type="checkbox"/> Traffic Management | <input type="checkbox"/> Foreign Trade |
| <input type="checkbox"/> Business Law | <input type="checkbox"/> Stenography and Typing |
| <input type="checkbox"/> Banking and Banking Law | <input type="checkbox"/> Business English |
| <input type="checkbox"/> Accountancy (including C.F.A.) | <input type="checkbox"/> Civil Service |
| <input type="checkbox"/> Nicholson Cost Accounting | <input type="checkbox"/> Railway Mail Clerk |
| <input type="checkbox"/> Bookkeeping | <input type="checkbox"/> Common School Subjects |
| <input type="checkbox"/> Private Secretary | <input type="checkbox"/> High School Subjects |
| <input type="checkbox"/> Business Spanish <input type="checkbox"/> French | <input type="checkbox"/> Illustrating <input type="checkbox"/> Cartooning |

TECHNICAL AND INDUSTRIAL DEPARTMENT

- | | |
|--|--|
| <input type="checkbox"/> Electrical Engineering | <input type="checkbox"/> Architect |
| <input type="checkbox"/> Electric Lighting | <input type="checkbox"/> Blue Print Reading |
| <input type="checkbox"/> Mechanical Engineer | <input type="checkbox"/> Contractor and Builder |
| <input type="checkbox"/> Mechanical Draftsman | <input type="checkbox"/> Architectural Draftsman |
| <input type="checkbox"/> Machine Shop Practice | <input type="checkbox"/> Concrete Builder |
| <input type="checkbox"/> Railroad Positions | <input type="checkbox"/> Structural Engineer |
| <input type="checkbox"/> Gas Engine Operating | <input type="checkbox"/> Plumbing and Heating |
| <input type="checkbox"/> Civil Engineer | <input type="checkbox"/> Chemistry <input type="checkbox"/> Pharmacy |
| <input type="checkbox"/> Surveying and Mapping | <input type="checkbox"/> Automobile Work |
| <input type="checkbox"/> Metallurgy | <input type="checkbox"/> Navigation |
| <input type="checkbox"/> Steam Engineering | <input type="checkbox"/> Agriculture and Poultry |
| <input type="checkbox"/> Radio <input type="checkbox"/> Airplane Engines | <input type="checkbox"/> Mathematics |

Name.....
Street.....
Address.....

City..... State.....

Occupation.....

Persons residing in Canada should send this coupon to the International Correspondence Schools Canadian, Limited, Montreal, Canada.

Please Mention Popular Mechanics

Why Good Dancers Are Popular

EVERYONE admires and wants to dance with the person who knows the latest steps. There is no need of being a wallflower! By my remarkable new easy method, anyone can learn the newest dances at home in a few hours. Much less expensive than from a personal teacher. No music or partner needed. So simple even a child can learn quickly. 60,000 have learned dancing by mail. Your own success is guaranteed.

To prove I can quickly and easily make you an accomplished dancer, I will send you FREE, in plain cover, a lesson in Fox Trot, Secret of Leading and How to Gain Confidence. For mailing of free lessons, send 10c. Learn in private—surprise your friends. Act now and be a good dancer soon!

ARTHUR MURRAY, Studio 440, 100 5th Ave., New York



BIG PROFITS FROM POULTRY

We Teach You How; Easily Learned at Home;

our guaranteed methods make success certain; write for free book, "How to Raise Poultry for Profit," Free. Don't delay; write today.

The National Poultry Institute, Inc., Dept. 312, Washington, D. C.



NO JOKE TO BE DEAF

—Every Deaf Person Knows That I make myself hear, after being deaf for 25 years, with these Artificial Ear Drums. I wear them day and night. They are perfectly comfortable. No one sees them. Write me and I will tell you a true story, how I got deaf and how I make you hear.



Address
GEO. P. WAY, Artificial Ear Drum Co. (Inc.)
80 Adelaide St., Detroit, Mich.



Medicated Ear Drum
Pat. Nov. 8, 1906
Drum Co. (Inc.)

STOP TOBACCO

If you cannot stop it, do you know why? Do you know its effect on efficiency? This subject discussed in common-sense manner in booklet written by one who conducted anti-cigarette clinic for L. A. Police Dept. for over a year. Treated thousands—all forms. Booklet free as long as they last. Write
Dr. T. H. Trinwith, Black Bldg., Los Angeles, Calif.

Buchstein's Fibre Limb
is soothing to your stump—strong, cool, neat, light. Easy payments. Braces for all deformities.
D. BUCHSTEIN CO.
113 6th St. S., MINNEAPOLIS, MINN.



BECOME A RAILWAY MAIL CLERK

Examinations soon. \$1600 to \$2300 a year. No strikes or lockouts. Common education sufficient. No "pull" necessary.

Patterson Civil Service School
Dept. 810, Rochester, N. Y.

Send me without charge your Catalog, describing this and other fine U. S. Government positions.

Mail coupon for Catalog.

Dept. 810
Patterson Civil Service School
Rochester, N. Y.

Name.....
Address.....

FREE

The Book Which Is Showing Hundreds the Way to Startling Salary Raises Through ELECTRICITY



The greatest, the most valuable free book ever offered by any school. 56 pages, 50 pictures, hundreds of vital facts. It is FREE.

"Give us trained men," is the great cry of large and small employers of men in the electrical industry throughout America. "Salary no object, give us men who know electricity."

There never has been such a demand for men at big pay. Millions upon millions of dollars are being spent in the electrical field. How about you? Are you making any effort to take advantage of this great wave of prosperity? You are unfair and unjust to yourself unless you get ready for one of the thousands of big positions waiting.

Get in the Game Be an Expert **EARN \$3500 to \$5000** **Per Year And More**

RETURN COUPON BELOW

The World Technical Institute Offers You What No Other School Can Offer—

- (1) Complete, practical, simplified instruction in every phase of electricity, including:
 - (2) Power plant management, maintenance, installation.
 - (3) Wiring, armature winding, batteries, motors, generators.
 - (4) Illumination, signs, motion picture operating.
 - (5) Ac and dc machinery of every description, repairs.
 - (6) Contracting, merchandising, telephony, telegraphy.
 - (7) Train lighting, farm lighting, welding, meters, instruments.
 - (8) Automobile ignition, lighting and starting.
 - (9) Complete instruction in wireless.
 - (10) Real working outfit, presented free.
 - (11) A real employment service.
 - (12) Information which will enable you to become an expert draftsman.
 - (13) Reviews of your work by an electrical engineer.
 - (14) Personal instruction by an electrical engineer.
 - (15) Money-back guarantee bond.
 - (16) Consulting service until you are earning \$100 per week.
 - (17) All the advantages of our Keysheet System.
 - (18) Information which will enable you to procure a license in any state or town where required.
 - (19) Instruction which will help you to begin earning money in a few weeks after you enroll.
 - (20) A diploma which means that you have completed the most practical course of training in existence.
- (All explained in the Free Book.)

You must decide upon your future NOW. You cannot afford to hesitate another day. As to whether you are going to be a big success or a big failure in life is SQUARELY UP TO YOU.

As-In-Practice Training at Home

Waste no time in getting into the big-pay class. The World Technical Institute's improved methods of training men of all ages makes your success and progress absolutely sure. You cannot secure this as-in-practice training from any other school in America.

No Matter About Your Age, Experience Or Previous Education

If you can read, write, add, subtract, multiply and divide we can make of you an expert. We will help you to earn more money than you have ever dreamed you could earn. Our course of training outclasses all others in simplicity, accuracy, modernity, thoroughness.

Free Tools, Instruments, Material

You will be supplied with a real working outfit, consisting of over eighteen standard articles. Superior to the working outfit of any other school.

Free Employment Service

We render a real employment service to students who wish to avail themselves of the same. We give real time and energy to placing students in satisfactory positions.

Money-Back Guarantee

You run no risk whatever in enrolling with us. The risk is all ours. We give you a Bond which guarantees satisfaction.

MAIL FREE COUPON NOW

Our great free electrical book, and all particulars in regard to the most remarkable offers ever made by any school will be mailed to you free and post-paid upon receipt of coupon.

WORLD TECHNICAL INSTITUTE
Fuller Bldg., Jersey City, N. J.

FREE COUPON

WORLD TECHNICAL INSTITUTE,
Fuller Bldg., Jersey City, N. J.

Gentlemen:—Send to me postpaid, and without obligation, your valuable illustrated book entitled, "Electricity Taught by a Master Teacher," also full particulars in regard to your course and the remarkable offers you are making to students.

Name.....

Address.....



MEN write

I Pay Your and guarantee

Good Jobs For You!

Pick the Job You Like

Chauffeurs	\$90 to \$150
Truck Driver	\$125
Tire Vulcanizers	\$100 to \$200
Welders	\$140 to \$200
Battery Men	\$150 to \$200
Auto Mechanics	\$6 to \$10 a day
Auto Electrician	\$225
Tractor Engineer	\$10 day
Garage Mgr.	\$150 to \$400
Demonstrator and Salesman	\$150 to \$500

I am printing in this ad right over my name a list of openings that I know of, and a list of wages or salaries a man can earn who knows his work. Start in with the easiest job of all—a chauffeur.

I say a chauffeur gets \$90 to \$150 a month. I know, I pay my own driver \$125 a month and board and lodging, so that he has a pretty nice job and saves good money. He has a lot of fun driving around and making tours and seeing the world. He is treated right; he gets as good food as I do and as soft a bed to sleep in. I think on the whole he has a better job than mine because he hasn't a worry on earth. Well, the chauffeur job is the easiest and most simple job of all, the first step on the ladder.

If you want to be independent and do the work you like and get real money now is the time to start. You haven't any idea of the possibilities in the auto business. Let me tell you what I can do for you.

LEARN A TRADE

Now is the time for you to learn a trade. I teach men to be successful auto mechanics. Can you make a tire? Can you weld a broken crank case? Can you build a battery? Can you repair an automobile? Can you go anywhere in the U. S. and get a job in a garage, repair shop, auto agency, tire shop, welding concern? Can you get a job as a driver or chauffeur?

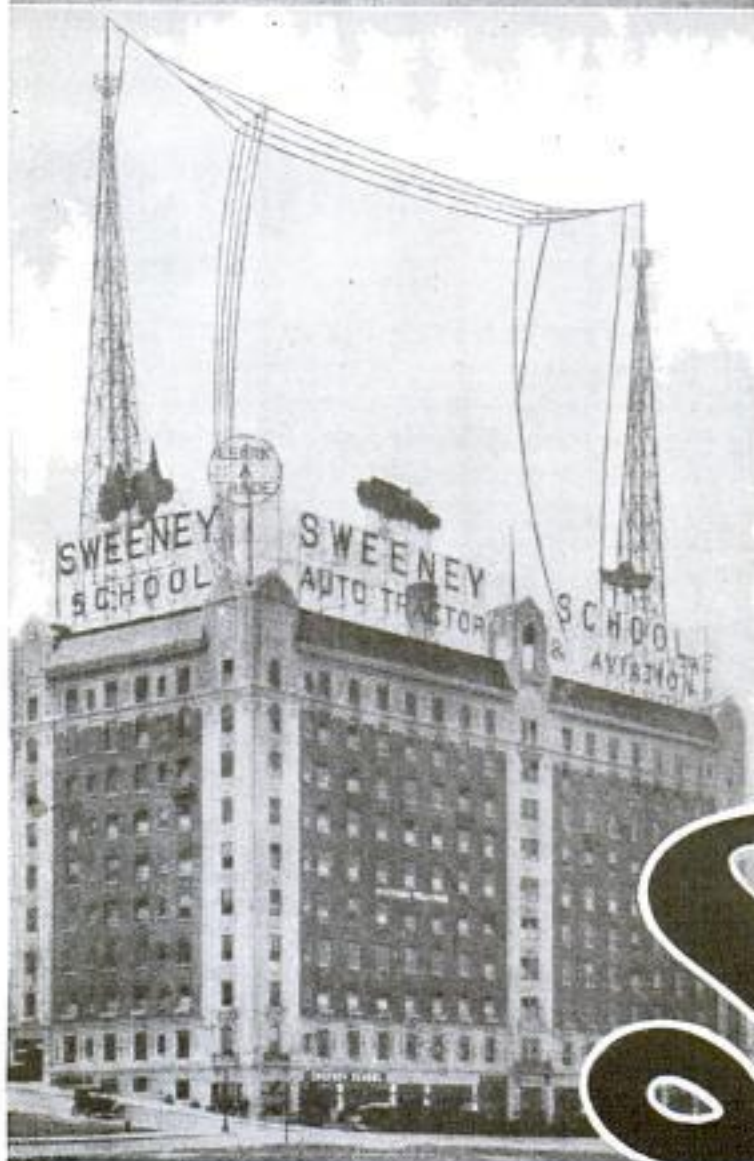

LEARN A Sweeney SCHOOL OF AUTO 1129 SWEENEY BLDG.

WANTED

today to Sweeney

Ry. Fare to K.C. tee You a Real Job

You Must Apply Now

If you are ready for PROFITABLE EMPLOYMENT after eight weeks' training, write me today. Do not delay—for this opportunity may not occur again. For when these jobs are filled, I cannot offer such employment agreement any longer.

For fifteen years I have trained young men mechanically inclined. This is the first time I have been able to GUARANTEE A JOB. And I can only guarantee a certain number. But you can be one of those who take training UNDER MY GUARANTEE OF EMPLOYMENT IF YOU ACT NOW. Please do not apply unless you are willing to take eight weeks' course of training.

W. H. B. Great Sweeney
Broadcasting.
Free Radio Course to all who
answer this ad. \$20,000
Radio Station. Largest and
finest radio outfit in the
world for Sweeney students.

FREE The first step is to send me the coupon or write a postcard for my 72-page illustrated catalog. It tells all about this Million Dollar Trade School. How thousands of men just like you, without any special knowledge, but simply a liking for mechanics, MADE A LIFETIME SUCCESS as a result of this simple training.

I don't care how old you are. I don't care how small your education, for I teach with TOOLS, NOT BOOKS. I need 5000 salesmen and representatives to handle Sweeney batteries and radio supplies. I want managers for branch offices. I will hire you if you are in earnest and will qualify. And if you are willing to go to work. I WILL PAY YOUR RAILWAY FARE to Kansas City. Write me NOW! No colored students accepted.

You cannot get the SWEENEY SYSTEM OF PRACTICAL EXPERIENCE anywhere else—the system that trains men in eight weeks for big paying jobs.

E. J. SWEENEY,
President

TRADE
Sweeney
TRACTOR-AVIATION
KANSAS CITY, MO

**This FREE Book
Tells You
Every-
thing**

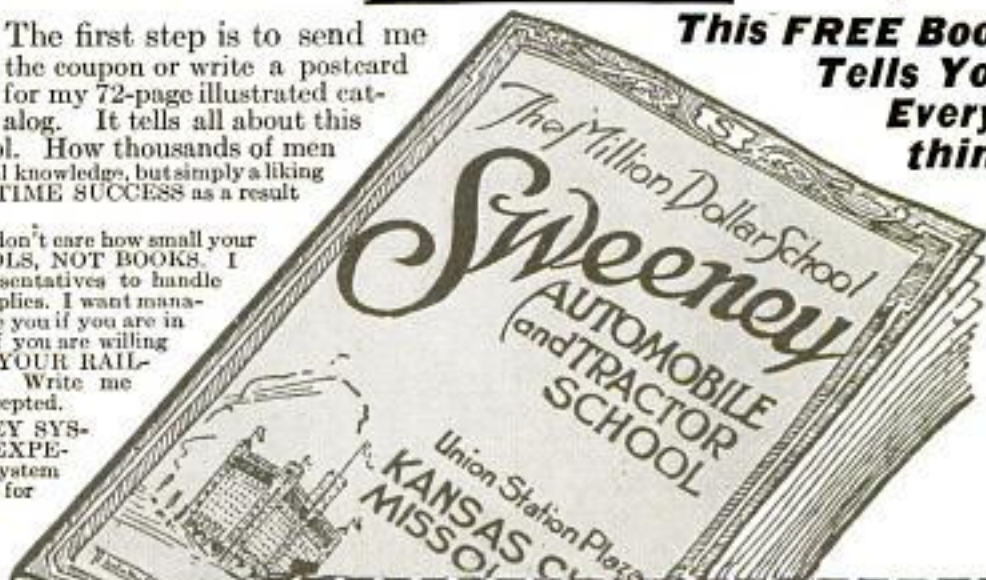

EMORY J. SWEENEY, President
1129 Sweeney Bldg., Kansas City, Mo.

Send me your offer of a guaranteed position, your big free catalog and full details of the Sweeney eight weeks' course leading to an immediate money-making opportunity.

Name.....

Address.....

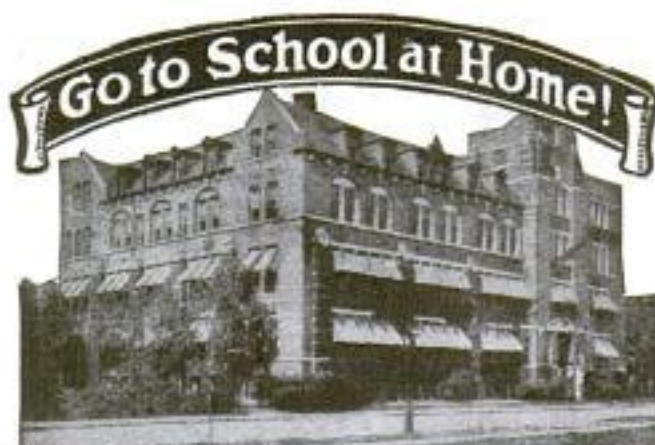

High School Course in Two Years!

You Want to Earn Big Money!

And you will not be satisfied unless you earn steady promotion. But are you prepared for the job ahead of you? Do you measure up to the standard that insures success? For a more responsible position a fairly good education is necessary. To write a sensible business letter, to prepare estimates, to figure cost and to compute interest, you must have a certain amount of preparation. All this you must be able to do before you will earn promotion. Many business houses hire no men whose general knowledge is not equal to a high school course. Why? Because big business refuses to burden itself with men who are barred from promotion by the lack of elementary education.

Can You Qualify for a Better Position

We have a plan whereby you can. We can give you a complete but simplified high school course in two years, giving you all the essentials that form the foundation of practical business. It will prepare you to hold your own where competition is keen and exacting. Do not doubt your ability, but make up your mind to it and you will soon have the requirements that will bring you success and big money. YOU CAN DO IT.

Let us show you how to get on the road to success. It will not cost you a single working hour. Write today. It costs you nothing but a stamp.

American School

Dept. H 774, Drexel Ave. and 58th St., Chicago

American School

Dept. H 774, Drexel Ave. and 58th St., Chicago
Send me full information on the subject checked and how you will help me win success.

- | | |
|-----------------------------|---------------------------|
|Architect |Lawyer |
|Building Contractor |Machine Shop Practice |
|Automobile Engineer |Photoplay Writer |
|Automobile Repairman |Mechanical Engineer |
|Civil Engineer |Shop Superintendent |
|Structural Engineer |Employment Manager |
|Business Manager |Steam Engineer |
|Cert. Public Accountant |Foremanship |
|Accountant and Auditor |Sanitary Engineer |
|Bookkeeper |Surveyor (& Mapping) |
|Draftsman and Designer |Telephone Engineer |
|Electrical Engineer |Telegraph Engineer |
|Electric Light & Power |High School Graduate |
|General Education |Fire Insurance Expert |
|Vocational Guidance |Wireless Radio |
|Business Law |Undecided |

Name.....

Address.....

STOP USING A TRUSS

Do Away With Steel And Rubber Bands

FREE TRIAL



Inner surface is made adhesive to secure the PLAPAO-PAD firmly to the body, keeping the PLAPAO continually applied and the pad from slipping. No straps, buckles or springs attached. Soft as velvet—easy to apply.

It's the Non-Slip- ping, yet Non-Rigid Pad and What is Within It That Counts

FREE to 5,000 Truss Sufferers

To the extent of 5,000 sufferers who may apply I will send, ABSOLUTELY FREE, a sufficient quantity of the Plapao to positively convince them that this is the only logical, common-sense way of treating ruptures. Plapao is a highly astringent medication placed within the Plapao-Pad and being absorbed through the skin, creates a wonderful feeling of relief and at the same time tends to strengthen the weakened muscles and thus permanently close the rupture opening. The process of recovery is natural, so you'll have no use for a truss—you can throw it away forever! Old and young have testified under oath that the Plapao-Pads cured their ruptures—many of them long-standing, aggravated cases—without delay from work. Patent allowed in U. S. and foreign countries. Awarded Gold Medal at Rome and Grand Prix at Paris.

Send No Money—for a sufficient quantity of the Plapao is sent without charge to enable you to give it a thorough test; you pay nothing for this trial now or ever. Write for it and full information today. Address: Plapao Laboratories, Block 1427 St. Louis, Mo.

Bowlegged Men

Your legs will appear straight when you wear

Straightleg Garters

Combination hose-supporter and pantleg straightener—Quickly adjusted to fit various degrees of bow-legs; as easy to put on and comfortable to wear as any ordinary garter—no harness or padded forms; just an ingenious special garter for bowlegged men—improves appearance wonderfully. Wearers are enthusiastic. You will be too. Write for free booklet, mailed in plain envelope.

S-L GARTER COMPANY

607 Davies Bldg.

DAYTON, OHIO

NO MORE BALD HEADS



WHEN our VACUUM CAP is used a few minutes daily. We accept no pay until you have tried the Cap 60 days and are satisfied. The Vacuum Cap is an appliance that draws the blood to the Hair Roots and starts a new healthy crop of hair. It stops Dandruff, stops the hair from falling out.

Bought by Doctors and men who know that it is the only reasonable HAIR GROWER known to science. No Drugs Used. Write for application blank, testimonials, and booklet on "HAIR," sent sealed in plain envelope. FREE.

THE MODERN VACUUM CAP CO.

C 559 BARCLAY, DENVER, COLO.



See How Easy It Is To Learn Music This New Way

YOU know how easy it is to put letters together and form words, once you have learned the alphabet. Playing a musical instrument is not very much different. Once you learn the notes, playing melodies on the mandolin, piano or violin is simply a matter of putting the notes together correctly.

The first note shown above is F. Whether you are singing from notes, playing the piano or banjo or any other musical instrument, that note in the first space is always F. The four notes indicated are F, A, C, E, easy to remember because they spell the word "face." Certain strings on the mandolin, certain keys on the piano, represent these same notes—and once you learn them, playing melodies on the instrument is largely a matter of following the notes.

Anyone can now learn to play a musical instrument at home, without a teacher. A new simplified method of teaching reduces all music to its simplest possible form. You can now master singing, piano-playing, or any musical instrument you wish right at home, quickly, easily, without endless study and practice.

Practice is essential, of course—but it's fun the new way. You'll begin to play melodies almost from the start. The "print-and-picture" method of self-teaching is fascinating;

it's simply a matter of following one interesting step after another. You learn that the note in the first space is F, and that a certain key on the piano is F. Thereafter you will always be able to read F and play it whenever you see it. Just as you are able to recognize the letters that make a word, you will be able to recognize and play the notes that make a melody. It's easy, interesting.

You don't have to know anything whatever about music to learn to play a musical instrument this new way. You don't have to pin yourself down to regular hours, to regular classes. You practice whenever you can, learn as quickly as you please. All the intricate "mysteries" of music have been reduced to a method of amazing simplicity—each step is made as clear as ABC. Thou-

sands have already learned to play their favorite musical instruments this splendid new, quick way.

You Can Play Your Favorite Instrument Three Months From Today

If you are dissatisfied with your present work, let music act as the stepping-stone into a new career. If you long for a hobby, a means of self-expression, let music be the new interest in your life. If you wish to be a social favorite, if you wish to gain popularity—choose your favorite instrument, and through the wonderful home-study method of the U. S. School of Music, play it three months from today.

You can do it. Youngsters of 10 to 12 years have done it, and men as old as 60 have found new interest and enjoyment in learning how to play a musical instrument. You don't have to listen while others entertain any longer. YOU can be the center of attraction, the talented person who holds the audience fascinated.

Is it the piano you wish to play, the

mandolin, the violin, the saxophone? Do you want to learn how to sing from notes? Are you eager to be able to play "jazz" on the clarinet, the banjo?

Free Book Explains New Method

It costs you nothing and obligates you in no way whatever to send for our free book called "Music Lessons in Your Own Home." Everyone who is interested in music should send at once for this valuable book. It not only explains the wonderful new simplified method of learning music, but tells about a special short time offer now being made to music-lovers.

Mail this coupon at once for your copy. Remember, it obligates you in no way whatever—it's free. But act now before the supply is exhausted. **U. S. SCHOOL OF MUSIC, 710 Brunswick Building, New York.**

Please Write Your Name and Address Very Plainly, so that there will be no difficulty about the booklet reaching you.

**U. S. SCHOOL OF MUSIC
710 Brunswick Bldg., New York City**

Please send your free book, "Music Lessons in Your Own Home," and particulars of your Special Offer. I am interested in the following course:

.....
(Name of Instrument or Course)

Name.....
(Please Write Plainly.)

Address.....

City..... State.....



He Earns \$10,000 a Year

This executive is one of the officers of a big corporation; he earns \$10,000 a year, and is still in his early thirties.

"He has a mighty good business head"—that's how the directors speak of him. "He's keen at a business problem, quick to pick out the essential points, sure in his decisions"—that's why the President is for him. "When he recommends a policy," declares the General Manager, "I know it's sound from a legal standpoint."

A big salary—\$10,000 a year—but this man has an asset that is vitally important in the management of big affairs—he is a law-trained man.

His Chance is Yours!

Why let the really big opportunities slip away from you—simply for lack of training?

Right in your own home, under the LaSalle Problem Method, you can study the same cases you would read at the resident universities, master the fundamental principles of law set forth by some of the most eminent authorities in the profession, develop under their direction a sound understanding of business relationships, a power for keen and logical thinking, a facility for analyzing business problems that in later years will make you the man the directors pick for the bigger job.

Read these statements, testifying to the thoroughness and income-value of LaSalle training:

"The Problem Method increased my salary nearly 150%."

"Passed bar examination with second highest honors in a class of seventy-one."

"Salary doubled in six months."

"Passed bar examination, third in a class of twenty-three, the youngest man who ever passed the examination in this state."

Send today for full particulars regarding LaSalle home-study training, together with details of our convenient-payment plan; also your free copy of that inspiring book, "Ten Years' Promotion in One." Mail the coupon NOW.

LASALLE EXTENSION UNIVERSITY

The Largest Business Training Institution in the World

Dept. 1064-LR Chicago, Illinois

Please send me catalog and full information regarding the course and service I have marked with an X below; Also a copy of your book, "Ten Years' Promotion in One."

LAW, Degree of LL.B.

LaSalle is the largest business training institution in the world. It offers training for every important business need. If more interested in any of these courses, check here:

- | | |
|--|--|
| <input type="checkbox"/> Business Management | <input type="checkbox"/> Banking and Finance |
| <input type="checkbox"/> Modern Salesmanship | <input type="checkbox"/> Modern Foremanship and Production Methods |
| <input type="checkbox"/> Higher Accountancy | <input type="checkbox"/> Personnel and Employment Management |
| <input type="checkbox"/> Traffic Management | <input type="checkbox"/> Expert Bookkeeping |
| <input type="checkbox"/> Railway Accounting and Station Management | <input type="checkbox"/> Business English |
| <input type="checkbox"/> Commercial Law | <input type="checkbox"/> Commercial Spanish |
| <input type="checkbox"/> Industrial Management Efficiency | <input type="checkbox"/> Effective Speaking |
| <input type="checkbox"/> Modern Business Correspondence and Practice | <input type="checkbox"/> C. P. A. Coaching |

Name.....

Present Position.....

Address.....

Please Mention Popular Mechanics

Do You Make these Mistakes in ENGLISH?

Does your English reveal your lack of education or does it prove that you are a person of culture and refinement? English is the one weapon you must use every day. Here is how you can improve it almost at once.

MANY people say, "Did you hear from him today?" They should say, "Have you heard from him today?" Some people spell calendar "calender" or "calander." Still others say "between you and I," instead of "between you and me." It is astonishing how many people use "who" for "whom," and mispronounce the simplest words. Few people know whether to spell certain words with one or two "c's" or "m's" or "r's," or with "ie" or "ei," and when to use commas in order to make their meaning absolutely clear. And most people use only common words—colorless, flat, ordinary. Their speech and their letters are lifeless, monotonous, humdrum. Every time they talk or write they show themselves lacking in the essential points of English.



SHERWIN CODY

An unusual command of English enables you to present your ideas clearly, forcefully, convincingly. If your English is incorrect it hurts you more than you will ever know, for people are too polite to tell you about your mistakes.

For five years Mr. Cody worked almost day and night on the study of the problem, "How to make correct habits in speaking and writing stick in your mind." After countless experiments he finally invented a simple method by which you can acquire a better command of the English language in only 15 minutes a day. Now you can stop making the mistakes in English which have been hurting you. Mr. Cody's students have secured more improvement in five weeks than had previously been obtained by other pupils in two years!

Wonderful New Invention

Learn by Habit—Not by Rules

Under old methods, rules are memorized, but correct habits are not formed. Finally the rules themselves are forgotten. The new Sherwin Cody method provides for the formation of correct habits by constantly calling attention only to the mistakes you make. One of the wonderful things about Mr. Cody's course is the speed with which these habit-forming practice drills can be carried out. You can write the answers to fifty questions in 15 minutes and correct your work in 5 minutes more. The drudgery and work of copying have been ended by Mr. Cody. You concentrate always on your mistakes until it becomes "second nature" to speak and write correctly.

Write for Free Book

A polished and effective command of the English language gives you not only the stamp of education, but it wins friends and impresses favorably those with whom you come in contact. Spare time study—15 minutes a day—in your own home will give you power of language that will be worth more than you can realize.

Write for new free book, "How to Speak and Write Masterly English." Merely mail the coupon or a letter, or even a postal card. You can never reach your greatest possibilities until you use correct English. Write to-day for the free booklet that tells about Mr. Cody's simple invention.

SHERWIN CODY SCHOOL OF ENGLISH

510 Searle Building - Rochester, New York

SHERWIN CODY SCHOOL OF ENGLISH,
510 Searle Bldg., Rochester, N. Y.

Please send me your new Free Book, "How to Speak and Write Masterly English."

Mr.....

Address.....

City..... State.....



The Magic Power of A Few Little Lines



Have you ever noticed a cartoonist draw? A short line here. Another there. A small curve. A splash of shading—and you have a wonderful picture! It was all so easy—because he knew how—he knew which lines to use and just where to put them. Through this New Easy Way to Draw you too can learn the Magic Power of a Few Little Lines and how to make big money in drawing them!

New Easy Way to DRAW

How Easy!



Note how these few little lines are transformed into a picture.

One of the most fascinating, best paid businesses—yours after a few minutes' training a day.



Delightful pastime! Endless fun! Acquire the knack in your spare time.

Invaluable asset in your present business. A few lines can drive home your intangible ideas. New way makes it easy to learn drawing.



THIS wonderful new method makes it possible for **anyone** to learn Illustrating, Cartooning or Commercial Art. Hundreds of our students are now making splendid incomes. And most of them never touched a drawing pencil before they studied with us.

The simplicity of this method will astound you. You will be amazed at your own rapid progress. You learn by mail—yet you receive **personal** instruction from one of America's foremost Commercial Artists, of 30 years' successful experience. Frank Godwin and Wynn Holcomb (Wynn), the famous artists, are but two of his many successful students. Get into this fascinating game, **NOW**. You can easily qualify and make big money. A few minutes' study each day is all that is needed.

Newspapers, advertising agencies, magazines, business concerns—all are looking for men and women to handle their art work. Car-

toonists and designers are at a premium. Dozens of our students started work at a high salary. Many earn more than the cost of the course while they are learning! **YOU**—with a little spare time study in your own home—can easily and quickly get one of these big-paying artists' jobs.

This amazing method has exploded the old idea that talent is an absolute necessity in art—that "it's all a 'gift.'" *Just as you have learned to write this new method teaches you to draw. We start you with straight lines, then curves. Then you learn how to put them together. Now you begin making pictures. Shading, action perspective, and all the rest follows in their right order, until you are making pictures that bring you from \$50 to \$500 or more!* Many artists get as high as \$1,000 for a single drawing!

Big money is gladly paid—and big money is waiting for anyone with foresight enough to prepare for this pleasant profession. Through our new easy method of teaching **YOU** can earn big money as an artist, **regardless of your present ability**. Mail coupon today for interesting booklet telling all about it.

Coupon Brings Fascinating Booklet

An interesting and handsomely illustrated booklet, "How to Become an Artist," has been prepared and will be sent to you without cost. It tells how you can easily become an artist in a few minutes' daily spare time and at the cost of a few cents a day. Explains about this amazing method in detail. Tells of our students—and their wonderful progress—and how we can qualify you for a high-salaried artist's position. Booklet gives full particulars about our "Free Artist's Outfit" Offer. This booklet will be sent free, and without obligation. Read all about this amazing New Easy Way to Draw and how you can quickly learn, at home in spare time. Fill out the booklet-coupon now. Mail it **TODAY**.



Mail coupon today for this fascinating booklet, and learn how you can become an Artist in a few minutes a day of your spare time. Cut out coupon and mail **NOW**.

The Washington School of Art, Inc.
1888 Marden Building, Washington, D. C.

Please send me, without cost or obligation on my part, your free book, "How to Become an Artist," and full details about your special Short-Time Offer.

Name.....
(State whether Mr., Mrs., or Miss.)

Address.....

Washington School of Art, Inc.
1888 Marden Bldg., Washington, D. C.



United Y Student Got the Job



His United Y. M. C. A. Schools' Course and the Personal Coaching of his Instructor Supplied Just What he Lacked. He is one of our Long Island students, and he wrote:

"I had been working at my trade 11 years, but had no theoretical knowledge. Now I am near the end of my Course and last week one of the firm asked me if I cared to take charge of running some of the jobs. Naturally, I said 'Yes.' The Course has done me a world of good."

Personal service is the keynote of the correspondence instruction of the United Y. M. C. A. Schools. Every student has the careful attention of a competent instructor who takes an interest in all problems and special needs—education, business relations, etc.

A Maryland student says: "I cannot understand how, with thousands of students, you can show so much interest in the welfare of each." An Endicott, N. Y., student writes: "Your lessons contain the exact things needed by the practical man in his daily work."

These letters—which are fair specimens of hundreds—show that the "Six Reasons" for preferring the United Y. M. C. A. Schools' system of correspondence instruction are well founded.

More than 30,000 ambitious young men have in the last two years enrolled for the tested instruction-by-mail service of the United Y. M. C. A. Schools—which is the result of a quarter-century of experience in helping young men in their spare hours to qualify for more responsibility, better pay, bigger manhood.

Mark and mail the slip below and get our friendly counsel on how you, too, can realize your ambition.

SOME OF OUR 300 CORRESPONDENCE COURSES

Business Courses		
Accountancy	Business Administration	Office Management
Advertising	Business English	Practical Speaking
Banking	Business Finance	Salesmanship
Better Letters	Business Law	Secretarial
Bookkeeping	Complete Letter-Writing	Show Card Writing
Business Arithmetic		Stenography
		Traffic Management
Technical and Other Courses		
Agricultural Courses	Foreign Languages	Plan Reading
Applied Psychology	Foremanship	Plumbing
Architecture	Highway Engineering	Poultry Husbandry
Automobile Courses	High School Subjects	Radio Engineering
Building Construction	Illustrating	Radio Telegraphy
Civil Engineering Courses	Insurance Courses	Radio Telegraphy for Amateurs
Drafting Courses	Mathematical Courses	Steam Engineering Courses
Electrical Courses	Mechanical Engineering	Structural Drafting
English Courses	Own-Your-Home Courses	Surveying
Factory Management		Use of the Slide Rule
		Vocational Courses

Are you an ex-service man?

United Y.M.C.A. Schools

Dept. 74-O, 375 Lexington Ave., New York City

Without obligating me, please advise regarding the course in

Name.....

Full Address.....

(Please write plainly.)

SHOP WORK with a

CARNES ARTIFICIAL ARM

FOR nearly ten years a Carnes Artificial Arm has kept Mr. Pahbe Yasse of Lawrence, Kan., on the payroll as a draftsman and machinist at a good salary. Thousands of other mechanics, artisans, office workers, farmers and laborers owe their independence to this improved arm.

Life-Like in Action and Appearance

The Carnes Arm cannot be detected from the natural except by close inspection. Its user can dress himself, use knife, fork, pen, pencil and keys; pick up large or small objects, carry grips—in fact, do virtually everything that was possible before. He can bend the elbow of the Carnes Arm, bend and turn the wrist and open and close the fingers at will, even if the amputation is at the shoulder.

192-Page Book FREE. A book of 192 pages, profusely illustrated with photographs showing what can be done with this remarkable invention, will be sent free to any person interested. Send for it now.

CARNES ARTIFICIAL LIMB CO.,
208 Carnes Bldg., Kansas City, Mo.

Deafness

Perfect hearing is now being restored in every condition of deafness or defective hearing from causes such as

Relaxed or Sunken Drums, Roaring or Hissing Sounds, Perforated, Partially Destroyed Drums, etc.

Wilson Common Sense Ear Drums

"Little Wireless Phones for the Ears"—require no medicine but effectively replace what is lacking or defective in the natural drums. They are simple devices, which the wearer easily fits into the ears where they are invisible. Soft, safe and comfortable to wear at all times.

Write today for our 168 page FREE book on DEAFNESS, giving you full particulars and plenty of testimonials.

WILSON EAR DRUM CO., Incorporated
145 Inter-Southern Building LOUISVILLE, KY.

Don't Wear a Truss

Brooks' Appliance, the modern scientific invention, the wonderful new discovery that relieves rupture, will be sent on trial. No obnoxious springs or pads.

Brooks' Rupture Appliance

Has automatic Air Cushions. Binds and draws the broken parts together as you would a broken limb. No salves. No lies. Durable, cheap. Sent on trial to prove it. Protected by U. S. patents. Catalog and measure blanks mailed free. Send name and address today.

BROOKS APPLIANCE CO., 1266 State St., Marshall, Mich.

Learn Electricity

In **3½**
Months

Earn
\$150
to
\$400
per
Month



In the Great Shops of

C
O
Y
N
E

Student Winding Stator

THE whole world of electricity is open to the Coyne trained man. He is trained completely. He can make big money as Power Plant Operator, Superintendent, Telephone man, Construction worker, auto, truck or tractor electrician, battery man, radio expert, or he can go into business himself as electrical contractor, dealer, auto ignition or battery expert and make from \$3,000 to \$20,000 a year. Hundreds of our graduates today are making big money and you can do the same if you grasp this opportunity—act now.

Big New Home

The increasing popularity of Coyne and a tremendous influx of new students simply forced us to move into larger and more spacious quarters. Here, in the big, new home, you will find added electrical equipment—new and larger departments—a more complete electrical

training—a school thoroughly equipped to train you for a big paying position.



B. W. Cooke, Pres.—Coyne Trade & Engineering School
552-598 So. Throop St. Dept. 10 Chicago, Illinois

Earn \$150 to \$400 per Month

No books or useless theory. You are trained on \$100,000 worth of electrical equipment. Everything from door bells to power plants. You work on motors, generators, house-wiring autos, batteries, radio, switchboards, power plants—everything to make you an expert ready to step right into a position paying from \$45 to \$100 a week. Learn electricity in the electrical center of the world. Send the coupon today for free catalog.

Radio Course FREE

We include the following free with the regular course:

- (1) A complete course in auto, truck and tractor electricity and storage batteries. Greatest outlay of auto electrical and battery equipment.
- (2) Course in Radio—the marvel of the age. Constructing, installing and operating. You can build your own wireless telephone set.
- (3) A life scholarship in the Coyne School. You can stay as long as you wish and return for further training any time in the future.

Earn While You Learn We help students to secure jobs to earn a good part of their expense while studying.

Send Coupon NOW!

Don't delay a minute—send that coupon in right now for our big free catalog and full particulars of this wonderful offer.

Act Now!

B. W. COOKE, President
COYNE TRADE & ENGINEERING SCHOOL
552-598 So. Throop St., Dept. 10, Chicago
Dear Sir:—Please send me free your big catalog and full particulars of your special offer of 3 extra courses.

Name.....
Address.....



Hotels Need Trained Men

Will You Accept One of the 40,000 Opportunities in America's 4th Largest Industry?

Do you know that in just ONE of America's big hotels there are over two thousand contented, well-paid, well-fed and well-dressed employees? Do you know that the Hotel Business is now rated as AMERICA'S FOURTH LARGEST INDUSTRY? Do you know that in the big hotels of the United States there are 40,000 EXECUTIVE positions—pleasant, high-salaried and dignified? Do you know that without the advantages of a higher education men are making \$5,000 to \$50,000 a year in the hotel business?

You Can Qualify for a Good Paying Job

Statistics show that ONE IN EVERY TEN HOTELS WILL HAVE AN OPENING FOR MANAGER THIS YEAR. The men who will fill them will be the TRAINED men. Some of them have taken years to obtain this training by slowly, laboriously "working up." Others have used their spare time to gain the knowledge that gives them a short cut to success.



Clifford Lewis
President

I Guarantee to Teach You

the valuable knowledge that it has taken some of the most successful hotel men years to obtain—men who are now making \$5,000 to \$50,000 a year. All your training will be under the personal direction of CLIFFORD LEWIS—a hotel expert of national reputation. Endorsed by managers of such hotels as Waldorf-Astoria, Biltmore, Copley-Plaza, New Willard, St. Francis. A few spare-time hours a week given to the simple, clear lessons of the Course open the way to a good position, a fine living, and a handsome salary. The training will in no way interfere with your present activities.

SEND FOR FREE BOOK

Big pay, fine living, free meals and apartment, fascinating work—all these may be yours if you will fit yourself for the thousands of opportunities in America's Fourth Largest Industry. Life membership in our Employment Bureau FREE to all graduates. We placed 3789 Lewis-Trained men and women in contact with good Hotel, Club and Tea Room positions in the last 12 months. Write today for interesting FREE BOOK—"Your Big Opportunity." Don't wait a minute—you may lose the one big opportunity of a lifetime. Mail the coupon NOW. Your whole future may depend on it.

LEWIS HOTEL TRAINING SCHOOLS

Founded 1916

Room 340

CLIFFORD LEWIS, President

Washington, D. C.

CLIP HERE FOR FREE BOOK

LEWIS HOTEL TRAINING SCHOOLS

Room 340, Washington, D. C.

Send me without obligation the FREE BOOK "Your Big Opportunity."

Name.....
Please print name

Street.....

City..... State.....

Reduce Your Waist in 10 Seconds



BEFORE

You can actually do it now with the "Wonder" Health Belt. It will take only the time required for adjusting the belt around your waist to accomplish this reduction and to bring relief from the strain of excess weight, which your abdominal muscles are carrying. You will be agreeably surprised at the immediate relief from bodily fatigue and discomfort. You will



AFTER

know the satisfaction of again having a well poised figure. And, best of all, the fat begins, at once, to depart. Then good healthy muscular tissue replaces it. In a month or so, you can take from 4 to 6 inches off your waist.

THE "WONDER" HEALTH BELT will do these things. It is scientifically constructed from strong, light-weight fabric. Easily adjusted and easily washed.

FREE TRIAL OFFER

Send your name, address and present waist measure. If no tape is handy cut a piece of string to the proper size and mail it to us. We will send you a "Wonder" Health Belt by return mail. At the end of five days if you are thoroughly delighted with the belt, remit \$3.00 in full payment. If not, return the belt to us and you will not owe us a penny.

Weil Health Belt Company
910 Hill St., New Haven, Conn.

Fibre-Lite Limbs

Easy Payments—Do Nature's Work.
AGENTS WANTED who use Artificial Leg. GOOD PAY.
FREE Fibre Sample. OUSCHLIDE STUMP TO WORMAN CO. MINNEAPOLIS, MINN.



\$1400 to \$2600 Year

U. S. GOVERNMENT WANTS
Railway Mail Clerks—City Mail Carriers—
Postoffice Clerks

Men, boys over 17, wanted

Common education sufficient. Send coupon immediately.

FRANKLIN INSTITUTE
Dept. H 178, Rochester, N. Y.

This coupon, filled out as directed, entitles the sender to (1) free sample examination questions; (2) a free copy of our book, "Government Positions and How to Get Them"; (3) free list of positions now open; and (4) to consideration for Free Coaching for the examination here checked.

COUPON

Railway Mail Clerk (\$1600 to \$2300) .. Postoffice Carrier (\$1400 to \$1800)
Bookkeeper (\$1400 to \$1800) .. Rural Mail Carrier (\$1100 to \$2600)
Postoffice Clerk (\$1400 to \$1800) .. Custom Positions (\$1100 to \$2000)

Name.....

Address..... H178

Use it before you lose it. Write plainly.



Knowing how
wins on
Pay Day

KNOWING HOW is the thing that puts the big pay in the pay-envelope. It's the thing that lifts men out of a poor-paying job into a man's size job with a man's size pay. *The man with the "know how" under his hat always wins out.* No matter what kind of work you are doing, or what you expect to do—you can learn more about that work and get more money for doing it. You don't have to go to school. Neither do you take any special training. One of these home study courses in book form gives you all the "know how" you need.

Some of the world's greatest experts prepared these books just to help ambitious men get ahead. They are written in plain, good old U. S. language that anyone can understand. No puzzling technical terms. Everything is explained. Thousands of pictures, plans, blueprints, diagrams, etc., in each set. Over 100,000 sets have been sold. Pick out a set in line with your ambition and send the FREE TRIAL coupon that brings the books without your sending any money in advance.

Pay-Raising BOOKS

Select From This List for Free Use in Your Own Home

Automobile Engineering , 6 volumes, 2000 pages, 2000 pictures. Was \$45.00. Now	\$23.80
Carpentry and Contracting , 5 volumes, 2128 pages, 1000 pictures. Was \$37.50. Now	19.80
Civil Engineering , 9 volumes, 3000 pages, 3000 pictures. Was \$67.50. Now	34.80
Accountancy and Business Management , 7 volumes, 3000 pages, 2000 pictures. Was \$52.50. Now	29.80
Fire Prevention and Insurance , 4 volumes, 1500 pages, 600 pictures. Was \$30.00. Now	14.80
Electrical Engineering , 8 volumes, 3300 pages, 3300 pictures. Was \$60.00. Now	29.80
Machine Shop Practice , 6 volumes, 2500 pages, 2500 pictures. Was 45.00. Now	21.80
Steam and Gas Engineering , 7 volumes, 3300 pages, 2500 pictures. Was \$52.50. Now	24.80
Telephony and Telegraphy , 4 volumes, 1728 pages, 2000 pictures. Was \$35.00. Now	14.80
Sanitation, Heating and Ventilating , 4 volumes, 1454 pages, 1400 pictures. Was \$30.00. Now	14.80
Drawing , 4 volumes, 1578 pages, 1000 pictures, blue-prints, etc., Was \$30.00. Now	14.80
American Law and Practice , (Including reading course,) 13 volumes, 6000 pages—illustrated, Was \$37.50. Now	49.80
Employment Management and Safety Engineering , 7 volumes, 1800 pages, 540 illustrations, charts and diagrams, Was \$52.50. Now	24.80



This picture shows the Automobile Engineering Books, five volumes closed and one open. The bindings will last a lifetime.

FREE Examination!

Don't send one penny. Just fill out the coupon and mail it. This will bring any set you select (the whole set, not a sample) by express collect. The books will be yours to use as you please for an entire week. You be the judge and decide whether or not they will do for you what they have done for thousands of other men. If you don't think they will help you, send them back at our expense and you won't owe a cent.

75 Cents a Week

Pay only \$2.80 within 1 week if you keep the books and send us \$3 each month until the special reduced price is paid. This amounts to about 10 cents a day. Mail coupon NOW. You'll be mighty glad you did when pay day comes 'round.

AMERICAN TECHNICAL SOCIETY, Dept. X-197, Chicago

AMERICAN TECHNICAL SOCIETY, Dept. X-197, Chicago, U. S. A.

Please send me set of _____ for 7 DAYS' examination, shipping charges collect. I will examine the books thoroughly and, if satisfied, will send \$2.80 within 7 days and \$3.00 each month until

I have paid the special price of \$_____. If I decide not to keep the books I will return them within a week at your expense.

Name _____

Address _____

Employed by _____

Please fill out all lines.

Three Talented Artists Joined in Designing This Lamp



The lines, proportions and coloring of most of the lamps you see in these days of commercialism are the work of designing departments of large factories. They are the fruits of a deep knowledge of what makes a "popular seller" in the stores.

But this exquisite little lamp—"Aurora" as it has been named by an artist because of the purity of its Greek lines—was designed by the united talents of an architect and interior decorator, a painter, and a famous sculptress, who were working not to make a "big seller" for the stores, but solely to design a lamp of truly artistic proportions, with real grace, symmetry and beauty yet of great practicability.

The price of this artistic gem is \$3.50. Think of it! In the few shops where lamps of this character can be found its equal would cost from \$15 to \$20. Only the Decorative Arts League could offer such a price and such a lamp.

"Aurora" is 16 inches high, base and cap cast in solid Medallium, shaft of seamless brass, finished either in rich statuary bronze with adjustable parchment shade of neutral brown or in ivory white, shade golden yellow. Inside of shades old rose to give mellow light. Equipped for electricity, wire, socket, etc., everything but bulb. Send no money, simply sign and mail coupon to **Decorative Arts League**, 175 Fifth Avenue, New York.

Aurora
\$3.50

DECORATIVE ARTS LEAGUE, (A.J.)
175 Fifth Ave., New York, N. Y.

Send me at the League members' special price, an "Aurora" Lamp, and I will pay postman \$3.50 plus the postage when delivered. (Shipping weight only 4 lbs.) If not satisfactory I can return lamp within five days and you are to refund my money.

Check finish desired — Statuary Bronze or Ivory White

Signed.....

Address.....

City.....State.....

I Make Strong Men

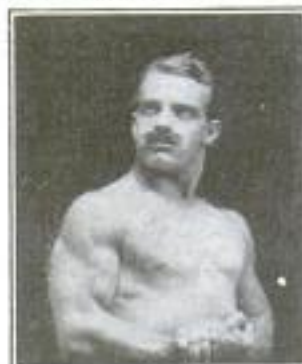

That is my business. I make no other claims. But what I promise, I fulfill. I will increase your arm one full inch in 30 days and your chest in proportion. In three months I will make you a finished strong man. Are you interested? Read my book "Physical Perfection." It tells you how. All I ask is 10 cents to cover postage and wrapping. Don't put it off. Send today.

Arthur L. Hyson
100 Langdon Bldg. New York City

FREE BOOK

CARE
of
DOGS

This illustrated, instructive book on how to select, train and feed your dog will be mailed you FREE with a 3 months' introductory subscription to America's most popular DOG, HUNTING and FISHING Magazine. Send 25c (stamps or coin) today.



SPORTSMAN'S DIGEST PUBL'G CO.
354A Butler Building Cincinnati, O.

13 WEEKS FOR
15 CENTS

The Pathfinder

INDEPENDENT NATIONAL HOME WEEKLY

You've heard your neighbor praise the Pathfinder, the wonderful illustrated news and story paper published at Washington for people everywhere. This paper is the Ford of the publishing world; has built a million subscribers. Check full of just the kind of reading you want. Unequaled digest of the world's news. Question Box answers your questions. Stunts for children; realism for all. Exciting serial story starts soon. Send 15 cents (coin or stamp) today for this big \$1 paper 13 weeks. You will be more than pleased.

PATHFINDER, 661 Langdon Sta., WASHINGTON, D. C.

New Easy Way to Play SAXOPHONE

In twenty easy lessons I teach you to play saxophone like a professional. Takes one-tenth effort to learn by this wonderful new method of personal instruction.

EARN BIG MONEY

as expert player. I will show you how. My method known from coast to coast. Write quick for full particulars—FREE.

NEWLAN SCHOOL OF MUSIC
495 Athenaeum Bldg. Chicago



RADIO RECEIVING SET GIVEN Just as Shown

Genuine scientific instrument with Tuning Coil, Detector, Condenser, all on base. Can hear 15 to 25 miles under right conditions. Given for setting 28 pecks. Blaine at 10 cts. a peck.

BLUINE MFG. CO. 140 MILL ST., CONCORD JUNCT., MASS.



Big Money

Made by agents selling our wonderful Facial Soap, Perfumes, Toilet Articles, Spices, Extracts, etc. Free cake of soap and agents' terms mailed to any address.

LACASSIAN CO. Dept. 455 ST. LOUIS, MO.

Whatever Your Question;—be it the pronunciation of Bolsheviki, the spelling of a puzzling word, the location of Murman Coast—the meaning of blighty, ace, tank, ukulele, etc., this Supreme Authority—

WEBSTER'S NEW INTERNATIONAL DICTIONARY

contains an accurate, final answer 400,000 Words, 2700 Pages, 6000 Illustrations.
Regular and India-Paper Editions. G. & C. MERRIAM CO., Springfield, Mass.

Write for specimen pages, prices, etc. and FREE Pocket Maps per Popular Mechanics



Make Money in the Auto and Tractor Business

\$50 to \$125 a Week!

THE Automobile Business is booming! This great industry is on a solid foundation and America is now an "automotive nation." Nothing can retard the development of this, the most fascinating and profitable business of all times. Thousands of trained mechanics are needed NOW. The GREER College daily receives more calls for capable men than we can supply. GREER TRAINED MEN are always in demand—they get preferred positions.

GREER College of Automotive Engineering

The "Success School" where men without previous experience get easy-to-master training by the Exclusive GREER Shop Method. Insures quickest learning, more practical knowledge and lasting success. The GREER Diploma gives you immediate standing as a **Certified Automotive Engineer** (C. A. E.) entitling you to Master Mechanic's pay from the start.

Unsurpassed Training In all Branches

The GREER Super-Course of Automobile Instruction is most complete. Covers all subjects simply and easily, as follows:

Truck, Tractor and Automobile Repairing and Overhauling.
Automobile Driving, Roadside Repairs, Primary Ignition, Electric Lighting and Starting Systems, Vulcanizing and Tire Repairing, Machine Shop Practice, Acetylene Welding and Cutting, Storage Batteries, Salesmanship.

Go Into Business for Yourself

GREER Graduates make good everywhere. There are opportunities for any man anxious to be his own boss. GREER Training starts you RIGHT.

GREER COLLEGE of Automotive Engineering

2060 Greer Bldg., Chicago, Ill.

MAIL THIS

Greer College of Automotive Engineering
2060 Greer Bldg., Chicago, Ill.

Send me your Free Book, "How to Succeed in the Automobile Business" and Special Tuition Offer.

Name.....

Address.....



More Than An "Automobile School"

Greer College gives its students the best possible instruction enabling men to quickly qualify as expert Mechanics, Garage Foremen, Demonstrators, Battery and Ignition Experts, Salesmen, Tractor Specialists, etc.

WRITE FOR FREE BOOK

Positions open NOW. Use the coupon below, or post card and send at once for new book, "How to Succeed in the Automobile Business"—a sure guide to lasting success and financial independence.

Wiring a Twin-Six Motor at GREER College



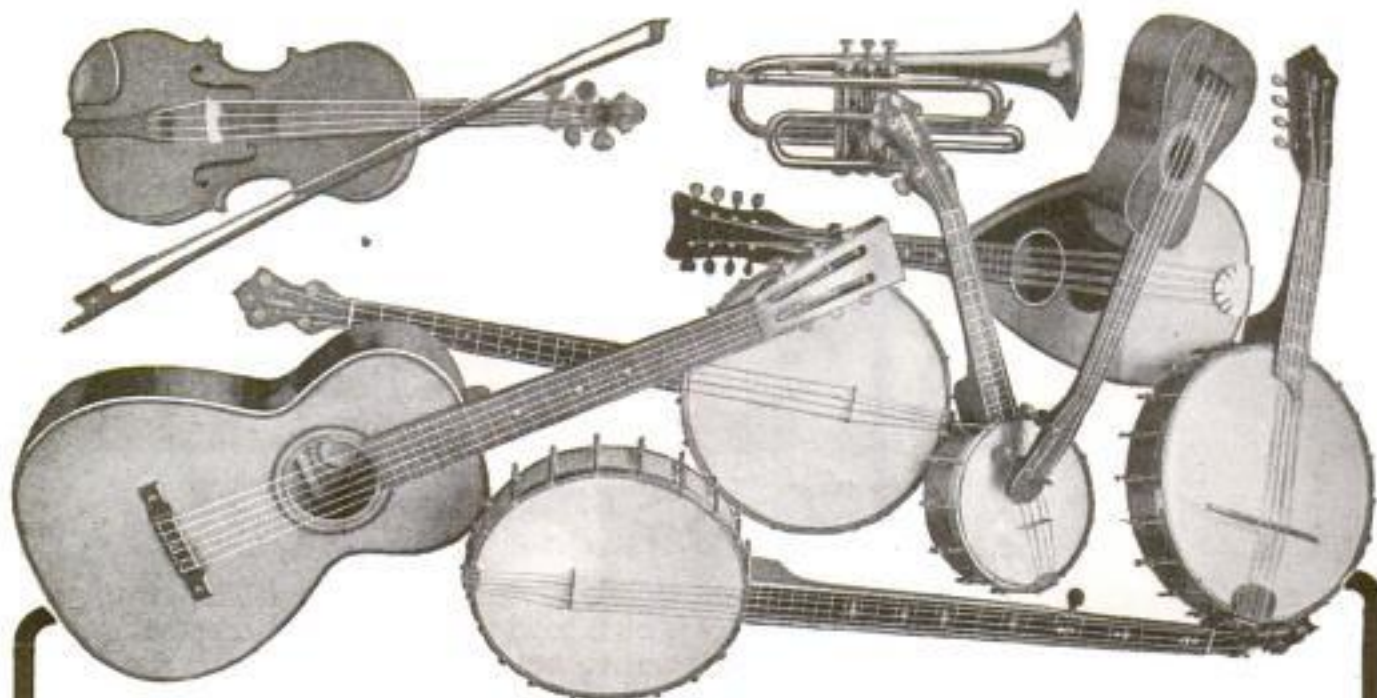

YOUR CHOICE \$ FREE 20

*Violin, Mandolin, Guitar,
Ukulele, Hawaiian Guitar,
Banjo, Banjo Mandolin,
Tenor Banjo, Cornet or
Banjo Ukulele.*

Actually given away, absolutely free, to pupils in each locality. Last year we gave away thousands of high-grade musical instruments on this sensational offer, now repeated for YOUR benefit.

We have the most wonderful new system of teaching NOTE music by mail. Take your choice of any of these magnificent instruments absolutely free and learn to play by this easy to learn method. Can have you playing standard note music in 4 lessons. A very small charge for lessons—just a few cents a week—your only expense. Your success guaranteed. Pay nothing if you fail to learn; you take no risk. Complete outfit free with every instrument. Don't wait a minute, but mail the coupon NOW.

To Advertise Our Copyrighted Course

Our plan is, \$2.00 monthly for lessons. No charge for instrument. Ukulele and banjo ukulele given free with 20 lessons at 50c a lesson. Tenor banjo, banjo and Hawaiian Guitar given free with 32 lessons at 50c a lesson; Violin, mandolin, guitar and banjo mandolin given free with

56 lessons, 43½c a lesson. Lessons are mailed one each week. Fill out the coupon and enclose \$2.00 or, we will send instrument and complete outfit subject to examination at express office C. O. D. \$2.00 for first month's lessons, and you will get an instrument you will be proud to own. At end of one week if you are not delighted with instrument and lessons, send outfit back and we will refund your money.

Do not delay, but mail the coupon today, before it is too late. Be sure to state whether you want a free Violin, Mandolin, Guitar, Ukulele, Hawaiian Guitar, Banjo, Banjo Mandolin, Tenor Banjo. We guarantee any one of these instruments positively worth \$20 or more. For cornet, piano, organ and further information, write for booklet.

SLINGERLAND'S CORRESPONDENCE SCHOOL OF MUSIC
Dept. 4, 1815 Orchard St., Chicago, Illinois

FREE INSTRUMENT COUPON

Slingerland's Correspondence School of Music
Department 4, 1815 Orchard Street,
Chicago, Illinois

Please send me one..... free.
(Name of Instrument)

- Plan No. 1. I am enclosing \$2.00 for first month's lessons.
 Plan No. 2. Send outfit and lesson C. O. D. \$2.00; but if I am not satisfied at end of one week's trial, I will return outfit and my \$2.00 is to be returned to me or, I will pay \$2.00 monthly until lessons are paid for.

Name.....

St..... R. F. D.....

City..... State.....

LISTEN AND LEARN

SPANISH-FRENCH-ITALIAN
GERMAN-ENGLISH-ETC.
by the **CORTINA PHONE METHOD**

CIRCUMSTANCES? I MAKE CIRCUMSTANCES. "Napoleon"

You control your destiny. Create your own circumstances! The late Charles R. Miller, at his death Editor-in-Chief of the N. Y. Times, spoke several languages. Many considered this the leading factor in his successful career.

The **CORTINA PHONE METHOD** is the most modern method of teaching languages. Merely "**LISTEN AND LEARN**" at home—using your own phonograph—Repeat often, and acquire exact pronunciation—records are made by skilled native instructors. Our system endorsed by leading schools and colleges.

CORTINA text books, records and demonstration may be had from Cortina Academies, leading phonograph shops or direct from the

R. D. CORTINA CO., Dept. 53, 105 West 40th St., N.Y.

Dope and Drugs Bring Disaster



Strongfort
The Perfect Man

When you lack pep, when you feel despondent, when you seem to grow stale—don't depend upon dope and drugs to bring you back. That way lies disaster. The more dope you take the worse off you'll be. Nothing is so certain.

STRONGFORTISM Rescues Men

Hopeless of ever being himself again, the man addicted to the use of Artificial stimulants sinks into utter despair. But Strongfort brings such men a message of hope—lifts them from the lowest depths up into the sunshine of health. No drugs or dope to add to your misery, but scientific methods of restoring by which you rebuild yourself and again become a new full powered man with a new outlook on life; another chance to walk upright, to look men in the face, to win social, business and financial success.

Get my Free Book. Mark the subjects on the free consultation coupon on which you want special information and send it to me with a 10c piece to help pay postage, etc., on my free book — "**Promotion and Conservation of Health, Strength and Mental Energy.**" It's a man-builder and a life-saver. Send for it **Right Now.**

LIONEL STRONGFORT

Physical and Health Specialist

Dept. 984 Newark, New Jersey

~~~~~ Cut out and Mail this Coupon ~~~~~  
FREE CONSULTATION COUPON

Mr. LIONEL STRONGFORT, Dept. 984, Newark, N. J.—Please send me your book, "**PROMOTION AND CONSERVATION OF HEALTH, STRENGTH AND MENTAL ENERGY.**" for postage on which I enclose a 10c piece (one dime). I have marked (X) before the subject in which I am interested.

- |                         |                      |                         |
|-------------------------|----------------------|-------------------------|
| .. Colds                | .. Female Disorders  | .. Rheumatism           |
| .. Increased Height     | .. Catarrh           | .. Pimples              |
| .. Asthma               | .. Blackheads        | .. Falling Hair         |
| .. Hay Fever            | .. Insomnia          | .. Weak Eyes            |
| .. Obesity              | .. Short Wind        | .. Gastritis            |
| .. Headache             | .. Flat Feet         | .. Heart Weakness       |
| .. Thinness             | .. Stomach Disorders | .. Poor Circulation     |
| .. Rupture              | .. Constipation      | .. Skin Disorders       |
| .. Lumbago              | .. Biliousness       | .. Despondency          |
| .. Neuritis             | .. Terpid Liver      | .. Round Shoulders      |
| .. Neuralgia            | .. Indigestion       | .. Lung Troubles        |
| .. Flat Chest           | .. Nervousness       | .. Steep Shoulders      |
| .. Deformity (Describe) | .. Poor Memory       | .. Muscular Development |
|                         |                      | .. Great Strength       |

Mention other ailments here .....

Name .....

Age ..... Occupation .....

Street .....

City ..... State .....

# I GUARANTEE YOU A POSITION



**Big Pay**

**Succeed!**

To make money, get into a field where money is made—and men are wanted. Today there is such a field—a big, profitable field that has been barely scratched. Men are succeeding in it and making money and uncounted opportunities for great success are still open. The Finger Print profession is the field that offers you this opportunity. Finger Printing is beyond the experimental. It is recognized as the one positive means of identification.

## Be a Finger Print Expert

Finger Print Experts earn big money and occupy the respected position of the professional man because their work is conspicuous and essential. There are no lay-offs nor shut-downs in the Finger Print profession. Everything you do counts for yourself. Daily, just a handful of men are trying to answer the demands of the thousands and thousands of instances where the Finger Print Expert is vitally needed. Trained Finger Print Experts share in big incomes, fame and importance. For years my time has been devoted to the Finger Print profession. I will teach you how to become a Finger Print Expert. My course of study is simple, easily understood and I guarantee to assist you in securing a position. Read the letter from the Phillip State Bank. You can study during your spare time. No special education is needed. My simplified course makes everything clear.

## Secret Service Course

In addition to my complete course in Finger Prints, I will also supply you free and without extra charge, a complete course in Secret Service. Study of this will equip you for all-round work. It gives you knowledge essential to the successful Finger Print Expert. Remember this course is free with my course in Finger Prints. It, alone, is worth the cost of my complete course in Finger Prints. But this offer, as is my Position offer and Free Professional Outfit offer, is limited. Men are needed at once. Unless you act at once, you may lose this remarkable free offer.

## Actual Secret Service Reports

**FREE** To all who write for complete information at once, I will send, Free, copies of actual Secret Service reports. These reports give inside facts of amazing cases of interest to you. Send for them and my complete explanation at once. I will tell you fully what you can expect as a Finger Print Expert and I will help you succeed. Today—write for this information and my guaranteed-position offer.

**U. S. SCHOOL OF FINGER PRINTS**  
Dept. 437, 7003 N. Clark St.  
CHICAGO, ILL.

**Send Coupon**

**U. S. SCHOOL OF FINGER PRINTS**  
Dept. 437, 7003 N. Clark St., Chicago, Ill.

Please send me Free information about your Finger Print Course, Free Course in Secret Service together with Guaranteed-Position Offer, Free Outfit, Secret Service Reports and Special Low Prices.

Name .....

Address .....

City ..... State ..... Age .....



DR. T. O'CONNOR SLOANE, A. B., A. M., LL. D., Ph. D., Educational Director of Chemical Institutes of New York, formerly Treasurer of American Chemical Society and a Practical Commercial chemist as well as a noted instructor.



# Get into an UNCROWDED PROFESSION



## Dr. T. O'Connor Sloane Will Teach You CHEMISTRY RIGHT IN YOUR OWN HOME!

Dr. Sloane is one of the most noted chemists in America. Our home study course, written by Dr. Sloane himself, has been described by one student as follows:

"I am highly pleased with the presentation of the subject matter covered in your Course. It is a delight, indeed, to study under the guidance of the mind who evolved this ingenious method of teaching chemistry."

Anyone with the ability to read and write plain English can understand every lesson. Dr. Sloane personally supervises the work of every student, giving each the same attention as he has given to thousands in the class room.

### Chemistry offers the Greatest Opportunities

Every day brings more announcements of the new ways in which Chemistry is employed in business and industry. The sudden and almost unbelievable expansion of the chemical field in the United States has increased the need for trained men in our country. If you are looking for more money—for fascinating work—let Dr. Sloane teach you Chemistry at home.

### Pay As You Go Along!

The price of our course is very low and includes everything—there are no extras to buy with our course. Our plan of small monthly payments places a chemical education within the reach of every man who is shrewd enough to use his spare time in preparing himself for better things.

Sign and Mail Coupon To-day for FREE Book "Opportunities for Chemists" and full particulars of our Unusual Offer.

**CHEMICAL INSTITUTE OF NEW YORK, Inc.**  
140-P LIBERTY ST. Home Extension Div. 10 NEW YORK CITY

CUT OFF HERE

CHEMICAL INSTITUTE OF N. Y., Inc., Home Extension Div. 10, 140-P Liberty St., New York City  
Without obligation or cost, send me your free book "OPPORTUNITIES FOR CHEMISTS," and full particulars about the Experimental Equipment given to every student and tell me about your plan of payment and special 30 day offer.

NAME..... ADDRESS..... CITY..... STATE.....

### Good Chemists Command HIGH SALARIES

All industry today is three-fourths chemical. In practically every line of industry the chemist is an important factor in the success of the products. The salaries are good—many firms pay tempting salaries to get the men they want. No field offers such unlimited opportunities for real constructive work.

### SPECIAL 30 DAY OFFER

Besides furnishing the student with his Experimental Equipment we are making an additional special 30 day offer. You owe it to yourself to find out about it. Clipping the coupon may prove the most important step of your life. Do it now. Receive particulars of our offer by return mail.

### Experimental Equipment Given to Every Student



We furnish every student with this equipment without one cent of additional charge. It includes the apparatus and chemicals used for the experimental work of the course. All enclosed in a fitted heavy wooden box.

### Shopwork Teachers in Demand

If you know your trade and have a common school education you can become a shopwork teacher. Demand greater than supply. A life job in a PROFESSION with short hours, long vacations and a pension. Write for free "Teacher Circular," Bureau of Vocational Research, 296-H Broadway, New York City.

# Electricity

## Taught By Practical Men

If you expect to become an electrical expert in four months this is not the ad you are looking for. Being an electrical engineer is a real job and cannot be learned over night. Haphazard methods of instruction may get you by for a time, but will not give you the solid foundation that opens the road to the biggest positions. You cannot learn everything about electricity in a few months. Steinmetz is still learning; and Marconi adds to his knowledge daily.

I am in business to teach men who are earnest in their desire to get ahead and want the real electrical foundation. I can give you the training, but how fast you get ahead, or how much you earn, depends on you. I give you a thorough teaching in **Electrical Engineering Principles and Applications**; you learn how and why to apply them.

You can get this training without losing a day or a dollar from your present work. Learn at home in your spare time. Hundreds of Burgess trained men have proven this and are earning bigger salaries. Burgess Home Study Methods are approved by **Electrical Engineers**. If you are earnest to succeed in any branch of Electricity write us today. You cannot reach the top unless you start right. Let me show you how I teach men so they keep on going. Write me today for the Burgess catalog on "Electricity" telling you of opportunities open, and how we teach by the Burgess Method. Take the sure road to success; write Burgess.

Yorke Burgess, Consulting Engineer.  
**BURGESS ELECTRICAL SCHOOL**  
744 E. 42nd St., Dept. 10, Chicago, Ill.



Professional Toned Instruments



### Violin, Mandolin or Mandolin Banjo FREE

Marvelous new way to learn Violin, Mandolin or Mandolin Banjo. I give you my instruction on phonograph record. Nothing ever like it. First lesson will convince you that you will be able to play music. Play real pieces in a few days. In 60 days play as professional and make big money. Any phonograph will do. My records and instructions do the work!

### New Way to be a Musician

Learn from Phonograph Records. Let me give you a fine Violin, Mandolin, or Mandolin Banjo FREE. Write today for my special offer and full description of my wonderful new method of teaching these instruments. A postcard will do. No obligation. My name known to whole music world of America and Europe. Write me today.

F. M. Schneider, Director, Schneider School of Music  
238 Vermont St., Blue Island, Ill. (A suburb of Chicago).

### PSYCHO—COLOR—HARMONY

A remarkable series of directions for using the radiant energy of color for obtaining health, personality, business success and for all artistic purposes. Something entirely new. Astonishing results obtained. Full explanation and first instructions sent for 25 cents to pay mailing costs. Address: Cecilia Barr's Studios, 812 North Mariposa Avenue, Suite 310, Hollywood, Los Angeles, Calif.

# TOBACCO OR SNUFF HABIT

Any form quickly conquered. No long waiting for results. Costs \$1 if it cures. Nothing if it fails. Perfectly HARMLESS. Full treatment on approval.

DR. C. M. SIMPSON CO., 100 W. 44th St., Cleveland, O

# The Secret of Making People Say "Yes"

**Learn it! Use it! It is the most important thing for you to know—the greatest money-making power you can possess.**

**W**HAT you want to know—what everybody wants to know—is how to make people say "yes."

It is the big thing we are all trying to do. It is the *one* great secret of success.

Without that knowledge you cannot expect to accomplish anything worth while. The attainment of *position, prosperity and power* depend upon it.

Doing business of any kind—getting a position—obtaining more salary—selling goods or services—collecting money—securing loans—raising capital, etc., depends in the final analysis, *simply and solely* upon your ability to make people say "yes."

## Brings Sure Advancement

And there are only *two* methods you can use in making people say "yes"—*talking and writing*. Therefore, it is perfectly plain that a knowledge of effective English—forceful language—*powerful, persuasive, positive* words—is of the utmost importance to every man and woman who is ambitious to *forge ahead and make more money*.

The ability to make your words strike home—commanding attention—arousing interest—creating good-will—securing influential friends—making sales—collecting accounts—obtaining credit—will bring you greater *business, social and financial* advancement than any other faculty you can acquire.

## Increases Your Earning Power

The scientific way of using English in a way that makes people say "yes" has been discovered, after years of study, by Frederick Houk Law, Ph.D., the prominent New York teacher, lecturer and writer in subjects relating to the practical use of the spoken and written word.

This important new work of Dr. Law's—the biggest thing he has ever done—makes it *easy and interesting* for you to learn how to use English that makes money—how to talk and write scientifically, using *clear, positive, persuasive* language instead of *weak, hazy, negative* language.

And the very minute you learn this important secret, you will become a more powerful person, capable of influencing others and earning more money, no matter what your daily task may be.

## Clip the Coupon

It is, of course, impossible to tell you, in the small space of a magazine advertisement, all about the many immensely important benefits that are sure to come to you, in every activity of your life, just as soon as you have learned Dr. Law's simple, practical and scientific method of using the English language in *talking and writing* in a way that makes people say "yes" instead of "no."

Therefore, we have prepared a booklet entitled *The Secret of Making People Say "Yes"*, a copy of which may be secured by you if you will simply sign and mail the "Free Book Coupon."

This booklet will be a revelation to you. You will find it one of the most *surprising and fascinating* things you ever read. It will show you a sure way—and an *intensely interesting* way—to advance more rapidly—make more friends—make more money—become more popular—achieve greater prominence—win the admiration and regard of those you care for.

It will show you how to multiply your power of accomplishment by multiplying your ability to persuade others to do what you want them to do. It gives you the power of conviction and persuasion, which is the real secret of success.

## Takes Only a Minute

If it were necessary for you to take a week off in order to get a copy of *The Secret of Making People Say "Yes"*, it would pay you well to do it. But it isn't. A minute's time and a postage stamp is all that is required.

Don't let the ease with which you can obtain this valuable booklet cause you to underestimate its value.

There is no way of measuring in advance the immense value to you of Dr. Law's secret of getting people to do the things you want them to do. But by showing you how to uncover greater opportunities—handle bigger deals—make more sales—get a better position—increase your salary—it will quickly prove to you that it is the most valuable booklet you ever got for nothing, and that in mailing the coupon you took a sure step toward greater *personal, social, business and financial* achievement. Independent Corporation, Dept. BE-4510, 22 West 19th St., New York.

## Free Booklet Coupon

Independent Corporation  
Dept. BE-4510, 22 West 19th St., New York

Gentlemen: Please mail me at once—without expense or obligation of any kind—a free copy of your booklet, *The Secret of Making People Say "Yes"*.

Name.....

Address.....

Pop. Mech. 10-22  
— (The world makes way for the man who says "I will.")



Whether the answer is "Yes" or "No" depends on what you say and how you say it.

# Do You Like to Draw?

Here Is a Simple, Easy Way  
to Draw a Comic Face

**TRY IT**

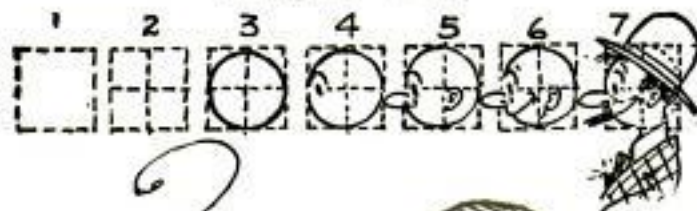

Make a square with pencil, then add to it with pencil as shown in the small squares above. Erase all pencil guide lines after the drawing is completed.

We will not give you any "grand prize," if you draw this picture. Nor will we claim to make you "rich in a week." But if you are anxious to develop your talent with a **successful cartoonist**, so you can **make money**, send a copy of this picture with six cents in stamps for portfolio of cartoons and sample lesson plate, and let us explain more in detail. Some of the **most successful cartoonists** are former students of this school. It is not hard to learn to draw **originals** when you are shown how in a **practical way**.



**THE W. L. EVANS SCHOOL OF CARTOONING**  
"The School That Has the Reputation"  
821 Leader Bldg. CLEVELAND, OHIO



**Don't Wait for  
Opportunity--  
Make It!**

**D**O YOU, an ambitious man, know that every great executive has made his own opportunities. That any successful man does not wait for someone else to act, but forces action. Before you can force action and command a high position you must know fundamentals and know them well.

One of the greatest helps to success in business today is a thorough knowledge of accounting.

If you are an employer of men you realize you should know how to keep books and analyze figures. If you are working for someone else you will find such knowledge your greatest help to progress. You cannot progress very far without this knowledge.

Thousands of opportunities paying big salaries are open now to men and women who know how to record and analyze the statistics of business.

Why not push yourself into one of these positions?

**We Will Teach You in Thirty Days**

We have an easily understood course in simplified book-keeping and accounting. It was written by an expert accountant and educator of national reputation. One basic rule of thirteen words covers all transactions. Students write us that they are able to hold good positions as bookkeepers and accountants after only thirty days of study.

**Quick Assets—Free**  
**Send for a Copy of this Remarkable Book**

It is chock full of information for people who want to forge ahead. It explains the course in detail and shows **why** a knowledge of accounting takes you out of the crowd and forces advancement. It tells of men and women who have gained high executive positions through a knowledge of these subjects. It's free for the asking and places you under no obligation. Send for it today. You'll find it interesting as well as instructive.

**Federal School of Accounting**  
1003 Federal Schools Bldg., Minneapolis, Minn.





## "Here's Where We Got Our Start"

"Look, Nell—this coupon! Remember the night you urged me to send it in to Scranton? Then how happy we were when I came home with the news of my first promotion? We owe it all, Nell, my place as Manager, our home, our comforts—to this coupon."

Thousands upon thousands of men now know the joy of happy, prosperous homes because they let the International Correspondence Schools prepare them in their spare time for bigger work. You will find them in city, town and country—in office, factory, shop, store, mine and mill, on farms and on railroads. There are clerks who became Advertising Managers, Salesmen and Executives; carpenters who became Architects and Contractors; mechanics who became Engineers and Electrical Experts; men and boys who rose from nothing to splendid responsible positions.

More than two million men and women in the last 30 years have advanced themselves in position and salary through I. C. S. help. Over 150,000 are studying right now. You can join them and get in line for promotion.

The first step to success in the I. C. S. way is to choose your career from this list and mark and mail this coupon here and now.

----- TEAR OUT HERE -----

INTERNATIONAL CORRESPONDENCE SCHOOLS  
Box 5672-C, Scranton, Penna.

Without cost or obligation, please tell me how I can qualify for the position or in the subject before which I have marked an X:

### BUSINESS TRAINING DEPARTMENT

- |                                                                           |                                                                           |
|---------------------------------------------------------------------------|---------------------------------------------------------------------------|
| <input type="checkbox"/> Business Management                              | <input type="checkbox"/> Salesmanship                                     |
| <input type="checkbox"/> Industrial Management                            | <input type="checkbox"/> Advertising                                      |
| <input type="checkbox"/> Personnel Organization                           | <input type="checkbox"/> Better Letters                                   |
| <input type="checkbox"/> Traffic Management                               | <input type="checkbox"/> Foreign Trade                                    |
| <input type="checkbox"/> Business Law                                     | <input type="checkbox"/> Stenography and Typing                           |
| <input type="checkbox"/> Banking and Banking Law                          | <input type="checkbox"/> Business English                                 |
| <input type="checkbox"/> Accountancy (including C.P.A.)                   | <input type="checkbox"/> Civil Service                                    |
| <input type="checkbox"/> Nicholson Cost Accounting                        | <input type="checkbox"/> Railway Mail Clerk                               |
| <input type="checkbox"/> Bookkeeping                                      | <input type="checkbox"/> Common School Subjects                           |
| <input type="checkbox"/> Private Secretary                                | <input type="checkbox"/> High School Subjects                             |
| <input type="checkbox"/> Business Spanish <input type="checkbox"/> French | <input type="checkbox"/> Illustrating <input type="checkbox"/> Cartooning |

### TECHNICAL AND INDUSTRIAL DEPARTMENT

- |                                                                          |                                                                      |
|--------------------------------------------------------------------------|----------------------------------------------------------------------|
| <input type="checkbox"/> Electrical Engineering                          | <input type="checkbox"/> Architect                                   |
| <input type="checkbox"/> Electric Lighting                               | <input type="checkbox"/> Blue Print Reading                          |
| <input type="checkbox"/> Mechanical Engineer                             | <input type="checkbox"/> Contractor and Builder                      |
| <input type="checkbox"/> Mechanical Draftsman                            | <input type="checkbox"/> Architectural Draftsman                     |
| <input type="checkbox"/> Machine Shop Practice                           | <input type="checkbox"/> Concrete Builder                            |
| <input type="checkbox"/> Railroad Positions                              | <input type="checkbox"/> Structural Engineer                         |
| <input type="checkbox"/> Gas Engine Operating                            | <input type="checkbox"/> Plumbing and Heating                        |
| <input type="checkbox"/> Civil Engineer                                  | <input type="checkbox"/> Chemistry <input type="checkbox"/> Pharmacy |
| <input type="checkbox"/> Surveying and Mapping                           | <input type="checkbox"/> Automobile Work                             |
| <input type="checkbox"/> Metallurgy                                      | <input type="checkbox"/> Navigation                                  |
| <input type="checkbox"/> Steam Engineering                               | <input type="checkbox"/> Agriculture and Poultry                     |
| <input type="checkbox"/> Radio <input type="checkbox"/> Airplane Engines | <input type="checkbox"/> Mathematics                                 |

Name.....  
Street..... 6-26-22  
Address.....

City..... State.....

Occupation.....

Persons residing in Canada should send this coupon to the International Correspondence Schools Canadian, Limited, Montreal, Canada.

Please Mention Popular Mechanics



## Make Your Voice an Asset!

### YOUR Voice Wins or Loses

THE executives of your firm, the men to whom you must sell yourself, the buyers to whom you must sell your firm's product, the men whose friendship you want, the girl, perhaps—all these people can make or mar your future. And, they judge you in a large measure by your voice. The speaking voice is your most vital point of contact with others—does it impress, charm, and interest those you meet? Or, does it grate upon them—cause them to shun you—hinder your chances of business success and social popularity?

### Haberstro's Complete Course in Voice Culture—NOW \$5

Haberstro, the World-Famous Voice-Culturist, has put his marvelous system into a handy and inexpensive form which is now offered to millions of people, where before only a favored few could avail themselves of his instruction, at great cost of time and money.

Through great economy in publishing, we are able for the first time to offer you the complete Haberstro course on The Speaking Voice for the small cost of \$5, postpaid, and guaranteed. If for any reason you conclude, after 5 days' trial, that the course does not benefit you, return it to us, and your money will be immediately refunded.

### Send the Coupon NOW—

Fill out the coupon below—pin \$5 to it—mail it at once. Make today a turning point toward success. Do it now!

### Personal Culture Society, Inc.

6 North Michigan Avenue

Chicago

Personal Culture Society,  
6 N. Michigan Avenue,  
Chicago, Ill.

(PM-1)

For the attached \$5 send me Haberstro's Complete System, "The Voice in Speaking," under your advertised guarantee.

Name .....

Address .....

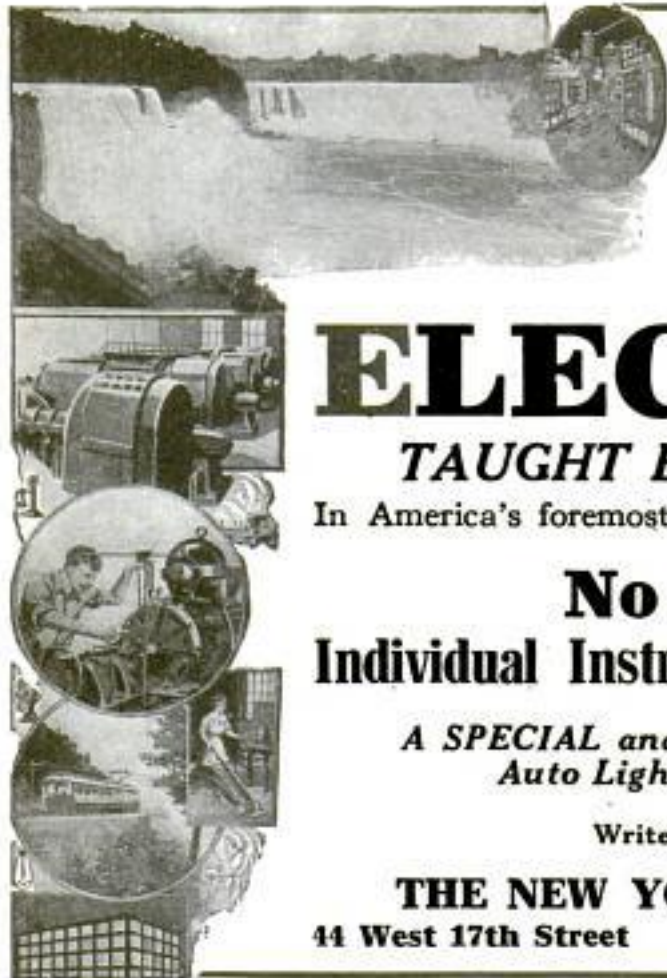

# LEARN BY DOING

Every phase of all branches of

## ELECTRICITY

TAUGHT BY ACTUAL PRACTICE

In America's foremost and oldest institution for trade training.

### No Books Used

Individual Instruction

Start Any Day

A SPECIAL and SEPARATE Course in Ignition,  
Auto Lighting and STARTER Systems

Write for FREE 64-Page Catalog

**THE NEW YORK ELECTRICAL SCHOOL**

44 West 17th Street

NEW YORK CITY

# A Workout

## BOXING Jiu-Jitsu Wrestling

~~\$5.00~~  
\$2.97



85 lessons — over 200 illustrations

HERE it is—the famous Marshall Stillman Course in Boxing, Jiu-jitsu and Wrestling, now at the extraordinary price of \$2.97 instead of \$5.00—85 lessons, 381 pages, 246 illustrations.

Sooner or later you'll have to "whip your man." It may come tomorrow. A bully insults you, your sweetheart or mother. Do you swallow the insult? No, you fight, but unless you know more about boxing and self-defense than your opponent, you're the one who's going to get licked.

Marshall Stillman Association  
Dept. 1222-K, 42nd St. and Madison Ave., New York

You may send me on approval the Marshall Stillman Course. I will deposit 97c with the postman, with the understanding that if, after 10 days, I wish to return the course I may do so and my money will be refunded. If I keep the course I am simply to send you two dollars in final payment.

Name.....

Address.....

You're not playing fair with those who love and depend upon you unless you prepare yourself. And think of the sport you're missing. There's barrels of fun in friendly boxing bouts and wrestling matches. You may even box rings around that "chap who thinks he knows it all" or pin his shoulders to the mat.

Marshall Stillman teaches you the game right in your own home from the simplest rudiments of hitting and guarding to the most scientific blows and guards, such as the Benny Leonard Triple, the Jack Dempsey Triple, the Fitzsimmons Shift, etc. So quickly do pupils learn that many outbox bigger opponents after only two weeks' training.

In wrestling you learn 15 Jiu-Jitsu holds—how to disarm an opponent, how to break a strangle hold, etc.—and 14 of the best mat holds—the Gotch Toe Hold, the Stecher Scissor Hold, the Head-lock, etc.

With the course you get a Free History of 69 Famous Boxers, with their pictures and "inside" stories about them.

**SEND NO MONEY:** Simply fill in and mail the coupon. When you have the course in your hands, merely deposit 97 cents with the postman. Then examine the course for 10 days—try it thoroughly. At the end of 10 days either send us the small balance of \$2 in final payment or return the course, and we'll send your deposit back. Mail the coupon to Marshall Stillman Association, Dept. 1222-K, 42d St. and Madison Ave., New York.

# Be An Auto Expert

I WILL MAKE YOU ONE!—by my complete, practical, simple, easy, auto, truck and tractor course—which you can master in your home—at your leisure—without giving up your present job. I will make you a "Cooke Trained Expert." With that title you can command **respect—and big money.**

When you work with me, you don't just "learn" things. **YOU DO THINGS!** YOU BEGIN TO ACHIEVE RIGHT FROM THE START.

## Choose Your Career NOW!

Think of it! Eleven million motor driven vehicles in this country today—and any one of them is liable to need attention any minute. The automobile field is a "gold field." **STAKE YOUR CLAIM NOW AND AVOID THE RUSH.**

Choose the right career—show some "pep" and enthusiasm—and **you can be your own boss.** Any one of the following careers is open to you. **TAKE YOUR CHOICE:**

**Owner or Manager of a Garage; Demonstrator and Saleman; Tractor Engineer; Auto Mechanic; Auto Electrician; Battery Expert; Welder; Tire Vulcanizer; Truck Driver; Chauffeur.**

**\$150 in 3 days!**

Men who have worked with me are now earning big incomes. You just ought to read the heart warming letters I receive from grateful students who feel that they owe their success in life to me. One tells of making \$150 in three days. Another says: "The man I used to assist is now **my helper!**" And that's just the point! One man, under my guidance, **goes ahead**, while the self-satisfied fellow

**stands still—or goes backward!** Enroll with me and go ahead! I promise to **push** you ahead.

Send for my free book and learn all about my course—just how I work with my men—how I give them practical work to do—how they secure the aid and advice of my big corps of experts—etc., etc. I can't tell you all about it here—**BUT SEND FOR MY BOOK!**

## FREE!

### Auto Design—4 Horse Power Gasoline Motor

Write me at once and learn how you can get this gasoline motor **FREE!** It's essentially like the biggest auto motors made—but, on account of its smaller size and the fact that it is mounted on a block, **it is much more convenient to work with.** I make you this remarkable offer because I want you to **DO THINGS**—instead of merely learning routine "lessons." **No text books—but real work!** That's my method. That's how I make "Cooke Trained Experts." **FIND OUT ABOUT MY FREE MOTOR OFFER AT ONCE!**

## Send for FREE BOOK!

**NOW** is the time to get started on a career. Send for my free book, and learn all about the possibilities—yes—the **certainties** in the automobile field. You just didn't realize they were there—but **I SHOW YOU IN MY BOOK!** You can have my **Complete Auto Course**—or you can have a **Special Electric-Auto Course** or a **Special Battery Course.** **SEND THE COUPON TODAY!**

**B. W. COOKE, President**

**THE COOKE AUTO SCHOOL**  
Dept. 1357, 500-530 S. Throop St., Chicago

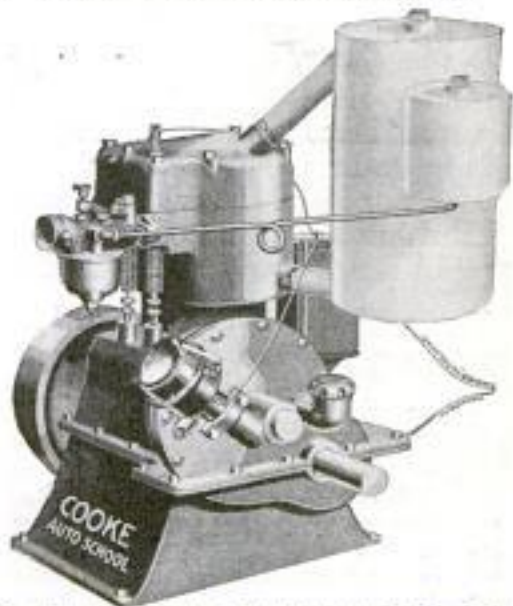

**THE COOKE AUTO SCHOOL**  
B. W. COOKE, President  
Dept. 1357, 500-530 S. Throop St., Chicago

Please send me your free book and full information as to how I can get the gasoline motor **FREE!** I am interested in:

- Your **COMPLETE** automobile Course, which covers everything.  
 Your **SPECIAL** Auto-Electric Course.  
 Your **SPECIAL** Battery Course.

(Put a cross in front of the course you want.)

It is understood I am not under the slightest obligation in asking for this information.

Name.....

Address.....



# Big Money

# For Auto Experts

**H**ARD times don't worry the Auto Expert. He is in constant demand. Did you ever know of an experienced auto engineer hunting a job? No, and you never will. The job hunts him.

Just consider for a moment that there are 9,000,000 automobiles in this country today. These millions of cars are in constant need for experts—repairmen and auto engineers.

A smattering knowledge won't get you very far in this line, but if you are willing to get down to brass tacks and really master this well paying line of work, then there will be no limit to what you can earn.

It is only one step from Auto Expert to Garage Owner, but think of the big money that is earned by the up-to-date garage. Here is your chance to become independent—to be your own boss with our help. Now don't say "Well, I'll think about it," but make up your mind right now to be a real success.

The coupon will give you full information on how to do it. Fill out and send it in right now while you are thinking about it.

### American School

Dept. A774, Drexel Ave. and 58th St., Chicago

### American School

Dept. A774, Drexel Ave. and 58th St., Chicago

Send me full information on the subject checked and how you will help me win success.

- |                                |                              |
|--------------------------------|------------------------------|
| ..... Architect                | ..... Lawyer                 |
| ..... Building Contractor      | ..... Machine Shop Practice  |
| ..... Automobile Engineer      | ..... Photoplay Writer       |
| ..... Automobile Repairman     | ..... Mechanical Engineer    |
| ..... Civil Engineer           | ..... Shop Superintendent    |
| ..... Structural Engineer      | ..... Employment Manager     |
| ..... Business Manager         | ..... Steam Engineer         |
| ..... Cert. Public Accountant  | ..... Foremanship            |
| ..... Accountant and Auditor   | ..... Sanitary Engineer      |
| ..... Bookkeeper               | ..... Surveyor (and Mapping) |
| ..... Draftsman and Designer   | ..... Telephone Engineer     |
| ..... Electrical Engineer      | ..... Telegraph Engineer     |
| ..... Electric Light and Power | ..... High School Graduate   |
| ..... General Education        | ..... Fire Insurance Expert  |
| ..... Vocational Guidance      | ..... Wireless Radio         |
| ..... Business Law             | ..... Undecided              |

Name .....

Address .....

Please Mention Popular Mechanics

# Stop Forgetting

## Make Your Mind a File—Not a Pile

Let me show you how to make your mind as forget-proof as a card index file. When you wish to recall a name, place or date, must you grope in vain in a pile of miscellaneous knowledge? Summoned to give facts and figures does your mind become a blank? Be master of your mind's infinite resources—instead of a victim of its disordered details.

## KNOWLEDGE IS POWER

and Memory Is the Basis of All Knowledge

## I HAVE HELPED THOUSANDS

The Dickson Method of Memory and Mental Training, perfected by 20 years experience, is recognized as the most thorough, efficient of its kind. Highly endorsed—easy to master. Give me 10 minutes a day and I will train your memory so you can classify ideas, names, faces, etc., and recall them instantly. Develop self-control, concentration; overcome bashfulness.

## Perfect Your Memory and Command What Salary You Will

Send name and address and I will send you free, my interesting booklet, "How to Remember," and unique, copyrighted Memory Test; also tell you how to secure free of charge my \$3.00 book, "How to Speak in Public."

Prof. Henry Dickson, Principal  
DICKSON MEMORY SCHOOL  
Dept. 705  
Evanston, Ill.



The Key to Success

## \$15.00 TENOR BANJO FREE

### YOU CAN PLAY THE TENOR BANJO Just Like the Experts

Because PROF. BARKER will help you

Our method of teaching is so simple, plain and easy that you begin on a piece with your first lesson. In half an hour you can play it! We have reduced the necessary motions you learn to only five—and you acquire these in a few minutes. Then it is only a matter of practice to acquire the weird, fascinating tremolos, staccatos, slurs and other effects that make this instrument so delightful. The TENOR BANJO plays any kind of music—melody or accompaniment.

**FREE** Our complete course of 52 lessons includes FREE a beautiful TENOR BANJO, all necessary playing equipment and 52 pieces of Music.

Special arrangement for lessons if you have your own TENOR BANJO.

Your favorite instrument given away FREE with first lesson. Special courses under Famous Teachers. Learn to play Violin, Hawaiian Guitar, or Ukulele. This Makes a Splendid Christmas Gift.



First Hawaiian Conservatory of Music, Inc.  
223 Broadway (Woolworth Bldg.) New York  
Please send me full information about your 52 easy lessons and FREE TENOR BANJO OFFER.

Name .....

Address .....

Town ..... State ..... P. M. 10



# Building Experts Wanted

## Greatest Building Boom in History Provides Big Jobs for Trained Men in the Building Trades

**Big Pay for Those Who Can Superintend Construction, Take Contracts, Read Plans, Estimate Costs, Etc.**

There is a big building boom coming—it's here now! Plenty of labor can still be had but expert builders who can direct and put work through are scarce. They can get big money—in fact, can name their own price. There are great days of opportunity just ahead for wide-awake bricklayers, carpenters, plumbers, plasterers and other builders who have training to back up their practical experience.

Skill at your trade in the building industry is good—but not enough. It is brains and training that put men in the big-money class today. The workman who knows more than those around him becomes foreman or superintendent, and later on often starts his own business. And the contractor who knows best how to estimate on jobs and to employ and direct men gets the paying business.

## America's Oldest and Largest School for Builders Will Train You at Home in Your Spare Time

Hundreds of carpenters, bricklayers, and other builders attend our Chicago school. For twenty years we have been training building experts, and hundreds of our graduates are now topnotchers in the building business. You can get this same training at home in spare time—by mail. Same practical blue print plans, same estimates, same

lessons, same expert teachers to guide you by easy stages to success in short time.

## FREE Book and Blueprints

Send coupon for our Free Book "How to Read Blue Prints." Just out. It contains a Trial Lesson in Plan Reading and with it we send blue prints, drawings, etc. Test yourself and see how quickly you can learn by our method. Other schools ask you to pay first; we send you this lesson first—it does not cost you one penny. Tell every man in the building lines about this great free offer.

**Send the Coupon** Get this free book and see for yourself how Chicago Tech. training will put you ahead. Just sign your name on the coupon and put "X" opposite course which interests you. Get ready now for bigger pay. Mail the coupon.



## Learn Draftsmanship At Home



No experience necessary; no special school training required to take up Drafting. Learn to draw plans and get in the big salary class. Architectural, Structural Steel, Mechanical, Electrical and other industries are calling for trained

draftsmen. Drafting is at the foundation of all industry. Clean, pleasant, interesting and highly paid work. Easy to learn by the Chicago Tech. Plan.

**Drawing Outfit Free** We send you a complete drawing outfit—Instruments, T-Square, Drawing Board, etc., if you enroll as a student in Drafting.

**Free Trial Lesson** Mark "X" in the coupon opposite "Drafting" and get this Free Trial Lesson and instructive matter showing the splendid opportunities for you as a Chicago Tech. trained draftsman.

**SEND THE COUPON TODAY**

### Chicago Technical College

1030 Chicago Tech. Bldg., Chicago, Ill.  
Without cost or obligation on me, please send instructive information on subject marked below.

- **Builders' Course**  
Plan Reading, Estimating, Superintending, etc.
- **Drafting**  
Mechanical, Electrical, Architectural, etc.
- **Surveying**  
and Topographic Drafting.
- **Plan Reading of Machinery**  
for Shop Men, Machinists, etc.
- **Aeronautical Engineering**  
Aeroplane Construction and Design.
- **Automobile Course**  
Gas Engines, Ignition, Starting, Lighting, etc.

Name.....

Address.....

City..... State.....



## "I Knew You'd Make Good"

"I ALWAYS felt you had it in you to get ahead. But for a time I was afraid your natural ability would be wasted because you had never trained yourself to do any one thing well. Yes, I was afraid you would always be 'a jack of all trades and master of none.'

"But the minute you decided to study in your spare time I knew you'd make good. You seemed more ambitious—more cheerful—more confident of the future. And I knew that your employers couldn't help but notice the difference in your work.

"Think what this last promotion means! More money—more comforts—more of everything worth while. Tom, those hours you spent on that I. C. S. course were the best investment you ever made."

HOW about you? Are you always going to work for a small salary? Are you going to waste your natural ability all your life? Or are you going to get ahead in a big way? It all depends on what you do with your spare time.

Opportunity knocks—this time in the form of that familiar I. C. S. coupon. It may seem like a little thing, but it has been the means of bringing better jobs and bigger salaries to thousands of men.

Mark and mail it today and without obligation or a penny of cost, learn what the I. C. S. can do for you.

----- TEAR OUT HERE -----  
**INTERNATIONAL CORRESPONDENCE SCHOOLS**  
 Box 5675-C, Scranton, Penna.

Without cost or obligation, please tell me how I can qualify for the position or in the subject before which I have marked an X:

### BUSINESS TRAINING DEPARTMENT

- |                                                         |                                                 |
|---------------------------------------------------------|-------------------------------------------------|
| <input type="checkbox"/> Business Management            | <input type="checkbox"/> Salesmanship           |
| <input type="checkbox"/> Industrial Management          | <input type="checkbox"/> Advertising            |
| <input type="checkbox"/> Personnel Organization         | <input type="checkbox"/> Better Letters         |
| <input type="checkbox"/> Traffic Management             | <input type="checkbox"/> Foreign Trade          |
| <input type="checkbox"/> Business Law                   | <input type="checkbox"/> Stenography and Typing |
| <input type="checkbox"/> Banking and Banking Law        | <input type="checkbox"/> Business English       |
| <input type="checkbox"/> Accountancy (including C.F.A.) | <input type="checkbox"/> Civil Service          |
| <input type="checkbox"/> Nicholson Cost Accounting      | <input type="checkbox"/> Railway Mail Clerk     |
| <input type="checkbox"/> Bookkeeping                    | <input type="checkbox"/> Common School Subjects |
| <input type="checkbox"/> Private Secretary              | <input type="checkbox"/> High School Subjects   |
| <input type="checkbox"/> Business Spanish               | <input type="checkbox"/> Illustrating           |
| <input type="checkbox"/> French                         | <input type="checkbox"/> Cartooning             |

### TECHNICAL AND INDUSTRIAL DEPARTMENT

- |                                                 |                                                  |
|-------------------------------------------------|--------------------------------------------------|
| <input type="checkbox"/> Electrical Engineering | <input type="checkbox"/> Architect               |
| <input type="checkbox"/> Electric Lighting      | <input type="checkbox"/> Blue Print Reading      |
| <input type="checkbox"/> Mechanical Engineer    | <input type="checkbox"/> Contractor and Builder  |
| <input type="checkbox"/> Mechanical Draftsman   | <input type="checkbox"/> Architectural Draftsman |
| <input type="checkbox"/> Machine Shop Practice  | <input type="checkbox"/> Concrete Builder        |
| <input type="checkbox"/> Railroad Positions     | <input type="checkbox"/> Structural Engineer     |
| <input type="checkbox"/> Gas Engine Operating   | <input type="checkbox"/> Plumbing and Heating    |
| <input type="checkbox"/> Civil Engineer         | <input type="checkbox"/> Chemistry               |
| <input type="checkbox"/> Surveying and Mapping  | <input type="checkbox"/> Automobile Work         |
| <input type="checkbox"/> Metallurgy             | <input type="checkbox"/> Navigation              |
| <input type="checkbox"/> Steam Engineering      | <input type="checkbox"/> Agriculture and Poultry |
| <input type="checkbox"/> Radio                  | <input type="checkbox"/> Mathematics             |
| <input type="checkbox"/> Airplane Engines       |                                                  |

Name.....  
 Street.....  
 Address.....

City..... State.....

Occupation.....

Persons residing in Canada should send this coupon to the International Correspondence Schools Canadian, Limited, Montreal, Canada.

Please Mention Popular Mechanics

Broadcasting  
 over WWJ  
 Detroit  
 News,  
 October  
 14, 1922  
 8:30 to  
 10:00  
 P. M.



"Listen In"  
 Hear the  
 Gibson  
 Melody  
 Maids  
 Concert

WWJ Detroit News Concerts are heard at great distances. Tune in on above date and hear the wonderful music possible on Gibson Instruments. You too will want to own a Gibson.

New friends, new pleasures, new and interesting experiences, in invitations galore—dinners, dances, week-end parties, outings,—are some of the good things playing a Gibson brings into your life.

**Gibson**  
 Instruments

are easily learned in spare time without previous knowledge of music. A few weeks of pleasant, interesting study and you'll be able to play. And there's no other joy in life quite equal to hearing music you make on your own instruments.

**\$5.00 Monthly** buys a Gibson. The ultimate in construction, finish, tone quality and volume. Built like a violin. Adjustable bridge, non-warpable truss rod neck. 30 other exclusive Gibson features. **Guaranteed for life.** Non-Gibson instruments exchanged.

**Make \$25 to \$200** weekly selling, playing, teaching. Own a stock, advertise, help sell, carry accounts. Gibsons easily sold on installment credit plan.

Send for FREE catalog, FREE music and information about Mandolin, Mandola, Mandocello, Mandobass, Guitar, Harp-guitar, Mandolin-banjo, Tenor-banjo, Cello-banjo, Guitar-banjo. If interested in Agency, check here.....Teacher?..... Clip, check and mail this ad today.

**Gibson Mandolin-Guitar Co.**  
 1370 Parsons St. Foreign Dept.  
 Kalamazoo, Mich. 25 Broad St., N. Y. City

## LEARN The BUSINESS of Advertising



### QUICKLY BY MAIL

We guarantee to teach you. It's easy to learn—and easy to get into! Make the start *this week*. This free book tells how.

**\$75 to \$100 a Week**

—frequently paid beginners. There is **no limit** to opportunities which men and women trained in advertising meet on every hand.

**FREE AD-WRITER'S COMPLETE WORKING OUTFIT**

Wonderful outfit of working instruments given free on special offer. Write for details before offer expires. We will also send you free and prepaid this stirring book on advertising. Tell us everything you want to know about getting into this fascinating field. Write today. Post-card will do.

PAGE-DAVIS SCHOOL, Dept. A22, Page Bldg., Chicago

## Work while learning Electricity

Set of tools given to producers. Write

S & H ELECTRICAL WORKS, Dept. K. 1, 308 So. Green St., CHICAGO

## "What Shall I Be?"

You cannot attain real success and happiness unless you enjoy your work. Latest scientific method shows you what occupation you are best fitted for, eliminating all guess work. Write for free information. Bureau of Vocational Research, 296-C Broadway, New York City.

## The WONDERFUL ERICKSON PATENT LEG

Will not chafe, overheat, nor draw end of stump.



ERICKSON ARTIFICIAL LIMB CO., 38 Wash. Av. N., Minneapolis, Minn.

# Drawing Outfit

# FREE

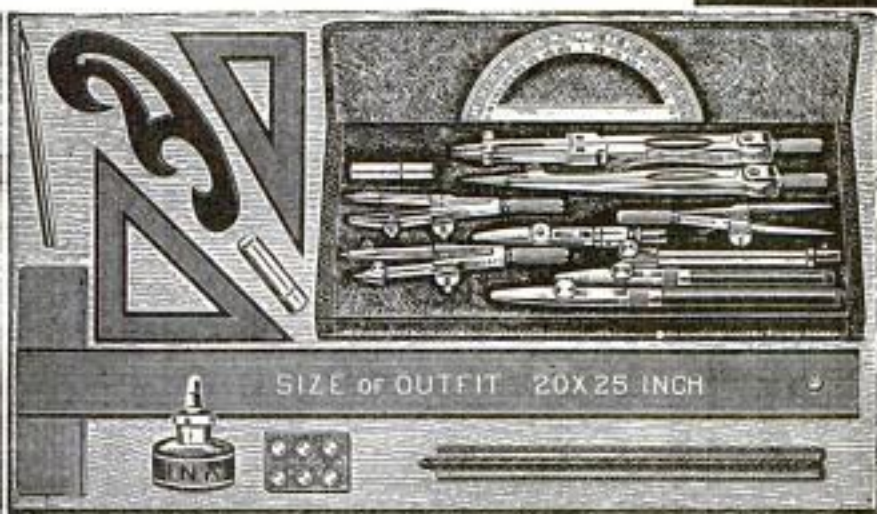

## Complete Set of Drawing Instruments Delivered AT ONCE

Yes, I will give you this complete drawing outfit absolutely free. The instruments are in a handsome high class, plush lined folding case. They are regular draftsman's working instruments. Besides I will give you absolutely free, a 20 x 25 inch drawing board, a 24 inch T square, a 12 inch rule, a supply of drawing paper, two triangles, a French curve, pencils, erasers, thumb tacks, etc.

## \$3600 a Year *Drafting Salary*

There is an urgent demand for skilled draftsmen. Companies are issuing calls every day for men to fill positions paying \$3600.00 a year. Work is light, pleasant and profitable.

## Chief Draftsman *Will Instruct You Personally*



I am Chief Draftsman of a large and well known firm. I have been doing the highest paying expert drafting work for a quarter of a century and I know just the kind of training that is demanded from men who get the big salaries. I train you by giving you actual, practical work, the kind you must be able to do to hold permanent, big paying positions. I give you my individual instruction. If your work is right, I will advance you rapidly. If it is wrong, I will show you where and make you do it right, and do all I can to make you an expert draftsman and designer in a short time.

*Write Today Without Fail!*

**I Guarantee**  
to train you until  
you are placed in  
a position paying  
\$250 to \$300 a  
month.

## Send Coupon For New Book!

Put your name and address on the coupon or a letter or a post card and send it to me today. I will send you absolutely free and postpaid, my new book, "Successful Draftsmanship," and the great special offer that I am now making on which you get the complete Draftsman's Working Outfit absolutely free. You assume no obligations of any kind in sending in the coupon. Get in line for a big paying position. Getting the book and full particulars of the special offer is the first step.

**Chief Draftsman Dobe**

**Div. 1357, 4001 Broadway, Chicago, Ill.**

**Chief Draftsman Dobe**

**Div. 1357, 4001 Broadway Chicago, Ill.**

Without any obligation on me whatsoever, please mail your book, "Successful Draftsmanship" and full particulars of your liberal "Personal Instruction" offer to a few students. It is understood that I am obligated in no way whatever.

Name.....

Address.....

# WIN \$1,000.00 OR AN OAKLAND TOURING CAR

## WHO ARE THEY?

- ① I PARCK MY FORD ⑥ G HE IS A HOT MMAN  
② ARE LAND WORN ⑦ PEWL HIT EAR  
③ BBAY NEVER LYE ⑧ READ ALL WICE  
④ SAT TUK NO BEER ⑨ TALCS GOT MEAN DANCE  
⑤ ART WEANS AT IT ⑩ HE CAN RICH PAILL



## CAN YOU ANSWER THIS MOVIE PUZZLE?

On the Movie Screen above are the names of 10 Popular Movie Stars, rearranged topsy-turvy. The operator played a joke on the audience and you'll admit it was a good one.

To solve the puzzle, and puzzle it is, rearrange the peculiar sentences on the screen so as to correctly spell each star's name. For example, No. 10 is Charlie Chaplin. You know him. If you can name all 10 Stars correctly you can win the \$1,000 or an Oakland Touring Car.

You most likely know the names of the most popular Stars, but just to refresh your mind we are mentioning a few of them:—Constance Talmadge, Otis Skinner, Buster Keaton, Anita Stewart, Charles Ray, Mary Pickford, Charlie Chaplin, Helen Chadwick, Thomas Meighan, Pearl White, Warner Oland, Beverly Bayne, Ralph Ince, Wallace Reid and Dorothy Dalton.

### 185 "POINTS" WINS FIRST PRIZE

For each name you arrange correctly you will receive 10 "Points" towards the Oakland Touring Car or the \$1,000 in cash, or you will receive 100 "Points" if you arrange all 10 names correctly. You can gain 60 more "Points" by Qualifying your answer. That is, by proving that you have boosted the Big Magazine, FRUIT, GARDEN AND HOME to five people. The final 25 "Points" will be awarded by 3 Judges, whose decision will be absolutely fair and is to be taken as final and without question, to the person making up the largest list of correct words from the name of the 10th Movie Actor listed on the screen above—CHARLIE CHAPLIN. It's easy! Can you make out 10-20-30 words like, are-lie-car-pie-hall, etc. Send in your list of words right away with the names of the 10 Movie Stars. RULES:—Number each word, and in making up your list, don't use proper names, abbreviations, prefixes, and suffixes, or obsolete and archaic words. Webster's Dictionary will be used as Final Authority. Use each letter only as many times as it appears. For example: There are 2 a's, therefore "a" may be used 2 times if necessary in forming a word.

The answer gaining 185 "Points" (which is the maximum), will win the Oakland or the \$1,000. In case of a tie, all tying contestants will receive a prize identically the same as the prize tied for. Send in your answer TODAY. As soon as it is received, we will send you a FREE circular telling you all about the Big New Magazine, FRUIT, GARDEN AND HOME, to assist you in qualifying.

### COSTS NOTHING TO TRY

You will not be asked to subscribe to FRUIT, GARDEN AND HOME, nor to spend a penny in order to win. Just write your answer to the Puzzle on one side of the sheet of paper and PRINT your name and address on the upper right hand corner. Send in your list of words with your solution before October 10th, the Final Day. Do your best and you can win. Answer the Puzzle NOW.

**The Publishers' Sales Co. Dept. 510**

Chamber of Commerce,  
ST. PAUL, MINN.



# \$1.00

**Down**  
Brings This  
**6-Piece**  
**Library**  
**Set**



**New**  
**Set with**  
**Large Roomy Divan**

Only \$1.00 with the coupon below brings this sensational furniture bargain to your home on 30 days trial. Complete 6 piece set of fumed solid oak living room furniture including a wonderfully comfortable and roomy divan. Only \$29.85 for the complete set on this offer—on easy payments, too. \$40 was the former price for a set like this—a special factory sacrifice makes this slash in price possible now. Seize this opportunity on our special approval offer—we take the risk.

## 30 Days Trial

When you get this magnificent 6-piece library set, put it in your living room or library and use it freely for 30 days. Note the massive, solid construction—the beautiful finish—the fine upholstery and graceful lines. Compare it with anything you can buy locally at anywhere near

the same price—even for spot cash. Then if not satisfied for any reason, return the set at our expense and we will refund your \$1.00 at once, plus any freight charges you paid.

**Only \$2.70 a Month** If you decide to keep the set, start paying only \$2.70 a month until you have paid \$29.85. A full year to pay—at the rate of only a few cents a day. This wonderful value is not listed in our regular catalog. We have only a limited number of sets. We trust honest people anywhere in the U.S. One price to all, cash or credit. **No discount for cash. Not one penny extra for credit. No C.O.D.**

## Price Slashed!—Send Now

### Free Bargain Catalog

Shows thousands of bargains in furniture, jewelry, carpets, rugs, curtains, silverware, phonographs, stoves, porch and lawn furniture, women's, men's and children's wearing apparel.

Don't delay. Just send \$1.00 along with the coupon as a deposit. If you wish to return the set after 30 days, your dollar will be refunded, plus all freight charges which you paid. Remember, this is a special, limited, reduced price offer. First come, first served. Get your set while this offer lasts. 30 days trial—we take all the risk. Send coupon now.

**Straus & Schram, Dept. 1777 Chicago**

**New**  
**6-Piece Set**  
**Fumed Solid Oak**

This superb 6-piece set is made of selected solid oak throughout, finished in rich, dull waxed, brown fumed oak. All the four chairs are padded; seats upholstered with brown DeVan Spanish leather, the best imitation of genuine Spanish leather known. The upholstery is a rich brown color.

**Large Divan** provides extra seating capacity. It is an unusually massive, comfortable piece with beautifully designed back. Arms are broad and comfortable. Measures 46 inches wide outside and 30 inches long inside. Thickly padded seat is 19 inches deep. Height of back is 22 inches. Posts are extra massive.

**Arm Chair** is a roomy, dignified piece of furniture, comfortable and big enough for a very large person while not seeming too large for the ordinary occupant. Seat 19 x 17 1-2 in., height 36 in.

**Arm Rocker** is a massive, stately, comfortable piece, with beautifully designed back, wide, shapely arms, and smooth operating runners. Seat 19 x 17 1-2 in., height 36 in.

**Swing Rocker** is unusually attractive and useful. Seat 19 x 17 in., height 36 in.

**Library Table**—A beautiful piece of library furniture. Beautifully designed ends to match chairs with roomy magazine shelf below. Legs cut of 2 in. stock; massive, dignified. Top measures 23 1-4 x 34 in.

**Jardiniere Stand** matches other pieces. A decoration to your living room or library. Carefully built throughout. Measures 17 1-2 in. high; the top 12 x 12 inches.

Entire set shipped knocked down construction. Easy to set up. Saves freight charges. Wt. about 175 lbs.

Order by No. B6944A. \$1.00 with coupon, \$2.70 a month, price \$29.85.

**Straus & Schram, Dept. 1777 Chicago, Ill.**

Enclosed find \$1.00. Ship special advertised 6-Piece Fumed Oak Library Set. I am to have 30 days free trial. If I keep the set, I will pay you \$2.70 monthly. If not satisfied, I am to return the set within 30 days and you are to refund my money and any freight charges I paid.

**6-Piece Library Set, No. B6944A. \$29.85.**

Name \_\_\_\_\_

Street, R. F. D. \_\_\_\_\_

or Box No. \_\_\_\_\_

Shipping Point \_\_\_\_\_

Post Office \_\_\_\_\_

State \_\_\_\_\_

If you only want catalog put x in box below:

Furniture, Stoves, Jewelry  Men's, Women's, Children's Clothing

# Hook Your Radio Set to These Sensational "A" & "B" RADIOBATS

Enjoy Uninterrupted Operation of your Radio Outfit, Without Battery Noises, Without Constant Adjustment and Without Continual Replacement Expense.

"A" and "B" RADIOBATS for your radio outfit are built on sensational new principles. RADIOBAT "B" as well as "A" is a genuine rechargeable storage battery that eliminates the constant "B" battery replacement expense.

RADIOBATS contain the first successful semi-solid electrolyte. They cannot leak. This principle plus the rugged strength of the RADIOBAT grid has made it unnecessary to use separators of any kind.

RADIOBAT "A" is smaller, lighter in weight and easier to handle than any other "A" battery of equal rating.

RADIOBAT "B" is absolutely quiet in operation. George Gaynor Hyde, well known consulting engineer, after making an entirely independent test of RADIOBAT "B" reports: "The total absence of any noises such as are common to the usual type of "B" battery."

This battery is easily rechargeable at home every three or four months and has on each charge, the life of approximately ten dry cell batteries.

The combination of "A" and "B" RADIOBATS forms "The permanent power UNIT for radio". If you now have a radiophone, replace your present batteries as they give out with "A" and "B" RADIOBATS. If you are expecting to buy or build a radio outfit, you are more fortunate. You can insist on RADIOBATS to start—and avoid all battery troubles and replacement.

Ask your dealer for a RADIOBAT demonstration. In the meantime, send for your copy of the booklet, "The Permanent Power Unit for Radio". Your name on a postcard brings it free.

**Multiple Battery Sales Corp.**  
350 Madison Avenue - New York



"A"  
and  
"B" **RADIOBATS**  
*The Permanent Radio Power-UNIT*

# Popular Mechanics Magazine

REGISTERED IN U. S. PATENT OFFICE

WRITTEN SO YOU CAN UNDERSTAND IT

Vol. 38

OCTOBER, 1922

No. 4

## 20 Electric Fire Truck Has Four-Wheel Drive

**F**IRE-FIGHTING apparatus has been improved upon to the extent of equipping large trucks with individual motor drives in each wheel and raising or lowering the ladders by air and hydraulic pressure. The current for the driving motors is supplied from powerful storage batteries which are suspended beneath the frame of the vehicle. While the wheels appear to be of the ordinary disk type, they possess removable covers, so that the mechanism can be quickly and conveniently exposed for proper maintenance. An air compressor, driven by a gasoline

engine, is incorporated in the outfit and furnishes the necessary elevating power for the heavy ladders, the lowering of these being accomplished with the aid of oil brakes, or compression cylinders. The action of the ladders is so simple that but one man is required to operate them, thus facilitating the actual fire-fighting work after the apparatus arrives at the scene of the blaze. The advantage obtained in many localities by the installation of these virtually noiseless electric trucks is obvious, and it is thought that they will be adopted by many cities.

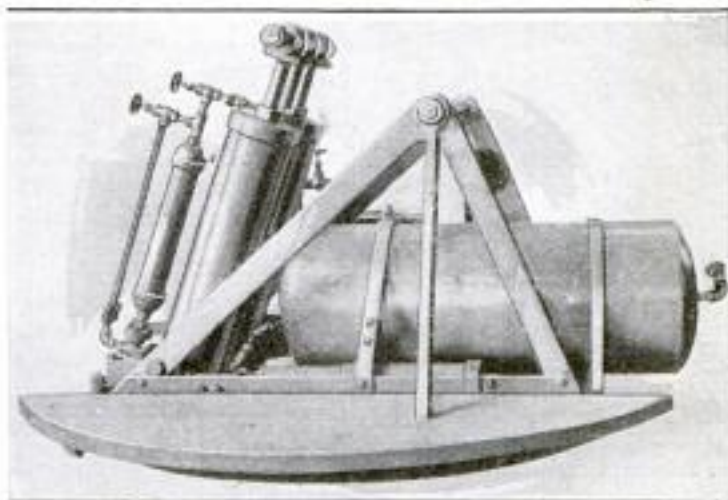

Ladder-Operating Mechanism for Fire Truck, Showing, from Left to Right, the Small Oil Cylinder, the Three Air Cylinders, and the Compressed-Air Tank

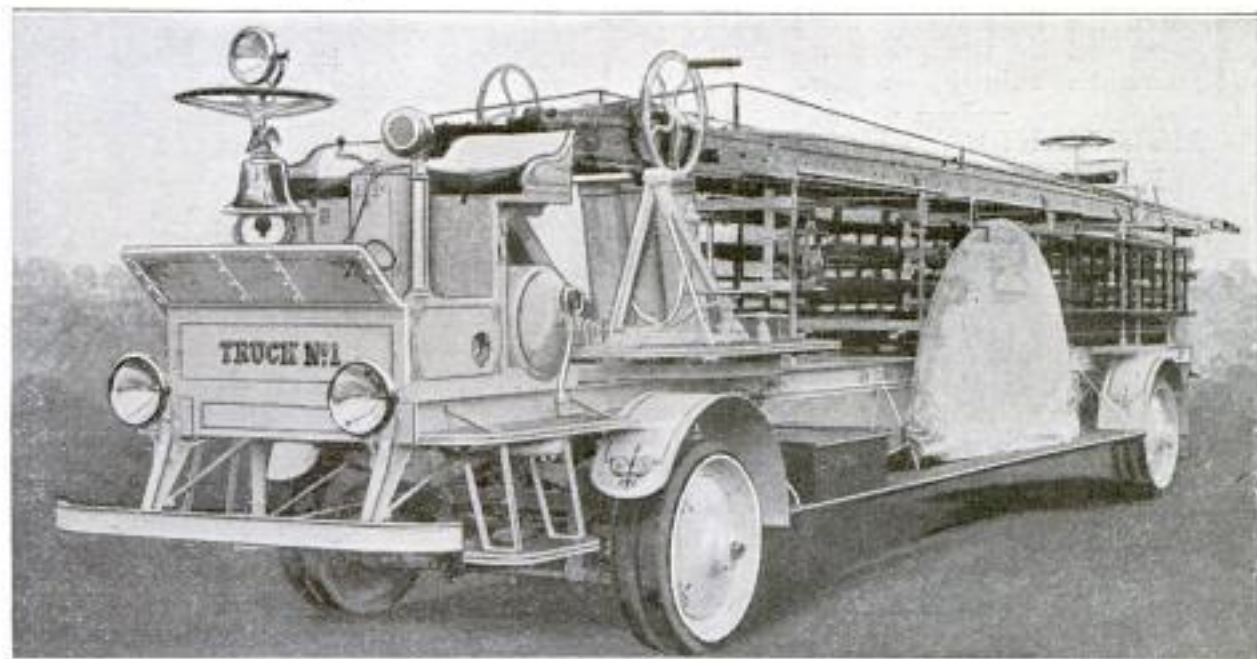

Latest Type of Virtually Noiseless Electric Fire Truck Which Contains an Individual Motor Drive in Each Wheel, and Has a Mechanism for Raising or Lowering the Ladders, Operated by Compressed Air and Oil

*Couple near Freight Wheel Rapids, Mich*

Hape & Jones  
 1st National Bank Bldg  
 494 2  
 POPULAR MECHANICS  
 9942 Worland Wyd.  
 N.Y. Times  
 8/10/22  
 P. 1

**PROTECTS SHIRTS OR WAISTS  
 ON AUTOMOBILE TRIPS**

Protecting the backs of shirts and waists during a hot and dusty automobile trip, when the occupants naturally per-



The Garment Protector—Shown in Detail in the Insert, as It is Worn, and Also Result of Not Wearing It

spire from the heat of the back upholstery, is possible with a simple arrangement. The contrivance consists of a piece of paper fitted with small adhesive disks which are fastened to the clothing before entering the machine. These shields, or papers, are quickly removed at the termination of the trip, after having prevented the pleasure of the ride from being marred by the prospect of soiled and sometimes ruined garments.

**MOUNTAIN PASS HAS NEW  
 ROAD AMONG CLOUDS**

The newly completed road through Tioga Pass in the Sierras of California connects Lake Tahoe with Yosemite Valley and puts Lake Mono within reach of tourists who can view from the pass way, which reaches a height of 10,000 feet, some of the most impressive mountain scenery in the world. Mark Twain, who felt the grandeur of the mountains, describes Lake Mono as being "the loneliest tenant of the loneliest spot on earth, under the surface of whose dull waters no living thing existed except a small feathery sort of worm." The route is made safe and convenient to autoists by patrols with trouble cars and by service stations at frequent intervals.

**MEN FIGHTING FOREST FIRE  
 AIDED BY AIRPLANE**

The airplane further demonstrated its usefulness in fighting forest fires, when a lumber company made use of one this summer in combating a fire that was raging on its property in the Province of Quebec. The plane was first used to reconnoiter the burning area and then to direct the men on the ground to the point where their efforts would accomplish the most. After that the aerial patrol made daily inspections of the fire area, so that the plan of attack could be adapted to any change in the situation. In addition, the plane was used to supply the fighters with food.

**DURABLE WIRELESS UMBRELLA  
 HAS DETACHABLE PARTS**

A ball-and-socket joint for the ribs instead of the usual wire-stringing method is one of the many features of an umbrella recently brought out. Other merits are, that solid-brass nickelplated parts are used throughout, except for the steel frame and enameled-steel rod. The ribs can be easily attached or removed, and it is claimed that the cover can be replaced by anyone in only three minutes. Detachable handles of the ordinary type are provided, so that the umbrella may be carried in a suitcase or traveling bag. As a woman's or man's style of handle



Left: Neat Appearance of the Wireless Umbrella. Insert: Manner of Attaching Handle, Also Ball-and-Socket Joint of the Ribs

can be quickly placed on the article, the umbrella is an economical investment.

The Parke Mfg Co.  
 209 89  
 8/10/22

73  
 N.Y. Times  
 8/10/22  
 P. 2

4 International Newsreel Corp  
*Collision near New York City*  
RAILWAY COACHES REDUCED TO KINDLING WOOD



WHEN an engineer on the Missouri Pacific Railroad failed to heed a block signal near Sulphur Springs, Mo., recently, his limited train, composed of steel cars and running at full speed, crashed through five heavily loaded wooden coaches of a local train. Thirty-eight persons were killed and 137 injured. The picture gives a general view of the disastrous wreck, and illustrates how the heavy steel cars virtually made kindling wood of the antiquated coaches.

*I no. E. A. Eberle, Jr.*  
*9992 231 E. 4th St*

496

POPULAR MECHANICS  
*Long Beach, Calif.*

**MUSIC ROLLS QUICKLY FOUND  
IN AUTOMATIC CABINET**

Finding a particular music roll without the usual annoying search among all the records in the cabinet, is possible with an automatically operated cabinet

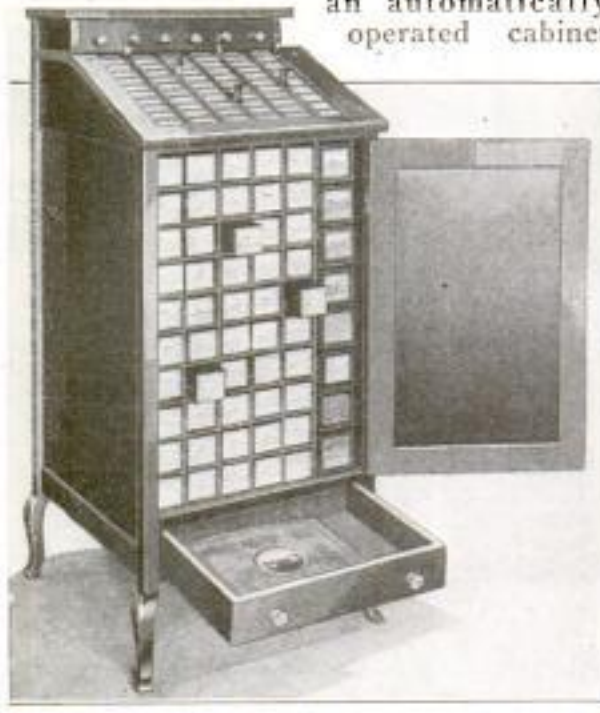

**Music-Roll Cabinet Which Automatically Pushes the Desired Record Part Way Out of the Files, Thus Eliminating the Usual Search**

produced by a western man. The top of the cabinet is built at an angle, and has six rows of interchangeable title plates arranged to correspond to the music rolls kept in pigeonholes below. A push button is at the head of each column, and

*9862*

between the rows are levers working in slots. When a certain roll is desired, a lever is adjusted to the name of the record wanted, the button at the top is pressed, and the roll slides partly out.

*9862*

**SPECTACULAR ILLUMINATION  
AT BRAZILIAN EXPOSITION**

Brazil is about to celebrate its one hundred years of independence by an international exposition at Rio de Janeiro which will be notable for its wonderfully picturesque setting, for some striking specimens of architecture, and, perhaps more than all, for its spectacular and novel methods of illumination. The exposition will occupy an area of 50 acres, and will include exposition buildings of 13 foreign nations, and many large Brazilian buildings with beautifully planted gardens and parks. At night all will be made brilliant with a system of exposition illumination that is an elaboration of that adopted seven years ago at the San Francisco exposition, and designed by the same man who planned that installation. One striking feature in this illumination will be a so-called "scintillator," consisting of a battery of sixteen 31-inch arc searchlights, individually operated, and each provided with a set of five color screens. The searchlight beams will be projected radially, with constantly changing colors, and, in combination with fireworks and streams of water spray and steam, will produce some very interesting effects.



**View to be Seen at the Forthcoming International Exposition at Rio de Janeiro, Brazil, Showing Effect of "Scintillator": The Apparatus Consists of a Battery of Sixteen 31-Inch Arc Searchlights Which Throw Their Beams of Light Radially over the Exposition Buildings. The Lights Are of Different and Changeable Colors**

*International General Electric Co*  
*Schenectady N.Y.*  
*Copyrighted material*  
*u + u.*  
*International*  
*Newsreel*

9537 navy Dept., Bureau of  
Construction & Repair, Washington, DC



One of the New Small High-Speed Torpedo Boats, Recently Acquired by the American Navy, Making a Trial Spin: Of the Three Men Seated Amidships, the Middle One Is Secretary of the Navy Denby. The Boats are Known as "Coastal Motorboats"

## NAVY ACQUIRES SMALL SPEEDY TORPEDO BOATS

**T**WO small high-speed torpedo boats, known as "coastal motorboats," recently acquired by the U. S. navy from one of the largest speed-boat builders in England, have been assigned to the Naval Torpedo Testing Station, at Alexandria, Va. On their arrival at Norfolk, Va., they made a trial trip to Washington, a distance of 190 miles, which they covered in about 5 hours at an average speed of nearly 37 miles an hour. The experience of the late war showed very clearly that in modern navies small high-speed torpedo boats are most essential.

The new boats are built with speed hulls, and are fitted with longitudinal troughs

for discharging the torpedo, tail first, over the stern, while the boat is attacking at full speed. The boat is moving at about the same speed as the torpedo, and it has to be skillfully maneuvered to get out of the way of the torpedo, which thus has been fired without any knowledge of the enemy, and without any diminution in the high speed of the attacking boat.

Many of these boats were secretly built for the British navy, and were used most effectively during the latter part



The Two High-Speed Torpedo Boats: The Nearer One Is 55 Feet Long with Two Torpedo Troughs, Seen at the Stern. The Smaller Boat Beyond Is 45 Feet Long

of the war against German submarines and mine layers. The two vessels of this type that now form part of the U. S. navy are respectively 45 and 55 feet long, the smaller having only one trough for an 18-inch torpedo, and the larger two. The smaller boat has a width of 9 feet 7 inches and a draft of 2 feet 9 inches, while the larger is 11 feet wide and draws 3 feet 3 inches of water. Each is fitted with the same type of internal-combus-

tion engine, much on the lines of an airplane motor, but the larger boat has two, while the smaller is propelled by one. Each motor develops 375 brake horsepower at 1,550 revolutions per minute. During the war these boats were used also for mine laying, their shallow draft allowing them to pass safely over enemy mine fields, and their high speed enabling them to escape before being observed and attacked.

### FAN COILS AND MOUNTINGS FOR RADIO SETS

Fan coils, used for tuning in radio sets, are being produced, together with a neat and attractive mounting, by a Pennsyl-

### NEW PROTECTIVE MATERIAL FOR RADIOLOGICAL WORK

The necessity of better protective material in connection with radiological work has led to the production in Eng-

land of a new substance made in either a pliable or a solid form. The former is for such articles as aprons, nurses' overalls, and the lining of tube boxes, while the latter is to be used for panel sections, portable screens, etc. The composition is a trade secret, and the ingredients vary, depending on whether the solid or pliable form is required. In tests, samples of the pliable form of 3.1-millimeter thickness, were found to be equivalent to 1 millimeter of metallic lead, and those of 5.3-millimeter thickness, equivalent to 1.7 millimeter of metallic lead. The results were the same whether the applied voltage to the tube was 100,000 or 120,000 volts. In the solid form, 9.9-millimeter thickness was found to be equivalent to 1.5-millimeter metallic lead, with an applied voltage to the tube of 100,000 volts,

and to 1.3-millimeter metallic lead, with an applied voltage of 120,000 volts. A full-length apron, equal in protection to 1 millimeter of metallic lead, although weighing 19 pounds, has been made, by means of special supporting straps, more comfortable to wear than the lead-rubber variety. In the pliable form it can be produced in widths up to 26 inches and in any reasonable length and thickness.

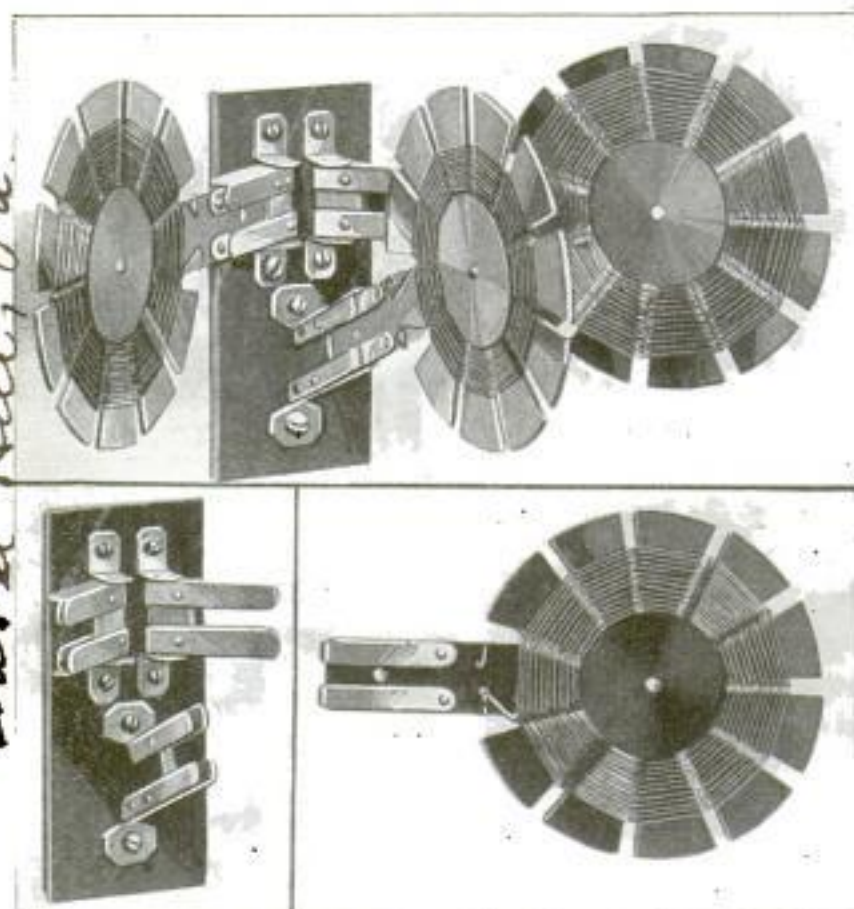

Top: Three Fan Coils in Their Holders on the Bakelite Mounting. Lower Left: Bakelite Mounting, Showing the Two Pivoted and One Stationary Holder. Lower Right: Fan Coil, Showing Neat Construction

vania manufacturer. The coils are made of bakelite and furnished wound with enameled wire, or delivered unwound if the amateur desires to use his own pet combination. The mountings are also of bakelite, with nicked-brass holders for the coils, one of the holders being stationary, while the other two are pivoted to permit proper adjustment in the delicate task of tuning in.



Z. J. Bell, Riverside, Calif.

9423

### CENTRAL-HEATING SYSTEM FOR ORANGE GROVES

BY C. R. BALDWIN, *Route 7, Box 43, Riverside, Calif.*

**F**ROST prevention is an ever-present problem with the orange growers of California. A dependable system of frost prevention would be of immense value to them.

Recently such a system has been de-

veloped which shows great promise. It is a permanent installation good for many years of service. The plant consists of a central-heating furnace. Oil is fed under pressure from a supply tank to the burners by a small motor. A 30-horsepower motor is attached to a blower which draws the air into the heating chamber and forces it out through the distributing pipes. These pipes are of concrete, varying from 10-inch pipes at the furnace down to 3-inch pipes at the point of delivery. Vertical galvanized pipes with distributing caps deliver a stream of hot air directly under each group of four trees. The temperature of the air at the point of delivery is approxi-

mately 400° F., and dampers control the amount of air delivered. The inventor claims that his equipment can displace the cold air in an orchard with warm air to a height of 10 feet in about 15 minutes. The distributing pipes from the cen-

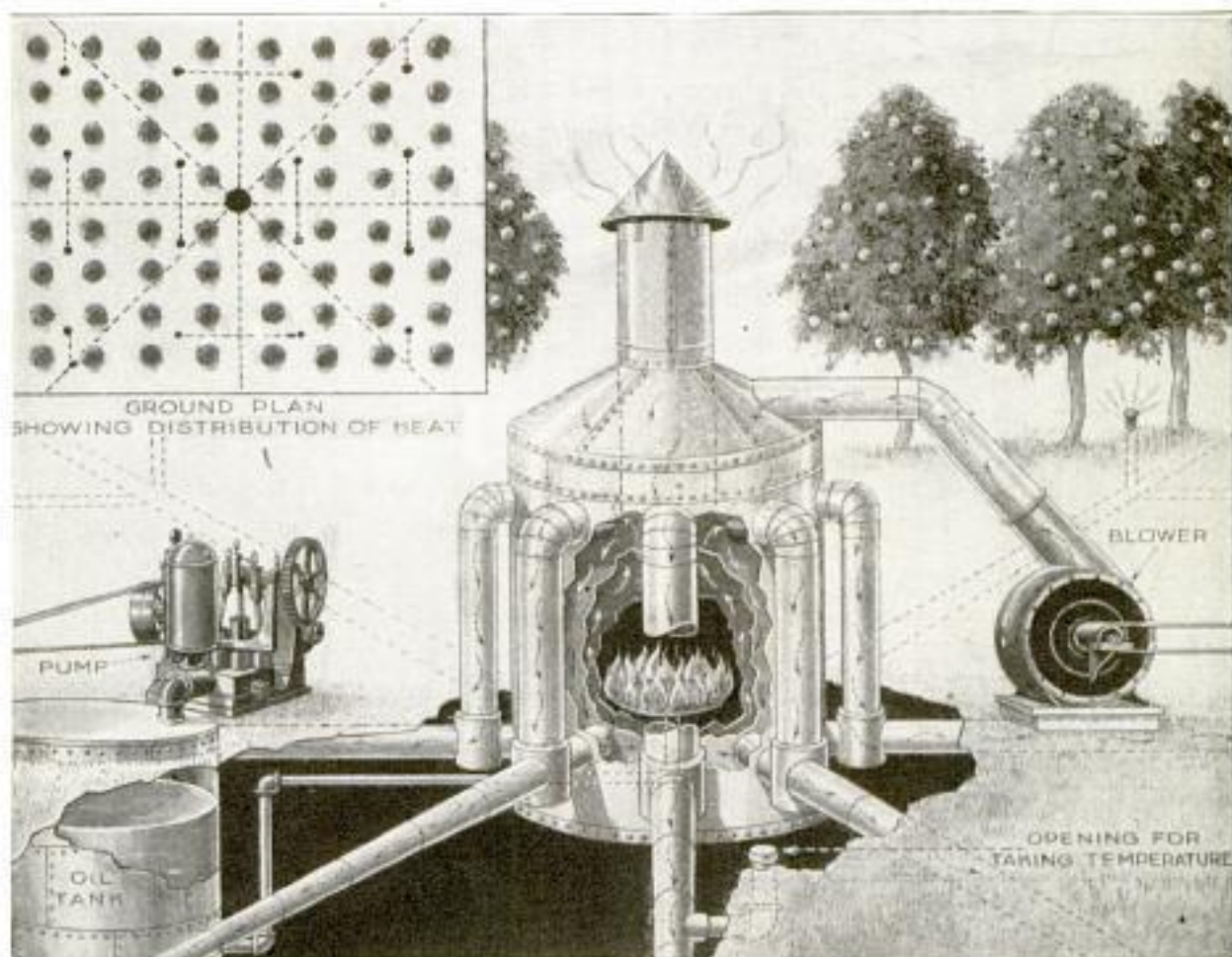

Sketch of Central-Heating Furnace for Orange Groves, or Orchards, to Prevent Damage to the Fruit by Frost: The Illustration Clearly Shows the Manner of Running the Many Heater Pipes, the Location of Vents, and Also the Position of Oil Tank, Pump, and Blower

veloped which shows great promise. It is a permanent installation good for many years of service. The plant consists of a central-heating furnace. Oil is fed under pressure from a supply tank to the burners by a small motor. A 30-horsepower motor is attached to a blower which draws the air into the heating chamber and forces it out through the distributing pipes. These pipes are of concrete, varying from 10-inch pipes at the furnace down to 3-inch pipes at the point of delivery. Vertical galvanized pipes with distributing caps deliver a stream of hot air directly under each group of four trees. The temperature of the air at the point of delivery is approxi-

mal furnace are placed one to two feet under ground. When the period of plowing and cultivating comes, the distributing caps are removed and the pipes covered until winter.

#### PHILADELPHIA MAY BECOME 9895 LARGEST FLOUR PORT

Experts believe that the recent acquisition of storage facilities in Philadelphia will make that city the leading flour port in the world. The application to the shipment of flour of the efficient methods now employed for bulk grains, is expected to put American agents on a par with English millers.

*Bureau of Standards  
Washington, D. C.*

9965 Located in *The Bristol Co., Waterbury Conn.*  
*Building of Palmer School*  
 500 POPULAR MECHANICS  
*Davenport, Iowa.*

**OAKEN LOG IS HOLLOWED OUT FOR PHONOGRAPH CABINET**

Hollowing out a large oaken log to make a phonograph cabinet, was the original idea conceived by the proprietor of a rustic ice-cream parlor in Davenport, Ia. The finished product, with its rough bark exterior, a hinged cover, and houses the mechanism of a high-priced talking machine in the top, while below is a receptacle for the records

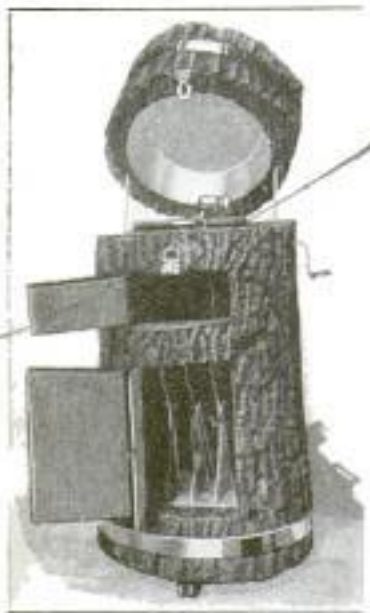

Around the cover and base are placed two polished brass bands about two inches in width, which add to the appearance of the instrument.

implement used was a 9 to 18-horsepower machine, this being backed to the fence and a chain hooked to the wire, which was then stretched 1,200 feet at a time. Fences containing 1,000 pounds of wire were drawn taut in this manner, the farmer claiming that in one hour with the tractor he accomplished as much work as two men did by hand in half a day, which illustration of efficiency should appeal to all fence builders.

9998 **HIGH-VOLTAGE LOUD SPEAKER NEEDS NO BATTERIES**

That it reproduces songs, instrumental music, speeches, etc., with just the right volume to be clearly audible in natural tones, is claimed for a new loud-speaker which has an odd-appearing horn of new design. The appliance is intended for use in conjunction with a third stage of amplification of radio broadcasts,



and has been constructed to operate at a voltage of 100 or more, thus eliminating the use of batteries.

9931 **WIRE FENCES ARE STRETCHED WITH AID OF TRACTOR**

Stretching barbed-wire fences with the aid of a tractor, was the method employed by a New York farmer to effect a considerable saving of time and labor. The

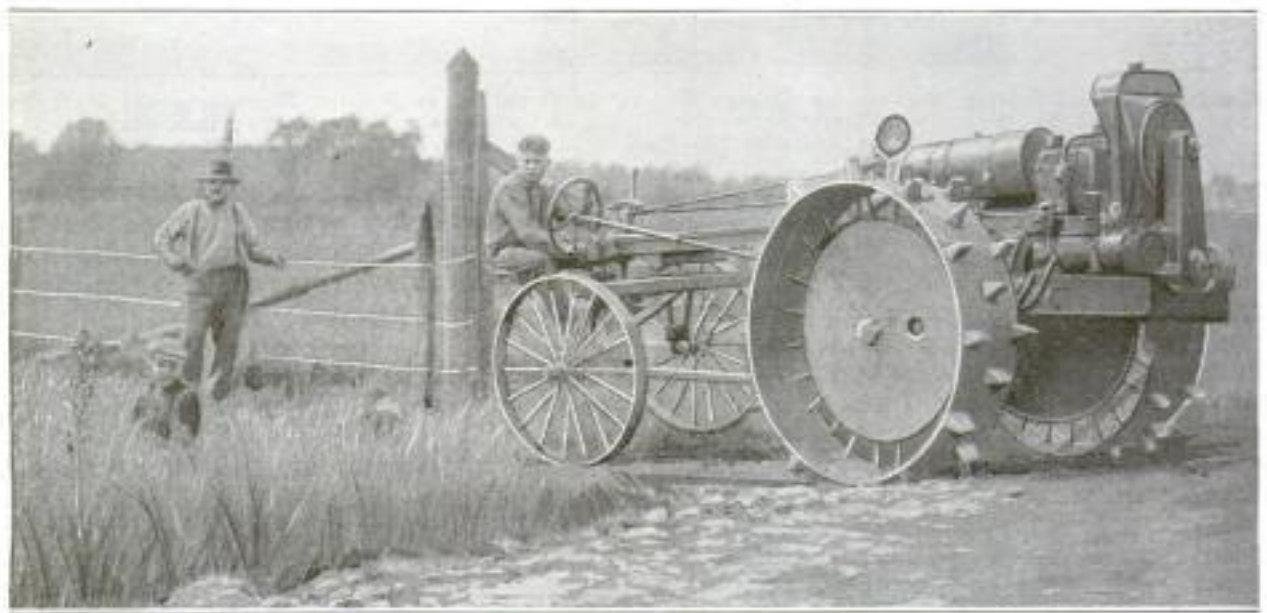

Tractor Outfit Which was Used by an Enterprising New York Farmer in Stretching Barbed-Wire Fences around His 170-Acre Property; The Powerful Implement, Rated at 9 to 18 Horsepower, is Seen at a Turn in One of the Fences, Where 1,200 Feet of Wire was Pulled Taut at One Time

*Demonstrated by - F. M. Green, A. L. Ballston Road, Schenectady, N.Y.*  
 Copyrighted material

9895

Bureau of Standards  
Auto  
Washington, D. C.

# NEW MOTOR-CAR TESTING APPARATUS GIVES COMPLETE ROAD PERFORMANCE DATA

BY G. H. DACY *National Press Club  
Washington, D. C.*

ENGINEERS of the Bureau of Standards have lately designed an apparatus which accurately measures and records the performance of a motor car in road tests, and the first of these appliances to be built has just recently undergone trials with pronounced success.

It consists of a flow-meter camera, which makes a photographic record of the gas consumption, and a multiple recorder which keeps tab on 16 distinct and separate operations of various machinery parts of the automobile. The present equipment is for use on any type of motor car accommodating four or more passengers, but it is expected that it will also be adapted to smaller cars. It takes about one day to equip a car with the testing devices, another day to make the tests, and a half day to dismantle the car again.

The multiple recorder, which is securely fastened to the frame of the tonneau, keeps track of the car speed over the road; the relative air speed; the acceleration and deceleration;

power output; rolling resistance; manifold depression, and the changes in the temperature of the fuel, lubricants,

inlet and outlet water, and other features associated with engine operation. After an official try-out of a motor car, the Federal engineers will know more about the automobile than its makers as regards its ability to handle gas and oil economically and operate efficiently. Briefly, the recorder consists of 16 automatic pens which operate as

the car moves over the road and register data concerning the efficiency of this, that, or other important part of the machinery. This record is written on a roll of paper, which is driven by a small motor at a constant speed of .2 inch per second. The roll contains enough paper to continue the test for 1 1/2 hours. In the camera, enough bromide paper can be carried for a two hours' test. The camera is so delicate and carefully adjusted that it will photograph the consumption of gasoline even where it occurs at so slow a rate as two drops per second. All the other results of the tests can be studied visually as



The Flow Meter, Shown in White, Makes a Photographic Record of the Flow of Gasoline to the Carburetor

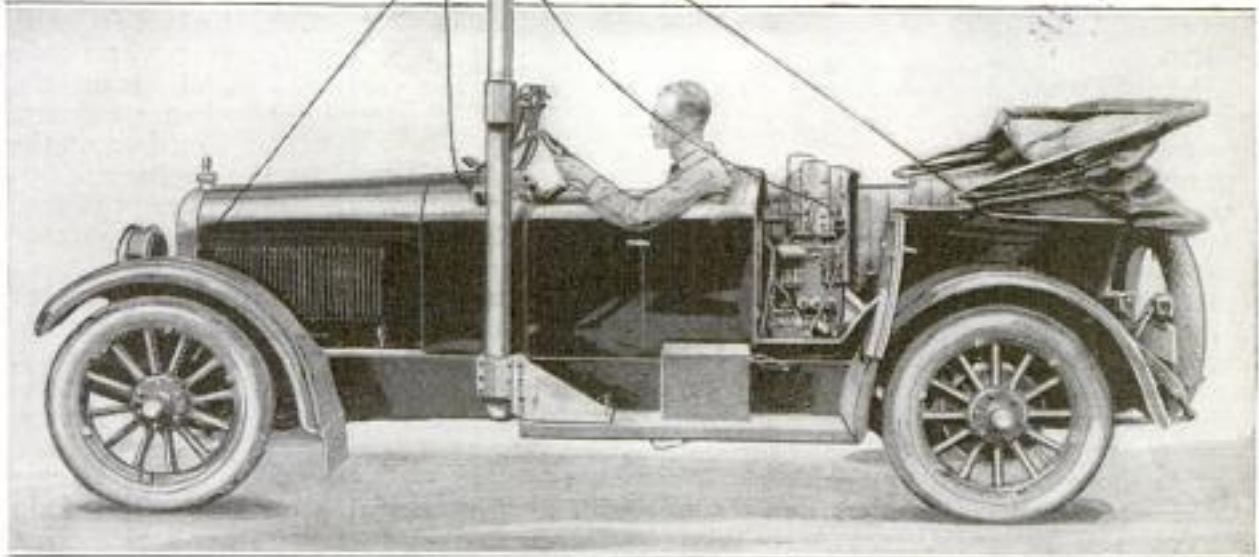
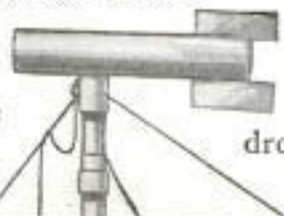

The Multiple Recorder, Shown Attached to Tonneau of Car, Gives Performance Data on Important Factors Involved in Motor-Car Operation. The Odd-Looking Device, Having the Appearance of a Weather Vane, is Constructed on the Principle of the Venturi Meter, and Measures the Wind Velocity

9895

they are being made, the picture making being the only operation concealed from view.

One of the test appliances is a double-tubed Venturi meter which is used to record the speed of the car through the air. This curious device looks something like a weather vane. It is made of metal, bolted to the running board, and extends to a height of 4 feet above the top of the car. The device is built on a large scale so that it can measure air velocities as low as 10 miles an hour.

The test car of the Bureau of Standards was driven over 600 miles of good, bad, indifferent, and, in some stretches, almost impassable roads, thus subjecting the engine to every possible kind of a performance and efficiency test. The testing appliances recorded accurately under all circumstances, and were not damaged by the violent jolting and bouncing about of the vehicle.

The flow meter is a vertical tube slotted parallel to its axis. A light piston runs up and down inside of this tube. The gasoline enters at the bottom and flows through the slot below the piston into a small space between the flow tube and the encircling tube of glass, which permits observation of the position of the piston at any given moment. The measurements registered by the multiple recorder are made at exactly the same instant as those obtained by the flow meter by the use of special timing devices on each of the instruments. A celluloid template is used in interpreting the records registered on the plain, unruled paper. This template is so graduated, and

provided with calibrated pen paths, that it can be oriented in the desired positions on the record chart and used as the key for working out the conclusions. The pressure, temperature, speed, and timing devices used in connection with the multiple recorder are mounted on shelves at the sides of the recorder placed on the floor of the tonneau and connected to the recording pens by means of link wires. The speed of the motor car under test

is recorded by use of an airplane tachometer. It is geared to one of the front wheels of the machine, its spindle being fitted with a small pinion and quadrant which are linked to one of the registering pens. The device has no time lag and records the average speed attained by the car during the preceding two seconds. Data regarding the engine speed are obtained from measurements of the car speed and the known ratio between the rear-wheel axle and transmission gearing. The data on the

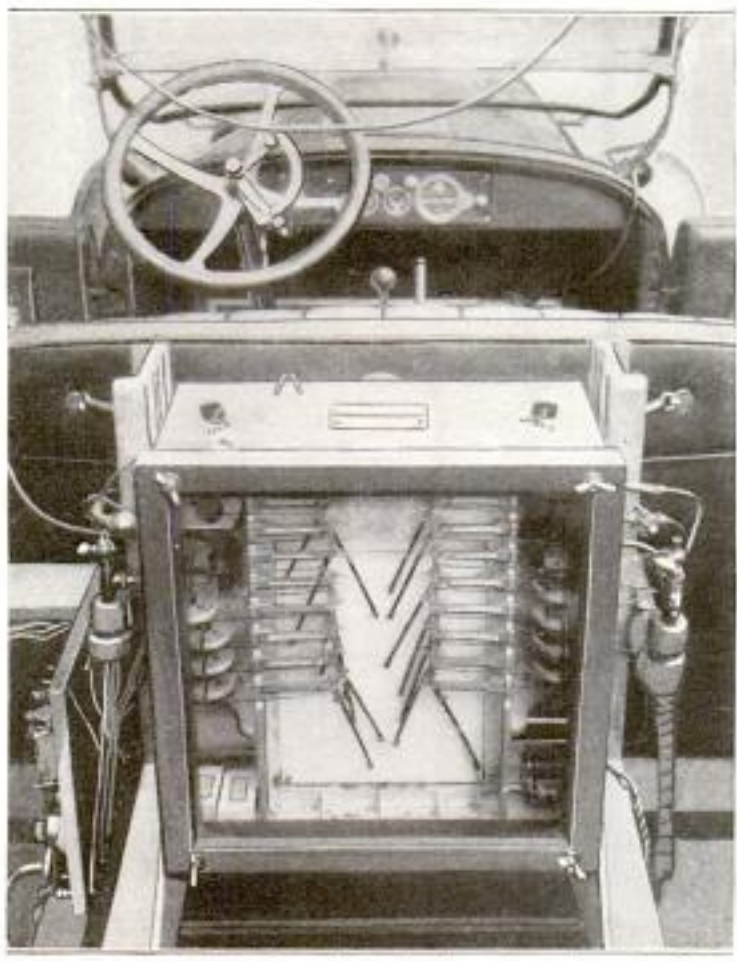

Close-Up of Multiple Recorder, Showing Glass-Covered Meter Box with 16 Pens, Each of Which Draws a Line Giving History, during the Test, of Some Individual Feature Entering into Operation of Automobile under Test

quantity of air used by the engine are obtained from pressure differences produced by the flow of air used by the carburetor through the Venturi meter.

Automotive experts from all parts of the country have examined the new apparatus and pronounced it satisfactory. They predict improvement in automobile-engine construction as a result of the invention.

¶The first aerial stowaway arrived in Cleveland the other day after a ride from Detroit, where he had sought a quiet sleeping place in the hull of a mail cruiser that was anchored in the harbor.

9893 J. V. Belnap, Engineer,  
 R. W. Baker & Co. Contractors,  
 POPULAR MECHANICS 503  
 Southfield Road, Oakland County, Mich

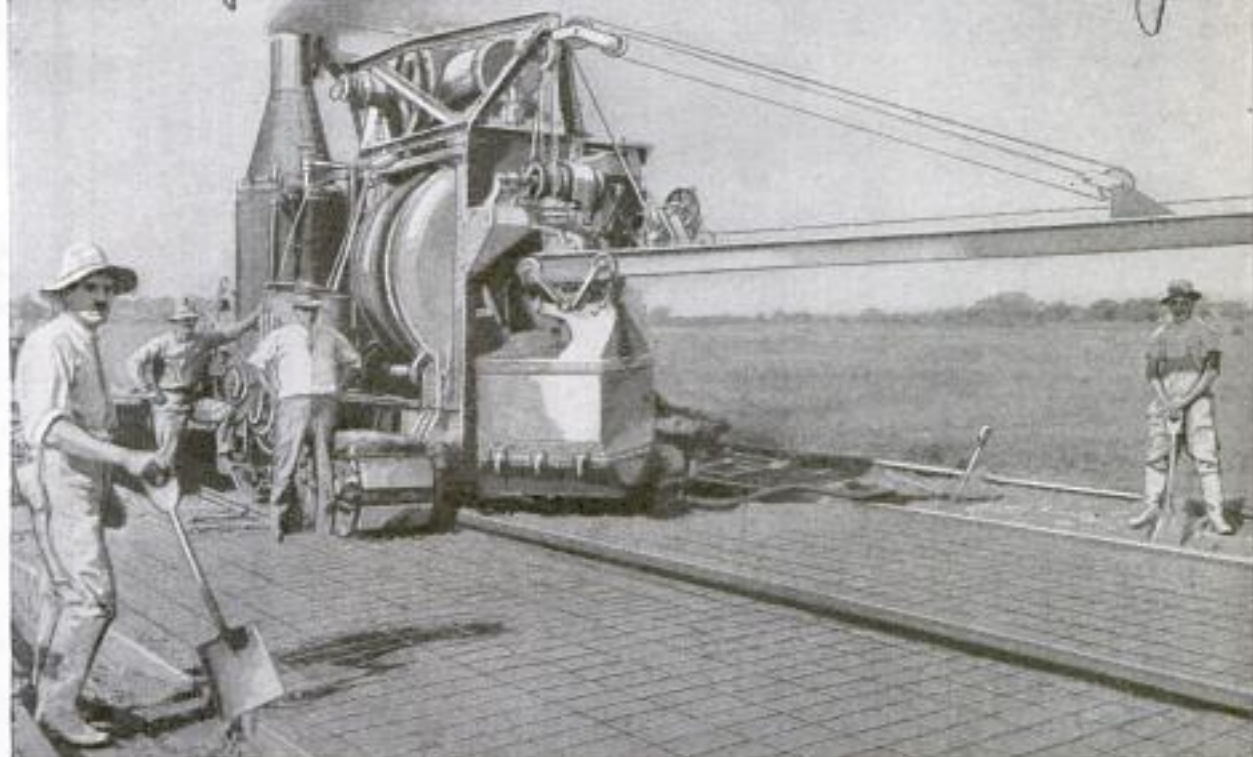

Steel Mats Laid on Foundation Ready for Imbedding into Concrete Subpavement of Improved Highway: This Construction has been Found to Meet the Requirements of Heavy Traffic and Eliminate Troublesome Surface Cracks

9893

### KEEPING CONCRETE ROADS FROM CRACKING

Flat sheets of heavy steel fabric are now imbedded in the most improved types of concrete roads to increase their life. The state highway departments of both New York and Pennsylvania have been so thoroughly convinced of the value of the innovation that hereafter the flat reinforcements will be specified in all contracts let by them. Of even greater significance is the use of a contraction joint in the center of the road, which overcomes cracking that has been hard to prevent hitherto. A dowel-type contraction joint forms a plane of weakness directly across the road. The slight contraction which takes place, instead of forming cracks like those of a drying mud puddle, will be effective at this plane of weakness. A fine hair crack is caused which is not nicked by the traffic.

9500

### WINDSHIELD AND SPOTLIGHTS FITTED TO A MOTORCYCLE

After cutting down the frame of a standard automobile windshield, and reglazing it, the owner of a motorcycle mounted it on the handlebar of his machine, behind the headlight. Con-

ducted to it are standard windshield spotlights, and the whole forms a very unusual equipment for a motorcycle. The windshield is adjustable, and the



Front and Rear Views of Motorcycle Fitted with Standard Automobile Windshield Cut Down and Mounted on the Handlebar: Standard Spotlights Operate in Connection with It

spotlights can be operated in the manner that is common on automobiles, but very unusual on motorcycles.

Cont J. B. Heine, H. report  
 Copyrighted material  
 ill



**DISABLED 9,000-TON SHIP TOWED 2,000 MILES**

**WITHOUT** precedent was the recent performance of the American steamship "Ala.," when it towed the steamship "Eastern Dawn," disabled 700 miles off the coast of England, the remaining 2,000 miles across the Atlantic. In fair weather and foul—very foul at times—the towing continued for 12 days when Nantucket Shoals was reached. Here a shipping-board tug took the "Eastern Dawn" in charge and towed it to New York.

52 Com. Gilbert Isardow,

*The Post-Intelligencer*  
SHIP SAVED FROM SINKING DESPITE CRUMPLED BOW  
*Wreck*

*Seattle Wash.*

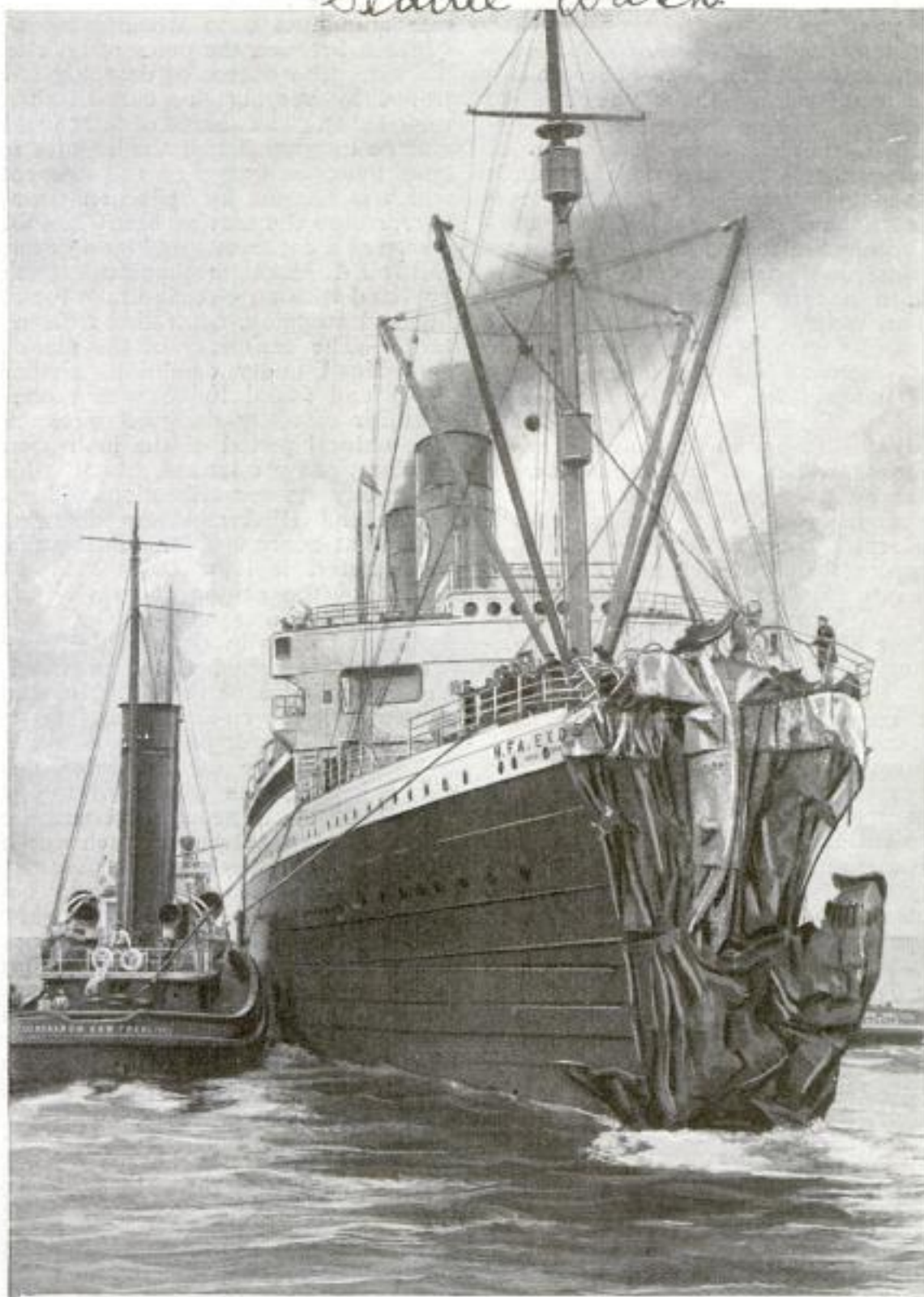

**W**HILE on the way from San Francisco to Seattle, the steamship "H. F. Alexander" crashed into a rock off the treacherous Washington coast. The impact crumpled up nearly 30 feet of the bow of the ship, which was saved by its water-tight compartments.

*F. H. Norton  
 + E. J. Allen  
 of the  
 Registrars*

Not long ago the National Advisory Committee for Aeronautics undertook to obtain information about the stresses that are produced in maneuvering an airplane. At the beginning of a series of experiments it was observed that, when the plane was flying a straight and level course, a spring balance with a one-pound weight attached to it, would register just one pound. If the craft was put into a turn or made to rise, the apparent weight of the one-pound object increased to two or three pounds, while on a downward dip the spring balance would indicate less than one pound or even zero. From these data it was calculated that a 180-pound person might exert a force equivalent to any value between zero and 800 pounds, toward setting up stresses in the craft during violent maneuvers. There is evidence of this in the experience of an airman being thrust down into his seat, during a tight spiral, with such force that it is almost impossible for him to regain a standing position, or even lift his feet from the floor.

Based upon the conclusions of these tests, an instrument, which has been called an "accelerometer," was designed, to detect and record the variations and relative magnitude of the forces that tend to set up stresses in an airplane structure when in flight. In doing this, it also gives an unbiased record of the relative ability of pilots in handling their machines in the air, and in making a satisfactory landing. In the accelerometer, a flat steel spring is fixed at one end, while the other end is free to be deflected by any force acting at right angles to the plane of the spring. This deflection is measured by a light tilting mirror, which owes its ability to rotate to the deflection of the spring, and thereby throws a beam

of light onto a moving film. The movement of the flat spring is damped by a thin aluminum vane attached to it and vibrated between the poles of an electromagnet. The degree of damping is controlled by varying the current through the magnet. The source of light is a low-voltage tungsten lamp, similar to a flashlight bulb, an image of the filament of which is focused by reflection from the mirror onto the moving film. The film is driven at a constant speed by a governor-controlled clock mechanism, which is provided with an electric brake for starting and stopping, controlled from a distance. The constancy of the clock was determined under conditions similar to flying and found to be within one per cent for carefully designed mechanisms. The natural period of the instrument is 70 vibrations per second, which is higher than any motor vibrations likely to occur, and eliminates any disturbances from that source. In mounting the accelerometer, it is placed within a few inches of the center of gravity of the plane, upon a sponge-rubber pad, to isolate it from vibrations of the fuselage. Two electric switches are provided for the convenience of the pilot in starting or stopping the clockwork and for turning the light on or off.

Tests with the accelerometer showed that whenever the wheels of the plane were clear of the ground, the entire craft had a constant vibration which was independent of the motor speed. It was also shown that excessive strain may be put upon an airplane structure by an unfavorable landing, and that running it needlessly along the ground, after landing, is likely to cause more vibration than the actual landing, especially on rough ground. On the other hand, the forces that are produced by accelerations arising from a spin are not great, unless the craft is made to dive precipitously.

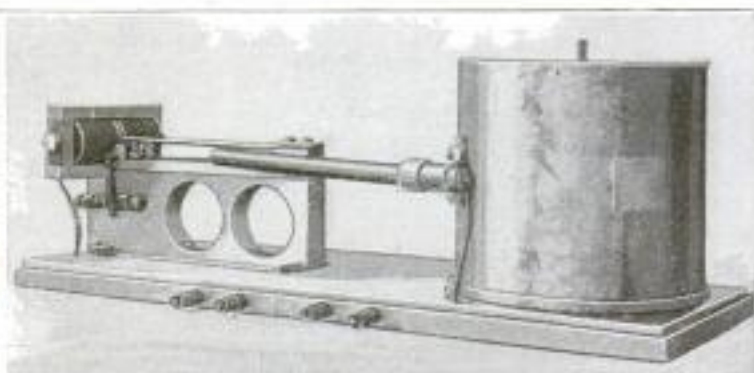
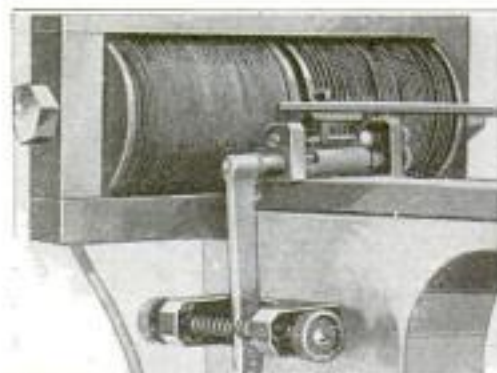

Left: Close-Up of "Accelerometer," Showing the Flat Spring, Two Magnet Coils between Which the Damping Vane Vibrates, and, under the Spring, the Tilting Mirror with Lever and Thumbscrew Adjustment.  
 Right: Accelerometer Assembled, with Recording Drum, on a Board for Mounting in the Airplane



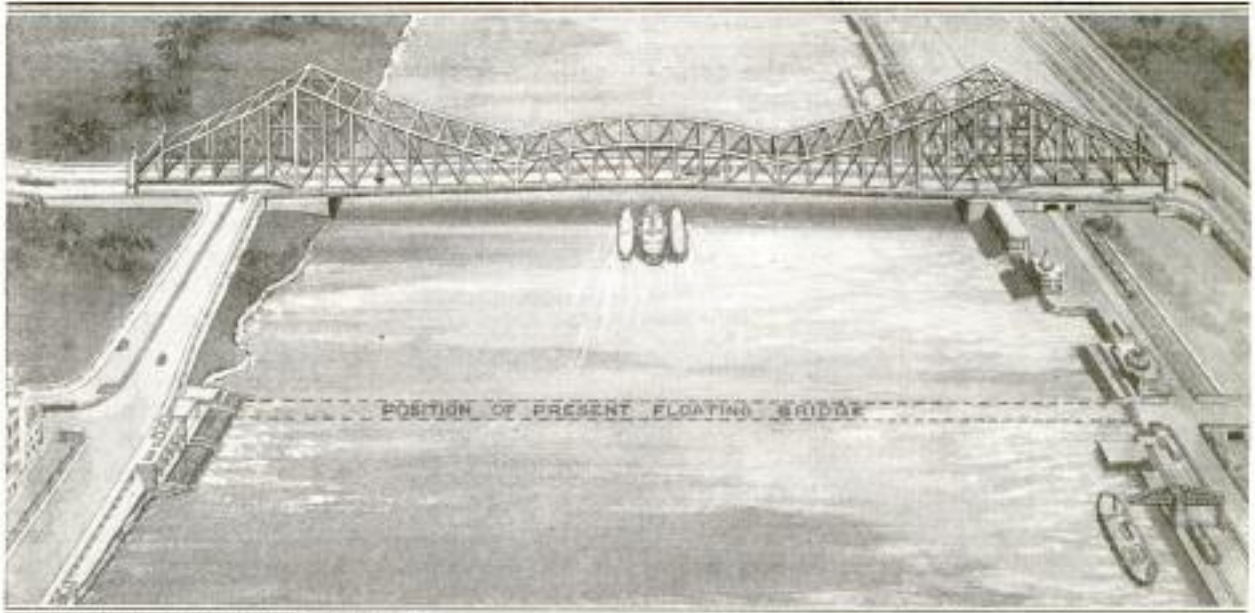

BY COURTESY OF THE TIMES (LONDON) TRADE SUPPLEMENT

This Bridge, of Cantilever Type, will Span the Hugli River between Calcutta and Howrah, India, and will Have a Span of More than 1,400 Feet, and a Width of 100 Feet. It will Take the Place of an Old Floating Bridge, the Location of Which is Indicated

9784  
**CANTILEVER BRIDGE TO SPAN  
 HUGLI RIVER IN INDIA**

At the present time, the only connection, by road, between Calcutta, India, and Howrah, on the opposite side of the Hugli River, is a pontoon bridge designed nearly half a century ago. Recent examination by a committee of engineers disclosed the fact that the entire structure was in extremely bad condition, and that, even with extensive repairs, it could be expected to last only a few years. It was, therefore, recommended that a new bridge of cantilever type be constructed some 600 feet upstream from the site of the present bridge. The span of the new bridge will be not less than 1,400 feet, with a width of 100 feet. Provision will be made for two railway tracks, sufficient space for six lines of vehicular traffic, and two 12-foot walks for pedestrians. It is estimated that the bridge will cost in the neighborhood of \$10,000,000 and take 3½ years to build.

outer edge of the record, and the instrument starts playing again.



Three Views of Device for Automatically Turning over Phonograph Records: In the Center It is Shown Turning the Record Over

9891  
**PHONOGRAPH RECORDS TURNED  
 BY AUTOMATIC DEVICE**

One can now place a record on his phonograph, start the machine going, and then sit down while it plays both sides of the record. When the needle reaches the innermost groove, a recently patented device raises the tone arm, swings it clear of the record, and turns the record over, laying it down on the turntable. At the same time the tone arm swings to the

Chas. Glenn R. Knuck  
 Troy, Ohio.

508  
9980

## TRANSCONTINENTAL RADIO CAR MAKES FIRST TRIP

An automobile driving along the countryside or through the crowded thoroughfares of busy city life, amplifying

radio news and concerts clearly audible a block away, is a rather stunning sight even in this day of the unusual. This has



been the experience of the people along the route of a specially equipped radio car that has recently completed an overland trip from Detroit to San Francisco in less than one month. In spite of apprehension as to the effect of vibrations in the automobile, it was found that the apparatus was able to pick up and hold broadcast messages and programs of any of the various wave lengths of the eastern sending stations, with perfect reproduction, whether the car was traveling fast or slow. There was apparently no damage to any of the delicate equipment, although steady and rapid driving was necessary throughout the trip to maintain a schedule prearranged to the minute. Supplies were carried in another car.

Automobile Equipped with Radio-Receiving and Amplifying Apparatus, Which Recently Completed a Successful Overland Trip, Giving Out News and Concerts along the Way

The Seybold Machine Co.,  
9902  
Layton, O.

## IMPROVED CONTINUOUS BOOK TRIMMER

An improved continuous book and magazine trimmer has a new method of jogging piles of books and chucking them true with their bound edges for accurate and uniform trimming. This is done in a trough feed, the sides of which are tapered so that the piles of books are automatically straightened as they are passed along from the wider to the narrower part of the trough, where it grips them. The pattern block that applies pressure to the pile of books, to hold it securely for cutting, is shaped to conform with the whole top surface of the pile, and is swiveled so that it applies a uniform pressure. The machine delivers the piles of trimmed books by belt conveyor, and all chips are removed by air suction.

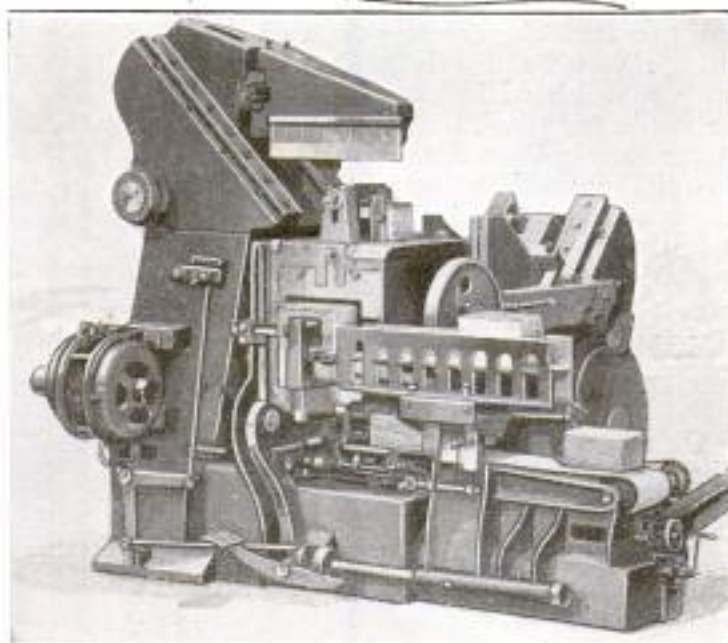

Automatic Book Trimmer: It Has a Trough Feed, with a New Method of Chucking Books, and an Air-Suction Chip Remover

9803

Emt. H. E. Thomas 911 Blunckley  
Ave. Portland, Oregon 509

POPULAR MECHANICS

509



**INDIAN PARTICIPATES IN BRIDGE-DEDICATION CEREMONIES**

**D**EDICATION ceremonies were held recently in connection with the modern steel structure that is being built across the Columbia River at the site of the legendary "Bridge of the Gods," as described in the June, 1922, issue of Popular Mechanics. A son of a Klickitat Indian chief took part in the ceremonies. He stood on one of the finished concrete piers, and shot across the river an arrow which was supposed to trace the exact course of the legendary bridge, now being replaced by the modern steel span. Construction of the bridge was begun on February 2, of this year, and the engineers in charge of the work hope to have it finished by the fall of next year.

**121  
GAS HOLDER EXPLODES, INJURING 100 PERSONS**

Thousands of dollars of property damage and injuries to over 100 people, many of them serious, resulted from the terrific explosion of an illuminating-gas holder at Chicago a short time ago. Parts from the top of the tank were hurled high in the air as the enormous volume of gas burst into a sheet of flame, sweeping over the roofs of houses and down upon the heads of pedestrians in near-by streets. This rare occurrence in the gas industry is thought to have been caused by escaping gas that in some mysterious manner became ignited.

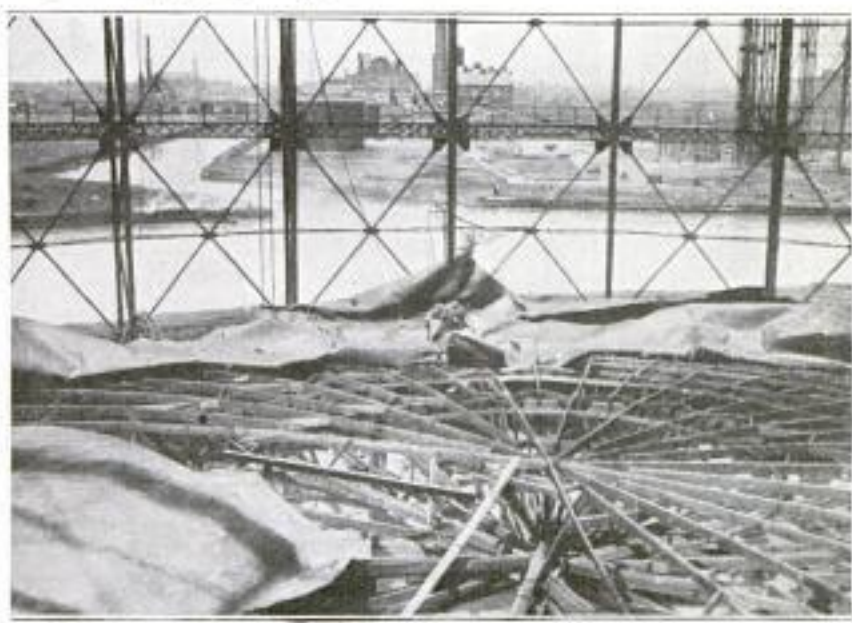

COPYRIGHT, UNDERWOOD & UNDERWOOD  
Wreck of Large Gas Holder Which Recently Exploded at Chicago, Doing Considerable Property Damage and Injuring Many People as the Flames Shot into the Near-By Streets

Peoples Gas Light + Coke Co  
Chicago

Copyrighted material



## LANDING from the NON-STOP AIR EXPRESS

By R. C. FOLGER

CONSIDER yourself aboard a giant airplane whose whirring propellers rapidly drive from view faint objects on the earth far below. As towns and hamlets recede in the distance you realize that you are fast approaching the one that is your destination, for the captain is giving orders to make ready for the discharge of passengers at one of the intermediate points along the route of the great air liner. The crew unfold from the capacious hold a small air boat, and lower it dangling from the huge hull by its special tackle. You and several fellow passengers climb down into the seats behind the pilot and buckle yourselves in as the big ship slows its engines to enable the little wings to catch the air. With a quick movement of a lever your steersman unleashes the small craft, which begins its motorless flight and gracefully glides downward to a safe landing, while the mother plane speeds out of sight.

Jules Verne's imaginary voyage in "1,000 Leagues under the Sea," we have seen so nearly realized in the exploits of the submarine of today, that it is not too far a stretch to consider possible air travel as announced by a German-Russian combine, which plans an organization for connecting the 5,000 miles over the steppes of Russia and the frozen wastes of Siberia, between Moscow and Vladivostok, with a service similar to the one depicted. Even now, large high-powered airplanes of all-metal construction are being built under contract to carry as

many as 100 passengers for 1,000 miles or more without stopping, and in the recent feats with gliders it is not impossible to see their adaptation to this use.

After the war, the Germans turned to motorless planes as a means of improving their planes to be motored with limited power, and Americans interested in flying, as well as some men in other countries, also began the construction of gliders. In June, a young American experimenter, flying in a plane of his own design, made a series of successful flights. These attempts to fly with motorless planes have generally been looked upon as a source of amusement that would appeal to the sporting instincts of many young men, or at most as a source of data leading to more efficient designs of motored airplanes. An international glider contest was held in France this summer in which there were entrants from many nations, and it was thought that great strides had been made. Only a few days later, however, a former German military airman, flying at a meet in the Rhine valley, eclipsed all former records for motorless flying, by making a sustained flight of over two hours in which he rose to a height of 3,000 feet and landed six miles from his starting point. Fokker, the famous Dutch airplane designer, has since added another record to motorless aviation by remaining in the air 13 minutes with a passenger, and maneuvering his glider like a power-driven plane.

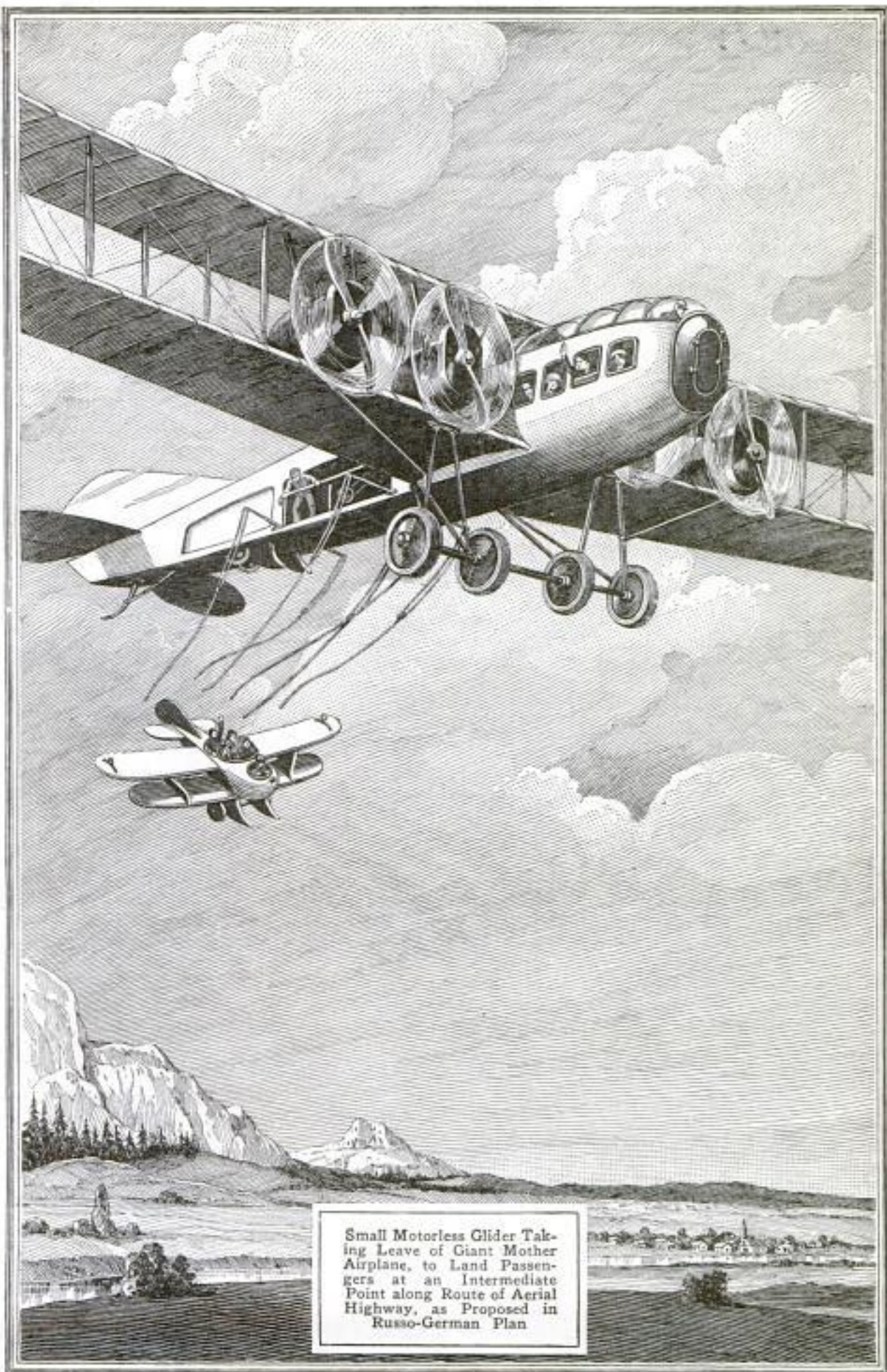

Small Motorless Glider Taking Leave of Giant Mother Airplane, to Land Passengers at an Intermediate Point along Route of Aerial Highway, as Proposed in Russo-German Plan

*Chas. E. M. Smith  
9612-52nd Ave. S.*

*Wheeler-Moore  
Sales Co. Inc.  
Bourse Bldg.*

512  
*Seattle, Wash.*  
**POPULAR MECHANICS**  
**TOOL-CARRYING ATTACHMENT**  
56 **FOR USE OF CARPENTERS**

To be attached to the overalls, or to a belt, a tool-carrying device has been developed by a Seattle carpenter. It is

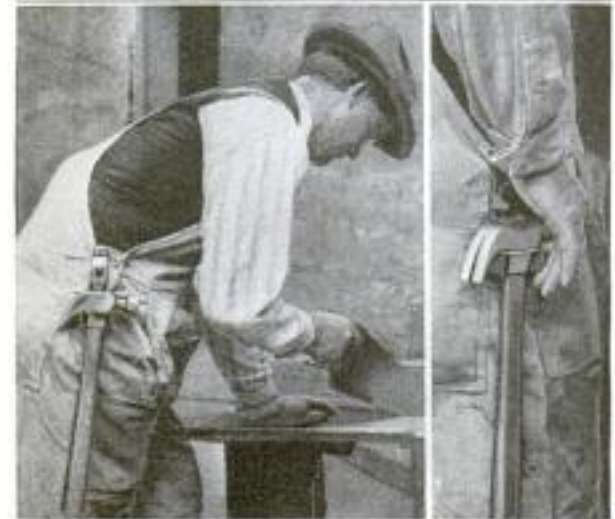

Left: Tool Carrier Attached to Overalls. Right: Method of Releasing the Tool from the Carrier

designed for a hammer, hatchet, or similar tool. It has two metal lugs which are caused to grasp the tool handle by the action of a spring latch operated by the weight of the tool. The hammer is grasped by the head and dropped, handle downward, between two protruding shoulders. In releasing it, the tool is grasped by the forefinger and thumb, while the palm of the hand is pressed against the protruding latch.

*9994*

**MECHANICAL DEVICE PASSES RIVETS AUTOMATICALLY**

A pair of tongs in the hands of a skillful heater and an empty tomato can on the receiving end, has so long been the means of relaying hot rivets to the man

with the hammer, that it is interesting to know about a mechanical gun that does this automatically. The red-hot rivet is placed by the heater in a suitable cavity at the head of the gun, from which it drops by its own weight, through a downward-opening valve, into a small chamber, the valve automatically closing behind it. Pressure on a treadle admits air into the chamber behind the rivet, which is forced out and into a length of flexible tubing ending in a suitable receiver, from which the rivet is easily extracted. It is claimed the standard machine can deliver rivets 125 feet and as fast as they can be received.

*8856*

**DRAIN AND RELIEF VALVE FOR STEAM CYLINDERS**

For use on any reciprocating steam-operated equipment as a means of draining condensation from the cylinders and steam chest, a relief valve that is self-opening and self-closing has recently been placed on the market.

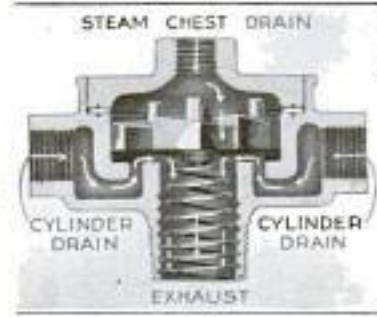

It is of the disk-valve type, and an adjustable spring raises the disk from its seat automatically when the engine is at rest, thereby permitting water to escape through by-passes to the waste pipe. When the engine is running, the disk is seated by the pressure in the steam chest, and any excessive pressure at one end of the cylinder will overbalance the steam-chest pressure, relieving this excessive pressure and also permitting water to escape from the other end of the cylinder.

*Philadelphia Pa.  
Wheeler-Moore Sales Co., Inc.  
Bourse Bldg.  
Philadelphia Pa.*

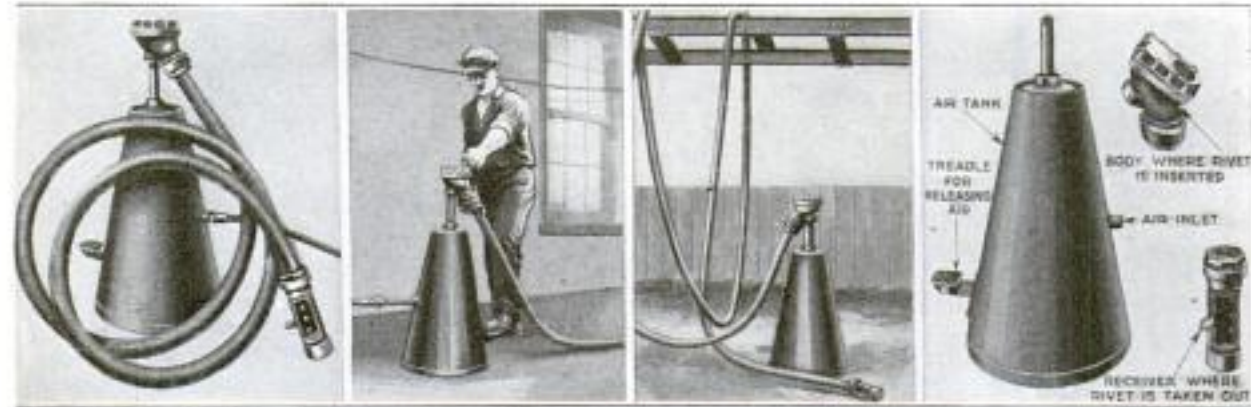

Left: Machine for Passing Rivets Automatically. Center: Man Operating Machine Which is Also Shown Set Up for Field Use. Right: View Indicating the Various Parts of the Machine Which Sends the Rivets as Fast as They can be Received

*Pennsylvania Abrasive Metallic Tubing Co. Broad + Race. Philadelphia Pa.*

9974

Cent. M. K. Brewery, 525 S

POPULAR MECHANICS

Warren St. Madison Wis 513



Ski Slide at the University of Wisconsin That was Designed Mathematically to Make Possible a Leap of 115 Feet; Inset Shows the Profile of the Ski Slide Drawn to the Scale Given Below. The Dotted Line Shows the Path of the Skis of a Jumper with a Fall of 58 Feet

9974

### LAWS OF MECHANICS APPLIED IN SKI-SLIDE DESIGN

In direct contrast to the old Norwegian practice of having the country's most experienced skier "guess" the best design for a contemplated ski slide, students at the University of Wisconsin determined the profile of their ideal slide mathematically. The topography of the hill was obtained with surveying instruments, and drawing instruments and calculations did the rest.

The "take-off" point, from which the leap into the air is made, was located on paper by moving the jumper's trajectory into the position which gave the maximum leap, the length of which is measured in the air from the take-off to the place where the jumper's feet resume contact with the snow. To determine the trajectory, the principle of the motion of a projectile was applied, approximations being made for the vertical jump of the rider and of his air resistance.

Actual results the past winter did not reach the theoretical, although it is thought that ideal snow and wind conditions will make the estimated leap of 115 feet possible. Thus far the longest jump for the hill is 103 feet, and it was made by the national amateur champion. The estimated speeds of 30 miles an hour at the

take-off, and 50 miles at the foot of the hill, were undoubtedly reached, for they are calculated with ample allowance for air and snow friction. To watch the jumpers, one would think they were in the air almost a dozen seconds, but calculations show the period to be only 2 1/4 seconds.

Falling from a height of 58 feet without injury is possible because the landing surface is not hit squarely. Only a glancing contact is made with the snow, owing to the steep slope of the hill. Although 50 jumpers participated in the one meet held last winter, none sustained any injury worth mentioning.

116  
 In order to show to as many farmers as possible a system of crop rotation adapted to their needs, the agent of Thayer County, Nebraska, laid off at the county fair, on a patch of ground 7 feet square, a miniature farm divided into fields proportionately. Corn, oats, and wheat were sown in time to be in full growth when the fair opened, imitation orchards were planted around miniature farm buildings, and everything was in shape for giving practical demonstrations of the rotation system.

U. Y. J. vines 8/19/12 e

The C. C. White Co.,  
Worcester.

514  
49 *Mass.* POPULAR MECHANICS  
ADJUSTABLE FLOOR LAMP AIDS  
GARAGE OR SHOP

Floor lamps that can be adjusted to any desired angle, or placed so as to illuminate usually obscure spots in a ma-

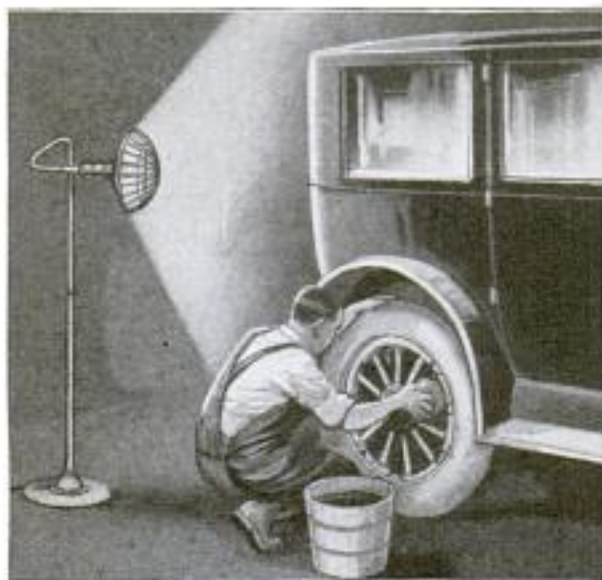

Adjustable Floor Lamp, Showing How the Appliance can be Used to Good Advantage around Motor Cars

chine shop or garage, are now available. The lamp is particularly adapted for making repairs on, in, and under an automobile, or around lathes, drill presses, etc., where delicate work is being done. The novelty is also manufactured as a wall or ceiling fixture and, owing to its extreme flexibility, the light can always be thrown exactly where it is wanted, thereby increasing the workman's efficiency.

Designed by  
R. J. Kirkpatrick,  
Chief Hydrographer.  
ODD-APPEARING PROTECTION  
FOR GASOLINE TANKS

55

Protecting gasoline tanks from the intense rays of the tropical sun in the Panama Canal Zone, and thereby reducing evaporation, is accomplished in an odd but effective manner. The tanks are set in depressions, as is common with these containers, and have the usual encircling dike. Around the sides of the tank are placed three corrugated-iron "petticoats," each of which overlaps the one beneath, while on the top is a corrugated asbestos "hood," that in turn is surmounted by a "monitor," or cap, of the same material, the whole presenting a strange sight.

*Bealva Heights  
R. J.*

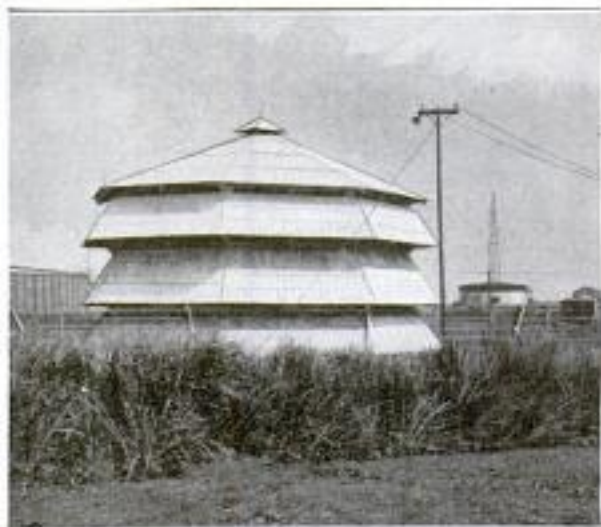

Gasoline Tank with Its Queer-Appearing Covering Which Protects It against the Intense Rays of the Tropical Sun

83

### FLOODLIGHTS ON TRAINS

BY H. A. LANE

**B**RILLIANT night illumination of its picturesque transcontinental route, is the plan contemplated by a large railroad system in this country. The idea, as conceived at present, is to equip the observation coaches of its fast limited trains with a battery of powerful floodlights. These lights would be arranged to cover a range of approximately 160 degrees, with sufficient height and depth to illuminate the cañons, rivers, lakes, and mountains in the vicinity of the right of way, as the train rushes on through the night. Power for operating the lamps would be furnished by the axle-driven generators with which railroad cars are now commonly equipped, and which ordinarily are never used to their full capacity.

Although, thus far, the location of the floodlights has been confined to the observation car, certain officials have suggested the advisability of placing them along the full length of the train. Also, further to enhance the effect, it has been proposed to employ lamps, or reflectors of various colors, which would undoubtedly yield fairylike scenes, particularly when directed upon snow-covered surfaces. Railroad men in authority have nothing but praise for the scheme, and while eagerly awaiting the completion of the initial floodlighting equipment, have pointed out the fact that there is an additional and practical value of the brilliant lights as a protection against rear-end collisions.

*Capt. Jno. L. Von Blon, Club, Los Angeles  
Los Angeles Athletic Club, Los Angeles  
Copyrighted material*



83

not yet in use.

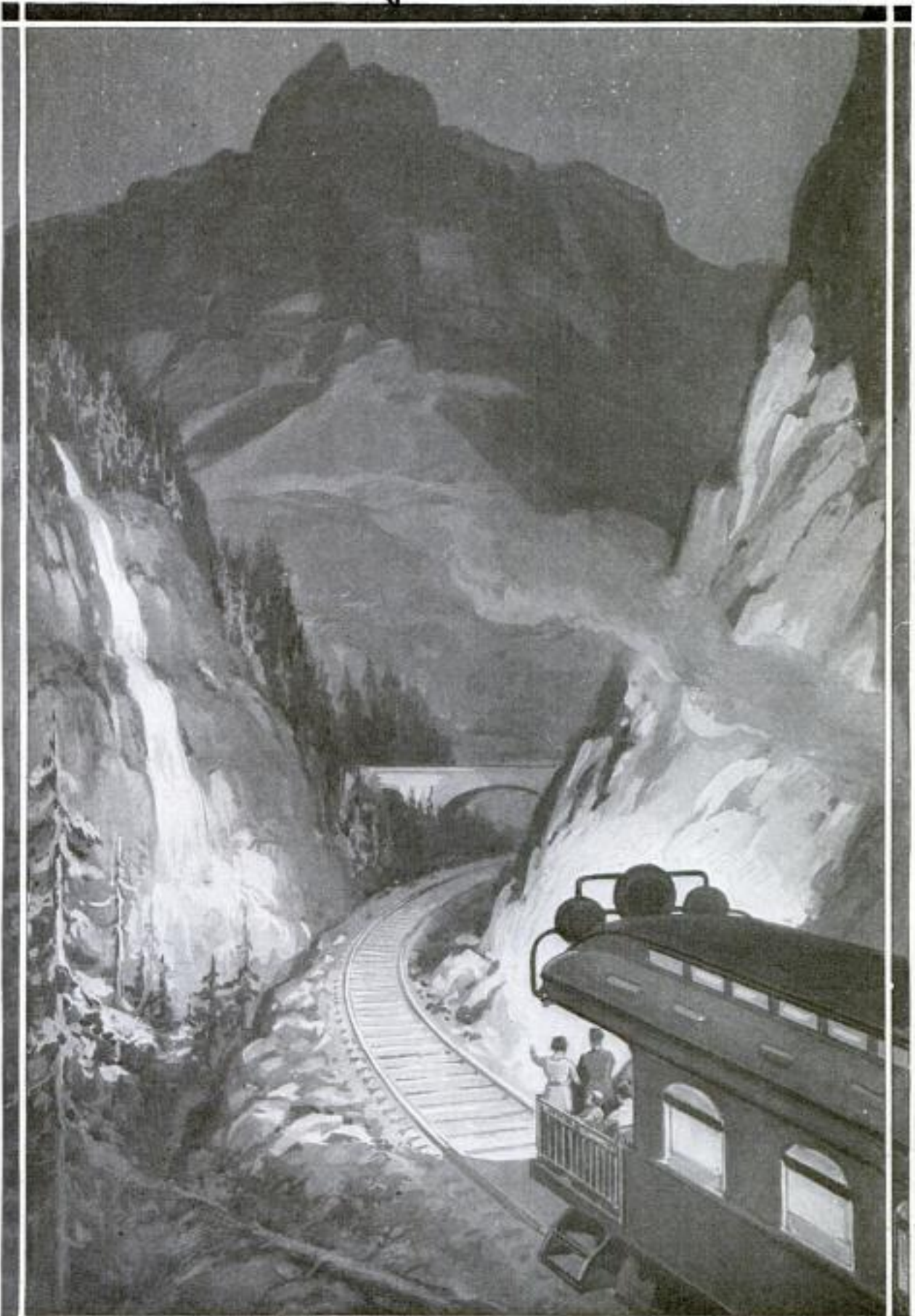

Observation Coach of a Railway Train, Equipped with a Battery of Large Floodlights for the Purpose of Brilliantly Illuminating the Vicinity as the Cars Rush through Narrow Gorges or over Picturesque Bridges, Thus Enabling the Passengers to Watch the Scenery at Night

116

*Worm antennas*

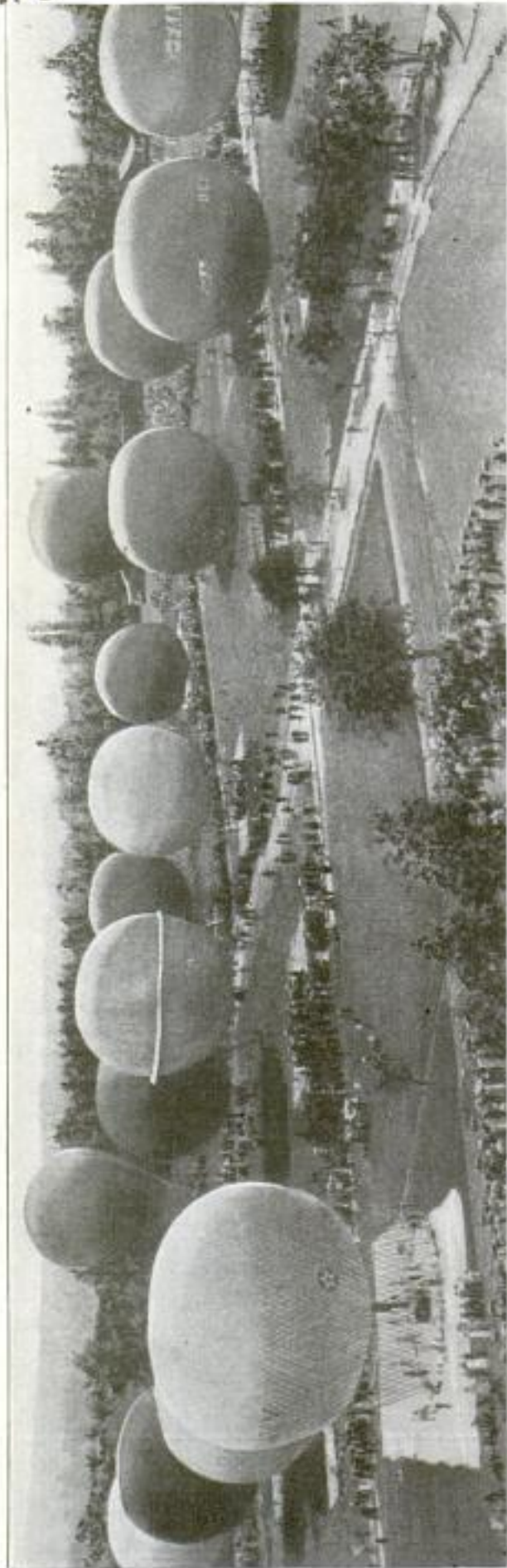

View of Châtelaine Park, near Geneva, Switzerland, Showing the 19 Balloons Representing Seven Different Nations, Ready to Start in the Eleventh Gordon Bennett Air Derby: Perfect Weather Conditions Prevailed, and an Enthusiastic Crowd was Present to Greet the Various Balloonists as They Cut Loose Their Fastenings

### INTERNATIONAL BALLOON RACE ENDS IN DOUBT

Nineteen balloons, representing seven different nations, started from Geneva, Switzerland, in the eleventh Gordon Bennett Air Derby, which took place this summer. The start was made under very propitious weather conditions and was witnessed by an enormous crowd which greeted with enthusiastic cheers the first American balloon to take the air. Decision as to whether the winner was Captain Honeywell, pilot of one of the American balloons, or Lieutenant de Muyter, the Belgian balloonist, was complicated by the reported escape of the latter's balloon some hours after he had effected a satisfactory landing, and remained unsettled when this magazine went to press.

120

### AMERICAN AIRPLANES FASTEST IN WORLD

*Military*

Realizing that the fast pursuit plane controls the air in time of war, the U. S. Army Air Service concentrated its efforts upon this type several months ago, and called for the construction of planes that would be speedier than others in the world. Recently four distinctly different models were delivered, all of which have a speed of over 200 miles per hour. One is of all-metal construction; one has its radiators built into the wings; one has a folding chassis, thus reducing wind resistance, and one has its wings under the fuselage, and open landing gear with no axles. The new landing device that replaces the rubber-tired wheels with skids similar to sleigh runners, except that they are fitted with shock absorbers, makes it possible to land and stop in a distance of 125 feet, and also permits landing on water.

*N. J. James 8/22/20 P. 26*  
**BEAUTIFUL CHURCH BUILT AT SMALL COST**

Although built without architectural drawing or specifications of any kind, a small church recently dedicated in a western state, presents an appearance of beauty. The structure, named "Bethany Temple," was erected for a Protestant body, solely

9952 } Bully by - Rev. W. H. Rawlings  
 } Sierra Madre, Calif.  
 POPULAR MECHANICS 517  
 } R. H. Cornuelle,  
 } Cincinnati, Ohio.

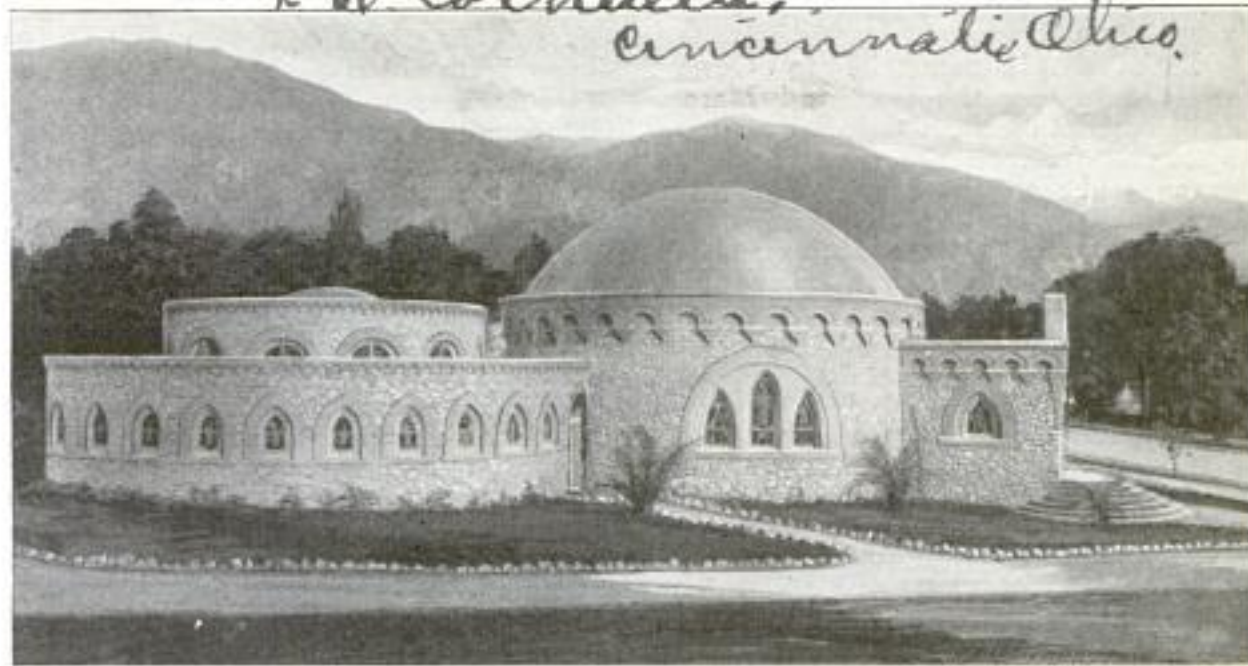

Beautiful and Inexpensive Church Which was Constructed, Mostly of Boulders and Cement, by Two Men:  
 The Dome of the Auditorium is Seen at the Front and the Smaller  
 Dome of the Sunday School, at the Rear

through the efforts of two men. One of these was a world-traveled and self-styled "Bible teacher," while the other termed himself "just a mechanic." The man who had marveled at the wonderful architecture of many churches during his extensive journeyings, furnished the structural ideas and rough sketches for the church, and the other man possessed the skill necessary to put the plans into effect. Financial straits caused the work to be conducted as economically as possible, and members of the congregation, numbering then but 50, offered stones from their own back yards. These, with boulders hauled from neighboring cañons, composed the bulk of the building material. Slowly the mechanic labored single-handed at his task, and in 18 months completed the church, which consists of an auditorium seating 300 persons, and an adjoining Sunday school. Under ordinary construction methods, it is thought that the building would have cost at least \$50,000, which sum the little congregation certainly could not have raised.

9992 ——— *Pratt*  
**NONSLIP CONCRETE SURFACES  
 MADE BY NEW METHOD**

A European railway, where many of the steps and footways are made of concrete, is using extensively a simple method of making these surfaces non-slipping. Silicon carbide, commonly known as carborundum, and other artificial abrasives are sprinkled on and

worked into the surface of the fresh concrete just before it sets. These crystals show little signs of wear and produce a pleasing effect.

10  
**COMBINATION PIPE FILLER  
 AND TOBACCO CASE**

Flat and convenient for the pocket, a combined pipe filler and tobacco case is now on the market in England. The tobacco is neatly contained in paper cartridges, each holding a pipeful, which fit the inside of the case. One of the cartridges is placed in the filling slot in the center of the case, which is then closed and held over the bowl of the pipe, when a small plunger on the other side of the case is pressed down with the forefinger, discharging the tobacco from the cartridge into the pipe bowl.

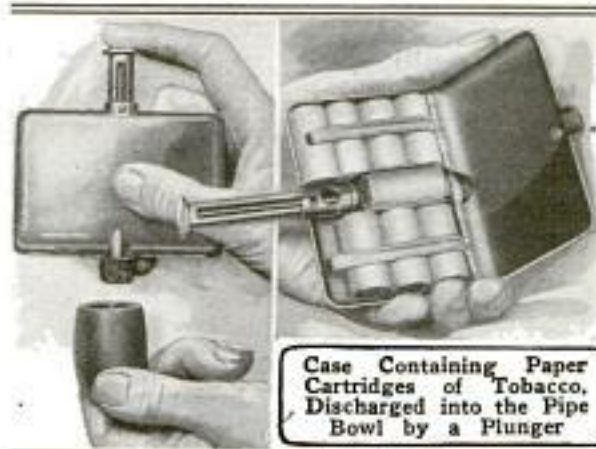

Case Containing Paper Cartridges of Tobacco, Discharged into the Pipe Bowl by a Plunger

London Times  
 Eng Section, 7/22/22

The 7 Leaf Agency  
 152 7 Leaf St. E.C.4  
 London, England

Mrs. Carreras, Ltd.  
 55 Piccadilly, W., London, England.

Cml. A. N. Murzaoff, 269 Leland Ave

## GEORGE WASHINGTON MASONIC NATIONAL MEMORIAL

9918 Plainfield N.J. BY R. C. FOLGER

**A** NATIONAL memorial to George Washington, the man and Mason, will be erected on a commanding ridge at Alexandria, Va., on the road to Mount Vernon, and six miles from Washington, D. C., where it will be plainly visible. Its form is inspired by the ancient watch towers of Greece and Rome, by the light of whose burning flares the mariner steered through the harbor entrance, emblematic of the guiding spirit of Washington to our "Ship of State."

Resting on the topmost of seven artistic terraces, approached by broad walks and stone steps, the tower will rise 200 feet above its base to a view of all the surrounding country in which Washington spent so great a part of his life. The dimensions of the ground floor will be 160 feet wide by 230 feet deep, in the center of which will be a great room 70 feet wide by 100 feet deep and rising by a clerestory to a height of 64 feet to form the memorial hall. In an arched recess of the memorial hall, an imposing statue of George Washington will be placed. The second story, 50 by 75 feet, will be

devoted to the George Washington Masonic Memorial Museum, where will be located the interesting relics connected with Washington's service as master of the Alexandria-Washington lodge, as well as many personal relics of Washington. Among these are the Masonic apron he wore at the laying of the cornerstone of the national capitol at Washington, D. C., and also the silver trowel he used at that time; the old Chippendale chair occupied by Washington as master of the lodge, and a fine picture of General Washington, by Williams. The third level will be for future assignment, and the fourth will be a covered observation platform. The memorial and grounds will represent an estimated outlay of more than \$2,000,000, and it is expected the official ground breaking will be done this fall, as the contract for the excavation and foundations has already been let.

The movement for the memorial was formally initiated on Feb. 22, 1911, when the first regular meeting of the George Washington Masonic National Memorial Association was held at Alexandria-

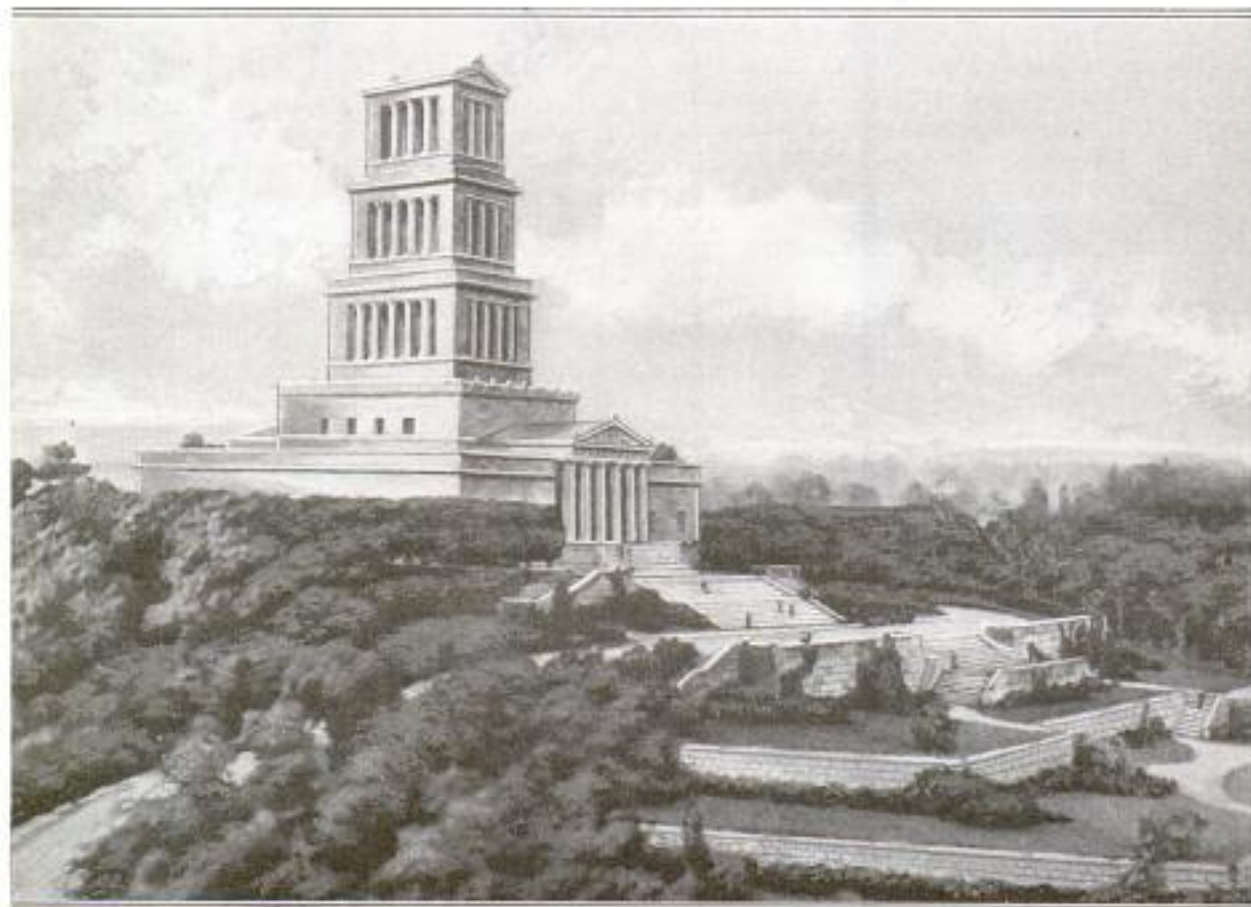

COPYRIGHT, GEORGE WASHINGTON MASONIC NATIONAL MEMORIAL

This Impressive Memorial will be Erected by the Masonic Orders of the United States and Dedicated by Them to George Washington. It will be Fittingly Located near Alexandria, Virginia, around Which Center Many Historic Events Connected with the Life of Our First President

9918

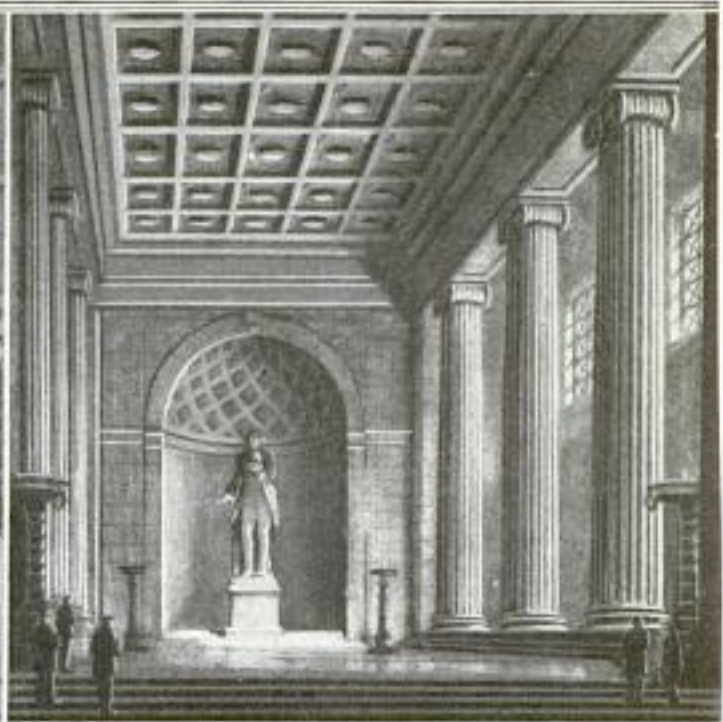

COPYRIGHT, GEORGE WASHINGTON NATIONAL MASONIC MEMORIAL

Left: Plan of George Washington National Masonic Memorial, Showing Grounds, Roadways, Terraces, Steps, and Location of Memorial Building. Above: Interior of Memorial Hall, Showing Recess and Statue of Washington. This Hall will be Flanked by Ionic Columns 40 Feet High, and will be Surrounded by Smaller Rooms

Washington Lodge No. 22, A. F. & A. M., which in Washington's time was lodge No. 39. This included representatives from 27 jurisdictions in the United States.

The plans for the memorial are the result of the work of a prominent firm of architects collaborating with consulting architects and famous landscape artists.

9982

### SCIENTIFIC SEESAW FOR STUDY OF SEASICKNESS

With the object of finding a cure for seasickness, an instrument has been devised at the instance of a French biological society for use in the study of the effects of rhythmic oscillations upon animals. The apparatus is composed of a board, 10 feet long and 16 inches wide, at each end of which is fastened a cage of the kind commonly used in laboratories. A 1/2-horsepower motor oscillates this board with movements corresponding to the pitching and rolling of a vessel at sea. These oscillations are controlled by a rheostat. Rabbits, chickens, guinea pigs, and pigeons have never shown any signs of suffering even after six hours in the moving apparatus. With dogs it was different, at least 30 per cent showing all the symptoms of seasickness. Experimental preventives are being tested, and it is believed

that ultimately a cure for seasickness will be discovered.

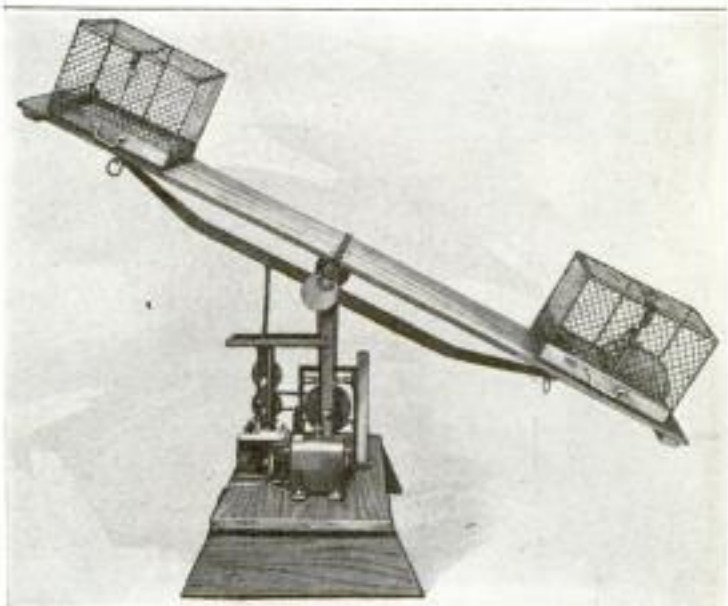

Apparatus for Making Animals Seasick: The Motor Imparts to the Caged Animals at the Ends of the Oscillating Board a Movement the Same as the Pitching and Rolling of a Ship

*Inv. Mr. E. Pozerski, Pasteur Institute, Paris, France*

Bought from: Kadel +  
Berthel, 153 E. 42nd St

N.Y. Times 8/28/22  
P. 26

520

POPULAR MECHANICS

45

new York City  
A PROPELLING RUDDER  
FOR SMALL BOATS

A new idea has appeared in the shape of a propelling rudder, for use in connection with small boats instead of oars.

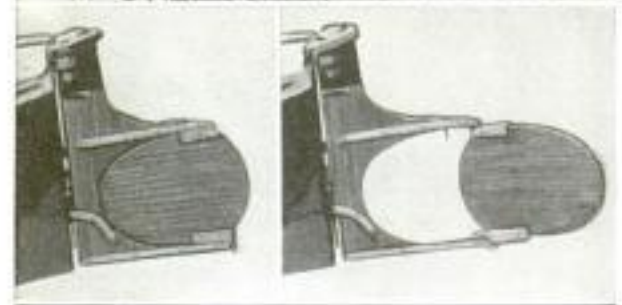

Above: Lever Which Actuates Propelling Rudder, Operated from Stern Seat. Below: Rudder Closed for Steering Only, and Open for Propelling

With this attachment one can sit facing forward in the boat, and simply move a lever back and forth. The lever is attached to the yoke or top pin of the rudder, which is caused to weave from side to side like the fin of a fish so as to propel the boat forward.

111  
NEW TYPE PERMITS SIGHTLESS  
AND SEEING TO CORRESPOND

A new type system, developed in France, which serves as a medium of correspondence between the blind and those who see, follows very closely the form and characters of the Roman alphabet, except that the letters consist of a series of dots instead of full lines. The idea is to supplement rather than replace the Braille system of printing for the blind, and it has the approval of the Interallied Congress of Mutilated.

ROUND-THE-WORLD FLIERS  
115 HALTED IN INDIA

Recent reports of the airmen who set out from England on May 24, this year, in an attempt to encircle the globe in an airplane, indicated they had been lost in the wilds of India, but it has since developed they were forced to land because of engine trouble. Previously the flight had been temporarily halted at Karachi, India, owing to illness of Major Blake, the leader of the expedition, who was forced to abandon the attempt and turn it over to Captain MacMillan. The plans are to fly from India by way of Burma, Japan, and the Aleutian Islands to the Alaskan peninsula and thence down the coast to Vancouver. From there the airmen intend to fly to Halifax, where they will transfer to a flying boat and cross the Atlantic by a route to be determined according to the season.

Permanently  
filed

115

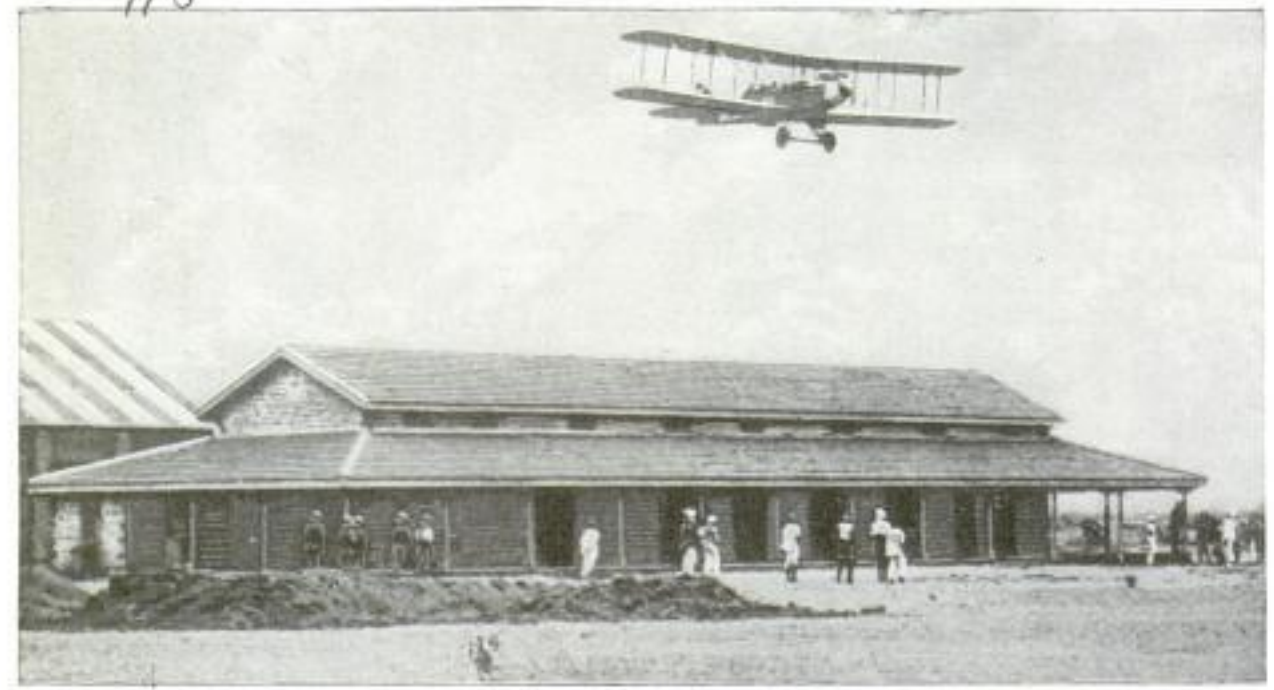

The Airplane Used by the English Airmen Who are Attempting to Fly around the World, is Here Seen Flying over the Officers' Quarters at Karachi, India, Where the Leader Abandoned the Attempt, Due to Illness

Wide World Photos  
New York City

*Paris XVI France.*

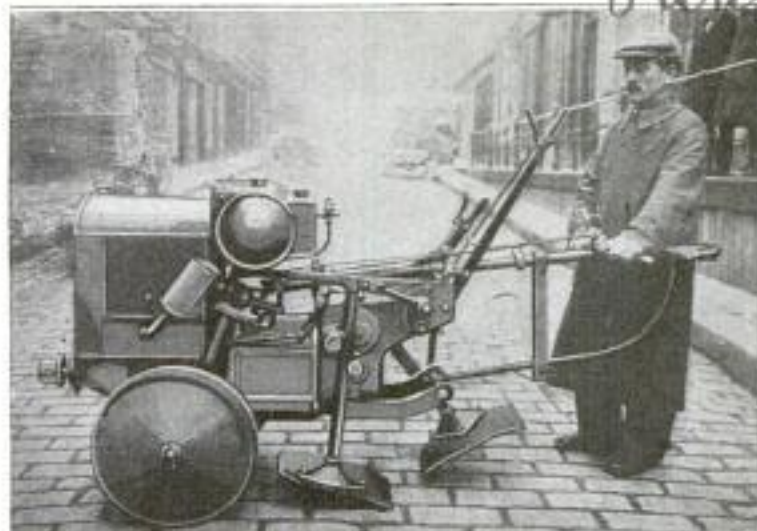

Side and Front Views of an Agricultural Tractor That is Propelled by the Two Feet on Vertical Oscillating Levers. Plainly Seen Above: The Driver Operates the Tractor Either on Foot or in the Small Seat Seen beside Him

*Journal*  
**TRACTOR PROPELLED BY FEET  
 FOR USE ON SOFT GROUND**

An agricultural tractor which is propelled by feet instead of by a wheel has been constructed in France. The purpose of the machine is to furnish a tractor that will operate equally well at all times on ground too soft or muddy for the effective use of propelling wheels. Mounted on a pair of steering wheels is a hood, with a radiator and power plant of automobile type. The sides and chassis of the hood are extended to the rear, and support two pivoted vertical levers, at the lower ends of which, in contact with the ground, are flat, horizontal propelling plates, or feet. By means of a system of connecting rods and cranks in connection with the motor, these levers are caused to move backward and forward alternately like the legs of any biped, and the propulsion of one foot continues until propulsion is started by the other. From the extreme rear of the machine, where there is a seat, the driver steers it, and at the same time overlooks the plow or other implement that may be hauled either by attaching it to the side or to the rear of the tractor.

*Journal*  
**NEW SWEDISH RADIO STATION  
 TO BE AMERICAN-BUILT.**

Gradually the entire world is being equipped for radio intercommunication. The latest development in this connection is the award by the Swedish government of a contract to an American corporation for the erection of a new radio station

near Gothenburg, on the west coast of Sweden, which will establish direct radio connection between that country and the United States. The contract calls for the installation of two 200-kilowatt alternator equipments, which will each deliver to the multiple-tuned aerial a current of 600 amperes. The entire plant will cost about \$2,000,000, and will be very efficiently equipped.

**DENTAL LIP PROTECTOR AIDS  
 OPERATOR AND PATIENT**

Specially adapted for use in all dental operations wherein it becomes necessary to distend and hold the corners of the mouth by means of a mouth mirror, a new device of this nature, which is also a lip protector, is held in place without any independent attachment. It is so shaped that it protects the inside of the cheek, and adds convenience to the dentist and comfort to the patient. It can easily be cleaned and rendered aseptic.



*N.Y. Times  
 8/22/22*

*E.C. Wacker Co.  
 Dental Supply Co.  
 Park Theatre Bldg.  
 Milwaukee, Wis.*

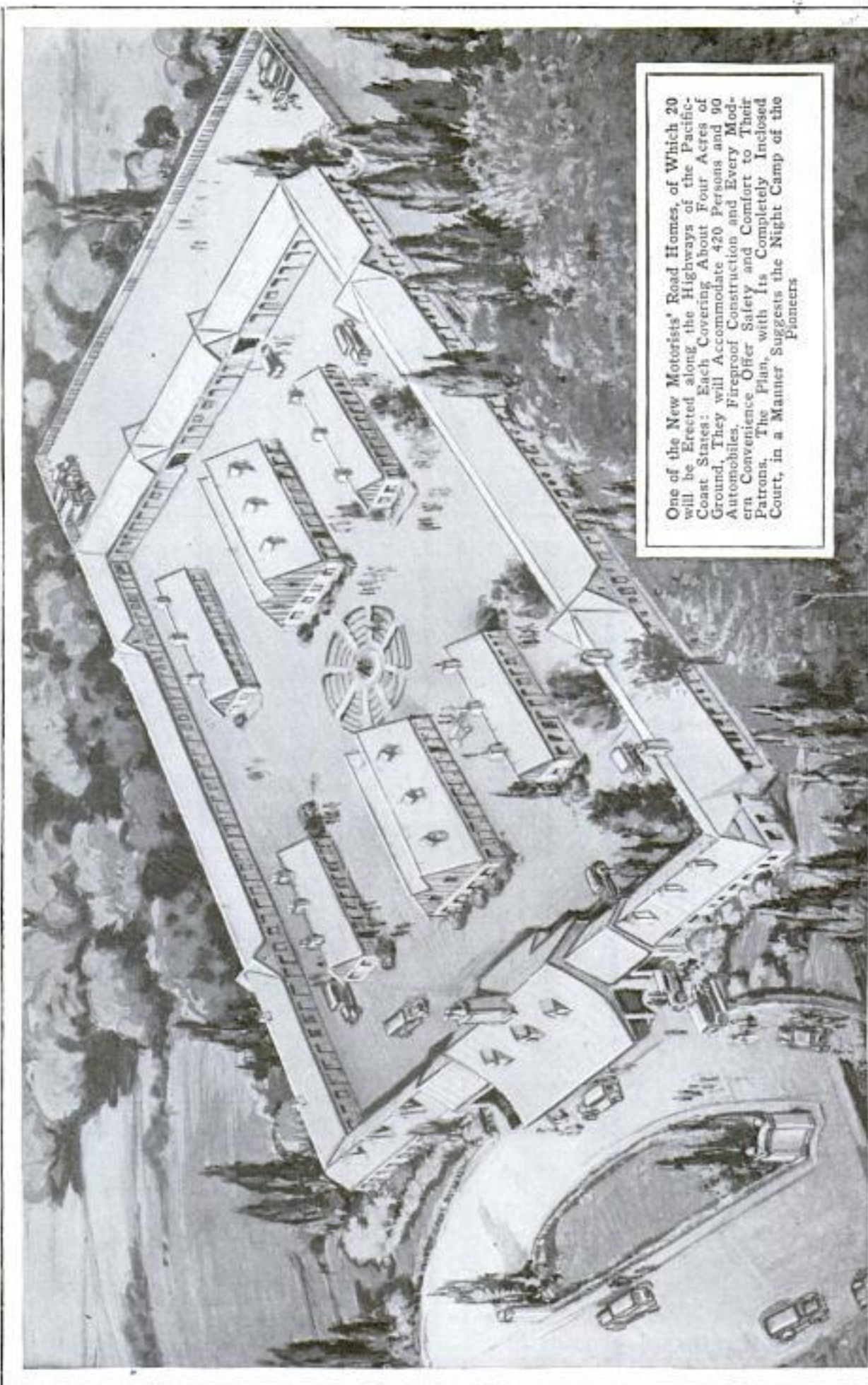

One of the New Motorists' Road Homes, of Which 20 will be Erected along the Highways of the Pacific Coast States: Each Covering About Four Acres of Ground, They will Accommodate 420 Persons and 90 Automobiles. Fireproof Construction and Every Modern Convenience Offer Safety and Comfort to Their Patrons. The Plan, with Its Completely Inclosed Court, in a Manner Suggests the Night Camp of the Pioneers



MOTORISTS' CARAVANSARY IS NEW INDUSTRY

*Camp, Journey*

BY LAWRENCE WM. PEDROSE,

1453 W. 64th St  
Seattle, Wash.

ONE of the most interesting developments of modern times has been the automobile-tourist movement. Owing to the improvement of highways connecting East and West, North and South, the wide range of utility of the motor car, and the average American's love for the outdoors—adventure—hundreds of thousands of persons this year have, with comfort, spent the summer traveling about the United States in automobiles.

The motor tourist who spends months on the road, aimlessly covering thousands of miles, rubbing up against nature in the modern equivalent of pioneering, is a peculiarly American product. He is not migrating, he does not travel from the urge of "green fields far away," because he is not going anywhere in particular. He is not dissatisfied, restless. Most of the motor tourists are successful business men permanently located in the larger cities. They simply decide to take a long vacation, load the family into the automobile, and "hit the open road." Their prototype was the pioneer who crossed the plains in the days of the early West—they are pioneers in spirit if not in purpose.

In early days the stage-coach, the pony express, and the tavern or road-house were the vehicles and centers of progress and civilized activities. People congregated at the taverns to meet the traveler—their point of contact with the outside world. With the coming of the railroads this interest swung to the depots and hotel lobbies, bringing about the building of the present type of hotel. The automobile, and the coordinate stupendous highway development, in a few brief years have swung the pendulum back to the highways. Railroads are acutely feeling the change. Stage depots are appearing in almost every city, and the center of activity has shifted from the train depot to the motor station on the thoroughfares where auto busses roar up and away, full

of twentieth-century pep and efficiency. Motor touring in recent years has increased about 50 per cent annually. Of the vast number of automobile tourists, many thousands are accustomed to the modern facilities and comforts of the city. The call of adventure is strong, but they cannot cast off their familiar environment overnight. It is they who fill the tourist camps provided by cities and towns along the highways of the country, where electric lights, fuel, water, and food can be purchased, and shelters and entertainment are also provided.

The latest development in providing attractive facilities for motor tourists is the "rodome," or huge tavern, 20 of which are to be built along the Pacific coast within the next few months. Construction of the first rodome, located at Sacramento, Calif., has already begun. The other 19 will extend from San Diego, Calif., to Vancouver, B. C.

The rodome accommodates 420 persons and 90 automobiles. It covers a tract of four acres. It offers a night-stopping place where travelers are socially and safely comfortable. It has such advantages as absolute privacy, fireproof building, reasonably priced accommodations, completely furnished apartments containing water, light, gas, with bath, toilet, and lavatory in every suite; garage adjoining each apartment, delicatessen and store carrying groceries, meats, vegetables, dairy

products, newspapers and periodicals, ice cream, tobaccos, and auto accessories; complete auto-service station, community camp fire where travelers can meet and exchange experiences of the road, radio station, wash racks and pits for cleaning cars, and a staff of auto mechanics. Rooms are in singles, doubles, or suites; clean comfortable beds are provided with daily change of linen. Tenants may have a kitchenette or obtain their meals at a cafeteria. Clothing will be laundered for them, or they may launder their own.



Map Showing Location of "Rodome" Stations, and Automobile Routes, along Pacific-Coast Unit of New Travel System

*Part 2, Hilborn Field Representative  
Travelers Hotel, Sacramento, Calif.*

## GOLF-STROKE COUNTER WORN ON THE PLAYER'S WRIST

An instrument designed to keep an accurate account of the strokes made between holes, and worn like a wrist watch, is a novel appliance for the golf enthusiast.



On the dial of the instrument is a small pointer which is

moved after each stroke, and at each number makes an audible click indicating that the count is made. Its use is said to become quite automatic after the first round or two.

## MONSTER MICROSCOPE TO AID IN DETECTING CRIMINALS

In order to facilitate investigations in connection with the identification of

criminals, a western criminologist has had built a large high-powered microscope. Possessing all the features and detail of the smaller instrument, as well as some additional adjustments, this special microscope has a number of distinct advantages in studying finger prints, blood-stains, hairs and fibers, bullets, handwriting specimens, and other clues such as are used in the scientific detection of criminals.

One of the main features is the 10-inch-diameter eyepiece which permits five persons to view the specimen at the same time. This field of vision, combined with the unusual range and degree of magnification, which can be varied from two to 5,000 diameters, makes it possible to examine several objects in minute detail simultaneously. For instance, the similarity of two rifle bullets can be determined in a manner heretofore not available. In keeping with the general design

are the arrangements provided for holding and manipulating the specimen. With a field, 18 inches square on the main stage, the object can be inspected over that area without having to shift its position on the stage, which can be moved in three directions by micrometer adjustments. As the stage and substage are some distance from the operator, these movements are regulated by controls conveniently located at the top of the barrel and connected to the mechanism of the stage by flexible shafting. By means of cross hairs in the tube, having a micrometer adjustment, together with the divisions on the operating controls, points on the specimen can be definitely located and noted. A finely graduated transparent scale at the eyepiece enables the observer to obtain any dimensions on the specimen. One-tenth of a turn on the most delicate control moves the specimen .0001 inch, which on the highest magnifications corresponds to a 1/2-inch movement of the image at the eyepiece.

Supplementary features of the design are the arrangements made for illuminating the specimen. Underneath the substage is a box containing a 1,000-watt nitrogen-filled bulb with two 5-inch lenses for concentrating the light upon an opaque object, with which is also used a plate-glass reflector set at a 45° angle at the other end of the tube, for throwing the light back to the upper side of the object. For transparent specimens a special lens is used below the substage, the reflector being omitted. The attachment of a vertical projector above the eyepiece makes it possible for an assembly within a radius of 40 feet, to obtain a view of the enlarged image of a microphotographic specimen.

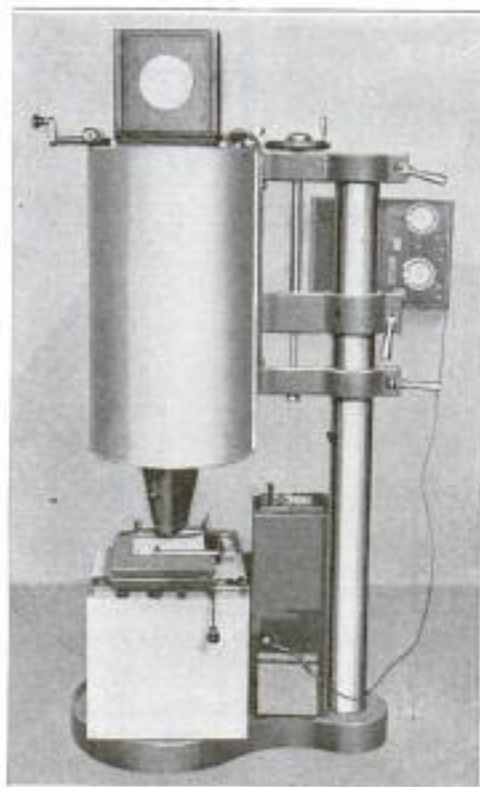

This Microscope of Unusual Size and Power is Used in the Scientific Detection of Criminals

The minimizing of vibration due to the instrument's weight of 525 pounds, is an added advantage. Some idea of its size can be realized from the principal dimensions, for the height is 6 feet 4 inches, length of barrel 34 inches, and circumference of barrel 54 inches.

*d. m. Luke & May, Pres. of Appl. Univ. of Northwest Criminology & Forensic Sci., Wash.*



*Aeronautes Hydro aeroplane*  
A SMALL FLYING BOAT RECENTLY TURNED OUT IN GERMANY

A SMALL flying boat, said to be the most efficient craft of its class yet evolved, represents the latest German development in this field. It is a monoplane type with a rotary motor and is of all-metal construction. This is one of the evidences of the great activity of the Germans in aviation, and indicates they do not intend to drop behind the rest of the world in building up their flying industry.

9964

## CONCRETE BRIDGE DEDICATED TO SERVICE MEN

"Victory Bridge," a beautiful concrete structure over the Chattahoochee River at the town bearing the same name, has lately been completed and formally dedicated to the soldiers and sailors of Florida, who served in the late World War. The bridge is constructed entirely of rein-

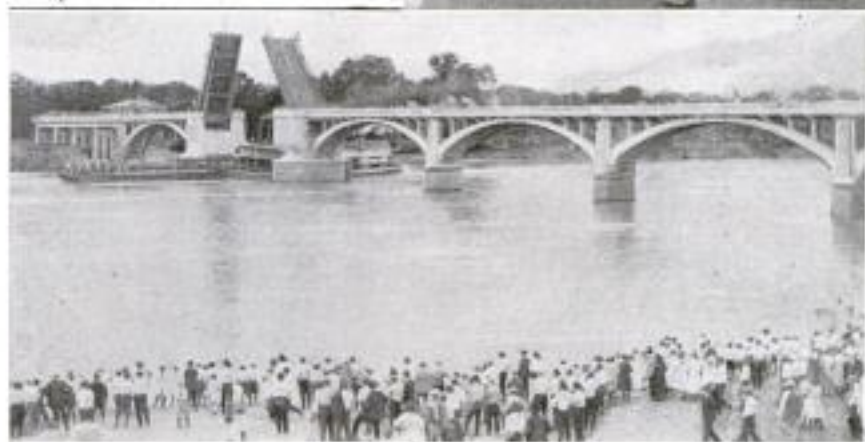
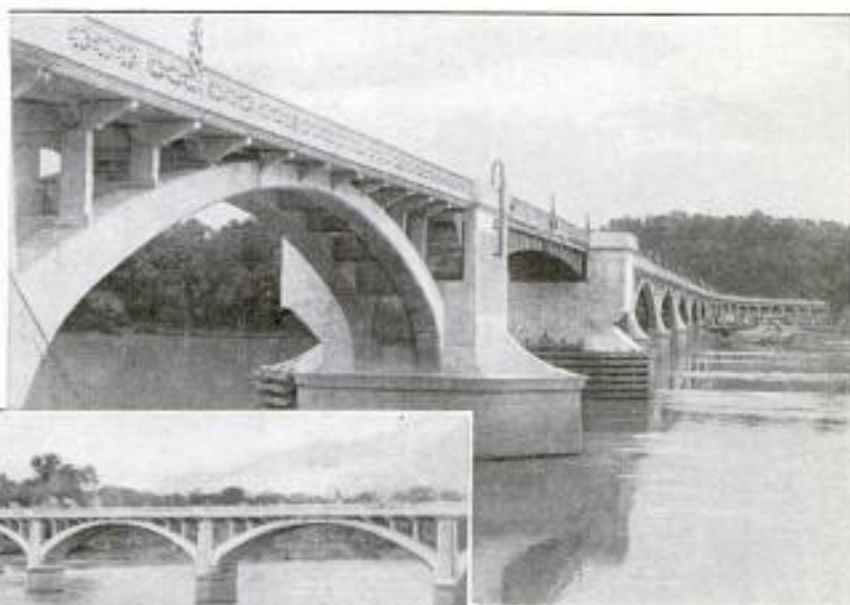

Another View of the Bridge, Showing Many People Watching the Bascule Lift Span being Operated, 15 Minutes After the Dedication Ceremonies were Finished, and the First Boat Going Through

Beautiful Concrete Bridge Which was Recently Completed and Formally Dedicated to the Soldiers and Sailors of Florida in the Late War

across the channel, and cost approximately \$1,000,000. The governor of the state officiated at the recent dedication ceremonies, which were

forced concrete and has seven 110-foot arches, and one 100-foot bascule lift span witnessed by an estimated crowd of 10,000 people.

*Capt. E. W. Holt, Quincy, Fla.*

42

d w. O. ls. Shurlow, /o Alabama  
Power Co., Birmingham, Ala

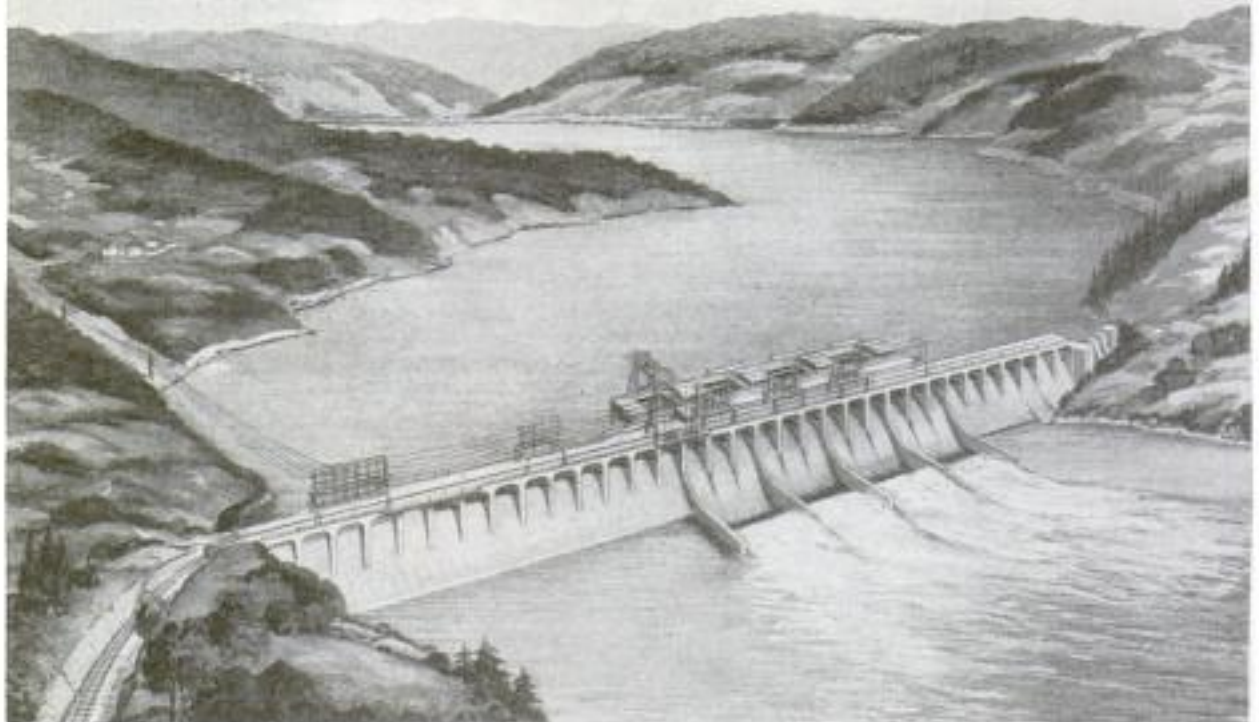

View of Water-Power Development, Showing the Storage Reservoir on the Upstream Side of the Dam and, on the Downstream Side, the Water Running through the Spillways and Backwater Suppressor: Note the Power House Located at the Middle of the Dam

43

### NEW DESIGN INCREASES POWER-PLANT EFFICIENCY

THERE are many power plants and possible sites for such plants where the supply of water is very irregular, and owing to the nature of the surrounding country, it is impossible to provide suitable storage for the utilization of all water flowing in the stream. These so-called run-of-river plants are greatly handicapped a considerable part of the time when plant capacity and the efficiency of the units are greatly reduced, which not only happens during low water but also in the flood periods. In the latter case, the loss has been due to the decreased head caused by the higher level of water in the tail-race.

In an endeavor to maintain a constant head on the water

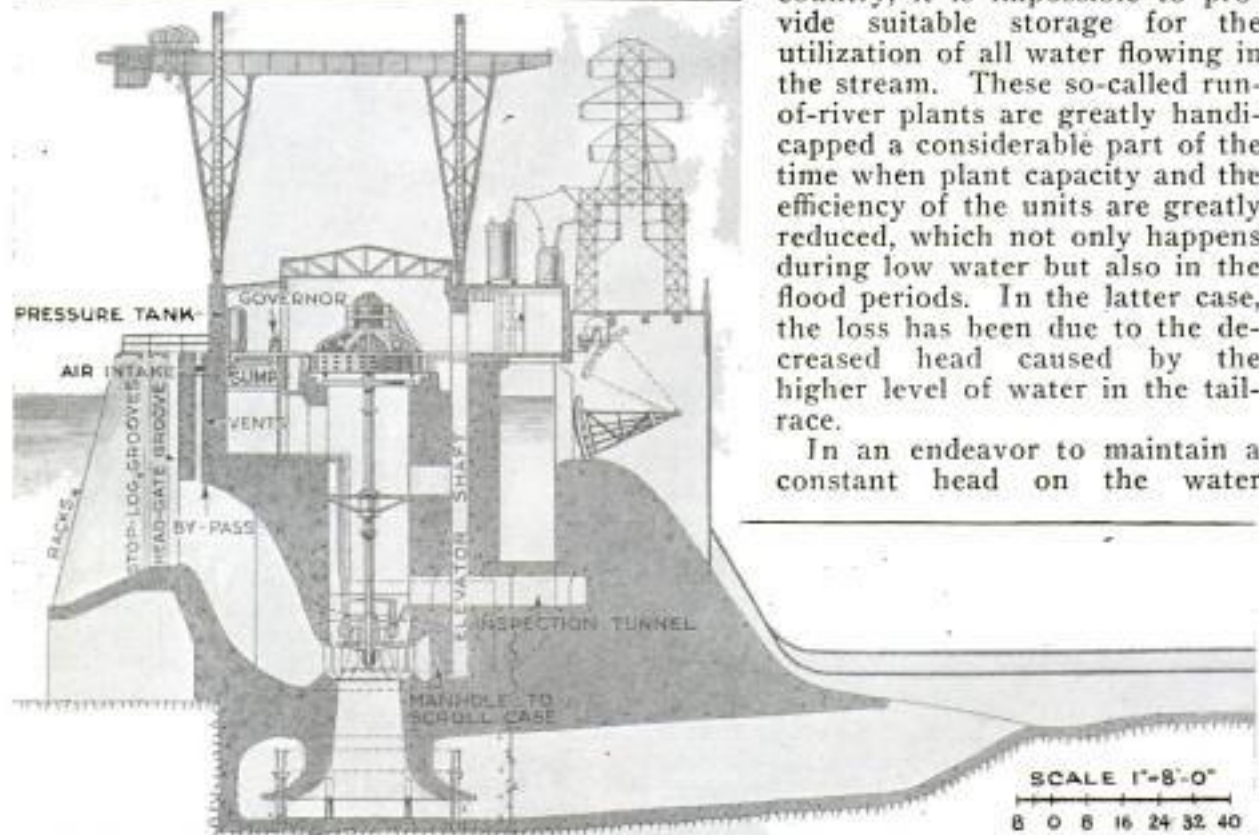

Cross Section through Dam and Power House, Showing Arrangement of Vertical Water-Wheel Generators: The Backwater Suppression Results from the Scientific Design of the Downstream Face of the Dam

Johnson & Apphance Co.

POPULAR MECHANICS

Cedar Rapids, Iowa 527

Grand Mfg. Co., Dayton, Ohio

wheels, a design, called a backwater suppressor, has been developed to remove the high tail water, utilizing the waste water coming through the spillway of the dam for this purpose. In a properly built dam, the water flows over the downstream face in a thin sheet and leaves it at a high velocity, forming at some distance farther on a standing wave or backroll. This energy, heretofore wasted, has been directed toward removing the backwater from over the outlets of the water wheels.

In addition to the increased operating efficiency obtained, careful estimates have indicated that water-power plants designed on the backwater-suppressor principle, can be built at less cost than the conventional types now in use.

9995

"IRONING DAY" A PLEASURE WITH ELECTRIC IRONER

"Ironing day," that day of drudgery for the housewife, can now be relegated to the past as far as the drudgery is concerned, if a recently introduced electric ironer is used. The appliance weighs only 65 pounds, occupies a space 3 feet long by 15 inches wide, irons everything in the family wash, and is so simple that

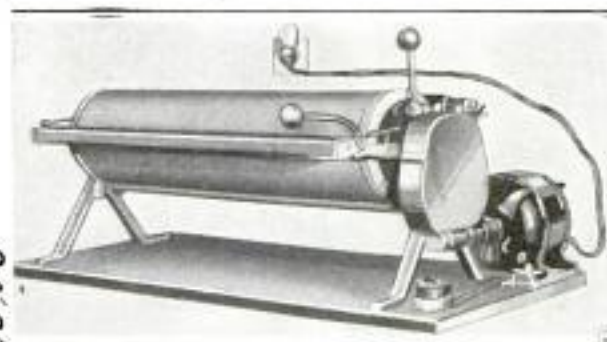

Electric Ironer, Showing the Driving Motor with Switch, and How the Outfit is Connected to Any Wall Plug

it can be operated by a child. It is so constructed that garments going through it cannot be caught or torn.

GAS-FIRED BENCH FURNACE HAS MANY USES

A gas-heated bench furnace of convenient design, has recently been placed on the market. A 20-pound capacity lead-melting pot may be heated by removing a lid from the top, while long rods or pipe can be inserted through an opening in the side, and soldering irons or small pieces can be heated at the front opening. The furnace accommodates a pair of 14-

pound soldering irons or two pairs of 4-pound irons. It is equipped with three very satisfactory Bunsen burners, which will maintain a temperature of 1,800° F., without resorting to preheated gas or the use of a blower

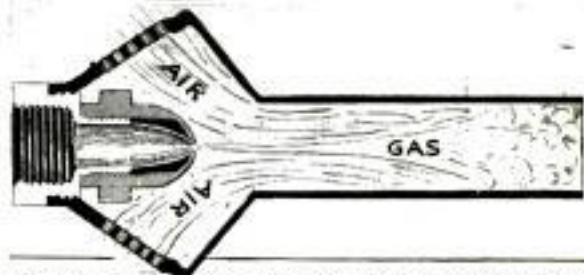

Above: Gas-Heated Bench Furnace with Melting Pot in Place. Below: Showing How Gas and Air are Mixed in Burner

pressed air for blast. In a recent test, it was found that 20 pounds of lead were melted in 10 minutes, with gas consumption at the rate of 40 cubic feet per hour.

58

ELEVEN DIFFERENT GRIPS IN SOCKET WRENCH

Practically every nut and bolt on a small motor car of well-known make can be gripped in one or another of the 11 different-sized openings of a lately introduced socket wrench. The tool is 9 1/2 inches in length, weighs 1 1/2 pounds, is made of metal carefully annealed to give



Socket Wrench Having 11 Different Grips Which will Fit Practically Every Nut and Bolt on Well-Known Small Car

strength, and should prove a valuable addition to the repair kit for this type of machine.

Lucky 'Seven Socket Wrench Co. 1416 Fisher Bldg Chicago

The U.S. Co., Beach St., Boston, Mass. Grand Mfg. Co., Price \$90.00

Price \$1.50

31 PLAN REBUILT BROOKLYN BRIDGE AS CABLES SHIFT

It was recently noticed that, of the four main cables supporting the Brooklyn Bridge, the two north cables had slipped in their saddles.

In the case of the north cable the movement was  $1\frac{1}{2}$  inches in the direction from the shore span to the main span, and for the next cable  $\frac{1}{2}$  inch in the same direction. No other change of condition in the bridge had been observed in the regular inspections, nor was any detected in a special examination, so this is regarded

only as a readjustment of strains arising from a similar movement of the south cables in 1898, when trolley cars were

first operated across the bridge. In addition to the rebuilding of this 40-year-old structure, plans are considered to span the river, near by, with a new bridge in order to meet the steadily increasing traffic demands at that point. Traffic diverted to the new bridge, when finished, will permit rebuilding the old one.



View of Brooklyn Bridge, Showing One of the Main Piers with Two of the Suspension Cables and Network of Smaller Cables Supporting the Decks

9988  
TWO-CYCLE ENGINE WITH AUXILIARY CYLINDERS

A two-cycle engine which has an auxiliary piston and cylinder in which the preliminary compression is done instead of in the crankcase, has been demonstrated, it is said, with perfectly satis-

factory results in Portland, Ore. The auxiliary cylinder is connected to the lower end of an ordinary two-cycle cylinder, which for a considerable length below its intake and exhaust ports has its

wall finished inside to fit the two-cycle piston at the end of its outstroke, and outside to fit the auxiliary piston at the end of its instroke. This auxiliary piston, U-shaped in section, is bored to fit this finished part of the two-cycle cylinder, and has its outside wall finished to fit the bore of the auxiliary cylinder, leaving a concentric space between the piston and the auxiliary cylinder head, where the charge is sucked in and partially compressed. The power piston and its connecting rod drive the shaft with one crank, and two other cranks at  $180^\circ$  with suitable connecting rods operate the auxiliary piston.

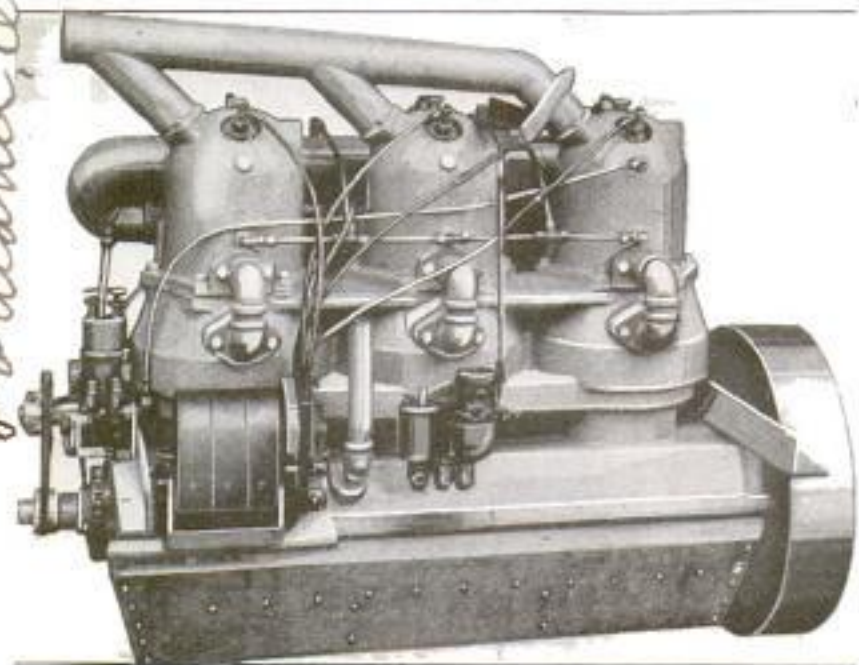

New Type of Two-Cycle Engine Built with Three Cylinders for Automotive Work: Intake of the Charge and Preliminary Compression are Done in the Lower Part of Each Double Cylinder, Which Work is Normally Performed in the Two-Cycle Crankcase

Mr. Louis S. Luce, 500 E. 41st St. Portland, Oregon.



#### DEATH OF ALEXANDER GRAHAM BELL

**A**MONG stories of invention none is more romantic than that of the telephone and its creator, Alexander Graham Bell. Both his grandfather, in London, England, and his father, in Edinburgh, Scotland, were lifelong experts and teachers of the mechanism of speech, and in time this became a family profession. Alexander Graham himself, early in life, took up the study of vibrations. First later on came the study of electricity, of which at that time he was entirely ignorant. He specially investigated Helmholtz's work in connection with the production of vowel sounds by electrically vibrated tuning forks. Later, after his arrival in America, he made a number of inventions based upon the utilization of

musical notes as telegraphic signals, and these led gradually to the perfecting of the telephone itself. This made him a world-wide celebrity. His bearded face became the subject of countless reproductions, none more faithful than in a bust for which he posed to the famous sculptor Moses Dykaar.

For many years the great inventor had made his summer home near the village of Baddeck, in Nova Scotia. Here he died August 2, in his 76th year. Two days later he was buried, as simply and unceremoniously as he had lived, on the peak of the neighboring Beinn Bhreagh mountain, beneath a steel watch tower built there years ago by the inventor himself.

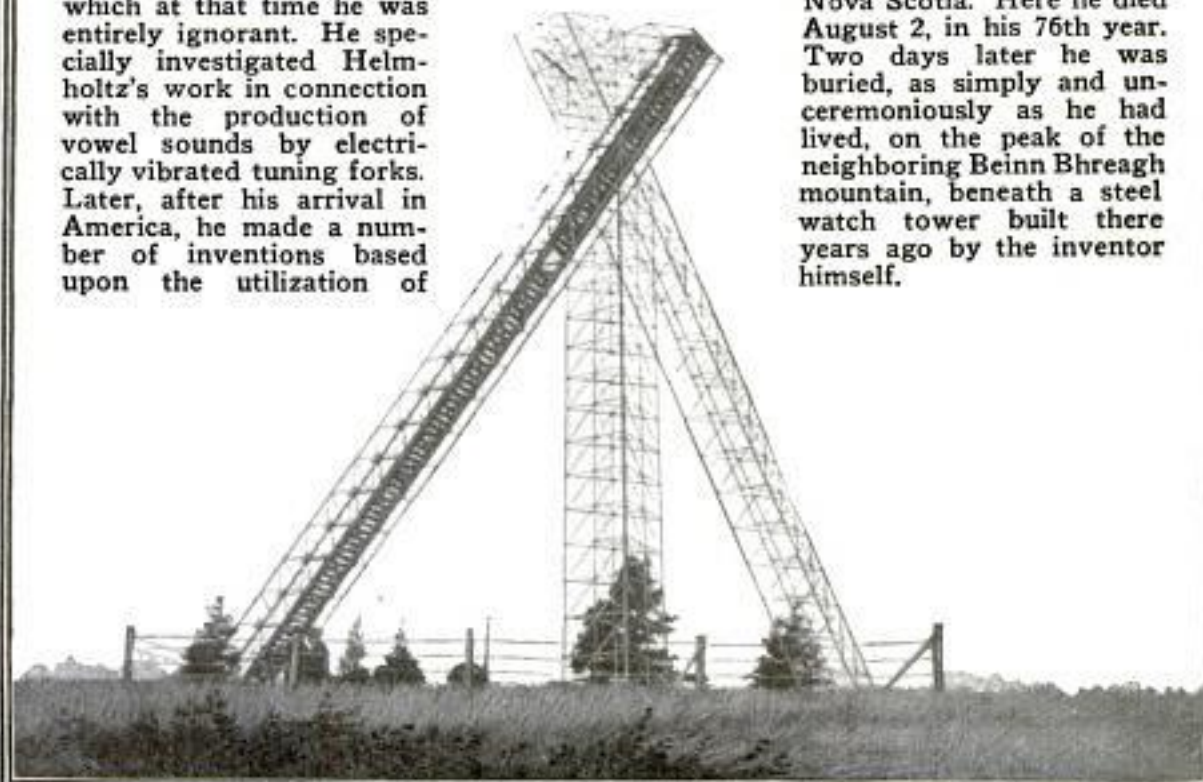

*Wm. Simon A. Dodd*  
213 W. Penn St.

530

POPULAR MECHANICS

*Hooperston, U.S.*  
**FOOTREST FOR SHOE SHINING  
SWINGS OUT OF THE WAY**

By adopting swinging footrests, the owner of a western shoe-shining parlor

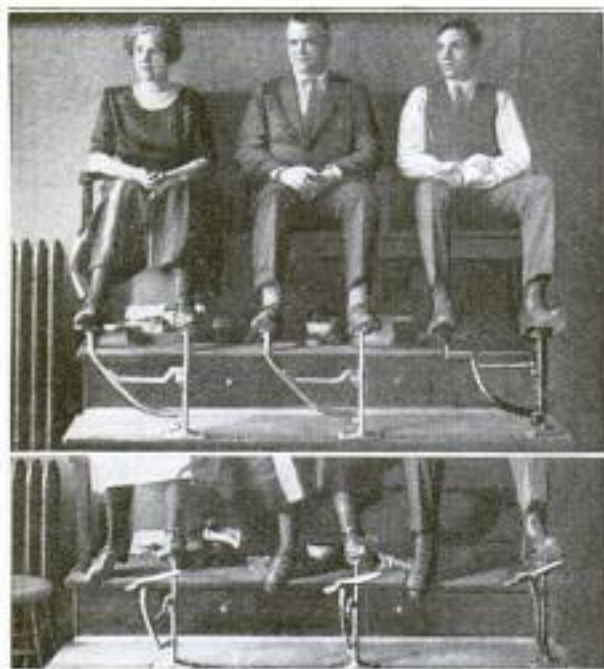

Above: The Footrests in Place. Below, They are Shown Swung Out of the Way, Allowing the Patrons a Clear Passage

has made it possible for his patrons to have a clear passageway when mounting or leaving the stand. Only one of each pair of footrests swings, being supported

by a bracket hinged to the other. The innovation is particularly pleasing to women because their skirts are less likely to be caught in one or the other of the footrests.

**OREGON LUMBER CAMP BOASTS  
LONGEST RADIO ANTENNA**

What is claimed to be the longest privately owned straight-line radio antenna in the world has been erected at a lumber camp in the state of Oregon. When it was decided to install a radio outfit, all the available standing timber had been removed for some distance from around the camp site, and the nearest suitable tree stood 1,015 feet away, with its lowest branches 150 feet above the ground and its top 300 feet in the air. In spite of the apparent difficulty, the lumberjacks were undaunted, and one of them volunteered to climb the tree, making fast, 200 feet above the ground, the end of the long copper wire that was stretched to the radio house. The climber wore scaling spurs and worked his way up, assisted by short ropes around the big trunk. This radio installation is said to be one of many that are now being put in at the large lumber camps of the Northwest, so that the hitherto isolated workers may have daily contact with the news and enjoy some of the entertainments of the outside world.



View of Western Lumber Camp Where a Single-Wire Antenna, 1,015 Feet Long, was Erected in Connection with a Radio Outfit Installed for the Entertainment of the Somewhat Isolated Inhabitants

*Pacific Northwest Lumber Camp  
Kerry Oregon*



4928

Detroit & Windsor Ferry Co  
Detroit Mich.

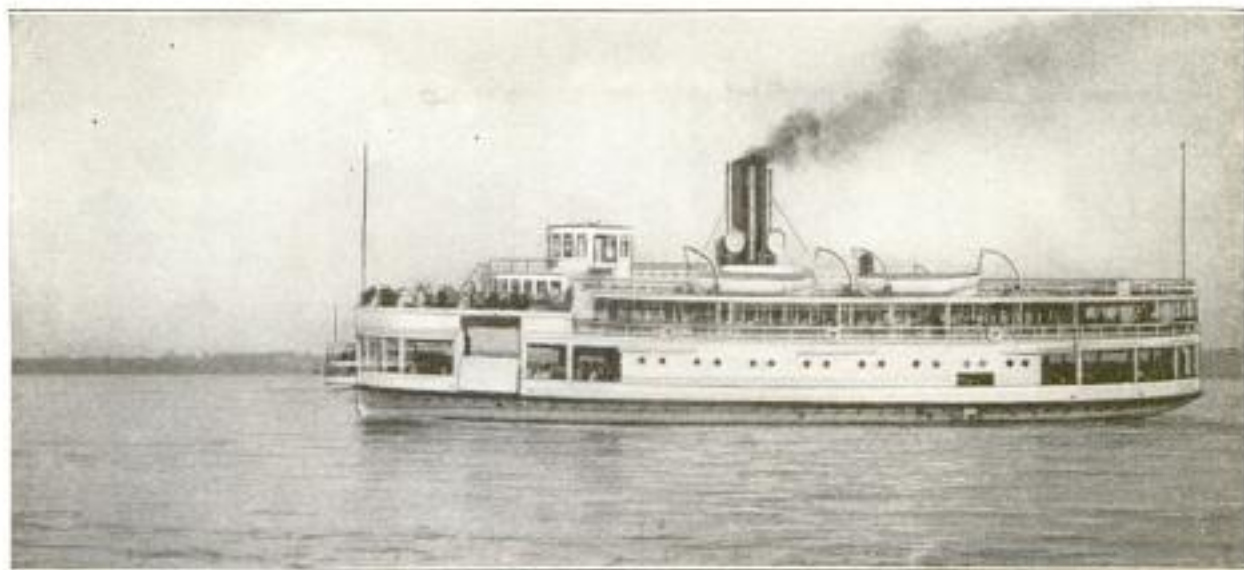

New Combined Passenger and Automobile Boat Put into Service as a Ferry between Detroit and Windsor: It Is 170 Feet Long, 66 Feet Wide, and Accommodates 2,000 Passengers and 60 Automobiles. It Is Also an Ice Breaker

**PASSENGER AND AUTO FERRY  
ON THE DETROIT RIVER**

To accommodate the heavy traffic between Detroit, Mich., and Windsor, Ont., a very large combined passenger and automobile ferry, named "La Salle," was put into service recently. The boat is 170 feet long, 66 feet wide, drawing 14 feet of water, with a net tonnage of 334. The automobile deck accommodates 60 cars lined up three abreast. One of the advantages of the boat is the short time it takes to bring aboard and unload the automobiles. The passenger capacity is 2,000. The big ferry is also an ice breaker, which is an unusual feature in a ferry of this size.

firmly against the roof of the mouth, but do not know the reason for its dropping away. It is the vacuum between the plate and the roof of the mouth that holds the plate in place, and to help maintain this vacuum, a suction valve has been devised which is placed in the forward center of the plate. This valve opens by suction against it, and closes mechanically, and is claimed to hold the plate quite firmly against the roof of the mouth.

9831

**HEAVILY LOADED SUITCASE  
SHOWS GREAT STRENGTH**

More than 2,000 pounds were loaded on a special platform and placed on top of a



The Combined Weight of the Sacks Shown Above Is 2,100 Pounds. They were Loaded on This New Steel-Bound Suitcase in a Test to Determine Its Strength

new steel-bound suitcase in an effort to determine just how much weight the case would withstand. The handle and two outside straps are of leather. It is designed for automobile and other travel, where it may be exposed to rough handling.

Chicago

P. P. Archer + Co.  
329 W. Monroe

Dr. J. Jacob Petry, Pittsburgh, Pa.

9124. *statue teeth*  
**DENTAL-PLATE SUCTION VALVE  
FOR MAINTAINING VACUUM**

Many persons who are forced to wear a set of artificial upper teeth know the annoyance caused by the plate not holding

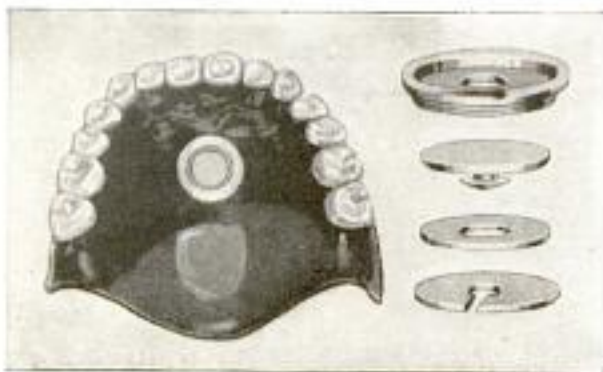

The Suction Valve can be Seen near the Center of the Plate. To the Right Are the Various Parts of the Valve

Dr. H. Whitman  
319 7th Ave., Pittsburgh  
Pa.

International  
Dental Mfg Co  
6 E. Lake, Chicago



Municipal Bathhouse at Salt Lake City, Which is Supplied with Natural Hot-Spring Water: It Contains Locker and Dressing-Room Accommodations for Over 1,200 Persons, and Has a Completely Equipped Modern Laundry for the Sterilization of Bathing Costumes

## HOT-SPRING BATHHOUSE FOR SALT LAKE CITY

By GEORGE F. PAUL,

*900 Ellsworth Bldg  
Chicago*

SALT LAKE CITY has at last made a reality out of what for years was but a dream. Now the western city has a \$330,000 bathhouse, which will provide her own people and her visitors with natural hot-water bathing and swimming. It contains a magnificent common pool, 120 by 50 feet in dimensions, a medium-sized pool for private parties, seven small pools for individual use, and complete

er plans for the building, decided upon a structure of the Spanish renaissance type, one that would have both airy grace and restful dignity. Furthermore, the building was constructed to make the best possible use of the natural hot waters. In 1920, there were 133,000 bathers at the old springs. It is believed that the annual attendance at the new bathhouse will reach the 300,000 mark.

Locker and dressing-room accommodations are provided for 440 men, 600 boys, 250 women, and 100 users of the private pools. There is a completely equipped laundry, which turns out 400 sterilized and dried suits every hour. It is believed that the institution will pay for itself within six years. The charges will probably be 25 cents for the main plunge, and 50 cents and \$1.00 for the individual pools.

Much has been done to provide for the comfort and convenience of the patrons. The southern part of the main floor is equipped with a three-chair barber shop, a massage room with Turkish baths, and a special room for physical exercises. A handsome lounging room is provided for the men.

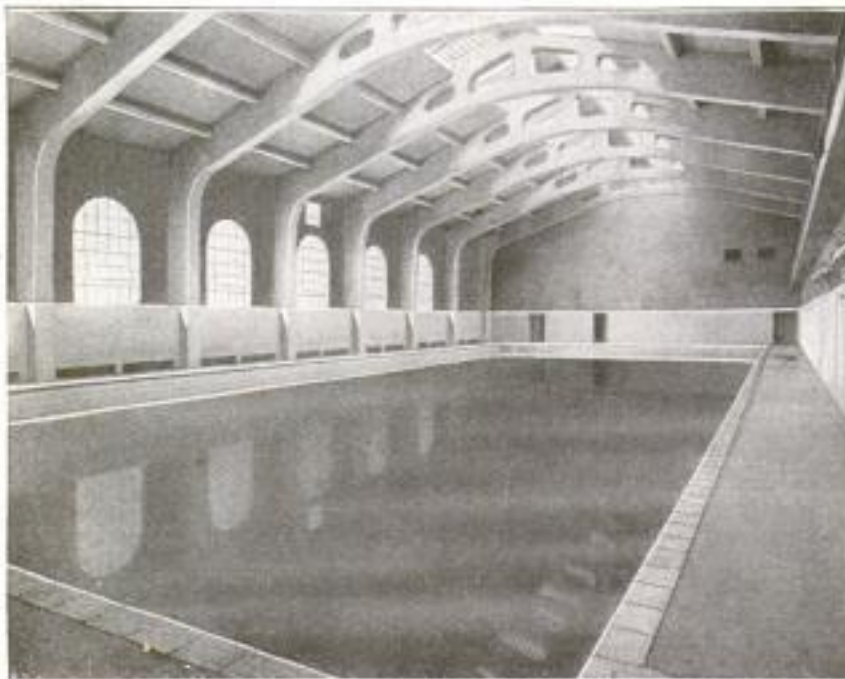

Interior of Municipal Bathhouse, Showing the Main Swimming Pool, Which Is 120 Feet Long by 50 Feet Wide: There Are Also Several Smaller Pools

equipment for accommodating the patrons. The city commissioners, in consid-

for physical exercises. A handsome lounging room is provided for the men.

## POPULAR MECHANICS

*Dr. W. J. B. Murphy  
205 St. Jean Ave.  
51 Detroit, Mich*

The women patrons will find a beauty parlor, a restroom, and quarters for a masseuse. For emergency cases, a pulmotor and other resuscitation apparatus have been provided. A completely equipped café will furnish the food for those who take the baths under the direction of a physician.

The waters are limpid and smell strongly of sulphureted hydrogen, and issue from the mountainside in a strong stream, at a temperature of 95 to 104° F. The people of Salt Lake City look upon this new building as a health investment. They feel that it will also be an added attraction for visitors to their city.

### 9 GAS, OIL, AND AIR DELIVERED FROM HOUSE TO HOUSE

Delivering gasoline, oil, and air from door to door, is the latest activity of a filling station in Denver, Colo., and has proved very popular. The vehicle used for the work is equipped with a 750-gallon gasoline tank, a 60-gallon tank for lubricating oil, a heavy-duty air compressor with a tank having a capacity of 160 pounds, all of which are mounted on the chassis of a two-ton motor truck. A complete line of accessories for emergency needs is also carried, it being the owner's intention to travel a regular route over the adjacent highways, dispensing general "first aid" during the summer months, while in the winter, a house-to-house service will be maintained. Judging from the popularity gained by the service, it is probable that other trucks will be similarly equipped.

### TOOL-HOLDING ATTACHMENT FOR GRINDING MACHINES

A new tool-holding attachment for use in connection with grinding machines is on the market. It may be built in as

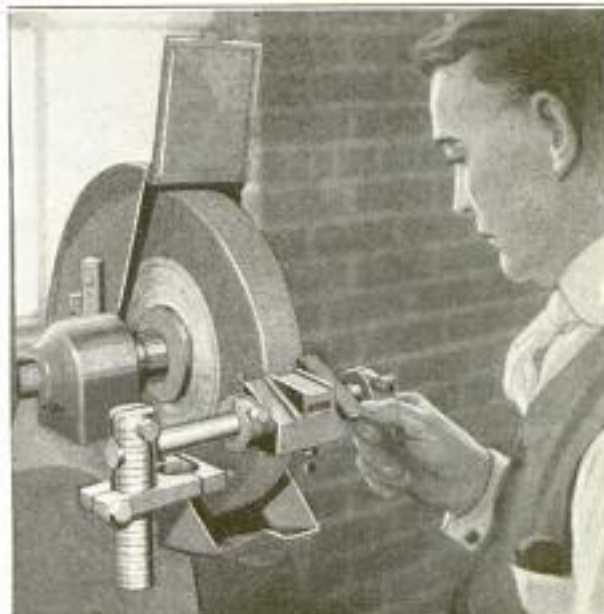

Tool-Holding Attachment as Applied to Emery-Wheel Grinder, Showing the Holder in Use for Accurately Grinding the Steel Die Chasers Used in Many of the Modern Threading Tools

part of the grinder or made to attach to the standard emery-wheel stand. The holder consists of a bracket carrying a vertically adjustable post, which in turn supports an adjustable horizontal bar, to the overhanging end of which is fitted the block for holding the tool to be ground. This block is adjustable to any desired angle.



This Traveling Filling Station, Which Delivers Gasoline, Oil, and Air from House to House, or Dispenses Them on the Highways, is Here Shown Inflating the Tires of, and Also Supplying Gasoline to, a Passenger Car Encountered on One of the Streets of the City

*Property of Jack Halgaard, 1445 York  
St., Denver, Colo.*

Copyright material

Albany Boat Corp.

The Isometric Tool Co., New Haven, Conn

534  
Waterwheel, N.Y.  
**FOLDING CHAIRS OR ROCKERS**  
**COMFORTABLE AND COOL**

9941

Folding chairs or rockers, which are comfortable and cool during the hot summer months, are now being manufac-



At the Left the Chair is Seen Folded as a Means of Saving Space, and at the Right Ready for Use

tured and placed on the market by an eastern concern. The chairs are simple to fold or open, weigh only 12 to 15 pounds, and are therefore easy to handle, in addition to which they have a flexible "floating" canvas seat, thus providing the greatest of comfort to the user.

**PACKING CASE OF MOTOR CAR**  
**CAN BE USED AS GARAGE**

That the packing case in which a small motor car of new design is shipped from the factory, can be used as a garage for it, is claimed by its manufacturer. The little automobile is interesting in many other respects. It has a two-cylinder, four-cycle V-type motor, disk wheels

with 26 by 3-inch demountable tires, sliding gear with three speeds forward and reverse, multiple-disk clutch, high-tension magneto, generator or battery lighting, the pedal arrangements and gear shifts being similar to those on an ordinary automobile. From 60 to 75 miles can be traveled on one gallon of gasoline, it is stated, and two persons can easily lift the diminutive machine.

9520  
**CHAMFER-GRINDING FIXTURE**  
**FOR THREAD CHASERS**

For grinding chamfers on thread chasers, a fixture has been devised that insures an exact chamfer ground equally on all the chasers of a set. The table of the chamfer-grinding fixture is graduated, and may be set for grinding long or short chamfers. An adjustable stop, which may be locked, regulates the position of the chaser in relation to the grinding wheel.



Chamfer-Grinding Fixture with a Thread Chaser in Position Ready for Grinding: When in Use, the Fixture is Bolted to the Grinder Table

The side of the fixture is graduated for tilting the table to the desired angle of chamfer clearance.

Martin Motor Co., Springfield, Mass  
Price \$250.00

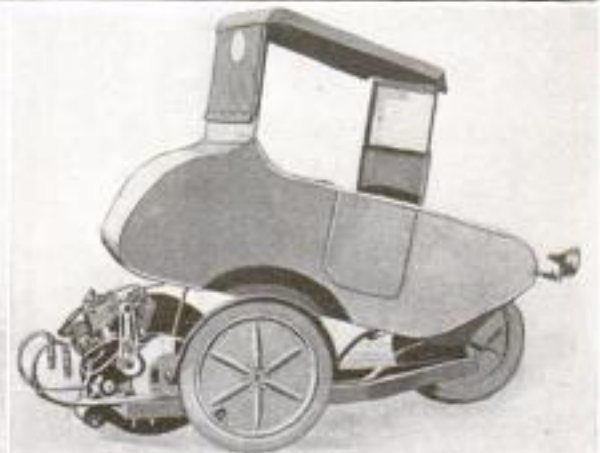
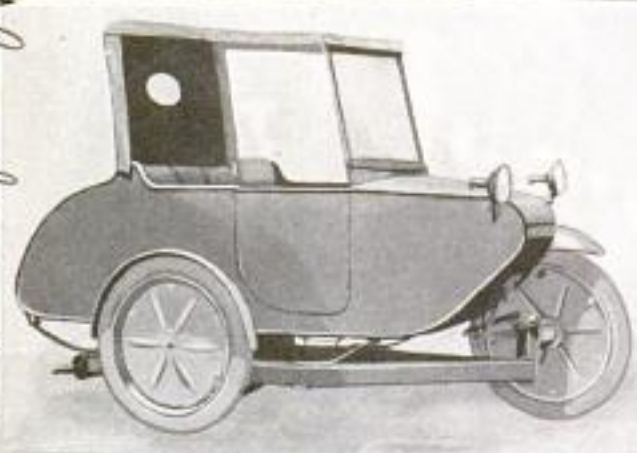

The Newly Designed Diminutive Motor Car, the Shipping Case of Which may be Used as a Garage: At the Right the Machine is Shown with the Body Elevated, So That the Engine is Easily Accessible for Repairs

Not yet in production

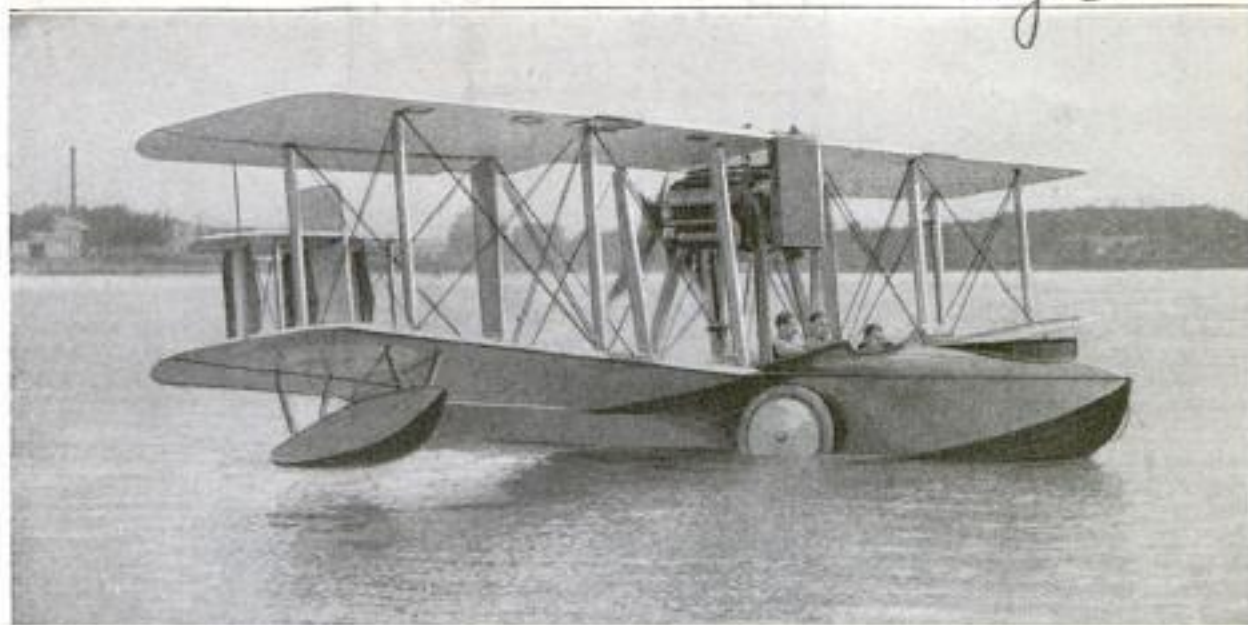

New Flying Boat Built for the Air Service of the United States Navy: Note the Wheels, Drawn Up against the Hull, Which Enable the Craft to Land on the Ground

**U. S. NAVY IS DEVELOPING LAND AND SEAPLANE**

A new airplane built for <sup>naval air</sup> service has the usual hull and pontoons of the flying boat for alighting on water, and the landing gear, with wheels that slide up alongside the hull, for landing on a firm surface like the deck of a warship or an open field. This is understood to be the forerunner of a more fully developed type for extended use in naval service. The activities of our own government and those of foreign nations, indicate the importance expected of air craft in future wars.

**GLOVE SIZER TAKES PLACE OF TAPE MEASURE**

Glove fitting is usually done with the aid of a tape measure, but a sizer, recently introduced, does away with this custom. In using the new appliance, the hand is placed, palm down, on a base which contains a scale and a spring

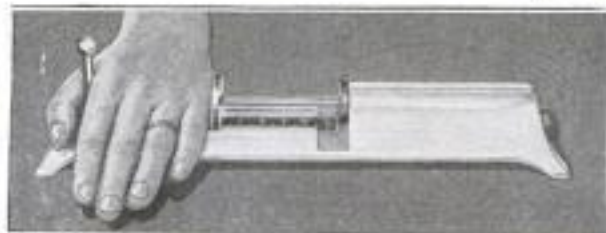

Glove Sizer, Showing How the Hand is Placed on the Aluminum Base with the Plunger against It

plunger which pushes tightly against the hand, and thus automatically shows its width, or the size of glove required.

**WHEELBARROW HEATER MADE FOR REPAIRING ROADS**

Heating a wheelbarrow with a gasoline burner so as to facilitate the repairing of roads, is the idea of an eastern equipment



Above: Wheelbarrow Which Has a Gasoline Heater Incorporated in It for Facilitating Road Repairs. Below: Interior, Showing Road Material being Heated. The Fuel Tank is Seen between the Handles

company, which has lately introduced a conveyance of this description. The heating apparatus operates on the same principle as the ordinary gasoline blowtorch used by mechanics, and has a two-gallon tank. The outfit is incorporated in the construction of the wheelbarrow in such a manner that the contents can be continually kept in a melted state.

*Warner + Paper Co. 57 E. 11 St. New York*

*Road Repair Equipment Co. Broadway, New York.*

95 Cmt. Andrew A. Boone  
503 U. S. National Bank Bldg  
MANEUVERS OF DESTROYERS NECESSARY  
San Diego, Calif.

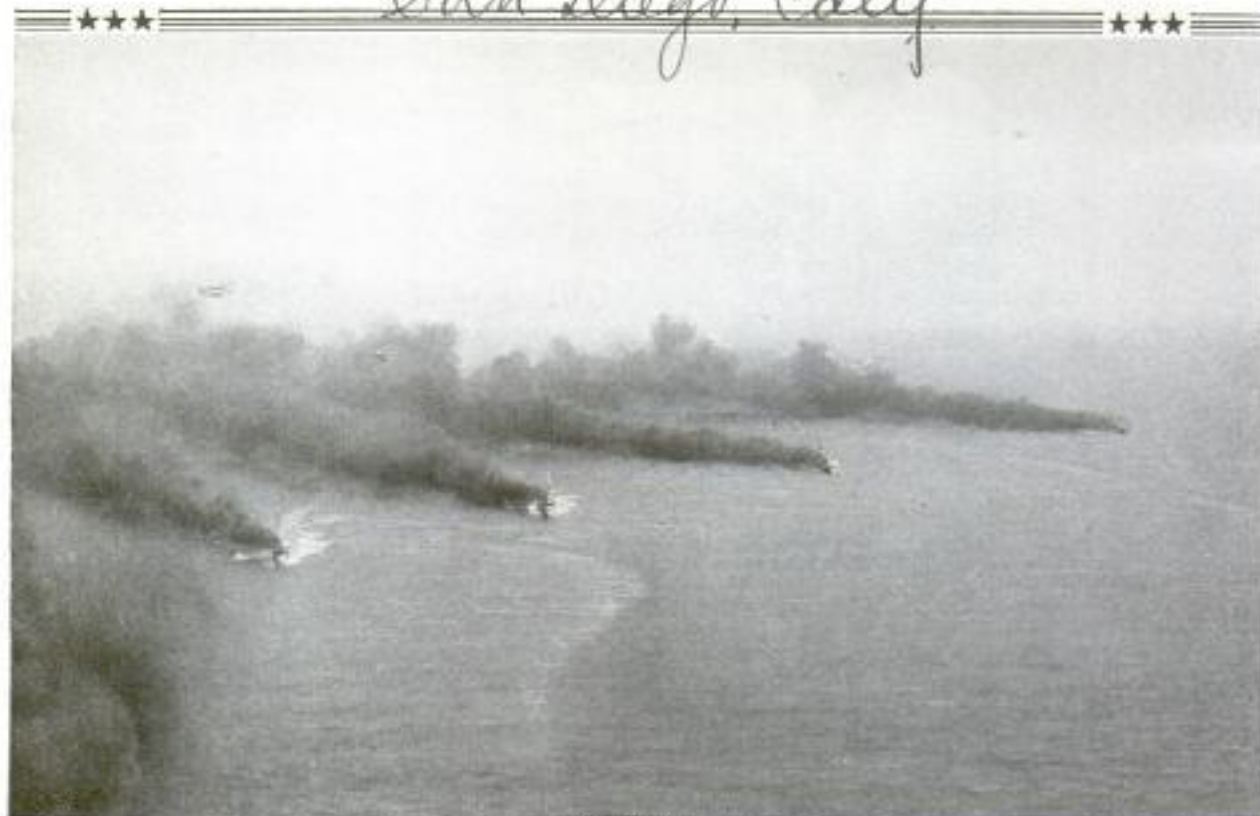

NAVAL officers are devoting much time these days to the development of effective tactics in the formation of smoke screens, so indispensable in both offensive and defensive naval warfare. As a first step in such tactics, destroyers move abreast at high speed, as seen above. They continue their rapid for-

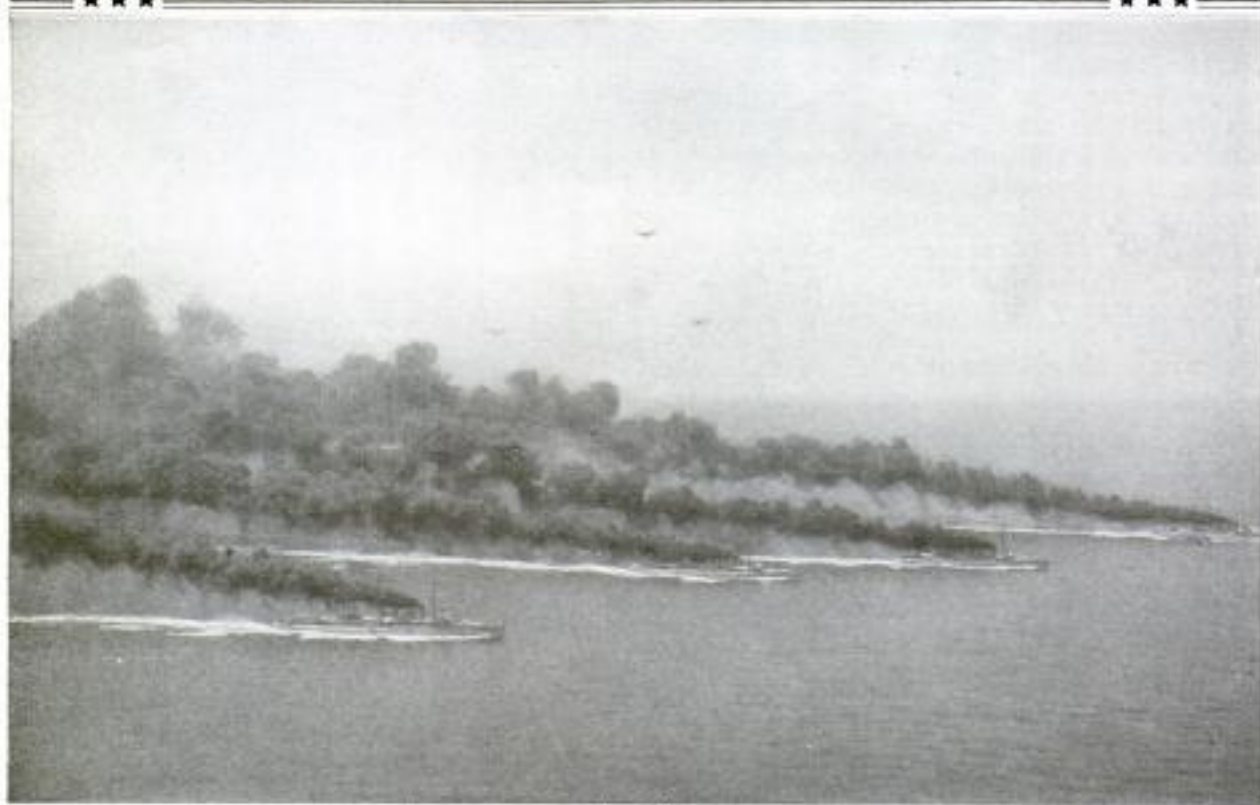

ward movement for the purpose of developing the required density of smoke, which is induced by cutting off the air from some of the oil burners in the boilers. This causes unconsumed oil to issue in clouds from the smokestacks. When the smoke is sufficiently dense, and is hanging in heavy clouds over the

## FOR THE FORMATION OF SMOKE SCREENS

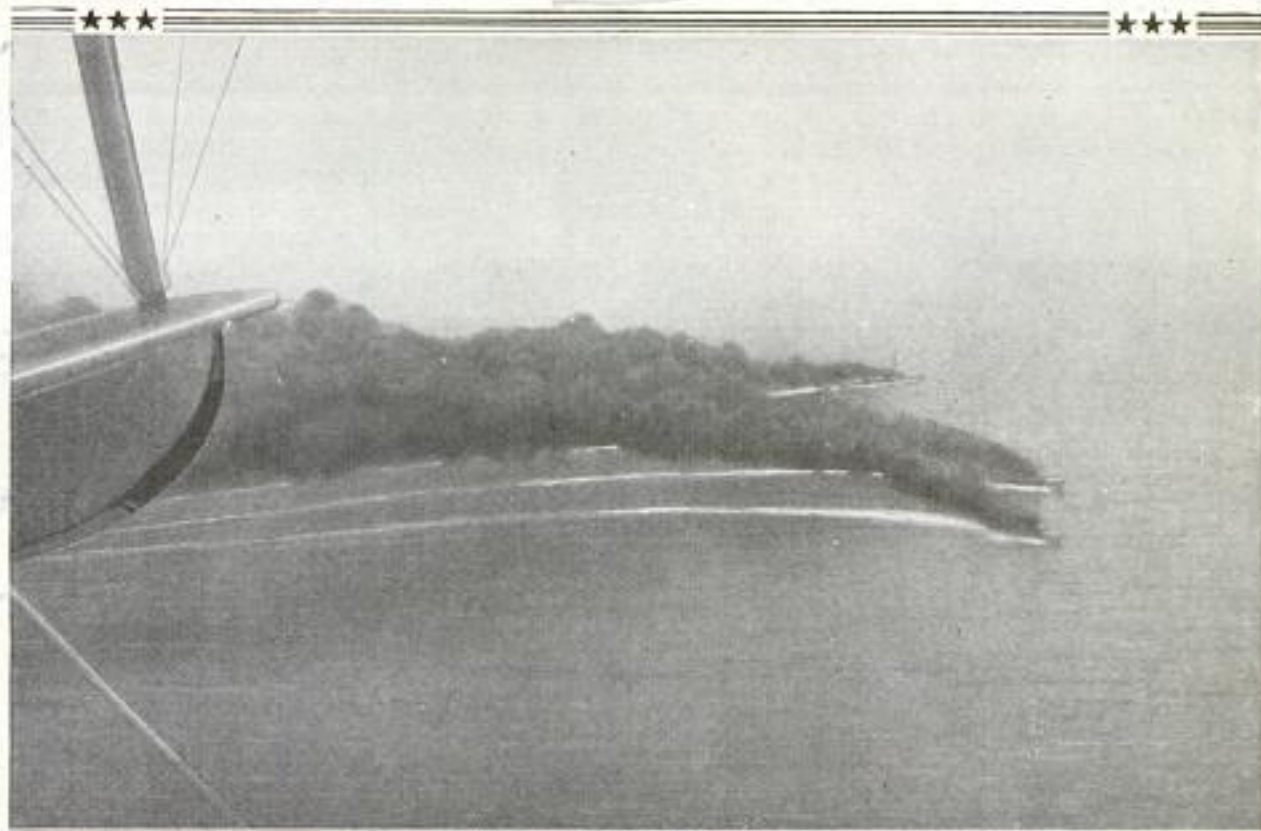

★★★

water—sometimes with a height of as much as 800 feet—the destroyers begin to move into echelon formation. This is the beginning of the object of the whole operation, which is to surround one or more battleships with a smoke screen that renders them invisible to the enemy. The maneuvers of the

★★★

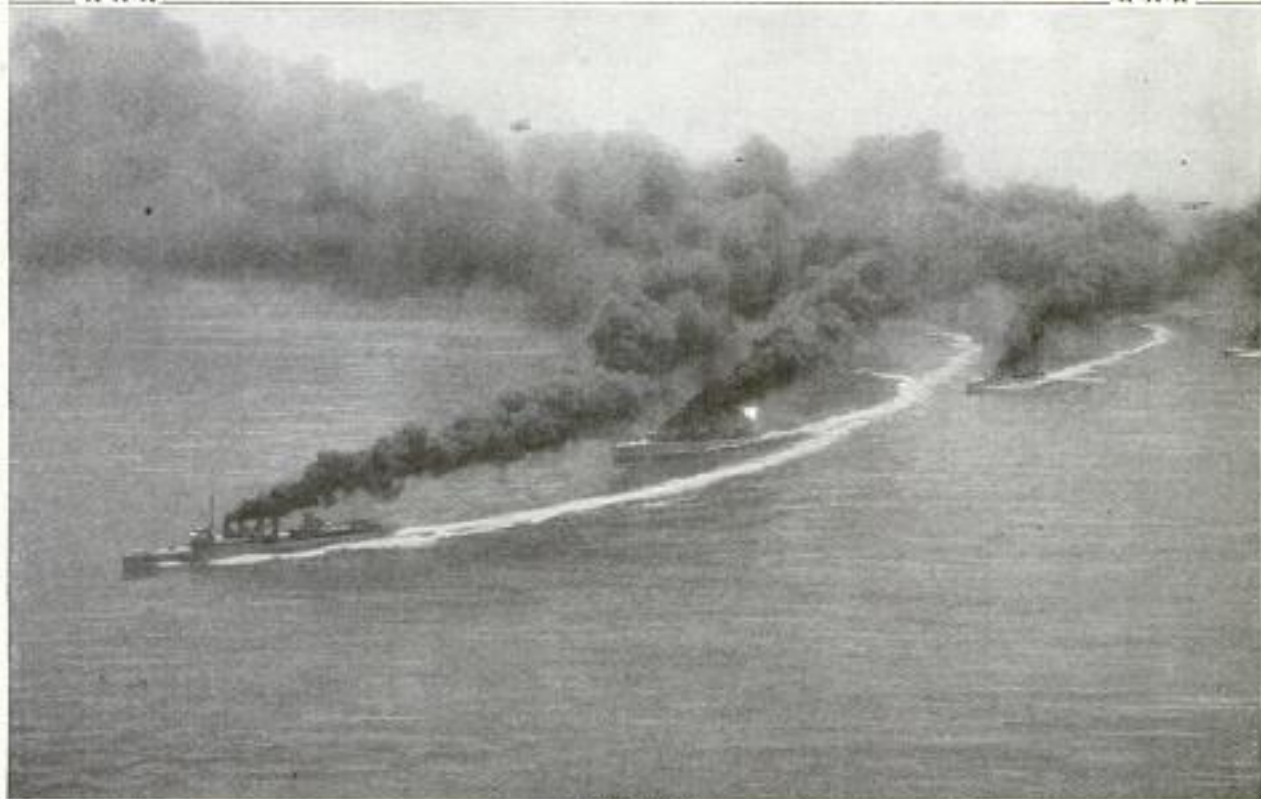

★★★

destroyers are partly directed by signals from airplanes or dirigibles. The smoke clouds may also be used by the destroyers to screen themselves from the enemy while preparing to fire torpedoes. The maneuvers depicted in these photographs were performed recently off San Diego, Calif., by the Pacific fleet.

★★★

27 **ELECTRIC HEATERS STRAPPED  
 ON SIDES OF TANK**

Electrical units which can be strapped to the sides of any metal tank for the

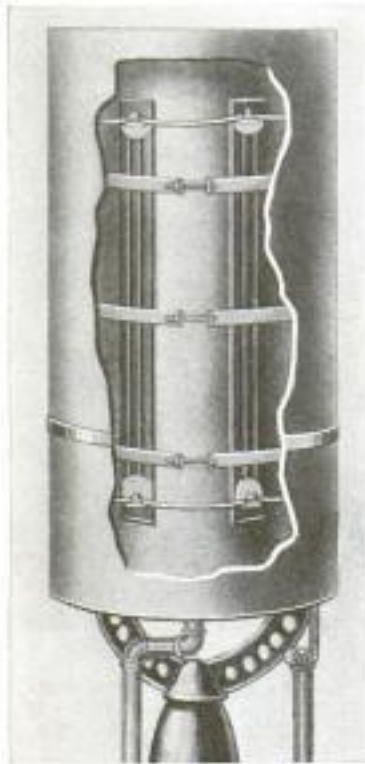

purpose of heating water in shops and homes, have lately been placed on the market. The heaters, which are of simple construction, are fastened by means of three adjustable steel bands, tightly against the lower half of the tank. The appliances are claimed to be entirely satisfactory for conditions not requiring a temperature to exceed 300° F., and are

easily removed for repairs or installation in other locations.

9622 **FOUR-WHEELED AUTO CYCLE  
 PROPELLED LIKE A BOAT**

A four-wheeled man-propelled vehicle that is driven with the same movements as in rowing a boat, has recently been tested with success at Lyons, France.



Four-Wheeled Auto Cycle That is Propelled with the Same Movements as in Operating a Pair of Sculls in a Boat with a Sliding Seat: The Left-Hand View Shows the Beginning of the Power Stroke, and the Right-Hand View the End of It

The driver sits on a sliding seat facing in the direction of travel, and moves two handles backward and forward in exactly the same manner as a boatman operates a pair of sculls, excepting that there is no feathering movement. The maximum speed of this rowing auto is over 18 miles an hour. Besides its use as a vehicle, it furnishes an excellent means for training,

9889 **IMPROVED BOTTLE CROWNER  
 OPERATED BY HAND**



A bottle crowner, operated by hand, that will give the results obtained by much more elaborate commercial bottlers, has been recently placed on the market. The hand crowner has a plunger backed by a heavy spring, that supplies the necessary pressure on the cork lining of the crown, before its skirt is crimped to the bottle. The table of the machine can be adjusted to suit bottles from 7 to 12 inches in height, and a push down on a

handle completes the crowning. A pressure of approximately 300 pounds is applied before crimping.

Wilmington, Del.  
 \$10.00  
 Modern Record Co.

M. Bourdon, 30 Robert  
 Pair, 35 Rue St Jean,  
 Lyons, France



New York City



## STAR ISLAND DEDICATED EXCLUSIVELY TO RELIGION

STAR ISLAND, one of the Isles of Shoals, 10 miles off the mainland of New Hampshire, has been dedicated exclusively to religious service for 120 years. On its rocky summit is a small gray-stone church which was built in the year 1800. This has been used ever since as a place of worship, first by fishermen's mothers, sisters, and sweethearts who prayed for the safe return of their loved ones. During the last 26 years, it has been a shrine for Unitarians and Congregationalists. At 10 o'clock each night, long lines of men and women, carrying small lanterns, wend their way thither and, a churchful at a time, hang their lanterns on the walls, and bow their heads in prayer or raise their voices in appropriate hymns.

9945

### AUTOMOBILE STOP SIGNAL ENTIRELY AUTOMATIC

An automobile stop signal has been devised that is absolutely automatic, being actuated exclusively by the effect of arrested momentum. The signal flashes, independently of anything else, by any slowing down of the car. The current is automatically cut off and the light disappears when the car comes to a stop, or at the instant it picks up speed or discontinues the slowing-down movement. In appearance and location at the rear of the car, it is much like any other stop signal, its novel use of the action of arrested momentum being its distinguishing feature. Being operated in this manner, it is exceptionally durable.



Automobile Stop Signal That Flashes Its Light Automatically and Exclusively by Any Retardation, Great or Small, in the Speed of the Car

Spengler Loomis Mfg Co  
58 E. W. Washington  
Chicago

9658

*Chas. W. M. J. Finner N.Y. Times*  
*Bailey - Farrell Mfg. Co. 8/10/22*  
*540 POPULAR MECHANICS P. 3.*

*Hirston & Wood St.*  
**AUTOMATIC PUMPING PLANT**

**FOR HOUSEHOLD USE**

*Pittsburgh Pa.*  
For use in isolated dwellings, a compact pumping unit is being manufactured

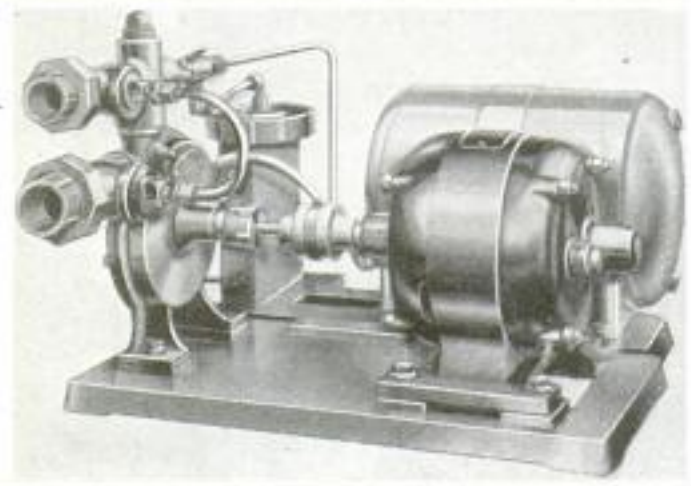

This Household Pumping Unit Operates Automatically; When a Faucet is Opened, the Motor Starts and Runs until the Faucet is Closed

that is so arranged that the objectionable storage tank is entirely eliminated. The pump is driven by a small electric motor, and the entire unit, including the control apparatus, is mounted on a small cast-iron base. The operation of the pump is controlled by the pressure in the water mains. As soon as a faucet is opened, the motor starts running, and continues until the faucet is closed. The pump is capable of drawing water from a depth of 22 feet and supplies water to the mains at 45 pounds' pressure. At this pressure, the water can be discharged at a height of 90 feet.

*Howey*  
**RECENT RAILROAD EXTENSION IN EAST CENTRAL AFRICA**

The opening recently of the Trans-Zambesia Railway marks an important stage in the development of Nyasaland, the British central-African protectorate. Nyasaland has for some time possessed a railway which connects Blantyre, the capital, with a point on the Zambesi River, and this is to be extended to Fort Johnston, at the southern end of Lake Nyasa, whence water transport is now available for 360 miles northward. The new railway connects with the old one at the Zambesi, and runs southward to the port of Beira on the Indian Ocean. The river will later be bridged, but for the present the two lines are connected by a ferry. The newly built railroad is 157 miles long.

*9921*  
*The Engineer*  
*7/19/22*

**RECONSTRUCTION HOSPITAL TO BE ENLARGED**

21 The Reconstruction Hospital of New York, which for some time has been devoted to the care of industrial-accident and disease cases, has seen its work so greatly increased this year, that an 11-story addition to the institution is contemplated. Patients from more than 30 states and of almost every trade have here been refitted for work, mainly by means of "mechanotherapy," as the system of treatment is called, administered in a specially equipped gymnasium. Unlike the ordinary gymnasium, which is equipped to make normal and healthy muscles stronger, that of the hospital is designed for crippled muscles, stiffened fingers, diseased joints, and particularly for their mental effect. Every exercise is prescribed by physicians,

and an expert supervises the work of re-educating the injured members. The successful operation of the hospital has led the government officials to advocate similar institutions in other centers of industry.

*4830*  
**LIGHTNING BUG'S "FLASHES" ON PHOTOGRAPHIC PLATE**

Photographing the "flashes" of a lightning bug was accomplished recently, when one of these insects was taken into a dark room and permitted to crawl around on the surface of a photographic plate. When the plate was developed, the flashes were found to be sharply defined, thus clearly demonstrating the actinic power possessed by the cold light produced by these tiny creatures.

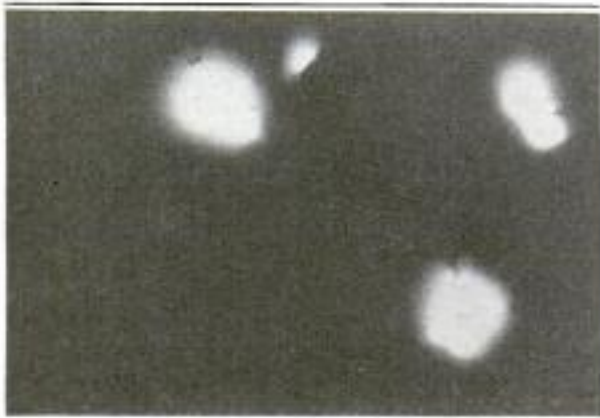

Photographed "Flashes" of an Ordinary Lightning Bug Appeared in This Manner When the Plate was Developed

*Cml. Nelson Edwards*  
*3054 Arundel Ave.*  
*Baltimore, Md.*

*drawn by M. Lucien Bull,  
Marrey Institute*

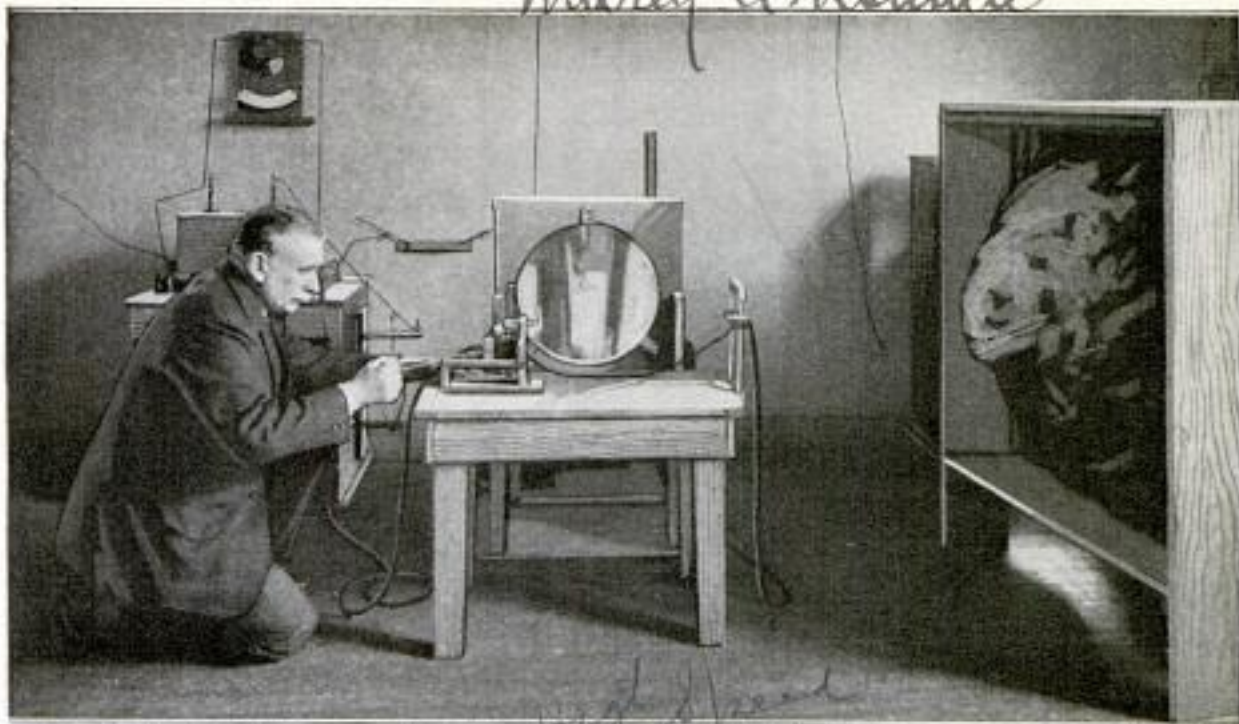

Set-Up of Electrical Apparatus and Camera for Photographing Flight of Bullet from Revolver, at the Rate of 92,000 Pictures per Second: Note Large Lens for Concentrating Light from the Spark on the Object

## PICTURES AT THE RATE OF 92,000 PER SECOND

By A. N. MIRZAOFF, *269 Leland Ave.,  
Plainfield, N.J.*

FROM an exposure lasting six minutes in the heat of a bright sun to taking pictures at the astonishing rate of 92,000 per second, is the record of 80 years of accomplishment in the science of photography. In considering this, it is interesting to trace some of the steps by which this development has come.

First, there was the clumsy tripod camera with its wet-process plates, simple lens, and crude shutter. Next came the dry plate, and a little later lenses and shutters capable of exposures of .04 second, making snapshots and the

hand camera possible. Further improvements in lenses, followed by the introduction of the focal-plane shutter and reflecting type of camera, gave exposures of .002 of a second, and, with some refinement, .001 of a second, of which there is evidence in the pictures, shown in the newspapers and on the screen, of athletes and race horses in action. Still faster speeds dictated the abandonment of the use of sunlight and the mechanical shutter with which it was controlled, and, as in many other instances, recourse was had in electricity. So the next high-

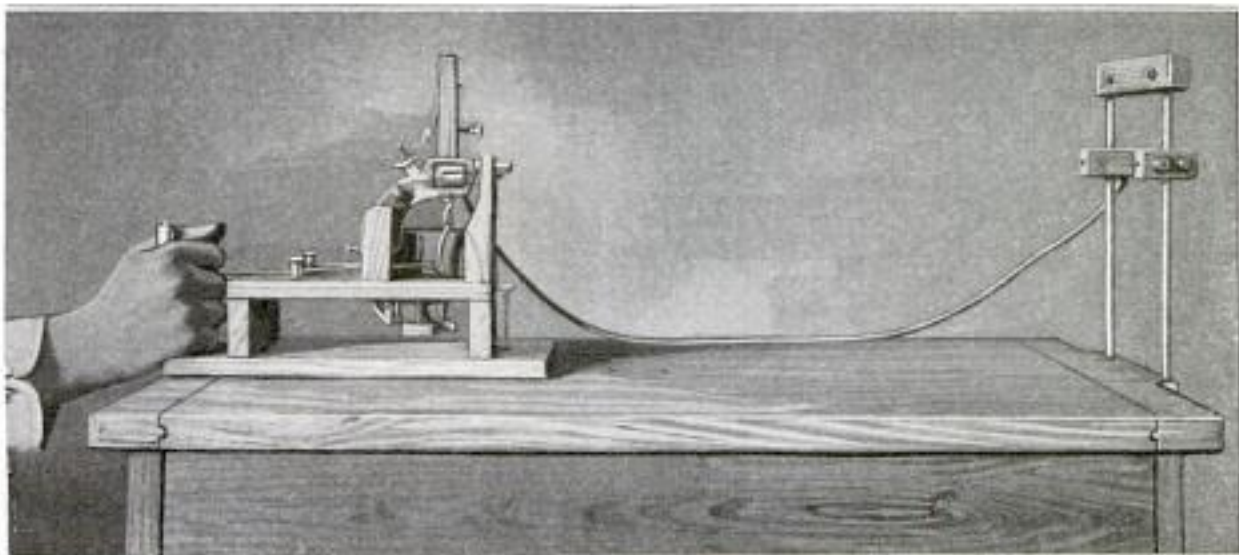

Close-Up of Setting for Filming the Flight of a Revolver Bullet, Showing Extension of the Revolver Hammer Arranged to Close the Electric Circuit That Starts the Camera: The Bullet Breaks a Fine Wire at the Opposite Side of the Table and Stops Camera



Left: Front View of Camera, Closed. Center: Front of Camera, Opened, Showing the Aluminum Ring for Holding the Film, and the Lens in the Center, behind Which Is the Rotative Prism. Right: Rear of Camera, Showing Small Electric Motor Which Drives the Prism

speed camera used a little spark of high actinic value, with a revolving film to produce 5,000 pictures per second. Except that the film is held stationary, this is the basis for the latest development.

The French scientist who has succeeded in making pictures at the rate of 92,000 in a second, secures the strip of film to the inner rim of a drum about 3

points of the stationary film. The small motor mounted on the back of the camera, so as to turn the prism at 160 revolutions per second, also runs a commutator device that causes the sparks to be made in step with the turning of the prism. In order to produce sparks of high intensity at regular intervals of short duration, a high-frequency generator

with a powerful induction coil and three condensers, is made use of. A large lens is made to focus the object to be photographed upon the lens of the camera, so as to obtain the maximum effect from the light value of the spark. It is arranged so that the action of the object to be photographed will control the starting and stopping of the camera, because the time required for the complete film of pictures is so small, when compared with the utmost rapidity of any human agency.

Photographing the flight of a bullet, and the wing motions of birds and flies, as well as other rapidly moving objects, and afterward studying these actions by slow-motion apparatus, is the interesting possibility this new camera suggests.

ⒸAn enterprising manufacturer has developed a lead-welding outfit, similar to the apparatus used by lead burners, that is particularly adapted to the needs of storage-battery repairmen. It is supplied for use with oxygen in connection with hydrogen, acety-

lene, city or natural gas, whichever is most conveniently available, and is complete in all details, including an assortment of burner tips, hose, regulators, gauges, burner, and tank connectors.

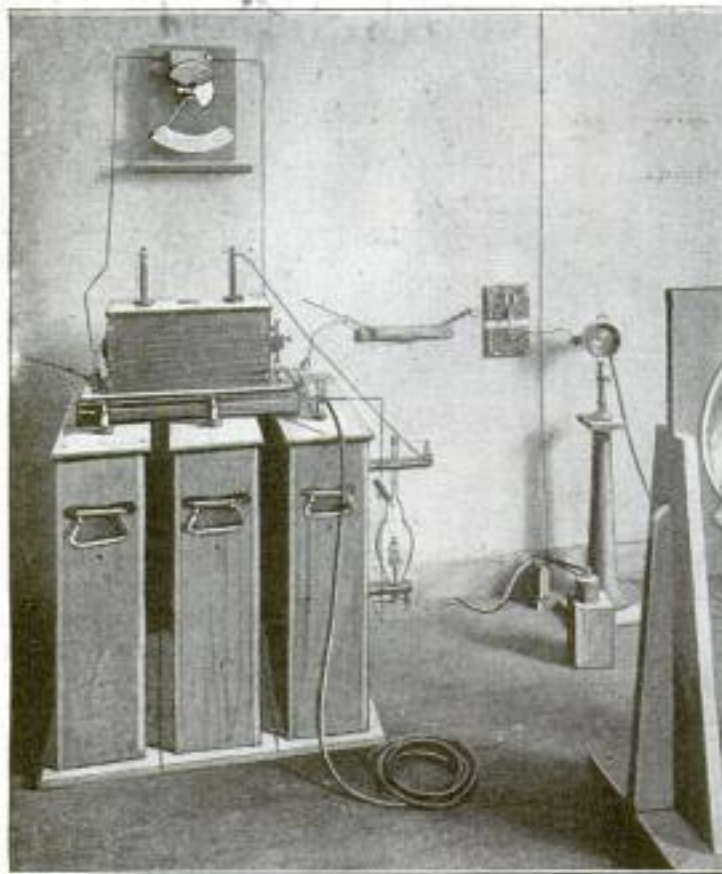

Electrical Equipment Used in Connection with the High-Speed Camera: The Induction Coil Which Raises the Voltage from 10 to 12,000 Volts Appears above the Three Condensers

feet in diameter, in the center of which is a prism mounted directly behind a high-speed lens. The prism is made to rotate so as to throw a beam of light, coming through the lens, successively on different

*data lost*

Standard B.C. Canada  
1004  
Wickers  
Frank  
Vancouver  
B.C.  
d.w. B. H.

N.Y. Jones  
8/10/22 P. 7

### POPULAR MECHANICS OUTPUT OF POWER STATIONS POOLED IN ENGLAND

Intended to bring about cheaper power for industrial and domestic uses, and to remedy certain absurd conditions now existing around London, the reorganization of the entire electrical distribution system is planned in England, by a parliamentary act. It is believed that an enormous expansion in the use of electric current will follow the adoption of the reorganization plan, and that if power stations are centralized and their outputs pooled, there will be a great saving in capital expenditure as well as in cost of production.

4981

### WINDOW KEPT FROM RATTLING BY INEXPENSIVE WEDGES

Rattling of windows—an annoyance so commonly experienced—can be averted by the use of small and inexpensive wedges introduced recently by a Canadian inventor.



The contrivance consists of two pieces of nickel-plated brass, or steel, that are quickly and easily attached to the sash by a half-inch

screw. In addition to eliminating the irritating noise caused by a loose window, the wedges conserve warmth and thereby save fuel by shutting out drafts from around the sash. They do not mar the woodwork, and are of such size as to be practically unnoticeable.

The Buffington Co  
Inc.

### BENT-WOOD FOLDING CHAIRS OF EXTREME COMPACTNESS

Chairs made of selected straight-grain oak, or ash, with metal back supports, can be folded so compactly that six of them will occupy a space of only 7 1/2 inches.



Pivoted in the bent-wood frame is an oval seat of black imitation leather. The metal parts are enameled and rustproof, and the wooden frame has a fumed-oak or bog-green finish. The chairs are very light, but are built strongly enough to be durable.

9792

### HARVESTER FOR SUGAR BEETS WORKS AUTOMATICALLY

Harvesting sugar beets has been facilitated by the invention of an Illinois man, which consists of a machine that tops, digs, and boxes the product. In operation, two shoes slide along the surface of the ground and carry a cutter which cuts off the beet top at the required height, throwing the severed portion to one side. Following the topper, comes a digger, or uprooter, which removes the beet from the ground and carries it to the rear, where it is deposited in a box or basket. The outfit is easily drawn by a team of horses and, due to its few working parts, should prove a popular implement.

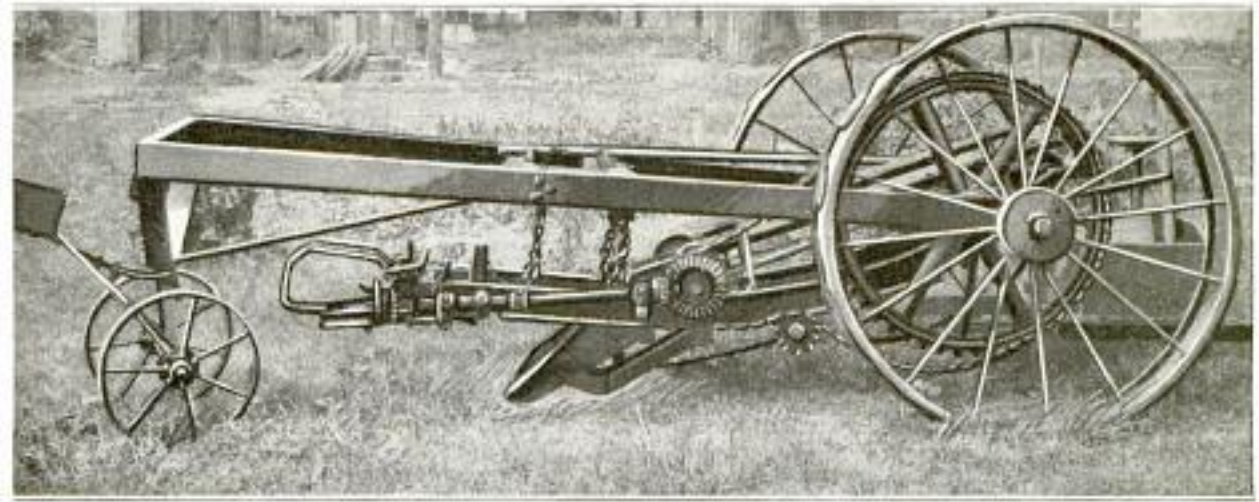

This Machine, Weighing Less than 500 Pounds, is Pulled over the Ground by Two Horses and Automatically Cuts Off the Tops of Sugar Beets, Digs the Beets, and Deposits Them in a Box at the Rear

d.w. O. H. Bartholomew  
703 E. Republic Ave.  
Peoria Ill.

44

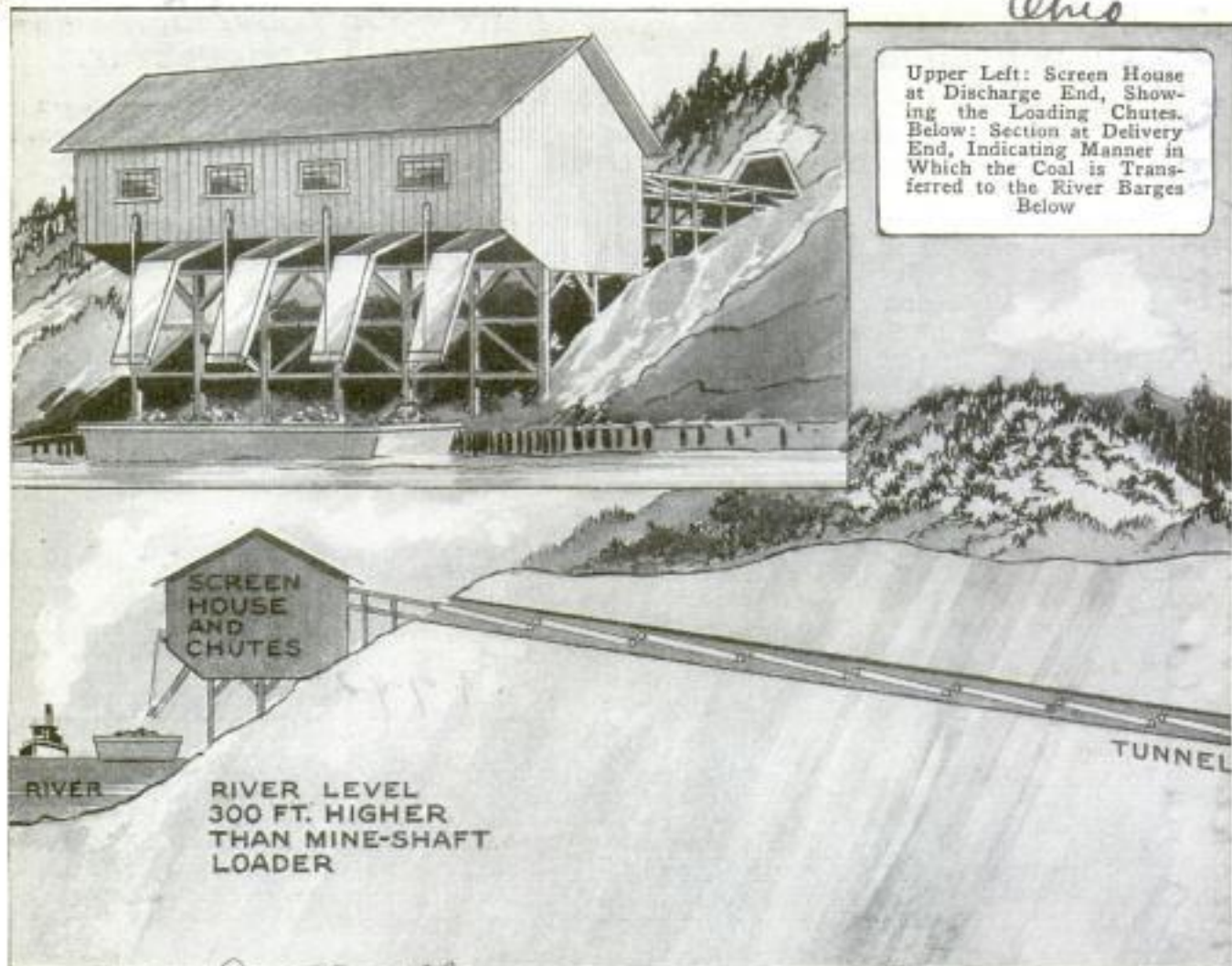

Upper Left: Screen House at Discharge End, Showing the Loading Chutes. Below: Section at Delivery End, Indicating Manner in Which the Coal is Transferred to the River Barges Below

*Auto Access*  
**SELF-THAWING OIL-PUMP DRIVE FOR OLD-MODEL AUTOS**

An oil-pump drive, designed to replace the conventional oil-pump spring used in some automobile motors, of models earlier than 1920, will automatically thaw out a frozen oil pump. The device is simply a friction clutch with a spring pressure on a fiber friction disk of special material, which is practically waterproof and a good conductor of heat. The pressure is sufficient

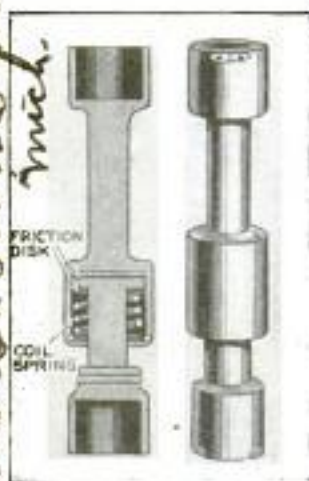

to drive the pump under normal conditions. When the pump is frozen the disk slips, creating enough heat by friction to thaw out the pump, after which the normal drive is resumed.

**BELT TO CARRY MINE'S OUTPUT THROUGH LONG TUNNEL**

An eastern coal company, in opening up three new mines situated close together, was confronted with the problem of transporting the output to a river  $4\frac{1}{4}$  miles away, with steep and rugged hills intervening. A railroad around the hills or one through them appeared to be too expensive in first cost and in operation, so it was decided to bore a small tunnel through the hills and convey the coal on a series of belts.

The distance of  $4\frac{1}{4}$  miles, in which there is a rise of 300 feet, will be made with 20 conveyors in series, each delivering the coal to the one ahead. At the loading end, the belt will be 5 feet wide for receiving the coal direct from the mine cars as they are hoisted up the shaft, and will carry the coal 1,500 feet to the next conveyor, which will be 4 feet wide. The unloading belt at the river will be 4 feet wide, and will deliver to four or six other belts, which discharge the coal through chutes into barges. The belt,

7109  
alters Bros.  
101 State St. Peabody, Mass.

Upper Right: Section of One of the Conveyor Belts, Showing Coal in Transit, Driving Arrangement, and Top of Transfer Chute. Below: Profile Section at Mine End, Showing Hoist and Headhouse

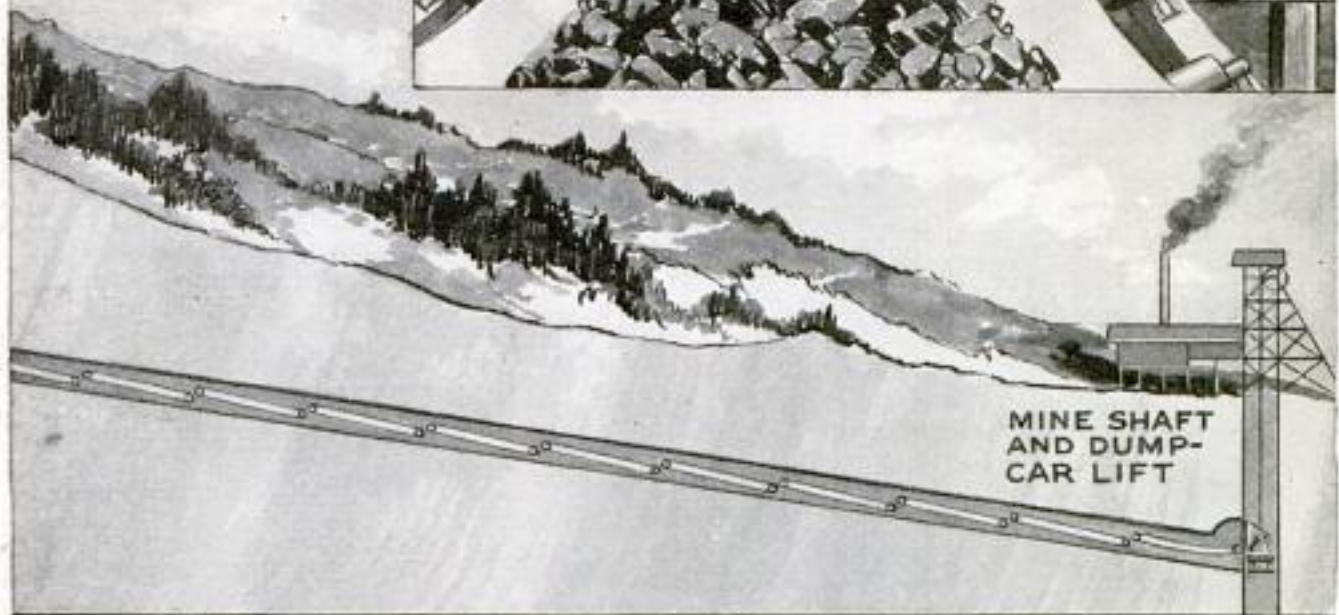
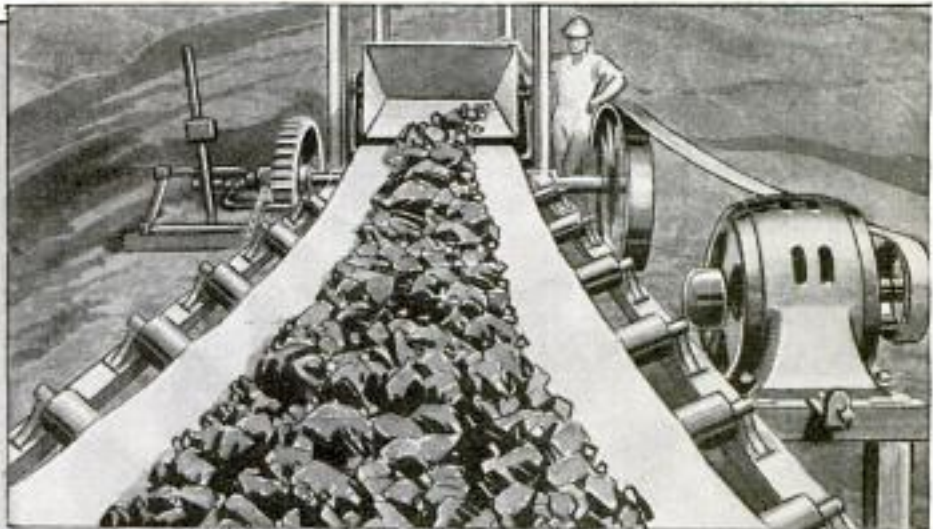

MINE SHAFT AND DUMP-CAR LIFT

which will be made of a rubberized fabric, similar to automobile tires, nearly 1 inch thick, is estimated to have a capacity of 1,200 tons of coal per hour. It will run on low-friction troughing idlers.

84 **GOLF CHART IS PRIMER FOR BEGINNERS**

A firm has put a new invention upon the market, which is a sort of primer for all golfers. By graphic, line-drawn pen-and-ink sketches all positions of hands and sticks are shown on a large folder. Every picture is numbered, there being 72 in all. The first one shows the position of the player's hands as it should be. Others show how to stand when putting, driving, or making other plays.

86 **NEW ADJUSTABLE HANDLEBAR CONVENIENT TO CYCLISTS**

A patent has been allowed on a new handlebar for bicycles, that permits horizontal rotary adjustment, making it possible to swing the bar readily from its

normal position to one at right angles to the frame, so that it can be used to support the bicycle against a building. There is an expanding handlebar stem surrounded by a collar with notches that engage a dog. The collar carries the handlebar extension which is adjusted, and held to the handlebar proper by a spring-actuated lock. No wrench is



A New Adjustable Handlebar for Bicycles, Which can be Turned, as Shown at the Left, So That the Cycle can be Rested Safely against a Wall

needed, as the dog can be operated and the sleeve adjusted with the thumb and forefinger.

*Chas. F. Hilber  
Trenton, N.J.*

*Straight Line Golf Chart Co. Cleveland  
128 127 out Hill Ave., E.*

Cont. H. Es. Mc Bean  
1401 W. Market St.

POPULAR MECHANICS

*Sandusky, Ohio.*

546  
9995

**STRETCHING OF STEEL CHAIN  
MAKES IT RIGID AS BAR**

Steel chains are usually thought of as being flexible—just the reverse of a bar—but one of these belonging to a large rail-



These Railroad Men are Holding a Steel Chain Which, after Using, was Found to Be Perfectly Rigid

road, recently underwent a curious transformation. The chain, which was 25 feet in length with  $\frac{7}{8}$ -inch links, was used to pull a derailed car back on the tracks. The strain was so great that when the task was completed the links were found to have straightened out enough to lock them together, and the whole chain was as rigid as a solid bar of steel.

9006 **ELECTRIC-DRIVE FERRYBOATS  
COMING TO THE FORE**

First tried on warships, the so-called electric drive later was tried on some merchant vessels and has lately been applied to ferryboats. Such boats are now in operation in the East and on the Pa-

cific coast, and two new boats of this type are to be used by the Staten Island ferry service at New York City. They will cost about \$1,000,000 each, and will be 218 feet long, with four driveways for autos and horse-drawn trucks on the lower deck, which will be open from the end to the side of the boat. A steel and concrete stairway at each side of either end of the boat will lead to the passenger deck.

The usual cabin seats will be installed on all sides of the boat, and to the rear a special line of seats for passengers who desire to smoke and at the same time be shielded from the wind. To a great extent the boat will be constructed of steel, with the four driveways entirely fire-proof. The four driveways themselves constitute a distinctly new feature.

Twin, independent screw propellers at each end of the boat, driven by electric motors with alternating current of 2,300 volts, and generated by a high-speed steam turbine, will be the power of propulsion.

9984 — **COMBINED MULTIPLE-DRILLING  
AND TAPPING MACHINE**

Designed for small work, a multiple-

drilling machine that can be instantly converted into a tapping machine has five adjustable spindles that may be used singly or collectively. Each spindle has a chuck for holding either a drill or a tap. The machine is driven by a  $\frac{1}{2}$ -horsepower motor, and by means of cone pulleys with a special adjustment for taking up the slack of the belts, speed changes of a wide range are made quickly and easily. The spindles can be adjusted from a minimum center distance of  $\frac{7}{8}$  inch to a maximum of  $4\frac{1}{2}$  inches.



*Landow Machinery + Drill Press Co.  
45 W. 18th St. New York.*

Jack Hyatt, Jr. Box 272  
White Plains, N.Y.



**HOTEL MOVED TO NEW SITE, 120 FEET DISTANT**

An eastern contractor recently completed the moving of a four-story hotel, weighing 60,000 tons, a distance of 120 feet. Jacks were placed



Upper Right: General View of Hotel Building in the Process of being Moved through City Street. Lower Left: Close-Up, Which Shows Timbering Necessary to Support Upper Floors While Moving, Also Timbers and Rails along Which the Building was Pulled

capstan and a pair of horses were sufficient to do the moving. To add to the difficulties, the building had to be turned halfway around. This work occupied the greater part of two months and cost \$85,000. The outcome of this undertaking has been watched with interest by con-

every 4 feet under the building, and it was kept so level and the work was otherwise so well arranged, that a

struction men throughout the country, because of the size of the building and the distance moved.

9509

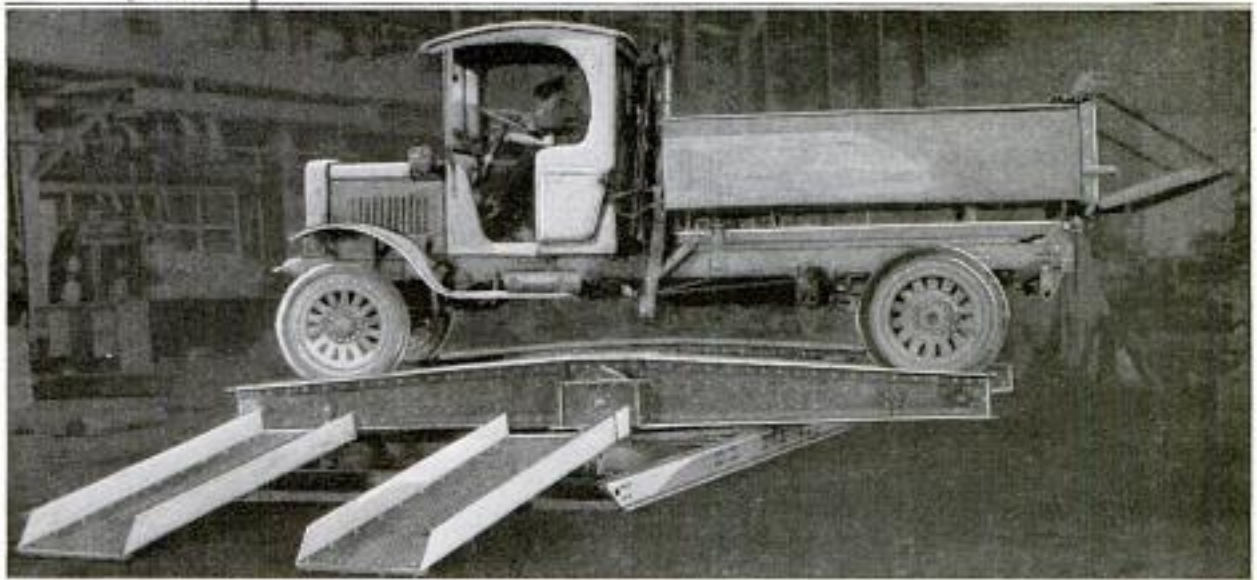

**TURNTABLE FOR MOTOR TRUCK SPEEDS ROAD CONSTRUCTION**

THIS turntable has been designed for use in road-construction work and is expected by the producers to be a great saver of time, labor, and money. Where highways are being built, it is usually a difficult task to turn the large machines which haul the stone, sand, or other materials, and this necessitates considerable backing of the trucks to reach the desired points. With the use of the newly introduced turntable, any kind of motor-driven car can be turned by power derived from its own rear wheels, these running on a treadmill arrangement that revolves the table.

*The Champion Engineering Co.,  
Kenton, Ohio.*

Copyrighted material

9667  
548

SPEED KILN-DRYING PROCESS AND IMPROVE LUMBER

No information in regard to companies using this process

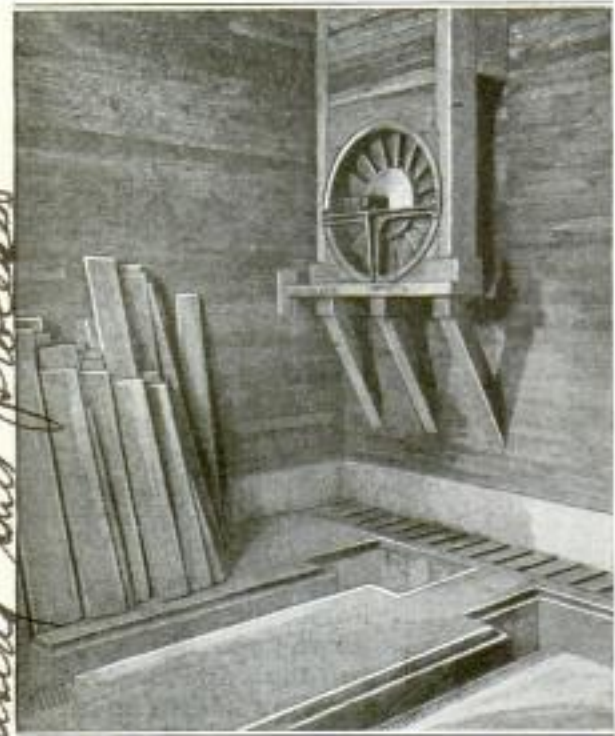

One of the Lumber-Drying Rooms: The Heated Air Comes Upward from Radiators below the Floor, and the Fan at the Right Keeps It in Circulation

In France, because of the need of speedy construction in the devastated regions, the older method of drying and seasoning lumber in the air has been found too slow for requirements. Now, however, a new process has been devised that makes it possible to kiln-dry lumber, ready for building construction, in a period of two days. The lumber is piled in a series of small buildings and heated air containing an excess of oxygen, or ozone, is circulated through them. This method not only speeds the drying process, but is very effective in killing the germs that infect the green lumber and are not always exterminated by ordinary kiln drying. As a result of this treatment, the building lumber is stronger and of better grade than that dried by the older and slower method.

Scientists who have been conducting experiments in sterilizing milk, are of the opinion that they have discovered a method of destroying typhoid and tuberculosis germs. Fourteen thousand quarts of milk have been used in their work.

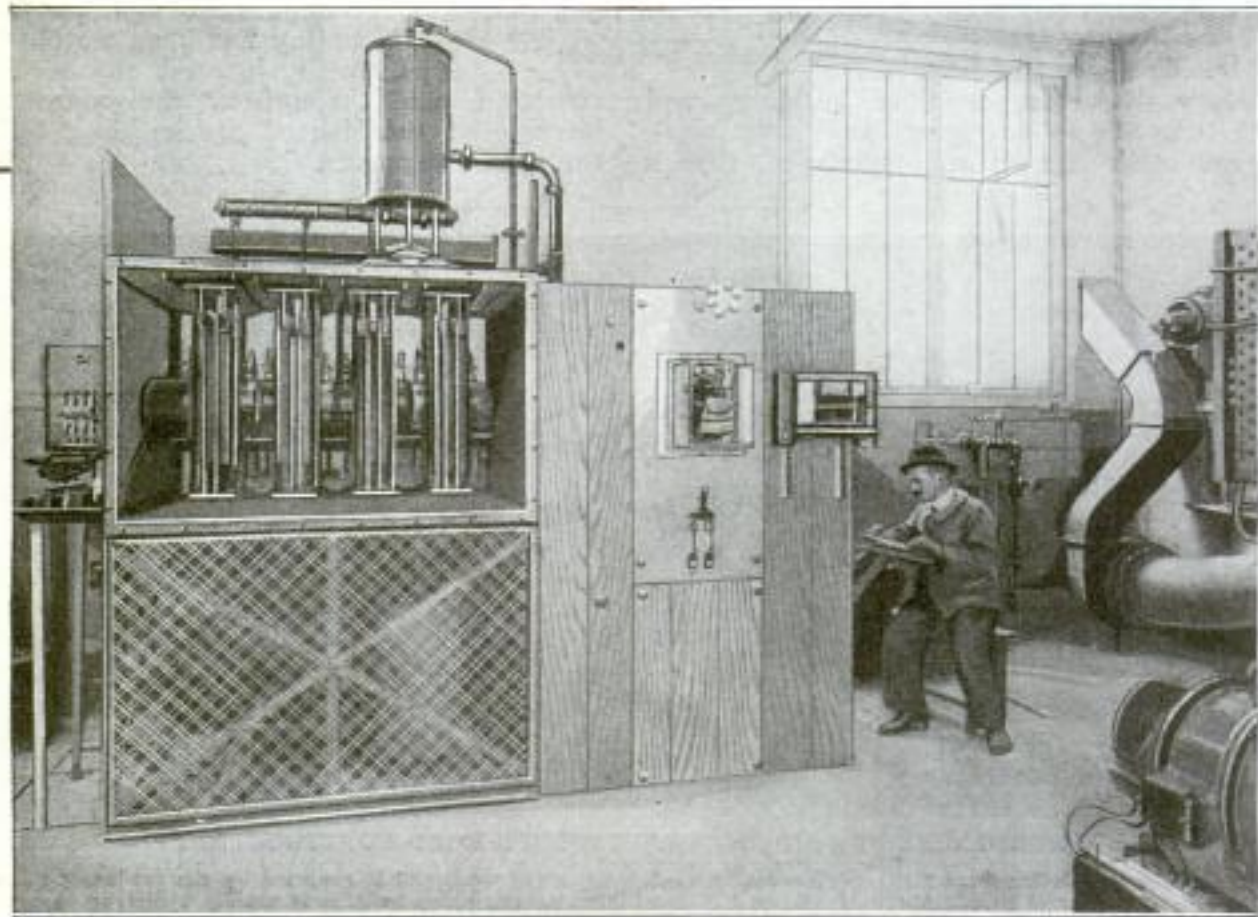

The Battery Room at the French Lumber-Drying Plant: The Apparatus Shown Is for Producing the Highly Oxygenized Air, or Ozone, Which is Later Heated. At the Right, above the Man's Head, Are Recording Instruments That Measure the Flow of Air on Its Passage to the Drying Rooms

94 3'5 20' I eteren Freres, S. A.,  
50. Rue du Mail,

POPULAR MECHANICS

349

*Brussels, Belgium*

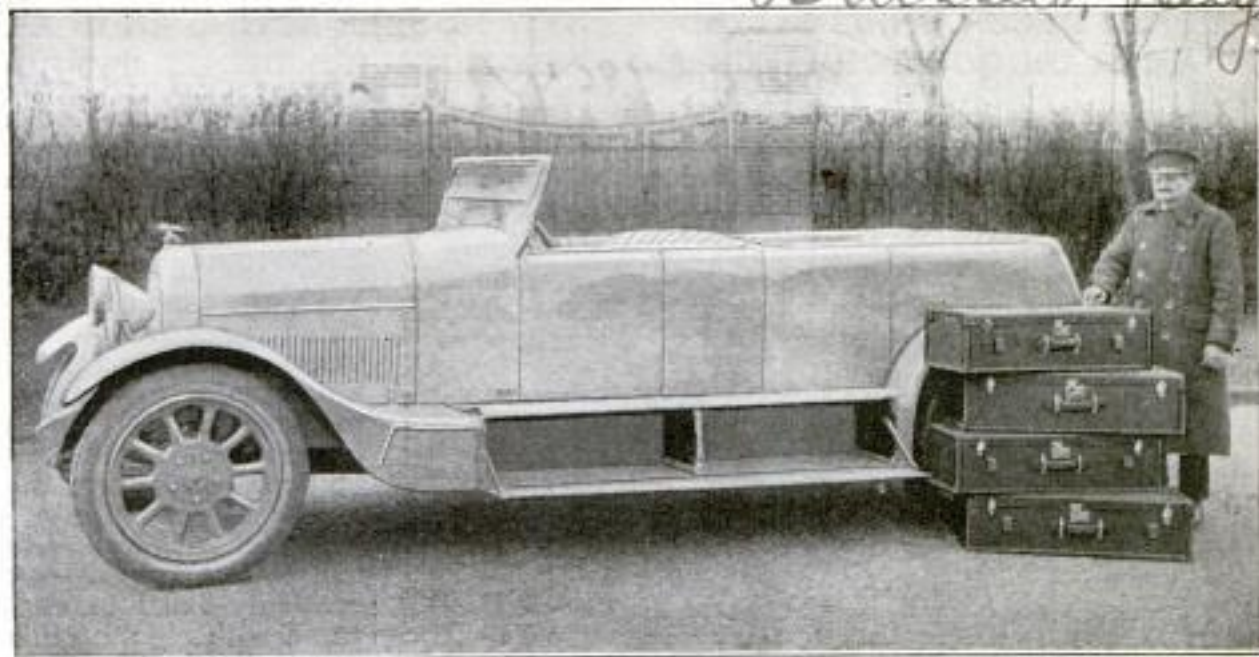

The Four Good-Sized Traveling Cases, Standing on the Ground at the Rear End of the Automobile, Fit Snugly into the Compartments Built under the Running Boards, There Being Duplicate Spaces on the Other Side of the Car

*Auto Storage*  
**SPACE UNDER RUNNING BOARD  
USED FOR LUGGAGE**

For the convenience of the motorist who uses his car to go on week-end jaunts or short trips, a body has been designed with luggage space under the running boards. There are two compartments on each side of the car, and neat cases fit snugly in these spaces. The construction of the running boards is such that the cases are protected from rain or mud. These running boards do not detract from the appearance of the car.

of their rigidity, the setting of the concrete is not interfered with by movements of the ribs. When the concrete has set, the ties and cables are removed.

**DRIVER HAS NARROW ESCAPE  
WHEN TREE KILLS HORSE**

*9763*  
In a storm that swept Manila not long ago, the wind reached a velocity of 90 miles an hour, and numerous vessels were wrecked, buildings were demolished, and practically every tree in the city was laid low. A curious incident of the storm was the almost miraculous escape from death of a native cab driver. Hurrying along a country road seeking shelter, his cab was hit by a falling tree and smashed. The horse was instantly killed, but the driver escaped without a scratch.

*9968*  
**CONCRETE BRIDGE ARCHES  
BUILT BY NEW METHOD**

In order to prevent the deflection of steel ribs when used in the construction of reinforced-concrete bridge arches, a method of bracing them with cables has been employed in Europe. Self-supporting arch ribs of standard steel shapes are set up and are kept rigid by ties connected to them from below and suspension cables from above. This allows them to be used for the support of the forms, without the necessity for any centering, and without deflection while the concrete is being poured. On account



Although His Horse was Instantly Killed, the Driver of This Cab Escaped without a Scratch in a Recent Great Storm in Manila When the Large Tree Fell across His Vehicle as Seen Here

*Lyman James  
Eng. Section  
7/2*

*cont. Amable Conde  
Box no. 1039, Manila, P.I.*

Cml. W. K. Crosson,  
4429 Townsend Ave

North British  
Diesel Engine  
Works, 8 South St.  
Whiteinch,  
Glasgow, Scotland

550  
9788

**POPULAR MECHANICS**  
**UPPER DECK OF BUS FITTED WITH UNIQUE TOP PIECE** **NEW DOUBLE-ACTING ENGINES OF MODIFIED DIESEL TYPE**

Improved tops built over the seats of the upper deck are being adopted by a Detroit bus line. A light wooden frame

Double-acting marine engines of a modified Diesel type are being developed with great success in England. After a



The Top Built over the Seats of the Upper Deck on the Bus Is an Innovation in Motor-Bus Equipment. There Is No Covering over the Aisle; Strips Similar to Auto Curtains Inclose the Sides in Rough Weather

supports the roofing. There is no covering for the aisle nor is the air shut off by bulky window cases. In disagreeable weather, the sides are inclosed by strips similar to auto curtains.

series of experimental investigations completed with the first models built, it has been decided to construct a three-cylinder engine of the same type, designed to develop 2,000 brake horsepower. At 100 revolutions per minute, this will be done with cylinders of 24½-inch bore, and 44-inch stroke — exceedingly small as compared with anything like the same power in single-acting cylinders. It will be a remarkable achievement in other ways, for the largest power that hitherto has been developed in commercial marine Diesel engines is about 650 brake horsepower per cylinder, so

that the double-acting type even at this early stage of development represents an advance on existing practice. Its weight will be only about one-half that of a corresponding single-acting motor.

9959

**CRUISE OF THE GREAT LAKES IN OPEN ROWBOAT**

In a 16-foot combined motor and rowboat two young adventurers from Detroit have recently started on a 4,000-mile cruise around the Great Lakes. Their destination is Duluth, via the American shore of Lake Huron, St. Mary's River to Lake Superior, and thence along the shores of Michigan and Wisconsin. They will return to Detroit the same way. The boat is fitted with a 2½-horsepower marine engine, which in ordinary weather and smooth water propels the boat at a speed of between 7 and 8 miles an hour. Oars are provided to help handle the boat in bad weather.

Navigation papers were taken out at Detroit, and the boat is outfitted to comply with the navigation laws.



Two Youthful Adventurers of Detroit About to Start on a 4,000-Mile Cruise of the Great Lakes in a 16-Foot Combined Motor and Rowboat. Its Motor Is 2½ Horsepower

Cml. Pearl Bendee  
60 Bull Island  
Detroit Mich

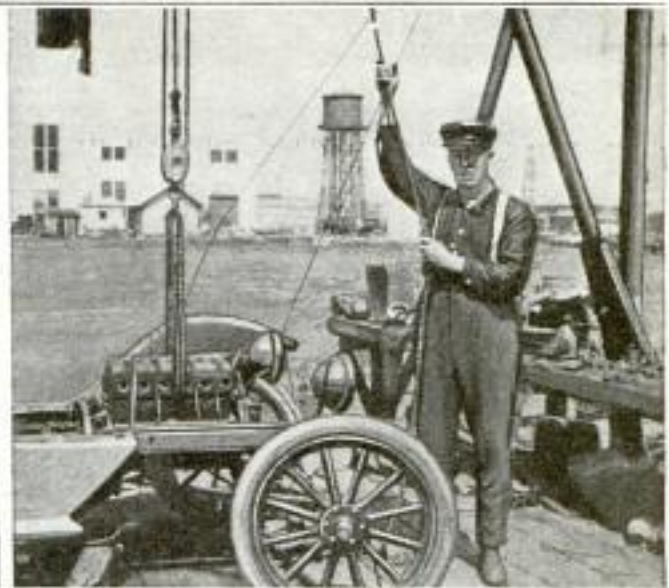
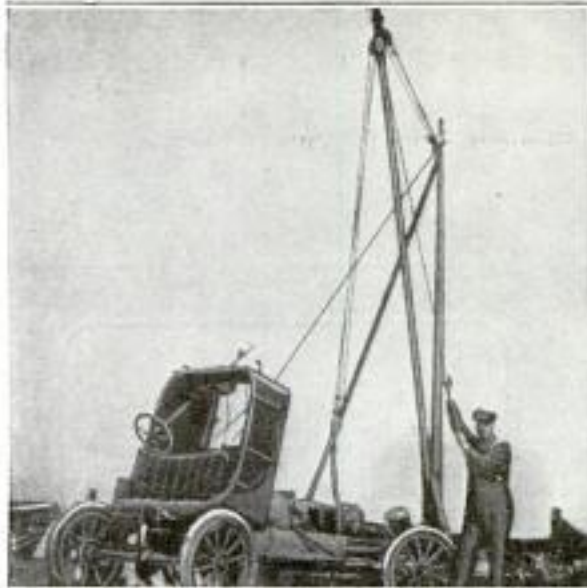

Left: Rigging Removed from a Yacht and Set Up Ashore, being Used for Hoisting the Engine from an Automobile and Moving It to a Workbench. Right: Mast and Boom from the Yacht Shown Set Up beside the Owner's Workbench Ashore, with an Automobile Engine Suspended from Its Tackle

**YACHT'S RIGGING UTILIZED  
4302 IN AUTOMOBILE WORK**

A resident of California, who is both a yachtsman and an automobile dealer, has taken advantage of this combination of occupations by using the mast of his yacht, with its boom and tackle, to help him dismantle his motor cars. He removes this rigging from his yacht, and sets it up near a workbench on shore. The boom is 35 feet long, and can be swung in any direction so that the tackle, dangling from the end of it, will reach an automobile from which the engine or other part has to be removed, and placed upon the workbench for repairs. The guys that brace the mast are detachable, and can be moved as needed to make way for the boom.

**HISTORIC DELAWARE CROSSING  
28 TO BE MEMORIALIZED**

It is planned to have a national park at the site where Washington made his strategic crossing of the Delaware, with highways marking the routes of the colonial forces, a memorial bridge having a section devoted to each of the 13 original colonies, and a monument of Washington actually crossing the river, erected in midstream, as the main features. Monuments to patriotic and illustrious Americans, as well as historic memorials by the various states and organizations, are a part of the plan to make the proposed park a great center of patriotic devotion. The park will be on both sides of the river.

**AMPHITHEATER ILLUMINATED  
9925 BY EXTERIOR LIGHTS**

Illuminating an open-air amphitheater by means of exterior lights, thus eliminating any objectionable and sight-obstructing posts, or towers, was the plan followed by the Masonic lodges of Detroit, Mich., recently, when these bodies staged a pageant entitled "The Awakening." Seven high platforms, each supporting a battery of five searchlights, were erected around the outside of the large arena, which covered approximately 15 acres and had a seating capacity of 15,000 spectators.

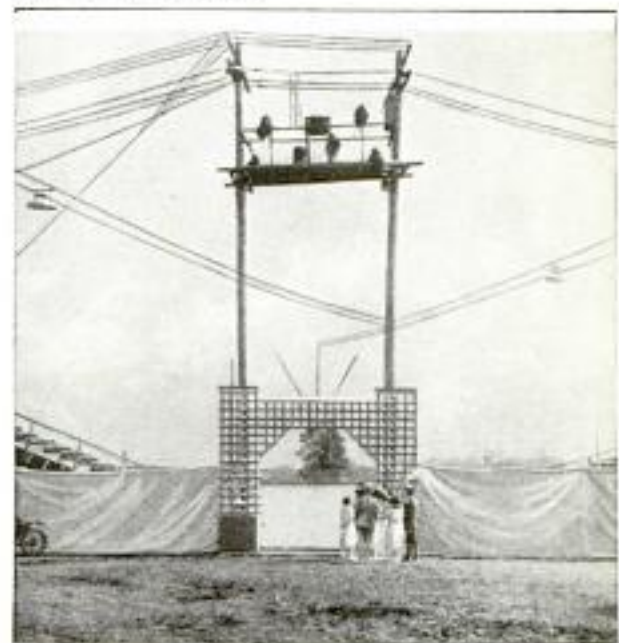

One of Seven Towers, Each Supporting a Battery of Five Searchlights, That were Erected around a Large Detroit Amphitheater for Illuminating It

N. U. Times 8/2/22  
P. 12

Comd. W. H. Crosson  
4429 Townsend Ave  
Detroit, Mich.

9917 Cmt. Sydney J Endacott  
Box 655 Melbourne.  
CAMELS AND OTHER CONVEYANCES USED IN  
Australia



Long File of Camels, Shown across the Tops of Both Pages, Carrying Provisions into What is Known as the "Back Country" in Central Australia: The Arid Nature of the Country Makes Camels Indispensable as Beasts of Burden

Immediately below the File of Camels is a Picture of a Long Mixed Freight and Passenger Train on Its Way to Oodnadatta, in the Northern Part of South Australia



Next Below is Shown a Camel Bridled and Saddled, upon Which is Mounted a Lady Rider. Necessarily She Rides Astride, for a Sidesaddle on a Camel would Be Quite Impossible. She is the Wife of the Missionary Shown Elsewhere

The Baby Camel Strapped to Its Mother's Back, Shown at the Bottom, is Amply Provided with Comfortable Trappings. The Driver of This Camel is an Afghan Who, on Account of Conscientious Objections in That Connection, had to be Photographed Warily



## THE ARID REGIONS OF CENTRAL AUSTRALIA



The Upper Right Picture Shows a Central Australian Team of Eight Goats Hitched to a Cart-load of Firewood, Which must be Brought from Afar in This Barren Country. The Animals are Harnessed and Driven in the Same Manner as Dogs in the Frozen North



The Next Picture Below Shows How the Reverend J. Armour, an Australian Missionary, Travels around His Parish. The Fact That This Parish Is 300 by 500 Miles in Size Accounts for the Large Amount of Baggage He has to Carry



In the Lowest of the Three Pictures to the Right the Same Missionary That is Driving the Buggy in the Picture Above, is Shown with a Motor Car on His Way across the Bed of a Dried-Up Lake



The Missionary Buggy is Shown Below with a Team of Camels Hitched to It with the Same Harness and Collars as Used on the Horses, Which Explains Its "Poor Fit." The Bridles, of Course, have to Be Different



Ensl. J. B. Holdcroft.  
485 Fort St

554

POPULAR MECHANICS

Victoria, B. C.

DIVERS WORK IN CAVITIES

OF BIG CONCRETE PILES

Canada

Most people nowadays know what a concrete pile is, but several hundred concrete piles extraordinary are being used in the construction of a new government pier at Vancouver, B. C. They are 7 feet in diameter, and because each pile is being driven right down through the mud to bedrock, any one of them may be well over 100 feet in length before it is completed.

For convenience of construction, these mammoth piles are made in sections, about 10 feet in length, and are hollow, the inner space being about 5 feet in diameter. This space is filled up with concrete as soon as the shell is down to the rock bottom. The hollow space makes it possible for divers to inspect the bottom, inside the shell, during the driving, and also makes it easy to dispose

of the large amount of earth which is necessarily displaced when so large a cylinder is forced into the harbor bottom. This material—mostly mud and sand—is lifted out by an orange-peel bucket, which removes from a quarter to a half cubic yard at each lift.

As the material is taken out of the center in this manner, the great pile sinks by its own weight, aided by enormously heavy cast-iron rings, which are laid on top of all as additional ballast. But sometimes even this is not enough, and recourse is had to powerful jets of water, directed against the sand or gravel around the bottom edge of the pile. This operation was in progress when the accompanying photograph was taken, and

it shows that the water inside the cylinder has risen to about 15 feet above the level of the water in the harbor, owing to the volume discharged by the powerful pumps used for the "jetting" operation.

In this particular instance, a peculiar accident had occurred just before the picture was taken, and the diver shown sitting in a sling just above the central opening had just returned from a trip to the bottom to investigate the occurrence.

Everything had been taking its normal course, and jetting was in progress, when a column of water suddenly shot up to a very considerable height from the surface of the harbor a few feet from the pile. It was thought at first that the lower edge of the big cylinder had broken through a submerged water main, of which there are several in the vicinity. This was found not to be the case, and the only explanation forthcoming was that the water from the jet had found its way through

a fissure of some kind, and thus had broken through the harbor bottom and caused the alarming, fountainlike occurrence.

### LOCATING UNCHARTED LAKES BY AIRPLANE

One of the latest uses of the airplane is locating and photographing many Alaskan lakes that heretofore have not appeared on any map. Recognizing that many of these "lost lakes" may be sources of valuable water power, the Forest Service, Department of Agriculture, with the approval of the Federal Power Commission, has laid plans to map this no man's land by means of aerial photographs.

Anation 8/2/27



Diver Returning from Inspection Trip to Bottom of Huge Concrete Pile, Nearly 100 Feet below Surface of Harbor: The Water Pouring Out of the Holes in the Heavy Cast-Iron Rings, Comes from Hydraulic Jets Employed to Aid in Sinking the Pile



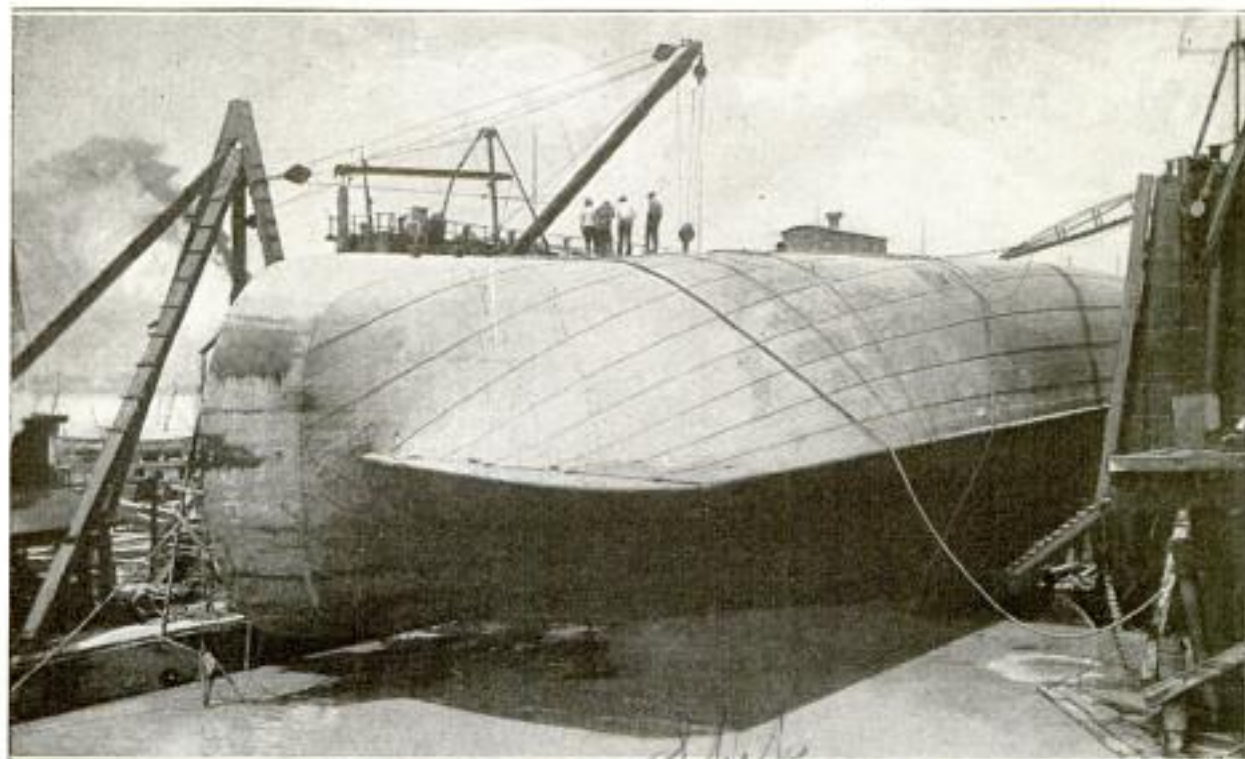

SALVAGING A WRECKED OIL TANKER BY DOCKING IT SIDEWAYS

VERY unusual conditions accompanied the salvaging of the oil tanker "Chagres," which sank off a marine repair plant's wharf at New Orleans. By the use of compressed air, which was pumped into the hull to make it partly buoyant, it was raised with derricks and cables, but as soon as it reached the surface, it turned over on its side, and began to sink again. Tugs made a dash for it, and before the hull had time to sink, they got about two-thirds of it into a floating dock, which was then raised and repair was started.

9821 *Wright*

**AUTOMOBILE SAFETY BUMPERS  
 STOP CAR AUTOMATICALLY**

With an external mechanism that replaces the ordinary bumpers of a motor car or truck, an automatic brake and ignition control that stops the car quickly in case of collision has been designed, primarily to prevent accidents at slow speeds and in heavy traffic. The substitute for the bumpers, at each end of the car, consists of three small cables,

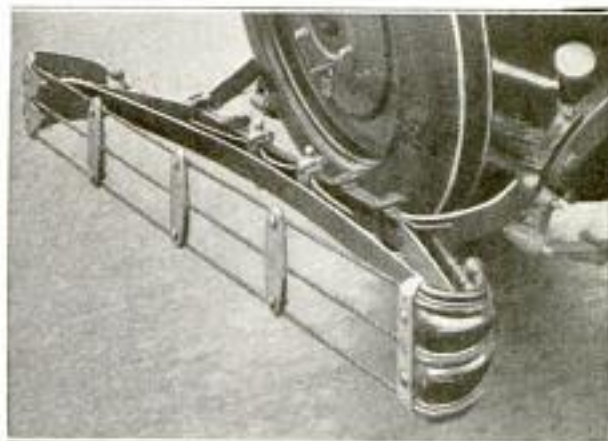

Above: Car Equipped with the Safety Bumper, Showing the Contact Cables Stretched between Goosenecks. Left: Phantom View of Automobile, Showing Wiring for Contact Bars, and the Brake and Ignition Control

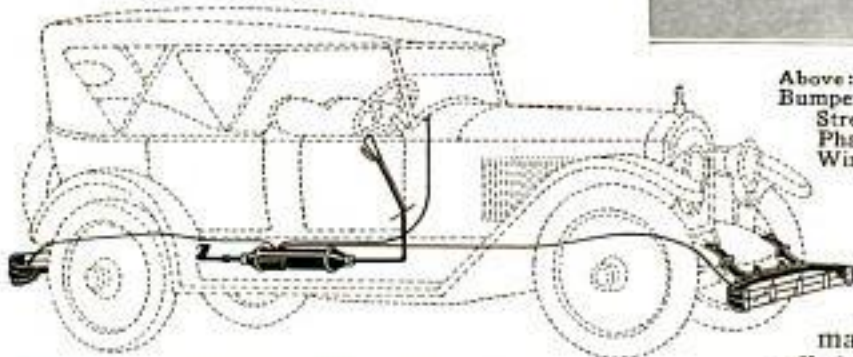

stretched between two goosenecks, the full width of the car like other bumpers. Any pressure on the cables that is sufficient to force them back  $\frac{3}{4}$  inch makes an electric contact that causes current to

flow to a brass case on the brake rod, which contains devices that automatically set the brakes, cut off the ignition to the engine, and also blow the horn. By this means, it is said, a car can be stopped in one-third of the time and one-half the distance that would be possible with hand or foot brakes.

*Mfr. Pacific Diesel Engine Co.  
 Oakland, Calif.*

9916

Chicago Automatic Ventilator Co

556

POPULAR MECHANICS  
30 S Clark St Chicago

**AUTOMATIC VENTILATOR  
CREATES NO DRAFT**

A new ventilator has been placed on the market for use in automobiles and other closed vehicles. It employs the

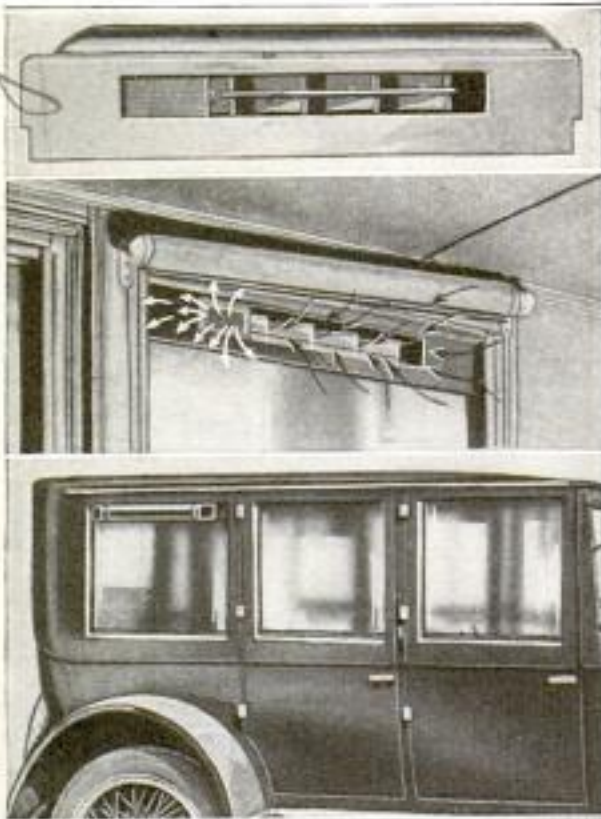

Top and Center Show Ventilator as It Appears from Inside of Car. Below, Ventilator is Seen on Outside of Car

vacuum principle, and is adjustable to any desired degree of ventilation, where it will operate automatically. With this arrangement, the air change is said to take place so gently and uniformly that the dangers of chilling drafts and sudden temperature changes are avoided. It does not add any inconvenience to the use or operation of the vehicle to which it is fitted, nor does it spoil its appearance.

**CITY SITE AND BUILDINGS  
MOVED TWO MILES**

The moving of Hibbing, Minn., for a distance of two miles, begun by a northern mining company some two years ago, has recently been completed. The town was founded and rapidly grew over a large and rich deposit of iron ore, and it was for the purpose of mining this ore that the moving scheme was conceived, as mentioned in the April, 1920, issue of this magazine. The numerous buildings, of all types of construction, were virtually transplanted in their entirety from

the old to the new location. The cost of the undertaking is not definitely known as yet, but is estimated at from 15 to 18 million dollars.

**GAS RANGE WITH EFFICIENT  
METHOD OF COMBUSTION**

A gas range, specially designed for hotels, restaurants, clubs, and hospitals, that is said to cost less for fuel than any ordinary coal range, is now on the market. In general appearance the range is much like other gas-burning ranges, excepting that its burners are completely inclosed, being covered on top with unobstructed plates which can be made uniformly red-hot from end to end in 15 minutes. This is done by means of a new type of siphon burners which are mounted the full length of the range in front, throwing a fan-shaped flame from front to back. The radiation of this flame encircles the oven, eliminating oven burners, and then passes out through the flue. A steam pipe in rear of the range extends through the flame passage and injects superheated steam into the oven, making it possible to obtain such high temperatures that roasting is done very rapidly and effectively. There is no cold-air intake, the air, before it reaches the combustion point, being heated by pass-

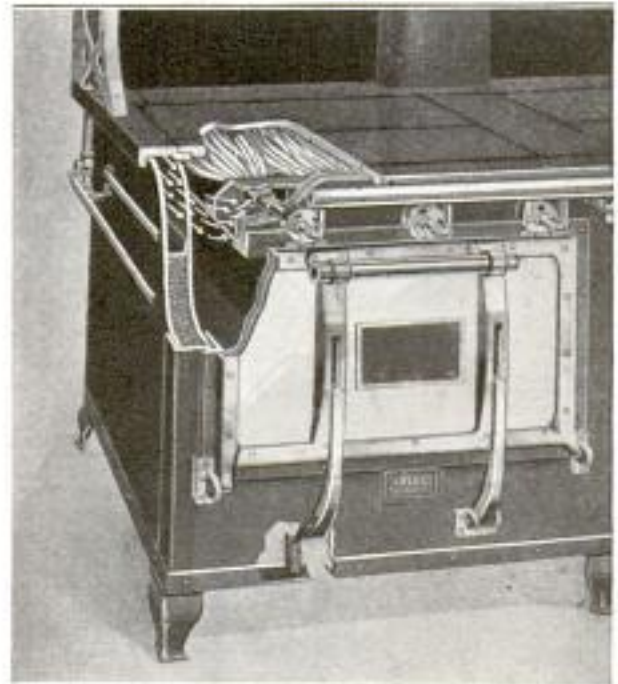

View of Gas Range, Showing by Arrows How Heated Air Mixes with the Flames in the Combustion Zone

ing up a hot duct and around the flues. The entire body of the range is well insulated, preventing excessive heat radiation.

Super Range Co  
508 Railway Exchange Bldg  
Chicago

Frank R. Stark  
519 E. 36th St. Chicago  
d. m.  
Christian Science  
Monitor 7/25/22  
9971

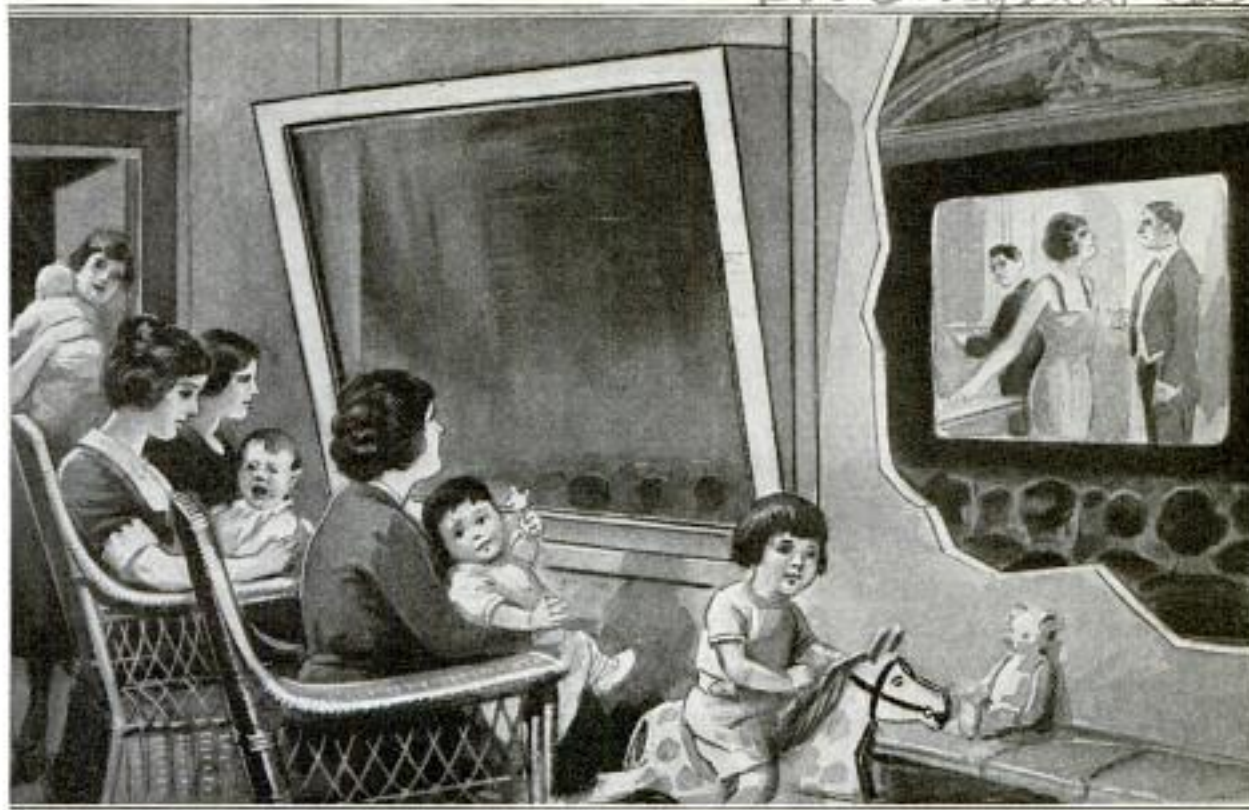

Soundproof "Crying Room" for Babies Which was Built in a Large Motion-Picture Theater: Mothers can Take Their Restless Children Out of the Audience and Watch the Picture through the Glass Wall of the Room

8208  
**"CRYING ROOM" FOR BABIES  
 BUILT IN THEATER**

Babies can cry to their hearts' content without disturbing anyone in a theater in Los Angeles, Calif., where a special room has been constructed for this purpose. A soundproof inclosure has been built at the rear of the first balcony and is provided with a wall of glass at the front, so that mothers can watch the picture while endeavoring to comfort their restless infants.

9828  
**YOUNG CATTLE EASILY WEANED  
 BY AUTOMATIC DEVICE**



BY COURTESY OF LA NATURE

A Frenchman has invented a halterlike arrangement which he puts on the head of young cattle, so that they may be weaned without having to separate them from the rest of the herd, and with little trouble to the farmer. A bit in the mouth allows them to eat and drink while it prevents them from sucking, thus forcing them to feed themselves.

9870  
**HUMAN THROAT INSPIRATION  
 OF TALKING MACHINE**

Claiming the human throat as the inspiration of his invention, a Colorado man has introduced a new type of talking machine. The exterior of the machine appears similar to others of the cabinet form, but the interior contains numerous departures from the usual make of instruments. The essential part of the innovation is a metal appliance fashioned after the throat and inclosed in the apex of a wooden horn of heavy construction. The tone is also increased by means of various other sound-absorbing and magnifying arrangements, the chief one of these being in the shape of a kettle-drum and suspended from the lower part of the wooden horn, or tone chamber, of this strange phonograph.

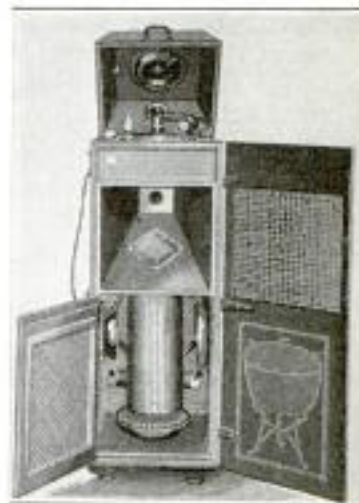

Dr. M. Cordonery, } Brantes, (Vaucluse)  
 M. Marrel } France

Dr. Burdette Stump  
 4980 Juniper St. Denver, Colo.

*Almonthus  
Horsing  
U.S.*

**SMALL LAMP FOR DRIVEWAYS  
SHIELDS AGAINST GLARE**



A shield eliminating the usual glare of the road light is the feature of a new miniature lamp which seems to have a high degree of practicability. The lamp is 2½ feet high, of cast iron, and sheds light over a radius of 15 feet. It is designed for use on private driveways, at country homes, or entrances, and other places of vehicle travel.

9558

**TWO-WHEEL CONCRETE MIXER  
OF EXTREME PORTABILITY**

A concrete mixer, of exceptional portability, is built in connection with a two-wheeled truck in such a manner that, when one end of the truck platform is raised to a height of 3 feet, the whole machine is in perfect balance on the wheels. This is accomplished by placing the mixer, with the engine directly above it, between the two wheels. The platform is used for charging the mixer from a wheelbarrow by dumping the material directly into the hopper of the mixer without any shoveling whatever.

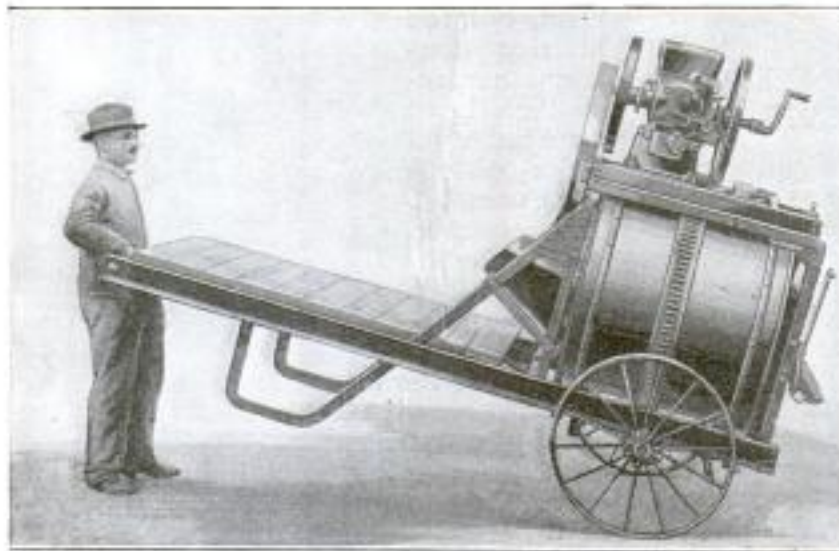

Concrete Mixer So Constructed That, When the Platform is Raised, as Shown, the Whole Machine Is in Perfect Balance over the Axle of the Two Wheels, and Therefore Easily Portable

**GIANT AIRPLANES TO CARRY  
100 PEOPLE 500 MILES**

9925

An Italian designer has undertaken to build a machine capable of carrying 100 passengers for a 500-mile flight without stopping. It will have 16 engines of 300 horsepower each, a width of nearly 180 feet, and a carrying surface of 10,500 square feet. Another Italian firm is building a hydroplane to travel about 1,800 miles without stopping, for the Portuguese airmen who will attempt to repeat their transatlantic flight.

9871

**ICE-CREAM CONE HOLDER  
MADE OF PASTEBOARD**

A handy pasteboard holder for ice-cream cones is now available for picnics, beach parties, and other places where the ice-cream cone reigns as a favorite. The pasteboard is 8 by 5 inches in size, and has circular holes for five cones. One of the sides is shaped so that it forms an easy handhold. The practical little device has found much favor among consumers.



One of the sides is shaped so that it forms an easy handhold. The practical little device has found much favor among consumers.

**BROAD TIRES ON MOTORCYCLE  
FOR DESERT TRAVEL**

Extra-broad tires and a high-powered engine are features incorporated in a special motorcycle being constructed in this country for a medical missionary of Arabia, who travels a regular route of 250 miles. This distance over the burning desert sands has always been covered heretofore on camel back, the tiresome trip requiring from 10 to 14 days. However, with his new mode of travel, the missionary expects to speed over the trackless waste in 24 hours, thus saving much time.

Our Bureau of Information will answer all questions regarding articles appearing in this magazine.

*new series 8/9/22  
p. 15*

*The Archer Iron Works,  
2438 W. 34th Place, Chicago*

*D. Myer. Royer Co.  
1509 S. Dearborn St.  
Chicago, Ill.  
1700 S. Walnut St.*

*Woodwin Co. Van Buren  
2949 W. Chicago  
The J. W. no price*



Elk Meadows, One of Nature's Beauty Spots on the Route of the Automobile Road That Loops Mount Hood: The Snow-Capped Peak of the Mountain can be Seen Towering over the Tops of the Intervening Pines

## LOOPING MOUNT HOOD

BY S. GERTSMON *Huber, Oregon.*

WHEN the automobile road, looping Mt. Hood, in Oregon, now under construction, is completed in 1924, the tourist who is so fortunate as to include Oregon in his itinerary will traverse 173 miles of scenic grandeur, not to be equaled the world over.

It is only after many efforts, and the coöperation of Multnomah and Hood River counties, through which this famous loop passes, that the building of a \$500,000 highway around Oregon's famous mountain has become an assured fact.

The Mt. Hood loop road is reached from Portland by way of Columbia Highway to Hood River, over 65 miles of never-to-be-forgotten wonders. One



Multnomah Falls, on the Columbia River Highway, Another of the Many Scenic Beauties to be Found near Mount Hood

passes, in succession, such interesting points as the Vista House at Crown Point, Multnomah Falls, Wahkeena Falls, Oneonta Gorge, Horsetail Falls, St. Peter's Dome, Bonneville Fish Hatchery, and Columbia Gorge Park. At the left, winds the Columbia River. At the right, and always in view, looms Mt. Hood, 11,225 feet high—a pure-white crystal set in a sea of blue.

At Hood River, the Columbia Highway is abandoned for the Mt. Hood loop road. Here, the road follows the Hood River and its east fork for 22 miles to Mt. Hood Lodge, then rises for 19 miles to Bennet Pass, and continues into the Oregon National Forest. Six and one-half miles from the

lodge the road crosses the east fork of the Hood River, skirting the east side of Elk Mountain, where it crosses several glacial streams from Mt. Hood before reaching the highest point of the loop, an elevation of 4,675 feet. From Bennet Pass, the road descends gradually, skirting the high southeast slopes of Mt. Hood, a distance of 10 miles to Government Camp, following, in a general eastward direction, the old Barlow Road, over which the early pioneers fought their way into the Willamette Valley. From here the road continues in its descent to the national-forest boundary at Zigzag Ranger Station. From this point, the south-



Looking across Lost Lake from Gifford's Point, Located near the Loop Road Encircling Mount Hood, Which can be Seen in the Background

the loop road, the tourist may return to Portland, a distance of 45 miles, by way of Gresham, with the choice of three highways entering the City of Roses.

At present, of the entire distance from Portland and back, circling Mt. Hood, 80 miles are paved, 22 miles macadamized, 14.5 miles partly gravelled, 40 miles are dirt road, and 17 miles cleared but not graded. Twenty-two are being macadamized this year.

Forest-service contracts for sections of the Mt. Hood loop road call for a minimum width of 16 feet, not including ditches. The maximum grade allowed is 6 per cent, but none has yet been built to exceed 5 per cent.

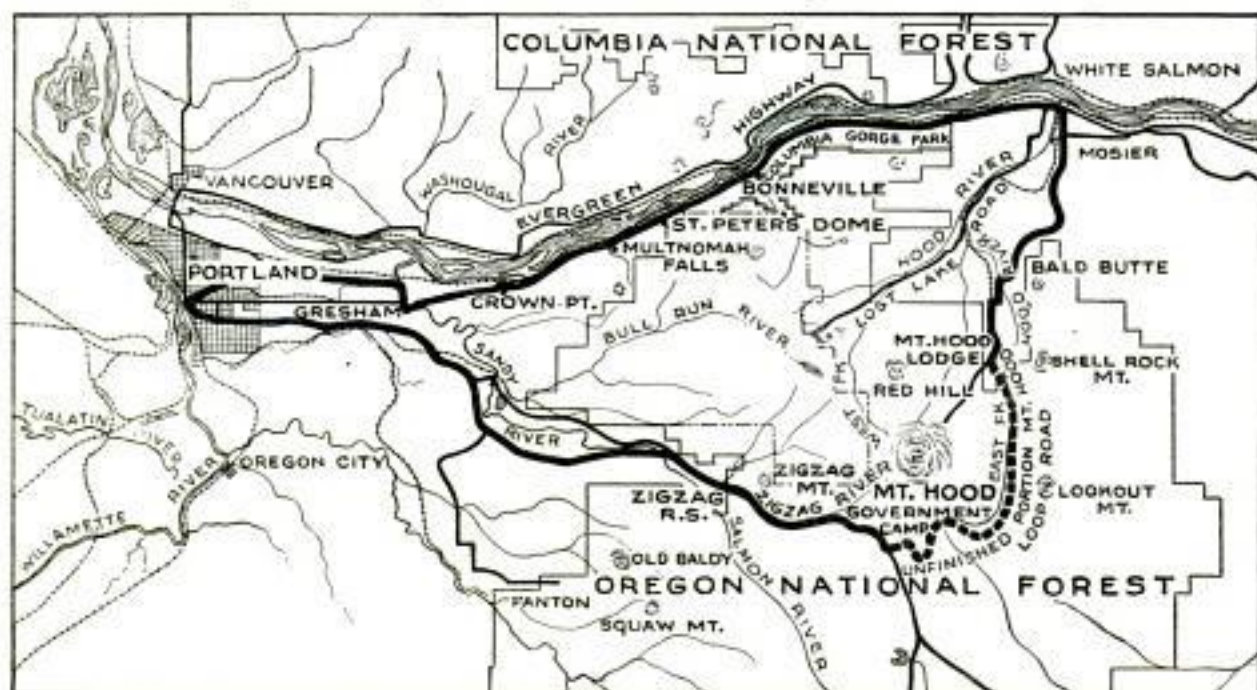

Key Map, Showing the Route of the Loop Road Which Begins at the Hood River and Winds through 173 Miles of the Mount Hood Region, with Columbia Highway Completely Encircling the Mountain, and Finally Returning to Portland, Oregon



*Soldiers' Graves*  
 Chiefs of the Colonial Troops, Who Served in France So Gallantly during the War, Recently Visited Paris. They are Here Shown Gathered to Decorate and Honor the Grave of the French Unknown Soldier, Which is near the Famous Arc de Triomphe, in the Champs Elysees. They were Accompanied by a Number of French Officials

**CHIEFS OF COLONIAL TROOPS VISIT FRENCH CAPITAL**

Twenty-eight chiefs of the colonial troops, who served so gallantly in France during the late war, recently visited Paris. All colored, they came from the French African dependencies, from the Sudan, from Mauretania, from Guinea, from Dahomey, and from the Congo. Clad in gorgeous costumes, they gathered, one day, at the Arc de Triomphe, in the Champs Elysees, where is located the grave of the French unknown soldier. This they decorated in the course of a ceremony participated in by several French officials.

9713

**SMOKESTACK BUILT SPIRALLY TO REDUCE WIND STRESSES**

By building a brick smokestack in the form of a long spiral, with about a quarter of a turn in its length, it is obvious that stresses caused by a wind blowing against it must be decreased, for it will not present as great an area of direct resistance to the wind as if it were built with four vertical sides when the wind is blowing at right angles to one of these sides. A spiral stack of this kind has been built in England in connection with

a small factory. The wind can never strike a side of the stack at right angles along its entire length.



Spiral Smokestack, Built in England, with a Quarter Turn from Bottom to Top, Causing Less Resistance to the Wind than if Built with Vertical Sides

*Engl. ls. Crowther, Keighley*  
 206 Fell Lane, England

9787

Message Exchange  
Grand Central Terminal,  
New York City

562

POPULAR MECHANICS

*Photo at  
New York*

### MESSAGE-CLEARING HOUSE AT NEW YORK TERMINAL



A clearing house which will deliver or exchange messages by phone, wire, or mail, has been inaugurated in the Grand Central Terminal, New York City, to assist the traveler who may find it inconvenient to attend to these details himself. It is only necessary to call an attendant, made conspicuous by a green cap. He will telephone a message to any office, make a business engagement, or arrange other matters. A standard fee of 10 cents is charged for all services.

Above: The Message-Exchange Booth at Grand Central Terminal, New York City. A Revolving File of Patrons' Names Is at the Left. Left: The "Green Cap" Taking a Message

☐ An inland system of low-speed wireless stations is about to be established by the government in India. This will form part of the British imperial wireless system when it is in operation.

*Col. H. D. Mc Cullough  
Arch. Farm manager  
Brookings S. D.*

### IMPROVED PLATFORM BUILT TO DRIVE POSTS

Driving posts in water lapping his stretch of road proved a disagreeable task for a South Dakota county commissioner until he thought of building a platform from his farm wagon. It took him only an hour to turn out the finished product, which consisted of several thick boards, chained to the bottom of the wagon, with a small platform at the outer end. This enabled him to hammer the posts more efficiently and with more comfort.

logs and other material needed for this improvement were conveniently carried



A County-Road Commissioner of South Dakota Standing on the Makeshift Platform Which He Built to Enable Him to Drive Posts in the Water in the same wagon from which the platform was built.



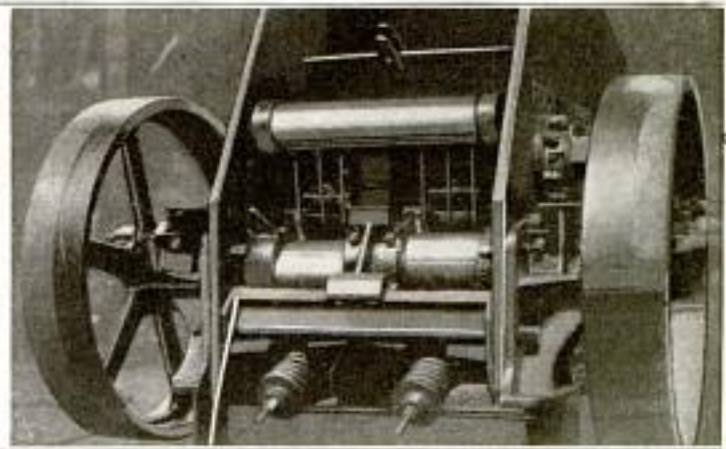
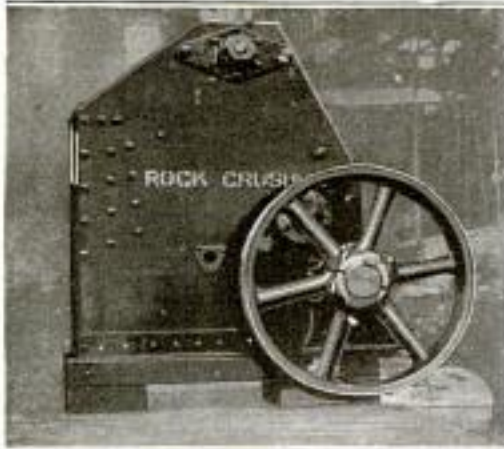

At the Left can be Seen the Gigantic Rock Crusher Which Has a Capacity of an Entire Wagonload at One Time. At the Right is Shown the Interior of the Crusher, Displaying the Pulverizing Mechanism

9886  
**LARGEST ROCK CRUSHER MADE  
HOLDS FULL WAGONLOAD**

Taking a full wagonload of rock in its maw at one time is the performance of what is claimed to be the largest rock crusher in the world. The huge machine was recently completed by a Pennsylvania concern, and delivered to a construction company operating in North Carolina. Considerable publicity was given the mammoth crusher during the time it was being manufactured, and when it was finally loaded on a flat car for shipping, the inhabitants of the little town where the machine had been built turned out en masse, in celebration of the record-breaking event.

9885  
**STEREOSCOPE OF SMALL SIZE  
AS AID TO SALESMEN**

Salesmen may now invoke the aid of a small stereoscope for the purpose of persuading the prospective buyer, a tiny, compactly folding outfit having been recently introduced. The innovation is approximately the size of an ordinary



The Stereoscope Folded, as Shown Above, Occupies No More Space than a Cigarette Case. At the Right It is Opened for Displaying Pictures



cigarette case, thus easily fitting into the pocket, and includes space for 10 photographs of the goods being sold.

982  
**PRODUCE ICE SLED TO CARRY  
PASSENGERS AND FREIGHT**

Difficulties presented when the waters of Green Bay, in Wisconsin, are frozen over, have been overcome in some measure by a man from that state, who has designed a freight and passenger-carrying ice sled for service between Sturgeon Bay



Ice Sled for Passengers and Freight, Showing the Propeller, Engine, and the Iron Steering Runner

and Marinette. The sled is 12 feet in length and has a high-powered automobile engine mounted on it, which drives an 8-foot airplane propeller. A speed of 60 miles an hour was attained last season on experimental trips with the conveyance, which is steered by an iron runner fastened to and extending in front of the sled.

Great Britain's standing timber, greatly reduced by exigencies of the war, is being gradually restored. The government has appropriated a sum of money sufficient for the afforestation of 150,000 acres of new land. The total number of plants set out in 1921 was 12,805,000, and consisted of pine, spruce, larch, and fir.

*A. E. Shoolittle, Supt. Peninsula State Park, Door Co. Wis.*

*The Bleh Co., Inc.  
53 Park Place  
New York.*

9801

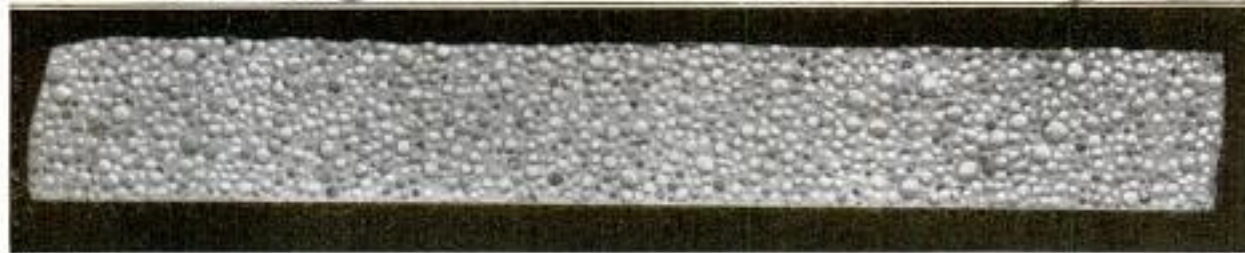
Porete Mfg. Co.  
Porete26 Verona Ave  
Newark, N. J.

Slab of New Building Material Composed of Cement, Sand, and a Substance Similar to Paraffin Wax, Showing Its Air-Cell Structure: The Other Side of the Slab is Backed with Wire Netting

## NEW-PROCESS CONCRETE MADE IN SHEETS

BY ALLEN P. CHILD

Box 73, E. Kansas City Mo.

A NEW JERSEY manufacturer has recently developed an interesting building material in sheet form, 1 inch in thickness, which is made of cement and sand, and reinforced with galvanized-wire netting. In making these slabs, 3 cubic feet of cement and 1 cubic foot of sand are mixed with 7 cubic feet of small pellets of a material similar to paraffin wax. The necessary amount of water is added, and this is worked in a mixer to the consistency of ordinary grout and then poured into a steel form in which the wire netting is placed. About 16 hours are required for the cement to set hard enough to permit the removal of the material from the steel forms without breaking. The slabs are then placed in vertical rows, on steel cars, which are pushed into a big tank and there exposed to steam. The steam heats the slabs rapidly; the waxlike material melts and runs to the bottom and is conveyed to other

tanks. About one-half to three-fourths of the material is extracted in this manner. In order to get rid of the balance, the steam is superheated to a temperature of approximately 300° Fahrenheit, the remaining chemical evaporating and escaping, together with the steam, through a pipe on the top of the tank, and into an ordinary coil condenser. It takes 24 hours to remove all traces of the chemical from the slabs by the steaming process. After being cooled for a few hours, the slabs are placed in a steam curing room, where they are kept wet and hot. Two or three days of steam curing give them the necessary strength, and they can now be stacked outside and are ready for building purposes.

The slab resulting from this process is nothing but a skeleton of cement concrete, and the setting process, though interrupted during the extraction of the chemical, goes on afterward as in any



Construction of a Roof Deck with Slabs of the New Kind of Reinforced Concrete: These Slabs Are Only an Inch Thick, and Are of a Porous Structure. When Used for Such Purposes as Roofing or Flooring, the Slabs are Covered with a Thin Cement Finish

other concrete products. The melting of the waxlike material makes possible the formation of a very porous and light slab, but one of great strength. It is claimed that the crushing strength of the slabs is 600 pounds to the square inch, but this is not sufficient for many purposes. In such cases the slabs are covered with a cement finish, varying from  $\frac{1}{8}$  to  $\frac{1}{2}$  inch in thickness. The reinforcing metal then takes the tensile stresses, and the top finish takes the compression stresses as in reinforced concrete. The slabs weigh only about 55 pounds a cubic foot. When used in building stucco houses, they are nailed to wooden studs with the rough face out, and this serves as a base for the stucco. Nails are driven through them easily without breaking the material. On account of

high heat, steam, or water does not affect their strength, they are particularly useful where fire-resisting qualities are needed. They have also found use in



Dwelling, with Siding Made of the New-Process Concrete: The Outside Face of the Slabs will be Covered with Stucco, Their Air-Cell Structure Making Them Good Heat and Sound Insulators

making roof decks and flooring, as well as for tile floors in bathrooms, hallways, and shops.

9907

## EMERY-WHEEL ATTACHMENT FOR FARM TRACTORS



Emery-Wheel Attachment for Use on Farm Tractors: The Belt Pulley has been Taken Off, and the Grinding Wheel Mounted in Its Place. Inset: Close-Up of the Emery Wheel being Used for Grinding



A special emery-wheel attachment has been devised for use on the track-runner type of farm tractor. The regular belt pulley is taken off, and the emery wheel is put in its place. It is particularly useful to the farmer when the tractor is hauling a mower, the knives of which can be sharpened at any time on the emery wheel without any more than a short interruption of the work. The wheel may also be used for sharpening any other tools or implement parts.

☐The British admiralty's leader cable that runs from Portsmouth about 20 miles out to sea, has been used for the first time by a merchant vessel, the steamship "Orbita." This is the only British merchant ship that is as yet fitted with the electric instruments that are necessary for the use of the leader cable.

*Avery Co. Peoria, Ill.*

Builder, J. E. Barnes, 3500 Seminary Ave  
Oakland, Calif.

POPULAR MECHANICS

566  
9813

**HOUSE BUILT SINGLE-HANDED  
BY INEXPERIENCED MAN**

Utilizing his spare time during a period of three years, a member of a high-school faculty in California has finally completed a home which contains all modern

improvements. The piece of land upon which the house was erected was purchased by the amateur builder in 1917. He was at that time living on a ranch near the ocean, when, observing the fine drift logs that were constantly being cast upon the beach, he decided to salvage them. Accordingly, he gathered a great number of the logs and then rigged up a crude sawmill, using an old automobile for power. With this outfit, the novice made all of the floor joists, posts, girders, rough boards, etc., for the contemplated home, and then, with the aid of the old motor car, hauled the lumber to his vacant lot.

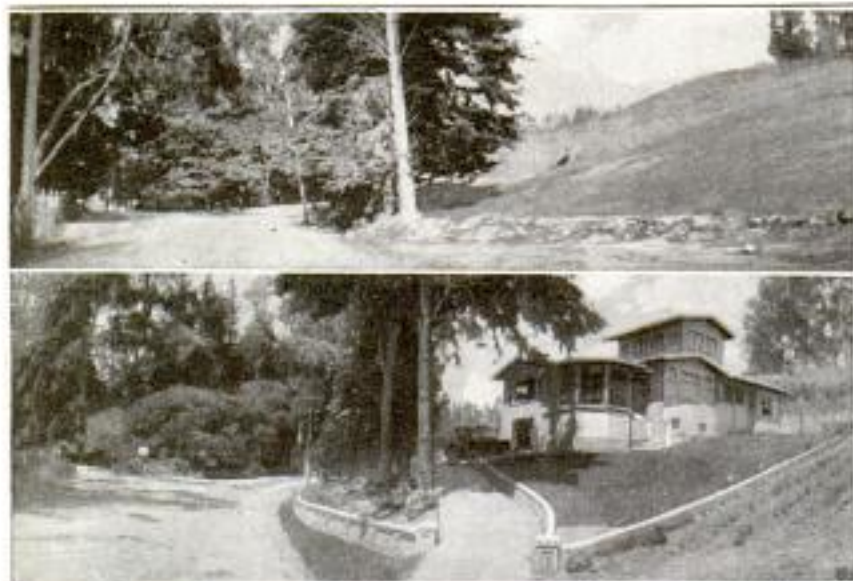

Above is Seen the Vacant Lot as It Appeared Three Years Ago; Below, the Completed Modern Home, Together with the Improved Property

Although he had no previous experience in any of the building trades, he next excavated for, and then put in, a concrete foundation. The construction of the house was slowly accomplished, single-handed, with the exception of the electric wiring, roofing, and the mason work in erecting the chimneys. The completed dwelling has hardwood flooring, a furnace, and hot-water heat, tile drain boards in the kitchen, and a tiled floor in the bathroom,

which includes a shower. The proud owner claims that his total expenditures amounted to only \$2,000, not counting his own labor, and places an estimate of \$12,000 as the present value of his property.

other object that could reach inside the mudguards. The fan has propellerlike blades, but does not revolve independently, simply setting the air adjacent to the wheel into an eddying motion.

**SMALL FAN ATTACHMENT COOLS  
AUTOMOBILE DISK WHEELS**

From the nature of their construction, disk wheels do not get the benefit of the cooling properties of the air to the same extent as do open wheels. To counteract this disadvantage, a French inventor has patented a device for increasing the air circulation over the face of the disk by means of a fan. This can be applied to any disk wheel without necessitating any change beyond the drilling and tapping of a few holes. The fan is so shaped that it is protected by the wheel itself from any damage when the car runs along a sidewalk curb, or against any

other object that could reach inside the mudguards. The fan has propellerlike blades, but does not revolve independently, simply setting the air adjacent to the wheel into an eddying motion.

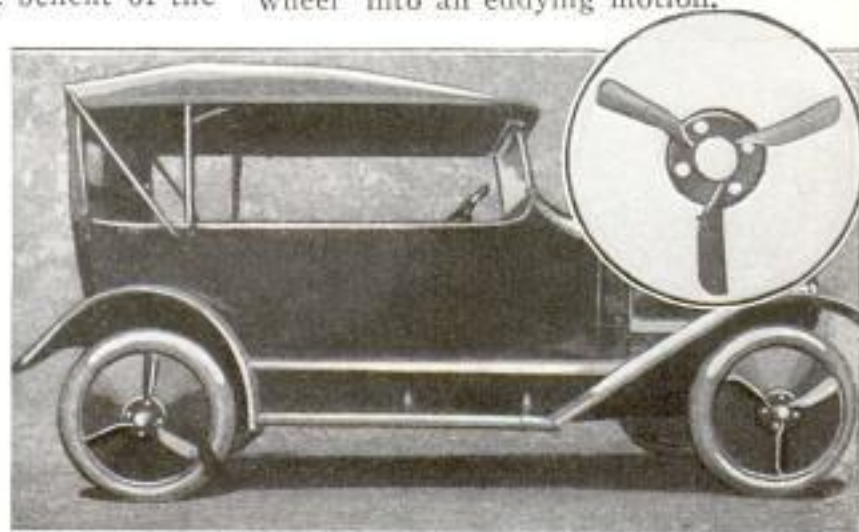

Automobile Disk Wheels Fitted with Fan Blades That Maintain a Rapid Circulation of the Air for Cooling the Disks: Inset Shows an Enlarged View of a Set of Fan Blades Connected to the Center of a Disk

6796  
Emb. E. Weiss, Heligoland, France  
5 Ave. Harding Paris, France

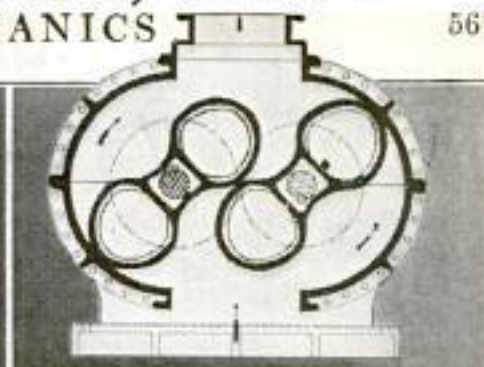
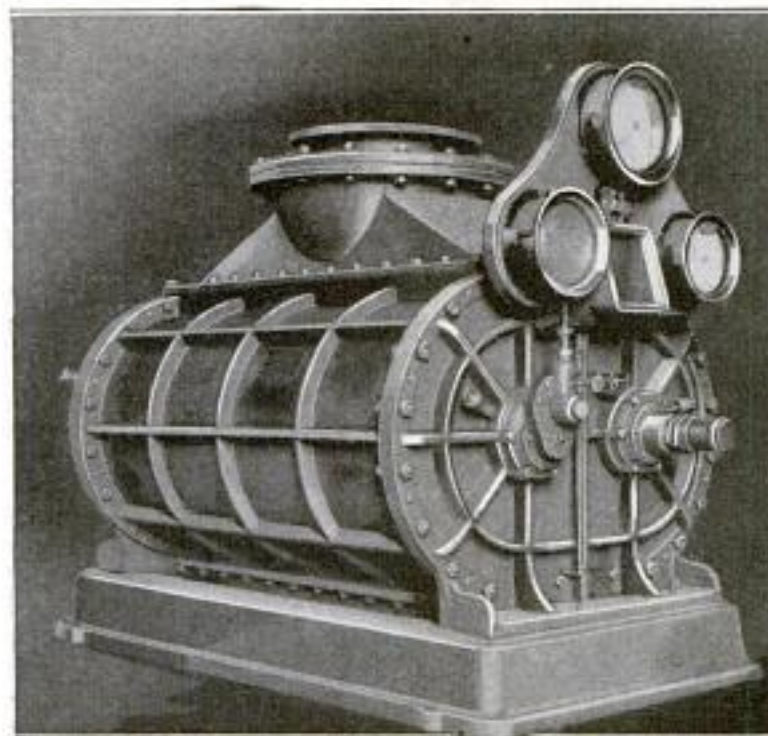

At the Left Is an Outside View of the Meter and Gauges. In the Upper Right Is a Diagrammatic Cut Showing a Cross Section of the Gas Meter, Indicating by Arrows the Rotation of the Two Impellers and the Inlet and Discharge Openings. Lower Right Is a Picture of the Two Impellers

9857  
**POSITIVE BLOWER MECHANISM  
BASIS OF NEW GAS METER**

A new meter for air or gas, now on the market, utilizes the principle of the well-known positive pressure blowers. In the new meter the impellers are constructed of reinforced aluminum and mounted on special roller bearings, so that they just clear the inside of the casing, making it unnecessary to provide internal lubrication. Due to this clearance, there is slippage of the gas back from the discharge to the intake, which, having been found to average about two per cent, is automatically corrected in a special recording gauge permanently attached to the meter. The meter also corrects for temperature and pressure, so that the gauge reading will be in cubic feet of gas referred to standard conditions. The cost is said to be considerably less than that of many older types of meters, which it equals in accuracy and efficiency.

9814  
**ANGULAR-NOZZLE SPRAYER FOR  
UNDERSIDE OF LEAVES**

Spraying a garden has been facilitated by the introduction of a portable compressed-air outfit, which is manufactured by a New York concern. In operation, the contrivance is hung over the shoulder of the user and a long angle nozzle extends down to the underside of the plants.

By this method, the under surface of the leaves, which is the starting point of most



At the Upper Left is Shown the Manner of Using the Angular-  
Nozzle Sprayer to Reach the Underside  
of the Plants. At the Upper Right is Seen a  
Close-Up of the Sprayer. While below It is  
Shown the Nozzle

plant diseases, is thoroughly treated in an easy and rapid manner.

☐ A bill has been introduced in the U. S. Senate to authorize the President to give Poland six American warships that, under the terms of the Washington agreement, would have to be scrapped.

E. C. Brown Co  
Rochester, N. Y.

Wide World  
9936 Photos

568

n.y.c. POPULAR

### RISKY METHOD OF CLIMBING A PEAK IN SWITZERLAND

Mountaineering in the Swiss Alps furnishes many thrills, but few equal to that in connection with the scaling of the



Climbing One of the Peaks of the Kreuzberg in the Upper Rhine Valley, Switzerland, by Means of Ropes Suspended from an Overhanging Rock

peaks of the Kreuzberg in the valley of the Upper Rhine. There are eight peaks, the lowest being 5,673 and the highest 6,207 feet above sea level. The ascent and descent have to be made with ropes suspended from a large protruding boulder. With the help of the ropes and the use of his feet, the mountaineer negotiates the almost vertical face of any of these peaks.

### SHORTER ATLANTIC PASSAGES WHEN NEW PORT IS BUILT

At none of the ports in England at present used by Atlantic liners can a vessel enter and discharge passengers and cargo at any state of the tide or weather. To avoid the loss of time often caused

The mail 7/12/20

National Association  
of Real Estate Boards

MECHANICS

1430 Consumers Bldg Chicago

by this condition, parliamentary powers have been obtained to build a port at St. Just, near Falmouth, on the coast of Cornwall, where there will be a depth of 44 feet at low water, so that the largest vessels afloat could dock at all states of the tide. By this route passengers could reach London eight hours before those landing at Southampton, and on the western journey the St. Just passengers could remain in London eight hours longer than those traveling via Southampton.

9918

### ILLINOIS ZONING LAW MADE VOID BY COURT DECISION

The validity of the proposed Chicago city-zoning ordinance is now in suspense on account of a recent ruling of the state supreme court. One basic principle of modern zoning ordinances is that they are not retroactive, but the court decision goes further, for it states that: "An ordinance is void which prohibits one citizen from conducting a particular kind of business in a certain locality and permits another to engage in the same character of business in the same locality merely because the latter had established his business before the ordinance was passed."

9974

### HAND SPEED RECORDER GIVES READINGS AT A GLANCE

For use in shops or manufacturing plants where the speed of machinery, or surface and cutting speeds, are of prime importance, a reliable hand recorder is now available. The instrument gives the readings direct on a dial without the ne-

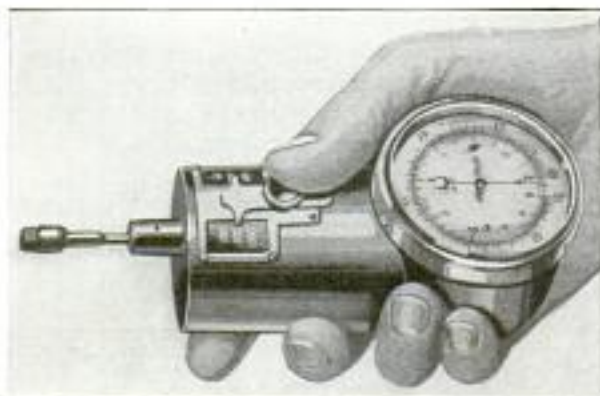

This Hand Speed Recorder Gives the Readings Direct on the Dial, and can be Used for a Large Range of Speeds

cessity of watch-timing or calculation. A gear shift is provided that gives the instrument an ability to record speeds and feeds over a remarkably wide range.

P. Zernichow  
15 Park Row, New York

*White Plains, N.Y.*

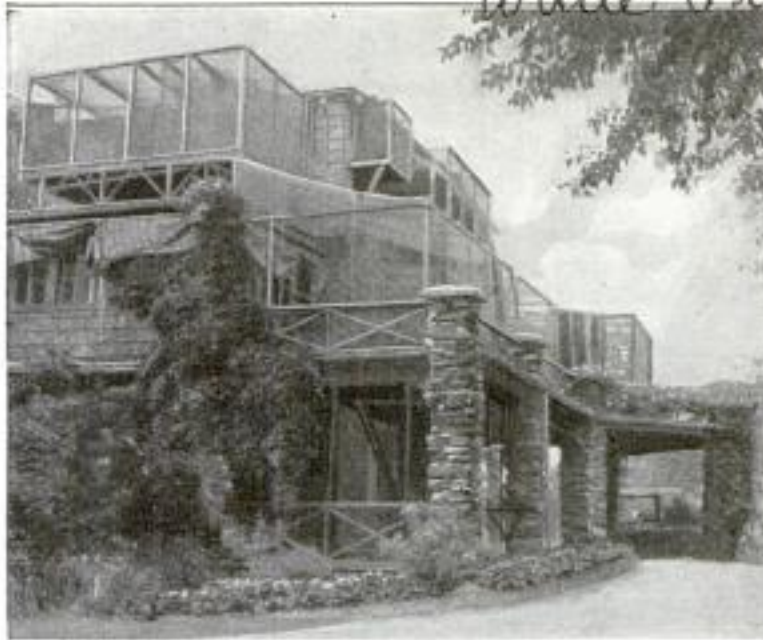

The Picture on the Left Gives the Front View of the Country Home of a New York Woman, Transformed by Her into a Squirrel Farm. In the Photograph to the Right, She is Seen Fondling Two of Her Prize Pets

*9868*

**FINEST SQUIRREL COLLECTION KEPT IN BEAUTIFUL HOME**

Three hundred and fifty squirrels, from all parts of the world, considered the finest collection of these animals in existence, are housed in the beautiful country home of a New York woman at White Plains. The cages extend from the windows and are fitted with every comfort. The collection is said to be worth a fortune.

*9978 Access*

**CORRUGATED FINGER BOARD HELPS VIOLIN PLAYERS**

Teaching of the violin is found to be very much facilitated by the use of a corrugated finger board, the invention of a Chicago teacher. At the point to be fingered for each note of the scale is a slight ridge, and this is said to greatly aid the learner in acquiring correct fin-



Corrugated Finger Board That Makes Violin Playing Easy: When the Student with Its Aid has Acquired Proficiency in Fingering, It can be Removed

gering. The corrugated finger board is removable, and when sufficiently expert, the student can dispense with it. It is also made for use with the violoncello.

*Arbinger Shaefter, 22 Quincy St. Chicago*

**GOLFERS CANNOT OVERSWING USING LEATHER DEVICE**

A leather device, to hold the arm in exactly the proper position while swinging, is now available for the aid of golfers

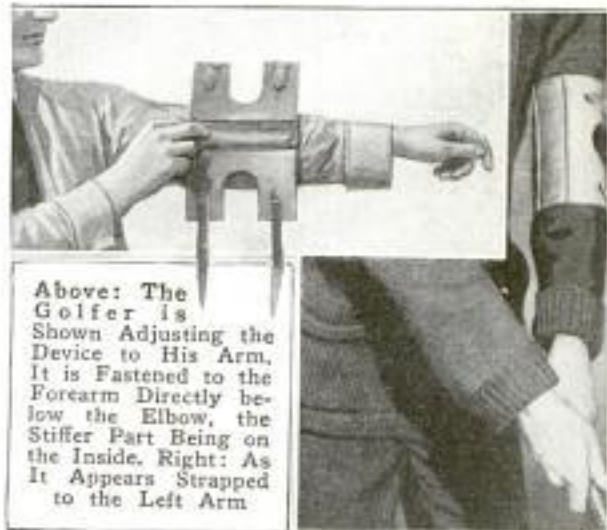

Above: The Golfer is Shown Adjusting the Device to His Arm. It is Fastened to the Forearm Directly below the Elbow, the Stiffer Part Being on the Inside. Right: As It Appears Strapped to the Left Arm

anxious to improve their game. The device, which is strapped to the left arm, allows the arm to be bent backward the necessary distance, but prevents too much bending.

ⒸA big wireless station is being built near Saigon, in French Indo China, for direct communication with the stations at Sainte Assise in France, and Tananarivo, in Madagascar. The necessary current will be furnished by a generating station near Saigon that has a capacity of 3,000 kilowatts.

*The Svingite Co., Providence, R. I.*

7861

# Central Fire Alarm Station Central Park, New York City



The Relay Receiving Board of the New York Fire-Alarm System, Which Distributes the Alarm to the Proper Stations, with Little Loss of Time, and Thus Assists in Speeding Up the Answering of Calls

## MODERN FIRE-ALARM SYSTEM FOR NEW YORK

NEW YORK CITY has just inaugurated a new fire-alarm system for the Borough of Manhattan, that has taken a number of years to complete, at a cost of \$1,500,000. The system has been so perfected that it takes only 10 seconds for an alarm to pass through the central station and reach the station intended to answer the call.

The central station has 217 working box circuits connecting it with the 1,528 street-corner alarm boxes, involving the use of 350 miles of cable and 17,000 miles of wire for the intricate telephone and telegraph system that interconnects the alarm boxes, central station, and fire houses.

When it is de-

sired to send in an alarm, the person goes to one of the fire-alarm boxes that are

located at every other street intersection, and, noting the instructions on the door, turns the handle until the bell rings. A mechanism is thereby set in motion that transmits to headquarters four complete rounds of the code signal indicating that particular box. After the first round has been received at the central station, the dispatcher takes from a file a perforated card corresponding to the box sending in the alarm, and places it in the selector switch. Directly after the second round from the box, he presses a key and sets in motion the automatic-transmitter control, which instantly



Old Tower and Bell, Relic of Early Fire-Alarm System, Still Standing in Mount Morris Park, New York City, Which at One Time Had a Number of These Bell Towers



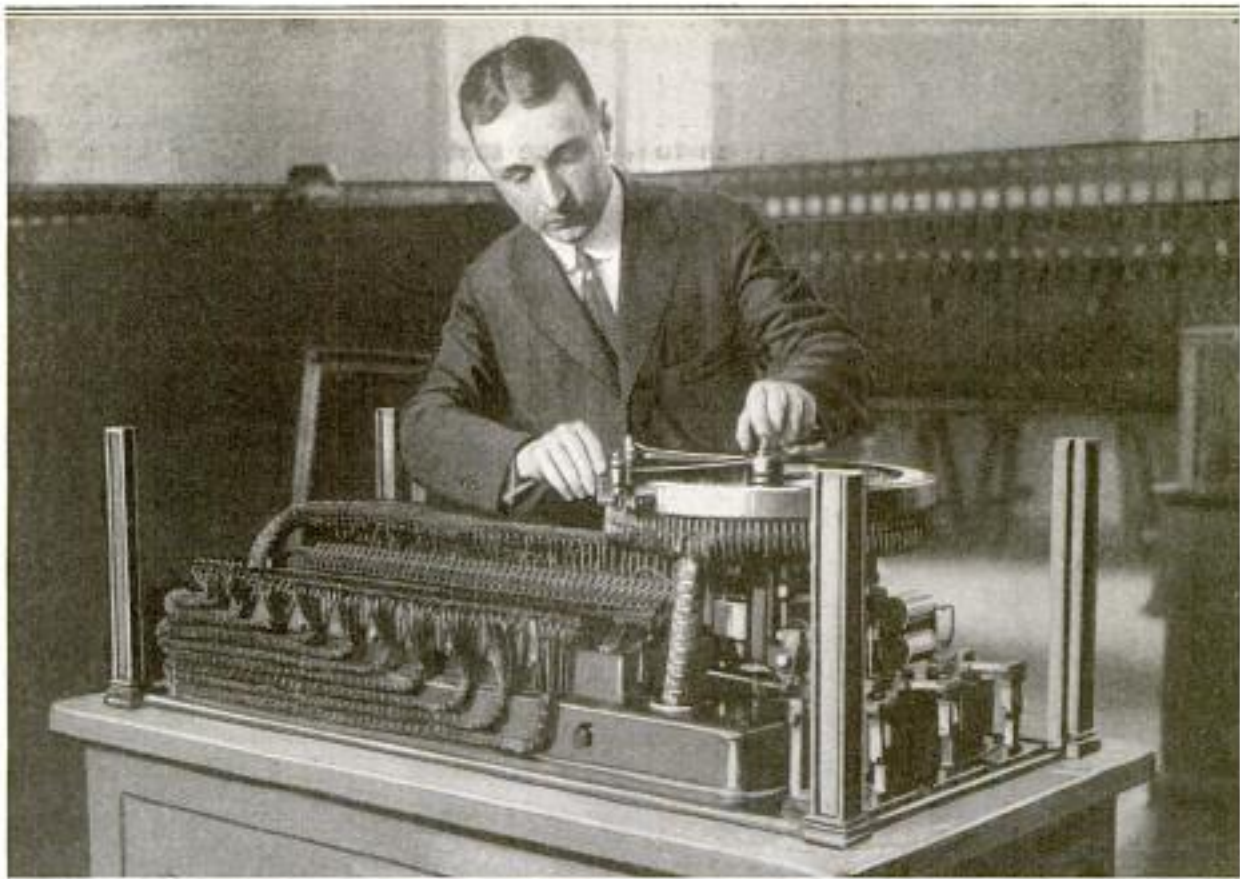

The Expert in Charge of the Central Fire-Alarm Station in Central Park. Examining the Mechanism of the Automatic Selector Switch, Which Does Its Work with Accuracy and Dispatch, in Spite of the Complicated Appearance It Presents

sends the alarm to all fire houses, during the day, and to all companies due at the station on the first and second alarm, at night. This signal is thus transmitted

twice over what is called a "combination circuit," and once over what is called the "gong circuit," to all the engine houses. The fire companies are under instruc-

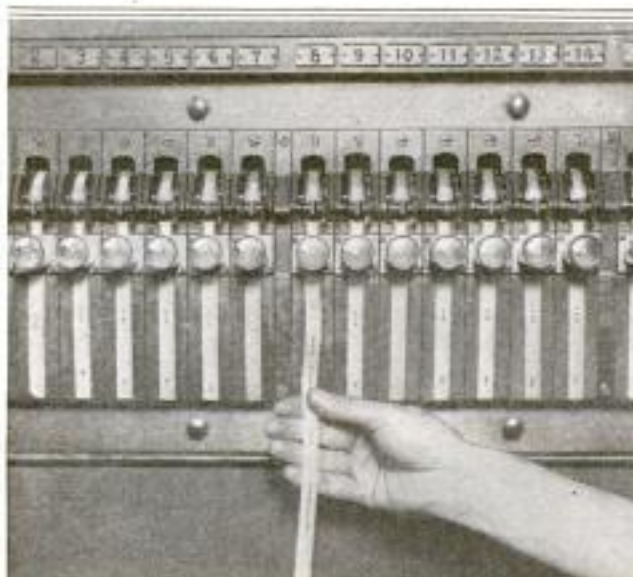

At the Right is Seen an Expert Operator Ready to Insert a Disk in the Selector Switch, Which, by Means of the Perforations in the Disk, Picks Out and Makes the Proper Contacts Corresponding to the Alarm Box Pulled, and Then Automatically Passes On This Information to the Transmitting Machine Shown Above. This Machine in Turn Delivers the Information as to the Source of the Alarm to the Various Fire Companies

tion to proceed to the point designated by the alarm, according to which station it is nearest. When the call comes in to the central station, it is heard and seen by the dispatcher and automatically registered to avoid error. The alarm boxes

are of the succession-noninterference type, meaning that, if two or more boxes on the same circuit are pulled for a fire, each box will transmit its signal of the alarm to headquarters with no interference to the signal from any other box.

9856 *no force*  
**NONSKID FALSE TEETH USE VACUUM-CUP IDEA**

The problem of making false-teeth plates that would be comfortable and

plate and the mouth, rendered difficult because of the irregular contours of individual mouths and the presence of rough membrane. A recent invention has apparently successfully made use of the vacuum-cup principle, familiarly used on the treads of nonskid automobile tires and some athletic shoes, for the alleviation of this difficulty.

The rubber vacuum cups can be fitted to any style of artificial set of teeth. They are made of flexible high-grade rubber and vulcanized to a reinforced rubber backing, which combines rigidity with the essential flexibility. The vacuum cups have been found to retain their life and effectiveness for a long time, and the plates to stay so securely in place that they have not become dislodged by violent coughing, sneezing, or laughter. They may be as easily removed as the older types, when

stay in place, has been largely one of desired. Many persons with troublesome contact between the cup flange of the mouths have already been benefited.

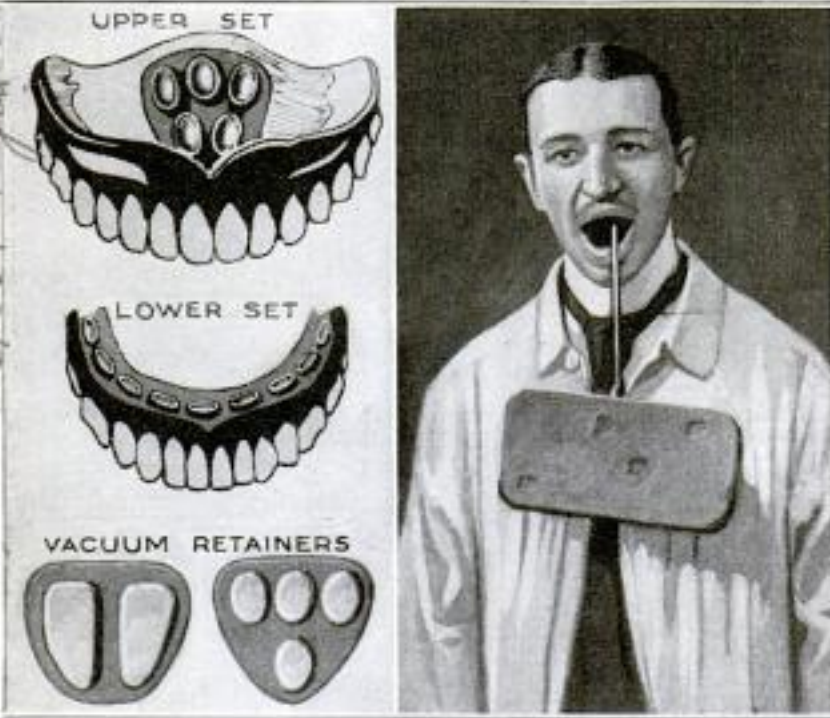

Left: Close-Up of the Vacuum-Cup Retainers, and an Illustration of How They are Applied to an Upper and Lower Plate. Right: Man with Weight Attached to Upper Plate

9789  
**MACHINE FOR TESTING RESILIENCY OF NEW GOLF BALLS**

The elasticity of golf balls, or other balls having solid-rubber cores, is tested by a new machine of English make. The machine consists chiefly of a standard, bolted to a baseplate, with a steel yard supported by the standard. The yard is notched for different positions of poise, and a deflection scale is arranged at the end of the beam. Two platens hold the ball. Variations of .001 inch are discernible.

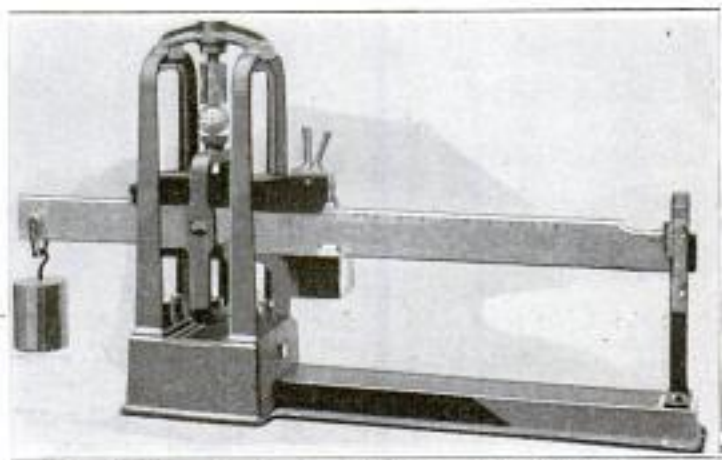

In This Machine for Testing Resiliency, the Ball is Placed between Two Platens, and the Variation in Diameter is Read on a Scale at the End of the Beam

*W. + S. Avery, Ltd.*  
*Soho Foundry, Birmingham, England*

*Dr. J. W. Whitman, 319 7th Ave Pittsburgh Pa.*  
*Dr. J. W. Whitman, 319 7th Ave Pittsburgh Pa.*

*Dr. J. W. Whitman, 319 7th Ave Pittsburgh Pa.*  
*Dr. J. W. Whitman, 319 7th Ave Pittsburgh Pa.*

3269

Bureau of Standards

POPULAR MECHANICS

Washington  
W.C.C.

57

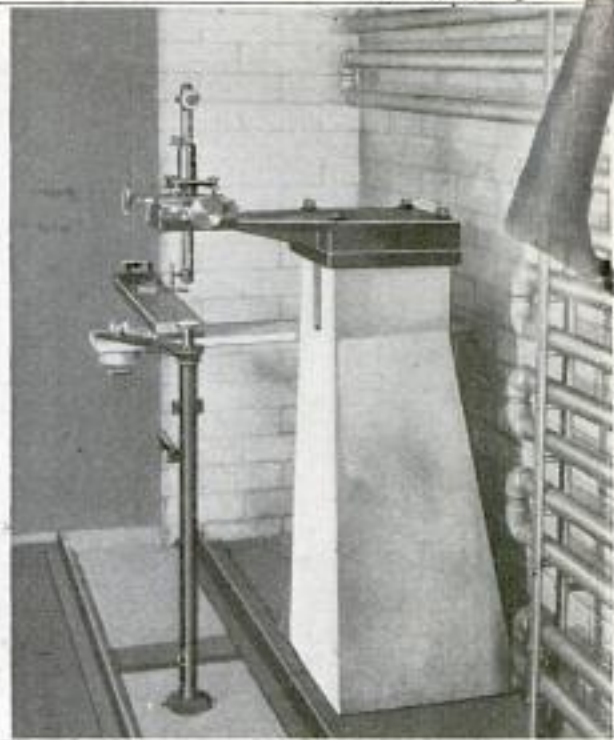
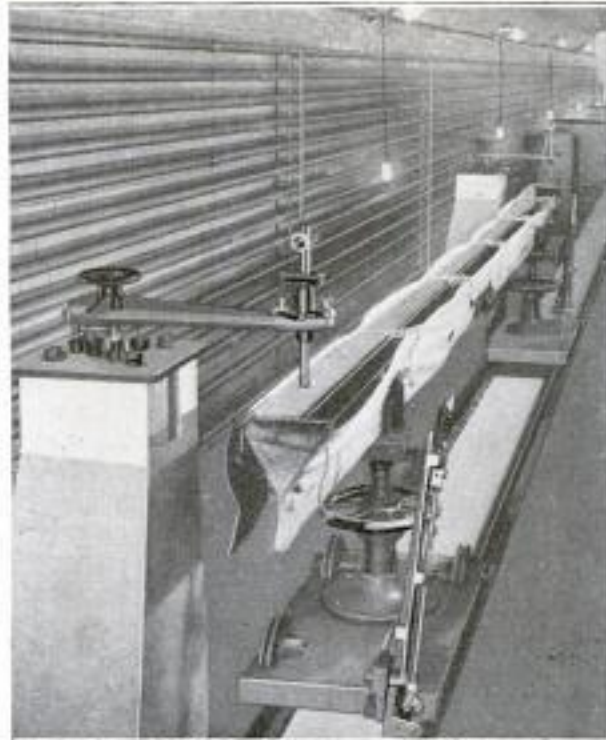

Left: Part of Tape Tunnel, Showing the V-Shaped Trough between Two of the Concrete Stands, Each Carrying a Microscope. Inside the Trough, Packed in Ice, is a Standard Meter Bar. Right: One of the End Stands with the Instrument for Positioning One End of a Tape When It is being Standardized

3269

## TAPE TUNNEL OF THE BUREAU OF STANDARDS

One of the least known of the Bureau of Standards' multifarious activities is carried on in the so-called tape tunnel of that institution. Here the tapes used in the measurement of land and water by the Coast and Geodetic Survey, the International Boundary Commission, and other government bureaus, are standardized, all measurements being deduced from one of the original prototype meters which were deposited at the bureau when it was established in 1901. Concrete stands, each carrying a microscope at a convenient height for observation, are lined up at 5-meter intervals along the tunnel for a length of 50 meters. The center one of these intervals is similarly subdivided with stands spaced 1 meter apart. Here a 5-meter length is established by placing the standard meter bar in a V-shaped trough, wherein melting ice keeps the bar at zero centigrade, the temperature at which it is absolutely correct. The trough is mounted on a carriage that runs on a track so that the meter bar can be moved from microscope to microscope, each one being successively adjusted, by means of its cross hairs, to the exact meter length. When all are thus adjusted, a 5-meter bar is correctly standardized, and is then used in a similar manner to adjust the 5-meter intervals successively until an exact 50-meter length

between the first and the last of the microscopes is established. At each of these end microscopes is an instrument for transferring this measurement to a ball set into a ring in the floor. Resting on each of these balls is a vertical post which carries below the microscope a support for the ends of the tapes when they are being standardized.

95/11

## IMPROVED BLOWTORCH USES KEROSENE OR GASOLINE

A combination blowtorch offers refinements in design for the convenience of users of such devices. An absolutely blunt burner needle, fitting into an open channel, is so constructed that it cannot easily be removed. Interchangeable gasoline and kerosene burner blocks are screwed into the burner or filler plug. Cleaning needles are kept in a pocket in the hollow handle.



W.C.C. Newark, N.J.

Copyrighted material

W. S. Weigle, Forest Supervisor  
 U. S. Dept. of Agriculture, Forest Service  
 574 POPULAR MECHANICS  
 9802 553 Stuart Bldg. Seattle Wash  
 "KEEP THE FORESTS GREEN," KEYNOTE OF PARADE



Floats Representing Smokers' Articles Carried in a Seattle Parade: Signs Warned against Their Careless Use in Forests

Assisted by prominent business men, automobile clubs, and civic organizations, Seattle recently held a parade protesting against an increase in forest fires which has come about, it is believed, because of the popularity of mountain automobile travel.

In addition to signs admonishing motorists and others to "Help Prevent Forest Fires," "Keep the Forests Green," etc., floats were used to further emphasize these points. Among the more interesting was a large pipe carried by two mountaineers, a large pasteboard match, and a cigarette. Each displayed a placard warning again the careless use of these articles.

9934 DOG CLINIC IN NEW JERSEY  
 OPENED BY KENNEL CLUB

With the sanction of the board of health, a kennel club at Closter, N. J.,



A Great Dane being Bound Up Preparatory to the Injection of the Rabies Vaccine at the Dog Clinic of Closter, New Jersey, Opened by a Local Kennel Club

has opened a dog clinic for the purpose of inoculating the animals with rabies vaccine. The reason for the innovation is that an ordinance passed by the city council permits dogs so treated to run the streets unmuzzled. The injection is claimed to make the dogs immune to rabies infection for one year.

9976 PROTECTION OF GRATE BARS  
 BY AN ALUMINUM COATING

Tests made in Europe have shown that pieces of metal protected by an aluminum coating, as applied particularly to fire-grate bars and cast-iron stoves, give at least four times and, as a general rule, six times the service of untreated pieces. The aluminum is melted and is sprayed upon the articles treated, instead of being applied by the calorization process, well known in this country. Coated fire-grate bars, tested in locomotives, besides having their life greatly increased, allowed the clinkers to be much more easily removed than untreated bars. However, the general results of the experiments show that the protection by the spraying process is not as effective under high temperatures as that obtained by calorization. Further investigations are now being conducted.

It has been found that the use of nickel fluoride, in place of nickel chloride or sulphate, gives a finer-grained deposit of higher tensile strength and greater hardness in nickelplating.

David A. Warke's Hazelhead Kennels, Closter, N.J.

9755

Wide World Photos

Hydro. Electric  
at 2000 ft.

## ALPINE LAKES TO FORM LINK IN POWER PROJECT

New York City

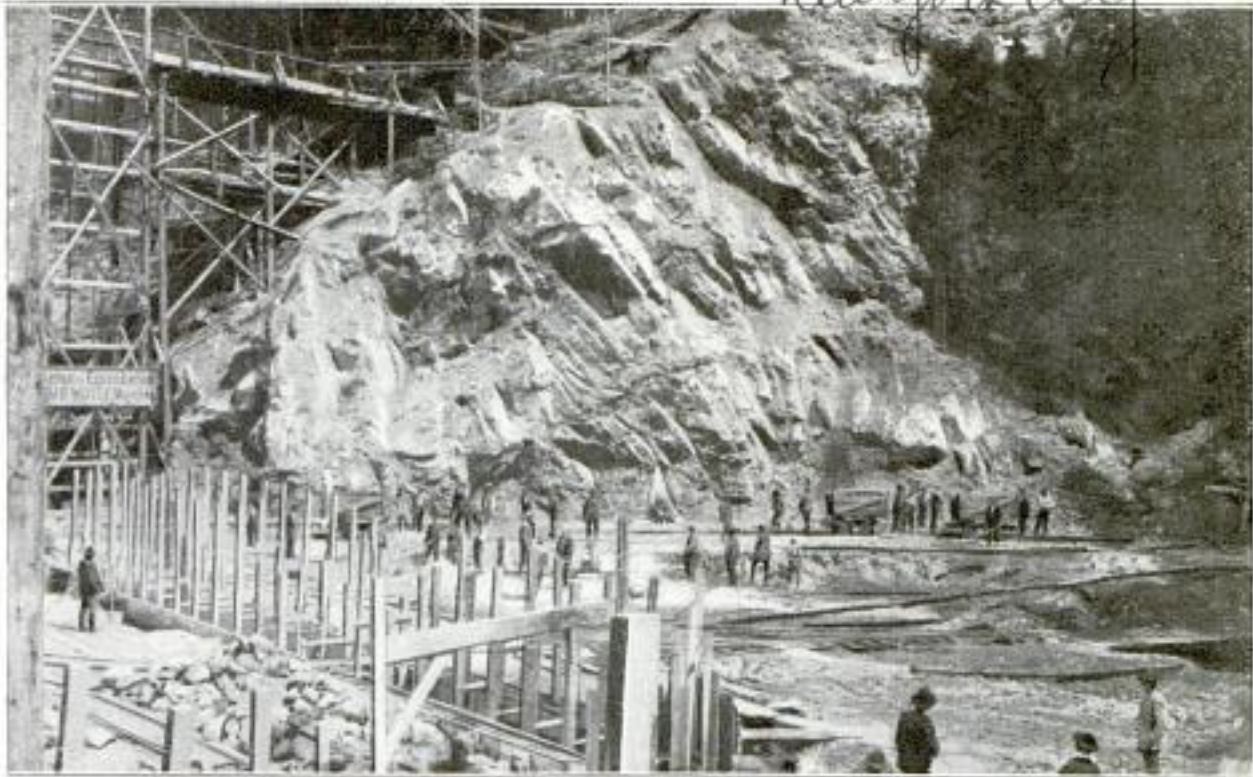

Tunneling through the Rocky Mountain between the Kochel See and the Walchen See, in Bavaria: The View Shows the Operations being Carried On at the Walchen See Side, Which Is About a Mile Distant from Kochel See, and 650 Feet above It

There is in progress in Bavaria an engineering project which, when completed, will make that country practically independent of foreign sources of coal supply. By boring a tunnel about  $2\frac{1}{2}$  miles long

through the Alps, a portion of the flow of the Isar River will be diverted into the Walchen See, a mountain lake some 7 square miles in area and very deep. This lake will be used as a storage reser-

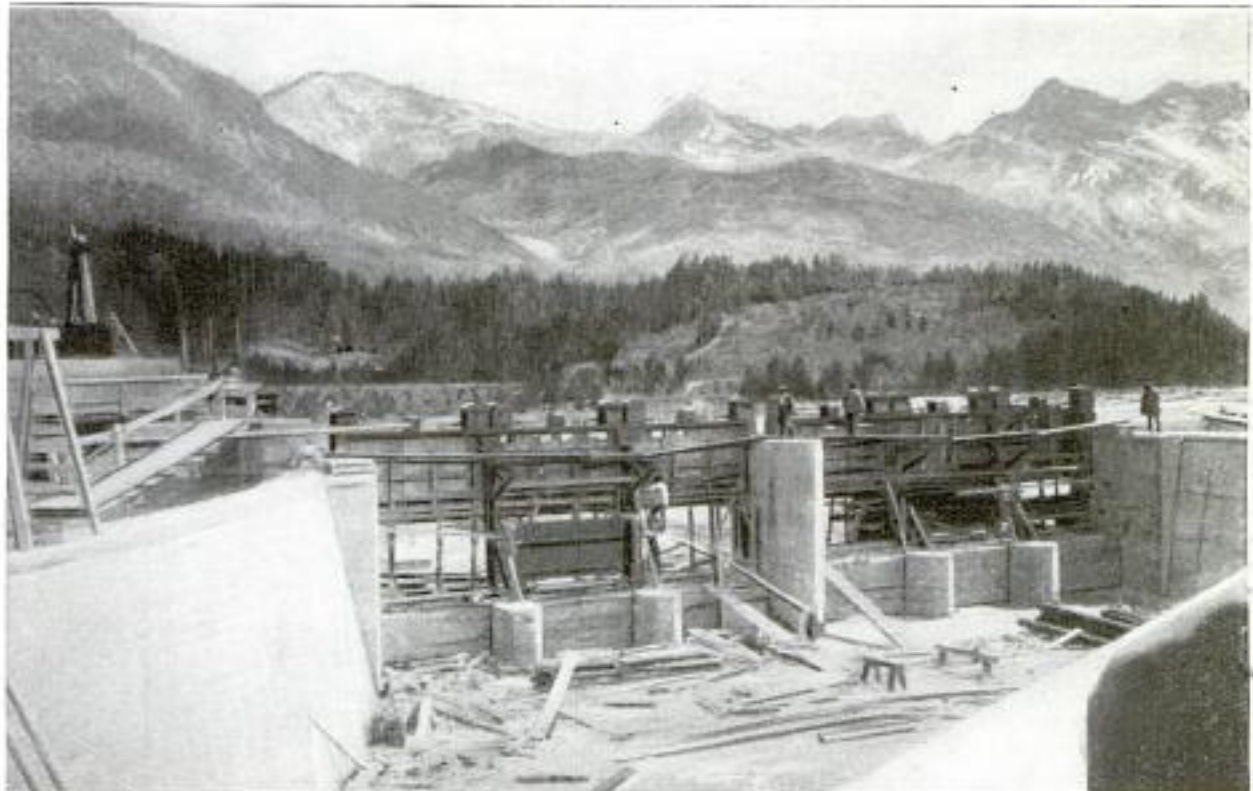

Building the Dam in Connection with the Development of the Power Plant That will Produce Enough Electric Current to Run All the Railroads in Bavaria, and to Supply Power for All Its Industrial Plants, and Light for All Its Cities

voir, and a second tunnel will lead the water to the Kochel See, less than a mile distant but 650 feet lower. This difference of elevation will make possible the development of sufficient electrical energy to operate all railroads and industrial plants in the country, besides furnishing light and heat for the cities.

the aid of a ventilating fan manufactured in Chicago. In installing the fan, no alterations or electrical work are required, as the outfit has an adjustable frame which can be fitted in any ordinary window casing and fastened by five screws. The window may be raised or lowered at will when the fan is not revolving, but still in place. Either alternating or direct-current reversing motors are available, for which power is obtained by a cord attachment to any socket, and which operate with no more consumption of current than is used by a 50-watt lamp.

*9758*  
**KITCHEN-VENTILATING FAN IS EASILY INSTALLED**

Smoke, odors, and hot stagnant air can be quickly drawn from any kitchen with

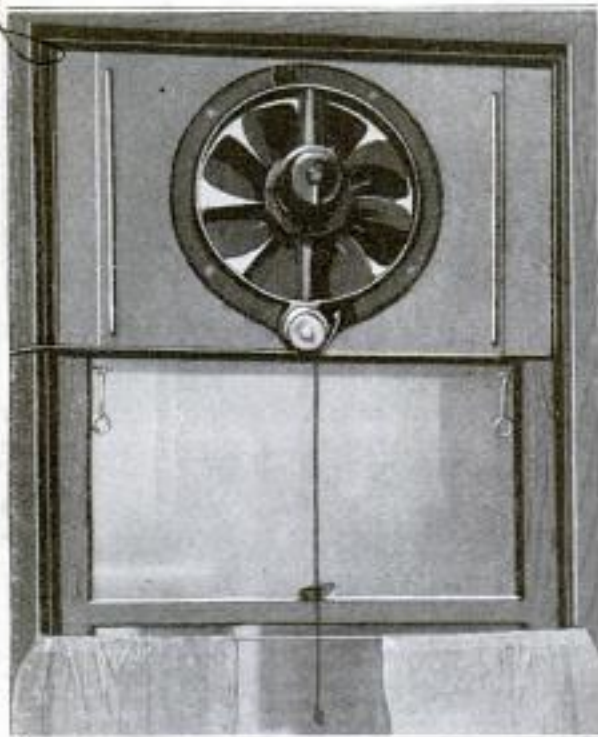

Kitchen-Ventilating Fan for the Removal of Smoke and Stagnant Odors, Shown Mounted in the Upper Section of the Ordinary Window

*9708*  
**NEW AUTOMATIC LIFE-SAVING FENDER FOR AUTOMOBILES**

To act in emergency as a life-saving fender, a substitute for the ordinary automobile bumper, occupying about the same space, has been demonstrated successfully in Alabama. The fender extends clear across the front wheels of the vehicle, and comprises parts that, when released by the operation of the emergency brake, automatically unfold a strong curtain, or flexible shield, which reaches to the ground. The result is that, if a person is struck by a vehicle equipped with this fender, the yielding cloth shield will push the person ahead of the car for the short distance that is required to stop the machine with the emergency brake. Though designed specially to be connected to the emergency brake, the fender may also be operated by the foot brake. After use, it is refolded and returned to its normal position by a lever mounted within convenient reach of the driver.

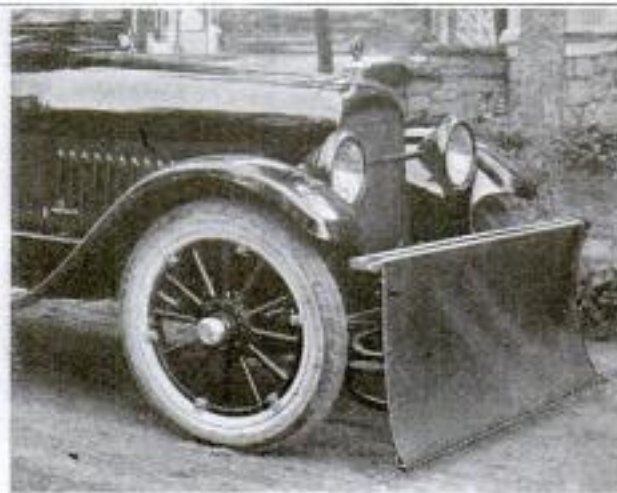
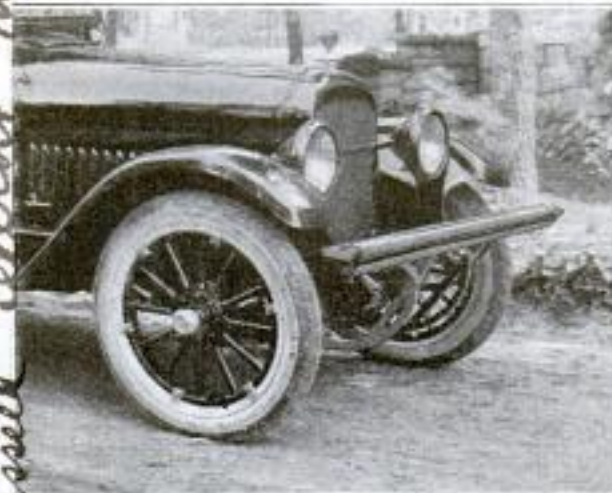

Two Views of the Automatic Life-Saving Fender, Showing, at Left, the Fender Folded Up and Looking like an Ordinary Bumper; at Right, the Curtain, or Flexible Shield, is Shown as It would be Automatically Unfolded by Striking Any Obstruction When Traveling. Any Person Struck is Pushed Forward until the Car is Stopped by the Emergency Brake

*6004*  
*Dr. Edward S. Jones Box 611*  
*Mobile, Ala.*

*Autorent Fan + Blower Co  
730 W. Monroe, Chicago  
American Electric Co.  
Russell Detroit Mich.*

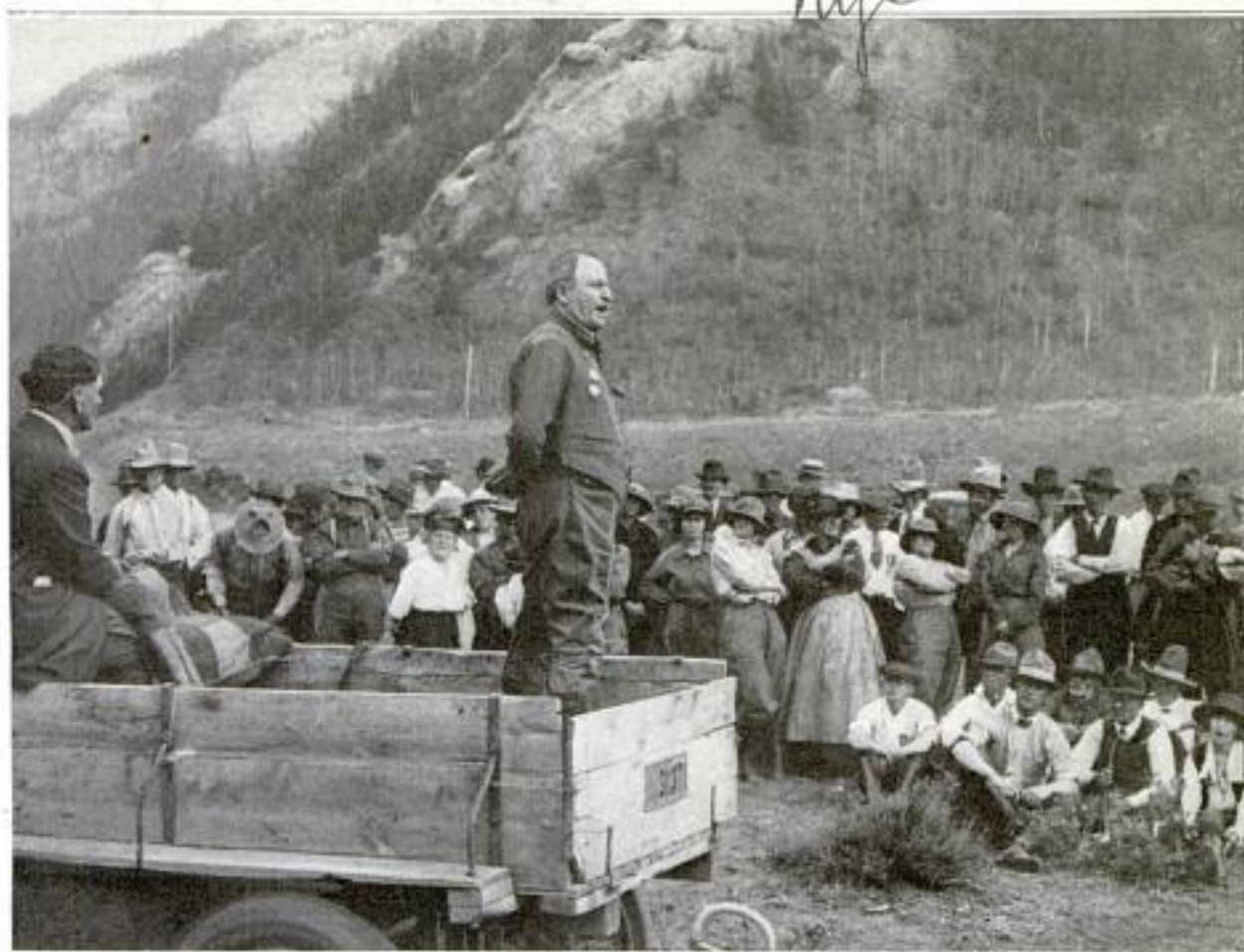

#### FAMOUS WILDERNESS PENETRATED BY HIGHWAY

CEREMONIES were held recently to celebrate the opening of the Hoback Cañon Highway, in Nebraska, which cuts through the heart of a wilderness famous in old-time western history and tradition. In the picture, the leader of the House of Representatives of that state is seen addressing a gathering at Jackson's Hole, designating one end of the newly completed highway which winds through what was formerly the "hang-out" of many notorious desperadoes of that section of the country. The swaggering poses assumed by some of the feminine members of the audience would seem to indicate that the dashing and independent spirit, so prevalent in the olden days, has passed from the male to the female branch of humanity.

9859

#### INCLINED TURNTABLE FOR NARROW-GAUGE ROAD

Rail

Turntables for railroads are usually located on level ground, but one of these, built for a narrow-gauge industrial road on Vancouver Island, B. C., is constructed on an incline of  $35^\circ$ . The motive power for the cars used on this railway is furnished by compressed-air winches and steel cables. About halfway up the grade, a turn of  $60^\circ$  is required, and here the turntable is installed. One winch pulls a car up to the turntable, whereupon another cable, coming from a winch at the head of the second stretch of track, is attached. The car is then turned to the other set of rails, and locked in position on the table while the cables are being changed.

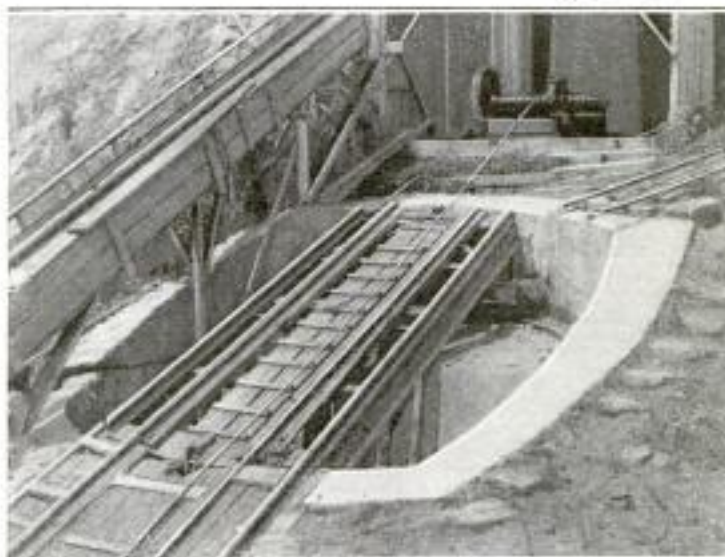

Turntable Built on an Incline: At the Upper Right are Shown the Winch for Pulling the Car Up to the Turntable and the Tracks Leading to the Second Winch, Which is Located at the Top of the Incline

Engr. J. B. Holdcroft, 1485 Ford St.

Victoria, B. C., Canada

Copyrighted material

Reliance Trailers  
+ Truck Co.

528 POPULAR MECHANICS  
9950 San Francisco

**ALL-STEEL LOGGING WHEEL  
FOR TRACTOR USE**

A California company is now using an all-steel logging wheel in connection with



Above: Close-Up of Logging Wheel. Below: Wheel under Pull and Log Raised

a crawler type of tractor. Aside from its all-steel construction, other features of the design are the wheels, 6 feet 6 inches



Crawler-Type Tractor and All-Steel Logging Wheel Engaged in Hauling a Large Log through the Forest in California: Note How the End of the Log at the Wheel is Held above the Ground

Mrs. Duquesne  
Burner Serv. Co.

Jenkins Arcade Bldg Pittsburgh

high, with tires 10 inches wide and special bearings in the hubs, and a rack and pinion on the reach for raising the load under pull. The gear ratio is such that the load is readily lifted clear of the ground when the wheels are under pull and quickly dropped if the wheels tend to crowd the tractor on downgrade. The wheel has a capacity of 2,000 feet of lumber per load, and it has been found that when logging at a distance of 800 feet, at an effective tractor speed of three miles per hour, this equipment will easily deliver 9,000 feet of lumber per hour.

**LARGE POWER PLANT OBTAINS EFFICIENT GAS BURNING**

Evaporation tests recently concluded at the world's largest gas-fired boiler plant of 12,600 horsepower, seem to upset the quite prevalent idea, that natural gas can only be burned economically under high pressure. In this test, lasting 14 hours, with an average gas pressure of less than 6 ounces, and at boiler loads of 110, 214, and 302 per cent, an average gross efficiency of 87.8 per cent was obtained.

These excellent results are attributed mainly to a recently invented low-pressure type of natural-gas burner, as it was recognized that economical results could not be expected from the older types of burners, requiring higher gas pressure than is now generally available.

Installed by Union Electric Co., Cincinnati, O.



9908 Burners made by: -  
 Duquesne Burner Service Co  
 POPULAR MECHANICS  
 Jenkins Arcade Bldg 579  
 Pittsburg Pa.

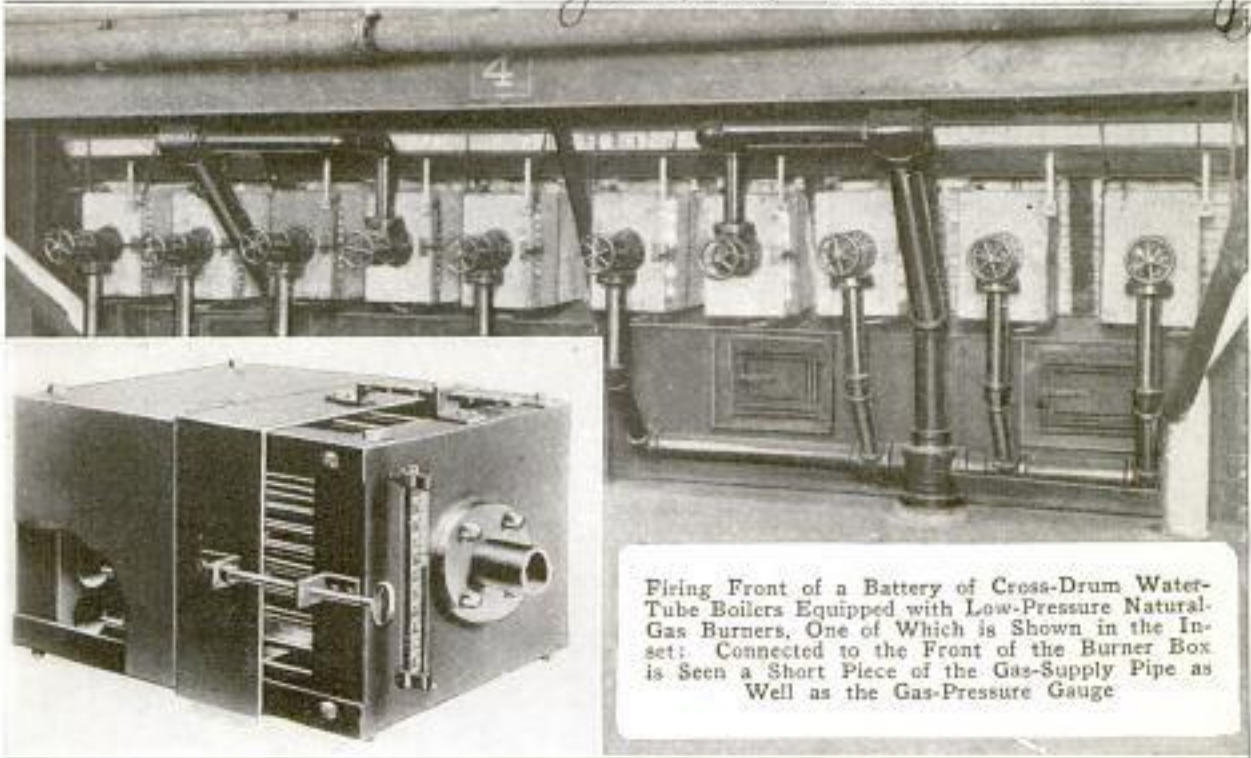

Firing Front of a Battery of Cross-Drum Water-Tube Boilers Equipped with Low-Pressure Natural-Gas Burners. One of Which is Shown in the Inset: Connected to the Front of the Burner Box is Seen a Short Piece of the Gas-Supply Pipe as Well as the Gas-Pressure Gauge

The advantages claimed for the new burner are: that it will operate efficiently at any practical boiler rating, with a gas pressure varying between 1 and 4 ounces; that back-firing is impossible; that the annoying vibration and roar of the high-pressure types is eliminated; that burning out of nozzles is prevented because of the low pressure, and that a nonoxidizing flame is produced.

The gas supply is connected to a cast-iron box at the front of the burner, from which lead a number of small pipes to the back or burning end, where the mixing plate is located. This is provided with holes corresponding to the number of nozzles. The whole is surrounded by a steel box, which, with the assistance of a telescopic slide, regulates the admission of air. A slight draft from the furnace supplies the necessary air.

9955  
**WINDSHIELD FOR REAR SEAT  
 ON AUTOMATIC ROLLERS**

Passengers in the rear seat of an automobile can now enjoy the ride without any discomfort caused by the strong wind, by the use of a simple and flexible windshield or screen which has lately been introduced in Paris. The contrivance, which is made of celluloid, has two sections, each of these being housed in a small nickelplated tube that is fastened to the side of the car. When the occupant of the rear seat objects to the wind, he merely reaches over and pulls the two

sections of the screen to the center of the machine and hooks them together.



Flexible Windshield for the Rear Seat being Pulled from the Cylinders and Fastened in the Center

When the windshield is no longer desired, it is simply unhooked, and a tension spring automatically rolls it back into the tubes.



Flexible Windshield in Position, Showing How the Rear Seat is Adequately Protected from the Wind

Paris. Brise Arriere L. C. Copyrighted material  
 4 Boulevard de la Madeleine, Paris, France

## INTERESTING MEMORIALS OF NOTABLE



The First of a Series of Tablets That will be Erected at the Various County Seats of the Eighth Judicial Circuit of Illinois, Which Abraham Lincoln Rode, between 1847 and 1857, While Practicing Law



Monument Built at Bloomington, Illinois, to Celebrate the Centennial of the Arrival of the First White Settler



Drinking Fountain Erected at Kansas City, Missouri, as a Memorial of Lieutenant William T. Fitzsimons, of the U. S. Medical Corps, Who Was the First American Officer Killed in the World War



Finally Adopted Model for the Statue of Theodore Roosevelt to be Erected at Portland, Oregon: The Monument Represents Roosevelt as Colonel of the Rough Riders during the Spanish War. The Statue, Made of Bronze, will Be 13½ Feet High, and 25 Feet Together with the Base

## HISTORICAL EVENTS AND PERSONAGES



The Actual Horse, Stuffed and Preserved, That was Ridden by General Sheridan during the Civil War: The Horse, Called "Winchester," has Long Stood on Governor's Island, New York, Bearing Sheridan's Own Saddle. It was Recently Moved to the Smithsonian Institution, Washington, District of Columbia, Whither It was Accompanied by Veteran H. W. Valentine, of Brooklyn, Who Was in Charge of "Winchester" during the Civil War

The Monument Shown Below has been Erected at Verdun, the Scene of France's Greatest Effort and Heaviest Sacrifice, during One of the Most Critical Periods of the Great War. The Heroic Defense of the City of Verdun, and Its Surrounding Fortifications, was Stimulated by the Determination That "They shall Not Pass." This Declaration was Not Disproved, For Not One German Reached Verdun—Except as a Prisoner

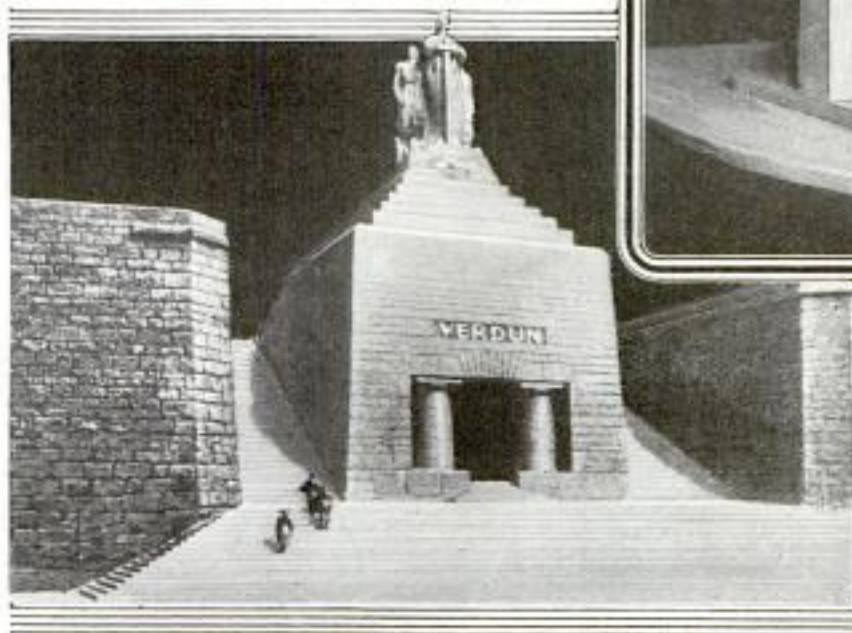

COPYRIGHT, AURELY VERMOULEN

Above Is a Photo of the World-War Service Memorial, with Drinking Fountain, That is to be Erected at Newport Beach, California. The Three Columns beneath the Effigy of "Victory" Symbolize Respectively the Army, the Navy, and the Marine Corps. The Monument will Be of Marble and Bronze

986<sup>3</sup> COLLAPSIBLE ROWBOAT MADE TO CARRY THREE

That it can be assembled in three minutes by the merest novice, is one of the features of a new collapsible boat which has a carrying capacity of 500 pounds, or three persons of ordinary size. The frame of the boat is of heavy waterproof canvas which folds in accor-



dion fashion, but when opened to full length, strong strips of ash are inserted into brass clamps along the sides and bottom, forming rigid gunwales and a keel. Latticed floorboards give further rigidity to the craft. The whole outfit weighs only 30 pounds.



Upper Center: Collapsible Rowboat Shown Packed Ready for Carrying on the Running Board of an Automobile. Lower Left: Boat Shown Partly Assembled, with Oars, Latticed Floorboards, and Ash Strips on Ground in Front of It. Lower Right: Boat Entirely Assembled for Use

9705 **INGENIOUS RIG FOR HAULING LONG BRIDGE TIMBERS**

Because of the sharp curves on the narrow roads in some parts of British Columbia, special methods must be adopted for hauling the long timbers needed in bridge construction. When building a bridge near Williams Lake, timbers 62 feet long were hauled by using a home-made rig fashioned like the ladder truck of a fire department. By fastening the front running gear under the rear end of the timber and connecting the tongue to a capstan above the tim-



ber. By fastening the front running gear under the rear end of the timber and connecting the tongue to a capstan above the tim-

Rig for Hauling Long Bridge Timbers around Sharp Curves: The Man is Operating the Steering Apparatus of the Rear Truck

Columbia, special methods must be adopted for hauling the long timbers needed in bridge construction. When build-



Full-Length View of the Rig, Showing That It would Be Impossible to Haul Such Long Timbers without the Special Steering Gear at the Rear

*Cmd. R. J. Island, Cariboo Logging Co. Canada  
 + Seed Co, Williams Lake, B.C.*

*Hartford, Conn*

ber, it was possible to steer the rear end of the timber and make the trailer follow the wagon that carried the front end of the long timber.

9958 — *engine accessories*  
**VENTURI-TUBE PRINCIPLE  
IN EXHAUST MUFFLERS**

By making use of the properties of the Venturi tube, a new muffler has been developed that will eliminate the noise of rapidly expanding gases, such as the exhaust of an engine, and as there is no retardation of the flow of the gases, there is also no back pressure, or, at the most, much less than in mufflers of the ordinary straight tubular construction. These silencers are cylindrical and are of two types. One that is used in connection with gas and oil engines is attached to the end of the exhaust pipe. It consists of a series of tapered tubes that alternate with straight tubes so as to give a series of Venturi discharges. The other type is intermediate on the exhaust pipe, and



New Type of Muffler That Connects to the End of the Engine Exhaust Pipe: The Small One Is for Three-Inch, the Large One for 12-Inch Pipes

is used on large engine installations on motor ships. Inside its cylindrical housing are a series of cast-iron units attached to the cylinder head, and these are in the form of spirallike passageways, in which at intervals are diverging and converging Venturi throats.

9965 — *Auto accessories*  
**AUTOMOBILE GREASE GUN  
OPERATED BY AIR**

Grease guns are now in favor for forcing grease under pressure into the working parts of automobiles. An improvement of this idea is a new grease gun that is not operated by a hand plunger but takes air from the spare tire, or other

source, which forces the grease into the desired part. A flexible hose supplies air to the gun, and a similar hose connects it

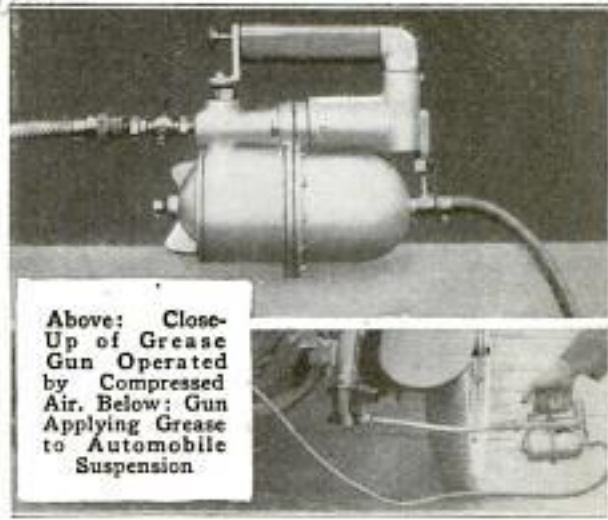

Above: Close-Up of Grease Gun Operated by Compressed Air. Below: Gun Applying Grease to Automobile Suspension

with the part to be lubricated. A trigger, operated by the thumb, serves to control the flow.

9980 —  
**HAND-OPERATED ICE MACHINE  
FOR USE IN THE HOME**

Making ice by hand is a rapid and inexpensive process when a small machine recently introduced in England is used. The action of the machine is based on the principle that water freezes when rapidly evaporated in a vacuum with sulphuric acid to absorb the vapor. The contrivance is especially adapted for icing mineral waters, making ice cream, cooling butter, etc., and if desired, a block of ice weighing 2 pounds can be produced in 20 minutes, thus proving the machine to be a valuable and handy addition in any home when it becomes necessary to provide ice in an emergency.

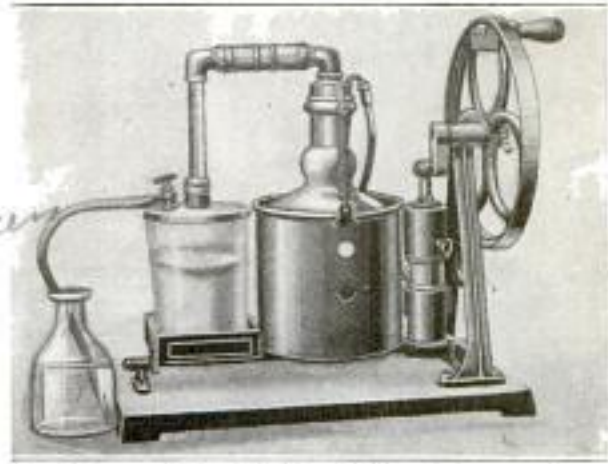

Hand-Operated Ice Machine Which Is Inexpensive & Use in the Home, Showing the Compact Form of Its Construction

*Great*  
d. us. Malcolm Mitchell  
Lubricating Co.  
Alameda, Calif.

*Engineering & Instrument Co. Ltd. 11 Southill St. Westminster S.W. 1, England*

584  
9956

### FIVE TOOLS FOR ONE HANDLE OF LIGHT GARDEN SET

Five tools which can be interchanged in one handle compose a garden set now on the market. The tools are constructed

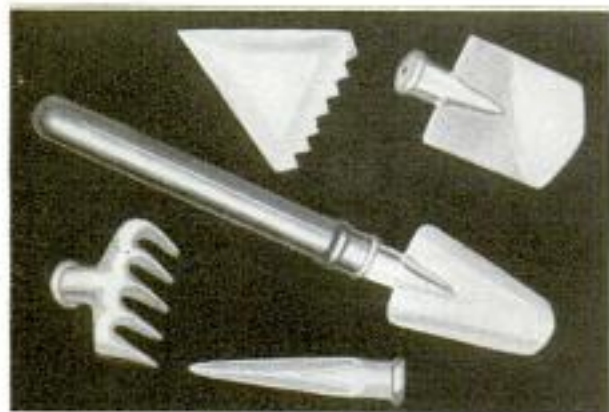

Garden Set Consisting of Five Aluminum Tools Which can be Conveniently Interchanged in One Handle

of aluminum, and consist of a trowel, spade, rake, weed scraper, and seed-trench hoe. The handle, made of wood, is only 9 inches in length, and the complete outfit is an efficient and lightweight set, which should be welcomed by anyone engaging in garden work.

### REAMER HOLDER TO PRODUCE ACCURATE REAMING

In order to obtain accurately reamed holes, the reamer should be rigid. A holder, adaptable to turret lathes, has been developed that insures the proper centering and alinement of the reamer with the work. This is accomplished by means of hardened and ground machine-steel faceplate adapters that can be at-

tached to the tool holder or the turret of the lathe. The reamer holder and the centering plug are made interchangeable to fit the faceplate adapter, and in this way the work is accurately centered, and alined, and afterward reamed.

9825

### NEW DEVICE FOR HANGING PICTURES AND MIRRORS

An adjustable device, for hanging pictures and mirrors, provides two hooks upon which to rest the lower edge of the frame. A chain, attached to the top of the frame with a hook, passes through a pulley fastened to the wall, down to a hook in the wall, where it is secured. With this arrangement the picture or mirror is adjustable to any angle and

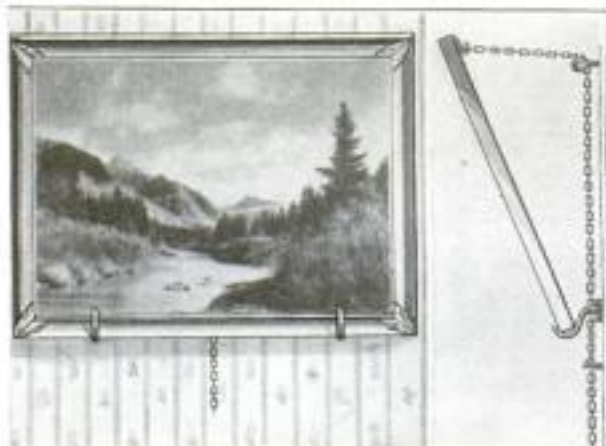

Convenient Device for Hanging Pictures and Mirrors, Which It Holds at the Desired Angle: It Is Adjustable to Suit the Frame

cannot mar the frame, work sideways, or jar down. This simple device accommodates itself to the size of the picture frame or mirror.

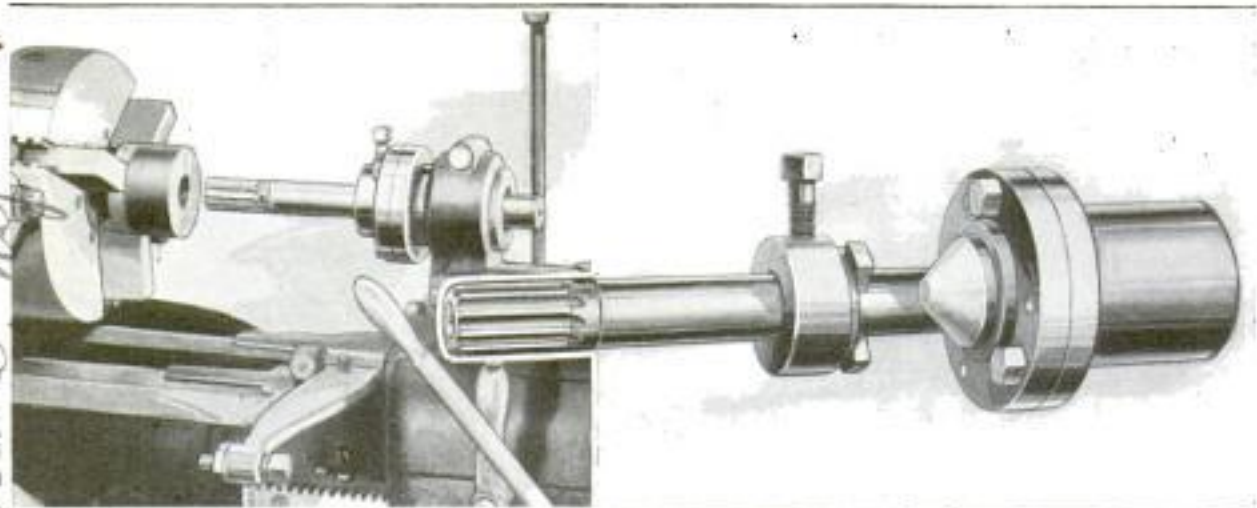

Left: Reamer Holder and Reamer as Attached to Turret Lathe, for Producing Accurately Reamed Holes.  
Right: Reamer-Holder Adapter with Faceplate and Centering Plug;  
Also Reamer and Reamer-Holding Collar

Marvin & Casler Co.  
Cincinnati, Ohio

*Reigley, England.*



A Motor Van Equipped with a Cooking Stove Brings Cooked Fish and Potatoes Direct to the Housewife Ready to be Served Hot on the Home Table, While a Counter Provides Service for Transient Trade

*Motor Van*  
**TRUCK BRINGS READY-COOKED  
9341 MEALS TO HOMES**

The tendency of modern times seems to be the reduction of household drudgery to the lowest possible limit, and with this idea in mind, a man living in Leeds, Eng., has fitted up a truck as a traveling kitchen, from which he delivers cooked fish and chipped potatoes to the housewife, ready to be served on the table. The food is cooked in specially fitted pans over a coal fire. The truck also makes the rounds of carnivals or athletic events where large crowds are accustomed to gather, serving the same fare from a counter in the side of the vehicle.

*9684*  
**TIERING MACHINE DOES WORK  
OF NUMEROUS KINDS**

Tiering machines, although primarily designed for the purpose of stacking or piling boxes, crates, etc., in warehouses and on docks, can also be used in various other ways. One of these machines, manufactured by a Chicago concern, was recently utilized by a rigging gang in hoisting radiators, motors, line shafts, and heavy pipe to hangers on the ceiling. The appliance is actually a hand-power elevator, having a platform that is raised by the turning of a crank and lowered by

gravity, a lifting capacity of 1,500 pounds, and a removable section so that it has a fair range of adjustability for operation with varying ceiling heights.



An Unusual Job for the Box-Stacking Machine: It is Here Used by a Gang of Millwrights to Hoist Fittings to the Ceiling of a Shop

*Economy Engineering Co.  
264th  
Van Buren, Chicago*

9860

Cml. Allen P. Child

Box 73, Station E, Kansas City  
Mo.

Magnificent View from One of the Heights near the Inn in the Recreational Park, near Butte, Montana: The Inn can be Seen in the Mid-Distance beside the Yellowstone Trail. The Park Has an Area of 3,600 Acres

## PLAYGROUND FOR THE PEOPLE IN NATIONAL FOREST

The city of Butte, Mont., has recently been the object of a signal piece of national legislation in acquiring the use of a playground area for its people in the Deer Lodge National Forest, as briefly recorded in the August issue of this maga-

zine. For some time the city authorities had been desirous of using this tract for a park, but as the national-forest lands are open to mineral prospecting, the fear that whatever improvements might be made by them would eventually be hurt



Close-Up of the Inn in the Park That Forms a Playground Area in the Deer Lodge National Forest Set Aside for the Use of the People of the City of Butte: The Inn Is Only About Nine Miles from the City





The Park Reserved for Recreational Development Viewed from Lookout Point, and Showing a Short Stretch of the Yellowstone Trail: This Part of the Trail has been Given the Name of "Harding Way"



Another Part of the National Forest That has been Set Aside by the Secretary of Agriculture, by Authority of Congress, for Recreational Development: It Is on the Yellowstone Trail. At This Part of the Park Are Many Ideal Sites for Summer Homes

or spoiled by claim locations, kept them from doing anything definite in the way of establishing the park. So, recently, Congress passed a bill which empowered the secretary of agriculture to set aside for the recreational development of Butte the tract which is located nine miles from Butte on the Yellowstone Trail. The only purpose of the bill was to prevent prospectors from entering the segregated portion and taking up land there under the mining laws. The Forest Service is given absolute control over all

9823

### CURIOUS ARMORED SUITS OF GILBERT ISLANDERS

Perhaps the strangest and rarest armor in the world is that once used by the Gil-

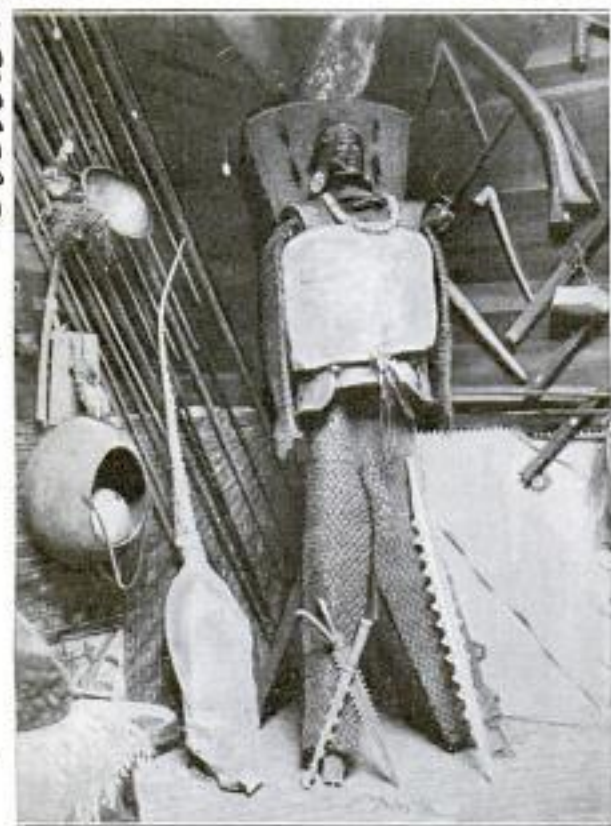

Suit of Armor, Made from Fish Skin and Woven Coconut Hair, Once Worn by a Chief of the Gilbert Islands

bert Islanders in the South Seas, the only branch of the Polynesian people who ever reached the height of producing a coat of mail. The armor, of which only a few examples remain today, consists of an undergarment covering the legs, body, and back of the head, and a breastplate. The under part is woven from the coarse hairy cover of the coconut. The skin of the ray fish, which dries almost as hard as steel, but is very light, is made into a breastplate. This armor will turn

forms of entry, so that the lands are as free from unauthorized use as if the city owned them in fee simple. One of the purposes of this service is that of encouraging all legitimate uses of the national forests, and it is felt that the legislation in favor of the development of the recreational life of Butte, will do more to help in that respect than any other that has been passed since the forest was created. The tract made available to the city is about 3,600 acres in extent, in Nine Mile Cañon.

any spear, sword, or knife of native make. But more interesting than its making is its former use, proving that knights who did chivalrous battle were not found in Europe alone. So difficult was the armor's manufacture that only one suit was owned by each Gilbert Island village. Thus, when trouble arose between two villages, the best man from each donned his armor suit and went out and settled the matter by single combat. The introduction of the white man's ways and his weapons has caused the almost total disappearance from native ownership of these strange but skillfully made suits, most of them having been carried away by collectors.

### CONVENIENT T-SQUARE GUIDE FOR DRAFTSMEN

Draftsmen often find it necessary to work on a drawing that is beyond the reach of their T-square, or on a long drawing that has to be rolled. In such instances a straightedge guide, readily attached to the board or table top with thumbtacks, will serve the purpose of holding the head of the T-square in alignment as, in the ordinary manner of working, the edge of the board does.



Draftsman Working on a Rolled Drawing and Using a T-Square Guide, Attached to the Board by Thumbtacks

*Jan Pranta Stepanek  
Lazenska 6, Prague 11  
Czechoslovakia*

*Cmd. Francis Shecke, Herold Bay B.C. Canada*

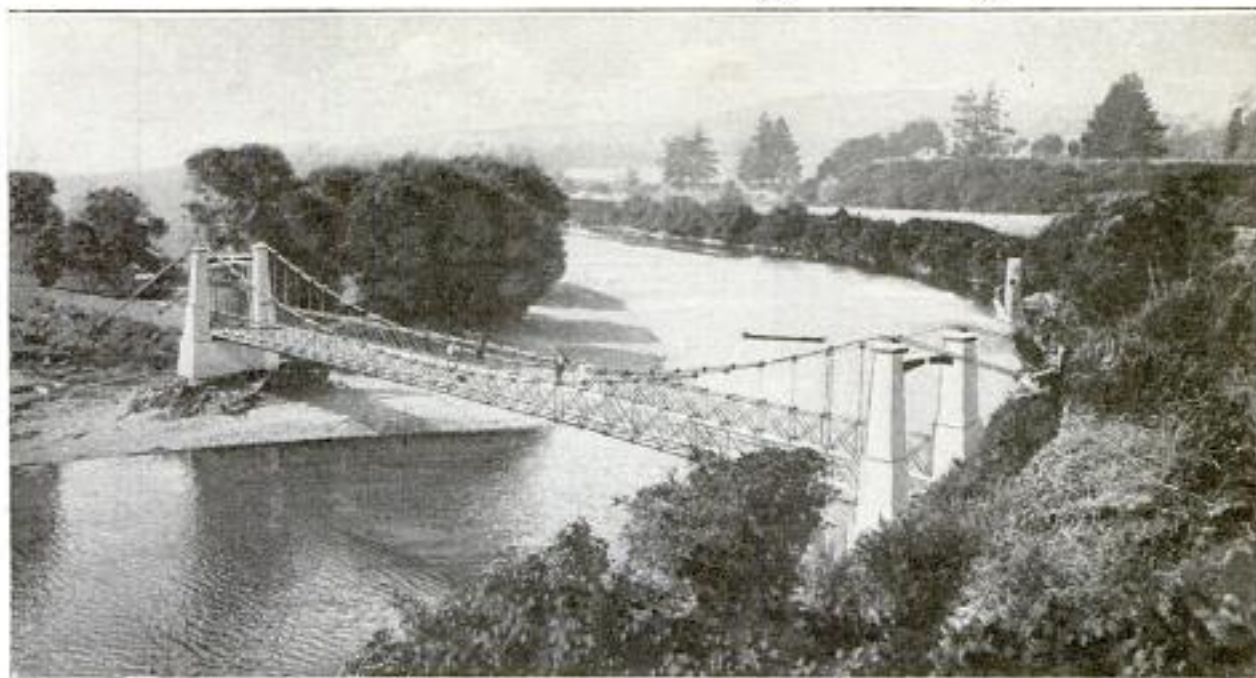

Suspension Bridge over the Hutt River at Maori Bank, New Zealand: It is Built Almost Entirely of Reinforced Concrete. On the River, in the Distance, is Seen an Old Native Canoe Which was Used for Bringing the Gravel for Making the Concrete down the River

9914  
**SMALL SUSPENSION BRIDGES**  
**BUILT IN NEW ZEALAND**

Several small suspension bridges of an improved type have recently been built in New Zealand. One of the best of them is over the upper Hutt River, at Maori Bank. It has a span of 170 feet, and is 12 feet wide. The towers are 25 feet high, and are of reinforced concrete on heavy foundations. The bridge span is suspended by 62 rods of  $\frac{7}{8}$ -inch iron, attached 5 feet apart by reinforced-concrete clips to eight suspension cables which pass over the tops of the towers on rollers and are anchored in concrete to a depth of 35 feet. The bridge deck is of reinforced concrete supported by the longitudinal girders, constructed with chords made of  $1\frac{5}{8}$ -inch pipe trussed with angle irons. The total load on the cables is 60 tons.

9924 — Haring  
**HEIGHT LIMIT OF BUILDINGS**  
**INCREASED IN LONDON**

The height limit of buildings in London, Eng., has been raised 20 feet, which nevertheless restricts them to the very limited height, according to American standards, of 80 feet from the pavement to the ceiling of the top story. This decision, recently made by the London county council, was accompanied by a regulation increasing the allowable floor area of any single compartment to 40,000 square feet, which will necessitate wall



Another View of the Bridge: The Towers Are 25 Feet High, the Bridge Deck Is of Reinforced Concrete and 12 Feet Wide

spans that will add considerably to the use of steel girders in their floor construction.

no information as to maker.

POPULAR MECHANICS

590  
9875

AMERICAN AUTO MAKES ATTRACTIVE HANSOM CAB



COPYRIGHT, UNDERWOOD & UNDERWOOD

Here is Pictured the Hansom Cab of Today, Built on a Light American Automobile Chassis. The Only Missing Parts Are the Shafts and Horse. The Driver's Seat Being in the Rear, the Passenger Enjoys an Unobstructed View and a Feeling of Greater Privacy

The introduction of the automobile with its conventionalized lines, has witnessed the passing of the picturesque horse-drawn vehicles of a generation ago. A revival of one of these has recently been seen on the boulevards of Paris, in the appearance of a modern adaptation of the once familiar hansom cab. The version of today shows the driver with his hands on the steering wheel instead of on the reins, and wearing a chauffeur's cap in place of the dignified "stovepipe." Our "cabby" does not worry about oats to fill the feed bag, nor about blanketing his horse.

9846

TRUCK WITH ELEVATING BODY FOR DUMPING

A motor truck with an elevating body for dumping directly into railroad cars, or wagons from the same ground level, obviating the necessity for loading platforms, is now in use in France. Guided in front by a vertical central post along which it slides, the body of the truck is raised from the chassis horizontally by the action of two pivoted

lever arms connected to the rear of the body, and which are operated by the truck motor. At the required height the front is raised further up the vertical guidepost, tilting the body so that its load is discharged. The rear end of the body swings open when discharging.

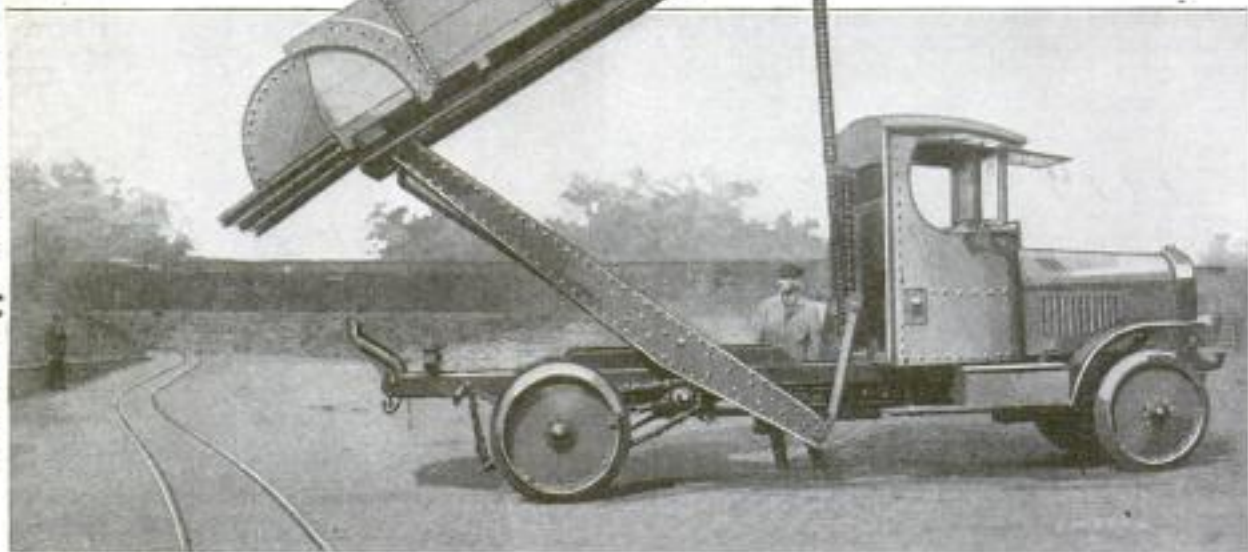

Truck with Dumping Body for Loading Cars or Wagons at the Same Ground Level: The Truck Body is Shown in Its Discharging Position after having been Raised by the Action of the Pivoted Lever Arms at the Rear, and the Vertical Post in Front of the Body

Krupp Plant, Germany



This Model of the "Leviathan," Built before the War by Expert Workmen Sent Over from Germany, was Held by the Alien-Property Custodian until Just Recently, When It was Turned Over to the United States Shipping Board and Now Stands in Its Offices at Washington

**MODEL OF "LEVIATHAN" PASSES  
9513 TO SHIPPING BOARD**

At the time when the "Leviathan," then the "Waterland," belonged to the Hamburg-American line, expert workmen were sent over from Germany to build a model of the famous ship. The model, 18 feet 6 inches long, 1 foot 11½ inches beam, and 1 foot 5½ inches in depth, was held by the alien-property custodian during the war, but has now been turned over to the United States Shipping Board and stands in the main hall of its offices at Washington. The model cost \$25,000 to build.

**9790  
USE AIR DRILLS AND WEDGES  
TO BREAK UP CONCRETE**

The difficulty of breaking up well-set concrete structures was forcibly illustrated at Second Avenue and 14th Street, New York City, when the work on the new subway along this street required a rearrangement of water mains, and electric and gas conduits. At Second Avenue two huge reinforced-concrete anchors were built for the hoisting and lowering cables used in this heavy work. Each of these artificial-stone bowlders was 15 feet long, 7½ feet tall, and 5 feet wide. As the two anchors were built on the outer edge of the sidewalk, their removal was begun immediately after the rearrangement work was finished. No blasting being allowed, the air drill was the only means of breaking up the concrete

anchors, so two drillers were put to work on each anchor, while two other men used the sledge and wedge for breaking off the drilled sections. While each



Above is Shown Men at Work with Air Drills, Making Holes in a Large Concrete Anchorage, Preparatory to Breaking It Up with Wedge and Sledge Hammer

anchor was built in a little over a day, it took almost two weeks to break up and remove each of them.

*Emil J. Benjamin Faucett  
40 R Parkside Ave  
Brooklyn, N.Y.*

9953

Hogal. Williams Safety  
Devices, Inc.

POPULAR MECHANICS

592

Quincy, Ill.

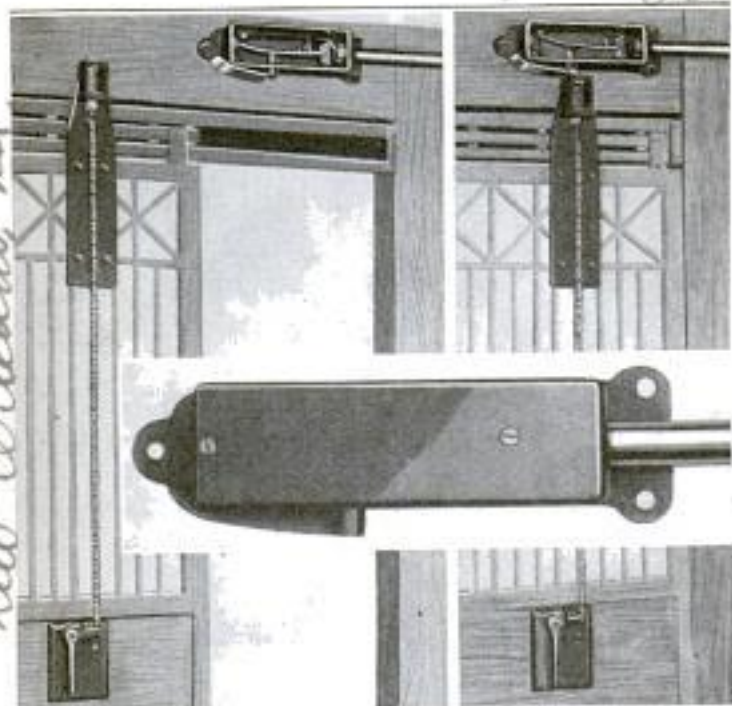
INTERLOCKING DEVICE  
FOR ELEVATOR DOORS

Interlocking Safety Device Shown at Left with Elevator Door Partly Open, and at Right with Elevator Door Closed and Locked. Inset: Dustproof Bakelite Switch Box Shown with Cover On

One constant danger of accident in connection with elevators in buildings can be eliminated by the use of an attachment that makes it impossible to start or operate the elevator when any of the shaft doors are open. Above each of the elevator doors is a dustproof electric-switch box which has a contact that operates in connection with a contact-making unit on the sliding door of the elevator, so that whenever any door is open, there is no contact at that point. This opens the elevator-control circuit, and the car cannot be moved until all the doors are closed, thus bringing the contacts into position for closing the circuit. An emergency switch is provided, so that the interlocks can be cut out in case of fire.

## CYLINDER GRINDER FOR LATHES AND MILLERS

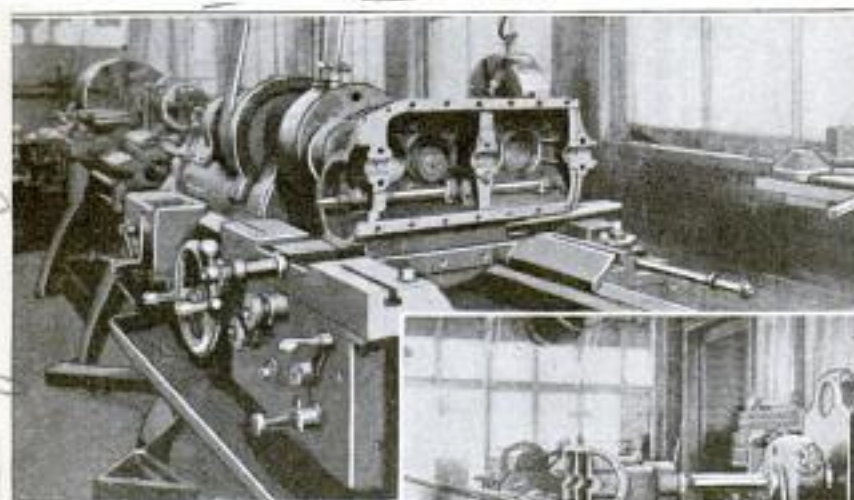

Above: Cylinder Block Shown Fastened to the Carriage of a Lathe, and being Ground

A cylinder-grinding attachment for either lathes or milling machines, produced in New Orleans, makes a special machine for this purpose unnecessary, and should therefore be of advantage to small service stations. The grinding head is mounted on the driving spindle of the lathe or milling machine, and the

cylinder block is centered and then fastened to the carriage of the lathe or the table of the milling machine. In the head is gearing for running the grinder at various speeds, and a special centering jig is provided.

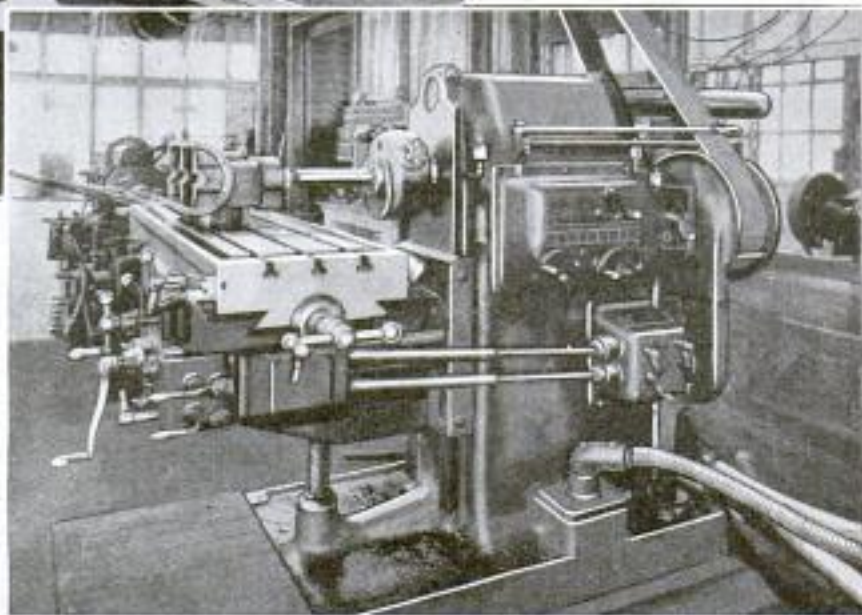

Cylinder-Grinding Device Operating in Connection with a Milling Machine: The Cylinder Block is Fastened to the Table, and the Grinding Head is Mounted on the Driving Spindle

Alexander & New Orleans  
New Orleans, La.  
9875  
Inclair Foundry & Engine Co.,

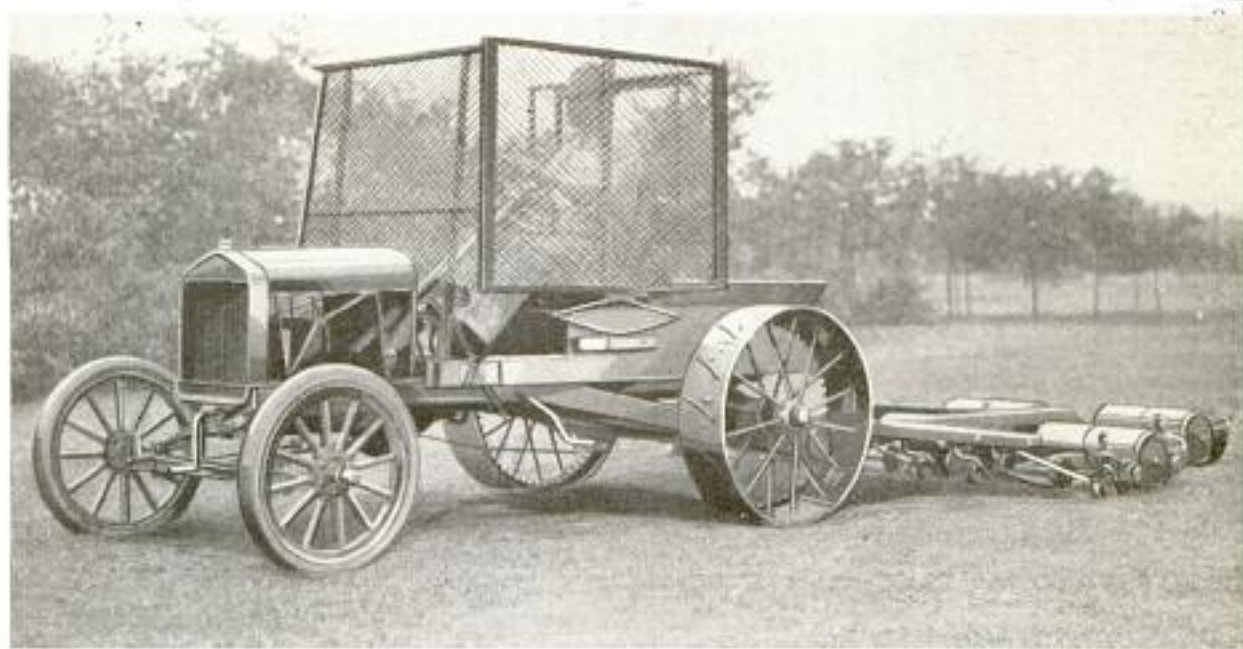

COPYRIGHT, UNDERWOOD & UNDERWOOD

The Wire Cage was Mounted on This Machine After the Driver had been Seriously Injured by a Stray Golf Ball. Two Horses were Killed on the Same Course before the Installation of the Motor-Driven Lawn Mower

### SHIELD LAWN-MOWER DRIVER FROM STRAY GOLF BALLS

Is the operator of a mowing machine on a golf course likely to meet with death? Authorities of the Lincoln Park golf course in Chicago answer in the affirmative. After two horses had been killed by misdirected golf balls, a small automobile was adapted to draw the lawn mower. The problem seemed solved. But the second day the driver sustained a blow on the head that resulted in a trip to the hospital. Now the driver is inclosed in a wire cage.

9797-3

### NEW FORM OF DOUBLE RUDDER BEING TESTED IN GERMANY

There is being fitted to an 8,000-ton motor ship now under construction at Hamburg, Germany, a new form of rudder, which has already been used with marked success, it is said, on comparatively small-sized vessels. Hinged to the rear end of the main rudder, which operates in the usual way, is an auxiliary rudder. To turn the ship to port, this auxiliary rudder is moved to starboard with the result that the water pressure on this auxiliary portion of the rudder moves the main portion to port. It is claimed that this greatly reduces the power required to move and hold the rudder, and that, consequently, smaller steering engines can be used.

9835

### DEVICE FOR STRINGING CORN IS SIMPLE AND RAPID

For rapidly stringing ears of corn so that they may be hung up for drying and for storage, a device has been invented that consists of inclined frames, over one of which the stringing cords are drawn tight, while on the other the operator weaves the cords successively around the ears. Horizontal guide bars, operated by the up-and-down movement of a treadle, cross the cords alternately over the ears, and weave them together without bruising them. The treadle operates against the tension of a coiled spring above it.



Device for Rapidly Stringing Ears of Corn So That They may be Hung Up for Drying or Storage, as Seen behind the Operator

Chr. Anton Flettner,  
(Seerman)

Dr. Charles  
M. Putnam, Alma, Mich.

Campbell, W. York +  
Cannon Foundry Co.

594

POPULAR

9882 *Muskegon, Mich*  
**REVERSIBLE FLANGE FEATURE  
OF NEW MANHOLE COVER**

In a new manhole cover, being adopted by the city of Chicago, the flange supporting the cover is made separate and reversible.



When the flange of the ordinary manhole wears out, the street must be ripped open and the entire support replaced. With the new cover, the base is permanent, and requires no attention after being firmly imbedded in the concrete foundation of the pavement.

Resting on the base is the inner curb, which has a flange to hold the lid. When the flange becomes worn, the curb is taken out and reversed.

**RUGGED ELECTRICAL HEATER  
HAS MANY APPLICATIONS**

Its ruggedness of construction and easy adaptation to many heating possibilities, are the features of an electrical appliance recently introduced by an eastern manufacturer.



The heater, which is made in various sizes, wattages, and voltages, has a sheet-steel outer casing containing holes for mounting purposes, while both of the terminals are on one side, leaving the other side

flat. Uses to which the contrivance can be put are the heating of presses, rolls,

London Times  
Eng. Section  
MECHANICS 8/22/22

ovens, rooms, booths, water tanks, and garages; the ripening of fruit; and protection of windows from frost, and drying of clothes in winter.

9969  
**TRACTION DYNAMOMETER GIVES  
NEW SOIL-TILLAGE DATA**

An amplification of the traction-dynamometer idea for measuring the soil resistance to tillage implements, records as well the distance, time, speed of travel, magnitude of pull, and average depth of cut. Oil in a cylinder is put under pressure, by a piston, varying with the tractor pull, the variations being recorded on a roll of paper. The drum carrying the paper is driven at a speed proportional to the rate of travel through a flexible shaft from a trailing wheel.

9940  
**SIMPLE DEVICE TO MAKE  
POPULAR CONFECTION**

Chocolate-coated, ice-cream-filled confections in various forms have become increasingly popular within the past year.



An interesting development of this idea is one recently advanced for putting them up in small cylinders that conveniently fit the hand. An added feature is that the confection can be easily

and quickly made fresh, as required, with a little machine for holding the shells, and a squirt gun for filling them.

9903  
**NEW CONTAINER IS A BOON  
TO CHEMICAL INDUSTRY**

Manufacturers and users of corrosive chemicals have long been handicapped in the matter of transport and storage. A patented container, now being put on the market, will enable them to realize the economy in first cost, handling and freight charges, and depreciation, as well as the safety and convenience that dealers of less active products have enjoyed. It consists of a flexible rubber cylinder suitably suspended in a wooden barrel.

Cleveland Cooperage Co.  
W. 61 1/2 street  
Copyrighted material

Westinghouse Electric Mfg. Co. 9944  
East Pittsburgh, Pa.

Chas. de C. Chicago 241 E. Illinois





The Cemetery of El Kur, on the Right Bank of the Nile, in the Sudan, Showing Several of the Tombs Uncovered by the Excavation, Which Revealed the History of 26 Generations of Ethiopian Kings, and the Arts of a Lost Civilization

## WORK OF THE ARCHÆOLOGICAL EXPLORER

By F. N. HOLLINGSWORTH,

168 *Charlmouth St., Boston*  
**P**EOPLE often wonder how the explorers of ancient ruins in Egypt, Palestine, Mexico, and elsewhere make their discoveries; how they know where to look for what they find, and how they know that anything may be found where they search.

The work of the Harvard University-Boston Museum of Fine Arts expedition to Ethiopia, which has spent 10 years in Egyptian archaeological exploration and is still working there, is an interesting example of how such explorations are carried out. Its search has resulted in the discovery, in an obscure village beyond the borders of Egypt, on the

213 *Trinity Bldg*  
 banks of the Nile River, of a great number of tombs which were found to contain the history of 26 generations of Ethiopian kings who ruled over Egypt, and

the recovery from beneath the deeply drifted sands of material buried and lost to human knowledge for thousands of years, revealing the arts and crafts of this lost civilization. The discoveries were made at Napata, the capital of Ethiopia.

Archæological exploration work requires engineering

and architectural knowledge, along with many other things, such as knowledge of ancient languages, hieroglyphics, ancient history, and the arts and crafts. The ex-



A View of the Burial Chamber of King Shebitku, with the Broken Coffin Bench Showing in the Foreground

plorer comes upon a mound, or series of mounds, of drifted sand in the desert in a region known to have been inhabited by ancient races. He sets his trained workmen to clearing away the sand, after first having made photographs of the undisturbed site. As soon as a tomb or pyramid is uncovered, the stairway leading into the tomb is the first to be cleared. This had been filled in after the funeral with the clean debris left after the excavation of the rock-cut chambers and the building of the pyramid. Then the plunderers came, at some time or other, and dug a hole in the clean filling of each stairway, this hole afterward becoming stopped up partly with the things that the grave robbers threw away as valueless, and partly with drift sand. The robbers were naturally after the gold and jewels they knew had been buried in the royal tombs.

It is easy to distinguish between the original filling and the debris of the thieves' tunnel. The objects found in the latter usually came from the royal burial chamber and, in the records of expeditions, have to be carefully distinguished from other objects. When the doorway at the foot of the stairs has been reached, the workmen begin to clear the pyramid above, or another stairway, until the record of the blocking and measurements of the stairs have been made. After that, the sand is removed, leaving only about 8 inches of the floor debris intact. Whatever is found in the sand—and it is usually little enough—is consid-

ered as having washed in from the thieves' tunnel outside. When the sand is out, then the serious and difficult work of examining the floor debris and removing it bit by bit begins, and for this only the most skilled Egyptian workers are employed, under the supervision of a member of the expedition. This floor dirt is to the Egyptologist what pay dirt is to the gold miner.

Detail photographs are made of the excavation as it progresses, both inside and outside of tombs and pyramids. Then the important objects which are found within are photographed, usually with a scale beside them, so that their actual size is shown. In the case of the Ethiopian expedition here referred to, some of the finds were unique. Outside of the importance of the discovery of a hitherto lost period of

ancient history, this expedition obtained a magnificent collection of specimens of the work of the royal craftsmen—of the goldsmiths, the copper-smiths, ivory carvers, makers of stone vessels, the faience workers, and the amulet cutters. In other words, the expedition established a practical monopoly of the royal works of Ethiopia, which have been brought to America and deposited in the Boston Museum of Fine Arts for the study and benefit of American craftsmen and designers. So small are many of the objects found in these ancient ruins, such as beads and amulets, that they would be lost or broken if picked up with



Necklaces of Garnet, Carnelian, Wrought Gold Beads, and Amulets, Taken from the Early Tombs of the Ethiopians



The Vaulted Burial Chamber of King Pankhi, with Stairway Seen Leading Downward

an ordinary shovel and turned over with the dirt. The work is done by hand, the débris being picked over and examined bit by bit. This care resulted in the finding of several strings of beads and necklaces of gold, garnets, faience, and semiprecious stones, which were later put together in matched order and photographed. Another discovery was a horse

cemetery—the first ever found in the Nile Valley. The graves were in four rows, and contained the horses of some of the famous Ethiopian kings. All had been plundered, but enough remained to show that each horse was buried upright with its head toward the south. The trappings found included a plume carrier of gilded silver strings and bronze balls.

9627

### NOVEL WHEEL PUMP FOR DRAINING MARSHLAND

But for a novel kind of wheel pump, designed by its owner, a now fertile farm of 196 acres bordering on Lake Erie, six miles west of Sandusky, Ohio, would still be mostly an untillable area of marshland, as it was only six years ago. The wheel, 16 feet in diameter, has a number of radial paddles, 14 inches wide, connected to a gear forming the wheel rim. Geared to this is a 9-horsepower gasoline engine that drives it. The wheel is mounted over a water pit, into which tile drains lead from all parts of the marshland. As the water collects in the pit it is lifted by the paddle wheel to a flume above, which carries the water into the lake. Whereas, before the use of this drainage system,

only a small part of the farm could be cropped, last year the farm produced



Wheel Pump That Drains 116 Acres of Marshland on a Farm Six Miles West of Sandusky, Ohio: The Wheel Is 16 Feet in Diameter

5,000 bushels of shelled corn, and wheat yielded an average of 35 bushels an acre.

9963

*Owner - Walter S. Harkness, Sandusky, Ohio.*

### BRICK CHURCH BUILT AROUND FRAME STRUCTURE

Building their big new brick church around the little old frame structure that

had served so long as a house of worship, was an idea conceived by the deacons of a colored congregation in Lexington, Ky. The reason for this odd procedure was the pardonable unwillingness of the zealous brethren in charge, to run the risk of losing any of the fickle members to a rival church during the construction period. Consequently, the imposing brick edifice was reared over the unpretentious wooden shack, the latter not being torn down until its presence hindered progress on the new building.



The New Brick Church of a Negro Congregation in Lexington, Kentucky, under Construction around the Old Wooden House of Worship

*Chm. James Ross, Box 132, Lexington, Ky.*

*Chas. Louis Fried 9814* *9966 London Times*  
*Box 301, Brooklyn, N.Y. Engineering Section*  
**POPULAR MECHANICS** *7/2*

**AUTO-THIEF SIGNAL OBSCURES  
 LICENSE WITH RED BARS**

A series of red bars which partly conceal the license plate and so draw atten-

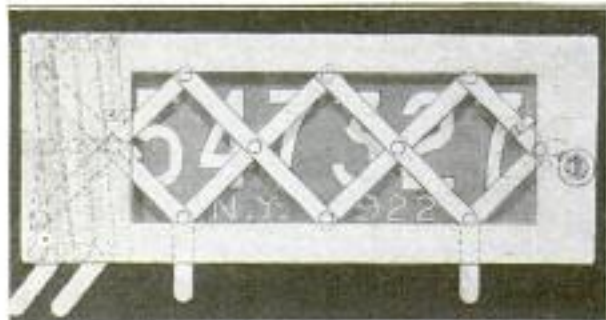

The Illustration Above Shows the Bars as They Appear When Extended and Locked. The Dotted Lines Show How the Bars Fold When Not in Use

tion to the fact that the car is illegally operated, is the feature of a new auto-theft device. The bars are manipulated on the principle of lazy tongs and are held by a bracket which forms a rim for the license plate. When the owner parks his car, the bars are extended and locked. Each bracket is equipped with an individual lock and key. The lock works on the regular snap-lock principle.

**TRANSFORMERS OF NEW TYPE  
 FOR DIRECT CURRENT**

Transformers, or "transverters," as they have been termed and which are to be used for converting alternating into direct current, are now undergoing extensive tests in London, Eng., preparatory to being installed for traction service in that city. These machines have successfully built up 100,000 volts for transmission lines, during experiments, and it is proposed to place similar apparatus along the lines at desired points, for the reduction of this high pressure to suitable working voltages.

*9656*  
**MIXER STIRS TANK CONTENTS  
 WITH VERTICAL MOTION**

Stirring the contents of vats, tanks, etc., with a vertical instead of the usual horizontal swirling motion, is possible by the use of a turbine mixer having a special multiblade rotor. The rotor extends to the bottom of the tank and its blades are placed at a 45-degree angle so that, in motion, they tend to draw the liquid, or semiliquid, contents downward at the center. Centrifugal force then throws the product being mixed outward against the sides of the vat, whence it is driven upward against baffle boards, thence in toward the center again, when a complete revolution will have been effected. Sand, cotton linters, pigments, fibers, and many other kinds of materials heretofore found difficult to mix thoroughly, or keep in suspension in a liquid, are easily handled by this mixer, which also greatly reduces the time of the operation.

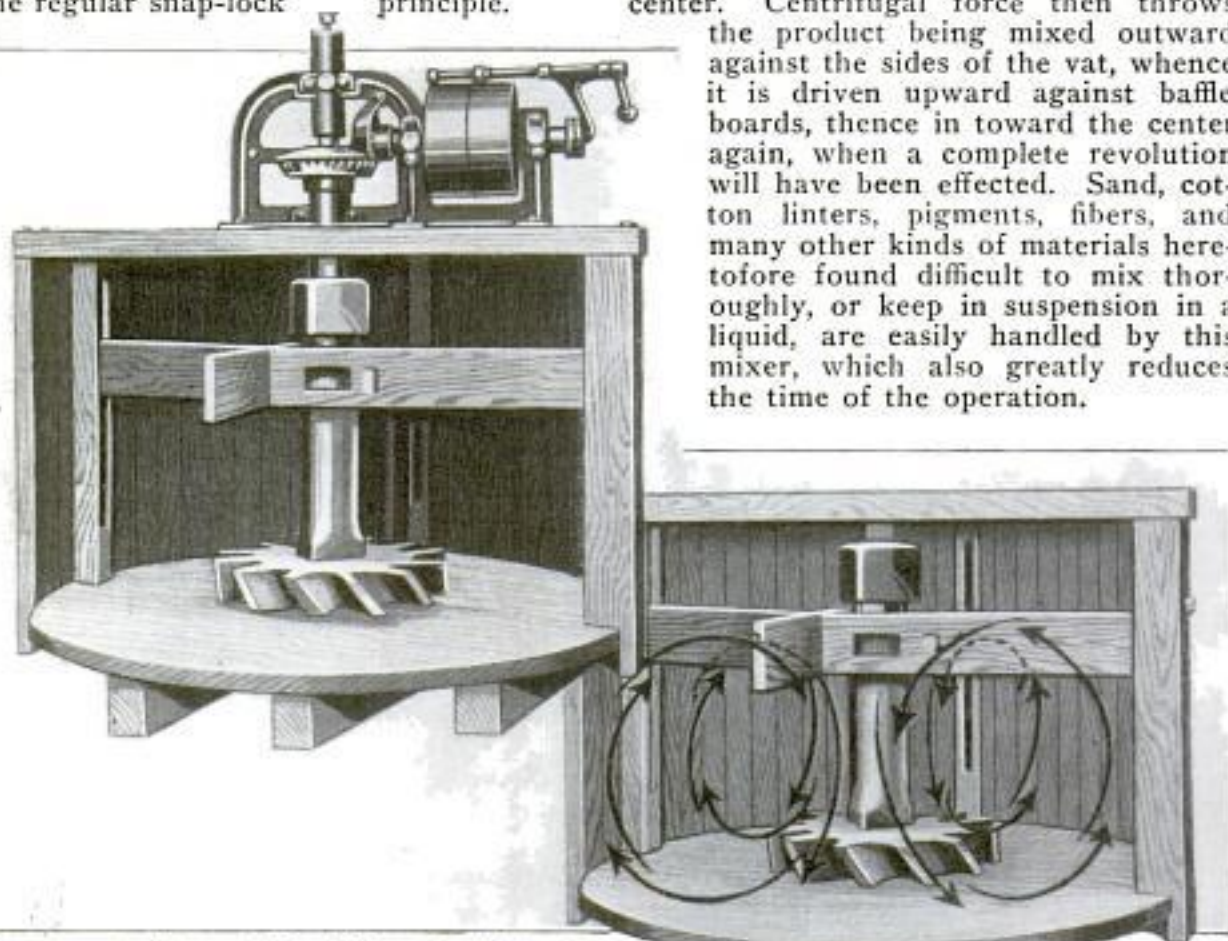

Two Internal Views of New Mixer, in Which the Angular Disposition of the Rotor Vanes Causes the Contents to be Stirred Vertically, as Indicated at the Right: The Baffle Boards Float on Top of the Liquid and Stop Any Tendency of It to Swirl Horizontally

*New England Lath & Tower Co.  
 Everett, Mass.*

*Chas. Frank H. Jones*  
*15 Rome St. Andover, Mass.*  
 Copyrighted material

9342 Cmt. H. J. Lundy, 137 E. 3rd St.

Los Angeles, Calif

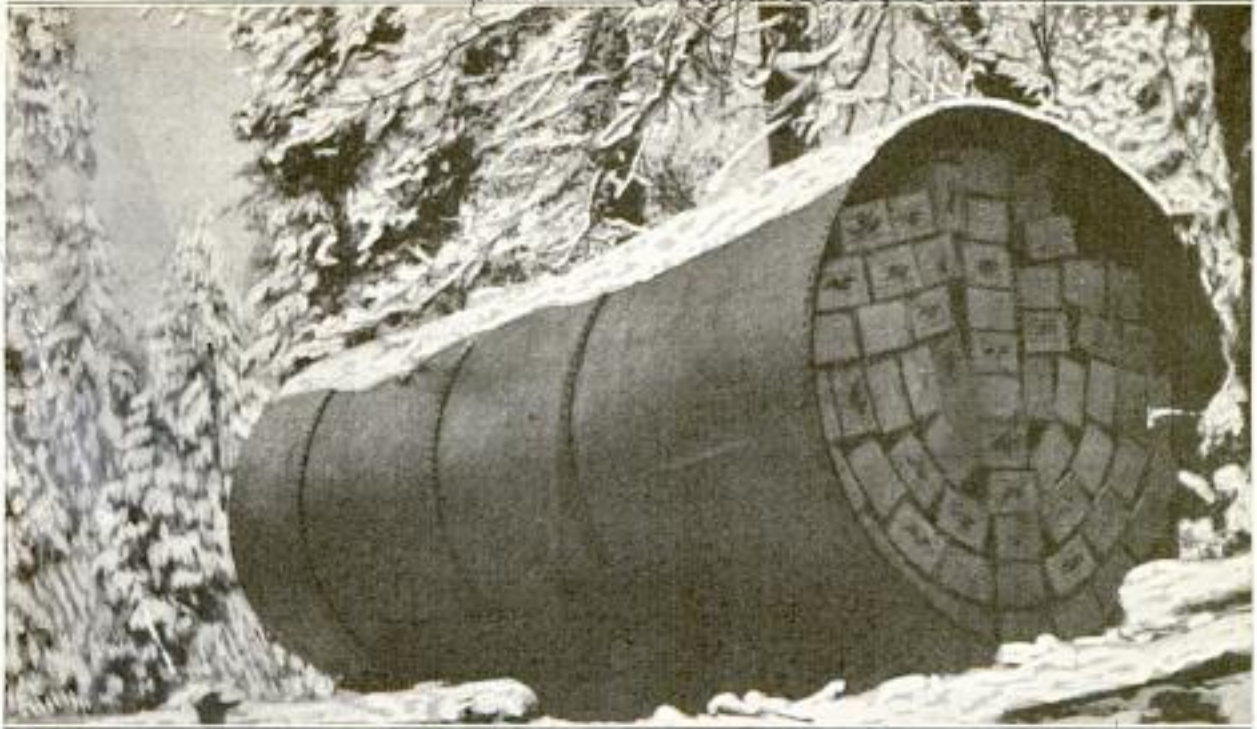

Penstock Pipe, 14 Feet in Diameter and 32 Feet Long, being Used as Storage for a Carload of Powder: The Pipe was Used in This Manner at the Railroad-Delivery Point of Materials and Supplies, Which Later were Hauled a Distance of 34 Miles over the Mountainous Country

9342

**PENSTOCK PIPES UTILIZED FOR STORAGE PURPOSES**

During the construction of a large power plant in one of the northern counties of California it was necessary to haul material and supplies by team over the mountainous country for a distance of 34 miles from the railroad to the power-plant site. Half the distance was at such an elevation that, in the winter, there was always plenty of snow to make good sleighing, while below the snow line there was a fairly good roadway. Among the material to be hauled were 90 pieces of penstock pipe, each 14 feet in diameter and 32 feet long. A bobsleigh was placed under the front end of the pipe, and the other end rested on a wide steel shoe, which acted like a runner. At the snow line the pipes were loaded onto motor trucks. While waiting transportation at the railroad station, as there was no other accommodation, these huge pipes were used as storehouses for groceries, explosives, and other merchandise easily damaged by the weather. 4649

**MONUMENT RECORDS ORIGIN OF POLAND-CHINA HOG**

The first monument ever erected to record the origination of a breed of stock was recently unveiled on a farm a mile north of the little village of Blue Bell, Warren County, Ohio, to commemorate

the birth, in 1850, of a strictly American breed of hog—a Poland-China. An opening was left in the foundation for a cop-



Monument Erected in Ohio to Commemorate the Origin of the First Strictly American Breed of Hog

per box containing a duplicate of the first pedigree, a volume of the first pedigrees printed, and other valuable articles. It will be sealed later.

Whenever you find that you wish to know more about any article in the magazine, write our Bureau of Information.

Cmt. Leonard A. S. Lye, 224 N. High St. Lebanon, O.

The Bleh Co. Inc.  
53 Park Place

600  
9887

POPULAR MECHANICS  
*New York*

PORTABLE RADIO EQUIPMENT  
SET UP IN FEW MINUTES

Portable radio sets for boy scouts, campers, motorists, yachtsmen, or vacationists in general, and which are con-



Portable Radio Outfit Opened, with Headpiece, Antenna, and Ground Wire Packed in the Cover, Ready to be Taken Out and Used

tained in a 6 by 6 by 3-inch box, weighing 3½ pounds, are now available. The outfit consists of a crystal-detector set having a range of 25 to 30 miles, which can be tuned to wave lengths of 100 to 600 meters; 90 feet of antenna wire; two insulators; 10 feet of ground wire; one ground spike, and a headpiece, all of which may be set up, ready for receiving, in 15 minutes.

DETACHABLE ROCK-DRILL BIT  
INDICATES ECONOMY

A radical departure in rock-drill practice is the adoption, by a western mining company, of a detachable drill bit. The bit and drill rod are fitted together

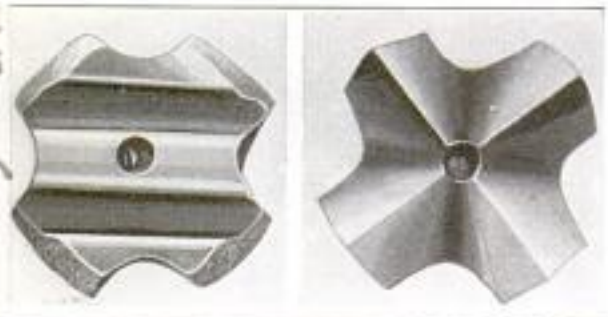

Right: Cutting Face of Detachable Rock-Drill Bit.  
Left: Showing Tongue on End of Bit, Which Attaches It to Drill Rod

with an accurately machined tongue and groove, which, being inserted on a taper, tighten with each succeeding stroke of the drill. A few blows from a hammer suffice to loosen the bit. This reduces the expense of handling the drill rods to and from the work for sharpening, and permits the use of the highest-grade steel in the bits, giving greater drilling speed. The bits can be reground, without retempering, to the next smaller size a number of times, thus eliminating another item of expense.

9832 *Pat. acc'd!*  
NEW SPARK-PLUG HOLDER  
PREVENTS FOULING

Some automobile engines pump oil into the combustion space. If the spark plugs are located in the cylinder wall so as to catch this oil, excessive fouling occurs. The result is irregular firing and unsatisfactory operation. A man exasperated with this trouble, has devised a holder which screws into the cylinder in place of the spark plug. The holder carries the spark plug in such a position that the oil does not reach the points, and fouling is prevented. An added advantage claimed

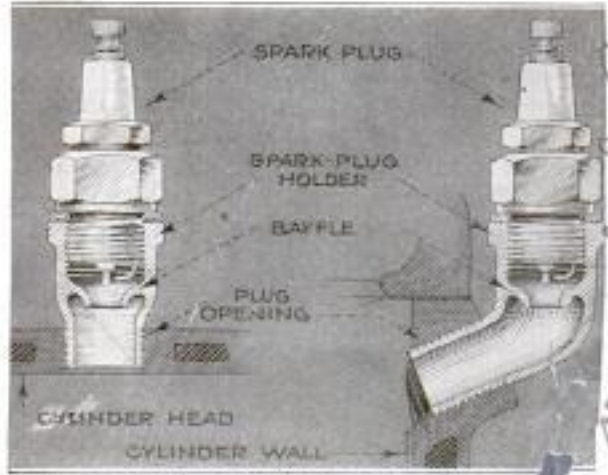

Left: Nonfouling Spark Plug Attached to Cylinder Head of Gasoline Engine. Right: Spark Plug Shown Attached to Cylinder Wall

for this device, is a perceptible increase in power. The holder does not become sufficiently heated to cause preignition, because the cylinder is water-jacketed at that point.

CA French scientific magazine reports that a method of utilizing earth currents of electricity has been found. No description of the apparatus is given, but it is inferred that ordinary electric lamps can be lighted by earth currents, and that when a special static transformer is available, distribution will be possible.

Hawkesworth Drill Mfg Co  
Butte, Mont.

Frank J. Heynolds  
Plymouth, Vermont  
Frank J. Heynolds  
Plymouth, Vermont  
Frank J. Heynolds  
Plymouth, Vermont

9949

Cont. Chas. W. Seiger, Press Club,  
 POPULAR MECHANICS 601  
 Powell + Sutter Sts, San Francisco

Calif.



#### MOISTURE TESTS MADE ON CONCRETE ROAD PAVING

ALONG either side of a test highway at Pittsburg, Calif., ditches were dug in such a manner that they could be filled with water to the level of the top of the subgrade. Through holes provided in the concrete paving, borings were taken of the subgrade, before the water was turned into the ditches and afterward, to determine the variations in its moisture content. In tunnels constructed under the paving, observations were made of the effect of different degrees of moisture on the carrying power of the paving under traffic conditions.

9821

#### SCHOOL WARDROBE CHANGES INTO BLACKBOARD

Wardrobe and blackboard are combined in a new piece of school furniture that seems both practical and convenient, especially for smaller rural schools. The wardrobe consists of five indi-

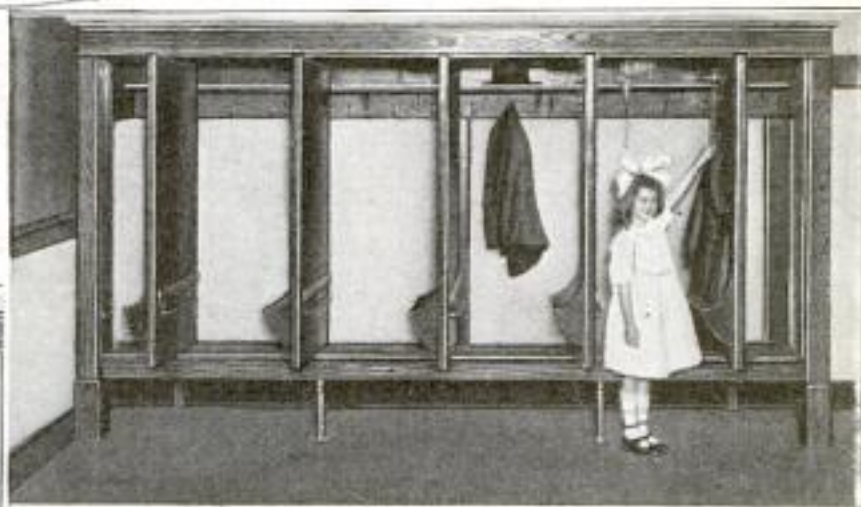

Open for Use as a Wardrobe:  
 Hooks for Hanging Clothing  
 Are along the Wall and on  
 the Inside of the Doors

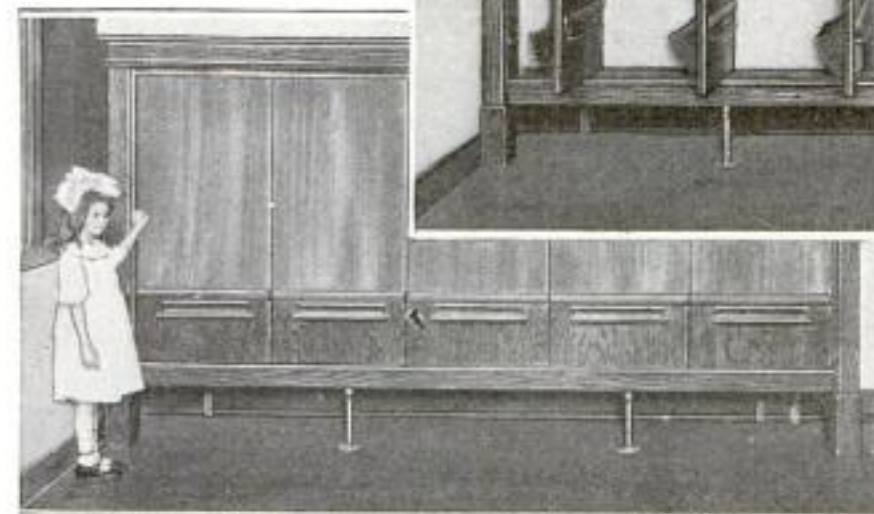

Closed and Ready for Use as a Blackboard: Notice a Ridge on Each Door for Holding Chalk. Beneath the Ridges Are Slits Opening to Small Trays for Books, Rubbers, or Other Odds and Ends

to the outer side of these doors, while clothing hooks are screwed both on the inside and along the wall. The doors also have small trays for odds and ends. Compared with the usual

vidual compartments with swinging doors, cloakroom, this wardrobe represents a saving in space of about two-thirds.

R. W. Supply Co. 123 W. 8th St.  
 Kansas City, Mo.

## CIVIC FEATURES THAT PROMOTE THE COMFORT



These Concrete Loading Platforms Are 12 Inches above the Street, and were Built by the Los Angeles Street-Railway Company to Prevent Reckless Motorists from Crowding or Injuring Prospective Passengers



In Memory of the Church Activities of a Morgan Park, Illinois, Woman, This Artistically Designed Drinking Fountain has been Erected, Showing a Child Holding a Squirrel Which is Gnawing a Nut



On This Post above a Front Porch in a Pacific-Coast City, is Mounted an Electric Lamp Which is Kept Lighted to Guide Visitors



In 1764, This Blockhouse, Located on What is Called the "Point," at the Junction of the Allegheny and Monongahela Rivers in Pennsylvania, was Added to Fort Pitt to Strengthen the Defenses of Pittsburgh, Then a Small Village



## AND ENJOYMENT OF VISITORS AND RESIDENTS



Motorists Stopping in the Public Automobile Camp in Woodland Park, Seattle, Washington, Make Good Use of This Huge Stove Which Accommodates 24 Cooks. A Tank is Included in the Outfit and Yields Boiling Water at Any Hour of the Day or Night

BRISTOL  
VA A TENN  
GOOD PLACE TO LIVE



When Passing through the City of Bristol, Located on the Virginia-Tennessee State Line, This Gigantic Electric Sign can be Seen. It is Mounted 200 Feet from the Railroad Station, 150 Feet in the Air, and on a Clear Night Is Visible from the Mountains, 18 Miles Distant

Above can be Seen the Artistic Arch of the Viaduct over the Church-Street Car Lines in San Francisco, California, with Seats for Prospective Passengers at Its Base. At the Right is Another View of the Viaduct Which Graphically Illustrates the Beauty of the Work

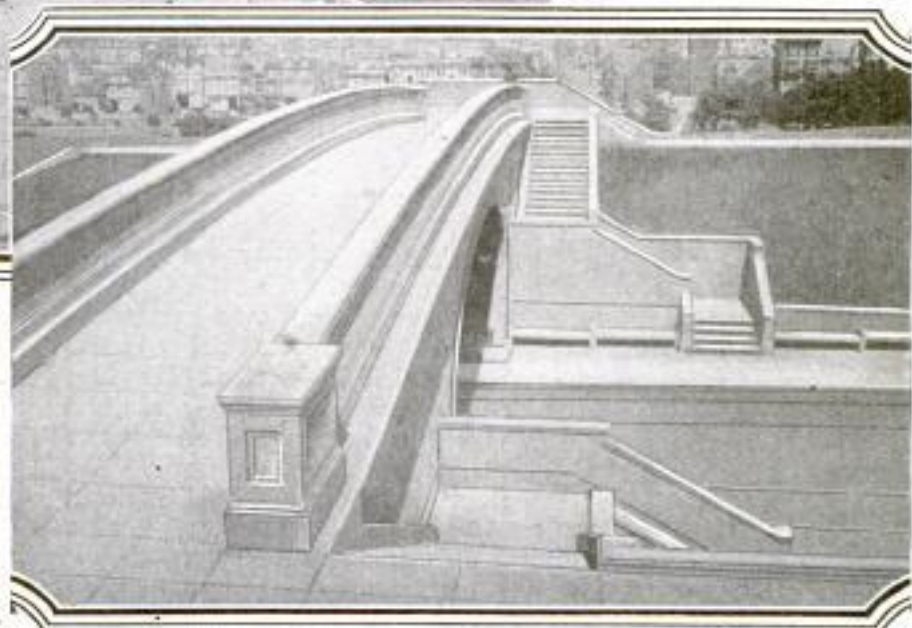

*Chas. W. Franklin & Taylor*  
330 S. 10th St.

604 *Lincoln Neb.* POPULAR MECHANICS  
8321 "GROWLER" ROPE WINDING AS HEAT CONDUCTOR

The "growler," an electrical appliance used in testing for grounds or short circuits between the coils of an armature, has been improved upon by a Lincoln, Neb., man.

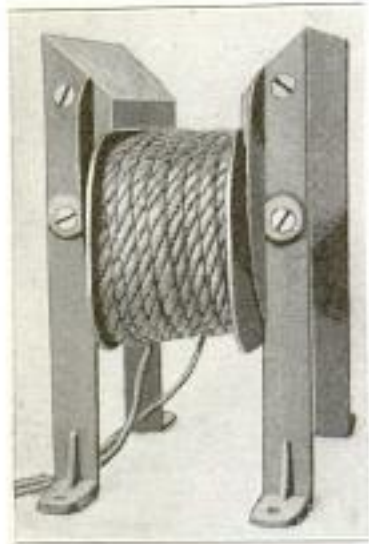

These growlers, which are so named because of the peculiar noise emitted by them during the testing operations, usually become excessively heated under continued use. The new unit has on the outside of its

coils, a winding of heavy rope, which is claimed by the inventor to be a better conductor of heat than is air, thus narrowing the possibility of burning out the apparatus.

9708 ELECTRIC MEASURING DEVICE FOR MINUTE DIMENSIONS

Measurements as infinitesimal as one five-hundredth of a millionth of an inch have been made by an electric measuring device recently constructed at the University of Cincinnati.

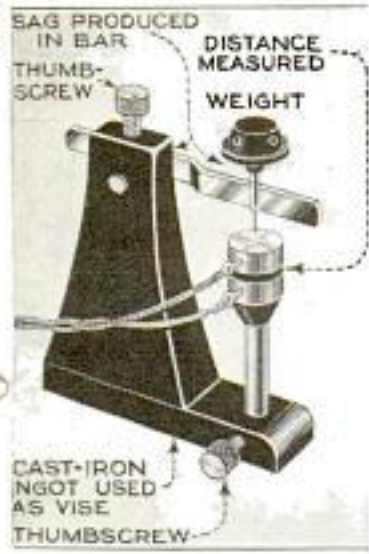

The instrument has an iron deflection bar 2 inches long and 1 inch thick, and when supported at one end, the deflection caused by the weight of a house fly on this bar has been measured. The device has been utilized in the field of radio

experimentation. If two continuously oscillating radio frequency circuits of slightly different frequencies are coupled to a common secondary circuit having

nearly the same natural period, an audible beating note will be set up. The unit of value of a variation of one beat a minute is first determined, and variations set up in the beats form a basis which makes the calculation of the minute measurements possible.

9947 LAMP MADE OF COWS' HORNS GIVES MELLOW GLOW

Cows' horns have been used in the construction of an ornamental table lamp, the finished product yielding a beautiful mellow glow.



The horns were rubbed down with emery cloth until they became thin enough to permit the rays of the electric lamp to penetrate them and disclose their natural coloring. All the pieces are perfectly fitted

together, and even the small nuts that hold the parts to the frame are made of polished horn, thus adding to the effect.

9461 EFFICIENT DEVICE HOLDS CARS SAFE IN TRANSIT

Some automobile manufacturers are using a new fastening for holding down the wheels in rail shipment.



Each wheel is prevented from moving sideways or endways by two pressed-steel blocks that fit the tire and are spiked to the car floor. The wheel is held down by a U-shaped rod which ends in a plate, bolted to the floor, and is suitably padded to avoid marring the spoke and rim.

*University of Cincinnati Ohio*

*Designed by Ernest Campbell, 200 Irving St., Wash. D.C.*

*Model by Ernest Campbell*  
Copyrighted material



New Trap Gun: At the Upper Left, the Man is Seen Setting the Trap After the Dirt has been Scraped Away, Exposing the Burrow of the Gopher. In the Upper Center is Shown a Phantom View of the Gopher Trap with Its Muzzle Pointed into the Animal's Burrow, Illustrating How the Cork is Placed at the End of the Trigger Wire. The Upper Right Shows the Gun Exploding After the Gopher has Exerted Pressure against the Cork Which Operates the Trigger. The Insert Explains the Different Parts of the Trap

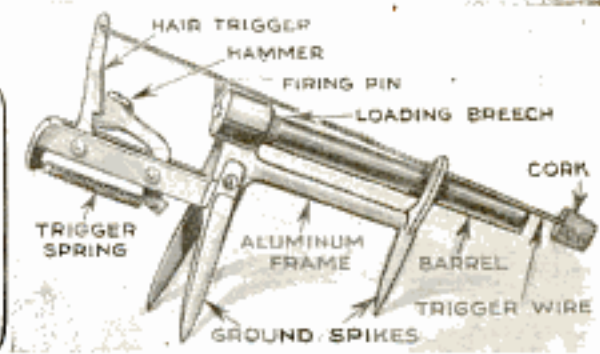

A self-exploding gun for the extermination of pocket gophers is now being used by a number of farmers who are bothered with these pests. It is also used, in some cases, against rats, ground squirrels, and skunks.

The gun looks like a miniature cannon. It is mounted on an aluminum frame with three ground spikes so arranged that the barrel can be pointed directly into the gopher's runway. It shoots a standard .410 shotgun shell. In setting, the dirt is first scraped away from the hole. The gun is then spiked

into the ground with the barrel pointing down into the burrow. A small piece of cork or cob is placed over the end of the trigger wire. With the trigger cocked and set, and the firing pin in place, the gun is ready for the discharge. As the gopher always tries to keep out all light from its runway, it will soon come up, pushing fresh dirt into the opening. The slightest pressure on the trigger-wire cork releases the hammer, and bang! the full charge of the shot hits the gopher in the face. The gopher virtually commits suicide.

Hubbers Equipment Co. Lincoln, Neb.

9898  
**HORSESHOE-PITCHING ARENA HAS TWENTY COURTS**

What is said to be the largest horseshoe-pitching arena in the United States was built at Des Moines, Ia., for the national horseshoe-pitching tournament, held at the Iowa State Fair in the last week of August. The arena contained 20 courts, all of them surrounded by bleachers. Women contestants used four, while the rest were occupied by men. Thirteen hundred dollars in prizes were awarded to the winners.

9923  
**METAL SNOWSHOE DESIGNED ESPECIALLY FOR CHILDREN**

Because there is no gut to be eaten or destroyed by ice, and because it is much lighter in weight and cheaper, an eastern company is manufacturing a metal snowshoe which it claims is practically indestructible. None of the standard features of the ordinary shoe have been

changed, except that nonrusting metal has been substituted for the gut weave and for the wooden frame. This makes

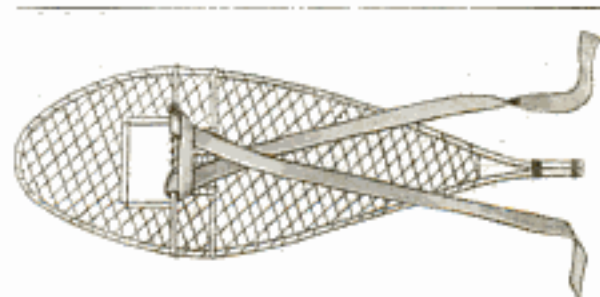

Nonrusting Metal is Used in the Construction of This Snowshoe Instead of the Regular Gut Weave and Wood

a lighter shoe which is especially useful for children.

□ We want all our readers to write us freely and often whenever they wish additional information on articles published in this magazine. Address Bureau of Information, Popular Mechanics, Chicago.

Letters returned 10/26/22

metal snowshoe Co. Inc. 739 Boylston St. Boston, Mass.  
 Copyrighted material

9867

## SOME NOVEL AND LITTLE-KNOWN ACCESSORIES



Electric Curling Iron Which Has a Swivel Attachment to Prevent the Cord from becoming Twisted



Rubber Heels Which can be Easily and Quickly Attached to Any Ordinary Slipper



Watch, the Size of a 10-Cent Piece, Which may be Used as a Cuff Link



Children's Bib, Which Has Sleeves in It to Protect the Garments and is Made of White Rubber So That It can be Easily Cleaned without Going into the Weekly Wash



Transparent Moth-Proof Garment Bag That Does Away with Search of Many Bags Before the Desired Garment is Found



Soap Container to be Hung on Edge of Pail When Scrubbing

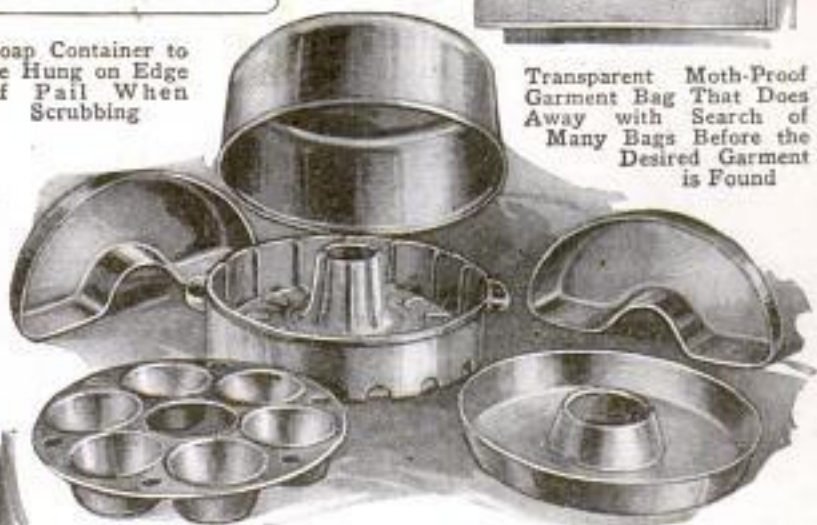

Bake Pot, and Some of the Pans That Go with It: The Pot is Designed to be Placed on Top of the Stove over the Gas Flame



Pantry Cabinet That is Ventilated, Rustproof, and Has Two Shelves Which can be Removed for Cleansing

Electric Hot Plate Which can be Used for Heating the Coffeepot, Making Toast, or Warming Baby's Milk at the Bedside



# INTENDED FOR THE HOME AND ITS MEMBERS

Fruit-Jar Holder Consisting of a Flexible Band That is Held around the Jar While the Other Hand Removes the Top



Combination Spoon and Fork for Use in the Preparing and Serving of Foods

Sc  
Pa  
B:  
B:  
R:  
Ga  
Fru  
by  
Camp  
G  
C  
F  
E



Evening-Dress Hanger That Prevents the Shoulder Loops from Slipping Off



Garden Set Consisting of Deck Chair, Square Cushion, Footstool, Table Cover, and Oval Cushion, in Many Colors, the Ensemble Yielding an Attractive Appearance on Any Lawn

Electric Toaster: The Knob on Top Turns Both Pieces of Toast at Once, Instead of the Usual Way of Turning One Piece at a Time

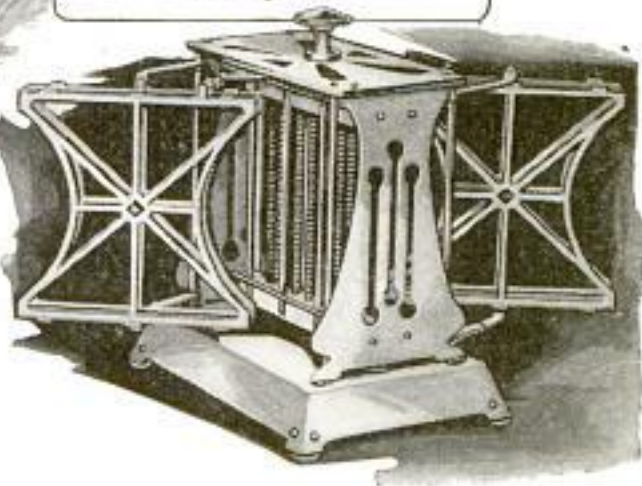

Electric Iron with Special Handle That Forms a Comfortable Grip for the Hand, and Thus Makes the Ironing Job Less Tiresome



Compact Camp Stove, Which Contains a Perforated Bottom Plate for the Embers, a Heavy-Wire Grating to Hold the Food being Cooked, and a Detachable Oven

obtain it by addressing Bureau of Information, Popular Mechanics Magazine, Chicago.

608  
9663

**SAND-DRYING STOVE BUILT TO RESIST HARD USAGE**

A strongly built sand-drying stove for use on railroads, in foundries, and other industrial plants, has a small furnace at its center which is surrounded by an upright cast-iron grating. Around this again is a conical skirting that incloses the space into which the wet sand is shoveled. As soon as the sand is dry, it runs through the grating into the hot-air space around the furnace, and then out through a perforated ring below the skirting and the grating. The furnace is fed through a fire door outside the skirting.



As the sand is dry, it runs through the grating into the hot-air space around the furnace, and then out through a perforated ring below the skirting and the grating. The furnace is fed through a fire door outside the skirting.

As the sand is dry, it runs through the grating into the hot-air space around the furnace, and then out through a perforated ring below the skirting and the grating. The furnace is fed through a fire door outside the skirting.

**USE CYLINDRICAL LUNCH BOX AS EXTRA AUTO SEAT**

A fiber lunch box which can be used as an extra auto seat has been designed to aid the motorist who desires to minimize the space taken by out-fitting equipment. The box looks somewhat like an oversized vacuum bottle. A tray held by three uprights forms an "elevator" which is lowered as the box is filled. When the contents are wanted the lid is removed and the elevator raised.



The box looks somewhat like an oversized vacuum bottle. A tray held by three uprights forms an "elevator" which is lowered as the box is filled. When the contents are wanted the lid is removed and the elevator raised.

When the contents are wanted the lid is removed and the elevator raised.

**LIME-SECRETING SEA PLANTS HELP IN REEF BUILDING**

The generally accepted idea that corals alone play any part in reef building was disputed recently by Dr. Marshall A. Howe in a lecture on "The Plant Life of the Sea." He stated that recent re-

searches show that in some localities lime-secreting plants have played a more important part than the corals, and that in all cases they have contributed more or less to the reef building. Doctor Howe showed more than 100 lantern pictures of the more interesting forms of marine plants, particularly those known popularly as seaweeds and mosses. He showed how the minute inclosing membranes of these organisms are permeated with silica, which renders the plants almost imperishable.

**LUMINOUS POISON INDICATOR PREVENTS ACCIDENTS**



Accidents caused by taking the wrong medicine or poison by mistake, in the dark, may be averted by the use of a new luminous indicator. The label, when fastened to any bottle, glows brightly in the darkest places, and is guaranteed to retain its luminosity for five years, when kept within the usual medicine chest.

**ATTACHMENT FOR AUTO HOODS PREVENTS RATTLING**

Made to fit a standard fastener on the hood of an automobile, a device for preventing the hood from rattling is now on the market. It is made of rubber, in one piece, and is attached to the rod of the hood fastener. In connection with it is a small vacuum cup that fits against the side of the hood and prevents it from moving. Being made of rubber, it is very durable.

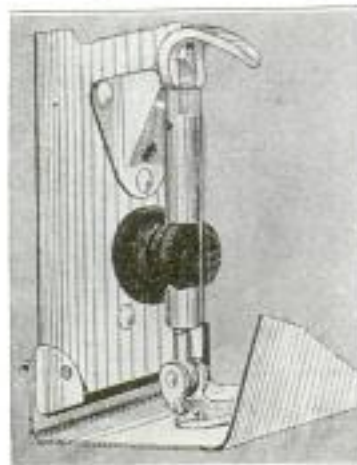

N.Y. Times 7/26/22 P.24

9919  
240 S. 7th  
Minneapolis  
Fibre Lunch Box Co.  
2 St., Minneapolis  
make

mp. H. es. Gorgensew. Stamford Road. Eve, Pa.

9873

**POPULAR MECHANICS**  
**BIRDS ANSWER DINNER BELL**  
**AT STATE GAME FARM**

Answering the dinner bell is one of the joys of bird life on the State Game Farm at Forked River, N. J., where thousands of pheasants are reared annually. Every effort is made to raise the young birds as near to wild methods as possible, since they are to be ultimately distributed for hunting purposes, but the scarcity of natural food has necessitated the introduction of one domestic trait, namely—"first call to dinner."

*Mr. James* 7/17/22  
**FORESTERS RISK HIGH CLIMB**

**AS PART OF DAILY ROUTINE**

Climbing a 100-foot ladder is the first job in the day's routine of a Canadian forest patrolman located in the province of Saskatchewan. Such towers are common in this service, but it is not often that the cameraman has an opportunity to snap the forester "en route." The accompanying photograph gives a good idea of the size of the towers and of the risk involved in climbing them. This takes about five minutes.



**PECULIAR WRECK OF AIRSHIP**

**9923 LANDS CREW IN SEA**

An unusual accident recently happened to an Italian airship which, returning from a trip over the Gulf of Taranto, encountered a storm. The fastenings between the car and gas bag broke, dropping the car and its 20 occupants 600 feet into the sea. Boats from shore were in time to rescue the crew.

*The Engineer* 7/7/22

*Edw. J. Leece*  
*719 Kemloch St*

**MECHANICS**  
**DESIGN OF NEW GAS VALVE**

**9804 US RADICAL DEPARTURE**

Taking advantage of the fact that there is less loss of pressure in a gas when passing through a thin-walled orifice than when passing through an orifice of channel type, a new

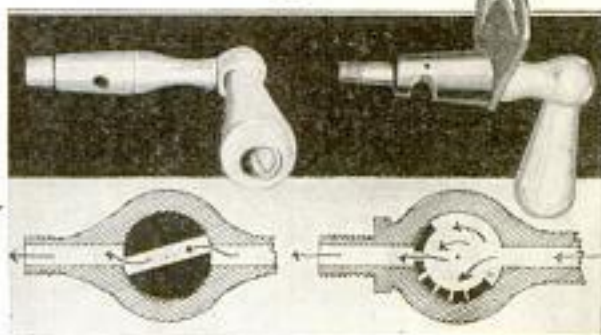

Loss of Gas Pressure in the Valve of a Gas-Range Burner is Remedied by Using a Number of Graduated Diameters Instead of the Usual Movable Plug

valve for gas-range burners has been designed that is a radical departure from the usual valves. Instead of one straight opening through the movable plug, there are a series of openings of graduated diameters, all connecting with the supply side of the gas main. This construction results in a considerable increase in efficiency.

**LINOTYPE-SLUG ADJUSTER HAS ANTIFRICTION ROLLER**

For the convenience of linotype operators who have had trouble with the slugs of type getting out of alinement or sticking in the slide, as they pass from the knife block to the slug tray, an adjuster, intended to overcome this trouble, has been patented. It holds a roller made of antifriction metal against the face of the slugs as they come from the knife block, insuring even delivery to the slug tray.

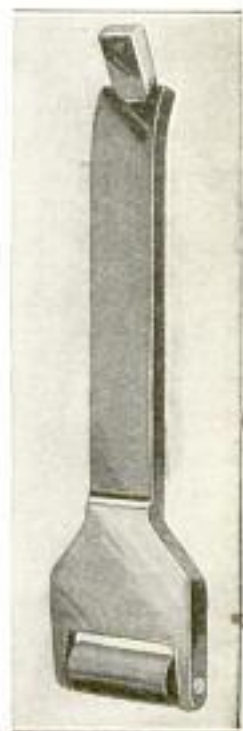

Those wishing further information on anything described in the editorial pages can obtain it by addressing Bureau of Information, Popular Mechanics Magazine, Chicago.

Copyrighted material

*E. W. Burton, Lundrum, Sask.*

*Chas. W. Denton, Weymouth, N. Amherst, St. 2.60  
+ info. Portland, Maine*

9711

~~Ed. W. E. H. Ing~~

Autopak Appliance Co.

610

Pittsburgh, Pa. POPULAR MECHANICS

### DEVICE CONVERTS ANY SCALE TO AUTOMATIC MACHINE

By attaching a recently invented electromagnetically operated device to any reliable scale, a complete automatic-weighing

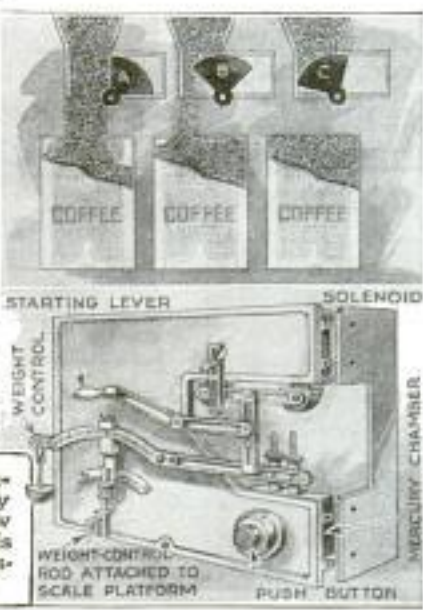
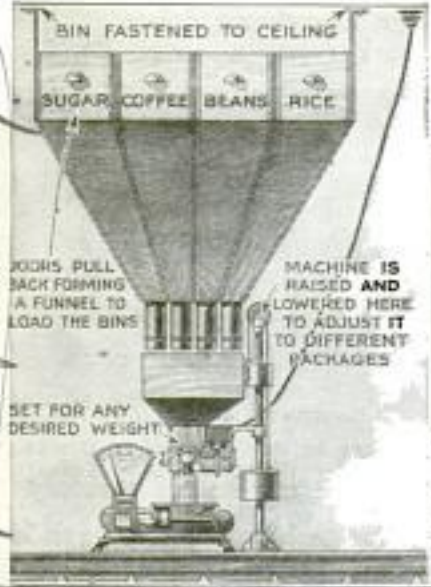

Above: Automatic Weighing Machine in Position over Ordinary Scale. Upper Right: Showing How the Flow of the Hopper Contents is Controlled. Lower Right: Illustrating the Operating Mechanism

unit is formed. The apparatus is readily connected to any size or form of hopper, and allows only an exact quantity to pass through an opening, which closes automatically when the predetermined weight has been reached. It is also adjustable to take care of the variations in weight of the containers, and gives in all cases the actual net weight of the product weighed. It is possible, without any inconvenience, to check its work by reading the dial of the regular scale. No changes in the adjustment of the scale are necessary.

The accuracy of the device is remarkable. In one instance a pound of beans was placed in the hopper. Three of the beans were removed. The pound of beans minus the three beans was delivered to the receiving container, but the hopper valve did not close. As soon, however, as the three missing beans were placed in the bag, the valve closed automatically. Such a degree of sensitiveness surely is not within the reach of the average clerk.

The hopper valve is electrically controlled by two solenoids. Assuming that the desired weight has been adjusted on the curved weight-control arm, the starting lever is pulled down. This changes the position of the hopper valve, allowing the material to discharge into the

waiting container. As the scale platform descends, the weight-control rod gradually lifts out of a mercury chamber a rod that completes the electrical circuit maintaining the magnetic properties of the solenoids. When the desired weight in the container has been reached, the rod-mercury circuit will be broken, and the hopper valve will close.

### 9905 TENNIS COURTS COVERED WITH ROOFING

A tennis club of St. Louis, Mo., has recently converted its outside clay courts into courts that may be played upon during wet weather and during the winter months. Cinders and an application of roofing material did the trick. First, 6 inches of clay were removed from the courts. Coarse cinders were then obtained and put in place of the clay. After rolling and packing the first course of cin-

ders, another layer of finer cinders was applied, which raised the courts one inch higher than the surrounding ground and thus facilitated drainage. The courts were then leveled, and two layers of three-ply roofing material were laid across the courts, in opposite directions. The net posts were left in the same position.

### NOVEL PISTON TO KEEP OIL FROM COMBUSTION SPACE

Carbonization in gasoline-engine cylinders largely results from oil leakage from the crankcase past the piston into the combustion chamber. A piston designed to eliminate this, provides a cupped groove to break the capillary action and to catch the oil.



Holes through the piston wall equalize the pressure on the oil, draining it back into the crankcase, also increasing ring pressure against grooves and cylinder walls.

*W. J. Evans M. D. Mgr. 1624 Long Ave. Pittsburg, Pa. Autopak Appliance Co. Home Wood, Pittsburg, Pa. Life Bldg. Pittsburgh*

*St. Louis, Mo. 5645 Page Ave. Frederick Athman*

*Copyrighted material 2819 Michigan Chicago*



**CHROME-PLATING POSSIBLE BY NEW PROCESS**

Chromium can now be deposited as a thin coating on the surfaces of iron, steel, and other metallic objects, similar to nickel and copperplating, by the process of a German chemist. The important properties of chromium are its resistance to corrosion and abrasion, and its relatively high melting point. The availability of this useful metal has been considerably extended, because it has only been prepared with difficulty by any of the processes heretofore devised.

rate in it as standard equipment a neat clock, seems a happy one. The timepiece is set flush with the panel of the instrument, and, to radio fans within receiving

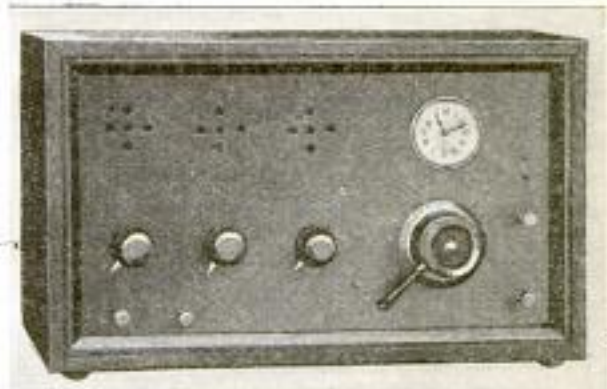

Clock Mounted in a Radio-Receiving Set, Which the Operator Watches for the Schedule Time of a Broadcast

**TUBE FOR GASOLINE TANKS PREVENTS EXPLOSIONS**

A tube which eliminates the danger of explosion of gasoline has been indorsed by insurance underwriters for use on automobiles and other types of gasoline tanks. The ordinary intake cap is replaced by a cap with a sprung hinge which keeps the cap closed. Attached to the base of the cap is a cylinder with small perforations, inclosed a fraction of an inch away by a brass strainer. Neither flame nor gasoline vapor can penetrate this tube. And if the tank is subjected to excessive heat, the cap opens automatically, releasing pressure and preventing combustion. Due to the fact that the air hole in the smaller tube attached to the cap closes automatically when the engine stops, the tank can be left for months without impairing the quality of the gasoline or losing any by evaporation.



the fact that the air hole in the smaller tube attached to the cap closes automatically when the engine stops, the tank can be left for months without impairing the quality of the gasoline or losing any by evaporation.

distance of two or more broadcasting stations, this will be a welcome innovation.

Knowing the transmitting schedule of the various stations, it will no longer be necessary to keep the receiving set on "closed circuit" for 5, 10 or 15 minutes in order not to miss a broadcast.

**DRILL HOLDER WITH GAUGE FOR RAPID MEASUREMENT**

For rapidly measuring the sizes of drills being manufactured, a holder that has, besides the usual holes for the drills, a long tapered slot in which the gauge of a drill can be instantly determined, is now available. Along the side of the tapered slot is a scale, graduated in thousandths of an inch, and from each point in this scale that corresponds to the number of a standard gauge, a guide line leads to the proper hole for the drill. The base is made of cast iron, but the



Drill Gauge and Holder: Drills are Measured by Placing Them in the Tapered Slot, Seen with a Scale along Its Side Graduated to Thousandths of an Inch

**CLOCK INCREASES EFFICIENCY OF RADIO-RECEIVING SET**

Since nearly all important broadcasting stations publish their schedules in the newspapers giving the time of day, program detail, etc., the idea of the manufacturers of a new two-step nonregenerative honeycomb-coil receiving set to incorpo-

tapered slot is lined with hardened and ground steel.

A mocking bird is giving a poultry fancier of Saluda, N. C., considerable trouble by imitating the clucking of a hen and thus luring baby chicks from their mother, so that he has to chase them among weeds and undergrowth.

Imperial Safety Tube & Tank Co  
735 W. 65 St.,  
Chicago

Harry Alexander  
1615 2nd St. S. St. Louis, Mo.  
H. J. Vaniman  
West Penn  
Pittsburgh  
Co. 7060 em

## CHILDREN'S PICTURE-STORY DEPARTMENT

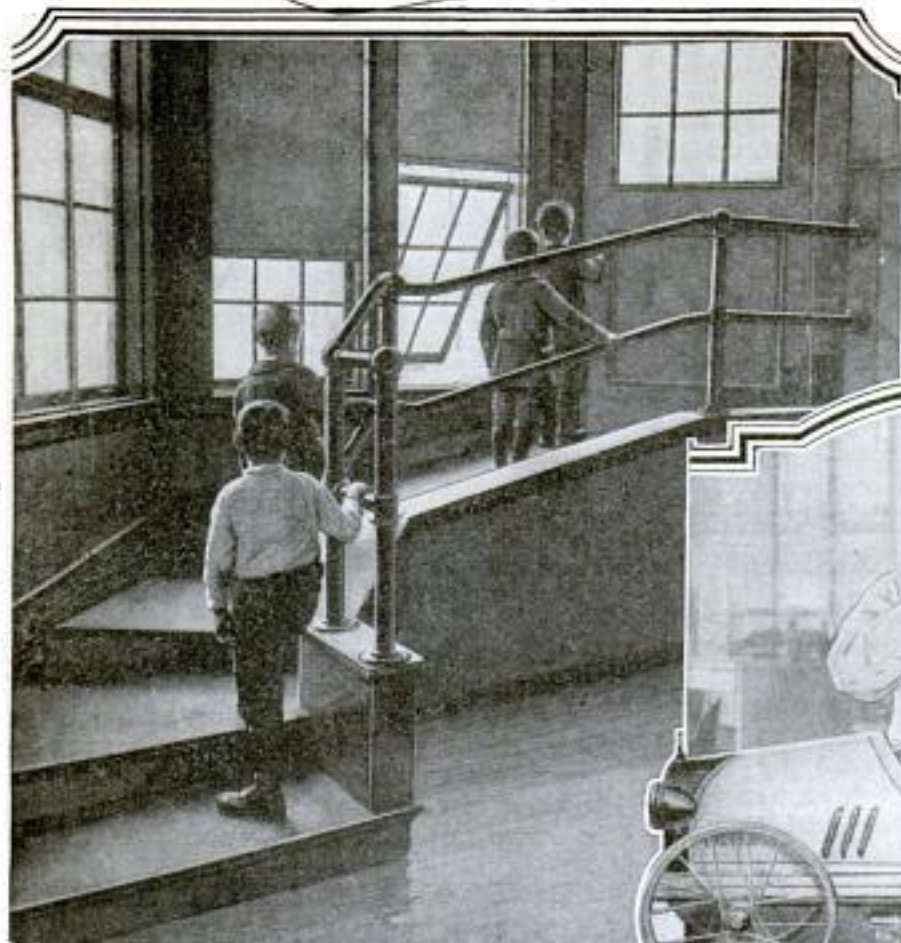

Flight of "Baby Stairs," Built with Very Low Risers, So That the Smallest Tot can Mount Them: They Lead from One of the Kindergarten Rooms to the Play Roof at the Michael Angelo School in the Italian Quarter of Boston. Around the Roof Is a High Brick Wall Guarded by a Curved Iron Rail

Below: Most Kiddies Are Restless in an Ordinary Barber Chair, but Never in One of This Kind—the Longer the Barber Takes to Cut Their Hair, the Better They Like It. Since This Barber Rigged Up the Cute Little Auto to Act as a Chair, He has Become the Kiddies' Favorite

COPYRIGHT, UNDERWOOD & UNDERWOOD



Mr. Porcupine and Mr. Coon, Both of Whom Are Tree Climbers, Very Seldom Meet in This Way, For Mr. Porcupine Attends to Business in the Daytime, While Mr. Coon Is a Sun Dodger. When They do Meet, Mr. Coon Gives Mr. Porcupine the Right of Way

Harnley's, 8. A, Allendale Road 9866  
 Uxmark Hill, London,  
 England.

OF MODERN ACTIVITIES AND INTERESTS



COPYRIGHT, PATENTED & REGISTERED

Eleven Pretty Girls, All High-School Students at Washington, District of Columbia, Wearing Sweaters of Their Own Handwork That Won Prizes in a Recent Contest: The First-Prize Winner is Seventh from the Left; the Second Winner is Just behind Her, and the Third is at the Extreme Left

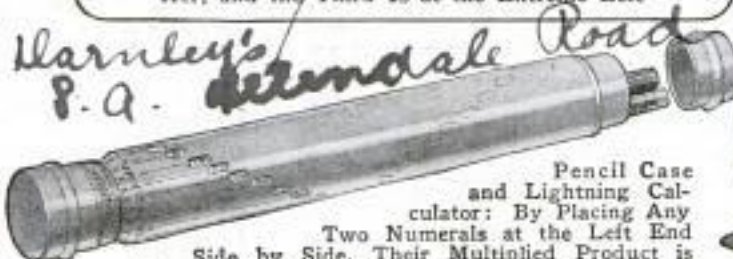

Pencil Case and Lightning Calculator: By Placing Any Two Numerals at the Left End Side by Side, Their Multiplied Product is Shown in Line with Them in the Slot to the Right



This Lucky Rooster, "Duke," was Doomed to the Cookstove, but He Saved His Neck by Doing Tricks. Here He is Riding the Handlebar of His Master's Bicycle



This Dog does Not Wear a Cap and Gown, but Makes an Excellent Nurse just the Same. "Brownie," as the Wonder Dog is Called, Holds the Bottle just the Way Baby Likes to Have It

L. Pyle, Professor of  
Physics, Washington  
University  
614  
993 St. Louis, Mo.

Manchester  
Guardian Commercial  
7/13/22

POPULAR MECHANICS  
HOW LONG DOES IT TAKE  
TO SEE A THING?

9922

Two British scientists, Professors Joly and Poole, have recently made measurements to determine what time is necessary to arouse the sense of vision in the human eye. The apparatus used for the purpose consists of a mirror, capable of

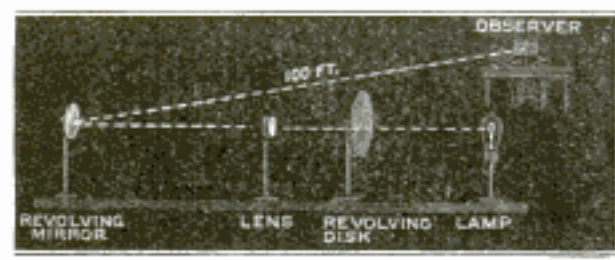

Apparatus Used in Making the Tests to Determine the Length of Time Required to Arouse the Sense of Vision in the Human Eye

rotating 8,000 revolutions per minute; an incandescent lamp, so arranged that a lens focuses the filament (used edge on) upon a slit behind which is the observing eye. With the mirror in rotation the eye will receive flashes of light due to the image of the filament crossing the slit, but these flashes will succeed each other so rapidly that persistence of vision will make the illumination apparently steady. In order to deal with just one flash at a time, a revolving disk, having a sector cut out, is interposed between the lamp and lens. This disk makes about 120 revolutions per minute, and the cut-out sector is so narrow that, while the light from the lamp is passing through it, the mirror does not have quite time enough to complete one revolution. Thus the eye receives only two flashes per second, and distinctly perceives the individual flashes.

The whole apparatus is placed in a darkened room and the observing eye is allowed to remain in the dark at least 20 minutes before observations are begun. (An eye that has rested in the dark may be as much as 10,000 times more sensitive than when in a lighted room.) Knowing the width of the observing slit and the width of the image of the filament, and also the rate of rotation of the mirror and the distance of the slit from the mirror, the investigators have been able to show that a flash of .0000002 second is still visible, while a flash of a duration of .0000008 second is found to be invisible.

It is of interest to note that since the speed of light is 186,000 miles per second, the length of the beam of light entering the eye in .0000008 second is approxi-

mately 80 feet. Assuming 50,000 waves of light to the inch, it is evident that 48,000,000 light waves register their tiny blows upon the retina during this minute interval of time.

9922  
NEW FORM OF SQUIRREL-CAGE  
INDUCTION MOTOR

All the advantages of the squirrel-cage induction motor, without the necessity of using a wound rotor with slip rings where a high starting torque is necessary, are embodied in a new type recently devised in Germany. The end rings of an ordinary squirrel-cage motor are cut at a number of points so that the current in the rotor has to follow a zigzag path through one bar after another instead of flowing through all the bars in parallel. This has the same effect as the slip rings, and will give about 1 1/4 times full-load torque with a starting current equal to twice the rated current. Centrifugal contacts close the cuts in the end rings when the motor is up to speed, and thus restore the winding to the regular squirrel-cage form.

9878  
FILLER FOR BATTERY CELLS  
PREVENTS OVERFLOW

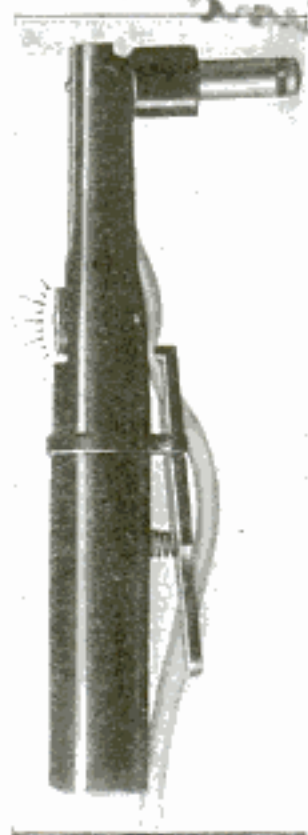

To fill storage-battery cells without fear of overflow and slopping of the electrolyte, is possible with a filler having an electrical indicator that includes a tiny lamp. The appliance is affixed at the end of a small hose and contains a trigger-like arrangement with which the flow of water is controlled. When a certain height of liquid is reached in the cell, the small lamp lights, thus enabling the user to shut off the flow and prevent any waste. By this method, the

adding of water to the battery cells is made a simple, easy, and clean task.

The Electric Storage Battery Co. Allegheny Pa. Phila.



Information as to where to obtain any specified materials or parts for making objects described in the following pages may be had, on request, from our Bureau of Information—Editor.

## A Convenient Folding Drawing Table

By EUGENE F. DAWSON

**A**RTISTS, draftsmen, and students of mechanical drawing, who find it necessary to do more or less of their work and study at home, will appreciate the desirable features combined in the folding drawing table illustrated. Unless

can be folded and stored away in little more space than that required for an ordinary drawing board.

When the table is folded, the legs fit snugly underneath the top, making the whole  $5\frac{1}{2}$  in. deep. The legs are about

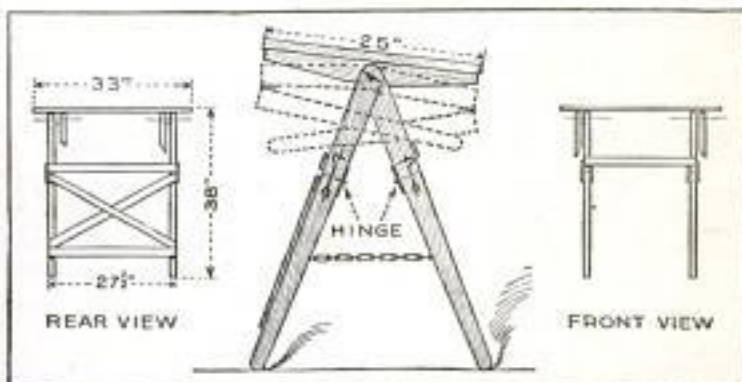

Upper Left: The Complete Table. Upper Right: Constructional Details. Lower Left and Lower Right: The Height of the Table Varied to Conform to the Posture of the User by Lengthening or Shortening the Chains That Hold the Legs Together. Center: Table, Folded

the amount of work done is great enough to justify it, the standard drawing table cannot be used, as it occupies considerable room—usually at a premium in the home. The table described, however, is light, but strong, and when not in use,

36 in. long, and are cut and hinged, 12 in. below the thumbscrew bolts, by which they are pivoted to the top.

The table top is made from an ordinary drawing board, 25 by 33 in., which is large enough for most purposes. The legs are

fastened to battens with bolts and thumb-nuts, the battens also helping to prevent warping of the top. It will be noted that the legs are hinged on the inner sides, and that hooks are provided to make a rigidly locked joint. The working height of the table can be varied to conform to the posture of the user, either sitting or standing, by lengthening or shortening

the chains between the legs. The top can be tilted to any angle desired, by manipulation of the thumbnuts on either side.

When completely folded, the table occupies a space 33 by 25 by 5½ in.; this, together with the fact that it can be lifted and carried with one hand, makes it most convenient for the purpose intended.

### Renewing Locomotive Piston Heads

A western railroad has solved the problem of renewing locomotive piston heads, which had previously been one of their most troublesome and expensive repairs. The worn piston heads are now placed

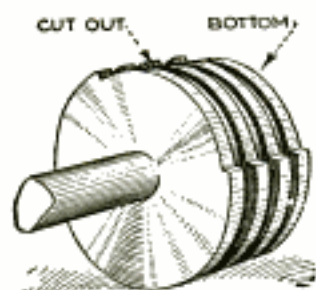

on the slotter and a small cut, generally about ¼ in. deep, is taken across, as shown, for about two-fifths of the diameter, on the bottom side; the ribs are then filled in with bronze by means of an acetylene torch, and the piston is made as good as new, after it has been re-turned in the lathe. The cost and delay of making a new piston head are avoided, and the time required to overhaul the engine is greatly reduced.

—A. A. Strafford, Reno, Nev.

### A Handy Split T-Bolt

Most machine operators have experienced the annoyance of having to take down all or part of an elaborate set-up in order to slide an extra bolt, the use of which has been found necessary, along the T-slot. This, of course, may happen on any machine having a slotted table, but more especially on milling machines, where an extra

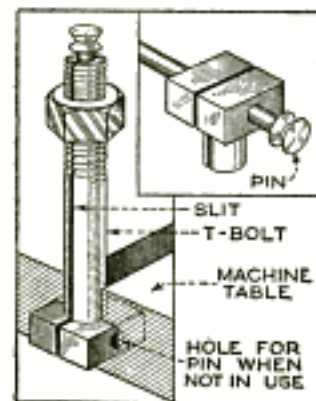

bolt is often needed and the slot is blocked at both ends. A pair of split T-bolts, such as that shown in the drawing, will make it possible to avoid disturbing the set-up in practically every case. The heads on these bolts should make a good fit in the slot. A hole is

drilled lengthwise through the bolt to take a pin, and another, of the same diameter, is drilled through the head, in which the pin is placed to hold the parts together when not in use. To insert the bolt, it is only necessary to drop the halves into the slot, slide them to a position opposite each other, and insert the pin, as shown in the drawing.

### Putting on Tight Belts

The problem of how to get a tight belt onto a pulley is one that is met with in every shop at some time or another. New belts are generally cut short to allow for the inevitable stretching that takes place when in use, and, while a belt will soon accommodate itself to the length of drive, considerable force is required at first to place it on the pulley. Various devices are used to do this, but the drawing illustrates a method difficult to surpass for simplicity. A short piece of rope is passed through a hole in a flat board and knotted on one side. The board is placed against the belt, and the rope

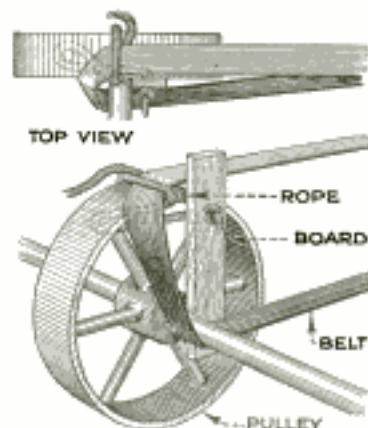

looped around the nearest arm of the pulley, then brought back and passed once around the outside of the belt and inside of the pulley, after which it is passed between the face of the pulley and the underside of the belt, and pulled tightly. When the shaft is turned, the pulley arm pulls the board around, while the belt binds the loose end of the rope tightly between it and the face of the pulley until the belt is properly placed. The board will fall away when the rope is released by the belt. Of course, the shaft should be revolved as slowly as possible.

### A Novel Wire Gauge

A peculiar form of wire gauge, especially useful to electrical workers, is a card or piece of metal having mounted on it short straight pieces of wire of every size within the range desired, each size being marked with the proper number. The wires should project for a short distance beyond the edge of the card. By holding this gauge close to any other piece of wire, it is easy for the eye to pick out the wire on the card which has the same diameter as the piece to be gauged.—Curtis Ralston, Chicago, Ill.

### An Oil Dropper for the Oilstone

Using kerosene as a lubricant on the modern sharpening stone makes a very fast and free-cutting tool, but, unlike the old-fashioned stone sprinkled with thick oil, fresh oil must be applied each time it is used. In most cases the oil is applied from oil-cans or even open cans; this is wasteful, as much of the oil runs off the stone altogether. A certain definite feed can



be obtained in a simple manner, as shown in the illustration, where the oilstone is held on a wooden stand, and a glass bottle used to hold the kerosene. The ends of a piece of tin wrapped around the bottle are secured by a nut and screw, and the bottle is held at a convenient height, out of the way, by passing some  $\frac{1}{8}$ -in. wire through a hole in the tin and bending it double, afterward driving the ends into the wooden stand. Above and below the hole in the tin, the ends are bent at right angles to form a stop that holds the bottle in a vertical position. A cut is made in one side of the cork stopper, and the feed is regulated by pushing in the cork more or less tightly. No oil is wasted by this device, as the drops fall on the center of the stone, and the oil is evenly distributed over the surface by the movements of the tool being sharpened. When not in use, the bottle is turned right side up in the clamp.

### Knife for Cutting Sheet Metal

Those who have difficulty in cutting tin, or other thin sheet metal, straight and without curls, will appreciate the tool il-

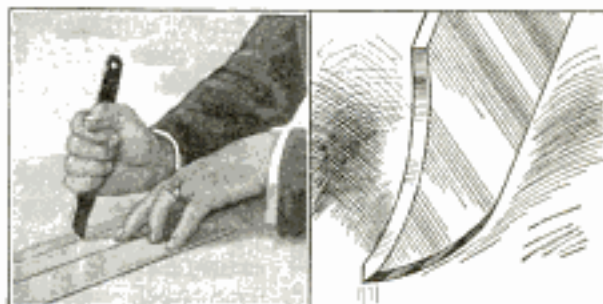

Cutting Sheet Metal Straight without Curls by Means of a Simple Tool Made from a Discarded Power-Hacksaw Blade

lustrated. The knife is made from a part of an old power-hacksaw blade; one end of the blade is ground as shown, and the teeth are also ground off. In cutting sheet metal with this tool, a straightedge is placed on the line to be cut, and the cutter, with its point in contact with the metal and against the straightedge, is drawn toward the body. If a single stroke is not sufficient to cut the metal, the cut can be repeated, care being taken that the point of the cutter is always placed in the same groove. When the score is deep enough, the metal can usually be separated by bending it back and forth once or twice. When the point becomes dull it can be resharpened by grinding the face.

### Quick-Reading Micrometer Attachment

A circular clip, that fits closely around the thimble of a micrometer, will be found very useful when turning or grinding a number of pieces to the same size; by means of this, the mechanic is enabled to read the instrument at arm's length, avoiding the usual bending over the machine. The clip is made of sheet metal, and is formed so that it will have enough tension to grip the thimble of the caliper tightly. The pointer is set at the proper graduation on the thimble, making the subsequent reading of the caliper a very simple matter.—Percy W. Thomas, Beloit, Wis.

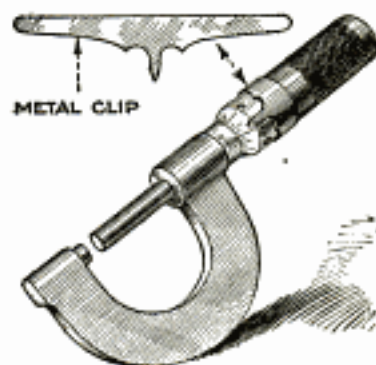

### Settling Chamber for Water System

At one time the water from the city mains contained so much fine sand that pump valves, washers, and other parts,

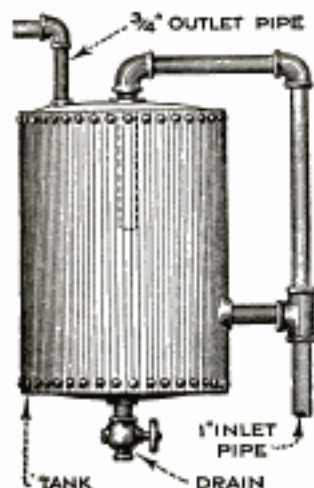

suffered considerable damage. To overcome the trouble, I tried out, with success, a simplified settling chamber. The tank used was a 100-gal. range boiler, connected to the water pipes as shown. The inlet and outlet pipes were made of different sizes, in order to reduce

the force of a jet of water entering the tank, which would have tended to keep the water agitated, and prevented the suspended matter from settling to the bottom. The dotted lines show a pipe usually supplied with a range boiler, which should be removed when the boiler is to be used as a settling tank. A valve is provided at the bottom of the tank for blowing out the sediment.—James E. Noble, Toronto, Can.

### Radiator Guard for Tractor

When plowing in brush land, or fields of heavy-growth cornstalks that have not been broken down, I have several times injured the radiator of my tractor. At one time a stick about 4 ft. long was thrown by one of the guide wheels so one end caught the radiator just as the other end struck the ground. The result was that, before the machine could be stopped, a hole was made through

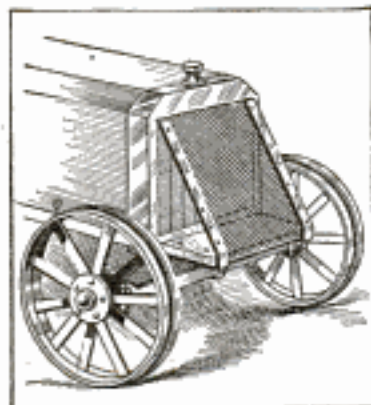

the radiator, breaking five of the tubes and bending many of the cooling fins. To prevent a recurrence of this, and also to prevent trash and corn husks from collecting over the front of the

radiator not to interfere with the functioning of the cooling system.

Two pieces of wagon tire, 40 in. long, were bent so that the lower part extended forward horizontally about 12 in., the rest of the stock being bent at an angle to meet the top of the radiator. One end of each iron was fastened to the tractor frame at the lower corners of the radiator, and the frame covered with a piece of heavy 1/4-in.-mesh screen, attached with rivets. A board was fastened across the space at the bottom to prevent anything from striking the radiator from below. The trash which would formerly collect on the radiator and hinder cooling is now caught by the screen, and ample space is left back of this for the circulation of the air.—G. G. McVicker, North Bend, Neb.

### Transferring Pinholes in Shafts

Trouble is often experienced with pinholes in worn shafts that are being replaced. Generally, only the shaft is sent to the repairman, with instructions to make an exact duplicate, which is easy enough so far as the diameter and length of the shaft are concerned, but, should the shaft carry collars or flanges pinned to it, a mistake is easily made, as pinholes are as likely as not to be off center. Unless the hole in the shaft matches up with the hole already drilled in the collar, or other part to be pinned to it, the pin will not enter unless it is filed away or otherwise fitted, the result invariably being an unsatisfactory job.

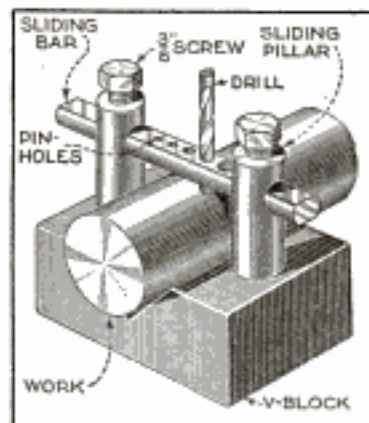

work. The special V-block shown in the drawing is very handy in cases of this kind, as it enables the operator to reproduce the exact position of the pinholes at once. On each side of the "V" a 3/4-in. hole is drilled to take two pieces of cold-rolled steel, these pieces in turn being drilled through for a piece of 1/2-in. tool steel. This forms a sliding bar that is flattened on the top and bottom and drilled, as shown, for standard-size pins.

The method used in transferring holes is as follows: Place the old shaft in the



V-block, the other end being supported by another V-block, or by packing; then, with the sliding bar loose, insert the drill required in the chuck, and bring it down through the corresponding hole in the bar and through the pinhole in the shaft. Tighten the screws provided for clamping the sliding bar, which is now lined up exactly with the pinhole in the old shaft; the latter is removed, and the new one put in place, clamped down, and drilled. The uprights are not clamped in any way, but are pushed down until the sliding bar touches the shaft.

### Knot for Wiring Electrical Fixtures

In order to relieve the terminals of lamp sockets, etc., of the weight of the shades, the ends of the wires should be knotted as shown in the drawing. The knot should be made so that the socket cap will bear against it and support the entire weight, or strain, which prevents the connections from being pulled loose. This knot is simple, and brings both ends of the wire out even. It should be pulled as tightly as possible, so that it will fit easily inside the cap.



### Holder for Short Nails

Cabinetmakers, and others required to drive small nails in difficult positions, will lessen the chances of pounded fingers and marred work by use of the nail holder shown in the drawing. A piece of  $\frac{1}{4}$ -in. rod of suitable length is bent to the desired form, and the short end is flattened on opposite sides. A piece of spring brass or steel is riveted to one of the flat surfaces, to serve as a clip for holding the nails.

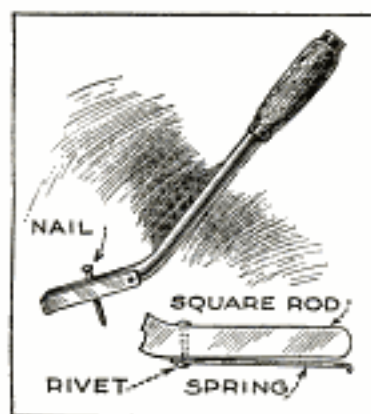

### A Handy Saw Oiler

Oiling handsaws before storing them away for any length of time is essential if they are to be kept in good condition and free from rust, and if means are provided for doing this quickly and easily, the chances of neglect are materially lessened.

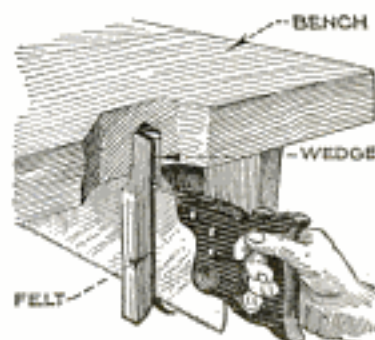

Cut two strips of pine,  $1\frac{1}{2}$  in. square by 10 in. long, and glue strips of felt to one side of each strip. Bore a hole in the underside of the workbench and secure the strips in the manner shown, with a wedge between them. The felt is saturated with a good grade of lubricating oil, and, by inserting the back of the saw in the slot, and drawing it back and forth several times, the tool will be covered with a thin film of oil.—G. E. Hendrickson, Argyle, Wis.

### Gauge for Setting Lathe Tools

To give the best results, a lathe tool must be used with its cutting edge exactly on, or a little above, the horizontal center line of the work being turned. After years of machine-shop experience, the machinist is able to set his tool without measurement, but the beginner will find the gauge illustrated useful for setting the cutting edge of the tool at its proper height. A piece of mild steel, about  $\frac{1}{4}$  by 1 in., is bent to make a right angle, one side of which is left considerably longer than the other. The short leg of the gauge is carefully ground, until its length exactly equals the vertical distance from the top of the toolpost block, or compound rest, to the center line of the lathe. The gauge is laid on the rest beside the toolpost, and the operator sets the edge of the tool even with the top of the gauge.—Lowell R. Butcher, Des Moines, Ia.

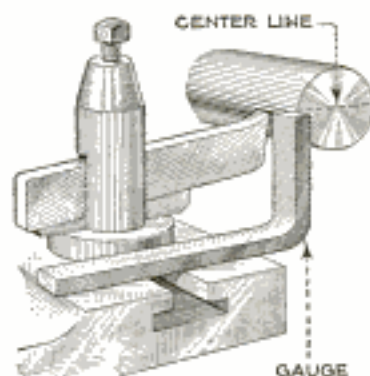

### Preventing Rolls of Roofing Paper from Crushing

It is no longer necessary to crate rolls of prepared roofing paper for transporta-

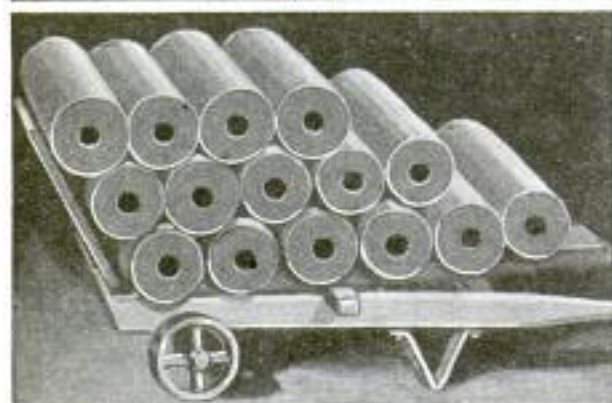

Cardboard Mailing Tubes, Inserted in Rolls of Roofing Paper, as Shown in the Upper Photo, Prevent Crushing During Transportation, as Shown Below

tion in order to prevent the rolls from being crushed flat. One manufacturer of this product inserts two 18-in. cardboard mailing tubes into the center of each 36-in. roll of roofing paper. This arrangement has been found to give adequate protection against crushing, and as a result, the firm is able to quote more attractive prices on export shipments, because of the reduced freight charges on the product.—Chas. W. Geiger, San Francisco, Calif.

### Removing Stains from Ivory

To remove brown spots from ivory, a bell glass or similar cover is required. Place some chloride of lime on a shallow dish, drop some hydrochloric acid on it, and put it underneath the inverted cover together with the object to be cleaned. The work should all be done in the open and in bright sunlight. The combination of the chlorinated lime and acid will generate chlorine gas, which should not be breathed, as it is highly irritating to the air passages. The powerful bleaching action of the gas will remove all discolor-

ations due to age and many other causes. Any spots or stains not removed by the treatment should be rubbed with a lump of tripoli, finishing with fine-powdered rouge. After bleaching the ivory in the chlorine gas, the piece should be washed in a solution of baking soda and water, rinsed in clean water, and dried with a piece of clean linen.

### Replating Worn Spots

It is sometimes necessary to plate worn spots on an article so large that it would be a quite expensive item to replate the whole surface. A quick and satisfactory method of plating such worn areas is to fasten the cathode wire to the article to be plated, and the anode wire to a piece of sponge, about 2 in. in diameter. The sponge is dipped into the plating solution, the current turned on, and the metallic deposit is painted on the worn spots by passing the sponge over them. If a slight ridge is created on the line of the old and new deposits, a good burnisher should be used to work down the irregularity.

### Fence Made from Discarded Porch Railing

A few years ago architectural styles demanded the addition of railings wherever they could be tacked onto a frame



The Owner of a Suburban Home Removed the "Ornamental" Railing Which Style Demanded When the House was Built, and Used It to Make a Neat Fence

house. Besides being of questionable decorative value, the railings added to the cost of painting. The illustration shows a railing which was removed from a suburban residence and used to make a fence around the yard. The square posts, being hollow, were slipped over stout stakes driven into the ground, holding the whole structure erect. Before driving, the stakes were given a coat of asphaltum paint, to serve as a preservative.—Walter C. Harris, Brooklyn, N. Y.

## A Handy Drag-Saw for the Farm

By A. R. FERGUSON

**M**ANY farmers still use the old hand methods of cutting up cordwood for storage, in spite of the fact that there are engines on their farms that can be harnessed to the work, with a very considerable saving in time.

In cases where the wood to be cut into stove lengths is too large for sawing on an ordinary buzz saw, the type shown in the drawing can be built on the side or end of the woodshed in a few hours, at practically no expense, as the materials required are usually at hand. All that is necessary for such a saw is a drag-saw blade, a piece of shafting about 5 ft. long, two pillow blocks, a pulley and flange to fit the shaft, two pieces of 2 by 8-in. plank, each 20 ft. long, and some short lengths of 2 by 6, 2 by 10, and 2

that the smallest type of farm engine can be successfully used to drive it.

The piece of shafting referred to and its pulley are mounted on the pillow blocks, as shown in the drawing, so that the engine can be connected to it. One end of the shaft projects beyond the side of the building, and a second pulley, or a flange, keyed to the shaft at this end, will simplify the attachment of the wooden crank, which is bolted to the shaft; this arrangement makes it unnecessary to provide a steel crank.

The crank is made from a short length of 2 by 10-in. plank, fastened to the pulley or flange on the outer end of the shaft with bolts. A bolt is used for the crankpin. The distance of the crankpin from the center of the shaft will determine

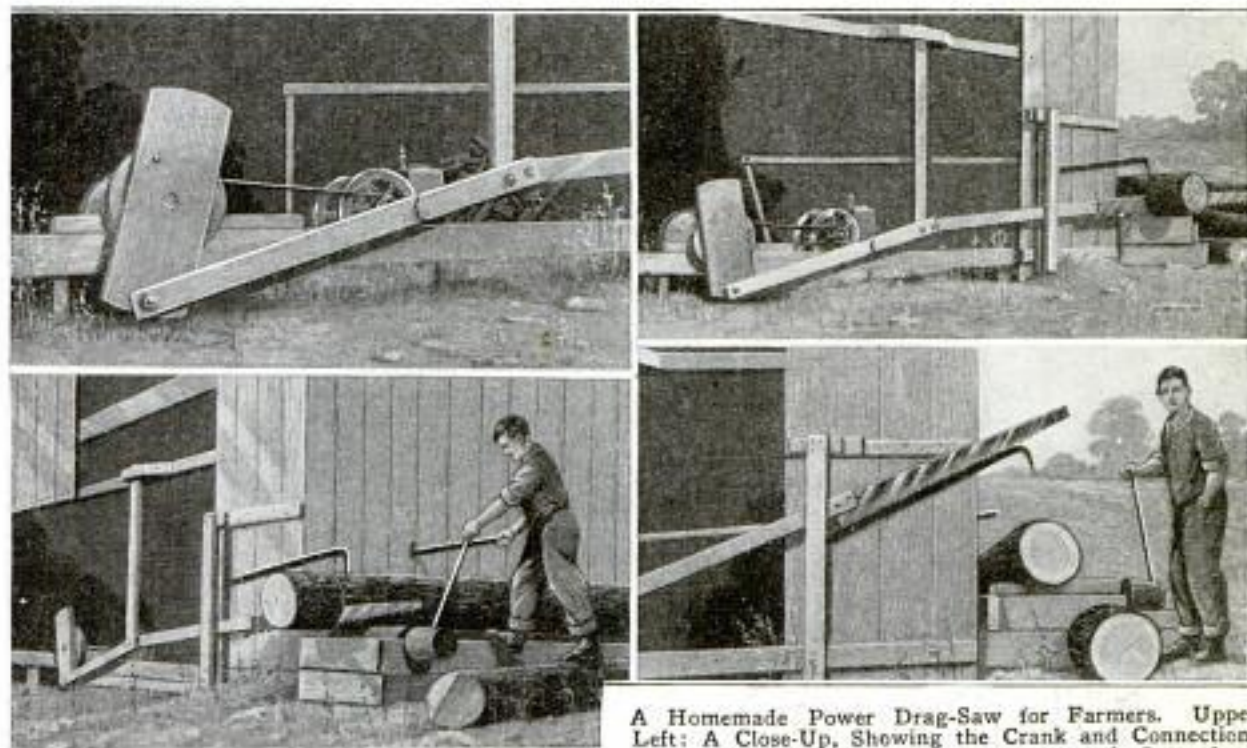

Right: General View of the Outfit. Lower Left: Dog and Saw in Position, the Saw Being Nearly through the Log. Right: The Saw and Dog

Lifted at the Completion of a Cut

by 4-in. lumber. If the shafting and pillow blocks are not already at hand, it is possible that their cost can be saved by borrowing them from some of the farm machines, which, as a rule, are in storage when wood is being cut.

A common one-man saw blade may be used in place of the drag-saw, and when a small engine is used, is preferable. However, the light saw must be run slower, and given a lighter feed, or it may buckle, particularly if green wood is being cut. The machine itself has so few parts, and so few sources of friction,

the length of the saw stroke. For engines of 2 hp. or more, the proper stroke will be about 34 in., which means that the bolt used for the crankpin should be located 17 in. from the center of the shaft. Small holes are drilled through the bolt that serves as a crankpin; these are for cotter pins; if locknuts are used on the pin, these cotters are unnecessary. Steel washers should be placed on each side of the pitman on the crankpin, and between all other moving wooden parts, so that the friction of wood against wood will be reduced. The end of the pitman

farthest from the crank is supported by a swinging crossarm, as shown in the drawing. The upper end of this arm swings on a bolt in a slotted wooden bracket, fastened to the side of the building, and the lower end on a bolt in a wooden clevis, screwed to the end of the pitman. The open end of the clevis receives the end of the saw arm, which should be long enough to clear the corner of the building. Sidewise movement of the saw arm and saw is prevented by a guide placed about 3 ft. back of the corner of the

the saw from dropping onto the ground. A catch can be provided for holding the saw arm in its elevated position, when a new log is being placed on the carriage, or when it is fed forward for another cut. The saw arm should just move freely inside the guide, while the swinging crossarm should not be less than 6 ft. long and the pitman about 5 ft. The sides of the clevis extend past the swinging crossarm far enough to take the saw arm; this arrangement gives the slight rocking motion to the saw which is es-

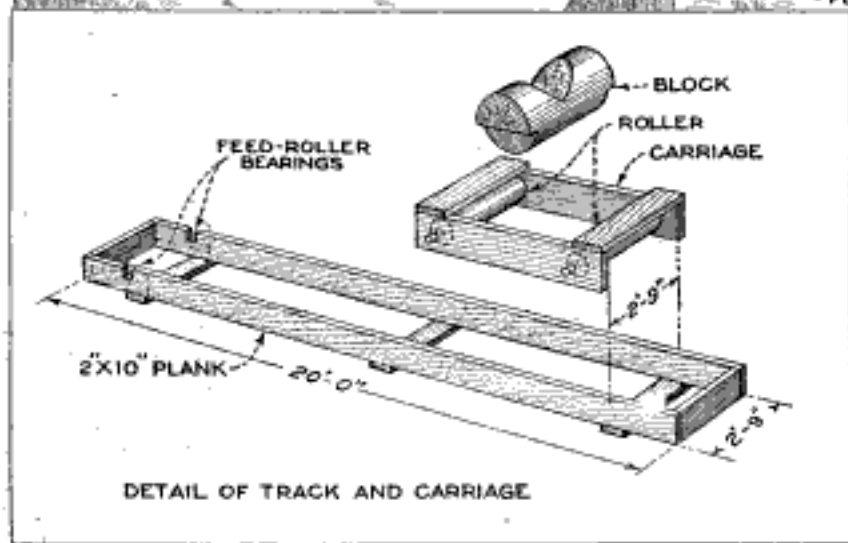
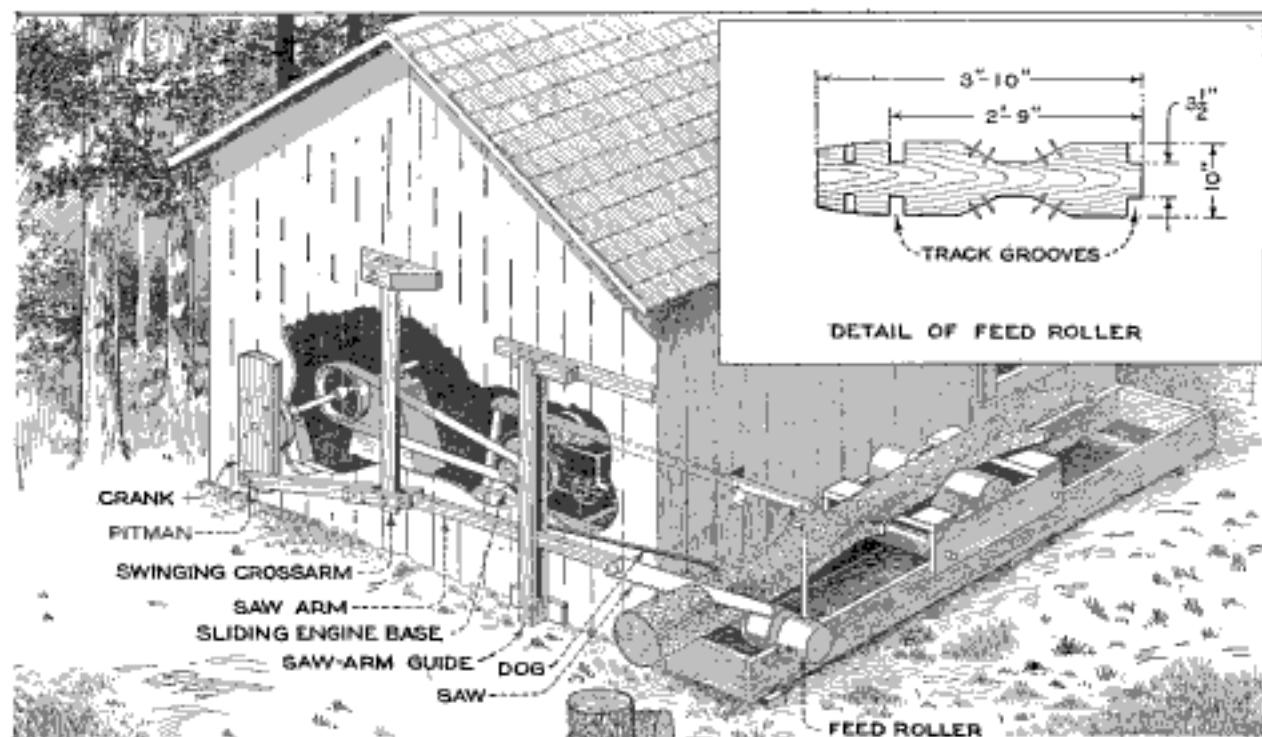

With This Machine, a Farmer can Cut the Product of His Woodlot into Stove-Wood Lengths at the Rate of from 5 to 25 Cords a Day

essential in the sawing of large logs. This movement, on factory-made rigs, is obtained by placing an eccentric on the driveshaft. The advantage of this is that, on the forward stroke, the saw cuts on the front side of the log, and on the back side on the back stroke. The driveshaft must revolve from left to right, or counterclock-

wise, else the sawdust will be pulled to the center of the saw cut or kerf, instead of being thrown out at the sides. Both the saw arm and pitman must be in a straight line and parallel with the side

wise, else the sawdust will be pulled to the center of the saw cut or kerf, instead of being thrown out at the sides. Both the saw arm and pitman must be in a straight line and parallel with the side

of the building, and the shafting must be level and at right angles to the pitman and saw arm.

If the engine is a small one, a 3-hp. or less, it can be placed on a sliding base in the manner suggested in the drawing, so that by moving it backward or forward the belt will be tightened or loosened for controlling the operation of the saw. The sawyer is thus able to start and stop his saw by means of a lever extending through the side of the building and located near his post; the lever is pulled out to start the saw, and pushed in to stop it. A notch cut out of the underside of the lever forms a catch to prevent movement of the engine while the saw is running. If the engine is too large to be moved readily by this means, an ordinary belt tightener can be used, unless a countershaft with a tight and loose pulley is available.

The carriage track is made 3 ft. wide and 20 ft. long, 2 by 8-in. material being used for the sides and ends, the other crosspieces being made from 2 by 6-in. plank. The end of the track is placed even with the end of the building; the track should be exactly at right angles to the saw, and must be level and solid. The feed roller is made from a piece of log,

about 10 in. in diameter by 3 ft. 10 in. long. Its journals, or track grooves, are  $3\frac{1}{2}$  in. in diameter, and just wide enough to turn freely in the notches provided in the forward end of the track. The spikes are made of  $\frac{3}{8}$ -in. steel sharpened on each end and driven into holes drilled about 3 in. deep, after which they are hammered for another inch into the solid wood, to hold them firmly. Four large holes are drilled opposite each other in the outer end of the roller for the insertion of the bar that feeds the log forward.

The log carriage is made as shown in the drawing, with the centerpiece saddled down to match the height of the feed roller, and prevent the log from moving sidewise; a few spikes set into the sides of the notch will prevent the log from slipping off as the feed roll is being turned. While the weight of large logs will be sufficient to prevent them from rolling, the smaller ones must be held by a dog. The latter is made from a piece of flat iron, the end of which is bent at right angles and sharpened, so that it can be driven into the log; this part of the equipment is bolted to the side of the building so that it can be swung up and down as desired. It should be heavy enough to stand a good blow. \*

### Putting Rubber Sleeving on Wire

In electrical work, it is sometimes either necessary or desirable to slip rubber tubing over wire, in addition to the regular insulation, to make sure that there will be no short circuits. To get the sleeving on is rather difficult, as the insulation will slide along with the tubing unless the latter is oversize. One method of simplifying the work consists in waxing the insulation and heating the tubing slightly; another is to soak the tubing for a while in water, which causes it to swell enough to slip on easily. When dry, the sleeving will contract to its original size.—Frank Jablecnik, Chicago, Ill.

### Self-Locking Drill Bushing for Slot Jig

In all cases where holes are drilled with their edges close to each other, the novel method of locking a drill bushing shown in the drawing will be found of great assistance. It is shown applied to a box jig used to drill the cores of boring-bar slots, but, of course, can be used in any work of a similar character. A slot is cut in the top plate of the jig, wide enough to

take the drill bushing snugly. In line with this slot a pin is driven in the plate;

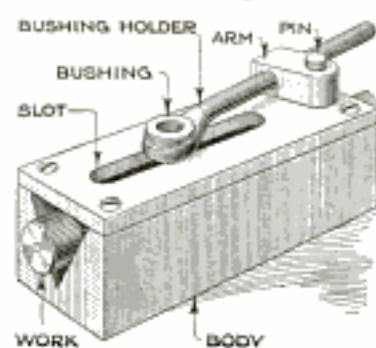

this carries a square steel arm, which in turn, carries the bushing holder, the latter being a piece of drill rod flattened at one end and drilled for the bushing.

It will be seen that, when the bushing is in the slot, it is impossible to move it backward or forward. When it is desired to change the location of the bushing, the holder is lifted, bringing the bushing out of its slot; the arm slides up the pin at the same time. The bushing holder is then pushed farther in or out of the arm, as required, and pushed down again until the bushing enters the slot. Holes can be drilled very closely together in this manner without danger of breaking through, or, if it is desired that they break into each other, no fear need be entertained that the drill will break.—Harry Moore, Montreal, Can.

### A Simple Corn Harvester

The contrivance shown in the drawing was devised to supplant the slow and

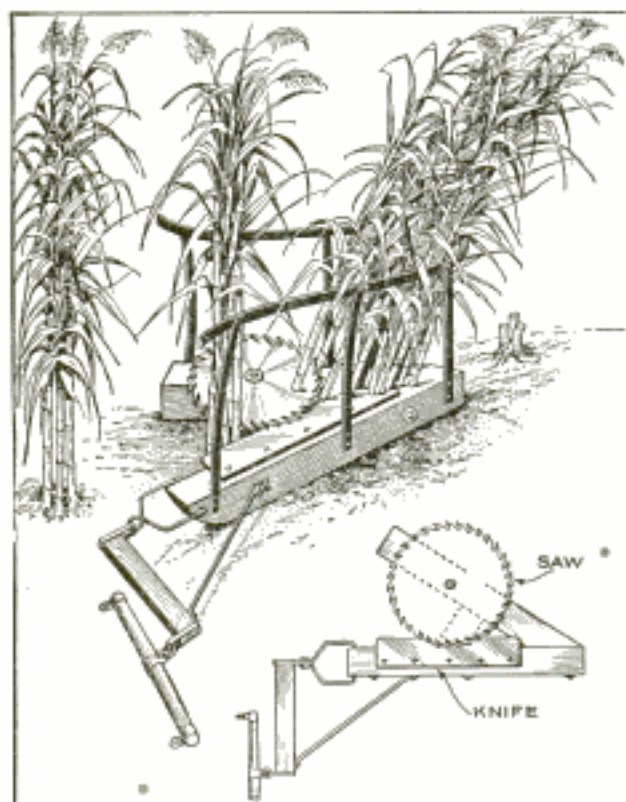

A Simple Corn-Harvesting Machine, Built by a Farmer to Overcome the Tedium of Cutting the Corn by Hand

tedious method of cutting corn by hand. A stout wedge-shaped timber frame was made, as indicated. A piece of flat steel was sharpened along one edge to form a knife, and this was bolted to the top side of one part of the frame in such a manner that about 1½ in. projected over the edge of the timber. On the opposite side of the frame an old circular saw was mounted so that it overlapped the knife for an inch or so. Discarded wagon tires were used for making the carrier, which is bolted to the frame, as shown.

In operation, a horse hitched to the device walks just outside the row, causing the cornstalks to strike against the teeth of the saw. As the stalks are carried between the saw and knife, the former revolves and cuts off the stalk, which falls into the carrier. When the carrier is filled, the stalks are removed, ready to be tied and shocked. On account of the unprotected knife arrangement, the operation of such a machine should not be entrusted to a youngster, who might become careless.

☛ A tire pump can be used for blowing lamp burners.

### Quick Method of Making Blueprints

In small shops, and other places where the facilities for making blueprints are lacking, the following method can be used to produce satisfactory results: Instead of making the original drawing on tracing cloth, use a piece of paraffined tissue paper which is backed up with a piece of new carbon paper. The waxed paper is placed over the carbon, so that pencil marks on it will be intensified by the carbon reproduction on the underside. The sketch is made in pencil, and the lettering can be printed in on a typewriter, still using the carbon. When finished, a print can be made from either the sketch intensified by the carbon backing, or from the carbon sheet itself. Blueprints made from the sketch will show white lines on a blue background, while prints made from the carbon copy will have a blue line on a white ground.

### Coppering Brass for Laying Out

Copperplating brass with a solution of copper sulphate (blue vitriol or blue-stone) and water is not so easily done as on steel. To enable the mechanic to lay out or scribe the work so that the lines can be easily seen, scatter a light coating of steel chips over the surface to be plated, and then apply the liquid. By using this method, brass can be given a thin coating of copper as easily as steel.

### Table for Computing English Exchange

The usual printed tables for computing the exchange rate of English currency can hardly be used where the rates fluctuate

| POUNDS |         | SHILLINGS |       | PENCE |           |
|--------|---------|-----------|-------|-------|-----------|
| 1      | \$ 1.00 | 1         | \$.05 | 1     | \$.004166 |
| 2      | 2.00    | 2         | .10   | 2     | .008332   |
| 3      | 3.00    | 3         | .15   | 3     | .012498   |
| 4      | 4.00    | 4         | .20   | 4     | .016664   |
| 5      | 5.00    | 5         | .25   | 5     | .020830   |
| 6      | 6.00    | 6         | .30   | 6     | .024996   |
| 7      | 7.00    | 7         | .35   | 7     | .029162   |
| 8      | 8.00    | 8         | .40   | 8     | .033328   |
| 9      | 9.00    | 9         | .45   | 9     | .037494   |
| 10     | 10.00   | 10        | .50   | 10    | .041660   |
|        |         | 11        | .55   | 11    | .045826   |
|        |         | 12        | .60   | 12    | .049992   |
|        |         | 13        | .65   |       |           |
|        |         | 14        | .70   |       |           |
|        |         | 15        | .75   |       |           |
|        |         | 16        | .80   |       |           |
|        |         | 17        | .85   |       |           |
|        |         | 18        | .90   |       |           |
|        |         | 19        | .95   |       |           |
|        |         | 20        | 1.00  |       |           |

Useful Table for Quickly and Accurately Converting Pounds, Shillings, and

Pence, Quoted at Any Rate of Exchange, into Its Equivalent Value in Currency of the United States

as they have done at periods during and since the World War. The table shown herewith is good for all exchange rates, and is used as follows:

Supposing it is desired to convert £16 3s. 4d. into its equivalent in currency of

the United States, and assuming that the rate of exchange is \$3.62 per pound sterling, add the totals of the following, which have been obtained by reference to the table:

|            |             |
|------------|-------------|
| £ 16 ..... | \$16.00     |
| 3s. ....   | .15         |
| 4d. ....   | .016664     |
|            | <hr/>       |
|            | \$16.166664 |

Multiply the sum obtained above by the exchange rate per pound sterling, or \$3.62, the result of which is \$58.52332368 or \$58.52 in currency of the United States. Any other exchange rate is used in the same manner.

### A Ratchetless Windlass

A windlass or hoist that is specially handy around the farm is very simply made by mounting a wooden roller or pulley as shown in the illustration. The

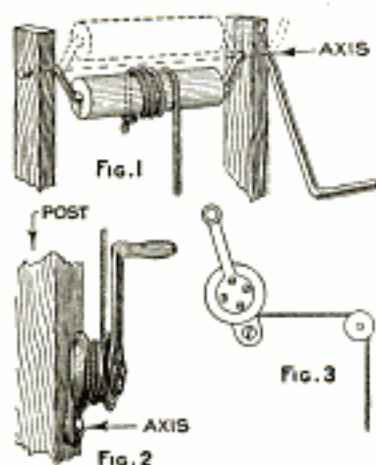

wooden roller, shown in Fig. 1, is bored along the axis, an iron rod of the proper diameter driven into the hole and bent to the shape indicated, to form the axle and crank;

this rod is journaled in two posts, and the crank should be long enough to furnish the proper leverage. A hole, through which the rope is threaded, is bored through the roller as indicated. The rope cannot unwind from the roller when the latter is on the bottom center. It is true that this arrangement has a considerable up-and-down movement, but the usual ratchet is eliminated, a factor of importance when a winch must be improvised from materials at hand. The same principle is applied to the design shown in Fig. 2, in which a small pulley is used. By the use of additional pulleys, as in Fig. 3, the windlass can be arranged to pull a load in any direction, or from any reasonable distance.—W. G. Partin, La Grange, Ga.

Ⓢ Do not tamp cinder concrete too much, as the cinders will crush and the surface to be covered by the cement will be increased considerably.

### Armrest for Draftsmen

In cases where the draftsman must do a lot of lettering or fine detail work near the bottom of his drawing, there is not,

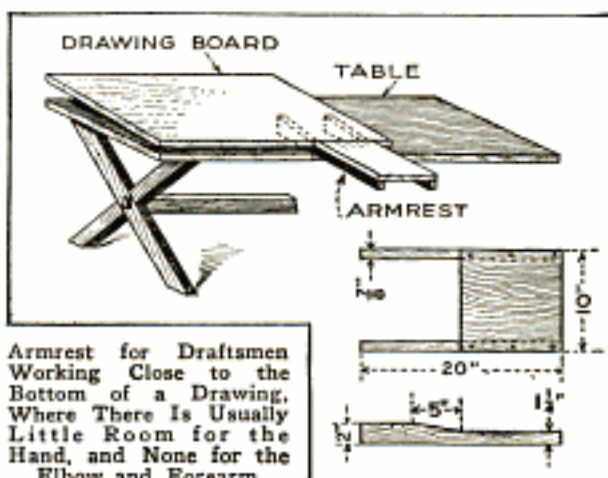

Armrest for Draftsmen Working Close to the Bottom of a Drawing, Where There Is Usually Little Room for the Hand, and None for the Elbow and Forearm

as a rule, enough space on the board for placing the hand, and no support at all for the arm. The armrest illustrated was designed to overcome conditions of this kind. The construction of the rest is amply described by the drawing, and, in use, the projecting ends of the side members are placed underneath the lower edge of the drawing board as shown.

### Fixture for Dressing Angular Grinding Wheels

When grinding straight-type formed cutters, it is sometimes necessary to dress the wheel to the exact angle, frequently a difficult

thing to do. The drawing shows a fixture for dressing the grinding wheel that can be used to produce accurate results.

A hardened and ground slide is attached to the angle plate by a stud; this can be adjusted to any angle by setting

with a protractor from the base. The diamond-tool holder fits on this slide, and is moved back and forth on it to dress the wheel. The fixture may either be clamped to the table of the grinding machine or held on the magnetic chuck. The diamond holder is held in place by a set-screw, as shown in the insert.

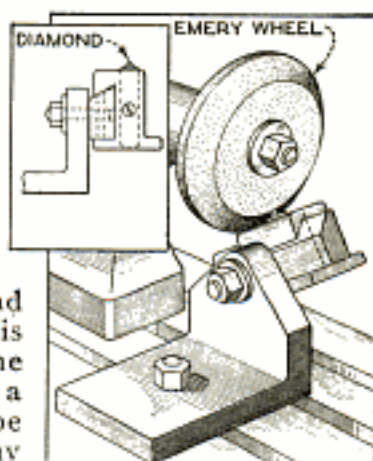

### Emergency Shank for Farm Implements

On farming implements using disk wheels, the shanks holding them are often broken, or so badly worn that they cannot be used.

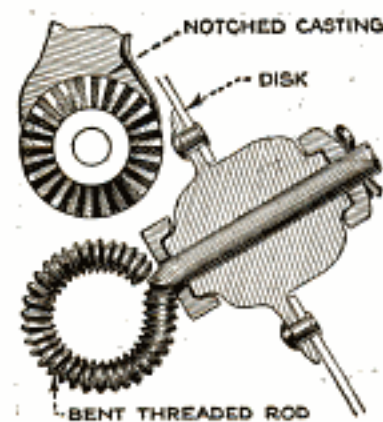

New shanks are easily made in the farm workshop, but the teeth for holding the adjustable shank tightly against the notched casting are difficult to form with the file or chisel

generally used. An easier method is to use a threading die that will cut threads corresponding as accurately as possible to the notches in the casting, and thread the end of the shank before the eye is formed. Although the threads may not coincide exactly with the notches in the casting, the parts can be bolted together tightly enough to hold.

### Screwdriver for Rapid Work

The novel screwdriver shown will be found a handy tool, in cases where a large number of screws are to be turned down, as in assembling operations of different kinds. Starting the screws by hand, as usual, they can be quickly spun into place and tightened. The blade is made of

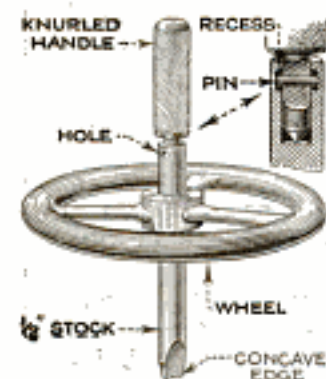

1/2-in. stock is used for the handle, one end of which is turned down to fit loosely into the hole in the blade section. The small end of the handle is turned to a taper point, which runs in the center provided. A pin, a little shorter than the diameter of the recess, is driven into the handle and prevents the parts from becoming separated. An old valve wheel, or any wheel of suitable diameter;

is then driven tightly onto the driver section of the tool, and, if necessary, further secured by a pin. With the screws all started in one or two threads, the screwdriver is placed on each in turn, a slight downward pressure being applied on the handle; this, together with the concave edge, holds the tool in place while the wheel is given a quick twirl which sends the screw home rapidly. A slight pull on the wheel seats the screw tightly.

### Double-Faced Finishing Tool

Many turning operations demand that the cut be taken to a shoulder at each end of the work, and ordinarily a change from right to left-hand cutters is necessary, which, unless some form of a turret tool holder is used, requires a separate operation or else a delay while the operator



changes from one tool to another. In order to speed up work of this character, the tool illustrated can be used. As will be observed, the tool is made with a clearance and slight bevel from the center, thus adapting it for either right or left-hand cuts without change.—John Harger, Kaimuki, Honolulu, T. H.

### Removable Jaws for Machine Vises

The narrow depth of milling-machine vises requires the use of some kind of false jaws when it is necessary to hold

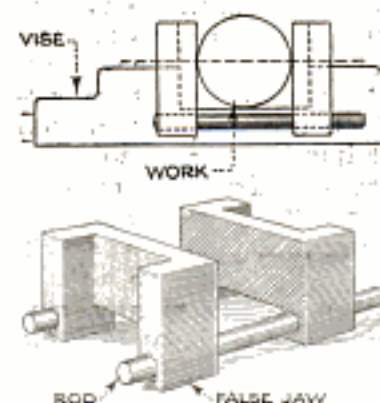

work with a bearing point above the fixed jaws; a shaft of such a diameter that the center is higher than the top of the vise jaws is a familiar example. Removing the regular jaws and attaching false jaws by means of screws and dowels, may take more time than the job warrants, but the removable jaws illustrated can be slipped into place



or out again in a second or two. Two pieces of flat stock are shaped as illustrated, to fit the vise, and cut away in the center to allow the sides to hang down against the sides of the vise. Two tool-steel rods are then driven tightly into holes drilled in one of the jaws, the holes in the other jaw being large enough to allow it to slide on the rod guides. The jaws provide a good bearing for the guide rods and are held in line by them when the vise is tightened on the work.

### Testing for Electrical Grounds during Winding Operations

Even the most skilled armature or field-coil winder often finds, on completing his work, that the final electrical test indicates a ground. Should this ground be at the bottom of a slot, where it is difficult to repair, it may be necessary to rewind the entire job. It is quite possible to save this time and expense by testing for grounds during the winding. As will be noted, the iron of the core or field, as the

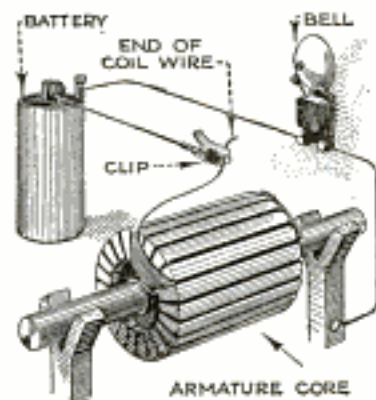

case may be, is connected electrically through a bell or low-voltage lamp to one terminal of a battery. A flexible lead, with a snap clamp attached, runs from the other battery terminal. When a

coil is about to be placed in position, the clamp is clipped to the end of one of the coil wires. By this method, if a ground is made at any time while the coil wires are being placed in the slots, the bell will ring or the lamp light. After one coil has been placed in position, the clamp is fastened to the second coil, and so on, until the job is finished. If it is not convenient or possible to use a snap clamp of the type shown, it is suggested that the battery wire be fastened to the pliers; then, when the wires are being connected or pulled into place, the grounds will be indicated as they are made.

☛ A four-per-cent solution of soda and water will lighten overexposed blueprints, or will bleach them nearly white if desired; add more soda to bleach completely.

### Handy Type of Scaffold Dogs

The dogs shown in the illustration will prove of value when erecting a scaffold for painters and carpenters, and for other purposes, as they eliminate the necessity of nailing the timbers together, and yet provide perfectly secure structure. The supporting arms are made of iron rod, bent to fit the 2 by 4-in. material commonly

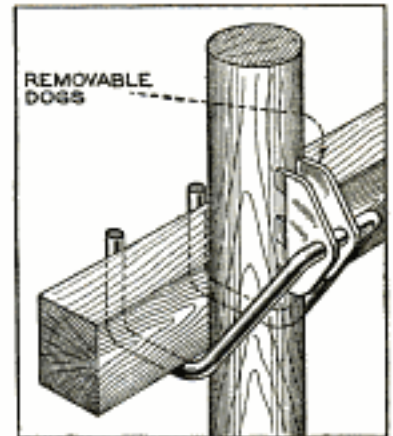

used for scaffolding. The toothed dogs are forged from steel, and bite into the uprights as soon as weight is applied. These dogs can be used with either round or square timbers.—Henry S. Laraby, New Haven, Conn.

### Water-Tight Pipe Connection for Concrete Tank

For some time, the making of pipe connections in the walls of concrete tanks has proved a troublesome problem, especially if the connection is to be made below water level, where it must be tight. The drawing shows a simple method of making a water-tight joint that can be easily disconnected.

Make up a short nipple, with both ends threaded, so that the flanges can be screwed up to be flush with the inner and outer surfaces of the tank.

The flanges are equipped with studs, and the flanges and nipple should be coated with tar before assembling. It should be understood that a sleeve of the same diameter as the outside diameter of the nipple used should be placed in the form before the concrete is poured. After the concrete has set, and the nipple and flanges have been screwed in place, companion flanges are bolted in place.

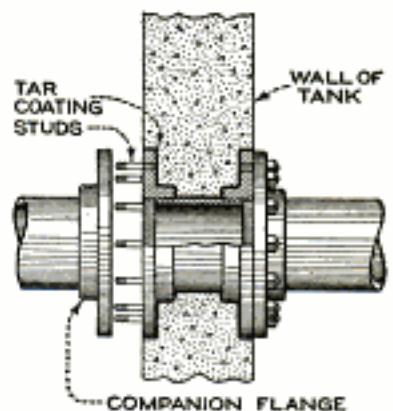

### Driving Pulleys for Magneto Testing

Magnetos are driven from the timing gears of an automobile engine through a coupling, and, when testing the magneto after being repaired, it is usually found unsatisfactory to drive it

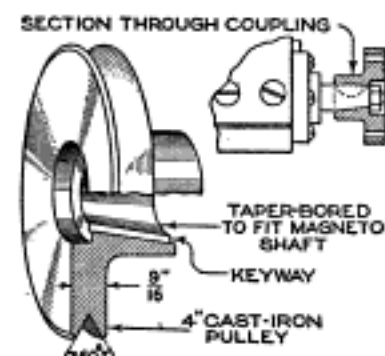

by running a belt over this coupling. Many repairmen try to use makeshift devices when testing, but the only fitting by which satisfaction can be obtained is a V-groove pulley, the bore of which is tapered, and having a keyway to suit the Woodruff key in the shaft. These pulleys can be made of cast iron, and a set of four or five should be made up at one time. Machined all over, they will have perfect balance, this being necessary, as they must turn at high speed. As the spindles of various magnetos are different in taper as well as in size, one pulley should be made for each of the most commonly encountered types. Some of the older makes use a straight shaft, holding the coupling with a taper pin through shaft and coupling.

### A Brace for Doubletrees

The tendency of a doubletree to wobble and teeter, with the tongue of the implement as a fulcrum, is always an annoyance, causing unnecessary rattle, and a hardship on the team. The brace illustrated over-

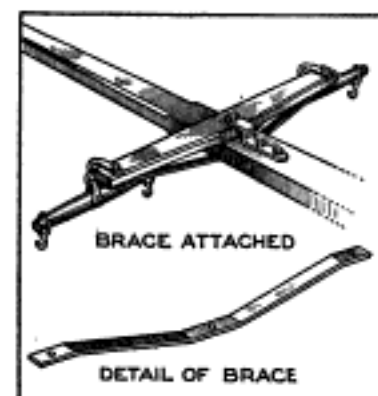

comes the troubles mentioned, holding the doubletree steady and without interfering with its swiveling movement. A piece of old wagon tire is used for the brace, which is bent in the manner shown. Three holes are drilled in the brace, one at each end for the clevis pins of the doubletree to pass through, and one hole at the middle for the doubletree pin through the tongue.—G. H. Glitzke, Kansas City, Mo.

### To Color Aluminum Black

A solution for coloring aluminum black is made up as follows: Dissolve 1 oz. white arsenic (poison) and 1 oz. sulphate of iron in 12 oz. hydrochloric acid, and add 12 oz. of water. The aluminum to be blackened is well cleaned with fine emery cloth and washed, before immersing it in the blackening solution. It is allowed to remain in this until the color is deep enough, when it is removed, washed in clean water, and dried in fine sawdust, after which a coat of lacquer is applied.

### Cutting Keyseats in the Shaper

When no milling machine is available, the work of cutting a round-ended keyseat is awkward. Drilling a hole at each end of the keyway and cutting out the intervening metal on the shaper is the method generally adopted, but as only a very slender tool can be used, breakage is naturally frequent. If the number of keyseats will warrant, the tool and holder shown will be well worth the time spent making them.

The holder is simply a piece of rectangular stock, slotted at one end, and drilled and tapped for a long-head screw. The tool is as thick as the width of the keyseat to be cut and as wide as the holder, as will be explained. When assembled, there should be a small clearance at the top between tool and holder, to allow the tool to rock.

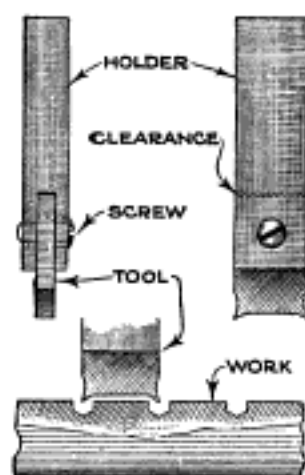

The keyseats are drilled at the ends in the ordinary way, and a hole is drilled in the middle, the length of the tool being equal to the center-to-center distance of the holes. In operation, the holder is gripped in the toolpost and the clapper box blocked up. The shaper is set to a stroke slightly longer than the length of the tool, which cuts away from the center hole on both forward and backward strokes, the clearance between the top of the tool and bottom of the slot allowing the noncutting end to clear the work. It will be seen that a substantial tool can be used by this method, and that the time required to cut the keyseats is reduced to almost half that required for the older method.

# Making Electrolytic Rectifiers

By CHAS. E. MULLIN

**M**OST experimenters feel the lack of direct current for recharging small storage batteries, such as are now widely used with radio apparatus; and for running small direct-current motors, electroplating, and such other purposes for which alternating current cannot be used. The residence zones of nearly all cities are, with but few exceptions, served only with alternating current. It is a very simple matter to transform the alternating-

all that might be desired from the standpoint of efficiency, but the power demand for experimental work is not usually very heavy, and therefore the technical efficiency becomes of minor importance when compared with considerations of low cost and convenience.

The rectifier here described utilizes both sides of the alternating-current wave, which makes it just twice as efficient as the single-cell type sometimes used. The

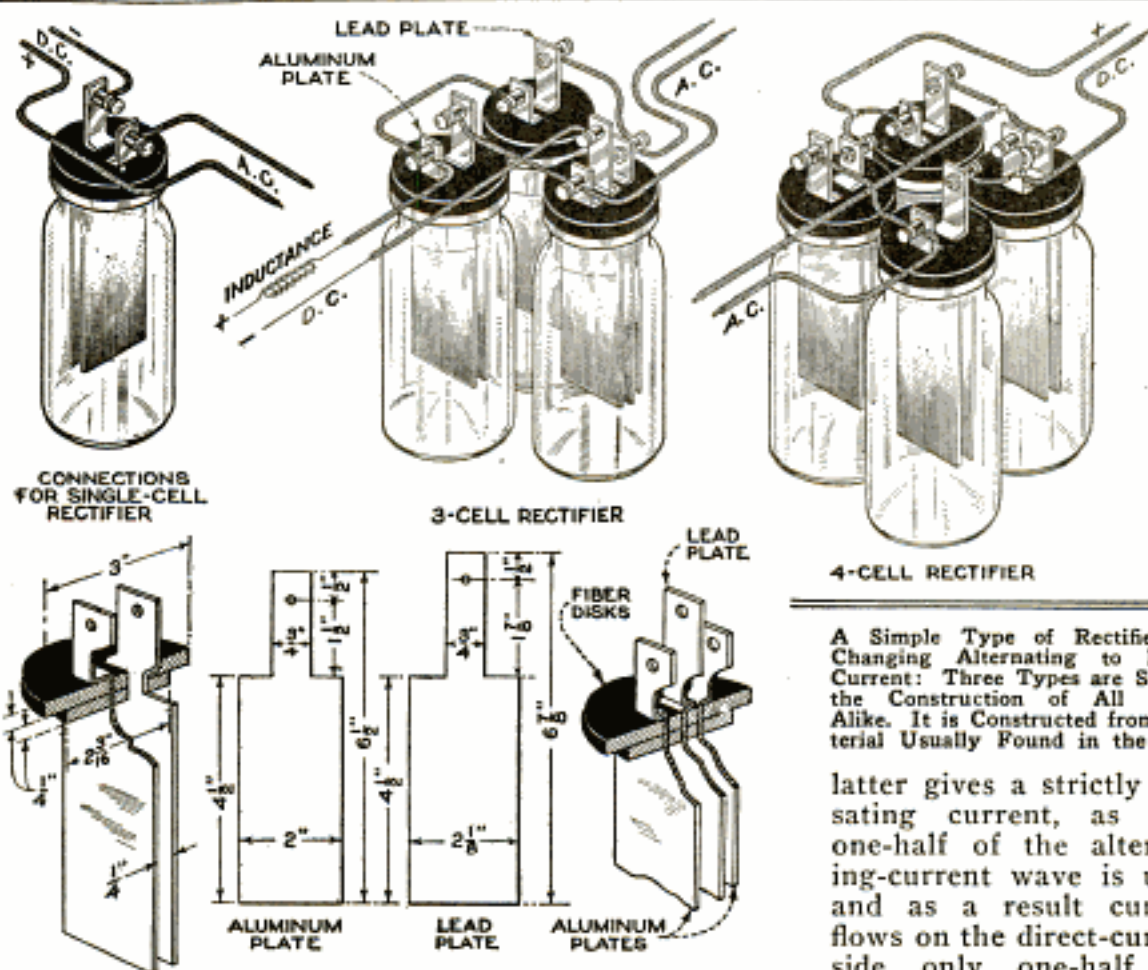

A Simple Type of Rectifier for Changing Alternating to Direct Current: Three Types are Shown, the Construction of All Being Alike. It is Constructed from Material Usually Found in the Shop

latter gives a strictly pulsating current, as only one-half of the alternating-current wave is used, and as a result current flows on the direct-current side only one-half the time.

The three and four-cell rectifiers utilize both sides of the alternating-current wave, and, while the direct current from this type of rectifier is also pulsating in character, current is flowing through the output side practically all the time, and these pulsations may be greatly damped or smoothed by means of an inductance, as will be described later on.

Direct current produced by rectification cannot be used in place of a storage battery for radio receiving on account of its pulsating character, but may be used for recharging the storage battery if it is of small size.

Either the single or multiple-cell type

current voltage to almost any other voltage, up or down, by using suitable transformers, but this does not change the character of the current. Rectification of alternating current into direct current is an entirely different matter, and is accomplished by various forms of rectifiers, or by a motor generator, all of which are rather expensive.

For the ordinary requirements of the small-shop man, experimenter, or radio-set owner, a three or four-cell electrolytic rectifier provides the cheapest and most satisfactory method of rectifying the alternating current. Such a rectifier is not

electrolytic rectifier may be readily constructed from materials usually at hand in the shop or laboratory, or which can be easily bought at very small cost. From my own experience I prefer the three-cell type of rectifier, but the four-cell combination gives a direct current that is slightly steadier. The instructions given apply to the construction of the three-cell type for use on 110-volt alternating circuits, but they may be readily adapted to either the single or four-cell rectifiers. This rectifier will give as much as 5 amperes for very short periods, but heats up under continuous service at even much lighter loads. However, by increasing the surface area of the plates, using larger jars, or by water-cooling the outside of the jars, the current capacity of the rectifier may be increased as desired.

For the three-cell rectifier the following materials will be required:

- 2 pieces of sheet lead,  $6\frac{1}{2}$  by 2 by  $\frac{1}{16}$  in.
- 1 piece of sheet lead,  $6\frac{3}{4}$  by  $2\frac{1}{4}$  by  $\frac{1}{16}$  in.
- 4 pieces pure sheet aluminum,  $6\frac{3}{4}$  by 2 by  $\frac{1}{16}$  in.
- 3 pint fruit jars.
- Bakelite or fiber board, about  $\frac{3}{8}$  or  $\frac{7}{16}$ -in. thick, sufficient to make three disks,  $2\frac{3}{16}$  in. in diameter, and three, 3 in. in diameter.

A good grade of sheet iron, or carbon rods or plates, may be substituted for the lead plates. The four aluminum and two of the lead sheets are cut into plates of the same shape and dimensions as indicated by the detail drawing marked "aluminum plate." The larger lead plate is formed to the measurements shown in the other plate-detail drawing. Three disks are cut to fit neatly inside the mouth of the jars, and three larger ones are provided to form covers. Ordinary wood may be used instead of the bakelite or fiber board, but it must first be boiled in paraffin, to prevent warping, and to increase its dielectric properties. One each of the large and small disks are fastened together to form single covers, and slots, about  $\frac{1}{4}$  in. apart, are cut in them; these slots should be just large enough to make a tight fit on the plate lugs. Two of the cells are arranged with one lead and one aluminum plate in each, while the third cell has two aluminum plates, one on each side of the larger lead plate. The plate lugs are offset slightly, as shown in the drawing, in order to hold them securely in place. If desired, holes can be drilled through the plate lugs and the lugs fitted with binding screws or posts to facilitate connecting.

The mouths of the jars should be dipped into melted paraffin for about  $\frac{1}{2}$  in.; this will prevent the electrolyte solu-

tion from "creeping." The jars are then filled to within about  $\frac{1}{2}$  in. of the top with a 5 or 10-per-cent solution of sodium bicarbonate (ordinary baking soda). The covers are then placed on the jars with the plates extending down into the electrolyte. Make certain that no two of the plates touch each other, and connect them as shown in the several drawings with No. 14 insulated copper wire. Suitable fuses and a switch should be provided on the alternating-current side, between the line and the rectifier, as a protection against accident. This switch should always be open when the rectifier is not in use.

To start the rectifier, switch on the alternating-current and close the direct-current circuit for a few minutes through about 100 ohms' resistance, such as a 100-watt lamp; this is only necessary when starting a new rectifier for the first time, but must be done in all cases, or else the device will not work.

In case a smoother current wave is desired than that furnished by the rectifier alone, an inductance may be introduced into the circuit in the manner shown. A suitable inductance is made by winding 200 or more turns of No. 16, or larger, insulated copper wire around a 1 by 1 by 6-in. laminated-iron core. Of course these inductance specifications can be changed, and the larger the core and the more turns of wire upon it, the smoother the direct-current wave will be, but this will cut down the power available.

### Chucking Narrow Work

Every mechanic knows the necessity of backing up work against the chuck jaws whenever possible, as this enables heavy

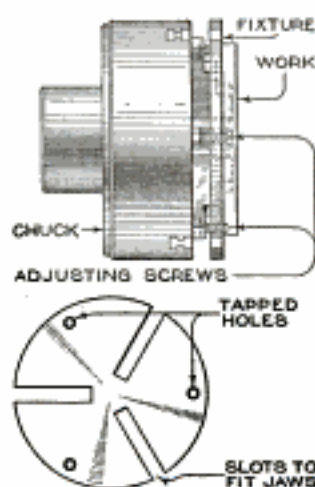

cuts to be safely taken and also greatly facilitates the setting up of the job. A handy fixture that can be instantly attached or detached to a three-jawed chuck is shown in the drawing; it is designed to be used when facing rings, flanges, or covers that are too thin to be

backed up against the step of the chuck jaws and still allow the surface to be

clear. The supporting piece is made from stock about the same diameter as the chuck, and thick enough to insure strength for the size of chuck used. Three slots are milled in this piece, 120° apart, and wide enough to form a sliding fit over the chuck jaws. Three holes are tapped in this piece, to take a corresponding number of hexagon-headed screws. When a number of pieces require to be faced, the fixture is slipped over the jaws, and the screws are adjusted until the piece is held in the proper position and is running true. The work is then held back on the fixture with one hand while the jaws are tightened. Very thin work can be securely held in this way, supported as it is all the way around. Furthermore, no time is wasted in tapping the work true, always an annoying operation on thin work and, if the job is a light casting, the danger of breakage is avoided.

### Flooring Clamp

Flooring clamps of some sort are a necessary part of the carpenter's equipment for laying floorboards, unless he clings to

the primitive method of nailing a piece of 2-by-4 stuff to the joist and wedging the warped stock against the rest of the floor.

The lever part of the clamp shown is made of 1-in. square steel, and the connecting link is made from a piece of  $\frac{3}{4}$  by  $1\frac{3}{4}$ -in. flat stock; it is slotted at

the front, for the lever, and drilled at the rear, for the spur. The spur is a piece of  $\frac{3}{4}$ -in. round tool steel, beveled at its lower end. A taper pin is used to hold the spur and link together. One or two holes can be drilled in the link in order to lighten it.

In use, the tool is brought up against the board, and the spur is driven into the joist with a blow of the flooring hatchet or hammer; this being done, pressure is exerted on the lever to bring the board into position for nailing.

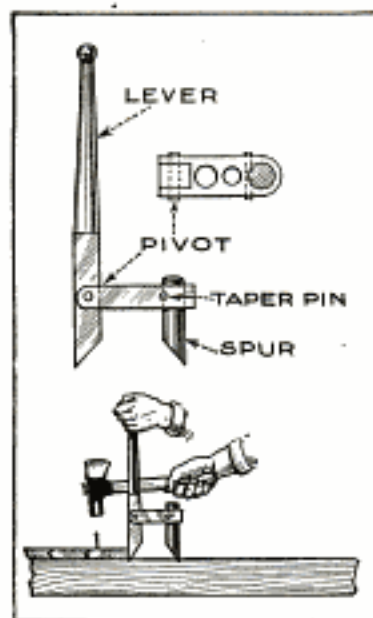

### Grinding Plane Bits

A practical way of grinding a plane bit at the proper angle is to reverse the plane clamp on the back of the bit and then reverse the grinder tool rest, which will serve as a guide. By placing the edge of the clamp against the straight edge of the rest, and lowering the edge of the bit against the face of the grinding wheel, the proper bevel will be found. Then tighten down the clamp screw, and, by sliding the bit and clamp back and forth across the face of the wheel, a good, straight edge and hollow grind will be obtained. It goes without saying, that the face of the wheel should be perfectly true.—Glen W. Noble, Jesup, Ia.

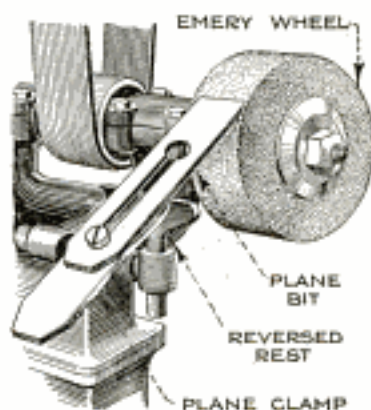

and, by sliding the bit and clamp back and forth across the face of the wheel, a good, straight edge and hollow grind will be obtained. It goes without saying, that the face of the wheel should be perfectly true.—Glen W. Noble, Jesup, Ia.

### Method of Mounting Window Sash

In doing some work where it was impracticable either to slide a window sash upward or sidewise, or to hinge it at the

top and swing it to the ceiling, the arrangement illustrated was found very satisfactory. The window was hinged to two short iron straps as shown. When the window is closed these straps fit into a mortise cut into the edge of the sash. Wooden dowels, driven into the edges of the sash

a short distance above the hinges, fit into the grooves on the sides of the window casing. Notches, cut in one side of the grooves as shown, allow the window to be held open at several angles.—Rufus E. Deering, Ottawa, Kan.

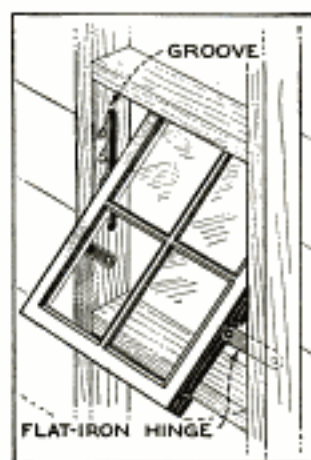

When cutters do not run true, when the work springs, or when the arbor of the milling machine is too light, wavy lines will show on the surface of the work.

### Flooring Saw for Wiremen

An electrical contractor, making a specialty of wiring old houses, devised the saw shown in the drawing for cutting neat openings in the flooring. It was found that this saw saved a great deal of time

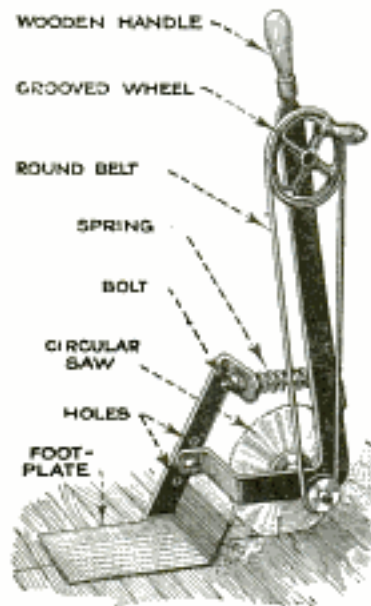

and labor, and made a much neater cut than could be obtained by any other method. A small circular saw was fastened to a  $\frac{3}{8}$  by  $1\frac{1}{4}$ -in. flat iron bar, bent to the shape shown and provided with a handle. A handwheel, with a groove for the round leather belt used, was fastened to the upper part of the bar, and a smaller grooved pulley was fixed to the arbor on which the saw was fastened. This arbor was made from a bolt, and was supported and held rigid by a long bushing, forced into a hole in the supporting bar. A lug was welded at right angles to the upright bar. A similar lug was provided on the member to which the footplate was fastened, and a bolt and spring connected the two lugs. The spring was open-wound, to give it resistance to compression or expansion, as the pressure on the handle demanded. The bar to which the footplate was fastened was made of the same material as the longer one, and several holes were drilled in it for the purpose of raising or lowering the saw when cutting flooring of different thickness.

### Yellow Stain in Hardwood

A troublesome defect often found in hardwood lumber is that known as yellow stain. It is usually distinguished by a pale-yellow color, generally occurs in streaks, and is detected most easily when the wood is surfaced, although it is present at times without discoloration of the wood. Its first symptom may be a moldy appearance of the wood.

The only damage yellow stain is positively known to do, is to mar the finish of the product, since it usually penetrates

the wood so deeply that it cannot be surfaced off. It is probable, however, that the fungus actually weakens the wood, and the use of yellow-stained lumber for airplane construction and similar purposes where strength is important, is to be discouraged, until a more definite knowledge is obtained about its action on wood structure.

Lumber can be protected from attack of the yellow-stain fungus by seasoning the stock without delay after it is cut, storing it in a dry place, or treating it with preservatives.

### Improving Cutting-Off Tools

The only fault that can be found with ready-made cutting-off tool bits is that there is no taper to the blade, so that clearance is only obtained at the bottom. If a quantity of such bits are on hand in the tool room, they can be taper-ground, to the dimensions shown, on a common surface grinder. This grinding should be done on both sides of the tool, as it is a good idea to remove the oxidized

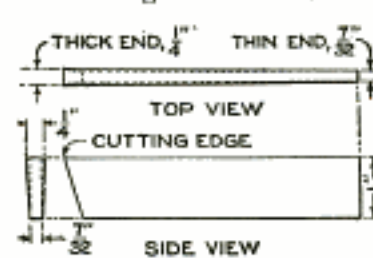

surface of the hardened steel. Tools ground with a taper from front to back will, when set square with the job, cut

without tendency to dig, and only require grinding on the front face to resharpen them. It is best to buy the ready-made kind and regrind, as the steel used by the makers is of the best and is properly hardened and treated.

### Making Concrete Bases for Steel Posts

The increasing scarcity and cost of wooden fence posts are gradually forcing the steel post into general use. It is well known that steel posts, when set in concrete, will stand firmer and last longer, but the common system of digging the post hole first, setting the post, and then filling the hole with concrete, is a slow and tedious job. I have found the following method much better: Make tubes 6 in. in diameter and 20 in. long from building paper; strengthen the splice by driving a few tacks through the double thickness of paper into a piece of lath placed on the outside. Drive the tacks from inside the tube. Place these tubes

in rows on the ground, about a foot from the barn wall and slanting a little toward it. Then drop a little sand or loose dirt into each tube to prevent the concrete from running out at the bottom. Place the lower ends of the posts in the tubes, leaning the upper ends against the barn wall so that they will be approximately centered in the tubes, and fill the latter with concrete. The mixture should be in the proportion of 1 part of cement to 5 parts sand. After the tubes have been filled with the cement and sand mixture, they should be allowed to remain undisturbed until thoroughly dry. When ready for use, the posts and their concrete bases can be loaded onto a wagon and hauled to their destination.—Ed Henderson, Lake Mills, Ia.

### Strap Handle for Pounding Block

The common lead block, used in every shop for the purpose of pounding different materials without marking or marring, can be more conveniently handled if a leather or thick felt strap is attached in the manner shown in the illustration.



As a rule, no particular attention is paid to the shape of the block, weight being the only consideration, but it will be found that blocks molded in the end of a tube are both easy to make and handy to use. To attach the handle, a hole is drilled through the lead, near one end, to take a stud about  $\frac{1}{4}$  in. in diameter. The strap is cut out in one piece, and one end is passed over the stud on one side, then brought over the top and over the stud on the opposite side, doubled and brought back to the first side again, leaving enough space between the parts of the strap to insert the hand easily. Then the nuts are screwed tightly. In this manner the bottom part of the strap forms a pad that lessens the shock of the blows, and the top piece enables the workman to lift the weight without gripping the sides all the time. The advantage of making the handle in one piece is that the top portion cannot fall out of an upright position.

### Filling Can for Auto Engines

The breather pipe through which oil is poured into the crankcase of automobile engines is usually so located that a funnel is required when the oil supply is to be replenished, if some of the lubricant is not to be spilled. A convenient filling can for this work can be easily made from an empty oil tin in the manner illustrated. The top and handle of the can

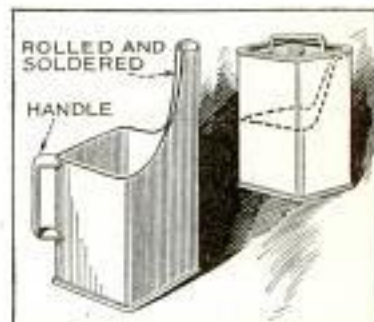

are removed, and the sides are cut away as shown by the dotted lines, leaving a section in one corner; this is rolled over and soldered to form a spout. The handle is soldered to the opposite corner. If made from a 1-gal. can, the filler will have a capacity of about one-half gallon.

### Eaves Trough Made Removable

Eaves troughs can be made so as to be easily removed from the house for painting and cleaning. A great many persons are under the impression that, because the material from which the eaves troughs are made is galvanized, it will last more or less indefinitely, with little or no painting. This is a wholly erroneous and expensive notion. Painting the troughs on the building is a laborious undertaking, and the work cannot be done as well from a ladder as it

can on the ground. The drawing gives a clear idea of a hanger that makes it possible to remove the trough, and apply the paint thoroughly and comfortably. The hook is made of sheet iron, and is riveted between the Z-shaped brace and the side of the trough, so that it can be swung back. If a large quantity of such fasteners is to be made, a simple blanking die could be used. A short spike, or heavy screw, driven into the side of the building, is used for attaching the hook.

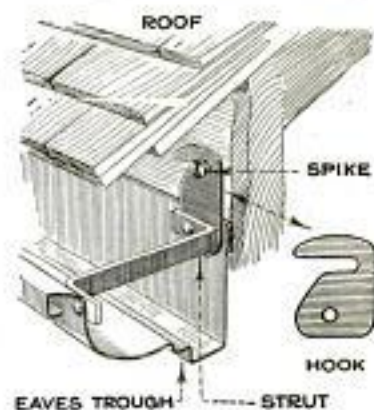

### An Adjustable Rest for the Workbench

The manual-training department of a school uses the adjustable work rest shown in the drawing on the work-

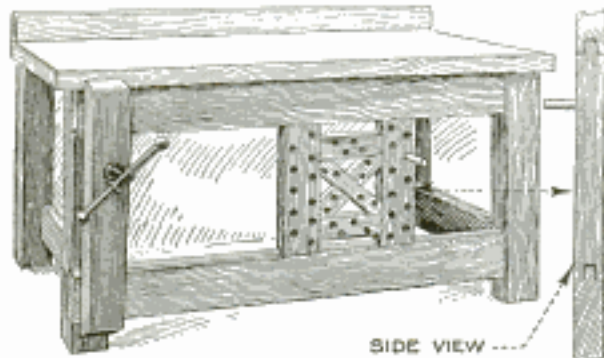

A Support or Rest for the Workbench That Accommodates Work of Any Width or Shape

benches. The rest is provided with a tongue and groove on its upper and lower edges, as shown at the right; these fit corresponding guides in the horizontal braces of the bench. The frame, or rest, is drilled with irregularly spaced holes so that work of any shape, held in the vise, can be supported by inserting pins in the proper holes. It will be noted that the groove is cut on the upper brace of the bench; this prevents its becoming choked with sawdust and other debris of the shop.—Irwin L. Morrow, Muncie, Ind.

### Neat Drill-Press Stop Collar

For the smaller sizes of drill presses, the split stop collar shown in the drawing will be found much more convenient than the type commonly used, as no screwdriver or wrench is required to fasten it to the spindle. Furthermore, this stop collar presents a neater appearance and is less likely to catch the operator's clothes than the common type. It is made in two pieces, the split collar itself and a

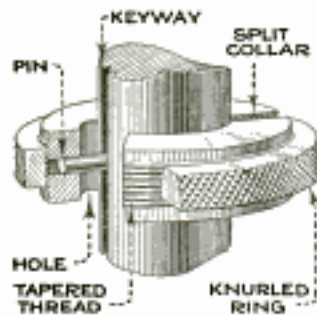

knurled ring that screws onto it. The collar is bored to make a close fit around the drill spindle, and a slightly tapering, fine-pitched thread is cut on the circumference. The thread is turned

down on both ends, only the center portion being left, the width of this being slightly greater than the width of the knurled ring. A hole is drilled through the side of the collar for a pin that fits

into the keyway of the drill-press spindle. To complete the stop, a hole is drilled through the collar, in line with the saw slot, to provide further spring, and the knurled ring is fitted. When slipped onto the spindle of the machine, the collar can be loosened or tightened in a second, the pin in the side preventing it from turning on the spindle while this is being done. Care should be taken to use a fine-pitch thread and turn down the ends to suit the narrow ring, as otherwise the collar will be difficult to adjust.

### Magneto Magnets Used for Clamps

Old magnets from the magneto of a well-known light automobile, which are obtainable at garages and service stations, can be used to make serviceable clamps for bolting work down to machine tables. What magnetism there may be remaining in the parts can be removed by heating them to a bright red, and quenching in water.—J. H. Rouse, San Francisco, Calif.

### Filling the Grease Gun

Filling the grease gun is a messy job, especially when one is in a hurry. A very convenient and easy way to fill the cylinder of the gun is illustrated in the drawing. Cut

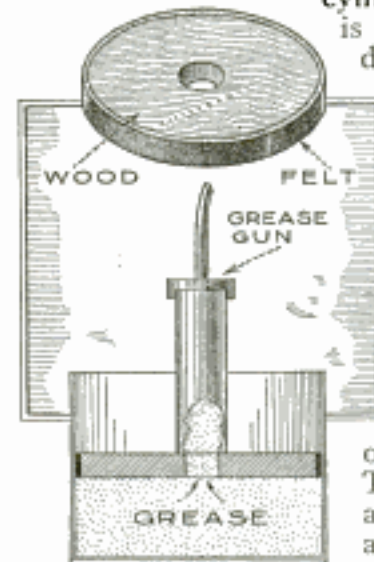

a disk of wood, slightly smaller in diameter than the inside of the grease can, and bore a hole through the center of the wood a trifle smaller than the end

of the grease gun. Then glue or tack a strip of felt around the circumference of the

wooden disk, so as to make a snug fit inside the can of grease. By placing the disk inside the can, with the end of the grease-gun cylinder over the hole in the center, and applying pressure, the lubricant will be forced upward through the hole into the barrel of the gun. The disk can be left in the can, until empty, to serve as a cover.—Rudolph H. Kasper, Philadelphia, Pa.





Information as to where to obtain any specified materials or parts for making objects described in the following pages may be had, on request, from our Bureau of Information.—Editor.

## How to Build a "Pushboat"

BY L. B. ROBBINS

**M**UCH fun can be had during the swimming season with a "pushboat" of the type illustrated, which operates on the same principle as a variety of popular small-wheeled vehicles.

The hull—for lack of a better name—is made from a single thick plank, the

stern end of the upright. Round off the edges so that they will not cut the legs. A mortise is cut in the upper edge of the upright, under the stern end of the seat, to receive the outrigger, and a recess under the forward end, to clear the rudder lever. A curved piece of timber, 5 ft. long,



A Hand-Propelled Paddle-Wheel Water Craft of the Catamaran Type: The Back-and-Forth Movement of the Hand Levers Drives the Paddles through Connecting Rods and a Crankshaft. A Curved Out-rigger is Provided with Wooden and Pneumatic Floats on Either Side

bow end of which is pointed. After smoothing off the surface of the board, it is given at least two coats of good paint. A piece of 10-in. plank, 3 ft. long, is spiked to the deck and in the center of the hull, as shown. Then a seat, made from a 10 by 18-in. board, is nailed to the

is used for the outrigger, and two round-end planks are fastened to its ends, as in the drawing. These outboard planks should be slightly lower than the hull. The outrigger is then spiked to its mortise in the upright so that the planks will be at the same distance away from the

hull and parallel with it. The planks are given buoyancy by tying an inflated inner tube around the edge of each; these can be protected with a wrapping of canvas or burlap.

Movement, forward or backward, of the craft is given by paddle wheels, operated by a pair of levers mounted in front of the seat. The paddle wheels are made by screwing four sheet-metal blades to the sides of an oak hub, as indicated in the detail drawing. Two such paddle wheels are required, and they are attached to the ends of a crankshaft, as detailed, each end of the shaft being threaded to screw into the pipe flanges fastened to

and screwed as tightly as possible, to prevent them from turning loose by the action of the wheels in motion.

Then bolt a pair of levers, about 30 in. long, one on each side of the bow end of the upright, in front of the seat. The pivot bolt goes through the top corner of the upright, and should be provided with washers. Form smooth handles at the top of the levers and drill holes about 6 in. below the pivot bolt, for the connecting-rod bolts. The levers must work back and forth freely. Motion from the levers is communicated to the paddle wheels by means of connecting rods, which are made of oak or ash. These

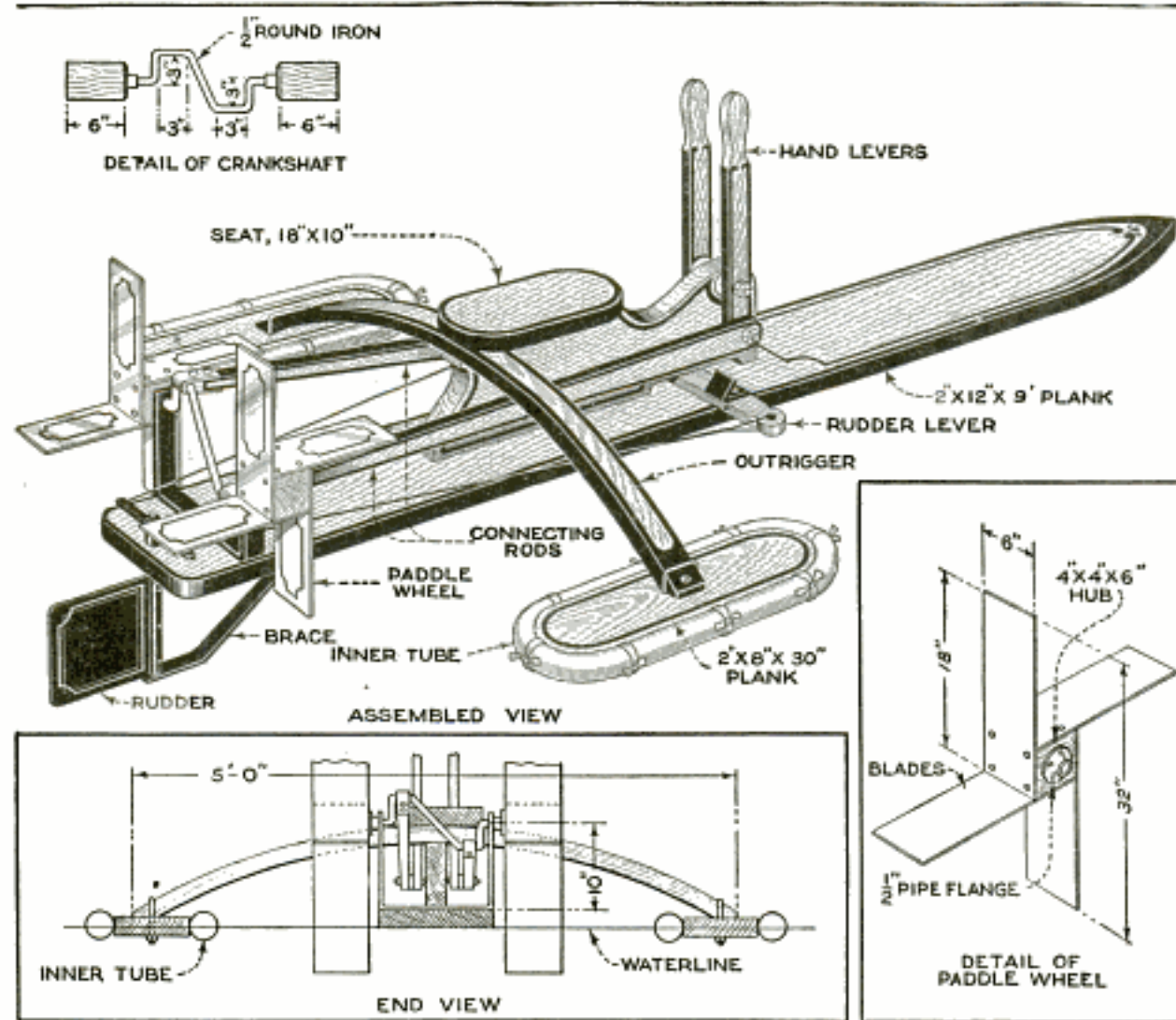

Detail Drawings of the "Pushboat" Which Clearly Show How the Craft is Assembled: Such a Boat Is Inexpensive to Build and can be Made Easily with Few Tools. The Outrigger Floats Make Capsizing or Sinking Difficult if Not Impossible, and It can be Driven at Good Speed in Quiet Waters

the paddle wheels. The crankshaft is supported on a U-shaped piece of heavy iron, the bearing holes being drilled 10 in. above the deck. In screwing the paddle wheels onto the crankshaft, the flange threads should be coated with white lead

rods are loosely bolted to the levers in front, while the rear ends are round-notched and fitted with flat-iron bearing straps which fit around the crankshaft. By moving the levers back and forth, the paddle wheels are revolved.

Any sort of rudder can be hung from the stern and fitted with a tiller as in the drawing, so that the hands are not required to guide the craft. After completion, the whole craft is given several coats of paint to protect it from the water.

With the operator aboard, the hull will be nearly submerged, but the two

inner-tube floats at the ends of the outrigger will keep it afloat and steady so that there will be no possibility of its capsizing or sinking in smooth water.

Sit facing the bow, grasping a lever in each hand and the feet on the steering lever, and then commence to pump the hand levers back and forth, at the same time steadying the rudder.

### Crumbs as Lure for Fish

Fish can be attracted to the spot where the fisherman is casting, by partly filling a paper bag with bread crumbs and meat scraps, and suspending it in the water. An ordinary paper flour bag is used, and, after it has been filled, weighted, and a cord tied around the neck, it is lowered



to within about 4 ft. of the bottom, at the spot selected. Two or three small holes are made in the sides of the bag and this will start a few crumbs falling, which will attract some fish. As the crumbs are seized upon by the fish, and other crumbs continue

to fall, still more fish will be drawn to the spot. After a suitable interval has been allowed for the lure to become effective, the baited hook is let down. This method is superior to the common one of scattering loose crumbs on the water.

### Violin as Phonograph Reproducer

Another of the multitude of experiments aimed at getting peculiar effects from a phonograph record, makes use of a violin as a sound box or reproducer. The bridge is fitted with a small wooden block, cut to conform to the curve; this block should be about  $\frac{1}{4}$  in. square and the same length as the bridge. A phonograph needle is inserted through the center of this block, which is held tightly to the bridge by the strings. The record is played by holding the violin so that the needle rests lightly on the disk.—H. M. Flint, Strathmore, Calif.

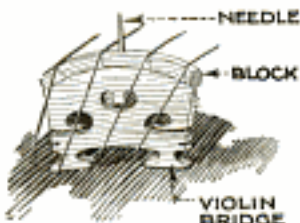

### A Novel Corn Cutter

The corn harvester can work faster and with less fatigue when the corn cutter shown in the drawing is used, as both

hands are left free to handle the stalks. The cutter has the general appearance of a lineman's climber, although worn in a different manner. The leg iron is made from a piece of flat steel or iron, provided with loops for straps. The steel cutter is riveted to the leg iron and sharpened on the edge toward the heel.—T. S. Stuart, Indianapolis, Ind.



### To Prevent Shade Tearing from Roller

It often happens that a window shade is a little short, or is pulled so far down that the tacks holding the shade to the roller are pulled out, or the cloth is torn away from them. A remedy for this trouble consists in removing the tacks from the middle section of the shade. Two cuts, about 3 in. long, are then made in the shade, as shown; this will form a section about one-third the width of the shade, and this section is passed to the opposite side of the roller and tacked. By this method the tacks will never come into the line of pull on the last turn of the roller, and there is always enough slack to allow easy starting again.—Chas. B. Post, New London, Ohio.



### Simple Water-Barrel Regulator

In order to simplify the installation of a rain barrel and do away with the inlet and overflow pipes, as well as provide an

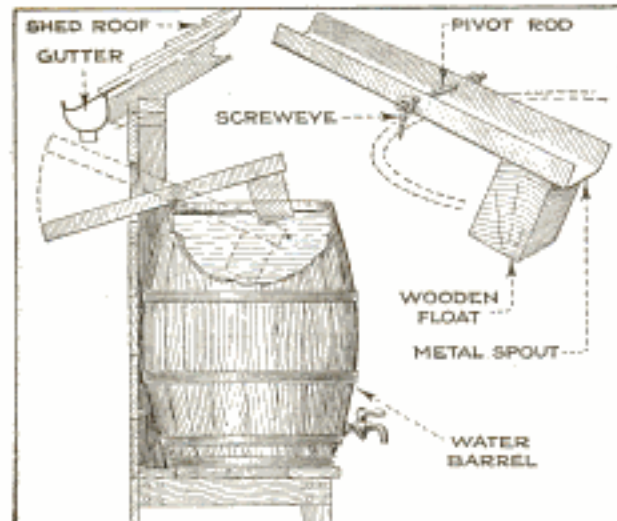

An Automatically Regulated Rain Barrel for Storing Soft Water: When the Barrel Is Full, the Auxiliary Spout Delivers the Rain Water on the Outside

automatic method for cutting off the flow when the barrel is filled, the arrangement illustrated was adopted.

A spout of sheet metal is pivoted to the edge of the barrel by means of screw-eyes and a transverse rod. The inner end of the trough is fitted, on the underside, with a wooden float so that as the barrel is filled, the float raises the spout and the water is diverted to the outside. As the water is drawn from the barrel, the outer end of the spout rises in readiness for the next rainfall.

### Shaker Top for Bottles

A printer uses the device shown herewith to prevent evaporation of the gasoline used in cleaning his type of ink.

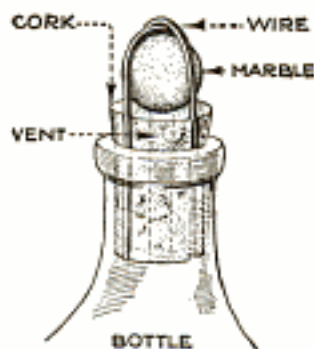

The idea is simple enough and can be applied to any vessel in which a cork stopper can be used. When the container is inverted, the marble uncovers the hole through the center of the cork so that the liquid can be shaken out freely. When the bottle is upright, the vent is closed by the marble, effectively preventing evaporation of the volatile contents.—Howard Lindsey, Sacandaga, New York.

### Soot Screen for Open Windows

A house cannot be well ventilated without open windows, but neither can a room be kept clean with soot and dust blowing in. Much, if not all, of the dirt nuisance can be overcome by covering the window opening with a piece of medium-heavy muslin, stretching it tightly across the window frame. The fabric is cut to fit the opening when tightly stretched, allowing an inch at top and side, to which the top parts of dress snaps or fasteners are sewed. The fixed, or bottom parts, of the snaps are fastened to the window molding, close to the sash. The cloth is then snapped into the corresponding fasteners and the screen is in place.

### Holding Tennis Nets Taut

A tennis enthusiast has attached an ordinary screen-door spring to the posts on either side of his court for keeping the net stretched taut. A snap-hook is attached to the outer ends of the springs, for attaching to the eyelets in the upper corners of the net. The result of this arrangement is that the net never sags in the center, and the bother of drawing up and securing it from time to time is entirely overcome.—Chas. C. Grant, Chicago, Ill.

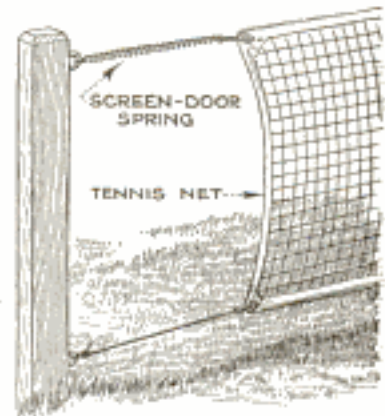

### Repairing Carburetor Needle Valves

Failure of the carburetor needle valve to seat when depressed by the float caused an experimental temporary repair to be made, by coating the worn end of the needle with solder. The needle had been worn so that a small shoulder had formed which prevented the tapered end from seating. When coated with solder this depression was evenly filled. Instead of grinding the point to a seat, the valve was placed on the seat and tapped lightly into place.



### Mildew on Leather.

Any leather article is almost certain to mildew if kept in a warm, damp, and dark place, such as a closet, cellar, or stable. This mildewing will probably not seriously reduce the life of the article unless it is allowed to remain too long. It may, however, appreciably alter the color, thus injuring the appearance. The simplest way to prevent mildewing is to keep the leather in a well-ventilated, dry, well-lighted place, preferably one exposed to sunlight. When mildew develops, it should be washed off with soap and warm water, or simply wiped off with a moist cloth, drying the leather well afterward. These simple measures are more satisfactory than the application of preparations designed to prevent the growth of mildew.

### A Novel Inverted-Light Reflector

An indirect-lighting fixture, which was made from a wicker basket to harmonize with the reed furniture of a room, was provided with a reflector made from a white china bowl. The handles were removed from the basket, which was suspended from the ceiling by three pieces of hemp rope, painted with gold bronze. The bowl is placed inside the basket. This suggests a use to which a basket with a broken handle, or a cracked bowl, may be put, as the handles are removed from the basket, and the crack in the bowl is not visible from below.



### Seesaw Built for One

A single child, seeking means of entertaining itself, has a hard time in getting any pleasure out of the ordinary seesaw.

The drawing shows a combination of seesaw and rocking-horse that can be used by one child. The construction is quite simple, the dimensions and weight of the counterweight being varied to meet

different requirements. The seat is supported on an iron axle by a pair of strap hinges, one end of each hinge being bent to fit around the axle. The counterweight, which may be an iron casting, or

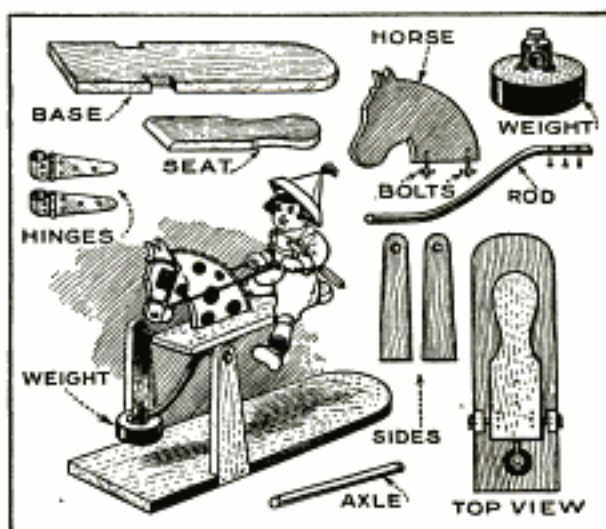

A Combination of Hobbyhorse and Seesaw That Makes It Possible for a Lone Youngster to Entertain Himself: A Counterweight is Provided for Balancing the Weight of the Child and Seat

a block of cement, is attached to a curved iron rod fastened under the front end of the seat. The counterweight should be a trifle heavier than the combined weight of child and board, and a little experimenting will be necessary to strike the correct balance. The exact mass of the weight can be found by first attaching a bucket or bag of sand to the end of the rod, and adding or removing sand until the proper weight has been found.

### A Manifolding Aid for Typists

Typewritten manifolds are frequently spoiled when the writing is carried down too close to the edge of the first sheet.

By sticking a strip of gummed-paper tape along the lower edge of the carbon paper, so that half is on the paper, then gumming a strip of cardboard to the projecting edge of the paper strip, the arrangement will

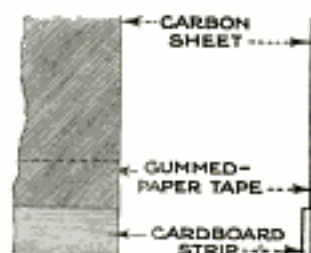

pinch between the platen feed rolls of the machine, and prevent the sheets from rising too far. Do not stick the tape to the carbon surface, and, in use, allow the cardboard to come below the edge of the sheets; just how much depends on the amount of margin desired at the bottom. —Warren Scholl, Cleveland, Ohio.

### Closet Concealed by Open Door

Occupants of an apartment in need of additional storage room noticed that a door in one of the halls was rarely closed,

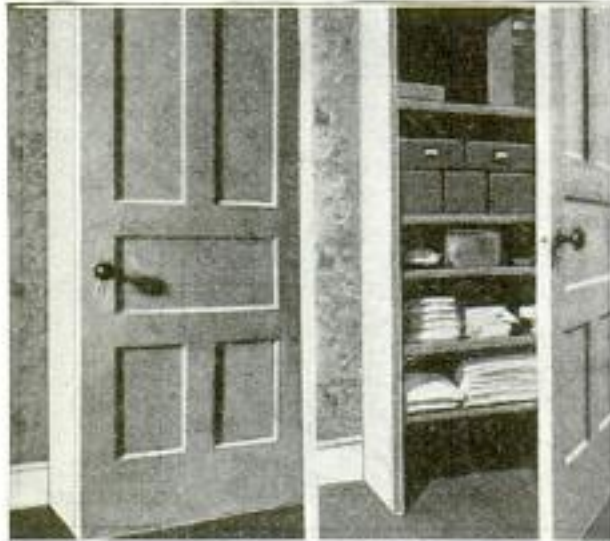

The 14-Inch Space behind a Door is Used to Provide Additional Closet Room. A Set of Shelves was Built to Fit into the Space, and the Closet is Entirely Concealed by the Open Door

and as this door was hinged 14 in. from the wall, it was decided to build a closet in the space behind. The closet itself is a simple affair of two upright boards, which serve as supports for shelves. When the door is open and hooked with a screen-door hook, the closet is entirely concealed. As the shelves are not fastened to the wall, there can be no complaint from the owner and they can be removed at any time.

### Lengthening the Life of Auto-Starters Gears

The constant use of the self-starter on an automobile during a period of three or four years will wear off the entering edges of the teeth on the rim of the flywheel, from the "clashing" contact with the steel driving pinion on the starting motor. On a four-cylinder engine, two badly worn spots will be noticeable on opposite sides of the flywheel rim, while on a six-cylinder engine there will be three such worn spots. If this wear is allowed to proceed too far, some of the teeth will eventually be broken, and may cause the complete wrecking of the starting motor.

The worn spots referred to occur between the compression points of an engine and are caused by the rotating starter pinion overcoming the inertia of the dead engine, and the sliding and grinding

action of the rounded teeth before they have properly meshed with those of the flywheel. This can be stopped and a new lease of life given to the flywheel teeth by removing the flywheel from the crankshaft flanges, and shifting its position a quarter turn on the flange. This will, of course, make the valve-timing markings on the rim of the flywheel useless, and it should be re-marked. As there is no mechanical connection between the flywheel and the rest of the engine except the crankshaft, it makes no difference in what position it stands. This change is best made when the engine is taken out of the car for a general overhauling.

### Rubber Mittens for Handling Brick

For rough work, such as handling brick, castings, lumber, and similar materials, damage to the hands from the sharp and jagged surfaces, or slivers, can be largely avoided by wearing mittens made from pieces of old inner tubes. A slit is cut in the side of the tube section; this allows the thumb to project, but protects the fingers and palm. It is unnecessary to close the end of the mitten, although this is easily done with a little rubber cement.—A. Swenson, Los Angeles, Calif.

### Consecutive-Numbering Stamp Made from a Dater

An old dating stamp can be used to make a consecutive-numbering machine, which, while lacking the automatic and



other desirable features of the regular machine, will answer the purpose in many cases. The date numbers of two stamps can be used, one of the frames being discarded. For numbering up to 99 no change is necessary, except to remove the bands stamping the month and year,

but if numbers of more than two places are required, open up the frame of one stamp and put the numbered bands, with their changing wheels, into the other frame; this combination makes it possible to stamp numbers of four figures.

### Double Horn for Autos

The alternating-current horn used on a familiar type of light automobile is not a particularly effective warning at low engine speeds. Many owners of such cars have therefore equipped them with hand-operated horns for use in emergencies.

In such cases, in order to avoid the necessity of having two separate horn buttons in different locations, the electric-horn button can be mounted on the top of the hand horn. By this arrangement, a light pressure will operate the electric horn, while, if a little more pressure is applied, both horns will be caused to sound simultaneously.—D. S. Crabtree, Bridgeport, Conn.

### Washing Machine Driven by Engine in a Detached Building

A farmer makes use of the arrangement illustrated for driving the family

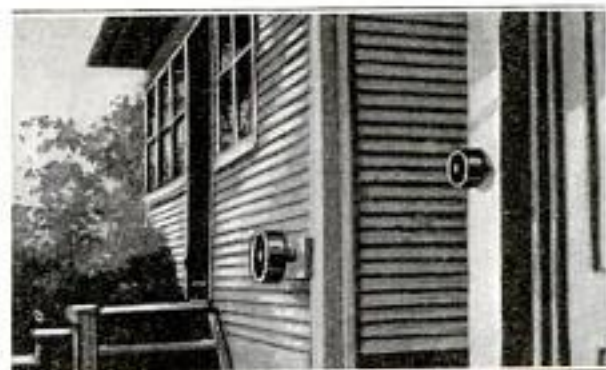

Using a Gas Engine Located in a Detached Building to Drive the Washing Machine in the House: Shafts Extend through the Buildings for the Belt Drive

washing machine, which is located on an inclosed porch of the house, by a small gasoline engine placed in a near-by engine room. Short shafts are run from the washing machine and engine to the outside of their respective buildings, and pulleys are provided for the belt drive, which is used only on wash day.—Dale R. Van Horn, College View, Neb.

### A Homemade Magazine Rack

The magazine rack illustrated will be found a great help in keeping the room tidy, and the magazines and periodicals in one place. Each side is cut from a single piece of  $\frac{1}{2}$ -in. board. The bottom is made from two pieces of 1-in. board, and is made to slope toward the center. There is a rack across the middle of the stand for holding the books

being read or referred to by members of the family. The magazines slip underneath the bookrack, and as they lie at



A Homemade Magazine Rack Which Is of Help in Keeping the Room Tidy and the Periodicals in Neat Order

an angle, one can easily read the titles and remove the publications desired without disturbing the others.—C. L. Meller, Fargo, N D.

### Container Saves Spark Plugs

Extra spark plugs are often carelessly thrown into the toolbox, with the result that the jack, pump, or other implement is dropped in on top of them, breaking the porcelain, and besides, a litter of tools must be

"pawed over" to find the plugs, when needed. A container similar to the one illustrated saves its cost by protecting the plugs against damage, and makes them instantly available. A wooden block,

2 by 4 in. in cross section, and of suitable length, has two  $1\frac{1}{2}$ -in. holes drilled in it, is fitted with a swinging cover, and fastened to the engine side of the dash. This container carries two spark plugs, and affords them ample protection.

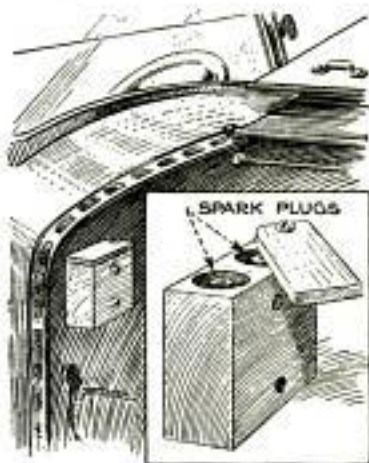

### A Simple Typewriter Stand

The illustration shows how a substantial typewriter stand can be easily made from a few scraps of lumber.

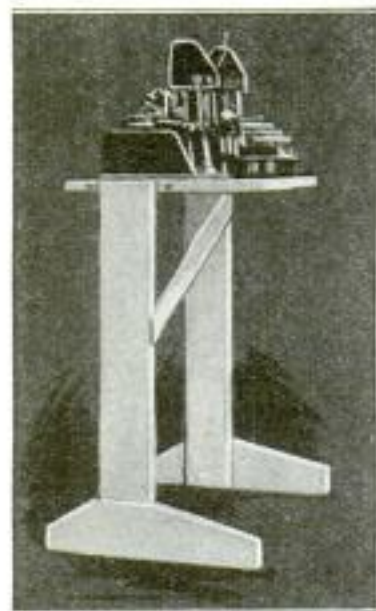

The table consists of two legs with long feet at the bottom, a top for the typewriter to rest on, and a brace across the legs. If the table is assembled solidly, using screws instead of nails, it is quite substantial. It is also neat in appearance and can be finished to harmonize with

the other pieces of furniture.—R. E. Deering, Ottawa, Kan.

### Instrument Knobs Made from Storage-Battery Plugs

The radio fan who is pressed for cash while building his set can save a little by making his own instrument knobs from old storage-battery plugs, which can be obtained for little or nothing at almost

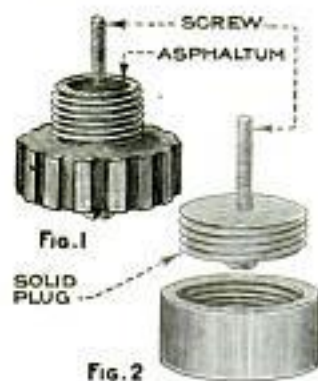

any battery station. There are two types of such plugs; those with an outside or male thread, Fig. 1, and those built like a cap, with internal or female threads, Fig. 2. The former are the easiest adapted and are stronger than the latter. Two meth-

ods of attaching the screws to the knobs are illustrated, although others will readily suggest themselves. In most cases it will be found easiest simply to center the screw in the cap and fill the cavity with melted battery-sealing compound, sealing wax, or asphaltum.

☛Your radio questions, if sent to our Bureau of Information, will be answered by an expert.

### Testing Lubrication of an Auto

A lubricating difficulty that shows itself by burning out the front connecting-rod bearings and scoring the cylinder of a light automobile, is caused by clogging of the oil-feed pipe that carries oil from the flywheel to the forward end of the crankcase. As a test, to determine whether the oil pipe is open, in cases where the engine shows symptoms of trouble from this cause, it is only necessary to remove the right-hand crankcase-cover screw and start the engine. A stream of oil issuing from the open screw hole will remove any doubt of the oil feed being clogged. If desired, this screw may be replaced by a small petcock which can be opened while the engine is running.

### Storing Extra Table Leaves

It is sometimes quite a problem to the housewife to know where she can best store the extra leaves of the dining-



room extension table, so that they will be out of sight and at the same time readily accessible; the drawing shows how one housewife solved it. Pieces of sheet iron, about 6 in. wide, were bent to the

shape shown; holes were drilled along the lower edge for screws, and the upper edge was slightly curved outward to prevent scratching and marring the finish of the leaves. These brackets were then screwed to the back of the buffet. The leaves drop easily into place without moving the buffet; as the baseboard prevents it from coming close against the wall, there is generally plenty of room for the leaves.

### Chain for the Clothes Closet

A piece of light chain, stretched taut between the walls of a clothes closet, is fine for holding coat hangers. The hooks of the hangers can be caught in the links so that there is no danger of their sagging together at one point, as they do when a cord, wire, or pole is used.



Bach's Mfg. Co. 3214 Woodland  
Ave. Philadelphia  
Pa.



## A STEAM BOILER FOR MODEL ENGINES

By D. M. RICE

**M**ODEL steam engines, of either stationary or marine types up to  $\frac{1}{4}$  horsepower, can be successfully operated by the miniature boiler shown in the drawing. Such a boiler is designed to be heated by a blowtorch, which makes it possible to generate the working pressure of steam in a very short time; by varying the design slightly, an alcohol lamp may be used under the copper coil, which will also give good results.

The boiler is a simple affair, although a little skill will be required to form the convex heads; these are made from disks of sheet copper,  $\frac{1}{8}$  in. thick and  $2\frac{3}{4}$  in. in diameter. The disks are beaten hollow

in. in diameter, and a convex face, that will fit neatly into the hollowed disk, turned on one end. A small hole is drilled in the center of each disk, and they are then fastened, one at a time, to the end of the rounded block with a small wood screw. The copper is hammered lightly along its outside edge, turning it down parallel with the sides of the block until a nicely flanged boiler head is obtained. After the heads have been flanged in this manner, the small hole in the center is stopped with a rivet and covered with solder.

The boiler shell is made from a 7-in. piece of copper or brass tube, 2 in. in

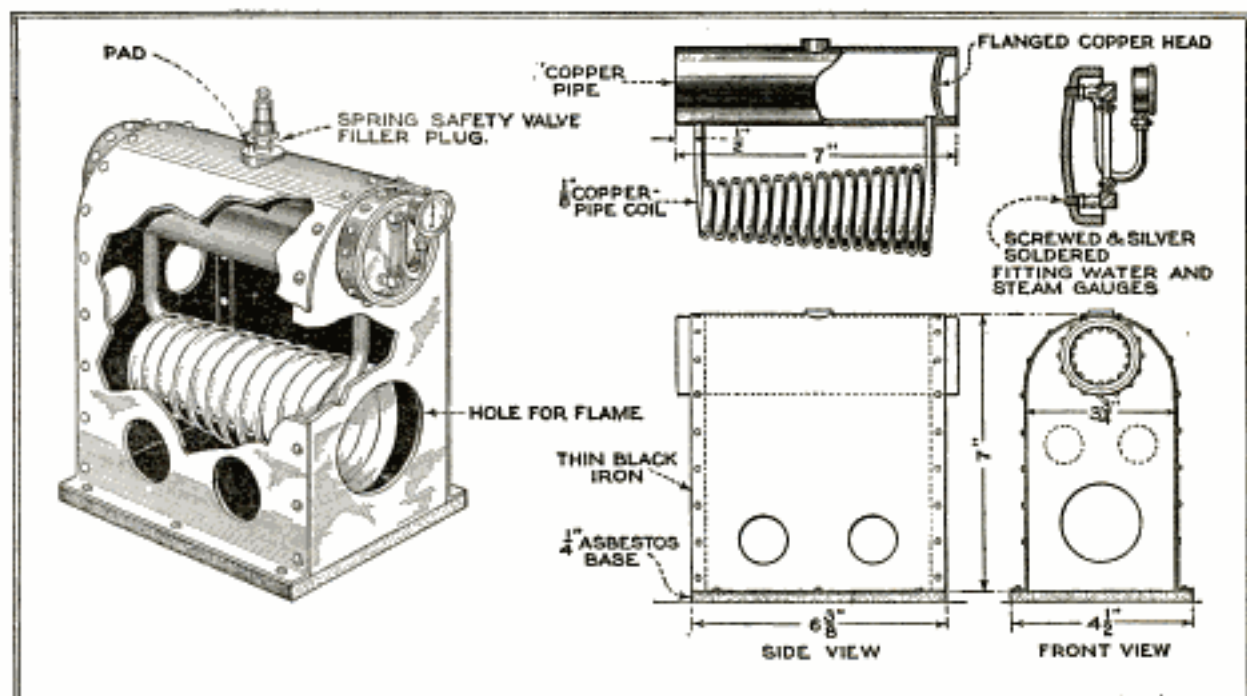

A Miniature Boiler for Model Steam Engines of Either Stationary or Marine Types: The Boiler is Heated by the Flame from a Gasoline Blowtorch Directed through the Center of a Coil of Copper Pipe Attached to the Underside of the Shell

with a light ball-peen hammer, or pressed out in a simple die. The depth of the hollow should be about  $\frac{3}{8}$  in., and, if the hammer is used, care should be used in beating the metal to see that the strokes are not so heavy that the thickness of the metal will be reduced. After the proper convexity has been given to the disks, a piece of hardwood is turned down to  $1\frac{3}{4}$

diameter. Drill a hole near each end to receive the ends of the copper coil, as shown. On the opposite side of the shell, rivet or braze a small metal disk, or pad, about  $\frac{1}{8}$  in. thick. This pad should be filed on its underside to conform to the curve of the boiler shell, and is necessary for attaching the safety valve, as the metal of the shell is not thick enough to

permit tapping the threaded hole. A safety valve is absolutely necessary. No provision is shown for the steam outlet of the boiler, as this may be located to suit different conditions, but a pad, similar to the one described for the safety valve, must be provided for the steam pipe. Although the steam outlet may be placed in various positions, it is, in all cases, necessary to place it above the waterline, and standard practice should be followed by placing the steam pipe on top of the boiler.

The spiral copper-tube heating coil should next be made and fitted to the holes provided for the purpose on the underside of the boiler shell. About 9 ft. of copper tubing, with an internal diameter of  $\frac{1}{8}$  in. will be required for this coil, which is wound around a piece of rod or pipe  $1\frac{3}{4}$  in. in diameter. The mandrel is placed in a vise and 21 turns of the tubing are made around it. The coil will be improved if it is tapered, as shown in the drawing, although this is not essential. The ends of the completed coil are fitted into the holes provided in the underside of the boiler, in such a manner that they project about  $\frac{1}{4}$  in. on the inside. The ends of the coil should be well brazed or silver-soldered to the inside of the 2-in. pipe forming the boiler body.

When everything else has been done in the order and manner described, the heads, which must be left to the last, are fitted into the ends of the boiler shell and

fastened with rivets. The easiest way to do the work is to fasten both boiler heads with the flanges out and with their convex faces toward the center of the shell; this arrangement makes it possible to rivet both heads from the outside with soft-iron rivets. After the heads have been riveted, both the rivets and the seam between the flange and boiler shell should be well sweated with silver solder, or brazed, to insure an absolutely steam-tight job and increase the strength.

The water glass and steam-pressure gauge, which should form a part of the boiler fittings in all cases, are screwed into holes tapped in the front boiler head, and then silver-soldered or brazed.

Very little description is required for the boiler setting, which, as shown by the drawing, is made of sheet iron, fastened to an asbestos-board base.

After completing the setting, the boiler is ready for testing. After unscrewing the safety valve, fill the boiler and coil to within  $\frac{1}{2}$  in. of the top with water; replace the safety valve and set it at the desired pressure, which should, in no case, exceed 50 lb. If the steam pipe has not yet been connected to the engine, remove it from the boiler and screw a plug into the steam outlet. The boiler should be heated slowly the first time, by applying the flame of a gasoline blowtorch through the hole in the front of the casing. Any small leaks which may be detected can be brazed, or stopped by calking.

### Simple Lock for Drawer or Chest

A simple lock for a drawer or chest, that will make it impossible for anyone not in the secret to open the drawer

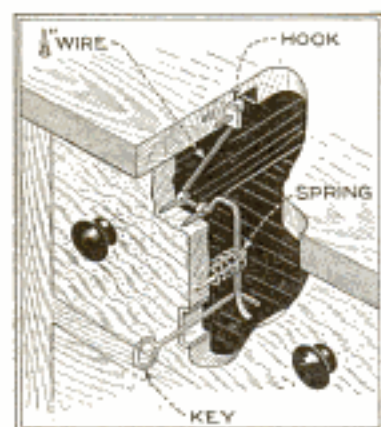

without resorting to force, can be made in a few minutes.

A piece of stiff wire is bent to the shape shown in the drawing and fastened to the inside of the drawer case with screweyes.

A piece of spring wire is wrapped around a rod to make a compression spring, which is slipped over the staple provided for the stem of the lock; this spring locks the

drawer automatically when it is closed. A hook, bent on the upper end of the wire, fits into a slot cut in the underside of the chest top; the front of this slot is fitted with a brass wearing plate, against which the hook bears. The lock is opened by a bent-wire key, inserted into the keyhole and turned until the bent end comes over the stem end of the lock, which is pulled forward.—A. K. Harrison, Chicago, Ill.

### Mounting of Shade Allows Top and Bottom Ventilation

There are occasions when it is desirable to admit light or air from the top of the window, which is impossible with the ordinary arrangement of the window shades. A simple method by which this is made possible is to mount the shade roller across the middle of the window opening. The blind is removed from the roller, folded in the middle and tacked on again at this point. This arrangement will make it necessary to hem the plain end so

that a stick or rod can be inserted. A weighted cord from the upper end of the blind passes over a pulley, or through a screw eye, in the top of the window frame, and serves to hold the shade taut. The curtain is operated from the bottom of the window, as usual, but when the lower half of the blind is pulled down, the upper part will be pulled toward the top by the weight, and when the lower half is rolled up, the upper section will also be wound around the roller. An arrangement of this sort makes it possible to ventilate a room from the top as well as the bottom of a window.

### Knife Switch Made from Old Snap Switch

When snap switches become so worn that they are beyond repairing, a knife switch can be made from the porcelain

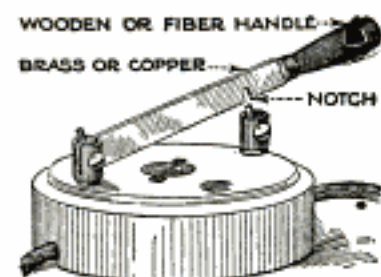

base and terminals that remain after other parts have been removed. Such a switch will prove quite an acceptable article in experimental work. The old center of the original switch is removed and discarded, as are also the spring clips on each terminal. A piece of brass or copper, about 3 in. long, is made into a switch blade, and provided with a wooden or fiber handle. A hole is drilled at the end for the terminal screw, and a notch is cut in the edge just back of the handle, to fit over the terminal screw on the opposite side. Slots must also be cut through the center of each terminal, for the switch blade.

### Repair-Shop or Farm Hoisting Gear

For hoisting automobile engines from their chassis, lifting bodies, and other heavy work, an automobile repairman uses the hoisting arrangement shown in the drawing. The main structure is of wood, with a piece of heavy 3-in. pipe supported on wooden bearings, parallel with the horizontal crosspiece. An eyebolt, to which one end of the hoisting chain is attached, is fastened to the center of the pipe. An old wagon wheel is pinned to the outer end of the pipe and provides a means for turning the pipe and winding up the chain. This arrangement produces a powerful leverage. A holdfast for retain-

ing the hoist in any position is provided by a short chain and hook fastened to the woodwork, the hook being slipped over one of the spokes in the manner shown.

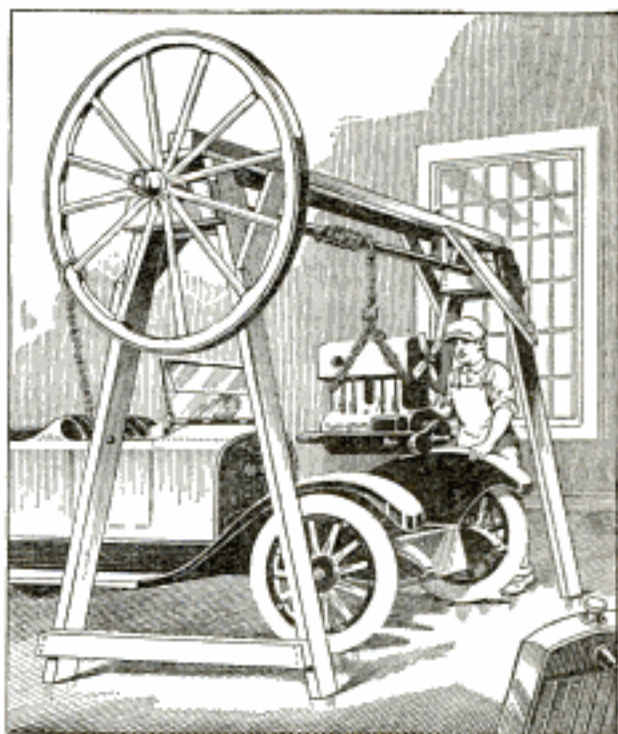

This Simple Windlass Arrangement Consists of a Wagon Wheel Pinned to the End of a Piece of Heavy Pipe, Which is Supported on Wooden Bearings

Iron straps, in addition to the bearings, are provided, for supporting some of the weight of the load on the pipe. The usefulness of this device is not confined to the shop. It will be found exceedingly handy around the farm, for lifting wagon tops, or other heavy work.

### Applying Auto-Tire Chains

Automobile users are familiar with the trouble encountered in applying a set of antiskid chains tightly enough to prevent them from coming

off the tire or striking the fenders. The drawing shows how the ends can be fastened together with the tire-chain repair pliers, which should form a part of the car's tool equipment. A notch is filed on

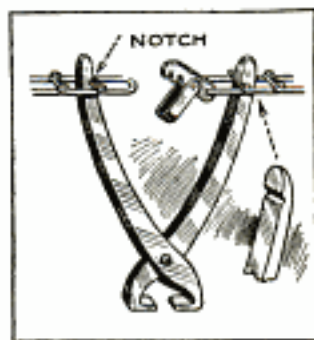

the inner side of each of the handles, which are inserted into the chain links as shown. The handles of the tool are then pressed together and the fastener hooked. —George Elleson, West Allis, Wis.

### Holding Garage Doors Open

All manner of devices are used to prevent the garage doors from blowing shut while the car is in the opening; the two

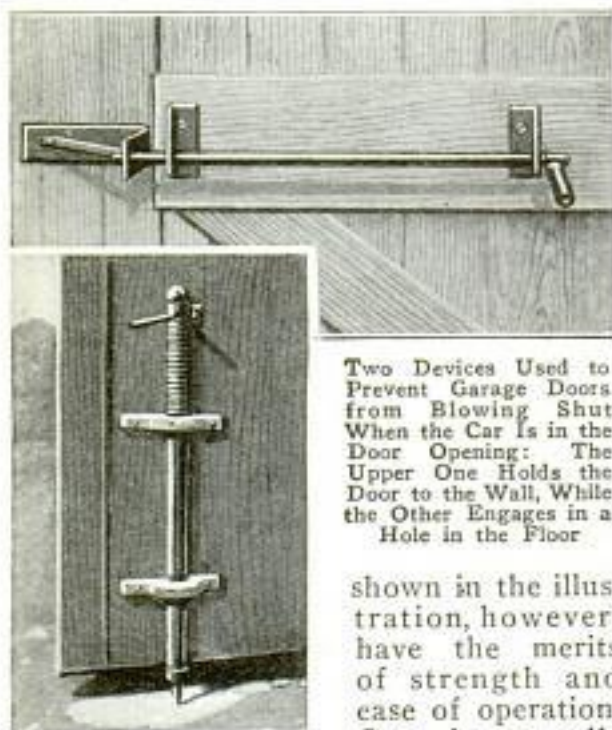

Two Devices Used to Prevent Garage Doors from Blowing Shut When the Car Is in the Door Opening: The Upper One Holds the Door to the Wall, While the Other Engages in a Hole in the Floor

shown in the illustration, however, have the merits of strength and ease of operation. One is an all-

metal fastener, which requires an angle iron fitted to the outside wall of the garage, but which works independently of the ground and floor. Instead of a simple hole in the angle iron, it is better to make a vertical slot to allow for sagging of the door. The other, a lighter fastener, consists of a piece of hardwood curtain pole, with a coil spring, to keep it up when not in use. When the door is to be held open, the rod is pushed downward, so that a metal pin driven into the lower end engages in a hole in a small block of cement which is imbedded in the ground. A pin in the top of the pole catches into a notch in an iron plate, when pushed down to hold the door; the other end of this pin forms a handle for swinging the rod around, to release it from the notch.

### The Use of Lacquers

There are two kinds of lacquers on the market—dip and brush. A dip lacquer is made in such a manner as to give the best results when the articles are dipped in it. Brush lacquers are intended to be applied to the work with a brush, and do not give satisfaction when used for dipping. To produce the best results it is necessary to use a lacquer that is made especially for the kind of metal on which it is to be

used. As a general rule, brass lacquer is colored yellow, while one used on silver articles is colorless. Lacquers should not be rubbed onto the work, like paint, but should be flowed on, like enamel, so as to obtain as smooth a finish as possible, without brush marks showing. After the work is done, all the brushes should be wiped on old newspapers until they are as dry as possible, cleaned with turpentine, and put away where they will not accumulate dirt.—W. S. Standiford, Youngstown, Ohio.

### A Dishpan Cat Guard for Birdhouse

To protect birdhouses and feeding tables from the raids of cats, an effective guard can be made from an old dishpan.

The pan is turned bottom up, and three slits are cut in the center, the metal between the cuts being turned back to form ears, by means of which the device is nailed to the pole. When the birdhouse is protected in this manner, a cat or other marauder cannot reach the top of the pole and disturb the bird residents or visitors.

—L. B. Robbins, Harwich, Mass.

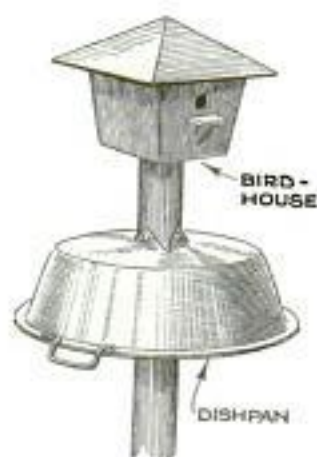

### Taking Up a Trot-Line

When taking up a trot-line, the usual result is a bad tangle of hooks and line,

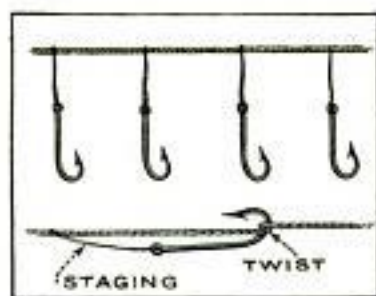

which is difficult to avoid unless the staging is removed entirely. The drawing shows a method that entirely overcomes the trouble. Each staging is

pulled tightly along the line, and the cord is given a single twist around the hook. After all the hooks have been treated in this manner, it is a simple matter to wind up the whole line without danger of tangling; when the line is set again, all the hooks will be in place and there will be no snarls.

### Cleaning Auto-Starting Gears

The pinion and driveshaft of the starting motor on most automobiles are usually neglected by the owner until the day comes when they refuse to turn over the engine.

The usual symptom of a dirty drive is the humming of the starting motor, without the engine being cranked, when the starter button is pressed. This is caused by dirt or even heavy oil getting on the driveshaft, and preventing the pinion from screwing out and meshing with the teeth on the flywheel. Generally, it is only necessary to remove the floorboards to expose the starter pinion and flywheel, and then wipe off as much dirt as possible with a clean rag. If a blow-torch is at hand for spraying gasoline, it can be used to clean the driving mechanism thoroughly. Gasoline applied with a brush will also remove all accumulated dirt and gum. After the gasoline has evaporated, oil the mechanism with a small quantity of very light oil. This part of the car should be cleaned at least once a year.—G. W. Greene, Madison, Wisconsin.

### A Long-Lived Blow-Out Shoe

Most blow-out shoes, when used inside a tire, have a tendency to blow out through the tire, as soon as one or two layers of the fabric have been worn through. This trouble was overcome, in one instance, as follows: Two thin blow-out shoes were laid together, with a layer of steel screening, which is somewhat finer than common screen wire, between them. The wire layer was held in place by sewing it to one of the shoes with waxed shoe thread, after which the two shoes were cemented together. The edges of the shoe that projected under the tire were fastened together at several points with split rivets. This reinforcing was found to impart superior wearing qualities. Later a homemade patch was made, along similar lines, from three layers of heavy canvas with a layer of wire between them, as shown in the drawing, the whole being cemented together, to prevent creeping.

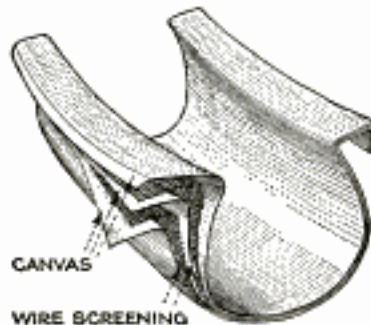

### Self-Feeder for Poultry

Every poultry raiser or farmer who keeps poultry knows the advantages of a self-feeder, and the pictures show how

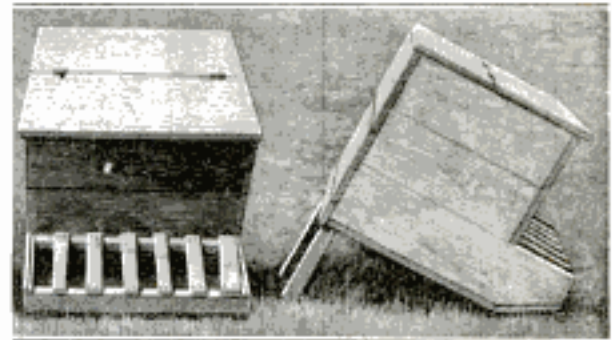

Front and End Views of a Poultry Feeder That can be Made at Little or No Expense: The Back is Elevated So That There will Be a Constant Supply of Feed at the Front

such an article can be made from an old box or scrap lumber. This feeder is 2 ft. wide, 2½ ft. long, 2 ft. high at the front and 2½ ft. at the back. By elevating the back in the manner shown, there is always a constant supply of feed at the front, which is not always the case if the feeder is set level.—H. J. Engel, New Braunfels, Texas.

### An Improved Leaf Rake

A rake which is especially useful for raking leaves from the lawn is shown in the illustration. It can be made from a

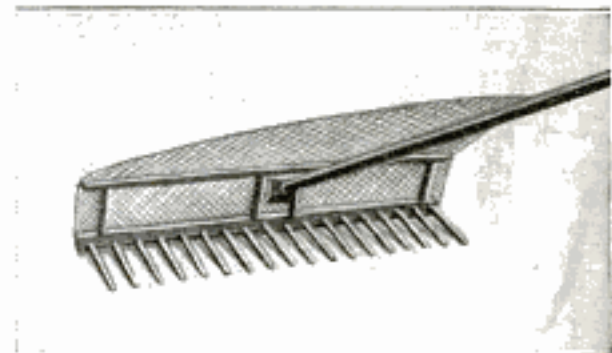

A Rake Which does Not Dig into the Ground Is Especially Useful in Cleaning a Lawn of Dead Leaves

common wooden rake, which has one edge planed to a slight bevel; on this edge is built a light framework to carry the handle, as shown.

The bevel throws the teeth slightly downward, so that the points just touch the ground. To prevent the accumulated leaves from flowing over the back of the rake, a piece of wire netting is tacked over the frame, a section being brought over and fastened to the handle.—H. N. Posz, Winona, Minn.

### Dispensing System for Oils and Other Liquids

A country resident bought his kerosene oil, for illuminating and cooking purposes,

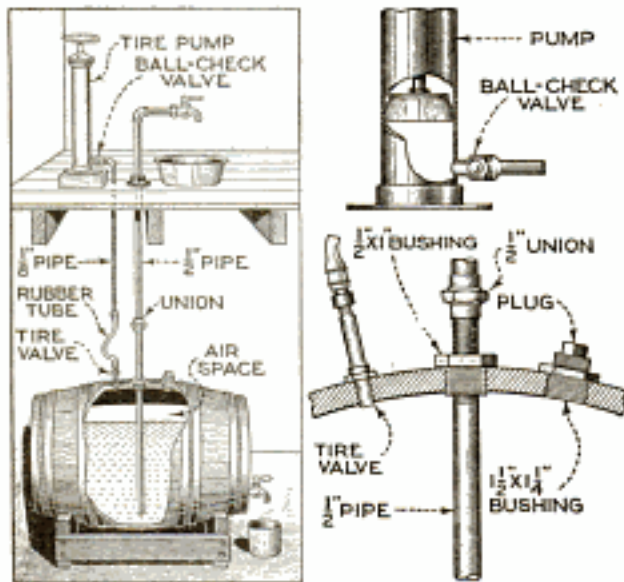

An Oil-Elevating System, Used by a Householder to Draw Off Supplies of Kerosene for Domestic Purposes: It can be Applied to Good Advantage in Garages and Shops

by the barrel, and kept it stored in the basement. In order to make it convenient to draw a supply of fuel from the barrel without descending to the basement, the arrangement illustrated was used to raise the oil to the upper floor.

A sound, tight barrel was set in a wooden cradle and three holes were drilled in the top of the vessel. The one in the exact center of the bilge was  $\frac{7}{8}$  in. in diameter, another hole, 6 in. to one side of the center was  $1\frac{3}{8}$  in. in diameter, and another on the opposite side of the center was made small enough to accommodate an ordinary tire valve. The large holes were threaded for reducing bushings, as shown, the  $1\frac{1}{2}$  by  $1\frac{1}{4}$ -in. bushing screwed home, and a plug screwed into it. The plugged hole was used for filling the barrel. The discharge line consisted of a piece of  $\frac{1}{2}$ -in. pipe, 6 in. longer than required to reach the bottom of the barrel. One end of this pipe was threaded for a distance of 8 in. and the 1 by  $1\frac{1}{2}$ -in. reducing bushing screwed on, so that the threaded end of the pipe projected at least 6 in. above the flange. The pipe was inserted into the oil barrel to within an inch of the bottom, and the bushing screwed home. A tire valve was threaded into the smallest hole, all joints and threads being coated with white lead to insure tightness. The oil was conducted to the upper floor by the piping arrangement illustrated. Air

pressure was used to elevate the oil to the outlet and this was provided by means of an ordinary automobile tire pump. A ball-check valve was connected to the base of the pump to prevent escape of the air. The pump stirrup was then bolted to the floor, and the air outlet conducted to the tire valve on the barrel as shown.

In use, the barrel was never completely filled, an air space of about 2 in. being allowed in order to create pressure. Then, when oil was desired, a few strokes of the pump created the necessary pressure to raise the fuel when the stopcock upstairs was opened. About  $\frac{1}{2}$  lb. of air pressure should be allowed for each foot the oil is to be raised.

### Miteless Poultry Roost

A piece of 2 by 2-in. material is molded as shown in the drawing, with a semi-circular groove. A strip of wood, about  $\frac{1}{4}$  in. thick and wide enough to cover the cavity, is glued into a recess cut in the top, as shown. This leaves a

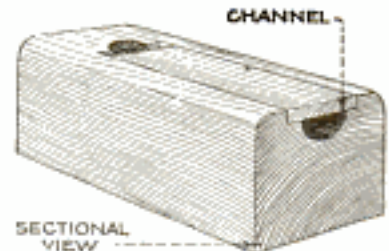

covered channel which extends to within 1 in. of the ends of the roost. The groove is filled with kerosene from time to time, and this effectively prevents mites from reaching the fowls. The pores of the wood will soon become saturated with the oil, and none of the parasites will go near the roosts.

### Easel for Showcards and Photos

By using a triangular piece of cardboard, a neat and inconspicuous easel for supporting photographs, show-



cards, and similar articles, can be easily made. The cardboard is folded in the center, and, if heavy stock which is liable to break, is used, a strip of muslin can be glued over the crease. Slots are cut into projections left on the bottom corners, and care must be used in cutting these, to prevent the projections from breaking off. In use, the article to be displayed is placed in the slots, after the easel has been bent.—Eugene O. Blessing, San Francisco, Calif.



# A PORTABLE RADIO RECEIVER

By F. L. BRITTIN

**B**OY scouts and other outdoors, who desire a portable radio-receiving set that has a receiving and tuning range beyond the usual crystal-detector instruments, will find that the single vacuum-tube apparatus described in this article meets their requirements. Honeycomb inductance coils are used so that the set can be tuned to any damped or undamped wave length between 200 and 15,000 meters.

At the outset it should be understood that no restriction is placed on the ingenuity of the individual builder, in adding features or refinements that he may deem necessary or desirable, and the dimensions given for the panel and other parts may be altered in any way to suit the available space. The original set was built into a school case, which is a miniature suitcase, having inside dimensions of  $5\frac{1}{2}$  by  $11\frac{1}{2}$  by  $14\frac{1}{2}$  in. The bakelite panel is set in  $\frac{1}{2}$  in. from the edge of the open case, so that there will be plenty of clearance for the knobs and switches when the cover is closed.

The panel is held in place inside the case against  $\frac{1}{2}$ -in. square wooden strips and the edge of the wooden partition. Small brass hinges are used for hinging the panel to the lower strip, and a cabinet catch is placed at the top; this arrangement makes it possible for the operator to swing the panel out at will, to get at the circuit or back-mounted instruments. The remainder of the space, at the right of the partition, is divided by shelves into

compartments for the B-battery, honeycomb inductance coils, and headset. The upper shelf is for the B-battery, which may consist either of 10 three-cell flashlight batteries or a standard unit; if flashlight batteries are used, they should be taped together with friction tape, connected in series, and tapped off to the B-battery switch on the panel. Small flexible lamp cord is used for the battery connections, and these are led through holes drilled in the partition. The middle shelf holds the honeycomb coils; holes are drilled in the shelf to take the plugs, so that the coils are carried upright, and without rattling. The telephones are carried in the bottom compartment, free from possible knocks and jars, on a piece of felt glued to the bottom. The phones, aerial, and ground binding posts are shown on the partition in the phone compartment.

The necessary instruments can be mounted in various ways, but the arrangement shown in the drawing is a very neat one, with the two 43-plate condensers and switch at the bottom, the 21-plate condenser and filament rheostat in the middle, and the B-battery switch holes for viewing the vacuum tube, and inductance at the top. The 43-plate condensers should have a capacity of .001 mf. each. The 21-plate grid condenser should have a capacity of .0005 mf. The honeycomb inductances are mounted on a standard mounting unit, which allows the coils to be swung back and forth to vary the coupling; these coils must, of course, be removed when the case is closed. A

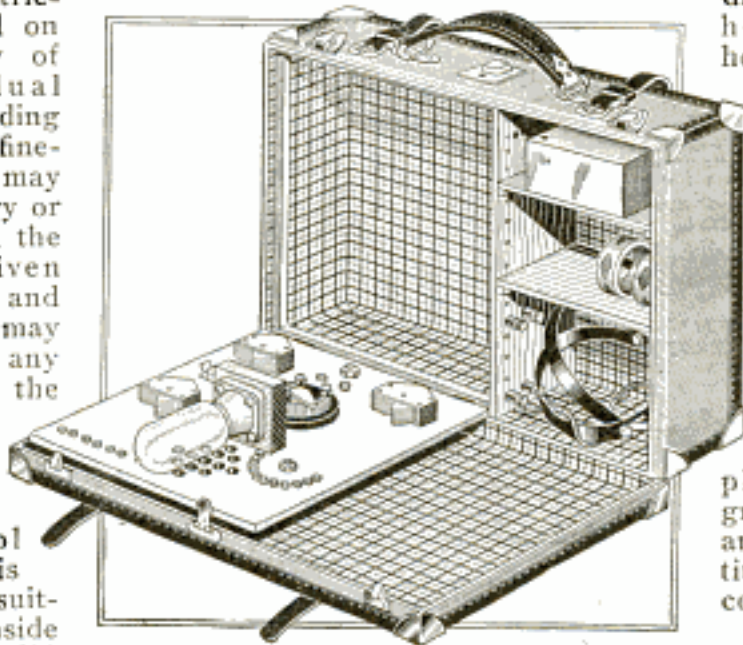

Panel Let Down Flat, Showing Back-Mounting of the Condensers, Rheostat, and Vacuum-Tube Socket

ment shown in the drawing is a very neat one, with the two 43-plate condensers and switch at the bottom, the 21-plate condenser and filament rheostat in the middle, and the B-battery switch holes for viewing the vacuum tube, and inductance at the top. The 43-plate condensers should have a capacity of .001 mf. each. The 21-plate grid condenser should have a capacity of .0005 mf. The honeycomb inductances are mounted on a standard mounting unit, which allows the coils to be swung back and forth to vary the coupling; these coils must, of course, be removed when the case is closed. A

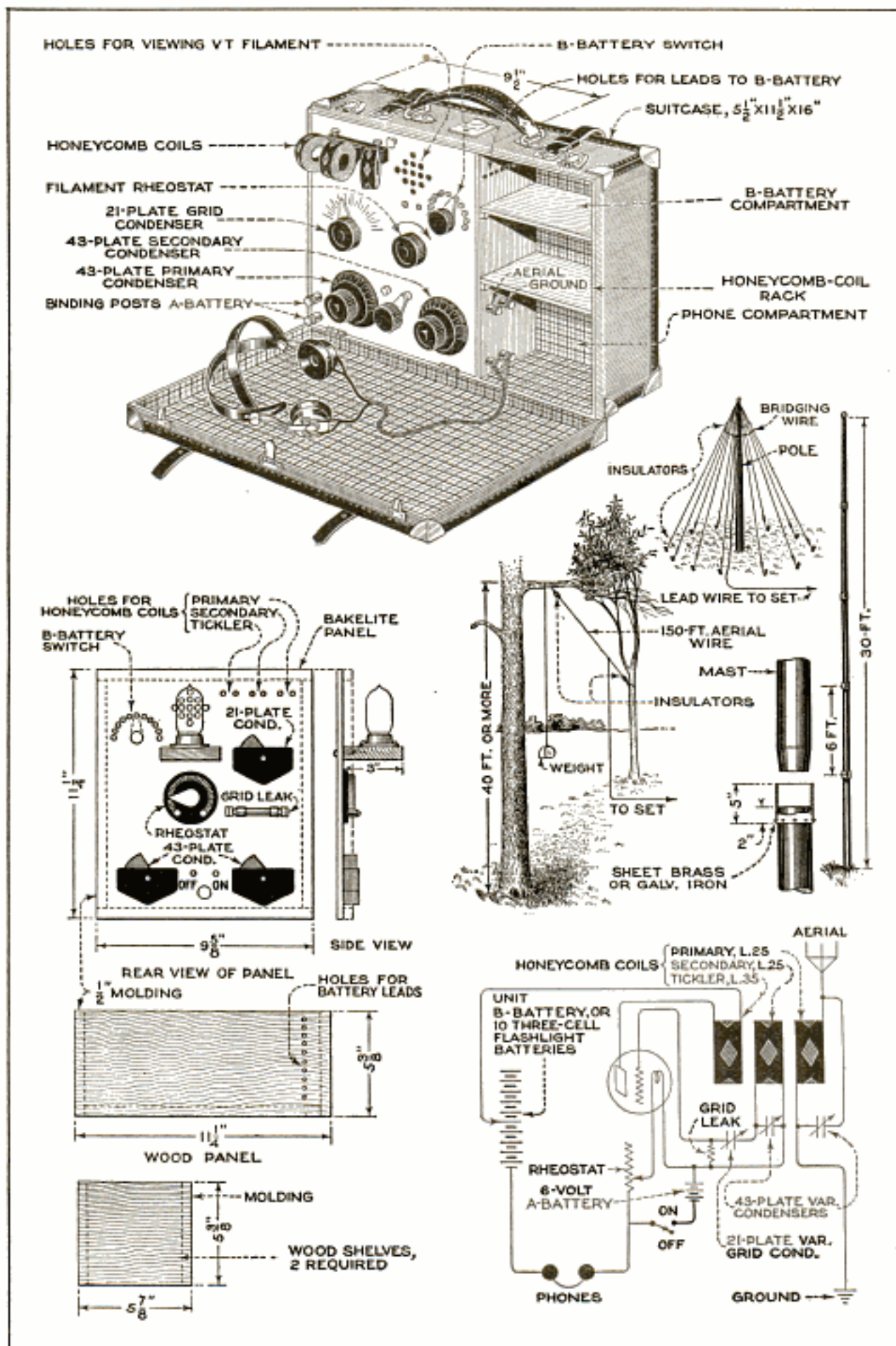

A Small Vacuum-Tube Radio Receiver for the Use of Boy Scouts and Campers: With the Proper Coils, the Wave-Length Range Is from 200 to 15,000 Meters. Two Types of Aerial, with the Method of Erecting, are Shown in the Right Center



standard 2-megohm grid leak is placed just above the switch, and the vacuum tube is mounted on a standard base, screwed to a wooden block that is fastened to the panel with two screws; tube sockets for mounting directly to the panel are available as an alternative to the method described. The wiring is No. 16 rubber-covered fixture wire; all joints should be soldered, and no more wire used than is absolutely necessary. The binding posts for the A-battery are shown in the lower left-hand corner of the panel; this battery is for lighting the filament in the VT-tube and four or five ordinary dry cells will answer, or, if an automobile is handy, the necessary current can be drawn from the storage battery. The phones should be wound to at least 2,000 ohms' resistance. In buying the several instruments for the panel, get short, flat knobs for the condensers and rheostat; for space is at a premium, and this should be kept in mind throughout the assembling of the set.

The simple wiring circuit is clearly

### Warming Up the Auto

When starting up the car on a frosty morning, or at any other time after the engine has become cold, when there is a persistent popping at the carburetor, and lack of power in the engine, a simple expedient is to place a piece of newspaper over the front of the radiator. The suction of the fan will hold the paper against the radiator, and, after a few minutes of running, the engine will attain normal operating temperature.

### Making a Toy Water "Scooter"

The drawing shows a water "scooter" that can easily be made by the average boy from a few bits of light board, some stiff wire, and a handful of rubber bands. The pontoons are tapered at the stem of the craft and are held the right distance apart by cross strips. The propulsive mechanism of the scooter is mounted overhead. The propeller is the most difficult part to make, and possibly some experimentation will be necessary to get the most effective result; however, the important thing to remember is, that it must be balanced accurately and lined up well to insure smooth running. It is mounted on a wire shaft supported by a tin bracket, but before assembling the propeller in its bearing, a few beads or a few loose turns of wire should be slipped over the shaft,

shown in the drawing, and, if carefully followed, will give excellent results.

The best outdoor aerial is a No. 14 copper wire, or stranded phosphor-bronze wire, 150 to 200 ft. long, with a small insulator (not porcelain) at each end. A piece of light rope, with a weight fastened to one end, is tied to one of the insulators and thrown over the limb of a tree as far as possible above ground, care being taken to have an open space free from obstruction for stretching the wire. The other end of the aerial is tied to another tree, about 5 or 6 ft. from the ground, and a lead wire to the set is soldered in place.

The umbrella type of aerial shown is generally used in the army signal corps for field work, but is more complicated. The wires are brought out from a common point from the top of the jointed mast and staked out from insulators. A 6-ft. iron rod driven into the earth makes a good ground for both types; if a stream is near by, the end of the ground wire can be weighted and submerged.

as indicated, to provide clearance. The actual power is furnished by a long rubber strip, or a number of rubber bands looped together, the rubber strip thus ob-

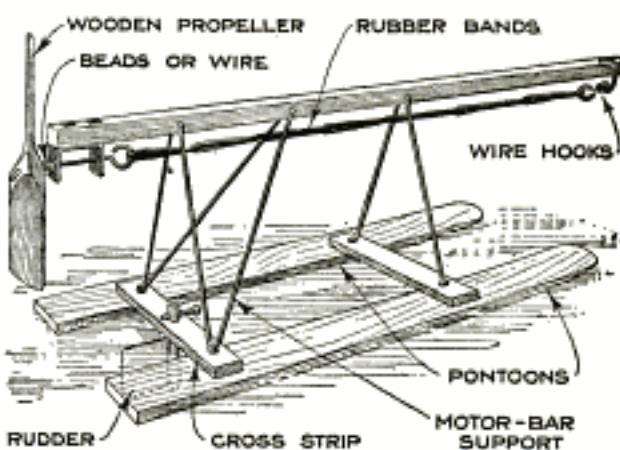

A Water "Scooter" Driven by a Rubber-Band Motor, That can be Easily Made from Light Strips of Wood, Is Capable of Good Speed for Voyages That Average About 50 Feet

tained being dusted with talcum powder and fastened, at one end, to the propeller, and at the opposite end to the overhead wooden strip, as shown. Powerful rubber bands can be cut from an old inner tube. If desired, a rudder may be added to the boat so that it can be made to travel in a circle instead of a straight line. Such a scooter, lightly constructed and with a sufficiently powerful rubber-band motor, will travel at good speed for about 50 feet.—D. W. Clark, Buffalo, N. Y.

### An Adjustable Portable Scaffold

A portable scaffold that is light in weight, simple in construction, and readily

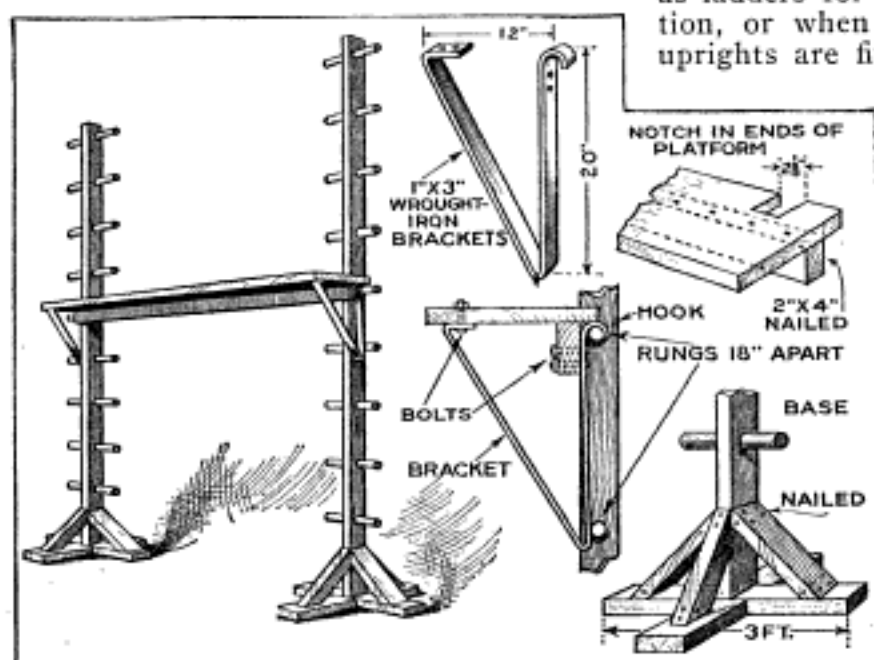

A Portable Scaffold That Is Light Yet Substantial, and That can be Adjusted to Varying Heights: The Uprights can be Used Separately, as Ladders, When Necessary

adjustable, is made in the manner indicated in the drawing.

The scaffold uprights are built of 2 by 4-in. lumber, and can be used individually as ladders for setting the horizontal section, or when moving it higher. These uprights are fitted with rounds of  $\frac{3}{4}$ -in. pipe or 1-in. oak, about 9 in. long, and the 3-ft. crossbars at the lower ends make the scaffold as stable as the usual ladder. The platform is a 12-in. plank with a 2 by 4-in. piece nailed near one edge, as indicated in the drawing. Wrought-iron brackets, provided with a hook at one end to catch over the projecting rounds of the uprights, are bolted to the ends of the platform, and notches are provided in it, to fit around the uprights, and prevent the platform from shifting sidewise.—G. A. Luers, Washington, D. C.

### New Type of Cage Antenna for Radio Stations

The cage type of aerial is gaining considerable favor with commercial and amateur operators, as it is easy to construct, economical in the number of insulators required, eliminates much trouble due to poorly soldered joints, occupies less space, and offers less resistance to the wind than the old flat-top type. Height is essential in this type, as the lead-in is also of the cage type, which adds to the capacity of the aerial. With this kind of antenna and lead-in it is possible to get greatly

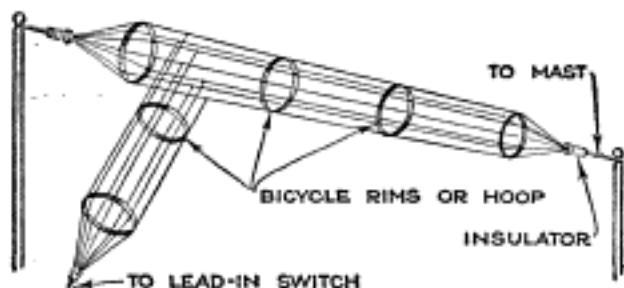

The Cage-Type Aerial is Highly Recommended to Amateurs, as It Is the Most Efficient Type for Stations Operating on a 200-Meter Wave Length

increased range of radiation on 200 meters. A good ground system is required, and good results cannot be obtained without giving as much attention to the ground-

ing as to any other detail of the transmitting equipment. Either a suspended counterpoise or buried ground should be used, the latter being formed by burying 60-ft. lengths of No. 14 bare copper wire in the ground, the wires being laid to radiate fanwise under the aerial. This size bare copper wire is also used in the construction of the cage aerial, and a long insulator is used at each end of the cage; the spreaders or hoops are made of heavy wire, or discarded bicycle rims, which are light and strong, can be used, the separate wires forming the cage being secured to the hoops by several turns of wire, and then soldered. The ends of the wires are brought together, carefully soldered, and fastened securely to the insulators. The lead-in wires are soldered to the cage wires, and too much emphasis can hardly be placed on the necessity of careful soldering, as loose joints greatly reduce efficiency. All guy wires should be "broken up" with small insulators. The masts that support the aerial should both be of the same length so that each end of the aerial will be the same distance from the ground.

☛ A small lump of sealing wax can be used to take the place of broken typewriter keys.

### Bathing-Cap Ornaments

The ordinary soft-rubber bathing cap may be decorated with designs and monograms cut from the cementless rubber-patch material that forms a part of the equipment of practically every motorist, or which can be obtained for a small sum. The design is penciled on the stock, then cut out with a pair of sharp scissors or a knife, and applied to the cap in the same manner as when patching a tire.—Harold McMahan, Hatchville, Mass.

### Trolling Rig for Autumn Lake Trout

Lake trout strike best in the autumn, and the drawing shows a method of getting down to them that will commend



itself to the angler. This fish as well as others, such as the wall-eyed pike, are found in deep water, and unless the lure is dropped deep no results are obtained. The main line is weighted at the bottom with an 8-oz. pear-shaped dipsey. The

branch lines are connected to the main one, at intervals of about 4 ft., by swivels, which prevent kinking and twisting. The minnows are fastened to the double hooks in the manner shown. The bottom depth is now found and the surface point marked on the line, so that the fisherman can troll some 3 or 4 ft. off the bottom.

### Overcoming Sagging Running Boards

The tendency of the running boards of a light automobile to sag down can be largely prevented by reinforcing the brackets by a horizontal brace underneath the car.

Referring to the drawing, it will be seen that a suitable length of pipe, placed over the truss rods, can be used to make a substantial brace and prevent bending of the running-board brackets—the real cause of sagging running boards.

A more substantial method, and one that gives greater rigidity, involves con-

siderably more work, justified, however, by the results. A piece of stiff angle iron is bolted to the running boards, a hardwood block being interposed, as indicated,

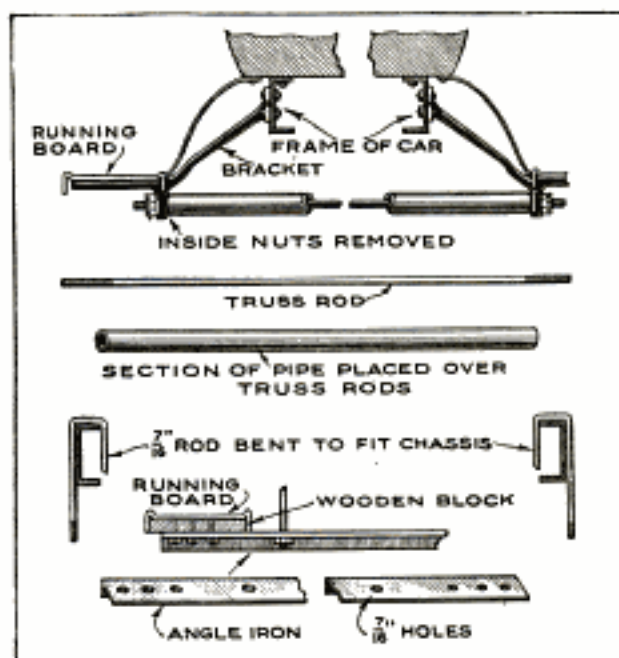

Two Systems of Reinforcing the Running Boards of a Light Car to Prevent Sagging: The Braces Also Permit the Carriage of Additional Weight on the Running Board

as a bearing for the ends of the brace. Two iron hooks are formed like the ones shown; these fit over the side channels of the chassis, with the threaded ends fitting into holes in the brace; they are drawn up tightly and locked with a castle nut and cotter pin.

### Using Bell on Lighting Systems

The drawing shows a method by means of which an electric doorbell is rung by current from the house-lighting system, without the

use of a transformer, the necessary reduction in the strength of the current being obtained by the interposition of a 40-watt lamp in one side of the cell circuit. The advantage of this over the usual dry-battery system is apparent, and, while the voltage at the bell or button is not heavy enough to be dangerous, the bell should be wired with fully insulated wire, such as used in the wiring of the lighting system, instead of the usual thinly insulated bell wire.—W. A. Duncan, Toronto, Ontario.

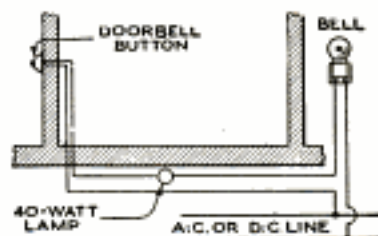

### A High-Tone Radio Buzzer

A buzzer with a clear, high-pitched tone is very desirable for radio-testing purposes, but, while it can be bought,

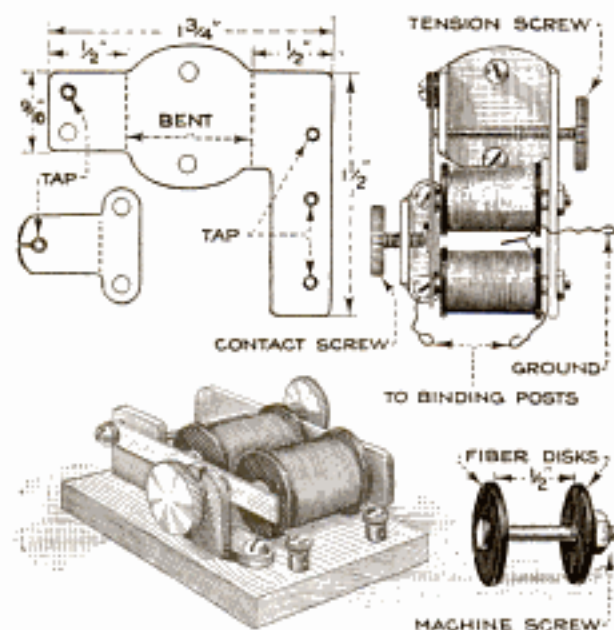

Operated by a Flat-Type Flashlight Battery, This Miniature Buzzer Produces the High-Pitched Tone So Desirable for Radio-Testing Purposes

such instruments are usually large, and cannot be used with a flashlight battery without exhausting it quickly. The home-made buzzer illustrated, however, is very small, and is particularly designed for flashlight-battery service.

The magnets are wound around cores made from 6-32 iron machine screws,  $\frac{3}{4}$  in. long, the hexagon heads of which are filed round. The spool heads are made from fiber disks,  $\frac{7}{16}$  in. in diameter, and holes are drilled through them to make a tight fit on the screws. A space,  $\frac{1}{2}$  in. long, is left between the disks for the winding, which is of No. 32 insulated wire; No. 30 wire, which is a trifle larger, can also be used, if necessary. Wind the space between the disks full, and, when finished, bring the ends out through small holes drilled in the disks, as shown. Then solder together the ends of the wires that begin the winding. One of the outside wires is grounded to the metal frame, and the other is connected to a binding post.

A piece of fairly stiff spring steel is used for the vibrator, which is mounted on the frame with a screw and two small washers. The tension screw merely presses against the vibrator. Contact points from spark coils, either new ones or old, which can be obtained for the asking at almost any garage, are soldered to the vibrator and the contact screw.

A piece of thick sheet brass or iron is cut to the pattern shown; then the necessary holes are drilled and tapped as indicated, a  $\frac{3}{32}$ -in. tap being used for the threads. The screw holes at the center of the frame can be made to any convenient size; these holes are for the screws that fasten the instrument to its base. The bracket for holding the contact screw is made from a separate piece and mounted independently. After the hole for the contact screw has been drilled and tapped, a slot is cut through the bracket, and the ends squeezed together a little, to make a tight fit on the screw and prevent it from working loose. After all holes have been drilled and tapped, the frame is bent up as indicated by the dotted lines. Two binding posts are used for connecting the wires to the coils and contact-screw bracket.—Harry L. Gray, Independence, Ia.

### Extracting Fishhook from Flesh

There is little that frightens a person so much as running a fishhook into the finger or flesh.

The first impulse is to withdraw the hook by working it out at the point it entered; the barb, however, sticks in the flesh, and causes more or less suffering before it is finally removed, if removed at all without the aid of a physician. A simple method of taking out a hook

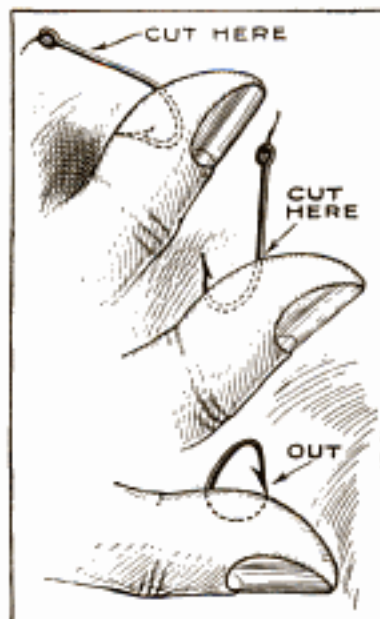

is illustrated in the drawing. In the upper example the shank of the hook is cut at the point indicated and instead of working the hook out the way it entered it is pushed out as shown in the bottom drawing. When the barbed end of the hook is pushed out of the flesh, cut the shank again at the point shown in the middle drawing, take hold of the barb with the pliers, and turn it out; then cleanse the wound and apply antiseptics. For this as well as other purposes, the fisherman will find a small pair of wire-cutting pliers a useful article.

# PRIZE OFFERS AND ANNOUNCEMENTS

Cont. W. W. Mc Elroy,  
 Door 241, Kaufmann's  
 Texas

46  
**NATIONAL FEDERATION OF MUSIC CLUBS' EIGHTH PRIZE COMPETITION**

The National Federation of Music Clubs announces its eighth prize competition for American composers. Prizes of from \$1,000 to \$100 each are offered for compositions of 10 different classes. The contest is open to all American citizens, except the violin solo which is open only to native-born Americans, preferably a woman. All compositions must be submitted before Dec. 15, 1922. Address, Mrs. Edwin B. Garrigues, Room 201 Bellevue-Stratford, Philadelphia, Pa.

12  
**PRIZES FOR THE BEST LIAISON SYSTEM BETWEEN ARTILLERY AND INFANTRY**

Nothing is of more general interest to the army than an efficient means of liaison between the infantry and its supporting artillery. Up to the present no entirely satisfactory system has been evolved, and, therefore, to encourage its study, the American Army and Navy Journal is offering prizes of \$100, \$50, \$25, and \$15 for the best stories on the subject. For particulars address that journal at 354 Fourth Ave., New York City.

23  
**FOR THE BEST SYMPHONIC COMPOSITION A PRIZE OF \$1,000 WILL BE AWARDED**

For the encouragement and recognition of American composers, the proprietors of five of the largest moving-picture theaters in Chicago are offering a prize of \$1,000 to the writer of the best symphonic composition submitted to them before Jan. 1, 1923. The five competing compositions considered next in order of merit will be performed by the Chicago Theater Symphony Orchestra at their Sunday noon concerts. The contest is open to all American citizens. Address, Balaban & Katz, 175 State St., Chicago, Ill.

9989  
**LEGITIMATE INVESTORS INSTRUCTED BY A STOCK-EXCHANGE PLAYLET**

Published by the New York Stock Exchange to show the way to safe and legitimate investments, ignorance of which has so often made investors the victims of fraudulent promoters and brokers, is a playlet entitled "Smith's First Investment." The play is a dramatization of a typical legitimate investment transaction. Copies can be obtained free by addressing Committee on Library, New York Stock Exchange.

47  
**PRIZE IS AWARDED SELECTED LIBRETTO WHICH IS NOW READY FOR COMPOSERS**

The winning librettist in the \$1,000 lyric-dance-drama contest offered by the National Federation of Music Clubs, in which \$400 goes to the librettist and \$600 to the composer, has been announced. Robert Francis Allen, of Coleraine, Mass., is the winner. Copies of the libretto will be ready for distribution among composers at an early date, and may be secured from Mrs. Edwin B. Garrigues, 201 Bellevue-Stratford, Philadelphia, Pa.

14  
**QUEBEC TO REWARD LITERARY EFFORT IN ANNUAL COMPETITIONS**

To encourage the production of literary or scientific works in the province of Quebec, Can., an act of the legislative assembly provides that the sum of \$5,000 shall be appropriated annually for the establishment of a fund for literary and scientific competitions. This initial amount of only \$5,000 will be increased if the results of the competitions show justification for such action.

9985  
**RATTLESNAKE CATCHING PURSUED FOR PROFIT AND PASTIME**

There is no accounting for taste, but it is hard to realize how a man can be actually fond of handling rattlesnakes. Such a man, by the name of Ed Metzner, but more generally known as "Captain

*Permanganate of potash smeared over wound or injected*

Snakes," for 10 years did nothing else but catch venomous reptiles in Texas and Mexico. During a period of nine months he is said to have captured 17,000 snakes, most of them rattlers. Though he has learned to do this work with little risk to himself, he has nevertheless been bitten 29 times by rattlers, and his body bears evidence of the fact by the number of scars on all parts of it. These bites have done him no harm; in fact, he claims that in one case the bite cured him of rheumatism. He neutralizes the snake's venom with permanganate of potash, which, he says, is an infallible antidote. He does not do this work for the fun of it alone, for he sells the snakes to zoos and shows, and to scientists.

9996  
**PRIZES OFFERED IN SEARCH FOR OLDEST U. S. FARMERS**

Search was recently made through a novel kind of prize contest, which closed August 10, for the oldest man and the oldest woman living on farms in the United States. Blanks were furnished which the venerable contestants filled in with their names and ages, and evidence that they lived on farms. The winner got \$50 in gold and a free trip to the Central States Fair and Exposition, at Aurora, Ill.

33  
**ONE THOUSAND DOLLARS IN PRIZES FOR MUSICAL COMPOSITIONS**

To stimulate the efforts of composers, a prize contest has been instituted by the Etude Music Magazine. There are offered 24 prizes for piano and vocal solos, and for anthems and part songs. The contest is open to composers of every nationality, and will close Dec. 1, 1922. Address, The Etude Prize Contest, 1712 Chestnut Street, Philadelphia, Pa.

16  
**THREE PRIZES OFFERED FOR BEST PHOTOS SUBMITTED TO A MAGAZINE MONTHLY**

For photographs judged to be the best of those submitted during each calendar month, three prizes of \$15, \$10, and \$5 are awarded by the magazine Motor. The photos must not have been published elsewhere. Address, 119 West 40th Street, New York City.

13  
**FOR A NAME TO REPLACE "SILVORE" VALUABLE PRIZES ARE OFFERED**

For a name to replace "Silvore," the present name of silverplated ware made by the Seymour Manufacturing Company, it offers prizes to the value of \$2,000. For conditions of the contest, address the company at Seymour, Conn.

77  
**WINNER OF CONTEST FOR HOTEL MEN TO GET A FREE TRIP TO EUROPE**

Open only to "Greeters" in good standing, a prize contest is announced by Hotel Management, the winner of which will be given a free trip to Europe and return. While abroad, the winner will be guaranteed a position with pay at one of the best hotels in Paris. The winner of the contest will be the Greeter who, before April 1, 1923, sends to Hotel Management the largest number of business-promoting ideas that are acceptable for publication in the magazine. Address, Greeter Contest Editor, Hotel Management, 342 Madison Ave., New York City.

59  
**FOR BEST 50-WORD BUSINESS CODE THREE PRIZES ARE OFFERED**

Prizes amounting to \$225 for a 50-word business code are offered by the Farm Mortgage Bankers Association of America. The first prize will be \$150, the second and third \$50 and \$25. The first 10 pages of the 1922 directory of the association, on file in all public libraries, will furnish the facts needed as a basis of the code. The contest closes Sept. 18, 1922. Address, Contest Committee, Farm Mortgage Bankers Association of America, 112 W. Adams Street, Chicago, Ill.

## CONTESTS PREVIOUSLY ANNOUNCED

**Medals, Diplomas, and Money Awards:** Announced August issue, 1921; awards offered by the Franklin Institute.

**For Service to City of Philadelphia:** Prize \$10,000; announced September issue, 1921; awarded each year by Edward Bok, former editor of The Ladies' Home Journal.

**One Million Francs for Best Motor:** Announced January issue, 1922; closes June 1, 1923; address, Aero Club of France, Paris.

**Research Thesis by a Woman:** Prize \$1,000; announced October issue, 1921; awarded annually; address, Dr. Lilian Welsh, Goucher College, Baltimore, Md.

**Annual Commercial Airplane Contest for "Italy's Great Trophy":** announced, July issue, 1922; address, Aero Club of Italy.

**Ideas for New Occupations for Shut-Ins:** Prizes, \$100, \$50, and \$25; announced July issue, 1922;

closes Nov. 1, 1922; address, Prize Editor, Popular Mechanics Magazine, 6 North Michigan Ave., Chicago.

**Fishing Contest:** Prizes, seven "Model 94" Winchester hunting rifles; announced July issue, 1922; no definite closing date.

**American Legion National Essay Contest:** Prizes, \$750, \$500, and \$250; announced August issue, 1922; closes Oct. 6, 1922; address, The American Legion, National Americanism Commission, Indianapolis, Ind.

**Best Backyard Railroads:** Prizes, 23, ranging from \$25 to \$2; announced August issue, 1922; closes Sept. 15, 1922; address, American Flyer Mfg. Co., 2219-39 South Halsted St., Chicago, Ill.

**Best Novel by an American Author:** Prize \$2,000; announced August issue, 1922; closes March 1, 1923; address, Harper & Brothers, New York City.

**Designs for Chicago Tribune Building:** Prizes, \$100,000; announced August issue, 1922.

**Best Essay on a Historical Novel:** Prize \$100; announced September issue, 1922; closes Dec. 1, 1922; address, Kenyon College, Gambier, Ohio.

In answering prize offers please mention Popular Mechanics Magazine

## LATEST DEVELOPMENTS IN SCIENTIFIC RESEARCH

## LIFE YIELDS A FEW OF ITS SECRETS

The study of the action of narcotics and other drugs, and of the perception of smell and taste, has given information of fundamental importance respecting the character of living matter and assisted in solving many of the secrets of life; and from the information already gained, new and valuable drugs have been produced, and the future may yield a means for combating mosquitoes and like pests.

At one time it was suggested that after all, life was only a matter of chemistry, and that when the facts were found, all its processes could be represented in a series of chemical equations. It is of interest to note, however, that in recent progress made in this field, chemistry plays a smaller and smaller part in the ideas as knowledge proceeds. In the old conceptions, which appear quite natural, it was supposed that the actions of poisons, narcotics, and the like, were the result of chemical reactions. It appears now that effects of similar nature can be produced by substances of markedly different chemical nature, and that their action depends to an important extent upon whether or not they penetrate readily the walls of the living cells. In fact, the matter appears to be one more of physics than chemistry; and the size, arrangement, and conditions of the components of the cell, and the presence of a relatively large amount of surface determine much of the nature of living tissue.

Studies in this field have made threefold progress; first, in finding out more and more about the processes of life and its true nature; second, in the creation, so to speak, of new drugs that have the benefits of old ones without many of their disadvantages. For instance, surgery now possesses means for obtaining local anesthesia by reagents which were sought for and found as the result of a definite theory to illuminate the way. The same ideas and processes have already led to the production of not only new and valuable drugs of a more or less predetermined nature, but new perfumes, new antiseptics, and new flavoring materials. The third development yielded by this method of research is the recent production of repellents for insects, one of which is a substance effective against the body louse. Similar work may yield the discovery of repellents for house flies, mosquitoes, and fleas. Thus this study, far from being a

matter of only academic interest, has resulted in achievements of the most practical importance in everyday life.

## NEW ANALYSIS OF HEARING DISCOVERED BY LABORATORY EXPERIMENTS

Recent experiments on the sensitiveness of the ear to sounds of different pitches have yielded information of both theoretical and practical importance. It appears that, in people with defective hearing, there is a very definite connection between the peculiarities of their deafness and the results obtained by experiment.

In the experiments the intensity of a pure tone in a telephone receiver is varied by moving a slider along a wire. The slider is set at the point where the subject is just able to perceive a faint sound. By repeating this for a number of pitches, it is possible to construct a curve showing the relation between the sensitiveness of the ear and the pitch of the sounds.

Perceptible differences were found to exist even in normal ears, but in cases of defective hearing, characteristic curves were obtained which are quite distinctive. It appears possible to employ these curves for diagnosing the nature of any particular case of deafness, and to show and record the progressive development of the disease. For instance, in middle-ear deafness, the hearing may be nearly normal for high pitches but deficient for low tones. For deafness arising in the inner ear, defective hearing begins for a high pitch and may not extend to the low ones.

In nerve deafness, where the trouble arises not from any mechanical fault in the ear parts but in the nerves themselves, total deafness may exist for some range of pitches, and this may be surprisingly pronounced. In one such individual, a sound of 200,000,000,000 times the energy required to be heard by the normal ear failed to produce a sensation, though sounds of less than 1,600 double vibrations per second could be perceived. The experiments also indicate that the ear acts like a complex electrical or mechanical vibrating system, and no definite frequency can be assigned to any one member of it. These results have an important bearing on the theory of hearing, and will help solve many questions which have been puzzling the scientists for many years.

IN accordance with the editorial policy of this magazine never to accept compensation in any form for what appears in our reading pages, and also to avoid all appearance of doing so, we are obliged to omit the name of the maker or the seller of any article described. This information, however, is kept on file and will be furnished free, by addressing Bureau of Information, Popular Mechanics Magazine, Chicago. [Editor.]



## As if across a desk

"New York is calling!" says the operator in San Francisco. And across the continent business is transacted as if across a desk.

Within arm's length of the man with a telephone are seventy thousand cities, towns and villages connected by a single system. Without moving from his chair, without loss of time from his affairs, he may travel an open track to any of those places at any time of day or night.

In the private life of the individual the urgent need of instant and personal long distance communication is an emergency that comes infrequently—but it is imperative when it does come. In the business life of the nation it is a constant necessity. Without telephone service as Americans know it, industry and commerce could not operate on

their present scale. Fifty per cent more communications are transmitted by telephone than by mail. This is in spite of the fact that each telephone communication may do the work of several letters.

The pioneers who planned the telephone system realized that the value of a telephone would depend upon the number of other telephones with which it could be connected. They realized that to reach the greatest number of people in the most efficient way a single system and a universal service would be essential.

By enabling a hundred million people to speak to each other at any time and across any distance, the Bell System has added significance to the motto of the nation's founders: "In union there is strength."

" BELL SYSTEM "

**AMERICAN TELEPHONE AND TELEGRAPH COMPANY  
AND ASSOCIATED COMPANIES**

*One Policy, One System, Universal Service, and all directed toward Better Service*





**Pocket  
Nail-Puller  
No. 634  
Price, \$1.25**

**“It’s no job to pull nails with  
this nail-puller,” says Mr. Punch**

“It looks like a mighty handy little tool—this Pocket Nail-Puller does. It’s small enough to go into a pocket or a nail-pouch, and it’s cheap enough so any man can afford to own one. And every carpenter, regular or amateur, can find a lot of work for it.

“You know there’s two ways of doing a job like opening a box. One is to knock the top off, breaking a chisel and splitting the cover in the process.

“The other way is to use a Goodell-Pratt Pocket Nail-Puller, and save your tools and your feelings—and maybe save the box so you can use it again.”

This Pocket Nail-Puller is a regular one of the Goodell-Pratt 1500 Good Tools.

And Mr. Punch says, “An honest tool is like an honest friend; they both stick it out to the end.”

*Write for free illustrated pocket edition catalog describing the Goodell-Pratt 1500 Good Tools. You’ll find much to interest you in it.*



GOODELL-PRATT COMPANY, Greenfield, Mass., U. S. A.

*Toolsmiths*



A tap with a hammer sinks the jaws in the wood close to the nail.



Then rap the bevel to close the jaws on the nail.



And pull it like this. Could anything be simpler?

**GOODELL-PRATT**  
**1500 GOOD TOOLS**



# An Easy Way to Make A Thousand and One Things

**I**F YOU are one of those fellows who "like to make things with your hands" here's something that will help you. When you want to saw a board, cut a groove, smooth a block, sand a joint, drill a hole, grind a tool, polish or buff a piece of metal, or do any one of a thousand similar jobs, you can do them quicker, easier, better and cheaper with the help of this machine than you can by hand.

A surprise to everyone who sees it operate. Some think it a toy until they see it used. Then they discover it is a wonderfully practical and efficient tool—almost a marvel in the mechanical world. No one ever dreamed that a tool so small could successfully handle so much work. Hundreds of owners are getting remarkable results with

## The **BOICE** Pony Bench Machine

Price  
**\$37.85**  
Without  
Motor or Base

**Six Machines in One:—Saw, Sander, Drill, Grinder, Polisher and Buffer Specially Adapted for Use in Wood and Soft Metals.**

**SIZE NO INDICATION OF CAPACITY.** The BOICE PONY BENCH MACHINE is properly constructed to handle an unbelievable quantity of work with surprising ease, whether it be brass, fibre, aluminum, steel or wood. Surprisingly simple, yet powerful in performance. Designed and built to meet the needs of thousands of men who do light shop work yet who require precision and accuracy combined with convenience and economy of operation.

### What You Can Do with This Machine

**FOR SAWING.** Dozens of jobs must be done on a saw—cutting, ripping, mitering, grooving, rabbeting and tenoning. Does all these easily and economically on one machine with only a few special attachments. No need for several special machines. Cuts, rips, and mitres stock up to 1 1/4" thick. Special saws for cutting type metal, brass, copper, aluminum, fibre, bakelite, etc. Can also cut steel tubing, rods, thin plates or sheets of iron, steel, mica, carbon, and similar materials with an elastic emery wheel. Special grooving saws for cutting tenons and rabbets. Table easily elevated for doing this work. Standard saw slot takes 3/16" grooving saw. Wider grooves up to 1/2" can be cut with use of dado head. This work also requires table top with special removable insert for widening saw slot. This special top with insert, \$6.50 extra. Be sure to specify when ordering.

**FOR SANDING.** Any work requiring close joints or a smooth finish can rapidly be done on this machine. Is equipped for handling sand or emery discs which make it easy to handle all such work with amazing

speed and precision. Smoothing surfaces, rounding corners, finishing to a line, drafting patterns, and all similar fine work is greatly reduced in cost and simplified in accomplishment by this machine.

**FOR DRILLING.** A chuck attaches to outer end of shaft shown in picture which will accommodate drills up to 3/8", or can be used for wood machine bits, for drilling holes for brads, screws and dowels. The exceedingly high speed obtained in this machine makes possible quantity results at low cost.

**GRINDING, POLISHING and BUFFING.** For this work the table top is removed and the special tools are attached to either end of shaft or arbor. This provides an easy method for sharpening tools, polishing various articles or buffing metals, even to nickel and silver plated articles,—a feature of special value to machine workers.

**WHO CAN USE IT.** The Boice Pony Bench Machine is practically adapted for use of carpenters, contractors, cabinet and pattern makers, furniture repairmen, toy makers, shipping departments, laboratories, printers, private work shops and any other similar places where speed, precision, and economy of operation are required.

**WHAT USERS SAY.** The following brief comments will indicate what users think of the Boice Pony Bench Machine: "Am well pleased." "Machine is all you claim and more." "Am more than satisfied." "More than meets my expectation." "A wonderful machine." "Am using it for cabinet work, and for buffing and polishing hammered copper." Many similar commendations in our files. Not a single dissatisfied customer. The Boice Pony Bench Machine makes good for everyone.

**WHAT YOU GET—OUR SPECIAL OFFER.** For a limited time we offer the Boice Pony Bench Machine and the following equipment: Bearded, with arbor and pulley; table top with dust chute attached; one square wheel, 4" x 1 1/2"; one 6" wood saw; one 8" by 1/2" wheel; one 6" sand disc; cut-off guide, and rip guide with clamp, all for \$17.85, f. o. b. Toledo, cash to accompany order. Same machine, mounted on metal base with 1/2 hp. 110 volt 60 cycle, A. C. ball bearing motor, \$72; D. C. motor, \$74.75; with 220 volt motor, or motor for 25, 40 or 50 cycles, \$79.00.

**SPECIFICATIONS.** In brief. All metal construction; height, 10"; length of

arbor 9 7/8"; bronze bearings; table top 10" x 12", planed smooth and true; arbor pulley 2 1/2" diameter for 1 1/2" belt. Grooved pulley if desired. Speed 3500 to 4000 rpm. Power required 1-4 to 1-3 hp. Finish, black enamel, weight 21 lbs.; shipping weight 56 lbs. Will cut 1 1/4" stock.

**OUR GUARANTEE.** Send for a Boice Pony Bench Machine today. Use it five days. If at the end of five days you are not satisfied, return machine at our expense and your money will be refunded. All Boice Machines and Boice Motors are guaranteed to give satisfaction. Lowest priced consistent with a quality that gives service. Ask for prices and descriptive literature. Use the coupon.

**W. B. & J. E. BOICE, Dept. PM-10, Toledo, Ohio**

### Fill Out and Mail TODAY!

**W. & J. BOICE, Dept. PM-10,  
114 23rd St., Toledo, Ohio**

Gentlemen: Enclosed is money order for \$37.85 for which please send me one Boice Pony Bench Machine with equipment specified, as per your special five day trial offer.

If desired with 110 volt, 60 cycle A.C. Motor and base at \$72.00 check here ..... If D.C. Motor at \$74.75, check here ..... If special motor at \$79.00 check here ..... and specify cycles required here .....

Name .....

Street and No. ....

Town .....

R.F.D. .... County ..... State .....

# Radio

## The Greatest Radio Offer of the Year—Absolutely Complete, \$49.50

This special receiving outfit will give as good results as any outfit of this improved type on the market. It is absolutely complete, there is nothing extra to buy. We include everything—you simply put up the aerial, connect the instruments, which is easy to do, and in less than half an hour you can be receiving signals, radio music, lectures, stock reports, market reports, or any other radio program sent out.

In making tests with this set in Chicago we regularly heard Detroit, Pittsburgh and other stations were often tuned in. Of course, atmospheric conditions affect the range of this or any other receiving set made.

### Highest Development in Radio Receiving

This outfit will equal in results any outfit of this type regardless of price. It is especially made for us and has behind it the fifty year old guarantee of Montgomery Ward & Co.: "Satisfaction guaranteed or your money back." You take no risk whatever in ordering this set.

### Long Distance Vacuum Tube Receiving Set

The complete outfit includes our special Combined Tuner and Detector; Special 2000 ohm Double Head Set; Radio Storage Battery; one Detector Tube, one "B" Battery; and complete antenna and connecting equipment including 150 feet bare copper wire and 25 feet insulated wire, porcelain tube; double throw switch; 2 antenna insulators; lightning protector; ground clamp, 2 screw eyes and 25 feet of wire for instrument connections.

Order this set at our risk. It will be packed carefully and shipped immediately from our nearest house. Shipping weight 40 pounds. 563Z599—Complete Outfit..... **\$49.50**

Order this outfit today and start at once enjoying in your home the most marvelous invention of the age.

Price of receiving Set without batteries, head piece, switch and aerial, shipping weight 8 pounds: 563Z598 — \$27.50. Send money order or check to the one of our five houses that is nearest to you.

**MONTGOMERY WARD & CO., Dept. 6-R**  
Chicago Kansas City Saint Paul Fort Worth Portland, Ore.



## RADIO CATALOG FREE

This FREE catalog tells you the kind of Wireless Equipment to own, so that you receive in your own home all the latest news, music, Church services, lectures, —everything that is broadcasted.

Every home should have a wireless telephone outfit. We now offer complete outfits from \$12.95 up.

Everyone interested in radio should see our low prices on parts and accessories. Write for this book. Learn about the miracle invention of the age. Easy to install, simple to operate.

One copy of this booklet is yours FREE. Write for your copy.

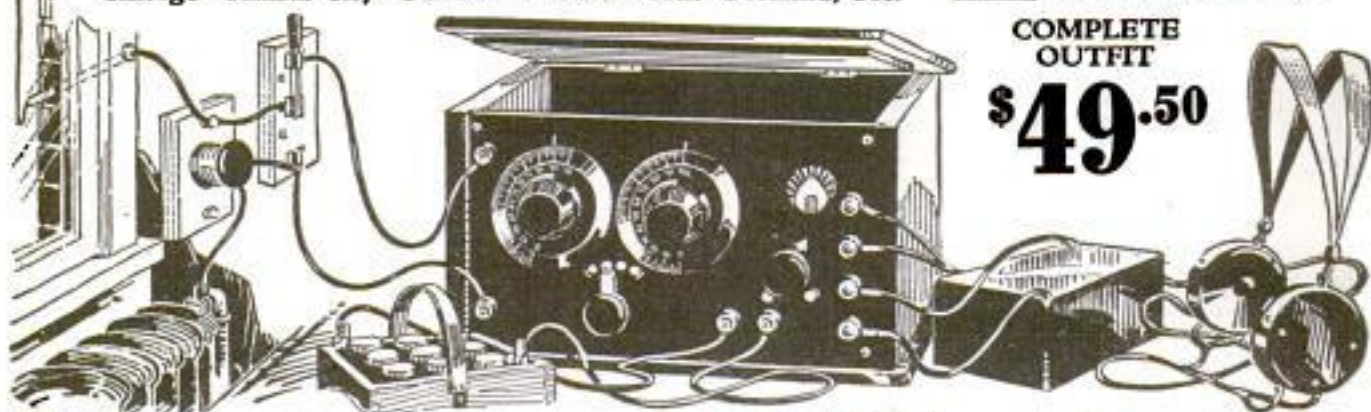

COMPLETE  
OUTFIT  
**\$49.50**

# Montgomery Ward & Co.

== The Oldest Mail Order House is Today the Most Progressive ==

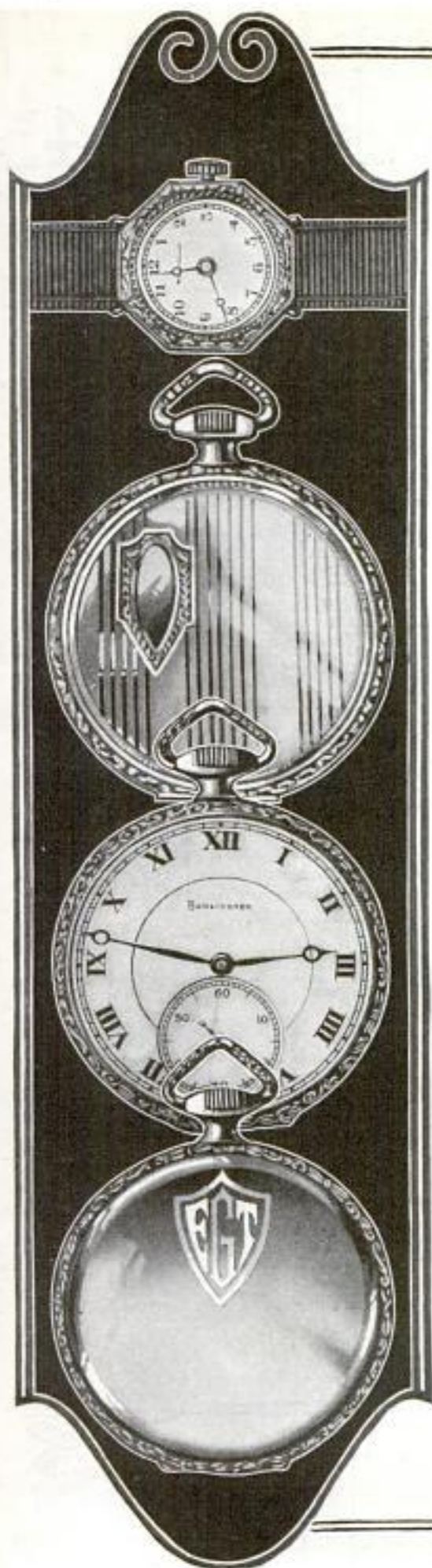

# 21 Jewel Burlington

Adjusted to the Second  
Adjusted to Temperature  
Adjusted to Isochronism  
Adjusted to Positions  
21 Ruby and Sapphire Jewels  
25 Year Gold Strata Case  
Your choice of Dials  
(Including Montgomery R. R. Dial)  
New Ideas in Thin Cases

## Only \$1.00 Down

Only One Dollar Down, will buy this masterpiece of watch manufacture. The balance you are allowed to pay in small, easy monthly payments. A 21-Jewel Watch — is sold to you at a price much lower than that of other high-grade watches. Besides, you have the selection of the finest thin model designs and latest styles in watch cases. Write for FREE Watch Book and our SPECIAL OFFER today.

### The Burlington "Petite"

This exquisite little 17-jewel ladies' wrist watch. A perfect timepiece. Beautiful, 14K Solid Green Gold case. Illustration is exact size of Burlington "Petite".

Send for this wonderful little bracelet watch. See how beautiful the dainty green gold case looks on your own wrist.

# Write

While this Special Offer Lasts

Get the Burlington Watch Book — write today. Find out about this great special offer which is being made for only a limited time. You will know a great deal more about watch buying when you read this book. You will be able to "steer clear" of the over-priced watches which are no better. Write for Watch Book and our special offer TODAY!

### Burlington Watch Company

Dept. 1357, 19th St. & Marshall Blvd., Chicago  
Canadian Address 62 Albert St., Winnipeg, Manitoba

Please send me (without obligations and prepaid) your free book on watches with full explanation of your \$1.00 down offer on the Burlington Watch.

Name .....

Address .....

# Balances in your hand as naturally as a Colt .45



Here's an "eye-opener" for the man who has always used the old style frame. A well designed, substantially built hack saw frame has a perfect "hang"—takes any length of blade from 8 to 12 inches and can be set to cut in four directions without removing the wing nut. A constant tension on the bolts holding the blade and a positive adjustment on the tubular back saves cuss words and much valuable time when changing blades. Hard rubber checked handle and stream line design. A Hack Saw Frame you will always swear *by*—never *at*.

Ask for *Starrett Pistol Grip Adjustable Hack Saw Frame No. 169*. You can get it at almost any hardware store.

Write for Catalog No. 22 "A.P." and the Supplement describing the new Starrett Tools.

## THE L. S. STARRETT CO.

*The World's Greatest Toolmakers  
Manufacturers of Hacksaws Unexcelled*  
ATHOL, MASS.



The Starrett Hack Saw Chart and "Hack Saws and Their Use" (a standard reference book on the subject) will be sent free on request.

42-391



# Use Starrett Tools



# Your Home Is Within Your Reach When You Buy From Us

## NOW is the time to build your Harris Home!

And here is a mighty organization of thirty great departments ready to serve you. Managed by expert material buyers, designers and practical builders. We have vast stocks bought at huge quantity price savings which are now at your command. Our sole aim and purpose is

*To help you get a home that will prove entirely satisfactory at a price that will mean a substantial saving in actual dollars of your money.*

The combined efforts of these great departments in experimenting and testing materials and methods of construction have produced for you a GUARANTEED home, expert machine cut, bundled and marked—the last word in building economy.

### Not One Penny in Advance

So sure are we of the super-excellence of our material and our GUARANTEED Ready-Cut System that we will ship you any HARRIS HOME without the payment of one cent down. Our Plan Book explains our liberal terms fully.

### FREE Plan Book

The latest edition is waiting for you, contains our FREE PLAN OFFER and photographic reproductions, with floor plans and specifications of 100 beautiful homes. Mail coupon today.

### Building Material of All Kinds

For over a quarter of a century, thrifty wise buyers have realized that here is the "open door" to real economy, whether it be a brand new home or material for improvements or repairs. Our big stocks of brand new building material, all purchased in tremendous quantities at savings that are passed along to you are ready for quick and complete shipments.

### "PRESTO-UP" Patented Bolt-together Buildings!

The wonder buildings of the age. Guaranteed buildings, for quick industrial housing. Individual Homes, etc., extra strong, practical and suitable for all year 'round habitation in any climate, 50 different plans. They come to you in easily handled sections—painted and stained, ready to bolt together and move in.

### Plumbing and Heating!

Hot water and heating systems, warm air heating plants, pipeless furnaces and plumbing material of every kind—the product of America's leading makers. Our mammoth plumbing stock offers unlimited possibilities for you to save money. Our heating plants are guaranteed to heat your home in any weather with big fuel economy. Mail the coupon for our Plumbing and Heating Book and get the benefit of our Expert Engineering Service.

Department NM-7

**HARRIS BROTHERS CO.**  
1349-1525 W. 35th St., CHICAGO

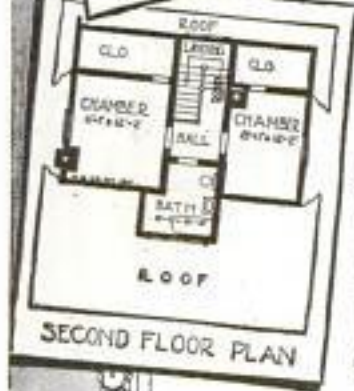

**FREE BOOK  
of Plans**

**HARRIS BROTHERS CO.**  
Dept. NM-7, Chicago

These books are FREE and sent post paid. Mark an "X" in the squares to indicate which ones you wish.

- Harris Home Book of Plans     Book of "Presto-up" Houses and Garages  
 Building Material Catalog     Plumbing and Heating Book

Name.....

Address.....



## No Money Down Sent on Approval

Our determination to this year double our sales of the world famous *Santa Fe Special* and *Bunn Special Watches* prompts this matchless offer.

While other watch dealers are raising their prices, asking you for larger monthly payments, and making payment terms harder for you to meet, we are offering you our new model *Santa Fe Special*, and the famous *Bunn Special*, no advance in price, no money down, easier terms and smaller monthly payments. WE realize the war is over and in order to double our business we MUST give you pre-war inducements, better prices, easier terms, and smaller payments.

## LOOK Santa Fe Special AND Bunn Special Watches

Without one penny of advance payment let us place in your hands to see, to examine, to inspect, to admire, to approve a real masterpiece in watch creation.

### Page Twelve of Our Watch Book is of Special Interest to You!

Ask for our Watch Book free—then select the watch you would like to see, either the famous *Santa Fe Special* or the 6 position *Bunn Special*, and let us explain our easy payment plan and send the watch, express prepaid, for you to examine. No money down.

**REMEMBER** No money down—easy payments buys a master timepiece—a 21 Jewel guaranteed for a lifetime at about half the price you pay for a similar watch of other makes. No money down—a wonderful offer.

**Santa Fe Watch Company**  
Dept. A.6, Thomas Bldg. Topeka, Kans.

SANTA FE WATCH CO., Dept. A.6, Thomas Bldg., Topeka, Kans.

Please send prepaid and without obligation your Watch Book free, explaining your "No Money Down" Offer on the *Santa Fe Special Watch*.

Name .....

Address .....

State .....

Trade Mark Registered  
**WURLITZER**  
 200 YEARS OF MUSICAL INSTRUMENT MAKING

**Professional and Amateurs  
 Praise Wurlitzer Instruments**

"I am proud to be the owner of one of your new cornets. The tone, tune and valve action are positively superior to any I have experienced in all my years of cornet playing."

**Harry L. Jacobs**  
*(Soloist with Sousa's Band, Brycke's Marine Band, Chicago Grand Opera)*

"If I could not get another like it, my Wurlitzer saxophone could not be bought from me for \$200.00."

**J. Russel David, Rockford, Ind.**

"Without your credit system it would have been impossible for me to own this beautiful instrument."

**Arthur M. Samp, Madison Wis.**



*Any Musical Instrument*

# On Trial

**W**URLITZER will send you *any instrument* for a week's trial in your own home. No obligation to buy—no expense for the trial—you do not risk a penny. Wurlitzer instruments are known the world over for artistic quality and excellence of workmanship. Used by the greatest musicians, bands and orchestras. The House of Wurlitzer has made the finest musical instruments for over 200 years.

## Easy Payments

Payments are conveniently arranged in small monthly sums—a few cents a day will pay. All instruments to you at lowest factory prices. Special combination offers on complete musical outfits—velvet lined case, all accessories, self-instructor, etc.—everything you need at practically the cost of the instrument alone.

## Send for New Catalog!

The greatest musical catalog ever published! Over 3,000 articles—every known instrument described and illustrated—many of them shown in full colors.

Wurlitzer has stores in over thirty cities, but no matter where you live, Wurlitzer is no farther than your nearest mail box. Send the coupon today!

**The Rudolph Wurlitzer Co., Dept. 1777**

117 E. 4th St., Cincinnati — 329 So. Wabash Ave., Chicago  
 120 W. 42nd St., New York — 250 Stockton St., San Francisco

Send me your new catalog with illustrations in color and full descriptions of every known musical instrument, also details of the Wurlitzer Free Trial Easy Payment Plan. No charge, no obligation.

Name.....

Address.....

(State musical instrument in which you are interested.)





**It Clamps  
Everywhere  
—stands  
anywhere**

**\$5**

**The  
LAMP  
With the  
CLAMP**

## Adjusto-Lite

A FARBBERWARE PRODUCT

Adjusto-Lite is the handy, economical light for home, office, store, studio—everywhere good light is needed. HANGS—CLAMPS—STANDS. The name says it—it's quickly adjustable. A turn of the reflector sends the light exactly where you want it. No glare—no eyestrain. And—*economy*.

Solid brass; handsome, durable and compact. Clamp is felt-lined—can't scratch. 5-yr. guarantee. Complete with 8-ft. cord and screw socket with 2-piece parallel plug.

Get an Adjusto-Lite today. If your dealer doesn't carry it order direct.

**S. W. FARBBER**

141 So. Fifth St. Brooklyn, N. Y.

Prices in U. S. A., brass finish, \$5; statuary bronze or nickel finish, \$5.50. West of Mississippi, 25c per lamp additional.

TRADE MARK



## Only 287 Motors

Left at  
**\$10**

Each

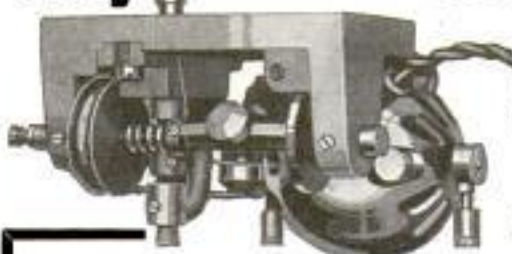

Ideal for home-made phonographs, experimental purposes and combination **phonograph-radio** sets.

We have 287 small motors which are greatly under-priced for quick clearance. You will never again equal this low price, when this lot is sold.

They are universal motors, 110 volts, 60 cycle single phase, complete with turntable, cord and socket for immediate use. 1400 R. P. M. Motor has 1" pulley with flange for 1/4" flat belt. Housed in highly polished, nickel-plated shell.

Don't lose out on this remarkable offer. Order your motor today. Tomorrow may be too late. **DO IT NOW!** Price in U.S.A., \$10.00 f. o. b. Steger, Illinois. Foreign \$12.50.

**Industrial Division**

**Steger & Sons Piano Manufacturing Company**  
Dept. 31, Steger Building Chicago, Illinois

## AGENTS: \$12 A DAY New Kant-Klog Coal Oil Burner



Most perfect burner ever invented. Can't clog up. Burns 85% air and 15% gas. Turns any coal or wood stove into a gas stove. Pays for itself in a short time. Cheaper than coal. Big seller. Popular price. Write for agency and territory.  
**PARKER MFG. CO., 278 Coal St., DAYTON, OHIO**

## Big ENGINE Sale

Prices Smashed Again!

Famous OTTAWA Engines back to 1914 prices! New Improved Models. Better built for long, hard service. Direct-From-Factory Sales Plan gives you \$15 to \$150. Big surplus over rated H-P. Built in largest, most modern engine factory. Prices way down on all sizes.

**OTTAWA 90 Days Trial**

**1922 MODEL ENGINES** stationary, portable or saw rig; gasoline or kerosene. Easy to start—easy to operate. Guaranteed for 10 years. Cash, or Easy Payments.

Write Today for book "How to Know Better Engines." Send at once while Sale is on.

**Ottawa Mfg. Co. 533-F King St. Ottawa, Kans.**





**5-Year  
Guarantee**  
**10-Day  
Free Trial**  
**Easy  
Payments**

Never in the history of the typewriter industry has a more liberal offer been made.

**Big Saving**

Read about the **Big Saving** you can make if you order now. Write for our wonderful three-color catalog, which describes a trip through our **Big Factory** and tells **YOU** how you can **Save a Lot of Money** by buying one of our rebuilt Underwoods **Now**

Write while our special offer is still open to you.

**Perfect  
Alignment**  
**Easy Touch**  
**Beautiful  
Finish**  
**Nickel  
Plated  
Trimmings**



Actual photo of one of our rebuilt Underwood Typewriters

**Guaranteed  
Five Years**

**ONLY  
\$3  
DOWN**

**and you  
keep this  
Typewriter**  
**This Famous Genuine  
Underwood  
Rebuilt in our own  
big factory**

Remember, every typewriter is fully guaranteed; it is a perfect typewriter and looks like a brand new machine. Looks like new, writes like new and every single part has been inspected, tested and pronounced perfect by our Inspection Department. This explains our **Five-Year Guarantee**, the guarantee which assures you an absolutely perfect machine.

**The  
Best Type-  
writer Offer  
you have ever had**

Remember, we own and operate the largest rebuilding typewriter plant in the world. We take pride in our product; we know that our workmanship is of the best and that the typewriter will please you in every way. Do not delay writing for our big free catalog which will be sent **FREE** for the asking, as we want you to realize that this is the best and biggest typewriter offer ever made.

**"Have Yet to Discover Anything Which Differs From a New Machine"**

I have used many Underwoods in my time, and I have yet to discover anything about this machine which differs in the least from a new machine. In fact, I would still be in happy ignorance if some unscrupulous person had sold me the machine as a new one, at the price of a new one.  
E. J. QUINBY,  
May 3, 1922. Bound Brook, N. J.

**"Rather Write With This One Than Any New One I Have Ever Used"**

It is impossible to tell from its appearance that it is a Rebuilt machine, and it is every bit as good as anybody could expect it to be. I have written on several new Underwoods, but I would a great deal rather write with this one than any new one I have ever used.  
WILBERT QUACK,  
April 11, 1922. Mt. Vernon, O.

**Four Rows  
of Keys**  
**Two-Color  
Ribbon**  
**Automatic  
Reverse**  
**Marginal  
Regulators**

**It Costs Nothing to Learn of Our Big Offer**

**FREE**



**This Electric  
Desk Lamp**

For a limited time only we offer this handsome flexible arm electric desk lamp free with a guaranteed Shipman-Ward Rebuilt Underwood. Lamp has flexible arm, can be moved in any position and comes complete with six-foot cord, shade, plug, etc., but without bulb. You can have your choice of lamp in four finishes. Send in the coupon quick and learn about this great free offer. Remember, we have only a limited number of these handsome lamps.

**Write Now**

Send in the coupon and let us prove to you that our offer is unprecedented in the history of the typewriter business. Learn about our **Ten-Day Free Trial Offer**, our easy terms and the big saving in cost you can make by ordering one of these truly wonderful machines of us right now. You don't have to buy, just send the coupon and we will send you full information **FREE**

**SEND IN THIS COUPON**

**FREE TRIAL COUPON**

Shipman-Ward Mfg. Co., 2127 Shipman Bldg., Chicago

Send me your big bargain catalog.  
 Enclosed find \$3. Send me the Shipman-Ward Rebuilt Underwood on 10 days' free trial. If I decide not to keep it I will return it at your expense and you will refund every cent paid by me. If I decide to keep it, I have the privilege of paying for it on easy monthly payments.  
(Mark the square with a cross)

Name .....

Street .....

City.....State.....

References.....

This is not an order. You are under no obligation.

**SHIPMAN-WARD MFG. CO.**  
**"Typewriter Emporium" 2127 Shipman Bldg.**  
**Montrose and Ravenswood Aves., Chicago**



**\$2** Brings this 2K. Size Genuine Diamond Ring

**Price Only \$48.50**

\$2.00 brings this genuine diamond ring for 10 days' free trial. Seven perfectly cut, blue white diamonds set in ALL PLATINUM by a patented process resembling a 2 Karat single diamond. The likeness is amazing.

**No Red Tape—No Delay**

Send only \$2.00 and ring comes to you charges paid. After 10 day trial, pay balance \$4.65 a month for 10 months. Price only \$48.50. If not satisfactory after trial, return it and your deposit will be refunded.

**FREE.** Write today for ROYAL catalog of Diamonds, Watches and Jewelry. Thousands of gift suggestions shown in our \$2,000,000.00 stock. 10 months to pay on everything. Address Dept. 594.

**ROYAL DIAMOND & WATCH CO.**  
35-37-39 Maiden Lane - New York

**SEND NO MONEY**

Try this Portable Typewriter 10 Days **FREE**



Now you can buy famous; 9-pound National Typewriter direct from the factory, after 10 days' trial—absolutely free. You be the Judge. Then we give you

**10 MONTHS TO PAY**

Same machine as used by thousands of doctors, lawyers, bankers, salesmen, students, writers and business men in 31 countries. Every feature of best, standard size machines, 28 keys, and size machines, 28 keys.

**10 Months to Pay**

84 characters. Brand new—not a rebuilt typewriter. Neat, compact carrying case free with every machine. Send today for our 10 Days' Free Trial offer and 10 Months' Easy Payment Plan.

**NATIONAL TYPEWRITER CO.**  
Dept. 7-J. Fond du Lac, Wis.

**BALBA** bouquet perfume



Get Our Money-Making Agency Offer  
**Balba Sales Machines**  
Make \$200 to \$1000 Monthly

This new plan of selling high quality perfume has taken the country by storm. Men everywhere are jumping at the opportunity to get into this big money-making field. See page 171 of March Popular Mechanics.

**Over 500 Cities Already Taken**

Remember the first who qualify get the exclusive sales rights. We do the local newspaper and national advertising. Get full particulars NOW.

**BALBA CORPORATION OF AMERICA, Inc.**  
Dept. 44, Adams and Jackson Sts.  
TOLEDO, OHIO, U. S. A.

**New Gum Vending Machine**  
Makes You \$10 to \$20 a Day

Pays Rent for Store Owner

Install one in your store or any public place and get this easy profit. Requires no attention. Always works. Machine's profits pay the rent. Write us about rebuilt penny and nickel machines. Finished like new. In excellent running order. Pay their cost in 10 days. Price \$85.

Write or wire today for full particulars. \$25 down payment. Balance C. O. D. Mints \$30 per case—2,000 5 cent packages. Single boxes, 100 5 cent packages, \$2.50.

**SILVER KING NOVELTY CO.**  
400 Williams Bldg. Indianapolis, Ind.



**PAUL REVERE BICYCLE**

A sturdy dependable Bicycle—all workmanship and parts absolutely guaranteed for five years. 7 models to choose from. 12 months to pay. Express charges prepaid. Beautiful Catalog free. Agents wanted.

**MYEROW BROS.**  
260-262 COLUMBUS AVE.  
BOSTON, MASS.

**Why Pay What Others Save?**



No one can make better stoves, ranges and furnaces—than Kalamazoo. And no one can give you more for your money than manufacturers dealing direct with you from the factory.

Write for the Kalamazoo Catalog and just find out what wonderful bargains you can get this year in our new designs—blue and gray porcelain enamel ranges—beautiful heaters, etc. Also new pipeless furnaces \$52.95 and up. 400,000 pleased customers. Cash or easy payments. 30 days' trial—money-back guarantee. Ask for Catalog No. 473

**"A Kalamazoo Direct to You"**

**KALAMAZOO STOVE COMPANY**  
KALAMAZOO, MICH.



24-Hour Shipments



Send  
today for  
this free  
booklet.

## Own a Corona!

*Increase your income*

**T**HIS wonderful little 6½ pound folding typewriter pays for itself in time it saves and work it turns out. Fold it up—take it with you—typewrite anywhere.

# CORONA

*The Personal Writing Machine*

REG. U. S. PAT. OFF.

Corona Type-  
writer Co., Inc.,  
108 Main St.,  
Groton, N. Y.



**VIOLINS**  
SPECIAL LOW PRICE SALE

We can save you money on standard makes and models best quality, guaranteed violins. Biggest offers ever made by us. SEND TODAY for list of bargains and information.

**JENKINS MUSIC COMPANY**  
(43 years in business—13 stores.)  
931 Jenkins Bldg. Kansas City, Mo.



**SAVE MONEY ON GUARANTEED MOTORS**

**Buy Direct from Headquarters**



**Fuerst-Friedman MOTORS**

Save from 25% to 40% on standard makes of new and rebuilt motors. Get the proper size and type of motor to suit your exact needs—and get it fully guaranteed by a motor merchandising house backed with 20 years of dependable service direct to users. Write today for catalog No. 70. It quotes prices on motors of every size and type.

*Electrical Equipment Bought, Repaired or Exchanged.*

**THE FUERST-FRIEDMAN COMPANY**

*"Reliability Built In."*

CLEVELAND

OHIO



Note the renewable cutting blades. There's the reason why Neverslips outcut and outlast any plier made.

## Just Change the Blades

—when they become accidentally nicked or broken.

Neverslip Pliers are made with renewable high carbon crucible steel cutting blades. Should they become accidentally nicked or broken, they may be quickly and easily replaced with a brand new pair—just like a safety razor. It can be done in a jiffy by anyone.

Neverslips are guaranteed to outcut and outwear any plier made.

Just go into any hardware store and ask to see a pair of Neverslip Pliers. If your hardware dealer can't supply you, send us his name and we'll see that you are supplied.

Write for Leaflet.

THE NEVERSLIP WORKS  
NEW BRUNSWICK NEW JERSEY

# NEVERSLIP

side cutting pliers

*Neverslip Pliers are furnished in 6-7 and 8 inch sizes.*

# W. L. DOUGLAS

FOR MEN AND WOMEN

**BOYS' SHOES**  
\$4.00 & \$4.50

BEST IN QUALITY  
BEST IN STYLE  
BEST ALL AROUND SHOES  
FOR BOYS

**\$7.00 & \$8.00 SHOES**

**ALSO MANY STYLES AT \$5.00 & \$6.00**

**W. L. DOUGLAS PRODUCT IS GUARANTEED  
BY MORE THAN FORTY YEARS  
EXPERIENCE IN MAKING FINE SHOES**

They are made of the best and finest leathers, by skilled shoemakers, all working to make the best shoes for the price that money can buy. The quality is unsurpassed. The smart styles are the leaders in the fashion centers of America. Only by examining them can you appreciate their wonderful value. Shoes of equal quality cannot be bought elsewhere at anywhere near our prices. W. L. Douglas \$7.00 and \$8.00 shoes are exceptionally good values.

W. L. Douglas shoes are put into all of our 108 stores at factory cost. We do not make one cent of profit until the shoes are sold to you. It is worth dollars for you to remember that when you buy shoes at our stores **YOU PAY ONLY ONE PROFIT.**

No matter where you live, shoe dealers can supply you with W. L. Douglas shoes. They cost no more in San Francisco than they do in New York. Insist upon having W. L. Douglas shoes with the name and retail price stamped on the sole. Do not take a substitute and pay extra profits. Order direct from the factory and save money.



W. L. Douglas name and portrait is the best known shoe Trade Mark in the world. It stands for the highest standard of quality at the lowest possible cost.

The intrinsic value of a Trade Mark lies in giving to the consumer the equivalent of the price paid for the goods.

Catalog Free.

*W. L. Douglas*

President

W. L. Douglas Shoe Co.,

128 Spark St., Brockton, Mass.



THE STAMPED PRICE  
IS YOUR PROTECTION  
AGAINST  
UNREASONABLE PROFITS



## MAKE YOUR FORD INTO THIS SPORT CAR \$ ONLY 6.40

Other types down to \$7.50. Famous are fit, *easy* life-size patterns and simple picture instructions show how. You can easily convert your Ford into this fast, easy Sport Car as hundreds have done with a few dollars worth of material from the hardware store. No need to lay up the car. The "PAL" with conical disc wheel patterns. Pressed Metal Streamline Rear only \$0.40 delivered. Built low, rides wonderfully easy. Order NOW while we can make good delivery. Send for our illustrated prospectus of "Sport Cars," "Fifty" Toys and "Games." Wards, Inc., Kemptel Co., 29 Kemptel Bldg., Guttenberg, Iowa

## NEW SINGLE PHASE A. C. MOTORS

### MARATHON

1/4 H. P.—110 volt, 60 cycle, 1725 speed, complete with cord, plug and grooved pulley, \$13.00

### General Electric

1/4 H. P., \$16.50  
1/2 H. P., \$39.00



ONE YEAR  
GUARANTEE

### EMERSON

3/4 H. P. \$58.00  
1 H. P. 62.00  
1 1/2 H. P. 75.00  
2 H. P. 89.00

Include Pulley and Base—All Motors, 1/2 H. P. or larger, 110-220 Volt Rep. Ind. Type.

Satisfaction guaranteed or money refunded

Illustrated Catalog of Motors and Supplies FREE

HYRE ELECTRIC CO., 615-M So. Dearborn St., Chicago

## DRIVE 100 TACKS AND SAVE \$25.00

Ford Top Re-coverings \$5.20, \$6.95, and \$9.95. All other cars \$14 and \$16.50, with plate glass lights. Winter Tops \$66 up. California Tops \$150. Regular Side Curtains \$5.95 up. Special Winter Side Curtains that open with doors \$11.90 up. Seat Covers \$3.15 up. Radiator and Hood Covers \$1.95 up. All goods same as car mfrs. use. Quality the best and guaranteed to fit. Printed instructions given how to apply. Send for samples

AUTO EQUIPMENT CO., 32 Canal Street, Cincinnati, Ohio

## KEITH'S \$2.50 OFFER



3 Plan Books, showing 100 designs of artistic bungalows, cottages, or two-story houses—in frame, stucco and brick—with floor plans and descriptions, and 8 months' subscription to Keith's Magazine, all for \$2.50.

Keith's Magazine for over 20 years an authority on planning, building and decorating homes—25¢ a copy on newsstands. With its help and Keith's Plans you can get the most distinctive, comfortable and satisfactory home with greatest economy. Set of 8 plan books (260 plans) and Keith's for 12 months—\$4.50 Keith Corporation, 566 Abbey Bldg., Minneapolis, Minn.



# BROWN & SHARPE

## MACHINISTS' TOOLS

bring you the high accuracy, clean cut graduations, correct design and long life that an experience of over 70 years in the successful manufacture of precision tools can give. These are real reasons for the superiority of Brown & Sharpe Tools—the tools you know are good.

We shall be glad to send our Small Tool Catalog No. 28, listing over 2000 different tools, if requested.

**Brown & Sharpe Mfg. Co.**  
Providence, R. I., U. S. A.

### For Band Saw repairs— **Briggs' Silver Solder**

1 oz. Tape—5 ft. long,  $\frac{3}{4}$  in. wide,  $\frac{3}{1000}$  in. thick, in non-waste, metal box, **\$1.25**

**J. Briggs & Sons Co., Mfrs.**  
67 Clifford St. Providence, R. I.

**Moore Push-Pins**  
*Glass Heads—Steel Points*  
**Moore Push-less Hangers**  
To hang up things  
*Ask your dealer to show them*  
Sold Everywhere **10¢** per packet  
Moore Push-Pin Co.  
Wayne Junction Philadelphia



**PLUMBING & HEATING**  
*Buy Direct—Save 50%*  
**\$66.95** Complete Bathroom **\$66.95**  
Outfit  
Send NOW for our FREE Catalog "A" of  
Wholesale prices  
**Satisfaction Guaranteed**  
**LAMPLUGH BEAUMONT COMPANY**  
99 So. Portland Ave. Brooklyn, N. Y.

# PANEL WITH IT AND SMILE!

Your Radio set will give you finer service panelled with wonderful Bakelite-Dilecto (Grade XX) — beyond all question the handsomest and most practical known substance for such use.

## IT HAS SUITED UNCLE SAM THESE EIGHT YEARS

Bakelite-Dilecto is enormously hard and tough, resistant not merely to water but even against acids, and has the handsomest finish imaginable. U. S. Navy and Signal Corps tests through eight years **GUARANTEE** it perfect in insulative qualities.

## UNEQUALLED FOR RADIO PANELS AND WIRELESS INSTALLATIONS

This super-resistant, rich, black, beautiful panelling has a proved Dielectric constant equalling 5.2. Machines wonderfully, and has immense volume and tensile strength.

**DEALERS:** B-D XX, in sheets, rods, tubes, etc., is getting heavy demand through aggressive advertising on a **QUALITY** basis. Ask for price lists and interesting offer.

**AMATEURS:** Accept only **BAKELITE-DILECTO** for your panels and radio parts. Write us direct to be told where to get it.

### The Continental Company of Newark, Delaware

Servicing from

NEW YORK.....233 Broadway  
CHICAGO.....332 Michigan Avenue  
SAN FRANCISCO.....75 Fremont  
SEATTLE.....91 Connecticut St.  
ROCHESTER.....85 Plymouth Ave.  
PITTSBURGH, 301 5th Ave.  
LOS ANGELES  
.....411 S. Main

# bakelite-dilecto

### Play a Tune in One Hour

Many, without previous musical experience, have done it with a Conn Saxophone. You, too, can learn this popular instrument quickly. Pleasure and profit yours to command.

#### Conn Saxophone Supreme

Important improvements found on no other make. Built by world's largest producers of Saxophones. Used and endorsed by world's great musicians. Write now for details of Free Trial, Easy Payment Plan.

C. G. CONN, Ltd.,  
831 Conn Bldg., Elkhart, Ind.



**CONN**  
WORLD'S  
LARGEST MANUFACTURERS  
OF HIGH GRADE SAXOPHONES AND  
ORCHESTRAL INSTRUMENTS

Be a  
Taxidermy  
Artist

### Marvelous Book Sent FREE

You can now learn Taxidermy, the wonderful art of mounting birds, animals, tanning skins, etc. Learn at home, by mail. The free book tells how. Mount your own trophies. Decorate home and den. Hunters, trappers, nature lovers, you need taxidermy. Interesting, fascinating, big profits. Join our school. 55,000 students. Success guaranteed. Get our free book without delay. Send right now—today.

N. W. School of Taxidermy, 1777 Elwood Bldg., Omaha, Neb.

### SELF-FILLING INK PENCIL

#### "INDEPENDENT"

Meets all requirements. Self-filling, non-leakable, safety cap. Attached clip. Smooth writing gold style point.

Guaranteed Improved Fountain Pen. Eliminates fatigue. Promotes efficiency. Writes uniform. A business necessity.

\$2 By Mail

Your Name in Gold—25 Cents Extra

#### AGENTS WANTED

J. C. ULLRICH & CO., 161 Washington St., New York

### TYPEWRITERS

We Save You 50%

#### FREE TRIAL—EASY TERMS

Your choice of all STANDARD MAKES, UNDERWOOD, ROYAL, SILENT L. C. SMITH. Self-starting REMINGTON, etc. Rebuilt by the Famous "Young Process." Guaranteed good as new. Lowest cash prices. Time payments or rentals with special purchase privileges. Largest stock in U. S. Write for special prices and terms.

YOUNG TYPEWRITER CO., Dept. 462 CHICAGO



### Are You All Primed?

We can supply you with Masonic books of reference, study, history, etc. Also fine aprons, regalia, novelties, jewelry and supplies.

Send for Free Catalogue P

REDDING & CO.

Publishers and Manufacturers

200 Fifth Avenue, New York



The  
**Prophy-lactic**

Tooth Brush

Most of your friends use it  
and profit by it

## Different from all others—the NEW BENJAMIN

### AIR RIFLE

Made on a different principle from all other Air-Rifles. The Benjamin is really a strong air-pump used to compress the air in the air chamber to any degree of power desired. From one to six strokes of the pump give all the force necessary. Each additional stroke gives increased power. The Benjamin works on the same principle as all air-drills and air-hammers—with this difference:

You control the shooting force as you desire. Look at this block of hardwood. It shows how Benjamin power is regulated as you wish.

You can't have accidents with a Benjamin. It's safe, always, because you control the power. The Benjamin never loses shooting force, and has no springs to get out of order or shake your aim. Write us for an interesting folder about this wonderful air-gun.

For sale by all dealers.  
Price \$5.00.

BENJAMIN  
AIR-RIFLE & MFG. CO.  
615 N. Broadway, St. Louis, Mo.

Ask your dealer for demonstration.



## FREE TRIAL



Cut out this ad and mail it to us with your name and address (no money), and we will send you our **FAMOUS KARNAK RAZOR** by return mail, postpaid. You may use the razor for 30 days **FREE**; then if you like it, pay us \$1.85. If you don't like it, return it. —SEND NO MONEY—

**MORE COMPANY Dept. 355 ST. LOUIS, MO**

**KEYS DUPLICATED**  
**2 FOR 25c**  
Any Type Key—Send Key with Order

Special rates to clubs and organizations

**PHILADELPHIA KEY CO. 170 N. Broad St. PHILADELPHIA**

**Salesmen** Sell our wonderful tailored to order \$29.50 virgin wool suits and o'coats direct to wearer—all one price—\$20 less than store prices. You keep deposit. Everything guaranteed. Big swatch outfit free; protected territory for hustlers.  
**J. B. SIMPSON, Inc., Dept. 125, 831 W. Adams St., Chicago**

## We Pay \$6 a Day

taking orders for Jennings Guaranteed Hosiery. Written guarantee with each pair to wear and give satisfaction or new hose free.

### Year Round Position--No Lay Offs

Regular customers and repeat orders make you steady income. Hose for men, women and children, all styles, colors and finest line silk hose, all guaranteed. Low priced. No experience necessary. Write for samples.

**JENNINGS MFG. CO.**  
Hose-825 Dayton, Ohio



*"Jim, get an Icy-Hot—you need a hot meal at noon to stand this work!"*

**T**HE doctor will tell you that the best stimulant when you're tired is a good hot drink or hot meal.

The man who tries to do a full day's hard labor with nothing but a cold bite at noon can't last long. He's easily fagged out.

Get an Icy-Hot Lunch Kit! Have a home-packed hot dinner every noon and feel fit all day!

An Icy-Hot Lunch Kit keeps lunch fresh and clean, keeps coffee piping hot—as good as it tasted at breakfast. Dust-proof, sanitary, easy to clean, all-metal construction, with pint-size guaranteed Icy-Hot Bottle.

Look for name Icy-Hot on bottom. Sold by reliable dealers everywhere. Send the coupon for complete catalog of Icy-Hots for every purpose.

THE ICY-HOT BOTTLE CO.  
194 W. Second St., Cincinnati, O.



# ICY-HOT

## VACUUM PRODUCTS

Made in America, of American Material, by American Labor. Built for Lifetime Service

The Icy-Hot Bottle Co.  
194 W. Second St., Cincinnati, Ohio  
Please send complete catalog of Icy-Hot products.

Name \_\_\_\_\_  
Street and No. \_\_\_\_\_ State \_\_\_\_\_  
P. O. \_\_\_\_\_

**KEEP CONTENTS HOT 24 HOURS; COLD 3 DAYS.**

Please Mention Popular Mechanics

**DIAMONDS-WATCHES**  
CASH or CREDIT

# LOFTIS

BROS. & CO. EST'D. 1850

**GENUINE DIAMONDS GUARANTEED**  
PRICES GREATLY REDUCED

We invite comparisons. You will be convinced that you can do better with LOFTIS. Our IMMENSE BUYING POWER for our Chain of Stores and our large Mail Order House enables us to make lower prices than small concerns. Liberty Bonds accepted.

**SEND FOR FREE CATALOG**  
Everything explained. Over 2,000 illustrations of Diamond-set Jewelry, Pearls, Watches, etc. Any article sent prepaid for Free Examination. Satisfaction guaranteed or money refunded.

The handsome articles shown are selected from our "A1 Best Sellers." Diamonds are dazzling, blue white, perfect cut. Mountings are all Solid Gold. Furnished at prices given, up to any price you wish. Order by Number.

**DIAMOND RINGS:** 1-White Gold, \$110. 2-White Gold, or Green Gold with White Gold prongs, \$75. 3-White Gold, \$75. 4-White Gold, or Green Gold with Diamond set in White Gold, \$37.50. 5-White Gold, Diamond set in White Gold, \$150. 6-WEDDING RINGS: Platinum, \$25. Green or Yellow Gold, \$10. 7-WATCH: 17-J. gold filled, guaranteed 25 years, \$27.50. 12-WRIST WATCH: White Gold, 12-J., \$33; 17 J., \$45. Credit Terms: One-fifth down, balance divided into equal payments within eight months.

**LOFTIS**  
BROS. & CO. EST'D. 1850

THE OLD RELIABLE CREDIT JEWELERS  
DEPT. E-294.  
108 N. State Street, Chicago, Illinois  
Stores in Leading Cities

# WINDOW SIGNS



**AGENTS** \$60-\$200 a week. Free Samples GOLD SIGN LETTERS for store fronts and office windows. Anyone can put them on. No experience necessary. Big demand. LIBERAL OFFER TO GENERAL AGENTS.

**METALLIC LETTER CO., 433B, N. Clark St., CHICAGO**

## Build and Fly Model Aeroplanes

Build your own Model Aeroplane; make trial flights and learn the principles of Aerostatics. With IDEAL Scale Drawings and Building and Flying Instructions you can easily build exact 3-ft. duplicates of Real Planes. Send now for the Plans for the one you want to build.

Curtiss JM4D-2 Training Plane; DeHavilland Battle Plane; NC-4 Naval Seaplane; Curtiss Military Tractor; Bleriot, Newport or Taube Monoplane; also Cecil Peoli Racer; 25 cents each, postpaid.

Catalogue IDEAL Model Aeroplanes and Supplies, 5c postpaid.

**EVERY-BOYS' Aeroplane** slips together without nails, wires or screws. Ready to fly in 2 hours. The newest idea. Send for catalogue and find out all about it.

**Ideal Aeroplane & Supply Co., 139 Wooster St., cor. W. Houston St., New York City**

**PLANS AND INSTRUCTIONS 25c**

## Free Book Tells How to Get More Eggs!

**Send Now!** **96 Pages**

**HOW** to save feed and get double egg yield. How to cull out poor layers. How Mrs. Hume made \$2000. How Mr. Luttrell makes \$5 net profit per hen. This book explains Prof. Quisenberry's system now being used by 46,000 successful poultry raisers. 1000 money-making secrets.

**Write Today!** Simply send name, a postcard will do, for this 96-page free book, "Dollars and Sense." No cost. No obligation. However, if you enclose 25c, we will send you 25 colored celluloid leg bands to mark your best layers without using trap nests.

**American Poultry School, Dept. 115 Kansas City, Mo.**

## TOOTH No Bristle BRUSH

"ERASES THAT FILM"

For Tender Gums  
Protects Against Pyorrhea

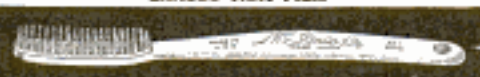

Made of Pure White Rubber. Will Clean Polish and Massage.

We guarantee this brush to outwear any bristle brush made. Clean—healthful—sanitary. Brush replaced if defective. At your dealer's or by mail postpaid 50c. Fine opportunity for agents.

**THE NO BRISTLE BRUSH CO., 10 High St., BOSTON, MASS.**

## Agents

**L**ARGE MANUFACTURER OF SHIRTS wants Agents to sell complete line of shirts direct to wearers. Exclusive patterns. Big values. No capital or experience required. Write for free samples.

**MADISON SHIRT MILLS**  
607 Broadway New York, N. Y.

## MONEY IN MUSHROOMS

**NOW TIME TO START**  
BIG DEMAND. HIGH PRICES BEING PAID

An uncrowded occupation. Exceptional opportunities for live men and women. Raised at home. Only small space needed. Small expenditure will start you in a practical money-making enterprise. Big profits. Booklet telling all free. Write **Nat'l Spawn Co., Dept. 12, Brighton, Mass.**

## TYPEWRITERS

17c a Day soon pays for a genuine visible Underwood or L. C. Smith rebuilt Typewriter. Save \$20 to \$30 on famous Larkin Easy-Payment plan. Handsomely finished. 5 Year Guarantee. 30 Days Trial. Send for FREE Book TODAY.

**Larkin Co. Inc.** Desk TPM-1022  
Buffalo, N. Y. Peoria and Chicago, Ill.



**GREEN AUTOMATIC MACHINE**



**ADD TO YOUR INCOME** WITH LITTLE EFFORT  
**\$5 to \$10 A DAY MADE EASY WITH**

**New Improved Green Automatic Machine**

Sharpens Razors and Straps all kinds of safety razor blades, in one operation, from four to six blades per minute. For both Quality and Quantity, this machine is in a class by itself. There is nothing like it on the market. Let us send you our descriptive literature explaining everything, including the "AMERICAN" Key Cutter—cuts square, angular or round slots.

**AMERICAN SHARPENING MACHINE CO. (Inc.), Dept. 18, 114 W. Washington St., CHICAGO**





**Only \$2 Down**

**Play Well in 4 Weeks**



**—Ten months to pay**

Write for Free Catalog Folder telling all about the Masterbilt—the world's finest Saxophone outfit. Price now lowest ever quoted—5 days' trial—very easy monthly payments. No interest to pay—no extras. Outfit includes finest nickel trimmed and richly lined Case, Instruction Book, Album of Popular Saxophone Solos, Music Lays, Carrying Strap, Mouthpiece and three Fine Reeds.

### "Masterbilt" Saxophones

Used by leading Bands and Orchestras. Highest quality, built in perfect tune, assembled and tested by experts. All latest key improvements, light, quick action and beautiful finish. Write today for FREE Catalog Folder fully describing these handsome Masterbilt outfits.

The Saxophone Shop, 429 S. Wabash Ave., Chicago  
Largest Exclusive Dealers in Saxophone Supplies in the World

**Rabbit Book FREE**



Illustrated. Facts about the easy, profitable home industry—growing domestic hares for meat, fur, fancy. Little space—cheap equipment. Big demand. We buy all you raise at \$7 to \$13 per pair. Turn your spare time into cash. Book free—write now.

**STANDARD FOOD & FUR ASS'N**  
407B Broadway New York City

**NEW AUTOMATIC ADDER, \$3.50**



Makes adding easy. It's accurate, quick, durable and easily operated. Capacity 8 Columns. Saves time, brain work and errors. 45,000 pleased owners. Fully Guaranteed. Price \$3.50. Delivered. With METAL OPERATING BANDS, \$1. Delivered. Agents wanted. Immediate shipment made. Send your order now.

**J. H. Bassett & Co., Dept. 216, 1458 Hollywood Ave., Chicago, Ill.**

**Do Your PRINTING**



Cards, circulars, labels, tags, book, menus, paper, Press, \$12. Larger \$15. Job Press \$150 up. Save money. Print for others, BIG PROFITS. All easy, rules sent. Write factory TODAY for press catalog, TYPE, cards, paper. **THE PRESS CO. D-37, MERIDEN, CONN.**

**SQUAB BOOK FREE**



Squabs are selling at the highest prices ever known. Breed them and make money. Write at once for free book, prices, etc.

**Plymouth Rock Squab Co., 634 Howard St., Melrose Highlands, Mass**

**SEND NO MONEY**



**If You Can Tell it from a GENUINE DIAMOND Send it back**

To prove our blue-white MEXICAN DIAMOND cannot be told from a GENUINE DIAMOND and has same DAZZLING RAINBOW FIRE, we will send a selected 1 carat gem in Ladies Solitaire Ring. (Cat. price \$5.50) for Half Price to introduce, \$2.63, or in Ladies Heavy Touch Heirloom Ring (Cat. Price \$6.50) for \$3.25. Our finest 12x Gold Filled mountings. GUARANTEED 20 YEARS. SEND NO MONEY. Just mail postcard or this ad, State Size. We will mail at once. When ring arrives deposit \$2.63 for Ladies Ring or \$3.25 for Gent's with postman. If not pleased return in 3 days for money back less handling charges. Write for Free catalog. Agents Wanted.

**MEXICAN DIAMOND IMPORTING CO., Dept. ET, Las Cruces, N. Mex.**  
(Exclusive controllers Mexican Diamonds)

# Wanted

## The Proposition

One of America's largest woolen mills—Taylor-Wells & Co.—for the first time in the history of woolen mill merchandising has decided to manufacture all wool products—overcoats, work-pants, bed-blankets, auto-robots, raincoats and suits—every one of superb quality, fashioned from their own wools, to be sold directly from the mills to the wearer. An organization of special representatives is now being formed to represent Taylor-Wells & Co. in exclusive territory. In view of the fact that this organization is to be composed of the best grade of men we can secure—we are going to be mighty particular about—

## The Man

He need not have selling experience. But he must possess loyalty, honesty, sincerity and a good reputation in his community. We do not want every Tom, Dick or Harry. We want men of whom we will be proud—and who in turn will be proud of us and our merchandise. We know our merchandise to be of the highest grade and we want men of a like calibre.

## His Earnings

Conservatively estimated a special representative should earn from \$5000 to \$7000 a year. The demand for our product will be great. Selling direct from the woolen mills to the consumer—we can sell all wool products at a price so low as to be astonishing. Our representative will practically build business for himself in his territory. Customers who buy Taylor-Wells all wool merchandise stay customers.

## His Future

The sales organization now being formed is in its infancy. Within a short time District Managerships will be open. The men who join us now—and who "make good"—place themselves immediately in line for a District Managership which should net him \$10,000 a year and more. The ambitious man with the determination to succeed will have no trouble in "landing" one of these openings.

This may be your one big opportunity! Do not delay! Write us immediately for full details of this amazing opportunity. Territories will be going fast—so if you believe yourself the "right man"—hurry.

## TAYLOR-WELLS & Co.

Department 2210, 2740 N. Paulin St.  
Chicago, Illinois

"From the Mills to the Millions"

# Look Prosperous!

## WEAR DIAMONDS

FOR A FEW  
CENTS A DAY

NO  
MONEY  
DOWN



18 kt.  
White Gold,  
7 perfect cut,  
blue-white dia-  
monds set in plat-  
inum. Looks like 3  
carat solitaires.

Special No. 6t  
Only  
**\$59.50**



Premier Cluster,  
7 carefully matched  
blue-white diamonds  
set in platinum.  
Looks like 1 1/2-2 carat  
solitaire.

Special No. 7t  
Only  
**\$69.50**

Don't send a single penny. Ten days Free Trial. When the ring comes, examine it—if you are not convinced it is the **Greatest Bargain in America**, send it back at our expense. Only if pleased, send \$1.50 weekly—at the rate of a few cents a day. These Bargain Cluster Rings with 7 Blue-White Perfect Cut Diamonds can be yours. No Red Tape. No Risk. 8% Yearly Dividends Guaranteed. Also 5% Bonus.

Million Dollar **FREE** Send for it today. It Bargain Book pictures thousands of Bargains. Address Dept. 1777.

**J.M. LYON & CO.**  
2-4 Maiden Lane N.Y.

In Business Nearly 100 years

## AGENTS-A Winner



The "Even-Edge" knife sharpener is the easiest, fastest and biggest seller we have ever come across. Entirely new does the work, sells at sight, and

**GETS THE MONEY**

every time. Takes only a moment to demonstrate it. Does such a good job on any kind of a knife that practically every call means a sale. Makes a great leader for interesting new prospects in the entire "Zanol" line of Food, Toilet and Household specialties. Write for particulars to-day.

The **AMERICAN PRODUCTS Co.**  
7070 American Bldg., Cincinnati, O.

## "BOW LEGS and KNOCK-KNEES" UNSIGHTLY

SEND FOR BOOKLET SHOWING PHOTOS OF MEN WITH AND WITHOUT THE PERFECT LEG FORMS  
**PERFECT SALES CO.**  
140 N. Mayfield Ave., Dept. 5, Chicago, Ill.

## \$3.00 to \$5.00 AN HOUR " FOR YOUR SPARE TIME

We want you to represent us in your locality and handle orders for **Goodyear Guaranteed Raincoats**.

Costs you nothing. You earn big money. Cloth samples and prices in Handsome Pocket Size **Style Book**. This book shows to friends and neighbors gets the orders.

**Goodyear Guaranteed Raincoats**, well and favorably known, at big saving in prices does the business. We give you a wonderful assortment of materials and styles. Orders come easy. **Write today for**

**Complete Sales Outfit FREE**

and start earning money as soon as it arrives. **You can do it.** 95% of our best agents had no previous experience. Pleasant, profitable, dignified work. Pay yourself every day. Hurry request for free outfit.

**GOODYEAR MANUFACTURING COMPANY**  
1748-D Goodyear Bldg. Kansas City, Mo.



# STOP LEAKS

in kitchen utensils, furnaces, pipes, house boilers, motor radiators, etc., at a few cents' expense with

**SMOOTH-ON IRON CEMENT NO. 1**

As easily applied as putty—makes lasting repairs quickly. Indispensable about Home and Garage.

Write for **FREE Book**: Sold by Hardware and General Stores in 6 oz., 1 lb. and 5 lb. tins. Also in larger sizes.

**SMOOTH-ON MFG. CO.**  
Dept. 37-J, Jersey City, N. J., U. S. A.

## SMOOTH-ON HOUSEHOLD CEMENT



## "Lighting Fixtures" READY TO HANG

(Direct from Manufacturers) Completely wired, including glassware. New designs. Send for catalogue No 24. Send for **DEALERS'** proposition.

**ERIE FIXTURE SUPPLY CO.**  
STA. A. ERIE, PA.

## Beautiful HOUSES \$900 and BUNGALOWS

CAN BE BUILT FOR AND UP

This and many others in my new book, **Building Plans for Modern Homes**, will save you hundreds of dollars. One of the most complete and comprehensive books of plans ever published by any architect. New edition just off the press. Nearly 500 floor plans and photographs of bungalows, Colonial houses, etc., costing from \$200 up; gives sizes and cost to build.

Sent postpaid for \$2.00



**FREDERICK H. GOWING**  
ARCHITECT

111 Tremont St., BOSTON, MASS.

## "Best" Hand Lantern



A powerful portable lamp, giving a 300 candle power pure white light. Just what the farmer, dairyman, stockman, etc., needs. Safe—Reliable—Economical—Absolutely Rain, Storm and Bug proof. Burns either gasoline or kerosene. Light in weight. Agents wanted. Big Profits. Write for Catalog.

ADOPTED BY THE U. S. GOVERNMENT

The Best Light Co., 324 E. 5th St., Canton, O.

## DEAFNESS IS MISERY

I know because I was Deaf and had **Head Noises** for over 30 years. My invisible Antiseptic Ear Drums restored my hearing and stopped Head Noises, and will do it for you. They are Tiny Megaphones. Cannot be seen when worn. Effective when Deafness is caused by Catarrh or by Perforated, Partially or Wholly Destroyed Natural Drums. Easy to put in, easy to take out. Are "Unseen comforts." Inexpensive. Write for Booklet and my sworn statement of how I recovered my hearing.

**A. O. LEONARD**, Suite 226, 70 5th Avenue, New York City

## AGENTS: We Pay \$9.00 a Day

taking orders for Reversible Raincoat. Two coats in one. One side handsome black raincoat—other side fine dress coat. Takes the place of an expensive overcoat. Guaranteed water proof. Latest style. Not sold in stores.

**\$50.00 a Week Guaranteed**  
for 2 average orders a day

No experience necessary. No capital required. All you do is to take the orders. We deliver by Parcel Post and do all collecting. Commission paid same day your orders are booked. Work full time or spare time. Easy to get orders on account of two coats for the price of one. Get started at once. Big season now on. Send for sample coat to wear and show.



**Thomas Mfg. Co.** R-2648, Dayton, Ohio

# MONARCH JUNIOR LATHES

"The Biggest Little Lathe Built"

**Accuracy and precision**—that's what you expect in lathe work and the only way to have the work done just as you want it is to do it yourself. The MONARCH Junior Lathe is made especially for small shops or home work-rooms. Inventors, experimenters, mechanics and auto repairmen find it to be just the tool they want, for it turns out any small work that other lathes will and does it with 1-1000 of an inch accuracy. The MONARCH Junior Lathe is small, compact, completely equipped and trouble-proof. **Write today for our Free Catalog.** MONARCH Lathes are built up to 30 inches swing.

Monarch Junior Lathe—9 inch swing—2½ ft. bed **\$225** Semi-quick change gear and bench legs  
**THE MONARCH MACHINE TOOL CO.**  
 400 Oak Street Sidney, Ohio

*This lathe is also made in a larger size, with 11 inches swing, at slightly higher price.*

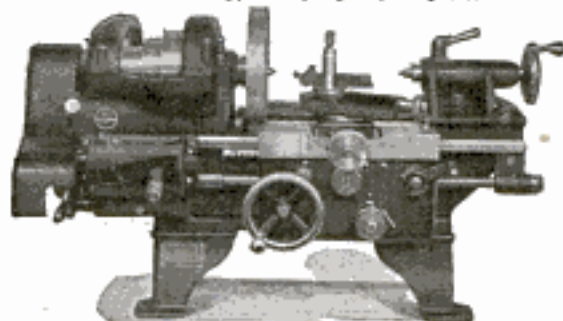

**The Midget "FIVE-IN-ONE" Slide Rule** is a combination Mannheim, Log-Log, Add and Subtract, Polyphase and Binary Slide Rule. It will instantly add, subtract, multiply and divide any combination involving whole numbers, fractions, decimals and mixed numbers. Gives every possible root and power of every quantity. The graduations are printed on metal, coated with white celluloid and are grooved and waterproof. While it is the most versatile calculator ever invented, its operation is simple and easily understood. Diameter 4 inches. Price with 16-page Instruction Book, \$1.50. Leatherette carrying case 50c extra. Catalog free. Your money back if you are not satisfied.  
**GILSON SLIDE RULE CO., Niles, Mich.**



Masterpieces! Master craftsmen make and fit Keen Kutter knife parts so exactly they seem grown together. The finished knives reflect this workmanship.

KEEN KUTTER

Simmons Hardware Company

## KEEN KUTTER

# BARGAIN OFFER

This 38 lb. ¼ h.p. **\$25.00**  
**Guaranteed**  
 f.o.b. Chicago  
**Grinder and Buffer**

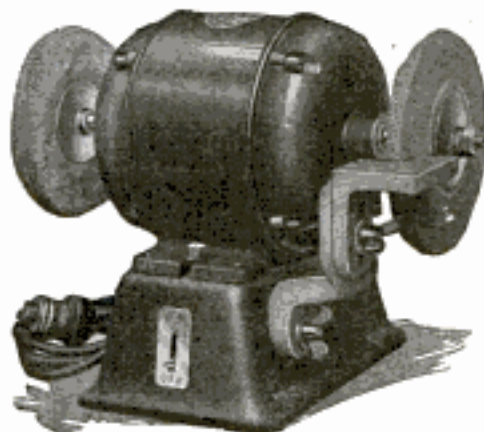

Thousands are now in use, giving un-failing satisfaction, in shops, garages, hotels and households. Keeps tools and cutlery sharp and silverware burnished.

Its 6 in. abrasive wheel and 7 in. buff do better work and are more convenient to operate than the small wheels usually found on tools of this class.

Motor is ¼ h.p. (tested for 50% overload) 110 volts, 60 cycle, split phase; A. C., totally enclosed and dust proof. Its speed of 1740 r.p.m. gives just the right periphery speed to the large wheels.

**A Guaranteed Service Tag**, wired to each motor, insures perpetual free consultation service—and a **new motor** in exchange for the old one should defects develop within 1 year of its purchase. You save **\$25.00** about 50% at our price.....

Wire wheel for tire repair work \$1.50 extra.

Motor alone, for running washing machines, ventilating fans, cream separators—all kinds of machines **\$13.50**

*Send cash with order. Our guarantee protects you fully*

## NORTHWESTERN ELECTRIC CO.

408 So. Hoyne Avenue  
 CHICAGO

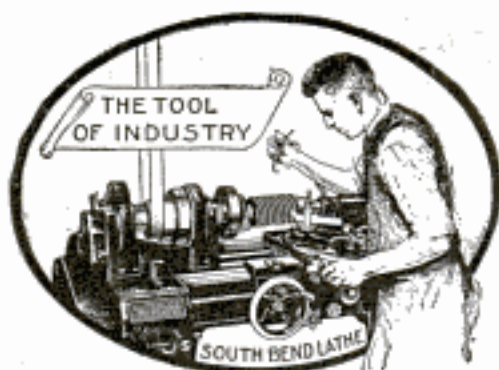

# REDUCED PRICES JUNE 1, 1922 SOUTH BEND LATHES

QUICK CHANGE GEAR

|                   |          |                    |          |
|-------------------|----------|--------------------|----------|
| 9'x3' Lathe.....  | \$189.00 | 16'x 8' Lathe..... | \$436.00 |
| 11'x4' Lathe..... | 233.00   | 18'x10' Lathe..... | 649.00   |
| 13'x5' Lathe..... | 301.00   | 21'x12' Lathe..... | 905.00   |
| 15'x6' Lathe..... | 367.00   | 24'x14' Lathe..... | 1218.00  |

64-page Catalog No. 76 for 1922 sent free to any address

ESTABLISHED 1906

**SOUTH BEND LATHE WORKS**

625 E. Madison St.

**SOUTH BEND, IND.**

**How to Run a Lathe:**—New 80-page book, Revised Edition No. 24, for 10 cents postpaid, silver or stamps.



**G**RIP! Clip! Snip! Job's done in a flash. Bernard's of course. Pliers with the bull-dog grip and the uncanny cutting power. Ask the hardware dealer.

MADE IN SEVEN SIZES

Send for illustrated Plier Booklet M



**BERNARD PLIERS**  
Wm. SCHOLLHORN CO.  
NEW HAVEN, CONN.



It is the well known quality of CRESCENT machines that justifies you in selecting one of these each time you have need for wood working machinery. The CRESCENT line is better than ever and will always give you satisfaction in every particular. Ask today for catalog of band saws, saw tables, jointers, shapers, planers, borers, planers and matchers, spring saws, disk grinder, cut off table, bottle chisel mortiser, variety wood worker, Universal wood workers.

THE CRESCENT MACHINE CO., 93 Columbia Street, Leontia, Ohio

## IT'S A METAL—



25c

**MOST WONDERFUL SOLDER EVER INVENTED** Per Tube

SOLDERS WIRES  
SOLDERS RADIO CONNECTIONS  
SOLDERS POTS & PANS  
SOLDERS ALL METALS

Put up in Paste Form in Collapsible Tube Ready for Instant Use.

Sold By All Up-to-Date Stores Or Sent By Us Post Paid

**SOLDERALL CO., Dept. P**

129 Sussex Avenue NEWARK, N. J.

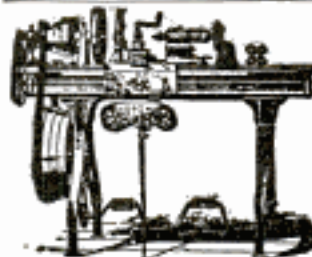

## LATHES

9 to 18-inch Swing

List price \$165 and up according to size. When ready to buy send for Lathe Catalog and prices.

**W. F. & John Barnes Co.**

100 Ruby Street, ROCKFORD, ILL.

Swing 4 in.; 11 in. between centers, 17 in. total length. Shipping weight 13 lbs. Bed of lathe is machined. Workmanship first-class. Equipped with wood turning chuck. Can be fitted with 3 in. face plate and drill chuck as special equipment. Order one today.

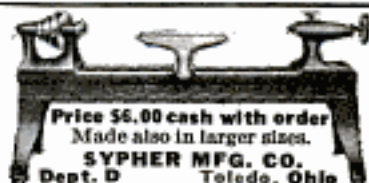

Price \$6.00 cash with order

Made also in larger sizes.

**SYPHER MFG. CO.**

Dept. D Toledo, Ohio



## TOOL CHESTS

For Machinists & Toolmakers

Every tool arranged in order. No up-to-date mechanic should be without one. A Gerstner Case costs no more than some tools, and will last a lifetime. Catalog free.

*Gerstner & Sons*

717 Columbia Street DAYTON, OHIO

## ONE-HAND-Y ELECTRIC DRILL

Price, \$32.40 Net  
Weight, 3 lbs.  
Capacity, 3/4"

For quick, accurate and easy drilling in wood or metal, the One-Hand-Y Electric Drill is unsurpassed.

It is a compact, serviceable electric drill for light work and saves time and labor.

Write direct to

**Knight Engineering & Sales Company**

30 W. Walton Place, Chicago

Westinghouse  
Universal Motor

210 W. Seventh Street, Los Angeles



# Selling Motors Below Cost

because of cancellations

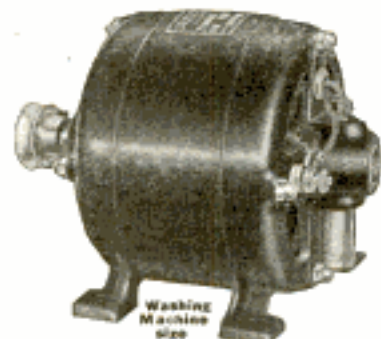

1/6 HP.  
\$10

Delivers full 1-6 H. P. with liberal overload capacity 1750 R. P. M. Alternating current 110 V. 60 Cy. (also for 25, 30, 40, 50 Cy., or 220 V. at \$1.00 extra.) Suitable for washing machine, ironer, dish washer, compressor, bench lathe, blower, fan, drill press, scroll saw or

any small machine around house, shop, garage.

### SOLD AT LESS THAN COST

Due to cancellation of several large contracts, we have on hand hundreds of the brand new motors which we are now offering at less than manufacturing cost in order to turn them into cash. Remember that these are "Reliable Reynolds Motors", known throughout the country for their lasting quality.

### GUARANTEED TO SATISFY

We absolutely guarantee these motors for one year. Free repairs or new motor if anything goes wrong within that time. Parts always obtainable. Rotating direction easily reversed. Attachment plug with 10 ft. cord, 50c. Pulleys, 1 1/2 inch or 2 inch, 50c.

Send cash or order C. O. D. by express.

**REYNOLDS**  
ELECTRIC COMPANY

2610 West Congress Street

CHICAGO, ILL.

## "Interlox" QUICK AND ACCURATE INSIDE MEASUREMENTS!

MASTER SLIDE RULE  
Exact Inside Measurement to Smallest Fraction of Inch

USE IT for all measuring—inside or out. The only interlocking, sliding rule. Ideal for Carpenters, Mechanics, Engineers, Electricians, etc. If not at dealer's, send his name and 20c per ft. for rule sent prepaid (any length, from 2 to 8 ft.).  
MASTER RULE MFG. CO., INC. (FORMERLY DAHL MFG. CO.)  
841-43 E. 136th St., NEW YORK CITY  
Dealers and Agents: Write for Liberal Proposition

## MYERS WONDERFUL SEWING AWL

Tools in Handle



A complete repair shop in itself. Sews anything heavy or light, leather, shoes, harness, buggy tops, canvas, belts, etc. \$1.00 Postpaid.  
C. A. MYERS COMPANY, 6339 Woodlawn Ave., Chicago, Ill.

## THE HANDIEST TOOL in the WORLD



Olson Manufacturing Company  
52 Commercial St., Worcester, Mass.

## BURN YOUR NAME ON TOOLS WITH ARKOGRAF

Protect your tools from theft. Write any name, engrave any design on metal with electricity like writing on paper with pen or pencil. Complete outfit \$3.50, prepaid anywhere. Interesting descriptive circular free. Write today. Agents Wanted. Arkograf Pen Company 1007 Yeon Building Portland, Oregon



"Red Devil" Rapid Boring Auger Bits are 33 1/4% easier boring, have 10% greater clearance, and bore with or against the grain of any wood. Style 2400—10/16 in., shown here, 75c.

## "Red Devil" Pliers

Multiply the Strength of Your Hand



THEY grip as your fingers can't possibly grip. No slipping, no bruised knuckles. They impart a giant's strength to your hand and wrist—they are your fingers of steel.

Red Devil  
REG. U.S. PAT. OFF.  
Plier No. 654

A serviceable forged steel tool for good work. With it you can repair many things yourself, that you would otherwise pay to have done. The long nose gets into hard-to-reach places. The cutting edges cut and stay sharp. Spring tempered handles have powerful leverage.

Try them out to your own satisfaction. At reliable dealers or from us, \$1.20 for a 6 inch size.

Mechanics' Tool Booklet Free

"Red Devil" Tools  
— American Made

SMITH & HEMENWAY CO., Inc.

Manufacturers of "Red Devil" Tools  
260 Broadway, New York, N. Y.

"Red Devil" Glass Cutters—the glaziers' standard tools of the world. "It's all in the wheel." Made in 40 styles. No. 024 shown here, 20c.



Please Mention Popular Mechanics

# FEDERAL

## BICYCLE TIRES



"My Dad Said Those Were the Best Tires on the Market, and he Knows, Because He Uses Federal on His Auto."

Federal Cord Bicycle Tires have the same wearing and service qualities which have made Federal Automobile Tires famous.

Six different styles to choose from, make it possible to match up with any tire now on your bike.

THE FEDERAL RUBBER CO.  
of Illinois  
Cudahy, Wisconsin

The "Big-Six"  
Quality Line

Cord  
Non-Skid

## FORD and CHEVROLET SPEED BODIES

Dealers:  
Write for Accessory Catalogue

MAKE DRIVING  
A PLEASURE



Equip your old Ford or Chevrolet Chassis with one of our new distinctively modern bodies. Up-to-date Roadster, Touring and Speedster designs. Ford bodies as low as \$29.50 and up. Territory open for live wire dealers and agents. Make real profits.

Buy Direct from Factory  
**FEDERAL MOTOR SUPPLY CO., Inc.**  
1424 S. Blue Island Ave. Chicago  
CANADIAN DISTRIBUTORS  
Federal Auto Body Co., Toronto, Ont.; Campbellton, N. B.



The Duncan will cure Two or Three times as many tires per day, as any other mould. Will cure Two 3 1/4" or Three 4" or Two 4 1/4" Tires at one time and will make as perfect a cure with sand bag pressure as with air bag.

## Earn \$600.00 a Month by Yourself with a DUNCAN Vulcanizing Plant

Includes every tool and vulcanizer for a high-grade repair business. Will handle the work of six men. Will cure either Cord or Fabric Tires in the same cavity, perfect to form and contour, without a reducing shell.

We teach you approved factory methods of tire repair, in your own home or in one of our many Schools FREE, when you purchase DUNCAN EQUIPMENT.

There is a big demand for high-grade shops and competent repairmen. We will start you in business for a small cash payment. Write today for all particulars of this really wonderful offer, and get started in this paying business for yourself.

**F. M. DUNCAN COMPANY**  
314-49 East Ohio Street, Department P., Chicago, U. S. A.

# CORDS

## @ 1/2 COST

### of FABRICS



First quality new cord tires fully backed by our ironclad guarantee for 10,000 miles.

| Tires      | Tubes  | Tires    | Tubes          |            |
|------------|--------|----------|----------------|------------|
| 30x3 87.25 | \$1.10 | 32x4 1/2 | \$19.10 \$1.75 |            |
| 30x3 1/4   | 8.95   | 1.30     | 34x4 1/2       | 20.75 1.80 |
| 32x3 1/2   | 11.50  | 1.35     | 35x4           | 21.75 1.90 |
| 32x4       | 12.75  | 1.40     | 36x4 1/2       | 24.20 2.00 |
| 32x4 1/4   | 13.95  | 1.45     | 33x5           | 26.50 2.15 |
| 33x4       | 14.55  | 1.50     | 35x5           | 27.50 2.25 |
| 34x4       | 15.95  | 1.60     | 37x5           | 29.00 2.50 |

Made in our factory of the best materials money can buy. These are rugged, sturdy Cords that run many miles over their guarantee.

**SEND NO MONEY.** Write and tell us the size of your tires and how many you want. Shipped C. O. D. Section unwrapped for your inspection.

**CHARLES TIRE CORP., DEPT. 756**  
2812 WABASH AVE., CHICAGO, ILL.

Guaranteed  
**10000**  
Miles

## MOTORCYCLE BARGAINS

Save 25% to 65%

on Slightly used and Rebuilt Motorcycles, Side Cars, Johnson Motor Wheels, Evans Power Cycles, Bicycles. Send for Free Bargain Bulletin and Money Saving Message, listing hundreds of bargains in used, rebuilt and new machines, supplies, accessories, etc.

AMERICAN MOTOR CYCLE CO.  
Dept. 1014 2047 W. Chicago Avenue, CHICAGO



## MOTORCYCLES

RELIABLE STANDARD MAKES that you can DEPEND on.

Enjoy the glorious experience of going wherever you like—whenever you like. The price is within your means—25% to 50% less than others. These machines are slightly used, thoroughly overhauled or rebuilt. Send for catalogue.

MYEROW BROS.,  
258 Columbus Ave., Boston, Mass.

**ENINGER WILL SAVE**  
**BIG MONEY SAVINGS FOR YOU**  
Used and rebuilt motorcycles, single and twin, \$20 to \$100. Used bicycles, \$5.00; tandem, \$10.00. All machines guaranteed in good working order. New bicycles and motorcycles at Factory prices. You save dealers' profits. Motorcycle and automobile tires too. \$2.50. Complete line of parts and supplies.  
Eninger Cycle Co., Rochester, N.Y.  
**YOU 25 TO 50 DOLLARS**

## RADIO & AUTO Storage BATTERIES CHARGED

FROM A LAMP SOCKET at Home For a Few Cents, With an

**\$15 F-F BATTERY BOOSTER**, which is a FULL WAVE

Magnetic Rectifier for 105-125 volt 60 cycle A.C. Leave Battery Just as it is in Your Car. Snap Charge Clips on Battery Terminals, Turn Switch, & Battery Will be Charged in the Morning. **AMMETER** Eliminates All GUESS WORK. A Complete Portable Automatic Charging Unit, with Infusible Carbon Rectifying Brushes, which Charge Completely. No Skill is Required. A Fully Charged Battery Starts Car & Truck Quick, thus fewer expensive Replacements. Storage Batteries must be bought, when Kept Fully Charged; So It Costs Less to Buy a Booster than to buy a new one. Do Not Think Your Battery is dead; and when not empty because it will not start Your Car, Buy a BOOSTER. Fill it with Life and Bear Engine Spin. F-F Anticorrosion Full Wave **BATTERY BOOSTERS SAVE YOU MONEY** and Last a Lifetime. **POPULAR PRICES:**

Type 6 charges "A" 6 volt Battery, at 6 amperes \$15  
Type 6 charges Radio "B" Batteries Up to 120 volt \$15  
Type A-B charges both "A & B" Radio Batteries \$29  
Type 12 charges 12 volt Battery at 5 amperes \$15  
Type 16 charges 6 volt Battery at 12 amperes \$24  
Type 1612 charges 12 volt Battery at 7 amperes \$24  
Type 1636 is a Combination of Types 1612 & 1636

Charges Auto & Radio Batteries  
The Largest Types are recommended for heavy Batteries, or where time is limited. Shipping Weights Complete with **AMMETER & BATTERY CLIPS** 11 to 15 pounds. Purchase from Your Dealer or Mail Check for Prompt Express Shipment. If for Parcel Post add Postage & Insurance Charges. Or **ORDER** us to forward **TYPE** desired **C.O.D.** For Dependable, Economical **GROUP CHARGING**, WRITE for **FREE** Descriptive 12 Battery, 3 Ampere **FULL WAVE**, Automatic **ROTARY RECTIFIER** Bulletin 24-A. **ORDER** Now or **WRITE** Immediately for **FREE** **BOOSTER** Bulletin 24. **THE FRANCE MFG. CO., CLEVELAND, OHIO, U. S. A.**  
Canadian Representative: Battery Service & Sales Co., Hamilton, Ontario, Canada

## Car Owners Wanted!!

To sell and introduce the World's Best Automobile Tires

Great Exclusive processes that enable us to guarantee these Wonderful Tires for 12,500 MILES AGAINST: RUT-WEAR RIM CUTS—STONE BRUISES and BLOWOUTS!

An Agent wanted in each community to introduce these wonderful Tires at amazingly low prices.

### FREE TIRES FOR YOUR OWN CAR!

Write for our Free Sensational Introductory Offer to one Agent in each locality.

Dept. 109

**INTERNATIONAL RUBBER CORP.**  
Grand Rapids, Michigan



**Auto Supplies**  
Knowing *HOW* to buy is merely knowing *WHERE*. This is Chicago's Great Wholesale House. **AUTO SUPPLIES AND MOTOR PARTS** WHOLESALE ONLY. Dealers send today for this big money-saving book.

**AKTELL AUTO ACCESSORIES COMPANY**  
397A South Michigan Avenue  
CHICAGO

## 12 Months to Pay

You can easily earn or save money for the small payments. Parents often advance first payment to help buy a **RANGER** bicycle. Choice of 44 styles, colors and sizes. **FACTORY-TO-RIDER** prices. **DELIVERED FREE** express prepaid on approval for **30 DAYS' TRIAL**, actual free riding test. Best quality, at factory prices, express prepaid. Lamps, wheels, and equipment, low prices. Send No Money.

**Mead Cycle Company**  
Dept. C18 Chicago

Write today for free Ranger Catalog, factory prices and marvelous easy payment terms.



## Use Insyde Tyres

Positively prevent punctures and blow-outs. Give double tire mileage, any tire—old or new. Use over and over again. Old worn-out casings will give three to five thousand miles more service. Car owners save \$50 a year. Over one hundred thousand satisfied customers. Low priced. Special representatives wanted.

**AMERICAN ACCESSORIES CO., B-1276, Cincinnati, Ohio**

## CUSTOM TAILOR MADE

To fit your individual car Made in our custom shops after your order is received. We ship ordinarily in 2 or 3 parcels days. Perfect fit guaranteed Post Paid when correct name, year and model of car is given. You can easily apply it yourself. We furnish instructions and all necessary tacks, welts and fasteners. Our catalog No. 10, with samples, is free for the asking.

**LIBERTY TOP & TIRE CO., Dept. E-7, Cincinnati, O.**

## FORDS RUN 34 MILES on Gallon of Gasoline

Wonderful new carburetor. Guaranteed to reduce gasoline bills from one-half to one-third and increase power of motors from 30 to 50%. Start easy in coldest weather.

**Sent on 30 DAYS' TRIAL** Fits any car. Attach yourself. Fords make as high as 34 miles to gallon. Other cars show proportionate saving. Send make of car and take advantage of our special 30-day trial offer. Agents Wanted.

**AIR FRICTION CARBURETOR CO.**  
3380 Madison Street Dayton, Ohio



## Miracle No. 6

Traveling salesman, using car every day, states he would not be without a can of Liquid

## RADIATOR NEVERLEAK

Several times when radiator started to leak he has completely stopped leak, without loss of time or costly repair bill, by pouring into radiator contents of 75c can of Radiator Neverleak. On one occasion this speedy repair enabled him to keep urgent appointment involving an order of several thousand dollars.

Be prepared! Carry a can of Radiator Neverleak for that inevitable leak. Guaranteed not to clog or impair cooling system.

At all dealers or sent postpaid for 75c.

## Buffalo Specialty Co.

The Liquid Veneer People  
357 Ellicott Street  
Buffalo, N. Y.



## LAUGH AT THE WEATHER

with

### "Wear Me" Windshield Wings

10" x 20" Beveled Plate Glass. Clamped not Bolted. Hardware Strong and Rustproof. No interference with Side Curtains. Fully Guaranteed.

**\$12.50 per set**

Ford Special \$10.00 per set

"The Kind You Have Been Waiting For"

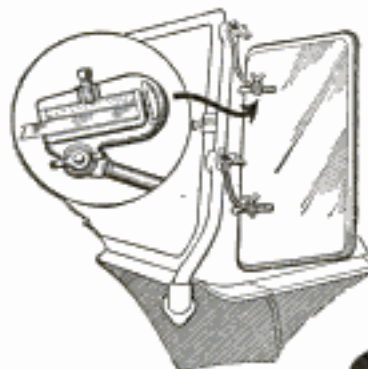

Order from your dealer or direct



## Ford Owners

Is your wiring system worth \$1.50?

It would cost many times \$1.50 to replace your wiring system if destroyed by a short circuit.

Prevent short circuits by installing a "Union" Fuse Block. Then, instead of wires burning, an inexpensive fuse will blow and tell where the trouble is, making repairs quick and easy.

Permits use of standard lamps for both bright and dim lights.

Sent postpaid for \$1.50 if not at your dealers. Money back if not satisfactory. Write for booklet.

**CHICAGO FUSE MFG. CO.**  
1503 W. 15th St., Chicago Eastern Branch: New York

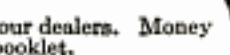
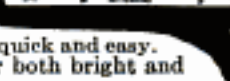
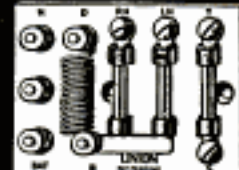

# Roofing Book FREE



**World's Best Roofing at Factory Price**

Don't buy Roofing of any kind until you get our big Free Roofing Book, describing full line of Edwards Famous "Tightcote" Galvanized Roofings, Sidings and Ceilings, and our lowest factory prices. Then see for yourself how much we save you by selling direct and saving you all in-between-dealers' profits.

## EDWARDS Metal Shingles

**Absolutely rust proof.** By our patented "Tightcote" process, edges as well as sides of metal sheets are heavily coated with zinc—not a space the size of a pin point exposed to weather. Fire and lightning proof. Outlasts three ordinary roofs. Forever wind and weather proof. Needs no repairs—end all roofing expense. Patent INTERLOCKING DEVICE makes water tight seams—all nail heads covered—no chance for rust or leaks.

**EDWARDS Galvanizing Test**  
Edwards "Tightcote" Galvanized Roofing can be bent, twisted or struck by lightning, and the galvanizing will not crack or flake. Bend it or hammer it—you can't loosen or scale the galvanizing. No other galvanized roofing can withstand this test.

**Low Priced Garages**



Wide variety of styles, all sizes of Portable Fireproof Metal Garages. Lowest prices ever made. Postal brings Big Garage Catalog free.

Write Today for free samples and proof that we can save you a lot of money on any kind of roofing siding or ceiling you may need. Ask for Roofing Book No. 160.

**THE EDWARDS MFG. CO.,**  
1000-1050 Pike St., Cincinnati, O.

**FREE Samples & Roofing Book**

## Jazz Style Suits

Now \$13.45 Express Prepaid



Get our fall and winter prices on suits, overcoats and pants. We tailor to your order. Perfect stylish fit guaranteed or money back. Good suits \$13.45—\$19.95 and \$24.95. Pants \$3.45—\$4.95, and \$5.85. Easy to take measures. Our chart shows how.

**AGENTS \$25.00 WEEK**

You can easily make \$10.00 to \$25.00 a week in your spare time. No experience needed. Thousands are doing it. Mail postal today for Fall and Winter cloth samples and full information about styles and prices—all free—Write today.

Chicago Tailors Assn., Dept. 127, Chicago, Ill.

## MAKE OVER \$800 MONTHLY

Owning and operating an Anderson Vulcanizing Station. We guarantee the Anderson as the best money-making vulcanizer made.

Write us for Terms and Prices.

**ANDERSON STEAM VULCANIZER CO.**  
Pop-Williams Building Indianapolis, Ind.  
An Anderson School is near you.



## SEND for the INTERNATIONAL CATALOG

Factory to Consumer direct—



Our net price list of auto bodies and body supplies at Wholesale Prices. Save big money by buying Direct from Factory

FOR FORD, CHEVROLET and DODGE.

PRICES FROM \$27.85 UP

International Body Works 914 W. Ohio Street, Chicago, Ill. Dept. 7

## AGENTS Wanted

# Big Money

to Active Agents

WRITE FOR DETAILS

**Converse Tire Co.**  
Malden (48) Mass.



## RAISE BELGIAN HARES

New Zealand Reds—Flemish Giants—American Blues.

**BIG PROFITS, WE PAY \$1.50 TO \$8 EACH.**

Also Cavies, Mink, Skunk, Fox, Muskrat, Etc. Easily raised anywhere. **FREE!** page Catalog and Contract. Illustrated book "COMMON SENSE RABBIT RAISING," quarterly journal, and copy of America's leading small stock magazine, all for 10 cents. Address Outdoor Enterprise Co., 1008 O. E. BLDG., KANSAS CITY, MO.



## World Batteries

FOR RADIO OR AUTOMOBILE

# SAVE YOU 50%

Buy direct from factory. Pay only one profit. Highest quality made.—lowest prices.

**WRITTEN TWO-YEAR GUARANTEE**

**AUTOMOBILE PRICES**

6 Volt, 11 Plate - \$12.50  
Ford, Chev., Mitch., Ilco., Grant, Elgin, Vette, Bazon.

6 Volt, 13 Plate - 14.50  
Overland, Buick, Reo, Paige, Hudson, Nash, Stude., and Dues.

12 Volt, 7 Plate - 18.00  
Maxwell, Dodge, Reo, Frank, Buick, and Crow-Kirkhart.

Give year and model of car.

We defy price competition, a glance at the prices below will convince you that the World Battery is the best buy on the market. Batteries shipped immediately. Express C. O. D. Begin now to get 100% battery service at half cost. Mail your order today.

**RADIO PRICES**

|                  |         |
|------------------|---------|
| 6 Volt, 40 Amps. | \$ 8.50 |
| 6 " 60 " "       | 10.00   |
| 6 " 80 " "       | 12.50   |
| 6 " 100 " "      | 14.50   |

**WORLD BATTERY CO.,** 1219 S. Wabash Ave., Dept. P., Chicago, Ill.



## Are YOU Old at 40?



A very common cause of early old age is the disturbed condition of an important gland. Even big strong men are not exempt from this serious irregularity. Our plainly written, interesting educational

## FREE BOOK

"Why Many Men Are Old at Forty" may bring a priceless message to you. It tells of a simple sensible way by which thousands have corrected this prostate gland condition. It tells how scatica, backaches, foot pains, interrupted sleep, mental depression, etc., are so often due to this gland. Sold for over five years upon a money back-if-not-satisfied plan. Do not confuse it with massage, medication, violet rays, etc. No obligation. Write today.

**The Electro Thermal Company** **Thermalaids**  
2114 Main St., Steubenville, Ohio





# PATENTS TRADE-MARKS AND COPYRIGHTS

## OUR OFFER—Free Opinion as to Patentable Nature

Before disclosing an invention, the inventor should write for our blank form "Record of Invention." This should be signed and witnessed and if returned to us together with model or sketch and description of the invention, we will give our opinion as to its patentable nature.

## Our Three Books Mailed FREE to Inventors

OUR ILLUSTRATED GUIDE BOOK

### HOW TO OBTAIN A PATENT

Contains full instructions regarding Patents, Trade-Marks, Foreign Patents, Our Methods, Terms, and 100 Mechanical Movements illustrated and described; Articles on Patent Practice and Procedure, and Law Points for inventors.

### OUR TRADE MARK BOOK

Shows the value and necessity of trade-mark protection and gives information regarding unfair competition.

### OUR FOREIGN PATENT BOOK

We have direct agencies in all the principal foreign countries and secure foreign patents in the shortest possible time and at the lowest cost. Write for our illustrated Guide Book on Foreign Patents, sent free to any address.

### LIST OF PATENT BUYERS SENT FREE

Containing unsolicited letters from manufacturers and others who are constantly writing us regarding the purchase or leasing of meritorious patents. We endeavor to assist our clients in the commercial development of their inventions.

### Specialization—Our Staff

The field of invention is so vast that it is impossible for any one man to become an expert in all the different classes of invention. For this reason Victor J. Evans & Co. employ a number of patent lawyers and mechanical experts who have been selected for their special knowledge and ability in certain lines of invention. Each case is placed in charge of experts in the classes to which the invention relates.

### THE VALUE OF YOUR PATENT

will depend much upon the skill and care with which your case is prepared and prosecuted in the United States Patent Office. That every case entrusted to us receives our best efforts, and that our work is done consistently, skillfully, and thoroughly is evidenced by the many unsolicited letters of commendation that we receive constantly from our clients. We will furnish upon request lists of clients from any State in the Union for whom we have secured patents.

### Our New York, Philadelphia, Pittsburgh, Chicago and San Francisco Offices

Owing to the growth of our business we have established for the benefit of our clients Branch Offices in New York City, Philadelphia, Pa., Pittsburgh, Pa., Chicago, Ill., and San Francisco, Cal. These branch offices being located in these large commercial cities together with our Main Office located near the U. S. Patent Office, in Washington, enables us to more promptly handle the business of our clients, particularly as the branch offices are in constant touch with the Main Office and fully equipped to handle patent business in all its branches.

**Highest References — Prompt Attention — Reasonable Terms**

—FREE COUPON—

## VICTOR J. EVANS & CO., Patent Attorneys

NEW YORK OFFICES  
1007 Woolworth Building

CHICAGO OFFICES  
1114 Tacoma Building

PHILADELPHIA OFFICES  
714-715 Liberty Bldg.

PITTSBURGH OFFICES  
514 Empire Building

SAN FRANCISCO OFFICES  
Hobart Building

MAIN OFFICES: 765 9<sup>TH</sup> STREET, N.W., WASHINGTON, D. C.  
Gentlemen: Please send me FREE OF CHARGE your books as described above.

Name .....

Address .....



# PATENTS

**I**F YOU HAVE AN INvention which you wish to patent you can write fully and freely to Munn & Co., for advice in regard to the best way of obtaining protection. Please send sketches or a model of your invention and a description of the device, explaining its operation.

All communications are strictly confidential. Our vast practice, extending over a period of seventy-seven years, enables us in many cases to advise in regard to patentability without any expense to the client. Our Hand-Book on Patents is sent free on request. This explains our methods, terms, etc., in regard to **Patents, Trade Marks, Foreign Patents, etc.**

## If you are a reader of the SCIENTIFIC AMERICAN

you are probably aware of the fact that it has a special appeal to the inventor. Each issue contains a description of a large number of recently patented inventions. Pending patent legislation as well as the most recent rulings of the Patent Office and the courts are considered in its columns.

## MUNN & CO.

SOLICITORS OF PATENTS

672 Woolworth Bldg., NEW YORK  
Scientific American Bldg., WASHINGTON, D. C.  
801 A Tower Bldg., - - CHICAGO, ILL.  
611 Hanna Bldg., - CLEVELAND, OHIO  
582 Market St. SAN FRANCISCO, CALIF.

Please Mention Popular Mechanics



## PATENTS

Send us sketch or model for patentability opinion and exact cost of patent. Our book "How to Obtain a Patent," Sent Free on request. It tells how to apply for Patents, Trade Marks, Foreign Patents, Copyrights, etc.; gives information on Patent Procedure; tells what every inventor should know. Thousands of Inventors, who are our clients, are our references.  
**Chandlee & Chandlee, 25 Years Experience.**  
435 7th St. Washington, D. C.

## PATENTS

**C. L. PARKER**  
Formerly Member Examining  
Corps, U. S. Patent Office  
**PATENT LAWYER**  
MCGILL BLDG.  
WASHINGTON, D. C.

Patents, Trade Marks, Copyrights, Patent Litigation

Handbook for Inventors, "Protecting, Exploiting and Selling Inventions," sent free upon request.



## PATENTS and TRADE-MARKS

As one of the oldest patent firms in America, and representing a clientele extending to all parts of the country, we afford Inventors and Manufacturers, at lowest consistent charges, a service noted for efficiency and results evidenced by many well-known Patents and Trade Marks of extraordinary value  
**Lacey & Lacey, 646 F St., Washington, D.C.**

ESTABLISHED 1869  
Our book Patent Sense - Free

## PATENTS

TRADE-MARKS

COPYRIGHTS

Send for our free book of patent information.

**Beale & Park** 802 F St., Washington, D. C.  
16 S. Broad St., Philadelphia, Pa.

## PATENTS Secured

Prompt service. Avoid dangerous delays. Send for our "Record of Invention" form and Free Book telling How to Obtain a Patent. Send sketch or model for examination. Preliminary advice without charge. Highest references. Write TODAY. **J. L. Jackson & Co., 327 Ouray Bldg., Washington, D. C.**



## GEARS ALL KINDS SMALL

The most accurate made and prices reasonable. We carry a complete line of gears in stock for immediate shipment. Can also quote on special gears of all kinds. Send us your inquiries.  
WRITE FOR CATALOGUE.

**CHICAGO STOCK GEAR WORKS**  
105-109 S. Jefferson St., CHICAGO

## TOBACCO

### Habit Cured or No Pay

Any form, cigars, cigarettes, pipe, chewing or snuff Guaranteed. Harmless. Complete treatment sent on trial. Costs \$1.00 if it cures. Nothing if it fails.  
**SUPERBA CO., E-41 BALTIMORE, MD.**

## HAWAIIAN IM. DIAMONDS



The Greatest Discovery the World Has Ever Known. Just to advertise these famous 14K diamonds we will send you one of these 14K gold 1. rings, postage paid. When it arrives pay postman \$2.98 C.O.D. charges to cover cost etc. Only 10,000 rings given away. Money refunded if you can tell it from a genuine diamond. Send size of finger.  
**KRAUTH & REED**



No. 2010 Special price \$2.98

Dept. C Masonic Temple Chicago

No. 2011 Special price \$2.98

# PATENTS

Booklet Free

Highest References

Promptness Assured

Best Results

Send drawing or model for preliminary examination

**ALL BUSINESS GIVEN PROMPT AND PROPER ATTENTION**

**WATSON E. COLEMAN, Patent Lawyer, 624 F St., Washington, D. C.**

## PATENTS

### To the Man with an Idea

I offer a comprehensive, experienced, efficient service for his prompt, legal protection and the development of his proposition.

Send sketch, or model and description, for advice as to cost, search through prior United States patents, etc. Preliminary advice gladly furnished without charge.

My experience and familiarity with various arts frequently enable me to accurately advise clients as to probable patentability before they go to any expense.

*Booklet of valuable information and form for properly disclosing your idea free on request. Write today.*

**Richard B. Owen, Patent Lawyer**

9-303 Owen Building, Washington, D.C.  
2276-E Woolworth Bldg., New York City

### Can You

think of a simple, practical idea that will fill one of the many requests we have on file for new inventions? It may mean a fortune for you. Thousands of things are needed **right now**. Your brains can help. Send today for our great new book—

**"Inventions and Trade-Marks, Their Protection and Exploitation"** and learn more about making money from ideas than you ever knew before. It tells many things that are wanted, too.

**A postal will do—  
It is free**

### We Help Our Clients

without charge, to get the dollars out of their ideas—having facilities none others possess. Advice free. Don't delay—get the book at once.

**American Industries, Inc.**  
200 Patent Dept.  
WASHINGTON, D. C.

### Patents Advertised For Sale Free

*in Invention and Manufacturing Supplement*

Published for the man with an idea. Send for free sample copy. One year's subscription, 50c.

## PATENTS If You Have an Invention and Desire to Learn How to Secure a Patent

Send for our Guide Book, **HOW TO GET A PATENT**, sent Free on request. Tells our terms, methods, etc. Send model or sketch and description of your invention and we will give our opinion as to its patentable nature.

**RANDOLPH & CO.**  
600 F St., N.W., Washington, D. C.

NAME.....

STREET.....

CITY.....STATE.....

## PATENTS PROMPTLY PROCURED TRADEMARKS REGISTERED

Send disclosure of invention, design, or trademark for actual search of U. S. Patents and novelty report. Validity and infringement investigations. Patent and trademark suits prosecuted and defended anywhere in the United States. Discriminating clients appreciate my efficient service. No literature will be sent you as this is a professional service, *individual* and *Personal*. Specific information and advice given regarding each individual case. Specialize in prosecution of pending cases that have been previously rejected by the Patent Office. Specialize also in unfair competition litigation before the Federal Trade Commission.

**George P. Kimmel, Master of Patent Law**  
53-M Loan & Trust Bldg., Washington, D. C.

## U.S. PATENTS



### DON'T LOSE YOUR RIGHTS TO PATENT PROTECTION

Before disclosing your invention to anyone send for blank form "EVIDENCE OF CONCEPTION" to be signed and witnessed. A sample form together with printed instructions will show you just how to work up your evidence and establish the same before filing application for patent. As registered patent attorneys we represent hundreds of inventors all over the United States and Canada in the advancement of inventions. Our schedule of fees will be found reasonable. The form "Evidence of Conception," sample, instructions relating to obtaining of patents and schedule of fees sent upon request. Ask for these—a post card will do.

PATENTS AND TRADE MARKS



204 Ouray Bldg. Washington, D. C.  
Originators of forms "Evidence of Conception."

**INVENTORS AIDED.** Ideas developed. Experimental Machinery Built. Individual Service.  
**RICHARDSON & ROGERS, 7 ALBEE, WASHINGTON**  
Practice in all Courts.  
**TRADE-MARKS.** We seek the valid **PATENTS**

**Pepsodent** PAT. OFF.  
REG. U.S.  
The New-Day Dentifrice

## PATENTS

Protect your rights. Before disclosing invention write for booklet and blank form **EVIDENCE OF CONCEPTION** to be signed, witnessed and returned with rough sketch or model of your idea, upon receipt of which I will promptly give opinion of patentable nature and instructions. **NO CHARGE** for preliminary advice. Highest references. Prompt, personal attention.

### CLARENCE O'BRIEN

Registered Patent Lawyer  
798 Southern Building Washington, D. C.

## Copper Steam Boiler

Latest improved Solid Copper High Pressure Steam Cooker—Complete and Perfect in every detail. Cannot explode. Absolutely steam tight. Note the safety features, steam gauge, safety valve and special  $\frac{1}{4}$  inch steam outlet valve. Made of absolutely purest heavy copper throughout. No solder inside. Can screw large enough for hand—easily cleaned. Has a thousand uses. You pay no more for this heavy solid copper pressure boiler than for those made of cheap metals.

### World's Lowest Prices

|              |         |              |         |
|--------------|---------|--------------|---------|
| 2 gal. ....  | \$ 7.50 | 10 gal. .... | \$17.50 |
| 4 gal. ....  | 10.00   | 15 gal. .... | 20.00   |
| 6 gal. ....  | 12.50   | 20 gal. .... | 25.00   |
| 8 gal. ....  | 15.00   | 30 gal. .... | 35.00   |
| 50 gal. .... | \$50.00 |              |         |

### Send Only \$1

Order any size boiler at the price shown. Just tell us the size you want. Enclose \$1. The Boiler will be shipped at once without red tape or delay. Pay the balance when Boiler is delivered. Also made in wash-boiler shapes—12, 15, 20, 25, 35 gallon sizes. Price \$1 per gallon.

General Products Co.  
Dept. 436  
1333 W. Fulton St., Chicago



# \$375.75 ONE DAY WITH THIS MACHINE



Profitable—cash pours in—Crisp-ettes delicious—people can't get enough—come again and again for more!

NOW is the time of opportunity! Good times coming back. Conditions growing better. Make and sell Crisp-ettes with this machine. Chances for quick success bright. **It's the business for you.** Gibbs reports: \$50 profit first night. Ira Shook, of Flint, took in \$375.75 in one day. Kellogg \$700 ahead after two weeks. \$1,000 month easily possible. **You will make money from very start.** You won't be scrambling for a job. Won't have to take reduced wages. You will have made your place. Will be on the road to fortune. Demand for Crispettes enormous. A delicious confection. Nothing like it. Amazing profits. Little capital required. Experience unnecessary. Send post card for illustrated booklet. Contains enthusiastic letters from successful men. Shows their places of business. Tells how to start. How to succeed, and all information needed. It's free. Write now.

**LONG EAKINS COMPANY**

1021 High Street

Springfield, Ohio



## MOTORCYCLES ONE YEAR TO PAY

Know the joy of owning—for business or pleasure—HARLEY-DAVIDSON, EXCELSIOR, HENDERSON, INDIAN, CLEVELAND, or any other standard make; thoroughly rebuilt in our own factory.

Write for Free Bulletin, Bulletin and Easy Payment Plan  
**HAVERTON CYCLE COMPANY**

America's Largest Cycle House  
Established 26 Years  
503 Market St., Philadelphia, Pa. Dep. P. M.

## The Versatile HAMMOND Folding Portable Typewriter

**MULTIPLEX HAMMOND'S**  
Instantly changeable type  
Many styles, many languages  
Just Turn the knob to change

Hammond Typewriter Corp., 569A East 69th Street  
New York City, N. Y., U. S. A.



STERLING razors are hand forged from special cutlery steel, hollow ground, tempered and finished by experts. Thousands used by barbers and self shavers. We will send you a STERLING on 30 days trial. If satisfactory, costs \$1.87. If not, costs nothing. Barber's double edge horseshoe strop FREE with each razor. Write today. Sterling Company, Dept. 300 Baltimore, Md.

"Will say I am highly pleased; find it does the work of \$100 machines. Have had several friends to see it; they were surprised that I got such a good machine for the money."

**AMAZING VALUE**

"I had an opportunity to investigate the other makes of typewriters and have come to the conclusion there is more real value in your machine at the price."

"I am well pleased with the typewriter and my friends have expressed surprise that a machine of such value could be turned out for the price. My son at the State Normal School says it is the smoothest running machine he ever tried and in many respects superior."

"Am pleased with typewriter; will take another five machines."

**Brand-New: From Factory To You.**



## BIG SAVING — FREE TRIAL

This beautiful machine is the only brand-new (unused), standard, full-size typewriter with a 4-row, 42-key, 84-character Universal keyboard that you can buy for less than \$100. It comes direct from factory to you at practically the wholesale price of other high-grade typewriters—a remarkable saving. Use Annell on your work at our expense, put it to the test for ten days; then if it doesn't satisfy you in every way, return it to us and we will refund even the express charges. You take no risk. Could anything be fairer?

### Easy Terms

While you are using the machine, small monthly payments scattered over a period of more than a year make it easy and convenient to own this full-size, brand-new (unused), 4-row, standard-keyboard typewriter.

### Mechanical Marvel

Strength and simplicity are the outstanding qualities of this machine. It embodies the ideas and experience of mechanical geniuses who have been making typewriters for generations. Every essential operating convenience is possessed by Annell, including the 4-row, 42-key, 84-character Universal standard keyboard. It will last a business lifetime and is fully covered by an ironclad guarantee.

### Send Coupon Today

for complete information about the greatest of all typewriter offers. Don't miss it. Act now.



NOT AN ORDER — MAIL TODAY

**ANNELL TYPEWRITER CO.**  
690 No. 230 East Ohio Street, Chicago.  
Send me free catalog and complete information about your wonderful typewriter offer; this places me under no obligation.

# ATKINS

SILVER STEEL SAWS

Improved  
Universal  
No. 93



Three  
Saws in  
One

## Does ALL Sawing Better and Easier

At last the saw of saws—no tool kit is complete without ATKINS No. 93.

Every man who uses a saw should be interested in this wonderful new saw from the great ATKINS factory.

The new ATKINS Universal No. 93 is *all* saws in one. Note the tooth edge with three styles of teeth—designed by Atkins experts for cross cutting, ripping, or mitering. And remember it's made of "Silver Steel" and taper ground—exclusive Atkins features, backed by the Atkins guarantee that it will cut faster and easier and hold its edge longer.

Before you buy any saw—find out about Atkins No. 93—the new saw made for YOU. Ask us for a description and name of a dealer who can supply you.

## "SAW SENSE" Sent You FREE

This useful book shows and describes the best saw for every cutting use, tells you how to buy and care for saws, gives interesting facts on building. Sent you FREE on request or just write your name and address on the margin of this page and mail it to—

**E. C. Atkins & Co., Inc.**  
Dept. P, Indianapolis, Ind.

Makers of "Silver Steel" Saws and Tools. Handled by Leading Hardware Dealers and Jobbers, Mill Supply Houses and Factory Branches all over the World.



## Their Spring Stretch Never Dies

That's Why

*Nu-Way*  
STRECH

Rubberless

Suspenders, Garters and Hose Supporters give easy comfort and long wear.

No rubber to rot; Phosphor Bronze Rustless Springs give lots of stretch. Suspenders have easy slip-loop back. Nickel trim, 50c; satin brass trim, 75c.

Men's Wide Web Garters—no metal can touch the leg—50c.

Ladies' and Misses' Hose Supporters and Corset Sew-Ons. Lasting stretch and no troublesome garter runs—25c.



A Year's  
Wear  
Guaranteed

Children's Hose Supporter Harness. Easy on stockings and give long wear. Only 50c.

Ask Your Dealer

If he hasn't them, send direct, giving dealer's name. Insist on Nu-Ways. Accept no substitute. Guarantee label on every pair. Ask for story of Nu-Way Stretch.

**Nu-Way Stretch** Dept. D, 410  
Suspenders Co. Adrian, Michigan



## Build Your Own PHONOGRAPH

### IT'S EASY WITH OUR HELP

A few hours' interesting work saves over half and gives you a machine to suit your ideas. We furnish motors, tone arms, case material, blue prints and full instructions. Plays any record. Make fine profit building phonographs for your friends.

Write today for our **FREE**

Blue print offer.

**AGENTS** wanted for Choraleon Phonographs.

**CHORALEON PHONOGRAPH CO.**  
1022 1st St., Elkhart, Ind.



SAVE  
OVER  
HALF

## MADE TO YOUR ORDER \$1.95

**Pants**



NO EXTRA  
CHARGES

Postage  
Prepaid

Send no money offer for 30 days, to prove the wonderful

value, style and fit of **Progress Tailoring**. We will tailor to your special order, a pair of these stylish, \$6.00 pants—guaranteed to wear like iron—and send them to you postage prepaid for only **\$1.95**. Send no money or measurements until you receive our samples.

**Write for Samples Today.** Our big free sample outfit will be sent you the same day your request is received.

**AGENTS WANTED—** Earn \$30 to \$35 extra every week, taking orders from your friends and neighbors for our high-class tailoring. No experience necessary. Suits at \$12.45 up and pants at \$1.95 up make orders come easy. Full details will be sent free. Write now.

The Progress Tailoring Co., Dept. X 145, Chicago, Ill.

**1/2 SAVED**  
BUY  
DIRECT  
GET BIG BOOK



## DO YOUR OWN PLUMBING & HEATING AT LOW COST

Send for our big instructive 256-page well-bound **HANDY-MAN Book-Catalog**. Every home-owner, contractor, farmer, mechanic, institution, etc., needs it. Shows over 10,000 fixtures and supplies in plumbing and heating at wholesale; how to save skilled labor, hard work and unnecessary material by our new



Pipeless Furnace

### Cut-To-Fit Method

This wonderful encyclopedia on plumbing and heating helps you select and install the proper plumbing, water system, hot air, water or steam plant. Besides being our wholesale catalog, it has many practical plans, diagrams, sketches, elevations, handy links, etc., showing how to do the work this newer easy way. Any handy man with a few tools can do his own installing with the aid of this

### Big Handy Man Book

We have spared no effort, and have gone to a **GREAT EXPENSE** to compile this valuable book, and to keep from sending it to uninterested persons, we request 25c, which will be refunded on your first order, or send for our free bulletin.

Write today and save.

### HARDIN-LAVIN CO.

50 Years at 4547-4557 Cottage Grove Avenue, CHICAGO

\$500,000 Plants Behind Our Guarantee



Hot Water Boiler

## Make Your Bike a MOTORCYCLE

Make your "foot-power" bike a dependable, easy-running, light-weight motorcycle at small cost. You can do it yourself with the

### SHAW MOTOR ATTACHMENT

Compact. Easy to attach. No special tools required. Battery or magneto. Thousands in use. Write at once for free book, prices, terms; also about Shaw Motorbicycle.

Write for  
**FREE  
Book**

**SHAW MFG. CO.**  
Dept. 375  
Galesburg, Kans.



95 to 125  
Miles per  
gallon!

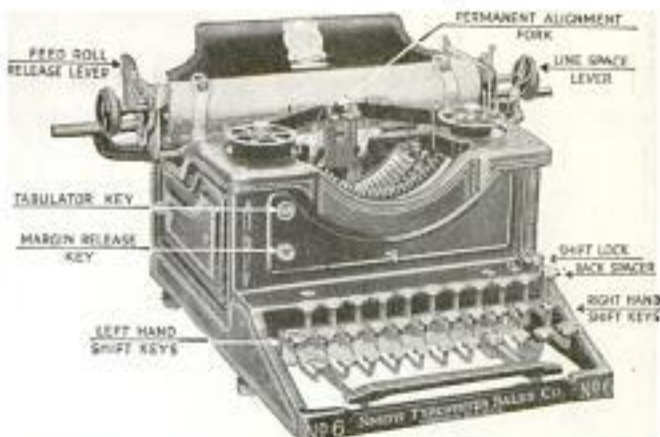

## TYPEWRITER SENSATION!

Free Trial—Use as You Pay

Send us only \$4.00 a month until the low total price of \$48.85 is paid, and the machine is yours.

This is absolutely the most generous typewriter offer ever made. Do not rent a machine when you can pay \$4.00 a month and own one. Cash price \$44.00, just a little less than half its original price.

### (STANDARD VISIBLE) SMITH Model No. 6

Perfect machines, Standard size, Keyboard of Universal arrangement, writing 84 characters. The entire line of writing completely visible at all times, has the tabulator, the two-color ribbon, the back spacer. In fact every late style feature and modern operating convenience. Comes to you with everything complete; tools, cover, operating book and instructions—nothing extra to buy. **You cannot imagine the perfection of this beautiful reconstructed typewriter until you have seen it.** We have sold thousands of these perfect late style machines and every one of these thousands of satisfied customers had this beautiful, strictly up-to-date machine on five days' free trial before deciding to buy it. We will send it to you F. O. B. Chicago for five days' free trial. It will sell itself, but if you are not satisfied that this is the greatest typewriter you ever saw, you can return it at our expense. You won't want to return it after you try it, for you cannot equal this wonderful value anywhere.

**SEND NO MONEY Put In Your Order Now**

**\$4.85 AFTER TRIAL**

When the typewriter arrives deposit with the express agent \$4.85 and take the machine for five days' trial. If you are convinced that it is the best typewriter you ever saw keep it and send us \$4.00 a month until our bargain price of \$48.85 is paid. If you don't want it, return it to the express agent, receive your \$4.85 and return the machine. We will pay the return express charges. This machine is guaranteed just as if you paid \$100.00 for it. It is standard. These typewriters are samples the manufacturer had at their branch offices throughout United States and have never been used except for demonstration purpose. Just like new but at extremely low price. **The supply at this price is limited, the price will probably be raised when next advertisement appears, so don't delay. Fill in the coupon to-day—the typewriter will be shipped promptly.** There is no red tape. We employ no solicitors—no collectors—no chattel mortgage. It is simply understood that we retain title to the machine until full \$48.85 is paid. You cannot lose. It is the greatest typewriter opportunity you will ever have. **Do not send us one cent. Get the coupon in the mails to-day—sure.**

SMITH TYPEWRITER SALES CO., 288, 218 N. Wells St., Chicago, Ill.

SMITH TYPEWRITER SALES CO., 288, 218 N. Wells St., Chicago, Ill. Ship me the Standard Visible Smith Model No. 6, F. O. B. Chicago, as described in this advertisement. I will pay you \$4.00 monthly as rent until the \$44.00 balance of the Special \$48.85 sale price is paid. The title to remain in you until fully paid for. It is understood that I have five days in which to examine and try the typewriter. If I choose not to keep it I will carefully repack it and return it to the express agent. It is understood that you give the standard guarantee.

Name .....

Street Address .....

City ..... State .....

Occupation or Business .....

# Make Your Own Gas for Heating and Cooking Instant-Gas



Cheaper than coal or wood, cleaner, no work, no dirt, no ashes, soot or smoke. No building of fires, no wood boxes or coal buckets. No shortage of fuel, no high prices and no strikes to worry about. No slaving with hatchets, axes and shovels. No dirt and ashes to make work for you.

## MAKES GAS IN ANY STOVE

Don't worry with dampers, flues and pokers. Don't interrupt yourself a hundred times a day just to keep the fires going. Don't be satisfied with a heat that is never what you want it. Use **INSTANT-GAS**

### TURN ON THE HEAT AND FORGET IT

Have as much or as little heat as you need, twice as much as coal or wood if necessary. Instant-Gas is started, stopped and regulated with a simple valve. Better cooking and baking because you can have the heat you want. Better heating because it can be controlled. No ups and downs to ruin your cooking and give the family colds. Less work because all you have to do is to keep the reservoir supplied with kerosene.

### WHY BURDEN YOURSELF

with coal or wood fires when Instant-Gas is just as economical and saves all the work? Can be put in any heating or cooking stove in a few minutes at a cost of only a few dollars. No drilling, cutting or other damage to the stove. Gas is made from coal

## Agents

Our free literature tells how others are making and how you can make tremendous profits as agent for the Instant-Gas. Men and women—part time or all time. Write today for agency and sample.

oil or kerosene automatically. All you have to do is to start it—a mere matter of turning a valve, applying a match and then regulating the blaze to the proper heat. From then on you are FREE. The fire will take care of itself. Already giving satisfaction in thousands of homes.

### THIRTY DAYS' TRIAL AT OUR RISK

You can try this wonderful burner in your own home without any risk whatever. We are anxious to prove to you at our own risk what a great time, trouble, labor and money saver it is. Write today for our thirty-day trial offer and special low price.

**INTERNATIONAL HEATING CO.**  
4553 North Broadway ST. LOUIS, MO.



## Have You SEEN SELFLO

the Alcohol Torch that **BLOWS ITSELF**  
In 20 Seconds after Lighting gives  
1,400° F. flame.

Hot enough to run any solder. No pumping, no priming. No blowing a rubber tube. Invaluable for many purposes besides soldering.

Price - \$2.00  
In Canada, \$2.50

If your dealer does not carry SELFLO, send us his name and cash or money order, and we will send you one by parcel post prepaid.

**HUNT-LASHER CO., Inc.**  
70-72 Willow St., Lynn, Mass.

Trademark goods are your protection. Ask for SELFLO by name and be sure you get it.



## Agents Over 200% Profit

Selling a big, complete line of high grade soaps and perfumes for an old established firm. Every housewife a prospect. Make big money. Fair prices. Territory open everywhere. Write today for catalog and a real proposition.

National Soap & Perfume Co.,  
20 E. Lake St., Dept. 2, Chicago

## PHONOGRAPH OWNERS: GOOD NEWS!

No More Changing Needles! No More Scratched and Raised Records!  
The Everplay Needle cannot injure your records like the steel needles. The playing point consists of a fine, soft, special alloy wire 9 inches long, coiled within the needle. It is extended as used by a turn of the little star head, each adjustment playing thirty to forty records. It exactly fits the record groove at all times, bringing out every note and vibration without the surface noise and scratch. Cleans and polishes the groove; saves \$25 to \$40 in steel needles and much more in wear of records. Can be adjusted loud or soft. Will last a lifetime. Guaranteed to play 27,000 records and the last as perfectly as the first. Adds to the appearance of your phonograph, and fits all reproducers just like an ordinary needle. Price \$1.00—10c extra if C. O. D. Money back if not satisfied. Agents wanted everywhere

**EVERPLAY** Needle Co., Desk 107  
McCleary Building, Chicago, Ill.

## Great Diamond Ring Bargain

Perfectly cut, genuine blue-white Diamond held aloft on six white gold prongs. Gentleman's 14K Green Gold, hand-carved mounting, trimmed with artistic scroll designs of White Gold.

\$ **5**<sup>00</sup>  
A Month

**Send No Money**—Ring sent FREE for your approval. If entirely satisfied pay only \$10, then \$5 a month, for ten months until the total price of \$60 has been paid.

**Free Gift Book** shows thousands of other bargains in Diamonds, Watches and Jewelry. Send for copy No. 532-R.



Buy Today 10 Months TO PAY

"THE HOUSE OF QUALITY"  
**L.W. SWEET INC.**  
1650-1660 BROADWAY, NEW YORK



## The COAL Shortage Is Your Opportunity



**PUT  
YOURSELF  
OVER**

## With the CROWN Fuel Saver

This timely utility meets the need for a sure method of fuel-saving in present coal shortage. Get on a solid financial footing. Become distributor for CROWN Fuel Saver. Establish a **big-profit**, permanent business.

The CROWN sells readily because it saves at least **1/5 the fuel**. Distributors thoroughly trained without cost, and backed by business-getting advertising in local paper.

Write or wire for exclusive distributor proposition. Profits are big and generous to workers with sales ability.

CFSCO, 15 N. 10th St.

Richmond, Indiana

## TYPEWRITERS

**UNUSUAL OFFER** Your choice of **SAVE 1/2 OR MORE**  
 REMINGTONS, ROYALS, or any standard  
 made typewriter rebuilt in our own factory. Every  
 one guaranteed as good as new. Lowest cash  
 prices possible. Easy terms if desired. Write for  
 our FREE circular, learn about our plan on how  
 to buy at a GREAT SAVING.  
 RELIABLE TYPEWRITER CO., Dept. 14, Chicago, Ill.

## HE MADE \$125 LAST WEEK!



This is his first selling experience, yet R. S. Burgeson made \$125 last week with our Special Permanent Income Sales Plan. You, too, can make splendid, steady profits. Our nationally advertised leader is without competition. Complete line of soaps and cleaners sell on sight—repeat quickly—80% to 90% profit to you. Write today for Free Sample and Details of this New Opportunity.

THE PIONEER SOAP CO., 35 St. Paul Ave., Dayton, Ohio

## "I Would Not Part With It For \$10,000"

So writes an enthusiastic, grateful customer. In like manner testify over 100,000 people who have worn it. Conserve your body and life first.

## The Natural Body Brace

Overcomes WEAKNESS and ORGANIC AILMENTS of WOMEN and MEN. Develops an erect, and graceful figure. Brings restful relief, comfort, energy and pep, ability to do things, health and strength. Does away with the strain and pain of standing and walking; replaces and supports misplaced internal organs; reduces enlarged abdomen; straightens and strengthens the back; corrects stooping shoulders; develops lungs, chest and bust; relieves backache, curvatures, nervousness, ruptures, constipation, after effects of Flu. Comfortable and easy to wear.

### Costs You Nothing to Try It

Write today for illustrated book, free, with full information and measurement blank. Address

HOWARD C. RASH, Pres. Natural Body Brace Co.  
223 Rash Building SALINA, KANSAS



For  
Children  
Also



When "Wally" Reid Plays  
He Plays a

# BUESCHER

## True Tone Saxophone

You, too, should play a True-Tone Saxophone. It increases your popularity and your opportunities, as well as your pleasure.

Nothing can take the place of a Saxophone for home entertainment, church, lodge or school. In big demand for orchestra dance music.

A True-Tone Saxophone is the easiest of all wind instruments to play and one of the most beautiful. Three first lessons sent free. You can learn the scale in an hour's practice and play popular music in a few weeks. Practice is a pleasure because you learn so quickly. You can take your place in a band within 90 days, if you so desire.

## Free Trial--Easy Payments

You may order any Buescher Saxophone, Cornet, Trumpet or Trombone or other Band or Orchestral Instrument without paying in advance, and try it six days in your own home without obligation. If perfectly satisfied, pay for it on easy payments to suit your convenience. Mention the instrument interested in and a complete catalog will be mailed free.

## Free Saxophone Book

Tells what each Saxophone is best adapted for; when to use singly, in quartets, sextettes, octettes, or in regular band or full Saxophone Band and how to play from cello parts in orchestra. Send for free copy.

## BUESCHER BAND INSTRUMENT CO.

Makers of Everything in Band and Orchestral Instruments

2560 Buescher Block

ELKHART, IND.

Buescher Band Instrument Co.  
2560 Buescher Block, Elkhart, Ind.

Gentlemen: I am interested in the instrument checked below:

..... Saxophone..... Cornet..... Trombone..... Trumpet  
(Mention any other instrument interested in)

Name.....

Street Address.....

Town..... State.....

*You can now wear and own a really fine strand of genuine French Priscilla PEARLS*

**for only \$1.00 DOWN**



Here's an opportunity to wear for only \$1, a beautiful strand of pearls which sells in our own retail stores for \$20. Our liberal plan makes it possible for you to easily possess them.

Thousands of women have often wished they could afford beautiful pearls like these and here is your opportunity to get them on terms to fit your pocket book. These **indestructible, iridescent Priscilla Pearls** are worn by the leaders of society and famous screen stars. They are sure to prove a charming adornment to those seeking appearance comparable to New York's so called "Four Hundred."

As an added feature, they are made with a **patented safety clasp** of sterling silver and are encased in a beautiful velvet box. These rare Priscilla Pearls can only be bought from us. Order a strand of these genuine French Priscilla Pearls from us **today**. You will be a sensation among your acquaintances.

#### HOW TO ORDER

Fill a dollar bill to your name and address and mail it to us. Your pearls will be delivered by return mail. When profession brings these charming 24-inch pearls to your door, pay him only \$1.00 and the pearls are yours to wear. Then send us \$1.00 a week for 10 weeks and these valuable pearls are your property.

**H. E. BROUD COMPANY**  
1757 Madison Ave. New York City  
Established 1901

#### GUARANTEE

Every individual pearl on this strand is guaranteed for 20 years against breaking, discoloring, or losing their beautiful lustre or money back. We will also restore them FREE of charge any time within 1 year.

**Handy Lunch Kit and Vacuum Bottle \$2.25**

**A GREAT convenience** for the man who carries his lunch. The vacuum bottle keeps liquids hot or cold 24 hours and fits snugly into top of black enamelled lunch kit. The leather handle on lunch kit makes it easy to carry and two clasps fasten it securely. Kit and black enamelled bottle \$2.25. Aluminum bottle and Kit \$2.55. Lunch Kit alone \$1.35. We pay postage. Order today enclosing money order or cash.



Write for our big Illustrated Circular of 75 magnificent bargains in household and novelty goods.

**THE RAYE CO., 1016 B Arch Street, Philadelphia, Pa.**

**Add \$5 a Day to Your Profits** WITH A TORIT ACETYLENE TORCH NO. 13

For radiator repairing, general soldering, light tinning, heating, battery repairing, etc. Produces instant hot flame, works rapidly. Furnished with 4 different tips and soldering copper, enabling you to do a wider range of work.

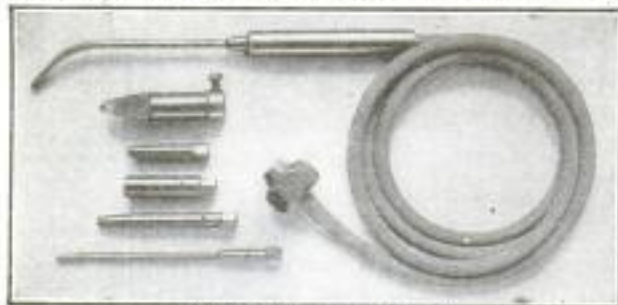

#### USES ACETYLENE GAS ONLY

A splendid tool for discarded auto acetylene tanks. Many owners make the Torit No. 13 pay for itself in a single day. Comes with 4 different tips, soldering copper, 6 ft. tubing and connection fittings. **Acetylene tank \$7.50**

**ORDER TODAY FROM YOUR JOBBER, OR**  
**St. Paul Welding & Mfg. Co., 177 W. 3rd St., St. Paul, Minn.**

## Home School Club MARVELOUS MOVIES Church Camp Office

The most beautiful and best constructed motion picture machine for the price in the world. Shows the same clear, crisp movies the big theatres exhibit. Child or grown-up can easily operate the **Paramount** without any previous experience. Do not confuse this machine with toys at the same price. The **Paramount** is not a toy. It is a real, wonderful, guaranteed machine made of best materials by skilled workmen.

Just attach the electric plug to any electric current and turn the crank and your show is on. The entire outfit, complete, weighs only twelve (12) pounds.

**Our Film Service Is Available**  
Includes best movie stars



Professional Construction  
Absolutely SAFE

The **PARAMOUNT** Motion Picture Machine (Patents Pending) Price **\$35.00**  
(Sent anywhere—ready for use)

Inquire at your nearest dealer. If he cannot supply you write us mentioning dealer's name and we will send you our free catalogue.

Remember there is no substitute for the **PARAMOUNT**

**PARAMOUNT MFG. CO.**

Box 1371, Dept. M.

BOSTON, MASS., U. S. A.

## Only \$45.00 For This Job Complete

Save exorbitant freight rates and one-half original cost by buying **Ford Speedster Bodies** knocked-down. Simple, complete instructions furnished, all parts cut to exact fit. Any one can assemble this job.

Complete with hood, radiator shell, instrument board, upholstery, metal parts, wood parts, bolts, screws, etc. Flat radiator shell furnished made up. Designed low with lack of wind resistance. Price set up \$40, further particulars on request.



Not Paper Patterns

All Parts Complete

Designed low

with lack of wind resistance. Price set up \$40, further particulars on request.

**The Central Auto Supply Co., Eng. Dep. 120, Louisville, Ky.**

## Ride A Ranger

The finest bicycle ever built. 44 Styles, colors, sizes; made in our new factory. **SAVE \$10 to \$25** by direct from the factory purchase.

Delivered free on approval, express prepaid, for 30 Days' Free Trial. 12 MONTHS to PAY, if desired.

**Tires** best quality at factory prices, express paid. Lamps, wheels, horns, equipment and repairs at unusually low prices. **Send No Money, do business direct with makers.**

**Mead Cycle Company**

Dept. C108 Chicago

Write today for free Ranger Catalog, factory prices and marvelous easy payment terms.



## Harley-Davidson

World's Champion Motorcycle

Prices Reduced

1/2

Rebuilt and Guaranteed

1915, three speed twin electric \$125; 1916, \$135;

1917, \$150; 1918, \$165; 1919, \$180; 1920, \$200.

Shipped on approval. Catalog A free, describing

Harley-Davidsons, Excelsiors, Indians, Smith

Motors at \$40 and upwards, Liberty Bonds taken at full face

value. Letters of recommendation from hundreds of satisfied customers. Ref.: Banks and Harley-Davidson Motor Co. Rapid

service on 1922 to 1925 Harley-Davidson parts. 100 page

PARTS catalog \$1.25 cents. Stamps or coin.

**WISCONSIN CYCLE SALES COMPANY**

726 NATIONAL AVENUE

Oldest and Largest

Dealers in the

Northwest

MILWAUKEE, WIS.

"Milwaukee"

World's Largest

Motorcycle Center





# Dependable Champions

For Every Engine Everywhere

## There is no Substitute

If your dealer is interested in your getting maximum motor efficiency and increased gasoline mileage, he will sell you genuine CHAMPIONS.

Ask your dealer to sell you a full set.



Champion AB-44  
For Dodge cars.  
Now 75 cents.

CHAMPION SPARK PLUG CO.

TOLEDO, OHIO

## TIRE Agents Wanted

An auto owner in each locality to use and introduce Mellinger EXTRA-PLY and CORD Tires. Make big money part or full time. No capital or experience needed. Sample Sections furnished. **GUARANTEED 8,000 and 10,000 Miles** (No Seconds) Hand made. Finest materials. Shipped prepaid on approval. **FREE Tires for Your Car** to one user in each locality for taking a few orders. Be first to write quick for Special Agents Offer and Low Wholesale Prices. **MELLINGER TIRE & RUBBER CO.** 510 North Oak Street Kansas City, Mo.



## Try This Typewriter 5 Days FREE



**\$3.00 Down — Balance \$5.00 Monthly**  
Any standard make. Perfectly rebuilt. Guaranteed satisfaction or your money back. Save \$25 to \$60. Pay while you earn. Try 5 days at our expense. Send postcard for special bargain prices. Save fully 1/3 to 1/2. Do it NOW!

WYNN TYPEWRITER EXCHANGE, 11 Reliance Bldg., Kansas City, Mo.

**SAVE MIDDLEMAN'S PROFIT**

**10,000 50 PER CENT MILES GUARANTEED**

**CORDS \$10.75**

**30 x 3 1/2**

Shipped C.O.D. if requested, direct from **FACTORY TO YOU**

|          |         |          |         |
|----------|---------|----------|---------|
| 32x3 1/2 | \$15.60 | 34x4 1/2 | \$26.40 |
| 32x4     | 17.95   | 35x4 1/2 | 27.00   |
| 33x4     | 18.95   | 36x4 1/2 | 27.60   |
| 34x4     | 19.95   | 33x5     | 31.20   |
| 32x4 1/2 | 25.05   | 35x5     | 32.25   |
| 33x4 1/2 | 25.85   | 37x5     | 35.00   |

**B NUELLE RUBBER CO.**  
1223 So. Wabash Avenue  
CHICAGO, ILL.

**AGENTS WANTED**

Please Mention Popular Mechanics

**NEW CORD TIRES**

**\$8.98 STRICTLY FIRSTS**

**30 x 3 1/2**

**Guaranteed 10,000 Miles**

Our Guarantee assures every customer full protection. You can't afford to overlook these wonderful quality tires at such low prices. Brand New—High Grade—Cords Guaranteed 10,000 Miles and adjusted at list price on that guarantee.

| Tires          | Tubes   | Tires   | Tubes    |         |         |
|----------------|---------|---------|----------|---------|---------|
| 30x3           | \$ 7.19 | \$ 1.19 | 32x4 1-3 | \$19.42 | \$1.00  |
| 30x3 1-2       | 8.98    | 1.36    | 32x4 1-2 | 20.00   | 2.00    |
| 32x3 1-2       | 11.05   | 1.49    | 34x4 1-3 | 20.00   | \$ 1.10 |
| 31x4 Clincher  | 12.80   | 1.45    | 35x4 1-2 | 21.90   | 2.30    |
| 31x4 Str. Side | 12.45   | 1.45    | 35x4 1-3 | 23.10   | 2.30    |
| 32x4           | 13.98   | 1.45    | 33x5     | 25.80   | 2.50    |
| 32x4           | 14.95   | 1.55    | 35x5     | 26.95   | 2.60    |
| 34x4           | 15.80   | 1.60    | 37x5     | 28.05   | 2.70    |

**RUSH ORDERS! DON'T DELAY!** No money in advance. Just write today to be sure of getting sizes and number of tires you want. Shipped C. O. D. Section unwrapped for your inspection.

**WILSON TIRE CO., Dept. 141-2804 So. Wabash Ave., Chicago**

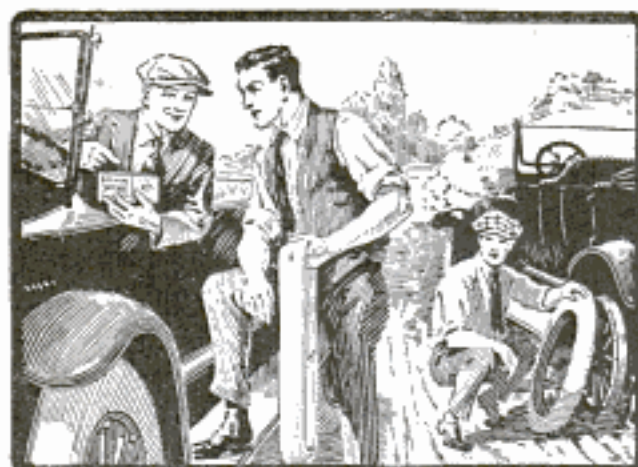

## Try My Shaler!

No tool-kit is complete without a Shaler 5-Minute Vulcanizer. It is a necessity and the greatest convenience ever offered to the motorist.

Why take chances with cold patches when you can make a heat-vulcanized repair that will "stick"—even outlast the tube—in five minutes?

The Shaler 5-Minute Vulcanizer is easy to use—you need only a match. Always ready—never bothered by wind or storm. Cannot injure or burn the tube. No gasoline—no danger of fire.

Get a Shaler 5-Minute Vulcanizer from your dealer. It will soon pay for itself by the saving in time, trouble and tire repair bills.

**\$1.50 at All Auto Supply Stores**

*Slightly Higher in Canada and West of the Rockies*

The outfit includes the vulcanizer, 12 Patch-&Heat Units (6 round for punctures and 6 oblong for cuts)—ready to use—with complete instructions. Extra Patch-&Heat Units 75 cents a dozen.

**C. A. SHALER CO.**

209 Fourth St. Waupun, Wis.



## WOODWORKERS! Make Big Money

Put this PARKS in your workshop!

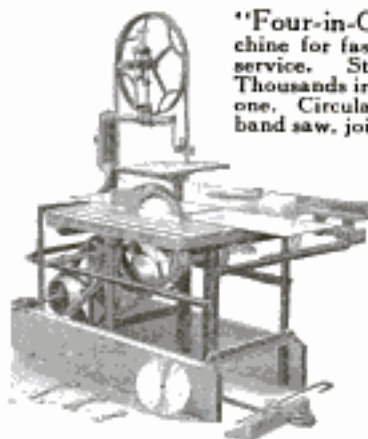

"Four-in-One"—a husky machine for fast, clean work and long service. Steel frame construction. Thousands in use. Four machines in one. Circular rip and cross-cut saw, band saw, jointer, and borer. Guaranteed 10 years. 10 days' free trial.

Many Other  
Combination  
Woodworkers

LOW PRICES  
Send for Catalog

**THE PARKS BALL BEARING MACHINE CO.**

1500-1540 Knowlton Street, Cincinnati, O.

Canadian Factory: 200 Notre Dame East, Montreal, Canada

# PARKS



## Pullman

Sleeper can be made of your car. Auto beds, stoves, tents, camp equipment.

Dep. 10-P VANDERPOOL CO., Springfield, Ohio.



## WHITE FLAME

BURNERS make your old kerosene lamps and lanterns give a brilliant white light better than electricity or gas. Doubles your light. Saves oil. **NO MANTLE TO BREAK.** Guaranteed Safe and Reliable. Delights every user. Send now for complete sample postpaid 20 cents, stamps or coin. 3 for \$1.25. Money Back if Not Satisfactory. Live Representatives Wanted. Exclusive Territory. **WHITE FLAME LIGHT CO., 68 Clark Bldg., Grand Rapids, Mich.**



## AUTO OWNERS Make Big Money



Earn big money in your spare time introducing our splendid tires in your community. By our plan you can start a permanent, profitable tire business of your own. **Harrison Hand Made Tires** are positively guaranteed **10,000 miles**, made by skilled workmen from finest materials. Easily sold at our low prices. Shipped on approval prepaid. No capital or experience necessary. Sample section **FREE.**

**WRITE FOR SPECIAL OFFER**

Our agency plan and confidential low prices to user agents sent you without obligation. **Write today.**

**Harrison Tire & Rubber Co.**  
230 Indiana St. - Hammond, Ind.

# Machine-Shops can now Cash In On Radio

*Practical hints in free book tell just how to profit big from nation-wide craze. Big new money-making field opened to every live owner of a machine-shop.*

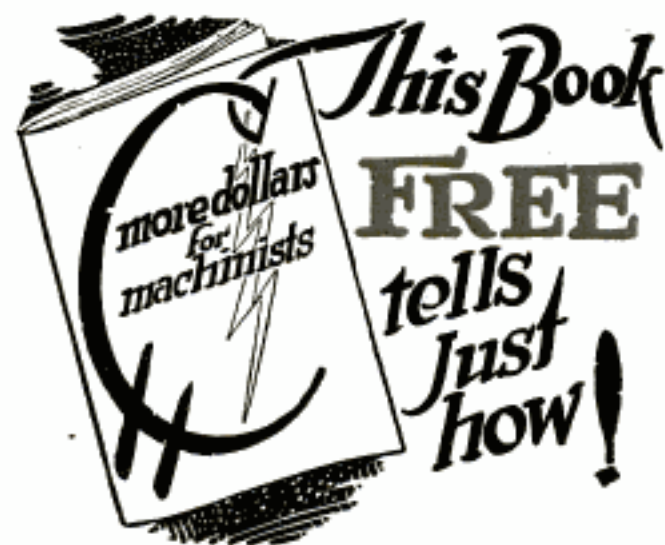

## Huge Demand for Radio Panels

Every real radio-fan insists today upon one certain material for panelling his outfit; and cutting that material to dimensions is as profitable and practical a job as any machine-shop can ever make money doing. The makers of that material, wanting reputable machine-shops to cash in on this proper preference of radio enthusiasts, have prepared a handy little book which gives the machinist all the particulars he wants to open up for him this immensely profitable new field. A copy is yours for the asking.

## Big Money-Maker for Machine-Shops!

This supremely demanded material comes in sheets 38x38 inches, is miles ahead of every other known substance for panelling and insulating radio installations, and can be readily machined by any decently-equipped machine-shop. The difficulty the machinist will have will be in taking care promptly of the orders that will be forced upon him; and that, though it sounds almost too good to be true, is absolutely a FACT. The free book tells all about it, giving every fact the machine-shop man wants to know; and there is not one cent to pay for a copy of it, if you are legitimately a machinist with a plant fit for ordinary work. Send for your copy today, ride the wave of radio development to your own profit, and understand that you commit yourself to nothing whatever by asking for a copy. Ask The Continental Fibre Company, Newark, Delaware.

*Please Mention Popular Mechanics*

# Ten Cents Brings Burgess U.S. Radio Map

*(Including Canada)*

Know where your calls come from. Tack this big Burgess Map right above your set, and see at a glance. Every radio district and all time divisions marked in red; state divisions in black. Broadcasting Stations, Army, Navy and Commercial Stations, and a down-to-the-minute alphabetical list of call numbers.

This is a real map—28 by 36 inches on bond paper, made to fold conveniently for the pocket. 6,000 name places. Latest U. S. Government Radio data. Usually priced at 50 cents. We'll mail one to you on receipt of 10 cents to cover postage and packing—if you'll send us your radio dealer's name. We're doing this because we want every radio enthusiast to know about Burgess "B" Batteries. Don't forget to send your dealer's name. Just address:

## BURGESS BATTERY COMPANY

15 S. Brearly Street

Madison, Wisconsin

# BURGESS "B" BATTERIES

**"ASK ANY RADIO ENGINEER"**

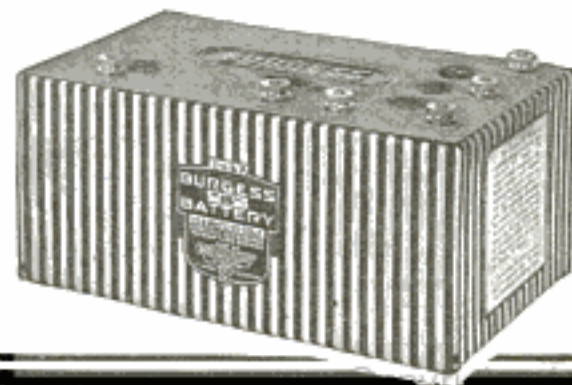



## "Why the menagerie?"

YOU wouldn't stand for a young menagerie howling around the house. Why permit your radio set to act that way? It's unnecessary. For just five dollars you can add an Acme Audio Frequency Transformer to your set. This ends the howling and distortion so prevalent in the ordinary detector unit and at the same time it greatly increases the volume of incoming sound. Music and the human voice assume their natural tones. No more thin squeaky voices and tiny elfin wails.

You will also want the Acme Radio Frequency Amplifying Transformer. You can use it with either a vacuum tube or a crystal detector set. It greatly increases the distance over which you can receive broadcasting programs. Just the same price as the Acme Audio Frequency Transformer. Two stages of Acme Audio Frequency Amplification with two stages of Acme Radio Frequency Amplification will give you maximum range, volume and certainty of natural tone. Your set is incomplete without them.

The Acme Apparatus Company (pioneer transformer and radio engineers and manufacturers) also make detector units, detector and two stage amplifying units, the Acme Clear Speaker, the Acme-fone, also C. W. and spark transmitting apparatus. Acme Apparatus is for sale at radio, electrical and department stores. If one is not close at hand, send money direct. Ask also for interesting and instructive book on Transformers. The Acme Apparatus Company, Cambridge, Mass., U. S. A. New York Sales Office, 1270 Broadway.



Type A-2 Acme Amplifying Transformer  
Price \$5 (East of Rocky Mts.)

# ACME

for amplification

## FROST-RADIO PROTECTOR

Listed by Underwriters' Laboratories under April, 1922, regulations. No interference with clear Radio receiving.

**Never Grounds  
Mounts Indoors**

**Price \$1.50**

**Good deliveries on  
this approved device.**

### FROST-RADIO

**Extension Cord and Plug**  
Comes in lengths from 10 to 100 ft. Loud speaker can be placed anywhere and connected with Radio set with FROST-RADIO Extension Cord.

**OTHER FROST-RADIO LEADERS**

Frost-Fones

Frost-Radio Improved Plugs and Jacks

Frost-Radio Receiving Transformers

Cunningham Vacuum Tubes

Remier Radio Apparatus

**Inquire of your Local Dealer.**

## HERBERT H. FROST

NATIONAL FACTORY DISTRIBUTORS  
TO THE ELECTRICAL-RADIO JOBBER  
154 W. LAKE ST. CHICAGO, ILL.

### THE BOOK YOU HAVE BEEN WAITING FOR

Gilbert Radio Telephone and  
Broadcasting - 35c postpaid

The A. C. Gilbert Company, 312 Blatchley Ave., New Haven, Conn.



## S-C Loud Speaker Horn

*Delivered at any door in U.S. for \$7.50*

**Largest Value on the Market**  
22 1/2" High; 8 3/8" Bell

Made of soft brass of remarkable tonal quality, on correct, tested acoustic principles. Takes any radio receiver in universal receptacle. Handsome gold bronze finish, lacquered. Counterweight prevents tipping.

In the same high quality with low prices: Variometers, Variocouplers, Variable Condensers, Amplifying Transformers and other Radio parts. Pink-a-Tone Sets, \$25. Ask for Bulletin R.

**S-C Products Company**  
1264 Nicholas Bldg. Toledo, Ohio

DOUBLE HEAD



## BOYS! A REAL RADIO SET ABSOLUTELY FREE

RUSH your name and address and we will tell you HOW you can get this RADIO SET ABSOLUTELY FREE.

RADIO SET comes to you complete, with single slide tuning coil, crystal detector and phone condenser. AND DOUBLE HEAD PHONES. No batteries required; no experience.

**Write Today for Free Radio Plan**  
HOME SUPPLY CO.,  
110 Nassau St., Dept. 559,  
New York City



# ELIMINATE OUTSIDE AERIAL— USE LIGHT CIRCUIT

No longer is it necessary to contend with the dangers incident to stringing antenna wires. You can now listen to the world by just inserting "Super-Antenna" plug in any electric light socket.

This unit has been designed by one of the country's foremost Radio Engineers. Gives perfect results—Saves Expense. Operates on any electrical circuit D. C. or A. C. with switch "ON" or "OFF."



## MAKES YOUR RADIO SET PORTABLE

By using the "Super-Antenna" unit you can move your set from room to room, or house to house. Entertain your friends anywhere. This wonderful unit safeguards your set, eliminates A. C. hum—is shock proof—will not blow fuses and reduces static effect. Has eight different hook-ups that give good results on any circuit. **ORDER TODAY—Price... \$2.80**

If your dealer cannot supply you send us his name, enclosing check or money order. West of Rockies, \$3.00. Canada, \$3.70.

Dealers and Jobbers—Wire or Write for Discounts and Special Territory

### SUPER-ANTENNA COMPANY

Dept. 1010,

QUINCY, ILL.

## Don't Waste Your Radio Money!

Stop costly experiments. We'll tell you how! New economic methods of installation and operation.

Intensify your results without lavish outlay. Short cuts. Newest Methods. Latest information.

Our new Book **FREE**

**BRYN MAWR SCHOOL OF RADIO**

of The DCK Radio Corporation

Dept. A

BRYN MAWR, PA.

## WESTINGHOUSE BATTERIES



**RADIO**  
HEAD SETS, JACKS, PLUGS,  
MICROPHONES

Manufacturers  
*American Electric*  
COMPANY

State and 64th Sts., Chicago, Ill.

## FREE Radio Catalog



Describes and illustrates our large complete stock of Radio Equipment of all kinds. We can make immediate shipments of proven, reliable equipment. Protect yourself against disappointment by taking advantage of our experience and reliability.

Send \$5.00 for Genuine Cunningham or Radiotron Detector Tube. Free catalog sent on request.

**JULIUS ANDRAE & SONS CO.**

358 Broadway In business since 1860 Milwaukee, Wis.

## F. R. L. Super-Receiver —Radio Frequency

This set is months ahead of any other unit offered the Radio Public. Made of best materials obtainable—tested by skilled engineers and gives perfect modulation of music, speech and signals without distortion.

### 30 Mile Range Without Antenna or Ground

This unit has 1,000 mile receiving radius and a range of 150 to 600 meters. Provision is made for an External Detector and Tuner for other wave lengths. Has no equal for sensitiveness and efficiency.



Price including tubes... \$240.00



## CROSLY RADIO APPARATUS

**BETTER—COSTS LESS**

If interested in Radio, write for free copy of a Crosley Catalog. In it are helpful suggestions as to selection of right instrument or parts, if you wish to build your own outfit. Sold by dealers and jobbers everywhere.  
CROSLY MFG. CO.  
Dept. P.32.1 Cincinnati

**FREE CATALOG**



## "MAMMOTH" TUNING COIL

With Wood Mounting

**\$1.50**

A superior tuning coil for amateurs and others—8 inches in length and 4 inches in diameter—bound at both ends with polished aluminum bands. The "Mammoth" is made of heavy fibre tube, SHELLACKED (not paraffined) inside and out. Wound with high quality No. 22 enameled copper wire, shellacked in place, the ends being brought through the tube and securely fastened. The "Mammoth" is the ideal tuning coil for sets designed to receive telephone messages and music within 40-mile radius. Mounting is made of three-ply veneer—will not warp. Sent postpaid to any address at the special introductory price of \$1.50, currency or money order. Coil alone, \$1.00. **Send today and take advantage of this special introductory offer.** Agents and dealers wanted.  
**Oakwood Radio Co. Dept. 10, Detroit, Mich.**

# MURDOCK RADIO PHONES

Have been  
**The Standard Radio Phones  
for Over 18 Years**

**T**HERE are no other Phones so good at so low a price. Examine Murdock apparatus at your dealers. Send for descriptive circular of the complete Murdock line of instruments.

WM. J. MURDOCK CO.  
349 Washington Ave. Chelsea, Mass.  
1270 Broadway New York  
509 Mission St. San Francisco  
2000 Ohm, Complete Set..... \$5.00  
3000 Ohm, Complete Set..... \$5.50



## You can be well

Electricity, in the form of RenuLife Violet Ray, offers you relief from pain, a revitalized body, brimming with vigor and energy, and the fine clear complexion that goes with perfect bodily health. You can not tell how much

### RenuLife Violet Ray

will do for you unless you try this marvelous treatment. You can do it—our 10 Day Free Trial Offer enables you

to put this method for regaining health and beauty to a thorough test in your own home. If, after this trial you are not entirely satisfied with the results, return the instrument.

Send in the coupon for full information and our 10 Day Free Trial Plan. This entails no obligation on your part.

#### USE THIS COUPON

RenuLife Electric Company  
1014 Newberry Bldg., Detroit, Michigan  
(In Canada, Pitt Street, East, Windsor, Ont.)

Gentlemen: Please send me your book Health and explain your 10 Day Free Trial Plan.

Name.....

Address.....

## "REEL EASY" VARIO COUPLER

Our BANK WOUND Vario Coupler is  
**BUILT FOR YOU**  
Because We Feel it is  
**JUST THE THING**

We Absolutely Guarantee Satisfaction  
**YOU ARE THE JUDGE**  
of Its Efficient Operation, Between 150  
and 3000 Meters

Price \$6.00 Shipping Weight 3 Lbs.  
Postage Extra

I. R. NELSON CO. BOND ST.  
NEWARK, N. J.  
RADIOPHONE STATION W-A-A-M

## Make Your Own Radio Receiving Set

Get Baseball scores, enjoy the concerts, market reports, latest news, etc., as sent out by large broadcasting stations. This NEW copyright book, "EFFICIENT RADIO SETS," shows how to make **INEXPENSIVE** sets for receiving wireless broadcastings. Sent postpaid for 25c. Address  
**J. C. DORN, Pub., 725 S. Dearborn St., Dept. 116, Chicago, Ill.**

## BUILD YOUR RADIO Save Money

**Build Your Own At Home**  
Complete Standard Parts for Long Distance Radio Outfits. We do all machine work; you do the hand work; we tell you how. Immediate delivery. Also complete Radio Sets — all sizes at bargain prices. Write now for our big bargain catalog.

Colonial Radio Equipment Co., 4759 Calumet Avenue  
Dept. 10 Chicago, Ill.



## Build This Phonograph Yourself

### TREMENDOUS SAVING IN COST

Easy, fascinating work with our SIMPLIFIED PLANS. We furnish blue prints, diagrams, motor, cabinet pieces, ready-built horn, etc. You don't need to be a cabinet maker. A few hours assembling and you will have a fine instrument at one-quarter the regular retail price. **AGENTS MAKE MONEY** making and selling these instruments. Write today for full details and our FREE OFFER. Address:

**MODERN PHONOGRAPH SUPPLY CO.**  
213 N. Morgan St. Dept. 701 CHICAGO, ILL.

## FINE OLD VIOLINS

On Easy Payments  
30 Days Free Trial

allowed, no matter where you live. If not more than pleased with our values return violin AT OUR EXPENSE—and no harm done. Ability to play the violin brings social and financial success. Get a violin with a rich, mellow tone and it will create in you a desire to master it.

### Free! Magnificent Album-Catalog

containing portraits of the world's greatest violinists since Paganini's time, a half-tone of "Stradivarius in His Workshop," and the romantic story of The King of Musical Instruments. A postcard brings all to you FREE — no obligations.

**CREMONA VIOLIN SHOP**  
17-15





# Now Ready!

## The DICTOGRAPH Radio Loud Speaker for the Home

THE Radio Public has been waiting for the Dictograph Radio Loud Speaker. Perfected by Dictograph Products Corporation, the pioneer manufacturer of loud-speaking telephones, and world-famous for its sound-transmission instruments; the same supreme quality as other Dictograph products.

Years of experience have made possible this new Loud Speaker—the best in the world—and sold at a price that gives you DICTOGRAPH quality at no extra cost. The great, assured demand has made possible a reduction from the price originally announced. Instead of \$25, it is only \$20—complete with 5 ft. flexible cord.

See the Dictograph Loud Speaker at your dealer. Dealers can be supplied by local jobbers—or inquire direct.



The Standard of the World



### 3000 Ohms Price \$12

## DICTOGRAPH Radio HEAD SET

Ask for the Dictograph Head Set—the best Head Set in the world, regardless of price. The name Dictograph is your guarantee of supreme quality. It insures the most sensitive and accurate transmission of sound known to Radio.

Price \$20

Complete with 5 ft. flexible cord

The Dictograph Loud Speaker is beautifully constructed; the cabinet is of hardwood, ebony finished, with die cast black enameled aluminum tone arm. The horn is spun copper, highly polished, French lacquered, non-tarnishable. Completely equipped with 5 ft. flexible silk cord. For any vacuum tube receiving unit. No extra batteries required.

DICTOGRAPH PRODUCTS CORPORATION, 220 West 42nd St., NEW YORK CITY (Branches in All Principal Cities)

### GET A RAZO!



This unique Razor-blade pocket knife is the handiest, safest general utility knife. Uses an old Gillette blade. Artists, writers, draftsmen, tailors, dressmakers, office men, women, school children all need RAZO. Send 25c for yours today. Great money maker for agents.

RAZO NOVELTY CO.  
23 E. Van Buren St. Chicago

### Imperial Sanitary Floor

Base and Floor one solid piece

Put on like Plaster  
Wears like Iron  
-waterproof  
-fireproof  
-resilient  
-noiseless  
-dust-less

A composition material emery applied in plaster form over practically any kind of floor. Laid about 3/8 inch thick. Imperial floor does not crack, peel or come loose from foundation. A continuous, fine grained, smooth, non-slipping surface. No crevices to gather grease, dirt, dust, disease germs or moisture.

Ideal Floor for Kitchen, Pantry, Bath Room, Laundry, Porch, Garage, Restaurant, Theatre, Hotel, Factory, Office Building, Railroad Station, Hospital—wherever a beautiful, substantial floor is desired. Several practical colors. Full information and sample FREE of your first and second choice of colors.

Imperial Floor Co., 82-84 Halsted St., Rochester, N.Y.

A Success for 15 Years

## VITALIC Bicycle Tires

TRADE MARK REGISTERED  
Tougher Than Elephant Hide

### HOMCHARGE YOUR RADIO BATTERY for a Nickel

ENJOYABLE Radio Concerts and Maximum Receiving Range are obtained only when your battery is fully charged.



charges your "A" or "B" battery over night. Silent and clean in operation—requires no watching—may be used right in your living room.

Connects to any lamp socket. Self-polarizing—fully automatic—cannot overcharge or injure the battery.

Entirely enclosed—approved by Underwriters. Unconditionally GUARANTEED. Lasts a lifetime.

Beautifully finished in Mahogany and Gold—the most efficient and handsome rectifier ever produced. Sold by all dealers, \$18.50 complete. Send for Bulletin 637. IT'S FREE.

THE AUTOMATIC ELECTRICAL DEVICES CO.

129 West Third Street  
Cincinnati, Ohio

Over 50,000 HOMCHARGERS in Use

## DIAMONDS, WATCHES ON CREDIT

YOU SHOULD HAVE THE JAMES BERGMAN JEWELRY BOOK IN YOUR HOME. It is full of many bargains. Diamonds, Watches, Jewelry, Toilet Articles, etc. Select any article desired, have it sent to you, all charges prepaid. If satisfactory, send one-fifth of purchase price and keep it, balance in TEN monthly amounts. No interest charged. No security required. Write Today for Big Free Catalogue No. 5. It tells about Our Low Prices and leading guarantees.

JAMES BERGMAN 27-39 MAIDEN LANE, Est. 1896, NEW YORK CITY



Copyrighted material

## Avoid That Embarrassing Moment!



It takes long experience in "wireless" to insure production of efficient and dependable Radio equipment. SIGNAL stands for that knowledge. SIGNAL—parts or sets—are the product of a plant that has been manufacturing telephone and telegraph equipment for over 30 years—that developed as "wireless" developed—that knows Radio from its very beginning—and whose output of Radio equipment is made by men who have been making *that kind* of apparatus ever since it was discovered.

Radio, becoming popular almost over night, created an insistent demand far exceeding the supply, and brought onto the market a flood of unreliable, inadequate, and disappointing material.

Avoid that "most embarrassing moment" when something goes wrong just as you expect to entertain your friends, by asking for SIGNAL when you want Radio parts or sets. You'll never be disappointed.

For sale by dealers everywhere. They can get it if you insist.

### AUDIOTRON AND V. T. CONTROL CABINET



Designed for use with old style supersensitive audiotron as well as modern four prong tube. Potentiometer control of plate voltage for either tube, so best operating position on their characteristic curves is easily found.

## Signal Electric Mfg. Co.

FACTORY AND GENERAL OFFICES

1910 Broadway, Menominee, Mich.

Atlanta Boston Cleveland Chicago Minneapolis  
Montreal New York Pittsburgh St. Louis  
San Francisco Toronto

(You'll find our branch offices in the Telephone Directory)

### COUPON FOR CATALOG OF RADIO SATISFACTION

Signal Electric Mfg. Co.,  
1910 Broadway, Menominee, Mich.

Please send your interesting catalog of SIGNAL parts and sets to the name and address written on the margin of this page.

(1875)

## MAKE YOUR OWN RADIO SET

Prices Slashed!



**Buy direct from the factory.** Satisfaction guaranteed or money refunded. Every part carefully tested and inspected by radio experts.

This is your opportunity to make your own, efficient radio receiving set at small cost. Send full payment with order, or if you prefer, you may send deposit, and pay balance C.O.D., and we will ship any of the following radio parts at the bargain prices quoted:

|                         | Regular Price | Special Price |
|-------------------------|---------------|---------------|
| Variometers .....       | \$5.00        | \$3.00        |
| Vario Couplers .....    | 5.00          | 3.00          |
| Transformers .....      | 5.00          | 3.00          |
| 23 Plate Condensers ... | 3.60          | 2.25          |
| 43 Plate Condensers ... | 4.50          | 2.75          |
| Vacuum Tube Sockets ..  | 1.00          | .65           |
| Dials and Knobs .....   | 1.00          | .65           |

**FREE** Wiring diagram and blue print with every order. This special bargain price offer is for a limited time only. Act at once! Remember—we guarantee satisfaction or refund your money. Circular mailed on request.

Write Dept. A

**METRO ELECTRIC CO.**  
1422-1438 RANDOLPH ST. CHICAGO

## THIS WONDERFUL INVENTION



converts any cook stove into a gas stove. Oxo-Gas made from kerosene and air is cheaper, cleaner and more efficient than coal. Send for catalog illustrating Oxo-

Gas appliances for all purposes where coal is used. We have openings for General Sales Managers and distributors. Only those who can finance themselves considered.

### GLORIA LIGHT COMPANY

111-119 N. MAY ST.

CHICAGO, ILL.

## DUCK'S NEW No. 16, 256-Page Radio Catalog

All Other Catalogs in One

Our new catalog is truly the wonder catalog. You can spend more than a dollar for other catalogs and yet you will not have the equal of this catalog. There are over 50 pages of diagrams and data on wireless. As a radio book alone it is priceless. The complete catalog of the Radio Corporation of America, with circuits and information for making powerful wireless telephone transmitters, the Remler, Murdock, Firth, and in fact all other catalogs are incorporated in this catalog, not to mention over 70 pages of our own goods.

Send 25c in coin carefully wrapped for this catalog today. Not sent otherwise.

The William B. Duck Company, 223-227 Superior St., Toledo, Ohio

# Pay Yourself \$500 a Month

## Showing This Marvelous New Lamp

You can set your own salary—pay yourself the actual number of dollars your time is worth—through this wonderfully big opportunity. Sales experience is not essential. The records of 17 men picked from our files show an aggregate earning for one day of nearly \$400. This was an average profit of \$23 per day for each representative.

G. B. Green, of New York, made \$33 in one day; none of the others made less than \$15. These were not exceptional cases. Hundreds of others are making from \$10 to \$40 a day. What they have done and are doing *You Can Do*.

### 300 CANDLE POWER LIGHT FROM GASOLINE OR KEROSENE

This new 300 candle power light is known as "The Diamond Light" because of its beautiful brilliance. Made in various designs to meet every need—Table Lamps, Hanging Lamps, Lanterns. Burns gasoline or kerosene. Absolutely safe. Lights with a match. Clean, odorless, economical. Almost 100 times brighter than a wick lamp and consumes only half as much fuel. Patented.



The  
Diamond Light

**THE AKRON LAMP COMPANY**  
110 LAMP BLDG., AKRON, OHIO

### YOU SIMPLY TAKE ORDERS—WE DELIVER AND COLLECT

When you join our sales force, you are a salesman, —not a peddler. You simply use your sample to demonstrate and take orders. At the end of the day you mail your orders to us and we ship by Parcel Post direct to your customers. There is no red tape. You keep customer's deposit as your commission. This means you have your day's profit in your pocket every evening when you get home.

### WORK ALL OR SPARE TIME— WRITE TODAY

Join our sales force now and get exclusive selling rights in your territory. No capital required. Work all or spare time. No experience necessary. We furnish complete instructions. **MAIL THIS COUPON TODAY.** There is no obligation.

### COUPON

The Akron Lamp Co.,  
110 Lamp Bldg., Akron, Ohio.

Gentlemen:—Send me "The Diamond Light" catalog and tell me all about how I can make \$10 to \$40 a day as your representative.

Name.....

Address.....

## Why Burn Coal

When you can get twice the heat at half the cost, by installing, in 5 minutes time, Uni-Hete Oil-Gas Burner in your range or heater. Thousands of homes now ending coal expense! Uni-Hete generates gas from common kerosene—cheapest fuel known. Red hot fire instantly. Cooks, bakes, heats. Sets in fire box of any stove. **FREE TRIAL.**



Saves its small cost in 30 days. Lasts for years. Made by factory making heating devices for 33 years.

**Agents—Special Offer—Act Quick**  
High coal cost makes Uni-Hete a big profit maker for agents. **Write at once.**

Acorn Brass Mfg. Co., 1067 Acorn Bldg., Chicago, Ill.

## TWO-YEAR GUARANTEED BATTERIES SAVE 50%



Famous "Royal" Batteries—highest quality made—now selling direct from factory to car owner. You save half. We give **written 2-year guarantee—longest on any battery.** Big responsible organization backs guarantee. Batteries for any car, tractor or gas engine. **Save time. Order from this ad. Battery, fully charged, shipped immediately—by express C.O.D.** You run no risk. Our location entire for eight years. Robinson; Nat'l Bank of the Republic, Dun or Breadstreet.

**Free Booklet** If you want descriptive matter first, send for free booklet. Gives full details of this superior battery. Get this booklet **before you buy any battery.** Write today! Give your name and model of your car.

**K - E BATTERY CO., Dept. 140**  
646 N. Michigan Ave., Chicago

© 1921  
**SPECIMEN PRICES**  
Ford-Dart-Chev. \$18.80  
Overland-Buick 21.85  
Maxwell-Dodge 25.60  
Name 50% saving on all cars

**Largest Exclusive Mail Order Battery House in America**  
Members of Chicago Association of Commerce

## Save \$10 to \$25 On Custom-made Re-covers

Easily attached; instructions sent. Top and back with 7x14 beveled plate glass, tacks, welts, etc. **\$10 and up.** Fords **\$5.20** and up. Ask for prices and samples—give name and year of car.

**S-C PRODUCTS COMPANY**  
1272 Nicholas Bldg. Toledo, Ohio

**AUTO SUPPLIES  
WHOLESALE  
3000 BARGAINS**

**SEND FOR THIS  
CATALOG—  
it's FREE!**

Everything you need  
in Auto Supplies at  
Amazingly LOW PRICES.

**NEMCO BARGAIN SUPPLY HOUSE**  
1017 Jackson Boulevard • Chicago, Ill.

Hand  
Forged  
Razor Steel  
Blades, No. 57



## Direct at Factory Prices

This \$2 KNIFE \$1.18 Postpaid  
**Hand Forged Razor Steel Blades**  
Handy shaped Blade makes this knife best for mechanics, sportsmen and farmers; light but strong; re-sharpened easily. Stab handle. German silver finish; blades file tested, hand forged from razor steel and warranted.

Sample \$1.18 3 for \$3.00 Postpaid.

Send for our 100-page List and "HOW TO USE A RAZOR" **FREE**  
**MAHER & GROSH CO., 106 A St., Toledo, Ohio**

# WORLD'S FAMOUS DANZIG SPORTING and HUNTING RIFLE \$14.95

With OIGEE Telescope and Shoulder Strap complete. Take-down model. Shoots standard cartridges.

Bolt action. **KRUPP STEEL**, checkered pistol grip, **WALNUT** stock, metal butt plate. Pocket pistols for target practice. **GENUINE GERMAN MAUSER**, 9 shot 25 cal., \$12.95; 32 cal., \$13.95; **WORLD'S FAMOUS LUGER**, 30 cal., \$21.95. Hand ejector swing out cylinder, 32 cal., \$16.95; 38 cal., \$17.95. Guaranteed brand new, genuine imported.

**\$8.45** Pay Postman **SEND NO MONEY** Satisfaction Guaranteed or money promptly refunded on Delivery

25 cal. BLUE STEEL—32 cal., \$10.45. Officers 3 safeties, 25 cal., \$10.50. MILITARY TRENCH—32 cal., 10 shot, extra magazine FREE, \$11.65.

**UNIVERSAL SALES CO., 141 BROADWAY, Desk DD14, NEW YORK CITY**

**YOU DON'T NEED TO BUY A STRADIVARIUS OR OTHER EXPENSIVE VIOLIN**

The Virzi "Tone Producer" installed in the violin or piano will render the tone free and clear as a bell, mellow, beautiful and brilliant—more than any other existing in the world. Try it and compare. It is recommended and used by Kreisler, Casals, Heifetz, Bena and other great artists. Write for booklet. If not satisfactory money refunded. We send instruments on trial.

**J. & J. VIRZI BROS.** No. 507 Fifth Ave., NEW YORK CITY  
Inventors, sole owners and distributors

**30 DAYS FREE TRIAL \$10 Worth of Records FREE**



Simply wonderful! The limit of value giving! Just think! A GENUINE DAVIS PHONOGRAPH on 30 Days' Free Trial, and on terms as low as

**\$2 A MONTH** In case you decide to buy. Magnificent instruments in quartered oak or mahogany piano finished cases, equipped with the finest worm gear motors, rich toned machines— at less than half the standard price—and \$10 worth of records FREE.

**Send No Money** Just a postal with your name and address. Only a limited number of machines shipped on this extra-liberal offer. Better act quickly. This is a life-time opportunity.  
**DAVIS, Dept. D41**  
**6101 MAY ST., CHICAGO**

**TIRRO**

**THE IDEAL MENDING TAPE**

At Drug Stores

**BAUER & BLACK, 2500 DEARBORN ST., CHICAGO**

**DIAMONDS**

ONLY \$2 DOWN AND 10 MONTHS TO PAY

Send only \$2.00 deposit as a guarantee of good faith and we will send your choice of the \$49.00 cluster diamond ring, or the \$50.00 beautiful solitaire diamond ring, or the \$12.00 wedding ring, or the \$25.00 wrist watch. Pay the balance in ten equal monthly payments. For the \$100.00 solitaire blue white diamond, send \$20.00 deposit. For the \$75.00 diamond, send \$15.00 deposit. Men's rings with same diamonds will be supplied at same price. Hundreds of similar bargains are described in our new catalog.

**30 DAYS FREE TRIAL**

Wear any article of your choice on trial for 30 days. If not satisfied send it back and we will return every cent you paid. Free examination at bank or express office before paying deposit, if desired. Written guarantee that if any other jeweler in the U. S. can sell you equal merchandise for less money, you can get your money back. On this guarantee you cannot lose.

14 Karat solid white gold rectangular wrist watch, 15 jeweled movement. Worth \$40.00. Full length indestructible pearls \$5.00. Our prices are the same for credit as for cash. Order article of your choice by letter and give also wanted. Everyone a wonderful bargain. Rings A-B-C-D are 18 Karat white gold. Ring E is 14 Karat yellow gold. Thousands of similar values in our beautiful catalog.

Write for our big catalog \$1,000,000.00 and 43 yrs experience back of our guarantee

**B. GUTTER & SONS**

Wholesale Jewelers & Diamond Importers  
172 NASSAU ST., DIV. 372, NEW YORK

**CARTER Oil Gauges**

If your dealer can not supply you, send remittance, or order by parcel post C. O. D. Easy to screw gauge on instrument board, connect copper tube in place of lower petcock on Ford or Chevrolet. No oil passes thru gauge or tube.

**Accurate—Durable—Guaranteed**

Order before cold weather; you will need it. It will save its cost many times in oil and wear on the engine.

**CARTER MOTOR ACCESSORIES, Inc.**  
340 Pearl Street Buffalo, N. Y.



**Ford Chevrolet Only \$3 Buick and \$5 Chandler**

**THE AJAX EYELET FASTENER**

**BINDS AND INSERTS AJAX EYELETS IN PAPER, CARDBOARD, LEATHER OR CLOTH**

It Saves Time by Punching the Hole, Feeding the Eyelet and Clutching It in One Operation.

Drop the eyelets into the magazine and go right ahead. Order from your stationer or direct.



PRICE WITH 1500 AJAX EYELETS, \$10.00 DELIVERED IN U. S. A.

Write for our catalogue of office tools  
**MACHINE APPLIANCE CORPORATION**

351-353 Jay St.

Spec. Dept.

Brooklyn, N. Y.



**2 TIRES FOR \$10<sup>25</sup>**

**FREE TUBE WITH EACH TIRE**

### Sensational Cut In Standard Tire Prices!

Two used tires for less than the retail cost of one, and a free inner tube with each tire! No double tread or second tires. Our big volume means best tire values! Act now and cut your tire cost in two. Thousands of steady customers are getting full mileage out of these tires and you, too, can get

**12,000 MILES**

You can see the mileage in our tires. Order and prove it—but order now! This is a special lot selected for record-breaking sale. Supply limited and going double quick.

#### Note the Bargain Prices on Two Tires of Same Size

| Size       | 1 Tire  | 2 Tires | Size       | 1 Tire  | 2 Tires |
|------------|---------|---------|------------|---------|---------|
| 28 x 3     | \$ 6.95 | \$10.25 | 32 x 4 1/2 | \$13.45 | \$21.45 |
| 30 x 3     | 7.25    | 11.45   | 33 x 4 1/2 | 13.95   | 22.45   |
| 30 x 3 1/2 | 8.25    | 13.65   | 34 x 4 1/2 | 14.45   | 23.45   |
| 32 x 3 1/2 | 9.45    | 15.45   | 35 x 4 1/2 | 14.95   | 24.90   |
| 31 x 4     | 10.65   | 16.90   | 36 x 4 1/2 | 15.45   | 25.45   |
| 32 x 4     | 11.85   | 18.90   | 36 x 4     | 14.95   | 25.95   |
| 33 x 4     | 12.45   | 19.85   | 35 x 5     | 15.90   | 26.45   |
| 34 x 4     | 13.25   | 20.85   | 37 x 5     | 16.45   | 26.95   |

**SEND NO MONEY!** Shipment C.O.D. express or parcel post. Because tires on arrival and if not fully satisfied return same at our expense and your money will be promptly refunded. State whether straight size or clearance. **DON'T DELAY! ORDER NOW!**

**ALBANY TIRE & RUBBER COMPANY**  
2721 Roosevelt Road Dept. 1644 Chicago, Illinois



**Quick action!**

So often, where a liniment is required, there is need for an antiseptic. And where an antiseptic is required, there is often need for a germicide. Have all three in one container. \$1.25 at druggists or postpaid. Liberal trial bottle, postpaid, 10c.

**W. F. YOUNG, Inc.**  
147 Temple Street  
Springfield, Mass.

**Absorbine, Jr.**  
THE ANTISEPTIC LINIMENT

### Does Your Camera Shutter Work?

Seneca, Kodak, Premo, Ansco or Ingento Shutters repaired and adjusted. Any style or size. Expert work done and guaranteed. Prompt Service. Reasonable Prices. Send your shutter in today.

Address Shutter Division  
**SENECA CAMERA MFG. COMPANY**  
Rochester, N. Y.

**WANTED! BY MILLION DOLLAR COMPANY.** A few high-class County and State Distributors to handle fast-selling automotive product, endorsed and used by thousands of motorists. Powerful newspaper advertising over distributor's name furnished to men who can qualify. Write, The Turbulator Corporation, Dept. B1 2635 So. Michigan Ave., Chicago

### 5 Master Keys

Work like magic in emergencies or prove whether your door or padlocks are burglar-proof. **Open and test thousands of different locks.** Recommended by users in ten different nations. Most wonderful and only keys of their kind. Send \$1 today. Novel key chain FREE with set. **MASTER KEY CO., 2-A Manhattan Block, Milwaukee, Wis.**



## "THE REAL THING" FOR Saxophone Players



### The All-Purpose

**HARWOOD PROFESSIONAL Melody 'C' Tenor SAXOPHONE**

For Solo, Quartet, Band or Orchestra

There's always a Solo or Part if you use the Celebrated Melody 'C' Tenor Saxophone.

Complete with Self-instructor, Position Chart, Extra Reeds, Carrying Strap, and a handsome Finished Case.

Makes Transposing Unnecessary Latest Improved System of Fingering with Single Octave Key, Tone, Tuning and Pitch Guaranteed Perfect. Easy Blowing, Light Weight, Artistically Engraved. All music is the same to the Melody 'C'—it being pitched in the Key of 'C'.

The Best Instrument of Its Kind in America.

All Keys, Styles and Prices in Stock. Write for booklet giving complete Saxophone Information. Easy payments can be arranged.

*Play While You Pay*

**J. W. JENKINS SONS' MUSIC CO.**

Established 1878

938 Jenkins Building  
KANSAS CITY, MISSOURI

### My new plan brings this man

**\$10<sup>76</sup> an hour**

L. G. Spindler of Akron, Ohio, made \$10.76 an hour the first time out! Almost took him off his feet! My men and women are cleaning up all over! **Gust Bergay made \$62.00 in one day!** E. T. Oliver sold \$30 in 2 hours. W. E. Gibson took 69 orders in 2 days. W. H. Marion got 36 orders from 40 calls. Why? The merchandise. It sells itself and you make 100 per cent profit.

### An Amazing Opportunity

I will positively show you the biggest selling profits and opportunities that any manufacturer has been able to offer you. No training. No experience. It's the biggest value they've ever seen—and the merchandise proves it.

### Make \$5,000 a Year

Many are making more! Under my remarkable new plan you go into business for yourself, and with each day your business keeps on growing. Each customer you make remains a customer, and before you know it you have a permanent, sound business that keeps you financially independent.

### Send Me Your Name

Just write me at once for full details of my proposition. There is no obligation—and it will mean real money for you. It's an honest to goodness opportunity! Write me this minute while you think of it. You'll never regret it.

**E. M. DAVIS, Dept. 2396, Chicago**

**E. M. Davis, Dept. 2396, Chicago**

Please send me full particulars of your new sales plan—and proof that there's big money in it.

Name .....

St. No. ....

Town .....

State .....



No. 1-J. G. Grinder

11¢  
a Day

## soon pays for this Grinder

CAN you afford to be without such a sturdy, accurate grinder when its cost per day is so trifling? Making difficult jobs easy. Limits of .0001 are possible with this handy grinder. Perfect balance combined with correct cutting speed eliminates chatter-marks, taper, or bell-mouth. Pivots on its base and is adjustable to any angle. Easily portable for quick set-up on any machine, this DUMORE No. 1—J. G. Grinder is the ideal tool for garages, repair shops and small machine shops.

Write for interesting booklet, specifications and prices.

WISCONSIN ELECTRIC CO.  
Dept. G-10 Racine, Wisconsin

DUMORE HIGH SPEED GRINDERS

## Be A Floor Surfacing Contractor



New uncrowded field. Contractors prefer to sublet floor surfacing to American Universal Contractors. Machine does work of 6 men. Works quickly, easily. We set you up in business of your own. Furnish office forms, advertising, etc.

Make \$5,000 to \$15,000 or More—Yearly

Prepare for big building boom. Make new floors perfect, old floors like new. Every floor a prospect. Big money in old floors. No town too small. Beginners often pay for machines first month with profit beside. Get full information.

THE AMERICAN FLOOR SURFACING MACHINE CO.  
523 So. St. Clair St. Toledo, O., U. S. A.



A Variocoupler  
anywhere on re-  
ceipt of \$2.50

## Manufacturer to Consumer

We manufacture 50  
standard Radio parts.  
Send 2-cent stamp for  
Catalog.



Variometer any-  
where on receipt  
of \$3.25

AJAX COMPANY  
7802 STONY ISLAND AVE.  
CHICAGO

3 SPLENDID SHIRTS  
AND  
3 SILK KNITTED  
TIES for \$3.99

**GUARANTEED \$8 VALUE!**  
Greatest bargain of a lifetime. Shirts are of best colored stripes, made of highest quality percale and madras material, with soft cuffs, finished beautifully. All sizes from 13½ to 17½. Ties are made of finest silk knit material, fast colors, full length, and closely knit to give long wear.

**SEND NO MONEY!**  
Just your name and address, and size of shirts. When shirts and ties are delivered, pay postman \$3.99 plus a few cents postage. Money cheerfully refunded if not satisfied.

**FREE** A dandy pair SNAP-ON CUFF BUTTONS, FREE to the first 500 ordering this great bargain.

Rush Orders Now Mention Size of Shirts  
Send for Free Catalogue of Bargains

PUBLIC TRADING CO.  
404 Fourth Ave., Dept. 250, New York City

## The Hunter's "Oars"

DEPENDABLE as your gun—the Evinrude. With this husky "stern-kicker" to breeze you up the lake to marsh or blind, you're there on the job, fresh and steady, when the earliest flights come over.

Go hunting—not rowing—this Fall.

There are two Evinrude models—the Standard for more rugged service, the popular 50-pound Lightweight for greater portability.

See these Evinrudes at your hardware or sporting goods dealer's. Or write for free catalog describing the Built-in-Flywheel Magneto, Tilt-up Attachment and other Evinrude features

Evinrude Motor Co.  
739 Evinrude Bldg.  
Milwaukee Wisconsin

## EVINRUDE Standard and Lightweight DETACHABLE MOTORS FOR WATERCRAFT

DISTRIBUTORS  
69 Cortland St., New York, N. Y. 119 Broadway, Oakland, Calif.  
780 Commonwealth Ave., Boston, Mass. 211 Morrison St., Portland, Ore.

## NOW ONLY \$2.48

### A Real Phonograph

An actual, serviceable talking machine that plays all records up to and including 10 inches, except Edison. Powerful Spring Motor, Universal Tone Arm and Reproducer. Easily portable. Weighs 4½ lbs.

THIS MACHINE FULLY GUARANTEED  
Order today, add 32c for postage

A. W. POMEAN & CO. 1648 Germantown Ave.  
Philadelphia, Pa.



## SPECIAL CLUB PLAN OFFER—SAVE 30 TO 40%

Get together with your friends and obtain a snappy Ford speed Body and pay only five dollars a week. Oh Boy, Oh Joy! no need of waiting till you save up the full amount of money. Send for our Special Club Offer, Now.

Ford-  
speed  
Bodies

8-16  
Valve Heads, 4 & 6  
Speed Transmissions



Crankshaft Counterbalances  
Wire and Disc Wheels  
Everything for Speed and Power

### SPECIALS FOR THIS MONTH

|                            | Price   | New     | Price                      | New     |
|----------------------------|---------|---------|----------------------------|---------|
| Foot Accelerator           | \$ 2.00 | \$ 2.50 | Drum Head, Light Nickel    | \$10.00 |
| 2½ Gear                    | 12.50   | 4.50    | trimmed with Brackets, pr. | 55.00   |
| 2:1 Gear                   | 12.50   | 4.50    | Brand new Dixie Magneto    | 25.00   |
| Speed and Power Crankshaft | 19.50   | 9.95    | Spiral Gear Magneto Drive  | 25.00   |

A limited number of each at above price. Order Now! Satisfaction or Money Back Guarantee. Terms—30% with order, balance upon delivery.

G. E. FORD SPEED & POWER EQUIPMENT MANUFACTURERS  
250 West 54th St., New York City, N. Y.

Please Mention Popular Mechanics

Copyrighted material

**NEW AUTO SWING** PAT. PEND.

**ONLY \$1 Complete** as illustrated

**MONEY BACK GUARANTEE**

Automatic swinging—the new safe drilling sport for children. Swings without effort—the weight of the hands swing the child. Let your boy or girl have the Auto Swing on

**TEN DAY Free Trial**

**Limited Time Special INTRODUCTORY OFFER**

And our method of placing this new invention for children in the greatest number of homes in the shortest time. Send us your name, address and One Dollar Bill or money order and we will immediately send you one Auto Swing with the privilege of Ten Day Free Trial and Money Back Guarantee. As a special inducement during this month

**We Pay Postage** \$1 is your first, last and only cost! For your kiddies sake mail the dollar and your name and address today!

**AUTO SWING CO.**  
Box 10 PM, NAPPANEE, IND., U. S. A.



## How to Get Rid of Moles



A simple, safe home treatment—15 years' success in my practice. Moles (Also BIG Growths) Dry Up. Ask for Free Booklet of Full Particulars

**WM. DAVIS, M. D.**  
124-5 Grove Ave., Woodbridge, N. J.

**Air-tight** **COPPER CANS** Screw Top.

**FOR GASOLINE AND HOME USE**

Postage & Insurance 50c extra. Chicago & West 75c Extra. Prices on large and special made cans by request. These cans furn. with 1/2 or 1 in. unions. Deposit Required on All C. O. D. Orders. Catalogue free on request

|         |        |
|---------|--------|
| 3 Gal.  | \$4.75 |
| 5 Gal.  | 5.50   |
| 8 Gal.  | 7.50   |
| 10 Gal. | 10.50  |
| 12 Gal. | 12.50  |
| 15 Gal. | 15.50  |

**NATIONAL CAN CO.**  
1826 A J. Ridge Avenue  
PHILADELPHIA, PA.

**DIAMONDS**

**One Year to Pay**  
Prices Cut to the Limit

Genuine perfect cut Diamonds. Prices cut to the limit. Must make room for our Fall stock. At ridiculously low prices we offer you real genuine diamonds. Pay on our special monthly payment plan to meet your pocketbook. You won't miss the money and you can wear the diamond while you pay for it. All correspondence strictly confidential. Nearly 25 years experience as diamond merchants. Send for our easy payment plan today.

**Free** Ask for our new De Luxe catalog which contains hundreds of unusual bargains in all kinds of diamonds, watches and jewelry.

**THE KLEIN WAY—A YEAR TO PAY—WRITE TODAY FOR FREE CATALOG.**

**Klein & Co.** 122 W. Madison St. Dept. 0710 Chicago, Ill.  
Nearly 1-4 century same location

**Use Your Credit**  
No Delay—No Red Tape

**\$400**  
A Month payments will buy this magnificent hand engraved "Lady Lorraine" ring. 14kt Solid Gold. Large Steel-blue white perfect cut Diamond of fiery brilliancy. Was \$100.00.  
Now \$68.00  
Pay Only \$14 Down

**WANTED—**  
for murder!

**\$1,000**  
**Reward!**

In a dirty, forelorn shack by the river's edge they found the mutilated body of Genevieve Martin. Her pretty face was swollen and distorted. Marks on the slender throat showed that she been brutally choked to death. Who had committed this ghastly crime?

Crimes like this are being solved every day by Finger Print Experts. We read in the papers of their exploits, hear of the mysteries they solve, the rewards they win. Finger Print Experts are the heroes of the hour.

**Not Experienced Detectives—**  
**Just Ordinary Men**

Within the past few years, scores of men—men with no police experience, men with just ordinary grade school educations—have become finger print experts. You can become a finger print expert, too. Can you imagine a more fascinating line of work than this? More trained men are needed. Here's your real opportunity.

**Learn Identification Secrets**

More and more the detection of crime resolves itself into a problem of identification. You can learn the methods of the famous identification experts. You can learn the science of Finger Print Identification—right at home in your spare time.

**T. G. Cooke, President**

**FREE** For a limited time, we are making a special offer of a Professional Finger Print Outfit absolutely free and FREE course in Secret Service Intelligence. Mastery of these kindred professions will open up a brilliant career for you. This coupon will bring you FREE book and details of this great offer. Don't wait until the offer has expired. Fill in the coupon now. Mail it today.

**University of Applied Science**  
1920 Sunnyside Ave., Dept. 9357, Chicago

## Not Experienced Detectives— Just Ordinary Men

Within the past few years, scores of men—men with no police experience, men with just ordinary grade school educations—have become finger print experts. You can become a finger print expert, too. Can you imagine a more fascinating line of work than this? More trained men are needed. Here's your real opportunity.

## Learn Identification Secrets

More and more the detection of crime resolves itself into a problem of identification. You can learn the methods of the famous identification experts. You can learn the science of Finger Print Identification—right at home in your spare time.



T. G. Cooke, President

**FREE** For a limited time, we are making a special offer of a Professional Finger Print Outfit absolutely free and FREE course in Secret Service Intelligence. Mastery of these kindred professions will open up a brilliant career for you. This coupon will bring you FREE book and details of this great offer. Don't wait until the offer has expired. Fill in the coupon now. Mail it today.

**University of Applied Science**  
1920 Sunnyside Ave., Dept. 9357, Chicago

## University of Applied Science

1920 Sunnyside Avenue, Dept. 9357, Chicago, Ill.

Gentlemen:—Without any obligation whatever, send me your new, fully illustrated, FREE book on Finger Prints and your offer of a FREE course in Secret Service Intelligence and the Free Professional Finger Print Outfit.

Name.....

Address.....

City & State..... Age.....

Please Mention Popular Mechanics



## Gee Whiz! She Pulls 20 Cars

over the track at full speed—a Lionel Electric Train just like a big transcontinental express.

**WHAT** a pack of fun—the liveliest sport of all! Start off your "Twin-Motor" Locomotive on your Lionel Electric Railroad. You are engineer, conductor, train dispatcher of your own railroad system.

Your Lionel Limited crosses real electric-lighted switches, rings crossing bells, flies over bridges. You can back her up or send her ahead, fast or slow, whenever you wish.

For pulling power, for hugging the track around curves and over switches, for workmanship and long life, Lionel Electric Trains are supreme. For twenty-two years Lionel products have been "Standard of the World." Lionel locomotive and car bodies are of one-piece all-steel construction, hand-enameled and baked like auto bodies, practically indestructible.

With a Lionel Multivolt Transformer you can run your outfit from any light socket or from dry or storage batteries.

The wonderful Lionel line is sold by department, toy, sporting goods, hardware and electric stores. Don't put up with a cheap imitation. Dad and Mother will understand why you want Lionel—insist on having Lionel and you'll be sure of the happiest Christmas of your life.

Send at once for the handsome 40-page Lionel Catalog—chock-full of outfits and every kind of up-to-date railroad accessories.



Lionel Automatic Warning Signal rings when your train approaches a crossing. Complete with special section of tracks.



These Lionel Electric Semaphores are equipped with real electric lights.



Here is a Lionel Electric Lamp Post equipped with two arms and two lights.

THE LIONEL CORPORATION  
52C East 21st Street New York City



**LIONEL ELECTRIC TOY TRAINS**  
& Multivolt Transformers

Please Mention Popular Mechanics



# Hard of Hearing?

## You Can Hear Clearly and Check Its Progress

The one sure way to prevent increasing deafness is to keep the ears alive to sound without strain. In short, to exercise the hearing functions. Thousands write us that their natural hearing has actually improved through using the Acousticon.

Whether it will make you hear clearly is entirely for you to say, for we offer you without obligation, the

**1923 ACOUSTICON**  
for 10 days **FREE TRIAL**  
No Deposit—No Expense

Don't let your hearing grow worse—Don't buy any hearing aid until you have first tried it—And above all things, don't be discouraged until you have tried the Acousticon; for half a million have done so to their entire satisfaction. Write for your free trial today.

**Dictograph Products Corporation**  
1307 Candler Bldg. 220 West 42d St., N. Y. City



## AGENTS-WE START YOU WITHOUT A DOLLAR

Soaps, Extracts, Perfumes, Toilet Goods. Extensive Line  
100% profit. Experience unnecessary. Catalog Free.  
Carnation Company, Dept. 380 St. Louis, Mo.



**U. S. GOV'T. CLERKS NEEDED**  
All men, women, boys, girls, 17 to 60, willing to accept Gov't. Positions, \$117-\$190, stationary or traveling, write immediately—**TO-DAY**.  
Mr. Ozment, Dept. 111 St. Louis



**\$5.00** Makes This  
Down

Genuine  
Diamond  
Ring—  
Yours



Engagement Ring entirely FREE. Ring is 14K. solid gold with 18K. white gold prongs. If satisfied pay only \$5 upon receipt, then send balance, \$4 a month. Price of ring, \$45.



**FREE** Send for your copy of 98-page colored catalog, showing the greatest assortment of DIAMONDS, WATCHES AND JEWELRY—gifts for all occasions. Write to Dept. 62-R. Capital, \$1,000,000

Send no money. We'll send you this beautiful, SWEET Diamond

THE HOUSE OF QUALITY  
CAPITAL \$1,000,000.

**L.W. SWEET INC.**

1650-1660 BROADWAY, NEW YORK

**25c** Brings Big 3 ft. Telescope  
(In 5 Sections)

See people and objects miles away just like they were close, see Moon and Stars as you never did before. Brass bound, useful and entertaining. "Could tell color of aeroplane 4 miles away"—Mrs. Yarbrough. "Watch my boy arrive at school 2 miles away"—Mrs. Bern. "Send numbers on freight cars mile after mile"—A. G. Palmer. Thousands pleased. **SPECIAL OFFER**—send only 25c with order. On arrival deposit \$1.75 with postman. Rent postpaid. Satisfaction guaranteed or money returned. **FERRY & CO., 6832 East End Ave., Dept. 1777 Chicago**

"I trained Womble Telescope on buttes 28 miles away, they looked to be 2 to 3 miles instead."—C. A. Storey, Ft. Robinson, Neb.

**BIG MONEY MAKERS**  
for AGENTS



**SHOCK-PROOF LAMP**, the new unbreakable mill type lamp, is fast replacing the old style. Stronger and gives many times the downward light. As its name implies, it is SHOCK PROOF; stands long and sudden knocks as prevalent in GARAGES, FACTORIES, MILLS, SHIPYARDS, STEAMSHIPS, MINES—yes, even in the HOMES. Lasts longer and is sold for less money. Big money-maker.



**FREE** Send for our AGENTS PLAN and Booklet; fully explaining how easy it is to sell SHOCK-PROOF lamps. Every GARAGE, FACTORY, MILL, RAILROAD YARD, STORE and HOME is looking for just this chance to get a better lamp for less money and to sell your share of BIG MONEY and EXCLUSIVE TERRITORY. GET THE AGENTS PLAN TODAY. IT COSTS YOU NOTHING.

**MIDWEST LAMP CO., Dept. B, 143 W. Austin Ave., CHICAGO**

**Great New**



**Invention**  
for seekers of  
**Health**  
**Power**  
**Beauty**

Elco Health Generators at last are ready for you! If you want more health—greater power to enjoy the pleasures and delights about you, or if more beauty is your desire—write! Ask for the book on these inventions which has just been prepared. It will be sent to you without cost. It tells you how Elco Health Generators aid you in leaving the lethargy and hopelessness of bad health and weakness behind forever. Re-vitalize yourself. Bring back energy. Be wholly alive. Write today!

10 Days Free Trial—Write for Free Book!



These great new inventions generate Violet Ray, Vibration, Electricity and Ozone—combined or separate—price as low as **\$6.85**

They operate on the electric light in your home or on their own motive power at less than 50 cents per year. Elco Health Generators are positively the only instruments which can give you in one outfit Electricity, Violet Ray—Vibration and Ozone—the four greatest curative agents. Send the coupon below. Get the Free Book NOW!



**For All These:**

Paralysis  
Pimples  
Falling Hair  
Headache  
Lumbago  
Nervousness  
Rheumatism  
Sore Throat  
Asthma  
Black Heads  
Catarrh  
Insomnia  
Skin Diseases  
Hay Fever  
Neuralgia  
Deafness  
Pain  
Development  
Neuritis  
Obesity

**Mail Coupon**  
for **FREE Book!**

Do not put this paper down without sending the coupon. Don't go on as you are with pains and with almost no life and energy. You owe it to yourself to be a better man or woman. You were sent here to enjoy life—not just to drag through it. So do not rest another day until you have put your name on the coupon here. That will bring the whole story of these great new inventions. Do it today—now.

**Lindstrom & Company**

442-448 N. Wells Street, Dept. 1357, Chicago, Ill.

Please send me your free book, "Health—Power—Beauty" and full information of your 10-day Free Trial Offer.

Name \_\_\_\_\_

Address \_\_\_\_\_



Please Mention Popular Mechanics

# Get the Manufacturers' Wholesale Prices

No matter where you buy a furnace, range or stove, the order must first go to the factory. Why don't you send your order to the factory and get the manufacturer's wholesale price that means a saving of 25 to 50 per cent? The Kalamazoo plan of selling direct from factory to user has won us over 400,000 satisfied customers. Kalamazoo values this year are greater than ever. A pipeless furnace for \$52.95 and up. Designed by heating engineers; burns any fuel; a size and installation for every home.

## MAIL A POSTAL

And get the new Kalamazoo Catalog. Wonderful offers on handsome new range designs in blue and gray porcelain enamel; finest heating stoves, etc. 30 days' trial; prompt shipments; cash or easy payments. Also get our low prices on furniture, kitchen cabinets, sewing machines, washing machines, dishes, aluminum ware, etc. Ask for Catalog No. 936

Kalamazoo Stove Company Kalamazoo, Mich.

Pipeless Furnaces  
**\$52.95**  
and up—



# "A Kalamazoo Direct to You"

Trade Mark Registered

**Get more for furs**  
Highest market prices—highest possible grading—quicker returns. No commission, spot cash. 20 years in business. Write for Rogers' Dependable Market Report and Price List.



## ROGERS FUR CO.

471 N. Main St., St. Louis, Mo.

## HOW TO GET FREE TRAPS-GUNS-BAITS

**UNUSUAL PREMIUMS to Trappers and Fur Shippers!** Get your Trapper's Supplies Free or at greatly reduced cost. Write today for FREE Catalog and Big List of Premiums. Free Subscription to "Trapper's Exchange," illustrated magazine with advance Fur Market News, Trapping Secrets, Game Laws, Hunting Stories, etc. Best FUR-BEEN starts soon. Higher prices this season for all furs.

**E. W. BIGGS & CO.**  
307 Biggs Bldg.  
Kansas City, Mo.  
Buyers of Raw Furs



SEND NAME TODAY.

## Big Season Ahead! TRAPPERS!

**FUNSTEN BROS. & CO.**  
178 Funsten Bldg., ST. LOUIS, MO.

Please send me Trapper's Guide and other material FREE.

Name .....

Address .....

R. F. D. .... State .....

# WRITE! FUNSTEN

Mail coupon or send a postal and get Funsten's 1923 Trapper's Guide, How to Grade Furs, Game Laws, regular Market Reports, Shipping Tags—all FREE! Catalog lists factory prices on all supplies. Save money! Write Today!

TRAP CATALOG 1923 How To Grade Furs

TRAPPER'S GUIDE FREE

Clip The Coupon!

# TRAPPERS!

## ship to SUMMERFIELD for a square! DEAL!

Get the biggest possible price for this season's catch! Ship us all your furs—you'll get honest grading, and we'll mail your check the day your furs reach us.

**WE CHARGE NO COMMISSION**  
This is our 51st season of square dealing. Ask the oldest trappers—they know us!

Write now for our reliable prices and free shipping tags

**Simon Summerfield & Company**  
"One Reliable Fur House"  
312-314 N. Main St., Dept. 80 ST. LOUIS, MO.

## Bringing Home the "Bacon"

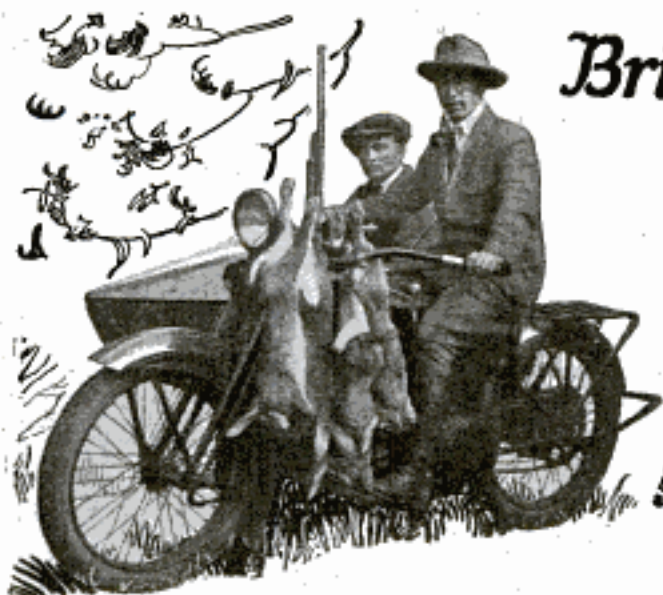

**S**WIFTLY, economically, comfortably, a Harley-Davidson speeds you and your pal anywhere—far from the humdrum of the city, to hidden haunts where the sport hasn't been spoiled by the crowds.

Ten Improvements for 1923, including new brakes and a roller-bearing hub, firmly establish the Harley-Davidson as the standard of motorcycle value.

Reduced prices on 1923 models! Only \$285 for the famous Twin, the luxurious speed-mount that travels 50 miles on a dollar's worth of "gas," oil and tires!

See your dealer for demonstration.  
Write us for new illustrated literature.

**HARLEY-DAVIDSON MOTOR CO.**  
MILWAUKEE, WISCONSIN

## Harley-Davidson

World's Champion Motorcycle

Attractive dealers' proposition  
for unassigned territories.  
Address Desk A-2



1923 Models  
**FINAL PRICE  
REDUCTION**

Taylor  
PRICE 147¢ POSTPAID  
**Fur Getter**

**FREE TO TRAPPERS**

**52 PAGE FUR BOOK**

**WRITE Taylor**

**BEST FOR FIFTY YEARS**

**in ST. LOUIS since 1871**

Get ready now for big trapping season—Fur prices will continue high. Send for new Book of Traps. Bigger and Better than ever this year—many entirely new trapping devices, including the Taylor Fur Getter, which is a Trap Gun—rifle and pistol combined—Smoke Torpedo, New Kompakt Traps, etc. Many new guns shown for the first time—correct shooting positions explained—also trapping laws, trapping methods, traps and baits to use—lists every article the trapper uses at money saving prices. It is the most complete fur book ever compiled for FREE distribution. Do not spend a penny for trapping equipment until you have received the Taylor BOOK OF TRAPS.

**F. C. TAYLOR FUR CO., 860 Fur Ex., St. Louis, Mo.**

Please Mention Popular Mechanics



### CATALOG No. 22 IS READY

Small Steam and Gasoline Engines, 1/2 H. P. up. Pumps, gears, model makers' supplies. Sent postpaid (2 dimes preferred) or 20c stamps.

**Modern Engine & Supply Co.**  
314 Meadmoat Bldg., Chicago



# FOUKE

Trappers: **wants your name and address if you are going to trap or buy FURS**

Write Fouke today—prospects very good. For best results it's important to have constant up-to-the-minute market information. Fouke gives it. Get the jump on the other fellow.

**SEND TO-DAY**

**FOUKE FUR COMPANY**

331 Fouke Building, St. Louis, Mo.  
Put my name on your books for Fouke Market Reports and "The Trapper's Partner," the new book on how to trap and grade furs, game laws, low prices on all supplies—all FREE.

Name \_\_\_\_\_

Town \_\_\_\_\_

State \_\_\_\_\_ R. F. D. \_\_\_\_\_ Box \_\_\_\_\_

# DELTA

## ELECTRIC BICYCLE LAMPS

WITHOUT a dependable light on your Bike, riding after dark is dangerous. Auto traffic is getting heavier daily.

Delta keeps you out of danger by lighting the road ahead and warning passing motorists

No. 80 solves problem of rear red light—complies with all laws. Mounts left side front wheel under axle nut. No. 27 mounts on handle bar.

Ask your dealer or either model prepaid for \$2.25 complete (less Battery.)

**DELTA ELECTRIC COMPANY**

100 DELTA BLOCK  
MARION, IND.



Standard Makers of Electric Lenses, Automobile Flashlights, Bicycle Lamps, Radio Apparatus, Flashlights and all kinds of Dry Batteries.  
New York      Winnipeg      San Francisco

See your dealer for information about  
**RADISCO** Radio Products  
THE RADIO DISTRIBUTING CO.  
Newark, N. J.      U. S. A.

### Wear Absolutely Waterproof Steels



Cost less than leather, wear 3 to 6 times longer, are lighter, easier, stronger. Stop big shoe bills. Eliminate repair bills. Stop foot troubles. Prevent Colds, Rheumatism, Corns, Bunions. Keep feet warm and dry in snow, rain, mud, slush. Never change shape—comfortable always. **FREE Shoe Book Tells All. Write Today.**

**N. M. RUTHSTEIN, President**  
Dept. 35, RACINE, WIS.

STEEL SOLE SHOE CO.,

### Smoke 6 Cigars On Approval



You should buy direct and cut your cigar bill in half—save retailer's and wholesaler's profits. **El Vandoma Cigars sold only on approval plan.**

**GUARANTEED** to be strictly long filler of superior quality—a mild Havana blend. You will thoroughly enjoy their rich, mellow taste. Packed in handsome useful **CEDAR CHESTS**. Just send your name and address on your business card or letterhead.

**YOU MUST BE PLEASED**

50 El Vandoma Cigars (Aristocrat Size) 5 inches long price \$5.00 will be sent post paid. **SMOKE SIX**—if thoroughly satisfied mail us \$5.00; if not, return balance at our expense and you will owe nothing.

Some of our customers prefer to send check, money order or have them shipped C. O. D. If you pay cash and are not pleased, full amount of your remittance will be promptly refunded upon return of the Cigars.

**YOU RISK NOTHING.**  
Order a box today—**NOW**  
**ON THE APPROVAL PLAN**

**EL VANDOMA CIGAR COMPANY, Dept. 504**  
290 Washington St., Brooklyn, N. Y.  
"El Vandoma"—the best cigar in America for the price—bar none."

### YANKEE VIOLET RAYS

Guaranteed to Last a Lifetime With Ordinary Use.

Positively will give beneficial treatment for most ailments and increases blood circulation, stops disease-destroying action and imparts a delightful stimulating effect on the whole body.

**SEND NO MONEY**

Just your name and address, we will send Home Outhit by mail, \$12.50 value—3 days' free trial. Money back if not satisfactory.

**YANKEE LABORATORIES, Inc.**  
113 Fourth Ave. Dept. 318 New York, N. Y.



## Baby Grand Lathes

**FOR METAL OR WOOD**  
**HIGHEST QUALITY—LOWEST PRICE**

A precision machine tool at a price within the reach of everyone, everywhere.

**A Practical Tool For Universal Use**

A dependable, low priced lathe for use by those engaged in light manufacture, model making, experimenting, repairing, etc., as well as the requirements of the amateur, the inventor and the student.

**Ideal For Use in the Home**

Interesting, instructive and profitable employment for your spare time.

**Develop Your Ideas in Private**

Build your experimental models with your own hands.

**Add \$5 to Your Income**

In spare time make salable product, radio equipment, Xmas gifts, etc.

**Lasts a Life Time**

A sturdy machine built for real work.

**Write NOW**  
**For Prices**  
**and Details**

6-in.  
Swing

12 in.  
or  
18 in.  
Between  
Centers

28 in. or  
26 in.  
Bed



**THE WATSON MFG. CO.**  
30 Post Street, Toledo, Ohio, U. S. A.

# Ives Trains



**A**N IVES Railroad System will make any boy smile. The Ives Railroad outfits suit any purse too. They range from \$1.75 to \$50.00. There are spring locomotives that whizz around an "O" gauge track and monster electrics, that operate on standard 2 gauge track which are exact copies of the latest New York Central models. The Ives Railroad Systems have a dazzling variety of bridges, tunnels, switches, passenger and freight stations, signals, and railroad equipment.

Boys can build a railroad, running a spur track to the edge of a pond or brook, ship the freight to a miniature wharf and load it on an Ives merchant ship—an entire transportation scheme all with Ives equipment. No other manufacturer furnishes this complete outfit. It can all be bought in separate units.

Send 10c for our dandy 1922 catalog ablaze with colors, showing Ives Trains and Boats.

THE IVES MANUFACTURING CORPORATION  
196 Holland Avenue Bridgeport, Conn.

## Special \$15 Combination

The Ives Electric Train Outfit 31 inches long, consisting of reversible locomotive with electric headlight, 3 cars with automatic couplers, 14 feet of track station, tunnel, semaphore, danger signal and 6 telegraph poles. If your dealer can not supply you send us the money and we will see that you are taken care of.

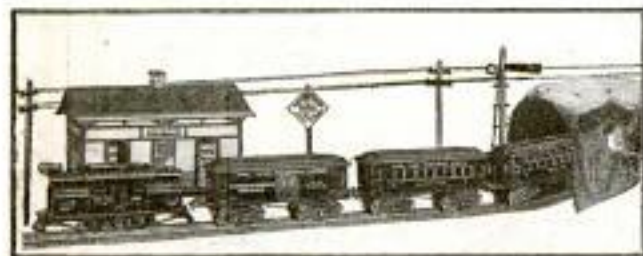

# Ives Toys

MAKE HAPPY BOYS



## \$95 An Hour!

"Every hour I spent on my I. C. S. Course has been worth \$95 to me! My position, my \$5,000 a year income, my home, my family's happiness—I owe it all to my spare time training with the International Correspondence Schools!"

Every mail brings letters from some of the two million I. C. S. students telling of promotions or increases in salary as the rewards of spare time study.

What are you doing with the hours after supper? Can you afford to let them slip by unimproved when you can easily make them mean so much? One hour a day spent with the I. C. S. will prepare you for the position you want in the work you like best. Yes, it will! Put it up to us to prove it. Mark and mail this coupon now!

----- TEAR OUT HERE -----  
INTERNATIONAL CORRESPONDENCE SCHOOLS  
Box 5674-C, Scranton, Penna.

Without cost or obligation, please tell me how I can qualify for the position or in the subject before which I have marked an X:

### BUSINESS TRAINING DEPARTMENT

- |                                                         |                                                 |
|---------------------------------------------------------|-------------------------------------------------|
| <input type="checkbox"/> Business Management            | <input type="checkbox"/> Salesmanship           |
| <input type="checkbox"/> Industrial Management          | <input type="checkbox"/> Advertising            |
| <input type="checkbox"/> Personnel Organization         | <input type="checkbox"/> Better Letters         |
| <input type="checkbox"/> Traffic Management             | <input type="checkbox"/> Foreign Trade          |
| <input type="checkbox"/> Business Law                   | <input type="checkbox"/> Stenography and Typing |
| <input type="checkbox"/> Banking and Banking Law        | <input type="checkbox"/> Business English       |
| <input type="checkbox"/> Accountancy (including C.P.A.) | <input type="checkbox"/> Civil Service          |
| <input type="checkbox"/> Nicholson Cost Accounting      | <input type="checkbox"/> Railway Mail Clerk     |
| <input type="checkbox"/> Bookkeeping                    | <input type="checkbox"/> Common School Subjects |
| <input type="checkbox"/> Private Secretary              | <input type="checkbox"/> High School Subjects   |
| <input type="checkbox"/> Business Spanish               | <input type="checkbox"/> Illustrating           |
| <input type="checkbox"/> French                         | <input type="checkbox"/> Cartooning             |

### TECHNICAL AND INDUSTRIAL DEPARTMENT

- |                                                 |                                                  |
|-------------------------------------------------|--------------------------------------------------|
| <input type="checkbox"/> Electrical Engineering | <input type="checkbox"/> Architect               |
| <input type="checkbox"/> Electric Lighting      | <input type="checkbox"/> Blue Print Reading      |
| <input type="checkbox"/> Mechanical Engineer    | <input type="checkbox"/> Contractor and Builder  |
| <input type="checkbox"/> Mechanical Draftsman   | <input type="checkbox"/> Architectural Draftsman |
| <input type="checkbox"/> Machine Shop Practice  | <input type="checkbox"/> Concrete Builder        |
| <input type="checkbox"/> Railroad Positions     | <input type="checkbox"/> Structural Engineer     |
| <input type="checkbox"/> Gas Engine Operating   | <input type="checkbox"/> Plumbing and Heating    |
| <input type="checkbox"/> Civil Engineer         | <input type="checkbox"/> Chemistry               |
| <input type="checkbox"/> Surveying and Mapping  | <input type="checkbox"/> Pharmacy                |
| <input type="checkbox"/> Metallurgy             | <input type="checkbox"/> Automobile Work         |
| <input type="checkbox"/> Steam Engineering      | <input type="checkbox"/> Navigation              |
| <input type="checkbox"/> Radio                  | <input type="checkbox"/> Agriculture and Poultry |
| <input type="checkbox"/> Airplane Engines       | <input type="checkbox"/> Mathematics             |

Name.....  
Street.....  
Address.....

City..... State.....

Occupation.....

Persons residing in Canada should send this coupon to the International Correspondence Schools Canadian, Limited, Montreal, Canada.

**RADIO****\$15** Down  
\$10<sup>00</sup>  
A Month**Unparalleled Offer**

"SENSITONE" Long Distance Receiving Set, COMPLETE ready to use—no parts to buy.

Just what you have been waiting for—a complete, dependable, easily-operated, long distance Radio Receiving Set, ready to use, at a reasonable price and on easy terms. No shopping around for tubes, batteries and other parts—just put up the wires and you're ready to listen.

For the business man or farmer Radio brings valuable market and weather reports, stock quotations and other business information; and, in the evening, the whole family will revel in wonderful concerts, operas, lectures by highly-paid city talent, bed-time stories for the children—something good for every member of every household from the 310 sending stations in all parts of the U.S.

And, on Sundays, sermons by famous preachers and sacred concerts by great choirs and orchestras.

**Easy Payments****\$15 Down—\$10 a Month**

A Thoroughly Reliable Set, manufactured under the Armstrong License (U. S. Patent No. 1,113,149).

Complete set in a handsome oak cabinet, vacuum tube, A and B batteries, head-set, antenna, insulators and ground wires.

Everything you need; with full directions, so you can set it up and begin listening at once to the good things of the world.

The SENSITONE is equal to any complete set you could buy at \$175.00, yet our price is only \$95.00 and you can pay for it \$15.00 down and \$10 a month, or if you prefer, send \$90 cash. Enjoy it while you're paying for it. Remember, set is complete—with nothing else to buy. You are buying from a reputable concern rated in Dun & Bradstreet or any bank will tell you.

**HAROLD R. WAKEM & CO.**

835 W. Washington Blvd. Chicago, Ill.

Please ship me one complete "Sensitone" Radio Receiving Set as described above for which I agree to pay \$15.00 here and \$10.00 per month until the full purchase price of \$95.00 is paid. Set to remain the property of Harold Wakem & Company until fully paid for.

Name .....

Address .....

**Ingersoll**  
**RELIANCE****\$6** A Fine  
7-Jewel  
Watch

THE RELIANCE is a remarkable watch. A lasting proof of success in applying Ingersoll economy methods in the fine watch field.

Outwardly, as handsome a watch as men wish—the thinnest 16-size, 7-jewel watch made in America. Inwardly, as pretty a 7-jewel movement as any man could ask. It has the same solid bridge-construction you find in expensive watches. A thoroughbred, and looks it.

**Ingersoll Yankee** \$1<sup>50</sup>

EVERYONE should have a Yankee—the sturdy, reasonable, reliable, best-known watch. Nearly everyone has.

**350 SHOT AIR RIFLE**

Automatic Repeater, with lever action. Shoots 350 times without reloading. A powerful, accurate air rifle—guaranteed to give satisfaction. Beautiful walnut finished stock, nickel plated one-piece barrel and slides—31 $\frac{1}{2}$  inches long. Send name and we will send you 12 art pictures to dispose of on special 25c offer. Remit the \$3 you collect and we will send you this 350-shot Air Rifle. This is a wonderful offer.

**C. M. THOMAS, 337 W. Madison Street, D91.****CHICAGO, ILLINOIS, U. S. A.****FREE**



**Brighten-Up  
Your Dining  
Room**

**For Only 20c a Day**

Complete suite if you wish in American Walnut, same design as this Queen Anne China Cabinet. Our latest 104 page Larkin Book of Better Homes shows 1200 other equally attractive offers. All on easy—monthly payments. Let this FREE Book help you as it has thousands of others to furnish your home. Check below offer interested in.

**LOWER PRICES NOW ON**

- Furnishings       Symphonic Player Pianos  
 Symphonic Pianos       Symphonola Phonographs

(Check offer and mail ad Today)

Let us quote our money-saving Factory-to-Family prices on these Furnishings and famous Musical Instruments.

**1 TO 4 YEARS TIME TO PAY**

Mail this ad—check Offer—and give full name and address NOW for Big FREE Book.

*Larkin Co. Inc.*

Desk FPM-1022      BUFFALO, N. Y.      Peoria & Chicago, Ill.

**9 CORDS IN 10 HOURS**



BY ONE MAN. It's KING OF THE WOODS. Saves money and backache. Send for FREE catalog No. B115 showing low price and latest improvements. First order gets agency. Folding Sawing Machine Co., 1005 East 75th St., Chicago, Ill.

**\$4.50 Guns for Brush Hunting**



Famous  
U. S. Cal.  
45-70

rebored smooth, to shoot Bird shot, total length 41 inches, weight 7 lbs. \$4.50  
Bird shot cartridges for the above 3c each.

Rifle Barrels interchangeable for above . . . . \$2.00  
Bags for School books . . . . . 55 cts.  
U. S. Army Krag Rifle, like new . . . . . \$15.00  
U. S. Drab felt campaign Hata, used . . . . 40 cts.

Send for Catalogue

**W. Stokes Kirk**      1627-P.M. N. 10th St.  
Phila., Pa.

# How to Invent

Edison Says "Invention is a Science and should be taught as a Profession"

## One Idea May Win You a Fortune

**T**HOUSANDS of inventions are needed today. Just one little idea can bring you fortune and fame. The world is waiting for new inventions in engineering, chemistry, household articles, radio, and other fields—and will pay big money for even the simplest idea. Little



things like the tin bottle cap, the crimped hairpin, the rubber on the end of a pencil brought their inventors hundreds of thousands of dollars.

Couldn't you make some equally simple invention? Haven't you ideas that could be turned into money? Inventing isn't a matter of blind luck—it isn't a question of guesswork. Invention is based on certain principles, just as any other profession. It follows a definite course of procedure step by step from the origination of the first idea to its final development on a commercial scale.

## Learn at Home in Spare Time

Hitherto, every inventor had to work out these principles of invention for himself. For every successful inventor knows and uses these principles. He knows **WHAT TO INVENT** and **HOW TO INVENT**. But now you can learn in a few months what it took great inventors years of discouragement and terrific struggle to acquire. Fifteen famous inventors have now revealed, for the first time, the secrets of invention. They explain how to originate ideas, how to develop and perfect your ideas, how to patent your inventions, and how to sell them to your best advantage. In short, they make it amazingly easy for you to become an inventor, simply by learning the whole wonderful science of invention, step by step, from beginning to end. It requires just fascinating moments of your spare time at home.

## First Course of Its Kind

This is the first course in practical invention that has ever been devised. Now you can take Edison's advice and actually learn **HOW TO INVENT**—how to make invention a profession! In simple, easy-to-understand language, you are told how successful inventors work; you learn how to use the secrets of invention that convert a simple little idea into money.

# FREE New Book on Inventive Science

A wonderful new book has just come from the press that tells all about the Science of Invention; that shows how great inventors work, how little ideas have made fortunes. Now you too can easily learn the secrets of successful invention. This fascinating book will be sent free to all those who are genuinely interested. Send for this book today, as only a limited number are available for free distribution. Write your name and address on the coupon below, or send a post card NOW! There is no cost or obligation.

**BUREAU OF INVENTIVE SCIENCE**  
Dept. 310 Wisner Building, Rochester, N. Y.

Bureau of Inventive Science,  
Dept. 310 Wisner Building,  
Rochester, N. Y.

Please send me your free book, "The Science of Invention."

Name .....

Address .....

City ..... State .....



**Build up your  
Body**

# Ra-Tone The Electric Tonic

**The Perfected  
VIOLET RAY**

Have you ever seen a faded, dying plant revive when brought from darkness into sunlight? Have you noted how you can almost see the pale leaves take on new color;—see them cease drooping and turn their face toward the sun;—see the entire plant resume its former sturdy, vigorous appearance?

Do you know that the human body will respond just as quickly—just as vigorously—to the stimulation of high-frequency electricity as the plant does to sunlight?

## Strengthens Entire Body

When the bulb is applied to any part of the body, the strengthening current instantly penetrates to the deepest cells and tissues. There is no shock, no pain, but you feel a warm, reviving stimulation that brings new life to every cell, floods the treated part with warm, fresh blood, and brings a feeling of strength and well being that cannot be described.

## Rebuild Your Health

Nature overcomes the weakness or disorder. More than 100 troubles are successfully treated. New tissues are built, aches and pains banished, nervousness overcome and the parts treated are developed as they should be.

Our big free book—written in simple language but in a scientific way—tells just what results can be expected in every common disorder. It gives detailed treatment for each ill. Send for your copy today and learn how you can gain buoyant health and a well developed body.

**RA-TONE ELECTRIC CO.,** 1010 Park Place W.  
Detroit, Mich.

Sales agents and distributors write for our attractive proposition

**Big Book sent FREE**



## Treat Yourself at Home for—

**Abscesses Anaemia  
Asthma Baldness  
Brain-Fag Catarrh  
Dandruff Eczema  
Falling Hair  
Female Complaints  
Goitre Gout  
Insomnia Lumbago  
Nervousness  
Neuritis Neuralgia  
Paralysis  
Pimples Rheumatism  
Sciatica Skin Diseases  
Weak Eyes Wrinkles**

**Build Health,  
Strength and Beauty**

# Bam-Bee-No

**Real Baseball**

Played on any table  
anywhere. Ask your  
dealer, or write

The Hambezzo  
Sales Co., Dept. G102  
Toledo, Ohio

## 2 LIGHTS in 1

**For Outdoors!  
For Indoors!**

Two hundred candle power—a powerful white light many times more brilliant than gas or electricity. A handy lantern—a beautiful reading lamp with shade. Hang it up—set it down. Use it early and late for every "chore." Carry it in your car. Ideal for camping, fishing, etc.

### The Combination HANDY LITE

Lights with matches—no torch. Burns common gas-line. Burns without flicker in strongest winds. No wick trimming. No smoking. No spilling or danger if tipped. Safe, simple, serviceable. Takes less space than an ordinary wick lamp and gives light of twenty! Nickled brass—a beauty!

### Special Agents Price

—to introduce into new territory. A big seller! Use sprays. Also wicks. Ask for details. Will order money-back guarantee. Write quick for Agents Price. Address Dept. 310.

**ENTERPRISE TOOL AND  
METAL WORKS**  
126-128 So. Clinton St.  
CHICAGO



## PRACTICAL AMATEUR WIRELESS STATIONS

An experience book containing the best suggestions of 33 experimenters on building, installing, and operating experimental stations for radio communication. 136 pp. 6x9. Illustrated. 75 cents, postpaid.

Popular Mechanics Book Dept., 6 N. Michigan Ave., Chicago

## Tires with 500 Nail Holes Leak No Air

Mr. N. E. Coats of the Milburn Puncture Proof Tube Company of Chicago has invented a new puncture-proof inner tube which in actual test was punctured 500 times without the loss of any air. It greatly increases your tire mileage. Many users have run from 10,000 to 12,000 miles without removing this wonderful tube from the wheel, and the beauty of it all is that this new puncture-proof tube costs no more than the ordinary tube and makes riding a real pleasure. Wonderful opportunity for agents. Write today. Simply send name—a postcard will do. Address

**N. E. COATS**  
333 West 47th Street, Chicago, Illinois

## YOU'LL LIKE "LYON" BODIES THESE

**For Fords, Chevrolets and Dodges**



**Because—**

They are snappy, roomy and built of good sturdy materials. They are low priced and are shipped direct from the factory. Send immediately for our completely illustrated body and accessory catalogue containing unlimited bargains.

**AUTO TIRE SALES CO., Dept. P.** Auto Division  
1346 S. Michigan Ave. Chicago





## Tobacco Is Hurting You

Look at the facts square in the face, Mr. Tobacco User. You may think tobacco is not hurting you.

That is because you haven't as yet, perhaps, felt the effects of the nicotine poison in YOUR system. For you know that nicotine, as absorbed into the system through smoking and chewing tobacco, is a slow working poison. Slow, yes—but sure.

Tobacco is lowering your efficiency. It slows a man down. Makes it harder for you to concentrate your mind on your work. You haven't near the amount of "pep" and energy you would have if you stopped using it. There's many a man twice as old as you in years who's twice as young in energy, simply because he lets tobacco alone.

Some day you will realize to what an alarming extent tobacco has undermined your system.

When your hands begin to tremble—  
and your appetite begins to fail—  
and your heart seems to "skip a beat" now and then—  
and slight exertion makes you short of breath—  
then you have a right to suspect that  
**TOBACCO** is getting the upper hand.

Any well-informed doctor will tell you that these are only a few of many symptoms of tobacco poisoning.

And YOU know that the use of tobacco in any form is an expensive, utterly useless habit. You know you ought to quit.

## Tobacco Habit Banished Let Us Help You

It doesn't make a particle of difference whether you've been a user of tobacco for a single month or 50 years, or how much you use, or in what form you use it—whether you smoke cigars, cigarettes, pipe, chew plug or fine cut or use snuff—**Tobacco Redeemer** will positively remove all craving for tobacco in any form in a very few days. Not the slightest shock to the nervous system. Your tobacco craving will usually begin to decrease after the very first dose—there's no long waiting for results.

**Tobacco Redeemer** contains no habit-forming drugs of any kind and is marvelously quick, scientific and thoroughly reliable.

It is in no sense a substitute for tobacco. After finishing the treatment you have absolutely no desire to use tobacco again or to continue the use of the remedy. It helps to quiet the nerves and make you feel better in every way.

**Results Guaranteed** A single trial will convince you. Our legal-binding, money-back guarantee goes with each full treatment. We will refund every cent you pay for the treatment if after taking it according to the easy-to-follow directions, it should fail to banish the tobacco habit completely.

**SEND Coupon for Free Proof** Let us send you our free booklet on the deadly effects of tobacco, together with testimonial letters from men all over the country telling how they have been absolutely freed from the tobacco habit by this simple home treatment. You could not ask for stronger proof that **Tobacco Redeemer** will free you from the habit than the evidence we will gladly send on request. Just mail the coupon—or a postal will do.

**NEWELL PHARMACAL CO.**

Dept. 300

St. Louis, Mo.



## Free Book Coupon

**NEWELL PHARMACAL CO.**

Dept. 300

St. Louis, Mo.

Please send, without obligating me in any way, your free booklet regarding the tobacco habit and proof that **Tobacco Redeemer** will positively free me from the tobacco habit or my money will be refunded.

Name .....

Street and No. ....

Town..... State.....



## "Yes sir—I'm proud of this Stevens"

**S**OUNDS a little boastful, perhaps; but still, you know, this Stevens certainly does shoot.

You see, the real value of a rifle depends upon its accuracy. And Stevens shines when it comes to accuracy. A Stevens certainly slings a bullet mighty hard and true.

Hold a Stevens barrel up to the light and take a peep through it. Smooth, isn't it? Not a flaw—that barrel is accurate. There's a good reason, too.

When a Stevens rifle is drilled, the final cutting cuts away less than *one half of a thousandth of an inch*. It's slow work—but a Stevens rifle shoots true.

And Stevens turns out these sturdy, accurate rifles at prices that you can afford. Just look at the prices of the two rifles shown on this page.

Ask at your dealer's or write for the interesting catalog describing our complete line of rifles and shotguns.

**J. STEVENS ARMS COMPANY**  
Department J-263      Chicopee Falls, Mass.

Owned and operated by the Savage Arms Corporation  
Executive and Export Offices: 50 Church St., New York

Retail price—including tax, \$9.85. Stevens "Favorite," 24-in. barrel take-down; .22 long rifle, .22 short, .25 Stevens and .32 long rim-fire. Other models ranging in price from \$5.40 to \$23.50.



Retail price—including tax, \$15.00. Stevens "Visible Loading" .22 caliber Repeater. You know when it is loaded and you know when it is empty.

# Stevens

Please Mention Popular Mechanics

## EASY FOR YOU TO OWN A FINE INSTRUMENT!

**Y**EARS ago the famous King Brass Instruments were sold only for cash to famous musicians. But now due to our easy payment plan anyone can own one of these wonderful instruments.

### SAVE MIDDLEMAN'S PROFITS

Simply order direct from the factory. You save middleman's profit—and you get a fine, new, sound-laboratory tested, acoustically perfect King Instrument. With it goes our guarantee plus free factory-service.

### IT'S EASY TO OWN A KING

Rebuilt instruments, refinished to look like new, we sell for cash at low prices. New instruments on the easy payment plan. Thus it's "easy to own a King". Send for our latest complete catalog and list of special bargains.

**THE H. N. WHITE COMPANY**  
5211 Superior Avenue      Cleveland, Ohio



## 5 Master Keys

Work like magic in emergencies or prove whether your door or padlocks are burglar-proof. **Open and test thousands of different locks.** Recommended by users in ten different nations. Most wonderful and only keys of their kind. Send \$1 today. Novel key chain FREE with set.

**MASTER KEY CO.**

2 MANHATTAN BLOCK

Milwaukee, Wis.



## AN EASY SHAVE FROM A KEEN EDGE

Every man wants a comfortable shave; every man can have it. In two minutes any man can put as keen an edge on his razor as a barber can, or a better edge on his safety razor blades than when new.

### The Mercury Edgemaker

gives a lifetime of clean, easy shaves regardless of beard or style razor used. Made from finest horsehide and shell cordovan, specially tanned and finished. Not an ordinary razor strop, but a real edgemaker. Makes a keen edge and keeps it. Cannot harm the finest razor. The achievement of thirty years of strop making. Thousands of satisfied users.

### Sharpens All Razors and Blades

Mercury Edgemakers are made in three styles. Style C-1 for straight razors, \$2.00; Style E-1 with bladeholder for all safety blades except AutoStrop, \$1.50; style F-1 for AutoStrop only, \$1.50. Postage prepaid.

### Sold On A Money-Back Guarantee

Send today for style Mercury you need. Try it exactly as directed. If it doesn't give you the easiest shave you ever had, return it and we will refund your money without question. Insurance Policy Against Dull Razors attached to every Edgemaker. Send today; our guarantee protects you. Write for descriptive circular if you prefer.

### Big Money For Mercury Men

Wonderful possibilities for business, exclusive territories. If you want to make REAL MONEY, here's your chance. Others are doing it. Write today for copy of "The Story of the Mercury Men." There's profit in it for you. ACT NOW!

**THE MERCURY MFG. CO.**  
110 Mercury Bldg.,  
Adrian, Mich.

MERCURY EDMAKERS SHARPEN ALL RAZORS

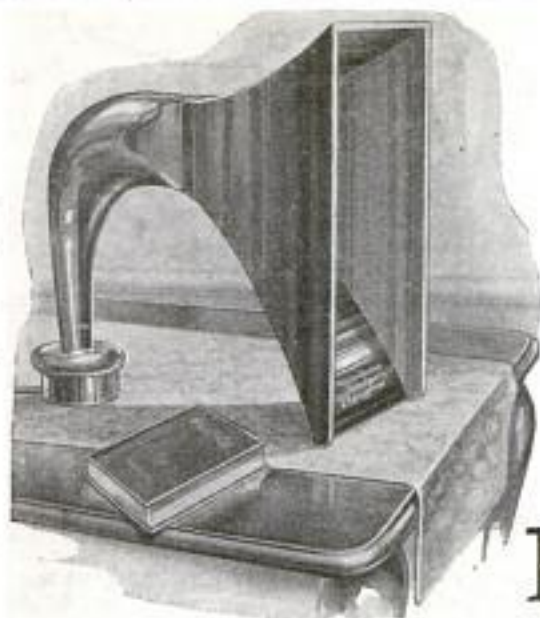

### Unequaled Low-Priced Offers

- The Master-Baldwin "Throatype" Clarophone, complete** Described below **\$22.50**  
**The Master-Baldwin Head Phone** **\$ 9.00**  
 The new and improved Baldwin Phone. Is sufficient for all except code work. One does the work of two ordinary phones.  
**The Baldwin Head-Set** - - - - **\$16.00**  
 The standard supersensitive head-set for those who want the double phone.

## This Amazing Radio Feature

means radio enjoyment for the entire family  
at a price within the reach of all

**YOU** who know radio equipment know the Baldwin Phone. You know its war record. The Government commandeered the Baldwin factory during the war to assure Baldwin Head-Sets for War Vessels and Army and Government Stations.

Where exacting work is done there you find Baldwins.

Now this amazing phone is available to the public in the *Master-Baldwin "Throatype" Clarophone*, the newest and most perfect speaker.

### A Clearspeaker

The *Master-Baldwin* is not a so-called 'loud' but rather a *clearspeaker*, which enables a roomful of people to hear every word or note. —hear perfectly every sound, every overtone, even the harmonics. No rasping, buzzing, breaking or any noises save those caused by your receiving set.

—hear clearly and distinctly throughout the average size room any broadcasting that your set will pick up.

No changing of a head-set from one to another. No one misses part of the program.

Now you can really enjoy radio with the *Master-Baldwin "Throatype" Clarophone*.

### Two Secrets of Its Perfection

One secret of this instrument is a marvelous mica disk, unaffected by heat, cold or electric current, which is actuated in both directions by an armature tone-arm superimposed in a magnetic field.

The other is a specially designed speaker, which follows almost exactly the shape of Caruso's throat.

And its rectangular mouth follows the principle which opera singers know and use to get full resonance from the roof of the mouth.

So the *Master-Baldwin "Throatype" Clarophone* follows scientifically a perfect model. It gives you the best from your receiving set.

### \$22.50 — An Amazing Price

The wonderful Clarophone costs but \$22.50 complete. So everyone may have one.

Simplicity of design and large scale production account for this revolutionary price on an instrument which is the highest quality the world affords.

### Try It at Our Risk

We make you the judge. Test it 10 days. Attach it to your set. Compare with others. We know you will be delighted. If not pleased, return it to your dealer and get your money back.

Ask your dealer for the *Master-Baldwin "Throatype" Clarophone*.

If he hasn't it order from us, inclosing \$22.50. We'll ship your Clarophone immediately, charges prepaid. (Reference: Citizens National Bank, Los Angeles, Calif.) Know the real joys of radio. Get this necessary equipment at once.

### Master Radio Corporation

Dept. 4010, 631 So. Spring St., Los Angeles, California.

## The Master-Baldwin "Throatype" Clarophone

**Master Radio Corporation.** Dept. 4010, 631 So. Spring St., Los Angeles, California. *Send this if your dealer cannot supply you.*

Enclosed is \$22.50 for one *Master-Baldwin "Throatype" Clarophone*, charges prepaid. My money will be refunded if I return the instrument within 10 days to you, in case I am not satisfied. I buy my radio equipment from

(Dealer's Name) .....

(Address) .....

(Your Name) .....

(Address) .....

# Air-Way Radio

## A Wonderful New Source of Home Pleasure and Profit

"Listen-in" at home with an "AIR-WAY" to the latest news of the world, music of wonderful artists, church services, lectures by famous men and women, weather reports, market quotations on stocks, bonds, cattle, sheep, hogs, grains and crops. Give your children entertainment—college extension courses, over the easily-installed wireless telephone. All these priceless advantages are broadcasted daily without a penny of cost to you. It is all within your range, no matter where you live, if your home is equipped with "AIR-WAY" Radio.

### Complete Sets or Easily-Assembled Parts of Guaranteed Quality



AIR-WAY Model "B" Complete Receiving Set. Long-distance vacuum tube outfit—detector and one-stage amplification.

"AIR-WAY" Green Seal Radio equipment represents the highest quality and latest in radio development—assures certain satisfaction in operation and reception of radio messages. With an "AIR-WAY" outfit you are capable of "tuning-in" to your choice of broadcasting stations. Pick up anywhere, any time, during day or evening, miracles in the air. Anyone can operate it. As simple to use as a telephone. Costs less than a good phonograph—more valuable to you and your family than an automobile.

## FREE RADIO BOOK

Illustrates and completely describes "AIR-WAY" Green Seal Guaranteed Radio Equipment. Tells you best parts to use in building your own set or how to buy a complete long-range outfit at an amazingly low price. You need this book to intelligently select the most perfect operating equipment for Radio Receiving. Send name and address for it, today. It's FREE.

**Air-Way Electric Appliance Corporation**  
Dept. R-101 Toledo, Ohio

Look for this Guarantee Tag attached to every Radio Instrument you buy. The AIR-WAY Green Seal Guarantee Tag attached to a Radio Instrument is the symbol of quality that is known and preferred by experienced Radio Buyers.

**Air-Way GREEN SEAL GUARANTEE**

## NEW WITTE KEROSENE LOG SAW

**Runs Steadier  
Cuts Faster  
More Power  
EASIER To Handle  
Burns Kerosene  
or Gasoline**

Saws  
'Em  
Down—  
Cuts  
'Em  
Up



Our  
Big  
New  
Outfit

New  
Price

**\$99<sup>50</sup>**  
F.O.B.  
K.C.

Built for  
Men Who Need  
A Rapid-Cutting  
Money-Making Log Saw

Portable and Easy to Operate. Use engine also to pump, grind, buzz wood, or do other belt work. Comes all set up ready to use.

**Only Log Saw Sold On LIFETIME GUARANTEE—Cash or Easy Terms**

**See What You Get**—Special 4-cycle Log Saw Engine—More power than needed—Less weight—Lever controlled clutch—Double arm swing motion and other valuable WITTE improvements. Users say: "Cut 30 cords hard maple in 8 hours"—"Downed 60 trees in 7 hours"—"Best on market"—"Runs smooth"—"Works fine". If that is the kind of a rig you want, write us. CATALOG FREE.

**WITTE ENGINE WORKS**  
1745 Oakland Avenue, KANSAS CITY, MO.  
1745 Empire Building, PITTSBURGH, PA.

## ANY BOY CAN BUILD THIS 20" CAT BOAT

with our complete Construction Set.

"Everything but the paint"

**\$5<sup>00</sup>**

We have other boats, engines, boilers, etc.

Catalog Free

The H. E. Boucher Mfg. Co.  
154 Lafayette St., New York

## UNION TOOL CHESTS

### Built for Service

Mechanics like Union Tool Chests because they are built as well as their tools. Made from substantial, durable material. Everyone who works with tools needs one. Write for illustrated literature, or ask your hardware dealer to show you his assortment.



**UNION TOOL CHEST CO.**

22 Mill Street Rochester, N. Y.

# 60% of Market Price

will buy

## Diamonds here



**\$42.65**

3/4 - 1/16 Ct.  
Perfectly Cut



**\$275**  
1 1/2 - 3/4 Ct.  
Blue White



**\$69.00**  
3 Ct. Show Center



**\$195**  
White Gold  
Large Diamond

**\$50.00**  
1/2 ct.  
White Gold



**\$250**  
1 1/2 - 3/4 Ct.  
Blue White



**\$45.00**  
Colored Center



**\$98.00**  
American  
Flowercut

**\$57.00**  
All Platinum  
Wedding Ring



## Why Pay Full Prices Costs Nothing to See

This famous 75-year old firm — the Largest and Oldest Diamond Banking Institution of its kind in the world — must sell the diamonds on which we loan money. This firm rated highest, at over \$1,000,000.00 capital, having made loans on diamonds, watches, other jewels in unpaid loans and other special advantage bargains that we must sell to get back our cash. Buy here where loan values the price basis, not market values. Send now for bargain list.

### FREE—On Approval! The Buys of a Lifetime!

The diamond bargains pictured here are merely a few of the many unusual offers on our lists, all with full and complete descriptions. At our risk—we send you any bargain you wish for Absolutely FREE Examination. No obligation. Compare it carefully, have it valued any way you wish. If you decide not to buy, you are not out one penny.

### As Low As \$60 Per Carat

Not all, but some. Yes, some even lower priced, but also diamonds of finest qualities at higher per carat charges. Get a diamond now around half its market price.

## Send for Latest List of Diamond Loans

Unlike the ordinary catalog. Hundreds of Diamond Bargains described in full detail with exact weight, color, quality, etc. You know what you're buying before you buy. Besides it tells of Guaranteed Loan Value, unlimited exchange privilege at full price paid, and complete details of free examination offer.

### Use Coupon NOW!

We'll send our latest Bargain list. It's free. No obligation. No expense to you. Write Now!

**Jos. De Roy & Sons**  
1991 De Roy Building  
Only Opposite Post Office,  
Pittsburgh, Pa.

References by permission:—  
Bank of Pittsburgh—N.  
A. Marine Nat'l Bank  
—Union Trust Co.,  
Pittsburgh, Pa.  
Your bank can  
look us up in mer-  
cantile agencies.

**Jos. De Roy & Sons**  
1991 De Roy Building  
Only Opposite Post Office  
Pittsburgh, Pa.

Gentlemen: Please send me free and prepaid, your latest bargain list of diamonds, watches and other jewelry. It is understood I assume no obligation of any kind.

Name \_\_\_\_\_

Address \_\_\_\_\_

### Guaranteed Cash Loan!

Diamonds bought here are like insurance policies. You know what you can receive before you decide to buy—SEE OUR CASH BACK GUARANTEE!



# BIG PROFITS FOR STATE AND LOCAL DISTRIBUTORS



## THE BRUNO TWO WIRE TIMER— HAS ONLY TWO WIRES AND ONE MOVING PART!

The most efficient timer on the market—every car owner can see its possibilities at a glance. Dealer everywhere report rapid turnover and big margin of profit. Guaranteed for one year. New timer may be obtained at end of year by sending used model and one fourth of purchase price. The fastest selling accessory on the market.

**WANTED STATE ORGANIZERS**—Are you a salesman—better than the average—and have you had experience in organizing sales forces; or before you have the ability, energy and force to create, maintain and finance a state organization, then write us your reasons for believing you are one of the men we want. **OUR PROPOSITION WILL PAY \$15,000 to \$25,000 ANNUALLY TO A GOOD MAN WHO CAN HANDLE A STATE.** We are rapidly completing our Sales Organization by States. Your State may not yet be closed. If you want to join a progressive, responsible organization and are big enough to handle a state, write today.

Send to your name and address and an illustrated circular fully describing the BRUNO TIMER will be mailed you free. A post card will bring it. Do it now.

THE BIGELOW BRUNO MFG. CO., 537 So. Dearborn St., CHICAGO, ILL.

## AGENTS FOR TERRITORIES

We want an agent to represent us in your territory. Every person who drives a FORD should have a BRUNO TIMER. An intelligent presentation sells it. Any one who examines and observes its merits, wants to keep it. That's how easy it is to sell. **AGENTS WITH ENERGY CAN EARN FROM \$10.00 to \$20.00 PER DAY.** If you are a good salesman—or believe you can develop into one—and are earnest in your desire to get into something that pays you more than you are earning, write us **DO IT TODAY.**

## "WITTE Power-Lite"

All the POWER You Need  
All the LIGHT You Want



Low Cost

Ready to Attach  
to Your  
Wiring

In our new "Power Lite" outfit we provide a specially built, Throttling Governor Electric Light Engine, connected to a 700-watt generator and 16-cell battery, making a practical Power and Light Outfit for farm and suburban homes. Besides running generator to charge battery, engine will operate cream separator, washing machine, churn, feed grinder, air compressor, pump, wood-saw or lineshaft.

**SAVE \$50 TO \$100**

You can operate engine on Kerosene, Distillate, Gasoline or Gas—run your machinery direct from engine—use battery for lights. Costs much less to install—more power. Plenty of light for house and barn—easy to operate. For particulars and prices, address,

**WITTE ENGINE WORKS,**

174 Oakland Avenue, KANSAS CITY, MO.

174 Empire Building, PITTSBURGH, PA.

174 Fremont Street, SAN FRANCISCO, CAL.

## Learn Drafting

Individual study at home may be successfully engaged in with the aid of our new enlarged book **A Practical Course in Mechanical Drawing** Cloth. 160 Pages. 157 Drawings. Price, 50c Postpaid. POPULAR MECHANICS BOOK DEPT., 75 East Madison St., CHICAGO

## MEN WANTED

to call on garages, stores, factories, schools, hotels, homes, auto owners and demonstrate and take orders for new

### Super Fyr-Fyter

Approved by Underwriters, makes spectacular demonstration. Sells easily. Blak made \$59.60 first week. DePries has averaged \$7,000 per year for last 3 years. We can train you, without cost, so you can do as well or better. No experience necessary. Write at once for free details showing how you can earn \$2,000 to \$10,000 a year.

**THE FYR-FYTER COMPANY**  
1103 Fyr-Fyter Bldg. Dayton, Ohio



**HUNTERS, TRAPPERS**  
Hit the vital spot with your first shot? Learn how from our book "Game and Target Rifles." Hundreds of rifle hints. Sent Free with 3-month introductory subscription to America's most popular hunting, trapping and dog magazine. Send 25c today.

**SPORTSMAN'S DIGEST PUBLISHING CO.**  
3543 Butler Bldg. Cincinnati, Ohio

**SPORTING GOODS CATALOG** Contains over 2000 Army, Navy and Sporting Goods Specials. Winter Clothing and sporting goods at genuine bargains. Ask for catalog 112 **FREE**  
**RUSSELL'S (Incorporated)**  
245 West 42nd Street Formerly Army and Navy Store Co., Inc. New York

## HOW TO MAKE DEVICES FOR OUTDOOR WINTER SPORTS

Motor-Driven Sleds—Ice Yachts—Coasting Bobsleds and Toboggans—Snow Speedsters—Skis and Ski Running—Air-Propelled Sleds and Ice Boats—Airplane Ski Gliders, etc.

64 Pages. Price 25 cents, postpaid.

Popular Mechanics Book Dept., 6 N. Michigan Ave., Chicago.

### No. 1 Outfit

1 Letterograph Large or Small  
2 Pens  
Copies and instructions (4 Sizes of Letters)  
**\$3.50**

## LETTERING MADE EASY

THE LILLY LETTEROGRAPH  
GUIDES THE HAND IN FORMING LETTERS

Used by Leading Technical Schools and Engineering Corporations.

**DURO METAL PRODUCTS Co.** 360 E. GRAND AVE., CHICAGO, ILL.  
DEPT "C" (LETTERED WITH THE LETTEROGRAPH)

### No. 2 Outfit

2 Letterographs  
3 Pens  
Copies and instructions (6 Sizes of Letters)  
**\$6.50**

**CLEARED MORE THAN  
\$1500  
THE FIRST YEAR!**

**T**HAT'S what Mr. W. O. Hopkins did—selling BUTTER-KIST Popcorn. Many are making much more. Do what he and hundreds of others are doing. Install a BUTTER-KIST Popcorn Machine in unoccupied space in your store. Takes up only a few square feet of space.

The famous BUTTER-KIST Popcorn Machine manufactures Butter-Kist Popcorn and sells Roasted and Salted Peanuts. Just the treats that appeal to all classes of people.

The BUTTER-KIST Machine makes its own profits. And *more*—it actually pulls trade. Let the people that come in your store, smell the fresh fragrance of BUTTER-KIST Popcorn and they'll buy it. Because people do like popcorn—especially the kind that's made by BUTTER-KIST Machines.

And profits? Out of every dollar's worth you sell you keep 60 to 70 cents! And you can sell many dollars' worth each day. People come back for more. BUTTER-KIST Popcorn actually develops regular customers. They like its delicious taste—its toasty flavor. All this means profits—and profits mean less worry about the rent. Write for the BUTTER-KIST Easy Payment Plan.

**HOLCOMB & HOKE MFG. CO.**

*World's Largest Manufacturers of Popcorn  
Machines and Peanut Toasters*

2110 Van Buren Street

Indianapolis



**BUTTER-KIST Popcorn  
"America's Oldest Treat"**

*The coupon, filled in, will start you on the road to Quick Profits. Get a "Location Survey." It tells you how much you can make in your particular location. We'll send you the information.*

*Send in the Coupon Today.*



HOLCOMB & HOKE MFG. CO.,  
2110 Van Buren St., Indianapolis, Ind.

Please send me, without obligation on my part, your free Butter-Kist book, "America's New Industry." I also want the Location Chart which I will fill out and return to you.

Name

Address

City and State

Business

**BUTTER-KIST POPCORN AND PEANUT MACHINES**

*The Motorcycle  
that's different*

*Indian  
Scout*

**\$250.**

Electric Equipped \$285

It's 75 to 100 pounds lighter than the average motorcycle.  
Lower, more easily handled. Economically operated, yet powerful.  
60 to 75 miles per gallon, all other upkeep correspondingly low.

Goes through traffic like walking, and the greatest sport in the world.

See the nearest Indian Dealer, or write  
Dept. 37 for information

**HENDEE MANUFACTURING CO.**

*Largest Motorcycle Manufacturer  
in the World*

Springfield Mass.

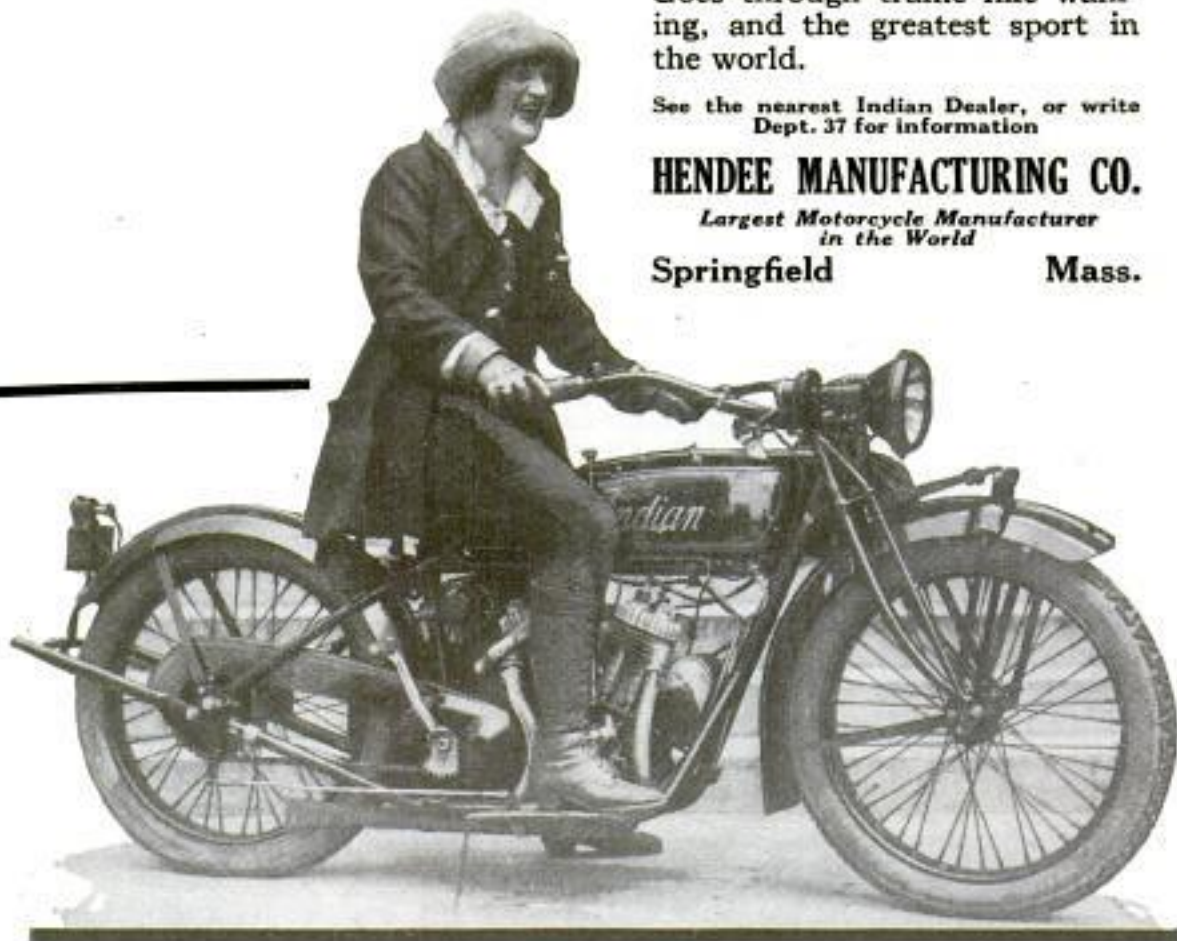



# New Idea Nets \$10,000 Year! Big Chance for You



## Read What Baker Says:

"Dear Mr. Haywood:—

You know when I first talked to you about starting in the reclaimed tire business, I had less than \$500 and was a little doubtful about that being enough. I certainly want to thank you for urging me to start. I am doing between \$8,000 and \$10,



000 a year with competition thicker than flies around a molasses barrel. I have four stations of my own and a half interest in the Rubber Manufacturers Outlet Co. (Signed) Baker Tire Stores, Ltd., Knightstown, Ind. E. L. Baker"



rolling in. Hadn't money enough of his own to buy the plant. Got financial help from friends Baker says his other shops are for sale. It's one way to make money in this game -- establish reclaiming stations and sell at profit. "I'm out to make money," says Baker. "I'm not tied to any locality. Can make money anywhere with your plan regardless of competition." Baker has done nothing you cannot do. Follow his methods -- send that coupon right now and get further particulars.

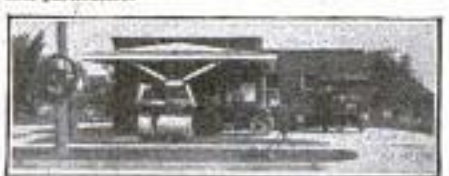

**T**HIS is Ernest Baker, Knightstown, Ind. Worked as druggist. Money didn't come fast enough. Cast about for something better. Wanted quick action. Saw big possibilities in auto industry. Read my ad. Wrote for particulars. Didn't have much capital. Asked my advice. **Acted upon my suggestion.** Started out with competition on every side.

## New Idea a Winner! Nets \$10,000 Year! Business Grows Your Opportunity

Baker took quick advantage of conditions. Cashed in on the cheap tire craze. **Business grew fast.** Competition left away behind. Sold motorists reclaimed, trade-marked tires at sensationally low prices. **Made from 200 to 300 per cent on every transaction.** Did **tremendous business** every way--retail--wholesale--by mail--through outlet companies. **My new idea did the trick.**

## Adds New Stations Kept on Growing

Baker didn't stop. Was accumulating surplus. Had working capital. Went to another town. Opened station number two. **Again the new reclaiming idea went big.** Station hummed with activity. Attracted attention. Was the talk of the town. **Sold reclaimed tires right and left.** Gave universal satisfaction. **\$50 and \$75 days were common.** Other stations were started.

New idea paid big. Baker's earnings now running around \$10,000 a year. Started little more than year ago with less than \$500. Launched out into auto field in **midst of fierce competition.** Now has **four stations going full blast.** Also has interest in big tire outlet company. **What Baker has done you can do.**

## Get My Proposition I Will Help You

You can clean up in your locality. I will help you to the limit. Will teach you free. Have put thousands of men in prosperous, big paying businesses. Send today for free literature. Get my wonderful proposition. Learn all about this big, new idea that is making Baker and others rich. Write today. Use the coupon. Within 48 to 72 hours you will have the whole matter before you. It is worth full investigation. **Clip and mail the coupon now.** Address

M. Haywood, President,

## The Haywood Tire & Equipment Company

1377 Capitol Ave.

Indianapolis, Ind.

This outlet store keeps Baker's four stations running.

This is a proposition you can handle. Get details.

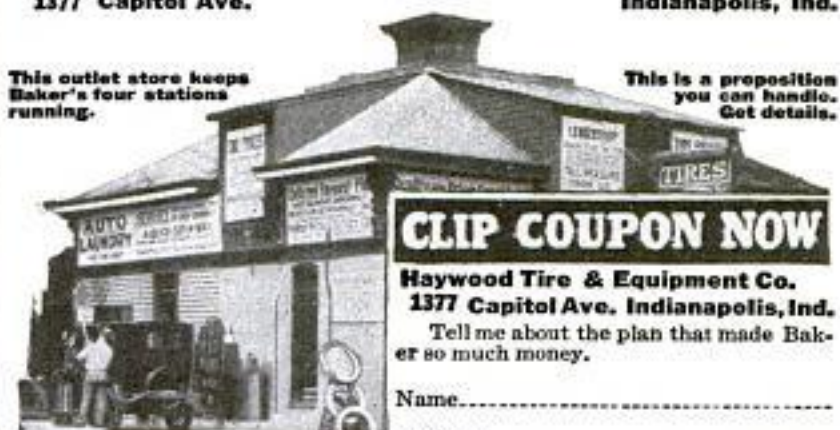

**CLIP COUPON NOW**

Haywood Tire & Equipment Co.  
1377 Capitol Ave. Indianapolis, Ind.

Tell me about the plan that made Baker so much money.

Name.....

Address.....

## Buy a Western Auto Radio Battery and Charge it From Your 110 Volt Lighting Socket

The Western Auto Radio Battery was designed especially for Radio work, furnishing a constant steady, strong current of low voltage. It is also equipped with extra heavy cell connectors and terminals which allow it to be used in any make of automobile for starting and lighting or in any capacity where a 6 volt storage battery is necessary. **NO BETTER BATTERY CAN BE BUILT AT ANY PRICE.** Prices quoted below are the lowest for which a high grade special Radio and Auto Battery has ever been offered:

|                                |         |
|--------------------------------|---------|
| 6 volts 40 ampere hours .....  | \$18.00 |
| 6 volts 60 ampere hours .....  | 20.00   |
| 6 volts 80 ampere hours .....  | 23.00   |
| 6 volts 100 ampere hours ..... | 26.00   |

**SPECIAL ADVERTISING OFFER.** If you will enclose this advertisement with your order, we will furnish absolutely free of charge, with every battery order, one complete "WESTERN" HOME BATTERY CHARGER, which allows you to charge any 6 to 12 volt storage battery in your home or garage from the lighting socket.

The charger has no delicate bulbs to break or burn out and has no moving parts to wear.

**YOU NEVER NEED TO BE WITHOUT THE USE OF YOUR RECEIVING SET WHILE BATTERY IS BEING CHARGED, OR REMOVE FROM YOUR AUTOMOBILE IF RECHARGING IS NECESSARY.**

**WESTERN BATTERIES ARE FULLY GUARANTEED FOR TWO YEARS.**

Terms: 25% with order, balance, C. O. D., or 2% may be deducted if full cash accompanies order; if for automobile use, state make and year of car.

Radio and Automobile dealers should send at once for our distributors proposition.

**WESTERN RUBBER MOLD & BATTERY CO.**

321 N. Crawford Ave., Chicago, Ill.

**NOW ONLY \$7 A MONTH**  
**STANDARD**  
*Artist's Model*  
**SAXOPHONE**



**Learn in an Hour**  
 The Saxophone is so easy to learn you can actually play tunes after an hour's instruction and practice! Most popular instrument in history of music. Favorite on stage, at dances, in the home—even in churches!

**Make Extra Money**  
 Saxophone players make **BIG MONEY!** Nothing you can learn so quickly pays so well! And all doors are open to the fellow or girl who can contribute Saxophone music to the evening's fun. The world holds new pleasures for those who can play!

**10 Months to Pay**  
 Standard Artist's Model. The choice of professionals and teachers everywhere because of its golden tone, perfect pitch and easy fingering and blowing. Now offered for only \$69.50, payable \$7 per month, only \$19.50 down! No interest, no extras! And you get FREE \$10 case, instruction book, extra reeds, pearl finger tips and leather strap. And we give you 4 days' FREE trial besides to prove that no Saxophone can equal this, and to show you how quickly you can learn! Illustrated Catalog, order blanks, and complete information Free! Write today!

**STANDARD MUSIC CO.**  
 Dept 222, P. O. Box 593, CHICAGO, ILL.

### ROPP'S CALCULATOR SHOWS THE ANSWER

as quickly as a watch shows the time to all problems likely to occur in the office, store, shop, bank, farm or factory.  
 Pocket size, paper, 35c. Cloth, 50c. Leatherette, \$1.  
 Popular Mechanics Book Dept., 6 N. Michigan Ave., Chicago.

## SHOT GUNS at REDUCED PRICES

**\$8<sup>50</sup> to \$59<sup>25</sup>**

|                                                                                       |         |
|---------------------------------------------------------------------------------------|---------|
| PARKER HAMMERLESS (V. H. GRADE)<br>10, 12, 16, 20 gauge; various length barrels ..... | \$59.25 |
| FOX STERLINGWORTH STANDARD HAMMERLESS 12, 16, 20 gauge; 30 inch barrel .....          | 45.25   |
| PARKER HAMMERLESS (TROJAN GRADE)<br>12, 16, 20 gauge; 28 & 30 inch barrels .....      | 44.75   |
| L. C. SMITH HAMMERLESS FIELD GRADE<br>12, 16, 20 gauge—26-28-30-32 inch barrels ..... | 43.50   |
| ITHACA HAMMERLESS FIELD GRADE<br>12-16-20 gauge—26-28-30-32 inch barrel .....         | 36.00   |
| FULTON DOUBLE BARREL HAMMERLESS<br>12-16-20 gauge—28-30-32 inch barrel .....          | 32.00   |
| AMERICAN DOUBLE BARREL HAMMER<br>28 gauge—26 inch barrel .....                        | 23.00   |
| AMERICAN VICTOR—"VICTOR EJECTOR"<br>12-16-20 gauge—30 or 32 inch barrel .....         | 8.50    |

**ALL OUR MERCHANDISE IS BRAND NEW**

Order one of these specials now. Supply limited. Mail orders promptly filled (charges prepaid) when accompanied by Money Order, Check or Bank Draft, C. O. D. Orders must be accompanied with deposit of \$3.00. Examine merchandise carefully and if not as represented just return same and get your MONEY BACK without any red tape whatsoever. Bank Reference. Send for FREE illustrated catalog of Sporting Goods and Field Glasses.

**EDWARDS IMPORT TRADING CORP.**  
 258 Broadway, Dept. 9, New York City

# Made \$400 in 39 Days

## Showing The Diamond Light



Geo. Vivian

are making from \$10 to \$40 a day just as these men are.

George U. Vivian, a Minnesota man, made \$400 in 39 days working spare time. One day's effort alone brought him \$39. Hartley, an Ohio man, made over \$1,000 in a few months. Connelly of Pennsylvania made \$39 the first day he showed this remarkable new light to friends and neighbors. Hundreds of others

### Resident Representatives Needed

We want more men to represent us in territory now open. Work all or spare time. No experience necessary. This is not a peddling proposition. No capital required. You simply take orders. We deliver by Parcel Post and do collecting. Commission paid same day you take orders. It is a straightforward money-making offer that gives you an opportunity to have a business of your own.



### New 300 Candle Power Lamps

"The Diamond Light" is the name of these marvelous Table Lamps, Hanging Lamps and Lanterns. Give a 300 candle power brilliant light. Burn either kerosene or gasoline. Clean, safe, odorless. Cost less to operate than old style wick lamp. Burn 96% air and only 4% fuel. Light with a match. Patented. Their need is instantly apparent when shown—that is why our representatives are all reporting big sales and easy profits.

### You, Too, Can Make Big Money

You can make big money taking orders for these new 300 candle power Lamps and Lanterns. You do not need sales experience. We furnish complete instructions telling you where and how to sell. Write your name and address on this coupon and mail it today. There is no obligation.

## THE AKRON LAMP CO.

110 Lamp Bldg., AKRON, OHIO

COUPON

The Akron Lamp Co.,  
110 Lamp Bldg.,  
Akron, Ohio.

Gentlemen: Send me "The Diamond Light" catalog and tell me all about how I can make \$10 to \$40 a day as your representative.

Name.....

Address.....



## BURROWES

### Home Billiard & Pool Tables

Magnificently made in all sizes, at all prices. Game exactly same as standard table. Become expert at home. Use in any room, on any house table or on its own folding stand. Quickly leveled. Put up or down in a minute. Small amount down, easy payments. Ask your dealer or WRITE TODAY for Catalog. E. T. BURROWES CO., 50 Free St., Portland, Maine

## STRAD MODEL VIOLIN

Half Price Sale!  
Why pay \$35 to \$50 for a high grade Violin when for only \$14.95 we offer this sweet-toned, full-sized, genuine Strad model, complete with case, instruction book, bow, rosin, chin rest and extra strings! Exact copy of Old-Master Violin.

# \$14<sup>95</sup>

6 Days' FREE TRIAL Order direct from this ad. Deposit price with Express Agent after examining this wonder outfit. He will return your money in 6 days if you're not satisfied.

FREE LESSONS Instruction book with charts that will get you started right and enable you to learn quickly, free with every outfit. Catalog FREE on request.

Standard Music Co. Dept. 322 Box 503 Chicago

## SLOWING UP?

### Are YOU sure of the next promotion?

TOBACCO is holding back thousands of men. It deadens their mental activities, just a little, maybe, but enough to let the other fellow get the heavy envelope on pay day. It makes your mind sluggish. Your brain slows up a bit. Be frank with YOURSELF! Are you as mentally alert as you used to be? Quit tobacco and see the difference! Give yourself a chance. (If it isn't worth while you can go back to tobacco. But, no man ever does.)

The Keeley treatment is pleasant to take, quick to relieve tobacco fagged nerves and definitely effective. Write us today for the free booklet. It's in a plain envelope. The KEELEY INSTITUTE, Dept. P. M., DWIGHT, ILL.

Backed by more than 40 years of success

The Keeley Institute, Dept. P. M., Dwight, Ill.

Please send me, without any obligation on my part, your free booklet which will tell me how to rid myself of the tobacco habit.

Name.....

Town.....

Street..... State.....

Please Mention Popular Mechanics

Copyrighted material



**"It's  
What You Get  
For Your Money  
That Counts"**

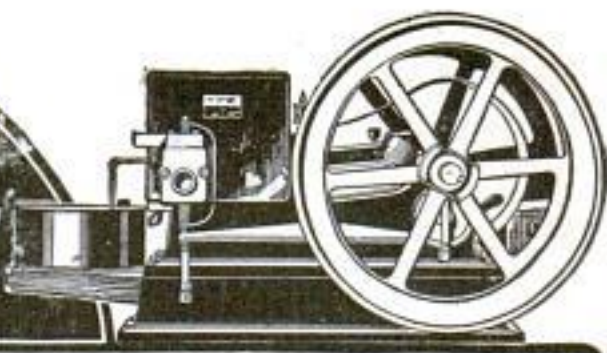

**2 H-P.** Chas. Beaulieu, Wis., says: "Good as the first day I had it."

**3 H-P.** M. W. Kopecky, Tex.: "Easy to start—stop—regulate."

**4 H-P.** Geo. A. Nester, Va.: "Used it 7 years. Not a penny for repairs."

**6 H-P.** Wm. Mittelstadt, Iowa: "Had several makes, but Witte is best."

**8 H-P.** Ralph Milliken, Calif.: "Engine gives splendid service."

**12 H-P.** A. B. Trest, Ala.: "Runs smooth as a sewing machine."

**16 H-P.** J. C. Clark, Va.: "I like the 16 H-P. fine."

**22 H-P.** J. F. Brown, Ark.: "Engine is just what you told me."

**30 H-P.** T. E. Walton, Miss.: "It is surely a fine puller."

**Engine Value Depends On EASY OPERATION,  
LOW FUEL COST and DURABILITY**

Records for 37 years show that WITTE Engines not only stand up, giving long service, but they have big surplus power, operate easy, cost less to operate, and sell for less. No matter what size engine or power outfit you need or where you live, I can supply you direct at a saving—make Immediate Shipment—Cash or Easy Terms, as you wish—in sizes 2 to 30 H-P.—most any style you want.

**WITTE Engines** are sold on a **Straight Lifetime Guarantee**

This guarantee applies to every size and style outfit I make—Stationary, Portable, Portable Buzz Saw, Log Saw, Tree Saw, Stationary Cutoff Saws, Power Stump Borers and my New "Power-Lite" Engine used on electric light plant. I furnish this new light plant complete, with engine, generator and batteries ready to attach to your wiring, at a big saving in price. Use it for both power and light. If you need power for any purpose—write to WITTE—get an engine you know is time-proven, reliable and durable. Read what users say.

**Tell Me What  
You Want**

**I Guarantee  
Safe Delivery  
Anywhere.  
CATALOG  
FREE**

**WITTE ENGINE WORKS, 1740 Oakland Avenue, KANSAS CITY, MO.  
1740 Empire Building, PITTSBURGH, PA.**

**forget**

Your old conception of a gasoline engine and consider only

The Air-Cooled, Multi-Purpose  
**New-Way**  
Engines (e. i.)



**Manufacturers and Users**

Universalize your product with the "New-Way" Engine and sell to the world.

Our engineering staff has had wide experience in the application of power to machinery of all kinds. They will be glad to help you.

Compact as an electric motor—flexible, dependable and light in weight. Especially designed to operate portable machinery, semi-portable, traction and stationary.

Operates by direct power or generator electric motor driven units and tools in remote places.

Variable control, 2 to 5 horsepower. Weight ready to mount on any equipment, 248 lbs. Write for Circular C-20.

**The "New-Way"**  
Motor Company  
Lansing, Mich., U. S. A.  
Eastern and Export Office,  
Woolworth Building,  
New York

**BUILD YOUR OWN** **50c RADIO BOOK 20c**  
SPECIAL OFFER. "Radio Reception Explained" tells how to make 3 types receiving sets with range of 25-2000 miles. Gives diagrams, bills of material and instructions. Price 20c. Our FACTORY-TO-YOU prices on parts, tools, complete sets will prove of interest and will save dollars.  
RADIO PARTS MFG. CO. 5 Park Place DETROIT, MICH.

**CUT PRICE SALE**

**Buy From FACTORY and save money.**  
100% pure heavy copper, soldered on outside. Strongest utensils for every purpose at 40 per cent less than others ask. Write for catalogue or order direct from ed.

**Pure Washboilers**  
Copper  
12 gallons.....\$6.90  
15 gallons..... 8.25  
20 gallons..... 9.50

**Pure Oil Cans**  
Copper  
2 gals.....\$ 2.95  
4 gals..... 3.90  
6 gals..... 4.85  
8 gals..... 6.75  
10 gals... 8.65  
15 gals... 10.55

**FIREPROOF!**  
**Air-Tight, Screw Top**  
Big 5-inch screw top permits hand-cleaning. Built over-size and strong enough to stand hardest usage. **Can't explode!** Dealers and agents can make good profits at the low price we quote.

**Send No Money**  
Don't wait! Copper going up and our prices must go up too! By express, in plain wood box. Remit in any convenient form or order C. O. D. Write TODAY!—At once.  
609 Fulton Street  
Dept. 132 CHICAGO

**Order Today!**  
**DORMAC MFG. CO.**

## VICTORY Canary Songster



The Victory Canary Songster produces a more natural and effective warble than any we have seen. The imitation is wonderfully sweet and perfect. The sweet musical notes, the trills and warblings are perfectly and easily produced, and at the same time the automatic movement of the bill and tail lend a touch of realism. It will make dumb canaries sing and teach parrots to warble in a very short time. Handsomely finished in Canary Gold Color, with rubber tube and mouthpiece. Each in handsomely decorated box. PRICE ONLY 25 cents each postpaid.

JOHNSON SMITH & CO., Dept. 899, 3224 N. Halsted St., Chicago.

## STAGE MONEY



With a bunch of these bills, it is easy for each person of limited means to appear prosperous. By flashing a roll of these bills at the proper time and peeling off a genuine bill or two from the outside of the roll, the effect created will be found to be all that can be desired. Prices, postpaid: 15 Bills 10c, 50 Bills 25c, 125 for 50c, or \$3.50 thousand.

## WONDERFUL X-RAY TUBE



A wonderful little instrument producing optical illusions both surprising and startling. With it you can see what is apparently the bones of your fingers, the lead in a lead pencil, the interior opening in a pipe stem, and many other similar illusions. A mystery that no one has been able to satisfactorily explain. Price 10 cents; 3 for 25 cents; 1 dozen 75 cents. JOHNSON SMITH & CO.



## Good Luck Ring

Quaint and Novel Design

A VERY striking and uncommon ring. Silver finish, skull and crossbones design, with two brilliant, flashing extra sparkling cut of the eyes. Said by many to bring Good Luck to the wearer, hence its name, Good Luck Ring. Very unique ring that you will take a pride in wearing. ONLY 25 CENTS.

Address orders for all goods on this page to

# JOHNSON SMITH & CO.

Dept. 899 3224 N. Halsted St. Chicago

Our large catalog (300 Pages) of all the newest and best novelties, unobtainable elsewhere, free with every order.

## The Dying Pig



The most laughable novelty yet produced. Made of rubber, and you have only to blow it up and stand the pig on his feet, when he begins to squeal as he slowly collapses and finally lies down and dies in the most natural manner. You can blow him up as often as desired, and each time he will go through the same performance to the great amusement and delight of your friends. Price, 15 cents; 3 for 40 cents; one dozen \$1.15, mailed postpaid.

## Popular Watch Charms



Very pretty little curiosities and decidedly novel. Fitted with Magnifying Lenses that enlarge the pictures to a very surprising degree; in fact, it seems almost incredible that a clear picture could be possible in such a small compass, and how sharp and distinct they show up when you look through. Come in assorted views—Astronomer, views of Panama Canal, Lord's Prayer in type, etc. Price 15c; 3 for 40c; \$1.35 doz.

## Mystic Skeleton

A jointed figure of a skeleton 14 in. in length, will dance to music, and perform various gyrations and movements while the operator may be some distance from it. Price 10c; 3 for 27 pd.



## Serpent's Eggs

Box contains 12 eggs. When lit with a match, each one gradually hatches itself into a snake several feet long, which curls and twists about in a most life-like manner. Price per box, 15c postpaid.



## NEW BOOK ON ROPE SPLICING

Useful Knots, Hitches, Splices, etc.

A most practical handbook giving complete and simple directions for making all the most useful knots, hitches, splices, etc. Over 100 illustrations. All about wire rope attachments, lashing, blocks, tackles, etc. 27 Illustrations. Of great value to mechanics, riggers, campers, boatmen. Price 20c ppd.



## MAGIC FLUTE

Wonderfully Sweet Toned and Musical

The Magic Flute, or Hugganston, is a unique and novel musical instrument that is played with nose and mouth combined. There is just a little knack in playing it which, when once acquired after a little practice will enable you to produce very sweet music that somewhat resembles a flute. There is no fingering, and once you have mastered it you can play all kinds of music with facility and ease. When played as an accompaniment to a piano or any other musical instrument, the effect is as charming as it is surprising. 25c postpaid.



## BLANK CARTRIDGE PISTOL

Protection against Burglars, Tramps, & Dogs

PRICES  
50c.  
\$1.00



Well made and effective, modified on latest type of Revolver; appearance alone is enough to scare a burglar. When loaded it may be as effective as a real Revolver without danger to life. It takes standard .32 Cal. Blank Cartridges obtainable everywhere. Price 50c., Superior quality \$1.00 postpaid. Blank Cartridges, by express, 50c per 100.

Johnson Smith & Co., Dept. 899, 3224 N. Halsted St. Chicago

## DANCING BEAUTIES

Get a Kinemograph and see the picture move. France's latest sensation. A great surprise. Is worth twice what they cost. Are made of solid brass, highly nickled and very durable. Satisfactory or your money back. Don't show your girl. Price 50c

Johnson Smith & Co., Dept. 899, Chicago

BOYS! BOYS! BOYS!

## THROW YOUR VOICE

Into a trunk, under the bed or anywhere. Lots of fun fooling the teacher, policeman or friends.



## THE VENTRILO

a little instrument, fits in the mouth out of sight, used with above for Bird Calls, etc. Anyone can use it.

Never Fails. A 32 page book on ventriloquism, the Ventrillo, ALL FOR 10 CENTS

## 1000 Silk Remnants

For patching Crazy Quilts, Sofa Cushions, Head Rests, Pin Pads etc. Large pieces, all colors and shades. Sure to delight you. stamps, we send a large package and Book of quilt designs. 3 packages (25c. 1 pound makes a lovely large quilt. Price 75c postpaid. Our silk is the best.

JOHNSON SMITH & CO. Dept. 899, 3224 N. Halsted Chicago

## LOOK 50c Look

Wonderful instrument. Greatest thing yet. Nine separate articles in one. Everybody delighted with it. Odd, curious and interesting. Lots of pleasure as well as very useful. It is a double Microscope for examining the wonders of nature. It is also an Opera Glass, a Sarcoscope, a Burning Lens, a Reading Glass, a Telescope, a Compass, a Pocket Mirror, and a Laryngoscope—for examining eye, ear, nose and throat. It is worth all the cost to locate even one painful cinder in the eye. Folds flat and fits the pocket. Something great—you need one. Don't miss it. Sent by mail, with 300 page Novelty Catalog. ONLY 50c or 3 for \$1.25



## Resurrection Plant

One of the most wonderful plants known. Possesses the strange power of turning in a few minutes from an apparently lifeless, dry herb to a

BEAUTIFUL LIVING FLESHLIKE PLANT of a dark green color. Simply place the plant in saucer of water, it will open up and start to grow in 30 minutes. When taken out it will dry up and go to sleep until placed in water again. Fine house plant—summer or winter. 10 cents each or 3 for 25c. AGENTS WANTED post paid.

JOHNSON SMITH CO. Dept. 899, 3224 N. Halsted, Chicago

**FULL  
CARAT  
SIZE**

**18K Belais  
White  
Gold**

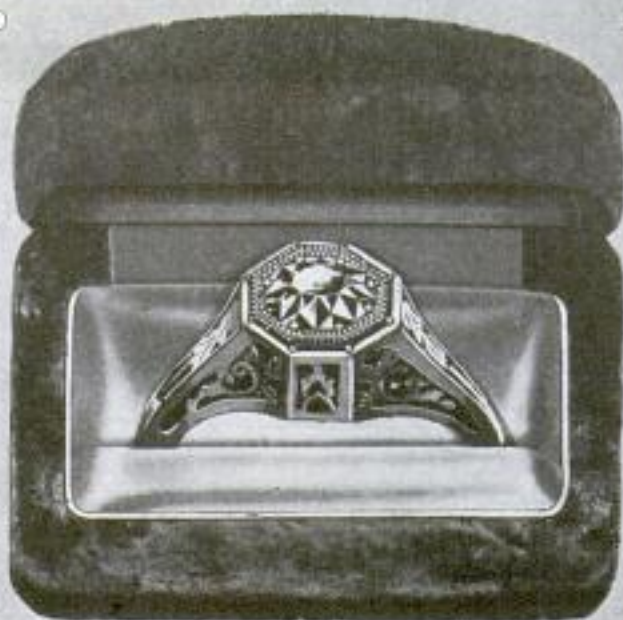

**\$97<sup>50</sup>**

**Newest  
Basket  
Filigree**

**Genuine Diamonds Reduced!**

**A** SLASHING of diamond prices by Basch! Price cut to \$97.50 per carat. Nothing like this in years. A sensational under-selling of the market. A chance to save from 35% to 50%. A saving made possible by our recent importations. On account of the increased buying power of the American dollar in Europe, we were able to make large purchases far below market prices. This, and our plan of selling direct by mail, enables us to offer diamonds now at the startling price of only \$97.50 per carat.

**A Wonderful Bargain in a Beautiful Diamond Ring**

Note the exquisite diamond ring shown above—a Belais 18k white gold ring, newest basket filigree design, choice of  $\frac{1}{4}$ ,  $\frac{1}{2}$ ,  $\frac{3}{4}$  or 1 carat genuine diamond. A wonderful diamond bargain at \$97.50 per carat. Order either size diamond for free examination at your bank or express agent.

A-1001— $\frac{1}{4}$  Carat, \$25.00    A-1003— $\frac{3}{4}$  Carat, \$ 77.50  
A-1002— $\frac{1}{2}$  Carat, 53.75    A-1004—1 Carat, 102.75  
(Price includes cost of ring itself in addition to diamond)

**L. BASCH & CO., Dept. K-4**  
State and Quincy Sts., Chicago

Gentlemen—Please send me your big free book, telling about your price cut in diamonds and showing your full array of diamond jewelry.

Name.....

Address.....

**SEND NO MONEY**

Just select from our catalog the diamond you would like to see and we will send it to you for free examination. No money down—no obligation to buy. If you decide that you don't want to keep diamond, return at our expense and you won't owe us a cent. This is an open free examination offer wherein we take all the risk. You are the sole judge—no salesman at your elbow to influence you.

**Money-Back Guarantee** We guarantee the carat weight, quality and value of every diamond in our catalog. We give a legal binding contract to refund in cash full price less 10% should you wish to return your diamond for any reason. We also guarantee to allow you another diamond any time.

Everything in diamond jewelry shown in this big book—and everything at the new cut in price. See the amazing offerings.

**FREE  
BOOK**

Write today for our big new Diamond Book. See the extraordinary diamond bargains we are offering. Rare values also in fine watches, cutlery, silverware, etc. Mail coupon today. Book comes FREE and postpaid. **Clip Coupon NOW!**



# Get Big OFFER!

## New 1923 Model-Throttle Governed

The Standard By Which All  
LOG SAWS Are Judged.



Saws  
Faster Than  
Any Other Log Saw.

Exclusive Features  
of the Best Log Saw  
Ever Built:

Saws Fastest  
Easiest To Move  
Most Powerful  
350 Saw Cuts a  
Minute  
Saws Human Way  
Saws Fast or Slow  
as you wish  
Clutch Control  
4 H-P (and you need  
all this power)

### USES CHEAPEST FUEL—Kerosene, Gasoline, Distillate

Send today for New Special Offer on this Fastest Cutting, Most Powerful, Easiest Moved One-Man Log Saw. More OTTAWA used than all others. Saw more wood with greater ease, using cheapest fuel. 4 H-P makes 350 saw cuts a minute; throttle governed. Learn how easy it is to own an OTTAWA and how others are making big money in spare time, selling wood during coal shortage.

**Run Saw Fast or Slow.** Now, with New 1923 Model, you can run saw fast or slow while cutting. Easy to change speed while the saw runs. Easy, now, to cut small as well as large logs. Quick and easy to operate new Speed Changer.

**Saws the Human Way.** The New Improved 1923 Model OTTAWA has a Power Force Feed. Saws as 2 men would, only many times faster. The OTTAWA not only makes more cuts a minute, but cuts deeper into the log each stroke.

# OTTAWA LOG SAW

Falls trees, saws limbs. This year, built in 2 sizes, 2 H-P and 4 H-P. Sold, only, direct from factory to you at Less Than Wholesale Prices. A great work-saver and money-maker. Use engine for belt work when not sawing. **CASH or EASY TERMS; 30 DAYS' TRIAL; 10-YEAR GUARANTEE.** Backed by the largest Engine and Log Saw Factory in the world—Builders of Better Log Saws.

### MECHANICALLY OPERATED VALVES

Now, inlet as well as exhaust valve opened mechanically—like automobiles and tractor motors—not used on other log saws. Makes engine easier to start, uses less fuel, develops more power. Exclusive feature 1923 model.

### SPECIAL CLUTCH—

Lever Controlled Friction Clutch enables you to start and stop saw while engine runs.

4-cycle frost-proof engine. When magneto equipped, no batteries ever needed. Mounted on wheels with swivel axles—easiest to move.

**ORDER NOW!** We will ship immediately from our Factory or from Branch House nearest you: St. Paul, Minn., Indianapolis, Ind., Dallas, Texas, Pueblo, Colorado, Albany, N. Y., Pittsburgh, Pa., Atlanta, Ga., San Francisco, Cal., Portland, Ore., Ottawa, Kan. Save one-half to one-third on freight; get outfit sooner—better shape. Send for Special Offer Today.

Saw  
Wood

## Beat Coal Shortage!

Make  
Money

Get your OTTAWA Log Saw, now, and let it pay for itself as you use it. Now, with the whole country facing most serious coal shortage in history and coal higher than ever before the OTTAWA will be a blessing to many. If you act at once you can get your own fuel free. You can make Big Money on every cord you sell and keep your friends from suffering.

**Latest Offer!** Send at once for Big Special Offer and New Reduced Prices. Learn how to make Big Money—easy.

**Free Book!** Send today—a postcard with your name and address will do. Rush—be the first to get a new 1923 OTTAWA Log Saw.

**OTTAWA MFG. CO.,**  
1748-R Wood St., OTTAWA, KANS.

**FREE  
WOOD-  
SAWING  
ENCYCLO-  
PEDIA**

Cuts Down Trees  
Level With Ground



EASIEST  
TO CHANGE  
TO LOG SAW  
AND BACK AGAIN.



# \$215<sup>00</sup> In One Day

## New Invention Does Away With Dirty Coal and Wood

NO wonder this amazing new invention is bringing fortunes to agents. All over the whole country this new device is doing away with dirty and expensive coal and wood in heating stoves, ranges and furnaces. Already over \$1,000,000 worth have been sold. You can readily understand why this new invention—the Oliver Oil-Gas Burner—is sweeping over the country like wildfire. It does away with all the expense of coal—making every stove a modern oil-gas burner. Saves money, time and drudgery. Three times the heat of any other method. No wonder agents are riding in on the tide of big Oliver profits.

### AGENTS Are Making Fortunes

These men know the secret of big money. They know a good thing when they see it and they know that the time is ripe for this new Oliver improved Oil-Gas Burner. They know that this age of high-priced coal and wood and the present serious coal famine makes it necessary for some substitute. They see ships and locomotives being run by oil and big buildings being heated by it. And they know that an invention that makes use of this cheap fuel for every home—and yet does it so as to give more heat than coal or wood—is the thing they want to tie up to.

### Big Profits Quickly Made

You too can use this secret of big money. You do not need to be a high-powered salesman. The Oliver's amazing features sell it for you. When people see it they know at once that it is the thing they want. You will realize that this is a proposition that will pay you as big money as it does others. We have a definite number of open territories which we are ready to dispose of to those who act quickly. Every territory allotted is filled with big-money opportunities. And this big money comes easily. Because not only does this invention practically sell itself on sight but when you have sold one this one will sell several others as soon as your customer's friends and neighbors see it. And thru our special plan you get credit and commissions for every sale in your territory.

You can also make big money just by using your spare time. Note how N. B. Chelan made \$43 in one evening.

### Coupon Brings Full Offer

If you want to make at least \$5,000 a year easily, mail this coupon now for our offer. We are not making any extravagant claims about this. We do not have to. We believe that your common sense will indicate a good proposition to you when you know about it. We want to give you the facts. Won't you write us? And by doing so quickly you will be allotted an exclusive territory with private selling rights.

The coupon will bring you the facts and will save you writing a letter. But mail the coupon at once.

**OLIVER OIL-GAS BURNER AND MACHINE CO.**  
2014-V Oliver Building, St. Louis, Mo.

#### SAYS

#### F. W. Bentley of Philadelphia

"Ye Gods—Some seller! I made \$215 today!"

#### Buys Car with Profits

"Have earned enough in one month to buy me a new auto."  
S. W. Knappan, Cal.

#### \$7 Profit per Hour

"I started out and made \$21.50 in about 3 hours. The Oliver does the work. It certainly is the real thing."  
L. Zucker, Ohio

#### "Sells Like Beer in a Dry Town"

"Am sending today for 7 Oliver's. This is one day's orders (\$85 profit). Selling like beer in a dry town."  
H. W. Drew, Mich.

#### Mr. T.'s 28th Order in Six Months

"Ship 32 Oliver's: 10 No. 20; 4 No. 1; 12 No. 2; 24 No. 4." (Mr. T.'s profit on this order alone is \$713).  
G. T., Ottawa, Ont.

#### Russell Earned \$3300 in Five Months

"Have averaged \$660 profit a month for last six months."  
A. M. Russell, Conn.

#### Carnegie—

#### \$1000 a Month

"Am making \$1000 per month. I have made big money before but did not expect so much. Your Burner is just the thing."  
J. Carnegie, S. D.

#### Barger—

#### \$258.50 per Week

"Send following weekly hereafter: 10 No. 1; 8 No. 2; 4 No. 5."  
R. Barger, Ont.

#### \$11.75 in Ten Minutes

"I took order for a neighbor, \$11.75 profit in ten minutes."  
Mrs. N. B., Hastingsburg, Minn.

#### \$43 in One Evening

"I made \$43 last night selling Oliver Burners."  
N. B. Chelan, Wash.

### It Sells Itself

Agents find it no work at all to sell this amazing invention—the Oliver's new improved Oil-Gas Burner. They just show it—taking only one minute to connect it—then light it. And the sale is made! This new invention is its own salesman. It sells itself! The Oliver Oil-Gas Burner is the most timely thing that could be put out. It dispenses entirely with coal and wood when all signs indicate that coal will be impossible to get this winter in every section. It burns the cheapest fuel—oil. It saves a woman work now in times when she is looking for just such things. Just as much or as little heat as wanted, off and on instantly by simply turning a valve.

### The Secret of Big Money

Of course, now that you know the facts you yourself can understand why this new invention is going over like wildfire! and you can understand why F. W. Bentley made \$215 in one day. Why J. Carnegie made \$1,000 in one month and why hundreds of other agents are cleaning up big too.

#### Oliver Oil-Gas Burner and Machine Co.

2014-V Oliver Building, St. Louis, Mo.

Please send me full facts about how I can make at least \$5,000 a year representing you in my territory. Also your plan if I just wish to make big money in my spare time.

Name.....

Address.....



# Be a Certificated "Electrical Expert"

You, Too, Can Learn  
to Boss This Job

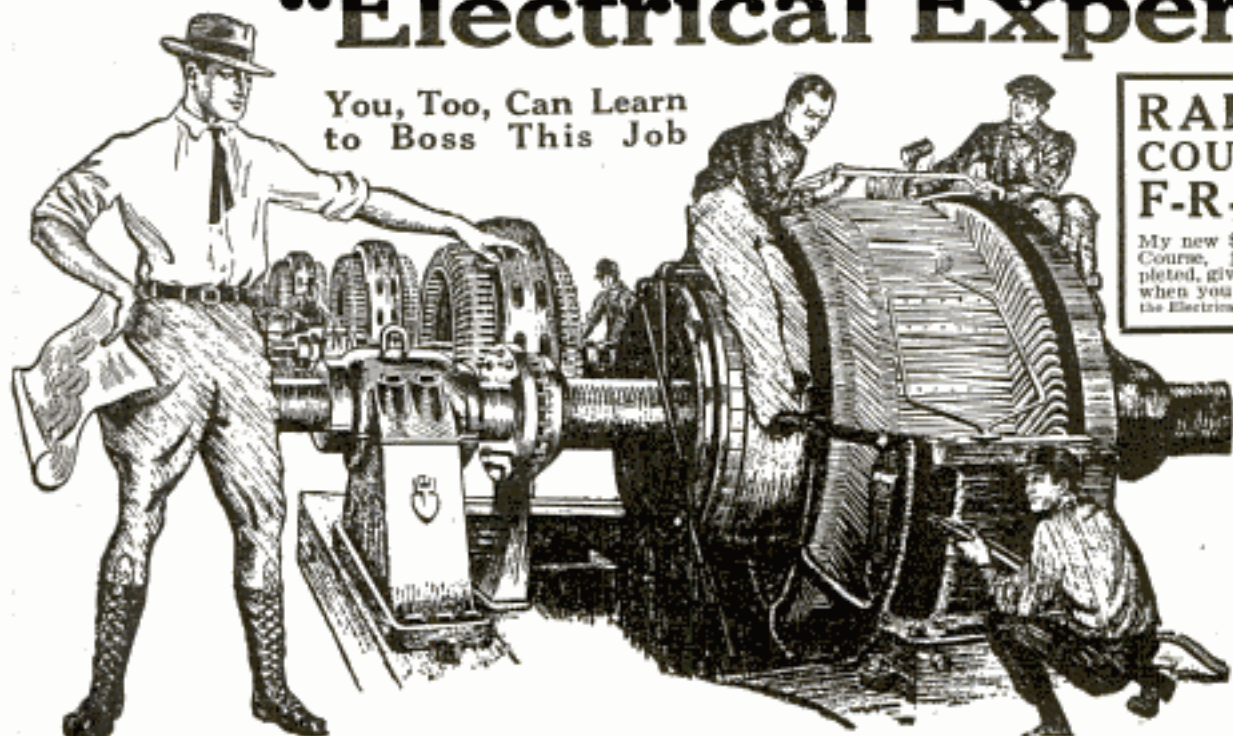

**RADIO  
COURSE  
F-R-E-E**

My new \$45 Radio Course, just completed, given FREE when you enroll for the Electrical Course.

## "Electrical Experts" Earn \$12 to \$30 a Day WHAT'S YOUR FUTURE

Trained "Electrical Experts" are in great demand at the highest salaries, and the opportunities for advancement and a big success in this line are the greatest ever known.

"Electrical Experts" earn \$70 to \$200 a week. Fit yourself for one of these big paying positions.

### Be an "Electrical Expert"

Today even the ordinary Electrician—the "screw driver" kind—is making money—big money. But it's the trained man—the man who knows the whys and wherefores of Electricity—the "Electrical Expert"—who is picked out to "boss" ordinary Electricians—to boss Big Jobs—the jobs that pay.

**\$3,500 to \$10,000 a Year**

Get in line for one of these "Big Jobs" by enrolling now for my easily learned, quickly grasped, right-up-to-the-minute, Spare-Time Home-Study Course in Practical Electricity.

### Age or Lack of Experience No Draw-Back

You don't have to be a College Man; you don't have to be a High School graduate. My Course in Electricity is the most simple, thorough, and successful in existence, and offers every man, regardless of age, education or previous experience the chance to become, in a very short time, an "Electrical Expert," able to make from \$70 to \$200 a week.

### I Give You a Real Training

As Chief Engineer of the Chicago Engineering Works I know exactly the kind of training a man needs to get the best positions at the highest salaries. Hundreds of my students are now earning \$3,500 to \$10,000. Many are now successful ELECTRICAL CONTRACTORS.

### Your Satisfaction Guaranteed

So sure am I that you can learn Electricity—so sure am I that after studying with me, you, too, can get into the "big money" class in electrical work, that I will guarantee under bond to return every single penny paid me in tuition if, when you have finished my course you are not satisfied it was the best investment you ever made.

### FREE—Electrical Working Outfit—FREE

I give each student a Splendid Outfit of Electrical Tools, Materials and measuring Instruments absolutely FREE. I also furnish them with Supplies, examination paper, and many other things that other schools don't furnish. You do PRACTICAL work—AT HOME. You start right in after the first few lessons to WORK AT YOUR PROFESSION in a practical way.

### Get Started Now—Mail Coupon

I want to send you my Electrical Book and Proof Lessons both FREE. These cost you nothing and you'll enjoy them. Make the start today for a bright future in Electricity. Send a coupon—NOW.

L. L. COOKE, Chief Engineer,

**CHICAGO ENGINEERING WORKS,**  
Dept. 517 2150 Lawrence Ave., CHICAGO, ILL.

**YOU CAN DO IT**

Name.....

Address.....

L. L.  
COOKE,  
Chief Eng.,  
Chicago Engi-  
neering Works,  
Dept. 517  
2150 Lawrence Ave.,  
Chicago, Ill.

Dear Sir: Send at once Sample Lessons, your Big Book, and full particulars of your Free Outfit and Home Study Course, the Free Radio Course—all fully prepaid, without obligation on my part.

## FREE-Book On Home Beautifying

S. C. JOHNSON & SON, Dept. P. A. 10,  
Racine, Wis. (Brantford and Montreal—Canada)  
Please send me free and postpaid your book on  
Home Beautifying and Wood Finishing.

My Paint Dealer is .....

His Address .....

My Name .....

My Address .....

This book explains how inexpensive soft woods may be finished so they are as beautiful and artistic as hard wood. Tells what materials to use and how to use them. Includes color charts—gives covering capacities, etc. It is the work of experts—beautifully illustrated in color. Fill out and mail coupon for a free copy.



## Make Inexpensive Soft Wood Furniture Look Like Hard Wood

WITH Johnson's Wood Dye inexpensive soft wood such as pine, cypress, fir, etc., may be finished so it is as beautiful and artistic as hard wood. Johnson's Wood Dye is very easy to apply—it penetrates deeply, bringing out the beauty of the grain without raising it—dries in four hours—and does not rub off or smudge. Made in fourteen popular shades, all of which can be easily lightened or darkened—full directions on every label.

# JOHNSON'S WOOD DYE

Johnson's Wood Dye has many uses, for both the artisan and amateur. **Architects** and **contractors** specify it for coloring woodwork and flooring in new buildings. **Painters** and **decorators** use it with equal satisfaction on new and old woodwork of all kinds. **Householders** delight in it for doing over old furniture and for coloring reed and wicker baskets, etc. **Manual training teachers** and **pupils** use it for finishing their models. **Upholsterers, furniture repairers** and **cabinet makers** find it "just the thing" for their work—old and new.

S. C. JOHNSON & SON, Dept. P. A. 10, Racine, Wis.

"The Wood Finishing Authorities"  
(Brantford and Montreal—Canada)



# New OLIVER Speedster

**USE THE  
COUPON  
FOR  
FREE  
5-DAY  
TRIAL!**

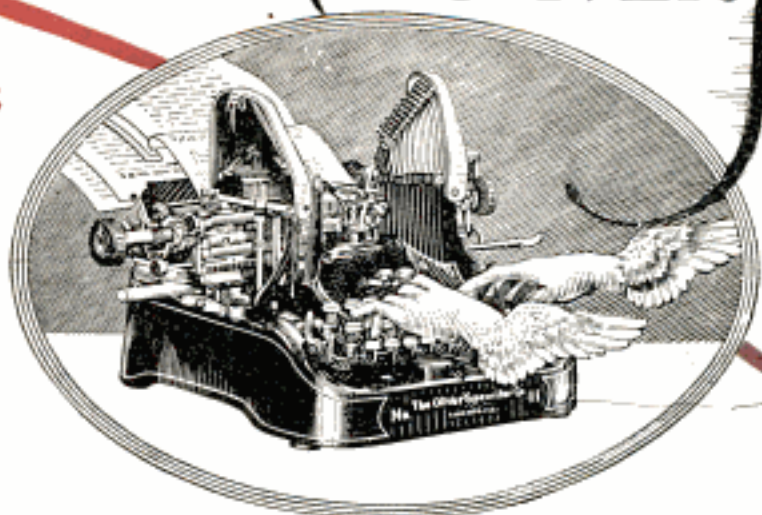

**Our Latest and  
Finest Model**

**—  
The Result of  
27 Years of  
Experience**

## Use It 5 Days Before Deciding

Then buy it, \$4 after trial, and \$4 a month. Or return it at our expense

You cannot gain any conception of the superiority of the new OLIVER Speedster Model, our latest and greatest creation, unless you test it yourself. You will be amazed at the ease with which you can operate it. You'll be delighted at its quiet action. You'll be astonished at the countless improvements and refinements it offers. The many automatic labor-saving devices.

So we offer to send you the OLIVER Speedster on FREE 5-DAY TRIAL so that you may test it in your own home, or office, and find out for yourself why it is called the SPEEDSTER. Expert operators tell us that with it they can increase their output by a third. They praise its freedom from nerve strain, its velvet soft touch. They tell us that it is the ultimate in typewriter efficiency.

### Use It—Compare It!

Printed claims may not convince you. We say, frankly, that if we said all the wonderful things about the OLIVER Speedster that we feel justified in saying, you might accuse us of exaggeration. So we say to you—TEST IT. Use it in any way you see fit. Compare it with any standard typewriter.

### Over One Million Sold

The new Speedster Model OLIVER was presented as our millionth typewriter. It is our newest, most improved, most refined model. It has all the splendid mechanical advantages which have made the OLIVER famous. It is the climax of our 27 years of manufacturing.

In this time a million OLIVERS have been sold to individuals and to great corporations like the N. Y. Central Lines, the N. Y. Edison Co., the U. S. Steel Corporation, Morris & Co., and other giant concerns. They bought the OLIVER after severe tests and comparisons.

### New Low Price Offer

We offer you this greater OLIVER—Speedster Model—for \$35 less than the \$100 price

of other standard machines. Our price of \$65 is the factory price, with the expensive and wasteful sales costs eliminated. And we offer you this startling new typewriter on *easy terms*.

### Send No Money—Easy Terms

Buy it *only after trial*. We send it to you without one cent down. You test it. It is built to give a lifetime of service. Note its symmetrical beauty and compactness. Note its rich enameled black and gold finish. Then test its quiet, easy, efficient operation.

If the OLIVER doesn't convince you, after 5-Day Trial, that it is the *best standard typewriter at any price*, return it at our expense, the trial will not have cost you anything.

### Fill Out and Mail Coupon

Asking for a free trial incurs no obligation to buy. The coupon will bring you an OLIVER Speedster, new from the factory, on FREE TRIAL. If you want more information before ordering an OLIVER sent on FREE TRIAL, check the coupon accordingly.

### The Oliver Typewriter Co.

1097 Oliver Typewriter Bldg.  
Chicago, Ill.

**SAVE  
\$35**

The Oliver Typewriter Company  
1097 Oliver Typewriter Bldg., Chicago, Ill.

Ship me a new Oliver No. 11 Typewriter for five days' free inspection. If I keep it I will pay \$65 as follows: \$4 at the end of trial period and then at the rate of \$4 per month. The title to remain in you until fully paid for. If I make cash settlement at end of trial period I am to deduct ten per cent and remit to you \$58.50. If I decide not to keep it, I will ship it back at your expense at the end of five days.

My shipping point is.....  
 Do not send a machine until I order it. Mail me your book—"The High Cost of Typewriters—The Reason and the Remedy," the Speedster catalog and further information.

Name.....

Street Address.....

City..... State.....

Occupation or Business.....



Peter Piper picked a pack of Pep-O-Mints,  
A piquant pack of Pep-O-Mints Peter Piper picked;  
Pete was piqued at pickles,  
Said he, "I'll spend my nickels  
For the candy mint that tickles."

Pep-O-mint  
Wint-O-green  
Lic-O-rice  
Cl-O-ve  
Cinn-O-mon



Copyrighted material