

POPULAR MECHANICS MAGAZINE

WRITTEN SO YOU CAN UNDERSTAND IT

TRADE MARK, GREAT BRITAIN, No. 410425.

REG. U. S. PAT. OFF.



SEE PAGE 347

Copyright © 1958

Offers No Premiums: Don't Join if Clubbist... www.popularmechanics.com

It takes *only* 8 weeks to get a big job



O. H. Justus owns a big agency and repair shop at Parkersburg, W. Va. He says "that my schools give motor secrets that will put any man 'on easy street.'"



Emanuel Rushfeldt, Alberta, says: "Earning \$10 a day and only 20 years old."



W. W. Peace gets \$250 a month and expenses operating a tractor in the oil fields.



Louis Beimer at 24 was made foreman over men many years older. That's not luck—it's Rahe training.

Read what these men are doing in the Auto and Tractor Business. Here is your big chance to get "on easy street." Come to these great shops on the biggest **FREE** offer ever made.

Big Firms Need Trained Men

The Auto and Tractor Business is on the boom. Thousands of trained men will be needed during the next few months. I get calls every day from Garages, Battery Stations, Auto Repair, Welding Shops and other successful concerns for Rahe men. When the big fellows need high grade men they know where to come for them. They want Rahe trained men.

My Training Unusual

Scientific tool training—that's the secret. You do things here according to the latest engineering standards. Thousands of dollars have been spent in modern tools and equipment. That's why my men are at home in the biggest shops in the country. If you want to succeed the way Beimer and Justus and the rest have—qualify by the same method.

I'll Pay Your Railroad Fare and Board You

In order to fill the openings that now exist, I am making an offer no one has ever made before—**Free railroad fare, Free board.** But even that is not all. I'll tell you about the rest in my letter.

Send for **FREE** Book

My big illustrated training book tells how others are succeeding. It tells many things you ought to know about Autos and Tractors. Write for it and my **short time** offer NOW. It soon expires.

Rahe *Auto & Tractor Schools*

CHICAGO
4445 Grand Blvd.

Dept. 895 CINCINNATI
Ninth and Walnut



Rahe Auto & Tractor Schools,
Dept. 895, (address school nearest you)
Chicago, Ill., or Cincinnati, Ohio.

Without any obligation, send me your big free book, "More Money." Also information regarding special temporary offer.

Name

Street

City State

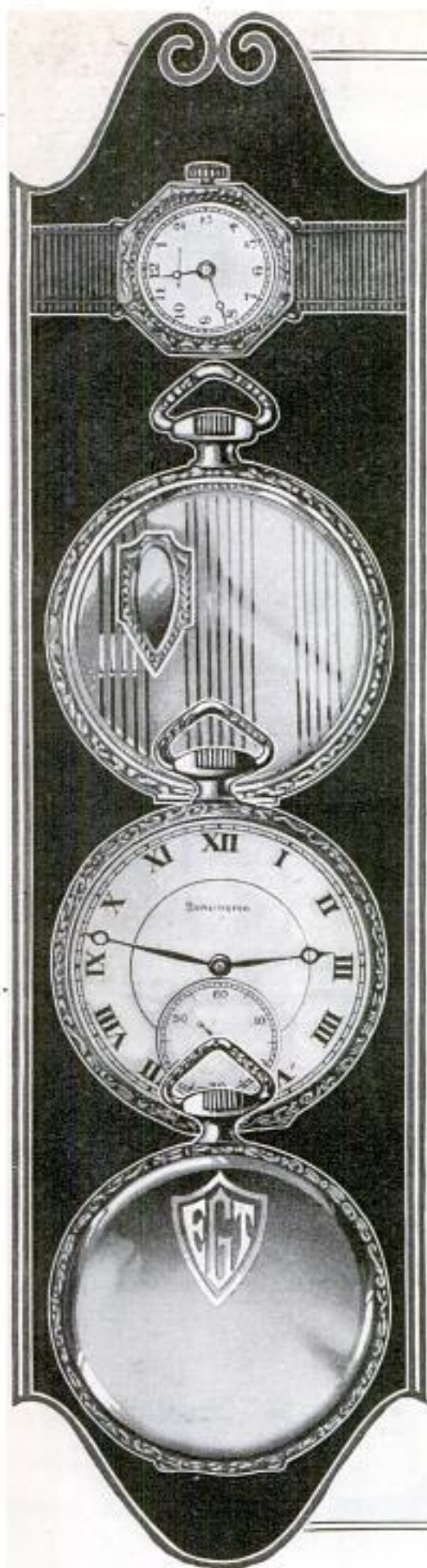

21 Jewel Burlington

Adjusted to the Second
Adjusted to Temperature
Adjusted to Isochronism
Adjusted to Positions
21 Ruby and Sapphire Jewels
25 Year Gold Strata Case
Your choice of Dials
(Including Montgomery R. R. Dial)
New Ideas in Thin Cases

Only \$1.00 Down

Only One Dollar Down, will buy this masterpiece of watch manufacture. The balance you are allowed to pay in small, easy monthly payments. A 21-Jewel Watch — is sold to you at a price much lower than that of other high-grade watches. Besides, you have the selection of the finest thin model designs and latest styles in watch cases. Write for FREE Watch Book and our SPECIAL OFFER today.

The Burlington "Petite"

This exquisite little 17-jewel ladies' wrist watch. A perfect timepiece. Beautiful, 14K Solid Green Gold case. Illustration is exact size of Burlington "Petite".

Send for this wonderful little bracelet watch. See how beautiful the dainty green gold case looks on your own wrist.

Write

While this Special Offer Lasts

Get the Burlington Watch Book — write today. Find out about this great special offer which is being made for only a limited time. You will know a great deal more about watch buying when you read this book. You will be able to "steer clear" of the over-priced watches which are no better. Write for Watch Book and our special offer TODAY!

Burlington Watch Company

Dept. 9356, 19th St. & Marshall Blvd., Chicago
Canadian Address 62 Albert St., Winnipeg, Manitoba

Please send me (without obligations and prepaid) your free book on watches with full explanation of your \$1.00 down offer on the Burlington Watch.

Name _____

Address _____

This One



XND9-JPD-AJQD

"THE WOOD THAT
ALL ITS USERS PRIZE,
THE WISE
INVESTOR
SAFELY BUYS."

"BUILD OF CYPRESS
the 'Wood Eternal'
AND YOU BUILD
BUT ONCE."

HERE'S MY OPINION OF

Tide Water
Cypress
"The Wood Eternal"

The following are excerpts from the U. S. Govt. Report on Cypress—Bulletin 85, Dept. of Agriculture, Forest Service. The complete report is reprinted in Vol. 1 of the Cypress Pocket Library, free on request.

"As siding it practically wears out before it decays." (Page 29, Vol. 1, Cypress Pocket Library.)

"When made into porch columns it retains its shape, holds paint, and has sufficient strength to sustain necessary loads." (Page 29, Vol. 1, Cypress Pocket Library.)

"Cypress is put to almost every use as an interior trim for houses. It may be finished in natural color or stained. The wood contains little resin and thus affords a good basis for paint, which it holds well."

"It is a popular wood for kitchens, where it is subjected to dampness and heat. It shrinks, swells or warps but little, and is used for drainage boards, sinks, kitchen and pantry tables, cupboards and kitchen cabinets."

"The farmer puts this wood to many uses, in all of which it gives good service."

"Its lasting qualities fit it well for 'etc.'— you can imagine the rest—it's a convincing list.)

If you care to learn the rest of the U. S. Govt. Report

WRITE AT ONCE FOR VOL. 1

Please Address

SOUTHERN CYPRESS MFRS' ASSN.



1219 Poydras Building, New Orleans, Louisiana or 1219 Graham Building, Jacksonville, Florida

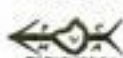

Popular Mechanics Magazine

6 N. Michigan Avenue, Chicago, U. S. A.

H. H. WINDSOR, Editor

London: Hachette & Cie,
16-17, King William Street, Charing Cross, W. C. 2

Paris: Hachette & Cie,
111 Rue Beaumais

Melbourne, Australia,
The Australasian News Co.

ISSUED MONTHLY

SUBSCRIPTION:

SINGLE COPY, 25 CENTS

In United States, and its possessions, Cuba, Mexico, and Canada, per year, postpaid . . . \$3.00
To all other countries in the Postal Union 3.50
All subscriptions are discontinued at expiration. Please examine the date printed on your wrapper.

Entered as Second Class Matter Sept. 15, 1905, at the Post Office at Chicago, Illinois, under Act of March 3rd, 1879.
Entered as Second Class Matter at the Post Office Department, Canada.

Published monthly by POPULAR MECHANICS CO.

Copyright, 1922, by H. H. Windsor.

Explains how 361

Automobile Curbans, Device for Holding 362

Vol. 38 Contents for September, 1922 No. 3

Air Craft, Nationality and Registry Marks for.....	358	Creek Dried Up during Engineering Job.....	349
Airplane Ambulances, Flying Fields to Have.....	424	Dams, Zoological Society, Serve Dual Purposes.....	380
Airplane, Army Passenger, Built on Foreign Lines...	410	Dance Pavilion and Palm Garden, Floating.....	337
Airplane, Motorless, Flies Five Minutes.....	364	Dishwasher, New, Uses Atmospheric Pressure.....	373
Alcohol, High Thermal Efficiency in, as Fuel.....	344	Drill and Grinder Combined, Has Wide Range of Speed.....	435
Altitudes, High, Effects of, on Human Beings.....	440	Drills, High Speed, Speed Changing Device on.....	445
Arc Welder, Electric, Has Automatic Feed.....	378	Elevator, Mont Blanc, Resume Work on.....	383
Arithmetic, Spinning <i>Top</i> Teaches to Children.....	450	Ellipse, Any Kind of, Instrument for Describing.....	410
Ash Removal System, Novel, for Power Plant.....	385	Excavation, Deepest Rock, for New York Store, by -T. Benjamin Faucett.....	384
Automobile Accident, Fatal, Locking Device Causes.....	410	Fine Grip, Rubber, Protects Hands.....	368
Automobile, Armored, for Rum Runners.....	446	Films, Photographic, Carnolite Ore Ruins.....	404
Automobile Carburetors, Air Cleaning Dust Trap for Automobile, Electric, Heel Pedal Control on.....	412	Fish Bait Snaps like Trap Used for Wild Animals...	353
Automobile Engines, Gasoline Vaporizer for.....	368	Fish Butter Displaces Cow's, by Francis Dickie.....	433
Automobile Lock Displaces Transmission Case Cover Automobile Lock Installed on Steering Wheel.....	354	Fish, Flying, Have Best Soaring Wings.....	422
Automobile Parking Lamp, Neat.....	400	Fishing Rod Joint, New, Prevents Sliding and Side- away.....	447
Automobile Pump-Inflates Tires Using Engine Suction Automobile Seat Cover, Rear, Used as Windshield...	350	Flag, Enamelled Upholstering Nails Used to Make...	431
Automobile Step Plate and Luggage Carrier Combined	415	Flags Washed on Pacific Steamships.....	368
Automobile Suspension, Four Point, Changed to Three Point.....	431	Flytrap, Electric, Made Ornamental.....	368
Automobile Temperature Indicator Has Dial on Dash Automobile Tilter Aids Repair Workers.....	356	Fort, Mysterious Floating, Opened to Visitors.....	390
Automobile Top Head Protector, Inflated Rubber...	345	Fuse, Refillable Plug Type, Simple and Efficient....	366
Barrels, "Mountain" of, Burn at Boston Celebration...	446	Gas Burners, Home, Rules for Testing.....	407
Batteries, Electric Storage, New Lightweight.....	382	Gas Burners, New Convertible Fixture for.....	330
Bee Families, Attractive Bungalows to House.....	436	Glass, Fine Powdered, Filter for Catching.....	435
Berry Crop, Overflow, Process Saves.....	379	Gluepot, Simple Electric, Has Rheostat Control....	380
Bird Mansions, Elaborate.....	400	Golf Clubs, Steel, Allowed by Western Association...	447
Birdcage Cups Supply Clean Food and Water.....	444	Gravel, Demand for, Makes Waste Land Valuable...	415
Blue Grass Seed, Kentucky, Is Valuable By-Product...	420	Grinding Balls, High Carbon, Give Good Service....	330
Box Testing Machine, New, at Federal Laboratory...	444	Grinding Machine, Internal, for Quantity Production...	420
Boy Day, Japanese, Flying Fish Signalize, by A. G. Clutterbuck.....	338	Grinding Machine, Portable, Operated by One Man...	426
Bridge—Drawbridge, Open, Steamer Wrecks.....	492	Hairpin Machine, Compact Automatic.....	386
Bridge, Steel Traveler on Barge Lightens Work on Building, Academy of Science, Planned for Washing- ton, D. C.....	414	Hammock Net, New, Resembles Bag.....	400
Cable, Submarine, Unusual Method of Laying.....	392	Hangar, Great Airship, Completed in Texas.....	420
Cable, Wire, Tool Holds and Cuts Easily.....	382	Horn, Hand Operated, Displaces Whistle.....	441
Cage, Oxygen Equipped, for Mine Rescue Birds....	395	Horse, Sea, Latest Fad for Bathing Beaches.....	409
Camera, Hand, for Snapshots or Motion Pictures....	408	Horse, Weakened, Supporting Rig for.....	432
Canal, Big Ship, United States to Have Another, by Robert Morgan.....	392	Horseshoes, Copper, to Help Prevent Forest Fires...	430
Canal, Dredging Outfit Cuts across Boulevard.....	421	Hospital, Building a \$10,000,000, by Charles Martel Niles.....	421
Cannon, Old Time, Used as Fog Signal.....	408	Hospital, Floating, Treats Foot Troubles.....	392
Car, Child's Play, with Clever Drive.....	383	Household Devices.....	442
Casting, Huge, Shipped Hanging between Two Cars...	350	Housing Plan, New, Combines Luxury and Low Rents.....	426
Celebration, "Days of '49".....	387	Hydroglider, Speedy French, Looks like Huge Fish...	333
Cement Successfully Used as Fire Extinguisher.....	435	Ice Cream Bricks, Individual, Device for Making....	424
"Chariots," Roman, Made from Wine Barrels.....	447	Ice Cream Sandwiches, Handy Outfit for Vending...	382
Child Portraiture, New Captivating Method of.....	353	Ice Harvest, Old Auto Engine Aids in.....	351
Children's Picture Pages.....	409	Irrigation Canal Débris Remover.....	394
Citrus Trees, Root Fungus Treatment for.....	367	Launch, Commodious River, of Famous Surgeon....	353
Civic Data, United States and Europe to Exchange...	444	Laundry Reel for Assorting Rough Dry Work.....	429
Civic Features.....	416	Levee, Undermining of, Solid Core Wall Prevents...	416
Cloudbursts, Two in Week at Syracuse.....	450	Lighthouse Lights, Clever Control Valve for.....	351
Coal Mining Film, American, to be Shown Abroad...	428	Literature, Agency to Send to Russian Scientists...	435
Coal, Polished, Attractive Novelties Made from....	418	Locomotive Sheds, Italian, Have Asbestos Roofing...	429
Coffin, Elaborate, Provided for Japanese Dignitary...	344	Lumber, Saving of By-Products Improves.....	405
Comment and Review, by H. H. Windsor.....	338	Man, Strong, Supports Eight Men and Framework...	345
Corn, Ear, Air Blast Outfit Loads in Cars.....	380	Melting Furnace, Gas Fired, Has Three Burners....	428
Cornet Mouthpiece, No-Pressure Attachment for....	432	Mortar, Novel Method of Stringing in Masonry Work...	344
	410	Mosquitoes, Drabs Sprayed with Asphalt to Control...	356
	376	Moths, European, Invade U. S. Trees.....	350
	359	Motion Pictures, Light Speaks for, by H. A. Lane...	334
	394	Motor Bus, Large Capacity, Has Detachable Body...	391
	386	Motor Bus Shower Bath Speeds Work.....	430

362
361
for change wiring
364
362
361

Burglar Gun 362 (Continued on Page 41)
Burglars + Transmission Lines 365
Launch, sea-line 361
Locomotive - Doppel Valve Gear 361

[Contents—Continued]

Motor, New Rotary, Weighs Only Ten Pounds.....	402
Motorcycle Map Holder Fastens to Handlebars.....	398
Mountain Drive, Tenderfoot Spiral, by J. H. Freeman	395
Mountain—Mount Everest, Latest Attempt to Scale.....	374
Moving Van Patriotically and Skillfully Adorned.....	381
Name, Oddity of, Made Advertising Slogan.....	450
Nutcracker, Powerful, Easy to Operate.....	400
Observatory Grounds, Mount Wilson, in Miniature..	348
Oil Refinery, Portable, for Use in New Oil Fields, by Curtis Vinson.....	418
Oil Well, Master Bushing in, Recovered by "Human Gopher," by Fred A. Herr.....	329
Oilcan, Leak-Proof, for Motorists.....	448
Orchard Heater Burns Carbon Briquettes.....	368
Organ Pipes, Huge, Voiced Outside Factory.....	398
Oxygen Cylinders, Frost in, Prevented by Heaters.....	391
Packing Plant, Largest in Australia.....	408
Padlock, Safe Type, Has Numbered Combinations.....	444
Paper and Carbon Sheets, Office Device Holds.....	373
Paper That can be Washed Made by Japanese.....	381
Pavement, Durable Wood, Dustless and Silent.....	354
Peace Exhibition, Beautiful, Japanese Hold.....	401
Peaches Resemble Pumpkins on Ohio Fruit Farm.....	382
Phonograph Records, Device for Holding.....	393
Pianos, Upright, Furnished with Tone Amplifiers.....	440
Pigeons, Artistic Bunkalow Houses for.....	407
Pile Drivers, Chinese, Singing Leaders Speed.....	430
Poem—Confession, by James A. Sanaker.....	492
Poem—Fishing the Ether, by George F. Staat.....	492
"Police, Wooden," Guard Lawns at Wyoming Uni- versity.....	356
Post Office Truck, Chicago, for Dumping Parcels.....	338
Prize Offers and Announcements.....	491
Projector Used for Study of Art.....	393
Radiator Covers, Steel, to Match Furniture.....	447
Radiator Steam, Device Controls as Desired.....	450
Rag Trade, Tariff Revision Expected to Reverse.....	445
Railroad Cars, Australian, Present Strange Sight.....	425
Railroad—Coal Train Wrecked When Deserted by Crew.....	404
Railroad Journal Jack, Simple and Compact.....	432
Railroad, Strange, Carries Boats from Lake to Sea.....	355
Railroad Weed Uprooting Machine.....	441
Reamer, Fluted Expansion, Has Aiming Pilot.....	445
Refrigerator, Scale and Meter Measure Ice in.....	392
Reindeers Branded by Cutting Notches in the Ears.....	444
River Front, New Orleans, being Raised, by Thomas Ewing Dabney.....	369
Road Maintenance System in Wisconsin Is Efficient.....	366
Safety Campaign, Extensive, to Reduce Injuries.....	353
Salt Mine, Rock, Visiting, by David H. Levington.....	411
Sander, Motor Driven Belt, of Novel Construction.....	385
Sandstone, Decaying, Two Methods of Preserving.....	423
School Children Aided by Society in Study of Birds.....	357
School, Largest Trade, Veterans' Bureau Becomes.....	338
Sewer, World's Largest, Kansas City Builds, by George F. Paul.....	377
Shear Serrating Grinder, Quick and Accurate.....	404
Shells, Old, Made Useful at U. S. Naval Station.....	428
Ship—Flagship, Model of British, on American Auto Truck.....	423
Ship—"Olympic" Makes New Speed Record.....	365
Ships, Phantom, of the Arctic, by Stratford F. Cor- bett.....	346
Shop Machine, Combination, Has Variety of Uses.....	366
Sidewalk, Damaged, Replaced without Disturbing It.....	436
Sign, Inlaid Glass, Gives Artistic Effect.....	428
Silo Moved from One Farm to Another on Wagon.....	332
Skinning Tool, Electric, for Packing House.....	437
Sound Made Visible with Wireless Vacuum Tube.....	424
Sound Vibrations, Photographic Records Made of.....	407
Stamp, Self-Inking, Homemade Stencils Used in.....	446
Stamps, Russian Letter, Worth 200,000 Rubles.....	394
Steel Making Plant Planned in India.....	417
Stool, Light Collapsible, for Autos and Camping.....	445
Submarines, Two, Added to U. S. Navy.....	357
Subway Car Lights, Flickering, Remedied by New Shoe.....	437
Sulphuric Acid, Simple Process for Making.....	376
Swimmer, Strong, Boat with Seven Passengers Towed by.....	424
Swimmers, Two Japanese, Swim Great Yangtze River.....	403
Telephone Headpiece Aids "Rewrite Men".....	349
Telephones, Free, Installed to Aid Motorists.....	425
Telescope Attachment Gives Three Magnifying Pow- ers.....	408
Town Moves Itself at a Profit, by Ivan E. Houk.....	389
Tractor, Motor Truck Convertible into.....	399
Tractor, Sanitary Breathing Pipe on.....	403
Traffic Signal Has Spikes for Careless Drivers.....	422
Trap, Fur Bearing Animals Caught Humanely in.....	330
Tree, Big, Tractor Quickly Removes.....	436
Tunnel, English-Channel, New Methods Seen in Bor- ing of.....	402
Vacuum Cleaner, Powerful, can be Easily Moved.....	354
Valve, Automatic Vacuum, Is Easily Removable.....	354
Ventilator Base Adjustable to Pitch of Roof.....	400
Violoncello, Collapsible, Portable and Quiet.....	337
Water Drawing Gear of Ancient Days.....	374
Water Lifting Machine, New Self-Operating.....	332
Water System, Cedar Stump Is Reservoir for.....	402
Weather Bureau, Amateur, Do Good Work.....	420
Window Display, Clever, for Fishing Season.....	426
Wireless Aerial Pole Erected by One Man.....	388
Wireless Booths, Remote Control, for Arlington Sta- tion.....	417
Wireless Installations, Office Building to be Wired for.....	422
Wireless Loud Speaker, Phonograph Used as.....	450
Wireless Megaphone Is Large Enough for Diving Platform.....	343
Wireless Station, Government Remedies for.....	398
Wireless Station, Gigantic, Opened in Germany.....	331
Wireless Station, Private, Owned by Eight Firms.....	419
Wireless Telephone, Transatlantic, Soon to be Achieved.....	436
Wireless Variable Condenser, Neat.....	356
Wireless Variometer, Neatly Designed.....	352
Woolens, German Product Makes Moth-Proof.....	418
Wrench Has Quickly Adjustable Jaws.....	354
Wrench, Pipe and Nut, Self-Adjusting.....	409
X-Ray Tube and Plate Holder, Frame for.....	343
Yacht, American Model, Wins in International Race.....	383

*Wireless attachment
for six persons*

SHOP NOTES

362

Annealing Machine, Rapid.....	468
Annunciators for Group Machine Operators.....	466
Anvil Vise for Blacksmiths.....	464
Automobile Cylinder Head Plugs, Removing.....	464
Babbitt Ladle Made from Wagon Skein.....	465
Bearing Clamp Aids in Fitting.....	462
Belt Ends, Clamp for Squaring.....	460
Blueprinting without a Frame.....	473
Concrete Mixer, Cheap Homemade.....	463
Covers, Tight Fruit Jar, Loosening.....	472
Drilling Head, Supplying Lubricant to.....	455
Drills, Small, Case for.....	460
Engine, Pumping, Hopper Cooling System for.....	456
Engine Shelter, Small.....	461
Gauge for Marking Tubes.....	453
Grinder, Bench, Homemade Utility.....	466
Guard, Lathe Grinder.....	453
Hammer and Drift Combined.....	457
Harrow, 24 Foot, Drawbar for.....	463
Lathe Center Driver.....	464
Lathe Used to Saw Logs.....	471
Lawn Sprinkler, Perforated Pipe.....	468
Linseed Oil, Miscellaneous Uses for.....	468
Micrometer Height Gauge.....	456
Micrometer Tip, Auxiliary.....	463
Nails, Driving to Prevent Splitting.....	454
Pencil Holder Made from Paper.....	465
Pinch Dogs Made from Nails.....	470
Pipe Center Base, Boring Out in Lead Chuck.....	454
Pipe Vise, Improved.....	457
Platinum Filings, How to Clean.....	452
Pulley Oil Grooves, Cutting.....	455
Pulleys and Flywheels, Old, Refacing.....	451
Pulleys, Disk-Grinding.....	472
Pumps, Small High Pressure, How to Make.....	462
Rifle, 22-Caliber, Rechambering.....	464
Shear, Powerful, Made from Bar Stock.....	470
Skid, Unbraced Excavation, for Removing Soil.....	471
Soldering Iron, Rest for.....	452
Springs, Small Coil, Hardening.....	469
Staples, Hay Hook Used for Pulling.....	452
Steel, Tough, Chipping Chisel for.....	465
Steps and Stairs, Proper Angles and Dimensions for.....	470
Swimming Pool, Skimming Flotsam from.....	461
Tapping, Hand, on Sensitive Drill.....	457
Test Indicator Attachment Increases Its Usefulness.....	463
Testing Block, Precision.....	454
Threading Arbor, Special.....	465
Truck, Roller, for Farm or Factory Yard.....	455
Truck, Steel, for Enameled Flywheels.....	453
Tubes, Thin, Chucking without Distortion.....	471
Valve Wheel, Loose, Making Secure.....	472

Stone Camp, Hadam [Contents Continued on Page 6]

363

DRAKE'S PRACTICAL MECHANICAL BOOKS

THEY WILL RAISE YOUR PAY— ORDER ON 5-DAY TRIAL

The books listed below will perfect you in your chosen trade — pave the way to the big positions. Written in non-technical language—easy to read and understand. *Every book covers its subject completely. An entire course of instruction condensed into one volume.* Your choice sent postpaid — you benefit 5 days — money refunded in full if not entirely satisfactory. Order direct from this page.



Automobile Books

Automobile Ignition, by Manly.....Leatherette	\$2.00
Automobile Starting and Lighting, by Manly.....Leatherette	\$2.00
Brookes' Automobile Handbook.....Leatherette	\$2.00
Ford Motor Car, Truck and Tractor, by Manly.....Cloth	\$1.50
Starting and Lighting Troubles, Remedies and Repairs, by Manly.....Leatherette	\$3.00
Automobile Battery, Care and Repair, by Manly.....Leatherette	\$2.00
Automobile Catechism and Repair Manual.....Leatherette	\$1.50
Tires and Vulcanizing, by Tufford.....Cloth	\$2.00
Gas and Oil Engine Handbook.....Cloth	\$1.50
Automobile Upkeep and Care, by Manly.....Cloth	\$1.50
Motorcycle Handbook, by Manly.....Cloth	\$1.50

Shop Practice Books

Sheet Metal Workers' Manual.....Leatherette	\$2.00
Oxy-Acetylene Welding and Cutting.....Leatherette	\$1.75
Sound Welds.....Cloth	\$2.00
Slide Rule and Logarithmic Tables.....Leatherette	\$2.00

ORDER DIRECT FROM THIS PAGE—ON OUR MONEY-BACK PLAN

The books listed above are only a few of the many in our catalogue, which you will receive promptly after filling out and mailing us the attached coupon. For quick action order direct from this page—cross name of each book wanted and send in with price quoted. We prepay postage and send the books on our money-back plan.

FREDERICK J. DRAKE & CO.

PUBLISHERS

1008 Michigan Ave., Chicago

Drake Books Are For Sale at All Book Stores

Mail Coupon For Free Catalogue
Your Guide to Home Study

Handbook for Millwrights.....Cloth	\$2.00
Modern Blacksmithing.....Cloth	\$1.25
Machine Shop Practice.....Cloth	\$2.00
Mechanical Drawing and Machine Design.....Cloth	\$2.00
Pattern Making.....Cloth	\$1.50

Carpentry Books

Cloth Binding	
Modern Carpentry, 2 vols.....	\$3.00
The Steel Square, 2 vols.....	\$3.00
Wooden Boat and Shipbuilding.....	\$1.50
Modern Estimator.....	\$1.50
Timber Framing.....	\$2.00
Builder's Architectural Drawing.....	\$2.00
Concrete.....	\$1.50
Practical Bungalows.....	\$1.00
Low Cost Homes.....	\$1.00
Roof Framing.....	\$1.50
Stair Building and Hand Rail- ing.....	\$1.50

Electrical Books

Practical Applied Electricity.....	\$2.00
Alternating Current.....	\$1.50
Electric Motor Control Systems.....	\$1.50
Wiring Diagrams and Descrip- tions.....	\$1.50
Electrical Tables and Data.....	\$1.50
Armature and Magnet Winding.....	\$1.50
Modern Electrical Construction.....	\$1.50
Modern Electric Illumination.....	\$1.50
Electricians' Operating and Test- ing.....	\$1.50
Motion Picture Operation.....	\$1.50
Drake's Electrical Dictionary.....	\$1.50
Electric Motors, D. & A.....	\$1.50
Electrical Measurements and Me- ter Testing.....	\$1.50
Drake's Telephone Handbook.....	\$1.50
Modern American Telephony.....	\$2.00
Easy Electrical Experiments.....	
.....Cloth	\$1.25
Wireless Telegraph and Tele- phone Handbook.....	Cloth \$1.25
Telegraphy Self-Taught.....	Cloth \$1.25

Steam Engineering

Swingle's Handbook for Steam Engineers and Electricians.....	Leatherette \$4.00
Examination Questions and An- swers for Marine and Station- ary Engineers.....	Leatherette \$2.00

Steam Boilers.....	Leatherette \$2.00
Swingle's Catechism of Steam, Gas and Electrical Engineer- ing.....	Leatherette \$1.50

Painting Books

Scene Painting and Bulletin ArtCloth	\$4.00
A Show at Sho' Cards.....	Cloth \$4.00
Sign Painting.....	Cloth \$4.00
Strong's Book of Designs.....	Leatherette \$4.00
Strong's Art of Show Card Writ- ing.....	Cloth \$4.00
Signist's Alphabets.....	Cloth \$1.50
Modern Painter's Cyclopedin.....	Cloth \$2.00
Automobile Painting.....	Cloth \$1.50
Estimates, Costs and Profits, Painting and Decorating.....	Cloth \$1.50
New Hardwood Finishing.....	Cloth \$1.50
The Amateur Artist.....	Cloth \$1.50
New Stencils.....	Cloth \$1.25

Farm Books

Farm Mechanics.....	Cloth \$1.25
Farm Buildings.....	Cloth \$1.25
Farm Engines.....	Cloth \$1.25
Traction Farming.....	Cloth \$1.50

Business and Reference Books

Better Business Letters.....	Leatherette \$1.50
Better Business English.....	Leatherette \$1.50
Better Advertising.....	Leatherette \$1.50
Finger Prints Simplified.....	Cloth \$2.00
Practical Bricklaying.....	Cloth \$1.25
Practical Instruction for Detect- ives.....	Cloth \$1.00
Practical Plumbing.....	Cloth \$1.50
Hot Water Heating.....	Cloth \$1.50
Elementary Chemistry.....	Cloth \$1.50
Courses in Civil Service.....	Cloth \$1.50
Cyclopedia of Recipes.....	Cloth \$1.50
American Star Speaker.....	Cloth \$1.50

Modern Languages

By Prof. P. S. Allen, U. of Chicago	
French without a Teacher.....	Cloth \$1.25
Spanish without a Teacher.....	Cloth \$1.25
German without a Teacher.....	Cloth \$1.25
Everyday French.....	Cloth \$1.25
Everyday Spanish.....	Cloth \$1.25

FREDERICK J. DRAKE & CO.
1008 Michigan Avenue
Chicago, Ill.

GENTLEMEN:—Please send me free, postage paid, your illustrated catalogue which lists and describes over 100 Practical Mechanical Books for Home Study.

My name is

and my address

St. Louis Man Discovers A New Kind Of Heat!



Mr. B. M. Oliver of St. Louis has invented an amazing device which ends forever the days of woman's slavery to dirty, mussy coal and wood fires. It sets into the fire-box of any kind of heating stove, cook stove or furnace without changes and just turning a valve it gives any degree of

heat from a tiny flame to a roaring inferno—3 times the heat of coal if it is needed.

Mr. Oliver calls his invention the Oliver Oil-Gas Burner because it makes its own gas from 95% air and 5% coal oil (kerosene) the cheapest fuel there is. The wonderful story of a woman's freedom from building fires, carrying heavy scuttles, emptying ashes has spread so rapidly that already over 100,000 burners are being used by American housewives. Mr. Oliver wants every woman to have the use of his invention. If you will write to him at 2014-I Oliver Bldg., St. Louis, Mo., you will receive an attractive booklet FREE that tells all about it. Mr. Oliver is now making a special Low Price Offer, including a Thirty-Day Free Trial. He is also looking for good, live distributors and will tell you how to earn \$500 a month in full or spare time if you are interested and request his sales plans.

Stop Forgetting

Make Your Mind a File—Not a Pile

Let me show you how to make your mind as forget-proof as a card index file. When you wish to recall a name, place or date, must you grope in vain in a pile of miscellaneous knowledge? Summoned to give facts and figures does your mind become a blank? Be master of your mind's infinite resources—instead of a victim of its disordered details.

KNOWLEDGE IS POWER

and Memory Is the Basis of All Knowledge

I HAVE HELPED THOUSANDS

The Dickson Method of Memory and Mental Training, perfected by 20 years experience, is recognized as the most thorough, efficient of its kind. Highly endorsed—easy to master. Give me 10 minutes a day and I will train your memory so you can classify ideas, names, faces, etc., and recall them instantly. Develop self-control, concentration; overcome bashfulness.

Perfect Your Memory and Command What Salary You Will

Send name and address and I will send you free, my interesting booklet, "How to Remember," and unique, copyrighted Memory Test; also tell you how to secure free of charge my \$3.00 book, "How to Speak in Public."

Prof. Henry Dickson, Principal
DICKSON MEMORY SCHOOL
Dept. 705
Evanston, Ill.

Stop forgetting

The Key to Success

[Contents—Continued from Page 4]

AMATEUR MECHANICS

Automobile Burglar Alarm.....	476
Automobile Cylinder Head Bolts, Replacing.....	474
Automobile Engine Valves, Overhead, Tool Aids in Work on.....	490
Automobile Headlights, Switch Brightens.....	489
Automobile Jack Head Saves Blocking Car.....	484
Automobile Jacks, Blocks for.....	487
Automobile Trouble Light, Headlight Made into.....	475
Automobile Vacuum System, Testing for Leaks.....	483
Boat Oars, Keeping in Rowlocks.....	481
Boats, Mooring in Tidal Waters.....	482
Brass, How to Make Black.....	484
Brief Case, File for.....	474
Cherry Picker, Effective.....	474
Connecting Rods, Model Machinery.....	477
Cultivator, Homemade Garden.....	475
Dandelions, How to Kill.....	482
Enamel, Making to Flow Easily.....	476
Feed Box, Portable, for Horses.....	483
Flower Bed Made from Auto Rim.....	475
Furnace, Pipeless, Auxiliary Register for.....	478
Gasket, Emergency, Made of Lamp Cord.....	490
Harness Made from Auto Tires.....	477
Harrow, Preventing from Injuring Bark on Trees.....	475
Hose Clamp, Universal.....	487
Ice Pick, Holder for.....	486
Jars, Preventing from Cracking while Canning.....	485
Laundry Cabinet, Handy Homemade.....	484
Leather, Soiled, Cleaning.....	481
Lunch Box and Table, Folding, for Motorists.....	476
Meat, Smoking with Applewood.....	477
Muffler, Engine, for Home Lighting Plant.....	483
Pack Sack Straps, Improving.....	484
Photography—Enlarger, Homemade Vertical.....	479
Photography—Films Soaked in Water before Developing.....	486
Photography—Focus, Sharp, Making Sure of.....	489
Photography—Photographing Small Articles with Folding Camera.....	485
Pump Arrangement for Deep Wells.....	485
Refrigerator, Electric Light for.....	489
Rubbish Box, Novel, for Parks.....	474
Skirts, Pleated, Pressing Easily.....	490
Swimming in Wading Boots.....	485
Switch, Three-Pole Double-Throw, Homemade.....	487
Tent and Pack Cover, Combination.....	478
Tires, Auto, How to Carry.....	478
Trees, Young, How to Water.....	478
Vacuum Bottle Corks, Repair for.....	478
Vacuum Cleaner, Lighting Fixtures Protected While Using.....	490
Water, City Drinking, Cooling.....	480
Window Ledge Guard.....	482
Wireless Transmitting Set, Simple.....	485
Wireless Vacuum Tubes, Adjusting to Voltmeter.....	484

Get This Car And the AGENCY



In Your Territory. Drive a new Birch Light Four. Prompt shipments. Experience not necessary. Big discount to dealers. Write quick for full information.

BIRCH MOTOR CARS, Dept. 919, 308 N. Mich. Ave., Chicago

RAILWAY MAIL CLERKS

\$135 to \$195 Monthly
WANTED

STEADY WORK.

Travel

Sample Questions,

FREE.

Common School

education sufficient.

No political "pull"

necessary.

MY FREE BOOK

Also Describes Internal Revenue, Customs House, Post

Office, Rural Mail Carrier and other Government posi-

tions. I will advise you free of cost regarding any Civil

Service position you want. Write me TODAY.

GEO. S. STEWART

Former U. S. Gov't Instructor

Dep't 10-A

5 Columbus Circle, New York City



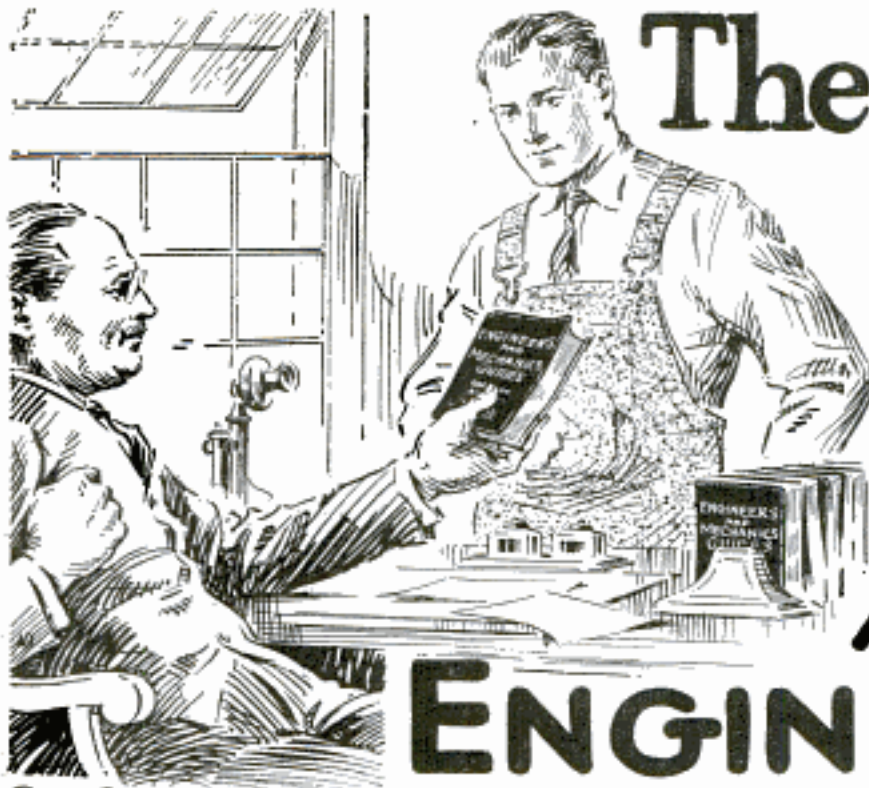

The CHIEF said—

"Tom, the way to **earn** more is to **learn** more. Audel's Engineers' Guide will help you. The biggest favor I can do you is to advise you to send for this Master Set. Remember—What you are tomorrow depends on what you think and do today."

AUDEL'S ENGINEERS ^{and} MECHANICS GUIDES

—the Master Set for the man on the job. Just completed. Contains latest practical information on every phase of Modern Engineering and Electrical Theory and Practice. Solves your problems. Answers your questions. Fits you for the **job higher up**. Points the way to better pay. Highly recommended by **Chief Engineers**, Master Mechanics and Instructors. Every engineer, mechanic and electrical worker that owns and uses this set will begin immediately to be a more valuable man.

"Gives fundamentals more clearly than any other set"—R. H. Wilson. "Should be in the house of every man on power house work"—Barney Meyer. "Gave me more common sense knowl-

edge than any other books"—Neil Crottean. "You certainly give a square deal; I'm delighted"—W. D. McGrew. "Congratulate you on such complete set at such low price"—W. H. Hailley.

THESE BOOKS TELL YOU ALL ABOUT—

Theory, Practice and Operation of ALL Steam Engines, Valve Motions—VALVE SETTING; complete information on ALL engines and pumps—CORLESS ENGINES and the Theory, Construction and Operation of all Steam Engines including UNIFLOW and POPPET VALVE ENGINES and LOCAL MOBILES—Locomotive-Marine Engines-Turbine-Boiler Engines—the Turbine—Turbines—PRACTICAL MANAGEMENT. How to use Indicator—GAS, GASOLINE, OIL, SEMI- and FULL DIESEL ENGINES—Aeroplanes, and Aviation—HOW TO SELECT AN ENGINE, working instructions, drawings on STEAM ENGINE DESIGN including rules and formulas, Theory and Construction of ALL Steam Boilers; Heat-Combustion; Fuel and Flue Gas Analysis—CO₂ recorder—Characteristics

of Boilers—Materials—Construction of all types of Boilers. (THE LATEST PRACTICE.)—Boiler Construction—Mechanical Stokers—Oil Burners—Setting—Chimneys—Mechanical Draft—HOW TO SELECT A BOILER—Complete instructions and drawings on BOILER DESIGN based on A. S. M. E. BOILER CODE—OPERATION, including installation, FIRING; care and repair of Steam Boilers—Pipes, Fittings and Pipe Fitting—Heating and Ventilation—Refrigeration—Cooling Towers—Condensers—Distilling Apparatus—Elevators—Cranes and Hoisting Machinery—Ropes and Cables—Splicing. Special Feature is Volume No. 8—a compendium of practical electrical engineering, a guide for electricians and electricians in obtaining a license—27 chapters—ready reference index, covering entire field of Modern Electricity.

POCKET SIZE 4750 PAGES 8754 ILLUSTRATIONS FLEXIBLE

\$1. Per
Month



FREE EXAMINATION

We want these books to be **their own salesmen!** Look them over yourself free—without any obligation—just as if you borrowed them from a library or a friend. If you like them send us \$1—and then \$1 a month. If you don't like them send them back. Each book is pocket size, gilt edged, clearly printed on light weight paper with flexible binding.

\$12 Complete

THEO. AUDEL & CO., 72 Fifth Ave., New York City
 for free examination, AUDEL'S MASTER SET FOR ENGINEERS AND MECHANICS, send \$1.00 to cover postage and handling charges. If satisfactory, I agree to send you \$1.00 within seven days and to further mail you \$1.00 each month until paid.
 Name _____
 Home Address _____
 Employed by _____
 Occupation _____
 Residence _____
 P.M. Sept. 22

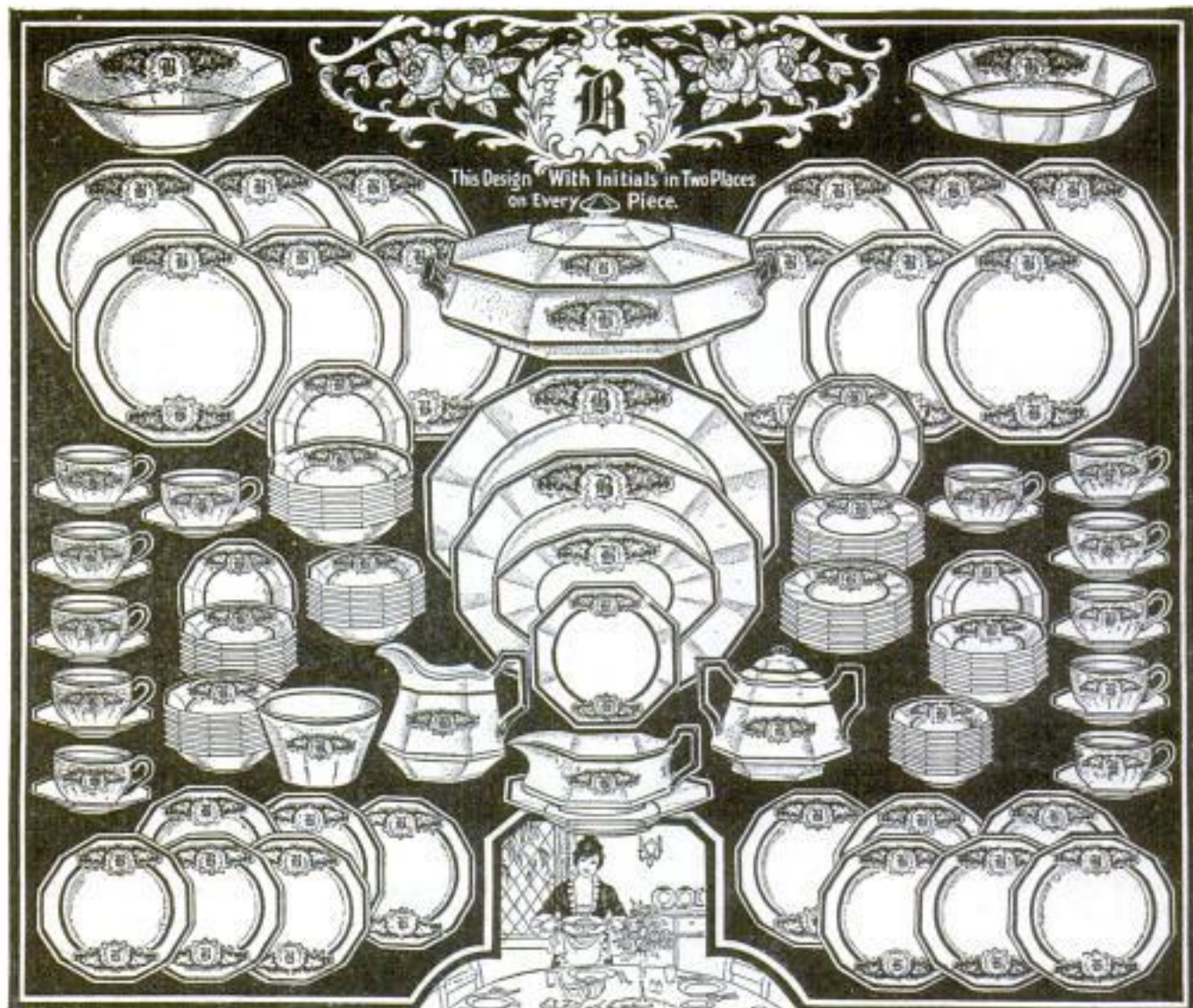

This Superb 110-piece Set, with initial in 2 places in wreath with 5-color decorations on every piece and gold covered handles, consists of:

12 Dinner Plates, 9 inches
12 Breakfast Plates, 7 inches
12 Cups
12 Saucers

12 Soup Plates, 7 $\frac{1}{2}$ inches
12 Cereal Dishes, 5 inches
12 Fruit Dishes, 5 $\frac{1}{2}$ inches
12 Individual Bread and Butter Plates, 5 $\frac{1}{2}$ inches
1 Platter, 13 $\frac{1}{2}$ inches

1 Platter, 11 $\frac{1}{2}$ inches
1 Celery Dish, 8 $\frac{1}{2}$ inches
1 Sauce Boat Tray, 7 $\frac{1}{2}$ inches
1 Butter Plate, 6 inches
1 Vegetable Dish, 10 $\frac{1}{2}$ inches, with lid (2 pieces)

1 Deep Bowl, 8 $\frac{1}{2}$ inches
1 Oval Baker, 9 inches
1 Small Deep Bowl, 5 inches
1 Gravy Boat, 7 $\frac{1}{2}$ inches
1 Creamer
1 Sugar Bowl with cover (2 pieces)

Brings 110-Piece Gold Decorated Martha Washington Dinner Set

Send only \$1 and we ship the full set—110 pieces. Use it 30 days. Then if not satisfied, return them and we refund your \$1 and pay transportation charges both ways. If you keep them, take nearly a year to pay on easy terms.

Your Initial in 2 Places on Every Piece; 5-Color Floral Decorations and Gold

Wonderful artistic effect is given by the wreath and rich design surrounding the initial. Your initial appears in 2 places on every piece.

All Handles Covered with Gold

Every handle is covered with polished gold. Shipping weight about 90 lbs.

Order No. 324DDMA13. Bargain price, \$32.85. Pay \$1 now, \$3 monthly.

HARTMAN Furniture & Carpet Co.
Dept. 4648 Copyright, 1922, by Hartman's, Chicago Chicago, Ill.

A B C D E F G H I J K L M N O P Q R S T U V W X Y Z



Important!

Hartman guarantees that every piece in this set is absolutely first quality—no seconds. This is a standard or "open" pattern. Replacements may be had for three years. Each piece wrapped in tissue paper. Excellent packing to prevent breakage. Shipped without delay.

FREE Bargain Catalog

368 pages of bargains in furniture, rugs, stoves, silverware, washing machines, kitchen ware, gas engines and cream separators, etc.—all on our easy terms—30 days' FREE trial. Post card or letter brings it FREE.

"Let Hartman Feather YOUR Nest"

HARTMAN FURNITURE & CARPET CO. CHICAGO, ILL.

I enclose \$1.00. Send 110-piece Golden Martha Washington Dinner Set No. 324DDMA13. I am to have 30 days' free trial. If not satisfied, will ship it back and you will refund my \$1.00 and pay transportation charges both ways. If I keep it, I will pay \$3.00 per month until full price, \$32.85, is paid. Title remains with you until final payment is made.

Name.....
Street Address.....
R. F. D..... Box No.....
Town..... State.....
State Your Occupation..... Color.....
Give Initial Wanted (Any One Letter).....

I Teach Piano a Funny Way

So people told me when I first started in 1891. But now after over twenty-five years of steady growth, I have far more students than were ever before taught by one man. I am able to make them players of the piano or organ in half the usual time and at quarter the usual cost.

To persons who have not previously heard of my method this may seem a pretty bold statement. But I will gladly convince you of its accuracy by referring you to any number of my graduates in any part of the world. There isn't a State in the Union that doesn't contain many players of the piano or organ who obtained their training from me **by mail**. Investigate by writing for my 64-page free booklet, "How to Learn Piano or Organ."

My way of teaching piano or organ is **entirely different** from all others. Out of every four hours of study, one hour is spent **entirely away from the keyboard**, learning something about Harmony and The Laws of Music. This is an awful shock to most teachers of the "old school," who still think that learning piano is solely a problem of "finger gymnastics." When you **do** go to the keyboard, you can accomplish **twice as much** because you **understand what you are doing**. Within four lessons I enable you to play an interesting piece not only in the original key, but in other keys as well.

I make use of every possible scientific help—many of which are **entirely unknown** to the average teacher. My patented invention, the **COLOROTONE**, sweeps away playing difficulties that have troubled students for generations. By its use, Transposition—usually a "nightmare" to students—becomes easy and fascinating. With my fifth lesson I introduce another important and exclusive invention, **QUINN-DEX**. Quinn-Dex is a simple, hand-operated moving-picture device, which enables you to see, right before your eyes, every movement of my hands at the keyboard. You actually see the fingers move. Instead of having to reproduce your teacher's finger movements from **MEMORY**—which cannot be always accurate—you have the correct models before you during every minute of practice. The **COLOROTONE** and **QUINN-DEX** save you months of wasted effort. They can be obtained only from me, and there is nothing else, anywhere, even remotely like them.

Men and women who have failed by other methods have quickly and easily attained success when studying with me. In all **essential** ways you are in closer touch with me than if you were studying by the oral method—yet my lessons cost you only 43 cents each—and they include all the many recent developments in scientific teaching. For the student of moderate means, this method of studying is **far superior** to all others; and even for the wealthiest student there is nothing **better** at any price.

You may be certain that your progress is at all times in accord with the best musical thought of the present day, and **this makes all the difference in the world.**

My course is endorsed by distinguished musicians, who would not recommend any course that did not maintain the highest musical standards. It is for beginners, or experienced players, old or young. You advance as rapidly or as slowly as you wish. All necessary music is supplied without extra charge. A diploma is granted. Write today, without cost or obligation, for 64-page free booklet, "How to Learn Piano or Organ."

**MARCUS LUCIUS QUINN
CONSERVATORY OF MUSIC**

Studio PM-49 598 Columbia Road
BOSTON, 25, MASS.



DR. QUINN AT HIS PIANO

From the Famous Sketch by Schneider, Exhibited at the St. Louis Exposition.



FREE BOOK

How To
Learn
Piano

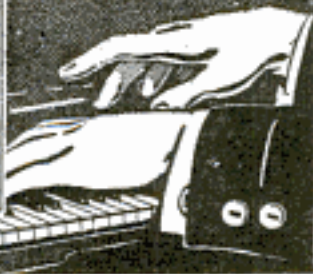

--- -- **FREE BOOK COUPON** --- --

**QUINN CONSERVATORY, Studio PM-49
598 Columbia Road, Boston, 25, Mass.**

Please send me, without cost or obligation, your free booklet, "How to Learn Piano or Organ," and full particulars of your Course and special reduced Tuition Offer.

Name

Address

\$80 Drafting Course Free

There is such an urgent demand for practical, trained Draftsmen that I am making this special offer in order to enable deserving, ambitious and bright men to get into this line of work. I will teach you to become a Draftsman and Designer, until you are drawing a salary of \$250.00 a month. You need not pay me for my personal instruction or for the complete set of instruments. All that is necessary is to get two other students.

\$250 a Month

Starting salary according to my agreement and guarantee. Draftsmen's work is pleasant and profitable. Positions are open paying \$3,600.00 a year in the best surroundings. They are open everywhere. Thousands of men are needed who have just the kind of training I will give you. You can get this training during spare time in your own home.

Mail the Coupon

for my valuable book—"Successful Draftsmanship." It explains how YOU can become a Successful Draftsman in a short time. The book is free at present, so write AT ONCE.



Free Course Offer Coupon Chief Draftsman Dobe

4001 Broadway, Div. 1356 Chicago
Without any obligation to me please mail your book, "Successful Draftsmanship" and full particulars of your liberal "Personal Instruction" offer to a few students. It is understood I am obligated in no way whatever.



Name _____

Address _____

Chief Draftsman Will Train You Personally

on practical Drafting-room work Until you are competent and Until you are in a permanent position at a salary paying at least \$250 per month. This is an exceptional opportunity for a few selected ambitious men, between the ages of 16 and 50 whom I will train personally.



Send the Coupon or a letter and let me tell you how you can become a Draftsman in your spare time and earn a good salary. Don't delay—send the coupon at once.

I Guarantee
To instruct you until competent and in a permanent position at a regular Draftsman's salary of at least \$250 per month and guarantee to furnish you free complete Draftsman's working outfit at once from the start.

FREE—this \$25.00 Draftsman's Working Outfit

These are regular working instruments, the kind I use myself. I give them free to you if you enroll at once. **Send the Free Coupon today.**

Earn While Learning

You can be earning a handsome income while learning at home. This is a special offer I am making. Absolutely no obligations of any kind in sending coupon. But you must write at once, as I limit the number of my students.

Mail the FREE Coupon at once for my book—"Successful Draftsmanship," also list of open positions and for the free offer to be earning good money at once while learning at home. This offer is limited and in order to benefit thereby—act at once.

Chief Draftsman Dobe
4001 Broadway, Div. 1356 Chicago, Ill.



"Don't tell me you never had a chance!"

"Four years ago you and I worked at the same bench. We were *both* discontented. Remember the noon we saw the International Correspondence Schools' advertisement? That woke me up. I realized that to get ahead I needed special training, and I decided to let the I. C. S. help me. When I marked the coupon I asked you to sign with me. You said, 'Aw, forget it!'"

"I made the most of my opportunity and have been climbing ever since. You had the same chance I had, but you turned it down. No, Jim, you can't expect more money until you've trained yourself to handle bigger work."

There are lots of "Jims" in the world—in stores, factories, offices, everywhere. Are *you* one of them? Wake up! Every time you see an I. C. S. coupon your chance is staring you in the face. Don't turn it down.

Right now over one hundred thousand men are preparing themselves for bigger jobs and better pay through I. C. S. courses.

You can join them and get in line for promotion. Mark and mail the coupon, and find out how.

INTERNATIONAL CORRESPONDENCE SCHOOLS

Box 3664-C, Scranton, Penna.

Without cost or obligation, please send me full information about the subject before which I have marked an X in the list below:

BUSINESS TRAINING DEPARTMENT

- | | |
|---|---|
| <input type="checkbox"/> Business Management | <input type="checkbox"/> Salesmanship |
| <input type="checkbox"/> Industrial Management | <input type="checkbox"/> Advertising |
| <input type="checkbox"/> Personnel Organization | <input type="checkbox"/> Better Letters |
| <input type="checkbox"/> Traffic Management | <input type="checkbox"/> Foreign Trade |
| <input type="checkbox"/> Business Law | <input type="checkbox"/> Stenography and Typing |
| <input type="checkbox"/> Banking and Banking Law | <input type="checkbox"/> Business English |
| <input type="checkbox"/> Accountancy (Including C.P.A.) | <input type="checkbox"/> Civil Service |
| <input type="checkbox"/> Nicholson Cost Accounting | <input type="checkbox"/> Railway Mail Clerk |
| <input type="checkbox"/> Bookkeeping | <input type="checkbox"/> Common School Subjects |
| <input type="checkbox"/> Private Secretary | <input type="checkbox"/> High School Subjects |
| <input type="checkbox"/> Business Spanish | <input type="checkbox"/> Illustrating |
| <input type="checkbox"/> French | <input type="checkbox"/> Cartooning |

TECHNICAL AND INDUSTRIAL DEPARTMENT

- | | |
|---|--|
| <input type="checkbox"/> Electrical Engineering | <input type="checkbox"/> Architect |
| <input type="checkbox"/> Electric Lighting | <input type="checkbox"/> Contractor and Builder |
| <input type="checkbox"/> Mechanical Engineer | <input type="checkbox"/> Architectural Draftsman |
| <input type="checkbox"/> Mechanical Draftsman | <input type="checkbox"/> Concrete Builder |
| <input type="checkbox"/> Machine Shop Practice | <input type="checkbox"/> Structural Engineer |
| <input type="checkbox"/> Railroad Positions | <input type="checkbox"/> Plumbing and Heating |
| <input type="checkbox"/> Gas Engine Operating | <input type="checkbox"/> Chemistry |
| <input type="checkbox"/> Civil Engineer | <input type="checkbox"/> Pharmacy |
| <input type="checkbox"/> Surveying and Mapping | <input type="checkbox"/> Automobile Work |
| <input type="checkbox"/> Mine Foreman or Engineer | <input type="checkbox"/> Navigation |
| <input type="checkbox"/> Steam Engineering | <input type="checkbox"/> Agriculture and Poultry |
| <input type="checkbox"/> Radio | <input type="checkbox"/> Mathematics |
| <input type="checkbox"/> Airplane Engines | |

Name.....
Street.....
Address.....

City..... State.....

Occupation.....

Persons residing in Canada should send this coupon to the International Correspondence Schools Canadian, Limited, Montreal, Canada.



Cartoon Stars make big money



"Sis"

Sidney Smith, Clare Briggs, Fontaine Fox and many other cartoon stars make from \$10,000 to \$100,000 a year. Bud Fisher makes over \$50,000 a year from Mutt and Jeff. R. L. Goldberg's yearly income is more than \$125,000. Yet both Fisher and Goldberg started as \$15 a week illustrators. Ministers, bookkeepers, and mechanics have become successful illustrators and cartoonists through the Federal School of Applied Cartooning. Don't let your present job hold you back. Capitalize your cartoon ideas. The way is now open to you.



"Skinny"

Send Six Cents for A Road to Bigger Things

This book shows studio pictures of the 32 greatest American cartoonists who are on the staff of the Federal School. It tells how in **one course** you can learn cartooning, animated cartooning, chalk talking, and window card writing. One of these is **your big field**. It shows how by home study, you can learn the skill, stunts, short-cuts, and the professional touch of these famous cartoon stars on the Federal Staff.

These stars make big money from simple cartoon ideas. Do you want their fame and incomes? Just fill in your name, age and occupation and address, and mail the coupon with six cents to cover postage for this book that tells you how you can qualify. Do it Now.



"The Toonerville Trolley"



"Powerful Katrinka"

Federal School of Applied Cartooning
903 Federal Schools Bldg. Minneapolis, Minn.

----- TEAR OUT COUPON ALONG THIS LINE -----

Please send by return mail my copy of "A Road To Bigger Things." I enclose six cents for postage.

NAME..... AGE.....

ADDRESS..... OCCUPATION.....

CITY AND STATE.....

5,000,000 Men Are After the Routine Jobs—

*Break Away From
This Competition—*

Command Big Pay!

When business slackens, can your employer "let you go"—and tomorrow hire almost any routine man from this army of 5,000,000 men and find him competent to take your place?

Observe that when a business trims its crew, it is almost never the big-pay men who walk the plank.

Not only are the specialists retained—the Accountants, Production Managers, Traffic Managers, and, in fact, the managers of any of the important departments of a business—but they are frequently promoted. Other concerns are in need of their ability, and come bidding for their services.

Many of these men who today are going rapidly ahead were no better off than you, several years ago. Today, while others walk the streets, these men walk into the better jobs.

There is no mystery about their swift advancement. There is a way that's interesting and practical whereby any man of average intelligence can get the training that will put him in the big-pay class. Literally thousands of ambitious men have found this way in the LaSalle Problem Method. They have chosen the line of work that most appealed to them—then, right in the quiet of their own homes, without losing an hour from work or a dollar of pay, they have solved the problems they today are meeting in the better jobs.

Situations which they face today are identical with those they faced in spare-time study. They have been shown exactly how to meet them—guided every step of the way by some of the ablest business men, in their respective fields, in America.



Read these statements, typical of over 1,000 which we will send you in booklet form and which represent but a small part of the many thousands of similar letters in our files:

"The most efficient and most rapidly promoted men in our whole organization are LaSalle-trained."

"Promoted to General Manager."

"Now a director in two banks."

"From bookkeeper advanced to chief accountant—salary increased 500%."

"Passed bar examination with highest grade, in competition with many resident school graduates."

"The Problem Method increased my income \$2,500 a year."

"Passed C. P. A. examination. You will be interested to know that 50% of the successful candidates were LaSalle-trained men."

An analysis of the letters from 1,089 LaSalle members reporting definite salary increases during 3 months' time shows an average increase per man of 56%.

While the axe hangs over every business office, it's the time of all times to free yourself forever from the treadmill jobs.

Mark on the coupon the training that attracts you, sign and mail it to the University. It will bring you full information, together with particulars of our convenient-payment plan; also your free copy of the inspiring book—"Ten Years' Promotion in One."

Break away from the crowd of routine pluggers. Find out today what YOU must do to put yourself among the men who command big money. Mail the coupon NOW.

INQUIRY COUPON

LASALLE EXTENSION UNIVERSITY, Dept. 964-R CHICAGO, ILLINOIS

Please send me catalog and full information regarding the course and service I have marked with an X below. Also a copy of your booklet, "Ten Years' Promotion in One," all without obligation to me.

- | | | | |
|--|--|--|---|
| <input type="checkbox"/> Business Management | <input type="checkbox"/> Law—Degree of LL. B. | <input type="checkbox"/> Banking and Finance | <input type="checkbox"/> Expert Bookkeeping |
| <input type="checkbox"/> Salesmanship | <input type="checkbox"/> Commercial Law | <input type="checkbox"/> Personnel and Employment Management | <input type="checkbox"/> Business English |
| <input type="checkbox"/> Higher Accountancy | <input type="checkbox"/> Industrial Management | <input type="checkbox"/> Modern Foremanship & Production Methods | <input type="checkbox"/> Commercial Spanish |
| <input type="checkbox"/> Traffic Management | <input type="checkbox"/> Efficiency | | <input type="checkbox"/> Effective Speaking |
| <input type="checkbox"/> Railway Accounting and Station Management | <input type="checkbox"/> Modern Business Correspondence and Practice | | <input type="checkbox"/> C. P. A. Coaching |

Name..... Present Position.....

Address.....

Come to Detroit

The big factories are in full production. Some are producing more than their normal output. The Auto, Truck and Tractor business is the most active business there is today. Garages, Tire and Battery shops have been making money. They are again making big money.

Learn the Automobile Business

Training is needed badly, but to succeed in the biggest way Michigan State Automobile School Training is absolutely essential. M. S. A. S. training is not one man's idea, it is the result of years of keen co-operation with the big factories here in the "Heart" of the Automobile Industry. The biggest, best and most successful men in every branch of the industry have helped in outlining our course. The factories loan equipment, send us the heads of the departments for practical lectures and assist us in every way.

Make \$125 to \$500 or More Monthly

FACTORY LETTERS

HUDSON MOTOR CAR COMPANY
DETROIT, MICH., U. S. A.

This school is thought very highly of by the automobile men of Detroit. You will make no mistake by entering for a course.



Detroit, Mich., U.S.A.

Do not believe you would make any mistake in attending this school if you wish to become thoroughly experienced in the automobile business.



BUICK MOTOR COMPANY

We believe the Michigan State Auto School located at Detroit, would best meet your requirements, as its course in technical training is most thorough and complete in every detail.

THE STUDEBAKER CORPORATION
OF AMERICA

We do not know a better automobile school that we could recommend to you than the Michigan State.

MAXWELL MOTOR SALES CORPORATION
AUTOMOBILES
DETROIT, MICH.

We heartily recommend the Michigan State Auto School of this city.



Money Back Guarantee

We guarantee that a graduate of our Automobile and Tractor Course will be qualified to fill a position as assembler, demonstrator, tester, repair man, auto electrician, riveter, tractor operator, or farm lighting expert, or we will refund his tuition fee.

In a Fine Job or in Business for Yourself

With Detroit training at the M. S. A. S. graduates are successful—we have trained more than 18,000 men who are located in all parts of the world, either holding big pay jobs or in business for themselves. Thorough training in our excellently equipped school fits our graduates for success. Men leave our school to go right into business and make money from the start—it's the M. S. A. S. thorough training that makes the successes. There's really no limit to the money that can be made.

11,750,000 Motor Vehicles Now in Use

As many cars were produced in the first six months of this year as in all of 1921. This will be the biggest year in the history of the industry. 11,750,000 cars now in use and only 50,000 garages. Think what this means—an average of 235 cars for each garage. You can easily see the urgent need for more garages. Think of the eleven million batteries to be repaired or replaced, sixty million tires to be repaired or new ones sold. Can you think of a better business to get into? Thousands of repair shops are needed now, thousands of trained men to run them. Now is the time to get started.

\$220,000,000 This Year For Roads

Beginning July 1, 1922, the Government will spend through the Agricultural Department in one year over 220 millions of dollars for good roads. These roads will be built in every state for National Parks and forests' road ways, besides thousands of miles will be added to present roads. This means more touring, more business, more heavy trucking between cities, and best of all, thousands of more trained M. S. A. S. graduates with new garages.

Quality Instruction—Complete Equipment

Our school is thoroughly equipped—we have about \$250,000 in equipment just for students to study and work on; there is nothing slighted in the entire course that could help the student. In fact, our policy is to give the best course in the land and to hold our tuition within the reach of all. Anything that is worth having is surely worth paying reasonably for and at the M. S. A. S. you get the biggest money's worth to be had.

Start Any Time

You start the day you arrive, if you wish. The welfare department arranges for fine rooms and board. You have nothing to worry about—just get right down to business. The instructions are very practical and easily understood—no previous automotive experience is necessary. Now is the time to get started.

Jump on the Train and Come NOW

Hundreds of men have not waited, but after reading our advertisement have jumped right on the train and come to Detroit. The factories say you will make no mistake by coming to the M. S. A. S. The tuition is reasonable and board and rooms moderate in price. There never was such an opportunity as now. If you prefer, just fill in the coupon and mail it at once. It will bring you Catalog, "Auto News" and complete information FREE.

Michigan State

"The Detroit Auto School"

309 Auto Building 3729 Woodward Ave.

the Auto Center

Study and

Learn Now—it is the thoroughly trained men who make the big successes in the auto, truck and tractor business. M. S. A. S. training will make you independent the rest of your life. You will secure in a few weeks of pleasant, practical study and training what hard times or adverse conditions can never take from you. Trained heads and hands always get first call on big money and in business.

Original and Only Factory Endorsed School

The M. S. A. S. is the original and only factory endorsed school. Ours is the only factory outlined course. The manufacturers and their service managers assisted us in outlining our course. They know it is right. They say you will make no mistake in attending the M. S. A. S. They heartily endorse our school and employ our graduates. Write to any automobile factory, business house or bank in Detroit and ask them about us.

Learn in Detroit the Auto Center

What is more logical than to learn autos where autos are made, in Detroit the auto center? 73% of the world's automobiles are made in Detroit, 94% in Detroit and vicinity. You make weekly trips to Packard, Hudson, Cadillac, Buick, Lincoln, Maxwell, Chalmers, Studebaker, Ford, etc. You meet the factory executives, service managers, etc. Study factory methods and service. Nowhere else can you do this. This is only one of the many advantages of learning at the M. S. A. S. in Detroit the Auto Center. When you go back to your home town it will mean more business if you can tell your customers that you trained in the M. S. A. S., in Detroit the heart of the auto industry.

Factory Trained Instructors

Many of our instructors had early training in the big factories—they practically grew up in the business. Those who did not, have gone into the factory methods in co-operation with the factory heads and give you the result of this intense research and training.

Complete Auto, Truck and Tractor Course

Our complete course includes training in the construction, operation, upkeep and repair of automobiles, trucks, tractors, farm lighting plants and stationary engines of every kind. Basically the instructions are alike, but we teach how to apply the knowledge to all motor vehicles. We have a large general garage for actual garage practice. We own a farm with all types of tractors for operation and upkeep practice. The course includes thorough training in automotive electricies with actual practice in overhauling, rebuilding all types of starting, lighting and ignition systems. You get everything from A to Z. We educate the head and train the hand in a thorough, complete way. Approved by the automobile industry.

Radio—Construction, Installation, Operation, Repair

Radio is here to stay. It is estimated that there are between 3 and 5 million receiving sets now in use. This fall 2 or 3 million more will be installed and will need service. There is big money in this work.

We are now equipped to teach a thorough course in addition to the regular Complete Automobile Course without additional charge. This we can do because of the thorough and complete electrical course already a part of the M. S. A. S. training. There is big money to be made in installation and repair. Prepare now for this work.

Tire Repairing

We have a separate course in this branch of the auto business—the best equipment and instructors train you. Our graduates are very successful.

Battery Repair

This important branch of the industry is also taught in a separate and complete course which equips our graduates to go immediately into this big profit business.

Welfare Department Gets Rooms

Our Welfare Department is every student's friend. The day you arrive, it locates you in a nice room and directs you to good table board. It helps you with personal matters, tells you where your church is located, helps you get the best care and attention. The M. S. A. S. Welfare Department is known around the world.

Mail the coupon for catalog and Auto News—all FREE—or, better still, just jump on the train and come right to the school.

Automobile School

"Endorsed by all Leading Manufacturers"

Detroit, Mich., U. S. A.

GOOD POSITIONS FOR YOU

We can get positions in the factories and garages for our graduates. In fact, we have more calls than we can supply men for. Detroit is booming and I want to share this permanent prosperity with you.

Arthur G. Zeller,
President



GRADUATES' LETTERS

Samuel Thomas, Pa. "I graduated and got a job immediately. Became foreman of the Dodge and Liberty Garage at a salary of \$200 a month, which job I still hold."

H. S. Bradley, Ohio. "From a job as shipping clerk at \$12.00 a week to a garage owner making \$500 a month."

J. B. Nelson, N. Y., took our course when 17 years old, now has five men working for him.

E. R. Greve, Cal. "Last year's business bought us a nice little home here, and we have started buying another for this year."

Geo. H. Purvis, Mich. "Am now experimental electrician with the Packard Motor Car Company. I give your school all the credit."

John Grahek, Minn. "I am now in business for myself. My earnings average \$350 to \$400 a month. Before I went to your school I hardly made enough for my family to live on."

SEND THIS COUPON TODAY!

Michigan State Auto School

309 Auto Bldg., Detroit, Mich.

Gentlemen: Send me your Catalog and Auto News FREE.

Name

Street or R. F. D.

Town

State

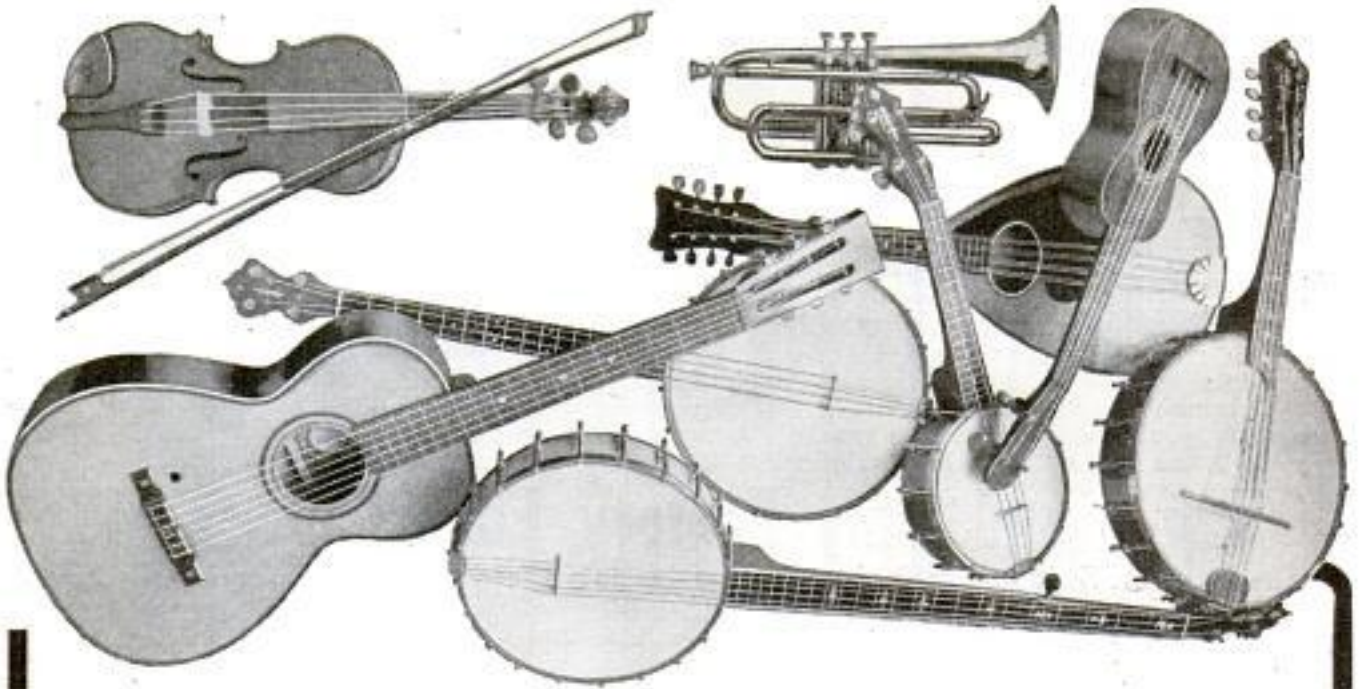

YOUR CHOICE \$ FREE 20

*Violin, Mandolin, Guitar,
Ukulele, Hawaiian Guitar,
Banjo, Banjo Mandolin,
Tenor Banjo, Cornet or
Banjo Ukulele.*

Actually given away, absolutely free, to pupils in each locality. Last year we gave away thousands of high-grade musical instruments on this sensational offer, now repeated for YOUR benefit.

We have the most wonderful new system of teaching NOTE music by mail. Take your choice of any of these magnificent instruments absolutely free and learn to play by this easy to learn method. Can have you playing standard note music in 4 lessons. A very small charge for lessons—just a few cents a week—your only expense. Your success guaranteed. Pay nothing if you fail to learn; you take no risk. Complete outfit free with every instrument. Don't wait a minute, but mail the coupon NOW.

To Advertise Our Copyrighted Course

Our plan is, \$2.00 monthly for lessons. No charge for instrument. Ukulele and banjo ukulele given free with 20 lessons at 50c a lesson. Tenor banjo, banjo and Hawaiian Guitar given free with 32 lessons at 50c a lesson; Violin, mandolin, guitar and banjo mandolin given free with

56 lessons, 43½c a lesson. Lessons are mailed one each week. Fill out the coupon and enclose \$2.00 or, we will send instrument and complete outfit subject to examination at express office C. O. D. \$2.00 for first month's lessons, and you will get an instrument you will be proud to own. At end of one week if you are not delighted with instrument and lessons, send outfit back and we will refund your money.

Do not delay, but mail the coupon today, before it is too late. Be sure to state whether you want a free Violin, Mandolin, Guitar, Ukulele, Hawaiian Guitar, Banjo, Banjo Mandolin, Tenor Banjo. We guarantee any one of these instruments positively worth \$20 or more. For cornet and further information, write for booklet.

FREE INSTRUMENT COUPON

Slingerland's Correspondence School of Music
Department 4, 1815 Orchard Street,
Chicago, Illinois

Please send me one.....free.
(Name of Instrument)

- Plan No. 1. I am enclosing \$2.00 for first month's lessons.
 Plan No. 2. Send outfit and lesson C. O. D. \$2.00; but if I am not satisfied at end of one week's trial, I will return outfit and my \$2.00 is to be returned to me or, I will pay \$2.00 monthly until lessons are paid for.

Name.....

St.....R. F. D.....

City.....State.....

SLINGERLAND'S CORRESPONDENCE SCHOOL OF MUSIC
Dept. 4, 1815 Orchard St., Chicago, Illinois

NOW FREE!



The Book That Has Shown Thousands The Way To Amazing Salary Increases.

Do you want to leave the rut of routine work and start right out making more money than you ever dreamed possible? We have done exactly this for thousands of men. Here is the book which gave them their start. Read how it is now offered to you—FREE!

TAKE this situation: A man who had worked all his life in a routine job at low pay suddenly surprises his friends, by moving into a better neighborhood, taking a big house, buying a car and blossoming out as a well-to-do and influential citizen in his new community. How did he do it? What is the secret that he used? Simple enough. He knew that the biggest money in business is in selling, and though he felt that he couldn't sell a thing, he suddenly learned the secrets that make Master Salesmen and then began to make big money.

If only one man had found inspiration enough in this remarkable book to jump to a sudden brilliant success in the selling field—into a job paying him many times his former salary—then you might call it luck. But thousands have done it.

Your One Chance to Make the Biggest Money of Your Life

READ!

Charles Berry of Winter-set, Iowa, stepped from \$18 a week as a clerk to a position making him \$1,000 the very first month. J. P. Overstreet, of Dennison, Texas, read this amazing book, left a job on the Capitol Police Force at a salary of less than \$1,000 a year and in six weeks earned \$1,800. F. Wynn, Portland, Ore., an ex-service man, earned \$554.37 in one week. Geo. W. Kearns of Oklahoma City found in this book a way to jump his earnings from \$60.00 a month to \$524.00 in two weeks, and C. W. Campbell learned from it how he could quit a clerking job on the railroad to earn \$1,632 in thirty days. It is now yours—FREE!

Not one of these men whose records are shown in the panel on the left had ever sold a thing before—not a dime's worth. Yet every one of them through reading this book discovered an amazingly easy way to jump suddenly from low pay to extraordinary earnings in the selling field.

Sounds remarkable, doesn't it? Yet there is nothing remarkable about it. There are certain ways to approach different types of prospects to get their undivided attention—certain ways to stimulate keen interest—certain ways to overcome

objections, batter down prejudices, outwit competition and make the prospects act.

Simple as A B C

"Modern Salesmanship" tells exactly how the National Salesmen's Training Association will teach you these principles in your spare time at home.

As soon as you are qualified and ready, the Association's Employment Service helps you to select and secure a selling position as city or travelling salesman.

Now Free to Every Man Who Will Act At Once

We are not making any extravagant claims about what we will do for you. We don't have to. All of the amazing proof and many important features about Salesmanship are contained in our new salary-raising book, "Modern Salesmanship." It is yours—FREE. Send the coupon for it today. It will show you how you can quickly become a Master Salesman—a big money maker. It will tell you about the National Salesmen's Training Association system of Salesmanship training—about the National Demonstration method that gives you actual experience while studying—and all about the amazing opportunities that await you in the selling field.

This may be the one big chance of your life to leave forever behind you the low pay of a routine job for a sudden, brilliant success at a big salary.

Is it worth 2c to find out? Then mail this coupon NOW.

National Salesmen's Training Association Dept. 12-M, Chicago, Illinois

National Salesmen's Training Association
Dept. 12-M, Chicago, Ill., U. S. A.

Please send me, without any obligation on my part, your free book, "Modern Salesmanship," and full information about the N. S. T. A. system of Salesmanship Training and Employment Service. Also a list showing lines of business with openings for salesmen.

Name.....

Street.....

City..... State.....

Age..... Occupation.....

New Secret of Perfect English

Does your English reveal your lack of education or does it prove that you are a person of culture and refinement? English is the one weapon you must use every day. Here is how you can improve it almost at once.

MANY people say, "Did you hear from him today?" They should say, "Have you heard from him today?" Some people spell calendar "calender" or "calander." Still others say "between you and I," instead of "between you and me." It is astonishing how many people use "who" for "whom," and mispronounce the simplest words. Few people know whether to spell certain words with one or two "c's" or "m's" or "r's," or with "ie" or "ei," and when to use commas in order to make their meaning absolutely clear. And most people use only common words—colorless, flat, ordinary. Their speech and their letters are lifeless, monotonous, humdrum.



SHERWIN CODY

Every time you talk, every time you write, you show what you are. When you use the wrong word, when you mispronounce a word, when you punctuate incorrectly, when you use flat, ordinary words, you handicap yourself enormously. An unusual command of English enables you to present your ideas clearly, forcefully, convincingly. If your English is incorrect it hurts you more than you will ever know, for people are too polite to tell you about your mistakes.

Wonderful New Invention

For five years Mr. Cody has worked almost day and night on the study of the problem, "How to make correct habits in speaking and writing stick in your mind." After countless experiments he finally invented a simple method by which you can acquire a better command of the English language in only 15 minutes a day. Now you can stop making the mistakes in English which have been hurting you. Mr. Cody's students have secured more improvement in five weeks than had previously been obtained by other pupils in two years.

Learn by Habit—Not by Rules

Under old methods, rules are memorized, but correct habits are not formed. Finally the rules themselves are forgotten. The new Sherwin Cody method provides for the formation of correct habits by constantly calling attention only to the mistakes you make.

One of the wonderful things about Mr. Cody's course is the speed with which these habit-forming practice drills can be carried out. You can write the answers to fifty questions in 15 minutes and correct your work in 5 minutes more. The drudgery and work of copying have been ended by Mr. Cody. You concentrate always on your mistakes until it becomes "second nature" to speak and write correctly.

Write for Free Book

A booklet explaining Mr. Cody's remarkable course is ready. If you are ever embarrassed by mistakes in grammar, spelling, pronunciation, or punctuation, if you cannot instantly command the exact words with which to express your ideas, this book will prove a revelation to you.

Write for this new free book, "How to Speak and Write Masterly English." Merely mail the coupon or a letter, or even a postal card. You can never reach your greatest possibilities until you use correct English. Write to-day for the free booklet that tells about Mr. Cody's simple invention.

SHERWIN CODY SCHOOL OF ENGLISH
59 Searle Building - Rochester, New York

SHERWIN CODY SCHOOL OF ENGLISH,
59 Searle Bldg., Rochester, N. Y.

Please send me your new Free Book, "How to Speak and Write Masterly English."

Mr.

Address.

City. State.

VALPARAISO UNIVERSITY

Founded 1872



VALPARAISO, INDIANA

The Fiftieth Year Will
Begin September 19, 1922

Known for Democracy, Economy, Hard Work

Departments—Education, Arts and Sciences, Engineering, Pharmacy, Law, Pre-Medicine, Home Economics, Public Speaking, Music, Manual Training, Preparatory, High School, Commerce, Stenography and Typewriting.

This university is governed by a board of trustees—all of whom are influential men with the welfare of the students at heart. Because Valparaiso is not operated for profit, because sound business principles are applied to its management, you get the benefit of an exceedingly

Low Cost of Living

The most satisfactory accommodations for board and room may be had from \$54 to \$90 per quarter of 12 weeks. Tuition, \$30 per quarter of 12 weeks or \$115 per year of 48 weeks, if paid in advance. If the entire tuition is paid in advance for a year, it includes instruction in all departments except Law, and private lessons in Music. Valparaiso University is beautifully situated forty miles from Chicago.

For Free Catalog Address President
Box 11 University Hall, Valparaiso, Ind.

ELECTRICAL ENGINEERING

men with training are in demand. For more than a quarter of a century this school has been training men of ambition and limited time, for the electrical industries. Condensed course in Electrical Engineering enables graduates to secure good positions and promotions. Theoretical and practical Electricity, Mathematics, Steam and Gas Engines, Mechanical Drawing. Students construct dynamos, install wiring and test electrical machinery. Course with diploma, complete.



Thoroughly equipped fireproof dormitories, dining hall, laboratories, shops. Over 3000 men trained.

Write for catalog. 30th year begins Sept. 27, 1922.

BLISS ELECTRICAL SCHOOL
404 TAKOMA AVENUE, WASHINGTON, D. C.

STAMMER

If you stammer attend non-stammering school till you get my large FREE book entitled "STAMMERING, Its Origin and the Advanced Natural Method of Cure," bound in cloth and stamped in pure gold. Ask for special tuition rate and a FREE copy of "The Natural Speech Magazine." Largest, best equipped and most successful school in the world for the cure of stammering, stuttering, etc. No sing-song or time beat. Write today. The North-Western School, 2317 Grand Ave., Milwaukee, Wis.

Keystone Institute

"The Service School"

A fully equipped school with expert instructors, organized to give intensive instruction in

2-Year Courses
Electrical Engineering
Mechanical Engineering
Accounting and Business Administration
16 weeks' course in Automotive Engineering

Day and Night Classes. Graduates are sought by large and small industrial establishments and are filling important positions in all sections of the country. Write for information on subject that interests you to Keystone Institute. Address The Vice President. 133 North 4th Street, Reading, Penna.



AUTO BOOKS

We've Cut the Price in Half
SAVE 23 DOLLARS

Earn increased hundreds. The biggest paying field in the world is the automotive industry. In it there is big pay and a steady job for every man who qualifies for a place. You can qualify with these books, they are the finest, most comprehensive automotive reference library ever compiled. It covers every phase of the industry. With these books within easy reach you can solve at once any problem that may confront you. Everyone who has purchased a set says they are the real

PAY RAISING BOOKS

They contain absolutely everything you want to know about the upkeep, care and repair of motor vehicles and tractors. Written in plain, easy to understand English; there are 2600 pages, 2300 pictures, diagrams and blue prints—bound in flexible morocco, gold stamped.

If you want to be the man in your shop who can solve any automotive problem—if you want to get ahead—if you want to make more money—if you want to succeed in the automobile or tractor game—send today for this library of reference books. They are yours for a week's

FREE EXAMINATION DON'T SEND MONEY

Just fill in the coupon and the entire library will be shipped you by express, collect, so that you may use them right in your own home or shop for seven whole days without any obligation. Put them to work—show them to your friends—ask them what they think of them, and if you are not absolutely satisfied that they are the greatest reference library in the world, send them back without cost of another penny to you—if you decide to keep them, send us \$2.80 within 7 days and balance \$3.00 month, until the special reduced price of \$21.80 is paid. Mail the coupon TODAY.

**American
Technical
Society**
 Dept. A-196
 Chicago, U.S.A.

FREE EXAMINATION COUPON

American Technical Society, Dept. A-196, Chicago, Ill.

Send me the 6 volume set of Automobile Engineering books for a week's free trial, by express collect. I will either return the books in one week at your expense or send you \$2.80 as first payment and \$3.00 every month until a total of \$21.80 is paid

Name

Address

City State

Employed by

"I'm at the Top of the Pole"



That's as high as I can climb in my present job."

So wrote an ambitious lineman to the United Y. M. C. A. Schools. He didn't want to climb poles all his life, so he enrolled for a practical course of home study to help him to a higher position in his chosen field of work.

He is making progress. He feels that ahead of him are the larger responsibility, the leadership, the higher pay and the better privileges, comforts and associations that are sure to come to the man who puts more into his head.

Have you gone as high as you can with what you now know? Do you need more knowledge to climb higher? Face these big questions.

During the last two years our friendly counsel has been given to more than 30,000 men who have enrolled for the United Y. M. C. A. Schools' correspondence courses—a new type of instruction from competent instructors that emphasizes service on all your problems.

If you want to climb higher, send the coupon for our friendly counsel.



United Y.M.C.A. Schools' Correspondence Courses
Business Courses

- Accountancy
- Advertising
- Banking
- Better Letters
- Bookkeeping
- Business Arithmetic
- Business Administration
- Business English
- Business Finance
- Business Law

- Complete Letter-Writing
- Office Management
- Practical Speaking
- Salesmanship
- Secretarial
- Show Card Writing
- Stenography
- Traffic Management

Technical and Other Courses

- Agricultural Courses
- Applied Psychology
- Architecture
- Automobile Courses
- Building Construction
- Civil Engineering Courses
- Drafting Courses
- Electrical Courses
- English Courses
- Factory Management
- Foreign Languages
- Foremanship
- Highway Engineering
- High School Subjects
- Illustrating

- Insurance Courses
- Mathematical Courses
- Mechanical Engineering
- Own-Your-Home Course
- Plan Reading
- Plumbing
- Poultry Husbandry
- Radio Engineering
- Radio Telegraphy
- Radio Telephony for Amateurs
- Steam Engineering Courses
- Structural Drafting
- Surveying
- Use of the Slide Rule
- Vocational Courses

Are you an ex-service man?

United Y.M.C.A. Schools
375 Lexington Ave.
New York City.

Dept. 2-5

Without obligating me, please advise regarding the course in

Name.....

Full Address.....
(Please write plainly.)

Learn to Write

I Teach by Mail

I CAN make a good penman of you at your home during spare time, no matter where you live or how poorly you now write. My simplified system has shown thousands of others the way to good penmanship during the past twenty years—it can and will do the same for YOU!

Beautifully Illustrated Book
"How to Become a Good Penman"
FREE!

It contains general information, with testimonials and beautiful specimens of penmanship showing what others have accomplished by the Tamblin System. (Your name elegantly written on a card if you enclose stamp for postage.) **WRITE TODAY.** Address

F. W. TAMBLIN
418 Ridge Bldg., Kansas City, Mo., U. S. A.

STUDY CHIROPODY

The rapidly growing, dignified, highly profitable profession for men and women. Day and evening classes leading to degree, Doctor of Surgical Chiropody. Excellent faculty of leading chiropodists and physicians. Thoroughly equipped, modern laboratory. Largest foot clinic in America. School occupies entire 4-story building, 9th successful year. Write for catalog. **ILLINOIS COLLEGE OF CHIROPODY, 1327 N. D. Clark Street, CHICAGO**

SHORTHAND IN ONE MONTH

Boyd—the Wonderful, New, Easy System. Writers hold Word's record. 100 to 150 words a minute in 30 days guaranteed. New Principles—dictation first week. Best for Court Reporting and Secretaries. Also Typewriting, Bookkeeping and Commercial Law. Send today for Catalog and Money-Back Guarantee. **CHICAGO HOME STUDY SCHOOLS, 802 Reaper Block, Chicago, Ill.**

Factory to Rider

Saves \$10 to \$25 on the **Ranger Bicycle** you select. You can have your choice of **44 Styles, colors and sizes.** Delivered free on approval, express prepaid, for **30 DAYS' FREE TRIAL.**

12 Months to Pay if desired. Possession and use at once on our liberal year to pay plan. Parents often advance first payment.

Tires best quality, at factory prices, express prepaid. Lamps, wheels and equipment, low prices. Send **No Money,** do business direct with makers.

Write today for free Ranger Catalog, factory prices and marvelous easy payment terms.

Mead Cycle Company
Dept. F10 Chicago

LEARN WATCH REPAIRING

You can learn by our modern and original system of instruction every part of the **Watch Repairing Trade** at home as good or better than at a shop. You can earn money while learning and secure a well paying position or start in business after completing our course of instruction. Good watch repairers are always in demand and earn from \$20 to \$70 per week. For particulars apply to the **WISCONSIN SCHOOL OF WATCH REPAIRING** 166 Mason St., MILWAUKEE, WIS.

\$225⁰⁰ to \$500⁰⁰ per Month!



Expert Draftsman's Complete Outfit

FREE

There is a tremendous demand for trained draftsmen. Easy, pleasant work and big pay, with limitless opportunities. Before a building can be put up—before a machine can be made—or before a bridge can be built, **draftsmen** must draw the plans. In machine shops—in manufacturing plants—in fact wherever there is industry **trained draftsmen** are **needed**. The pay is **big** and because the work brings you in direct touch with the captains of industry the draftsman has an unusual opportunity for advancement. Read these facts:

Now is the time to start. Draftsmen get good pay from the beginning and can work up to \$500 a month and more. Draftsmen are needed everywhere. Once you are trained you can choose your own business and work in any part of the country you please. Coyne training makes everything easy for you. Coyne student, L. T. Dubendorf, writes: "Immediately after completing Coyne course I went to work for Armour & Co. Work was easy for me. Five months later I accepted a position in New York at a large increase in salary."

Complete Outfit FREE

Gives you practical Drafting Training

Outfit includes complete set of fine "professional" drawing instruments with double set of compasses and dividers all in velvet lined case. Drawing board, T square, two triangles, protractor, universal curve, triangular, standard scale, water-proof ink, pens, pencils and all accessories. Coyne methods are practical.

This expert's superb complete outfit given **free** to every Coyne student. Coyne training makes you advance. Coyne Student Joseph Jehany writes: "Your drafting school put me on the road to success. I am very thankful for the instructions received and I have recommended your school to my friends."

MONEY BACK GUARANTEE

We guarantee that the training of the Coyne Course will place you in a good position as an expert draftsman or we will refund your money.



B. W. COOKE

PRESIDENT

COYNE

TRADE AND ENGINEERING SCHOOL

Recognized Producer of Successful Men

39-51 E. Illinois St., Dept. 1776, Chicago, Ill.

Easy to Learn at Home

The Practical Teaching Methods of the Great Coyne Schools Brought to Your Home

The Coyne Home Study Course guarantees to train you until you are permanently located in a job. Remember, the Coyne Trade and Engineering Schools are recognized by educators all over the world. Students come from all over the world to get Coyne training. Why? Because of the Coyne school's long established, tremendous reputation for successful teaching by its great staff of experts. Coyne is not a "one man" school, but a great educational institution, 23 years old, an acknowledged leader and originator. Coyne originated the "Learn by Doing" method now endorsed by educators everywhere. Coyne has graduated thousands of successful, prosperous men all over the world. Heretofore the valuable Coyne training could be had only at our residence school. **But now, you can enjoy the advantages and the special Coyne training under the personal direction of our experts right in your own home, at a fraction of the cost of the residence school.** You can't make a mistake if you write for the Coyne free book. Coyne students say every minute of the course was enjoyable. Some students took good positions three months before their course was finished. Here is your opportunity.

FREE Book

Send Now for Your Copy and FREE Outfit Offer

Mail this coupon for our interesting illustrated book, "Drafting, the Foundation of Industry," sent you free. It explains all about the Coyne home-study method and shows you how to become a draftsman in the quickest and easiest way. You want to know all about this great institution. Don't put it off. Send for this book now. Get the free drafting outfit offer. It's absolutely free, no obligation. The book contains the most valuable information you will ever get in your life. **Send the coupon now.**

Coyne Trade and Engineering Schools
Dept. 1776
39-51 E. Illinois St.
Chicago, Ill.

Dear Sirs:—Please send me, absolutely free, without obligation, your book, "Drafting, the Foundation of Industry," also full information about the Course in Drafting and your Special Free Outfit offer. (Check which course you prefer.)

Check Coupon and Mail NOW!

Home Study Course School Course

Name.....

Address.....

City..... State.....



Do You Want to Be A Surveyor?

ARE you fond of outdoor work? Would you like to become a Civil Engineer? Then take up Surveying. It is a profession that not only pays big salaries itself, but it is the stepping stone to something even better. Probably 99 out of every 100 Civil Engineers were surveyors first.

Fill out the coupon below and let us tell you how you can prepare for success in Surveying, Engineering, Drafting, Chemistry, etc., through spare-time study at home with the I. C. S.

----- TEAR OUT HERE -----

INTERNATIONAL CORRESPONDENCE SCHOOLS
Box 5668-C, Scranton, Pa.

Without cost or obligation, please send me complete information about the subject before which I have placed an X in the list below:

- | | |
|---|--|
| <input type="checkbox"/> SURVEYING | <input type="checkbox"/> ADVERTISING |
| <input type="checkbox"/> DRAFTING | <input type="checkbox"/> Salesmanship |
| <input type="checkbox"/> Mechanical Engineering | <input type="checkbox"/> BOOKKEEPING |
| <input type="checkbox"/> Civil Engineering | <input type="checkbox"/> Civil Service |
| <input type="checkbox"/> ARCHITECTURE | <input type="checkbox"/> Railway Mail Service |
| <input type="checkbox"/> Electrical Engineering | <input type="checkbox"/> Pharmacist |
| <input type="checkbox"/> Stationary Engineering | <input type="checkbox"/> Traffic Manager |
| <input type="checkbox"/> CHEMISTRY | <input type="checkbox"/> Business Management |
| <input type="checkbox"/> Automobiles | <input type="checkbox"/> Certified Public Accountant |
| <input type="checkbox"/> STENOGRAPHY | <input type="checkbox"/> Airplane Engines |
| <input type="checkbox"/> High School Courses | <input type="checkbox"/> Radio |

Name.....

Address.....

Occupation.....

Persons residing in Canada should send this coupon to the International Correspondence Schools Canadian, Limited, Montreal, Canada.

Please Mention Popular Mechanics

WE TEACH COMMERCIAL ART

Meyer Both Company, the largest commercial art organization in the field, offers you a different and practical training. If you like to draw, develop your talent. Study this practical course—taught by this widely known institution, with twenty-two years success—which each year produces and sells to advertisers in the United States and Canada over ten thousand commercial drawings. Who else could give you so wide an experience? Commercial art is a business necessity—a highly paid, intensely interesting profession, equally open to men and women. Home study instruction. Get facts before you enroll in any school. Write for our special booklet, "YOUR OPPORTUNITY"—for one-half the cost of mailing—four cents in stamps.

MEYER BOTH COLLEGE OF COMMERCIAL ART
Michigan Ave. at 20th St., Dept. 16 CHICAGO, ILL.

NOTE:—To Art and Engraving Firms: Secure practical artists among our graduates. Write us.



HOW TO BECOME A PROFESSIONAL PHOTOGRAPHER

Earning \$35 to \$125 a Week

An interesting illustrated booklet (free) on choosing a vocation, the exceptional opportunities Photography offers you and how to avail yourself of these advantages.

Motion Picture—Commercial—Portraiture

Three to six months' Practical course. Modern equipment. Day or evening classes. Easy terms. Call or write for Catalog No. 49.

N. Y. INSTITUTE OF PHOTOGRAPHY
NEW YORK CHICAGO BROOKLYN
141 W. 36th St. 630 So. Wabash Ave. 505 State St.

Learn Autos and Tractors



Wonderful opportunities constantly offered trained men; we train you thoroughly to start your own business or make good money as motor expert, driver, shop foreman, etc.

7,000 Graduates making good. Catalog Free

Cleveland Automobile School, 1814 E. 24th St., Cleveland, O.

Radio for amateurs and beginners taught in a new, rational and practical way.

Write for our interesting, informative,
FREE BOOK to

BRYN MAWR SCHOOL OF RADIO

of The DCK Radio Corporation

DEPT. A BRYN MAWR, PA.

Genuine \$20.00 Imported **VIOLIN** Will Be Given To You **FREE**

Help me introduce this beautiful Violin in your district. Be first to show how easy it is to play with help of three new inventions and my scientific instructions. You can play it in one week.

10,000 Students Found Violin Playing Easy to Learn

You can learn as easily as others. Surprise your friends. My three new inventions make it very easy. Have been teaching 40 years. Write your name and address on bottom of page and send for free violin offer and three new violin inventions.

PROF. A. HINCHCLIFFE, 233 Broadway
Woolworth Bldg. Dept. 509 NEW YORK



A Big Raise in Salary!

Is Very Easy to Get, If You Go About It in the Right Way

You have often heard of others who have doubled and trebled their salaries in a year's time. You wondered how they did it. Was it a pull? Don't you think it. When a man is hired he gets paid for exactly what he does, there is no sentiment in business. It's preparing for the future and knowing what to do at the right time that doubles and trebles salaries.

Remember When You Were a Kid

and tried to ride a bike for the very first time? You thought that you would never learn and then—all of a sudden you knew how, and said in surprise: "Why it's a cinch if you know how." It's that way with most things, and getting a job with big money is no exception to the rule, if you know how.

We Will Show You How

Without loss to you of a single working hour we can show you a sure way to success and big pay. A large number of men in each of the positions listed are enjoying their salaries because of our help—we want to help you.

Make check on the coupon against the job you want and we will help you to get it. Write or print your name on the coupon and send it in today.

American School

Dept. G. 674, Drexel Ave. and 58th St., Chicago

American School, Dept. G. 674, Drexel Ave., and 58th St., Chicago

Send me full information on the subject checked and how you will help me win success.

- | | | |
|------------------------------|-------------------------------|----------------------------|
|Architect |Electrical Engineer |Steam Engineer |
|Building Contractor |Electric Light and Power |Foremanship |
|Automobile Engineer |General Education |Sanitary Engineer |
|Automobile Repairman |Vocational Guidance |Surveyor (& Mapping) |
|Civil Engineer |Business Law |Telephone Engineer |
|Structural Engineer |Lawyer |Telegraph Engineer |
|Business Manager |Machine Shop Practice |High School Graduate |
|Cert. Public Accountant |Photoplay Writer |Fire Insurance Expert |
|Accountant and Auditor |Mechanical Engineer |Wireless Radio |
|Bookkeeper |Shop Superintendent |Undecided |
|Draftsman and Designer |Employment Manager | |

Name..... Address.....

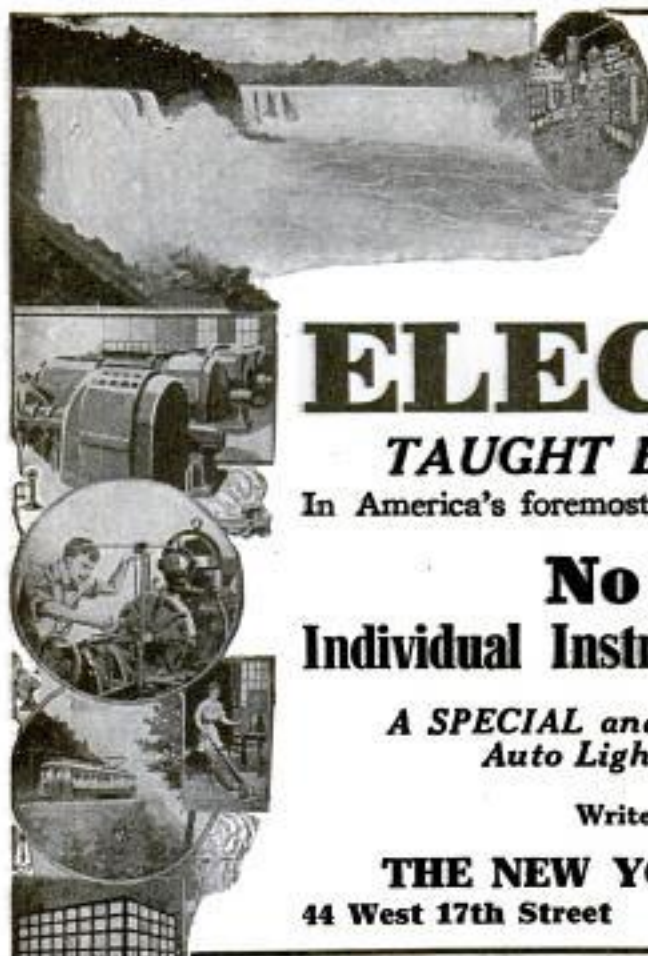

LEARN BY DOING

Every phase of all branches of

ELECTRICITY

TAUGHT BY ACTUAL PRACTICE

In America's foremost and oldest institution for trade training.

No Books Used

Individual Instruction

Start Any Day

A SPECIAL and SEPARATE Course in Ignition,
Auto Lighting and STARTER Systems

Write for FREE 64-Page Catalog

THE NEW YORK ELECTRICAL SCHOOL

44 West 17th Street

NEW YORK CITY

TRI STATE COLLEGE OF ENGINEERING

Makes you a Civil, Mechanical, Electrical or Chemical Engineer in two years, 48 weeks each. No entrance examinations. High School Diploma not required. Compact courses made up of essentials only. Expenses low. For catalog address 100 "M" STREET, ANGOLA, IND.

RAG JAZZ PIANO, SAXOPHONE, or TENOR BANJO in 29 lessons. Christensen Schools in most cities or Learn by Mail. Write for Booklet, or money-making teacher's opportunity. AXEL CHRISTENSEN, 16 E. Jackson, Chicago, Ill.

BE AN ARTIST

We can teach you **DRAWING** in your own home during your spare time.

Our 18 years of successful teaching prove our ability. 10 Courses in Commercial and Illustrative Drawing. Teachers Normal and Applied Art. Endorsed by high art authorities. Students trained by members of our Faculty are filling high-salaried positions. Artist's Outfit FREE to Enrolled Students. Write today for Art Year Book.

OUR HANDSOME ART YEAR BOOK "FREE TO YOU!"

SCHOOL OF APPLIED ART
ANUEP ART BLDG. No. 2 BATTLE CREEK MICH.

SPEED TYPEWRITING

Learn at Home

Write 80 to 100 words a minute. Big money for speed typists, trained by the Tulloss "New Way." Learn in spare time at home. 10 easy lessons. Cost a little. Many Tulloss pupils make double former pay. Send for big catalog. Tells you all. Shows how to train for best positions. Write today. **THE TULLOSS SCHOOL 941-T College Hill Springfield, Ohio**

Taxidermy Book FREE.



Stuff Beautiful Birds.

Learn by mail to stuff and mount all kinds of birds, animals, fish and game heads, make rugs, tax skins. Mount your own specimens and make money preserving for others. Men, women and boys learn easily and quickly. Success guaranteed or no tuition. Write today for our wonderful FREE book "How to Learn to Mount Birds and Animals. N.W. School of Taxidermy, 1776 Elwood Bldg., Omaha, Neb.

WANTED

Railway Mail Clerks
\$1600 to \$2300 Year

MEN-BOYS OVER 16
SHOULD WRITE IMMEDIATELY

Steady work. No layoffs. Paid Vacations

Common education sufficient:
Send coupon today—SURE



FRANKLIN INSTITUTE, Dept. G176, Rochester, N. Y.
Sirs: Send me without charge, (1) Sample Railway Mail Clerk Examination questions; (2) Schedule showing places in all coming U. S. Government examinations; (3) list of many government jobs now obtainable.

Name.....

Address.....

Be A Master AUTOMOBILE MECHANIC

a certified
Automotive
Engineer

Earn \$50 to \$125 a week

GREER Trained Men are better trained because the policy of the GREER COLLEGE OF AUTOMOTIVE ENGINEERING is now, as it always has been, to give its students the very best instruction possible, enabling men without previous experience to quickly qualify as Expert Mechanics, Garage Foremen, Demonstrators, Battery and Ignition Experts, Automobile Salesmen, Service Managers, Garage Owners, Automobile and Tractor Dealers, etc. Calls are received daily for capable men to fill positions now open, with splendid pay assured. From \$50 to \$125 a week. Ambitious men with the determination to succeed and a thorough knowledge of Motor Mechanics gained through the GREER Super-Course of Automobile Instruction, are recognized as Master Mechanics and naturally entitled to Master Mechanic pay.

Greer Training is Complete

The GREER Super-Course of Automobile Instruction covers the following subjects—all included in the complete course long experience has proved necessary:

Truck, Tractor and
Automobile Repairing
and Overhauling
Automobile Driving
Roadside Repairs
Primary Ignition
Electric Lighting
and Starting Systems

Valenzizing and
Tire Repairing
Machine Shop
Practice
Acetylene Welding
and Cutting
Storage Batteries
Business Management

Garage and Repair
Shop Management
How to get an Auto-
mobile Truck or
Tractor Agency
How to Sell Autos,
Trucks and Tractors

FREE RADIO COURSE

Limited number of Free
Radio Scholarship available
now. Cash in on the de-
mand for mechanics with
this additional knowledge.
WRITE AT ONCE.

The GREER Diploma Insures Your Success

—because it means you are a Graduate Master Mechanic—a Certified Automotive Engineer—"The Man Who Knows." The GREER College is something more than an "automobile school." This is a real college that makes real Master Mechanics—men who can qualify as Certified Automotive Engineers and are awarded preferred positions. With GREER training behind you, you can quickly qualify for a permanent position at Big Pay, or go into business for yourself and be certain of success from the very start. Use the coupon below and mail at once for FREE BOOK, "How to Succeed in the Automobile Business."

ERWIN GREER, Pres.

**GREER College
of Automotive
Engineering**

2059 South Wabash Ave.
CHICAGO, ILL.

MAIL THIS COUPON NOW!

Greer College of
Automotive Engineering,

2059 S. Wabash Ave., Chicago, Ill.

Send me your Free Book, "How to Succeed
in the Automobile Business" and Special
Tuition Offer.

Name.....

Address.....

BE A RAILWAY TRAFFIC INSPECTOR

EARN Up to \$250⁰⁰
per Month



YOU ARE WANTED

for this fascinating profession with its many opportunities! Healthful outdoor work; travel or remain near home. You come in contact with big railway officials; good chances for advancement.

Position GUARANTEED or Money Refunded

Prepare in three months' spare-time study at home. You can easily qualify. We then guarantee you a position paying at least \$110 per month and expenses or refund your money. You take no chance. Institute enjoys highest endorsement.

Don't Delay - Send Coupon!

Get full particulars and copies of letters from satisfied students. Send coupon today for free booklet No. D-724.

Standard Business Training Institute
BUFFALO, N. Y.

Standard Business Training Institute
Buffalo, N. Y.

Send me, entirely free, Booklet No. D-724 giving full particulars about course in Railway Traffic Inspection.

Name.....

Street.....

City.....

Earn \$35-\$125 a Wk



Your Opportunity in MECHANICAL DENTISTRY

Ambitious men of all ages can rise above small salaried positions into this profession of unlimited possibilities.

Taught by actual practice—day or evening. Three months' course. Modern laboratories. No previous knowledge or experience required. No charge for tools or equipment. The men we train are in demand. Established 30 years. Catalog free.

Address your inquiry to Dept. 2

BODEE DENTAL INSTITUTE

NEW YORK, 136 W. 52d St.—PHILA., 15th & Walnut Sts.
BUFFALO, 1226 Market St.—BROOKLYN, 15 Flatbush Ave.

Learn to Dance!

at home

to music



FREE PROOF record teaches you to dance in one hour

All your friends dance. Why don't you? Surprise them with the latest steps. You can easily learn by yourself without embarrassment. It's not necessary to know the first thing about dancing.

Just slip these wonderful records on your phonograph—and do as they say. That's all there is to it.

I'll Prove It FREE

Convince yourself at my expense how remarkably easy my unusual method is. For a short time I will send my first lesson, including ten-inch record, free and prepaid. Try it out for 5 days and decide whether you wish to learn dancing the modern way. You may then enroll or return the record. I have set aside only a few hundred for this special offer. You must write at once.

WILLIAM CHANDLER PEAK

"The Man Who Makes Better Dancers"

Studio 33 4737 Broadway, Chicago, U. S. A.

WM. CHANDLER PEAK, M. S. The Originator of Dance Instruction by Mail. Nationally known—he is an outstanding figure in teaching dancing at home, having taught over 60,000 men and women of high social standing. He is Special Instructor in the oldest and most exclusive dancing association—The American Society of Teachers of Dancing, New York. Also President of the now famous Peak School of Dancing, Inc., established since 1890.

MUSIC LESSONS FREE



You can read Music like this quickly

IN YOUR
OWN
HOME

Piano, Organ, Violin, Mandolin, Guitar, Banjo, etc. Beginners or advanced players. One lesson weekly. Illustrations make everything plain. Only expense about 2c per day to cover cost of postage and music used. Write for FREE booklet which explains everything in full.

AMERICAN SCHOOL OF MUSIC, 51 Lakeside Building, CHICAGO

Learn Drafting

Increase
Your
Income

Expert Draftsmen earn from \$60 to \$150 a week and are in line for promotion to executive positions. You can become an expert by the Chicago "Tech" Method. Train by mail in spare time and put yourself in the high salaried class.

Free Trial Lesson

Send for Free Lesson which shows how easily you can get this practical training at little cost and on easy terms. Write today.

CHICAGO TECHNICAL COLLEGE
930 CHICAGO "TECH" BLDG., CHICAGO, ILL.

LAW High-Grade Instruction

By Correspondence
Prepares You for
the Bar—Est. 1892

University Methods.

Standard Text-Books. Approved by Bench and Bar. Graduates practicing in every state. Send today for Free Catalog and Rules for Admission to the Bar.

Chicago School of Law

520 Reaper Block

Chicago, Ill.



BE AN EXPERT Penman

I TEACH BY MAIL. You can become an expert penman right in your own home by my method. Small Cost. All that is required is some of your Spare Time. Write for my book, "HOW TO BECOME AN EXPERT PENMAN." It contains specimens and tells how others became expert writers by the TEVIS METHOD. Your name written on a card if you enclose stamp. FREE BOOK. Write today. T. M. TEVIS, BOX 25K, CHILLICOTHE, MO.

WOMEN ADMIRE MEN for Their Strength—

Man was meant to be woman's protector. The better he can meet this qualification, the more will he be admired. Read back through the ages and you will find this has always been true. There was a time when men fought with each other to decide who would own a certain woman just as they would fight over a pot of gold. Civilization and culture has overcome such savage conditions, but the man of strength and power has continued to have the advantage. Ivanhoe describes the knights entering into combat, after which the conqueror would kiss the hand or show respect in some manner to the lady he held in highest regard.

The Man of Today

What must womanhood think of the present day man? Statistics show that over 95 per cent. of us are suffering from some ailment. Our indulgence in worldly pleasures has made us a race of anemic, flat chested, dyspeptics. It is no wonder that man's years on earth have been shortened. What can he expect when he wastes the very strength that God gave him.

I heard one girl say the other day: "Of course I admire a strong, healthy man, but the men I meet are so weak-kneed they can barely stand up straight." It is true. The strong man of today is the exception. And that is my task. To make the exceptional man.

Do You Seek Ad- miration?

Do you wish to be one of these weak-kneed dyspeptics? Or have you enough manhood left to say: "I will be strong"? I don't care what your present condition is. If you have a spark of will power left, I can make you a man to be admired by all. Just think! I guarantee to put one full inch of muscle on your arms in 30 days. Yes, and two full inches on your chest in the same length of time. But that is only the start. From then on you will notice a complete change in your physical make-up. You not only develop big, brawny arms and a full chest, but a complete armor plate of muscle surrounding a body that has been re-built inwardly as well. You will have the flash to your eye and the spring to your step that shows you to be a human dynamo. You will be admired and sought after in both the business and social world. You will be a leader of men. All these things and more are awaiting you. It is now up to you to decide just what manner of man you will be. Come then, for time flies.

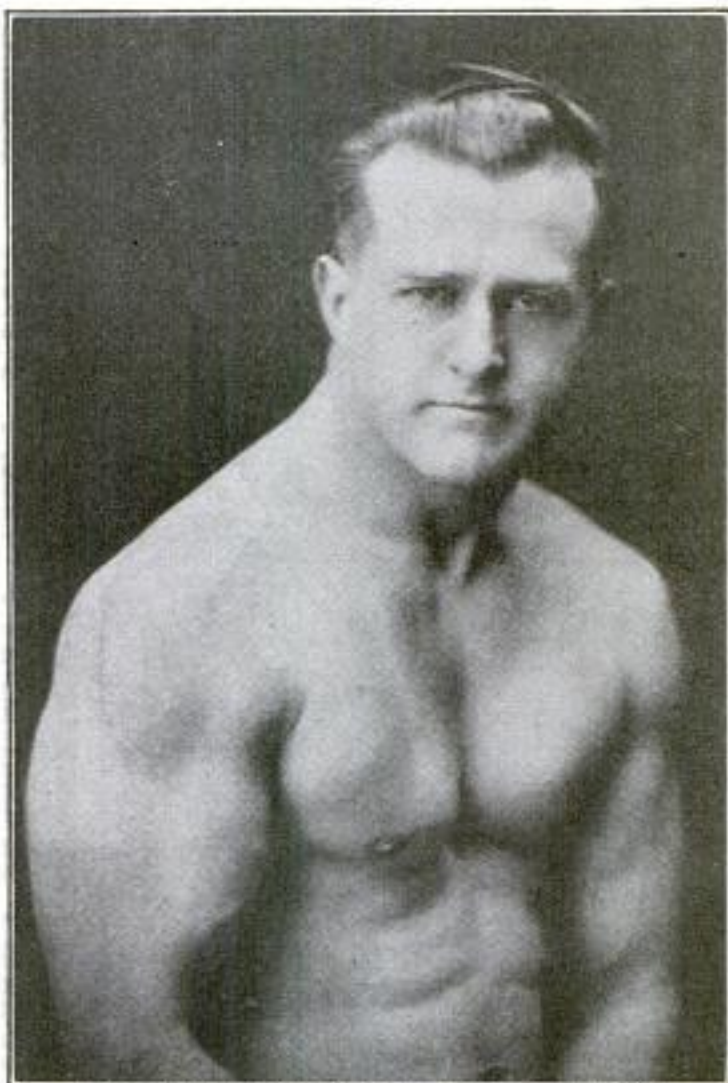

Latest photograph of Earle E. Liederman taken February, 1922

Send for My Book

"MUSCULAR DEVELOPMENT"

It is chock-full of photographs of myself and my numerous pupils. Also contains a treatise on the human body and what can be done with it. This book is bound to interest you and thrill you. It will be an impetus—an inspiration to every red blooded man. All I ask you to cover is the price of wrapping and postage—10 cents. Remember this does not obligate you in any way. Don't delay one minute. This may be the turning point in your life today. So tear off the coupon and mail at once while it is on your mind.

EARLE E. LIEDERMAN
305 Broadway Dept. 2009 New York City

EARLE E. LIEDERMAN

Dept. 2009, 305 Broadway, New York City

Dear Sir:—I enclose herewith 10 cents for which you are to send me, without any obligation on my part whatever, a copy of your latest book, "Muscular Development." (Please write plainly.)

Name.....

Street.....

City..... State.....

Do You Like to Draw?

Here Is a Simple, Easy Way
to Draw a Comic Face

TRY IT



Make a square with pencil, then add to it with pencil as shown in the small squares above. Erase all pencil guide lines after the drawing is completed.

We will not give you any "grand prize," if you draw this picture. Nor will we claim to make you "rich in a week." But if you are anxious to develop your talent with a **successful cartoonist**, so you can **make money**, send a copy of this picture with six cents in stamps for portfolio of cartoons and sample lesson plate, and let us explain more in detail. Some of the **most successful cartoonists** are former students of this school. It is not hard to learn to draw **originals** when you are shown how in a **practical way**.



THE W. L. EVANS SCHOOL OF CARTOONING
"The School That Has the Reputation"
821 Leader Bldg. CLEVELAND, OHIO

I Can Train You For A \$3500 Hotel Job in 20 weeks



The Hotel Business offers wonderful opportunities to the trained man or woman! Now fourth largest industry in America. Hundreds of high-salaried executive positions now standing open—waiting for the trained worker. You can easily qualify for one of these big-paying jobs—in your spare time at home. No previous experience necessary.

I Guarantee to Teach You

in my 50-lesson home-study course on hotel work, all that the leading hotel experts know about the business—men making from \$5,000 to \$50,000 a year! My students are eagerly sought by the biggest and best hotels in the country. You won't have to start at the bottom. You won't have to look for a job. Big pay, fine living, free meals and apartment, fascinating work—these are only a few of the many advantages of hotel work.

Send for FREE Book

20 Years' Experience in 20 Weeks is what this wonderfully complete course gives you. Course prepared by Clifford Lewis, a hotel expert of national reputation. Endorsed by managers of such hotels as Biltmore, Waldorf-Astoria, Copley-Plaza, Commodore, etc. Interesting free book explains all. Send for it today.

CLIFFORD LEWIS, President

LEWIS HOTEL TRAINING SCHOOL

Room 330 Founded 1916 Washington, D. C.

LAW Course In 2 Years

Be a lawyer. Law trained men earn big money and occupy top positions in social, business and public life.

\$5,000 to \$10,000

a year is what you can earn. Our improved system guides you step by step until you have passed the bar examination in any state. Low cost, easiest terms. We furnish everything, including complete Law Library. Send for free catalog. AMERICAN SCHOOL, Dept. L, 674 Drexel Ave. & 58th, Chicago



Wonderful, new device, guides your hand; corrects your writing in few days. Big improvement in three hours. No failures. Complete outline FREE. Write C. J. Ozment, D-34, St. Louis, Mo.

STAMMERERS

For 55 years we have successfully corrected stammering by our simple and natural course of individual lessons. Attend no school until you have read our free booklet, "How To Stop Stammering." SAMUEL A. ROBBINS, Director, Boston Stammerers' Institute, 246 Huntington Ave. Boston 17, Mass.

LEARN WATCHMAKING

and become independent. Good-paying positions secured.

Easy to learn. Send for FREE CATALOG.

ST. LOUIS, WATCHMAKING SCHOOL, Dept. 5, ST. LOUIS, MO

Wrestling Book FREE



Learn to be an expert wrestler. Know scientific wrestling, self-defense, and jiu-jitsu. Develop a splendid physique, and have perfect health. Join this popular school and learn by mail. The famous world's champions—the marvelous

Frank Gotch and Farmer Burns

offer you a wonderful opportunity. Wrestling is easily and quickly learned at home by mail. Men and boys write now for splendid free book. Learn all the science and tricks. Be able to handle big men with ease. Accept this wonderful offer NOW. Send for free book today, stating your age. Farmer Burns School of Wrestling, 1776 Ramo Blvd., Omaha, Neb.

You Can Play the Hawaiian Guitar Just Like the Hawaiians!

Because Our Native Hawaiian Instructors Will Help You

OUR STUDENTS SAY

Koster School,
214 So. Franklin St.,
Chicago, Ill.

First Hawaiian Conservatory of
Music, Inc.

I shall certainly be very glad to recommend your course whenever the chance is given to do so. Mr. W. B. Johnson has not pleased me yet, and if he does not phone in a day or so, will write him. Am sending a letter to Miss Helen Slavik today which I think may help to secure her enrollment, and I shall be glad at any time to write a personal letter to anyone whom you may suggest.

Your former student,
W. L. Walker.

San Quentin, Calif.

First Hawaiian Conservatory of Music,
633 Woodworth Building, N. Y. City.

Dear Sirs:

Lessons 18 and 19 come last evening and I was pleased to see that they are beginning to get hard, or at least a little bit more to learn in them. I have a great deal of spare time to put in on the guitar and I enjoy it. Your course is the simplest and most interesting I have ever tried to learn. I am getting along fine and can play every lesson up to the last one and I can readily see that when I have finished with all of the lessons I will be able to play most anything and play it good. I am, in appreciation,

Yours truly, J. E. FERGUSON,
P. B. If at any time you wish to see my name as a reference for your course you may do so, as I think that any one who takes it up will derive a great benefit from it and never regret it.

Our improved method of teaching is so simple, plain and easy that you begin on a piece with your first lesson. In half an hour you can play it. Thousands of successful students prove this to be true.

ONLY 4 MOTIONS We have reduced the necessary motions you learn to only four, and you acquire these in a very few minutes. Then it is only a matter of a little practice to acquire the weird, fascinating, tremolos, staccatos, slurs and other effects that make this instrument so delightful. The Hawaiian Guitar plays any kind of music, both the melody and the accompaniment.

FREE Just think of it. 52 lessons on this wonderful guitar. You get a beautiful large sized Genuine Hawaiian Guitar absolutely free as soon as you enroll for the lessons. All the necessary picks, the steel playing bar and 52 pieces of music are included without cost to you.

Special Arrangements for Lessons if You Have Your Own Guitar

Play Any Music

In half an hour after you get the free Hawaiian Guitar and the first lesson, you can play Hawaiian Melodies.

In a very short time after a little practice you can play any kind of music as well as Hawaiian, both the melody and accompaniment.

[TEAR OUT COUPON]



Tear Off and Mail Today

First Hawaiian Conservatory of Music, Inc.
233 Broadway (Woolworth Bldg.), New York City

Please send me full information about your 52 easy lessons and FREE GUITAR OFFER.

NAME.....

ADDRESS.....

TOWN..... STATE.....

Print name and address clearly. P.M.9

Whatever Your Question;—be it the pronunciation of Bolsheviki, the spelling of a puzzling word, the location of Murman Coast—the meaning of blighty, ace, tank, ukulele, etc., this Supreme Authority—

WEBSTER'S NEW INTERNATIONAL DICTIONARY

contains an accurate, final answer. 400,000 Words. 2700 Pages. 6000 Illustrations.
Regular and India-Paper Editions. G. & C. MERRIAM CO., Springfield, Mass.
Write for specimen pages, prices, etc., and FREE Pocket Maps per Popular Mechanics



BE AN ARTIST

Comics, Cartoons, Commercial, Newspaper and Magazine Illustrating, Paste-Cutout Portraits and Fashion. Our simple method quickly develops your talent in spare time. By Mail or Local Classes. Write for terms and list of successful Students.
ASSOCIATED ART STUDIOS 67-B Flatiron Building, NEW YORK

LEARN WATCHMAKING AND ENGRAVING



Earn while learning. Most practical watch school. Individual instructions. Graduates in great demand. Book free. Chicago School of Watchmaking, Dept. 20, 4340 Lincoln Ave., Chicago

"THERE'S MONEY IN IT" AT HOME LEARN TELEGRAPHY AT HOME MORSE AND WIRELESS

TEACH YOURSELF

in half usual time, at trifling cost, with the wonderful Automatic Transmitter THE OMNIGRAPH. Sends unlimited Morse or Continental messages, at any speed, just as an expert operator would. Adopted by U. S. Government, and leading Universities, Colleges and Telegraph Schools. 3 styles. Catalog free.

OMNIGRAPH MFG. CO.

16-22 Hudson St., NEW YORK



WANTED! \$1600 to \$2300 Year U.S. RAILWAY MAIL CLERKS

MEN—BOYS OVER 16 SHOULD
MAIL COUPON IMMEDIATELY

Franklin Institute, Dept. G177, Rochester, N. Y.

Sirs: Send me, without charge, (1) sample Railway Mail Clerk Examination questions; (2) schedules showing places of coming U. S. Government examinations; (3) list of many Government jobs now obtainable.

STEADY WORK NO LAYOFFS
PAID VACATIONS

Common education sufficient
Send coupon today—SURE

Name.....

Address.....

BOYS



Learn Drafting

DRRAFTING offers exceptional opportunities to boys and young men because drafting itself not only commands good pay, but it is the first step towards success in Mechanical or Structural Engineering or Architecture. And drafting is just the kind of work a boy likes to do. There is an easy, delightful way by which you can learn right at home in spare time. For 30 years the International Correspondence Schools have been giving boys just the training they need for success in Drafting and more than 300 other subjects.

Let the I. C. S. help you. Choose the work you like best in the coupon, then mark and mail it. This doesn't obligate you in the least, but it will bring you the information that will start you on a successful career. This is your chance. Mark and mail this coupon now.

----- TEAR OUT HERE -----

International Correspondence Schools
Box 5670-C, Scranton, Penna.

Without cost or obligation, please send me complete information about the subject which I have checked below:

- | | |
|---------------------------------------|---|
| <input type="checkbox"/> DRAFTING | <input type="checkbox"/> BUSINESS |
| <input type="checkbox"/> CARTOONING | <input type="checkbox"/> CIVIL SERVICE |
| <input type="checkbox"/> AUTOMOBILES | <input type="checkbox"/> PHARMACY |
| <input type="checkbox"/> CHEMISTRY | <input type="checkbox"/> ARCHITECT |
| <input type="checkbox"/> ADVERTISING | <input type="checkbox"/> BOOKKEEPER |
| <input type="checkbox"/> SALESMANSHIP | <input type="checkbox"/> GOOD ENGLISH |
| <input type="checkbox"/> ELECTRICITY | <input type="checkbox"/> RADIO |
| <input type="checkbox"/> ACCOUNTING | <input type="checkbox"/> CIVIL ENGINEER |
| <input type="checkbox"/> SURVEYING | <input type="checkbox"/> AIRPLANE ENGINES |

Name.....

Address.....

Occupation.....

Persons residing in Canada should send this coupon to the International Correspondence Schools Canadian, Limited, Montreal, Canada

Lefax

LOOSE-LEAF FACTS

RADIO HANDBOOK

helps you get expert results in radio every time. Whether you buy a complete outfit, or build one yourself, Lefax will explain clearly just how it works and how to change it to get best results under varying conditions. The authors are the heads of the United States Bureau of Standards Radio Laboratory. Every page is technically correct in every day language. Lefax

**knows all—tells how—
never grows old!**

New pages, covering new events as fast as they happen, will be sent free to every owner up to July 1st 1923. Get your Handbook now for a full year of Lefax Service free! Order through your dealer or send \$3.50 direct to

LEFAX, INC.,
175 South 9th St.,
Philadelphia,
Pa.



Elinor Glyn says—

"Thousands who don't dream they can write really cash. YOU have ideas for stories and photoplays—why don't you turn them into cash? There are just as many stories of human interest right in your own vicinity as there are in Greenwich Village or the South Sea Islands. And editors will welcome a story or photoplay from you just as quickly as from any well-known writer if your story is good enough. They will pay you well for your ideas, too—a good deal bigger money than is paid in salaries. You can't accept my advice because millions of copies of my stories have been sold. My book, 'Three Weeks,' has been printed in every tongue, except Spanish. My photoplays are known to millions. I do not say this to boast, but merely to prove that you can be successful without being a 'genius.' I believe thousands of people can make money in this absorbing profession. I believe this so firmly that I am going to show YOU how easy it is when you know how. Simply write to my publishers, The Authors' Press. They will send you a handsome little book called 'The Short-Cut to Successful Writing.' This book is ABSOLUTELY FREE. No charge—no obligation. Write for it NOW." Just address Elinor Glyn's publishers: **THE AUTHORS' PRESS, Dept. 208 Auburn, N. Y.**

12 Months to Pay

You can easily earn or save money for the small payments. Parents often advance first payment to help buy a **RANGER** bicycle. Choice of 24 styles, colors and sizes. **FACTORY-TO-RIDER** prices. **DELIVERED FREE** express prepaid on approval for **30 DAYS' TRIAL**, actual free riding test.

Tires best quality, at factory prices, express prepaid, lamps, wheels, and equipment, low prices. **Send No Money.**

Mead Cycle Company
Dept. F103 Chicago

Write today for free Ranger Catalog, factory prices and marvelous easy payment terms



LEARN WATCH REPAIRING

Be a watchmaker—you can learn this profitable trade by correspondence in a few weeks in your own home by the DeSelms Chart System. After you complete the course you will know a watch from A to Z. You will know just what the matter is and how to repair one. When you graduate you will be a practical watchmaker and repairer and competent to fill any position. Posters for our graduates.

Ask for our Free Book. It explains our system and terms

THE DeSELMS WATCH SCHOOL
23 Perry Street ATTICA, INDIANA





He Starts at \$5,200 a Year

One hundred dollars a week! And only a few years ago his weekly wage was less than \$30. Didn't dream he could do it when he first took up the study of Higher Accounting under the LaSalle Problem Method; but he just couldn't help getting ahead—so he wrote—because he found it the most interesting thing he ever tackled.

Knew nothing about bookkeeping, but LaSalle quickly gave him the necessary foundation. Then, step by step, he was trained in the practical work of Cost Accounting, Auditing, Business Law, Organization, Management, Finance, Income Tax Procedure—not theoretically, mind you, but by the solving of actual problems lifted bodily from business life. As a result, he sits as Auditor at a big mahogany desk and commands a salary of \$5,200 a year.

Unusual Opportunities in Accounting

Typical, this man's experience, of that of thousands of ambitious men who have found their path to success in the LaSalle Problem Method. Never in the history of business has the need for trained accountants been so great or the rewards so attractive. The files of LaSalle Extension University contain literally thousands of letters reporting rapid advancement—incomes doubled, tripled and quadrupled as the result of home-study training. During three months' time, 1,089 LaSalle members wrote to the University telling of the "raises" they had got as a result of their training. *The average increase per man was 56 per cent.*

These men were not unusual; they had no "pull" or "luck;" they got their start by signing just such a little coupon as appears directly below this text. Mark the coupon, sign and mail today—and get the facts. We will promptly send you complete information regarding the training you are interested in; also a copy of that inspiring book, "Ten Years' Promotion in One." "Get this book," said a prominent Chicago executive, "even if you have to pay five dollars for it." We will send it free.

Remember, the cost of LaSalle training is small and can be covered in easy monthly payments, if you so desire. The decision that you make this moment is important. Mail the coupon now.

LaSalle Extension University

The Largest Business Training Institution in the World
Dept. 964-HR Chicago, Illinois

Please send me catalog and full information regarding the course and service I have marked with an X below. Also a copy of your book, "Ten Years' Promotion in One," all without obligation to me.

Higher Accountancy

Training for positions as Auditor, Comptroller, Certified Public Accountant, Cost Accountant, etc.

Other LaSalle Training Courses

LaSalle is the largest business training institution in the world. It offers training for every important business need. If more interested in any of these courses, check here:

- | | |
|--|--|
| <input type="checkbox"/> Business Management | <input type="checkbox"/> Banking and Finance |
| <input type="checkbox"/> Salesmanship | <input type="checkbox"/> Modern Foremanship and Production Methods |
| <input type="checkbox"/> Traffic Management | <input type="checkbox"/> Personnel and Employment Management |
| <input type="checkbox"/> Railway Accounting and Station Management | <input type="checkbox"/> Expert Bookkeeping |
| <input type="checkbox"/> Law—Degree of LL.B. | <input type="checkbox"/> Business English |
| <input type="checkbox"/> Commercial Law | <input type="checkbox"/> Commercial Spanish |
| <input type="checkbox"/> Industrial Management | <input type="checkbox"/> Effective Speaking |
| <input type="checkbox"/> Efficiency | <input type="checkbox"/> C. P. A. Coaching |
| <input type="checkbox"/> Modern Business Correspondence and Practice | |

Name.....

Present Position

Address

ELECTRICITY

Needs You To Boss Jobs Like This



Be a **Certificated Electrical Expert**
EARN \$3500 to \$10000 a Year

IT'S a shame for you to earn less than \$100.00 a week when I trained Electrical Experts are in such great demand. You ought to get more. You can get more.

Cooke Trained "Electrical Experts" earn \$70 to \$200 a week. Fit yourself for one of these big paying positions. Get into a line of work where there are hundreds and hundreds of opportunities for advancement and a big success.

What's YOUR Future? Today even the ordinary Electrician—the "screw driver" kind—is making money—big money. But it's the trained man—the man who knows the whys and wherefores of Electricity—the "Electrical Expert"—who is picked out to "boss" ordinary Electricians—to boss the Big Jobs—the jobs that pay up to \$10,000 a year.

Age or Lack of Experience No Drawback

You don't have to be a College Man; you don't have to be a High School graduate. My Course in Electricity is the most simple, thorough and successful in existence, and offers every man regardless of age, education or previous experience, the chance to become, in a very short time, an "Electrical Expert," able to make from \$70 to \$200 a week.

L. L. Cooke,
Chief Engineer

Chicago Engineering Works

Dept. 16, 2150 Lawrence Ave., Chicago, Ill.

Dear Sir:—Send at once the "Vital Facts" containing sample Lessons, your Big Book, and full particulars of your Free Outfit and Home Study Course—all fully prepaid without obligation on my part.

I Give You a Real Training As Chief Engineer of the Chicago Engineering Works I know exactly the kind of training a man needs to get the best positions at the highest salaries. Hundreds of my students are now earning \$3,500 to \$10,000. Many are now successful **ELECTRICAL CONTRACTORS.**

Your Satisfaction Guaranteed So sure am I that you can learn Electricity—so sure am I that after studying with me, you, too, can get into the "big money" class in electrical work, that I will guarantee under bond to return every single penny paid to me in tuition if, when you have finished my course, you are not satisfied it was the best investment you ever made.

FREE—Electrical Working Outfit—FREE I give each student a Splendid Outfit of Electrical Tools, Materials and Measuring Instruments absolutely FREE. I also furnish them with Supplies, examination paper, and many other things that other schools don't furnish. You do practical work **AT HOME.** You start right in after the first few lessons to **work at your profession in a practical way—make extra money while you learn.**

Get Started Now—Mail Coupon I want to send you an Electrical Book and Proof Lessons both FREE. These cost you nothing and you'll enjoy them. Make the start today for a bright future in Electricity. Read in coupon—NOW.

L. L. COOKE, Chief Engineer Chicago Engineering Wks.
Dept. 16, 2150 Lawrence Avenue, Chicago, Illinois

Some Features of My Course That Have Revolutionized Home Study Training

1. Practical Instruction—no useless, high-sounding theory.
2. Free Electrical Outfit—Finest outfit ever sent out for home experiment.
3. Free Employment Service.
4. Free Consulting Service.
5. Free Engineering Magazine.
6. Free use of my Electrical Laboratory.
7. Extra Courses Free—Radio—Electrical Drafting.
8. Spare time work—Special earn-while-you-learn lessons.
9. Reduced prices on all Electrical Supplies.
10. Cash Refund Guarantee Bond.

These features are all explained in my big Free Book.

Name.....

Address.....

The "Cooke" Trained Man is the "Big Pay" Man

CLASSIFIED ADVERTISEMENTS

WORLD'S BEST WANT AD MEDIUM

Advertisements in this section, 25 cents per word, each insertion, minimum 10 words, payable in advance. To be inserted under proper classification in October issue, copy should be in our office August 25th.

AUTOMOBILE SUPPLIES

FORD Top Recovering, 32 oz. rubber complete with rear curtain, guaranteed to fit. Touring, \$5.95; Roadster, \$4.95. Prices delivered at your door. Send money order. Stop paying high prices for auto accessories. Write for our latest catalogue. National Auto Supply Co., 1514 Broadway, Denver.

AIR compressors, ball bearing, automatic, \$28 cash. Balance terms. Motors, battery chargers, buffers on same easy payments. Write postal to Hobart, Troy, Ohio.

DOUBLE-HEAD Spark Plugs turn over proposition. One end cleans the other. Fire thru oil, made in all states. Reardon Mfg. Co., Peoria, Ill.

BUILD your battery charger for seven dollars; charges one to ten batteries from 110 v. A. C. No transformers, reactances, etc. Blue prints, specifications, for \$2.00. Address Perry Bros., 523 Essex St., San Antonio, Texas.

AUTO Accessory—Just out; every owner of an automobile a prospect; "muf ced." agents wanted; write quick. The Cincinnati Specialty Mfg. Co., Cincinnati, O.

\$195.00 TAKES brand new \$425.00 Titan Tire Vulcanizer. Box 73, Minneapolis, Minn.

BATTERY charging pays big profits, \$20 starts your business. Profits pay balance. Write us. Holbartson, Troy, Ohio.

AUTO Top Roof Covers easy to put on. You drive 100 tanks and save \$15 to \$19. Ford Roadster, \$5.20; Touring Cars, \$4.95 and \$9.95. Chevrolet, Dodge or Maxwell, \$13.95. All other cars, \$16.50 with plate glass lights. Regular side curtains, \$5.95 up. Special winter side curtains that open with doors, \$11.90 up. Seat covers, \$3.15 up. Ford cushions, \$5.95. All goods same as car manufacturers use and guaranteed to fit. Printed instructions given how to apply. Send for samples. Prices delivered at your door. Equipment Co., 29 Canal, Cincinnati, Ohio.

AIR Compressor, \$28.00. With tank, \$51. With motor, \$70.75; suitable for private or public garage, tire shop, painting or cleaning. Motors, 1/3 H.P., \$19.75. Battery charging outfit, home or garage size, \$14. Send for our large 100-page catalog describing all kinds of Air Compressors, Vulcanizers, Garage and Battery outfits. Equipment Co., 29 Canal, Cincinnati, Ohio.

AUTOMOBILE parts, guaranteed new, for all cars. Save money; get our wholesale prices on gears, shafts and bearings. State make of car, model and parts wanted. Parts shipped immediately from stock. We refund your money, including transportation charges, if not satisfied. Mechanics Gear Co., 3708 No. Halsted St., Chicago.

PROTECTION from the wind, dust, rain and snow. Use "Wear Me" windshield wings and motor with pleasure. Fully guaranteed. Money back if not satisfied after ten days' use. Regular set, \$12.50; Ford special, \$10.00. Wear Me Auto Specialty Company, No. 1602 Broadway, Pittsburgh, Pa. See "Ad." page 113.

EXCLUSIVE state, city or county distributors wanted for most wonderfully successful, necessary automobile device. Latest out! No competition. Big field, big money, clean cut. Live men desired. Little capital and big returns guaranteed. Write immediately for territory. Emmons Mfg. Co., Alliance, Ohio.

AUTOMOBILE Specialties, Manufacturing, repainting, retrimming automobiles is a paying business. 10 million cars need this service constantly. Easy to learn; make \$150.00 weekly—indispensable to motorists, garagemen, repairshops, auto painters, retrimmers, dealers' service stations. Auto-Finisher, Sheboygan, Wis.

STORAGE Batteries, guaranteed two years; Ford, Chevrolet, eleven plate, six volt, Ten Dollars. Thirteen plate, six volt, for Buick, etc., Twelve Dollars. Dodge, Fourteen Dollars net. Starite Battery Co., Louisville, Ky.

AUTO Parts—Save 25-90%. New gears, axles, bearings, springs, radiators, magnets—4,000 models. Bankrupt supplies, retopping outfits. Brightman Auto Exchange, 321 Windsor Ave., Hartford, Conn. Largest in the East.

FOR Sale—Quick re-detachable rim tires; change in five minutes. Patent Pending. Fredrick Todd, Box 519, Moberly, Mo.

BEST and cheapest retread made; doubles mileage; absolutely guaranteed. Thousands in use. Write Sectional Retread Co., Cherryvale, Kan.

MOTORISTS—Jem rubber repair for tires, tubes, tops and rubber goods. John Woolven, Rosemont, Pa.

PROTECT Your rights. Write for "Record of Invention" and booklet about Patents. Prompt personal service. Advice without charge. J. Reaney Kelly, 612-G Columbian Bldg., Washington, D. C.

AUTOMOBILE Specialties Formulae—best, different, dependable. Circular Free. Address W. Thaxly Co., Washington, D. C.

BIG Money made charging magnets, Ford's charged for one cent, without removing bolts. Use any light socket. Storage of dry batteries. Guaranteed magnetizers, \$5.00 up. Beemer Mfg. Co., Webb City, Mo.

LIBERTY Air Compressors, for garages, tire-shops, filling stations, also paint spraying equipment. Air Compressor & Equipment Co., 1133-37 Carroll Avenue, Chicago, Ill. Distributors wanted.

AMERICAN Garage & Auto Dealer publishes each month interesting and helpful suggestions and information on sales, merchandising, advertising, business management, accounting, welding, cutting, brazing, practical and progressive hints for office and shop for "small-town" automotive dealers, garagemen, repairmen, mechanics. Subscription price \$1.00 per year. Sample copy on request. American Garage & Auto Dealer, 1004 Lake View Bldg., Chicago.

AUTOMOBILE Owners, Garagemen, Mechanics, Repairmen, send for free copy of our current issue. It contains helpful, instructive information on overhauling, ignition troubles, wiring, carburetors, storage batteries, etc. Over 140 pages, illustrated. Send for free copy today. Automobile Digest, 505 Butler Bldg., Cincinnati.

SAVING fuel and oil, stopping oil pumping, decreasing carbon deposits is accomplished by Zelco, the zinc-coated piston ring, price 45c each; peened by special process. If your dealer doesn't handle, order of Zelco Piston Ring Division, Zelnicker, St. Louis. Distributors wanted.

AUTO Owner Tire Agent wanted each locality to use and take orders for hand-made Mellinger extra ply and cord tires; guaranteed by bond for 8,000 and 10,000 miles (no seconds); shipped prepaid on approval; get your tires free; no capital or experience required; make \$100 to \$300 weekly. Write for wholesale prices and sample section. Mellinger Tire Co., 929-K Oak, Kansas City, Mo.

VULCANIZING and Repairing is a paying business. Forty million tires need repairing every day. Make big profits in tire repair. Easy to learn. Instructions free. No hard times. Always busy. Get into this moneymaking business quick! Plants \$200 up. Write for free catalog. Equipment Co., 1 Canal, Cincinnati, Ohio.

OIL Tanks, all sizes. Oil Stations, Garages, Repair Shops, Small Stores, all of steel. Lowest prices. J. O. Dickson, Hammond, Indiana.

KEEP your car like new; 50c secures my home made receipt for cleaning and polishing. H. Charles, 361 Kent, Wash.

AIR Compressors—Genuine Brunner Compressors, new, on very attractive terms; send post card. Brunner Mfg. Co., Dept. A, Utica, N. Y.

AUTOMOBILES

AUTO Owners: Use and sell an automobile and trade secret. To one person in any community mailing this address with \$2.50 we mail two valuable methods of great benefit. Use them and sell to others—we protect you by returning subsequent requests intact and guarantee results. This spells Op-por-tu-ni-ty! Grasp it and make money. Minutemen Dist. Agency, Carrolls, Wash.

DYKE'S Automobile Encyclopedia contains the greatest array of automobile facts ever published in one volume. Several separate books containing the same information would cost in the neighborhood of \$21.00. New, enlarged edition, 968 pp., 3262 illus., cloth, \$6.46. American Morocco, \$7.96, postpaid. Popular Mechanics Book Dept., 8 N. Michigan Ave., Chicago.

PATENTS. Protect your rights. Before disclosing invention write for booklet and blank form Evidence of Conception, to be signed, witnessed and returned with rough sketch or model of your idea, upon receipt of which I will promptly give opinion of patentable nature and instructions. No charge for preliminary advice. Highest references. Prompt, personal attention. Clarence B. O'Brien, Registered Patent Lawyer, Southern Building, Washington, D. C.

AUTOMOBILE Mechanics, Owners, Garagemen, Repairmen, send for free copy America's Popular Motor Magazine. Contains helpful, instructive information on overhauling, ignition wiring, carburetors, batteries, etc. Automobile Digest, 505 Butler Bldg., Cincinnati.

PATENTS—Write for our free illustrated Guide Book and Evidence of Conception Blank. Send model or sketch and description of your invention and we will give our opinion of its patentable nature. Highest references. Prompt service. Reasonable terms. Victor J. Evans & Co., 185 Ninth, Washington, D. C.

FOR FORD OWNERS

FORD Car Repair Book sent free. This complete, well illustrated, valuable book explains in a simple way the Causes and Cures of Overheating; Repairing Ford Timer; Curing Piston Ring Troubles; Carburetor Adjustments and Repairs; Connecting Rods; Transmission Troubles; Care and Repair of Rear Axle; Stopping Axle Grease Leaks; also covers practically every other phase of Ford Car Repairing. Send 25c coin for three months' trial subscription and get the valuable repair book free. Ford Owner and Dealer Magazine, 521 Montgomery Bldg., Milwaukee, Wis.

CYCLE "Dynamic" hot-spot controls gas temperature automatically without dampers. Powerful and efficient. Cyelo Manifold Co., South High St., Akron, Ohio.

SPEEDSTER Fans: Don't fail to see "Red-I-Kut" ad. Page 139.

Is it worth \$3.00 to you to absolutely eliminate that disagreeable and costly 5-rk-ing chatter in your Ford? Write for details. Satisfaction guaranteed. Good selling proposition for whole or part time worker. Reo Cup Lubricator Co., 1603 Michigan, Chicago.

"BLUE Ribbon Battery". Ford battery, \$15.00. Non-breakable jars, indestructible case. Send for descriptive pamphlet. Address Blue Ribbon Battery Mfg. Co., 1707-1709 West Fayette St., Syracuse, N. Y.

SPORT Fenders for every Ford; classiest, individual crowned type; similar Mercer and Stutz; with front axle shield; eleven-inch straight side shields; large aluminum steps; gives the Ford that snappy low up-to-date appearance. Send for picture and introductory price. Address E. C. Ford Speed & Power Equipment Manufacturers, 250 West 54th, New York.

FORD 220 Simplex Starter Guaranteed. American-Simplex Co., Anderson, Ind.

FORD owners and all other makes. Increase your mileage 75%; eliminate 75% of spark plug and carbon troubles. Put 100% more pep into your car. Buy a Sturdevant Aerator. Sample, \$3.50. Mail prepaid. Agents wanted—Make big money. Federal Engineering Company, 711 Elgin St., Detroit, Mich.

MOTORCYCLES, BICYCLES AND SUPPLIES

THREE-SPEED Indian, \$125. Two-speed Harley, \$100, perfect motor. New Indian Scout, \$300. New and used Indian parts. R. E. Haesly, Winona, Minn.

GET our prices on used motorcycles and motorbikes. Seiber Hofheins, Buffalo, New York.

USED Motorcycle Sale—1922 Excelsior Twin, brand new, elec. equipped, \$275. 1920 Excelsior 3 speed, overhauled thoroughly, electric equipped, \$150. 1917 Excelsior 3 speed, fully equipped, in running condition, \$85.00. 1917 Eagle Twin, fully equipped, in running condition, \$45.00. Brand New Auto-peds, former price, \$125; our price \$47.50. Send for catalog. 1917 Indian Twin 3 speed, fully equipped, \$65.00. 1918 Henderson-4, in excellent running condition, \$125.00. 1918 Indian Twin, good tires, in excellent running condition, \$75.00. 1920 Cleveland Lightweight, overhauled thoroughly, \$100. Brand New Evans Power-cycle, never been used, \$65.00. 1918 Harley-Davidson Twin, in good condition, \$90.00. Machines shipped on deposit \$25.00, balance C. O. D. Many other used motorcycles. Write for catalog. Myerow Brothers, 258 Columbus Ave., Boston, 17, Mass.

MOTORCYCLISTS! Send your work direct to the factory. Perfectly ground cylinders, correct fitting pistons and rings put new life in your engine. Cylinder grinding only, per bore, \$3.00. Cylinder grinding with new pistons, rings and wrist pins, \$6.00 per bore, 2 or more cylinders. Vogt-Zanone Seale & Mfg. Co., Successors to American Motorcycle Mfg. Co., Louisville, Ky.

SEND for our Bargain Bulletin and Money-Saving Message. It will save you money on Motorcycles, Side Cars, Motor Wheels, Repair Parts, and Accessories. Some used parts at less than half. Cleveland and Henderson Motorcycles our specialty. See our ad on page 139. American Motor Cycle Co., 2043-5-7 W. Chicago Ave., Chicago.

NFRACAR now \$185.00. Thirty-five miles per hour, eighty-five to one hundred miles to gallon. Catalogue free. Ner-a-car Corporation, Syracuse, N. Y.

NEW Briggs-Stratton motors, \$65.00; almost new Flyer, \$90.00. Real bargains. Beam, 810 Coleman, Johnstown, Pa.

BARGAINS in used Harleys, Hendersons, Cleavelands, R. E. Knorr, Lincoln, Ill.

USED parts for all motorcycles cheap. State wants. Schuck Cycle Co., 1922 Westlake, Seattle, Wash.

NEW Rogers Side Cars, Extension Axle, Fittings Complete, \$69.50. Rebuilt Bargains. Stamp Brings Folder. Erickson, 438 W79, Chicago.

'19 INDIAN 3 Speed \$85.00. '20 Indian 3 Speed \$100.00. '21 Indian 3 Speed \$150.00. Howard A. French Company, Baltimore, Md.; Washington, D.C.

SEND for big list of slightly used motorcycles on our easy payment plan. Howard Cycle Co., 152 N. Broad St., Trenton, N. J.

DON'T buy a Bicycle Motor Attachment until you get our catalogue and prices. Shaw Mfg. Co., Dept. 27, Galesburg, Kan.

NEW motorcycles have been reduced 10%. Our prices have been reduced 35%. Send for big bargain list of rebuilt motorcycles. Western Supplies Co., 359 Hayutin Bldg., Denver, Colo.

AVIATION

PROPELLERS for aeroplane propulsion, 5 ft. diameter, \$12; other sizes in proportion. Motorcycle Sleigh blue prints, 75c. Ford prints, \$1.00. Address Crawford Motor & Aeroplane Manufacturing, 2225 American Ave., Long Beach, Calif.

BUILD your own aeroplane, materials cut to fit, ready to assemble, on easy terms. Address A. Angeles, East Seattle, Wash.

FOUR cylinder air-cooled Aeronautical Motor, thirty H. P., \$85.00. C. D. Hibbs, Ft. Worth, Texas.

REAL aeronautical bargains—turnbuckles, 20c; aero cloth, 30c; shock absorber, 5c; Gnome motors, \$150.00; tubing, 5c per foot; airplane sheet steel, 5c per lb.; tape, 3c; spark-plugs, 25c; high tension wires with terminals, 20c; wheels, 20x4, \$6.00; brass screws, 40c per gross; plywood, 20c; aircraft nuts, 5c. Many other bargains. Sale sheet, 2c. Heath Airplane Co., Chicago.

"FLYING Instruction." Ten lessons, 20 minutes (airtime) each, four weeks ground schooling included, \$100. Curtiss planes. Army pilot instructors. Write, wire, or come ahead. We're ready. Aviation Engineering Co., Lawrence, Kan.

COMMERCIAL Engraving and Printing—the most practical and complete book on engraving, printing and allied subjects ever published. Over 800 pages and 1500 illustrations presenting over 3500 distinct ideas on 35 separate subjects. Cloth, price \$15.00 prepaid. We highly recommend this book. Popular Mechanics Book Dept., 6 N. Michigan Ave., Chicago.

BUILD and fly your own plane. Small cost. I start you making big money. C. E. Lay, 5727 Sawbrook, Cincinnati, Ohio.

LEARN to fly with America's oldest aircraft company. Six hours' flying worked in with three months' shop training at \$190.00, makes our course the most complete ever offered, and an opportunity long waited for. Enroll at once. Heath Airplane Co., Chicago, Ill.

LATEST Aerodrive Sled Blueprint, 50c. Sport Fuselage, \$100. Aircraft supplies list for stamp. Ostergaard Aircraft Works, 4289 North Narragansett, Chicago.

"MOTORCYCLE Engine Monoplane." Very efficient for learning flying. Materials cheap. Building plans and flying instructions, \$1. Aviation Directory, Lawrence, Kan.

WANTED, a one passenger Biplane. V. H. Kennemir, Como, Texas.

INVENTORS desiring patents should write for our Free Illustrated Guide Book and Evidence of Conception Blank. Send model or sketch for our opinion of its patentable nature. Highest references. Prompt service. Reasonable terms. Victor J. Evans & Co., 187 Ninth, Washington, D. C.

BIGGEST, best catalogue Model Aeroplanes, Parts and Supplies; 5c postpaid. Ideal Aeroplane Co., 67 1/2 West Houston, New York.

HEATH propellers represent the most efficient method of aerial drive. Each propeller individually designed for the particular work to be done, as laid out by America's oldest aeronautical engineers. Propeller catalog, 5c. Heath Airplane Co., Chicago.

WELDING

WELDING Encyclopedia—A complete instruction book on all welding processes; oxy-acetylene, electric arc, electric resistance and thermal. Welding of all weldable metals fully discussed. 326 pp., 375 illus. The accumulated experience of the welders of America is yours for \$5. Money back if not satisfied. Popular Mechanics Book Dept., 6 N. Michigan Ave., Chicago.

BOOKS AND PERIODICALS

"BOYS" toy-maker book, 64 pages, illustrated, 10c. Amateur Electrician, 61 pages, illustrated, 10c. Radio Sets, how to build, illustrated, 25c. Western Puzzle Works, St. Paul, Minn.

1,000,000 INDUSTRIAL Facts, Calculations, Receipts, Processes, and Trade Secrets for every business are contained in the 1016 page book "Moore's Universal Assistant and Complete Mechanic," 500 engravings. Cloth, Price \$2, postpaid. Popular Mechanics Book Dept., 6 N. Michigan Ave., Chicago.

BIG money in writing photoplays, stories, poems, songs. Send today for free copy America's leading writer's magazine, full of helpful advice on writing and selling. Writer's Digest, 708 Butler Building, Cincinnati.

LEARN Shoe Repairing at home; good money in it; our book of instruction teaches you every detail, only \$1 prepaid. American Bench Shoe Makers, Dept. 2, Aurora, Ill.

"MIND-READING"—Any distance; wonderful; 30c. "Hypnotism" controls others—25 easy lessons, \$1.00. Science Institute, PM92, 1014 Belmont, Chicago.

"MASTERFUL Thinking". Inspiring book, 20c. John D. Black, Los Angeles, Calif.

OUR new catalogue listing over five hundred carefully selected practical books under eighty different subject groupings will be sent free upon request. Popular Mechanics Book Dept., 6 N. Michigan Ave., Chicago.

SOVEREIGN Publishers, 291 Rhode Island, Buffalo, \$35 "Master Key" Course, \$5.00. Catalogue, Wonderful Books, 2c; Comedy Hit, 10c.

"MAGIC." Edward M. Massey. Just published, 36 entirely new and original effects, clearly described, illustrated with 25 full-page plates and 11 smaller illustrations. Attractively bound, elaborate gold stamping 8"x5 1/2". \$3.00 postpaid. Spon & Chamberlain, 120 P. M. Liberty Street, New York, N. Y.

RADIO books, Automobile books, Lists free. Wells & Edwards, X852 George, Chicago.

BOOKS, All Kinds. Lists. Higene's, A2141 Post Street, San Francisco, Calif.

PLANS for Poultry Houses. All styles. 150 illustrations; secret of getting winter eggs, and copy of "The Full Egg Basket." Send 25 cents. Inland Poultry Journal, Dept. 74, Indianapolis, Ind.

INDUSTRIAL Alcohol, Wright's book everybody wants. Full directions for making with drawings of necessary apparatus, \$2.50 postpaid. Spon & Chamberlain, 120 P. M. Liberty Street, New York, N. Y.

INSTRUCTION Book (for shop use) on vulcanizing auto tire, boots and shoes, \$1 bill. Equipment Co., 3 Canal, Cincinnati, O.

PICTURES, POSTCARDS, ETC.

TEN mountain views, thirty cents. Return for mailing. Surprise friends. Hadler, 4085 E. Broadway, Denver, Colo.

JOIN Live Postcard club; Sample paper, list, catalog, 10c. Harvey Teeple, Decatur, Ind.

NOVELTIES

CURIO Fiends; Button clam shells with button holes in. 2 for 25c; 4 for 50c; 1 good for 50c. A. Kere, Lone Tree, Iowa.

"HOLIVIAN Lucky Beans," something original; each bean everlasting, natural, brilliant, scarlet and black; for earrings, brooches, watch chains, rings, bangles, etc., \$2.50 per dozen. Address, Woods, Chacabuco, 433 Valparaiso, Chile, South America.

GAMES AND ENTERTAINMENTS

BIG Premium Budget, 250 riddles, 15 puzzles, 26 parlor games, 31 magic tricks, 40 experiments, 14 stories, 50 money-making secrets, 80 album verses, 12 songs and dream dictionary. All 10c, postpaid. Curtis Co., Box 172, Denver, Colo.

VENTRILQUIST taught almost anyone at home. Small cost. Send 2c stamp today for particulars and proof. George W. Smith, Room M-290, 125 N. Jefferson Ave., Peoria, Illinois.

GET Dollar Dazzler Book of Real "Buff" Rhythms, Sensational Song Supplement. Elegant offer. (Book only, 50c.) New York Trend, 652 Thirty-ninth Street, Brooklyn, N. Y.

67 TRICKS, 400 Jokes, Riddles, Toasts, Fortune Telling Secrets, Funny Readings and big catalog, 10c. Ideal Book Shop, 5531NC, North Robey, Chicago.

HOUDINI'S Paper Magic—by Houdini. All who are looking for "something different" for instructive amusement will welcome this book on tricks with paper, puzzles, paper-folding, etc. Price, \$2.50, postpaid. Popular Mechanics Book Dept., 6 N. Michigan Ave., Chicago.

250 MAGIC Tricks, only 10c. Andee, 4649-TK, North Whipple, Chicago.

MAGIC—Tricks, Books and Supplies. For Amateurs as well as the great professionals. Anyone can learn through our instructions. Feature Acts in Mind Reading, Spiritualism, Rope Ties, etc. Large illustrated Professional Catalog, 10c. Chicago Magic Co., Dept. B, 140 S. Dearborn St., Chicago, Ill.

TRICKS, Puzzles, jokes, magical apparatus, plays, stage supplies, mind-reading acts, and sensational escapes. 160-page illustrated professional catalogue, 10c. Oaks Magical Co., Dept. 548, Oshkosh, Wis.

REDUCED Prices! Tricks, Jokes, Puzzles, Imported Novelties. Catalog and "Ten Pocket Tricks," 6c. Send today! Lyle Douglas, Station A, Dallas, Texas.

250 MAGIC Tricks 25c. Big Catalog 2c. Harvey Teeple, Decatur, Ind.

MAGIC TRICKS, BOOKS AND JOKERS' NOVELTIES

MYSTERIOUS Spirit Pad.—Writing appears and disappears; questions asked and answered. New! Just from Europe! Price, 30c. Complete 120 page illustrated catalogue of books, superior grade of magic tricks and jokers' novelties, 10 cents; money refund with first order. Free souvenir of California. Chelsea Trick & Mystery Company, Station R, Box 24, New York, N. Y.

"NEW Tricks"—Exclusive line; lowest prices; magic catalog, stamp. McQuade, Leonard, Texas.

STAMP COLLECTING

SNAPS—150 different stamps, 18c; 60 different United States Stamps, 12c. With each order we give free our price list of sets, packets, albums, etc., and our pamphlet which tells "how to make a collection properly." Queen City Stamp Company, Room 36, 694 Race, Cincinnati, Ohio.

BEST one cent approvals in America. F. P. Hand, 1117 S. 60th St., Philadelphia, Pa.

START!! Auto Top Building—new invention. Write Schives, 19 S. La Salle St., Room 1229, Chicago.

105 CHINA, etc., stamp dictionary, 1st. 2c. Album (500 illustrations), 3c. Bullard, Sta. A, Boston.

STAMPS on approval 1/4 cent up. Free premium. Herbert Keirwin, Middletown, N. Y.

STAMPS, 100 different for ten cents with fine approvals at 50% discount. J. A. Goldsmith, Box 313, Kansas City, Mo.

NEWFOUNDLAND stamp bargains! Lists sent. Rev. Butler, St. Georges, Newfoundland.

NEW world largest postage stamp, free. Nielsen, 1923 Melrose, Chicago.

FOR 10 CENTS—Abyssinian Stamp, Guatemala Parrot Stamp, Thirty Varieties British Colonies, 250 Hinges, Large Perforation Gauge, Big Price Last, and finest approvals. We buy collections. Address, Allen Sears, Inc., Dept. P, Kemper Bldg., Kansas City, Mo.

FREE—New Europe, 20 diff., to applicants for my 1/4, 1/2, 1, and 2c approvals; also the higher-priced stamps at 50% disc. Send reference and receive extra premium. Chas. T. Egner, 1335 Pike St., Philadelphia, Pa.

LIBIA, New Venus Picture set, 4 values, 10c postpaid. U. S. 8c. price list free. Send for a selection of approvals today. Address, Midwest Stamp Company, Kemper Building, Kansas City, Mo.

KANGAROO set and 55 other different foreign stamps, hinges, pocket album and lists for 10c to approval applicants. Address, Moseley, 1904 Tower Grove, St. Louis, Mo.

FREE—Complete set current Austria unused for approval request and references. Bargains in New Europe. G-M Stamp Company, 366 Hay State Road, Boston, Mass.

500 DIFFERENT stamps, \$1.00, 125 different, 10c. 50 different French Colonials, 25c. 15 different Peruvian, 10c. Nickles, 122 Florida, Washington, D. C.

FUME Set featuring Post Annunzio; also 65 different from France for 27c. Jacob Fischer, 1539 North Lawler, Chicago.

ABYSSINIA, Zambesia, Holkar, Herzegovina, Ukraina stamps, menagerie packet, 250 hinges, 10c. Liberty, 3974 Arsenal, St. Louis, Mo.

1500 DIFFERENT stamps, \$5; 1,000, \$2.50; 550, \$1; 300, 45c. Fred Onken, 630 79th Street, Brooklyn.

FREE—Watermark Detector with lists to approval applicants. Allen Sears, Inc., Dept. P, Kansas City, Mo.

CZECHO-SLOVAKIA—23 different, cat., \$1.15 for 25c. D. R. Watson, Homer, Ill.

200 DIFFERENT stamps, 15c. Lists free. Michael, 5692 Prairie, Chicago.

3,600 MIXED stamps, 25c; 15,000, \$1.00. Alvin Johnson, Hawarden, Iowa.

LIKE Triangular Stamps? To introduce our Sudden Service Approvals we'll send triangular Fume, set China ships, large \$1.00 United States revenue, also packet 50 foreign, millimetre scale, perforation gauge, ruler and bargain lists for only 9c! Fennell Stamp Company, Dept. P, Fullerton Bldg., St. Louis, Mo.

BEGINNER'S Special—Loose-leaf album (complete)—1,000 different stamps; liberal quantity hinges, etc., \$5.00 postpaid. Lists free. Baumann, 1033 Levick, Philadelphia.

500 MIXED U. S., old and new, 10c; 100 different Foreign, 10c; 1,000 hinges, 10c; Stamp Album, 15c. Weatherby, Medina, Ohio.

STAMPS sent on approval at 70% discount. Reference required. Emory Renoll, Hanover, Pa.

200 STAMPS and Bargain Stamp Magazine, 15c. Harvey Teeple, Decatur, Ind.

FREE packet of desirable stamps, exceptional quality, to approval applicants sending satisfactory references. H. Argenbright, Box 352, Staunton, Va.

FREE 7 beautiful French Colonials to new approval applicants. Frank Hadley, Plainfield, N. J.

STAMPS—50 different Jamaica, Venezuela, etc., only 7c; 100 all diff., 10c; 1000 all diff., \$2.50; 100 diff., U. S., 25c; 1000 Hinges, 10c; 50 per cent approvals with every order. List free. I buy stamps. Write L. B. Dover, Dept. A, Longmont, Colo.

STAMPS Free—War Stamps, Surcharged, Unused, Pictorials, British, French Colonials 2c postage. Midland Stamp Co., Toronto, Canada.

158 GENUINE Foreign Stamps—Mexico War Issues, Venezuela, Salvador and India Service, Guatemala, China, etc., only 10c. Finest approval sheets, 50 to 60%. Agents Wanted. Big 72-p. Lists Free. We Buy Stamps. Estab. 29 yrs. Huseman Stamp Co., Dept. 51, St. Louis, Mo.

FOREIGN Stamp Collection Sent Free. Cornish Company, Schenectady, N. Y.

FRENCH Colonies Free—Beautiful Picture set, including Native Chiefs, Tigers, Pictorials, 2c Postage. Empire Stamp Company, Toronto, Canada.

3 NYASSA Giraffe stamps free to approval applicants. Wilmar Edgar, Cherokee, Iowa.

STAMPS, 50 Varieties, Africa, Brazil, Peru, Cuba, Mexico, etc., 10c. 50 different U. S., 25c; 1,000 mixed, 40c; 1,000 hinges, 10c. List free. C. Stegman, 5948 Cote Brillante, St. Louis, Mo.

FREE! Sectional Loose Leaf Postage Stamp Album at the rate of 8 pages each month given with subscription to our monthly Journal. Send two-cent stamp for prospectus. United Stamp Co., 140 S. Dearborn St., Chicago, Ill.

BIG Variety Packet Foreign Stamps free for 2c postage. Gray Stamp Co., Station E., Toronto, Canada.

24 VARIETIES Cuban stamps, 10 cents. List of 6,000 low-priced stamps free. Address Chambers Stamp Co., 111P, Nassau St., New York City, N. Y.

20 UNUSED stamps free. All different. Postage, 2c. Fisk Stamps, Toledo, Ohio.

PACKET of 23 stamps, no two countries alike. Packet hinges. Set of \$1 and \$2 U. S. Rev. all for 5c. Mention paper. Miami Stamp Co., Toledo, Ohio.

STAMPS, 20 unused, all different, free. Postage 2c. Mention paper. Quaker Stamp Co., Toledo, O.

FREE 10 different Scandinavian, millimetre scale, gauge, book, lists, etc., to all sending 10c for 57 different Siam, Ceylon, Guatemala, etc. 200 different, 25c; 800 different, 60c; 100 different U. S., 25c. Hawk-eye Stamp Co., Cedar Rapids, Ia.

RARE COINS

POLITICAL Cent, Jackson Cent or "Hard Times" Token, issued in 1834 to 1842. Highly interesting, some with jacks, turtle, etc. Get one now with my large 50-page illustrated Coin Catalog for only 20 cents. This is just a special "get-acquainted offer." B. Max Michl, Numismatist, Michl Bldg., Dept. P., Fort Worth, Texas, Largest Rare Coin Establishment in the United States.

1 LARGE Cent, over 100 years old, 25c; hundreds of other bargains. Address Fred Greenclay, Box 207, Alton, Ill.

CENTS worth dollars. Do you know that coin collectors pay up to \$100.00 cash for certain old U. S. Cents—as well as high premiums for all rare coins. We buy all rare coins. Send 4c. Get large coin circular. It may mean much profit to you. Numismatic Bank, Dept. H., Ft. Worth, Texas.

COIN catalog sent to collectors on application. F. Stolteben, 2319 Osgood St., Chicago.

CALIFORNIA gold, 3/4 size, 27c. 3/4 size, 52c. 3c piece and catalogue, 10c. Address Norman Shultz, Colorado Springs, Colo.

OLD coins, large Spring selling catalogue of coins for sale, free. Catalogue quoting prices paid for coins, ten cents. William Hesselein, 101B Tremont St., Boston, Mass.

FOR BOYS

MOUTH-ORGAN Instructor, 25c. Play in one hour. G. Elsea, Bowling Green, Ohio.

BOYS!—You who like gripping, thrilling stories of achievement will want to read "Victories of the Engineer," a book that tells in a way you can understand it how the great feats in railroad engineering, building great bridges, ships, dams, canals, harbors, tunnels, mining, etc., have been accomplished. By A. Williams, 487 pp. 259 illus. Price \$2.00, postpaid. Popular Mechanics Book Dept., 6 N. Michigan Ave., Chicago.

BOYS, Get flying model aeroplane free. Write to Aero Shop, 3650 Hurbit Ave., Detroit, Mich.

SCENERY TO RENT

SETTINGS for Opera, Plays, Minstrels, Plush Drops. Catalog, Amelia Grain, Philadelphia.

CAMERAS AND PHOTO SUPPLIES

JUST Published—Our new complete 128-page catalog and bargain book of new and used cameras and supplies. Our goods are guaranteed finest quality obtainable. We have thousands of satisfied customers. Write at once for this bargain bulletin, just hot from the press. Address Central Camera Co., 124 S. Wabash Ave., Dept. E-61, Chicago, Ill.

SOMETHING new, Kodak enlargements, Oil painted. Everybody is going wild over them. Send your favorite Film; will enlarge to 10x12 and Oil paint for \$1.50. Be sure to state colors. Address Cassen's Art Studio, Box 183, Litchfield, Ill. Agents write.

PHOTOS enlarged; latest styles; save 40%. Black Studio, Los Angeles, Calif.

5x7 KODAK Enlargement, beautifully hand-painted, fifty cents. Holt Studio, Quincy, Fla.

FILM Developed and 6 prints 20c. Or 6 prints from negatives 20c. Trial offer. Young Photo Service, 14 E. Alden Ave., Albany, N. Y.

SAMPLE Enlargement, dime, and negative (returned). Roll developed and six prints, 25c silver. Brown Studio, Lake Elmo, Minn.

KODAK Prints 3c. Postcards 5c, developing 5c. Altine Photo Co., Dept. P, 192 Kinney, Cincinnati, Ohio.

TRIAL Order—Mail us 20c with any size film or six negatives for development and six velvet prints. 24-hour service. Get premium list. Roanoke Photo Finishing Co., 290 Bell, Roanoke, Va.

HAVE You a Camera? Write for Free sample of our big magazine, showing how to make better pictures and earn money. American Photography, 790 Camera House, Boston, 17, Mass.

KODAK Finishing—Kodak, Camera repairing. Developing and printing for amateurs. One-day service. Complete line of photo supplies. Write Radium Studio No. 21, 847 Belmont, Chicago.

ESTABLISH yourself—at home—as an Expert Photographer and train with R. Vant, director International Studios, 343-B—3691 Michigan Ave., Chicago.

KODAKS, Cameras, Lenses, Photo Supplies, Radio outfits. Ask for bargain list. Hyatt's Supply Co., 417 N. Broadway, St. Louis, Mo.

BIG Money Saved on Photographic Lenses and Apparatus—goods exchanged; repairing done. Ralph J. Golsen, 1128 Argyle St., Chicago, Dept. P.

BASS Camera Bargains are known the world over. Write your needs. Largest stock of Graflex, Kodaks and Motion Picture Cameras in the world. Bass Camera Company, Mail Order Division, Chicago, Ill.

MOTION PICTURES

SEND stamp for catalog illustrating wonderful 1923 Kinograph Grand Home Movie Projector. Bargains in films. Address Werner Brothers, High Ridge, Missouri.

FILMS \$3.00 per reel; Movie Camera, 200 foot, \$85.00; tripod and tilt, \$25.00; Motor-driven projector, \$75.00. Ray, 326 Fifth Ave., New York.

BIG Money Nightly—Get my installment figures Complete Moving Picture Outfit before buying. Ralph J. Golsen, 1128 Argyle St., Chicago.

EARN money writing photoplays. Beginners' plan free. Los Angeles Photoplay Company, Los Angeles, Calif.

WE buy used portable suitcase and professional moving-picture machines. Highest prices paid. What have you for sale? Monarch Theatre Supply Co., 724 So. Wabash Ave., Chicago, Ill.

AMERICA'S Greatest Fortunes have been made in the Moving Picture Business. Small investment needed. We furnish complete theatre equipment. Easy payments. Openings everywhere. Catalog free. Monarch Theatre Supply Co., Dept. F, 724 So. Wabash Ave., Chicago, Ill.

FREE to Writers—A wonderful little book of money-making hints, suggestions, ideas: the A B C of successful story and play writing. Absolutely Free. Just address Authors Press, Dept. 12, Auburn, New York.

JUST Out! Send for one at once! The Complete Cinema Hand Book, A complete course in motion-picture making from raw film to the projected image. 508 pages crammed full of authoritative information. Postpaid to any part of the world on receipt of \$3.00. Everything in Motion Picture Apparatus. Cameras from \$30.00 to \$1500.00. Write for information to the Motion Picture Headquarters of the World, Bass Camera Company, Dept. 114, 109 No. Dearborn St., Chicago, Ill.

CLEARANCE Sale—500 reels high-grade film. Two to six reel subjects Famous Movie stars. Special \$3.50 per reel only while they last. Stock up now. List free. Monarch Theatre Supply Co., Union and Fourth, Memphis, Tenn.

BUY direct from Manufacturers—New or rebuilt Moving Picture Machines for Homes, Schools, Lodges, Churches, Traveling Shows and Theatres. Mazda—Arc or Gas complete outfits—Film and Supplies. Dept. X, Monarch Theatre Supply Co., Memphis, Tenn.

FILMS for Toy and Professional Machines. All famous movie stars, \$3.00 per reel and up. Machine bargains also. Write for big list free. Monarch Theatre Supply Co., Dept. P. M., 724 S. Wabash Ave., Chicago, Ill.

FILMS For Sale—\$2.50 per Reel up. Address Queen Feature Service, Birmingham, Ala.

MAKE money writing photoplays; details free to beginners. No correspondence course. Producers League, 230 Wainwright, St. Louis.

EDUCATIONAL AND INSTRUCTION

LEARN to draw—With our magic tracing device you can copy any drawing. Entertaining and instructive. Anyone can operate. Postpaid \$1.00. Address Tracing Company, Long Branch, N. J.

ARCHITECTURAL draftsmen offered big pay. Opportunities everywhere. Quick, practical, inexpensive instruction. Easy payments. No bank. Designer Evers, Englewood, Denver, Colo.

HARMONICA, Violin, Piano, Ukulele, or Mandolin instructors, 25c. G. Elsea, Bowling Green, Ohio.

BIG Money in writing photoplays, stories, poems, songs. Send today for Free copy America's leading writer's magazine, full of helpful advice on writing and selling. Writer's Digest, 603 Butler Building, Cincinnati.

CARTOONISTS—Improve your style by following the work of the greatest cartoonists found in the bound volumes of Cartoons magazine. Eight volumes, each covering six months, Jan.-June, 1917, to July-Dec., 1920, inclusive. 1,200 cartoons, 900 pages to a volume, 7 by 9 1/2 in., 3 in. thick. New books; durable and attractive binding. Sold separately at \$2 per vol. postpaid. Supply very limited. Send at once. Popular Mechanics Book Dept., 6 N. Michigan Ave., Chicago.

THE most profitable Art as well as the easiest to learn: Sign Painting and Show Card Writing. Complete course \$2.50. Hall's Sign Shop, Franklin Square, Worcester, Mass. Dept. A.

USED books, educational nature, sold, rented, bought, exchanged. Bargain list free. Lee Mountain, Dept. 86, Plagah, Ala.

BOOKKEEPING in a week. Dukes, 1857-9 Walton Ave., New York.

ROPP'S Calculator and Short-Cut Arithmetic shows the answer as quickly as a watch shows the time to all problems likely to occur in office, store, shop, bank, farm or factory. Price, pocket size, paper, 35 cents, cloth, 50 cents, leatherette, \$1. Desk size, cloth \$1.50 postpaid. Popular Mechanics Book Dept., 6 N. Michigan Ave., Chicago.

BECOME a Laboratory Expert—Learn interesting, profitable, Profession of Bacteriology, Microbiology. Extension and Residential Courses. Diplomas—degrees granted. Help secure position. 48-piece urinalysis outfit free to students. Send today for free 34-page Prospectus. College of Microbiology, 955 Belden Ave., Chicago.

"WHAT to Invent For Profit" free. Patent News, N. Washington, D. C.

HAVE a business of your own; the most fascinating, best paying business-profession in the World, a foot correctorist; easy terms for training you at home in a few weeks, a new protected system that has enabled men and women to rise in one step to greater earnings than they ever thought possible; no capital required or goods to buy, no agency or soliciting. Address, Stephenson Laboratory, 1 Back Bay, Boston, Mass.

WANTED: Information exchanged about commercial uses for air compressors. Address Engineering Dept., Brunner Mfg. Co., Utica, N. Y.

AMBITIOUS writers—send today for free copy America's leading magazine for writers of photoplays, stories, poems, songs; instructive, helpful. Writers Digest, 703 Butler Bldg., Cincinnati.

WRITE articles, stories, news, in spare time for newspapers and magazines. Big pay. Copyright book free. Press Syndicate, 552 St. Louis, Mo.

ARTIFICIAL Marble, sanitary flooring instructions, ornamental casting, concrete plaster, papier-mache decorations, garden furniture, statuary, Rubber-moulds, Electro-metallurgy, particulars and 200 illustrations free. Chris Mahler, Box 122, Huntington, N. Y.

INVENTORS—Write for our illustrated guide book and Evidence of Conception Blank. Send model or sketch and description for free opinion of its patentable nature. Highest references. Prompt attention. Reasonable terms. Victor J. Evans & Co., 147 Ninth, Washington, D. C.

DOUBLE Entry Bookkeeping mastered in 60 hours with 8 keys; guaranteed; diploma. Our graduates lead in bookkeeping, auditing, accountancy, balance sheets, financial statements. International Bookkeeping Institute, Dept. 3, Springfield, Mo.

STUDY Bacteriology—become a laboratory expert. Course interesting, can be mastered in few months at home or in school. Good paying positions open. Degree granted our graduates. School 13 years old. Send for Announcement. American College of Bacteriology, 2923 S. Michigan Ave., Chicago, Ill.

TELEGRAPHY

TELEGRAPHY—Morse and Wireless—taught at home in half usual time and at trifling cost. Omnigraph Automatic Transmitter will send, on Sounder or Buzzer, unlimited messages, any speed, just as expert operator would. Adopted by U. S. Govt. and used by leading Universities, Colleges, Technical and Telegraph Schools throughout U. S. Catalog free. Omnigraph Mfg. Co., 18 Hudson St., New York.

TELEGRAPHY (both Morse and Wireless) and Railway Accounting taught quickly. Big salaries. Great opportunities. Oldest and largest school; established 48 years. All expenses low—can earn large part. Catalog free. Dodge's Institute, 11 St., Valparaiso, Ind.

RADIO OUTFITS AND SUPPLIES

ROTORS, Variometers, Variocouplers. Discounts to dealers. E. U. Mack, Mfr., Florence, S. C.

14x20 BLUEPRINT plan for assembling 109-mile Radiophone, 5c. Ray, 326 Fifth Ave., New York, N. Y.

VARIABLE Condensers, 43 plate, regular price \$4.50, now \$3.75; 21 plate, regular \$3.55, now \$2.80. Switch contacts .01. Switch levers .35. Nickel binding posts .04 each; Crystal detector \$1.00; Bakelite \$.02 per square inch. Pottstown Radio Supply Co., Pottstown, Pa.

COMPLETE Crystal Radio Set ready to install. Finely finished instrument with Aerial, 2,000 Ohms headset and everything complete for receiving local concerts. Full instructions. Price \$18.00. Address, C & R Radio Co., 2910 Holmes St., Kansas City, Mo.

WATER Jet Vacuum Pump. Radio experimenter. Make vacuum tubes and evacuate with this efficient pump. Screw to ordinary water faucet. Pump with instructions for novel experiments \$1.00 postpaid. Schmidt-Holland, Inc., 915 Woolworth Building, New York City.

TRIO Radio Receiving Sets, complete with double standard 'phones, aerial and full instructions. Will receive news, music, reports, etc., within 50-mile area, telegraph code within 150 miles. Bakelite panel 6x7 mounted with nickelplated parts. Cabinet 1/2-inch Mexican birch, lock-cornered, Walnut finish. Bus-bar wiring, all soldered connections. No batteries or tubes to burn out. Costs nothing to keep up. No experience needed to install or operate it. Maker to user only. Price complete \$22.50. C. O. D. We pay postage in U. S. A. Trio Radio Laboratories, 9514-9522 E. 14th St., Oakland, Calif.

RADIO Sensation! Invincible Crystal Radio Set with Head Phone and Ducon Plug, ready for Instant Use. Simply place plug in Electric Socket. No outside wires necessary. Complete \$20.00 cash, prepaid. Reliable agents and dealers wanted. Invincible Products, 159 North State, Chicago.

RADIO for the Amateur-Building, Installing, Operating Stations for Radio Communication treated simply in "Practical Amateur Wireless Stations" a 136-page book compiled by Editor of Wireless Age. 115 ill. and diag. Size 6x9 in. Price 75c post. Popular Mechanics Book Dept., 6 N. Michigan Ave., Chicago.

WESTINGHOUSE and other Standard Radio Sets and Parts. Liberal commissions paid for interesting orders which enable you easily to earn your set and make money. Write for price list and proposition. Wheeler-Thomas Radio Co., Dept. 29, Holland, N. Y.

\$12.00 NAVY type 2200-ohm double headset assembly for wireless. Experimenters and amateurs, this is complete with headband and leads, assembly instructions. \$3.50 with order. Act quick. Model Wireless Engineering Co., 330 East Adams Ave., Detroit, Mich.

SEND \$12.00 for Radioset, complete, double headgear, aeriols, switches, everything. Can hear 40 miles. Nothing else to buy. Two hours after you get it, you will have it up listening. Radio Sales Company, Hutchinson, Kan.

VARIABLE Condenser, 17 plate, with 3 in. hard rubber dial, \$2.15. Variocoupler with dial, \$2.15. Complete Sets. Money back if dissatisfied. Send for circular R. M. The Q. T. Light Co., East Orange, N. J.

ALL About Radio, Radio Gazette tells all about radio, illustrated plans, call numbers, instructions, etc. Real Radio Magazine. 4 months, 50c. 2 months, 30c. Radio Gazette, Hutchinson, Kan.

CONVERT your Crosley Harko into a regenerative receiver with a range equal to any. Regenerator \$10.00. No inside connections to make. Guaranteed. Central Mfg. Co., Fairfield, Iowa.

RECEIVING Set \$7.50. Description free. Condenser .001 MFD, 17c. Grid Leak Grid condenser .005 MFD, 25c prepaid. Address Busch-Murphy, 195 Mason St., Rochester, N. Y.

RADIO Manual, Plans for Building Sets. Cost of Material, Terms Defined. Necessary Information, etc., 20c prepaid. A. M. Hudson Co., 2725 Mildred Ave., Chicago.

RADIO Books—Send for our specially selected list of 20 leading volumes among the reliable radio publications and also our complete book catalog. They are sent free upon request. Popular Mechanics Book Dept., 6 N. Michigan Ave., Chicago.

DIALS—Celluloid, 0 to 100, for Radio use. Ten cents each, postpaid, Johnson Printing Co., Louisville, Ky.

BUILD your own Radiophone. Instruction book ten cents. Radio Service Inst., U. S. Bank Bldg., Washington, D. C.

BUSINESS OPPORTUNITIES

YOU'RE looking for a business opportunity. Here it is. Our one-price Line of Tailoring offering All-Wool Made-to-Measure Suits, regular \$50.00 values, at \$29.75, offers you \$50.00 to \$100.00 a week and up sure-fire profits. We supply everything. Experience not necessary. Write for full facts at once. Park Tailoring Company, Dept. 355, Chicago, Ill.

I HAVE over 100 stores paying \$5 monthly maintenance. You can do the same in your City. Month's practice qualifies. Only one person in each City chosen. Address Midnight Alarm System, 6411 Mack Ave., Detroit.

START Profitable Mail Order Business at home. Make and sell your own goods. Enormous profits. Write Ritco Company, Ritco Bldg., Elkton, Wis.

121 QUARTERS in One Mail. Best plan running. Send stamped envelope for circular. Johnson Bros., 5319 Princeton Ave., Chicago, Ill.

BECOME a Battery Manufacturer. Write for particulars to Lavender Battery Mfg. Co., Webster City, Iowa.

BUSINESS opportunity: Learn scientific Storage Battery Recharging and Repairing. \$50.00 for complete course of training; two weeks completes course; if we cannot make an expert of you, we make no charge. Trained Battery Men draw from \$45.00 to \$60.00 per week. Or start business for yourself, the most profitable of the Automobile industry. The Compo Battery Co., Defiance, O., Pioneers in the Battery Field.

ATTENTION!! Go into business for yourself. Establish and operate New System real estate; business brokerage and Insurance Agency in your community. Office at home; earn \$5,000 year. Representatives wanted everywhere; send stamp for booklet. Hayes Realty Association, Cincinnati, Ohio.

GREATEST Opportunity Ever Offered Live Wires to make Clean Money on Latest Invention for Automobiles. Exclusive. Necessary. City, County or State rights given. Best Territory Going Fast. Hurry Your Application. Guaranteed Proposition. Emons Mfg. Co., Alliance, Ohio.

WANT responsible Sales Managers. Prefer those having sales force selling consumer direct. New Process Waterproof fabrics; no rubber. Best selling line ever produced. Give references and will forward samples. Marengo Company, Rockford, Ill.

"MONEY and Health"—20 ways of making money in your back yard. \$10.00 per day easy. Start at once. Send \$1.00 for complete instructions. David Hansen, 1243 Thorndale Ave., Chicago.

EITHER by mail or by house-to-house selling you can run the territory agency for our excellent, big profit-bringing remedies. Send 10c for samples. Germsan, 1429 Lexington, New York.

OPEN clothes, hat cleaning and pressing establishment. Easy cleaning methods makes clothes, hats, etc., look like new. Wonderful opportunity. Particulars free. Address Byron 27, Sts. I, New York.

GENERAL Sales managers to open branch offices, handle salesmen wanted by manufacturers of Ruby Furniture Polish. No investment necessary. William J. Oberling, Central Specialty Company, Indianapolis, Ind.

EXCELLENT Opportunity: Make your own goods; Generous profits; Full protection; Complete advertising matter furnished; Particulars free. Address F. Busler, 1912 8th Ave., Beaver Falls, Pa.

BE Independent. Sell by mail. 20 complete money-making plans, postpaid 50c. W. B. Dower, Box 432, Westerly, R. I.

I MADE \$30 a Week Home. French Breadmaking. 15 years' experience; Free Booklet tells. Ashbrook, 67, Marengo, O.

WAKE up Sales by Mail! Use Authentic reliable mailing lists. 20,000,000 new names! Martineke Company, Corona, N. Y.

MAKE money with your camera. Booklet free. Address Lancaster, 409B Wright-Candler Building, Los Angeles, Calif.

AMBITIOUS people: \$8.00 day easy made. Plan Free. Peters, 12 Harrison Avenue, Gardiner, Maine.

START your own business selling Chesco Specialties. Particulars free. Chesco Company, West Chester, Pa.

PROTECT Your rights. Write for "Record of Invention" and booklet about Patents. Prompt personal service. Advice without charge. J. Reaney Kelly, 612-G Columbian Bldg., Washington, D. C.

PATENTS. Protect your rights. Before disclosing invention write for booklet and blank form Evidence of Conception, to be signed, witnessed and returned with rough sketch or model of your idea, upon receipt of which I will promptly give opinion of patentable nature and instructions. No charge for preliminary advice. Highest references. Prompt, personal attention. Clarence B. O'Brien, Registered Patent Lawyer, Southern Bldg., Washington, D. C.

PATENTS Procured, Trade Marks Registered. A comprehensive, experienced, prompt service for the protection and development of your ideas. Preliminary advice gladly furnished without charge. Booklet of information and form for disclosing idea free on request. Richard B. Owen, 30 Owen Bldg., Washington, D. C., or 2176-B Woolworth Bldg., New York.

MR. WIDE-AWAKE!—I'll show you how you can start a profitable Mail Order or Local Business, quickly, inexpensively, without unusual experience. Others made \$15-\$25 a day. You can too. Write "Kraft," Box 894-P, San Francisco, Calif.

AMBITIOUS Men, write today for attractive proposition, selling subscriptions to America's most popular automobile and sportsman's magazine. Quick sales. Big profits. Pleasant work. Digest Pub. Co., 9545 Butler Bldg., Cincinnati, Ohio.

GET into the specialty manufacturing business. Amazing profits. We will send you free book explaining our system. Write immediately. A wonderful opportunity awaits you. Thos. Steel, President, 624 Main, Richmond, Va.

ENTER a new business. Earn \$3,000 to \$6,000 yearly in professional fees making and fitting a foot specialty, openings everywhere, with all the trade you can attend to; easily learned by anyone at home in a few weeks, at small expense; no further capital required, no goods to buy, job hunting, soliciting or agency. Address Stephenson Laboratory, 11 Back Bay, Boston, Mass.

"WHAT To Invest for Profit" free. Patent News-C, Washington, D. C.

MAIL Order Business is your opportunity. Brenner's Famous Handbooks teach how to start small, grow big. Sell merchandise, service, ideas; enormous profits. Spare time to begin. Get complete set, 11 books, \$8.00, and be posted. Brenner, 335 Walnut, Philadelphia. Descriptive Catalog and big batch interesting mail order information, 25c. None free.

EXCEPTIONAL Opportunity for Sales Manager capable of handling state distribution. Marvelous new Adding Machine. Retail \$15. Work equals \$350 machine. Tremendous possibilities. Unlimited profits. Write quick for details. Lightning Calculator Co., Dept. B, Grand Rapids, Mich.

\$100,000 CORPORATION wants capable man; open office; manage sales for High Class New Device. Every Home a Prospect. Big money-making possibilities for the right man. Opening in every city. Cost \$2.00, retails \$5.00. \$500 to \$2,000 necessary to finance exclusive agency. Scott Corporation, 82 W. Washington, Desk G, Chicago.

RESPONSIBLE Corporation wants general sales managers to open branch office, manage salesmen. \$500 to \$5,000 necessary; expenses allowed to Baltimore if you qualify. Address Manager, 663 N. Eustaw St., Baltimore, Md.

WE Start You in Business, furnishing everything; men and women, \$30.00 to \$100.00 weekly operating our "New System Specialty Candy Factories" anywhere. Opportunity lifetime; booklet free. W. Hillier Ragsdale, Drawer 4, East Orange, N. J.

"SCHEMER Magazine," Alliance Ohio, prints big profit schemes; one subscriber making \$25,000 from three; another \$10,000 from one. Try your luck. Year, only \$1.00; three months, 25c.

CHEMICAL Expert will furnish Formulas and Trade Secrets. All lines. Lists Free. W. L. Cummings, Ph.D., 228 Gordon Ave., Syracuse, N. Y.

MAKE money at home making toys and novelties. Particulars free. New Specialty Company, 417 East 71st Street, New York.

SIGNS, cards, banners, easily painted with letter patterns. Samples free. Address, Outdoor Adv. Service, Lockport, N. Y.

NO money needed if you are responsible or have excellent reputation; big commissions; prefer men calling on power plants, railways, large factories. You can make plenty of money if you are right; have a real article. We are nationally known and highly rated in Dun's and Bradstreet's. Manufacturers, 1690 Kingsland Ave., St. Louis.

DOLLARS yearly in your backyard. No Mushroom dope. Particulars free. Metz, 313 East 89th, New York, N. Y.

\$3,000 TO \$6,000 Yearly. Want it? Others are making it. Send check or money order today for our invaluable books "How to Sell Real Estate," \$3.00—and "How to Conduct Real Estate and Insurance Business," \$1.50. Absolute satisfaction guaranteed. Free catalogs. Realty Book Co., Dept. 52, Cleveland, Ohio.

BE Independent. We teach by mail how to manufacture unexcelled Toilet Preparations. Earn while you learn. Results guaranteed. Particulars Free. School of Cosmetics, Box K, Omaha, Nebr.

"HOW To Sell Patents" free. Patent News-H, Washington, D. C.

LEARN the collection business. Good income, quick results. Interesting booklet. "Skillful Collecting," free. National Collectors Assn., Long St., Newark, O.

START a Paying Business of Your Own. Be a business man. Any location. 3,000 new Tire Vulcanizing and Repair Stations needed. Business always good. Are you ambitious? \$200 will start you. Write at once. Wonderful opportunity. Equipment Co., 11 Canal, Cincinnati, Ohio.

MARBLE mixing instructions, covering wood or cement flooring 1/2 inch thick, fireproof, waterproof, low cost, sanitary, all colors. Particulars, 209 Illustrations free. Chris Mahler, Box 122, Huntington, N. Y.

SILVERING Mirrors! My exclusive French Tartaric method opens enormously profitable business. Booklet free. H. Barstow, 514 25d Street, Oakland, Calif.

UNLIMITED Possibilities; Formula, Trade Secret Business, Particulars Dime. Co-Operative Service Bureau, Kokomo, Ind.

FREE—Formula Catalog, S. & H. Laboratories, Poplston Building, Chicago.

GOOD money easily earned at home, spare time silvering mirrors; no capital. Free instructive book tells how. Patterson & Co., Brooksville, Ky.

IF you have about \$1,000 and capable of organizing sales force, to sell article needed by every merchant, wholesaler and retailer, which should net you \$10,000 profits first year, write Sales Director, 326 Reaper Block, Chicago.

CHEMISTRY

CHEMICAL Analysis. Chemical and Industrial Formulas. Burson Chemical Laboratory, 227 West Fourth, Ottumwa, Iowa.

FORMULAS AND TRADE SECRETS

500 FORMULAS, 20c. Luminous paint—Resilvering Mirrors—Renewing dry batteries—Mechanics' Soap—Gas Tonic—Carbon remover. Puncture Plugger, 20c each. Entire collection, 50c. Ideal Book Shop, 5501FG, North Robey, Chicago.

500 RARE Formulas for 25c (coin). We can furnish any formula wanted for 50c. Catalog Free. Allen's Enterprises, 1227 Milwaukee Ave., Chicago, Ill.

3,000 FORMULAS. Money-makers, 400 pages, \$1. Bestovall Laboratories, 4049-BK, North Whipple, Chicago.

MONEYMAKING Formulas—Catalogue free. Clover Laboratories, 5501C, North Robey, Chicago.

10,000 SELECTED scientific, chemical, technological and practical recipes and processes including hundreds of so-called trade secrets for every business alphabetically arranged in one large volume of 800 pages. Price \$4 postpaid. Popular Mechanics Book Dept., 6 N. Michigan Ave., Chicago.

FORMULAS; guaranteed. Catalog free. Bestovall Laboratories, 4049-K, North Whipple, Chicago.

1,000,000 FORMULAS, Trade Secrets, Processes, \$2.00. Jay-Hersheger, Kokomo, Ind.

1,000,000 FORMULAS. Trade Secrets. 1014 pages, \$2.00. Ideal Book Shop, 3501M, North Robey, Chicago.

500 SUCCESSFUL money-making formulas and trade secrets for 50c. Postpaid. Rudolph Berggaard, Bollag, Minn.

1,000,000 FORMULAS and recipes—1014 pages, \$2.00. Englewood Book Shop, 7021A, South Winchester, Chicago.

FREE—Formula Catalog. S. & H. Laboratories, Boylston Building, Chicago.

AGENTS WANTED

NO Dull Times Selling Food. The greatest, surest and safest business in the world today is selling Federal Pure Food Products, and here is your opportunity to get into this business. You can make \$3,000, \$5,000, \$10,000 or more per year—the only limit is your ability to take care of the business. We print your name and address as distributor on every package, thus making sure that you will get the thousands of dollars' worth of repeat orders which will be sent to you. No Dull Times, for the People Must Eat, and our food products are the fastest selling, surest and quickest repeat order getters in the world. Sell on sight in every home where food is used—Repeat orders immediately and every week thereafter. A Real Big Business All Your Own. Every new customer adds a great deal to your weekly income. Your business once established, has a market value just like a store and can be easily sold. The greatest money-making opportunity of your lifetime because you risk absolutely nothing, as we guarantee your sales, and we will not let you fail. Remember! Guaranteed! Best products, biggest sellers, surest repeat orders. No capital or experience is required. We furnish capital and everything necessary for you to become a Federal Distributor. Exclusive territory will be given honest men or women who will write at once asking us to send our "Success Guaranteed" proposition. Address: Federal Pure Food Company, Dept. 15, Chicago, Ill. Largest inventors of and packers of Pure Food specialties in the world. Reference, any bank, Dun or Bradstreet rating agency, Express or Railway Company in America.

WE want men and women who are desirous of making \$25.00 to \$200.00 per week clear profit from the start in a permanent business of their own. Mitchell's Magic Marrel Washing Compound washes clothes spotlessly clean in ten to fifteen minutes. One hundred other uses in every home. Nothing else like it. Nature's mightiest cleanser. Contains no lye, lime, acid or wax. Free Samples make sales easy. Enormous repeat orders—300% profit. Exclusive territory. We guarantee sale of every package. Two other "sight sellers" and sure repeaters give our agents the fastest selling line in the country. No capital or experience required. Baker, Ohio, made \$600 last month. You can do as well. Send for Free Sample and proof. L. Mitchell & Co., Desk 76, 1302-1314 E. 61st, Chicago, Ill.

LIVE Representatives Wanted! Agents, crew managers, salesmen, distributors, side line men and house to house canvassers who desire a splendid opportunity to make big money with "Tearless Minceers." This is a product that every housewife wants. Now on sale at all State Street Department Stores, Chicago, also handled by dealers and jobbers of consequence. Agents working alone are now making \$12.00 to \$20.00 per day. Crew managers are earning at the rate of \$10,000 annually by having a small crew working from house to house. If you have the ability and experience and are looking for something good, write for our Agents Proposition. It is a Big Money Maker. The Ernest Belch Company, 337 W. Madison St., Chicago, Illinois.

MONEY—Money—Money! Make it selling Handick, the new and unbeatable hand-cleanser—the original powdered hand soap! Removes grease, grime, ink, paint, etc., without injuring skin. Spreads like wildfire. Cheaper than all others. Sells in cans (or bulk with dispensers) to garages, autoists, auto supply companies, mechanics, factory and office folks, to housewives, hardware stores. Huge quantities used weekly by mercantile houses. Big repeat business assured. Exclusive agencies, crews working for you, fast sales, splendid profits, permanent business for hustlers. Live ones can clean up \$300 a month. Send 10c (coin or stamps) for liberal sample can. Complete sales plan goes with it. Write quick to Solar Products Co., 124 W. Lake St., Chicago, Ill.

MAKE \$75.00 per week and up selling our fine, made-to-measure, all-wool suits at \$29.50 retail, direct to wearer; biggest value ever offered; positively sell on sight; liberal profits paid in advance. We attend to delivery and collections. Write at once, giving full particulars as to your past experience. Full line of samples and everything to work with will be sent with the least possible delay. W. Z. Gibson, Inc., Dept. J-142, 161 W. Harrison St., Chicago, Ill.

90% PROFIT—Quick, easy seller, Kleen-Rite. New Clothes Washing Compound. No rubbing. Women simply amazed. Free premiums make sales easy. Fast repeater. Distributing samples free. Everybody grabbing for territory. Write quick, Bestever Products Co., 1941-K9, Irving Park, Chicago.

TAILORING Agents: You can make more money with a one-price line than with any other. Ours is a Better one-price line. It offers All-Wool Tailor-Made Suits, regular \$50.00 values, at only \$29.75, including a good profit for you. You get your profit in advance with every order. We supply everything. Can use a few more good men. Write at once. Address: Park Tailoring Company, Dept. 352, Chicago, Ill.

AGENTS—30,000 Miles without a puncture with Inside Tyres. Wonderful invention. Just slip inside casing before replacing tube. No tools needed. Will not heat or pinch. Positively prevent punctures and blowouts. Guaranteed double tire mileage. Old worn out Castings give 3 to 5 thousand miles more service. Biggest thing on the market. Low priced. \$8 to \$20 a day. Write for territory. American Accessories Co., B-978, Cincinnati, Ohio.

TAILORING Salesmen: Make \$75.00 a week selling our strictly All-Wool Made-to-Measure Suits at \$26.50. You collect profits in advance and keep them. We supply finest Selling Outfit in America. Many exclusive money-making features. Tailoring, raincoat and side-line men, part or full time, get in touch with us immediately. Goodwear Chicago, Inc., Dept. 131, 843 W. Adams St., Chicago, Ill.

AGENTS Wanted (in U. S. only). Make your Christmas Money. Sell our exclusive line of engraved Xmas Cards. The very best in design, quality and price. Big commission allowed. No money needed. Write for free samples and particulars at once, as no answers will be considered if received later than November 30th. Knight & Co., Box 276, Riverton, N. J.

\$10 To \$20 daily taking orders for new auto invention that removes carbon, stops oil pumping and saves 25% on gasoline. Sells on sight to every car owner on our money-back guarantee. Everybody can afford it at \$2.00. You make 100% profit. Write for free sample booklet. Address: Warren Mfg. Co., 653 Gray Bldg., Kansas City, Mo.

START in a permanent business of your own selling guaranteed Hosiery and Underwear direct from mills. No capital or experience is needed; many representatives make \$3,000 to \$5,000 per year. Become our district manager—get other working for you. Write for details to Malloch Knitting Mills, 529 Grant St., Grand Rapids, Mich.

WOULD you like to receive a beautiful 21-piece genuine French Ivory manicure set, 26-piece Rogers silverware set, or elegant 21-jewel gentlemen's or ladies' wrist watch? Any of the above given free for only an hour of your spare time; very easy and interesting. Write Weinman Bros., Memphis, Tenn.

HOSIERY Agents Wanted. House to house canvassers, selling Ladies', Men's and Children's Hosiery; capable of earning \$400.00 to \$800.00 monthly. District managers also can earn big money in their territories. Get your application on file now. Write today for particulars. Address, H. & S. Hosiery Mills, Reading, Pa.

AGENTS—\$15 a day—Easy, quick sales—Free Auto—Big weekly bonus—\$1.75 premium free to every customer. Simply show our beautiful, 7-piece, solid aluminum handle cutlery set. Appeals instantly. We deliver and collect. Pay daily. New Era Mfg. Co., 803 Madison St., Dept. 21-C, Chicago.

GREATEST Sensation! Eleven-piece soap and toilet set, selling like blazes for \$1.75 with \$1 dressmaker's shears free to each customer; other unique plans. E. M. Davis Company, Dept. 506, Chicago.

\$1,680 MADE by Wingo in six weeks selling Never Fail Razor Sharpener. Purdy made \$40.50 first day. Other inexperienced men cleaning up big money. Applewhite, La., six orders in thirty minutes. Hurry—investigate—exclusive territory. Write today. Never Fail Co., 126 Allen Bldg., Toledo, O.

AGENTS wanted by large raincoat manufacturer to take orders for our guaranteed made to measure Raincoats, Gabardines. \$75 to \$150 weekly easily earned; commission in advance. We deliver and collect. Write at once for further details and free outfit. Universal Raincoat Co., 607 Broadway, New York.

AGENTS—Quick sales, big profits. Outfit Free. Cash or Credit. Sales in every home for our high-class line of Pure Food Products, Soaps, Perfumes, Toilet Articles, etc. Write today for Money-Making Plan. American Products Co., 5889 American Bldg., Cincinnati, Ohio.

AGENTS For "Hudco-Ford"—new patented Transmission Cover for all Fords—change Bands 20 minutes—sells \$15 Eastern Zone, \$16 Western Zone—your profit \$5.00—easy seller—get circular, Hudco-Ford Co., 1 S. 21st St., Philadelphia.

AGENTS. \$6 a day taking orders for Blue Ribbon Cutlery Set. Stainless steel. Guaranteed. Aluminum handle. We deliver and collect. Pay you daily. Write quick for sample outfit. Parker Mfg. Co., 178 Aul St., Dayton, Ohio.

LIGHTNING—Wonderful new electrolyte charges discharged batteries instantly. Eliminates old Sulphuric Acid method entirely. World has waited half a century for this invention. One gallon, retails \$10.00, free to agents. Address Lightning Co., St. Paul, Minn.

AGENTS: New reversible raincoat. No sold in stores. One side dress coat, other side storm overcoat. Saves \$20. Guaranteed waterproof. Big commission. No capital required. Sample furnished. Parker Mfg. Co., 378 Roe St., Dayton, O.

GREAT Profits Assured capable men joining immediately national selling organization for Everflo Self-filling ink-pen-cil pen. Writes with ink instead of lead. Send for Profit Proposition, Everflo Pen Co., Dept. 58, Grand Rapids, Mich.

WILLIAMS' No Water Hand Soap, in tubes, has taken Auto owners by storm; washes dirtiest hands perfectly clean without water. Easy demonstration makes quick sale; 150% profit. Address W. B. P. Williams, Montclair, N. J.

AGENTS, enormous profits, permanent repeat business, exclusive territory, selling highest quality products at low prices. Coconut Oil Shampoo retails 50c bottles, costs \$1 dozen. Soaps, Perfumes, Extracts, etc. Verdina, A-16, East 13th, New York, N. Y.

GOLD Sign letters for stores and office windows. Photo pillow tops, portraits, frames, sheet pictures, medallions, waterproof aprons, novelties. Samples, catalogue free. Thirty days' credit. James C. Bailey Co., Desk J-B, Chicago, Ill.

AGENTS and Branch Managers—Most complete line wet and dust mops, dusters, polishers and swabs. Earn \$50.00 to \$250.00 weekly. Guaranteed sales. Factory Connection. Exclusive territory. Bartels Hamilton Co., Dept. 15, Toledo, Ohio.

YOU can make \$10 to \$20 daily selling Rex India Fibre Brooms. Outlast three ordinary brooms. 100% Profit. Write Rex Fibre Products Company, 145-C New Jersey Ave., Brooklyn, N. Y.

SELF-THREADING Needles; Needle Books; Needles of all kinds for Agents, Streetmen, etc. Lowest wholesale prices. Write for price list. Address Palmetto Needle Company, Box 312, Dept. A, Spartanburg, S. C.

AGENTS, \$25.00 a week for spare time. Suits \$13.45, pants \$3.45 up. Money-back guarantee. Guaranteed Quality. Line well known. Samples free. Write Chicago Tailors Association, Dept. 106, Chicago.

\$1,600 BEFORE Christmas—you can make it; no experience necessary. Rapid selling \$1.60 household necessity, wonderful gift. You sell, we deliver, pay daily. Address Eastern Kewware Co., Franklinville, N. Y.

REAP harvest selling Lightning Carbon Remover. Guaranteed solution to carbon troubles. Tremendous seller; large profits. Repeat orders build permanent business. Kosmos Chemical Company, 120 E. Sixth St., Cincinnati, O.

REGAL Keyless Spare Tire Lock—newest, greatest auto invention. Quick, easy seller. Tremendous money maker for agents. Baffles thieves. Cannot be picked—forced—sawed—filled or nipped. Opens only by secret combination. Simple for owner—he just moves combination till letters on discs spell secret word and presto! it opens. Safer than a safe. Every motorist buys. Low price. Unlimited guarantee. Nothing like it. Novel features and safety attract customers. Sell motorists and dealers—make \$2.66 per sale. Write quick. Regal Keyless Lock Co., 1308 N. Clark St., Dept. 10, Chicago.

MONEY-BACK guarantee makes Premier Sharpener fastest seller. Hundreds getting rich. You can. Write Premier Mfg. Co., 813 E. Grand Blvd., Detroit, Mich.

AGENTS—Crew men, novelty men, Gloo-Pen, a 50c mucilage fountain pen; everybody buys on demonstration. Write for big profit plan. Gloo-Pen Co., 56-PP Pine St., New York.

LADIES—Cash for spare time. New unique goods. No investment. Enormous Profits. Territory. Enclose Stamp. Experience Unnecessary. W. A. Colby Printing Co., 2447 Park Blvd., Detroit, Mich.

LATEST Invention—my Fuel Economizer saves one-third of your coal. Exclusive territory to live agents. Sample and outfit, 50c. Engineer, 2924 South 66th St., Philadelphia, Pa.

FREE — Custom-made, Year-guaranteed Shirt business. Shirt sells for \$2.95. Will send sample C. O. D., less salesman's commission. Territory assigned. World Merchandise Co., 526D Broadway, New York, N. Y.

SELLS Like Hot Cakes; big profits; new ironing wax pad and asbestos rest; clamps board; perfumes clothes; outfit 10c. Yankee Mfg. Co., 380 Atlantic Ave., Brooklyn, N. Y.

AGENTS wanted for Ford accessory with merit that retails for \$1.50. Saves 15% to 30% gasoline. Write Embler Carburetor Co., Inc., 303 Fifth Avenue, New York.

WE want 50 more representatives to sell our children's and ladies' gingham dresses direct. New, exclusive styles. Loretta Frock Co., Dept. 18, Dayton, Ohio.

TEN Dollars Daily. New toilet specialty. Never sold through agents. Stamp for special offer. Address Manager, Box 38, Newport News, Va.

AGENTS, dollar starts your own business. Full or spare time. Get particulars. Dept. P, Box 1472, Sta. C, Los Angeles, Calif.

AGENTS to sell Kerosene Burners for all purposes. Big Profits. Economy Mfg. Co., 616 W. Monroe St., Chicago.

"POLMET" Polishing Cloth cleans all metals. Retail 25c. Sample free. Gale & Co., Inc., 15 Edinboro St., Boston.

AGENTS wanted; big profits; territory free; sample \$1.10 postage paid. Wendell Washer Company, Galesburg, Ill.

AGENTS—\$5 to \$10 daily selling Snow Dust Washing Compound. Washes clothes without rubbing. Women wild about it. Big repeater. Free samples boost sales. Exclusive Territory. 300% Profit. Sample Free. Norman E. Conrad, Wabash, Ind.

STAINLESS Steel Cutlery; samples furnished; \$17 daily easy; pay advanced; display guaranteed rustless steel cutlery. Absolutely new; no scouring; always bright; no competition; full or spare time; free auto. Cameron Mfg. Co., 1465 Broadway, New York.

AGENTS and portrait men, Crew managers. We give you more for your money. Better and quicker service. Lowest prices on frames and glass. Rejects credited. Catalog free. The Pioneer Corporation, 6395 Yale Ave., Chicago.

CLARKE made \$18 an hour selling vest-pocket windshield cleaner needed by every autoist, motorman, engineer; one rub keeps glass clear 24 hours; 60,000 sold; amazing proposition free. Security Mfg. Co., Dept. 627, Toledo, Ohio.

GET this Brand New Winner. French and Italian Briar Smoking Pipes (patented). Prevents spouts; Tamps automatically; sells on sight to every Autoist. \$6.00 a day easy. Nospark Pipe & Mfg. Co., Montclair, N. J.

100% PROFIT selling our felt rugs to homes, hotels, offices, etc. Everybody buys. We are manufacturers, not jobbers. Prices defy competition. \$75 week easy. Newark Felt Rug Company, 58-C Bergen Street, Newark, N. J.

AGENTS make 100% profit selling Fibre Brooms. Free Sample. National Fibre Broom Co., St. Louis, Mo.

27,000 RECORDS guaranteed with one Everday Phonograph Needle. New; different; no competition, cannot injure records; retails \$1.60; agent's profit 100%. Free sample to workers. Everday (A), McClurg Bldg., Chicago, Ill.

\$15.00 DAILY Easy selling Unbreakable "Golden Beauty" Combs, kind you can hit with a hammer, saw wood with the teeth. Easily demonstrated—quickly sold. 100 per cent profit. Day's supply carried in pockets. Top-notch sellers at fairs, with agents, streetmen, etc. Many street workers selling over \$100.00 worth on Saturday afternoon and evening. You can do as well. 25c Comb and terms, 10c postage. Terms and convincing proof free. Oliver Gandy, Crisfield, Md.

AGENTS—Demonstrators, salesmen, season now on; Owens and Mordant made as high as \$68 in one day selling to auto owners, dealers, garages and housewives; our No-Cement, self-vulcanizing patch repairs everything from a pinhole puncture to a 46-inch blowout; also anything around the home, like hot-water bottles, rubber boots; in fact, all rubber goods; big profits; send for free particulars today. Time-saver Patch Co., 1312 Ontario St., Cleveland, Ohio.

AGENTS: \$60 a week selling guaranteed hosiery for men, women and children. Must wear 12 months or replaced free. All styles and colors, including finest line of silk hose. Mrs. McClure makes over \$2000 a year. Mrs. Schurman averages \$60 a month working spare time. Geo. Noble made \$35 in one day. Write for sample outfit. Thomas Mfg. Co., Class 562, Dayton, O.

ACTIVE Men wanted as general distributors for a Ford accessory that sells at sight; you can clean up \$10 to \$15 daily; one man made \$200.00 in one day. Send for free folder and qualification blank; tells how to build independent, incoming cash business of your own. Hy. J. Otto Mfg. Co., 418 Sycamore St., Evansville, Ind.

AGENTS, Something new. First popular-priced Fire Extinguisher ever made. Every home, garage or car owner needs one. Demand enormous. Over 10,000 ordered by our Territory Salesmen. No experience or capital needed. All you do is take orders. We deliver and collect. Pay you daily. Write for territory. Thurston Mfg. Co., 473 Foe St., Dayton, Ohio.

AGENTS \$3.00 to \$5.00 an hour. Full or spare time. Commissions in advance, no delivering or collecting. Turner \$72 first week. Mrs. Thomas averages \$35 week spare time. New line combination coats going great. Every man, woman and child prospect. Outfit and sample coat free. Write now. Liberty Mfg. Co., 180 Liberty Bldg., Dayton, Ohio.

AGENTS, Good salary and commission for selling "Ratskyl," our new Rat and Mouse Exterminator. Ready for use, no bait required, non-poisonous. Harmless to man, poultry, cat, dog and other animals. Rodents die outside premises. No odor. Exclusive territory, no competition. Empire Specialties Co., 1549 N. Wells, Dept. 301, Chicago, Ill.

HOW to make, bottle and sell all kinds of Food Flavors, both liquid and tubes. Crystallized, greatest washing compound known to science. Maple Syrup at 50 cents per gallon. Our book "How" tells all, 50 cents. Coupon good for this amount on first order. Order today! Mystol Co., Glens Falls, N. Y.

AGENTS make 140% profit. Iridium (luminous) crucifix shines in the dark. Sells for \$2.00. Costs 84c. Complete line religious articles, crucifixes, bulbs, switch plates, house numbers and match boxes. Novel! Ornamental! Useful! Every home a prospect. Big sales. Get free demonstrating outfit. The Pioneer Corporation, 6391 Yale Ave., Chicago, Ill.

IF they wear socks, they need garters. Sell them a pair of our New Serpentine Garters. A real article for a real salesman. Price \$8.50 per gross, \$4.50 1/2 gross, \$1.00 doz. Sample free. Made by The E. Z. Art Needle Co., 513 N. Dearborn St., Chicago, Ill.

MAKE \$50 Daily, Something New! 400% Profit. All Business, Professional Men Need It. Sells \$5. Costs \$1. Brooks, Texas, sold 20 first day, profit \$80. Big weekly repeater. Sells quickly. Experience unnecessary. Write today for territory wanted. Sample outfit free. Federal Association, 71-K Asylum St., Hartford, Conn.

SELL Tire Armor, an inside casing for all auto tires; prevents punctures and blow-outs, saves tire repair expenses and doubles mileage. Costs less than tubes and outlasts several tires. Liberal discounts. Big opportunity in every locality. Write for exclusive agency. Motor Products Co., Lunt Avenue, Chicago.

TAILORING Agents Make \$100.00 a week sure, selling our wonderful all wool tailored to order suits—overcoats. All one price, \$20.00 cheaper than store prices. Collect your own profits. Protected territory. Swatch outfit free. Write J. B. Simpson, Dept. 189, 831 W. Adams St., Chicago.

AGENTS—Steady Income. Large manufacturer of Handkerchiefs and Dress Goods, etc., wishes representative in each locality. Factory to consumer. Big profits, honest goods. Whole or spare time. Credit given. Send for particulars. Address Freeport Mfg. Co., 59 Main St., Brooklyn, N. Y.

AGENTS: Big profits, no competition. Make \$5 to \$15 daily selling our beautiful Scripture Text Calendars. Agents now selling from 10,000 to 50,000 yearly. Write now. Address Messenger Publ. Co., Dept. 116, 314 W. Superior St., Chicago, Ill.

ALADDIN'S Magical Polishing Cloth. New. Every Home Buys. Sales Guaranteed. You cannot lose. Repeats. Big Profits. Make \$60.00 weekly. Free sample. Aladdin Mfg. Co., 9 S. Clinton, Dept. 53, Chicago.

SALESMEN—Agents, sell 15c article, cost 2c; new selling plan; no canvassing or talking required. Plans Free. Sample 15c. H. & E. System, Dept. P2, Lock Box 477, Chicago.

100% PROFIT each 50c sale. Why not make this for yourself? Snap for hustlers. Sell to Auto Owners and Chauffeurs. Territory valuable. Quick action. Perkins, 350 Broadway, New York.

SELL Wilson hats from factory to wearer. Extraordinary commission. We deliver and collect. Every man a customer. Wilson Hat Works, Dept. P, Montclair, N. J.

COMBINATION floor and wall broom going like wildfire. Commission over 50%. Outwears four corn brooms. Convenient shipping points. Address Harnack Co., Keene Building, Fort Worth, Tex.

AGENTS—Six new fast-selling necessities; big demand; unique selling plan; makes dollar an hour; credit given; samples free. Consolidated Portrait Co., Desk E, Chicago.

"SHAKELESS" Salt and Pepper cellars. Everybody buys. Over 100% profit. Easy seller. No competition. Territory offered. Suren Churchill Company, 25 N. Dearborn, Chicago, Dept. 129.

AGENTS—Sell Cresco Raincoats. Best line. Lowest prices. Profits in advance. Outfit free. Big fall season coming. Improved Mfg. Co., Dept. 280, Ashland, Ohio.

AGENTS: Get in—sell Sectional Retreads. Every car owner buys. Guaranteed. Thousands in use. Big profits, \$50 daily. Write Sectional Retread Co., Cherrylee, Kan.

WANTED—District Purchasing Agents, \$250 per month. Steady employment and exclusive territory. Write now. Experience unnecessary. National Instrument Company, 4703 North Hamilton, Chicago, Ill.

AGENTS—Cresco Shopping Bags and Waterproof Aprons sell rapidly. Big profits. Outfit free. Selling experience not necessary. Improved Mfg. Co., Dept. 281, Ashland, Ohio.

MEN—Women—Sell Shopping Bags, Ironing Board Covers, Water-Proof Aprons, during spare time; \$10 day easily made. Write today. Flomar, 2539 Drake, Chicago.

AGENTS—Biggest money-making agencies in America (2 propositions). Exclusive territory. Sample, particulars free. Thayer Consolidated Factories, Armitage and Mangrove, Chicago, Ill.

AGENTS, Either Sex, Sell our Dish Cloths at every house. Sells on sight. Write quick for particulars. Address W. H. Stebbins, Norwich, Conn.

EARN \$10.00 daily silvering mirrors, plating and refinishing metalware, autos, chandeliers, bedsteads, headlights. Outfits furnished. E. Deede Laboratories, 1183 Broadway, New York.

SPIRAL Curtain Rods, broom protectors, Ironing Sheet Clips, factory prices. Other fast sellers. Address Hunt Mfg. Co., Box 1652P, Paterson, N. J.

SIGN Specialties that sell good. Leaf-gold Letter Co., 561 1st Ave., New York.

HANDKERCHIEFS. Bedrock factory prices to agent. Get into this staple, permanent, profitable business. Address Turnover Company, 18A East Seventeenth, New York.

800 PERCENT profit. Agents applying Goldfoil Window Letters. Samples Free. Lowest Prices. Luckysign Letter Co., 515 Evergreen Ave., Brooklyn, N. Y.

RUMMAGE sales make \$50.00 daily. We start you. Representatives wanted everywhere. Permanent business. "Crosby Co.," 609 Division St., Chicago.

BIG Proposition to Agents—Penkala Automatic Fountain Pen—awarded Gold Medal 1915. Sample 50c. William Muller, 419 Pine, San Francisco.

HOME employment evenings. Start little Mail Order business anywhere. Stamp brings Instructive Booklet. Alfred Pier, 72 Cortlandt Street, New York.

NOVELTY from Alaska. Over 300% profit. 10c package free postpaid. Voltine Company, 1258 East 61st Street, Cleveland, Ohio.

THE Agent's Guide—Tells where to buy almost everything. Copy 10c. Wilson Publishing Co., 1406 Broadway, New York.

AGENTS: \$5 Hourly. Wonderful \$1 Auto Specialty. Costs 40c. Repeater. Address, Maher Mfg. Co., Dover, N. J.

AGENTS: \$15 Daily. Brand new \$3 Adding Machine. 100% Profit. Address A. Maher Co., Dover, N. J.

I'VE best proposition for making Big Easy Money without Capital. Address Stokes, Box 798, Dallas, Texas.

SUCCESSFUL plan appeals to theatres; nets you \$50 weekly. Theatre Bulletin Company, Washington Building, Los Angeles.

FREE—Twenty big money-making opportunities—Free. Lawrence Products Company, Dept. M, Beaver Dam, Wis.

AGENTS: Wonderful opportunity in Japanese Novelty. Write P. Fencos, U. S. Wholesaler, New Richmond, Wis.

BIG Mail Order Magazine 10c. Thompson Publishing Co., Box 848, Cincinnati.

500 TWO-COLOR Letterheads \$2.65. Samples free. "Adverpress," Station C-3, Milwaukee.

PATENTS. Protect your rights. Before disclosing invention write for booklet and blank form Evidence of Conception, to be signed, witnessed and returned with rough sketch or model of your idea, upon receipt of which I will promptly give opinion of patentable nature and instructions. No charge for preliminary advice. High references. Prompt personal attention. Clarence B. O'Brien, Registered Patent Lawyer, Southern Bldg., Washington, D. C.

AGENTS Wanted—Something New—Fire Fighter sells easily. Makes a spectacular demonstration; car owners, homes, factories, stores, practically buy on sight. Our men make \$10.00 to \$50.00 a day; exclusive territory. If you wish to establish a business of your own with unlimited possibilities for making big money, write us today. Fry-Fyter Co., 93 Fry-Fyter Bldg., Dayton, Ohio.

\$5 TO \$15 Daily Easy—Your pay in advance introducing new style guaranteed hosiery. Must wear or replaced free. No capital or experience required. Just show samples, write orders. We deliver and collect. Elegant outfit furnished. All colors and grades, including silks and heathers. Mac-O-Chee Mills Company, Desk 109, Cincinnati, Ohio.

EVERY Raincoat Agent should get our proposition at once. If you have never sold raincoats and waterproofed overcoats now is the time to start. Any man able to talk is able to sell raincoats. Write for our "profit sharing, collective buying, superior quality" offer. Associated Raincoat Agents, Inc., 448-A North Wells, Chicago.

MAKE \$5,000 every year—\$2,000 in spare time. You share profits besides. Show "Weather Monarch" Raincoats and Waterproofed Overcoats. Ask about "Duel Cost" (No. 999). Get sample raincoat free. Associated Raincoat Agents, Inc., 448-A North Wells, Chicago.

"HOW to Sell Patents" free. Patent News-O, Washington, D. C.

SELL Fraternal Wall Emblems and other money-making novelties. All the rage. Big variety. Write for free sample plan. Kier Fraternal Emblem Co., Dept. C-107, 538 S. Clark St., Chicago, Ill.

BECOME our local salesman selling high grade shoes direct to consumer. Liberal commission. Capital or experience not necessary. For particulars address Tanners Shoe Manufacturing Co., 493 C Street, Boston, Mass.

AGENTS and distributors wanted to sell our Radio-Gaslighters. 25 cent sellers. 300% clear profit. Universal demand. Write for proof. Ignition Products Company, Inc., 122 Union Square, New York.

PROTECT your rights. Write for "Record of Invention" and booklet about Patents. Prompt personal service. Advice without charge. J. Beane Kelly, 612-G Columbian Bldg., Washington, D. C.

MONEY for the Holidays. Plenty of it. Just show and take orders for our line of household and office necessities. Rockford Sales Co., Rockford, Ill.

AGENTS—Signs of all kinds. Big money-making line. Prices right. Address Atracto Sign Works, P. O. Box 100, Chicago.

AUTOMOBILE Specialties Formulas—best, different, dependable. Circular Free. Address V. Thawley Co., Washington, D. C.

\$5 TO \$15 Daily Easy—Your pay in advance, introducing New Style Guaranteed Hosiery. Must wear or replaced free. No capital or experience required. Just show samples, write orders. We deliver and collect. Elegant outfit furnished. All colors and grades, including silks and heathers. Mac-O-Chee Mills Company, Desk 109, Cincinnati, Ohio.

WHY work for others? Make and sell your own goods. We show you how. Enormous profits. Write quick for free book explaining everything. Thos. Steel, President, 624 Main, Richmond, Va.

"\$10 A DAY and More" our new book, shows clearly how you may gain sure success and large profits selling Guaranteed Hosiery and Underwear, factory to family. It is Free. Write today, C. & D. Company, 41-E Grand Rapids, Mich.

EASY, pleasant work for Mechanics. Shop Men, Clerks, during spare hours; will add many dollars to their salaries. Also want persons who can give full time. Big wages assured. Novelty Cutlery Co., 67 Bar St., Canton, O.

AMBITIOUS Men, write today for attractive proposition, selling subscriptions to America's most popular automobile and sportsman's magazine. Quick sales. Big profits. Pleasant work. Digest Pub. Co., 9505 Butler Bldg., Cincinnati, O.

EARN big money fast applying gold initials to autos. Every owner buys—\$1.35 profit on \$1.50 sale—particulars and samples free. Write quick. Lithogram Co., Dept. 17, East Orange, N. J.

YOUR chance to make big money re-silvering mirrors, auto reflectors, metal-plating. Outfit furnished. Write for particulars. International Laboratories, Dept. 26, 309-311 Fifth Ave., New York.

LARGE Shirt Manufacturer wants Agents to sell complete line of shirts direct to wearer. Exclusive patterns. Big values. Free samples. Madison Mills, 503 Broadway, New York, N. Y.

WHY work for others? Make and sell your own goods. We show you how. Enormous profits. Write quick for free book explaining everything. Thos. Steel, President, 624 Main, Richmond, Va.

WANTED—Agents and Salesmen to handle Europe's Famous Wunder Glass, the newly imported Prism "Binoclette." For theatre, hunting, yachting, races, touring, aviation, etc. This is the smallest and of its size the most powerful Glass in the world. Can be carried in vest pocket or ladies' bag. Retail at \$25.00. Confidential wholesale price to agents \$12.50. Sent with privilege of examination, if satisfied pay expressman, otherwise return at our expense. George Mayerle Optical Co., General Importers, established 1894, 900 Market St., San Francisco, Calif. (Order before the new tariff doubles prices.)

A BIG Money Maker and a Pleasure for Men, Women and Children. You can make the most beautiful Marble, Turquoise, Agate, Tile and art work from common Portland Cement, also beautiful pictures, picture frames and scenery. I will also tell you how you can make from twenty-five to one hundred dollars in an hour's time after learning how to do the work. Will pay five dollars if you cannot do the work by following instructions. My twenty-five-dollar course of instructions for twenty-five cents silver. Based on 40 years' experience. B. F. Spencer, Instruction Dept., Elsinore, Calif.

GET our Big Money proposition and Free Samples on Easy Applied Transfer Letters and be convinced. Auto Monogram Supply, 16 Green St., Newark, N. J.

WHY Buy Your Goods. Use Miller's Guaranteed Manufacturer's Reliable Formulas for Manufacturing Agent-Specialty Salesman's Big Selling Specialties—all lines. Free Descriptive Literature Concerning Non-Thermal Ice Cloths, Grape-Oils, and Flavors for all beverages, New Food Specialties. Launderite and New Laundry products. All latest Automobile Specialties including 666 Polish and Amazon Rubber Repair and many other meritorious sellers which can be manufactured in your home, store or office without machinery. Make your start now. Stamp brings Valuable Information. Miller, Chemist, Tampa, Fla.

A WONDERFUL Seller! Any man, woman, boy or girl can make big wages. Some agents make from \$8.00 to \$20.00 per day. Crimp Grip Clothes Line fasteners are a simple, time-saving device for holding a rope—also used for many other purposes. It pays for itself quickly in time saved on wash days. No knots—it fastens and releases quickly. Every home a prospect. Every housewife who uses Crimp Grips—and there are thousands of them—is a booster. There is but one Crimp Grip. Write for particulars, or send 50c for one pair and a mounted sample, with full particulars to agents. Crimp Grip Company, Belvidere, Illinois.

PHENOMENAL Sales! Record breaker! Send postal. Warren & Howell, 441 Eighth Ave., New York, N. Y.

"IDEAL" Sideline. "Sureshot" Selling Method Free. K. Home, 1937 Warren, Chicago.

AGENTS. \$60 to \$200 a week. Free samples gold and silver sign letters for office windows, store fronts and glass signs of all kinds. Anyone can put them on. No experience necessary. Big demand everywhere. Over 500% profit. Fred Foley, Binghamton, N. Y., made \$485.00 first month. Albert Gibbons, Kansas City, made \$212.00 in ten days. Liberal offer to general agents. Write today for sample of our high-grade window letters. Address, Metallic Letter Co., 431-C North Clark St., Chicago, Ill.

WHY work for others? Make and sell your own goods. We show you how. Enormous profits. Write quick for free book explaining everything. Thos. Steel, President, 624 Main, Richmond, Va.

\$8.00 TO \$20.00 per day. A wonderful seller. Any man, woman, boy or girl can make big wages selling Crimp Grip Clothes Line Fasteners. It is a perfect rope holder and can be used for many purposes. Crimp Grips are a simple, time-saving device. They last a life time and will not rust; it holds the line tight, and saves time on wash days. Every buyer is a booster. Send 50c for Mounted Sample and one pair of Crimp Grip Clothes Line Fasteners. Write for particulars. Crimp Grip Company, Belvidere, Illinois.

GERMAN razors for barbers. Hand-made. Manganese steel. Highest quality. Guaranteed. Sell for \$2.25. Cost you \$1.50 doz. Sample, \$1.45. Money Order. Schwartz, Importer, 880 East 141st Street, Cleveland, O.

ASKO—Agents to sell auto accessory. Can carry sample in vest pocket. Exclusive county rights open. Big commission. Send for sample. Allen Spec. Co., 2751 W. Lake St., Chicago.

A BUSINESS of Your Own—Make sparkling glass name plates, numbers, checkerboards, medallions, signs; big illustrated book free. E. Palmer, 511, Wooster, O.

AGENTS—Make 100%. Toilet articles, Perfumes, Extracts, Household necessities. Sample Case Free. LaDerna Co., Dept. A, Main and Walnut, St. Louis, Mo.

ONE Student sells \$24.50 worth of "Success" Products in two hours. Write for information. Sales Department Elms Commercial College, Newark, N. Y.

FORTUNE Maker—The only Thread-Cutting Thimble. Live wires only. Sample 15c. Automote Mfg. Co., 3753 Monticello, Chicago.

AGENTS! A sale in every home for our beautiful dress goods, silks and general yard goods. Quick sales! Big profits! Large book of 1000 handsome fabric samples. Write today. National Importing & Mfg. Co., Dept. 6X, 573 Broadway, New York, N. Y.

AGENTS. Sell lightning needle threaders. \$10 daily. Costs 5c, sells 25c. Address Maher Co., Dover, N. J.

BIG earnings and steady repeat business assured agents selling to women and homes, finest, most complete line toilet preparations and specialties. Sure Success Plan. Get details today. Colonial Chemical Company, 631-N, Penn Avenue, Pittsburgh, Pa.

SELL "Amenz" Shirts: best-looking, biggest value. Manufacturer to wearer. Every order nets profit \$1.50-\$2.25. Write for winning sales plan. Menzin Shirt Co., 3883-A, Third Ave., New York.

AGENTS: Get into a good repeat proposition. Sell our high-grade flavoring extracts. Build up steady income. Liberal terms. Acme Extract Co., 520 West Broadway, New York.

MEN-Women. Sell Yarborough hair products. Quick sales, large profits. Write today. Colored agents preferred. Territory going fast. Address, Yarborough Mfg. Co., Winston-Salem, N. C.

FREE Samples Rolly's Washday Wonder—new chemical dirt solvent—harmless—no rubbing, \$1.00 weekly. Enormous profits, repeat orders. Rolly Chemical Co., Al, Hastings, Nebr.

AGENTS—A demonstration sells our Marvel Can Opener, and doubles your money. Clinch your success with our proposition. Staples Mfg. Co., Mt. Vernon, Ind.

AT Last—World's Greatest Adding Machine. Almost human. Retails \$15; work equals \$300 machine. \$500 monthly easily made, demonstrating to stores, offices, garages, factories. Simple, easy; adds, subtracts, multiplies, divides, automatically. Speedy, accurate, durable handsome. Five year guarantee. Tremendous demand; amazing profits. Liberal trial offer. Protected territory. Write quick, Lightning Calculator Corp., Dept. F, Grand Rapids, Mich.

SOMETHING new! Sixnone. 200% profit. Retails 25c to houses and offices. Gale & Co., Inc., 15 Edinboro St., Boston.

WE Start You Without a Dollar. Soaps, Extracts, Perfumes, Toilet Goods. Experience unnecessary. Carnation Co., Dept. 201, St. Louis.

\$30.75 PROFIT on \$2.50 outfit: gold initials for automobiles, etc. Write National, Station D, Brooklyn, N. Y.

FREE—Formula Catalog. S. & H. Laboratories, Boylston Building, Chicago.

ANY man handy with paint brush or light tools can start new mechanical business on nearly nothing; needed everywhere; nearly all profit; experience not required. John Braceland, 1457 So. Ninth, Philadelphia, Pa.

PORTRAIT Agents—Earn big money selling our Photo Medallions. Everybody buys. You charge \$3.00; make \$2.40 each sale. \$10 daily easy. Big variety designs. 4-day service. Perry Photo Novelty Corporation, Section 16, 360 Bowery, New York.

EVERYBODY uses extracts. Sell Duo Double Strength Extracts. Complete line household necessities. Big repeaters. Write today. Duo Co., Dept. E1, Attica, N. Y.

LARGE manufacturer wants agents to sell guaranteed made to measure raincoats, Gaberdines and Reversible top and raincoat combined. Make \$75 to \$100 weekly. Profit in advance. We deliver and collect. Outfit free. Standard Raincoat Co., 163 West 21st Street, New York, N. Y.

IMMEDIATE Commissions—no investment—no delivering—no collecting. Pay-day every day. Profits larger than usual. That's our proposition No. 1. For the agent that buys to resell—our proposition No. 2 would instantly appeal. 100% profit and Free Goods. High grade guaranteed aluminum cooking utensil specialties and staples. Our Free Goods Offer is unusually interesting. We maintain a 24-hour shipping schedule. Exclusive territories granted and protected. Get yours before it's too late. Perfection Aluminum Mfg. Co., Desk A, Lemont, Ill.

AGENTS—Sell Skimit Kitchen Cream Separator; nationally advertised; sells on sight; attractive terms; big profits; retails \$1. Skimit Mfg. Co., Oskaloosa, Ia.

AGENTS—Send for sample "Fretnot"—the washday wonder. Be convinced you can do a whirlwind business. You can clear at least \$20 to \$100 weekly, according to spare or whole time. You don't have to talk; if she doesn't buy at sight, leave sample; she will be looking for you long before you are able to make the rounds again. Samples furnished free. Premiums for your customers. Exclusive territory guaranteed to agents who can produce. Credits given. Don't call. P. M. Motter & Sons, 20 E. Jackson Blvd., Chicago.

CENTRAL Indiana Manufacturers now marketing an entirely new auto accessory that makes night driving safe, eliminating glare from approaching headlights. Want general sales managers to open branch office, handle exclusive territory and manage salesmen. Some investment necessary. Profit possibilities practically unlimited. Ray Auto Filter Co., Marion, Ind.

\$195 EARNED by Schleicher in first twelve hours. Self-selling proposition establishes new money-making records. Automatic hot or cold running water bath equipment, without plumbing or waterworks, only \$7.50. Exclusive territory. Investigate. Send no money. Terms. Write today. Allen Mfg. Co., 678 Allen Bldg., Toledo, O.

MOST Wonderful Seller. 96c profit every dollar. No stock to carry. License unnecessary. Sample free. Mission, 2421-MP, Smith, Detroit.

BIG Money Makers. Large factory offers you big profits on 150 fast sellers. Toilet gift sets, flavoring extracts, remedies, soaps bring you \$8.00 to \$25.00 daily. Howe of Illinois makes \$4.00 an hour. Sample outfit free to workers. Lincoln Chemical Works, Dept. 155, 2954 No. Leavitt, Chicago.

PORTRAIT Agents—\$50,000 is what "Picture Man Friedman" made canvassing. Free circular "Profits in Portraits" tell how. 24-hour service prints, finished portraits, frames. Samples free. "Picture Man Friedman," Dept. 8, 127 N. Dearborn St., Chicago.

AGENTS—Earn \$50 to \$100 a week selling Marquette Tire Tool. Simple demonstration sells it. Removes tires in a jiffy. Every owner wants it. Thousands in use. Exclusive territory going fast. Agent's sample \$1.25, retails at \$2.50. Write for full particulars or send \$1.25 for sample and particulars. Marquette Mfg. Co., Dept. A, 218 S. Wabasha Ave., St. Paul, Minn.

CALIFORNIA Rosebuds selling like hot cakes. Agents earning money; new stuff. Big profits. Catalog free. Mission, 2421-PM, Smith, Detroit.

AGENTS—Enormous profits selling Genuine Gold Leaf sign letters. Guaranteed not to fade. Establish a permanent business or travel. Anybody can do it. Free samples. Guarantee Sign Service, A 430 South California Ave., Chicago.

MOTOR Ignition Amplifier—A Wonder Invention! Gives new power to an old motor and more power to the new. Sell to garages, accessory dealers and users. Quick action, big money and satisfaction. Write for prices and literature. Motor Ignition Corporation, Mfgs., Albany, N. Y.

SALES Representative wanted every county to give all or spare time. Position worth \$1,200 to \$3,000 yearly. No previous experience or capital necessary. Write for full particulars. A. A. Silver-Chamberlin Co., Clayton, N. J.

GALLAGHER made \$336.00 in one week selling guaranteed Collection Systems, used by all business men. Sayers Mfg., 2815 Sheffield Ave., Chicago, Ill.

AGENTS: Men and women, in spare or full time, make big money selling household necessity. Every home a prospect. Quick sales, big profit. Territory open. Write for particulars. Judd & Leland Manufacturing Company, Box 21, Clifton Springs, N. Y.

AGENTS—Sell Patented Cigar Lighters and Cigar-Case Moisteners. Big Profits. Start making money at once. Write for circulars, cuts and sales plan. Drake Mfg. Co., Dept. M., Milwaukee, Wis.

LIVE Agents make \$10 Day selling Eureka Strainer and Splash Preventor for every water faucet. Takes on sight. Widely advertised and known. Get details today. A. B. Seed Filter Company, 73 Franklin, New York.

MAKE 600% Profit. Free Samples. Lowest priced Gold window letters for stores, offices. Anybody can do it. Large demand. Exclusive territory. Big future. Sideline. Acme Letter Co., 2500-D, Congress, Chicago.

SELFOLITE—Agents, Streetmen—Selfolite lights any fire while user sleeps, or any time. Performs surprising stunts. Newly patented. Sample 25c, postpaid; money back. Particulars. Kaytwo Mfg. Co., C195 Station A, Boston, Mass.

AGENTS: Big Profits. Genuine Gold Leaf Window Letters anyone can put up. Scripts and 57 varieties. Chicago Agency Co., 842 Algeid St., Chicago.

AGENTS—Big Profits. Gold Sign Letters easily applied, samples free. Liberal offer to General Agents. Dept. C Interstate Sign, 2620 No. Halsted St., Chicago.

GOOD income, spare time, refinishing chandeliers, brass beds, automobiles, etc., by new method; producing amazing results; every household possible customer; experience unnecessary; simple plan of manufacturing at home starts you in big money-making business. Write for free samples, showing finishes, etc. Gunmetal Finish Co., Ave. H, Decatur, Ill.

GOLD Leaf Sign Letters; make and sell; profits exceed 1,000%; immense demand; particulars free. Johnston Co., Quincy, Ill.

AGENTS make 500% profit handling Auto Monograms, New Pictures, Window Letters, Transfer Flags, Novelty Signs. Catalog Free. Write Hinton Co., Star City, Ind.

PORTRAIT Agents, who want good work and prompt service and who desire to purchase their frames at factory prices, should write us at once for catalog and price list. W. G. Hannan Co., Dept. A-5, 57 E. 18th St., Chicago, Ill.

AGENTS—New patented curtain rod, necessity in every home; big profit; 4 to 10 sales at every house. Write for free sample. Home Curtain Rod Co., Providence, R. I.

AGENTS—Clever Invention! Inkspoon makes every pen a fountain pen. Fast office seller; big profit, demand increasing everywhere. Exclusive territory offered. Sample free. H. Marul Company, Tribune Bldg., New York, N. Y.

AGENTS: Big Money Monogramming By Transfer Method. Catalogue Showing Over 50 Styles and Particulars Free. Motorists' Accessories Co., Mansfield, Ohio.

\$200 WEEKLY. Free samples. Sell gold sign letters to stores, offices. No experience. Big future guaranteed. Can travel. Exclusive territory. Become our general agent. Acme Letter Co., 2800-D Congress, Chicago.

MAKE \$25 to \$50 week representing Crows' Famous Philadelphia Hosiery, direct from mill—for men, women, children. Every pair guaranteed. Prices that win. Free book "How to Start" tells the story. George Crows Company, Desk 31, Philadelphia, Pa.

MAKE \$31.00 Profit With Only \$1.50 Selling Pure Gold Leaf Monograms for Automobiles, Trunks, Bags—Window and Wagon Letters. Applied instantly. No experience necessary. No. 1 Outfit brings you \$32.50—cost only \$1.50—you make \$31.00 profit. Get colored catalog. Full particulars—free samples (36 designs). "Hurry." Nullife Auto Aid, Hartford, Conn.

TAILORING Agents Wanted—Must be big producers—We have snappy Fall and Winter Swatch line at prices you can't help but sell (Union Made). Write for samples. Leeds Woolen Mills, Chicago.

WANTED—Tailoring Sales Agent—Make big money from very start—\$60.00 to \$75.00 weekly. Largest made-to-measure tailoring house, furnishing an equipment of five hundred wools, wants you to take orders. Satisfaction guaranteed. Biggest merchants in many towns have started with our line. If you want to establish yourself permanently in business and make big money write for full particulars, giving your experience as salesman or tailor's sales agent. H. F. Foster, Sales Manager, Lock Box 482, Chicago.

BIG Profits Selling New \$3.50 Automatic Adding Machine. Absolutely accurate. Fully guaranteed. Quick sales. Ten daily easy. No competition. Pocket size. Business people everywhere positive customers. Thousands being sold. Tremendous demand. Here's high-grade money-maker. Bassett Co., 1458-J, Hollywood Ave., Chicago.

AMERICO booster auxiliary water carburetor makes autos burn water, eliminates carbon. Low cost; liberal profits; details free. Americo Co., Dept. 178, Cincinnati, Ohio.

SELL Necessities. Everybody needs and buys the "Business Guide." Bryant cleared \$80.00 in July. Send for sample. It's free. Nichols Co., Box 4-B, Nagerville, Ill.

WHY work for others? Make and sell your own goods. We show you how. Enormous profits. Write quick for free book explaining everything. Thos. Steel President, 624 Main, Richmond, Va.

AGENTS: Big Returns. fast office sellers; particulars and samples free. One Dip Pen Co., 2 Daily Record, Baltimore, Md.

AGENTS—If you are making less than \$300 a month our proposition on Sentinel Burglar Alarms for windows and doors will interest you. Many agents earn \$20 daily. Brand new inventions. No wires, batteries or nails. Instantly attached to any door or window. Handsomely nickel plated. Sell on sight. No competition. Provides cheap burglar insurance. Big money makers. Write today for extremely liberal terms to agents. Sentinel Alarm Co., 140 S. Dearborn St., Chicago, Ill.

BEST Proposition on Earth. Kitchen Specialty Every Woman Wants. Nothing like it in existence. 200% profit. Best Novelty Mfg. Co., Dept. C, 160 N. Wells, Chicago.

MAKE \$2 an Hour. Article that removes iron rust, grass, medicine, fruit, mildew stains. Cleans Panama and Straw Hats. Bleaches clothes. Sells Every home. Write for free demonstrating outfit and start taking orders at once. Christy, 81A Union, Newark, N. Y.

AGENTS make a dollar an hour. Sell Mendets, a patent patch for instantly mending leaks in all utensils. Sample package free. Collette Mfg. Co., Dept. 404-B, Amsterdam, N. Y.

BIG money and Fast Sales. Every owner buys Gold Initials for his auto. You charge \$1.50; make \$1.35. Ten orders a day easy. Write for particulars and free samples. American Monogram Co., Dept. 40, East Orange, N. J.

OUR Ex-Cel Luminous Crucifix shines brilliantly in the dark. Churches, hospitals and individuals are only waiting for a demonstration before buying. Agents make handsome profits. W. G. Hannan Co., Dept. B, 57 E. 18th St., Chicago.

AGENTS—Stamping names on Pocket Key Protectors; sample check with your name and address. 25c. Stamping Outfits, Emblem Checks, Check Fobs, Name Plates. Hart Mfg. Co., Desk 2, 303 Degraw St., Brooklyn, N. Y.

YOU can be your own boss with our Key Check outfit. Good for \$5 a day stamping names on pocket key checks, fobs, etc. Sample check with your name and address, 20 cents. Pease Die Works, Dept. M, Winchester, N. H.

AGENTS: Big profits. Best and cheapest window letters made. Easily applied. Dime brings five samples. Particulars free. Stalbritte Co., 1115 Second Ave., New York.

PATENTS—Write for our free illustrated guide book and Evidence of Conception Blank. Send sketch or model for our opinion of its patentable nature free. Highest references. Prompt attention. Reasonable terms. Victor J. Evans & Co., 143 Ninth, Washington, D. C.

PORTRAIT Agents: Our goods will make you big profits. Delivery guaranteed. Subjects credited. Prompt shipments. Send for latest catalog and prices. Adam J. Kroll & Co., 605 Blue Island Ave., Chicago, Ill.

AGENTS—Best seller; Jem Rubber Repair for tires and tubes; supersedes vulcanization at saving of over 80%; put it on cold, vulcanizes itself in two minutes, and is guaranteed to last the life of the tire or tube. Sells to every auto owner and accessory dealer. For particulars how to make big money and free sample, address Amazon Rubber Co., Amazon Bldg., Philadelphia, Pa., Dept. 545.

HIGH-GRADE SALESMEN WANTED

SOME people say that high-class salesmen don't answer ads. We don't believe it, for they do answer our ads—and they go to work for themselves on our plan—and they make big money through our aggressive co-operation—they draw down over \$60.00 per average sale—they sell the highest grade motion picture advertising service that is made—they have built the largest business of its kind in the country. If you have a creditable sales record and an ability to work for big results and want to join this happy and aggressive sales force, just mail a post card for the complete story. Alexander Film Co., 1151 Main Ave., Spokane, Wash.

SALESMEN, experienced—or inexperienced if a worker—to sell an article to automobile owners that increases mileage, lessens spring breakage, and adds remarkable riding comfort—convincing, money-saving sales arguments. For every car. Reasonably priced. Average good man is earning \$50-\$75 a week. Rush your application, giving details. R. T. Portal, Room 511, 53 State Street, Boston.

SALESMEN Sell Tailoring—one of the most profitable of all lines. Our better one-price line of Guaranteed All-Wool Suits at \$29.75 sells on sight. Every order pays you a good profit in advance. Experience not necessary. We supply everything. This is a rare opportunity. Get the facts—today. Park Tailoring Company, Dept. 353, Chicago.

A BUSINESS of your own. Aggressive, ambitious men who seek new and larger business opportunities and expect to scratch and hustle to build real prosperity. Such men can secure factory sales connection and exclusive wholesale distribution on high-grade automobile necessities becoming well-known through national advertising. More than sales job; an opportunity to build permanent and profitable business with "Money back" merchandise that sells and repeats. Must have references, financial standing, evidence of past success and business promotion experiences outlined. Waste no time on postal cards or letters that do not state particulars requested. Correspondence with new, wide-awake specialty distributors solicited. Write Robert Bowes Company, Indianapolis, Ind.

ADVERTISING and Novelty Salesmen of ability, experience and large earning capacity can connect with manufacturer leather and advertising specialties in ready demand among banks and big business concerns. Fine contract, commission basis. \$150 on single order not unusual. Selling aid extended. Write us fully about your experience. David H. Zell, Inc., Dept. F, 532 Broadway, New York.

AGENTS, Distributors, Salesmen wanted in every city to handle Arctic Cowl Ventilators, for all makes of cars. Easy to install; sell on sight; practical necessity for all-season driving. \$50-\$100 weekly in this for you. Send for Our Income Plan. National Aluminum Co., Dept. 6, Racine, Wis.

SALESMEN—\$135 to \$420 a week. Salesmen with slight knowledge of motors who can reach car owners can earn \$135 weekly without making single sale. If they can also make sales their profits may reach \$25,000 a year. Phillips, 223 W. 29th Street, New York City.

SELL Auto and Tractor Oils. Regular or part time. Samples free. Get the money making terms. Address The Ivison Company, Cleveland, Ohio.

SALESMEN—Commission salesmen calling on hardware dealers. We have a fast catcher Fly Trap. Address F. Day & Co., Alcester, S. D.

CALENDAR house wants to communicate with experienced calendar salesman, one who can organize sales force. Address Consolidated Company, Erie, Pa.

ONLY one policy a day means \$130 per month profit; same on renewals. Policy pays \$5,000 death; \$25 weekly benefit for injury or sickness. Premium \$10 yearly. Full or spare time. Easy seller. Write quick for territory. Underwriters, Dept. K-33, Newark, N. J.

WE want experienced salesmen to sell our line of advertising materials and service to bankers, merchants, manufacturers, wholesalers, and other well rated concerns. The men we want must have some successful experience selling to business men, and must have ambition and a willingness to work for the development of a permanent and profitable business. Leads and comprehensive sales help furnished. Liberal commissions with weekly remittances. This is no soft snap but a real business proposition for competent men seeking bigger opportunities. Let your letter of application reflect your sales ability. Write fully including references. The American Art Works, Coschocton, Ohio.

MAKE \$50 daily. Something new! 400% profit. All business, professional men need it. Sells \$5. Costs \$1. Brooks, Texas, sold 29 first day, profit \$80. Big weekly repeater. Sells quickly. Experience unnecessary. Write today for territory wanted. Sample outfit free. Federal Association, 71-D Asylum St., Hartford, Conn.

AGENTS—J. B. Simpson, \$29.50 virgin wool tailored to order suits—overcoats are \$29.50 cheaper than store prices. You keep deposits. Protected territory. Beautiful assortment of fabrics—6x9 swatches free. Hustlers write J. B. Simpson, 831 West Adams Street, Chicago, Dept. 190.

SALESMAN-Distributor—Establish permanent business. Household article. Sells readily. Our liberal discount allows distributors handsome profit. Other distributors making good. Write today for exclusive distributor proposition. Crown, Richmond, Ind.

CLIMAX Oil Burners wonderfully successful in residence furnaces and stoves. Also Ozark Filters. Liberal proposition. Address, E. L. Miller Mfg. Co., 3224 West Third, Kansas City, Mo.

SIDELINE: Baby Shoe Specialties to the trade. Little Chick Shoe Company, Chicago.

SALESMEN Wanted—Our suits, overcoats, blankets, work pants, raincoats are made in our own factory from woolsens made in our own mill and sold direct to the consumer at prices that defy all competition. Fabrics and tailoring are the finest. If you have a clean record, stand well in your community and can spare 2 hours a day or more, you can add \$25.00 to \$150.00 per week to your present income. No experience or capital required. For full particulars write Taylor Wells Co., 1735-A Diversey Parkway, Chicago, Ill.

HIGH-GRADE Specialty Salesmen Wanted—Something New—Fire Fighter sells easily. Makes a spectacular demonstration; car owners, homes, factories, stores, practically buy on sight. Our men make \$19.00 to \$50.00 a day; exclusive territory. If you wish to establish a business of your own with unlimited possibilities for making big money, write us today. Fyr-Fyter Co., 950 Fyr-Fyter Bldg., Dayton, Ohio.

SIDE Line for Salesmen: The Kern Card and Label Holder; used in all business having merchandise on shelves as groceries, stockrooms, accessory stores, etc.; outfit carried in pocket. Address John Ph. Kern, Dept. M, 1205 W. Market, Louisville, Ky.

SOMETHING New—a necessity—Zim's Peerless Collection System. Salesmen making big money. Exclusive collecting features aid salesmen. Creditors' Association, 312-E McKnight Bldg., Minneapolis, Minn.

SALESMEN. Local or traveling, can make \$10.00 a day selling our new, practical advertising specialties. Pencils, yardsticks, kites, icepecks, shoeorns, etc. Attractive outfit. Excellent "side." Sell year round. Liberal terms. Pershing Mfg. Co., Southend, Ind.

AMBITIOUS Men, write today for attractive proposition, selling subscriptions to America's most popular Automobile and sportsman's magazine. Quick sales. Big profits. Pleasant work. Digest Pub. Co., 9505 Butler Bldg., Cincinnati, O.

SALESMEN make good side money selling small acetylene torch to garages and shops. Easy to sell. St. Paul Welding & Mfg. Co., St. Paul, Minn.

SALESMEN Can make \$5.00 a day selling our Calendars, Pencils, Signs, Advertising Novelties, Yardsticks, Whistles, etc. Liberal terms. Sells entire year. Fine side line. Local and traveling agencies. Model Calendar Co., Dept. 226, South Bend, Ind.

SOMETHING New, a necessity. All business and professional men need it. Sells \$7.50, costs you \$1.40. Big repeater. Write for sample. Merchants Assn., Minneapolis, Minn.

MAKE big money selling new, self-adjusting Robert Wrench. Most wonderful tool on market. Sells for \$1.85. You make almost 100% on each. No free samples. Robert Wrench Co., 71-C Murray St., New York.

MINUTES pay dollars demonstrating world's greatest specialty. Wonderful new three-pound Adding Machine. Details \$15. Work equals \$300.00 machine. Adds, subtracts, multiplies, divides, automatically. Speedy, accurate, durable, handsome. Five-year Guarantee. Tremendous demand everywhere. Amazing profits, main or sideline. Experience unnecessary. Write quick for liberal trial offer and protected territory. Lightning Calculator Co., Dept. G, Grand Rapids, Mich.

AGENTS—\$60-\$200 a week. Free samples. Gold sign letters anyone can put on store windows. Liberal offer to general agents. Metallic Letter Co., 451-E N. Clark St., Chicago.

EVERYBODY Eats Every Day. You can handle Sugar, Flour, Canned Goods, Dried Fruit, Coffee, and entire line of groceries, as well as Paints, Roofing, Aluminum Ware and Automobile Oils, with no rent to pay; no money invested; take large orders from samples. Goods are guaranteed and proven quality. Selling experience not necessary. Steady, profitable work for "workers." Address Hitchcock-Hill Co., Dept. 206, Chicago, Ill. Reference: Any Bank or Express Co.

57 MILES per gallon made with new patented gasoline Vaporizer. Write for particulars. Vaporizer Co., Pukwana, S. Dak.

CALIFORNIA Rosebuds selling like hot cakes. Agents coining money. Absolutely new. Big profits. Catalog free. Mission, 2421-SP, Smith, Detroit.

EASY to sell Groceries, Paints, Automobile Oils, Roofing, Stock Food to consumers from samples, no capital or experience necessary; steady, profitable work. Commissions advanced. Satisfaction guaranteed. 50 years in business. Write for full particulars. Loverin & Browne Co., Wholesale Grocers, 1775 S. State Street, Chicago, Ill.

BEST Seller: Jem Rubber Repair for tires and tubes; supersede vulcanization at saving of over 800%; put it on cold, vulcanizes itself in two minutes, guaranteed to last life of tire or tube; sells to every auto owner and accessory dealer. Get particulars how to make big money and free sample. Amazon Rubber Co., Philadelphia, Pa., Dept. 510.

HELP WANTED

WE want a few more men to take orders for our one-price line of Tailoring offering All-Wool Made-to-Measure Suits guaranteed \$50 values at only \$29.75. Every order you take pays you a good profit, in advance. Experience not necessary. Hustlers can clean up big. Write today, Park Tailoring Company, Dept. 354, Chicago, Ill.

WHAT is it worth to you Distributors—District Manager—Salesman or Agent to have the agency for the best line of Rubber Specialties on the market? Hot Water Bottles, Bathing Caps, Combination Shopping Bags, Pure Rubber and Rubberized Aprons, Rubber Gloves, and fifty other fast selling articles needed in every home. Profits range from 100 to 150 per cent. Write B. & G. Rubber Mfg. Co., 618 Penn Ave., Pittsburgh, Pa., Dept. 514.

WANTED: Men and Women Demonstrators to introduce, take orders, make deliveries, 150 household necessities. Food products, spices, extracts, toilet articles, etc. Now used by 20 million consumers. Largest company, most useful products. Large profits. Our system gets the business. No capital required. W. T. Rawleigh Co., 956 Liberty St., Freeport, Ill.

SALESMEN—Become Independent. Own your business; experience unnecessary; selling our \$7,500 Accident Death, \$50 Accident, \$25 Sick Weekly Benefits; \$12.50 yearly; other amounts proportionate. Guaranteed income from renewals. \$250,000 deposited Insurance Department. Registration Dept. A, Newark, N. J.

DISTRICT Managers—Big profits, men capable of organizing and managing crews of lady solicitors, can easily clear \$100 to \$200 per week with the B. & G. Protector, the original and best protector on the market. Every woman needs and buys it. Two grades. B. & G. Rubber Co., 618 Penn Avenue, Dept. 513, Pittsburgh, Pa.

SALESMEN—Independence awaits the live wires who grasp this opportunity. Warehouses, terminals, steamship companies, factories, hotels, cafes, etc., are desperately in need of our scientific, positive but simple method of extermination of rats and mice; grateful clients and long contracts await you. Best exclusive territories going fast, must carry a small stock; commission only. Write today. The Ratlin Laboratory, Inc., 115 Broad St., New York City, N. Y.

MEN—Boys over 17. Get U. S. Government positions, \$92-\$192 month. Quick, sure raise. Steady work. No "layoffs." No strikes. Sure pay. Life positions. Work pleasant. Paid vacation. Common education sufficient. Influence unnecessary. List positions easily obtained—free. Write today sure. Prompt action advisable. Franklin Institute, Dept. H-8, Rochester, N. Y.

WANTED—Men over 17. Railway mail clerks. Travel. Commence \$135 month. Steady. Common education sufficient. List positions free. Write immediately. Franklin Institute, Dept. H-21, Rochester, N. Y.

START a pressing, cleaning and dyeing shop, excellent field, splendid profits. We tell you how. Write for booklet. Henry-Young System, Dept. C, Charlotte, N. C.

EARN \$10 daily silvering mirrors, plating and refinishing metalware, autos, chandeliers, bedsteads, headlights. Outfits furnished. E. Deice Laboratories, 1133 Broadway, New York, N. Y.

MEN, women, over 18, desiring Government positions, \$1400 up, write immediately for full information. Chicago Civil Service College, A-41 Kesner Building, Chicago.

\$92-\$190 MONTH. Men-boys, over 17, Government clerical jobs. Steady. List positions free. Write Franklin Institute, Dept. H-21, Rochester, N. Y.

HOME employment evenings. Start little Mail Order business anywhere. Stamp brings Instructive Booklet. Arthur Pier, 72 Cortlandt Street, New York.

WANTED—Men over 17. \$135-\$195 month. Railway mail clerks. List positions free. Franklin Institute, Dept. H-21, Rochester, N. Y.

FIREMEN, brakemen, baggagemen, sleeping car, train porters (colored), \$150-\$200. Experience unnecessary. 810 Railway Bureau, East St. Louis, Ill.

DISTRICT managers to appoint salesmen; exclusive rights, sanitary brushes, dusters, mops. Big profits. Neway Brush Co., Hartford, Conn.

BOYS—men. Become automobile experts. \$45 week. Learn while earning. Write Franklin Institute, Dept. H-401, Rochester, N. Y.

MEN-Boys—Wanted. Railway mail clerks. \$135 month. Write immediately. Franklin Institute, Dept. H-21, Rochester, N. Y.

GOVERNMENT jobs. Men-women. Good pay. Write for information. Secretary, Box 1715-F, Washington, D. C.

\$5 TO \$15 Daily Easy—Your pay in advance, introducing new style guaranteed lossery. Must wear or replaced free. No capital or experience required. Just show samples, write orders. We deliver and collect. Elegant outfit furnished. All colors and grades, including silks and leathers. Mac-O-Chee Mills Company, Desk 1059, Cincinnati, Ohio.

LOCOMOTIVE Firemen, beginners, \$150, later \$250 monthly, for railroads nearest their homes, everywhere in United States and Canada. Address Railway Association, Desk M-1, Brooklyn, N. Y.

\$100 MADE in one week by young man in small town without capital or experience in local advertising business. Why can't you do likewise? Free book tells how. S. Meyer, 211 Seventh St., Louisville, Ky.

AMBITIOUS Men, write today for attractive proposition, selling subscriptions to America's most popular Automobile and sportsman's magazine. Quick sales. Big profits. Pleasant work. Digest Pub. Co., 9545 Butler Bldg., Cincinnati, O.

MEN wanted to qualify for Firemen, Brakemen. Transportation furnished. Write W. Boggess, St. Louis.

WANTED: Railway Mail Clerks—\$1,600 to \$2,300. Exams everywhere. Write today for full information. Patterson, Civil Service Expert, Box 4025, Rochester, N. Y.

SIGN Letter Agents and Painters: 500% Profit. Gold and Silver Sign Letters for Stores and Office Windows. Anyone can put on. Big demand. Free Samples. Metallic Letter Co., 481D N. Clark St., Chicago.

ALL men—women over 17, willing to accept Government Positions \$135 (Traveling or Stationary), write Mr. Ozment, 101 St. Louis, Mo.

SILVERING mirrors, French plate taught. Easy to learn, immense profits. Plans free. Wear Mirror Works, Excelsior Springs, Mo.

UNITED States Government Wants Men. Excellent positions at attractive salaries. Railway Mail Clerk Examination soon. Let our expert (former United States Civil Service Examiner) prepare you for this and other fine positions. Write today for free catalog P.M. Patterson Civil Service School, Rochester, N. Y.

BE a Railway Traffic Inspector! \$110 to \$250 monthly; expenses paid after 3 months' spare-time study. Splendid opportunities. Position guaranteed or money refunded. Write for free booklet CM-46. Stand. Business Training Inst., Buffalo, N. Y.

STORIES, poems, plays, etc., are wanted for publication. Good ideas bring big money. Submit manuscripts or write Literary Bureau, 322, Hannibal, Mo.

WRITE Articles, stories, news, in spare time for newspapers and magazines. Big pay. Copyright book free. Press Syndicate, 558, St. Louis, Mo.

MAKE money writing Photo-plays; details free to beginners. No correspondence course. Producers' League, 230 Wainwright, St. Louis.

INVENTORS desiring to secure patents should write for our book, "How to Get Your Patent," tells our terms and methods. Send sketch for our opinion of its patentable nature. Randolph & Co., Patent Attorneys, 620 F. Washington, D. C.

OUR genuine gold window sign letters are an excellent money-making proposition for handy men. Stann Sign System, St. Antonio St., Detroit, Mich.

SITUATION WANTED

FIRMS offering home work please send your propositions to A. E. Horst, 1122 W. 17th Street, Davenport, Iowa.

FOR ADVERTISERS

BLOTTERS will advertise your business or product. Samples for stamp. Labarre Company, Pittston, Pa.

CLASSIFIED advertising brings many inquiries—big profits. Agents; salesmen; business; for sale. Catalogue of leading publications. Send stamps. Dept. One, Climax Advertising Agency, Clinton Iowa.

LET us get up some real sales-producing literature, letters, etc., for you. We specialize on direct circular campaigns. The Wolfke Company, Louisville, Ky.

ADVERTISE in 24 Big Sunday Newspapers, 25 words \$15.00. Catalog listing 1,000 leading Dailies, Weeklies, Magazines, 4c stamps. Union Advertising, Baltimore Bldg., Chicago.

INCH Display Advertisement 161 Magazines Thrice \$15. Year \$50. Page \$100. Wood's Popular Services, Atlantic City, N. J.

24 WORDS 37 biggest Sunday papers, \$48.96. Proof guaranteed. Kline, Kline Bldg., Kent, Ohio.

SIGNS AND ADVERTISING

THE creating of a good impression is one of the most profitable forms of advertising, and a very good way to create such result is by the judicious use of Morgan Signs, Morgan Aluminum and Bronze Cast Signs and Memorial Tablets are Ever-lasting, Economical and Artistic. Circular upon request. Morgan Sign Co., Dept. K, 402 W. 27th St., New York City.

INFORMATION

RELIABLE information furnished on any subject or money refunded, 75c. Co-operative Service, Times Plaza, Box 864, Brooklyn, N. Y.

PUZZLE contestants' lists of B. C. P. R. and S. words. All words possible objects; single list \$1.00; all for \$3.00. Fred I. Cooner, 18 Boston Ave., Youngstown, Ohio.

LITERARY SERVICE

LITERARY Assistance. Prepare speeches, lectures, special articles, letters. Prompt expert service. Authors Research Bureau, 500 Fifth Avenue, New York.

LETTER SPECIALISTS

SALES letters, \$5.00. Write fully. Jacobus Advertising, Irvington, N. J.

MAILING LISTS

WE found \$9,000.00 recent sales. Names of our rural mail-order customers, \$3.50 per 2,000 names; \$1.00 each additional thousand. C. H. Davis & Son, News & Products, 614 Jefferson, Greenfield, Ohio.

HOUSEWIVES \$1.00 thousand; recent weddings, auto owners, agents—\$2.50 thousand. Can procure any list, Miller, Box 41, Berwick, Pa.

1,000 1922 MIDDLE western mail-order buyers, \$3.00. D. L. Sanborn, Elmhurst, Ill.

20,000,000 NEW names! Authentic, reliable lists are order pullers. Martineke Company, Corona, N. Y.

830 GARAGE dealers, establishments, five states, \$2 100. F. Mason, Whitewater, Wis.

TYPEWRITERS AND SUPPLIES

TYPEWRITERS. All Makes. Save one-half. Thoroughly Rebuilt in our factory by the famous "Young Process." Fully guaranteed. Free trial. We handle all standard makes. Cash or sold on easy terms. Write for Catalog. Young Typewriter Co., Dept. 412, Chicago, Ill.

UNDERWOOD Typewriters at far less than manufacturers' price; rebuilt, all worn parts replaced, guaranteed good as new. Cash, installment payments. Write for Catalog 1518. Typewriter Emporium, estab. 1892. Montrose and Ravenswood Ave., Chicago, Ill.

RIBBONS. 3c. Visible makes. Typewriter Supply, 7927 Colfax Av., Chicago.

TYPEWRITERS. all standard makes. \$10 up. Fully guaranteed. Free trial. Write for Illustrated Bargain List. Northwestern Typewriter Exchange, 329 West Goethe St., Chicago.

DUPLICATORS AND DEVICES

"MODERN" Duplicators save Time, Labor, and Money. Gets Business. Reproduces Typewritten or Panned Letters, Drawings, Lessons, Music, Memos, Bills, Notices, Specifications, Maps or anything in one or more colors. Prints Two per minute. Special Sale On 30 Days Free Trial. \$2.25 up. Booklet Free. J. E. Durkin-Reeves Co., Pittsburgh, Pa.

YOU can make 50 to 100 copies of a letter, notice, etc., on three cents' worth of Heyer Quality Compound. Write for free catalog and samples. The Heyer Duplicator Co., 162 N. Wells St., Chicago.

ADDING MACHINES

NEW \$3.50 Automatic Adding Machine. Adds, Subtracts, Multiplies. Absolutely accurate. Capacity \$999,999.99. Fully guaranteed. 75,000 pleased users. Makes adding easy, positive, quick. Eliminates Mistakes. Saves Time. Postpaid. \$3.50. Bassett Co., 1454-H, Hollywood Ave., Chicago.

PRICE Trial. Marvelous new Adding Machine. Adds, Subtracts, Multiplies, Divides, automatically. Work equals \$350.00 machine. Price only \$15.00. Speedy, durable, handsome. Five-year guarantee. Used by largest corporations. Write today for catalog and free trial offer. Lightning Calculator Co., Dept. E, Grand Rapids, Mich.

PRINTING, ENGRAVING AND MULTIGRAPHING

1000 20 LB. Bond Letterheads printed for \$3.75; 5000, \$17.50. Multigraphing: 5000 \$12.50; 5000 envelopes, \$17.50. United Sales Company, Aberdeen, So. Dakota.

5000 CIRCULARS, 5 1/2 x 8 1/2, \$8.50; envelope slips, \$4.00. Samples, Bargain List free. Good's Printery, Harrisonburg, Va.

1,000 HAMMERMILL Letterheads or Envelopes, \$4.00. Full Line Samples Free. Quality Printshop, Marietta, Ohio.

EMBOSSED business, personal stationery. Samples, stamp. Daniels Company, Pittsboro, Pa.

200 NOVEL letterheads and 200 envelopes, \$1.35; 5,000 letterheads, \$10.00; 2,000 envelopes, \$1.40. Postpaid. Champion, Wauwatosa, Wis.

PRINTING—"The Better Kind." Get our samples and estimates. Salesmen wanted. Drewton's Press, Detroit, Minn.

GUMMED Labels!!! Rubber Stamps!!! Interesting Samples Free!!! Edward Harrison, "Attractive Printing," Baltimore.

100 LINEN finish bond note sheets and 100 envelopes to match, printed with three-line address, \$1.00 prepaid. Other printing at equally attractive prices. Samples free. Burrill Printing Co., Kankakee, Ill.

DUGFOLD Size Business Stationery paper, 7 1/2 x 10 1/2, envelopes, 3 1/2 x 7 1/2, watermarked Machine Bond printed with your name and address on 100 sheets and 75 envelopes, \$1.50 delivered. West of Denver 10% extra. Dept. F, Paramount Paper Co., Kalamazoo, Mich.

5,000 BOND letterheads or envelopes, \$12.50. Trial offer 250 each, \$2.50, postpaid. Address, Spafford Company, Martville, N. Y.

WEDDING Invitations and Announcements neatly printed. Write for samples, prices. William Helm, Printer, 2135 N. Sayre Ave., Chicago, Ill.

ONE Thousand Letterheads or Envelopes, watermarked bond, \$3.75. Sample free. The Automatic Print Shop, Newcastle, Ind.

REDUCED prices for better printing, 1,000 Bond letter-heads, \$5.00; 1,000 good envelopes, \$1.25; 1,000 four-page folders, 3 1/2 x 6 1/2 inches, \$12.00. Catalogues, circulars, booklets our specialty. All printing at reduced prices. Samples free. Fantus, 525 S. Dearborn St., Chicago.

100 LINEN finish note sheets and 100 envelopes to match, neatly imprinted your three line address \$1.00 prepaid. Samples of quality printing for stamp. Model Company, Manchester, Iowa.

WE print anything. Circulars, stationery, Catalogs, Samoles. Commercial Press, Batavia, Ohio.

PRINTING Outfits—Presses, type supplies, type novelties. Send stamp for catalogue. Model Press, York, Penna.

250 LETTERHEADS, 250 white envelopes, printed and mailed, \$3.09. Samples printing free. Address Source, Mohawk, N. Y.

PRE-USED Printing Presses, Type and supplies. List for stamp. Popular Bargains, Richland, Pa.

RAZORS AND BLADES

DON'T destroy blades. "Bladeknife" most useful invention ever; beautiful pocket novelty; delights whole family; 25c. Martin, Box 1635, Paterson, N. J.

BLADES resharpened, 3c; any make, guaranteed service. Standard Safety Razor Corporation, Pittsburgh, Pa.

BLADES resharpened. Work guaranteed. Double edge, 3c; single, 2c. Triggs Co., Ostrerville, Mass.

VEST Pocket Gillette Blade Sharpener. Easily operated. Fifty cents postpaid. Satisfaction or money back. Specialty Shop, 427 10th St. N. W., Washington, D. C.

BLADES, resharpened, one edge 2c; double 3c. New York Edge Co., Glen Cove, N. Y.

FOR SMOKERS

PURE Red Leaf Tobacco, quality guaranteed. Best chewing, 4 lbs. \$1.25, 10 lbs. \$3.10. Mild smoking, 4 lbs. \$1.00, 10 lbs. \$2.10, delivered. O. D. Collier, Agent, Martin, Tenn. "Collier is absolutely honest and reliable." Martin Bank, Harmer, Cashier.

BOATS AND LAUNCHES

16' ROWBOAT easily made. Construction blueprint, 30c. Wee-Sho-U Co., West Market, Detroit, Mich.

"HOW to make your boat leakproof." Send for booklets. L. W. Ferdinand & Co., 152 Kneeland St., Boston, Mass.

GUNS, SPORTING GOODS, ETC.

MAUSER, Luger, Mannlicher Arms. Catalog, ten cents in stamps, Pacific Arms Corporation, San Francisco, Cal.

LOWEST prices in America. Revolvers and automatics. All standard American and foreign makes. Big illustrated price list free. Geiger's, 843-845 Broad St., Newark, N. J.

ANTIQUES AND WAR RELICS

SEND 5c for my best list, coins, Indian relics, antique firearms. F. E. Ellis, Webster Groves, Mo.

FOR Dens—Relics Collected from Europe's Battlefields. Catalogue and War Photographs 10c. Will also buy relics. Lieut. Welsh, 2117 Regent Place, Brooklyn, N. Y.

GENUINE Indian Baskets and Wampum. Wholesale catalog. Gilham, Kelseyville, Cal.

FOR THE HOME

HOME Builder's Guide plan book, \$1, postpaid. L. O. Bostad, Architect, Palisado Bldg., Duluth, Minn.

OIL portraits of yourself or dear ones! Strikingly beautiful and wonderfully life-like. Nothing like them anywhere! Agents, Samples free, any photo. Bruck Studio, 219 North 8th, Philadelphia, Pa.

3 AND 5 ply Vencer, immediate delivery. Dunn And Dauser, Canal at Roosevelt, Chicago.

MAKE Inexpensive Iceless Refrigerator. Blueprint 25c, William Quomere, Camden, New Jersey.

WEARING APPAREL

WEAR Double Sole Socks. Positively Darnproof. Black or assorted colors. True sizes, 9 1/2 to 11 1/2. Dozen pairs guaranteed one year. \$3.00, postpaid. Harry G. Seltzer, Dept. PM, Reading, Pa.

MEN, buy your hats direct from factory. Send for catalogue. Model Hat Mfg. Co., East Orange, N. J.

OPTICAL GOODS

POCKET Telescope—of real merit—of \$2.10, prepaid. Magnifies 4 1/2 times. Ralph J. Golsen, 1128 Argyle St., Chicago.

ARTIFICIAL Eyes, Special Selections of finest make. Reform eyes with blinded Iris. Direct by mail at Pre-war Prices. Perfect fit guaranteed. Otis Balcom, O. D., Shelby, O.

DIAMONDS, WATCHES AND JEWELRY

BEAUTIFUL Turkish Lucky Stones, One Dollar. Red stamp brings list California precious stones. Old and Young King Brady Gem Co., 5015 South San Pedro St., Los Angeles, Calif.

PHONOGRAPHS AND RECORDS

BEST quality phonograph parts, assuring finest results at big saving. Catalogue for stamp. Superior Phonoparts Co., Erie, Pa.

BUILD a genuine Choralcon phonograph and save over half. Big profit building and selling. We furnish motors, tone-arms, full instructions and all necessary parts. Send for catalog and free blueprint offer. Choralcon Phonograph Co., 922 11th St., Elkhart, Ind.

GOLDSTEEL Talking Machine Needles play many times without changing. Tone unexcelled. Eight for 25 cents. Lewis, Mfr., 220 North Fourth, Reading, Pa.

AMERICAN phonograph parts are best and lowest priced. Write for catalog today. American Phonograph Co., 3513 North Crawford, Chicago.

SAVE records and money. See Everplay Needle advertisement, page 143.

BUILD your phonograph. Quality Phonoparts. Highest quality spring and electric Motors, Tone Arms, Reproducers, Amplifiers, Case Material and Accessories. Free Blue Prints and Building Instructions. Big saving. Wonderful results. New catalog mailed for ten cents. Hessler Manufacturing & Supply Co., Phonograph Supply Department, 213 Baldwin Block, Indianapolis, Ind.

BUILD your own Phonograph. Write for prices of Cabinets, Motors and Tone Arms. Arthur Davis, Livingston, Ill.

MUSIC AND MUSICAL INSTRUMENTS

PLAYER music rolls rent, exchange or on approval. All makes. Write for particulars. New York Music Roll Exchange, 5 Columbus Circle, New York.

SONG Writers—Have wonderful proposition for poem or melody writers. Ray Hübeler, D110, 4610 Dickens Av., Chicago.

VIOLINS—Deep, Mellow, Soulful—on credit. Easy terms for wonderful instrument. Get details today. Gustav F. Hennig, 2124 Gaylord St., Denver, Colo.

"MUSIC Composed" to words, Bauer Bros (formerly of Sousa's Band), Oshkosh, Wis.

CORNETISTS—Trombonists—Saxophonists—Clarinetists. Send for "Free Pointers." Name instrument. Virtuoso School, Buffalo, New York.

WRITE Songs. Big money and reputation. Write for information. J. Gordon Publ. Co., 201 N. Hoyne Ave., Chicago.

I WANT song poems. Casper Nathan, Garrick Theatre Building, Chicago.

* PATENT ATTORNEYS

PATENTS—"How to Obtain a Patent" is the name of a book which every inventor should have. It will be sent free upon request, and will tell you what you want to know about patents. It contains the whole story. It describes the different parts of the application and explains in simple language the prosecution before the Patent Office. It tells about joint applications, releases, agreements, assignments, licenses, interferences, infringements, process patents, design patents, trade-marks, and prints and labels. If you are interested in patents either as an inventor, manufacturer or owner of a patent you will enjoy reading this book which was written by a lawyer who has had twenty-five years' experience in patent matters. If you have an invention and will send us a sketch, model or photograph of it we will promptly make a search of the Patent Office records and advise you whether or not, in our opinion, your invention is patentable, our charge for the service being \$5.00. We feel that our experience of twenty-five years has fitted us to render prompt and efficient service which will merit your confidence. Write today. Talbert & Talbert, 463 Talbert Building, Washington, D. C.

PATENTS Secured. Prompt service. Avoid dangerous delays. Send for our "Record of Invention" form and Free Book telling how to obtain a Patent. Send sketch or model for examination. Preliminary advice without charge. Highest references. Write today. J. L. Jackson & Co., 244 Ouray Bldg., Washington, D. C.

PATENTS promptly procured. Personal, careful and efficient service. Highest references. Moderate fees. Send sketch or model for actual search and advice. George P. Kimmel, Master of Patent Law, 54-L Loan and Trust Bldg., Washington, D. C.

PATENT. Trade-mark and Copyright specialist. Prompt, personal, efficient service. Advice on request. M. E. Jones, Lawyer, 509H 7th St., Washington, D. C.

INVENTORS! Write to U. S. Patent Office for free copy of "Information Concerning Patents," then engage a competent Patent Lawyer to protect your ideas. Ralph Burch, Patent Lawyer, Jenifer Bldg., Washington.

HERBERT JENNER, Patent Attorney and Mechanical Expert, 624 F St., Washington, D. C. I report if patent obtainable and exact cost. Send for circular.

PATENTS. Protect your rights. Before disclosing invention write for booklet and blank form Evidence of Conception, to be signed, witnessed and returned with rough sketch or model of your idea, upon receipt of which I will promptly give opinion of patentable nature and instructions. No charge for preliminary advice. Highest references. Prompt, personal attention. Clarence B. O'Brien, Registered Patent Lawyer, Southern Building, Washington, D. C.

PATENTS Procured. Trade Marks Registered. A comprehensive, experienced, prompt service for the protection and development of your ideas. Preliminary advice gladly furnished without charge. Booklet of information and form for disclosing idea free on request. Richard B. Owen, 30 Owen Bldg., Washington, D. C., or 2276-R Woolworth Bldg., New York.

MILLIONS spent annually for ideas! Hundreds now wanted! Patent yours and profit! Write today for free books—tell how to protect yourself, how to invent, ideas wanted, how we help you sell, etc. 509 Patent Dept., American Industries, Inc., Washington, D. C.

PATENTS—Trademarks. Thirty-five years' experience. Send model or sketch for opinion as to patentability. Free "Inventors Guide." Highest references and personal attention assure best results. Franklin H. Hough, 523 Washington Loan & Trust Bldg., Washington, D. C.

PATENTS—Prompt, personal efficient service by an attorney-at-law, skilled in all branches of Patent Practice. Over 18 years' actual experience; full information upon request. B. P. Fishburne, 331 McGill Bldg., Washington, D. C.

PATENTS, Trade Marks, Designs and Copyrights. Registered firm of attorneys-at-law. Careful, prompt personal service assured. Moderate fees. Full information free upon request. Gross & Collins, 605 Ouray Building, Washington, D. C.

PROTECT Your rights. Write for "Record of Invention" and booklet about Patents. Prompt personal service. Advice without charge. J. Reaney Kelly, 612-G Columbian Bldg., Washington, D. C.

PATENTS and Trade-marks obtained. Prompt service. Write for our new book on patents. Established in 1889. D. Swift & Co., 369 7th St., Washington, D. C.

PATENT application filed on partial payment plan. Trade-marks, copyrights, etc. Milo B. Stevens & Co., 685 F St., Washington; 352 Monadnock Bldg., Chicago. Estab. 1864.

INVENTORS—Send for form "Evidence of Conception" to be signed and witnessed. Form, fee schedule, information free. Lancaster & Albino, 221 Ouray Building, Washington, D. C.

PREPARE and Sell Your Own Products—Modern Formulas, trade secrets, commercial information. Different, dependable. Catalog free. Address B. Thaxly Co., Washington, D. C.

INVENTIONS Patented; Trade-marks Registered; reasonable charges; prompt service; plain advice; request detailed information. Jaynes & Jaynes, 700 Kellogg, Washington, D. C.

MONROE MILLER, Ouray Building, Washington, D. C., patent attorney, mechanical and electrical expert. Best quality of work and results. Moderate charges.

SHREVE, Crowe & Gordon, Attorneys and Counsellors at Law, Patent and Trade-Mark Practice. Correspondence invited. Address, Fendal Building, Washington, D. C.

"INVENTORS' Guide," free on request; gives very valuable information and advice. Write Frank Ledermann, 15 Park Row, New York, N. Y.

PATENTS. Booklet free. Highest references. Best results. Promptness assured. Send model or drawing for preliminary examination. Watson E. Coleman, Patent Lawyer, 624 F Street, Washington, D. C.

ROBB, Robb & Hill offer a strictly professional service to manufacturers and inventors in patenting inventions and registering trade-marks, a service which is the result of 20 years' experience. Write for free booklet and names of prominent manufacturers and inventors represented by us. Send sketch for preliminary advice. 811 McLachlan Bldg., Washington, D. C.; 1348 Hanna Bldg., Cleveland, Ohio.

PATENTS—Trademarks—Write for our free illustrated guide book and Evidence of Conception Blank. Send model or sketch and description and we will give our opinion of its patentable nature free. Highest references. Prompt attention. Reasonable terms. Victor J. Evans & Co., 166 Ninth, Washington, D. C.

PATENTS. My fees in installments. Advice book free. Frank Fuller, Washington, D. C.

INVENTORS! Send sketch or model of your invention for opinion concerning patentable nature and exact cost of applying for patent. Book, "How to Obtain a Patent," sent free. Gives information on patent procedure and tells what every inventor should know. Established twenty-eight years. Chandler & Chandler, 426 Seventh St., Washington, D. C.

PATENTS—Herbert Jenner, patent attorney and mechanical expert, 622 F St., Washington, D. C. I report if a patent can be had and its exact cost. Send for circular.

FOR INVENTORS

PATENTS Secured. Prompt service. Avoid dangerous delays. Send for our "Record of Invention" form and Free Book telling how to obtain a Patent. Send sketch or model for examination. Preliminary advice without charge. Highest references. Write today. J. L. Jackson & Co., 242 Ouray Bldg., Washington, D. C.

GET action Sell your Patent quickly! Order the "Patent Salesman" at once! It tells you exactly how to sell your Patent. Only \$1.00 per copy. Simon, 297 North Seventh Street, St. Louis, Mo.

PATENTS—"How to Obtain a Patent" is the name of a book which every inventor should have. It will be sent free upon request, and will tell you what you want to know about patents. It contains the whole story. It describes the different parts of the application and explains in simple language the prosecution before the Patent Office. It tells about joint applications, licenses, interferences, infringements, process patents, design patents, trade-marks, and prints and labels. If you are interested in patents either as an inventor, manufacturer or owner of a patent you will enjoy reading this book which was written by a lawyer who has had twenty-five years' experience in patent matters. If you have an invention and will send us a sketch, model, or photograph of it we will promptly make a search of the Patent Office records and advise you whether or not, in our opinion, your invention is patentable, our charge for the service being \$5.00. We feel that our experience of twenty-five years has fitted us to render prompt and efficient service which will merit your confidence. Write today. Talbert & Talbert, 463 Talbert Building, Washington, D. C.

PATENTS. If you have an invention which you wish to patent you can write fully and freely to Munn & Co. for advice in regard to the best way of obtaining protection. Please send sketches or a model of your invention and a description of the device, explaining its operation. All communications are strictly confidential. Our vast practice, extending over a period of seventy-seven years, enables us in many cases to advise in regard to patentability without expense to the client. Our Hand-Book on Patents is sent free on request. This explains our methods, terms, etc., in regard to Patents, Trade Marks, Foreign Patents, etc. "Scientific American" contains Patent Office Notes. Decisions of interest to inventors, and particulars of recently patented inventions. Munn & Co., Solicitors of Patents, 623 Woolworth Bldg., New York; Scientific American Bldg., Washington, D. C.; 801 A Tower Bldg., Chicago, Ill.; 611 Hanna Bldg., Cleveland, Ohio; Hobart Bldg., San Francisco, Calif.

AMASA HARTWELL BALCOM, Engineering Counselor and Master of Patent Law, 806 Munsey Bldg., Washington, D. C. Send sketch and I will report what has been patented nearest your invention. Highest references.

MANUFACTURERS and other addresses, every known line. Lowest rates. Capital Advertising Agency, Washington, D. C.

PATENTS. Protect your rights. Before disclosing invention write for booklet and blank form Evidence of Conception, to be signed, witnessed and returned with rough sketch or model of your idea, upon receipt of which I will promptly give opinion of patentable nature and instructions. No charge for preliminary advice. Highest references. Prompt, personal attention. Clarence B. O'Brien, Registered Patent Lawyer, Southern Bldg., Washington, D. C.

PATENTS Procured—Trade Marks Registered—A comprehensive, experienced, prompt service for the protection and development of your ideas. Preliminary advice gladly furnished without charge. Booklet of information and form for disclosing idea free on request. Richard B. Owen, 30 Owen Building, Washington, D. C., or 2276-R Woolworth Bldg., New York.

PROTECT your rights—Write for "Record of Invention" and booklet about Patents. Prompt personal service. Advice without charge. J. Reaney Kelly, 612-G Columbian Building, Washington, D. C.

MODEL Making and experimental work; Modern Shop; expert workmen. Manufacturing, Lamson Model and Experimental Works, 625 W. Jackson, Chicago.

I SELL Patents. Established 1900. Address, Charles A. Scott, 773PM Garson Avenue, Rochester, N. Y.

PATENTS. Write for free illustrated guide book. Send model or sketch and description for free opinion of its patentable nature. Highest references. Prompt attention. Reasonable terms. Victor J. Evans & Co., 157 Ninth, Washington, D. C.

"INVENTOR'S Guide," free on request; gives very valuable information and advice. Write Frank Ledermann, 15 Park Row, New York, N. Y.

HAVE You an invention? If so, write for our free book. "How to Get Your Patent," tells our terms and methods. Send model or sketch for our opinion of its patentable nature. Randolph & Co., Dept. 144, Washington, D. C.

909 MECHANICAL Movements and 59 Perpetual Motions Illustrated and explained in my book, *Inventor's Universal Educator*, 5th Edition—Tells how to procure and sell patents. Government and other costs. Covers the matter from A to Z—160 pages—Elegantly bound. Contains noted decisions of U. S. Supreme and State Courts on Patent cases. Mechanical Movements greatly assist inventors—suggest new ideas that might prove of great aid in perfecting inventions. Tells how to select an Attorney. Has valuable information regarding Patent Sharks, Selling Agents and Promoters. Price, \$2. Postage free everywhere. Fred G. Dieterich, 621 Ouray Bldg., Washington, D. C.

GET your own patents. Application blanks, complete instructions \$1. Cutting Sons, Campbell, Cal.

PATENTS FOR SALE

HAVE four patents on small articles of real merit. Will sacrifice to highest bidder. \$1,393,238—\$1,316,815—\$1,316,816—\$1,284,944. Party interested must send for patent office drawing at 10c a copy. Commissioner of Patents, Washington, D. C. Patent sharks save your stamps. O. J. St. Pierre, 511 E. 61st St., Chicago.

FOR Sale—Patent on a hinge gauge by means of which correct position of a hinge or any hinged articles may be quickly and correctly located. Will sell outright or on royalty basis. For further particulars address Andrew G. Murdock, 72 Arizona Ave., Detroit, Mich.

FOR Sale—Will sell both patent No. 1,369,429 and 1,423,501. Patent on a soft metal furnace for use in aluminum foundry, die casting and aeroplane foundry. Highest bidder buys both or each one alone. Address John B. McClain, 893 4th Ave., Brooklyn.

MANUFACTURERS, Attention: Terminal clip for electric wires for sale. American and Canadian Patent. Can be made at very low cost and make good profits on same. Arnold Greenstein, 17629 Cannon Ave., Lakewood, Ohio.

WE buy and sell patents; are in constant touch with patentees and manufacturers. If you have a patent or a good idea, write us first for free suggestions. The Wolfe Company, Louisville, Ky.

FOR Sale—Recent patent on animal traps—catches mice, rats, gophers and other animals. No locks, no springs—self-adjusting, always ready. Alexander Skulinski, 342 So. Broadway St., Room 409, Los Angeles, Calif.

OUTRIGHT or Royalty. Pocket exerciser. See Scientific American July. Weighs 1 oz. Can be used on street, at movies, in bed, when reading, etc. C. E. Lincoln, Box 24, Station A, Boston, Mass.

PATENT (1,387,402) Stove Board for sale or manufacture them on royalty—a good household article in the tin line—good proposition to the right man. A. Hutch, 2721 Wilcox St., Chicago, Ill.

HOUSEHOLD necessity. Article sells on sight. Good chance for young mechanic to manufacture as a side line. Dies and patent for sale. F. Murray, 3010 Lake Park Ave., Chicago.

PATENTED automatic winding mechanism for automobile clocks. Connects when clock has run five days, disconnects automatically when wound up full. Write S. Strommer, 421 W. 57th St., New York City.

U. S. AND Canadian rights: Automatic plane. Time and labor saver. Bit automatically raised when plane drawn back. Other improved features. For full details write C. Bailey, Western Springs, Ill.

FOR Sale—Patented keyhole guard. Fits any mortise lock, inside, outside; cheap to manufacture. Burglars cannot remove for pass key. Address Vase Shaw, 702 E. Chestnut, Dodge City, Kan.

OUTRIGHT or Royalty—aeroplane radiator patent. Built into the wing. Have already received offers for it. Keretey, 6358 Drexel Blvd., Chicago.

OUTRIGHT or Royalty. Patented Spring Leaf Spreader; operates with movement of lever; locks and is adjustable. Harold Schuster, Oconomowoc, Wis.

YOU have a worth-while patent, haven't you? Why don't you tell our two million readers about it? Most of them are specially interested in patents and new inventions. Ask me to tell you how other inventors successfully sold their patents. J. Roy McClellan, Manager, Classified Advertising, Popular Mechanics Magazine, Chicago, Ill.

PATENT Cooking Utensil Attachment; also Flash Light, Outright or Royalty. Address John Hauenstein, 2714 E. 27th, Kansas City, Mo.

WANT useful patents, cash or royalty; strong company, best references. Address: Vital Products Company, Des Moines, Iowa.

PATENT, Trade-mark and Copyright specialist. Prompt, personal efficient service. Advice on request. M. E. Jones, Lawyer, 509 B 7th St., Washington, D. C.

THE only patented Sink Drain and Strainer in the world for sale. Marie Niblo, patentee, 1210 1/2 Second Ave., Seattle, Wash.

PATENT 1,258,145 for sale; novelty pipe cleaner; cheap to manufacture; good mail order article. Theo. J. Carroll, 316 E. 4th St., Amarillo, Texas.

PATENTS For Sale: To sell, buy or obtain patents write Patent News—P, Washington, D. C.

PATENT 1,351,702. Valve and Valve Gear for steam engines. William Smith, Carterville, Mo.

FOR Sale—Patent Expandable Steel Rim Split pulley. J. Muller, 1843 Norman St., Brooklyn, New York.

NON-REFILLABLE Bottle—13,615-1; Lamp Attachment—12,988-1; Eye Glass Temple Holder—12,293-3; Folding Box or Crate—13,153; Reverse Pulley for Machine Tools, Elevators, etc.—12,788; Combination Lock—13,614. Talbert & Talbert, Talbert Bldg., Washington, D. C.

FOR Sale—New patent Spring Wire Clothes Pin, a great money making proposition. Can be made cheap in great quantities. For full particulars address Hermann Stammer, Box 1494, Bartlesville, Okla.

SHEET Metal Oil Stove and Fireless Cooker—oren, single burner heats six vessels. Patented. States, Canada. Cash Royalty. Here's a business, Arthur Clark, Dyerille, Calif.

I WILL sell patent on Universal Wrench. Nothing like it. Cash or royalty. Serial No. 513,496. M. L. Brady, Tyndall, S. Dak., Box 163.

SEPARABLE fasteners, outright or royalty, only button of its kind, John P. Becker, 1916 Erie St., Toledo, Ohio.

FOR Sale, outright or royalty, patent velocipede for children; resembles airplane. Address Elmer Williamson, Box 161, Blackstone, Va.

PATENT Pending—Baby carriage; by moving handle changes to a cradle. Very simple. R. C. Leeson, Aitcaists, Va.

PATENT for sale—Non-slipping and Non-skidding device. Gustave Meyer, 28 Wilmer Ave., Coboes, N. Y.

POCKET Check Protector Patent. Bargain. Fred Rothe, 1937 Warren, Chicago.

LACEY Patent Sense. See page 146.

MODELS AND MODEL SUPPLIES

MODEL Steam Engines, Boilers, Boats, Model Ship and Naval Fittings, Model Makers' supplies. Send 20c for new, enlarged illustrated catalogue and handbook. Barbe Mfg. Co., Dept. D, 5214 Woodland Ave., Philadelphia, Pa.

PATENTS. Protect your rights. Before disclosing invention write for booklet and blank form Evidence of Conception, to be signed, witnessed and returned with rough sketch or model of your idea, upon receipt of which I will promptly give opinion of patentable nature and instructions. No charge for preliminary advice. Highest references. Prompt personal attention. Clarence B. O'Brien, Registered Patent Lawyer, Southern Bldg., Washington, D. C.

PUNCH Press work, tool and die making, model and special machine work wanted. Completely equipped with new machinery of the latest type. Prompt delivery, reasonable prices guaranteed. Quality Hardware & Machine Co., Dept. A, 6154-56 N. Clark St., Chicago.

MODEL Making and experimental work; Modern Shop expert workmen. Manufacturing, Lamson Model and Experimental Works, 625 W. Jackson, Chicago.

MODELS and Patterns made. Light manufacturing. Address H. W. Hathorn, Mason City, Iowa.

WE make working models for inventors and do experimental work and carry a complete stock of brass gears and model supplies. Send for catalogue. The Pierce Model Works, Tinley Park, Ill.

INVENTORS—Write for our free illustrated guide book and Evidence of Conception Blank. Highest references. Prompt attention. Reasonable Terms. Victor J. Evans & Co., 185 Ninth, Washington, D. C.

FOR MANUFACTURERS

UNUSUAL Opportunity—Manufacturer interested typesetting machine designed. Use smaller plants; simple construction and operation. Costs little more to build than typewriter. Box 8, Muscadine, Ala.

MANUFACTURERS and Inventors. For developing your invention, designing and constructing Automatic Machinery, Labor-saving Devices for all purposes. Coin-Controlled Beverage and Food-Dispensing Machines. Consult John Frick, Mechanical Engineer, 1105 Arch St., Philadelphia, Pa.

MODEL making and experimental work; Modern Shop expert workmen. Manufacturing, Lamson Model and Experimental Works, 625 W. Jackson, Chicago.

WANTED—Metal Stamping and Model work taken on contract basis. We are ideally located and equipped to develop patents. Meyers Company, Box 263, Bedford, Ind.

MANUFACTURING

WE are equipped to manufacture all kinds of wire and light metal goods. Stampings, Dies and Tools. Punch press work. Patented articles wanted. Safety Wire Gas Globe Company, Columbus, Ohio.

WE manufacture anything, design and build special machinery, develop inventions, build models, make drawings of every description; our facilities the best. Write for booklet. R. G. Clynne Engineering Co., St. Louis, Mo.

DIES, tools, models, screw machine work, stampings and light manufacturing. Experimental work. Leslie H. Moulton Manufacturing Co., Mill Creek Blvd. and Archibald St., Kansas City, Mo.

ATTENTION! You invent it, let us make it. Models, dies, manufacturing. Sheldon Tool Co., Rosedale Station, Kansas City.

PATENTED Articles, Models, Brass Work, Machine Construction; Dies Made, Baum's Metal Specialties, Kansas City, Mo.

USE our factory. Half million dollars invested in special and automatic machinery. Wire and metal products in quantity our specialty. Send sample your product for quotation. The Autoyre Company, Oakville, Conn.

LET us be your factory! Write today. Logan Machine Company, 222 South Clinton Street, Chicago, Illinois.

IF you want dies and metal stampings, write us. Lyons Machine Works, Lyons, Ia.

SPECIAL Devices and Machinery developed and built at reasonable rates. Jigs and fixtures designed and built for interchangeable and economical manufacturing. Punches and dies made for all kinds of metal stamping. Machine work to order. Simplex Tool Company, Woonsocket, R. I.

WIRE Goods, all kinds made to order. Cooley Mfg. Co., 524-530 N. Western Ave., Chicago.

LET us be your machine shop! We build models and will do your manufacturing. Victor Eng. Co., 2524 W. Chicago Avenue, Chicago.

MODEL making and experimental work; Modern Shop expert workmen. Manufacturing, Lamson Model and Experimental Works, 625 W. Jackson, Chicago.

MACHINERY, TOOLS AND SUPPLIES

READY September 1st, most complete fool-proof sanitary safety razor blade sharpening machine made. Consists machine, cabinet, table and chair, all white enameled; confined territory. Our contract necessitates us to co-operate and assist you life of contract. Address R. S. Spahr, care Elmsere Hotel, Kansas City, Mo.

DRILL Chucks—Good usable manufacturer's seconds; 3-jaw, geared sleeve type. Limited number in two sizes. Capacity 0-11/32" at \$3.65, and capacity 0-17/32" at \$6.05, postpaid. Send cash order or write for particulars. The E. Horton & Son Co., Windsor Locks, Conn.

\$2.75, **HAND-BREAST** drill, capacity 9 to 3/4. \$2.98, 23 twist drills in 44th size, 1/32 to 3/4. Frank Lemieux, 78 Front, Woonsocket, R. I.

BOLTS, nuts, rivets, screws. Address O. L. Dickey, Bayonne, N. J.

BOLTS, nuts, rivets. O. L. Dickey Co., Bayonne, N. J.

LIGHT Power Transmission Machinery, Bearings, Hangers, Pulleys, Reducing Gears. Send for Catalog. Winfield H. Smith, Buffalo, N. Y.

WANTED: Information about new air compressors. Write for free manual. Engineers Dept., Brunner Mfg. Co., Utica, N. Y.

16x6 **NILES** engine lathe, \$125.00. 16" crank shaper, \$150.00. One 20" drill press, \$88.00. Cincinnati Machinery and Supply Company, 1322 Central Ave., Cincinnati, Ohio.

ENGINES, MOTORS, AND DYNAMOS

SURPLUS Stock Single Phase Motors, 1/4 hp., new, \$7.50; 1/4 hp., used General Electric, \$19.50; repulsion induction, 1/2 hp., new Century, \$45.00; 1 hp. used Wagner, 1200 rpm, \$88.00; 1 hp. used Wagner, 1200 rpm, \$60.00; 2 hp. used Wagner, 1200 rpm, \$75.00; one year guarantee. We buy, sell and repair all sizes. Arthur Wagner Company, 164 S. Dearborn, Chicago.

HIGH Speed Toy Motor—110 volts, \$2 postpaid, including pulley, cord and plug. Annis Motor Co., 398 S. 17th St., Columbus, Ohio.

AUTOMOBILE Owners, Garagemen, Mechanics, Repairmen, send for free copy of our current issue. It contains helpful, instructive information on overhauling, ignition troubles, wiring, carburetors, storage batteries, etc. Over 140 pages, illustrated. Send for free copy today. Automobile Digest, 567 Butler Bldg., Cincinnati.

ALTERNATING and direct current motor bargains. New and rebuilt. All guaranteed for one year. Special prices. Get our price list before buying. Motors exchanged and repaired. Hyre Electric Co., 633-3M South Dearborn St., Chicago.

ELECTRICAL

POWERFUL Electro-magnets, six volts, lift forty pounds, \$3.25; seventy pounds, \$4.00; 150 pounds, \$5.50. Satisfaction guaranteed. J. Nania, 141 Butler St., Paterson, N. J.

ELECTRICAL Experimenters—Here is the book you have been waiting for—"How to Make Things Electrical," 256 articles, 427 pages, 353 illustrations. Size 4 1/2 x 7, cloth binding. Price \$2.50 postpaid. Popular Mechanics Book Dept., 6 N. Michigan Ave., Chicago.

ELECTRIC motors and supplies, including sockets, wire conduit, cleats, boom, rosettes, switches. New revised wholesale prices. Illustrated Catalog free. Hyre Electric Co., 633-3H, South Dearborn St., Chicago.

ELECTRICITY For 10c Per Hour. Motor Auto Generator. Operates on any make automobile. Produces electricity for Moving Picture Machines, Theatres, Schools, Churches, Homes, Etc. Write for free particulars. Monarch Theatre Supply Co., Dept. AG 724 South Wabash Ave., Chicago.

FOR MECHANICS

SHOP Notes, Volume 17, contains 702 practical articles such as Half-ton Traveling Crane, Boring Machine, Toggle Press, Gas-Fired Forge, Oil-Gas Generator, Movable Table for Drill Press, etc., 224 pp., 496 Ills., 50 cents postpaid. Popular Mechanics Book Dept., 6 N. Michigan Ave., Chicago.

PATENTS. Protect your rights. Before disclosing invention write for booklet and blank form Evidence of Conception, to be signed, witnessed and returned with rough sketch or model of your idea, upon receipt of which I will promptly give opinion of patentable nature and instructions. No charge for preliminary advice. Highest references. Prompt personal attention. Clarence B. O'Brien, Registered Patent Lawyer, Southern Bldg., Washington, D. C.

PATENTS—Write for our free illustrated guide book and Evidence of Conception Blank. Send model for sketch and description of the invention for our opinion of its patentable nature free. Highest references. Prompt attention. Reasonable terms. Victor J. Evans & Co., 134 Ninth, Washington, D. C.

BLACKSMITHS

BLACKSMITHS. Listen: Any Handy man can make more money doing hard jobs easy. Forging and welding solid, with Toy's Modern Methods of Blacksmithing. Hardening and tempering to a standard with colored tempering charts. All for one dollar. Samples Free. W. M. Toy, Sidney, O.

SURVEYING INSTRUMENTS

NEW and used surveying instruments direct from factory. Satisfaction guaranteed or money refunded. Wissler, 619 Broadway, St. Louis.

FOR SALE—MISCELLANEOUS

FOR Sale. Patented 1921. Device for separating laying hens from non-laying hens automatically; no human help required. No springs, ropes or pulleys used and simple in construction. Large demand for this device. Forster Bros., Box 422, Sunnyvale, Calif.

FOR Sale: Long's Crispette and Cretons Butter Pop Corn Machines; also 2 1/2 H. P. General Electric Motor. Fred Voigt, Mt. Vernon, Ill.

AIR Compressor \$28.00. With Tank \$51. With Motor \$70.75. Suitable for private or public Garage, Tire Shop, Painting or Cleaning. Motors, 1/3 H. P., \$19.75. Battery Charging outfit, Home or Garage size, \$14. Send for our large 100-page catalog describing all kinds of Air Compressors, Vulcanizers, Garage and Battery outfits. Equipment Co., 167 Canal, Cincinnati, O.

FOR Sale—Gearhart's Knitting Machine. Cheap. M. F. Kobal, 1297 6th St., La Salle, Ill.

\$17.50 **GENUINE** Carl Zeiss Field, Marine and Aviation Glasses, eight power, adjustable focus and eye pieces; cost \$38.00 with carrying case. Sent C. O. D. subject to examination. Money refunded. We have other Glasses, Binoculars and merchandise. Wolf's Curiosity Shop, 29 S. 2nd St., Philadelphia, Pa.

ADDRESSOGRAPHIC, Letter Folders, Multigraphs, Envelope Sealers, Duplicators, less than half price. Guaranteed. Pruitt Co., 112-B N. La Salle, Chicago.

FOR THE SHOP

SHOP Notes for 1922—Bench Lathe, Electric Soldering Outfit, Jib Crane, Pump Troubles, Road Roller, Bench Grinder, Bench Miller, are among the 655 articles in this new volume. 224 pp., 50 cents postpaid. Popular Mechanics Book Dept., 6 N. Michigan Ave., Chicago.

LANDSCAPE ARCHITECTURE

BE a Landscape Architect. We will mail you 3 different sets of plans in color from which you can copy; also specifications and a book that tells you about planting and money-making; all this for \$3.00. Send money order. David Hansen, 1243 Thornedale Ave., Chicago, Ill.

REAL ESTATE AND FARM LANDS

LAND Seekers! Attention! You can get 20, 40, or 80 acres near thriving city in Lower Michigan on terms of \$10 to \$50 down; with balance on long time. Investigate this opportunity to get a farm home. Write today for Free booklet giving full information. Swigart Land Co., P-1259 First National Bank Building, Chicago.

\$500 **SECURES** 105-Acre Farm, 8 cows and heifers, horses, tools included; 8-room house, barn, poultry house. Only \$2,050, 1/4 down. Page 298 Free Catalog. Strout Farm Agency, 150 Nassau St., New York City.

LOS ANGELES leads building world; never stops growing; large restricted lots, best built, highly improved section; \$100 cash, \$20 monthly; should double money when fully paid. Address Dwiggins, 712 Hibernian, Los Angeles, Calif.

MAKE money fast. New plans. Learn Real Estate and Building Business. Free House Plans and Super-Salesmanship. Money making system. Write Casto Realty System, Columbus, Ohio.

\$5.00 **DOWN**; \$5.00 monthly; Five acres fruit; poultry, fur farm. Riverfront; Ozarks; \$100; hunting, fishing, trapping. Address Harvey Hubbard, 1973 North Fifth, Kansas City, Kan.

ATTENTION! "Get Acquainted." Cash for your property. Farm, Hotel, or Retail Store, no matter where located; confidential service. Hayes' Business Agency, Cincinnati, Ohio.

FOR Sale—Three full sections in McKenzie County and two sections in Billings County, North Dakota. Each section contains land suitable for crops, balance for cattle. Each section has valuable deposits of lignite which some day will alone be worth many times the present value of the land. This part of the state is developing very rapidly, with good schools within easy access. As owner cannot use this land himself will sell one or more sections at a price which almost anyone can afford to pay. Address: W., care Popular Mechanics, 6 North Michigan Ave., Chicago.

FLORIDA Oranges are most profitable as well as most delicious. Grow your own in a land of sunshine, away from winter blizzards and coal bills. Money you'll not miss will buy you land for a grove in a high, rolling, lake-jewelled land of many golden groves. If you mean business, write today for Book of Facts and Photos. Lake County Land Owners' Association, 93 Arbor Avenue, Fruitland Park, Fla.

I WANT Farms for cash buyers; will deal with owners only. R. A. McNowa, 312 Wilkinson Bldg., Omaha, Neb.

SELL your property quickly for cash, no matter where located. Don't pay big commissions. Particulars free. Real Estate Salesmen Co., Desk B, Lincoln, Neb.

HOMESEKERS: Send for Virginia farm list; best climate. Dept. 59, Emporia, Va.

WANTED—MISCELLANEOUS

MAIL us your discarded jewelry. Gold Crowns and Bridges, Watches, Diamonds, Silver, Platinum, War Savings Stamps and Old False Teeth. Money sent at once. Goods Ref. if offer is refused. United States Smelting Works, (Old Reliable) Dept. 71, Chicago.

DOGS, BIRDS, POULTRY AND PETS

ARISTOCRATS of Dogdom. Scotch Collies, sired by England's most noted champions, from imported bitches today's best breeding, puppies and grown dogs. Loggia Collie Kennels (A K C Registered), Importers and Breeders, Binghamton, N. Y.

FOR Sale—Coon, opossum, skunk and squirrel dogs; fox, cat and rabbit hounds, sent on trial. Catalog free. Address Mt. Youah Farm Kennels, Cleveland, Ga.

RAISE Silver Black Foxes. Breeding stock your own terms. Write for particulars. Todd & Moore, St. Stephen, N. B.

COONHOUNDS and Combination Fur Hunters—trial. J. King, Selmer, Tenn.

AIRDALE puppies—Pedigreed hunting stock. Address Sauer's Kennels, Dept. D, Powhatan Point, Ohio.

SILVERBLACK foxes, \$300.00, Skunks, \$10. Booklet, dime. Arthur Schumacher, Lockland, O.

TRY Arkansas Kennels, Russellville, Arkansas, this season, for trained tree and running dogs.

RABBIT Hounds, Foxhounds, Coon, Opossum, Skunk, Squirrel, Groundhog dogs, Setters, Pointers, Circular 10c. Brown's Kennels, York, Pa.

1,000 RINGNECK Pheasants and Pheasant Eggs for sale. All other game birds and eggs and animals, Charles C. Garland, Oldtown, Maine.

BREED Squabs, Book free, E. Rice, Melrose Highlands, 77 Massachusetts.

BELGIAN HARES, GUINEA PIGS, ETC.

RAISE guinea pigs. Pay better than poultry or rabbits; easy to raise; little space required. We guarantee market. Particulars and booklet how to raise free. Carles Distributing Co., 3102 Grand Ave., Kansas City, Mo.

PERSONAL

ARE you interested in the relationship of Vibration and Color to your life? Forceful facts free. Robert Knox, Box 728, San Francisco, Calif.

TOBACCO, liquor and morphine habits can be overcome with the aid of Hill's Chloride of Gold Preparations. Liquor remedy can be given secretly. Particulars free. Ohio Chemical Works, Dept. 9, Charleston, S. C.

HOROSCOPE—Life revelation. Send birthdate, 10c. Astrolite Company, Sharpsburg, Pa.

BE Wise! Be Cheerful! Be Prosperous! New way plan brings wonderful results. Valuable pointers and your personality revealed for 10c and birthdate. Thomson-Heywood, Dept. 985, Chronicle Bldg., San Francisco, Calif.

YOUR Horoscope covering full year for 35c. Includes an extensive reading, valuable daily guide, large pictorial chart and special forecasts for each month. Scientific, complete. Try it! Money back if dissatisfied. Give birthdate. Address: H. Daniels, Flatbush Sta., Box 52, Brooklyn, N. Y.

FREE—Stop using tobacco. We will give free information how to conquer habit easily and permanently. Results guaranteed. Anti-Tobacco League, Box K, Omaha, Nebr.

TOBACCO or Snuff Habit cured or no pay. \$1.00 if cured. Remedy sent on trial. Superba Co., TP., Baltimore, Md.

MISCELLANEOUS

GENERAL Information. Positively anything you need to know, business, law, medical, technical, personal, recipes, miscellaneous. Ten cents per answer, none higher. Send questions without money. Pay only if satisfied. Address General Information, Ann Arbor, Mich.

GREATEST opportunity ever offered live wires to make clean money on latest invention for automobiles. Exclusive, necessary. City, county or state rights given. Best territory going fast. Hurry your application. Guaranteed proposition, Emmons Mfg. Co., Alliance, Ohio.

SAVE the cream, protect your health, open your milk bottle the sanitary patented way. Opener and cap, 25c. postpaid. Agents get our wonderful proposition. J&N Specialty Co., 339 East Adams Ave., Detroit, Mich.

ART Metal Workers—You will find our book "Metal Work and Etching" a complete manual on making book ends, desk sets, pad corners, paper knives, letter openers, stationery racks, rocking blotters, desk calendars, arts and crafts jewelry, etc., 96 pp., illus. Price, 50 cents, postpaid. Popular Mechanics Book Dept., 6 N. Michigan Ave., Chicago.

STOP! that repair bill—lower your cost of operation and be familiar with your auto by having in your vest pocket for emergency reference a copy of a new, compact little book entitled "Causes and Remedies for Ills and Ails of an Automobile." Price \$1 postpaid. Popular Mechanics Book Dept., 6 N. Michigan Ave., Chicago.

5 MASTER Keys. Work like magic in emergencies or prove whether your home is burglar-proof. Test and open thousands of locks. Send \$1 today. Novel key chain free. Master Key Co., 3 Manhattan Block, Milwaukee, Wis.

ARIZONA Incorporation completed day papers are filed, without nominal or par value shares. Least cost. Greatest advantages. Operate anywhere. Forms free. Stoddard Incorporating Company, 8-B, Phoenix, Ariz.

MAKE big money opening safes and setting combinations. Wayne Strong, Box 1459, Los Angeles, Cal.

CUTS anybody can make. Simple, cheap process. \$1. Specimens, particulars, 2c stamp. M. Day, Windfall, Ind.

SAVE incorporating expenses and excess profit taxes and avoid personal liability by organizing your company on the Common Law Plan under a Declaration of Trust. Anyone, anywhere, can fill in Demaree Standard Forms, issue shares and begin doing business same day. Pamphlet B-53 free. C. S. Demaree, Legal Blank Printer, 613 Walnut, Kansas City, Mo.

ARTIFICIAL Eyes, \$3. Booklet free. Denver Optic, 539 Barclay, Denver, Colo.

WANTED—Stamping work for power presses. The W. & P. Toy Mfg. Co., Lawrence, L. I., N. Y.

I Want 235 Salesmen Who Want to Earn at Least \$5000 a Year



B. M. OLIVER

KNOWING that this magazine is read by the progressive type of salesman I take this means to "tell the world" that I want to get in touch with some live-wire salesmen. I am not looking for supermen—just fellows who have confidence in themselves—and particularly the fellow who wants to make real money; say about \$5,000 a year or more.

I want to show you the way to big money. Many of my sales representatives are averaging \$500 a month; others exceed that amount. Right on my desk here I've got a letter from F. W. Bentley of Philadelphia telling how he made \$215 in one day—and one from A. M. Russell of Hartford, Conn., who made \$660 in one month. I have scores of other similar letters in my files—from R. Berger of Ontario who makes \$250 a week, from J. Carnegay of South Dakota telling how he is making \$1,000 a month; from W. Drew of Michigan who makes \$85 a day. There is no reason under the sun why you should not make a minimum of \$100 a week right from the start.

**Oliver Oil-Gas Burner & Machine Co.,
2314-U Oliver Bldg., St. Louis, Mo.**

Please send me full facts about how I can make big money representing you in my territory. Also your plan, if I wish to make big money in my spare time.

Name

Address

City.....State.....

I want you to be the representative of the famous **OLIVER OIL-GAS BURNER**—an invention that instantly turns any stove or furnace into an oil-gas stove, making an even oil-gas fire in any stove or furnace at the turn of a valve, with three times the heat of coal and wood and none of the bother or dirt.

Every Home Wants This New Invention

The Oliver Oil-Gas Burner does away with coal and wood. Banishes all worry about strikes, scarcity and high prices. Turns any range, furnace or stove into an oil-gas stove. 16 different models. Burns 5% kerosene (coal oil) and 95% air. Think of the appeal you can make in every community! Cheaper than coal, wood or gas—absolutely safe.

Does away with drudgery—no fires to make, no ashes, dirt, smoke, chopping, carrying coal and wood. Easy to install. Doesn't change stove. Protects health from exposure and uneven heat. Easy to demonstrate—slips in or out of stove in one minute. Show any woman what it will do right in her own home and the sale is made. Big demand all year—does away with that housewife's dreaded hot summer kitchen.

Write Me At Once

Now, if you are ambitious and really want to connect with a live proposition then just mail-coupon today and I will promptly forward you full details with absolute proof that you can make a minimum of \$5,000 a year as an Oliver Salesman. Address:

B. M. Oliver, President.

OLIVER OIL-GAS BURNER & MACHINE CO.

*Oldest and Largest Manufacturers
of Oil-Gas Burners in the World*

2314-U Oliver Bldg.

St. Louis, Mo.

The Woman Who Wished She Could Play the Piano

And How She Found an Easy Way to Turn Her Wish Into a Fact

A YEAR or so ago this woman didn't know one note from another. Today she plays the piano—entirely by note—better than many who have been playing for years. Here she tells how she learned and why it was so easy. Thousands of others, from school children to men and women of 50 to 60, have also learned music in the same easy way.

FROM the time I was a child I have always had a yearning and longing to play the piano. Often I felt that I would gladly give up half of my life if some kind fairy would only turn my wish into a fact. You see, I had begun to think I was too old to learn, that only some sort of fairy-story magic could give me the ability to play. I was 35 years old—and the mother of a small family—before I knew one note from another.

Until I learned to play, hearing music—especially the piano—always gave me almost as much pain as pleasure. My enjoyment of it was always somewhat soured by envy and regret—envy of those who could entertain and charm with their playing, regret because I myself had to be a mere listener. And I suppose it is that way with everyone who has to be satisfied with hearing music instead of playing it.

Again and again, parties and other social gatherings have been all but spoiled for me. I could enjoy myself until some one suggested music or singing; then I felt "left out"—a lonesome wall-flower—a mere looker-on, instead of part of the party. I was missing half of the fun.

The way I have suddenly blossomed out in music (almost overnight, you might say) has been a big surprise to all who know me, and to myself as well. My friends seem to think it must be that I had a previously undiscovered genius for the piano. But if there was any genius about it, it wasn't on my part, but in the lessons I took—a new and simplified method that makes it remarkably easy for any one to add music or singing to their daily lives.

I learned entirely by home study—in my spare time—from fascinating Print-and-Picture lessons that make everything so simple and easy that one simply can't go wrong on them. I call it a short-cut way to learn—it is so much simpler and so entirely different from the old and hard-to-understand methods. I know that I made better and faster progress than I ever could by bothering with a private teacher or joining a class. In fact, while I don't like to brag, within six months after I took my first lesson, my playing was better than that of many of my friends who had studied two or three years under private teachers—not because I was any more apt than they, but simply because the wonderful Print-and-Picture lessons sent me by the U. S. School of Music were so easy to understand.

Within a year after I took my first lesson, I began teaching my two little girls to play—using exactly the same lessons I myself had studied. And I noticed that both of them seemed to be getting along better than any of their playmates who have private teachers. In addition, I am saving the money it would cost to have a private teacher—I figure it would cost at least \$3 to \$5 a lesson to have a teacher whose instruction could compare with that contained in the printed lessons from the U. S. School. Yet, from the first lesson to the last, the total cost of learning the way I did averaged only a few cents a lesson.

My only regret is that I didn't know of this really wonderful method years before. The ability to play is such a great comfort. No matter how much I am alone, I never get lonesome—I can always turn to my piano for amusement. I am never at a loss for a way to entertain callers. I no longer feel that I am "out of it" at



social gatherings. Do you wonder that I so gladly recommend the method that has brought me so much pleasure and satisfaction?

This woman's experience is by no means unusual. Over 300,000 others—from school children to men and women of 50 and 60—have learned to play their favorite instrument, or learned to sing in the same way this woman did. Largely through the recommendations of satisfied pupils, we have built up the largest school of music in the world.

Whether for beginners or advanced pupils, our method is a revolutionary improvement of the old and hard-to-learn methods used by private teachers, and our method is as thorough as it is simple and easy. We teach you in the only right way—teach you to play or sing entirely by note. No "trick" music, no "numbers," no makeshifts of any kind. Yet it is a short-cut method, simply because every step is made so simple and clear.

The total cost averages only a few cents a lesson, with your music and everything included.

When learning to play or sing is so easy, why continue to confine your enjoyment of the music to mere listening? Why not at least let us send you our free book. Just now we are making a special short-time offer that cuts the cost per lesson in two—send your name now, before this special offer is withdrawn. No obligation—simply use the coupon or send your name and address in a letter or on a post card. Please write name and address very plainly so that there will be no difficulty about booklet reaching you. Instruments supplied when needed, cash or credit.

U. S. SCHOOL OF MUSIC
79 Brunswick Building New York

U. S. SCHOOL OF MUSIC,
79 Brunswick Bldg., New York City.

Please send your free book, "Music Lessons in Your Own Home," and particulars of your Special Offer. I am interested in the following course:

.....
(Name of Instrument or Course)

Name
(Please Write Plainly)

Address

City State

FOR BEGINNERS OR ADVANCED PUPILS

Piano	Mandolin
Organ	Drums and
Violin	Traps
Banjo	Harmony and
Clarinet	Composition
Flute	Sight Singing
Harp	Ukulele
Cornet	Piccolo
Cello	Trombone
Guitar	Saxophone

Voice and	Speech Culture
Automatic	Finger Control



Big Jobs For Trained Traffic Men

High-salaried, executive positions are waiting for the men who will master the profession of Traffic Management. No man need stay in a small job when the railroads, steamship lines and leading industrial organizations in America are in urgent need of trained traffic experts—men who are experts in routing, who know how to organize and manage, who are informed on modern traffic methods, who know transportation costs and the laws of interstate commerce, and can adjust important claims and direct large shipping operations. LaSalle's large staff of more than 150 traffic and transportation experts can train you by mail for an important traffic position. By the LaSalle Problem Method you soon become able to handle the actual, every-day problems which come to the traffic executive's desk. And you can get this training in your spare hours at home, while you hold your present job.

Send Coupon Today

Simply mark X in coupon below and we will send full particulars about our training and the attractive opportunities in the field of railroad or industrial traffic management. Also our valuable book, "Ten Years' Promotion in One." Act today.

— INQUIRY COUPON —

LaSalle Extension University

The Largest Business Training Institution in the World
Dept. 964-TR Chicago, Illinois

Please send me catalog and full information regarding the course and service I have marked with an X below.

- Traffic Management—
 Foreign and Domestic:

Training for position as Railroad or Industrial Traffic Manager, etc.

Other LaSalle Training Courses

LaSalle is the largest business training institution in the world. It offers training for every important business need. If more interested in any of these courses, check here:

- | | |
|--|--|
| <input type="checkbox"/> Business Management | <input type="checkbox"/> Modern Business Correspondence and Practice |
| <input type="checkbox"/> Salesmanship | <input type="checkbox"/> Modern Foremanship and Production Methods |
| <input type="checkbox"/> Higher Accountancy | <input type="checkbox"/> Personnel and Employment Management |
| <input type="checkbox"/> Railway Accounting and Station Management | <input type="checkbox"/> Expert Bookkeeping |
| <input type="checkbox"/> Law: Degree of LL. B. | <input type="checkbox"/> Business English |
| <input type="checkbox"/> Commercial Law | <input type="checkbox"/> Commercial Spanish |
| <input type="checkbox"/> Industrial Management Efficiency | <input type="checkbox"/> Effective Speaking |
| <input type="checkbox"/> Banking and Finance | <input type="checkbox"/> C. P. A. Coaching |

Name.....

Present Position.....

Address.....

Please Mention Popular Mechanics

LEARN *The* BUSINESS of Advertising



QUICKLY BY MAIL

We guarantee to teach you. It's easy to learn—and easy to get into! Make the start *this week*. This free book tells how.

\$75 to \$100 a Week

—frequently paid beginners. There is no limit to opportunities which men and women trained in advertising meet on every hand.

FREE AD-WRITER'S COMPLETE WORKING OUTFIT

Wonderful outfit of working instruments given free on special offer. Write for details before offer expires. We will also send you free and prepaid this stirring book on advertising. Tells you everything you want to know getting into this fascinating field. Write today. Postcard will do.

PAGE-DAVIS SCHOOL, Dept. A21, Page Bldg., Chicago

Learn Photography at HOME

Make \$75.00 a Week on the Side

Establish yourself as a Photographic Expert quickly—during your spare time—under a leading photographer. I'll show you how to start your own business—on a large salary. Good permanent offer—it's only temporary. Act at once. A postal will do. H. R. VANT.

INTERNATIONAL STUDIOS, Inc.
Dept. 1196, 3601 Mich. Ave., Chicago, U.S.A.



RADIO For Everybody

Thousands of men needed now in Radio. Splendid positions open. You can earn big money as a Radio Expert. Learn by mail, in spare time, how to design, construct, install, repair, maintain, operate, sell and demonstrate complete radio outfits. Write for free 32-page catalog describing our course "How to Learn Radio at Home."

National Radio Institute

Dept. 1293K,

1345 Pennsylvania Ave., N. W. Washington, D. C.

PLAY PIANO BY EAR in 4 Weeks!

Young and old can now learn to play piano by ear without notes or music by our brand new quick and easy 10 lesson method. Send now for

FREE Sample Lesson!

and play real chords at once. The World's simplest, easiest method. Nothing else like it. No musical experience necessary, play piano as easy as you hum or whistle a tune. Be a ragtime artist. Send for FREE sample lesson now before edition is gone. Don't delay.

DAVID PIANO COURSE 1500 CUTLER-HAMMER BLDG. CHICAGO, ILLINOIS

ELECTRICITY LEARN AT HOME

Send for catalog which tells how Burgess Home Training enables men and boys to get good jobs and keep them. Burgess Electrical School, Dept. P-9, 744 E. 42nd St., Chicago

Learn Watchwork, Jewelrywork and Engraving.

A fine trade commanding a good salary, and your services are always in demand. Address HOROLOGICAL, Dept. P, Bradley Institute, Peoria, Ill., for our latest catalog.



WANTED—Railway Mail Clerks

\$1600 First Year

Men—Boys
Over 17

SEND COUPON
TODAY SURE

FRANKLIN INSTITUTE
Dept. G-179, Rochester, N. Y.

(1) send me, without charge (2) sample Railway Mail Clerk Examination questions; (3) schedule showing places next examinations; (4) list of many government jobs now obtainable.

Name.....

Address.....

**Develop your talent
for drawing**



Big Prices Paid to ARTISTS

YOU are indeed fortunate if you like to draw! Develop your talent—make good money—perhaps become a well-known commercial artist! Thousands of business firms pay millions of dollars yearly for good advertising drawings and designs. Well-trained artists command \$50, \$75, \$100, \$150 a week—sometimes even more. “Top-notch” designers receive \$250, \$500, \$1000 and up for single drawings.

Learn Quickly at Home in Your Spare Time

Get into this fascinating profession which has come into its own, and has a future as big as **modern advertising and modern business**. The Federal “Master Course” teaches you the methods and secrets that make your drawings worth **real money**. It gives you **individual personal criticisms** on your lessons. It brings you rapidly to the producing point, without previous training or experience. And best of all—

Leading Successful Artists are Authors of Exclusive Lessons in the Federal Course. Think of it! Artists, both men and women, whose names are constantly seen in the magazine—whose signatures on drawings are worth hundreds, sometimes thousands of dollars—will give you the benefit of their experience and advice only in this Course. Leading illustrating companies, designers, artists, and hundreds of successful Federal Students the country over have enthusiastically endorsed Federal Training.

Get this Free Book, “YOUR FUTURE”

Training **always** gets the big incomes—and gets them quickest. Invest your spare time and a little money in your ability to draw. Many Federal Students **earn more than the Course costs** while they are studying, from sale of their work. Investigate now—by all means send for this book. It's free to anyone 16 years old or more who is in earnest about his or her future. Beautifully illustrated in colors, it gives facts about the field of commercial art, names of the famous artists who are Federal Authors, and every detail you will want to know about the Course. It is a proven result-getter. Mark and mail the coupon **right now**—kindly stating your age and occupation.



**FEDERAL
SCHOOL OF
COMMERCIAL
DESIGNING**

680 Federal Schools Bldg.,
MINNEAPOLIS, MINN.

Please send me “YOUR FUTURE,”
without charge or obligation.

Age Occupation

Name

(Write your address plainly in margin)



**\$100,000.00 Worth
of Electrical
Apparatus**



**In 3½
Months**

**Forced
Into**

Larger Quarters



H. W.
Cooke, Pres.

Learn

The Great Shops of Coyne with \$100,000.00 worth of electrical apparatus has moved into larger and more spacious quarters. The increasing popularity of the school and the tremendous influx of new students simply forced us to move. Why did this happen? It happened because Coyne has been the most successful institution of its kind in the country. Coyne men were well trained—they learned electricity thoroughly—they went out into the business world and were successful—these men told their friends. With this solid foundation built over a period of years during which time over 10,000 men were successfully trained and graduated, Bennett Wellington Cooke has realized his greatest ambition—a larger and greater Coyne where *all* might be accommodated. Here, in these large, light, airy quarters you will find the finest equipment and best training that money can buy.

Coyne Training Is Complete

You learn quickly because you work in a class of One—with a special instructor to help you—on our immense and modern equipment of dynamos, switchboards, generators, locomotives, etc. This REAL work with REAL tools on REAL machinery trains you five times as fast as studying from books, and enables us to put you through in about one fifth the time—3½ months instead of one to four years. And when you graduate, you KNOW your business, for you have DONE everything in a practical way.

Your Success Is Assured

Remember, we use no books, have no classes and do not teach by correspondence. You do the actual work here the same as you will do later on the outside, only under expert instructors. From the simplest doorbell to the mighty generator—motor—electric locomotive, everything is made simple, understandable. Light—power—heat are mastered easily—quickly—surely. And all at small expense.



In the Great Shops of COYNE

Earn \$65 to \$175 a Week

Hundreds of our graduates are making this big money as Power Plant Operators, Electrical Engineers, Telephone Men, Superintendents, Electro Auto Engineers, etc. Hundreds of others are in the electrical contracting business for themselves and making from \$3,000 to \$20,000 a year. I want you to drop your present line and come to Coyne now and let us prepare you for big opportunities.

Earn While You Learn

Our Employment Department helps place students in jobs to earn a good part of their expenses while studying. No charge for this service. The catalog explains fully.

SEND COUPON NOW

Don't delay a minute—send that coupon in **right now** for our big free catalog and full particulars of this wonderful offer.

Free Radio Course

Besides the regular electrical course, we include the following:

- (1) A complete course in auto, truck and tractor electricity and storage batteries. Greatest outlay of auto electrical and battery equipment in the country.
- (2) Course in radio—the marvel of the age. Constructing, installing and operating. You can build your own wireless telephone set.
- (3) A life scholarship in the Coyne School. You can stay as long as you wish and return for further training at any time in the future. The aim of the Coyne School is to turn out men completely trained in all branches of electricity—capable of succeeding in the highest paid positions.

Bennett Wallington Cooke,
President

COYNE TRADE AND ENGINEERING SCHOOLS

Dept. 19
1300-1310 W. Harrison
Street
CHICAGO,
ILL.

**COYNE
TRADE &
ENGINEERING
SCHOOLS**

B. W. COOKE,
President

Dept. 19, 1300-1310 W.
Harrison St., CHICAGO

Dear Sir:—Please send me free your big catalog and full particulars of your special offer of 2 extra courses free.

Name.....

Address.....

Town.....

State.....

He Mailed This



He was a young Ohio business man. He realized that in order to get ahead he had to put more into his head. He wrote to the United Y. M. C. A. Schools, telling of his work and his ambition. The Schools advised enrolling for the very practical course in Salesmanship—a course of study that gives the student the benefit of the experience of scores of successful salesmen and sales managers.

20 months later he writes:

"The Course has done me a world of good. I have been made sales manager of a \$300,000 corporation."

You have as good a chance to get ahead as this young Ohioan—maybe better. Let us counsel you. We will tell you, free of obligation, about a new type of correspondence instruction that emphasizes an educational service to ambitious men that has brought thousands of appreciative letters from a group of more than 30,000 students enrolled during the last two years.

The larger responsibility, the better pay, the positions of leadership that these men are winning with our aid, may be yours also.

Mail This Coupon

United Y. M. C. A. Schools' Correspondence Courses

Business Courses

Accountancy
Advertising
Banking
Better Letters
Bookkeeping
Business Arithmetic
Business Administration
Business English
Business Finance

Business Law
Complete Letter Writing
Office Management
Practical Speaking
Salesmanship
Secretarial
Show Card Writing
Stenography
Traffic Management

Technical and Other Courses

Agricultural Courses
Applied Psychology
Architecture
Automobile Courses
Building Construction
Civil Engineering Courses
Drafting Courses
Electrical Courses
English Courses
Factory Management
Foreign Languages
Foremanship
Highway Engineering
High School Subjects
Illustrating

Insurance Courses
Mathematical Courses
Mechanical Engineering
Own-Your-Home Course
Plan Reading
Plumbing
Poultry Husbandry
Radio Engineering
Radio Telegraphy
Radio Telephony for Amateurs
Steam Engineering Courses
Structural Drafting
Surveying
Use of the Slide Rule
Vocational Courses

Are you an ex-service man?

United Y.M.C.A. Schools, Dept. 74-S, 375 Lexington Ave., New York City
Without obligating me, please advise regarding the course in

Name.....

Full Address.....

(Please write plainly.)

FORTUNES in a single year

The real truth of how they are made and how you, too, now have the same opportunity

DO YOU sometimes wonder why some people with only ordinary brains and intelligence make such astonishingly large incomes?

Take, for instance, many salesmen in the paint industry. Over \$60,000 was made in a single year by a salesman for one well known paint company; Mr. B, representing another, earned over \$50,000; Mr. G, representing a third, made over \$25,000. Yearly earnings of from \$4,800 to \$12,000 are common.

What is the secret of such amazing success? How can you—how can any one with average intelligence and the willingness to work make big money, too? There is only one answer—

Choose work with great opportunities and then become a specialist in that work

We can cite you many examples of the big incomes made in the paint industry—prove to you beyond the question of a doubt the wonderful opportunity—the almost unbelievably large incomes it offers.

But only men with real paint knowledge can enjoy these extraordinary incomes. Paint is a semi-technical product. A man must be a trained paint specialist to know how to advise his customers. That knowledge is his power. With it he renders real service. Because of this he gets the big orders and earns an amazingly large income.

Easy to Gain Knowledge That Brings Rich Earnings

You can easily acquire the knowledge that makes possible such rich earnings in the paint industry. The Cleveland Paint Salesmen's Training School offers a course easily mastered by anyone of only average intelligence. You need no previous experience—only the ability to read and write and the ambition to be a great success.

This course has been worked out by a master paint sales manager in conjunction with one of the most able paint chemists in the country. It is endorsed by leading paint manufacturers. They want to secure men who have completed it.

You will be placed with one of them immediately upon your completion of the course. This is without any cost to you whatever. No fees. No extras of any kind.

OPEN THE DOOR TO OPPORTUNITY

Opportunity is knocking at your door now in the shape of this announcement. Tear it out; write your name and address on the margin; mail it to us and it will bring you details of the wonderful possibilities for trained paint salesmen. It will show you the path to knowledge and success—perhaps fortune. Opportunity knocks but cannot enter unless you open the door. Don't let opportunity slip away from you. NOW! While it's here—within your grasp—Let it enter! Write your name and address on this announcement and mail it at once.

CLEVELAND PAINT SALESMEN'S TRAINING SCHOOL
336 Bangor Bldg. Cleveland, Ohio

Bank THE STATE BANKING & TRUST CO.
References CLEVELAND OHIO

This Professional Drawing Outfit FREE

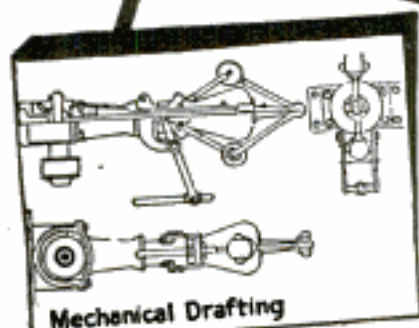

All these Free to
Columbia Students
and Graduates

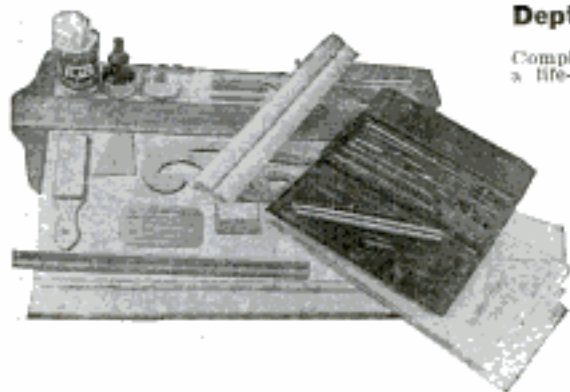

Good tools go a long way toward making a good draftsman. The set shown is of highest quality, and comprises the identical articles used by thousands of draftsmen holding top-notch positions. Consists of 16 pieces and 11-piece instrument set in plush-lined case. You get the COMPLETE OUTFIT FREE.

Make Drawings With this Set and Get \$35 to \$100 a Week

This FREE drawing set, together with the instruction we furnish will enable you to do expert drafting work—mechanical, architectural, map, radio, automobile, electrical, etc. We'll make a real draftsman of you. And we'll send this complete drawing outfit FREE with your first lesson.

You don't need artistic talent or "pull" to get a draftsman's job paying \$35 to \$100 a week. Our training has put thousands of men in these fine jobs. We teach everything you need. Never mind what work you've been doing all your life—we can fit you for these big, BETTER jobs.

Draftsmen Get Quick Promotions

Columbia graduates climb fast. We have hundreds of letters on file from graduates who have been promoted to Assistant Chief, Chief Draftsman, Production Manager, Engineer, etc. It is because the training we give is the very best. We promote initiative in our students, and that in turn promotes them to bigger jobs. The training we give is more complete than you'd get in many years work in the ordinary Drafting Room. Our instruction covers all the phases of drafting, while the draftsman who tries to learn at "the school of experience" gets training along only one line.

Easy Money "On the Side"

A draftsman can make a lot of money "on the side." Many of our graduates make as much and more than their large salaries this way. There is always a lot of side-issue work to be had. Many graduates have built up businesses of their own this way. Wouldn't you like to see your name on the door of an office of your own as a Drafting Engineer or Consulting Draftsman? You CAN! We show you how.

Get the Right Training

"Training" is the whole secret of success as a draftsman. Columbia training is simple, sure, complete, PRACTICAL. Roy C. Claffin's method of practical mechanical drawing will make a Master Draftsman of you in a few months of home study. Mr. Claffin personally supervises your instruction—personally criticises and corrects your work. He makes the study pleasant and easy. You get plain, commonsense, brass-tack instruction.

Columbia Draftsmen in Big Demand

The largest concerns in America, and the U. S. Government, employ Columbia draftsmen. We help you get a position. We have constant demand for our graduates. We keep employers advised as to your abilities, and thus help you get quick promotion.

Send for this Book

Send the coupon to-day for illustrated book, "Your Future in Drafting." It tells all about the Columbia Course. SPECIAL OFFER FOR THOSE WHO SEND THE COUPON NOW. Do it.

THE COLUMBIA SCHOOL OF DRAFTING

Roy C. Claffin, President

Dept. 1787, 14th and T Sts., N. W., Washington, D. C.

Complete Drawing Outfit free. Employment service free. Consultation privilege for a life-time free. Diploma free. Publication for Draftsmen, "The Compass" free.

— Send This Coupon Now —

COLUMBIA SCHOOL OF DRAFTING,
Dept. 1787, 14th and T Sts., N. W., Washington, D. C.

Without obligation to me, please enter my name to receive "The Compass," and send me your illustrated book, "Your Future in Drafting," telling me about your complete home study course and your help in securing me a position as draftsman.

Name.....Age.....

Address.....

City.....State.....

Why haven't
you
clipped this
coupon

INTERNATIONAL CORRESPONDENCE SCHOOLS
Box 5666-C, Scranton, Penna.

Without cost or obligation, please send me full information about the subject before which I have marked an X in the list below:

BUSINESS TRAINING DEPARTMENT

- | | |
|---|---|
| <input type="checkbox"/> Business Management | <input type="checkbox"/> Salesmanship |
| <input type="checkbox"/> Industrial Management | <input type="checkbox"/> Advertising |
| <input type="checkbox"/> Personnel Organization | <input type="checkbox"/> Better Letters |
| <input type="checkbox"/> Traffic Management | <input type="checkbox"/> Foreign Trade |
| <input type="checkbox"/> Business Law | <input type="checkbox"/> Stenography and Typing |
| <input type="checkbox"/> Banking and Banking Law | <input type="checkbox"/> Business English |
| <input type="checkbox"/> Accountancy (including C.P.A.) | <input type="checkbox"/> Civil Service |
| <input type="checkbox"/> Nicholson Cost Accounting | <input type="checkbox"/> Railway Mail Clerk |
| <input type="checkbox"/> Bookkeeping | <input type="checkbox"/> Common School Subjects |
| <input type="checkbox"/> Private Secretary | <input type="checkbox"/> High School Subjects |
| <input type="checkbox"/> Business Spanish <input type="checkbox"/> French | <input type="checkbox"/> Illustrating <input type="checkbox"/> Cartooning |

TECHNICAL AND INDUSTRIAL DEPARTMENT

- | | |
|--|--|
| <input type="checkbox"/> Electrical Engineering | <input type="checkbox"/> Architect |
| <input type="checkbox"/> Electric Lighting | <input type="checkbox"/> Contractor and Builder |
| <input type="checkbox"/> Mechanical Engineer | <input type="checkbox"/> Architectural Draftsman |
| <input type="checkbox"/> Mechanical Draftsman | <input type="checkbox"/> Concrete Builder |
| <input type="checkbox"/> Machine Shop Practice | <input type="checkbox"/> Structural Engineer |
| <input type="checkbox"/> Railroad Positions | <input type="checkbox"/> Plumbing and Heating |
| <input type="checkbox"/> Gas Engine Operating | <input type="checkbox"/> Chemistry |
| <input type="checkbox"/> Civil Engineer | <input type="checkbox"/> Pharmacy |
| <input type="checkbox"/> Surveying and Mapping | <input type="checkbox"/> Automobile Work |
| <input type="checkbox"/> Mine Foreman or Engineer | <input type="checkbox"/> Navigation |
| <input type="checkbox"/> Steam Engineering | <input type="checkbox"/> Agriculture and Poultry |
| <input type="checkbox"/> Radio <input type="checkbox"/> Airplane Engines | <input type="checkbox"/> Mathematics |

Name.....
Street.....
Address.....
City..... State.....

Occupation.....
Persons residing in Canada should send this coupon to the International Correspondence Schools Canadian, Limited, Montreal, Canada.

Please Mention Popular Mechanics



**Why Miss Half
the Fun in Life?**

BE POPULAR—Learn to dance well! Arthur Murray, America's greatest dancing teacher, has invented a remarkable new easy method which enables anyone to learn all the newest dances at home—in a few hours—at very little cost!

No music or partner needed. Success positively guaranteed! "60,000 learned dancing by mail."

FREE DANCING LESSON—To prove you can learn easily and quickly, Arthur Murray will send you a lesson absolutely free. Also, the Secret of Leading, How to Gain Confidence and other dancing helps, in plain cover. For mailing, send 10c. Act now and be a good dancer soon.

Arthur Murray, Studio 420
100 Fifth Avenue New York

**ILLINOIS COLLEGE OF
PHOTOGRAPHY**

Est. 1893. Thorough instruction in **Photography** and **Photo-Engraving**, complete in six months. **Three-color work** two extra months. No examinations for entrance. All year term, students may enter first or fifteenth of any month. Salaries of \$35 to \$100 per week open to graduates. College assists in locating positions. Tuition low. Moderate living expenses. Three buildings.



For full information address
LoGrand A. Flack, Pres., Box 492, Ellingham, Ill.



**NAVIGATION
TAUGHT BY MAIL**

Hundreds of Ship Officers needed in Merchant Marine and Navy. Salaries up to \$412 monthly and living expenses. You can qualify through Captain Warren Sheppard's Home Study Course on Navigation. Chance of a lifetime to see the world as a ship's officer at a big salary. Write for free Book, "Your Future is on the Seven Seas."

World Technical Institute, Dept. 100A, Fuller Building, Jersey City, N. J.

"HOW I BEAT THE GAME"

The Inspiring Story of how one poorly paid garage mechanic won success, his own business and a big income. Tells how you can increase your salary from 100 to 500%. Send for it today FREE.

Ambu Engineering Institute
Dept. 110 2632 Prairie Ave., Chicago, Ill.

LEARN ENGINEERING

Courses, 3 months to 2 years practical-technical training under experts. Not a Trade School, but a practical-technical college teaching electricity, steam, gas, auto-electric, sensory welding, drafting. Extensive laboratory and shop equipment. Degrees awarded. Day and night sessions. Enroll any time.

FINLAY ENGINEERING COLLEGE
1901 Indiana Avenue Kansas City, Mo.

LEARN TO GET DOLLARS OUT OF WATCHES.
WATCH-REPAIRING, ENGRAVING, JEWELRY REPAIRING.

WRITE NOW.

ENICAR TRADE SCHOOL
830 W MONUMENT SQUARE. RACINE, WIS.

Work while learning Electricity

Set of tools given to producers. Write

S & H ELECTRICAL WORKS, Dept. J. 1, 398 So. Green St., CHICAGO



Study Law

Win for Yourself a Real Career!

Would you be independent, command a substantial income and an opportunity for public service that will make you an influential figure in your own community?

The one profession above all others that brings to those who make good not merely wealth but also prominence and public leadership, is—LAW. Successful law-trained men—both in business and in active practice—are today earning from \$10,000 to \$50,000 a year. For the ablest minds in this great profession, there is practically no income-limit.

Train at Home by the Problem Method

Start today toward this wonderful goal. Right in your own home, under the LaSalle Problem Method, you can study the same cases you would read at the resident universities, master the fundamental principles set forth by some of the most eminent authorities in the profession.

LaSalle text-books, "lesson talks," lectures, quizzes and examinations have been prepared by leading members of the American bar—prominent practitioners, judges, law professors in the great universities. You graduate with the degree of LL. B.—prepared for independent practice or for a responsible position with one of the big corporations.

Send today for definite information regarding the unusual opportunities in law, together with letters showing just how scores of LaSalle-trained men are cashing in on home-study training. With this data we will send you particulars of our convenient-payment plan; also your free copy of "Ten Years' Promotion in One." Mail the coupon.

LaSalle Extension University

The Largest Business Training Institution in the World
Dept. 964-LR Chicago, Illinois

Please send me catalog and full information regarding the course and service I have marked with an X below. Also a copy of your book, "Ten Years' Promotion in One."

LAW, Degree of LL. B.

LaSalle is the largest business training institution in the world. It offers training for every important business need. If more interested in any of these courses, check here:

- | | |
|--|--|
| <input type="checkbox"/> Business Management | <input type="checkbox"/> Banking and Finance |
| <input type="checkbox"/> Salesmanship | <input type="checkbox"/> Modern Foremanship and Production Methods |
| <input type="checkbox"/> Higher Accountancy | <input type="checkbox"/> Personnel and Employment Management |
| <input type="checkbox"/> Traffic Management | <input type="checkbox"/> Expert Bookkeeping |
| <input type="checkbox"/> Railway Accounting and Station Management | <input type="checkbox"/> Business English |
| <input type="checkbox"/> Commercial Law | <input type="checkbox"/> Commercial Spanish |
| <input type="checkbox"/> Industrial Management | <input type="checkbox"/> Effective Speaking |
| <input type="checkbox"/> Efficiency | <input type="checkbox"/> C. P. A. Coaching |
| <input type="checkbox"/> Modern Business Correspondence and Practice | |

Name

Present Position

Address

I GUARANTEE YOU A POSITION

Big
Pay

Succeed!

To make money, get into a field where money is made—and men are wanted. Today there is such a field—a big, profitable field that has been barely scratched. Men are succeeding in it and making money and uncounted opportunities for great success are still open. The Finger Print profession is the field that offers you this opportunity. Finger Printing is beyond the experimental. It is recognized as the one positive means of identification.

Be a Finger Print Expert

Finger Print Experts earn big money and occupy the respected position of the professional man because their work is conspicuous and essential. There are no lay-offs nor shut-downs in the Finger Print profession. Everything you do counts for yourself. Daily, just a handful of men are trying to answer the demands of the thousands and thousands of instances where the Finger Print Expert is vitally needed. Trained Finger Print Experts share in big incomes, fame and importance. For years my time has been devoted to the Finger Print profession. I will teach you how to become a Finger Print Expert. My course of study is simple, easily understood and I guarantee to assist you in securing a position. Read the letter from the Philip State Bank. You can study during your spare time. No special education is needed. My simplified course makes everything clear.

Secret Service Course

In addition to my complete course in Finger Prints, I will also supply you free and without extra charge, a complete course in Secret Service. Study of this will equip you for all-round work. It gives you knowledge essential to the successful Finger Print Expert. Remember this course is free with my course in Finger Prints. It, alone, is worth the cost of my complete course in Finger Prints. But this offer, as is my Position offer and Free Professional Outfit offer, is limited. Men are needed at once. Unless you act at once, you may lose this remarkable free offer.

Actual Secret Service Reports

FREE To all who write for complete information at once, I will send, free, copies of actual Secret Service reports. These reports give inside facts of amazing cases of interest to you. Send for them and my complete explanation at once. I will tell you fully what you can expect as a Finger Print Expert and I will help you succeed. Today—write for this information and my guaranteed-position offer.

U. S. SCHOOL OF FINGER PRINTS
Dept. 436, 7003 N. Clark St.
CHICAGO, ILL.

Send
Coupon

U. S. SCHOOL OF FINGER PRINTS
Dept. 436, 7003 N. Clark St., Chicago, Ill.

Please send me free information about your Finger Print Course, Free Course in Secret Service together with Guaranteed-Position Offer, Free Outfit, Secret Service Reports and Special Low Prices.

Name

Address

City.....State.....Age.....



New Easy Way to Become An Artist

THIS wonderful new method makes it possible for *anyone* to learn Illustrating, Cartooning, or Commercial Art. Hundreds of our students are now making splendid incomes. And most of them never *touched* a drawing pencil before they studied with us.

The simplicity of this method will astound you. You will be amazed at your own rapid progress. You learn by mail—yet you receive **personal** instruction from one of America's foremost Commercial Artists. Get into this fascinating game **NOW**. You can easily qualify. A few minutes' study each day is all that is needed.

Crying Demand for Trained Artists

Newspapers, advertising agencies, magazines, business concerns—all are looking for men and women to handle their art work. There are hundreds of vacancies right this minute! A trained commercial artist can command almost any salary he wants. Cartoonists and designers are at a premium. Dozens of our students started work at a high salary. Many earn more than the cost of the course while they are learning! **YOU**—with a little spare-time study in your own home—can easily and quickly get one of these big-paying artists' jobs.

No Talent Needed

This amazing method has exploded the old idea that talent is an absolute necessity in art. Just as you have learned to write, this new method teaches you to draw. We start you with straight lines, then curves. Then you

learn how to put them together. Now you begin making pictures. Shading, action, perspective, and all the rest follow in their right order, until you are making pictures that bring you from \$50 to \$500 or more! Many artists get as high as \$1000 for a single drawing!

Write for Interesting Free Book

Mail coupon now for this interesting free book, "How to Become an Artist." Explains about this amazing method in detail. Tells of our students—and their wonderful progress—and how we can qualify you for a high-salaried artist's position. Also tells of our free artists' outfit to new students and special low offer to a limited number of new students. Mail coupon NOW.

Washington School of Art
Room 1880, Marden Bldg., Washington, D.C.

FREE COUPON

WASHINGTON SCHOOL OF ART, Inc.
Room 1880, Marden Bldg., Washington, D. C.

Please send me, without cost or obligation on my part, your free book, "How to Become an Artist."

Name

(State whether Mr., Mrs. or Miss)

Address

LEARN A TRADE



AND GET A GUARANTEED JOB

If you are mechanically inclined write me today—don't bother about a letter—just a postcard will do—or clip and mail the coupon.

So confident am I of the practical automotive, tractor and Radio training that is offered you in this Million Dollar Trade School, that if you will agree to take the necessary preliminary work, I will agree to employ you upon graduation. This position requires not only automotive training but radio training as well. But to equip you for this work I will give you a free course in radio.

Furthermore, I need you NOW. And to make it possible to get the right sort of men I will pay your railway fare to Kansas City.

I want Sweeney Trained men to act as my salesmen and representatives to sell radio sets, storage batteries, accessories, etc.—to run garages, tire shops in 5000 places where I am opening sales branches.

If you are mechanically inclined and want an assured position as branch manager, write me today for sample contract. I will make this offer only to those who are sufficiently in earnest and sufficiently energetic to write me at once. Naturally, I will only employ Sweeney trained men.

The Sweeney System

famous the world over, can be had only in the Sweeney School. Trains men to be mechanics by practical work. You learn by doing—no books—you do the actual work. The course takes only 8 weeks. No place in the world can you get so much real instruction—so much actual value, for so little money. Over 46,000 graduates. Write me today—don't put it off—I've got some information that will open your eyes—but you must take the first step—Write for my Big Free Book.

Good Jobs for You

With your radio experience here you can go back home and install receiving sets or sell them. You can make sets for yourself. You can run a garage. You learn to make a good \$25 Ford battery for \$7.00. You learn how to weld a broken crank case. You learn how to make a real 4000 mile tire from old casing and rubber. You can be a chauffeur or truck driver. You can be an auto mechanic—a repair man in a shop or factory. Learn about stationary engines. Learn tractor work. Be a demonstrator or salesman. Hundreds of good jobs open to Sweeney trained men. Even before he finished his course Runsey was grabbed by the American Radiator Co. at \$150 a month as an expert welder.

Pick the Job You Like

Chauffeurs	\$90 to \$150
Truck Driver	\$125
Tire Vulcanizers	\$100 to \$200
Welders	\$140 to \$200
Battery Men	\$150 to \$200
Auto Mechanics	\$6 to \$10 a day
Auto Electrician	\$225
Tractor Engineer	\$10 a day
Garage Mgr.	\$150 to \$400
Demonstrator and Salesman	\$150 to \$500

With inexpensive receiving set you can get daily service from the Sweeney station. Sweeney students are furnished with the very latest and most powerful radio equipment.

Free Radio

Come to the Sweeney Auto School and learn Radio work without a cent's extra charge. Receive messages—learn to build and install Radio sets—get agencies and sell sets—receive messages from all over the world—all this is now part of the regular eight weeks' course without advance in tuition.

Great Broadcasting Station

Aerials 325 feet above the ground send Sweeney news, concerts, weather and market reports to the U. S. Station cost \$20,000 to erect. Call is W.H.B. Wave length 360 and 485 meters A 500 watts W.E. set provides the power for this great station.

FREE

I will gladly send my 72-page illustrated catalogue FREE. Also a copy of the Sweeney School News, a most interesting monthly school paper published here. You will enjoy them.

Read the worthwhile stories of men like yourself who came to Sweeney's and found success. Read how Frank Powell and Harry Wilson built up a \$30,000 business in about two years after graduating. Read how Elbert A. Pence built up a \$25,000 yearly garage business. These stories and others are told by the Sweeney students. Also I want you to learn how my students enjoy themselves after work in the swimming pool, club and reading rooms, etc. No colored students accepted.

LEARN A TRADE
Sweeney
 SCHOOL OF AUTO-TRACTOR-AVIATION
 1102 SWEENEY BLDG. KANSAS CITY, MO.



EMORY J. SWEENEY
 President

1102 Sweeney Bldg.
 Kansas City, Mo.

Please send me free without any obligation on my part your 72-page catalog and your Sweeney School News. Tell me of the opportunities in the Auto and Tractor Business.

Name.....

P. O. State.....

SEE OUR OTHER ADVERTISEMENT ON THE BACK COVER OF THIS MAGAZINE



FREE—

Actual Reports of Secret Service Operator 38

HERE is something money can't buy. More fascinating than detective stories. Confidential reports of a real operator—No. 38—to his Secret Service Bureau, headed by the most famous detective in America. Absolutely free. No cost. No obligation. Don't fail to send for them. They may point the way to Big Money for you. See how the modern detective works. Read these inside stories of the solution of great mysteries. See what possibilities this most fascinating and eventful of all professions offers to you—and how you may fit yourself for it.

Be a Finger Print Expert

To command the highest fees, the Secret Service man must also be a Finger Print Expert. These reports show why. This profession may be easily learned at home, in your spare time. Wonderful opportunity in this UNCROWDED, PROFITABLE field.

Make \$5,000 to \$10,000 a Year

The unfiled demand for trained Finger Print men is increasing daily. Opportunity is waiting for you. No time to lose. Send today for these reports, also our big Free book on Finger Prints. Gives all particulars and success stories of our graduates! Brilliant future ahead if you act now.

Special Offer Limited Time

Everyone getting these Free Reports will also receive my Special offer of a Professional Finger Print Outfit, absolutely Free. Made for a limited time only. Send coupon today—sure, Reports, Finger Print Book, and special outfit offer, all Free and Prepaid. Don't delay and perhaps forget. Do this right now.



← Also FREE
Send the Coupon

UNIVERSITY OF APPLIED SCIENCE

1920 Sunnyside Ave., Dept. 1356 Chicago, Ill.

T. G. COOKE, Pres. University of Applied Science
1920 Sunnyside Ave., Dept. 1356 Chicago, Ill.

Dear Mr. Cooke: Please send me FREE and prepaid, Reports of Operator 38, your new illustrated book on Crime and Crime Detection and your Special Outfit Offer. It is fully understood I assume no obligation.

Name _____ Age _____

Address _____

Town _____ State _____



Write for
Book No. 22

\$1,500 to \$6,000 a Year
Dental Laboratory Work

Be a mechanical dentist—a high class, agreeable occupation for men or women. Course is inexpensive. Takes only short time to complete. Experience or entrance requirements unnecessary. No license required. McCarrie graduates make big successes and are in great demand everywhere. Largest and best equipped school laboratory and clinic in America; individual practical instruction, modern up-to-date methods. Write for total scholarship offer. Find out how easy it is to fit yourself for this highly paid and dignified profession. Learn the McCarrie way. It pays.

Mc CARRIE
SCHOOL OF MECHANICAL DENTISTRY
34 and 36 W. LAKE STREET, CHICAGO, ILL.



LISTEN AND LEARN
SPANISH · FRENCH · ITALIAN
GERMAN · ENGLISH · ETC.
ON **CORTINA PHONE METHOD**

Another World is opened to you by acquiring knowledge of a foreign tongue. Whether for commercial purposes or merely as an accomplishment. Old Masters in Art and Literature brought right into your home. Ours is the Ideal Method. "Merely Listen and Learn." Write for full particulars.
R. D. Cortina Co., Dept. 53, 109 W. 48, New York

LAW

IN YOUR SPARE TIME
Learn law with only institution giving same course by correspondence as was given for years at resident classes of this college. **DEGREE OF LL. B. CONFERRED.** One year business law course prepares you for success in demand. Three year university course covers preparation for bar examination. Money back guarantee if not satisfied. Low fee, easy terms, includes complete 1921 thirteen volume library, text material and all expenses. Write for **FREE BOOK.**
Hamilton College of Law
431 South Dearborn St., Dept. 69 Chicago

AVIATION INFORMATION FREE

Send us your name and address for full information regarding the Aviation and Airplane business. Find out about the many great opportunities now open and how we prepare you at home, during spare time, to quality. Our new book "Opportunities in the Airplane Industry" shipped free if you answer at once.

AMERICAN SCHOOL OF AVIATION
Dept. 1196 3601 Michigan Ave. CHICAGO

"BECOME A LIGHTNING TRICK CARTOONIST"
MAKE MONEY CHALK TALKING. SEND \$1.00 FOR SNAPPY, MODERN TRICK DRAWINGS WITH INSTRUCTIONS BY A PROFESSIONAL CARTOONIST. SATISFACTION GUARANTEED. CIRCULAR FREE. BALDA ART SERVICE, 21, OSHKOSH, WIS.



BECOME A RAILWAY MAIL CLERK

Examinations soon. \$1600 to \$2300 a year. No strikes or lockouts. Common education sufficient. No "pull" necessary. Mail coupon for Catalog.

Patterson Civil Service School
Dept. 89, Rochester, N. Y.

Sirs:—Send me without charge your Catalog, describing this and other fine U. S. Government positions.

Name _____
Address _____

Dept. 89
Patterson Civil Service School
Rochester, N. Y.

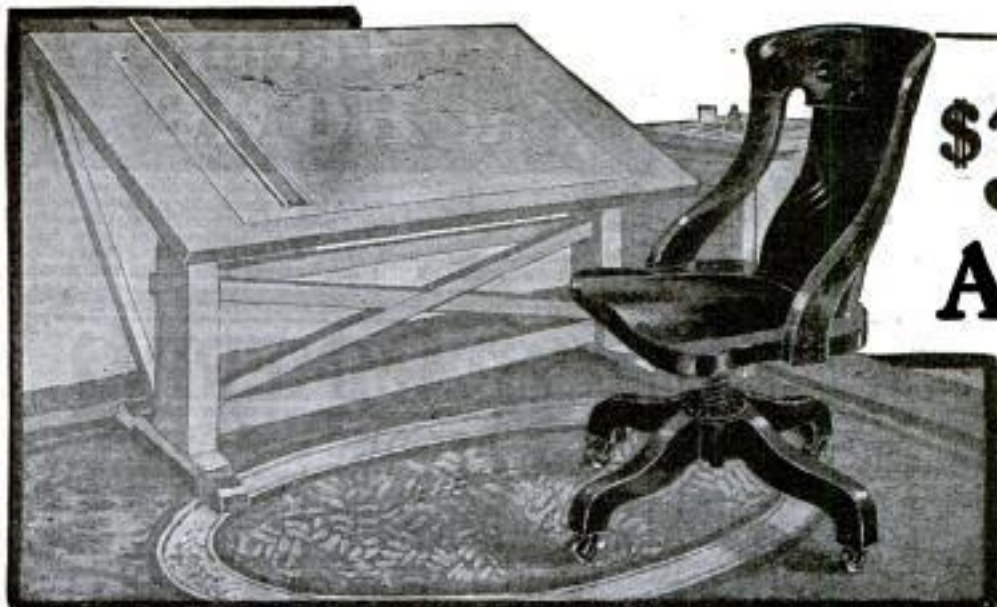

**\$3600
A YEAR**

to fill this
chair

Wanted

all over
the
country

72,000 Men at \$3,600 Per Year

Write to me today if **YOU** want to sit in one of the many vacant chairs like this—if you want a splendid position as a skilled draftsman at \$3600 a year. Now is the time to get ready for the big building boom everywhere.

Closest estimates fix the number of men who will be needed every month during 1922 at 6000. Write to me and I will tell you how I can make you a first class, big money-earning draftsman in a few months—in plenty of time so that you will be ready.

Many a man who has written to me now earns \$2000 or more. The draftsman's training they got from me gave them the power to command this price. There will be no obligation on you if you send me your name. Now, more than any other time, it is your duty to find out how I can train you personally to fill a position as a high grade draftsman. This chair is yours if you want to fill it. Will you accept the opportunity?

No other man or institution can imitate my method. I teach you personally. I give you private instruction. I make you see how I made a success as a draftsman. For 20 years I have been doing the highest paid expert drafting work as chief draftsman. So the instruction you get from me is practical. That is the kind of instruction you need to hold one of the big paying positions. I know what the big firms demand. Remember, I train you until you are actually placed in a position paying from \$250 to \$300 per month. So write today. Do not put this opportunity off. Positions are open right now—this very minute.



I Guarantee
to Train You Until You Are
Placed in a Position Paying
from \$250 to \$300 a Month.



FREE!

\$25.00 Drafting Outfit

Here is the high-grade drafting outfit which I give you without one cent of expense to you. Every instrument of the highest quality. Everything you need. Packed in a handsome plush lined case. Just the kind I use myself.

Chief Draftsman Dobe, 4001 Broadway, Dept. 9356, Chicago, Ill.

Earn Money While Learning

I even give you an opportunity to begin earning money as soon as you enroll as one of my personal and private students. This enables some men who might not be able to begin this practical training now to pay their way as they go along. Write for this plan today, if you are a man dreaming of a big successful future.

Mail Coupon Today

There are no obligations in sending your name and address to me on this free coupon. Send it today. I will mail you at once absolutely free and prepaid my new book, "Successful Draftsmanship." It will tell you why so many men are needed right now and it will tell you how to earn money while learning. So send the coupon now.

Chief Draftsman Dobe

4001 Broadway, Dept. 9356, Chicago, Ill.

Without any obligation whatsoever, please mail your book, "Successful Draftsmanship," and full particulars of your liberal "Personal Instruction" offer to a few students.

Name

Address

LEARN CARTOONING

the Right Way



Have your ability trained by the school that has developed many famous cartoonists.

If you like to draw—if you find pleasure in picking up a pencil and paper and trying to make sketches or cartoons, don't regard it merely as a hobby. Have your ability developed and earn a good income as a cartoonist.

Hundreds of nationally known cartoonists, such as Branner of the Chicago Tribune; Blosser, who draws "Freckles and His Friends"; Gene Byrnes, creator of "Reg'lar Fellers"; Thiele of the Sioux City Tribune; Fung, of the Seattle Times and others equally well known, took the Landon Course at home, in their spare time, and fitted themselves for their present positions at salaries ranging from \$50 to \$200 and more per week.

Have YOUR talent developed by the same method

What the above mentioned boys did you can do, with the same training. The Landon method of teaching makes cartooning easy to learn. By means of an extensive series of Big picture charts all the necessary details of ORIGINAL drawing are explained step by step, in a clear and simple manner.

FACTS that determine the superiority of the Landon School:

1. Landon School Students are securing the best cartooning positions which open up everywhere.
2. The picture chart method of instruction was originated and is used exclusively by the Landon School.
3. From the very beginning, the Landon Course teaches ORIGINAL drawing. No copy work.
4. Individual attention and criticism of student's work. Personal coaching whenever necessary.
5. Specialized instruction on how to originate cartoon ideas. This is an exclusive feature of the Landon Course.
6. Practical assistance in securing positions for students and help in marketing their work.
7. The price is within reach of everyone who is ambitious to succeed. Easy payments can be arranged.

Write today for full information about the Landon Course, and sample chart by means of which you can test your own ability. Find out what the possibilities are for YOU in this interesting profession. Please state your age.

The Landon School

1138 National Bldg.

Cleveland, Ohio

Learn Chemistry at HOME

Chemistry offers the greatest opportunities to-day of any profession. If you want to know how you can learn chemistry at home, in your spare time, write to one of the foremost authorities on Chemistry, Dr. T. O'Connor Sloane, care Chemical Institute of New York, Home Extension Division 9, 140-P Liberty St., New York City. Dr. Sloane will send you full information FREE, by return mail.

"STAMMERING Its Cause and Cure"

You can be quickly cured if you stammer. Send 10 cents, coin or stamps, for 288 page cloth bound book on Stammering and Stuttering. It tells how I cured myself after Stammering and Stuttering for 29 years. **BENJAMIN N. BOGUE**
741 Bogue Building, 1147 N. Ill. St. Indianapolis

TELEGRAPHY

(Morse and Wireless) and RAILWAY ACCOUNTING taught thoroughly. Big salaries; great opportunities. Oldest, largest school. Endorsed by Telegraph, Railway, Radio, and Government officials. Expenses low—opportunities to earn large portion. Catalog free. **DODGE'S INSTITUTE, Dyke Street, Valparaiso, Ind.**

Play Piano by Ear Learn at Home in 90 days



NO MATTER how little you know about music—even though you "have never touched a piano"—if you can just remember a tune, you can learn to play by ear. The Niagara School of Music has perfected a method of instruction which will enable you to play all the popular song-hits perfectly by ear. All you need to know is how to hum a tune. Our method—only 20 lessons taken at home—which you can master in less than three months' time, will enable you to transform the tunes you hum into actual Jazzy music on the piano. All by ear.

A Simple Secret to Success

No need to devote years in study, to learn piano nowadays. Neither is special talent necessary. Every lesson is easy, so interesting and fascinating that you can't keep your hands off the piano. Just devote a part of your spare time to it for 90 days and you will be playing and entertaining your friends almost before you realize how this wonderful accomplishment has been acquired.

---Write for Free Book---

Niagara School of Music, Dept. 462, Niagara Falls, N.Y. Without obligation to me, send your booklet, "The Niagara Method."

Name..... Age.....

City..... State.....

Ever take piano lessons?..... How many?.....



"Why do so many men never amount to anything? Because they don't think."
—Edison.

This book will give you some valuable information about a new practical system of constructive thinking that brings business and personal achievement.

MARK TWAIN once said that the average man didn't make much use of his head except for the purpose of keeping his necktie from slipping off.

And Prof. William James claimed that the average man uses only about a tenth part of his brain.

How about *you*? Are you using *your* head simply as a scarf-retainer? Are you using only 10% of *your* brain? Are you sitting, discouraged and discontented, at the foot of the ladder simply because you don't *think*?

Mind is the measure of every man. Mental power—not physical power—wins business battles and builds bank accounts.

The man with *brains* to sell fixes his own price, but the man who brings only brawn to market must be satisfied with the lowest wage that brute force brings.

In every age, in every clime and in every field of human endeavor the *trained thinker* wins where the *thoughtless toiler* fails.

Twain, James, Edison, Roosevelt, Rockefeller, Schwab, Carnegie, Woolworth, Wanamaker, Morgan, Hill, Harriman, Ford, Marconi, the Wright brothers and all other successful men reached their goals not because they knew how to use their *muscles* but because they knew how to use their *minds*.

Only One Road to Success

Yes indeed, there is only *one* road that leads to success, and that is the *mental* road. If you expect to accomplish anything worth while by any other method than the *development* and *use* of your mental faculties, you are simply deceiving yourself. And the biggest fool in the world is the man who fools himself.

Isn't it simply absurd, when you stop to think about it, that most people are striving for success and yet are doing absolutely nothing to strengthen and develop their *minds*, which is the *only* part of them with which they can ever hope to win success?

The principal reason that the *trained thinker* gets ahead is because he has so little competition.

The *unthinking toiler* works hard for small pay because almost anyone can do his work.

What are *you* doing—as the days go by—to develop *your* mind? Are you more efficient mentally than you were a month ago—or a year ago?

Missing Success by a Hair's Breadth

The difference between *success* and *failure* is often but the breadth of a hair.

The man who is making *twice* as much as you are, has *nowhere* near *twice* the intellectual ability. The man who enjoys an income of \$10,000 a year is not *five* times the mental superior of the man who receives only \$2,000.

Probably the man who makes \$1,000 a month is only 10% to 20% better trained mentally than the man who is trying to make both ends meet on \$100 a month. This is a *fact*. And it should be a most *encouraging* fact to every man who wants to be *somebody* and *get somewhere*.

Improve your mental power only 10% and you will multiply your earning capacity by at least 100%.

Get This New Book

We have just published a new book—*The Secret of Mental Power*. We will gladly send you a copy free of charge upon request. And we want to *state*—as forcibly as we know how—that you will find it one of the most interesting and mind-spurring books you ever read.

Send for a copy today. It tells about the most practical, common-sense system of constructive thinking—the easiest and quickest method of mind-building ever discovered—the secret of developing mental power in a way that is as fascinating as a game.

Now Is the Time

Send for *The Secret of Mental Power* now. Do not delay. Do not put it off. Tomorrow you may forget all about it. And the loss will be yours, not ours. For although we have printed an edition of 20,000 copies, we do not expect to have a single one left at the end of thirty days. They are going—and going *fast*. Therefore act at once, for as Sophocles so truly said, "Heaven never helps the man who will not act."

Mail the coupon now. Or, send a postal if you prefer. Independent Corporation, Dept RM-459, 22 West 19th St., New York.

FREE BOOK COUPON

Independent Corporation,
Dept. RM-459, 22 W. 19th St., New York.

Gentlemen:—Please mail me at once—without expense or obligation of any kind—a copy of your free book, *The Secret of Mental Power*.

Name.....

Address.....

Town..... State.....

Get This FREE BOOK if Interested in Learning

How to think like an arrow.
How to compel attention.
How to master important problems.
How to overcome fear and worry.
How to "tune up" your mental motor.
How to develop new methods.
How to originate new ideas.
How to learn quickly and easily.
How to attract valuable friends.
How to have more time for play.
How to out-think the average man.
How to make your mind a mental mazda.
How to stop thinking in circles.

THE SCIENTIFICALLY BUILT WATCH



Model 1102

Hammered by Myriad blows

AND yet it keeps dependable and accurate time. The Waltham Automobile Clock is in use wherever cars run over American roads. It is hammered in each car by thousands of blows every year (the roughness of the road treats it rough)—but it goes on telling the time as if it were reposing on velvet.

This same immunity to shocks and vibrations is also built into every Waltham Watch and is one of the reasons why Waltham Watches keep accurate time under the most difficult conditions.

The genius in the Waltham Watch is the genius in the Waltham Auto Clock and Speedometer. A trinity of usefulness, dependability and truth-telling.

The Waltham Speedometer also excels. Invented by Nikola Tesla but developed and perfected by Waltham, it is the only Air-Friction Speedometer in the world. It tells speed and mileage instantaneously and accurately.

The World's leading cars are equipped with Waltham Speedometers and Clocks. And men and women who invest their money wisely wear Waltham Watches.

WALTHAM WATCH COMPANY
WALTHAM, MASS.

Service Stations in all leading cities



Waltham Colonial 1420
15 Jewels
\$45 — \$75
Depending upon the case

WALTHAM

THE WORLD'S WATCH OVER TIME

Where you see this sign they sell Waltham Watches
GIFTS THAT LAST

Popular Mechanics Magazine

REGISTERED IN U. S. PATENT OFFICE

WRITTEN SO YOU CAN UNDERSTAND IT

Vol. 38

SEPTEMBER, 1922

No. 3

“Human Gopher” Recovers Master Bushing 9631 from Deep Oil Well

BY FRED A. HERR, 333

*Lowell Ave.
Long Beach,
Calif.*

WHEN the Interstate Oil Company of Los Angeles lost a master rotary bushing down the casing of Jonah No. 1 well in the Signal Hill oil field, three alternatives were available for continuing operations at the well. The lost tool could be dynamited out of the casing, the

rig could be “skidded” over a few feet and a new well started—or a man could be let down the hole to bring up the bushing.

Dynamiting involved the virtual destruction of the well, and skidding the rig meant the sacrifice of approximately \$25,000 spent in drilling the hole to its present depth. Then some one mentioned the name of Walter McCay, of Taft, Calif. McCay is known as the “human gopher” in the west coast fields. He was brought to Los Angeles, examined the well, and agreed to go down the hole and bring up the lost tool.

The bushing had lodged at the 110-foot level in the 20-inch casing. Below it for 1,200 feet to the bottom of the hole the well was filled with mud, pumped in to counteract the heavy gas pressure. Sinister bubbles on the surface of the mud indicated the presence of much gas, making the attempt to enter the well a hazard-

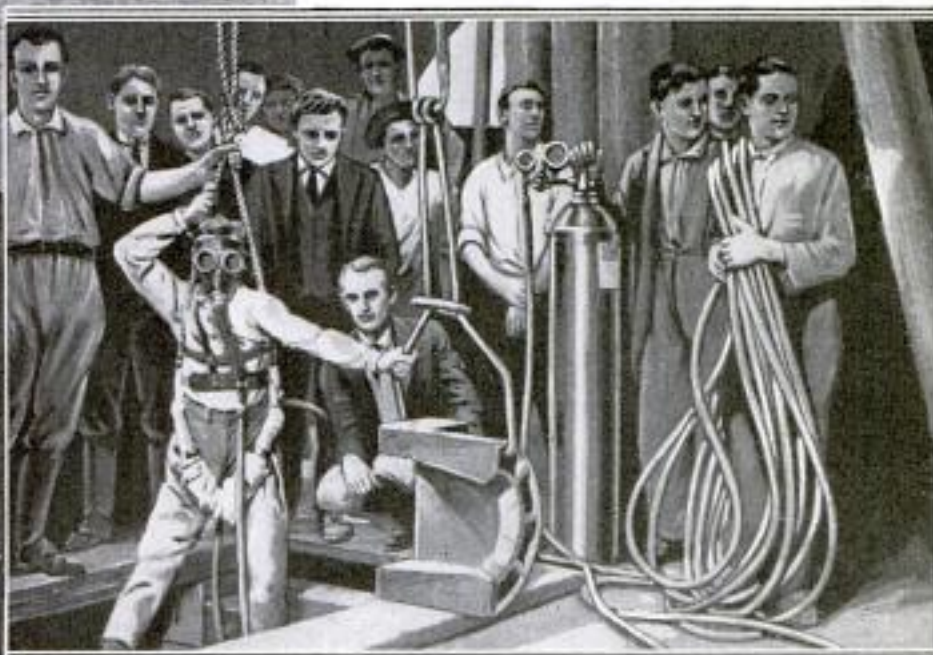
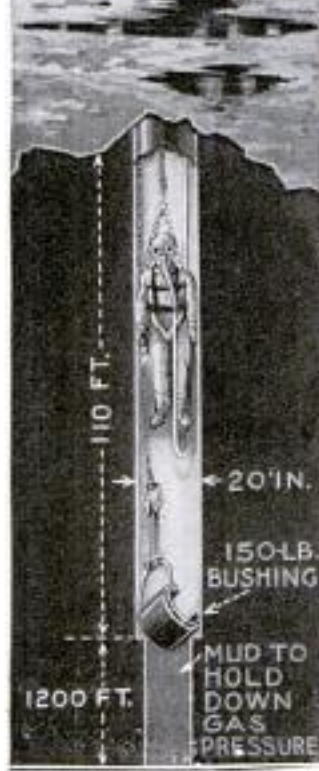

Left: The Sectional Diagram Shows How the Man was Lowered to Fasten the Grab Hook to the Bushing Lodged Where the Large and Small Casings Join. Right: Walter McCay in a Special Rope Harness and Equipped with Oxygen Breathing Apparatus as He Appeared after the Recovery of the Bushing.

ous undertaking. It was McCay's pleasant job to get down the narrow 20-inch pipe and attempt to "hook" onto the bushing with a pair of iron tongs.

A harness, constructed of 1-inch hemp rope with loops for the insertion of the legs, was prepared to suspend him in the gas-filled hole. The sides of the harness were padded with cotton. The man sat suspended in the loops in the manner of an aerial performer sitting in the iron-rings of a trapeze. Wearing a gas mask, attached by a rubber hose, 150 feet long,

to an oxygen tank, and carrying a flashlight, the man was suspended from the cat-reel line over the cavernous well opening and lowered slowly into the narrow, muddy, gas-filled pipe. Oxygen was continuously pumped down to him. Six trips were made down the casing before a satisfactory connection was made with the tongs. Finally the bushing was "hooked," and the human gopher was drawn out of the well, pulling the bushing up after him. He spent more than 45 minutes in the hole.

9781

TRAP CATCHES FUR-BEARING ANIMALS HUMANELY

To take the place of the steel-jawed leg trap, the cruelest means of catching fur-bearing animals on account of the

HIGH-CARBON GRINDING BALLS GIVE GOOD SERVICE

The grinding balls used in tube and ball mills are subject to most severe conditions of abrasion and shock and must be especially made in order to render good service. It has been found that grinding balls made of an alloyed steel-base white iron of high-carbon content give excellent results. These balls are cast in such a way that the crystals radiate from the center of the ball, reducing wear and breakage to a minimum.

mining & Scientific Press

NEW CONVERTIBLE FIXTURE FOR GAS BURNERS

9702 FOR GAS BURNERS

For converting the open-flame gas burner to the mantle-type of burner, there is now being placed on the market a fixture that has several interesting points. The fixture may be screwed on in place of the open-flame burner, and the "gooseneck" is of such dimensions that it will fit inside the standard shades or globes. The shade holder may be placed at the top or bottom of the globe adapting the fixture for either direct or indirect lighting, a threaded knob being provided at the top of the fixture for supporting the holder.

U. W. Ernest Cole 413 S. Church St. Belleville, Ill.

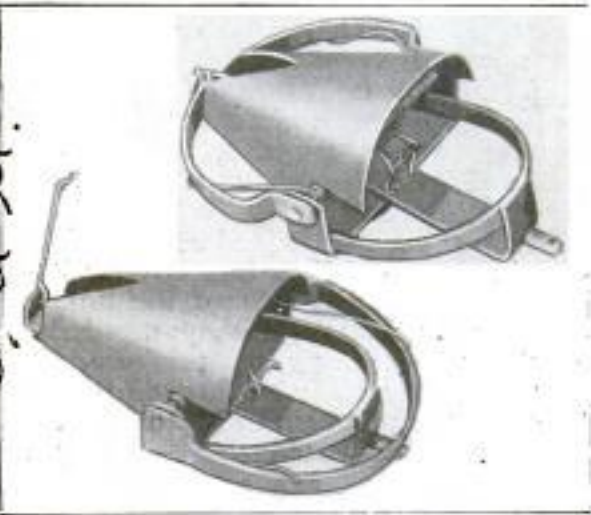

Trap for Catching Fur-Bearing Animals Humanely: The Upper Jaw Swings Over Rapidly When the Bait is Touched by the Animal, and Breaks Its Neck

length of time that may elapse before death, a trap has been invented that breaks the neck of the animal, killing it instantly. The trap is composed of two jaws, one stationary and the other movable. The stationary jaw is connected rigidly to the horizontal framework of the trap, and is raised slightly above the ground in front of the hooks that hold the bait. Outside this jaw, pivoted on a spindle on which is a strong coiled spring that operates it, is the movable jaw. When set, this jaw is swung clear back to the rear of the trap, where it is held by a trigger. When the bait is touched by the nose of an animal the jaw is instantly released, and the spring swings it over so that the animal's neck is clamped between the two jaws and broken. It is claimed by the makers that a 10-year-old boy can easily set the strongest trap.

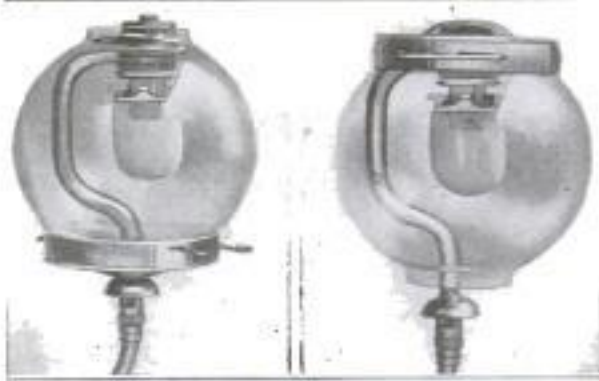

Left: Burner and Shade Holder Arranged for Indirect Lighting. Right: Same Fixture Used for Direct Lighting

The General Gas Light Co. St. Charles Hotel Bldg. Pittsburgh, Pa.

Los Angeles Laundry Co. 7 Calif. St. Alameda, Cal.

6/10/2

GIGANTIC RADIO STATION OPENED IN GERMANY

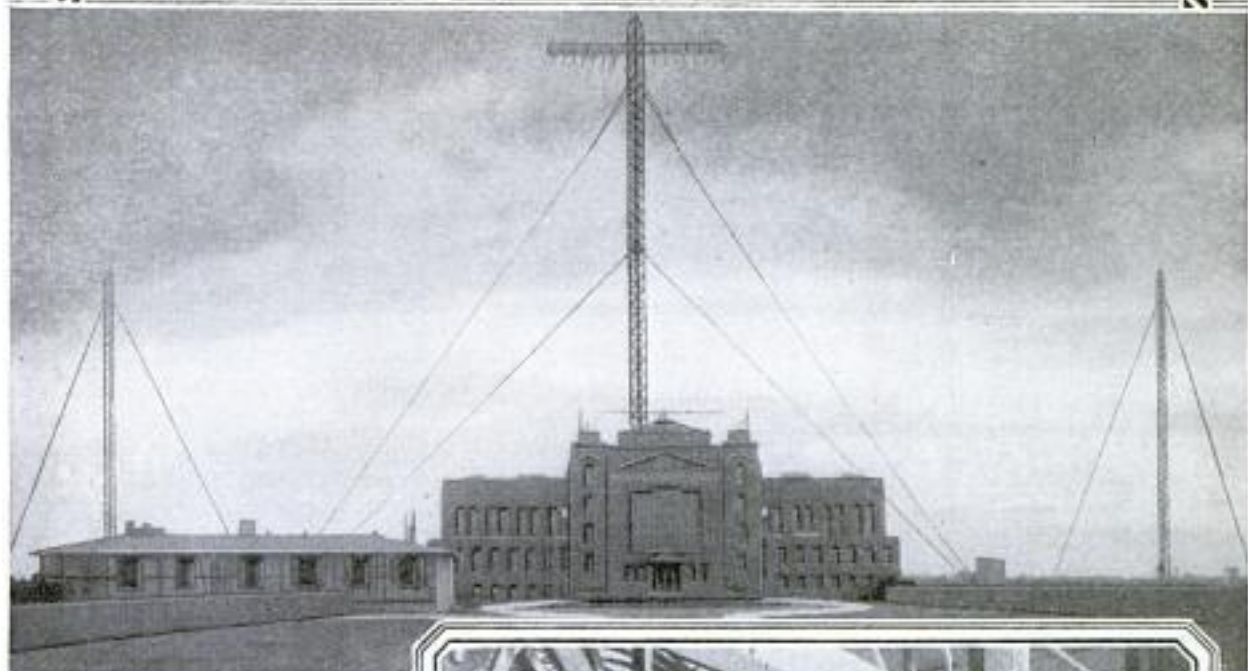

At the Top is Seen the Exterior of the Large Wireless Station Recently Opened at Nauhen, Germany, Showing the Three Gigantic Towers Constructed to Support the Antenna. In the Center is Shown Some of the Mammoth Tuning Coils with Which the Station is Equipped, and the Method of Mounting Them upon Insulators. Below can be Seen the Sending Room, Containing the Large Installation of Storage Batteries Necessary in This Powerful Radio Station. The Opening of This Station Graphically Illustrates the Way Germany is Endeavoring to Keep Abreast of the World's Progress

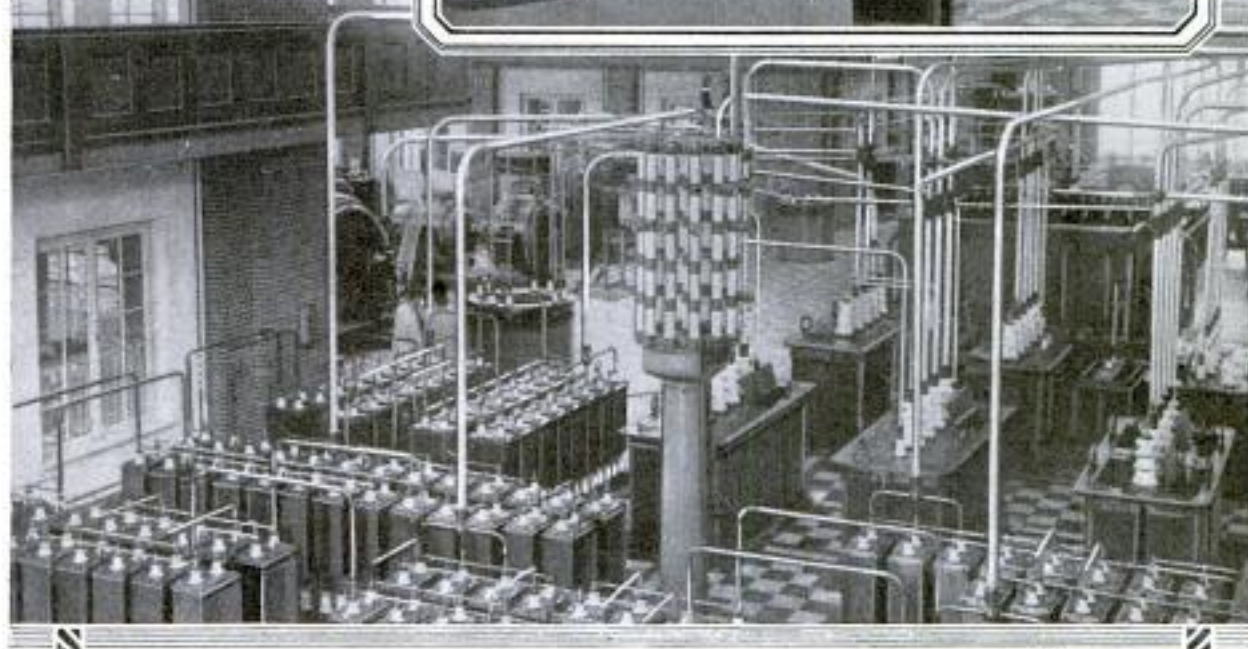
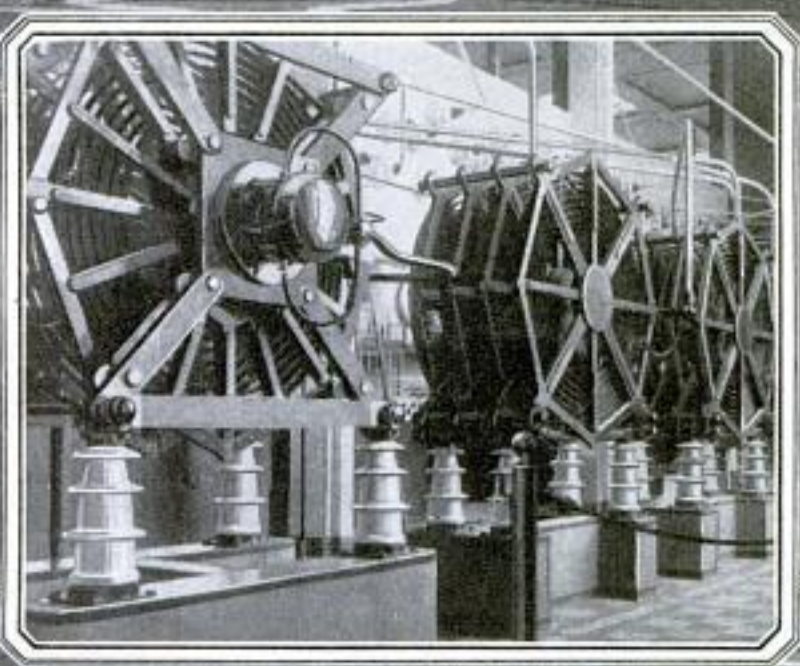

Chas. J. Es. Allen, Carshalton,

106 Victoria St. London, Eng.

POPULAR MECHANICS

NEW WATER-LIFTING MACHINE SELF-OPERATING

332

9676

Chas. J. Es. Allen, c/o Messrs Liversidge & Co. Ltd., 106 Victoria St., Westminster, London S.W. 1, Eng.

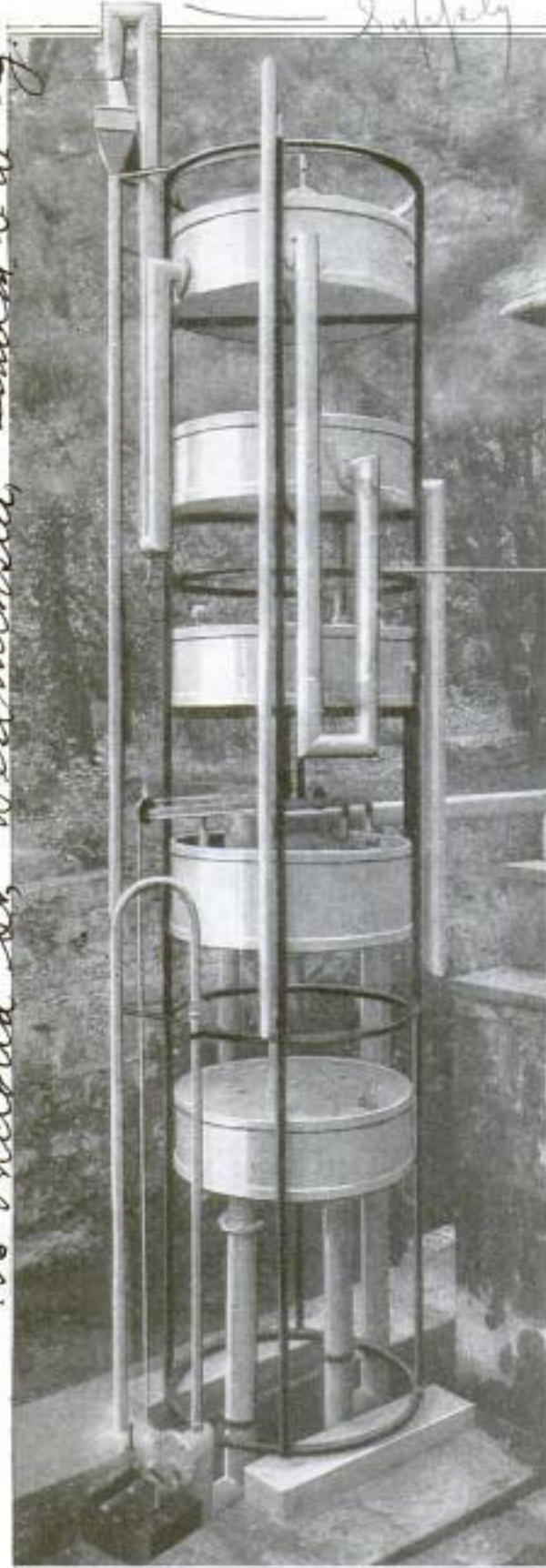

A machine that is entirely self-operating, and that lifts water in any quantity to any desired height, has been installed on the river Wandle, England. To operate the machine there must be an available fall in the river between an upper level, which may be called the headrace, and a lower level or tailrace. Halfway between is a closed tank which is the operating chamber of the apparatus, and which is connected by an inlet pipe to the headrace, and to the tailrace by a discharge pipe in the nature of a siphon. Above this operating chamber are a series of alternately open and closed tanks, one above the other, at equal distances, to the required height. Each pair of closed and open tanks are interconnected by pipes, and each closed tank is connected by an air-conducting pipe to the operating chamber below. In operation, first by means of an automatic valve the water from the headrace is admitted to the operating chamber, which at that time is full of air. The filling of this chamber with water under pressure forces the air, also under pressure, into the overhead closed tanks, which at that time are full of water. This, therefore, in each case is forced into the open tank above it. The valve then cuts off the water supply to the operating chamber, and its contents are discharged to the tailrace, leaving a vacuum in the chamber. This vacuum is communicated by the air pipe to each of the closed tanks, and thus the water in each open tank, filled by the previous stroke, is sucked up to the closed tank immediately above it. The machine is now in the same condition as before the first stroke, and each of these strokes—one a pressure and the other a suction stroke—is alternately repeated by the operation of the automatic valve.

9682
SILO MOVED FROM ONE FARM TO ANOTHER ON A WAGON

Recently a silo of 3-ton capacity was moved intact from one farm to another in Ohio, and was reerected on a new foundation without injuring it in any way. At its original location, the silo was loaded onto a lumber wagon, and was then hauled to its new site. Here the rear wheels of the wagon were removed, and the bottom of the silo was placed against the side of the new foundation. Then, by means of a block and tackle connected to its top, the silo was

Automatic Water-Lifting Machine: From Bottom Up, the First and Second Tanks Are the Operating Chamber and Headrace, Respectively; the Third and Fifth are Closed, and the Fourth Open. The Open Lower End of U-Pipe at the Left Is the Tailrace

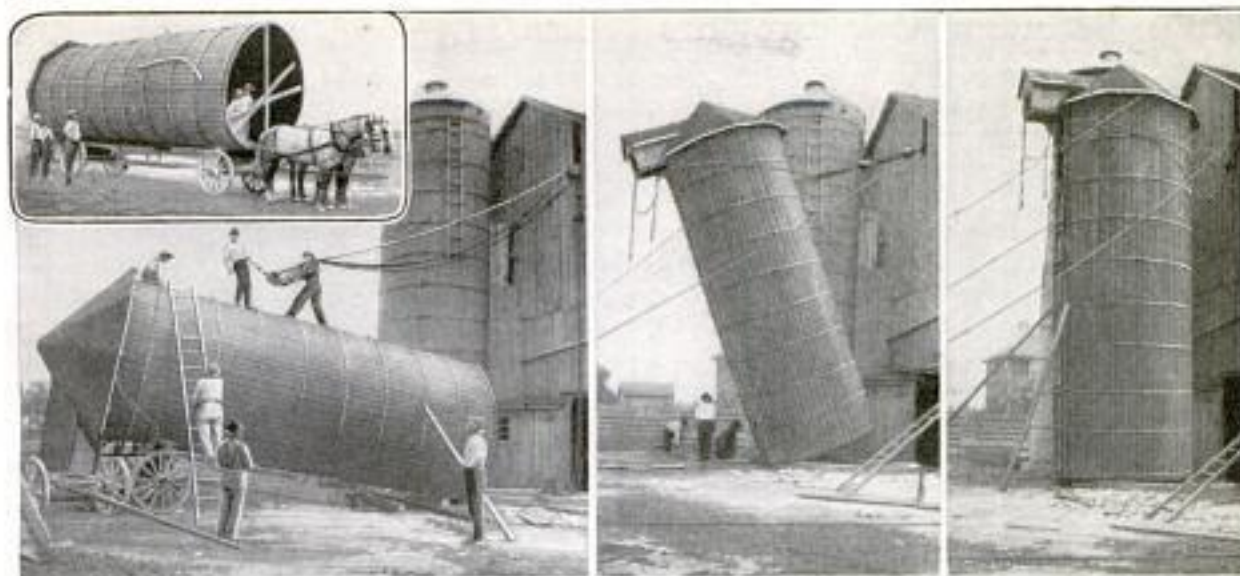

Insert Shows the Silo being Moved along the Road. The Other Views Give a Clear Idea of the Means Used to Erect and Place It in Its New Location

hoisted from the front wheels into an upright position, and properly adjusted upon the foundation. It was a matter of only one morning's work to remove the silo, and erect it ready for use in its new position. The method was found to result in a considerable saving, but is advisable only when the silo is in good condition.

¶ To aid the retail lumber dealers, the National Lumber Manufacturers Association has started a correspondence course on "Lumber and Its Uses and the Merchandising of Lumber."

W. Moore Chicago

SPEEDY FRENCH HYDROGLIDER LOOKS LIKE A GIANT FISH

9551
 With a speed of 63 miles an hour, claimed to be the world's record, a new French hydroglider has much the appearance of a giant fish. Its air propeller is driven by a 300-horsepower motor that is supported and strongly braced above the craft at about its center and just behind the small compartment in which the passengers ride. It glides on horizontal planes, and is steered and controlled like a flying boat, which in other respects it very much resembles.



New French Hydroglider That Has a Speed of 63 Miles an Hour: The Motor, Directly Connected to the Air Propeller, Develops 300 Horsepower. In Every Respect It is Built Very Much on the Lines of a Flying Boat

International Newsreel Corp
 New York City

Inquiries to: J. H. Wood,
 706 Flanders Bldg., Philadelphia
LIGHT SPEAKS! Pa.

9810

Little Selenium Cell Provides Voice for Motion Pictures—Old Inventor Pioneers in New Field—Vast Possibilities for Research Opened Up by Perfected Coil

BY H. A. LANE

NATURE seems to have decreed that stupendous results in scientific research shall always emanate from the most meager beginnings. Also, that long struggles shall have been put forth before she consents to relinquish any of her secrets. Any inventor will testify to this from the facts of his own experiences. Many of these inventors or experimenters have been interested for some time in the wonderful properties of selenium.

This substance, belonging to the sulphur family, displays peculiar characteristics when exposed to light rays of changing intensities. Due to its mysterious nature, selenium has been made the basis of extensive experiments in the electrical field. Coils of wire, when treated with a compound of selenium and connected in an electrical circuit, can have their resistance raised or lowered by exposing the treated portion of the coil to light. From this basic principle, numerous adaptations of this astonishing material have arisen. Chief among these, in the past few years, has been the attempt to obtain a synchronous rendition of sound and motion which would be applicable in the motion-picture field.

One of the pioneers of this talking-movie idea is a Chicago man who, some six or eight years ago, began to experiment along this line. Carefully reviewing such possibilities as were commonly known at that time, the experimenter concluded that, to achieve results, a selenium coil, or cell, was a necessity. Casting about for one of these, he learned that no satisfac-

tory cells were available. Refusing to be halted by the circumstances, he hunted up an old friend, L. A. Brinkman, also of Chicago, who had tinkered with numerous small inventions for the greater part of his life. Unceasingly the worried man burst upon the old inventor one day abruptly pronounced: "You've got to make a selenium cell."

His gray-haired friend smiled quietly and queried: "Selenium? What is it?—I've never heard of it."

Nevertheless, Brinkman, in his peculiar way, strove to oblige his life-long friend and immediately began to work on his new problem. Pamphlets from various universities and advice from scientific sources caused him to try elaborate mixing and baking methods in order to produce the proper compound for creating a satisfactory cell. But after many months of unsuccessful trials, he impatiently brushed aside all the proffered formulas, and acting under a sudden impulse, mixed a compound of his own. Then, taking a tiny coil of wire, he spread, or to quote his term, "smeared" the mixture over the surface. Placing the coil in an electrical circuit, he was astonished to observe the extreme sensitiveness of the midget cell when light of varying intensity was directed upon it.

By the time Brinkman had succeeded in producing a satisfactory selenium cell, his friend had been obliged, through financial obstacles, to put aside his talking movies, and the old genius promptly lost interest in his discovery. Vague accounts of the



Miniature Lamp (Exact Size) Which Aids in Changing Sound Waves to Light Waves When Voice Variations in the Transmitter Vibrate the Filament

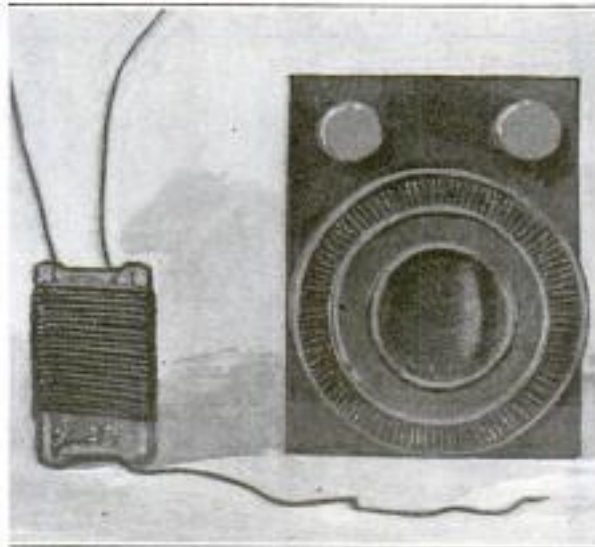

Left: One of the Wonderfully Sensitive Selenium Cells, Showing, in Actual Size, the Winding of Copper Wire upon a Soapstone Core. Right: Selenium Cell Inclosed in Its Case



Tuning the Radio Amplification Apparatus to Obtain a Reproduction of the Tones of the Human Voice from a Strip of Motion-Picture Film: This Picture, Taken during the Development of the Talking-Movie Idea, Shows the Inventor behind the Table, being Assisted by His Friend

cell found their way into print, and though it was known that he had produced the article, no one seemed to have a use for it. This was the state of things up to the latter part of last year. At that time another man was searching the country for a selenium cell to aid in the work of photographing the sound waves of the human voice. Finally, through devious channels, he was directed to Brinkman, and requested by mail one of the tiny treated coils for experimental purposes. The inventor obligingly presented him with one, and he quickly realized the possibilities of the amazing sensitive-to-light qualities of the small cell.

In six months' time, they had reached the stage of comparative success. The underlying principle of their labor was to change the sound waves, or vibrations of the human voice, into light waves, and then obtain a photograph, or record, of these light

waves upon a strip of ordinary motion-picture film. Then the light waves, which appear on the film as fine lines of different shadings, were to be detected, or "taken off," amplified by radio apparatus, and the voice thereby reproduced in its natural tones.

In brief, their method of procedure is as follows: The vibrations of the voice are carried into a telephone transmitter and from there, as electrical impulses, they pass through a miniature lamp connected in a battery circuit. The variations of the sound waves change the impulses in the battery circuit, and cause a vibration of the tiny light. These vibrations, invisible to the naked eye, are recorded through a narrow slit which permits the light to fall upon the swiftly moving film. The film is then developed in the usual manner, the

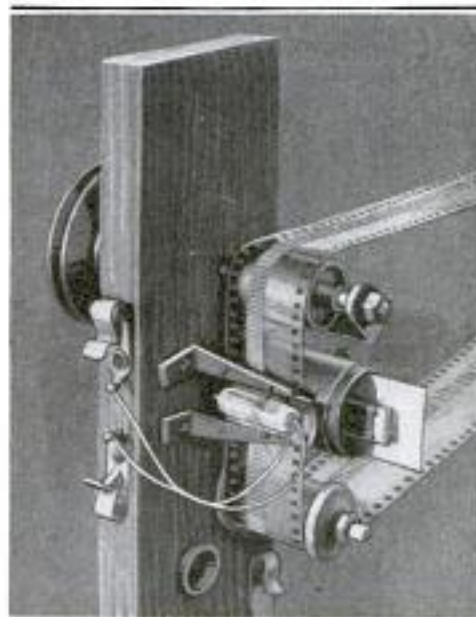

Close-Up of Reproducing Mechanism, Showing How the Film Passes between the Light and the Selenium Cell

vibrations appearing, as stated above, as lines of different shadings. For reproduction, the film is passed between a

selenium cell and a bright light. The lines or shadings on the film cause a change in intensity of the light which is shining through them and on the selenium cell, thus causing a change in resistance of the sensitive coil when it is connected in an electrical circuit. From this point, by proper radio-amplification methods, these variations in the electrical circuit are transformed into sounds, which are the exact duplicates of those carried into the transmitter at the beginning of the operation.

By being able to record the voice at the same time the pictures are filmed, on the

the screen, there is no possible chance for the voice and action to get "out of step," which fault has been the stumbling block of all other systems of this kind, heretofore.

Taking into consideration the fact that sound waves, which travel at the approximate speed of only 1,100 feet per second, can be changed into light waves having a velocity of 186,000 miles a second, the possibilities of the tiny selenium cell are inconceivable. This fundamental fact alone opens broad fields of theory. The three men responsible for the bringing forth of the marvelous discovery, however, are concentrating upon the talking motion picture.

Other uses to which the innovation can be put, are the making of films, or records, of entire operas, and symphony concerts. These will be recognized as being greatly superior to the four or five-minute records now available on the common talking machine. In addition, the metallic, or "tinny," sound will be entirely eliminated, owing to the absence of any mechanical contact between the record and the reproducing mechanism.

Further adaptations based upon the merits of the selenium cell are: fire alarms, by giving notice of the glare of flames; burglar alarms, by indicating the presence of flashlight beams; the measurement of light intensities; the testing of materials or substances by colors; the recording of entire court proceedings without error, and the switching on and off of lights in isolated places by the automatic action of daybreak and nightfall upon the supersensitive little cell.

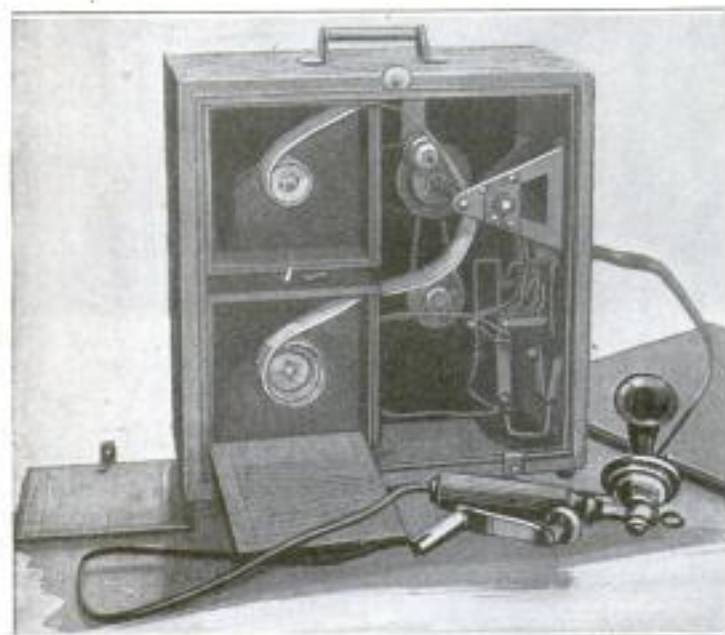

Portable Outfit for Obtaining a Record of the Voice at the Same Time the Pictures are Taken: The Crank for Turning the Reels, and the Transmitter, are Seen in Front

margin of the same strip of film, and with the developing process being exactly the same, the absolute synchronism of the sound and action is clearly apparent. And when the film is eventually projected on

of entire court proceedings without error, and the switching on and off of lights in isolated places by the automatic action of daybreak and nightfall upon the supersensitive little cell.

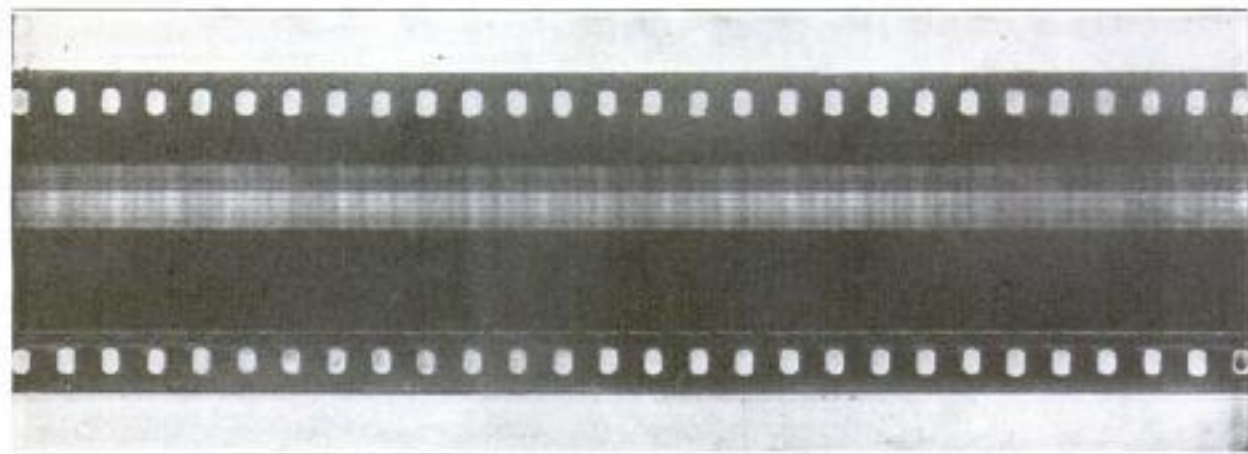

Section of Motion-Picture Film Used during the Early Experiments, Which Shows, by Means of the Shaded Lines, How the Record of the Human Voice Appears on the Finished, or Developed, Surface

9736

P. E. Peck, Peck's Dancing Pavilion
Palm Garden
POPULAR MECHANICS
Jacksonville, Fla. 337

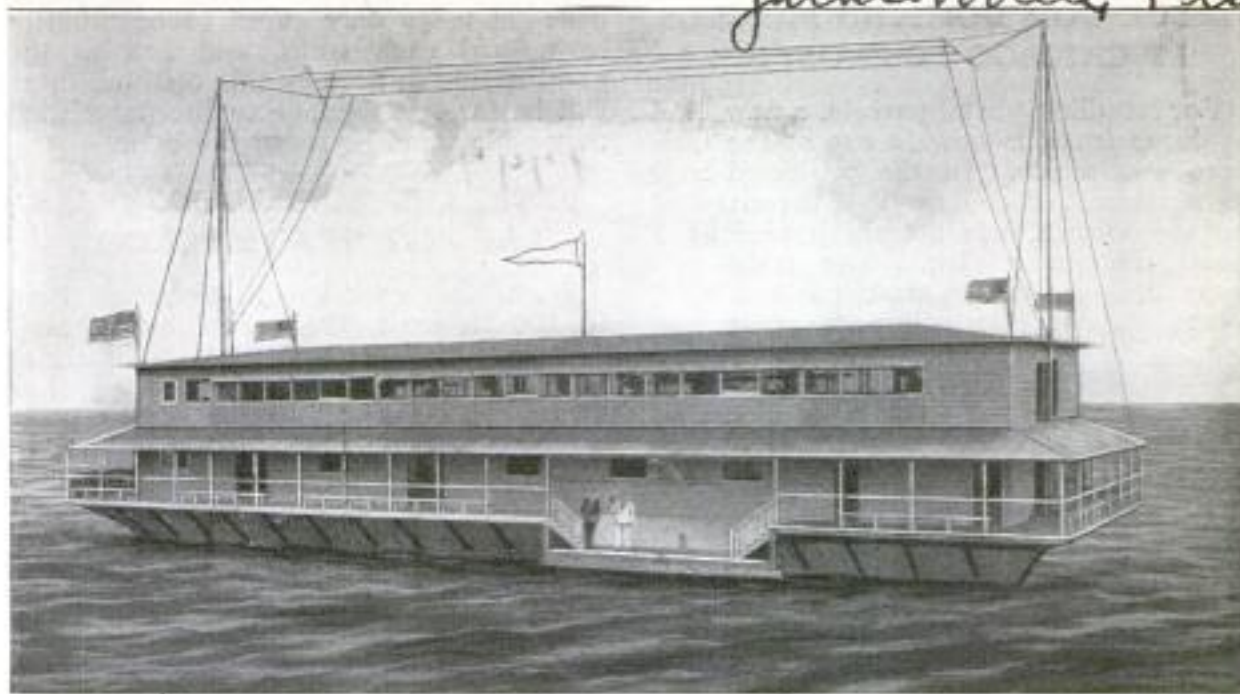

Floating Dance Pavilion Which is Anchored but a Short Distance from Jacksonville, Florida, and is Used as a Popular Resort by the People of That City

9736

FLOATING DANCE PAVILION AND PALM GARDEN

Anchored in the beautiful St. Johns River, a short distance from the city piers, a floating restaurant and dancing pavilion is the novel pleasure resort for the people of Jacksonville, Fla. A large barge was used as a foundation for the pavilion, which is built to accommodate 1,500 persons. The dance floor, on the main deck, is probably the most popular feature of the boat. An orchestra stand is in the center of the floor, while at one end are found check rooms and rest parlors for guests.

Double stairways lead from the main to the upper deck, which is devoted to a palm garden, attractively decorated and furnished, where is served sea food fresh from the Atlantic. Loud-speaking radio-receiving sets are also installed on this deck. Numerous small launches run from the pavilion to the shore dock at frequent intervals. The venture is proving successful.

9619

COLLAPSIBLE VIOLONCELLO PORTABLE AND QUIET

As portable as a violin is a knockdown violoncello invented by a woman musician in Paris, France. The instrument has a skeleton body so constructed that it is sufficiently mute to be heard only in the room where it is played. Thus it can be carried about, giving the musician the

opportunity of practice, anywhere at any time, without danger of disturbing people in the vicinity. There are three detach-



Violoncello Shown Dismembered at the Left, While at the Right It is Seen in Use

able parts to the instrument, and it is also partly collapsible, so that the whole can be folded together to form a moderate-sized package.

Shipped from London, England, in 1914, a trunk went astray and journeyed from place to place for eight years, being finally delivered in New York City, its proper destination.

Inv. Mademoiselle Adèle Clement
Paris France
Copyrighted material

**TRUCK FOR DUMPING PARCELS
AT CHICAGO POST OFFICE**

For handling postal parcels, a new kind of dump truck is now in use at the Chicago post office. In the projected new terminal post office 8 or 10 of these trucks will be formed into a train hauled by a small electric tractor. The train will carry the parcels to a trough in the floor, where an operator will release the tilt-

belt. It takes only about seven minutes to unload each train, and besides the great saving in time by this method, there will be far less damage to the parcels, as they slide smoothly onto the belt.

9747
**VETERANS' BUREAU BECOMES
LARGEST TRADE SCHOOL**

With the enrollment of more than 130,000 students, the rehabilitation division of the United States Veterans' Bureau has become the largest trade and industrial school in the world. The students are scattered all over the country and are being trained in the leading colleges, technical and commercial schools, as well as in business establishments, in shops, and on farms. Practically every vocation is represented in the training, and the courses selected for the men are such that their disabilities will not prove a handicap. Contrary to general opinion, only a small percentage of the

men receiving vocational training suffer from amputations.

Washington, D.C.
N.P. 3800

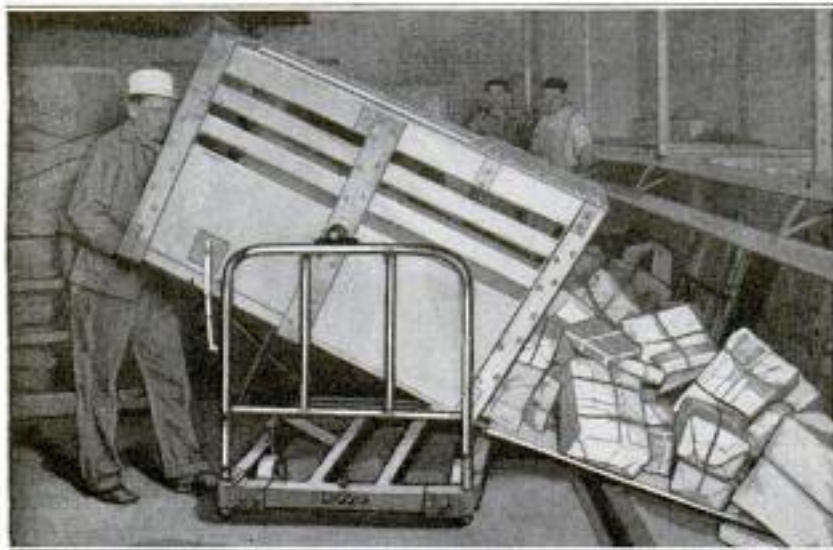

New Parcel Dump Truck Now in Use at the Chicago Post Office: The Parcels Slide onto a Conveyor Belt That Operates in a Trough in the Floor in Front of Them

ing device, dumping all the packages in each truck successively onto a conveyor

9638



KENTUCKY BLUE-GRASS SEED IS VALUABLE BY-PRODUCT

BECAUSE of the nature of the famous blue grass of Kentucky, cattle can be raised and fattened on it all during the year, yet, at harvest time, the seed can be harvested and sold at a good profit. Advantage has been taken of this peculiar property, and many large stock farms annually sell thousands of dollars' worth of the seed. There is always a good demand for it for lawns and pasturage, and also for seeding the fairways of golf courses.

Wide World Photos
Chicago
Copyrighted material

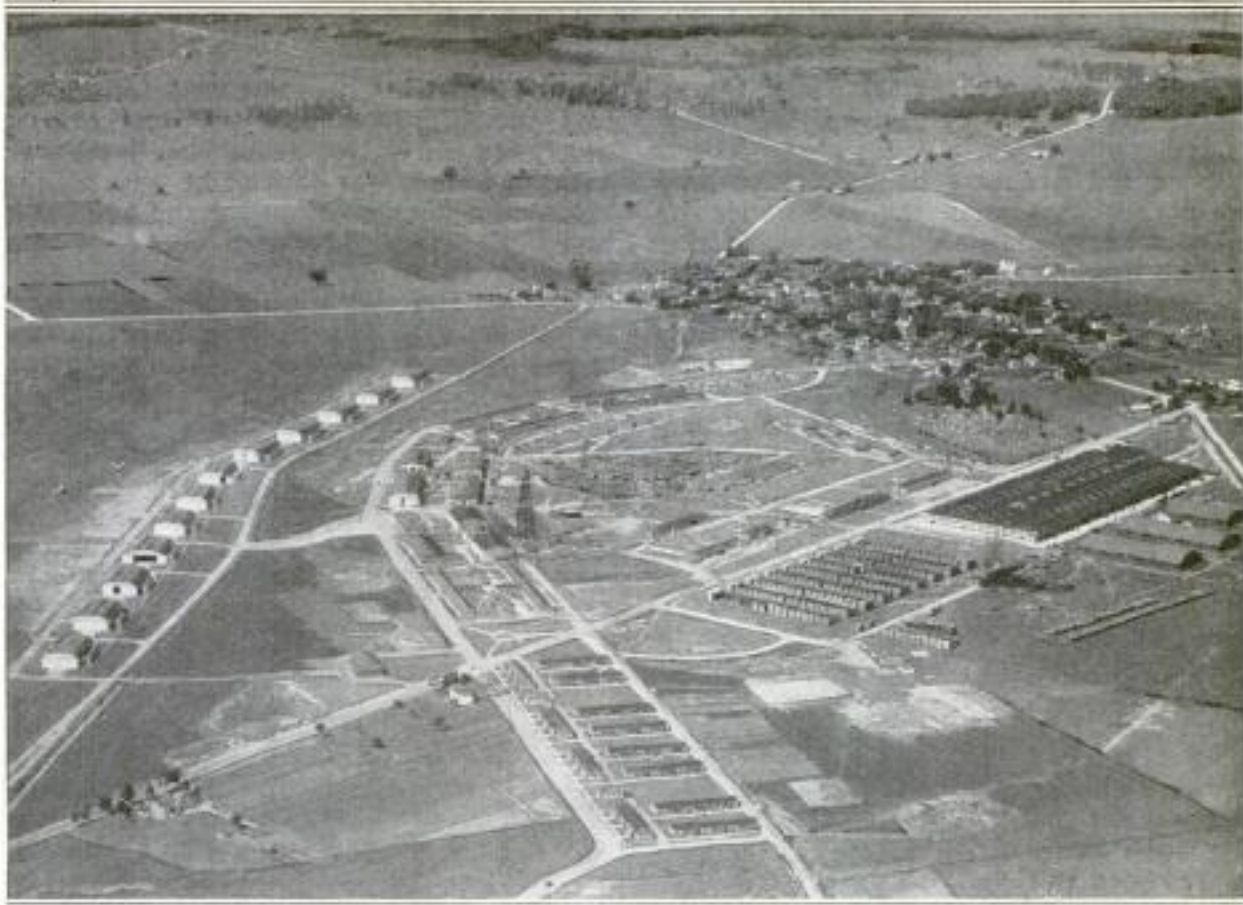

This Aerial Photograph was Taken over the Wilbur Wright Aviation Field and Shows, to the Right, the Town of Fairfield, and below It the New Site for Osborn, Not Yet Laid Out

TOWN MOVES ITSELF AT A PROFIT

Old Site Menaced by Flood Waters of New Retarding Basin of Big Dam—
Unusual Plan Adopted for Moving and Rebuilding at New
Location on Higher Ground

BY IVAN E. HOUK, *City Engineer*

IN southwestern Ohio there is a small town named Osborn. This village of about a thousand population grew up along the banks of Mad River some 12 miles northeast of Dayton, not far from the scene of the Wright brothers' world-renowned aviation experiments. Prior to the great flood of March, 1913, Osborn's existence had been comparatively uneventful. Up to that time there had been no unusual circumstance to distinguish it from the several thousand similar villages scattered throughout the United States. Today, however, the situation is different. Its people are now doing something out of the ordinary: they are moving their entire town from its present location in the bottom of the valley to a site on higher ground about two miles away.

There have been instances before where it was necessary to move entire towns. Clinton, Mass., was moved because of the Wachusett Dam. Sulphur, Okla., was moved because of the drainage of the

town wastes into the mineral springs near that place. The moving of American Falls, Ida., in connection with the Snake River development and the construction of the American Falls Dam took place a year or so ago. In no instance, however, so far as can be learned, was the actual moving carried on by the residents themselves as is the case at Osborn.

Osborn is being moved because its original location is within the retarding basin formed by the Huffman Dam, one of the recently completed Dayton flood-prevention dams. Although Osborn did not suffer serious flood damage in 1913, it would have if the dam had been built, since the calculations of the flood-prevention engineers show that in the future the original townsite will be covered with backwater about once in 40 years, and this is enough to prohibit the future existence of the town in such a location, especially when it is considered that the next flood of great enough proportions to flood the place is just as likely to come

this year, or next, as 40 years hence. The village was acquired by the flood-control authorities in 1918, about 75 per cent of the property being obtained by direct purchase and the remainder by condemnation. Inasmuch as there was at that time no need for haste in wrecking or otherwise disposing of the structures, owing to the fact that the dam had been barely started, the homes and business houses were rented to their former owners. The intention of the flood-prevention directors was to hold the property until they could dispose of it advantageously, either as a whole or piece by piece, with the stipulation, of course, that it be either wrecked or moved out of the flood zone. It was then the leading men of the village got together and worked out a plan for buying back their town and moving it in its entirety to higher ground — the plan they are executing today.

These men, headed by the mayor and the city attorney, organized the Osborn Removal Company and incorporated it under the laws of Ohio as "a corporation for profit." While the incorporators hope to make a reasonable profit, their real purpose is to preserve the town of Osborn. They assured the people when they formed the company that there would be no profiteering, that the interests of the people would come first and the matter of profit second; and they have adhered to their original intentions.

The company was capitalized at \$100,000, and stock was sold at par to the residents of Osborn. Each block of 10 shares entitles the owner to buy a lot at the new

site. The new site, covering 129 acres, and all of the movable property at the old, were purchased from the flood-prevention authorities at a price which represented a fair valuation for the new land and the actual wrecking value of the property to be moved.

Besides the new site it was necessary to purchase a strip of land running between the two locations. The reason for this was that the Ohio laws provide no method for moving a town. They do, however, provide for the annexation of

contiguous territory and for the separation of unnecessary lands. Consequently the strip of land leading to the new site and the new site itself were annexed by the village council, according to law, and as soon as the moving is completed, the old location will be given up by the same process. It was necessary to comply with the laws in this way in order to retain the original charter, and thus keep possession of the money in the town treasury and in the school fund. If the original charter had

been surrendered and a new one granted for the new site, this money could not be transferred but would revert to the township.

Having secured the village, the next step was to sell the individual properties back to their former owners. Here was where the sincerity of the removal-company officials was put to the test. They might have sold the properties to the highest bidders, but they did nothing of the kind. They assessed a fair valuation against each property and then offered it to its former owner at that

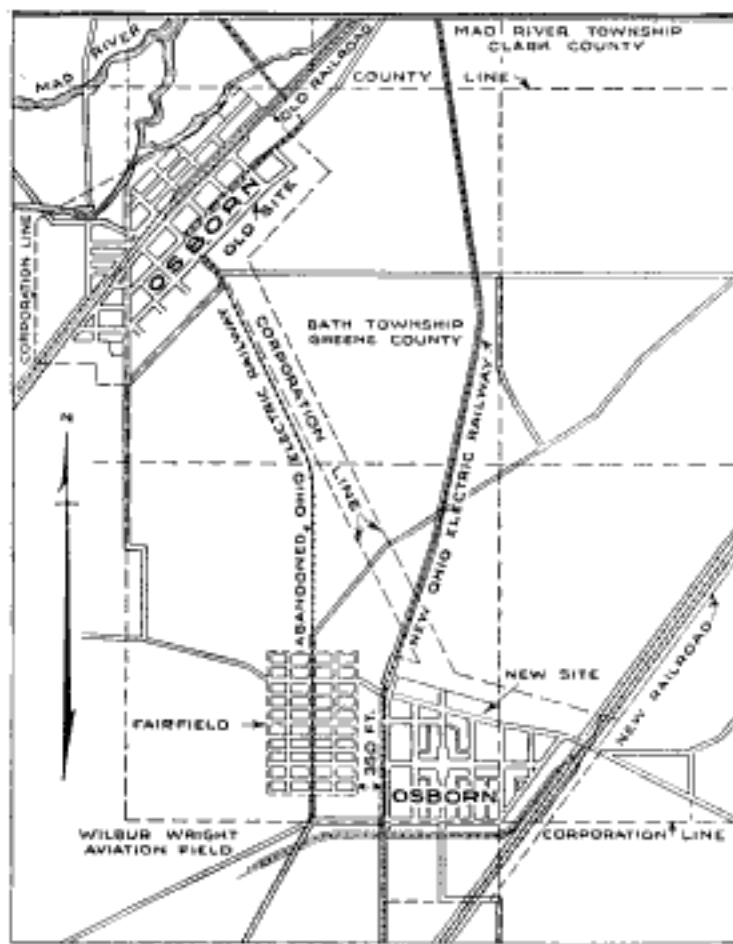

This Map Shows the Old Townsite in the Upper Left Corner, and the New Site Below, with the Strip of Purchased Land Joining the Two. This Purchase Was Necessary in Order to Comply with the Law and Retain the Original Charter of the Town

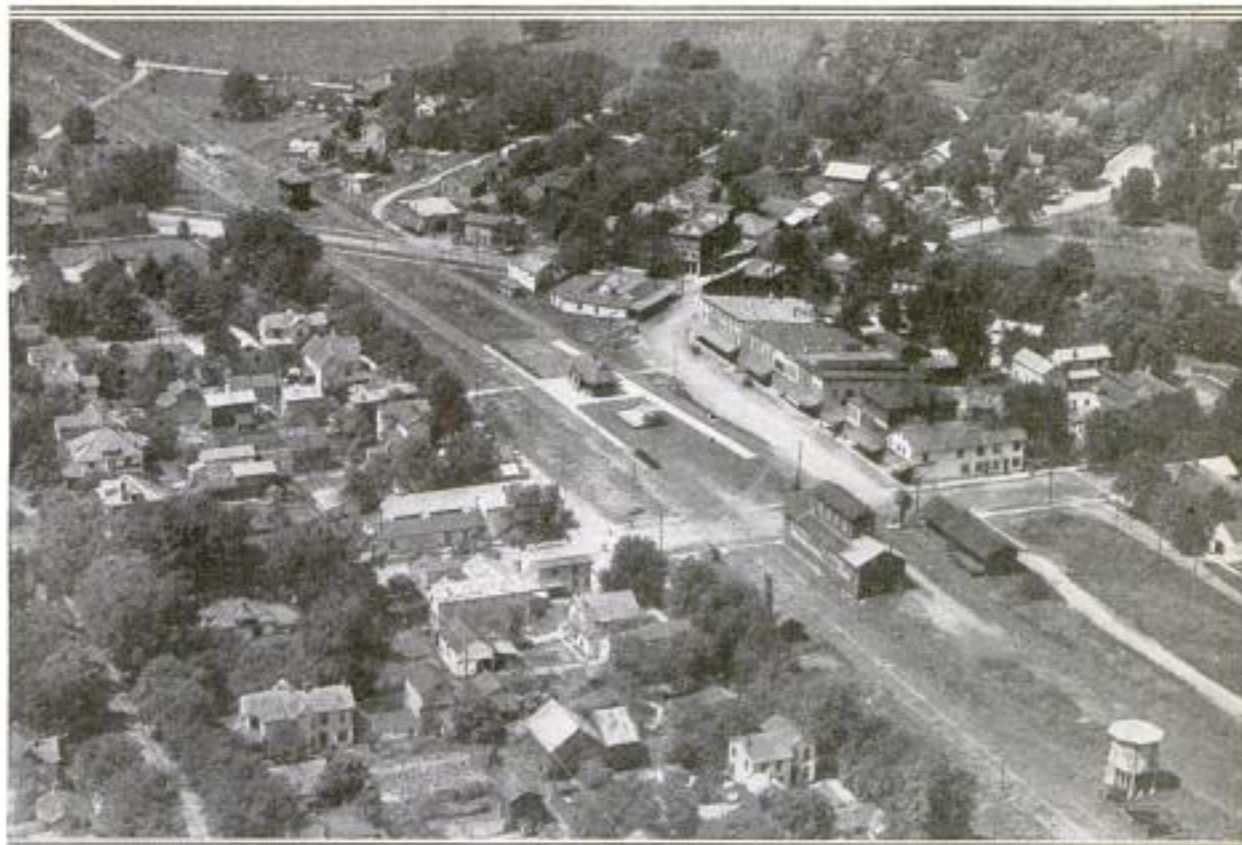

This Location of the Old Town of Osborn is Menaced by the Backwater Created by the Construction of One of the Dams Built near Dayton as a Flood-Prevention Measure

price. They paid no attention whatever to the people who came along and offered twice the assessed valuation for some other man's house, unless the former owner had advised them that he did not care to buy it and there was no one else who had a personal claim on it. If the former owner did not care to purchase a given house, and there was a renter who had lived in it for some time and become attached to it, the renter was given

the same opportunity to purchase it as was given the former owner. If neither the owner nor the renter cared to purchase, it was offered to anyone who did.

The next step was to sell the lots at the new location. Since there were no personal ties involved in this case, it was decided to sell the lots at auction. The lots were numbered and a minimum price placed on each. The only lots reserved were those to be occupied by the four

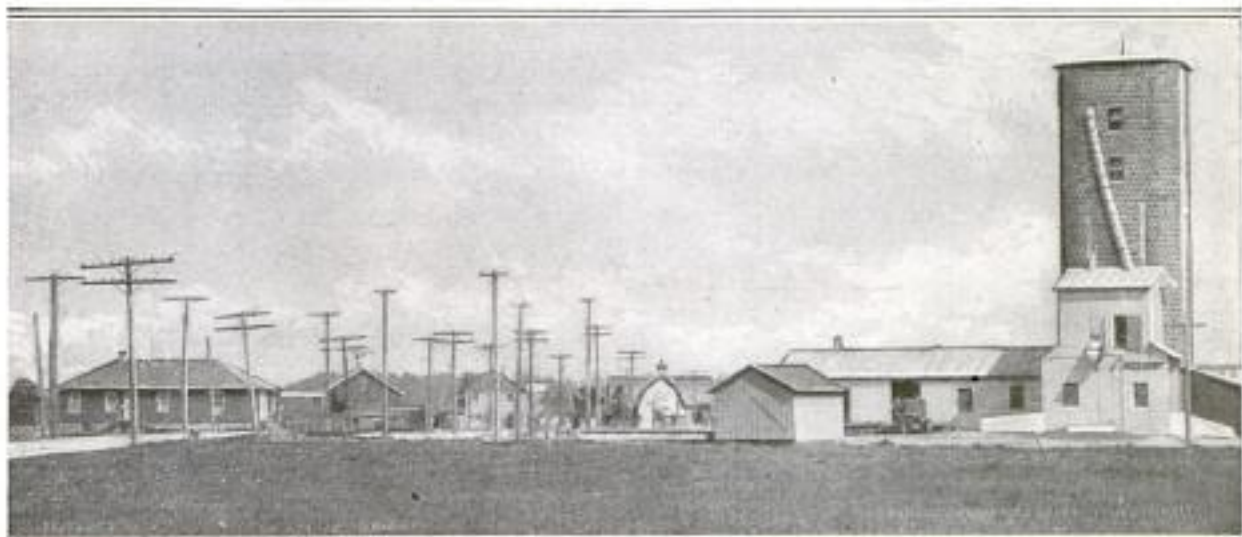

The New Location as It Appears Today: A Few New Houses have been Built, and Some have been Moved from the Old Townsite. An Elevator has been Constructed near the Railroad, and Curbs, Sewers, Gas Mains, and Electric-Light Lines have been Installed

churches and by the business houses. The lots in the business block had been platted with special reference to their use, and therefore could not be sold for residential purposes. The churches could be located almost anywhere outside the business block, but it was believed that the people would be better satisfied if they knew before buying their lots where the churches would be built.

Before starting the auction, which was an invitation affair attended only by the stockholders and their immediate relatives, a vote was taken to determine the comparative value of the various lots, each stockholder voting for the lot he preferred. The lot receiving the highest number of votes was then auctioned first. The disappointed parties were then permitted to vote again, a new poll was taken, and the new lot having the highest number of votes sold. This process was continued until the stockholders had all obtained lots, after which the remaining lots were placed on the open market and sold to anyone who desired to purchase.

One of the most noteworthy things connected with the project was the care with which the new town was planned. Generally town plans, if made at all, are made in one generation and carried out in another; but here was a case where a town could be planned and also built, all within a period of one or two years. The incorporators, recognizing the importance of careful town planning as well as the unusual opportunity afforded in this instance, engaged an engineering

firm to lay out the streets, subdivide the blocks into lots, and take general charge of the construction activities. Consequently the new Osborn will be a well-proportioned village, with large lots, playgrounds, and parks.

About 200 houses will be moved, practically all of which are residences. Business houses will not be moved, but will be built new at the new site. The same is true of the schoolhouse and churches. The waterworks system will be moved so far as it is practicable to do so.

Combined cement curb and gutters, and cement sidewalks will be built soon. An elevator and railroad station have been built at the new railroad location, and trains are now making regular stops.

From the financial standpoint the work is progressing nicely. Contracts have been let for practically all the work yet to be done, so that the officials know where they stand. It now seems certain that the people will get their houses moved to their new locations, all of their lot grading and sidewalks completed, and their houses repainted, repapered, repaired, and refinished in first-class condition at a total expenditure of about 75 per cent of the prices they received from the flood-prevention authorities. In other words, they will be established in their new locations and will have about 25 per cent of their money left to pay them for the mental anxieties they suffered in being forced to move, which seems very reasonable. Besides, the stockholders of the removal company will have a fair profit to pay them for their work.

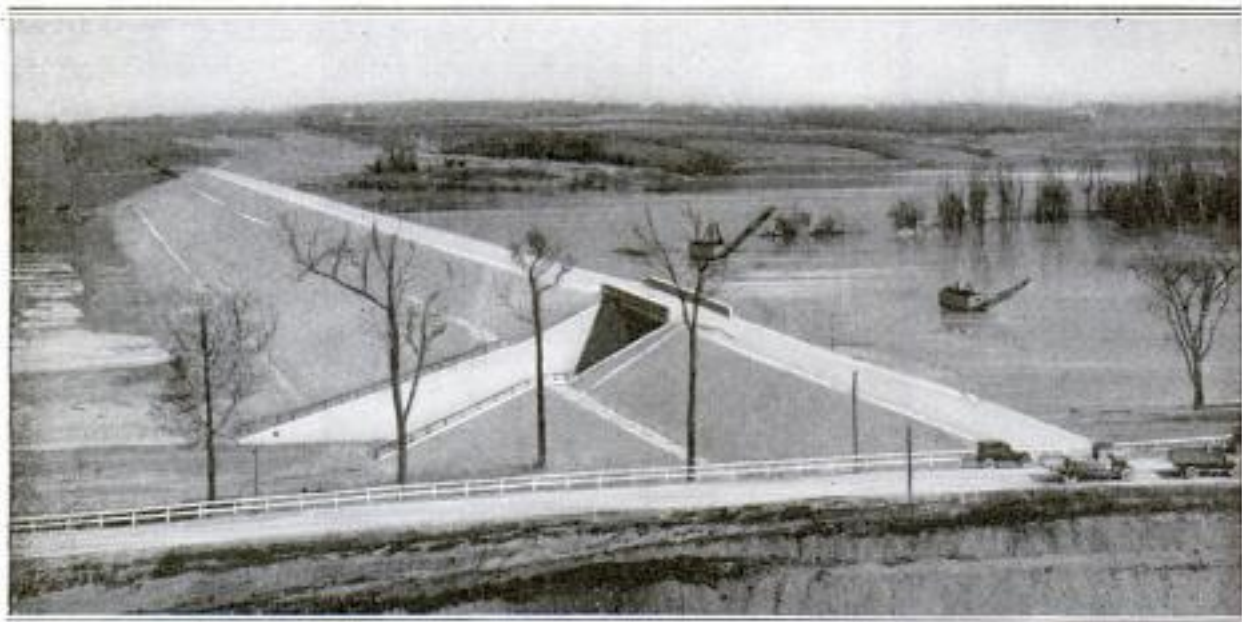

The Huffman Dam, About Five Miles from Dayton, Shown during a Spring Freshet: It Is the Backwater from the Dam That Threatens the Town of Osborn at Its Original Location

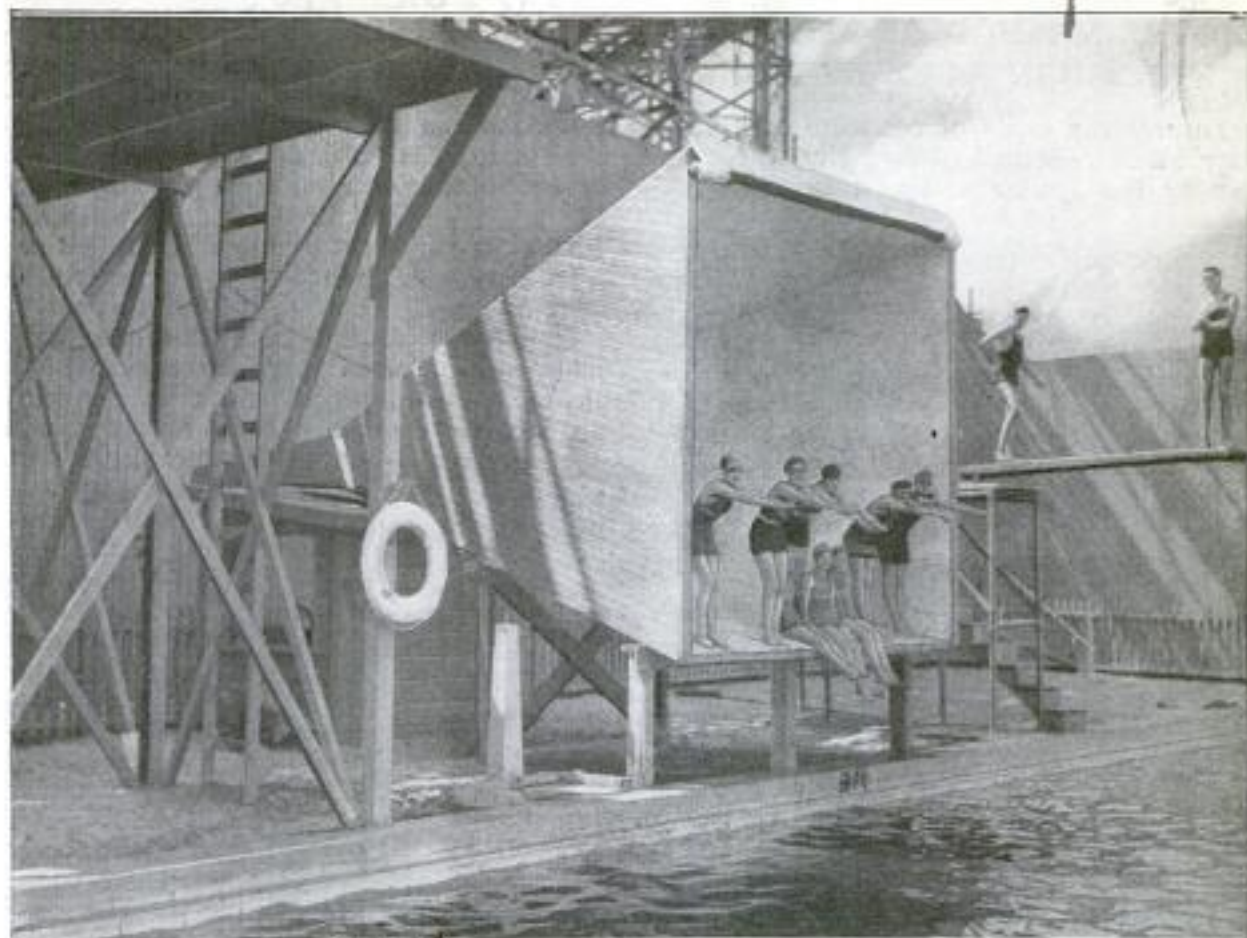

COPYRIGHT UNDERWOOD & UNDERWOOD

RADIO MEGAPHONE IS LARGE ENOUGH FOR A DIVING PLATFORM

TERMINATING at the edge of the pool, a radio megaphone has been constructed at a California bathing resort, that, for size, eclipses anything of the kind that has been built, up to date. The opening of the megaphone is rectangular, and is so large that it can be used as a diving platform by at least seven persons at one time. The music coming from the loud speaker is of such volume that, on a quiet night, it can be heard for several miles. When radio concerts are not being given, a phonograph may supply the music.

8991

FRAME FOR X-RAY TUBE AND PLATE HOLDER

In order that an X-ray picture may show the same conditions as disclosed by an examination through a fluoroscopic screen, it is necessary that the plate holder should occupy the exact position formerly held by the screen. To insure this condition, a frame has been devised for holding the screen and plate holder interchangeably in a bracket. This bracket and the X-ray tube are supported on an arm in such a way that they are always the same distance apart and in exact line. The bracket holds the screen or plate exactly centered with the X-ray tube. The tube and bracket can be moved together along the supporting arm to accommodate fat or thin persons, the focus always remaining the same.

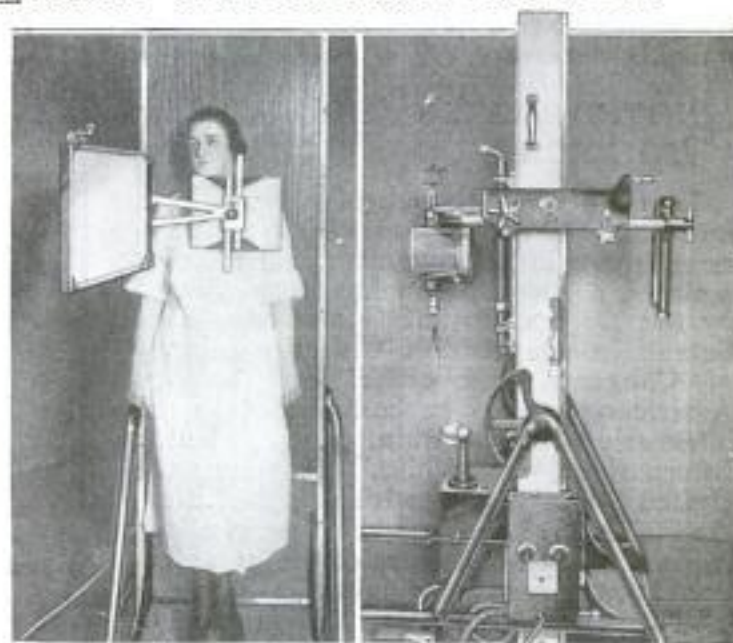

Left: The Fluoroscopic Screen and Photographic Plate-Holder Bracket in Use. Right: The X-Ray Tube and Bracket are Adjusted by a Rack and Pinion

Roentgen appliance Co,
San Francisco
Calif.

344
9677
Novel Method of Stringing Mortar in Masonry Work
In erecting walls of concrete or hollow clay blocks, instead of stringing the mortar by hand with a trowel in the usual

Cml. E. F. Lange, Brownell Bldg
POPULAR MECHANICS
Lincoln, Neb.

NOVEL METHOD OF STRINGING MORTAR IN MASONRY WORK

In erecting walls of concrete or hollow clay blocks, instead of stringing the mortar by hand with a trowel in the usual

9768

Alcohol as a motor fuel has recently been made the subject of extensive tests by a British commission to determine its

IN ALCOHOL AS FUEL

value, and interesting facts have been established by the experimenters. Some of these are, that the thermal efficiency obtainable is higher than with petrol or benzol; that there is no evidence whatever of corrosion in the engines; that the power output is increased by the low temperature of the circulating water; that supplying heat to the carburetor reduces the power output, but at the same time slightly increases the thermal efficiency, and that under all conditions of mixture or throttle, alcohol requires a more advanced spark than is the case with gasoline or benzol.



Above are Shown Two Forms of the Mortar-Stringing Apparatus Which was Designed for the Purpose of Speeding Up the Work of the Stone Mason. At the Left can be Seen a Row of Concrete Blocks That are Standing on End and upon Which have been Laid Two Symmetrical Strings of Mortar Preparatory to Placing Them in the Wall

way, a builder in Nebraska makes use of a device for stringing the mortar on the top and the ends of each block before placing it in position on the wall. With this device any unskilled laborer, it is claimed, can lay a string of mortar on a block as rapidly as it could be done with trowels by three skilled masons, and with such evenness that very little trimming is necessary.

A further series of experiments is being carried on at the present time with a view to determining the effect of alcohol when used in conjunction with gasoline, benzol, and other motor fuels.

ATTRACTIVE BUNGALOWS MADE OF HOUSE BEE FAMILIES

Attractive beehives, modeled after bungalows, have been built by an apiarist of Sioux City, Ia. A porch, a front door,



Two of the Attractive-Appearing Beehives Which have been Constructed to Represent Tiny Bungalows

and several windows help make the small houses faithful miniatures of human dwellings, in addition to which the tiny structures are carefully painted.

UNITED STATES AND EUROPE TO EXCHANGE CIVIC DATA

To facilitate exchange of data with an international association of cities interested in civic improvement, and similar matters, a new bureau has been created by the Department of Commerce. This bureau in coöperation with the Library of Congress, will collect and arrange American data to be contributed to the international association, called "l'Union Internationale des Villes." In return the United States is to receive valuable information from Europe and other civilized lands. The headquarters of the organization is at Brussels, Belgium, and members pay a small fee for the support of the central office there. Great expense will thus be saved by eliminating local investigation committees.

The American City
April 1922
P. 348

Cml. H. M. Blomig.
1700 Jackson St.
Sioux City, Iowa.

983

6/22

Copyrighted material

Königsplatz Strasse 62.

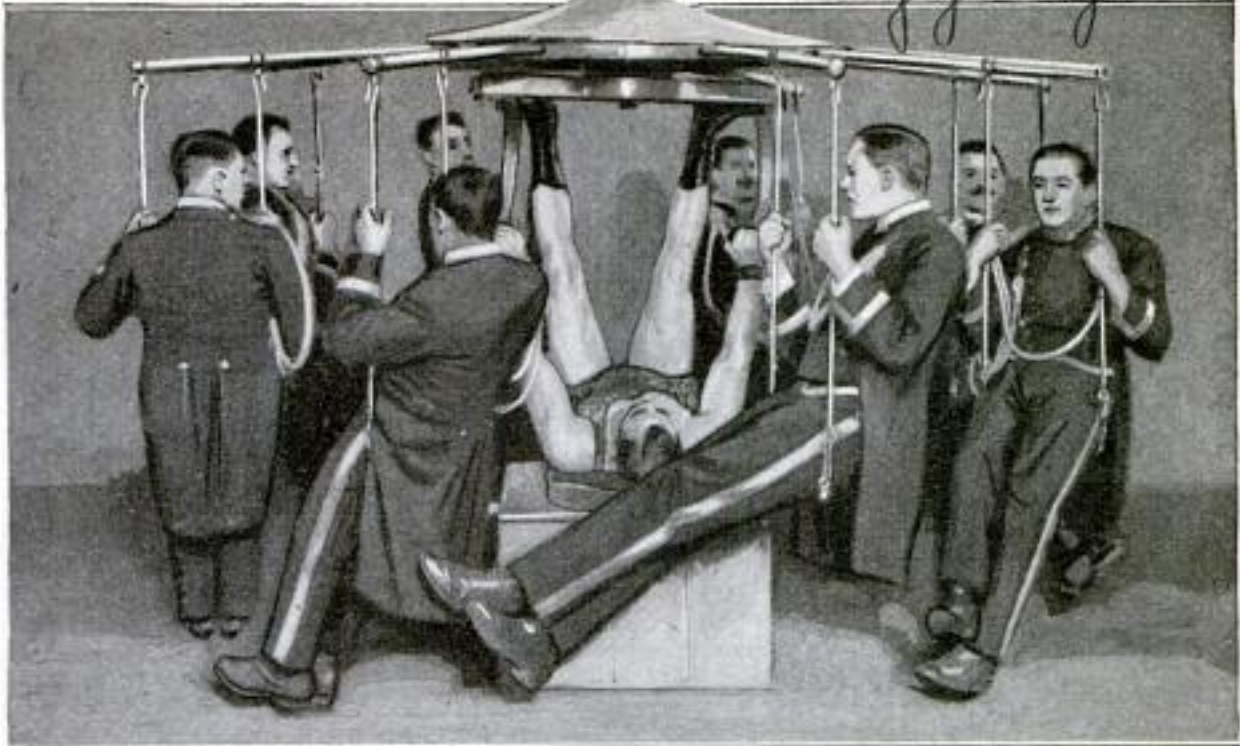

This Strong Man in a German Circus Supports on His Extended Legs the Framework of a Merry-Go-Round upon Which Eight Full-Grown Men Ride

9698 STRONG MAN SUPPORTS EIGHT MEN AND FRAMEWORK

In an effort to excel in their chosen profession, performers are constantly devising new ways of showing their skill or strength. As an example of this nature, a circus performer of Berlin makes himself the center support of a merry-go-round on which eight full-grown men ride. The strong man lies on his back on a raised pedestal and supports the frame on his feet.

☐ Built in honor of seamen who lost their lives in the World War, a memorial tower, standing 180 feet above the water at Victoria Pier, Montreal, Canada, has recently been completed. It comprises a clock and signal tower for harbor use, and is electrically operated.

9557 TILTER FOR AUTO REPAIRING GREAT AID TO WORKER

Automobile repairing has been facilitated by the introduction of a tilter which does just what its name implies—tilts the car over on one side, exposing the bottom—thus greatly aiding the repairman. With the use of this outfit, the workman can stand upright, or sit down comfortably in the open air, and work naturally to the best advantage. This method will be quickly recognized as being far superior to the old way of lying on one's back, or crawling into a dirty pit beneath the machine. The apparatus will lock at any angle without strain to the car, and the raising or lowering mechanism can be operated easily by one man. The outfit is 2 feet high and about 8 feet longer than the usual car.

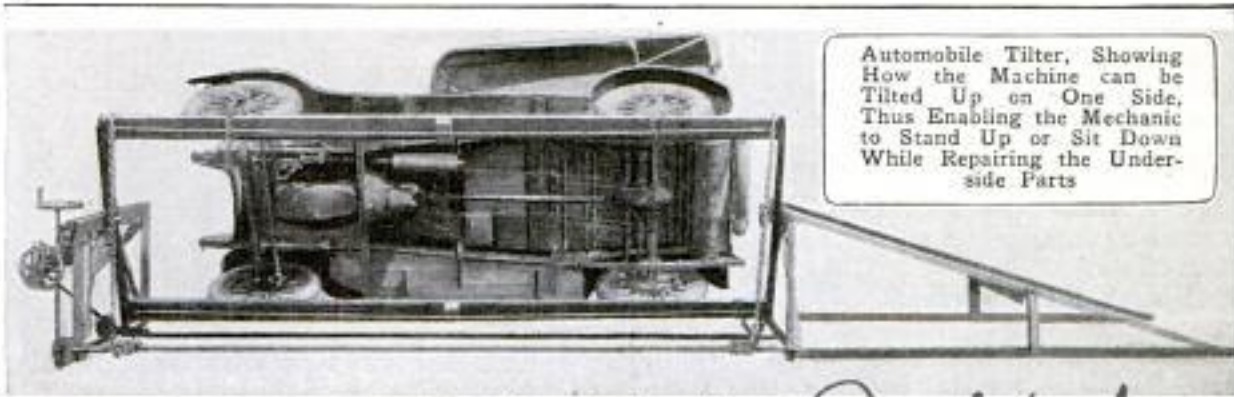

Automobile Tilter, Showing How the Machine can be Tilted Up on One Side, Thus Enabling the Mechanic to Stand Up or Sit Down While Repairing the Under-side Parts

Wm. A. J. Halle, Rushford, Minn.

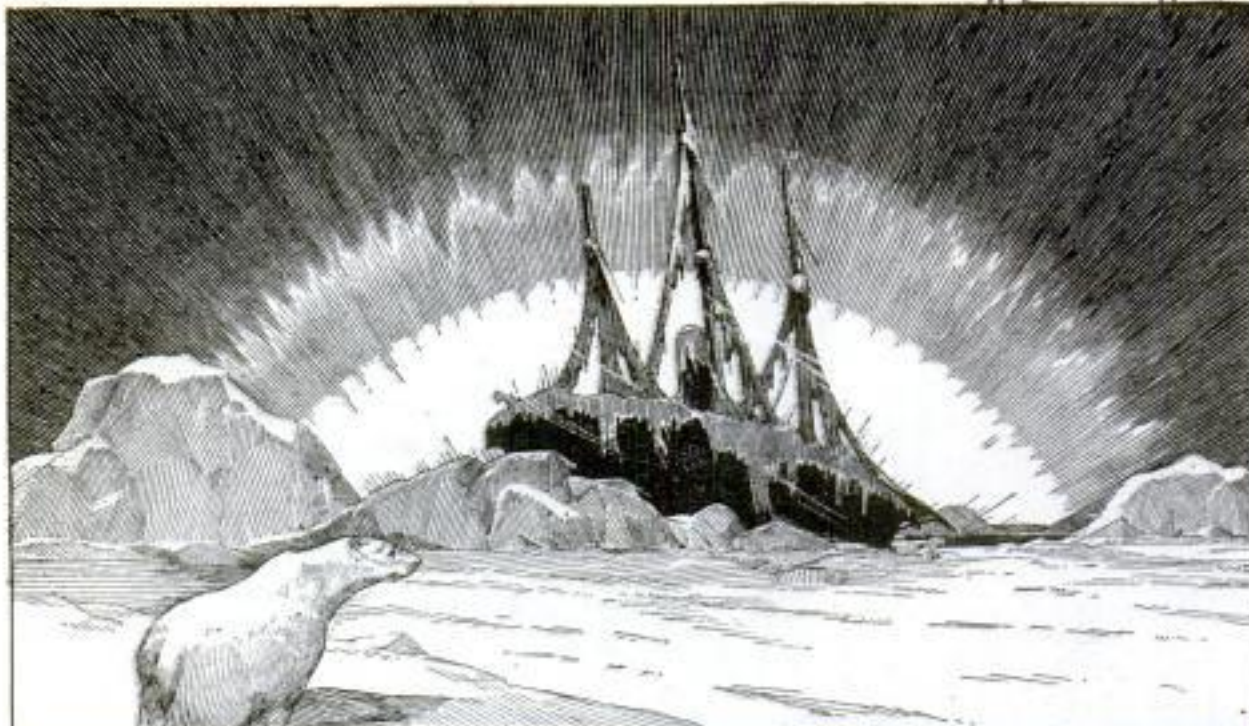

PHANTOM SHIPS of the ARCTIC

Sighting of Old Side-Wheeler Revives Story of Polar Mystery
Fleet—Other Lost Ships may have Drifted
North—Find "Teddy Bear" Safe

BY STRATFORD F. CORBETT

EVERY winter deserted ice-locked ships are seen in the mists of the polar seas, drifting at the mercy of wind and current, their broken masts and crumbling rigging hung with ghostlike icicles, and their decks and cabins buried in drifts of snow. At least, so run the stories of Eskimo narrators.

A Russian side-wheeler, the "Polotofski," built 70 years ago, is the latest addition to this "phantom fleet." She was discovered, toward evening, by a party of Eskimos hunting walrus. Plans were made to board her next morning, but during the night the changing wind swept the ship far north into the unexplored wastes.

The "Polotofski," according to the only accounts available, was caught in the ice at St. Michael, in December, 1915, and disappeared the following spring in the great storm off Cape Nome. It was thought that she had been ground to kindling and sunk.

Vessels have been disappearing in this great unknown ever since the beginning of arctic navigation. In 1845, the "Erebus" and the "Terror," of the British navy, sailed with 129 souls on board to attempt the northwest passage. They were last seen by civilized men in Baffin

Bay. More than a score of ships, with crews of nearly 2,000 men, at an expense of millions of dollars, vainly sought, between 1847 and 1853, news of the missing squadron. The fate of the vessels is shrouded in mystery.

One dread night in the autumn of 1897, a gale carried off eight ice-locked whaling vessels. Most of the men escaped and reached Point Barrow and other points along the coast. A few refused to leave their ships, and, holding men and ships in its relentless grip, the great pack swept them far out into the vast uncharted polar basin.

Were these ships crushed? Have they been battered to pieces, or are they still afloat? Did the men die from starvation and cold, or can it be that somewhere in the frozen north there still exists a remnant of the men who stuck to their ships?

These questions have never been answered. Only seldom is it that any definite trace is left. The "Polotofski's" name plate could be made out. The ship had a distinctive build. Usually the Eskimos can do no more than guess at the ships' identity. It is impossible to be certain.

Before the days of wireless a number of large ships were swallowed up, per-

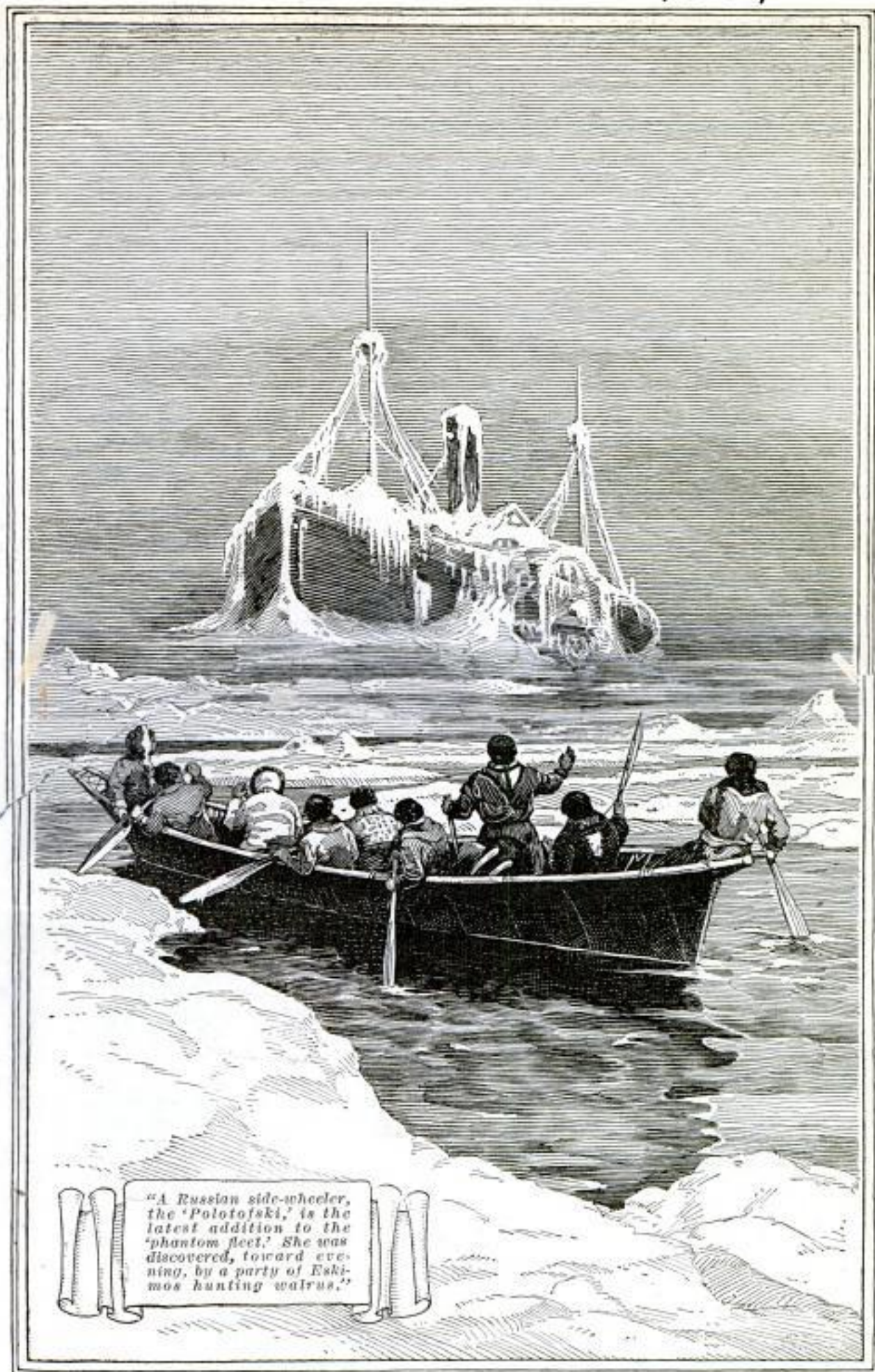

"A Russian side-wheeler, the 'Polotofski,' is the latest addition to the 'phantom fleet.' She was discovered, toward evening, by a party of Eskimos hunting walrus."

haps the victims of a floating iceberg, a heavy gale, a tidal wave, or fire. One of these was the "City of Glasgow." In 1845, she sailed from the Mersey for Philadelphia with 480 passengers. Port was never reached. The captain of the "Westmoreland," a vessel that preceded the "City of Glasgow" by a few days, reported that on the third day out he became entangled in ice floes and was imbedded in them for 30 hours. His evidence, and that of other captains, indicates that this extraordinary ice mass extended in one direction for 347 miles, almost compact, and that it was studded with numerous icebergs of gigantic size. What had become of the "City of Glasgow" was never learned.

Loaded with passengers, the "City of Boston," in 1870, left Liverpool never to return. Months afterward bits of wreckage were sighted with her name on them. Why, how, when, or where she entered the "Port of Missing Ships" has never been discovered.

Another mystery is that of the "President." She was due in Liverpool from New York in November, 1841. Severe weather had prevailed in the Atlantic and unusual quantities of ice were reported in low altitudes. For months the owners queried adjacent ports in a vain effort to get some news of her. Years later there was found in the logbook of a Portuguese sailing vessel an entry which stated that a large steamer, resembling the "President," with her machinery ap-

parently disabled, had been sighted. This entry was dated a month after the disappearance of the "President."

Could these ships have drifted northward? Are they, too, part of that fleet of silent ships held hard and fast in the great ice pack, white with frost and manned by frozen crews?

Sometimes a vessel is found abandoned at sea without any trace of accident or other means of discovering the cause of her condition. Such was the case with the "Yula Maru," a Japanese steamer found in mid-ocean with eight dead men on her deck. What had become of the rest of the crew was never known.

The "Marie Celeste" was discovered with all sails set, clipping along toward Labrador. Not a man was on board the vessel nor was there any evidence of a struggle; nothing in the log to tell of storm, disease, fire, or other disaster.

The little schooner, "Teddy Bear," missing eight months and believed lost, was found this June frozen in, near the mouth of the Potem River, 12 miles south of Emma, a village on East Cape, Siberia. All on board were well and required no assistance from the coast-guard vessel which discovered them. The captain was waiting for the ice to clear out of the river. When this should happen he intended sailing back to Nome.

Only miraculous luck saved the "Teddy Bear" from joining the phantom fleet, of which the "Polotofski" remains the sole materialization.

946 MOUNT WILSON OBSERVATORY GROUNDS IN MINIATURE

An accurate reproduction, on a miniature scale, of the Mount Wilson observatory grounds located in the southern part of California, has recently been completed by Ferdinand Ellerman of that state. The model clearly shows the shel-

ter for the 100-inch Hooker telescope, the 60-foot tower for the Snow telescope, and the 150-foot tower on which is mounted the 60-inch reflector. Imitation snow on the ground around these and the numerous small buildings, together with many tiny pine trees which are scattered over the work, give the whole a natural and attractive appearance.



Model of the Mount Wilson Observatory and Grounds, Showing, from Left to Right, the 60-Foot Tower with the Snow Telescope, the 150-Foot Tower and 60-Inch Reflector, and the Structure Housing the 100-Inch Telescope: Among the Other Buildings Is a Monastery, at the Extreme Left

Carl H. Ellerman, Pasadena, Calif.

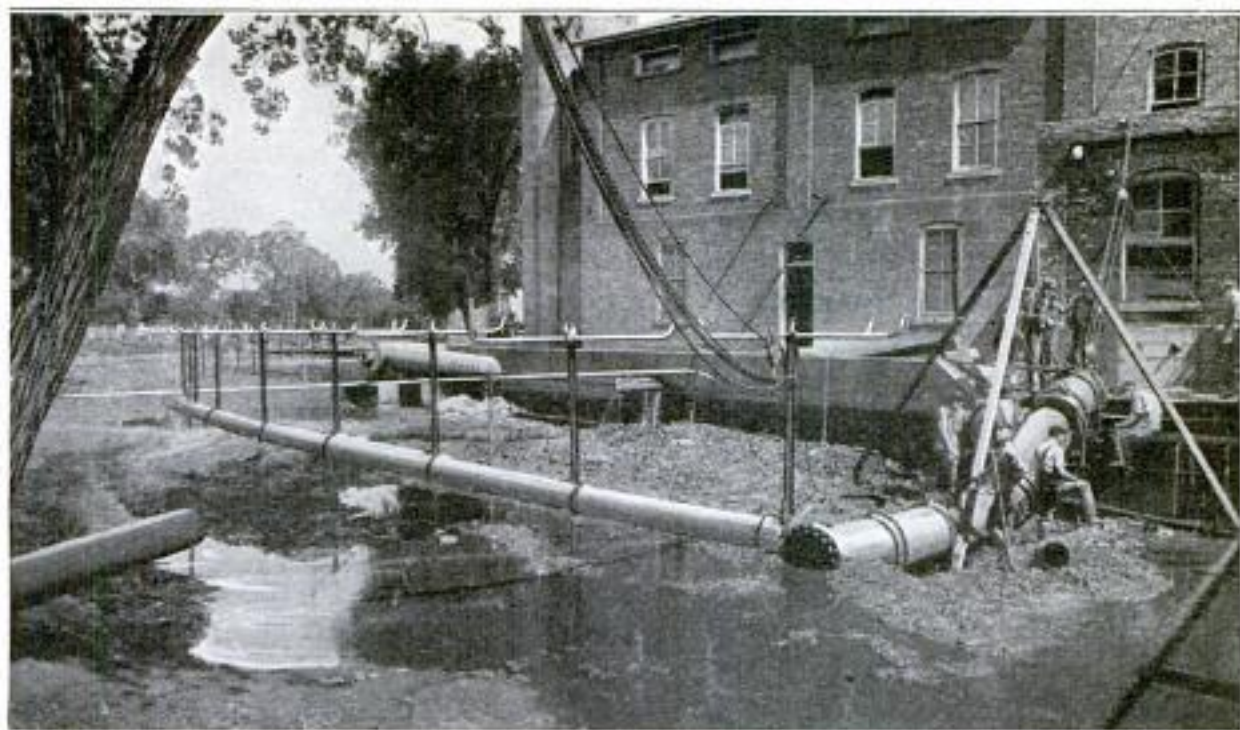

Spray System for Cooling Water being Installed at Hutchinson, Kansas: Water is Passed to the Sprinklers by Pipes on the Bed of the Creek; after Cooling, the Water is Caught by an Intake Earthen Downstream

CREEK DRIED UP FOR 276 FEET DURING ENGINEERING JOB

To install a spray water-cooling system in the water plant of the United Water, Gas & Electric Company, at Hutchinson, Kan., the engineers in charge of the work dammed up the creek and dried the bed for a distance of 276 feet. The water was held back for two weeks while the pipes were being laid and connected by a dam consisting of three thicknesses of 1-inch planks dovetailed so as to be water-tight.

The spray system was installed to enable water taken through the plant once, to be cooled and drawn into the pipes again, instead of being emptied into the creek below the intake and allowed to flow away. This precaution was thought necessary because, although there is a dam below the plant to hold water for use, the hot water could not be emptied above the dam for use again. In the summer, the operation of the plant was endangered by water shortage.

The water is now pumped back above the dam through a large 16-inch pipe. At intervals of 13 feet, there stand 2-inch pipes, 9 feet high, at the top of which are five nozzles. The surface of the creek is about 5 feet above the main pipe. The water is forced up to the nozzle, and projected for 15 feet into the air. The drop of 19 feet sprays the water and cools it sufficiently for use in the cooling system of the plant another time.

"REWRITE MEN" GAIN TIME USING PHONE HEADPIECE

Planning to gain the time ordinarily used in taking the telephone receiver from its hook, a large western daily recently equipped the telephones of its

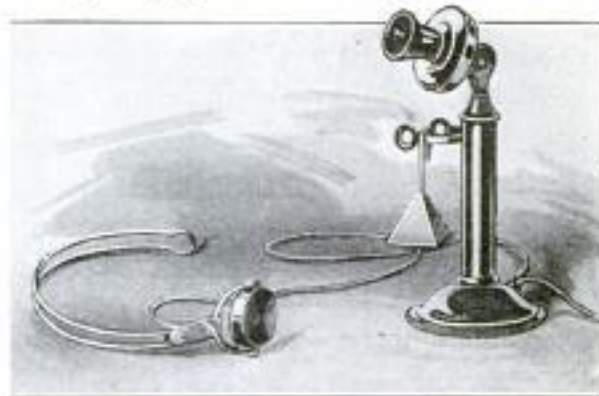

Headpieces are Attached to the Telephones Used by the "Rewrite Men" on a Western Newspaper

editors and "rewrite men" with simply constructed headpieces. The receiver now used is about the size of a radio receiver and is attached to a wire bracket. A paper weight with the tip of its spindle curved, holds the telephone hook when the phone is not in use.

Ⓐ fleet of motorcycles whose riders sweep up glass has been put into service by the Chicago Motor Club. The motorcycles respond quickly when notified of an accumulation, and carry the glass away.

S. Clinton, Chicago

500

Western Electric Co.

HAND CAMERA FOR SNAPSHOTS OR MOTION PICTURES

9704 There is now being manufactured a camera which can be carried in the pocket, operates automatically with the precision of a high-grade watch, and



Contact Prints from Two Sections of Film Which Show the Type of Pictures Obtained with the Pocket Camera

takes either motion pictures, snapshots, or time exposures simply by pressing a button. No tripod or hand crank is required, the camera being held in the hands and the image located by either of the two methods provided. A metal spring propels the film, at the same time opening and closing the shutter. Loading is accomplished in daylight by means

of special metal magazines, six of which are supplied with each camera.

The camera weighs less than 4 pounds, measures 4 by 5 by 6½ inches, and is fitted with a high-grade lens capable of producing results equaling the professional motion-picture outfit. Standard-width films are used, and each picture is ¾ by 1 inch. There are four perforations on each side of each picture, making it possible to project the pictures on any standard motion-picture machine. The camera accommodates 15½ feet of film, allowing 248 exposures, or 16 to the foot. The film is moved from one magazine to the other at the rate of 1 foot per second.

INVASION OF U. S. TREES BY EUROPEAN MOTHS

9842 Immigrated from its native haunt in Europe, a species of moth, commonly known as the satin moth, has been doing great damage to the poplars, willows, and cottonwoods of the New England states. The new pest has become thoroughly established within the last few years, but was not discovered until recently. It is exceedingly difficult to control the insects. They fly readily, often in swarms, and flit from one place to another. Both male and female have pure-white wings and their bodies are covered with long white hairs, giving an appearance of a coat of satin.

COVER FOR REAR AUTO SEAT

9636 USED AS WINDSHIELD

The development of the sports body for an automobile that is mainly used as a roadster, but can upon occasion provide seats for passengers in the rear, has brought some interesting problems to



Left: Rear of Camera, with Release Button on Top, Winding Handle and Timing Mechanism at Side. Center: Interior, Showing Film Magazines. Right: Front; Lens in Middle and View Finders at Upper Right

9636

The Albany Carriage Co.
174 Spring Street
St. Albans, Vt.

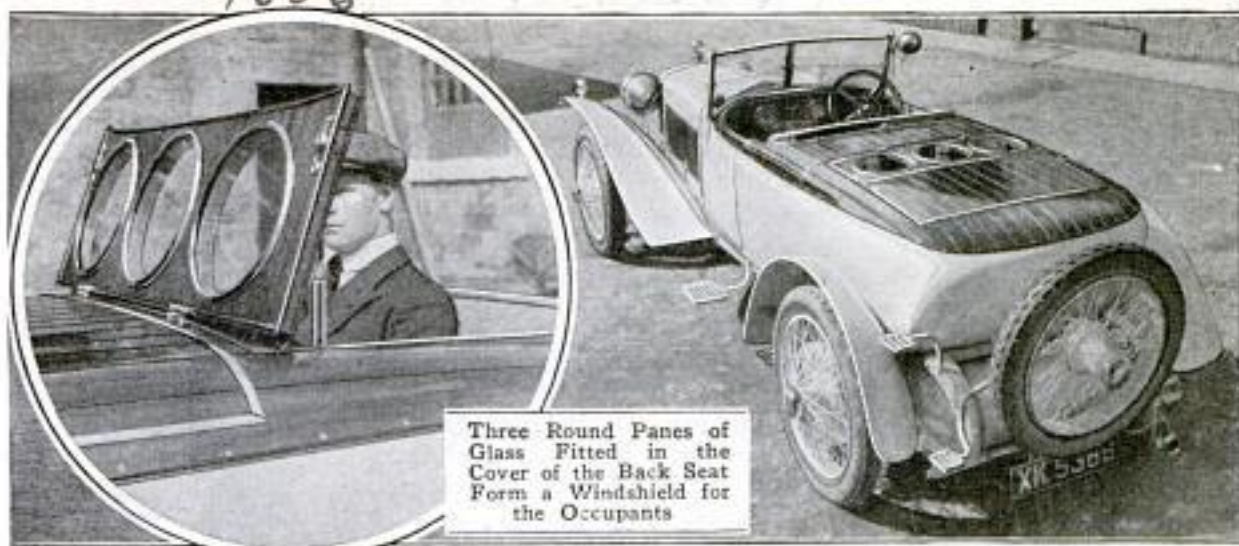

Three Round Panes of Glass Fitted in the Cover of the Back Seat Form a Windshield for the Occupants

the designers. The disposal of the cover, when the rear seat is in use, was one of the most difficult questions, but has been answered by one manufacturer in a neat and attractive manner. It is made in two portions, the front part being hinged at the forward edge and supplied with three round panes of heavy glass. When the rear seat is to be used, this part of the cover is raised and locked with brackets on the sides. In the raised position, it forms a serviceable windshield for the occupants of the back seat.

8739 **OLD MOTOR-CAR ENGINE HELPS WITH ICE HARVEST**

Ingenuity played an important part in the harvesting of the ice crop at the village of Mascoda, Wis. Two brothers who do automobile-repair work decided that they might just as well as not put to work during the ice harvest one of the engines that they had salvaged from a wrecked motor car. After some planning and experimenting, they rigged up a power ice saw that cut its way through the ice, running at high speed. They used a saw 40 inches in diameter and found that they could cut ice 16 inches in thickness. The machine proved so compact that one man could operate it, and thus take the place of several men working with ordinary handsaws. It is thought

9780 **CLEVER CONTROL VALVE MADE FOR ISOLATED LIGHTS**

For use in marine or aerial lighthouses where the lighting of the lamp is to be automatic, a new control valve has been devised that has some marked advantages over older instruments of this character. Two glass bulbs, filled with volatile liquid and vapor of the same, are connected and supported on a carrier. This is free to rock on pivots and is connected to the valve supplying gas to the light. One of the bulbs is blackened and the other left transparent. When exposed to daylight, the blackened bulb absorbs more light than the transparent bulb with a consequent increase in temperature. This causes liquid to move to the transparent bulb, and the carrier rocks on its pivots, thus closing the gas-supply valve.

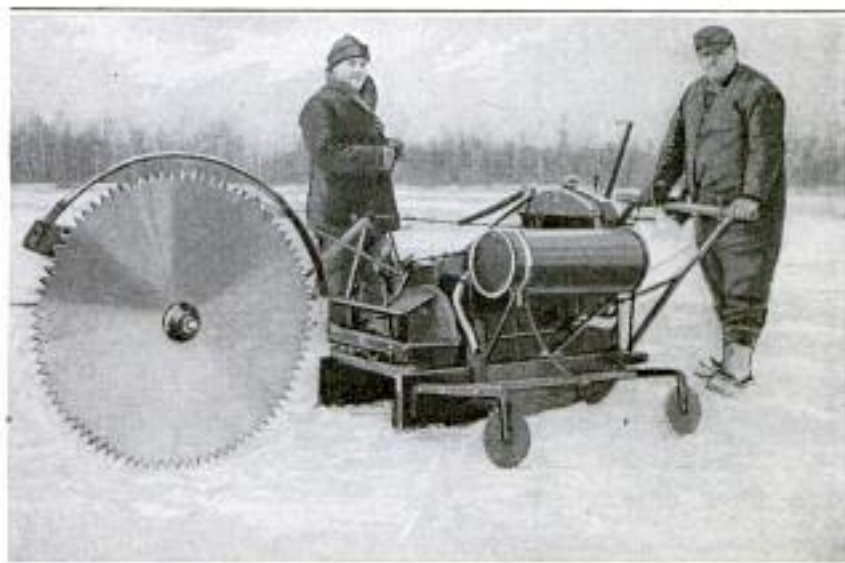

Ice-Harvesting Outfit, Showing the Large Circular Saw Which Cuts through 16 Inches of Ice, Rigged Up in Conjunction with an Old Motor-Car Engine

that outfits similar to this could be operated at a profit on any ice field.

Built by: Kratchowill Bros., Mascoda, Wis.

920 VARIOMETER FOR RADIO SET
IS NEATLY DESIGNED

Variometers—those little coils sometimes so necessary for the correct "tuning in" of a radio set—are being manufactured after a neat pattern by a Missouri company. Two coils of the usual concentric design, the inner one pivoting on a fiber shaft, are fastened to a wooden base by a fiber strap. The whole is then screwed onto



a brass strip which contains holes for the proper mounting on the panel of the receiving set.

COMMODIOUS RIVER LAUNCH
OF FAMOUS SURGEON

9996

What is said to be the largest pleasure craft ever built on the upper Mississippi has just been completed for Dr. William J. Mayo, the famous Rochester, Minn., surgeon. The boat, christened the "North Star," measures 120 feet in length, 23 feet

vided with the most modern equipment, the "North Star" has cost close to \$100,000. The framework is of white oak. The woodwork of the cabins, staterooms, and deckhouse is of mahogany, which is light and yet extremely durable. The boat was designed especially for cruising along the Mississippi, which is not always deep, particularly along its upper reaches, and for this reason draws only 30 inches of water. Twin screws, 32 inches in diameter, are fitted in tunnels in the bottom of the boat, so that they will not strike obstructions in the shallows. This saves about 20 inches on the draft, and means but a slight loss in efficiency. The boat also has twin rudders.

The power is derived from two 200-horsepower gasoline motors, which drive the launch at a speed of about 14 miles downstream and 7 miles upstream. Eight fuel tanks having a total capacity of 2,500 gallons have been installed. In normal cruising, the consumption will be about 45 gallons per hour.

A spacious salon occupies the forward end of the main deck, with piano, built-in bookcases, and other attributes of comfort. The dining room has built-in china closets, and the galley likewise has all the latest conveniences, including a gas cookstove and an electric iceless refrigerator. There are 11 staterooms and an office for the owner. In all, eight guests may be accommodated in addition to the crew of from four to six. Sleeping quarters for the crew also are on the main deck. The staterooms and the salons, as well as the pilot

house and the observation cabin, have windows covered with bronzed screen. Thus the sides may be thrown open to the breeze, or closed entirely when the weather is bad. The windows are of the Pullman type.



Doctor Mayo's New Boat Tied Up along the Bank of the Mississippi just after the Launching



The Mayo Boat from the Stern, Showing Workmen Putting on the Final Touches Before the Boat Took Its Initial Cruise

in width, and displaces about 75 tons.

Built of the finest imported woods, and pro-

End. Carri Christmas
Door 155, St. Paul, Minn.

9756

Hahl Autoaster Corp.
 224 N. Sheldon
POPULAR MECHANICS

353

Chicago



Above: One of the New Play Cars for Children, Which, Except for the Large Pneumatic Tires, is Constructed Entirely of Steel. Underneath the Handlebar can be Seen the Lazy-Tongs Motive Arrangement to Which is Attached the Small Fourth Wheel. Right: Lazy-Tongs Apparatus Extended by Operation of the Handlebar

The boat is equipped with a complete filtration system, and after going through it, the drinking water is cooled by the refrigeration system, two 5-kilowatt generators furnishing the current. Each stateroom has access to a bathroom. All auxiliaries, such as pumps and capstan, are electrically driven. There is also an electric-light system, and a hot-air heating system operated by oil.

Provisions have been made for cruises lasting up to six or seven days. Though built for the Mississippi, the boat is large enough for short coastwise trips.

9732

**FISH BAIT SNAPS LIKE TRAP
 USED FOR WILD ANIMALS**

By a slight pull on the tail hook of a new bait, the fish that nibbles it is caught both in and outside the jaw, so that it cannot get loose. A second hook, swung back and attached to a trigger on a small metal frame, catches the fish

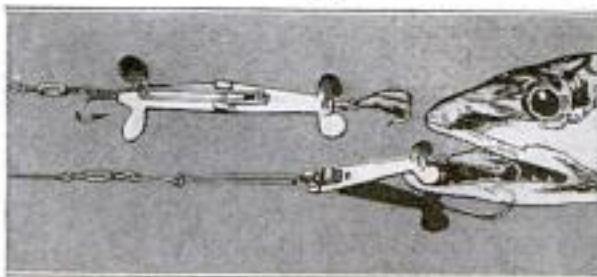

The Bait, as It Looks with the Hook Swung Back, is Seen Above, and Below, as It Appears When the Trigger has been Released

from the outside. The trigger is released automatically by a slight pull on the tail hook. The bait is swiveled and revolves by means of propellerlike vanes.

Info. C.A. Carlson

11124 S. Russell Los Angeles

Vehicles for Children
**MAKE ATTRACTIVE PLAY CAR
 WITH CLEVER DRIVE**

9756

Adapted for the use of boys or girls from 7 to 15 years of age, an attractive play car is now being manufactured that has several striking features. The car has three ball-bearing wheels equipped with pneumatic tires, and is of steel construction, including the wheels. Steering is accomplished by turning the front wheel with a foot lever operating through a parallel-motion device. The car is propelled by a small fourth wheel fastened to a lazy-tongs arrangement. A handlebar is used to operate the lazy tongs, and the little wheel is so constructed that, when force is applied to the handlebar, the wheel is locked. In this way it acts as a pusher, giving the maximum push at the beginning of the stroke and the maximum speed at the end of the stroke. The most surprising feature of the car is the ease with which it moves ahead, a speed of 12 to 15 miles per hour being possible.

**EXTENSIVE SAFETY CAMPAIGN
 TO REDUCE INJURIES**

9855

Reducing injuries—not accidents—is the aim of the Chamber of Commerce in a western city, where an extensive campaign against carelessness is now being carried on. Personal inspections are made of industrial plants, business houses, garages, gasoline stations, etc., with a view of eliminating unnecessary fire hazards, while cards and booklets containing safety hints and traffic rules are distributed by mail through information bureaus of factories, stores, and schools.

The American City 7/1922

Invincible Vacuum Cleaner Mfg. Co

354 *Power* POPULAR MECHANICS

9772 *Cheio*
POWERFUL VACUUM CLEANER
CAN BE EASILY MOVED



Mounted on two large rubber-tired wheels, a powerful vacuum cleaner which can be moved quickly and quietly from place to place is now attracting the attention of building superintendents.

The machine is designed to clean the heaviest of floor coverings thoroughly. By the use of a brush or felt attachment, it cleans tile or wooden floors equally well.

AUTOMOBILE LOCK INSTALLED
ON STEERING-WHEEL HUB

9678

A new safety lock for automobiles is attached to the steering wheel in such a manner as to make the latter inoperative.



Made of hardened steel that resists filing or cutting, it covers the hub of the wheel, and grips all four spokes. Above the wheel and in front of the driver is the keyhole. After removing

the steering-wheel nut, it can be installed with a wrench and hammer in about five minutes.

DURABLE PAVEMENT OF WOOD
DUSTLESS AND SILENT

954

That it will last three times as long as the usual pavement, is but one of the many merits claimed for a road material introduced by an Englishman. It is of wooden-block construction, the blocks having dovetail-shaped slots in them, of which one extends the length of the block

and three others reach across it at an angle of 30 degrees. These slots range from 5/16 inch at the top, to 3/4 inch in width at the bottom, and are 1 1/4 inches in depth. When placed in the road, the slots are filled with a special bituminous rubber, or asphaltum, composition, which is said to be unaffected by either extreme heat or cold, to provide a firm footing for horses in all kinds of weather, and to eliminate skidding of motor cars.

9798
QUICKLY ADJUSTABLE JAWS
ARE WRENCH FEATURE

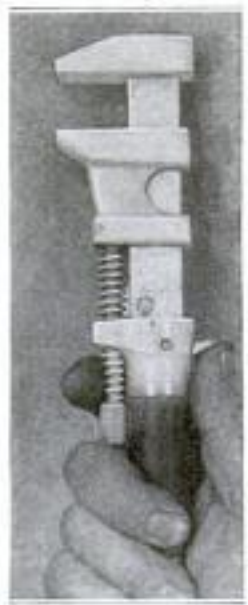

Quickly adjustable jaws are the main feature of a monkey wrench, introduced by a Chicago man, which can be opened or closed by a pressure on a trigger. Besides the innovation that permits the rapid operation of the jaws, the tool also has incorporated in it the usual knurled thumbscrew attachment, with which the wrench can be manipulated in the ordinary manner, for the accurate adjustment of any size nuts.

AUTOMATIC VACUUM VALVE
IS EASILY REMOVABLE

9335

A self-contained automatic vacuum valve, now on the market, has a cylindrical valve body cast from highest-quality copper and tin, machine-finished, and with a threaded nozzle. Inside this body, above the nozzle, is a cross-bar perforated in the center to act as a guide for a plunger rod, the other end of which, above the plunger disk, slides in a similar perforation in a cap connected to the top of the valve body. In this cap is an air opening, and on it is machined a small seat for the plunger disk. On the plunger rod is a spiral spring, so light that the least suction will open the valve.

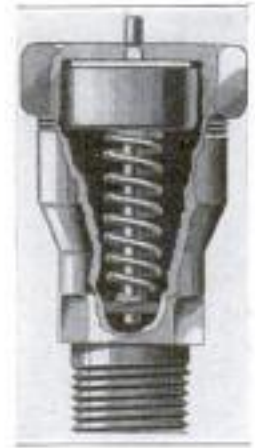

*Chicago
 220 E. 34th St.
 George C. Korb
 Chicago*

*Packard Engineering Co
 Cleveland, O.*

*Sold by: J. R. D. Nelson, 10. High St. Boston, Mass.
 Strawberry Hill, Wickham, England.*

9685

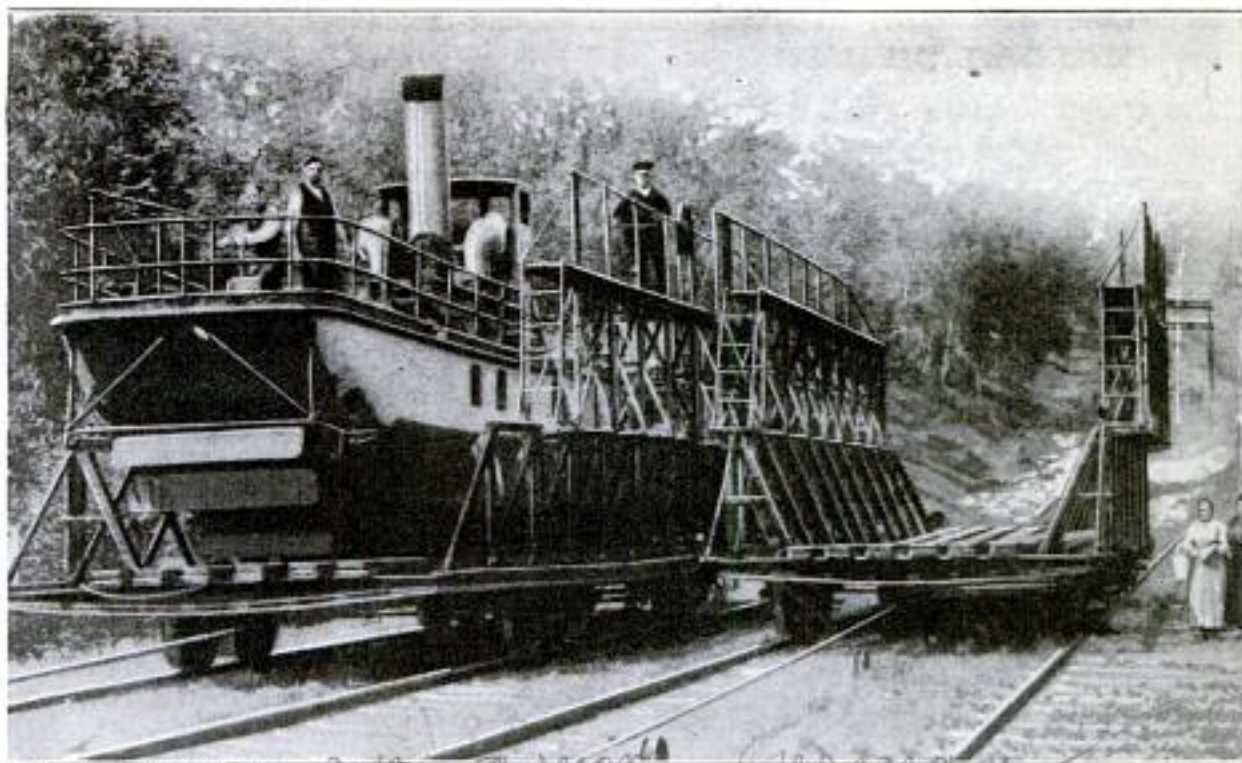

COPYRIGHT, UNDERWOOD & UNDERWOOD

ref. Foreign
STRANGE RAILWAY CARRIES BOATS FROM LAKE TO SEA

AT one point in East Prussia, when passengers book their passage for a trip by boat, they also receive a rail-road trip for good measure, yet at no time leave the boat. The small boats with their passengers run on an inland lake and are then transferred on special cars overland to the sea. The cars run on rails laid under the water, to take up the boats for the cross-country journey.

9693

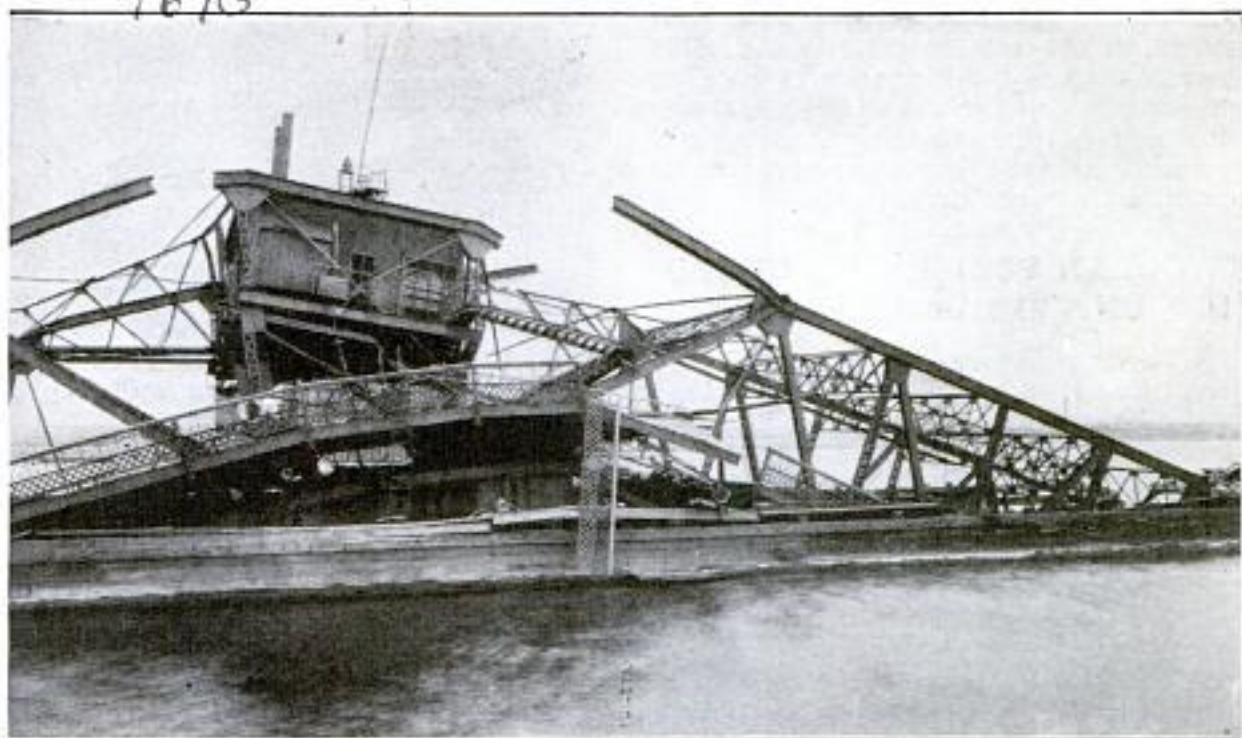

STEAMER RUNS INTO OPEN DRAWBRIDGE AND WRECKS IT

THE swing span of the drawbridge over the Hackensack River, between Jersey City and Newark, N. J., was wrecked recently when a 2,100-ton steel steamer ran into it while the span was fully open and in position directly above the fender piling. As seen, the span broke in two at the center pier, and each half fell upon the piling. Five men in the operating tower escaped unhurt. Ferry service was established immediately after the destruction of the bridge, which was the crossing for the Lincoln Highway traffic, and a temporary crossing erected pending the construction of a new draw span. There was a strong tide running in at the time the vessel came up the river, and it is believed that this might have been the cause of the accident.

*Comd. Thomas K. Flanagan
5 Virginia Ave., Jersey City, N.J.*
Copyrighted material

Borg & Beck Co.
 914 S. Michigan Ave
 356 Access Chicago POPULAR MECHANICS

AUTO-TEMPERATURE INDICATOR HAS DIAL ON DASH

9776 The temperature at which a gasoline motor operates has an important bearing

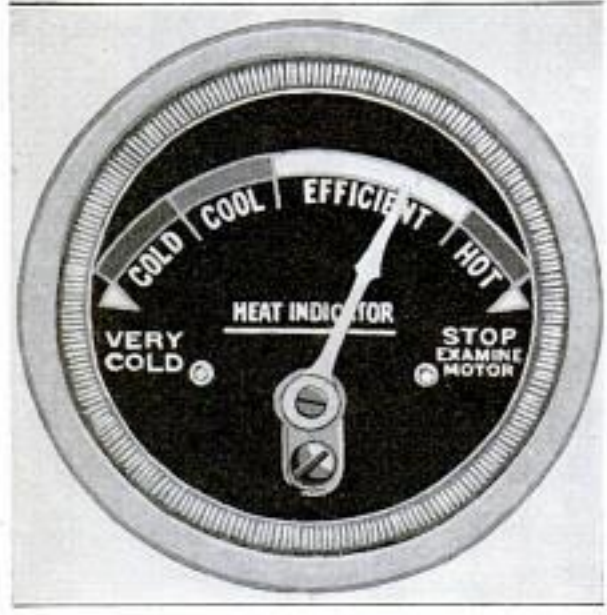

Dial of Temperature Indicator for Automobiles Which can be Mounted on the Dashboard of the Machine

on its economy and upkeep, and should be known at all times to insure best results. There is now on the market a device, consisting of a control unit, that fastens to the motor and has a flexible shaft leading to the instrument board. It is there connected to a pointer that shows on a colored dial whether the motor is operating at an efficient temperature or is running too hot or too cold.

"WOODEN POLICEMEN" GUARD UNIVERSITY CAMPUS

4694 "Wooden policemen" brandishing heavy spiked clubs on which is written "Keep off the Grass!" are used by the University of Wyoming to keep pedestrians from



Students of the University of Wyoming Made a Number of These Wooden Figures to Keep Pedestrians from Walking on the College Campus

trampling the college lawns. The effigies are 26 inches high and mounted on a stake about 10 inches long. They were made by a student organization.

9853 **SPRAY DRAINS WITH ASPHALT TO CONTROL MOSQUITOES**

Finding the use of ordinary water drains inadequate in a fight to control the breeding of mosquitoes, the health department of Trinidad, British West Indies, is spraying the drains with liquid asphalt. It was found that clearing the drains of grass was not only expensive but ineffective; for the heavy tropical rains often washed down the banks, leaving little pools of water, in which mosquitoes bred freely, scattered along the sides. Asphalt is spread along the drains and burned, while a combination of oil is thrown on to provide the heat necessary to volatilize its lighter constituents.

9759 **RADIO VARIABLE CONDENSER OF NEAT CONSTRUCTION**

One of the neatest of the many variable condensers for use with radio apparatus, is the type now being manufactured by

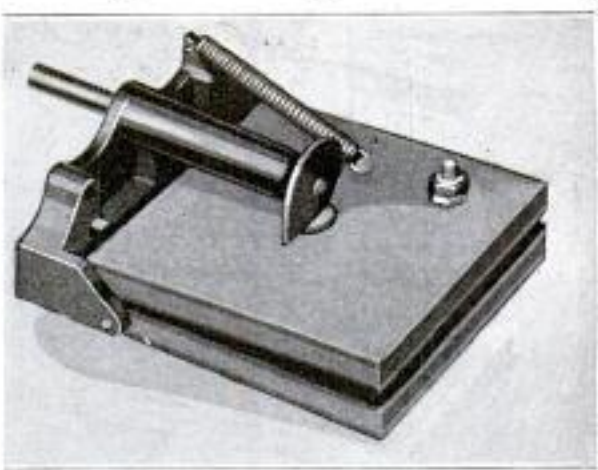

Variable Condenser for Radio Set, Showing the Two Wooden Plates with Spring Tension on Top and the Specially Designed Cam

a concern in Cincinnati, Ohio. The essentials of the condenser are two thin sheets of copper—one of them covered by a sheet of mica—fastened on two small laminated wooden plates. The plates are so arranged that they are opened from the side with a booklike action which is controlled by a specially designed cam and spring tension. There being no friction between the different parts, these last indefinitely, and are said to be absolutely proof against voltage punctures or showering.

Crosley Mfg. Co.,
 Cincinnati, Ohio

The American City
 July, 1927

Encl. Agnes W. Spring
 Box 324, Laramie Wyo

9552

Lake Torpedo Boat Co.,

POPULAR MECHANICS

357

Bridgeport, Conn.

TWO SUBMARINES ADDED TO U. S. NAVY

Having passed all acceptance tests, with new records established, the submarines "S-49" and "S-50" have been commissioned, and are now a part of the under-sea flotilla of the United States Navy.

are powered by storage batteries through motor-driven reduction gears.

The vessels are also equipped with a complete high-powered wireless outfit. Experiments on these boats with under-

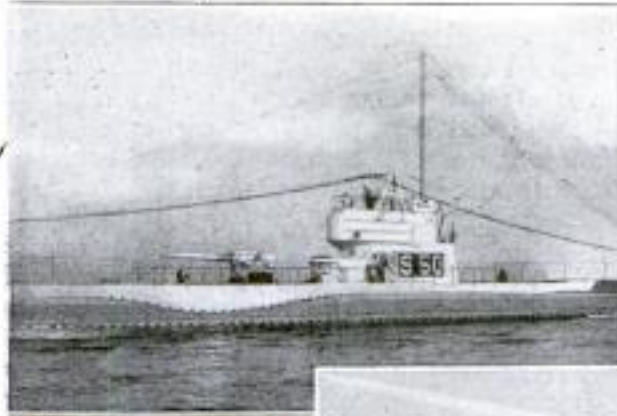

The Submarine "S-50" Leaving Brooklyn Navy Yard after being Provisioned for Regular Service: New Records were Established in the Preliminary Tests

The addition of these two underwater craft provides the last word in submarine defense for the United States. They are two of four sister ships, the others being the "S-51,"

which is now undergoing preliminary acceptance trials, and the "S-48," which sank off Bridgeport Harbor in Long Island Sound during acceptance trials, but was later raised. All four S-boats have an average length of 240 feet, with a surface displacement of over 900 tons. They have a cruising radius of 3,000 miles under normal conditions, but it is estimated this can, under duress, be extended to a greater distance.

The sting of these wasps of the sea is provided for by the mounting of a 4-inch rifle on the forward deck and the installation of five torpedo tubes, four in the bow and one in the stern. To take up the recoil from the rifle fire, special steel framing reinforces the deck below the gun-mounting platform.

According to unofficial reports the speed of the latest S-boats is between 22 and 23 miles an hour on the surface. Propulsion is by the latest-type Diesel engines, designed by the navy engineering department. Under water the craft



Formal Acceptance of the "S-50" at Bridgeport, Connecticut, by Officers of the United States Navy: Note How the Breechlock of the Rifle is Made Water-Tight

While on a Two-Hour Run during Trial Tests, the "S-51" Kept in Touch with Its Base by the Use of Carrier Pigeons. Wireless was Not Installed Yet

water communication by wireless have resulted in valuable data for further development of the equipment required for this purpose.

During the official tests of the Navy Department, constant communication with land was kept up by the use of carrier pigeons which were periodically let loose with messages to be returned to the test base. This step was taken to prevent a repetition of the "S-48" mishap which nearly resulted fatally. The two remaining boats, now being prepared for final trials, will complete the program of the United States Navy in the S-boat class.

SOCIETY TO AID CHILDREN

9841 IN STUDY OF BIRDS

Thirty thousand dollars has been received by the National Association of Audubon Societies to be used in aiding teachers and pupils in the study of wild birds. Teachers who form clubs are to be given free material to help them in their work. More than 1,700,000 children are already enrolled in schools throughout the United States and Canada. The headquarters of the association is in New York City.

The American City
4/1922

Charles J. Gilbert, President, National Audubon Society, New York, 1924

1 no. M. Holst, 1335 Esrant St.

358

Blender. Colo. POPULAR MECHANICS

**MAP HOLDER FOR MOTORCYCLE
FASTENS TO HANDLEBARS**

9718

Motorcyclists will appreciate a handy and inexpensive map holder which can be fastened to the handlebars of the machine, and is always in plain view. The road map is folded to show the

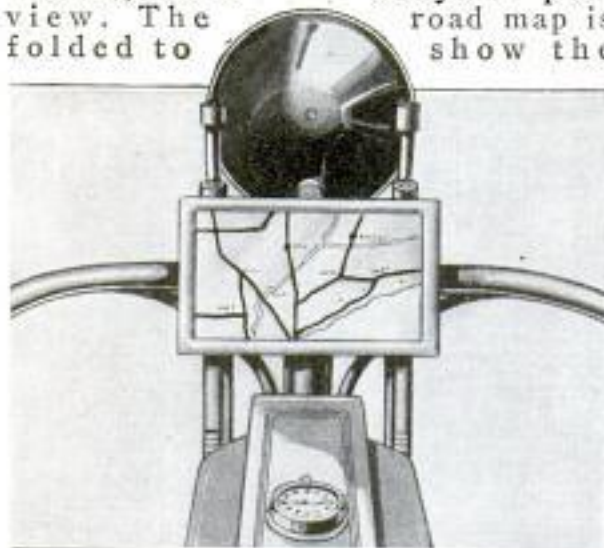

Motorcycle Road-Map Holder Which Fastens to the Handlebars, Showing How It is Placed Directly before the Eyes of the Rider

route to be traveled and then inserted in the holder, which has a transparent celluloid cover. The rider thus has the map before his eyes at all times, and need not stop every few miles to take it out of his pocket for consultation.

Aeronautics
**NATIONALITY AND REGISTRY
MARKS FOR AIR CRAFT**

9785

As part of a comprehensive program to assist in assuring safe practices in aircraft operation, an airship register has been devised. This movement is fostered by the National Aircraft Underwriters' Association. That organization has felt

the pressing and growing need for nationality and registration marks for private and commercial airplanes.

The nationality mark is represented by a capital letter, as, for instance, "N" for the United States. Its use is not required for air craft that remain within the United States, but only for those following international routes.

The registration mark consists of four capital letters, at least one of which is a vowel; for this purpose the letter "Y" is considered a vowel. On air craft other than state and commercial, the registration mark is underlined with a black line.

Specific rules govern the painting of the nationality and registration marks. They must be in black on a white ground, painted once on the lower surface of the lower main planes and once on the upper surface of the top main planes, and also along each side of the fuselage, between the main planes and the tail planes. It is provided, in addition, that the nationality mark be painted on both sides of the rudder. The letters on the wings are to have a height of four-fifths of the chord, and in the case of the rudder, to be as large as possible. The prescribed width of the letters is two-thirds of their height, and all letters are to be in plain block type and uniform in shape and size. A hyphen separates the nationality and registration marks. In general, the marks should be displayed to the best advantage, and must be kept clear and visible. The registration marks will also serve as the "call signs" of the air craft in all radio or other signaling.

Whenever an owner or operator applies for registration of his air craft, he must give all essential information regarding it. This information, as abstracted in the register, will have an important bearing upon many phases of insurance.

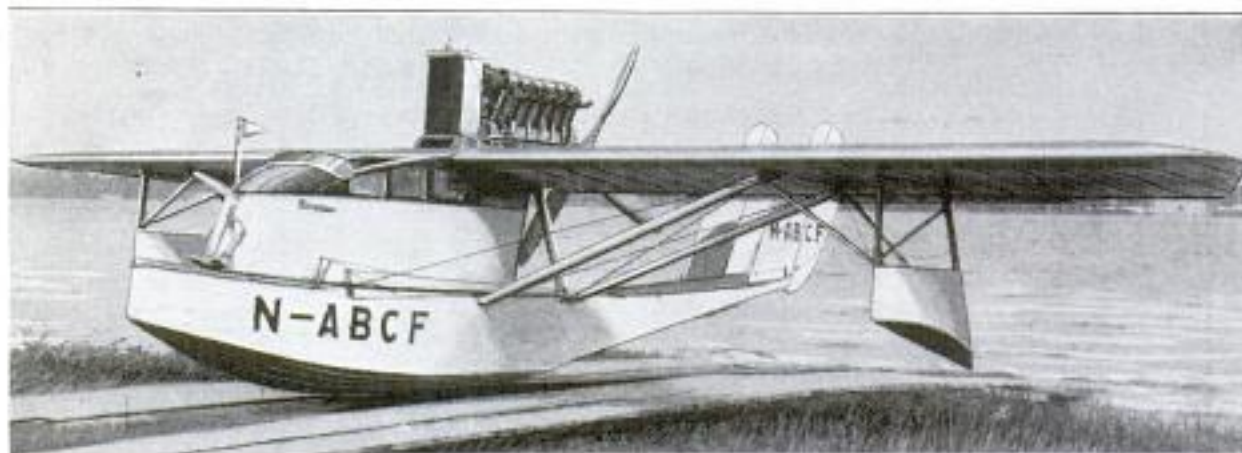

Hydroplane, Showing the Markings Which the National Aircraft Underwriters' Association has Designed to Appear on Flying Craft, and Which will Serve as a Ready Means of Identifying the Owner

Cvt. George F. Paul, 900 Ellworth Bldg
Chicago

copyrighted material

9938

COMMENT AND REVIEW

[These pages were printed July 25, 1922.]

STORIES are not wanting of locomotives with no one aboard suddenly going into action and dashing off down the line, to the consternation of trainmen and dispatchers and danger of collision with other trains. Machinery also will start or stop at times without human intervention. Derelicts at sea frequently accomplish voyages of thousands of miles before they are reported, sought out, and sunk. It is impossible to convince the old salt-water seaman that ships do not possess certain mysterious powers of action over which captain and crew have no control.

A Runaway Ship

A curious instance of this kind happened recently in the Boston harbor. The Shipping Board steamer, the "Wakanna," had been condemned to end her days by being taken to a lonesome beach far from the busy lanes of vessels, and burned. She had been for some time securely anchored, while the nature of her fate was being considered. Finally it was decided. Then, at night, she slipped her moorings, and without captain, pilot, or crew on board, silently threaded her way through the harbor, out among tortuous channels, and around dangerous rocks and reefs, to navigate which, even in daytime, requires experienced pilots to pass in safety, and out toward the great ocean.

Early next morning the escape was discovered, and government tugs chased out after the truant. Finally she was overtaken, and towed back to await the ordeal by fire which occurred a few days later. Old salts shook their heads and declared, "She knew what was coming," and one might as well try to convince them the ocean is fresh water as to reason them out of their belief.



AFTER the petition for independence of the Philippine Islands, which has been so strongly and ably urged by a distinguished delegation to Washington from the islands, and all the arguments for and against, which the politicians so confidently declare, it is informing to have the views of an American who is now and has been in successful business there for several years. During our interview he explained why it is not practical at present, and in his judgment cannot be for many years to come.

Independence for the Philippines

He paid the highest tribute to the educational, judicial, and financial systems which the United States has established and maintains there. Our government of the islands has been excellent, and in the larger cities and a considerable zone about them the natives have developed to a point where they could doubtless stand alone in many respects, for the Filipino is possessed of no small amount of natural ability, which education quickly develops. The great difficulty is the want of solidarity, and the huge task of bringing about any such condition. Conditions there are comparable to those small European mountain states where the people of one province have centuries-old customs and habits, each peculiar to itself; and where the inhabitants of one cannot read, speak, or understand the language of another, perhaps only a few miles away. The same is true in the islands, with the additional handicap that as yet the great majority of the people are very ignorant, and many of them semi-savage or worse. There are scores of tribes numbering thousands of members each, who still maintain their hatred of certain other tribes, and it is only the presence of our forces there which restrains many tribes from warfare and plunder of others. The Spaniards made little or no effort to prevent these periodical incursions, and, he said, with American restraint removed, it would be a matter of only a few days, or even hours, before many tribes would be in action again, so overwhelming is the preponderance of what may be designated as "wild men" over the civilized. Then, too, distances between the various islands, of which there are hundreds, are much greater than we here at home realize, and there are periods of days, at times, when travel between certain islands is impossible.

By no means do all the islanders want to be educated, and thousands of adults are quite incapable of learning even what we call the rudiments. They love their wild state, in which they and their ancestors have lived for centuries; it satisfies every want, then why make the radical change to the white man's mode of life?

The difference in mentality among different tribes is more pronounced even than the social status of the classes was in European countries 50 years ago.

In many, probably most, ways we would be better off had we never acquired these possessions. It is doubtless a matter of indifference to most of our citizens whether we have them or not.

We may fairly ask ourselves the question, "When will all the islanders become civilized?" in our sense of the word.

We may also ask ourselves, "When will the millions of square miles of useless and now waste land in the United States become productive?"

Some day, perhaps, but not in our time.



IT is not so long ago that lepers were scarcely thought of except as connected with incidents in the Bible. Even with a better knowledge of what are now the Hawaiian Islands, and increased travel among oriental lands, we unconsciously thought of lepers as something a long, long way off. Certainly we never entertained the idea that it was anything which immediately concerned us personally, and least of all as ever becoming a danger and menace here at home.

*What
about the
Lepers?*

But like many other things which could not happen, it has. We have lepers in 25 states. In spite of the research and noble efforts of the medical profession, and the confident claims from time to time that a cure had at last been found, the terrible fact

is that as yet there is no certain remedy to remove the curse or prevent it if one is effectively exposed.

The very best that medical science has as yet to offer is the absolute quarantine of the afflicted, that their living death be not communicated to others.

The Federal government has but one leprosarium, in Louisiana, and its limit of 200 patients is already filled to capacity. Something must be done, and at once, or like a deluge or forest fire, it will get beyond control.

The Red Cross, with its national organizations, which functioned so promptly and efficiently in the great war, might well lend itself to this growing menace here in our own midst. It is not a matter which villages, towns, cities, or even states can handle effectively by themselves. It requires an organization of national reach and strength such as the Red Cross already has. Aid to the needy and suffering on the other side of the globe is commendable, but not more so than the care of the 1,000 lepers who at present are properly denied admittance to almshouses, hospitals, and sanitariums. Dr. C. H. Lavinder, assistant surgeon-general, declares isolation is at present the only way.



THE cyclonic-minded captain of the vastest pirate crew ever assembled, is now in a fair way to lose that mind, and with it his grasp on the soviet government of Russia.

*Russia
the
Helpless*

Exhausted are the fabulous hoardings of the czars; stripped of gems and gold, the Russian churches are as bare as a barn; banks and the possessions of merchants are alike looted; granaries which could be located are empty, and the husbandmen refuse to plant more than enough to supply their smallest actual needs. The proverbial drunken sailor in his wildest excesses is a miserable piker to the debauch of a whole nation. And now, after sending millions to spend in bolshevistic propaganda in other

lands, the gold basis of a monetary system which Lenine declared to despise finally is recognized to the extent of asking a gold loan, at the Hague, from any nation which will lend.

The structure of centuries, with tremendous power and apparently inexhaustible resources, that great tower of strength, has been steadily falling, piece by piece, and now like the man who tore it down, is a monstrous wreck.

Some day a real leader, using brain force instead of brute force, will be raised up. What most glorious opportunity of the centuries to redeem and rehabilitate a great empire!

H. H. WINDSOR

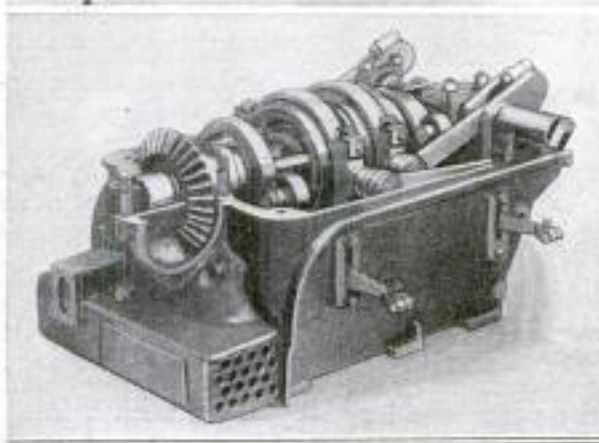
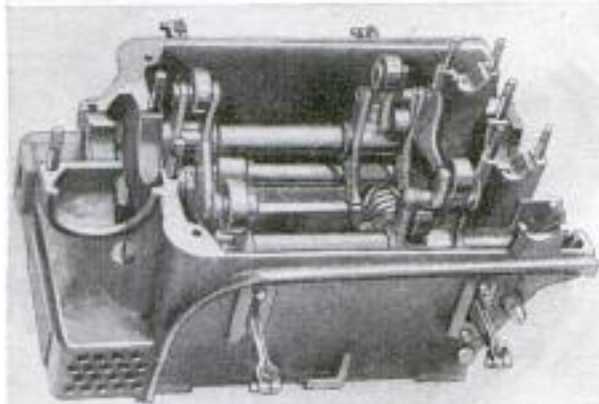
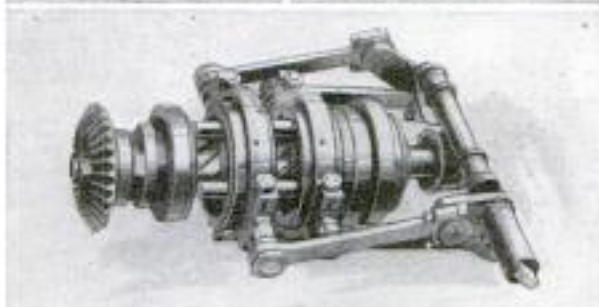
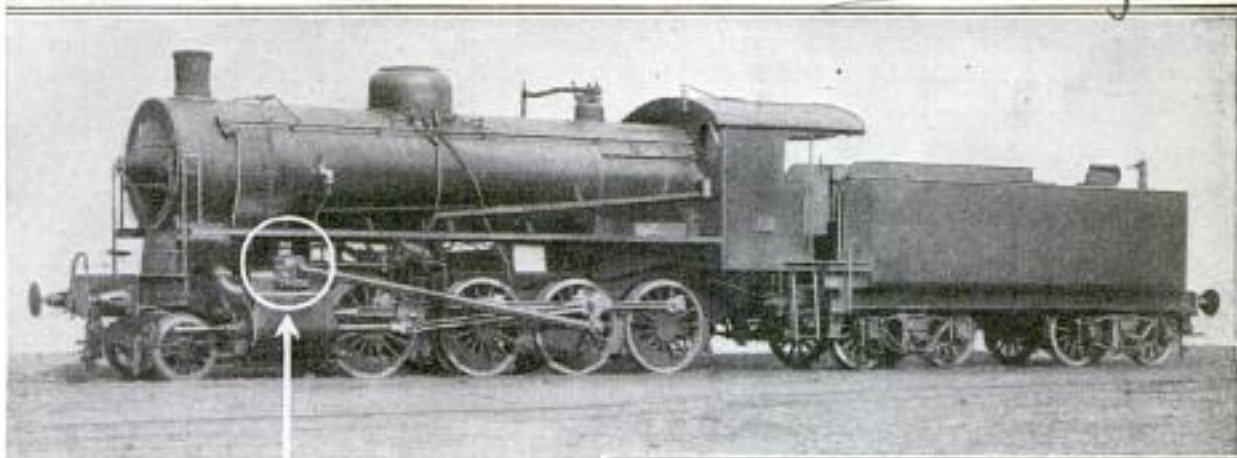

Above: Italian Locomotive Fitted Experimentally with a New System of Poppet Valves, Installed in a Box Connected with the Steam Chests of the Cylinders. Left: The Driving Gear, Cams, Reversing Shaft, and Rods Removed from the Box, Leaving It in the Condition Shown Below; and Below That Again Is the Whole with the Box Cover Removed

the new system, poppet valves are used, to avoid the faults of both the flat slide valve and the piston valve. The operation of the poppet valves is controlled by cams located on a short shaft incased above the steam chest, the shaft being driven, through bevel gears, from the driving axle of the engine. The angular position of the cams on the shaft may be changed while running, through the use of a screw and sliding sleeves. Advantages claimed are that no strangulation of the steam occurs, and more effective use of the power of expansion of the steam is possible.

9911
NEW EXPLOSIVE COMPOUND HAS IDEAL QUALITIES

A Minnesota inventor has compounded an explosive which has demonstrated remarkable qualities in recent experiments. While appearing to have great disruptive powers if closely confined, as in a shell or drill hole, it can then be exploded only by means of a blasting cap or electric detonator. It is reported to give off no noxious fumes, that it will not explode when heated to 212° F., that it will not freeze, and that it cannot be accidentally exploded by shock.

In an effort to overcome the faults common to the standard types of link-motion valve gears used on locomotives, a new gear has been designed that, in trials, has shown marked economy of coal and water for the power developed. In

☞ To suit different kinds of glass, it is recommended that the limes used in their manufacture be divided into three classes, containing, respectively, 96, 91, and 83 per cent of oxides of calcium and magnesium. The variation from day to day should not exceed 2 per cent.

*dr. John R. Crosson
 Kenyon, Iowa*

**DEVICE HOLDS AUTO CURTAINS
READY FOR INSTANT USE**

Auto side curtains are held ready for instant use by means of a new device,

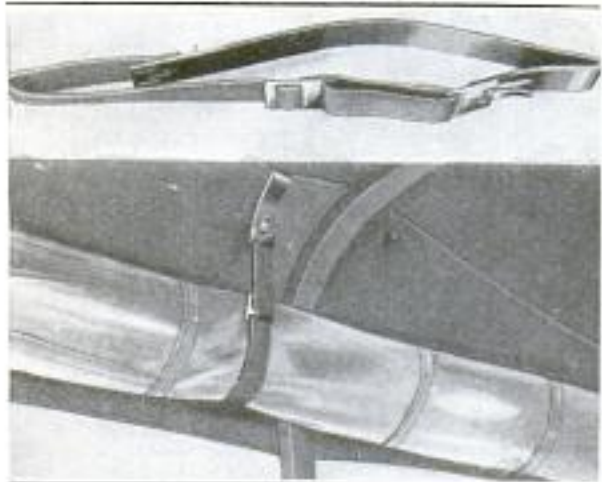

Above: Strap for Holding Side Curtains of an Automobile. Below is Shown the Manner in Which the Straps are Used

consisting of a metal clasp which fits under the padding strip, and a web strap that goes around the rolled curtain and hooks to the clasp. To let down the curtains it is only necessary to unhook the straps holding them.

9724 **SANITARY HEN'S NEST
MADE OF METAL**

The old-fashioned dirty hen nest seems to be doomed to extinction by a metal

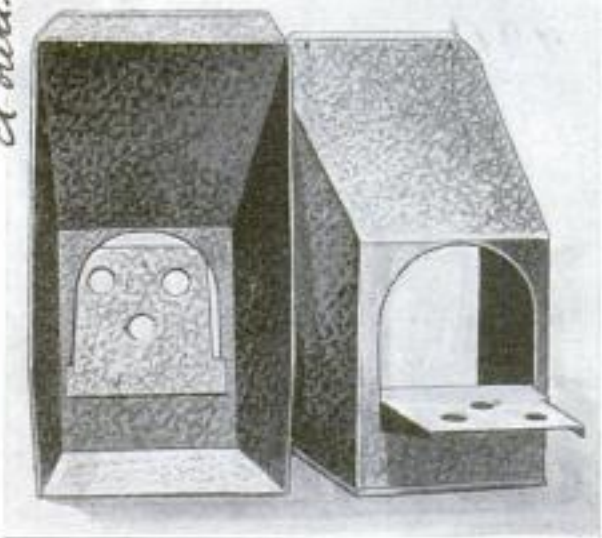

Two Views of Sanitary Hen's Nest. Made of Sheet Metal, So That It can be Scalded to Keep It Clean

nest—the recent invention of an Iowa farmer—which can be scalded periodically. A false bottom is another feature of the nest. It consists of a metal frame

with holes, through which the eggs roll out of sight. This prevents the hen from sitting on the eggs, eating them, or getting them dirty. The nest can also be used as a coop. It is hung on two nails and is easily moved.

**BURGLAR GUN IS EFFECTIVE
TO FRIGHTEN OR KILL**

Burglars or other prowlers may be effectively guarded against with the aid of a contrivance resembling a small cannon, which has been produced by an Alabama man. The invention consists of about 10 inches of a shotgun barrel, mounted in a substantial breech and so arranged that a plunger spring, which fires the shell, is loosed by a disarrangement of the thread or string attached thereto. The outfit is especially adapted for the protection of isolated buildings in small towns or villages, and may be loaded with deadly buckshot to kill, or with merely a blank

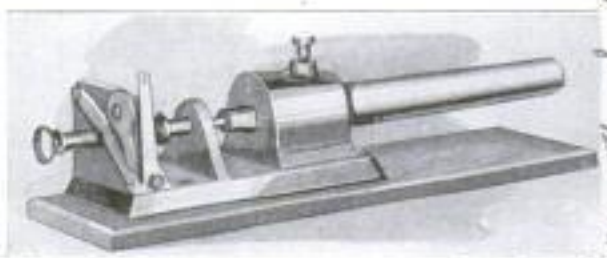

This Burglar Gun may be Loaded with Blank or Loaded Shells, and is Operated by the Breaking of a String

shell to frighten away the would-be intruder.

**GASKETS FOR FLANGE UNIONS
IN THE FORM OF A PASTE**

Every man may be his own gasket maker by using a paste, now on the market, which is applied with the fingers to any flange union where a gasket or washer is required. It is specially applicable for use on gasoline engines, as it will stand high pressures and temperatures, and it is leakproof against gasoline, kerosene, oil, and water. Although the paste permanently seals the union, it does not cement it. The parts can be readily separated, whenever desired, and the paste can be scraped off with a knife blade. "Tom-a-gasket"

We want all our readers to write us freely and often whenever they wish additional information on articles published in this magazine. Address Bureau of Information, Popular Mechanics, Chicago.

The Perfect nest + Coop Co.
P.O. # 3, Box 29, Magnolia,
Iowa.

F. D. Johnson, Mentone, Ala.
d.w. (P)
E. Hepperhead, Day, N.C.

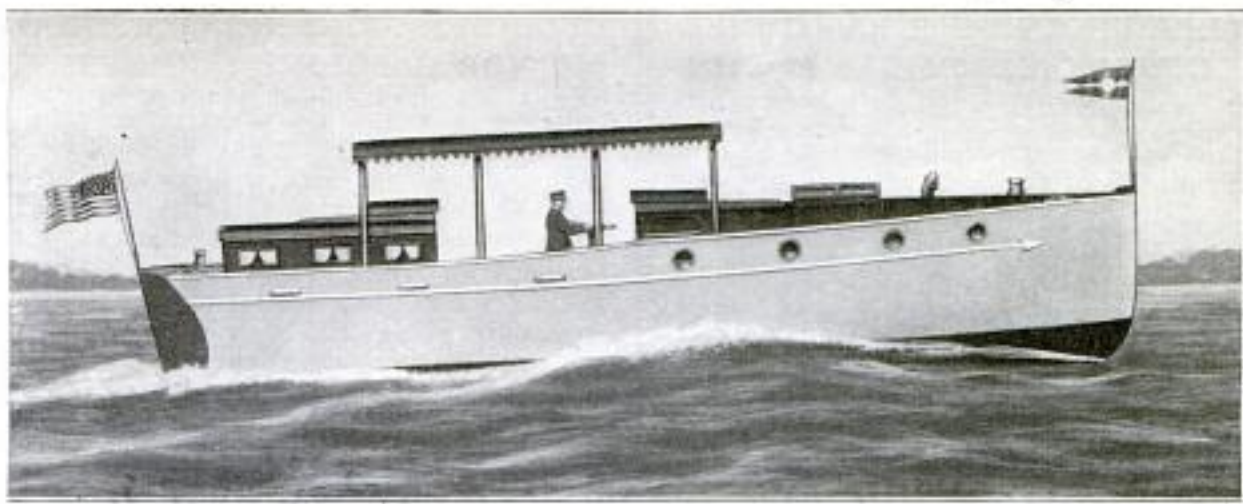

Gasoline Cruising Launch with Fore and Aft Cabins, and Single Control under the Awning Amidships: The Boat Is 36 Feet 6 Inches Long, 9 Feet 10 Inches Wide, and with a 35-Horsepower Motor Makes 15 Miles an Hour. There Are Sleeping Quarters for 8 to 10 Passengers

9775

**GASOLINE CRUISING LAUNCH
 BUILT WITH TWO CABINS**

Constructed particularly for use on inland waters is a cruising launch that is 36 feet 6 inches long, 9 feet 10 inches wide, and that normally has a 35-horsepower motor, giving it a speed of 15 miles an hour, but is so rigidly built that any motor up to 100 horsepower can be installed in it, giving the launch a proportionately greater speed. The boat has fore and aft cabins, electrically lighted, a lavatory, and sleeping quarters for 8 to 10 passengers. Under an awning amidships is a single-handed control.

9795

**SIX PERSONS MAY LISTEN IN
 WITH RADIO ATTACHMENT**

Six persons may listen in to radio concerts, simultaneously and with rubber-tube ear pieces instead of the more expensive amplifiers and loud-speaking horns. A Pennsylvania man has designed a nicked-brass attachment that fits into the ear apertures of two receivers and possesses six branch tubes, to which the half dozen listening contrivances are affixed.

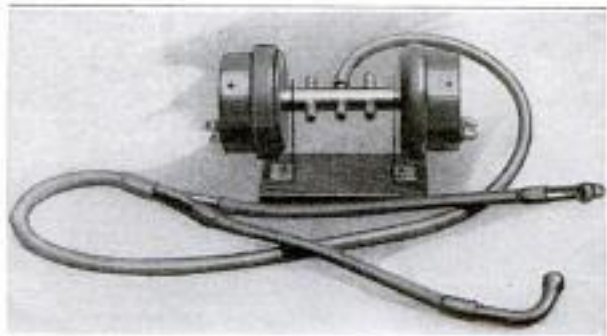

Simple Radio-Receiver with Attachment Enabling Six Persons to Listen In at Same Time

Chas. W. K. Thomas,
 963 Liberty Ave.
 Pittsburgh, Pa.

**CAMP STOVE THAT FOLDS
 HAS BAKING OVEN**

9675

Designed to burn either wood or charcoal and equipped with a baking oven, water container, and coffeepot, a seem-

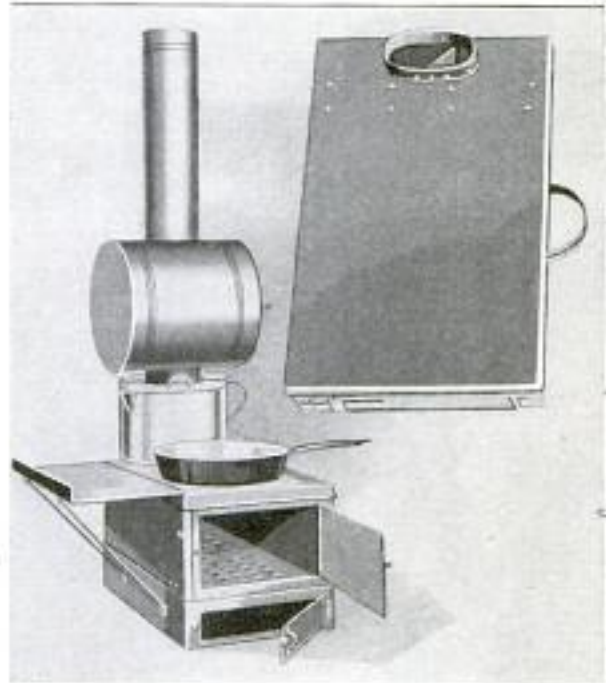

This Practical Camp Stove, Which Is Collapsible and Burns Wood or Charcoal, Has a Water Heater and a Baking Oven. It Folds into a Flat Package, That is Easily Carried in the Rear Seat or on the Running Board of a Car

ingly very practical camp stove is now being marketed by an eastern concern. Its chief advantage, however, lies in the fact that it can be folded into flat compact size with its largest measurement 20 1/2 inches, so that it is easily carried in the back seat or on the running board of an automobile, or packed with other camp equipment.

Mr. R. S. Livingston,
 Elverade, Pa.

Mr. R. S. Livingston,
 Elverade, Pa.

LIFELIKE DOLLS FASHIONED OF WAX AND PAPIER-MÂCHÉ

Lifelike dolls, of which the head and shoulders are modeled in wax, while the remainder of the body is made of papier-



Two Samples of More Than Usually Lifelike Dolls, Fitted with Real Human Hair and Artificial Eyes

mâché, are the product of a Chicago manufacturer. Human hair adorns the heads and is also used for the eyebrows and eyelashes. The eyes are of glass, such as are sometimes used by persons who have lost an eye, and the teeth are constructed of the same material as the false sets made for dentists.

CYLINDER-GRINDING COMPOUND FOR GASOLINE ENGINES

For gasoline motors there is now available a cylinder-grinding compound that is mixed with the lubricating oil, and it is claimed for it that when the engine is run, it grinds the cylinder walls and the piston rings to a perfect fit. The compound is fast-cutting at the start, but it gradually pulverizes to a polishing fineness, and then escapes from the cylinders altogether. The work of regrinding cylinders can therefore be done speedily and by an unskilled operator.

Agent - Edward A. Cassidy,
 ROAD-MAINTENANCE OUTFIT
 OPERATED BY ONE MAN

Road-maintenance work on the rural highways has been benefited by the introduction of an outfit which is constructed as an attachment for a tractor. The implement has but one pivot wheel at the rear, thus permitting the workman to execute a square turn, and four blades instead of the customary single cutting edge. The blades are operated by power from the motor and are controlled by pedals under the driver's feet, the whole contrivance being manipulated by one man.

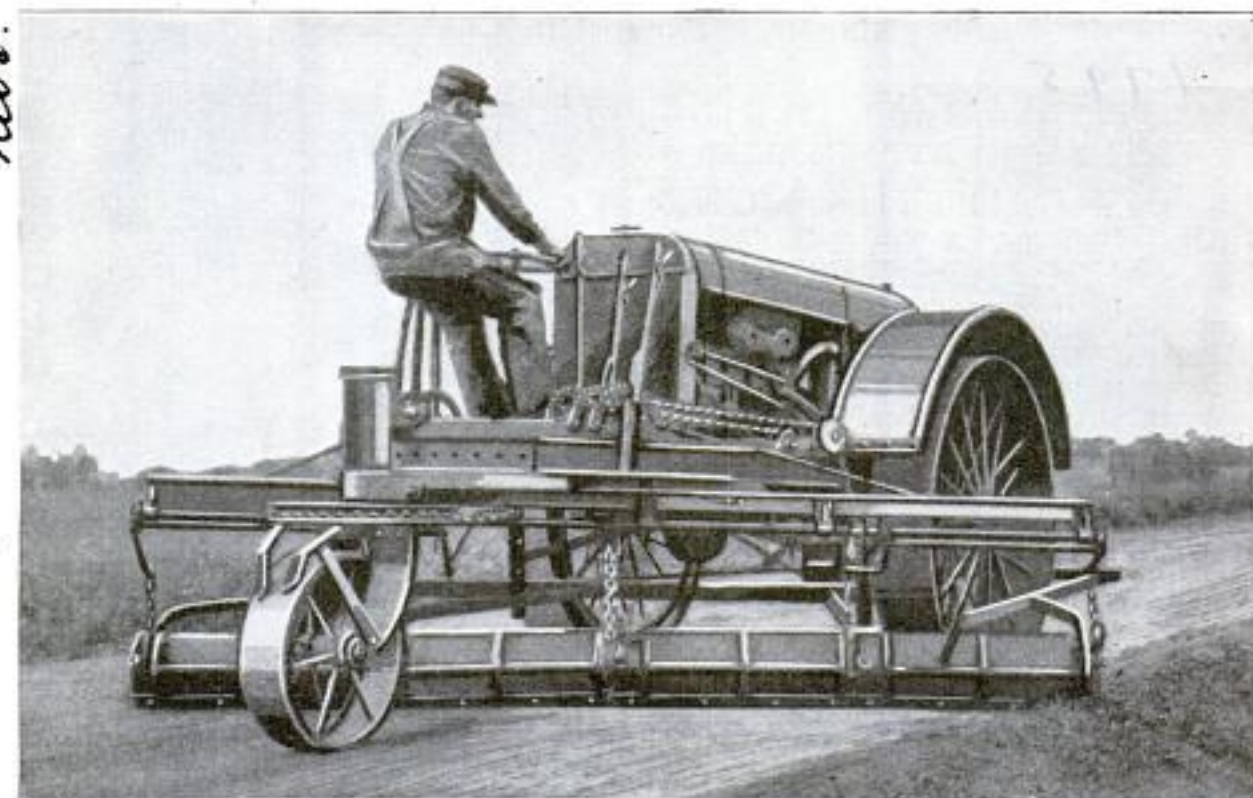

This New Road-Maintenance Machine Consists of a Three-Wheeled Tractor and the Scraper Attachment, Which Has Four Independent Blades Instead of the Customary Single Cutter. The Blades are Adjusted to the Road Surface by Means of Foot Levers

mfr. The Square Turn Tractor Co
 Norfolk, Va.

Law Schmitt & Son,
 1201 E. Chicago

Edw. A. J. Colwell, Norfolk, Va.

U. S. Products Co
 127 Elmiston Ave
 Pittsburg, Pa.

BUZZARDS AND HIGH-VOLTAGE TRANSMISSION LINES

By NORMAN C. McLOUD

1717 St. Paul St.
Baltimore Md

BUZZARDS are getting educated. They are rapidly learning that it is poor and dangerous business to attempt to take liberties with high-voltage transmission lines charged with electricity.

The buzzard is a born sentry, for it finds the carrion flesh which is its food by the sense of sight rather than by the sense of smell, and with the building of the first long-distance electric - transmission lines, the buzzards hailed the steel supporting towers as something new in the matter of sentry stations. But in taking advantage of this man-made improvement they created a new hazard for themselves and, incidentally, a new problem for the engineers of the electric - power companies.

Engineering charts kept by the Pennsylvania Water and Power Company show that the buzzards have been no mean factor in the interruption of current transmission. The so-called turkey buzzard is the largest of the native birds in Pennsylvania and Maryland, with a normal height of 2 feet, and a wing spread of from 5 to 6 feet. The towers of the transmission line range in height from 60 to 130 feet, and it is not surprising that the buzzards should choose these vantage points for their lookout stations. As long as they sat still on one of the crossarms,

they were perfectly safe, but when it came to spreading their wings for flight, something was quite certain to happen. The space between the perch and the wire was not sufficient to accommodate their wing spread without establishing contact, and a short circuit was inevitable. This mishap invariably killed the buzzard and sometimes resulted in placing the transmission lines momentarily out of commission.

In seeking a remedy, the engineers were more concerned for continuity of power flow than for saving the lives of the birds. The results have been of importance to both sides, however, for by increasing the clearance space between wires the company has reduced the likelihood of interference by the buzzards. From 26 inches the clearance space has been increased to a maximum of something over

40 inches, thus giving the birds a better chance to escape without being killed.

Two army airmen recently made an unusually long flight from San Antonio, Tex., to Washington, D. C., during two days of ten and eight flying hours, respectively. Leaving Kelly Field early one morning, they made stops at Houston, Tex., and Pensacola and Jacksonville, Fla., arriving at Bolling Field that evening.

Copyrighted material

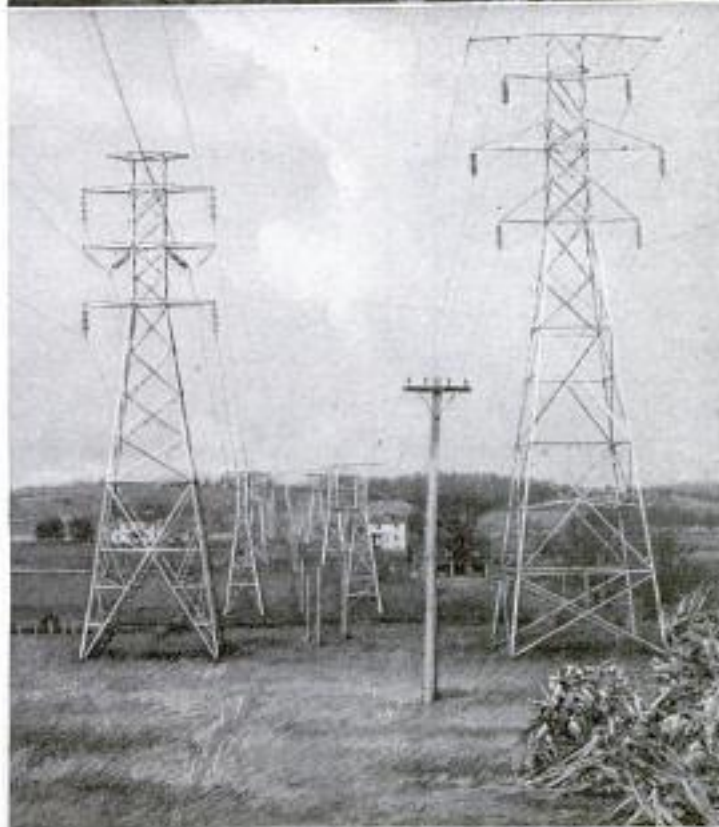

At the Top is Shown One of the Buzzards Which was Electrocuted When Its Wings Came in Contact with the High-Tension Transmission Lines. At the Bottom are Seen Different Types of Towers with Increased Clearance Space between the Wires

9689
**POLE FOR WIRELESS AERIAL
 ERECTED BY ONE MAN**

Easily erected by one man and standing 30 feet 3 inches above its base, a pole

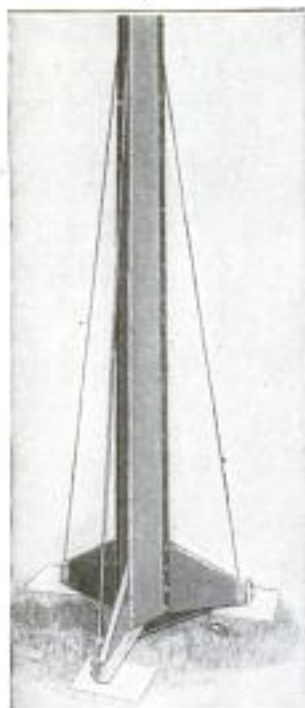

for supporting a radio aerial that is being manufactured by a Cincinnati, Ohio, concern, commends itself to the wireless enthusiast. The pole is shipped in knock-down form, consisting of four sections of bent sheet steel, each section 7 feet 10½ inches in length, and the necessary bolts, etc., for assembly. When assembled and ready to erect, the total weight is only 140 pounds, and by means of anchor lugs on the base,

it can be placed on flat-cement or composition roofs as well as on the ground.

9714
**WISCONSIN ROAD-MAINTENANCE
 SYSTEM EFFICIENT**

Until that day in the far future when all roads in the United States are hard-surfaced, dragging of dirt roads will continue to be, as it is now, a matter of paramount importance.



Many states maintain a force of "patrolmen" who give their entire working days to dragging, and in no other state, perhaps, is this service better organized than in Wisconsin. "They drag

the roads in Wisconsin," any motor tourist will tell you who has toured through the state. The white signs with black lettering every few miles along all the

main dirt highways suggest how this efficiency of service is obtained. When once a patrolman is appointed to take charge of a certain section of road, he alone is responsible for the proper maintenance of that section. He is given a number which he must wear on the front of his hat, and his name, number, and territory are inscribed on the signboard. The effect of these signboards in getting good service has been excellent.

9735
**PLUG-TYPE REFILLABLE FUSE
 SIMPLE AND EFFICIENT**



Plug-type refillable fuses, which can be handled freely by the novice in replacing any "dead" ones in the circuit, have been introduced by a Chicago manufacturer. The innovation resembles the ordinary plug fuse, and when "blown," is unscrewed from the circuit, its top removed, the old filler dropped out, a new one put inside, and then screwed back into the circuit, the whole operation requiring but a few seconds.

9670
**COMBINATION SHOP MACHINE
 HAS VARIETY OF USES**

Designed to be equally well adapted for use in the small or large shop, a new combination power tool is now being manufactured that can be used for many operations. In general appearance, it resembles a drill press, but in addition to this, there is also a rip saw and horizontal disk grinder, driven from the horizontal and vertical shafts respectively. An emery wheel or a surface wheel sander may be substituted for the rip saw.

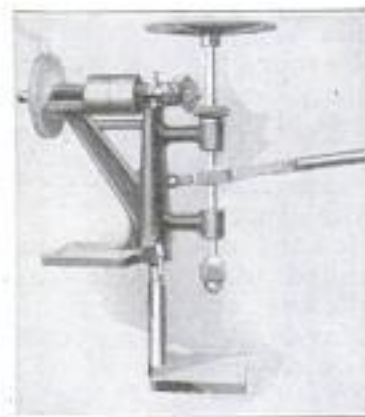

9735
 Littleford Bros. Co., 7 S. Dearborn Chicago

*Emil Florence L. Clark
 Mc Gregor, Iowa*

Littleford mtd. 10/28/12

*Star O. Lock Mfg. Co
 417 S. Dearborn, Chicago*

9845. Combs. } Chas. W. Seiger, Powell & Sutter St
 San Francisco, Calif.
 Mr. Marvin Ingler, Director, News Bureau,
 Celebration Sacramento,
 Calif.

ROMANTIC "DAYS OF '49" ARE COMMEMORATED

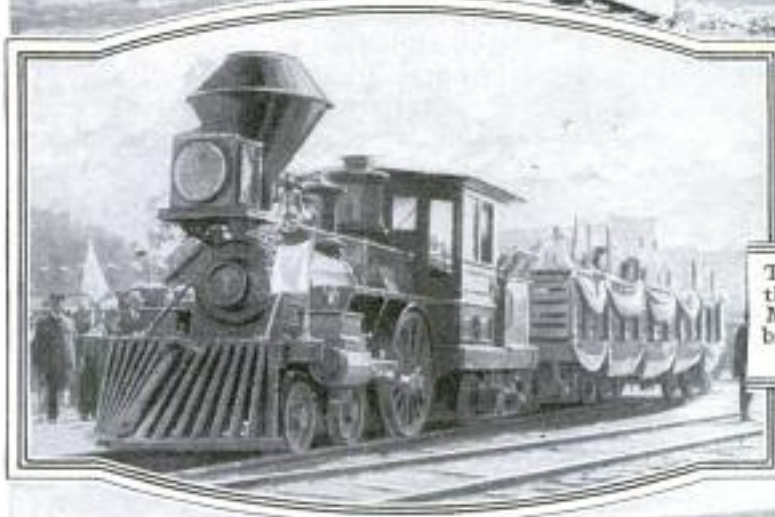
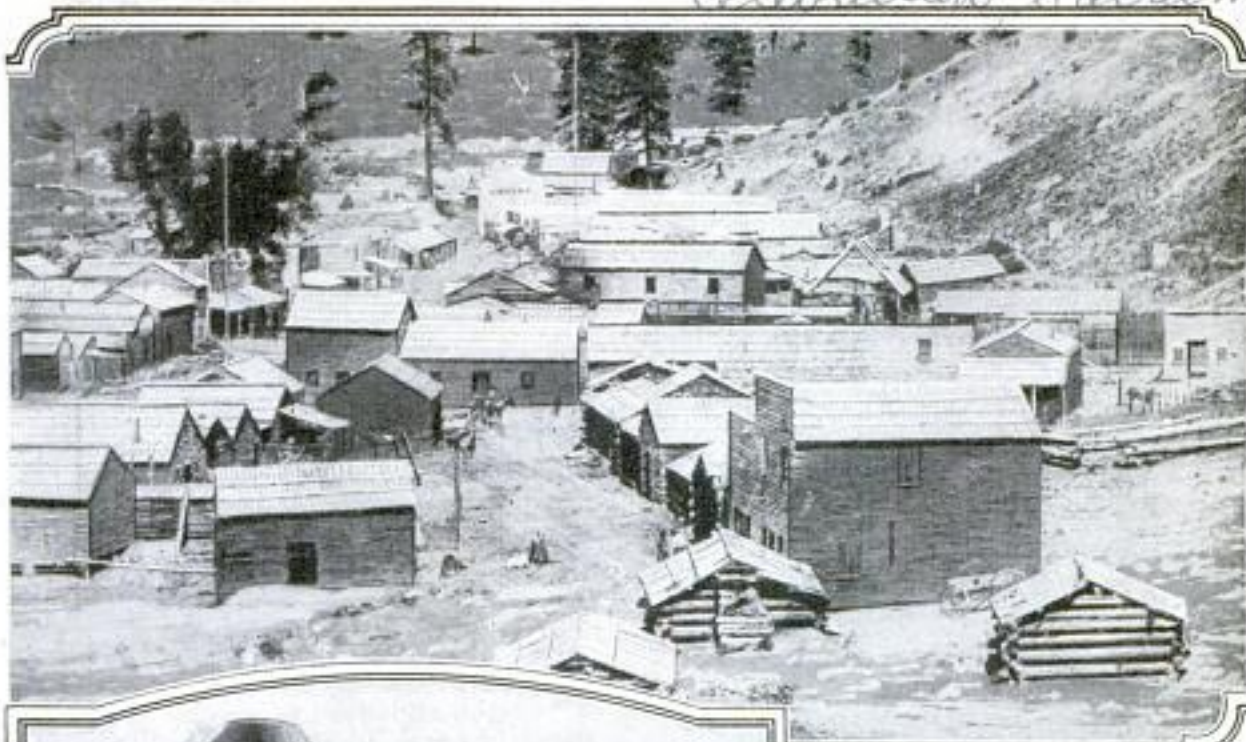

This is the Typical Mining Camp with Exact Replicas of the Miners' Shacks during the Process of Construction for the "Days of '49" Celebration. Recently Held in Sacramento, California

This Antiquated-Appearing Engine, One of the First in the West, Made Regular Six-Mile Trips around the Scene of the Celebration and Hauled a Flat Car Fitted with Seats for the Passengers



This Shows the Difference in Transportation in 1849 and 1922, the Modern Motor Bus Furnishing Quite a Contrast to the Old-Time Stagecoach, Many of Which were Used as Much as Possible during the Picturesque "Days of '49" Celebration

Mr. E. Homaine
 126, Rue Saint-maur, Corp. 78.42nd St.
 Paris (XI) France
 POPULAR MECHANICS
 SLIGHTLY ELECTRIC FLYTRAP
 FRENCH INVENTION

The Butler Vaporizer
 78.42nd St.
 New York City

4786

An electric flytrap, invented by a Paris electrician, is distinguished by its almost ornamental appearance. It consists of a

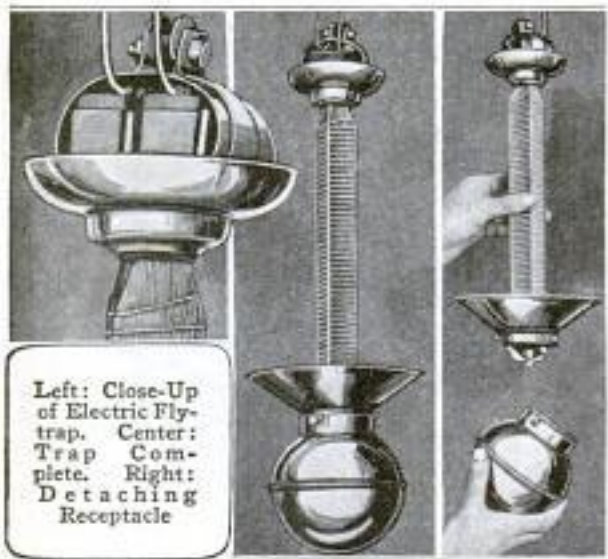

Left: Close-Up of Electric Fly-trap. Center: Trap Complete. Right: Detaching Receptacle

four-sided piece of wood with grooves in which is wound a wire connected with the electric current. This live wire is coated with a waxy preparation which attracts the flies by its peculiar odor. The coating must be removed twice a month. When a fly settles on the coil, a short circuit is produced and death follows. At the bottom is a detachable spherical receptacle into which the dead flies fall, and from which they are removed from time to time.

HEATER FOR ORCHARDS BURNS CARBON BRIQUETTES

Briquettes of carbon are used as fuel in heaters which have been installed recently in California fruit orchards as an improvement upon the smoky crude-oil smudge pots employed heretofore to pre-

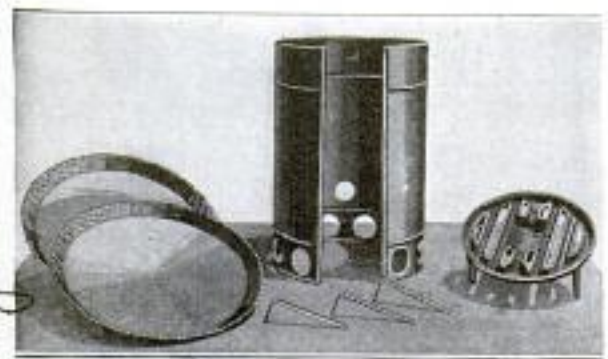

Orchard Heater, Showing, at Left, Heat Deflectors; Center, Sheet-Iron Shell and Deflector Holders; Right, Cast-Iron Grate

vent damage by frost. The outfit consists of a cylindrical sheet-iron shell, a cast-iron grate, and heat deflectors in the shape of inverted pie pans. The grate contains an oil reservoir with an asbestos wick to burn coal oil for the purpose of igniting the carbon briquettes. Ten pounds of these, which cost but 7½ cents, provide sufficient heat for five hours.

ACCESSORY TO HEAT GASOLINE VAPOR GOING TO ENGINE

If the low-grade gasoline being distributed today can be thoroughly vaporized, it makes a satisfactory motor fuel, but considerable heat is required to prevent liquid-gasoline spray from finding its way into the engine cylinders. To supply this heat, a vaporizer has been designed that may be placed between the carburetor and the intake manifold. The vapor is conducted through thin copper tubes, while a portion of the hot exhaust gas is circulated between the tubes and the cast-iron shell of the device. Tests

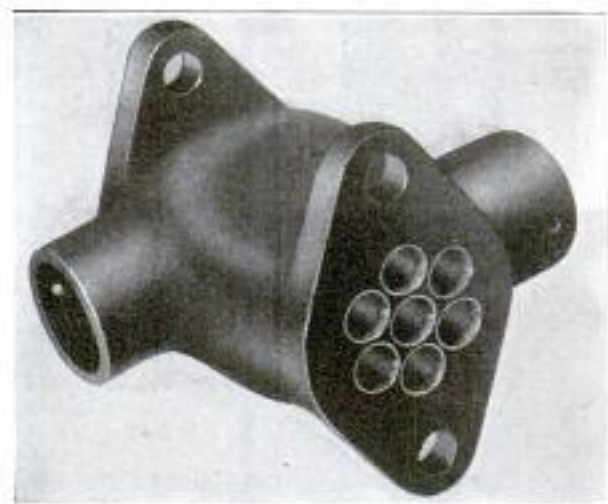

This Gasoline Vaporizer Leads the Gasoline through Thin Copper Tubes, Heated by the Gases from the Exhaust Manifold

have shown a surprising increase in power and mileage, and a greater flexibility of the motor.

STARS AND STRIPES WASHED ON PACIFIC STEAMSHIPS

Started by the steamship "Kennedy," which runs between Bremerton, Wash., and Seattle, a custom has spread among ships on the Pacific to give Old Glory a regular weekly washing. Heretofore flags have usually been burned when too soiled for use.

Times Picayune 7/10/22
 Copyrighted material

Mr. C. S. Vance,
 Los Angeles Gas & Elec.
 Corp.
 Los Angeles
 Calif.

Flag
 P. M. V. Co.

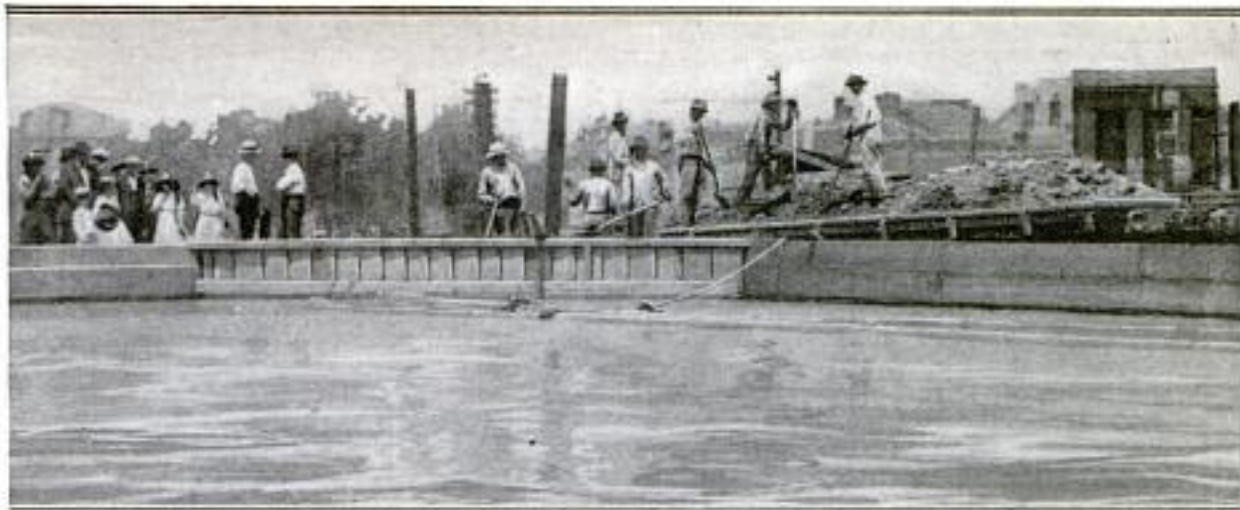

Scene during the Record-Breaking Flood at New Orleans, This Year: The Workers are Building an Improved Sheet-Piling Levee at a Point Where the Actual Levee Was a Foot below the Surface of the Water

NEW ORLEANS LEARNS THE LESSON OF THIS YEAR'S FLOOD

By THOMAS EWING DABNEY

NEW ORLEANS' entire commercial river front is being raised so that the city may be given better protection against the flood waters of the Mississippi. This means that, besides the wharves, the network of railroad tracks, street-car lines, streets, and other facilities immediately behind the wharves—representing millions in investment—must be raised to conform to the new levee grades that have been prescribed by the state authorities.

It would seem reasonable to expect that, if any part of the country had ade-

quate levees, such as recommended by the Mississippi River Commission, it would be New Orleans, a city with a population of 400,000 and a property valuation in excess of \$800,000,000; but the fact is that the levees of New Orleans are lower than in many country districts, and of a cross section that compares with the commission's specifications as scaffolding does with the finished building. The city has been trying to avoid the inescapable logic of the situation by denying the premises, written in many past flood warnings, but the experience this

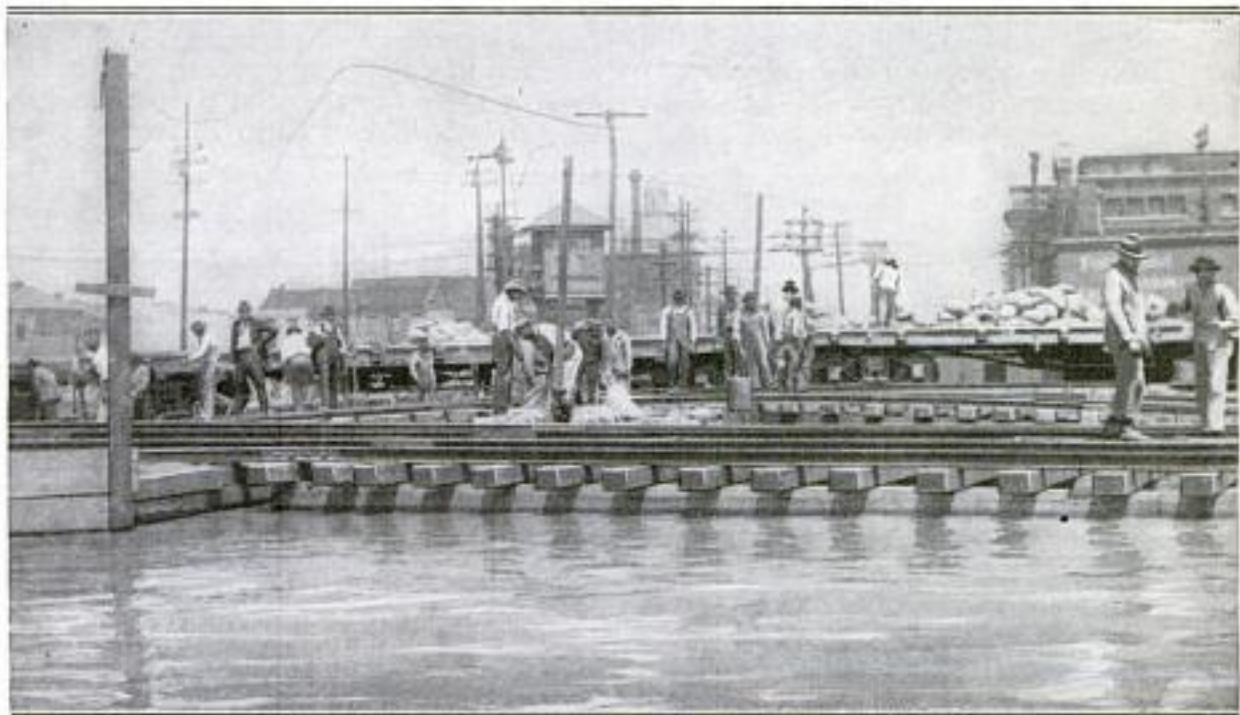

Another View of One of the Threatened Places during the Flood-Water Fight at New Orleans: This Shows the Water at the Foot of Esplanade Avenue, Where a Rise of But a Few Inches would have Flooded the City

year finally killed the old "hush-hush" policy, by which the people were lulled into a feeling of false security, and orders have been issued by the levee board, in accordance with the demand of the

the elevation of the public belt and all other railroad tracks, as well as all intersecting city streets to the same grade, removal of all pipes running through the levees, the raising of all railroad-crossing inclines and terminals, the closing of all existing gaps in the protection levees, and the removal of any and all objectionable matter and materials from any levees built within this district for the protection of the public in general."

New Orleans' commercial front is about three miles long. It is in this section that the protection is least adequate. The remaining 23 miles of levee, on both banks of the river, are higher and stronger than those in the region indicated. Wharves in the outlying districts are built at proper grade, and the

strengthening of the levees in these sections is a comparatively simple matter.

The practically unbroken line of wharves on the commercial front extends over the water on the river side, and is built upon earth-filled, concrete-enclosed embankments on the land side, that take the place of the usual type of levee. Because of the height of the river banks, due to overflows of past generations, and a general building-up process, it is necessary to raise the artificial protection here only to a height of 10 to 15 feet, varying

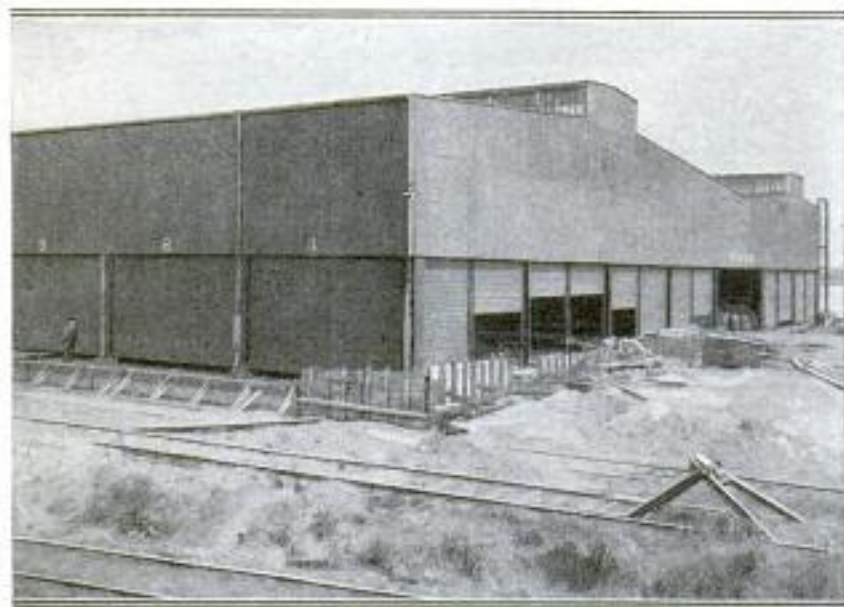

Typical New Orleans Wharf, Showing the Usual Manner of Erecting These Structures: Under the Provisions of the New City Ordinance Several Miles of These Wharves will have to be Raised

whole community, to give the city the absolute protection it should have had years ago.

The levee board's orders, as expressed in recent resolutions, give some idea of the magnitude of the problem:

"All interests located on, crossing through, or over and along, said levees [are] required to arrange their appliances so affected to meet the policy of the board in the premises, the rearrangements necessary being the raising of all dock-board wharves to standard grade,

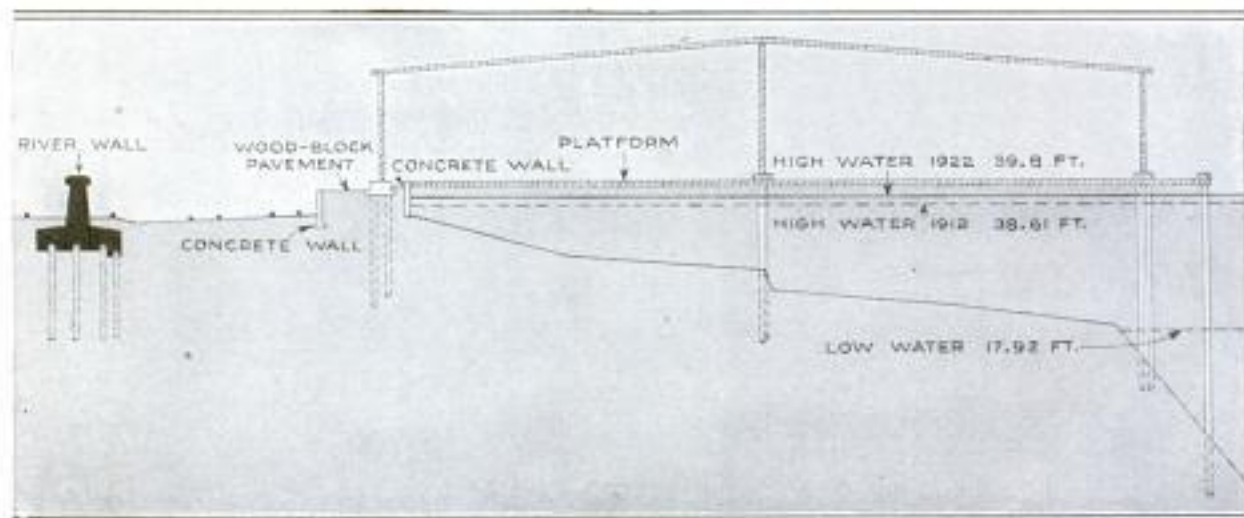

Sketch, Showing the Reinforced-Concrete River Wall Which has been Proposed by the Board of State Engineers of Louisiana as a Substitute for Dirt Levees and Embankments along the Commercial Waterfront of New Orleans: The Estimated Cost of the Improvement Is \$1,000,000 a Mile

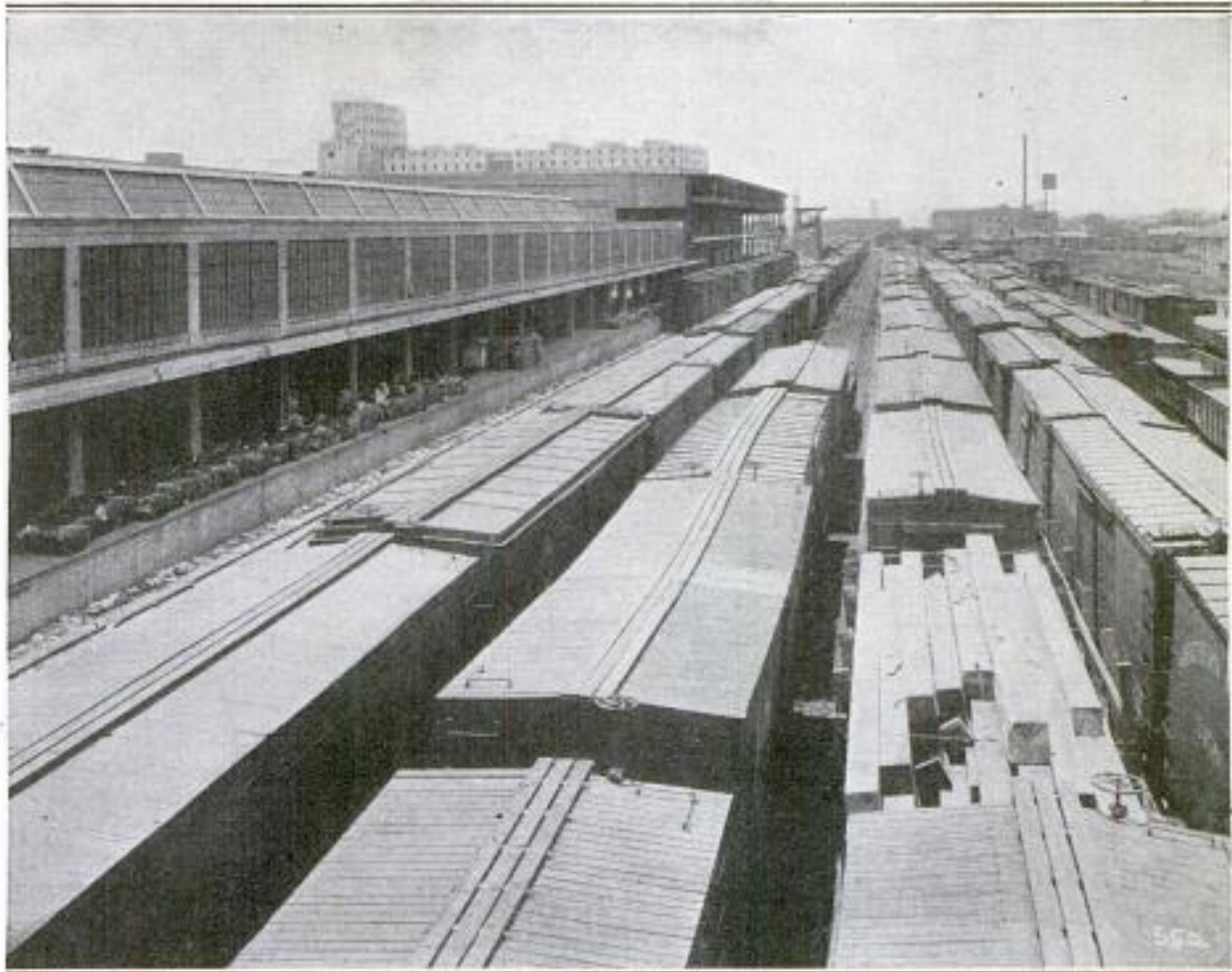

Behind the Wharves of New Orleans, Showing the Railroad Yards, Loading Platforms, and Industrial Plants Located There: This Illustrates the Magnitude of the Task the City is Obligated to Undertake in Raising the Waterfront with Its Wharves and Transportation Facilities

with local conditions, whereas in other river sections, the levees must be 25 feet high. But New Orleans did not go to even this trouble. As a result, several of the wharves this year were under water; the flood was a foot higher than the levees along two miles of the river front, and within a foot of the top for two miles more. Engineers declare that 3 feet is the least margin of safety that should be considered.

Likewise, little effort has been made to build reinforcing embankments to support the levees against the terrible thrust of the flood river. For instance, there was a levee at one place barely 15 feet wide to hold a head of water of 5 feet. A large manufacturing plant was immediately behind it. At another place a box levee less than 15 feet wide held a head of 6 feet of water. The city met the flood crisis by sandbag levees; by improvised piling; by small dirt embankments, protected by tarpaulin, down the center of the wharf sheds; by eleventh-hour strengthening of weak spots up and down the line—weak spots that appeared

as by magic, and some of which were discovered by the merest chance.

The actual raising of the wharf levels will be comparatively simple, from an engineering standpoint, though somewhat costly. The concrete-inclosed embankments will simply have their levels raised to grade height, the iron pillars supporting the sheds will be jacked up, new sills will be laid over the entire wharf area, and the new flooring built. This work will be done gradually, to avoid interrupting the foreign-trade movement. The first wharves to be raised will be those at Robin Street, Celeste Street, Seventh Street, Market Street, Erato Street, and St. Andrew Street.

This work will cost about \$1,000,000. The other wharves will be raised as soon as possible. The section at the foot of Canal Street—which is the “water gate” of the Mississippi Valley—will be raised in connection with the elaborate development work the dock board contemplates there. Probably the cost of raising the entire river front will be around \$5,000,000—though this is only a rough estimate.

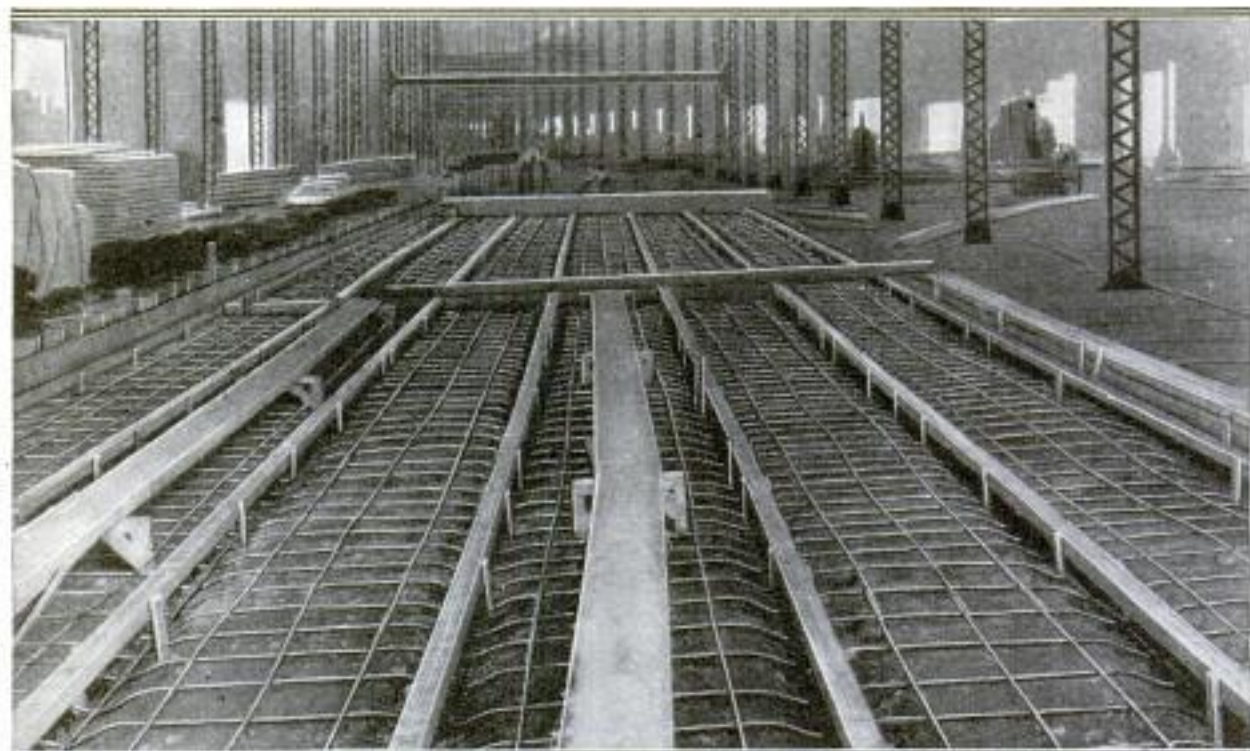

Interior of One of the Large Wharves at New Orleans, Showing How the Reinforced-Concrete Levee Protection is being Raised for the Purpose of Preventing a Recurrence of the Flood Danger That Caused the State Authorities to Issue Orders for the Raising of the Waterfront

But the building of the embankment or its equivalent presents a more difficult problem because of the railroad tracks and other facilities that now occupy the ground. Two methods of making the cross section of the levee conform to government standards have been suggested: Building an embankment, at least 300 feet wide, with a river-side slope not steeper than 1 in 3, and a city-side slope not steeper than 1 in 10; this embankment would be raised by material dredged from the river, or hauled from inland points; or building a reinforced-concrete river wall behind the wharves and as near to them as conveniently possible. This wall would rest upon creosoted pilings sunk 15 feet into the river bed, to withstand the pressure due to the 20-foot variation in the height of the river; the pilings to be 4 feet apart, and the base of the wall 15 feet wide, and 10 to 15 feet high, according to local conditions.

The advantage of the latter alternative lies in the fact that it would disturb established facilities less than the making of a fill 300 feet wide and rebuilding everything on top. Under proper safeguards, tracks could parallel and cross the river wall. On the other hand, this type of construction has the disadvantage of higher cost, which is estimated at \$1,000,000 a mile.

No decision has yet been reached as

to which method will be adopted. It is, of course, obvious that the river-wall type is ideal, and ultimately this, or something resembling it, will have to be built.

The need of immediate action, however, is emphasized by the facts that, at flood stage, about 2,000,000 cubic feet of water a second pass New Orleans, and that, as measured on the Canal Street gauge, the flood level has jumped from 15.8 feet in 1882 to 22.8 feet in 1922—a rise of 7 feet. According to the city engineer of New Orleans, the trend is toward still higher flood elevations, as proved this year, when the ultimate high-water elevation predicted by the Mississippi River Commission was reached at Vicksburg, Miss., and points below, and the lower river broke all previous high-water records, although the stages reached at Cairo, Ill., at Memphis, Tenn., at Helena, Ark., at Louisville, Ky., and at Cincinnati, Ohio, fell below that record by amounts varying from 1 to 20 feet.

To meet the past and future rise of flood levels, the Federal and state governments have spent something like \$186,000,000 on levees. Many of these are up to standard, but many are not. The remarkable part of the entire situation is that New Orleans, in which is concentrated one-third of the wealth of Louisiana and a fourth of the population, should have been content to drift along with a levee protection of such a

temporary character. With a concrete river wall, the city could meet, economically and quickly, the danger of floods if the water should rise higher than the engineers now think it will, because this type of construction lends itself readily to emergency work.

With its decision to set its own levees in order, New Orleans has launched a movement that bids fair to become nation-wide, to secure the highest and strongest levees possible for the entire river and such other supplementary relief as may be possible. This relief is to be determined through a survey made by nationally known engineers, who will be employed by a Safe River Organization, the nucleus of which has been formed in the Committee of One Hundred in New

Orleans. This committee is now organizing the entire Mississippi Valley. If the engineers declare the plans feasible, the additional relief on the lower river will take the form of spillways, or other artificially built outlets into the Gulf and into swamps, through which the surplus water will run when it reaches a certain stage, say, 18 feet on the Canal Street gauge at New Orleans. Such outlets above and below New Orleans would prevent the water from rising to dangerous levels. After this year's levee breakages the river dropped 2 feet in a few days. But it is recognized that these preventive measures cannot be put into effect for several years; and in the meantime, New Orleans is building levee bulwarks equal to those in other sections of the country.

9642 *Supplies*
**PAPER AND CARBON SHEETS
FED FROM OFFICE DEVICE**

Soiled fingers, creased carbon sheets, and smudged letterheads are avoided by the use of a new office appliance which ejects paper and carbon sheets in proper order, ready for insertion in the typewriter.

The machine is a small steel cabinet having compartments for supplies of paper and carbon sheets. By operating a central lever, a fine steel point in each compartment engages the top sheet of its pile and pushes it forward. The sheets appear simultaneously and in order. After typing, the carbon sheets are deposited on a cardboard tray under a hinged cover on the top of the cabinet. When the supply of carbons in a compartment is exhausted, the empty tray is

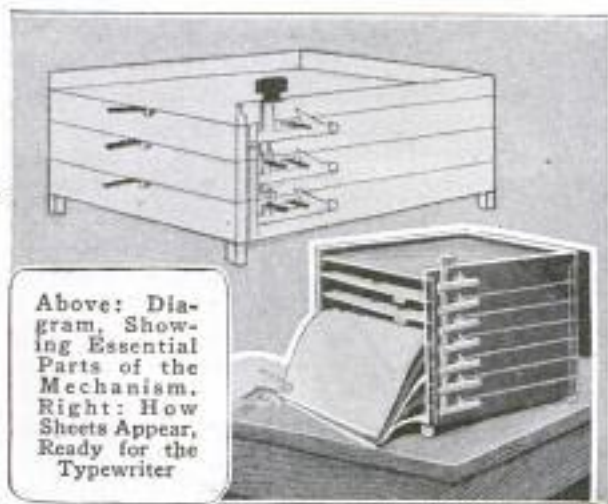

Above: Diagram, Showing Essential Parts of the Mechanism. Right: How Sheets Appear, Ready for the Typewriter

exchanged for the full tray from the top. The capacity of each compartment is about 100 sheets of average weight.

Best
**ATMOSPHERIC PRESSURE USED
IN NEW DISHWASHER**

9721
Utilizing the atmospheric pressure is the principle employed in the operation of a new portable dishwasher which



Above: Dishwashing Machine Which Utilizes Atmospheric Pressure in Cleansing the China and Silverware. Left: Interior View of Machine, Showing How Dishes are Packed

sterilizes and dries the dishes in 10 minutes. The only moving part inside the machine is a small suction fan that creates a vacuum at the top of the tank above the water. This causes air to rush in at the bottom and up through the water, agitating it so as to speed the washing process. The fan is driven by an electric motor, mounted outside of the outfit and connected by an extension cord to any light socket or base plug.

Letter returned 5/29/24

The Ejectafoil Co. 70 Cortlandt St. New York.

Order - Van Horn. Parker Co, Cleveland, O. 5100 Superior

No price

9864

Wide World Photos, New York City
The Sphere, London, England

MOUNT EVEREST SUMMIT STILL UNTROD BY MAN

N.Y. Times 6/2/22 P. 1

By HENRY S. WHITE

Washington Post 6/25/22 P. 10

THE highest point above sea level ever reached by a human (being afoot—

bers of the Mount Everest expedition, at noon, the 27th of last May. This brought

the explorers within 1,702 feet of the summit, the highest point on the earth's surface. The final attempt was to have been made June 6, but the monsoon broke June 3, definitely frustrating any further efforts for this year at least. When the monsoon breaks on Mount Everest, there is no alternative but to get off the mountain as soon as possible.

It has now been definitely proved that the mountain itself at the highest points reached is not difficult to climb, and the two explorers who came so near to reaching the actual summit were able to proceed along the north face without ropes. The one and only obstacle that made the summit unattainable was the bad weather, and with the monsoon left out, it is certain that the summit will be reached at the next attempt.

An altitude of 26,800 feet was reached without any oxygen. The oxygen apparatus consisted of four specially light oxygen cylinders similar to those used by airmen. These are carried on the back and the oxygen is piped to a box respirator that fits over the mouth and nose. Some idea of the rarefied condition of the air may be conveyed by a comparison of the barometric pressures at sea level and at the summit of Everest, the former being about 30 inches, according to the temperature, and the latter being only 10.6 inches. At this altitude the average temperature

is about 25 degrees below zero, another indication of what the explorers had to

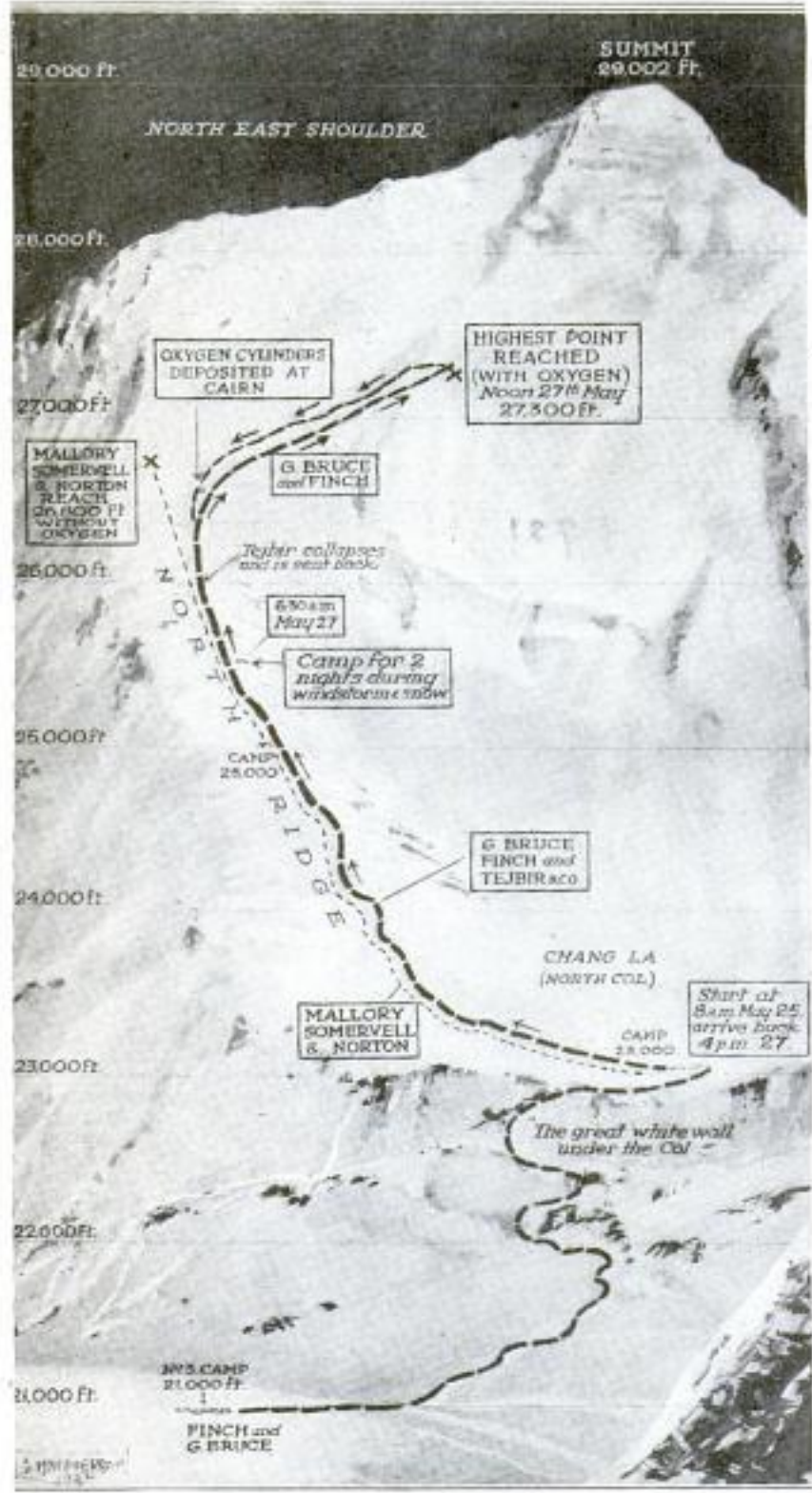

Notated Diagram Divided into 1,000-Foot Sections, Showing the Route Taken by Two Parties up the North Face of Mount Everest in Their Attempt to Reach the Summit of the Peak

27,300 feet—was attained, with the aid of oxygen-breathing apparatus, by two mem-



The Baggage Connected with the Mount Everest Expedition Packed Ready for Transportation by 50 Coolies and 350 Yaks, the Central Asian Beast of Burden

contend with. The two explorers who reached this highest point were Capt. Geoffrey Bruce, one of the leaders of the expedition, and George Finch, a scientist attached to it.

By careful organization, and after continued coöperation of all members of the expedition, the indomitable pluck of the two highest climbers brought up the record at one bound from 24,000 to 27,300 feet, and this in spite of the fact that, when carrying the oxygen apparatus, the load of each of the explorers at the start weighed 28 pounds. Such an effort would have been impossible without the aid of the oxygen, but even so, reports show that the climbers suffered actual torture from the rarefied atmosphere, the cold mists, and the biting winds. The comfort of a really hot drink was denied them for the simple reason that at that altitude water boils at about 170 degrees.

Much of the success of the expedition depended upon the exertions of the coolies who acted as porters. These were native Sherpas from the southern face of the Himalayan range, and Tibetans from the northern face. Although virtually untrained to snow and ice, they carried loads up to an altitude of 25,500 feet, some actually making four trips a day, and one beating all records by carrying a load of 40 pounds in spite of the rarefied atmosphere. All this was done by them without a murmur or a complaint of hard work.



COPYRIGHT IN THE UNITED STATES BY THE SPHERE, LONDON
The Two Members of the Everest Expedition Equipped with the Oxygen-Breathing Apparatus That Enabled Them to Reach an Altitude of 27,300 Feet

The three members of the expedition who reached 26,800 feet were Messrs. Mallory, Somervell, and Norton.

9549

Wide World Photos
New York City

Chemical Age
1/1922

376

P. 39

Patent owned by: Ed Swenitzer by Co.
Patent, Switzerland

ELABORATE COFFIN PROVIDED FOR JAPANESE DIGNITARY

Extremely elaborate coffins are used for the burial of Japanese dignitaries, the one provided for the late Marquis Okuma be-

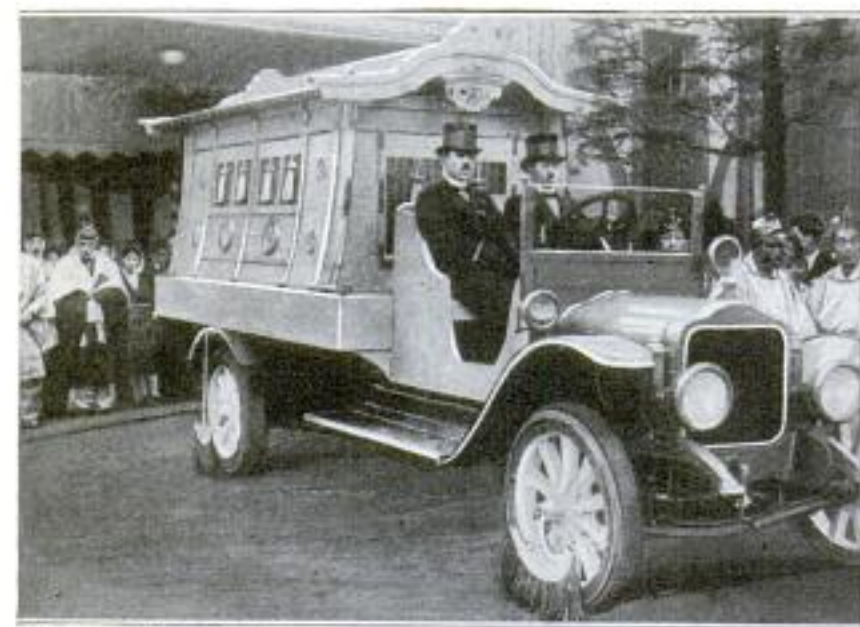

Elaborate Casket Which was Used for the Burial Services of the Late Marquis Okuma, at Hibiya Park, Tokyo

ing representative of the type. Resembling a small fantastic pagoda, highly ornamented with scrollwork, the coffin was carried on a motor truck to Hibiya Park, Tokyo, where a public funeral service was held, according to Japanese custom.

SIMPLE PROCESS FOR MAKING SULPHURIC ACID

One of the greatest sources of initial expense and costly upkeep, are the lead-lined chambers necessary in the manufacture of sulphuric acid by the contact process. Many attempts have been made to work out a process for making this essential acid without the use of the lead chambers, but none of these has proved successful. Now, a patent has been granted for a process in which the sulphur-dioxide gases are brought into intimate contact with a large amount of nitrosyl acid, of determined strength, present in a finely divided state. The chambers in which the sulphur-dioxide gases are mixed with the nitrosyl acid may be arranged separately, in parallel, or in series. The process is, to a great extent, regenerative, it being only necessary to denitrate daily an amount of nitrosyl acid equal to the daily production of sulphuric acid. The complete plant is very simple and requires only limited space.

9653

Well drawing

WATER-DRAWING GEAR RELIC OF ANCIENT DAYS

Primitive wells may still be found in everyday use in China. An interesting example is that shown in the accompanying illustration. The well gear, constructed by the great-great-grandfather of the present owner, consists of a slender tree trunk supported by two crudely built tripods and running through a drum which serves as a wheel for the rope by which the water is drawn. The well, about 25 feet deep, is cased from top to bottom with sandstone. Any improvement of the gear would be considered disrespectful to the original builder.



This Well Is Still in Everyday Use in China. The Owner is Shown Raising the Pail with the Same Apparatus His Forefathers Used Several Generations Ago

Carl Ray C. Bennett 1208 N. 3rd St. Philadelphia, Pa.
Copyrighted material



This Shows Excavation and Construction Work Progressing on the Outfall Portion of the Main Sewer, Where It Empties into the Kansas River, and Gives Some Idea of Its Immense Size

KANSAS CITY BUILDING WORLD'S LARGEST SEWER

By GEORGE F. PAUL

*900 The Worth Bldg
Kansas City Mo*

THE Turkey Creek Sewer, which is now being built at Kansas City, is declared to be the largest ever constructed on this continent or abroad. The great size of the main section can be judged from the fact that there are twin boxes, each 17 feet in width and 18 feet in height, containing 13.5 cubic yards of concrete and 1,975 pounds of steel per lineal foot. It will discharge approximately 1,000,000 gallons every minute.

This sewer, which will involve a total expenditure of more than \$2,000,000, has been planned to protect vast terminals and great industries from flood waters. In months past the Kansas River and Turkey Creek have combined to threaten the

western portion of Kansas City. Turkey Creek itself is a very crooked stream and

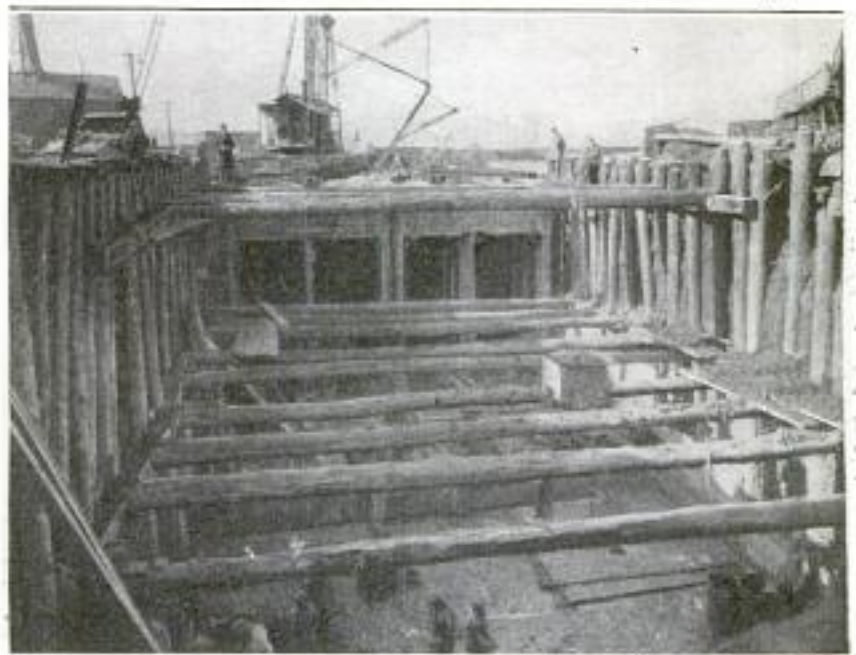

This Gives an Idea of the Amount of Bracing That Was Necessary in Places Where the Channel Passed through Soft or Swelling Ground, as a Proper Foundation could Not be Found Even below Hardpan

has a gradient of 40 feet per mile. When a cloudburst or heavy rains start it on a rampage, it rushes down with overwhelming force. After it reaches Rosedale, it

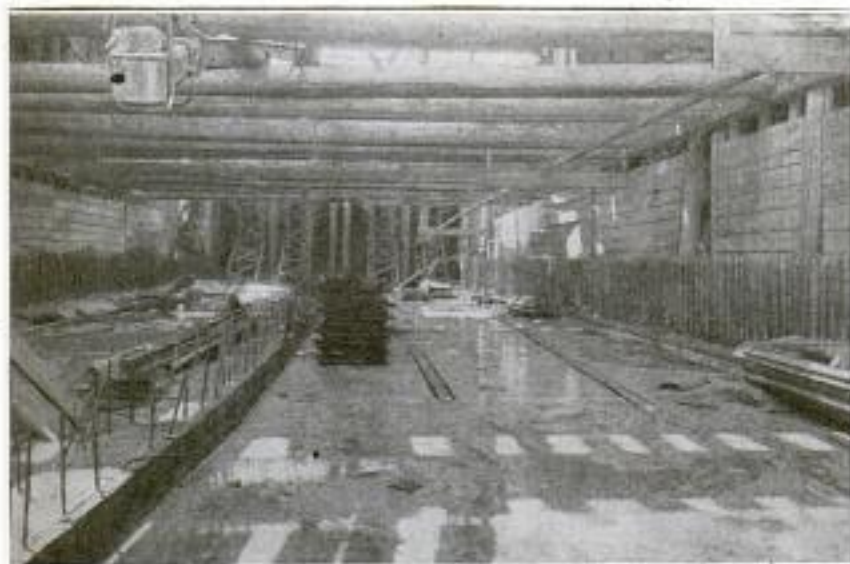

View Looking down the Main Concrete-Lined Twin-Box Sewer: This was Taken at a Point Where It Passes under No Less than 15 Railroad Tracks

is obstructed by many railroad trestles and bridges that cause it to leave its channel and tie up traffic and shut down industries. Water has been known under some circumstances to rise to a height of 16 feet at 28th Street and Southwest Boulevard.

Many construction difficulties have been encountered in pushing this work. While building a portion of the 7-foot section lying in the old bed of Turkey Creek, a

proper foundation could not be found for a depth of 17 feet. Piling was resorted to, and after the piles had been placed in leads, an ordinary steam hammer was allowed to rest on the pile, but the weight alone caused a penetration of 17 feet without a blow being struck. The piling was then driven through 3 feet of hardpan to solid rock, but the subgrade was too soft to allow steel to be placed, and certainly it was too weak to support a concrete footing. A lumber grillage helped to solve this difficulty.

The main sewer, in traversing its total distance of more than 8,000 feet, intersects and crosses 36 railroad tracks. In the case of main-line tracks that had to be kept in use, 60-foot piles were first driven on a line with the outer dimensions of the sewer. These were capped, and three 24-inch I-beams, 60 feet long, were bolted together and placed under each rail. As the excavation proceeded downward, it was necessary to use many piles.

New difficulties have been encountered at almost every turn, yet the work has been pushed vigorously, and should be completed within a few months.

ELECTRIC-ARC WELDER IS EQUIPPED WITH AUTOMATIC FEED

Welding operations on objects having an irregularity of shape or seam contour, and also on those of unusual bulk, may be efficiently accomplished by the use of a new electric-arc welder which has an automatic feed. The metal electrode, or wire, which is melted into the seam is fed through a tool in the hands of the operator, the speed of the wire being controlled by a small electric motor. This motor, in turn, is regulated by the voltage across the arc at the welding point, thus assuring a constant and correct feeding of the electrode from the coil on the reel to the operator's hand.

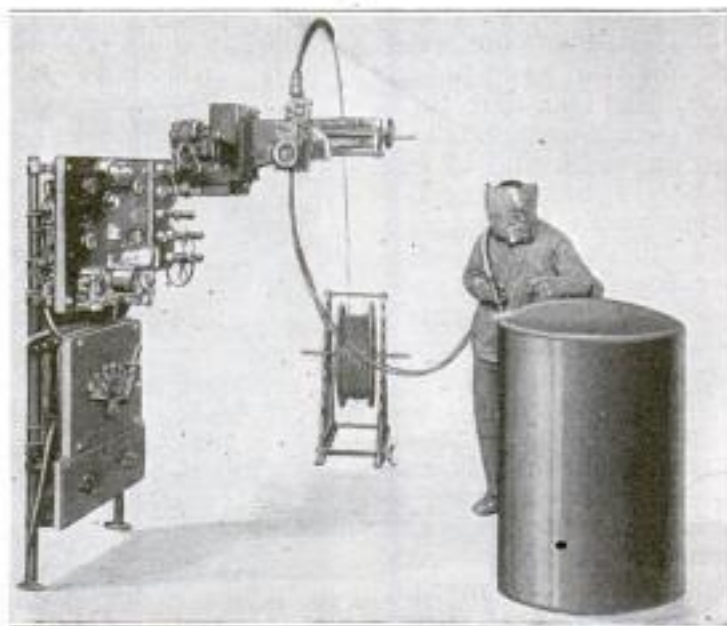

Electric Arc-Welding Outfit, Showing the Automatic-Feeding Apparatus Projecting from the Top of the Control Panel, While the Reel of Electrode is Seen Below

9701 Cmt L. W. Pedrose, 1453 W. 54th St

Seattle Wash.



This Shows the Simple Process of Preserving the Excess of the Strawberry Crop. The Berries are Mixed with Sugar in Proportion of Two Pounds to One, and are Packed in Casks

PROCESSING SAVES OVERFLOW OF BERRY CROP

AIR-CLEANSING DUST TRAP FOR AUTO CARBURETORS

Through the recent discovery of a practical method of preserving fresh strawberries and other soft fruits, berry growers of the Northwest this year saved the overflow from the retail markets, worth millions of dollars, which heretofore had been lost every season. In previous years, if the berry growers produced more than the retail market and the canneries could absorb, they either took for part of the crop whatever prices were offered them—usually not more than enough to pay for the crates—or let the berries dry on the vines.

After suffering severe losses last year, the growers decided to provide a safety valve for their market by devising a method of preserving the fresh fruit, which can be utilized in this country and abroad as fresh-fruit coverings for ice cream.

The new method is very simple. It consists merely of packing the berries in sugar in the proportions of 1 pound of sugar to 2 pounds of berries. Casks of wood holding 500 pounds are used for packing. If for export to foreign countries, the casks are given a thick coating of wax inside, or are lined with porcelain. After the heads are put on the casks, the berries are placed in cold storage and will keep in a fresh state indefinitely.

If the air in the vicinity of an automobile carburetor is permeated to any extent with dust or dirt, this will certainly be sucked into the motor cylinders, where it may do considerable damage. A dust trap for use on a popular-priced car takes the place of the hot-air pipe that connects the carburetor with the exhaust mani-

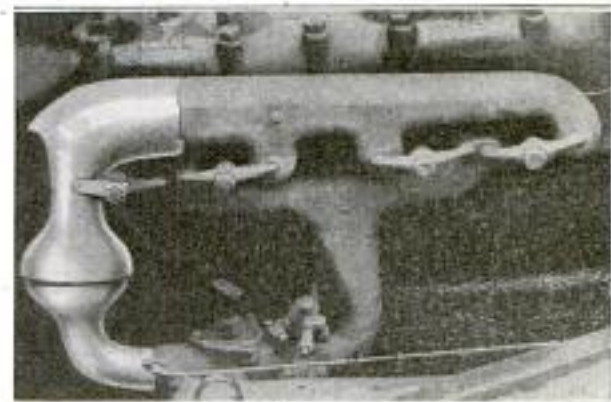

Dust Trap for Use in Place of Regular Hot-Air Pipe That Connects the Exhaust Manifold with the Carburetor on a Popular-Priced Light Automobile

fold. Above the carburetor a bulb-shaped enlargement of the pipe contains a special composition that traps the dust and prevents it from reaching the carburetor.

Henry Auto Part Co
Milwaukee, Wis.

National Fruit Canning Co
1720 W. Spokane St.
Seattle Wash.

North Pacific Cooperative
Berry Growers, Pier 9,
Seattle, Wash.

9706

San Diego, Calif.



One of the Dams Constructed by the San Diego Zoological Society for the Double Purpose of Displaying Wild Life in Water and the Type of Barrage Used to Impound the City's Water Supply

ZOOLOGICAL SOCIETY'S DAMS SERVE DUAL PURPOSE

Miniature dams built by the San Diego, Calif., Zoological Society, served in a dual capacity recently, when they were displayed to the public. The society has constructed outdoor pools in which are kept seals, alligators, birds, and other animals. The tiny dams required to impound the water, were made in exact replica of the huge structures in the neighboring mountains from which the city's supply of water is drawn, thus demonstrating the construction of the water-supply dams as well as providing other education in the form of wild life in the water.

4683 TWO CLOUDBURSTS IN A WEEK AT SYRACUSE

Although in the past the city of Syracuse, N. Y., had never experienced anything in the nature of a cloudburst, recently not only one occurred there, but

at the junction of Furnace Brook and Onondaga Creek where a street runs parallel with the latter and crosses the former on a concrete bridge. The banks

of the creek were lined with reinforced-concrete walls. After destroying the bridge, the torrent of water tore away the street, until it undermined the wall of the creek, of which it cut off a huge section, that was rolled over and deposited, upside down, across the channel.



Part of the Wreckage Caused by the First Cloudburst That Syracuse, New York, Ever Experienced and Which was Followed in a Week by a Second

actually two in less than a week. Being entirely unprepared for such an emergency, the city suffered a great deal of damage. The most remarkable of the results of the destructiveness of the cloudbursts occurred

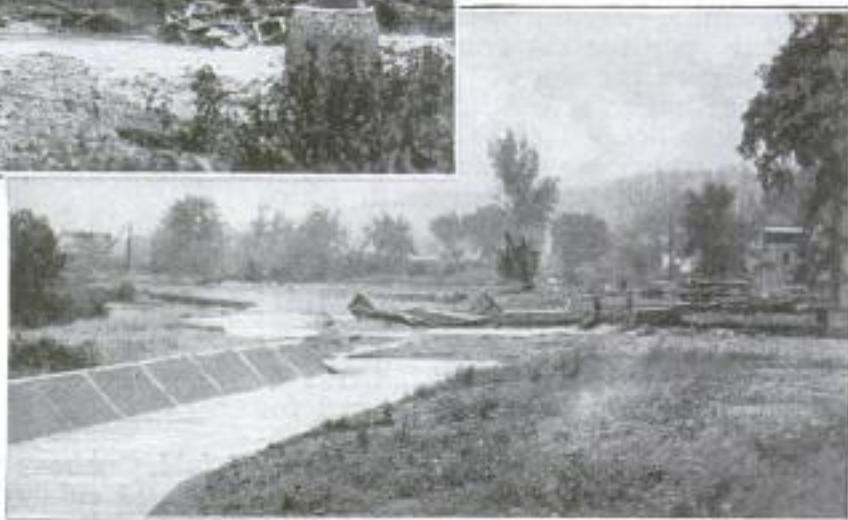

This View, Taken after the Second Cloudburst, Illustrates the Havoc Wrought by the Water; Houses, Bridges, and Tunnels being Destroyed. Part of the Walls of the Creek was Carried Across the Channel

Emil A. Waters 203 E. Levee St. Syracuse, N.Y.



This Moving Van Displays on Each Side an Elaborate and Artistic Painting of an Historic Incident. One Side Shows the Crossing of the Delaware and the Other Side the American Eagle on a Field of Draped American Flags

MOVING VAN PATRIOTICALLY AND SKILLFULLY ADORNED

Decorated in a manner that certainly cannot fail to attract the attention of the public, a motor truck used as a moving van has recently made its appearance in Buffalo, N. Y. Each side of the van is entirely covered with a framed painting, elaborately and artistically depicting a patriotic subject. One, entitled "The Dawn of Freedom," is a reproduction of the well-known picture of George Washington crossing the Delaware. On the other side a picture, called "Pride of the Nation," portrays an American eagle with widespread wings across the front of two star-spangled banners, and standing upon a shield bearing the American coat of arms.

9697

JAPANESE MAKES NEW PAPER THAT CAN BE WASHED

Many possible uses suggest themselves for a special paper recently produced and patented by a Japanese inventor. The paper is remarkably strong and can be crumpled up and washed with soap and water, much as one would wash clothes. So durable is this paper that it can be used as a covering for umbrellas, and when soiled, can be easily cleaned at home. As a wrapping paper, it could be used over and over, being washed when

soiled. No special precautions are necessary in washing, and the paper is dried in the usual manner. It is said that the

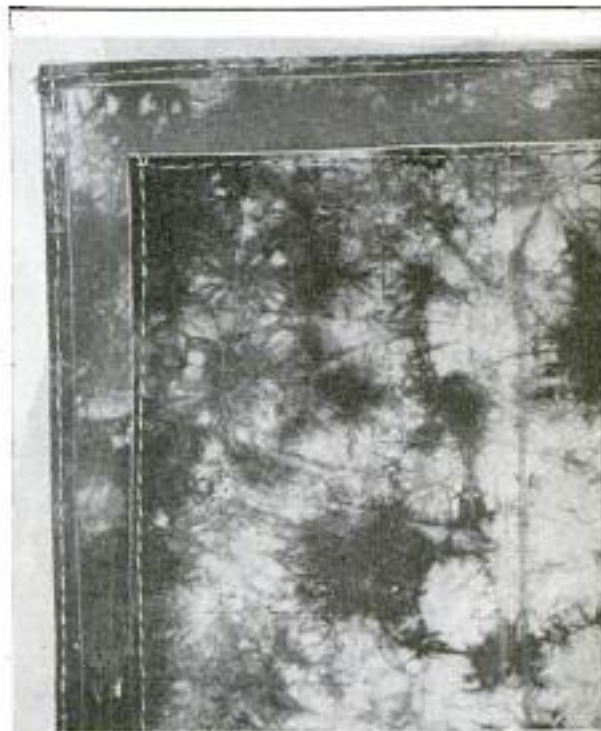

This Japanese Paper Is Waterproof and can be Crumpled Up and Washed with Soap and Water

product can be made at a very reasonable price. It has a texture somewhat like cloth, and is not to be confused with oiled paper.

Saito Infg. Co
 Tokyo, Japan
 Takato + Co.
 1110 Seachome
 21 Yamachi
 Kajimachi, Ky. Tokyo, Japan

BURN "MOUNTAIN OF BARRELS" AT BOSTON CELEBRATION

9742 Fifty thousand persons witnessed a monster bonfire in Boston on July 4, when a "mountain of barrels," more than



"Mountain of Barrels" Which was Burned to Celebrate July Fourth in Boston, as It Appeared Shortly Before the Torch was Applied

100 feet high, built in 30 tiers, and containing just 3,500 barrels, was sent up in smoke and flame as part of the Fourth-of-July celebration.

The "mountain" was built up in a remote part of the city, and no damage of any kind resulted from the fire. It is proposed to hold a similar event next year.

UNUSUAL METHOD OF LAYING SUBMARINE CABLE

9779 Recently, when laying seven submarine cables under the Harlem River in New York, unusual methods were adopted to meet the special conditions encountered. The cables were each 700 feet long and were laid beneath the Park Avenue drawbridge. Because of the center pier of the bridge, it was not advisable to lay the cables from a barge in the usual way. It was decided, therefore, to pull the cables

across the river by placing the reels on one side and a hauling winch on the other side of the river. A hauling cable was run across the river and threaded between the piling supporting the center of the drawbridge. The cable reels were jacked up, and the engine on the opposite bank hauled the free end of the cable across, each cable being hauled separately. Special precautions were taken to seal the free ends of the cables.

9745 PEACHES RESEMBLE PUMPKINS ON OHIO FRUIT FARM

Among the strange varieties of fruit grown by an Ohio orchardist who makes a hobby of grafting, are garden huckleberries which are as large as small grapes, peaches that look like small yellow pumpkins, and strawberries thriving on raspberry bushes.

9660 HANDY OUTFIT FOR VENDING ICE-CREAM SANDWICHES

For use at fairs and carnivals, a portable outfit has been made for dispensing ice-cream sandwiches, the vender strapping it about his shoulders and circulating where the crowds are thickest. In the center of a metal case is an insulated icing chamber with a capacity of a half gallon of ice cream. A compartment at one side holds 150 of the small sugar wafers used in making the sandwiches,

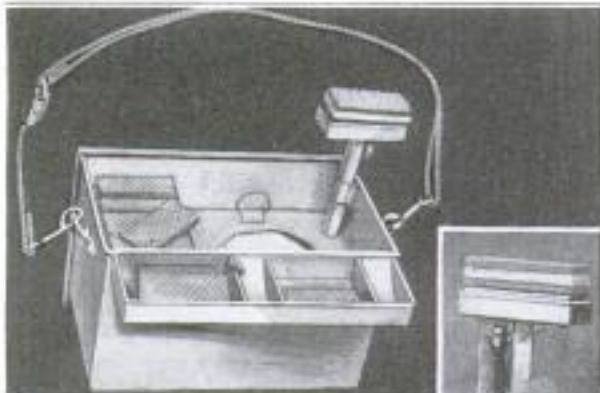

This Portable Outfit for Serving Ice-Cream Sandwiches Has Space for One-Half Gallon of Ice Cream and 150 Sugar Wafers. The Insert Shows How a Sandwich is Raised Out of the Former, for the Customer to Pick Off

and the forming machine is held upright in one corner of the case. All parts of the outfit are removable for cleansing.

*Emd. C. M. Langman
Piqua, Ohio.*

*The Times...
Inquirer...
5/20/12*

*Wm. George F. Hess
& William Stender
Louisville, Ky.*

9720

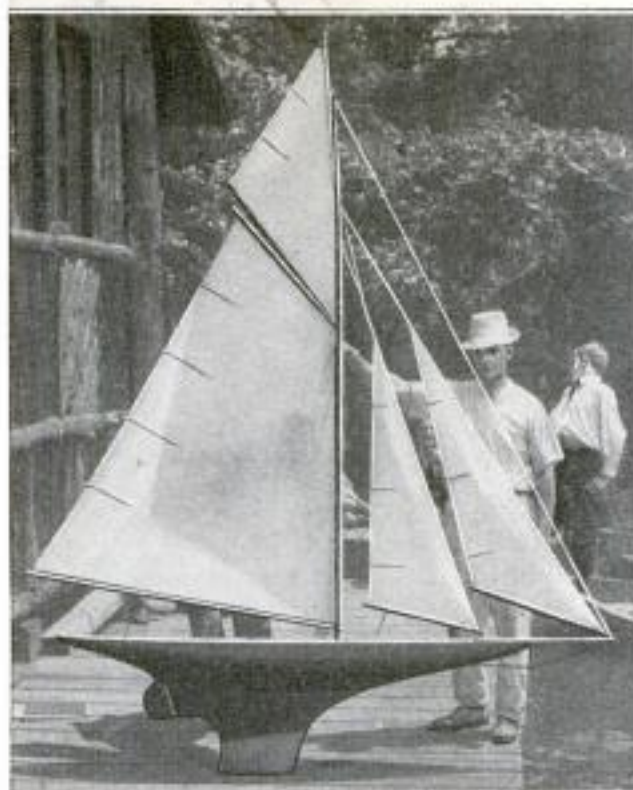

Left: Model Yacht "Polka Dot" and Its Owner, E. A. Bull of the Prospect Park Yacht Club, Brooklyn.
Right: The "Endeavor" and Its Owner, W. J. Daniels of London, England, Which Sailed and Lost a Series of Three Races against the American Craft

9720
AMERICAN MODEL YACHT WINS IN INTERNATIONAL RACE

The international model-yacht race for a cup offered by the magazine Yachting, sailed in three matches at Bayside, L. I., was easily won by the American yacht "Polka Dot." The model is full sloop-rigged, with a sail area of 3,000 square inches. It is 47 inches long, and weighs 34 pounds. Its only rival was an English model called "Endeavor," Marconi-rigged, with a sail area of 2,700 square inches, measuring 52 inches in length, and weighing 44½ pounds. The course in each race was 3 miles long, sailed in different directions, and the best time made by the winner was 1 hour 33 minutes 22 seconds, nearly 10 minutes better than the English boat.

9739
OXYGEN-EQUIPPED CAGE USED FOR MINE-RESCUE BIRDS

Because the canary bird is easily overcome by the poisonous gases found in coal mines, one of them is carried into the workings by mine-rescue crews to indicate the presence of dangerous gas. The cage used for carrying the little bird is equipped with a glass door and an oxygen tank. When deadly gas is encountered and the canary is overcome by it, instead of being allowed to die, the door is closed and oxygen is administered until it revives.

9822
RESUME WORK ON ELEVATOR TO TOP OF MONT BLANC

Work, halted by the war, has been resumed on an aerial cableway which will run from Chamonix, France, to the summit of Aiguille du Midi, some 3,000 feet lower than Mont Blanc. Eighty passengers will be carried by the cableway. Instead of a difficult journey of from 13 to 14 hours afoot, the tourist will now have a brief comfortable ride.

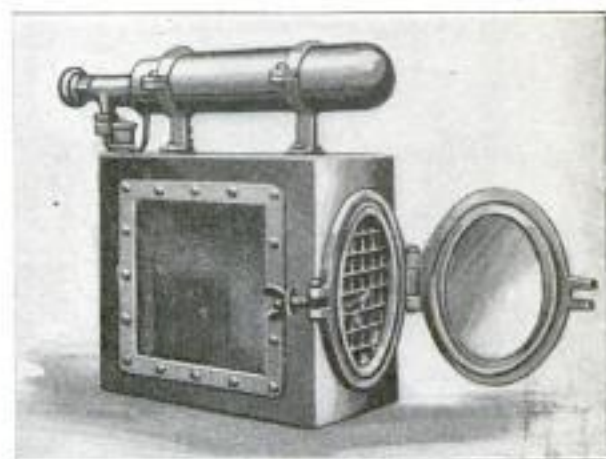

This Cage, Used for Carrying Canaries Employed in Mine-Rescue Work, is Equipped with an Air-Tight Glass Door and Oxygen Tank

Detroit Free Press
7/11/22

Emil. Alan Mc Cowan,
Box 40, Copyrighted material
Sault Ste. Marie, Canada

no information as to maker

9650

DEEPEST ROCK EXCAVATION FOR NEW YORK STORE

BY T. BENJAMIN FAUCETT

*492 Parkside Ave
Brooklyn, N.Y.*

EXCAVATION operations in New York offer a variety of obstacles seldom found in any other city. In the

cañon of Broadway, quicksand requires that these structures be anchored upon concrete. The Woolworth Building foundation is sunk through 115 feet of quicksand to bedrock and consists of 69 reinforced-concrete piers. Within three blocks a new municipal-court building is under construction. Here the excavation contractors found themselves up against the problem of an underground stream that ebbed and flowed with the tide of near-by East River. By the use of many high-power pumps and caissons, the concrete piers were sunk to bedrock in a manner resembling that of bridge construction.



New York's Deepest Solid-Rock Building Excavation: It Goes to a Depth of 42 Feet. An Addition to a Large Store will be Erected Here

But Manhattan Island gradually loses its "soup soil" with every block toward the north, and before reaching 34th Street, it consists of solid rock that may reach hundreds of feet below the surface. Still farther north, and especially in University Heights, the rocky outcrops resemble miniature mountains that must be blasted away before even the shallow excavations for houses and apartments can be made. Here the caissons of the downtown section are superseded by the steel drill and dynamite. New York's deepest foundation through solid rock is for an addition to one of the city's largest department stores. Thousands of persons daily stop and marvel at the prodigious job of blasting out a 42-foot



Raising the Wire-Cable Matting after a Blast: Under It Is Another Mat of Two-Inch Rope, and at the Sides Heavy Log Buffers

depth in the 100-foot front extending from 33rd to 34th Street, between Sixth and Seventh avenues. And they have plenty of time to observe every detail of the work, as the removal of this huge "underground mountain" will require almost four months of constant effort. After about a month of work only a deep crevice had been blasted in the unyielding rock. The shovel hasn't picked up a handful of soil since it began work in this unwelcome quarry, broken rock and heavy gravel forming the loads that the derricks hoist to the trucks above, while the workmen at the 42-foot level

downtown section, where the tallest buildings in the world make a narrow

look like pigmies laboring in a giant mine.

Just a little over five blocks distant, on West 39th Street, near Fifth Avenue, another foundation has been blasted out of the solid rock, but its depth is only a trifle more than half that of the 34th Street excavation. Several other smaller excavations are being made in the immediate neighborhood, and the air has been thick with the pungent dust that arises after

every blast. The explosions are muffled by a heavy matting of 2-inch hemp rope, over which is placed another matting of 1-inch steel cable, while the sides are protected by log buffers. The largest pieces of blast rock are broken into suitable sizes by dropping a 1-ton iron ball from the derrick arm. This rock can be used in foundations of smaller buildings.

8242

NOVEL ASH-REMOVAL SYSTEM FOR POWER PLANT

It was found difficult to remove by normal methods the ashes from the boiler house of an electric generating plant at Bedford, Eng., so the engineers decided to utilize the condenser discharge to assist in this removal. The condensers discharge water to a reservoir under the stoking floor, and this reservoir discharges flushes of about 5,000 gallons by means of a swinging weir. A duct leads beneath the road beside the plant to a sump. The ashes are dumped into the water duct and thus conveyed to the sump, where the water is filtered and returned to the river. The ashes remain in the sump, and are periodically removed by a grab crane.

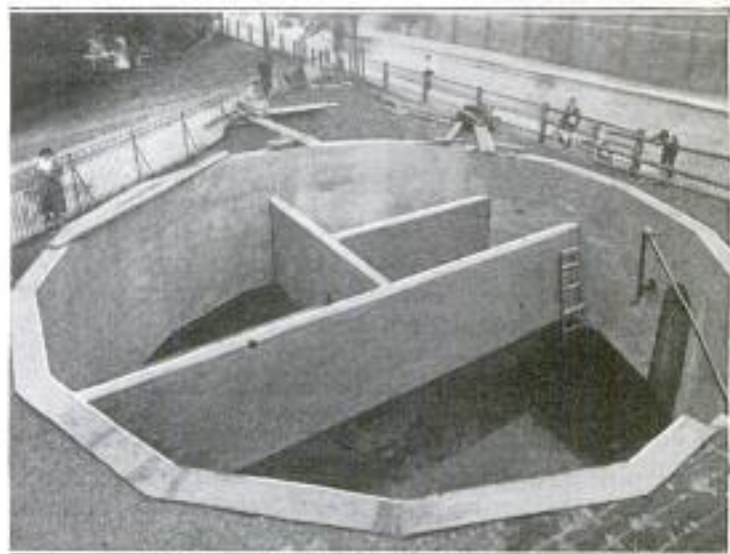

Sump beside a Road, on the Other Side of Which is an Electric Generating Plant: The Ashes from the Boilers are Removed by Dumping Them into a Duct That Carries Them to This Sump

9625

MOTOR-DRIVEN BELT SANDER OF NOVEL CONSTRUCTION

Self-contained in every respect, a new motor-driven belt sander consists of two

pulleys that drive a horizontal belt and are mounted in ball bearings upon upright stands connected to a base that supports a table beneath the belt. Directly connected to the driving pulley is an electric motor. Each pulley has a vertical adjustment of 48 inches, and the idler can be adjusted to take up slack in the belt. The table has a vertical adjustment of 14 inches, a horizontal travel of 36 inches, and runs on ball bearings. It is 96 inches long and 32 inches wide, constructed of planed wood strips with gaps between them to allow the dust to fall through, thus keeping the table clean. The machine is designed for sanding rapidly all kinds of woodwork, and can also be used for polishing metal surfaces.

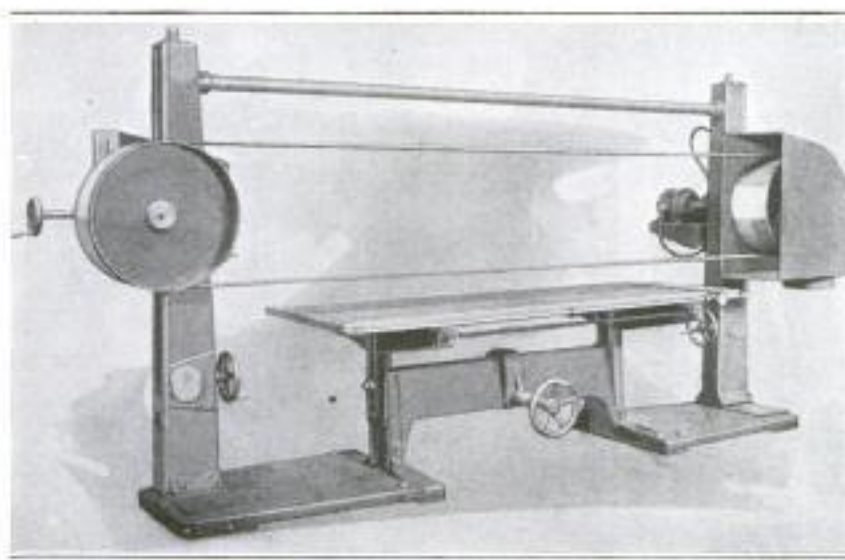

Motor-Driven Belt Sander with Belt About 31 Feet Long and with a Vertical Adjustment on the Pulley Brackets of 48 Inches: The Table Travels Horizontally 36 Inches, and Adjusts Vertically 14 Inches

9625

Oliver Machinery Co.
 Grand Rapids, Mich

Engineering Staff at Electricity Generating Station of Corporation of New York, England

East Pittsburgh, Pa.

9403 SIMPLE ELECTRIC GLUEPOT HAS RHEOSTAT CONTROL

Persons doing extensive work with a gluepot will appreciate the development of an electric pot which is fitted with a rheostat control.



The appliance need not be affected by changing room temperatures, climatic conditions, different grades of glue, or various kinds of work, as the rheostat is easily adjusted to meet any changes, thus continually supplying the contents with a uniform heat.

9198 COMPACT AUTOMATIC MACHINE FOR MAKING HAIRPINS

Hairpins are made very rapidly and entirely automatically with a motor-driven machine that is only about 6 feet long, 30 inches wide, and 20 inches high. The hairpin wire is first fed through straightening rollers to a die that splits the wire so as to form sets of six small diamond-shaped loops. Then the wire is cut off at points between these sets of loops, and each of

the lengths is bent U-shaped, leaving three of the loops on each prong of the "U." The points are then sharpened, and each "U" is a hairpin. They are then dipped in a cleansing solution, enameled, and baked in a temperature of about 350° F., when they are ready for use.

9470 NO-PRESSURE ATTACHMENT TO CORNET MOUTHPIECE

The inexpert cornet player is likely to put so much lip pressure on the mouthpiece, particularly in trying to get a high note, that the lips are hurt and strained.

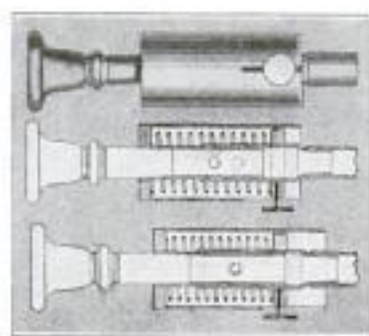

To make this impossible and to train the beginner to avoid this excessive pressure, an attachment has been constructed that is placed between the cornet and the mouthpiece. Inside a small cylinder, which is connected to the tube of the mouthpiece, is a coiled spring that, by compressing, absorbs any excessive pressure, and at the same time allows the tube of the mouthpiece to slide into the cornet until a hole in the former registers with a hole in the latter, causing a discord that warns the player to relieve the pressure.

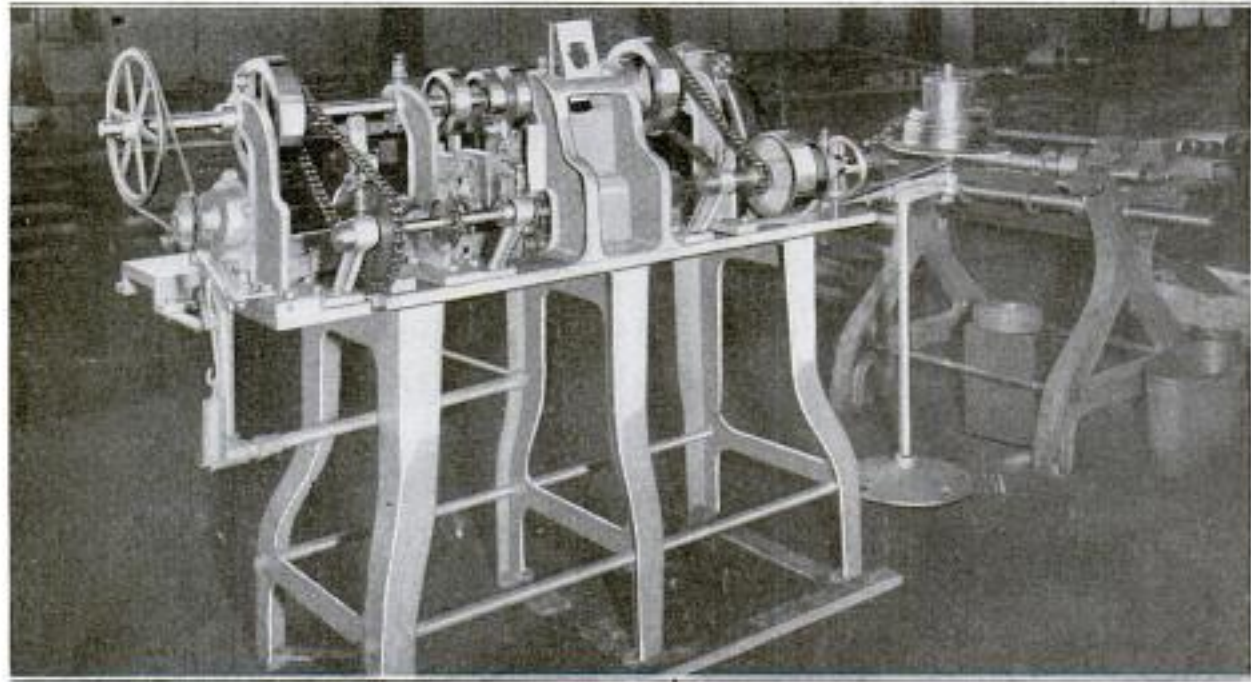

Motor-Driven Automatic Hairpin-Making Machine That Runs About 80 Revolutions a Minute, Each Revolution Making a Finished Pin Ready for Enameling: The Hairpin Wire is Split and Formed into Loops on a Die, and There Are Tools and Bending Fixtures for Cutting and Bending the Pins

The Diamond Hair Pin Co. 711 Franklin St., Chicago

9686

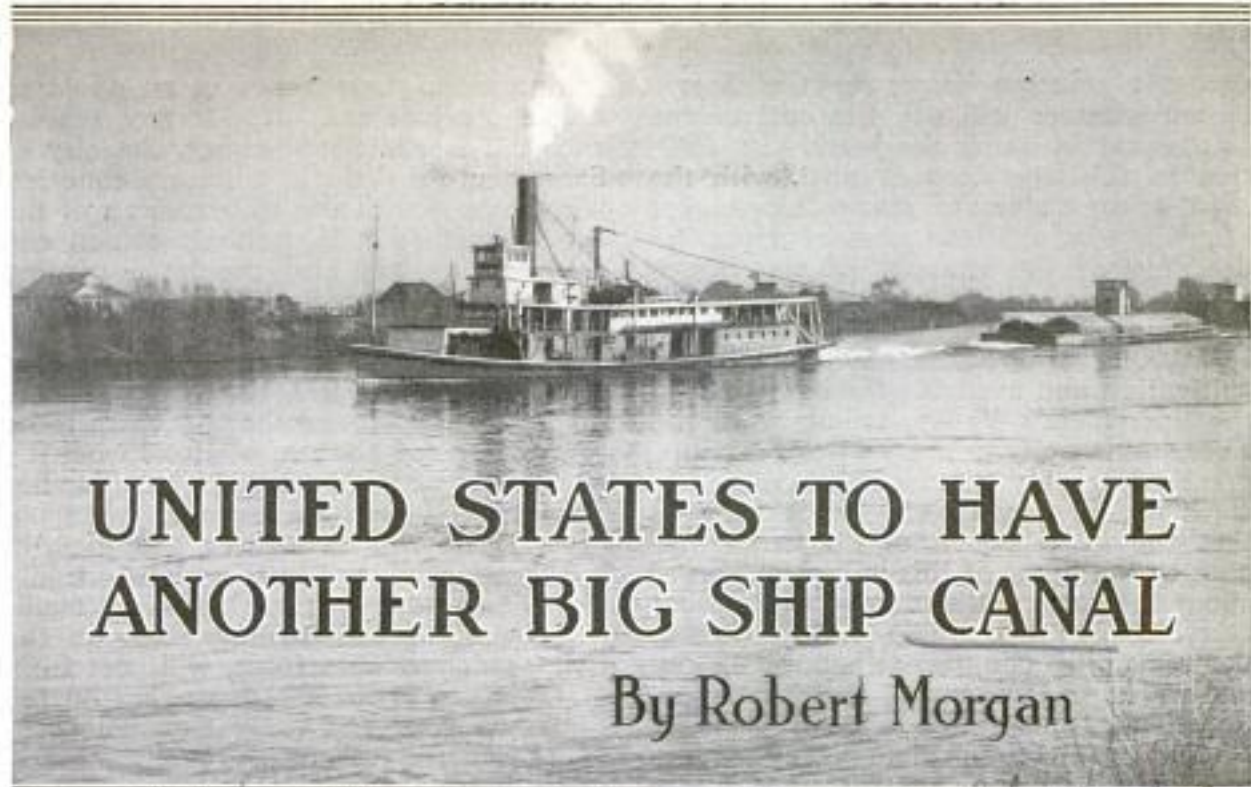

UNITED STATES TO HAVE ANOTHER BIG SHIP CANAL

By Robert Morgan

H. H. Munro, 2722 Prince St., Berkeley, Calif.

SURVEYS have been completed, and a report is being prepared for presentation to the Federal government for another of the world's large ship canals, to be located in California, and to connect Sacramento, the capital of that state, with the Pacific Ocean, by way of San Francisco Bay. The canal will be 35

miles long, 150 feet wide at the bottom, 350 to 360 feet wide at the surface of the water, and 30 feet deep, capable of floating all but the very largest of deep-sea vessels, and is designed to convert Sacramento, which is 90 miles from the Pacific, into an ocean port. Out of Sacramento, on steamboats, barges, and schooners, are shipped every year 1,000,000 tons of products of the grain ranches, fruit orchards, vegetable farms, and mines of 29 counties. This production is valued at \$95.95 per ton, the most valuable—and the largest—river traffic in the New World in proportion to the length of navigability of the stream, about 200 miles.

All this large volume of shipments has to be rehandled at San Francisco, Oakland, or other deep-sea ports on San Francisco Bay, and the cost of this transshipment is so great that the saving in this one item alone by the bringing of

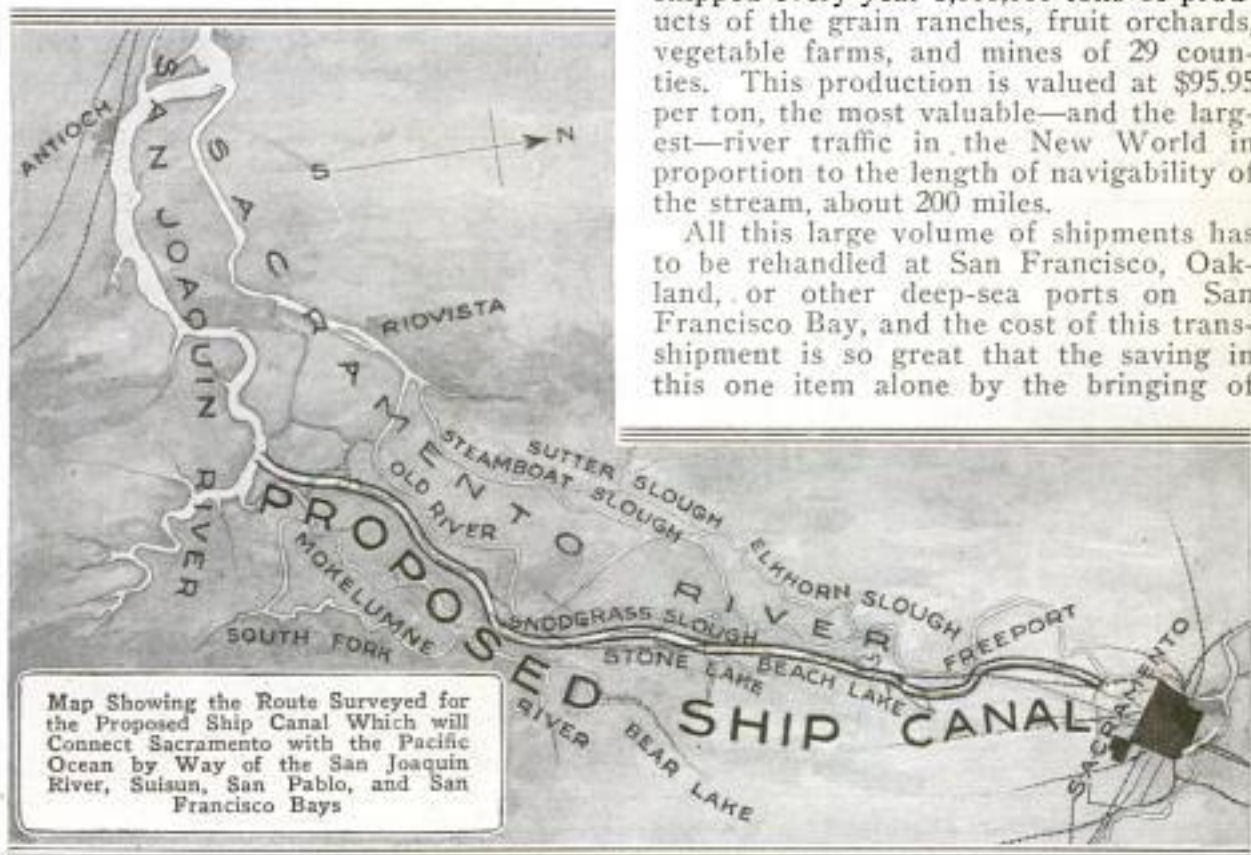

Map Showing the Route Surveyed for the Proposed Ship Canal Which will Connect Sacramento with the Pacific Ocean by Way of the San Joaquin River, Suisun, San Pablo, and San Francisco Bays

9686

deep-sea tonnage direct to the Sacramento wharves will pay the cost of the ship canal in about 10 years. In addition to this, the deep channel, with the silt-bearing waters of many streams cut off, will eliminate the present expensive dredging of the channel of the Sacramento River, which has to be kept up continuously the year around. There are 3,000,000 acres of arable land, suitable for cultivation and available for irrigation, in the Sacramento Valley, tributary to the river and the city of Sacramento. Of this great area, only about 25,000 to 30,000 acres are in production. It is believed that the introduction of deep-sea shipping to the heart of this valley will bring about the early cultivation of these other acres. How much arable land lies idle in the remaining counties tributary, by rail and water, to Sacramento it is impossible to estimate, but it must be nearly as large as that in the immediate valley of the Sacramento River.

For 55 miles of the 90 which separate Sacramento from the Pacific Ocean, there is deep water—from 40 to 80 feet—so that only 35 miles of the canal need be excavated, and these through soft delta land, with no complicated engineering problems, and no difficulties to overcome other than the walling out of the silt-bearing streams, and the establishment of crossings for railroads and highways. Under direction of the ship-canal committee of the Sacramento Chamber of Commerce, which is the prime mover in the plan, a complete survey has been made of the canal route, and cost estimates have been made for presentation to

the national government, in an effort to obtain Federal aid. If, for any reason, such aid is not forthcoming, the city of Sacramento and the 29 tributary counties, will proceed with the construction of the canal, which will be publicly owned and operated, as will also the large turning basin and the port facilities to be established at the Sacramento end.

The cost of excavation is estimated at \$825,000 to \$1,000,000, the comparatively low cost being due to the soft earth to be moved and the absence of stone from the course selected. Much of this course lies through sloughs and bayous, which in some places will have to be deepened, in others widened, and in some left virtually as they are today. The waterfront facilities, including the turning basin on the San Francisco waterfront, will cost from \$1,000,000 to \$1,500,000, depending on the prices of labor and materials. The proponents of the plan believe that the maximum figure for total cost will be within \$3,000,000, a comparatively insignificant sum considering the economies gained in the handling of freight and elimination of the dredging of the channels.

The route of the new canal, which is longer than the Welland Canal, as long as the famous Manchester Ship Canal, and wider and deeper than either, will not follow the course of the Sacramento River, which is maintained at a minimum depth of seven feet for barge and shallow-steamer traffic, but runs for two-thirds of its length south from the city of Sacramento, and then turns west of south, through Georgiana Slough and into the wider and deeper San Joaquin River a

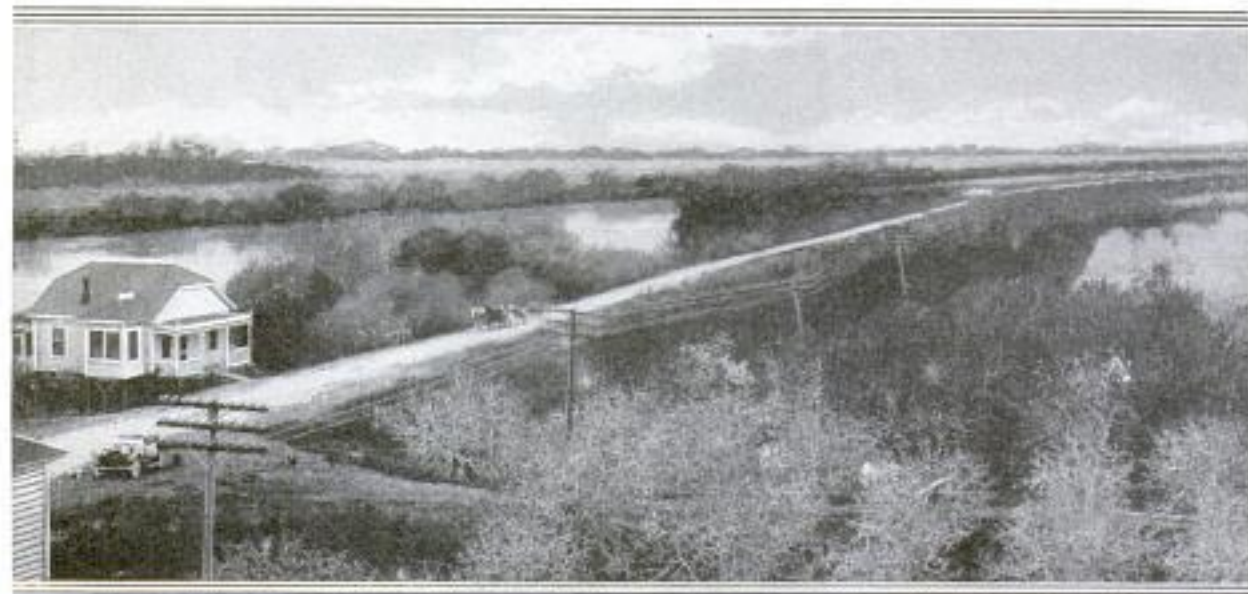

Sacramento River Bottoms, Showing Some of the Rich Fertile Lands Which could be Easily Cultivated So as to Produce a Great Many Shiploads of Fruit, Grain, and Vegetables for Shipment on the Proposed Canal

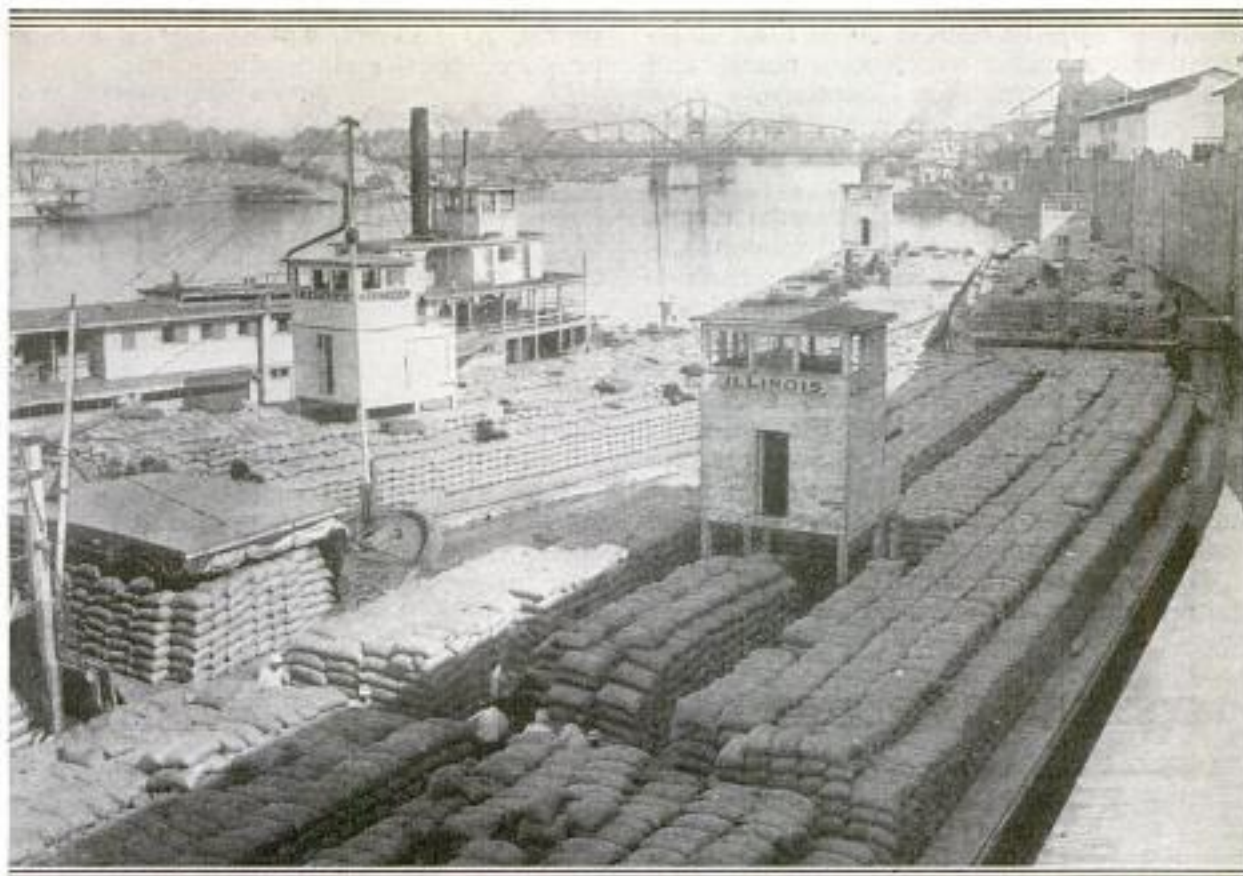

River-Front Scene at Sacramento, Showing Several Barges Loaded with Grain, and Illustrating the Enormous Quantity of This Commodity Which is Handled Every Year at This Point, Coming down the River from the Interior

short distance above Antioch, which, incidentally, also will become an important deep-water port for the San Joaquin Valley when the canal is completed. This route was selected as the best after an exhaustive survey of several proposed routes. It will start at the southern part of Sacramento city, follow substantially the line of the city drainage canal to Snodgrass Slough, thence down the latter channel to a point near its junction with the Mokelumne River. Thence it will cut through to Georgiana Slough. At this point, the natural channel will be abandoned, and a straight cut made into the deeper waters of the San Joaquin River. The low-water depth of the San Joaquin at the proposed point of entry is 31 feet, and all the way down to Antioch this depth is maintained as a minimum, though much of the water is 60 to 80 feet deep. The depth off Antioch is 54 feet, but a short distance below this place the river divides into several channels which shoal, in places, to a depth of only 18 feet.

The canal is to be constructed in five sections of varying lengths, which can be easily identified by a glance at the map. These sections are outlined by the engineers as follows:

Sacramento to Snodgrass Slough, 17

miles; in Snodgrass Slough, 5 miles; cut to Georgiana Slough, immediately to the south of Snodgrass Slough, 2 miles; in Georgiana Slough, 9 miles; and the last cut direct to the deep water of San Joaquin River, 2 miles, a total of 35 miles. Of this, at least 14 miles are in river and slough channels which already are in use by river craft, and will require only so much excavating as may be necessary to straighten bends and to increase the depth to 30 feet. The other 21 miles will be in original excavation, but in soft earth, the surface elevation of which varies from about 5 feet below to 10 feet above mean tide level, and, in several places, is some feet below sea level.

Investigation by the ship-canal committee shows that the large majority of ports of the world are not accessible to vessels drawing more than 30 feet of water, and that considerably more than half these ports offer only 27 feet of water. The record of bottoms entering and leaving San Francisco Bay shows that 45 per cent of the deep-sea traffic to and from that port is borne in vessels of 20-foot draft or less, and that 80 per cent of it is carried in ships that draw not more than 25 feet of water. Thus it appears that a ship canal offering 30 feet of water

would be able to handle more than four-fifths of the traffic which now comes and goes to and from San Francisco.

The plan adopted for the new ship canal provides that no waters shall be admitted to the canal from either the Mokelumne or the Sacramento rivers, except through gates that will prevent the ingress of sand silt or debris. To so exclude the sands and silts of these streams, locks will be required at the head of Georgiana Slough; otherwise, the canal will be at tide level. Protective works also will have to be constructed at the point of entry of the canal into the San Joaquin River, and estimates of these have been included in the figures of the cost of the completed waterway.

The Sacramento Ship Canal will compare with the other great canals of the

world, as follows, according to a table prepared by the state engineers:

Canal.	Length in Miles.	Bottom Width in Feet.	Surface Width in Feet.	Depth in Feet.
Panama	40	350-650	500-1,000	40-50
Suez	100	108	254	36
Manchester ...	35.5	104	220	28
North Sea ...	60	164	394	32
Kaiser Wilhelm	61	144	361	35
Welland	22	150	260	25
Sacramento ...	35	150	350-360	30

Traffic this year on the waterways which will, in part, be replaced by the ship canal, will total approximately \$100,000,000 in value and will considerably exceed 1,000,000 tons in volume. The growth of this traffic in the past decade has been enormous, since it amounted, in 1910, to only 400,000 tons. When the canal is completed, it is estimated that this traffic, both in volume and in value, will be increased by at least one-third.

9616 *see ship salvage*
MYSTERIOUS FLOATING FORT OPENED TO VISITORS

One of the mammoth British naval floating forts that have been the subject of so much mystery before and since the completion of the first one, and from which the mystery of their real purpose has never yet been dispelled, is now located at Shoreham on the south coast

of England. Recently it was towed to Southwick, a neighboring seaside resort, where it was thrown open to visitors, who were allowed to climb to its upper tower, about 170 feet above sea level, whence they had a bird's-eye view of the whole structure. The mammoth mystery tower was fully described and illustrated in the January, 1921, issue of this magazine. The tower has a huge concrete base and steel upper structure, the total weight being about 10,000 tons.

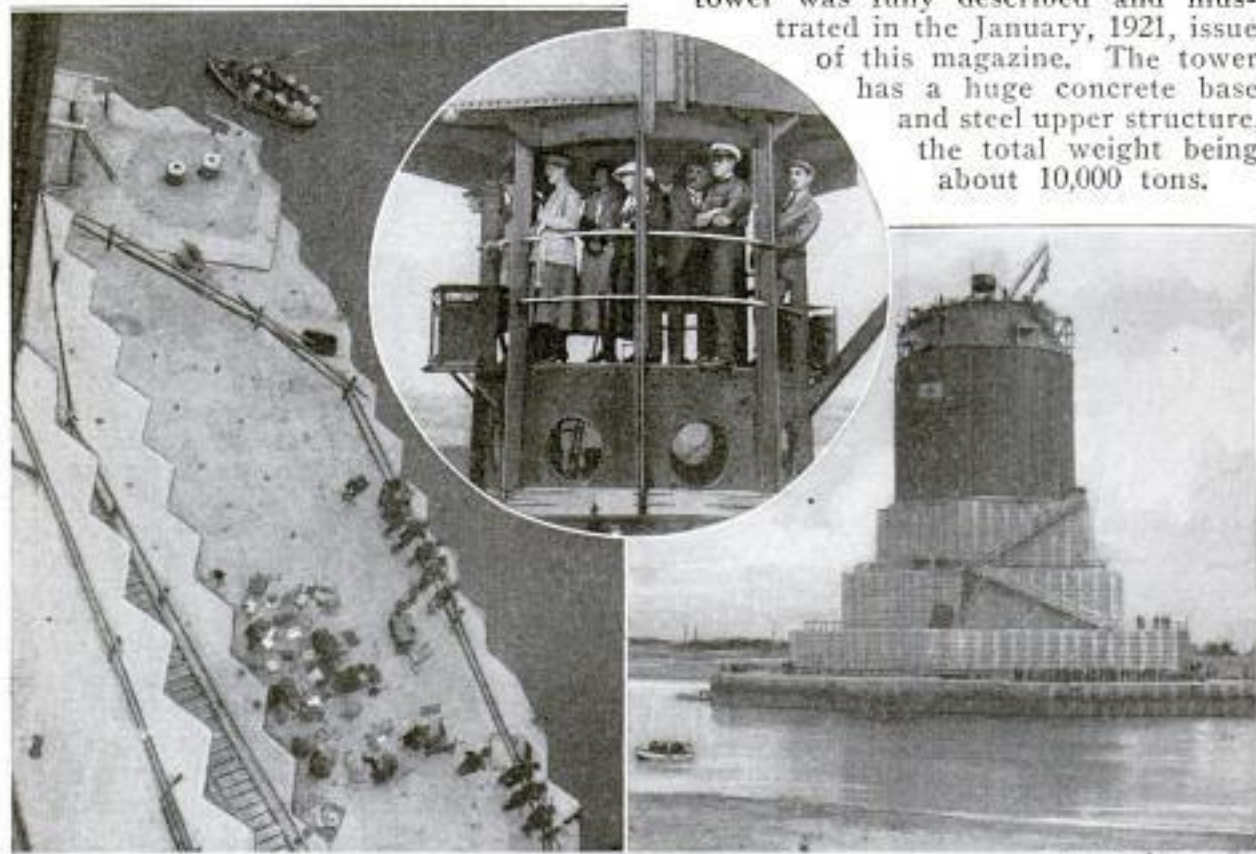

Left: View Looking Down from the Top of the Tower to the Huge Concrete Base, 170 Feet Below. Center: Visitors Enjoying the View from the Observation Tower. Right: The Mystery Tower as it Appears at Southwick on the South Coast of England

9687

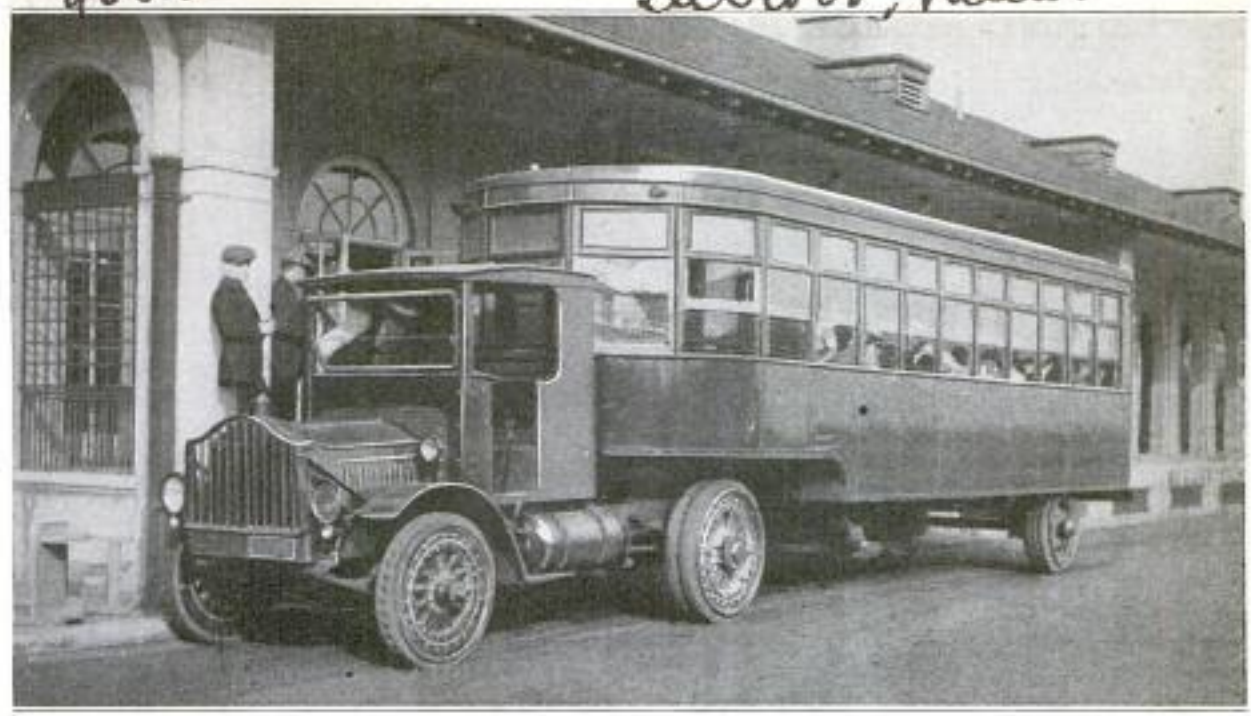

This Huge Passenger-Carrying Motor Bus Provides Accommodations for 135 Persons. The Power Plant and Body Are Separate Units; When the Passenger Body is Detached, It Rests on Folding Legs, and the Power Plant can be Used with a Truck Body

9687

LARGE-CAPACITY MOTOR BUS HAS DETACHABLE BODY

The size of passenger-carrying motor busses has continued to increase until now there has been placed in operation in Detroit, Mich., a bus that has a capacity of no less than 135 passengers. The power plant and body of this huge vehicle are separate units, and when the passenger body is not in use, the power unit may be used with a truck body. The former is designed along the lines of a street car, and is supplied with folding legs at the forward end, on which it rests when detached from the power unit. Only one man is required for the running of the bus, and the doors are operated by compressed air. The gasoline consumption is claimed to be only slightly greater than that of the smaller busses seating only 28 passengers.

9652

FROST IN OXYGEN CYLINDERS PREVENTED BY HEATERS

In the oxygen cylinders used in connection with oxyacetylene-welding torches, the great amount of expansion that takes place in the reduction valves lowers the temperature of the gas to such a degree that the moisture in it often freezes and clogs up the ports of the valve. To prevent this, electric heaters are now being used on the reduction valves at several places on the Pacific coast. An ordinary reflecting electric heater is wired beside

the reduction valve, and is kept in operation while the oxygen is being used. Besides the prevention of frost, a natural

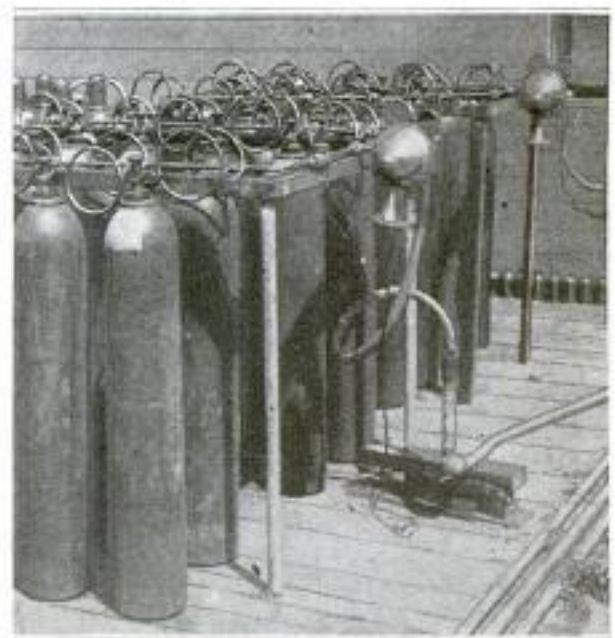

Battery of Oxygen Cylinders in an Oxyacetylene-Welding Outfit, with Electric Heaters Mounted beside the Reduction Valves

result is a slight increase of pressure in the service line.

Paris police are instructed to seize all automobiles figuring in accidents or serious collisions. If the driver is found guilty, he is put in prison and the car sold. If acquitted, the car is returned to him.

No data on maker.

Dr. W. Mr. Langehening, 310 W. 13th St. Oklahoma City Okla.
POPULAR MECHANICS

SCALE AND METER MEASURE ICE IN REFRIGERATOR

Automatically indicating the quantity of ice in the box, and also registering

the amount consumed in any given period, are features incorporated in a refrigerator

produced by an Oklahoma man. The innovation appears not unlike the ordinary style of container except that the scale and meter are mounted in plain view on the top. When ice is placed in the chamber, the scale is operated like the common spring type, while the meter is actuated from the scale shaft by means of gears. Thus the householder can learn the weight of the ice in the box without opening the door, and also has a record of the total number of pounds that have been used. A water bottle and cooling coils are also incorporated in the refrigerator.

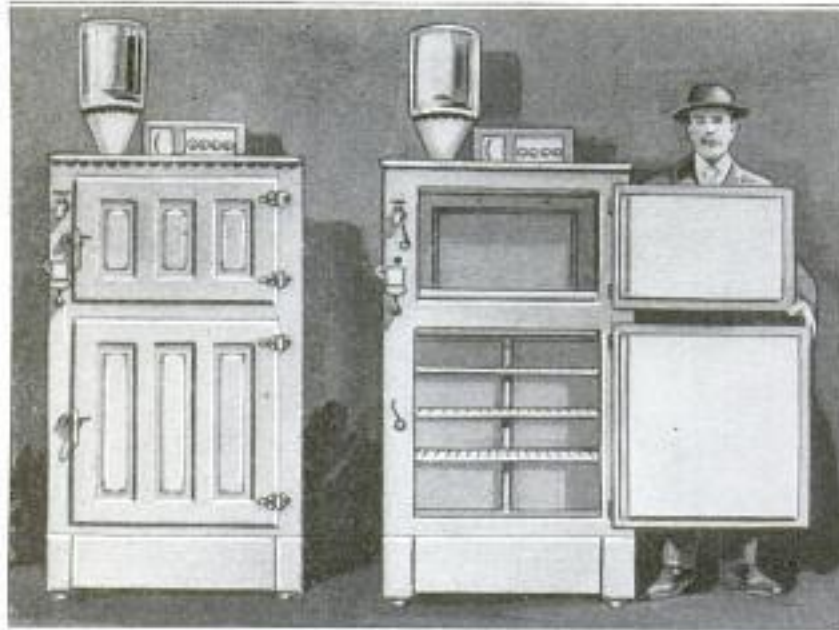

Left: Refrigerator Closed, Showing Water Bottle, Scale, and Meter on the Top. Right: Door Opened, Displaying the Ice Scale in the Upper Compartment and Usual Complement of Shelves in the Lower

9665
FLOATING HOSPITAL TREATS FOOT TROUBLES

9749
EXHIBIT SCIENTIFIC TRUTHS FOR BENEFIT OF PUBLIC

For treating injuries to the feet of boatmen, dock workers, and bathers, a

Educational and interesting sights will be witnessed in a magnificent building



Floating Hospital That Makes Regular Trips around Manhattan Island Treating Injuries to the Feet of Boatmen, Dock Workers, Bathers, or Others

boat, suitably outfitted for the purpose, will make regular trips around Manhattan Island, N. Y., stopping at various points. Patients may board the vessel at any stopping place, and will receive treatment by a staff of doctors.

latest discoveries in the mathematical, physical, and biological sciences, the latest results in industrial research, and will contain laboratories and observatories, in which the displays will change with the progress of science.

Traded at foot of 86th St. East River, N.Y.

Paver 5/16/12 p. 496 Vol. 55 Copyrighted material

Mfr. M. Hussard, 19, Rue Guillaume Tell,
Paris, France

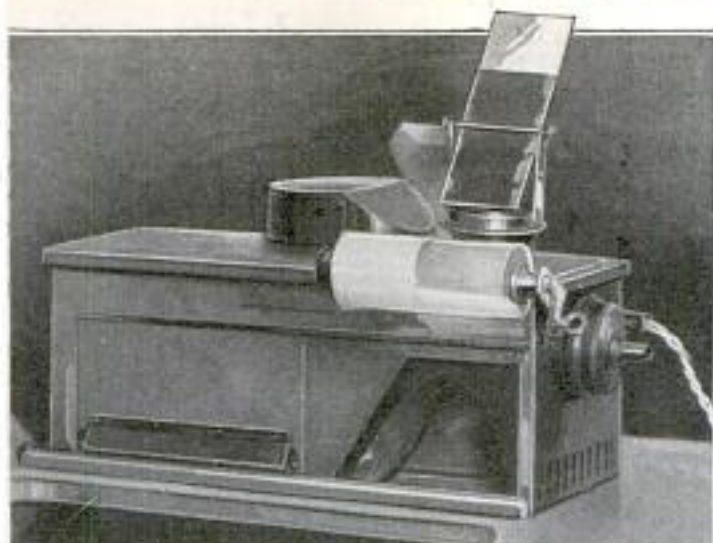

Apparatus in Use at the Art School of the Louvre, in Paris, That Projects the Image of an Object onto a Screen in a Room Sufficiently Lighted to Allow the Writing of Notes by the Students: The Apparatus will Project Greatly Enlarged Reproductions of Insects, as Shown to the Right, Where the Magnified Image of a Moth is Reflected by the Inclined Mirror onto the Screen.

9476

PROJECTION APPARATUS USED FOR THE STUDY OF ART

An apparatus for the direct projection of the image of an object onto a screen in a room sufficiently lighted to permit the writing of notes, has been applied at the art school of the Louvre, in Paris, for educational purposes in very large classes of students, and has given very gratifying results. This apparatus will project enlarged reproductions of drawings, engravings, or moldings, and also of such objects as living animals or insects, the latter magnified so that they resemble prehistoric animals. The object to be projected is placed upon a small table which is adjustable, by a wedge under it, to the required elevation. Above this table is a lamp of five candlepower, suitably adjustable for illuminating the object to be projected, which is placed upon the table. An inclined mirror above the apparatus reflects the projected image of the object onto a screen, about 20 feet square, located at some distance from the apparatus. The projections show the objects in relief, and with their colors, all with an elaboration of detail impossible by any other method.

☐ Congress has authorized an expenditure of \$1,000 for the purchase of trophies to be conferred by the Bureau of Mines at the International Mine-Rescue and First-Aid Contests, upon miners who have performed noteworthy feats.

NEAT DEVICE FOR HOLDING PHONOGRAPH RECORDS

9594

Believing that there is room for improvement in the methods of keeping phonograph records, a Canadian inventor has patented a holder that has several good features. An upright rod is fastened to one side of the cabinet, and the records are held, in a horizontal position, on light plush-covered arms that swing on the rod. Each arm has a pin that fits the hole in the center of the record, and small spacers are provided between the arms to keep the records apart.



This Device Holds Phonograph Records in a Horizontal Position, and can be Used with a Cabinet, or as a Sales Device for Displaying Records

Chas. Philip Morgan
Lindsay, Ont., Canada

4 no Francis Cottle, Riverside, Calif.

9512

DÉBRIS REMOVER FOR IRRIGATION CANAL

Removal of débris from the water of irrigation canals is efficiently done by a

contrivance introduced by a western man. The apparatus has a revolving cylinder



Débris Remover of Irrigation Canal. Showing Fingers of Cylinder Supporting a Man's Weight: In the Background is Shown the Paddle Wheel

composed of metal strips bent to a circular shape and placed about one inch apart, which is set in the concrete side walls of the canal. The water flows freely through this screen but the rubbish is retained against the sides. Extending through the strips from the inside of the cylinder, are fingers which pick up the débris and deposit it on a conveyor at the top, by which it is carried to one side of the canal. A paddle wheel, installed a short way downstream, provides the motive power to operate the mechanism, and can be lowered or raised to start or stop the cylinder.

EAR CORN LOADED IN CARS BY AIR-BLAST OUTFIT

9976

Loading ear corn into box cars has been facilitated by the production of a portable air-blast outfit, which is manufactured by an Illinois concern. When the front end of a wagon is elevated by a jack, its contents fall upon an endless belt that conveys the grain to a powerful blast of air, which blows the corn inside

the car. Both ends of the car are filled simultaneously by means of a two-way spout, and it is claimed that a 60-bushel wagon can be emptied in approximately five minutes.

STAMPS WORTH 200,000 RUBLES ON LETTER FROM RUSSIA

9446

The first letter to have sufficient Russian postage came to the Minneapolis post office late last June. It had stamps in 100, 500, and 1,000-ruble denominations, and so great was their number that they were attached to sheets which in turn were connected with the envelope. The sheets of stamps fastened together were 5 feet in length. The total value of the stamps was 200,000 rubles which in American money amounts to about 10 cents. According to pre-war exchange rates, this sum would have been equivalent to a little under \$100,000—a striking illustration of depreciated money.

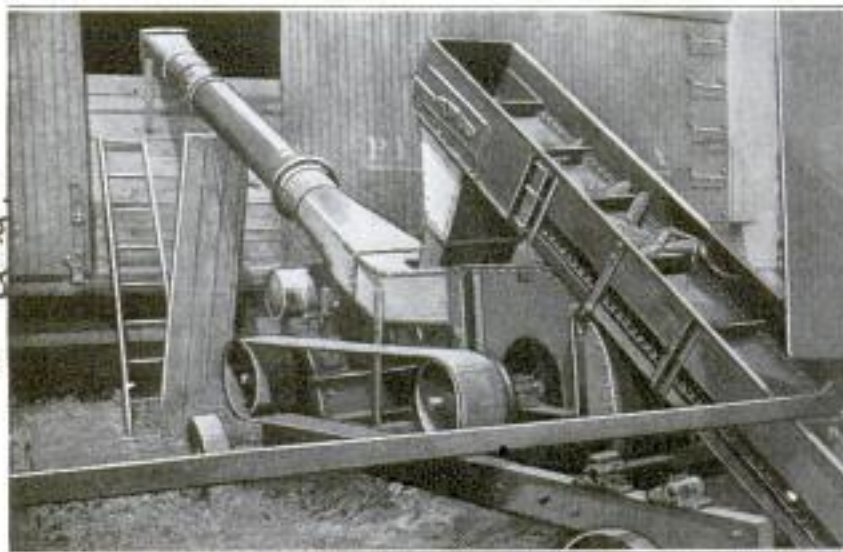

Pneumatic Ear-Corn Loader, Filling a Railroad Car: The Conveyor Is in the Foreground, and the Air Blast is Located Below the Hopper at the Near End of the Delivery Spout

The Maroon Mfg. Co. n. d. l.

George J. Meda, 3606 Dearfield, Minneapolis, Minn.

9544

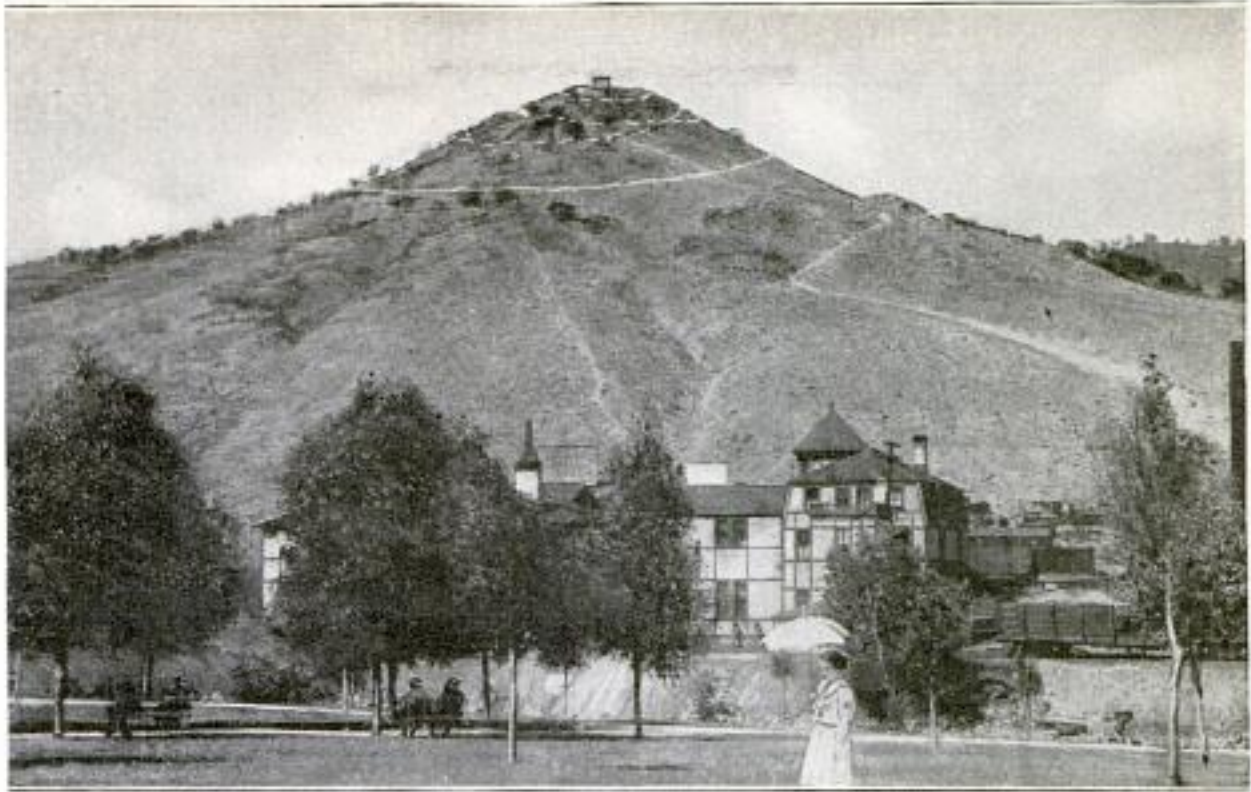

View of Tenderfoot Mountain Taken from City Park, Showing the Spiral Drive to the Summit as It will Appear When Completed: It can be Plainly Seen How the One-Way Road Crosses Itself on Its Way to and from the Top of the Mountain

THE TENDERFOOT SPIRAL DRIVE

By J. H. FREEMAN

Salida, Colo.

PERHAPS the most unusual road in the world, is the Tenderfoot Spiral Drive, now nearing completion, at Salida, Colo. It is so named, because one spirals four times around Tenderfoot Mountain in traveling over it to the top and back. Its entire length will be less than 2½ miles, of which 2 miles already are in use, being finished, except for the removal of a few rocks. This portion of the road is 18 feet wide, and the grade is six per cent.

The first mile and a half constitutes the approach from the county

road to the mountain, but even this part describes some wonderful curves to gain altitude. At the so-called "double-back,"

the road cuts through the ridge into Monument Gulch, close above Jiggs and Maggie, runs up along one wall of the cañon, turns round in the Punchbowl, and climbs back along the other wall, high overhead, finally leaving the cañon just opposite the point where it entered.

The last half mile of the double-track road is almost a perfect circle, around Tenderfoot to the turn-around, at the back of the



Diagram of the Tenderfoot Spiral Drive: As Far as the Turn-Around, the Road Is Full-Width, and from There On It Is Only Wide Enough for One Car

9544

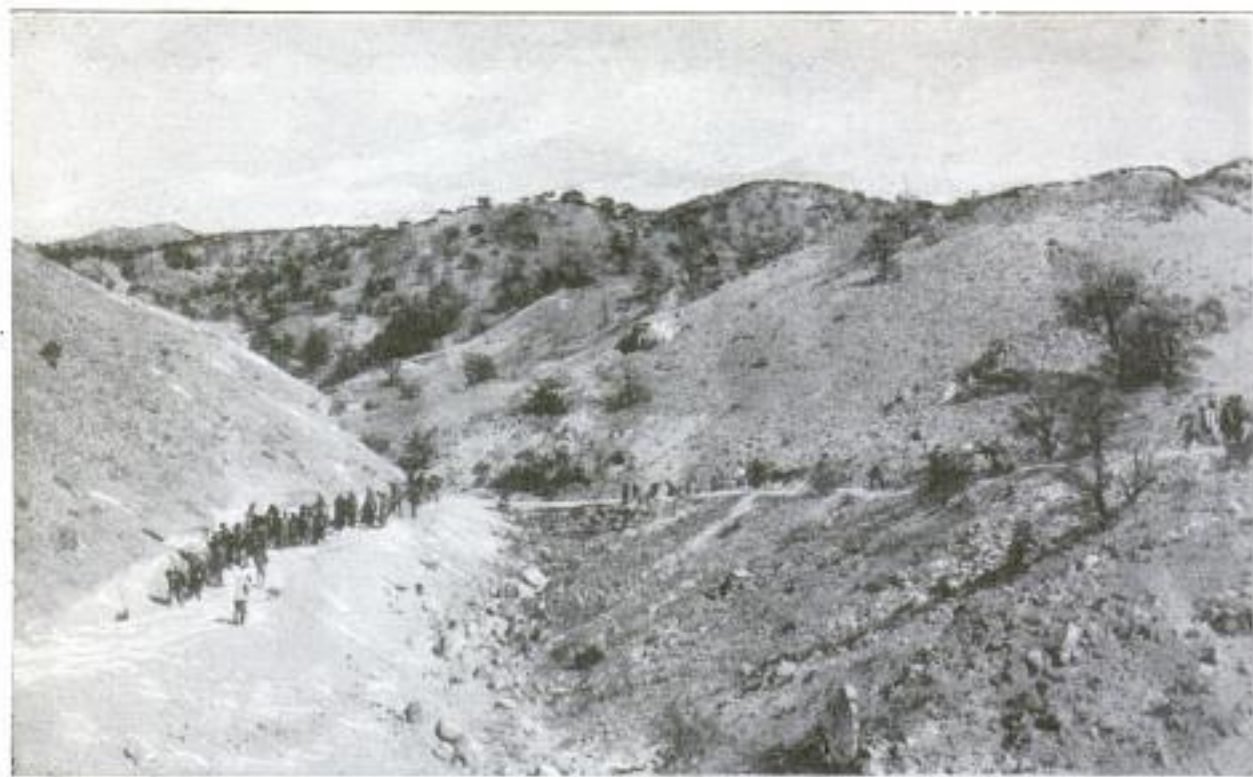

Some of the Prominent Citizens of Salida Working on the Part of the Great Circle Road Where It Crosses One of the Gulches on the Way to the Turn-Around

mountain. Here ends the section of the road that is now open to travel.

Tenderfoot Mountain rises more than 500 feet above the railroad station, at the north end of the main street of the city, and the great circle is more than halfway up its steep side. Its summit is a mile and a half above the level of the sea.

Above the turn-around, the road will be a single-track or one-way road, spiraling three times round the cone-shaped peak, to a point near the summit and returning to the starting point. The first circle will ascend spirally once around. The second will pass around the top nearly on a level, rising slightly in the first half and descending in the second. The third circle will spiral down again to the turn-around, crossing the ascending circle halfway down.

The traveler will go up one, and down the other to the starting place, traveling all the time in the same direction around the mountain. Hence there will be no danger of "meeting a fool," and the road need not be made more than 9 feet wide. Each driver will have as much right of way as he has on the 18-foot road, and will be in no danger of meeting a "road hog," who will not keep on his own side. At no point on the mountain road can an approaching vehicle be seen more than a few lengths away, owing to the continual curve, and

this increases the danger on the two-way road.

Aside from the novelty of the double spiral, the single-track road has a great advantage over the double-track, in cost of construction, since much less material must be excavated in building it.

The supervising engineer says in his report: "To make a safe easy road without destroying the rugged beauty of the mountain, it was necessary to run it in a spiral, to a point within 25 feet of the summit, once round the top (less than 500 feet), then descend spirally to the turn-around. The top is too small to accommodate cars, and the mountain too precipitous to allow a turning place; hence the return road. The narrower cut thus allowed, will not interfere with the fill from the next circle close above (as the double-track cut would), nor make an unsightly excavation around the sides of the mountain.

"The constantly changing panorama of grand vistas from all parts of the road is unexcelled. Every turn brings to view some new scene of beauty or grandeur."

The Tenderfoot Spiral Drive will be safe, but the motorist will instinctively hug the mountain side, and try to avoid dropping a monkey wrench into the busy streets far below.

It is proposed to erect a silent guide on the summit of Tenderfoot. A large dial will be cut on top of a pedestal, 4 or



Working on the Road at the Turn-Around: This has Appropriately been Called "The Punchbowl." From Here the Motorist may Follow the One-Way Spiral Road to the Summit, or may Retrace His Path to the Foot of the Mountain

5 feet high. There will be a raised point in the center, and other raised points in a circle near the circumference, marked with the names of prominent mountain peaks, and other places of special interest within view, with distances to them. These points will be so placed that by sighting along the center and one of the

points, the object named at that point will be in the direct line of sight. This will make it possible for any visitor to identify all the points of interest by consulting the silent guide.

This is important, as a great many places of historic interest are visible from the elevated summit of Tenderfoot. A



Grading a Portion of the Great Circle Drive: In the Center Is Tenderfoot Mountain with the Spiral Drive Showing at Two Places on the Side, as It Winds up the Mountain

dozen or more peaks above 14,000-foot elevation—the highest in the state—can be seen along the main range of the Rockies. Many of the highest passes are also visible, as well as the peaks of the San Gre de Christo, or Snowy Range.

The Tenderfoot Spiral Drive is being built by labor donated by all classes of citizens. Most of the business and professional men of Salida have blistered their hands, and "cricked" their backs by their ardent attacks, with pick and shovel, on the rocky sides of Tenderfoot, and many who have not even a burro to drive over the road, have joined heartily in the good work. Merchants have donated a specified per cent of their sales for a day to the enterprise. Besides, some 150 of the state-reformatory boys have worked

on the road for four days. The Rio Grande Railroad donated a train, and the train men donated their services. Wednesdays were designated as railroaders' days, and Thursdays as business men's days, and there was an interesting rivalry as to which should accomplish the most. The women, too, have done their share, by serving hot meals to the laborers regardless of wind and dust, and by giving home-cooking sales to raise money to buy explosives for the road work. So far, about \$8,000 in labor has been donated, and another \$2,000 ought to complete the road as originally planned.

In short, the Tenderfoot Spiral Drive is a fine example of what can be accomplished by a whole community pulling together in a common cause.

HUGE ORGAN PIPES VOICED OUTSIDE THE FACTORY

Some of the organ pipes made by a California manufacturer were so huge that the process of voicing them had to be done outside the factory building. The approximate length of the sound wave produced by the largest of these pipes is 64 feet, and there are only 16 vibrations per second. The tone produced is hard to distinguish, and to the average hearer sounds like a low murmur or continually repeated sound, but the vibrations are so powerful that they cause reciprocal vibrations in ceilings and walls.

GOVERNMENT REMEDIES FOR RADIO STATIC

Static, that bugbear of radio enthusiasts during the summer months, has recently been made the subject of an explanatory discussion by the U. S. Bureau of Standards and different methods advanced to overcome as much as possible, these annoying disturb-

ances. The installation of a coil, or loop antenna, consisting of a suitable number of turns of wire wound upon a wooden frame about 4 feet square, is one of the ways suggested. Another is the

"ground antenna" consisting of an insulated wire laid on top of, or buried in a shallow trench in, the ground, for a distance of several hundred feet in the direction of the station from which the greater amount of broadcasting is to be received. The amateur should bear in mind, however, that in sacrificing the familiar elevated, or roof, antenna, he also loses considerable strength of the signals or waves received, and consequently must use a higher stage of amplification to obtain anywhere near the same results.

ⒸA building which is expected to be the finest and best equipped laboratory for the study of iron and manganese ores is now in process of erection at Minneapolis, to be used jointly by the University of Minnesota and the U. S. Bureau of Mines.

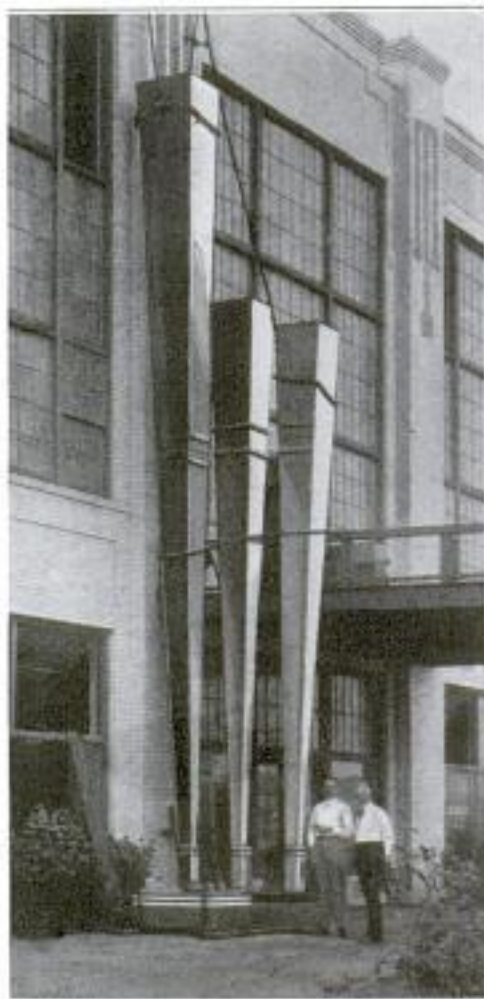

Three Organ Pipes That Were So Huge That They had to be Voiced outside the Factory: In the Largest Pipe the Sound Wave Is 64 Feet Long

The American Photo Player 9633
Co. 108 S. 1st St. Denver, Colo.
H. H. Jones 7/17/22 P. 6.

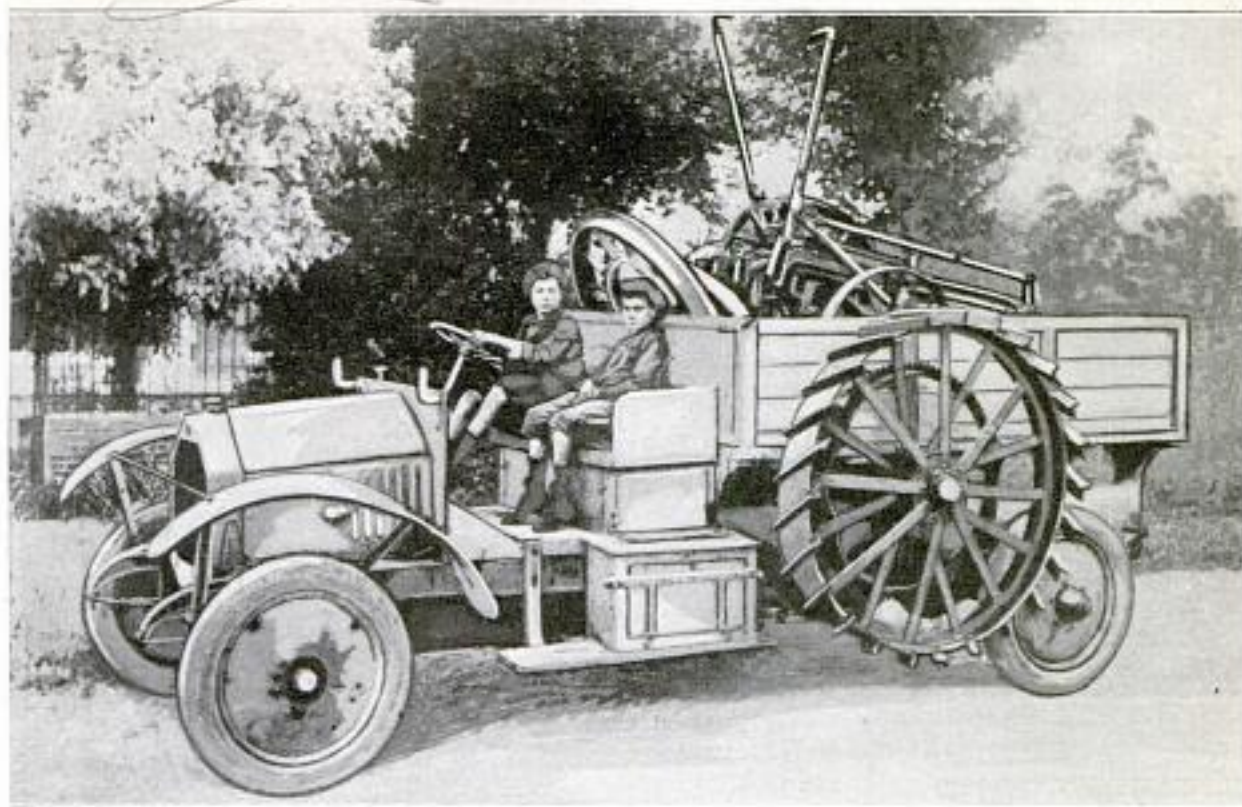

Interchangeable Power Car in Use as a Road Truck: The Rims for the Front Wheels When in Use as a Tractor, are Seen behind the Driver's Seat. In Front of the Rear-Truck Wheels Are the Upraised Tractor Wheels

A motor vehicle that is interchangeably a truck or a tractor is in use on farms in France. To transform the truck into a tractor, a wheel rim of considerably larger diameter than the front-truck wheels is mounted around each of them, with rigid connections formed of radial struts. Just in front of the rear-truck wheels are a pair of tractor wheels on a special axle that can be lowered to bring these wheels to the ground when the tractor rims are on the front wheels. The rear-truck wheels are then taken off, and

on their driving axle a sprocket wheel drives a chain which engages a second larger sprocket on the tractor wheels. The change can be made in a short time, and does not require the service of a machinist.

Five coal-mining companies, whose properties are located close together in Utah, have formed a coöperative mine-rescue association, which maintains eight sets of mine-rescue apparatus and a combined motor rescue truck and ambulance.



Interchangeable Power Car in Use as a Tractor, Shown Hitched to a Plow Ready to Start to Work on the Stubble: The Rims are Mounted on the Front Wheels. The Rear-Truck Wheels have been Removed, and the Sprocket on Their Axle Is for Driving the Tractor Wheels

Built by: U. S. Playing
Card Co., Norwood Ohio
400 POPULAR

Wm. H. M. Pitman
4223 Bryan St.
Dallas, Texas
MECHANICS

**BIRD MANSIONS CONSTRUCTED
ON ELABORATE LINES**

9608

Bird mansions of artistic and elaborate structure, each having in the cupola a



clock with faces in four different directions, are to be seen on the lawn surrounding the factory of an Ohio manufacturer. The miniature "hotels," which are "seven stories" in height and contain many "rooms," measure approximately 3 by 3 feet and

are mounted on high iron poles. Bird lovers have expressed themselves in admiring terms concerning these houses, in which, it is said, numerous species of feathered families dwell in harmony.

back far enough to allow the man to climb into the hammock, when it is pulled up and tightly closed by a drawstring. To keep the net away from the sleeper, spreaders are provided for the bags, the use of which is said to have greatly reduced the number of fever cases.

9611

**NUTCRACKER IS POWERFUL
—AND EASILY CONTROLLED**

Perfect control of the power exerted on a nut in cracking the shell is possible



with the use of a nutcracker invented by a Texas man. The appliance has a solid felt-lined base and a ratchet, or gear, arrangement operated by a long handle, that gives the user ample leverage in breaking the hardest shells. The regulation of the

crushing power is valuable in that the nuts can be cracked to any desired degree, without scattering the shells in all directions, or smashing the kernels into little bits.

9621

**VENTILATOR BASE ADJUSTABLE
TO PITCH OF ROOF**

By making the flue base adjustable to the pitch of the roof, an Indiana man has

produced a ventilator which should be popular among poultry raisers. The contrivance, which is constructed of tin, has a setscrew attachment in its base that permits the flue to be raised or lowered, so that the ventilator will always be in a vertical position.



Wm. Cyril J. Jettel
Alexandria, Ind.

**AUTOMOBILE PARKING LAMP
HAS NEAT APPEARANCE**

For the motorist who must, at times, park his car in dark places, a parking lamp has been placed on the market that seems to be the last



word in simplicity and neatness. The lamp has the usual full-size red and white lenses. The light bulb is easily accessible, and it is only necessary to press down and turn the ferrule to cause the lenses to part.

**NEW AND BETTER NET PLACED
LIKE BAG OVER HAMMOCK**

A new and better net for protection against mosquitoes carrying deadly malarial-fever germs has been designed by an English medical officer stationed on the west coast of Africa. The white men at this place all sleep in hammocks, and before retiring, a tube of netting is slipped over the hammock, one end being tied at the foot. The other end is rolled

The Lancet 6/17

Allan Parking Lamp Co.
Baltimore, Md.
Box 305

9726

Copyrighted material

9443

Mikimoto & Co. Tsingtao, Tokyo

POPULAR MECHANICS

Japan

401

JAPANESE HOLD BEAUTIFUL PEACE EXHIBITION

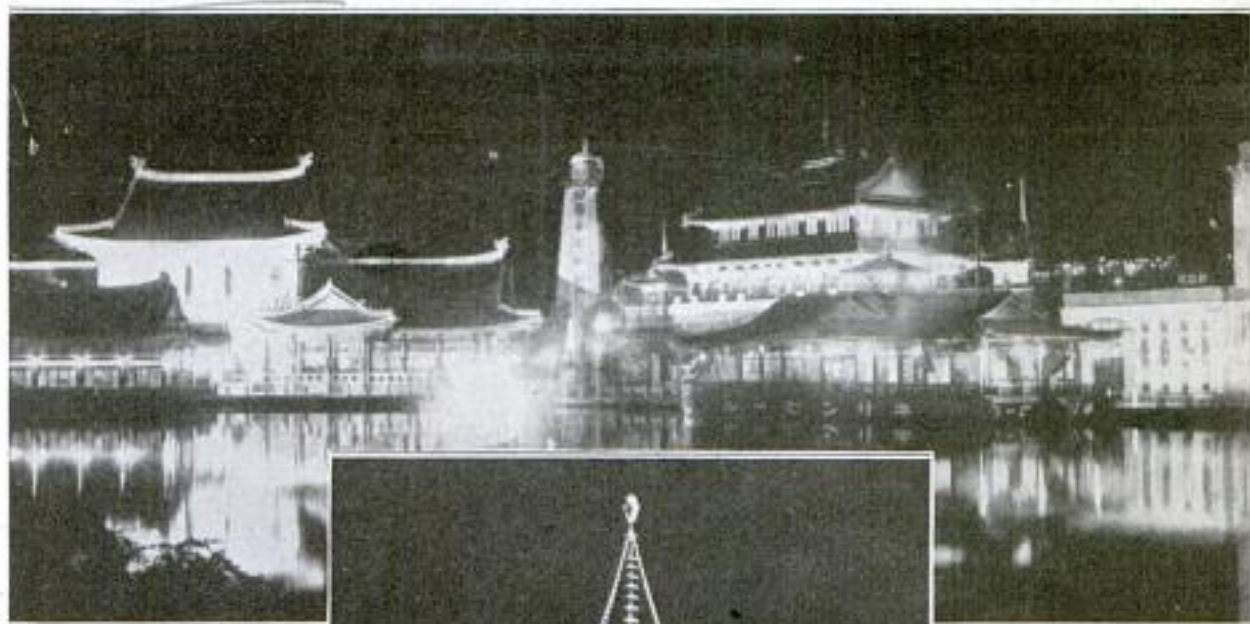

There was held recently in Tokyo, Japan, a peace exposition, that for size and beauty far surpassed anything of like nature done in that country. The exhibition buildings were lighted during the evenings with searchlights throwing beams of various colors. Among the many marvelous exhibits there



was a jewel pagoda, 2 feet 4 inches high, made of mother-of-pearl, and decorated with real pearls. Some 120,000 small pearls were scattered about the base of the pagoda to resemble pebbles. This little model, besides its rare beauty, represented a value of about \$150,000 at the present market price of the jewels.

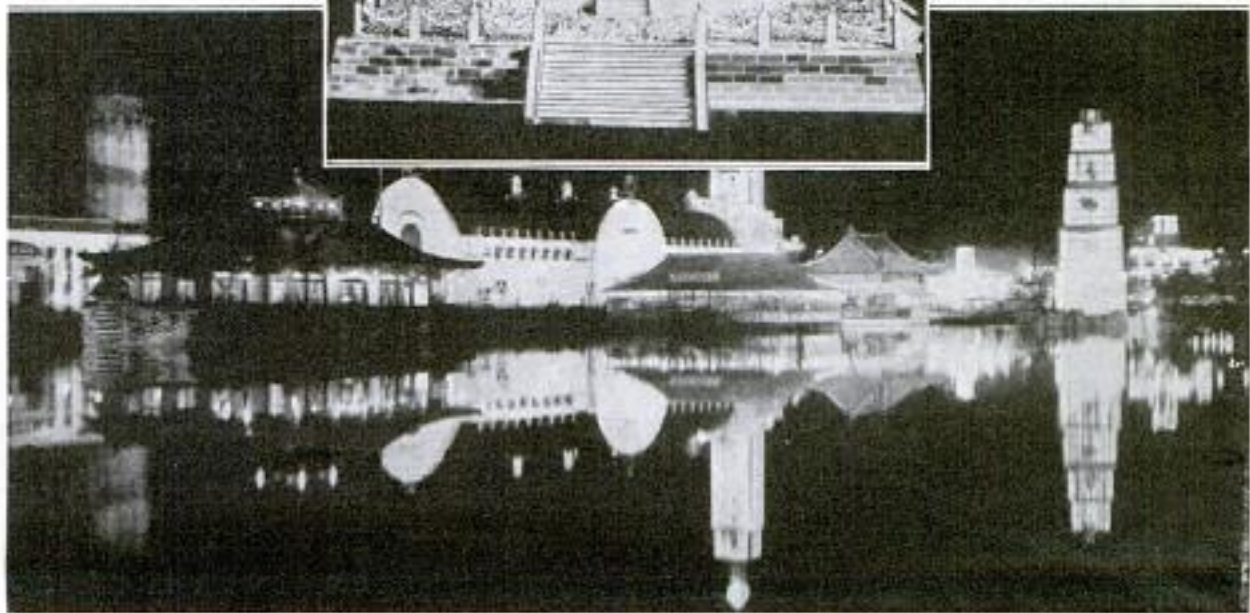

The Upper and Lower Views of the Buildings and Grounds of the Tokyo Peace Exhibition were Taken at Night. Center: One of the Exhibits; a Pagoda Made of Mother-of-Pearl and Real Jewels

Onl. N. Sakata, #10, 5-Chome
Tadamachi, Kojimachi-Ku, Tokyo, Japan

Copyrighted material

no data + Iserman

402

9690

Engine

NEAT ROTARY MOTOR WEIGHS ONLY TEN POUNDS

A small rotary gasoline motor has recently been developed that would be par-

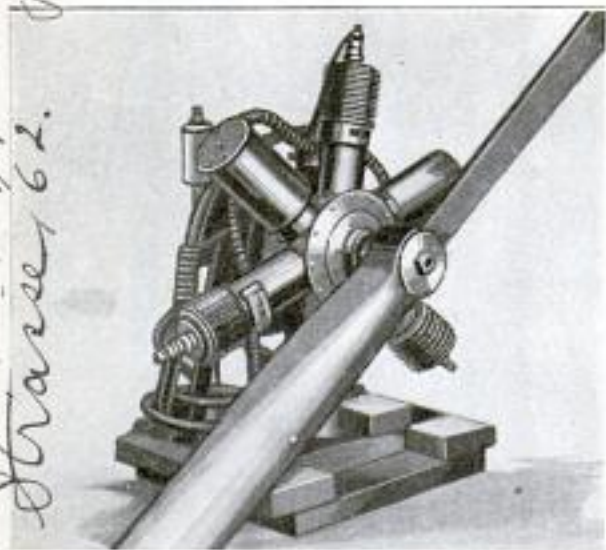

This Little Rotary Gasoline Engine Develops 1½ Horsepower, Yet Weighs Only 10 Pounds without the Magneto. It Operates on the Two-Cycle Principle

ticularly well suited for use in airplane gliders. Without the magneto, this

motor weighs only 10 pounds and develops 1½ horsepower. It operates on the two-cycle principle, giving one explosion in each power cylinder at every revolution. The engine is supplied with three power cylinders and three cylinders in which the explosive charge is compressed before going to the firing cylinders.

BORING OF CHANNEL TUNNEL WILL SEE NEW METHODS

If the boring of the tunnel under the English Channel is decided upon, new methods may be inaugurated for doing this kind of work, according to recent announcements. An excavating machine is now being assembled which, it is thought, will have a far greater output than any hitherto used for tunnel boring, and to further insure speed in construction, a considerable number of working points are under consideration. Removing the borings has been made the subject of special study, the way most likely to be employed being that of converting the refuse into semiliquid form by adding water and then discharging it through pumps.

London Times Weekly 6/15/22

CEDAR STUMP IS RESERVOIR FOR WATER SYSTEM

Probably no cedar stump was ever put to more original use than the one which forms the reservoir of a perfectly service-

able waterworks system constructed by an Indian living in the very hottest part of the dry belt in British Columbia.

Some little distance behind his house, a small mountain stream winds its way through a low range of hills. This stream the Indian tapped on the hillside above his house with an aqueduct which he extended down to the cedar stump. The stump was hollowed out to form a reservoir, and from this he ran one pipe into a trough. The water being always cold from a distant glacier, the trough served the purpose of a refrigerator. A second pipe brought water to the house for all sanitary and culinary needs, while a third, attached to a long hose, made possible the cultivation of an extensive tract which would otherwise have been barren in this dry region. Stock can also be watered at the trough.



Water is Brought by Gravity from a Near-By Stream to This Cedar-Stump Reservoir and Distributed through Pipes for Refrigeration and Household Use

Atlantic Photo Co.
Berlin S.W. 11, King Street
Traces 62.
9522
Cnd. A raggs Collicie, Herald Bay.
B.C. Canada

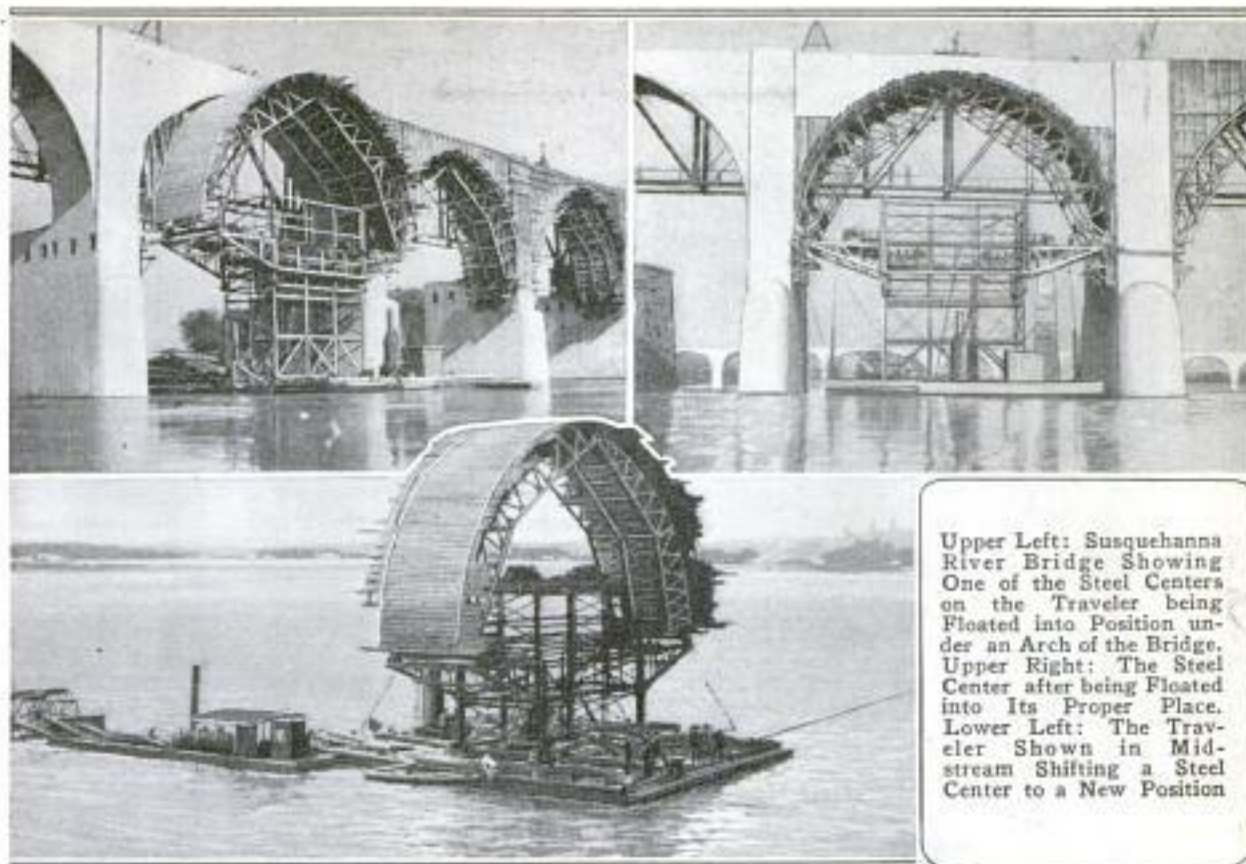

Upper Left: Susquehanna River Bridge Showing One of the Steel Centers on the Traveler being Floated into Position under an Arch of the Bridge. Upper Right: The Steel Center after being Floated into its Proper Place. Lower Left: The Traveler Shown in Mid-stream Shifting a Steel Center to a New Position

9571 / STEEL TRAVELER ON BARGE LIGHTENS BRIDGE WORK

In building the concrete arches for the new bridge across the Susquehanna at Harrisburg, Pa., good use was made of a steel traveler mounted on a barge and carrying steel centers. The entire bridge is more than 3,000 feet long and is over the water for nearly its whole length. It was decided that, under the circumstances, the centers could be handled to the best advantage in this manner. While the work on the new bridge is in progress, it has been necessary to keep traffic in operation on the existing steel bridge. A part of the new bridge is being built first; then the track will be moved over to the new portion, and the rest of the bridge will be concreted.

Between the two ends of the bridge there is a difference in elevation of over 20 feet. For this reason, it was necessary to design a traveler that had sliding parts, enabling it to reach the centers at the high end and yet pass readily under the centers at the low end.

When all is in readiness for placing a center, the traveler is towed underneath, and then the sliding frames are hoisted until they engage the heel of the steel ribs. Worm-gear safety winches are used to raise or lower the centers. Whenever it is necessary to move the

centers, they are pulled in horizontally by means of ratchets, lowered with the winches, and towed to position at the next span, where the operation is repeated.

The forms and reinforcing steel are handled by a derrick boat. The whole structure calls for a total of 92 set-ups of the arch ribs.

9222 "SANITARY-BREATHING" PIPE PLACED ON TRACTOR

"Sanitary breathing" for a tractor is possible with a special pipe which is fitted into the crankcase and extends above the top of the implement. Oil-soaked steel wool is placed in a container at the top of the pipe to keep out the dust and grit encountered during the day's work, thus preventing any foreign matter from reaching the internal parts of the engine.



Eng. Ed. E. Palfrey
Esplanade Club
St. Louis, Mo.

9618

**SHEAR-SERRATING GRINDERS
SPEEDY AND ACCURATE**

Serrations on the edge of a shear blade that heretofore have usually been made with a hand file, after the temper has been removed, can now be much

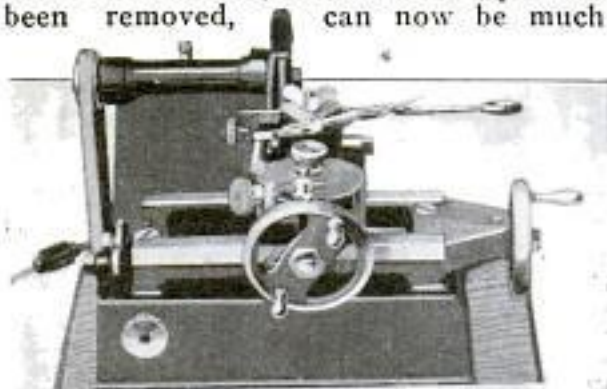

Shear-Serrating Grinder Seen at Work on the Blade of a Shear: The Small Knurled Wheel in Front Adjusts the Machine to Cut a Plain Edge When Desired

more efficiently ground by a machine specially designed for the purpose. The machine is self-contained and has a framed base, inside of which is a small motor. This drives a combined oscillating bed and traveling carriage in such a manner that the grinder will impart to a

shear blade any desired number of serrations per inch. A slight turn of a knob in front of the machine will throw out the serrating mechanism, and a plain edge will then be obtained.

H.A. Wood,

**PHOTOGRAPHIC FILMS RUINED
9674 BY CARNOTITE ORE**

Recently a photographer had the unpleasant experience of having some exposed films ruined because he placed some samples of high-grade carnotite ore in the safe where the films were stored. The radioactive properties of the ore caused peculiar designs to appear on the films when they were developed.

**COAL TRAIN BADLY WRECKED
9678 WHEN DESERTED BY CREW**

On a steep grade on a rocky hillside of a western mining camp a loaded coal train, consisting, besides the locomotive, of 20 steel gondola cars, was left standing recently while the conductor went to a telephone to get orders, and the engineer and fireman seized the opportunity to go for some cigars. While thus deserted, air leakage released the brakes, and the train went full-speed down the steep grade. After traveling two miles, the heavy train crashed through an open switch and was entirely wrecked. The locomotive and most of the cars crumpled, and great masses of coal were scattered over the hillside.

Denver to Rio Grande R.R.



Wreckage of a Train of 20 Gondola Cars, Loaded with Coal, That Ran Uncontrolled for Two Miles down a Steep Grade in a Western Mining Camp: The Locomotive and Most of the Cars were Completely Smashed, and the Coal was Scattered over the Ground

Emb. H.J. Lundy, Palmdale, Calif.

Spring Canyon, Carbon County, Utah.

9432 Mrs. William H. Mason,
Laurel, Miss.

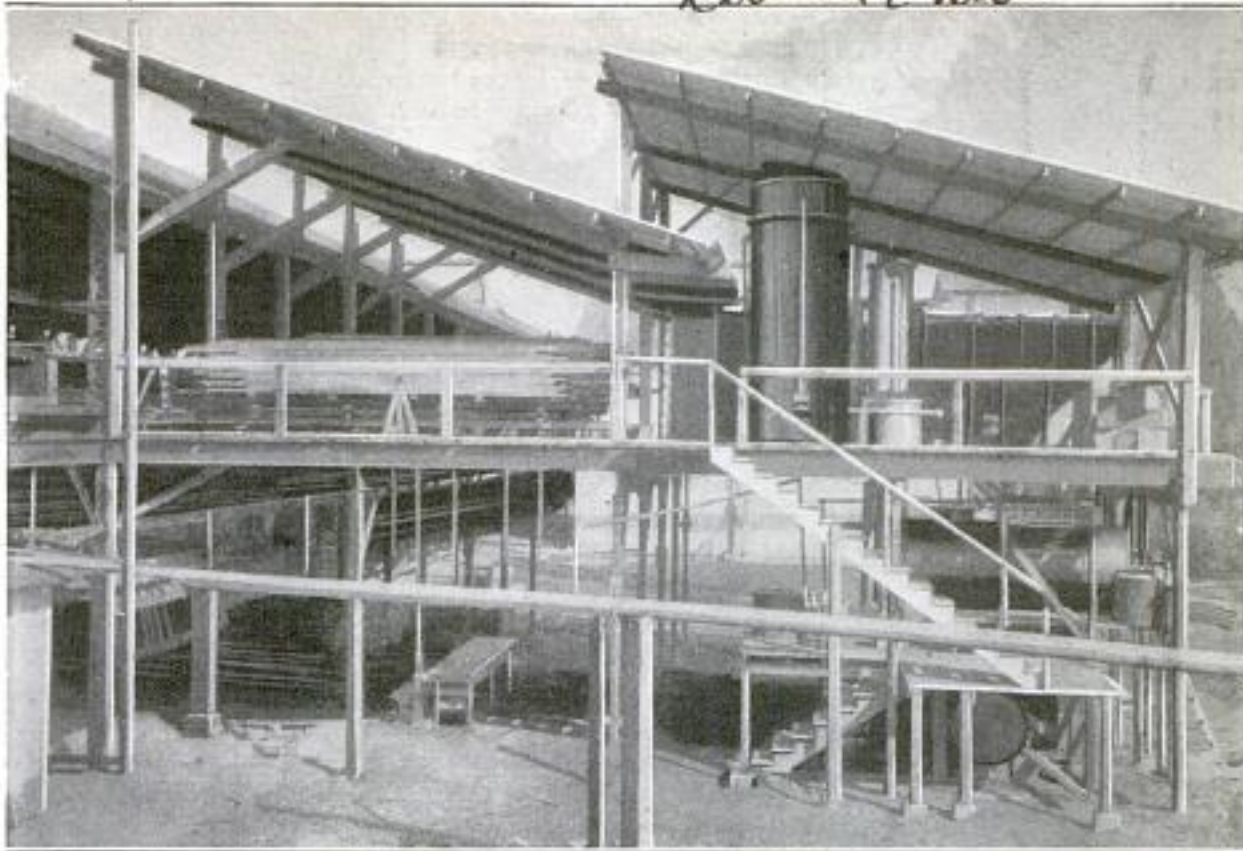

9432 This Shows One of the Pitch-Extraction Plants Where a Large Percentage of the Turpentine and Pine Oils are Removed from the So-Called "Fat" Lumber. The Still, Condenser, and Steam Kiln Are on the Second Floor, and the Storage Tanks Below

SAVING OF BY-PRODUCTS IMPROVES LUMBER

THE tendency of modern times is to eliminate waste of all sorts and to recover by-products once considered of no value. Many a flourishing business today owes its prosperity to the fact that some waste product has been converted from a source of expense to one of revenue. In the southern lumber industry this principle is now being applied in such a way that not only are valuable by-products recovered, but the value of the lumber is also increased.

The process that is being adopted is a method of extracting from lumber a considerable portion of the contained resin, turpentine, and pine oils. Lumber that has a high percentage of these substances is of low commercial value for

several reasons. It will not hold paint; it is hard to work; it splits easily; the pitch boils out in hot weather, and it costs more to ship because of its extra weight. At the mills, this so-called "fat" lumber has a value of only about one-third that of first-grade lumber. Yet the

substances that lower its value have a considerable value of their own, and their removal increases the value of the lumber itself.

The recovery process, developed at two southern mills, is extremely simple and requires the labor of only two men to operate a commercial-size plant. The

lumber as it comes from the saw, is loaded on cars and run into kilns, which are then closed and sealed. Heating coils in the floor of

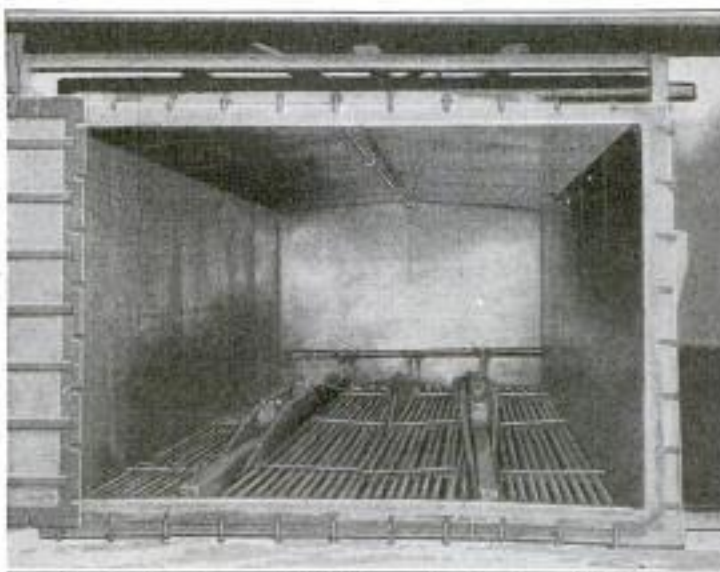

Interior of the Steam Kiln Where the Lumber is Run In on Cars and Subjected to Heat from the Steam Pipes in the Floor

Used by: Wausau Lumber Co } Laurel, Miss.
Marathon Lumber Co.

9432

the kiln serve to keep the temperature at the required degree, and live steam is circulated around and through the lumber. As the temperature in the kiln increases,

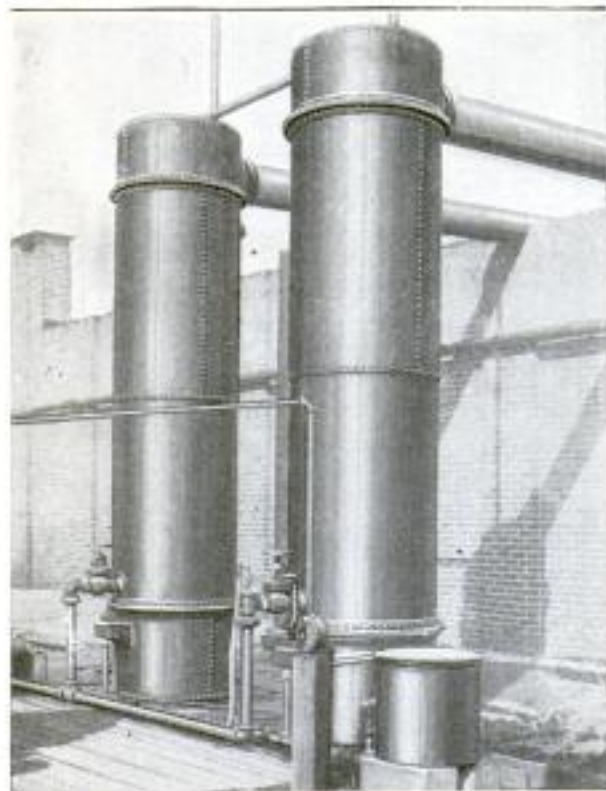

In These Stills the Crude Resinous Liquid is Subjected to Further Heat and the Turpentine and Pine Oils Separated from the Water

the moisture in the lumber boils out, carrying with it, in the form of vapor, much of the resin and turpentine. The live steam that is introduced into the kiln aids materially in speeding this extraction and carrying it to completion. The kiln treatment lasts 24 hours, and the lumber is then sent to the usual drying kilns. The treated lumber dries out much more rapidly than the untreated lumber.

The vapors coming from the treatment kiln go to the refining plant, which consists of a still, condenser, and storage tank. The still is charged with the mixture of crude turpentine, pine oils, and water, and is heated by live steam introduced through a spray pipe. As the temperature is raised, vapors are given off, consisting of approximately 60 per cent turpentine and 40 per cent water. This vapor is condensed, and the liquid passes to an automatic separator that removes the turpentine from the water. Toward the latter part of the run, the percentage of turpentine decreases and the percentage of pine oils increases. The turpentine produced by this method is high-grade, water-white, and can be used for any purpose to which gum turpentine is suited. The pine oil recovered finds use in the mining industry, where it is applied in the flotation process for the recovery of finely divided mineral particles from the worthless gangue.

The extraction process is not confined to the treatment of cut lumber, but can be used for the treatment of stumps that have been left on cut-over land. These stumps usually contain a higher percentage of resin and turpentine than is found in run-of-mill lumber, and the value of the extracted products should go far toward the cost of clearing the land.

It is believed by persons in a position to know, that the process can be economically installed in any mill having a capacity of 70,000 feet of lumber a day. Actual tests have shown that the weight of the lumber treated by this method is reduced from 20 to 30 per cent with a consequent saving in the freight charge for shipment. The value of the recoverable products, based on the total cut of the southern mills, runs into startling figures.

9490

PACKING PLANT LARGEST IN AUSTRALIA



Airplane View of the Largest Packing Plant in Australia, Situated on the Banks of the Ross River, at Townsville, Queensland

The largest packing plant in Australia, known as the Ross River Meatworks, handles annually from 50,000 to 90,000 cattle and 50,000 sheep. The plant covers an area of five acres. During the operating season, which lasts about seven months, from 500 to 600 men are employed. It is located in Townsville, Queensland, on the banks of the Ross River. Large quantities of tallow and other by-products are exported from this plant.

Carl George Oliver of Townsville, Queensland, Australia. Hubberts Ltd.

Dr. Mrs. A. M. Low, Woodstock Road W. London, England.

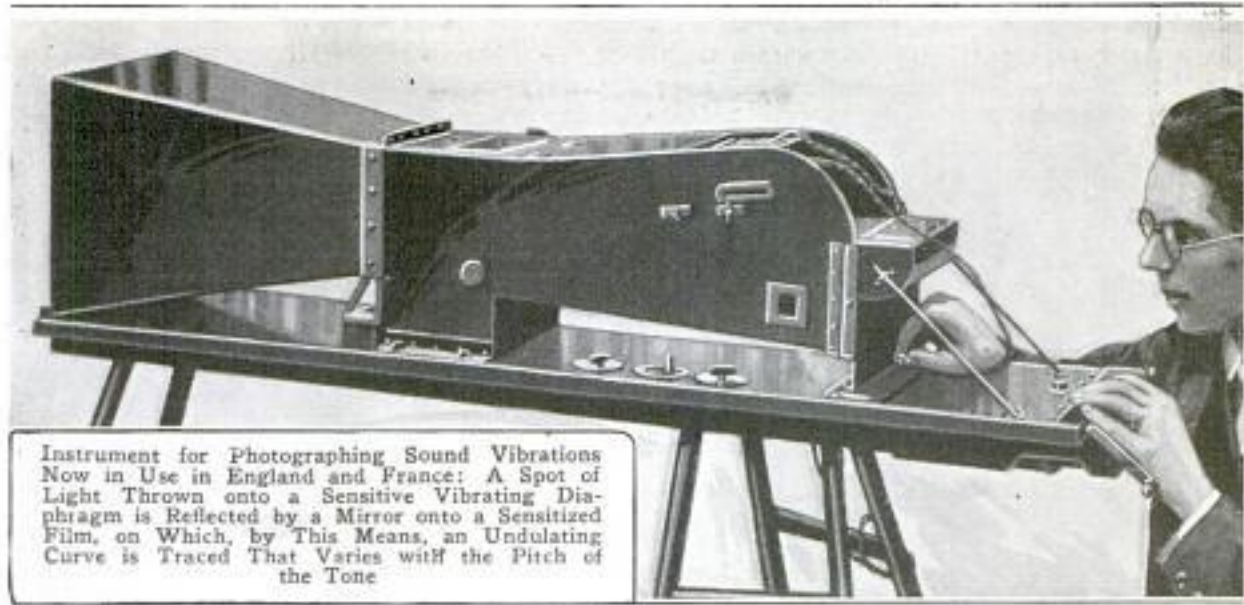

Instrument for Photographing Sound Vibrations Now in Use in England and France: A Spot of Light Thrown onto a Sensitive Vibrating Diaphragm is Reflected by a Mirror onto a Sensitized Film, on Which, by This Means, an Undulating Curve is Traced That Varies with the Pitch of the Tone

PHOTOGRAPHIC RECORDS MADE OF SOUND VIBRATIONS

9629

An instrument for photographing tones, or sound vibrations, called an "audiometer," has recently come into use in England and France. Inside the apparatus is a sensitive diaphragm that responds precisely to any sound vibrations. In connection with this is a mirror which reflects onto a sensitized film a spot of light from an electric bulb. This spot of light moves with the vibrations of the diaphragm, and therefore, when the film is rolled along in a direction at right angles to this movement, an undulating curve, which varies with the intensity of the sound, is traced upon the film. This then passes into a tank below the apparatus where the film is automatically developed. Without the film, the spot of light may be observed on a ground-glass screen, in the way observations are made with any ordinary camera.

SIMPLE RULES FOR TESTING HOME GAS BURNERS

Simple home tests have been outlined for the householder who wishes to determine if his gas burners are properly adjusted. If they light easily and turn off quietly; if they burn in sharp blue cones with purple edges; if they can be turned down and still burn evenly, and if cooking utensils keep clean where the heat from the burner tips strike them, then the burners are all right. If the burners do not come up to these tests, it is well to have experts from the gas company make proper adjustments, as this plan will insure the best results.

*Illinois Committee on Public Utility Information
125 S. Clark, Chicago*

FLOCK OF PIGEONS HOUSED IN ARTISTIC BUNGALOW

1523

Believing that even the pigeon house should harmonize with the surroundings, a California man built his in the form of an artistic bungalow. The house rests on a stone pillar that rises from the center of a fishpool, both the pool and the pillar being made of cobblestones set in cement. At a point about halfway up the pillar, a circular bath for wild birds has been constructed where the birds will be safe from prowling cats.



This Bungalow-Type Pigeon House Rests on a Pillar Made of Cobblestones That are Set in Cement

*Emb. Howard C. Pegley, Los Angeles, Calif.
1349 Larcia Terrace*

For sale by: Watry & Heidekamp,
17 W. Randolph St. Chicago.
408
9572

POPULAR MECHANICS

TELESCOPE ATTACHMENT GIVES THREE MAGNIFYING POWERS

A new attachment for portable telescopes furnishes three magnifying powers instead of only one. The attachment

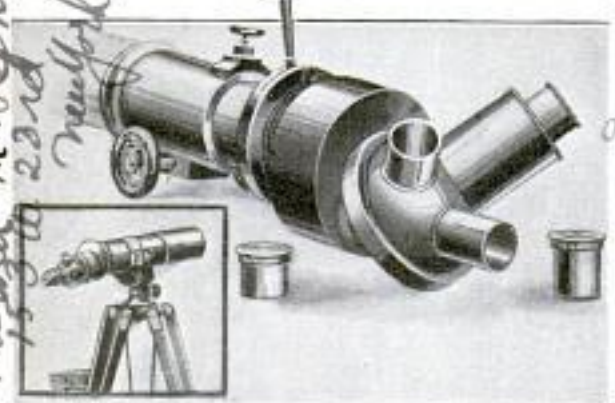

Attachment for Portable Telescopes That Has Interchangeable Eyepieces Furnishing Three Magnifying Powers: Its Position on a Telescope is Shown in Inset

has the same general appearance, and operates on the same principle as the revolving objective of a microscope, but instead of being at the objective end of the instrument, it is clamped over the barrel at the eye end of the telescope. When used on a telescope having a normal magnification of 12 powers, the three eyepieces of the attachment make it possible to view objects magnified either 12, 20, or 40 times.

HANDY TOOL HOLDS AND CUTS WIRE CABLE EASILY

Anyone who has had occasion to cut a piece of wire cable with a cold chisel and hammer knows what an exasperating job it is, and will appreciate a tool recently introduced.

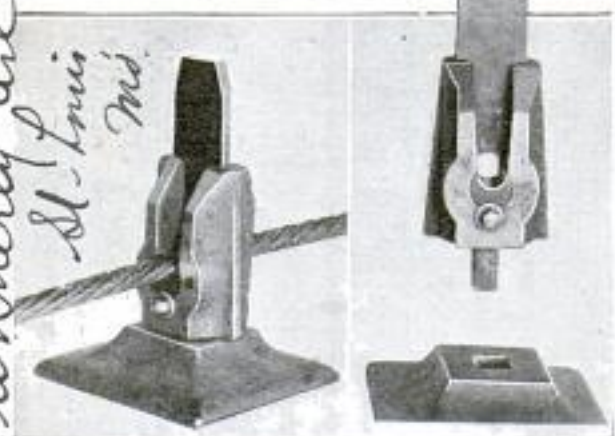

This Cutter Holds the Cable in the Body Casting, and the Cutting is Done between the Lower Die and the Bar, Which is Struck with a Sledge

The device consists of a body casting, base plate, and cutter bar, and is so made

that it can be used on an anvil or other solid foundation. The cable is held securely in the body casting, and is cut between a lower cutting die and the cutter bar, when the latter is driven down by a sharp blow with a sledge.

SIMPLE PIPE OR NUT WRENCH ENTIRELY SELF-ADJUSTING

For gripping objects such as pipes and nuts, a very simple wrench is so constructed that it is entirely self-adjusting. At the base of an opening in one handle, near its jaw, is a fulcrum for the other handle, which acts as a lever as it slides through the opening, until it grips the pipe or nut-between its own jaw and that of the other handle. The wrench is made adjustable to widely varying sizes by means of an auxiliary fulcrum, which can be swung into position so as to bring the jaws closer together for smaller-sized



Self-Adjusting Wrench: In Lower Views Where Handle is Cut Away, Movable Fulcrum is Shown in Position, at Left for Small Objects, and at Right for Larger Ones

objects. It has a hammer head on the back of one jaw, and a screwdriver at the end of one handle.

TWO JAPANESE SWIM GREAT YANGTZE RIVER

On May 21, two Japanese swimmers, named Nishimura and Urakami, succeeded in establishing the record of swimming the great Yangtze River of China at a point between Hankow and Wuchang. This is the first crossing to be made at this point. The hazard of such a swim does not lie in the distance, seven miles, but in the strong uncertain currents and the submerged rocks in the river.

Laboratory tests have demonstrated that bituminous-clay pipe can be used for drainage and sewerage in place of cast-iron pipe. A special bituminous compound is used in the joints.

Carl Zeiss Optical Works Jena. Germany. Sold to Harold W. Pynch. 150 to 23rd Street New York.
A. Larcher & Sons Refr. Co. 5909 Kennerly Ave. St. Louis Mo.

9471
Wrench + Tool Co
Cliffenbaugh Wrench + Tool Co
Paraboo, Wis.
Japan Tokyo.
Allan. Beichime
Kojimachi, Japan
Sahata #10

95.1

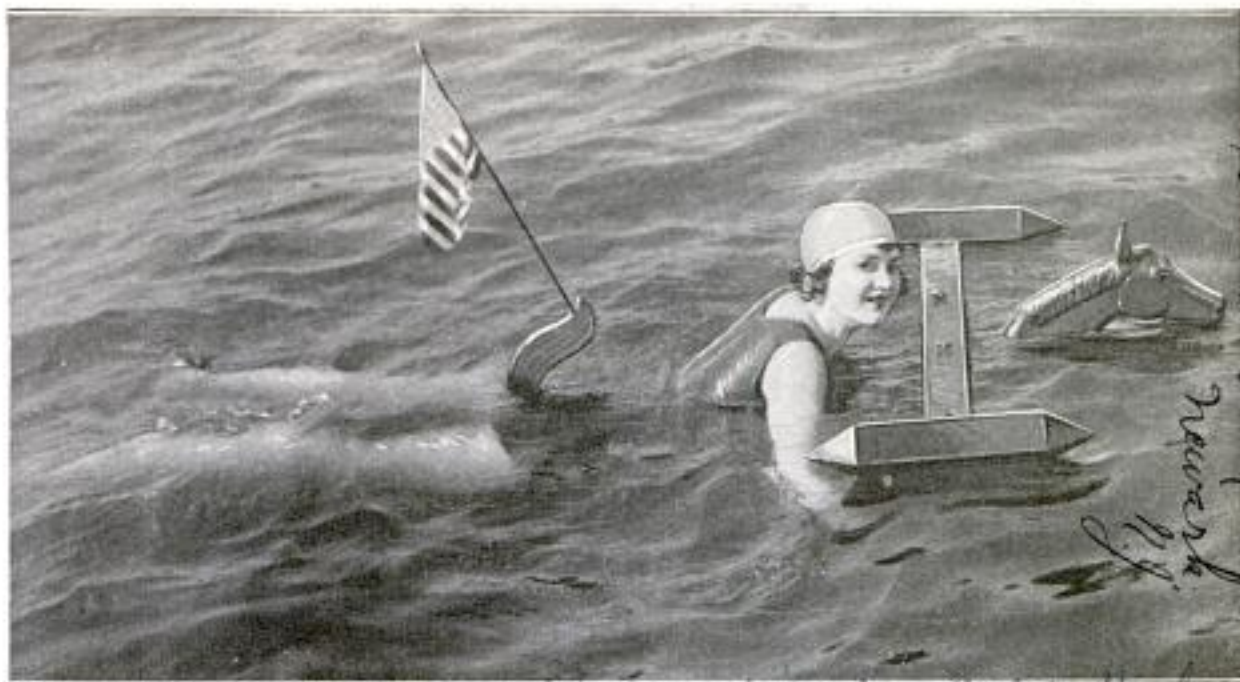

ms. of similar device
American Water Sport & Recreation Co.
New York City

Aboul. "SEA HORSE" IS LATEST PAD AT BATHING BEACHES
*Accessories made by Herbert
New York City*

RIDING "sea horses" is the latest fad introduced at the beaches at New York City, and the illustration shows one of the fair mermaids enjoying a "canter" through the surf. The novelty is constructed of light wood having strong buoyant qualities. Although originally designed as a means of teaching beginners to swim, the innovation has become exceedingly popular with feminine bathers who already have conquered the art.

9436

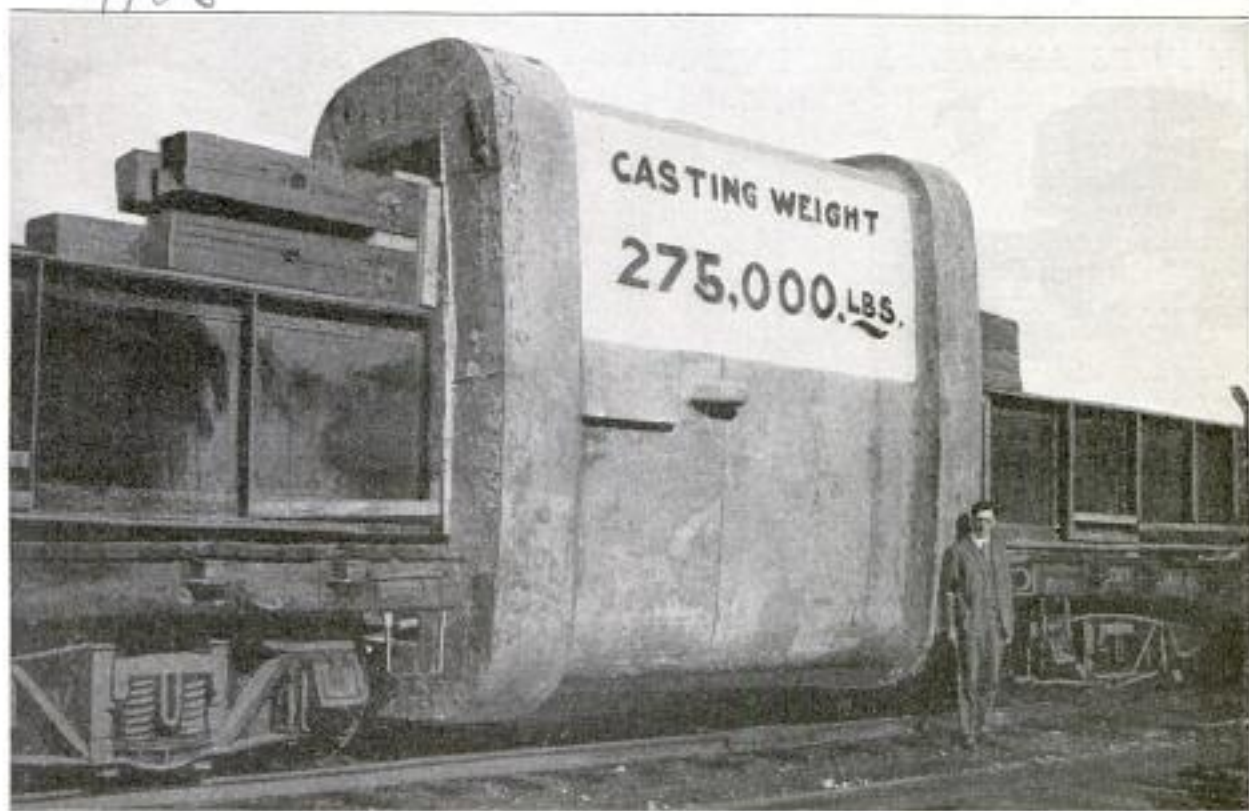

HUGE CASTING IS SHIPPED HANGING BETWEEN TWO CARS

WHEN the time came to ship a large ingot mold from a West Virginia foundry, special arrangements had to be made because of its great size and weight. By placing bridge girders, made for the purpose, inside the casting and allowing the ends of the girders to rest on two 75-ton-capacity cars, the casting was hung between the cars and shipped to its destination without mishap. A special train was required for the trip. The shipping weight of the casting was 275,000 pounds, and when it was made, it had to be left lying in the sand for eight days before it was cool enough to be removed. It took only four minutes to pour the molten metal when the casting was made, the iron being melted in six furnaces and poured from four ladles.

Send to Naval Ordnance
plant, Sand Charleston.

Wheeling Ingot & Foundry Co
Wheeling, W. Va. Copyrighted material

Draw. David Lorieve, Chicago Tribune
 2696 Ferry Park Ave. 6/26/22
 410 POPULAR MECHANICS

9626 **INSTRUMENT FOR DESCRIBING ANY KIND OF AN ELLIPSE**

For describing an ellipse of any shape within its scope, an instrument for the use of draftsmen or machinists has been

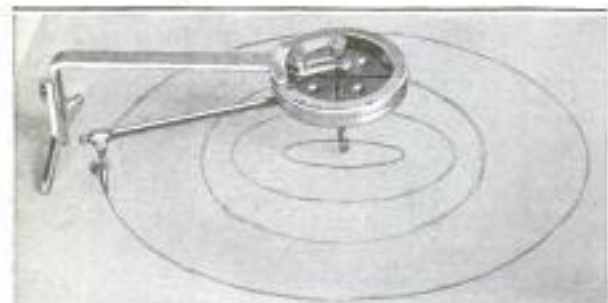

Instrument for Describing an Ellipse of Any Shape and at Any Desired Point: In Place of the Pen, a Pencil or Scriber may be Used

recently patented. By placing the center point of the instrument at the desired center of the ellipse and alining its supporting bracket parallel with the major axis, the scribing point may be adjusted to the required distance from the center, and will then draw an accurate ellipse. An ordinary drafting pen, a pencil, or a scriber may be used with the instrument.

9600 **ARMY'S AERIAL "BUS" BUILT LIKE FOREIGN PLANES**

The Army Air Service at McCook Field, Ohio, recently added to its equipment a passenger-carrying monoplane designed and built by Fokker of the Netherlands Airplane Company. The plane has a cabin with a seating capacity for 10 persons, and is fashioned along the lines of the planes used in Europe on the air route from Berlin to Moscow. The wing spread is 78 feet, and the flying speed ranges from 41 to 95 miles per hour. The plane is powered by one standard Liberty engine, located in the very front of the fuselage. The pilot's cockpit is above and just behind the engine.



This Fokker Monoplane, Recently Delivered to the Army Air Service at McCook Field, Ohio, Seats 10 Passengers Comfortably and Has a Flying Speed of 41 to 95 Miles an Hour

Netherlands Airplane Co

9661 **AUTO-LOCKING DEVICE CAUSE OF FATAL ACCIDENT**

A recent fatal automobile accident in Wisconsin shows that one demand that should be made of any steering-wheel lock, is that it be inoperative except when intentionally locked. While two men were driving along a country road, a patent lock on the steering wheel became locked, making the car unmanageable. Before the brakes could be applied, the car crashed into a post and overturned, killing one of the occupants.

9602 **ATTRACTIVE NOVELTIES MADE FROM POLISHED COAL**

That coal—plain ordinary coal—can be used for making ornamental novelties has been shown by an eastern manufacturer. Match holders and ash trays have been machined from lumps of coal, and after having been polished and buffed, have the appearance of black glass. Two surpris-



This Ornamental Match Holder was Machined from a Solid Lump of Coal and Buffed to a High Polish

ing features of the articles are, that they may be handled freely without soiling the hands, and that they will stand nearly as much rough handling as though made of solid glass.

Those wishing further information on anything described in the editorial pages can obtain it by addressing Bureau of Information, Popular Mechanics, Chicago.

Mr. S. Longwood Fifth Ave. Arcaded Bldg. Pittsburgh, Pa.



Scene in a Rock-Salt Mine, Showing One of the Electric Drilling Machines Boring a Hole in the Salt: The Machine is Clamped to the Vertical Bar, and the Augerlike Steel is Fed Forward through the Center of the Electric Motor That Drives It

A VISIT TO A ROCK-SALT MINE

BY DAVID H. LEVINGSTON

Lake Charles La.

THERE'S a thrill in being lowered down through a black hole into the earth 600 feet. One becomes used to it, they say, but, believe me, not at once.

One morning recently, the big elevator lowered in the shaft at the salt mines on Avery Island, nine miles southeast of New Iberia, La., having on board a camera man, who was going down on a special assignment to try out a new light. With him were the superintendent of the salt mines, some of his office force, and the writer.

There are no preliminaries nor ceremony about the descent. The shaft is a very uninviting affair, and has an appearance of "come down if you wish; I'm not promising you anything." The elevator is not a handsome brass or steel-netted cage nor is there a boy in attendance. After all got on, it just went down.

The elevator consists of a suspended plat-

form, large and commodious. On that downward trip the trick is to stand as near the center as possible and remain still while the bottom gradually sinks from your feet. There's no handhold for the nervous, nor any place to lean against for those whose knees wilt.

When the elevator starts below there's no noise nor purring of a motor. A faint sound of dripping water reaches the ear occasionally, but it's imagination; there's no water. You suddenly feel yourself leaving, and instantly realize that you are going down a hole, made like a large, square, concrete smokestack, and then blackness comes—not mere darkness. You get a splendid definition of the word dark. Not a thing can be seen that even suggests light, and a strange feeling of absolute loneliness comes over you. You can't feel the presence of any but yourself and you wonder if all the origi-



The Rock Salt as It Appears after having been Broken Down by the Charges of Dynamite

nal party are still aboard. It's very quiet. There isn't much laughter nor talk; the others feel about the same way you do. All the jokes have been left up on the surface of the earth. Then in that black, downward drop there comes a rush of cool, salt air. One member aboard exclaimed, when he felt the weird change of temperature come up his legs, "My goodness! I believe my pants came off!" He had the correct sensation, all right.

But, when the bottom is reached, what a change! And what a surprise to find down there that the temperature is pleasant, standing around 72°. The atmosphere is as balmy as early summer. A cleaner spot could hardly be imagined. The long avenues, as I would call them, with their strings of electric lights hung on the walls, the arches spanning 60 feet overhead, form an inspiring and beautiful sight. On every hand there's salt and nothing but salt, rock salt, hard as flint, dry and warm. There is not the slightest suggestion of damp or chill.

Accustomed to the behavior of salt as we are in this southern climate, expecting it to drip and cause everything around it to be messy, one has constantly to remind himself that he is down in a solid rock of salt, with nearly 500 feet of the mineral above and 1,000 feet of it below. Tests have proved this bed of salt to have a depth of exactly 2,999 feet in places.

A minute or so after we landed at the foot of the shaft, there came a rumbling noise as of distant thunder. It seemed

to roll on and on, reverberating down the long corridors, in and out of those tall arches, sometimes increasing in its growl, then diminishing as it entered one of the lower-roofed cavities. It was not a noise that would fill anyone with dismay, fear, or anxiety, but something that seemed, in a way, to be expected in this strange underground cavern. It was all so new and different that it thrilled one with a pleasing satisfaction of having entered upon an adventure worth while. No questions were asked. The natural supposition was that the summerlike thunderstorm had been caused by a blast away back in one of those dark channels.

The camera man wanted to "shoot" a scene showing how the salt was torn from its bed. This led the party down one of those long avenues, with the small lights strung alongside, just as though they were so many tiny street lamps, and the tall arch glittering overhead. A narrow-gauge railroad ran down the center, reminding one of a miniature street-car line, laid flat in the hard, dry salt that crushed under the foot.

About halfway down this aisle, one of the party remarked, "Gee whiz! Let's go back; I can't breathe."

"That's just imagination," the superintendent said, laughing.

The party marched on toward a strong light in the distance which foretold of some operation going on. At the spot, there was a crew of men drilling, with



The Broken Salt is Loaded into Small Cars Which are Drawn to the Bottom of the Shaft and are Then Raised in the Cage to the Surface of the Ground



Where the Salt has been Recently Blasted, the Surface Is a Glittering, Silver-White Mass. At This Point, a Drill Operated by Compressed Air is being Used to Make the Holes That will Receive the Charges of Dynamite for Breaking Down the Salt

long steel drills driven by electricity, into the solid rock. They bored deep holes into the sides for the charges of dynamite, and overhead to test if any loose salt from the last blast remained. Every measure for safety is observed before another blast is set off. A million and a half tons of salt have been mined to date, and no accidents, caused by lack of precaution, have happened.

Then they guided us to another of those long lanes, perhaps 50 feet across and 50 to 60 high. We were taken to a spot that showed the loading of the shattered salt after the dynamite had done its work. They load the small cars with a shovel that is driven by electricity instead of steam. That's one wonderful thing about the operation of these salt mines. Everything below is controlled by electricity; the large wires lie harmlessly at your feet everywhere, running over the dry pebbles and chips of bonedry salt. The shovel operates on a continuous-tread base and walks around the mines at the will of its driver, swinging easily from side to side, noiseless—no smoke, no ashes, no dirt.

Where the salt is blasted away, the walls are silver-white and glitter like millions of diamonds. The beauty is amaz-

ing. The salt falls off sometimes in perfectly square layers, measuring from one to three or four inches thick, and is transparent. One cake, measuring just about an inch thick, was so clear one could read through it. The old walls become a little discolored in time, because there is some trifling condensation during the summer months, but they are not black and there's no dirt nor dust down there—and no mosquitoes!

Mules are used to haul the cars to a central point where they are picked up by electric cars. The crew worked hard and fast to load their cars, and then a small, fat mule was brought forward, attached to the front car, and told to pull away. Just as the nervous animal started off, the camera man signaled for the touching off of the light.

It came on ablaze!
The mule, having been down in those mines longer than we, knew that no sudden light could be natural, and when the flash came, he made a noise that sounded much like stepping on a ripe tomato. He turned right around and started for the rear to hide behind the train, and we caught a view of his retreat.

The men arranged the loading of three cars on the elevator. From away off,

some place in those dark lanes, the small train could be heard approaching over its steel rails. Echoes came from everywhere of the rumbling and bumping cars. Soon, from around the corner of one of the large columns of the immense lobby, a trolley pole was seen flashing sparks from the wire, pushing its loaded train. The cars went up, and, as they left, the camera man cranked his machine. A moment later the rattling noise of the auto-

matic machinery, in the rear of the shaft, that takes care of the "empties," could be heard, and, by the way, this is the only noise-making machinery in the mines.

A few minutes later we were again on the surface and in the midst of a cold drizzle that had been coming down in New Iberia and the island for a solid week. It was quite a change and rather disagreeable compared with the snug, warm atmosphere 600 feet below.

FEAST OF THE FLYING FISH JAPANESE BOY DAY

BY A. G. CLUTTERBUCK

ON the fifth day of the fifth month of each year, in Japan and among the Japanese in foreign countries is celebrated the Tango-No-Sekku, or the Feast of the Flying Fish, known to the white people as Japanese Boy Day. Swaying in the wind and flirting their tails gaily, thousands upon thousands of paper and cotton fish, resplendent in flesh pink and vermilion, fly from myriads of poles, from clotheslines, and from roof tops. They are of all sizes from 2 to about 5 or 6 feet long.

Tango-No-Sekku is a big feast with the Japanese—especially the Japanese



These Gaudy Paper Fish Are Only Some of Thousands That are Flown in Japan on May 5 Each Year, to Celebrate Tango-No-Sekku, or Japanese Boy Day

boys. To them May 5 is set aside as an occasion of honor to the first-born of every family, and to Japanese boys in general. The flying fish are but a small part of the feast, for besides that, there are presents and gifts of images, toys, statuettes, and manikins of Japanese legendary heroes, all given with the idea of teaching the youngsters lessons of courage and manliness. It is a kind of Christmas season for the Japanese youth.

Sometimes the number of fish on the pole indicates the number of males born in the house, and sometimes it indicates the number of friends the family has. It

is customary to present a paper fish to the Japanese family to which a boy has been born since the previous festival.

The living rooms of all homes having male heirs are specially decorated for the occasion. Out from heavy wooden chests, where they have been hidden until that day, come the toys and gifts. Flowers are used in profusion.

There is nothing of a formal nature in the festival. The boys spend the afternoon visiting one another and comparing their gifts, and many picnics are held. Special foods are served at the Feast of the Flying Fish. One is the chimaki, which is composed of beans and red rice wrapped in lily leaves. Another is the kashiwa mochi, a rice cake wrapped in oak leaves—the oak leaves being a symbol of strength and endurance.

Games played by the boys on that day differ from those of other days. The lads arm themselves with shobu leaves, and with these long swordlike blades they have exciting battles.

The principal toys given usually take the form of images or manikins which represent famous characters of Japanese history. The chief of these is Jimmu Tenno, the first mortal emperor of Japan, and direct descendant of the sun goddess. Benkei, a sacred bull, is the second favorite. The third favorite is Kato Kiyomasa, the son of a blacksmith, who commanded an army sent to invade Korea in 1592. He is celebrated because of his feats of strength and daring. Another hero, also a favorite with the boys, is Kintaro. In appearance he is a nude little fellow, not unlike Cupid. He is a fabled strong boy who lived in a mountain cave years ago.

The carp is the patron fish of the Japanese boy, and is a symbol of strength, being the only fish that can swim against the swift currents of the mountain streams of the island empire.

Emt. A. G. Clutterbuck U. S. A.
Kawai, S. H.

9474



This Power-Driven Scraper Scoops the Gravel from the Bank and Delivers It to the Elevator Which Carries It to the Storage Bin, and from There It Goes to the Waiting Railroad Cars

9474

DEMAND FOR GRAVEL MAKES WASTE LAND VALUABLE

The road-building era is responsible for many new developments, and among other things, it is turning a lot of the nation's waste places into wealth. Rock bluffs have become quarries to supply the crushed stone for concrete paving. Gravel banks that have been considered of practically no value now suddenly have become little gold mines for their owners. An example is the big gravel bed at Prairie du Chien, which Wisconsin road builders are now utilizing. A big stretch of high bank along the Mississippi, so gravelly that it has not even been good for pasture land, let alone for farming, has become of high value, because the gravel there is classed one of the finest in the country. Big power-driven scrapers are scooping out the gravel and delivering it to elevators that drop it into railway cars ready to be shipped to places where road building is in operation. The "poor land" of so many years has become "rich land."

For the use of the city-planning committee of New Orleans, La., an aerial map of the city is to be made. The photographs will be taken from an elevation of 8,000 feet, a special camera being used. Two previous attempts to make such a map have failed due to adverse weather.

COMBINED AUTO STEP PLATE AND SUITCASE CARRIER

9575 A combined aluminum step plate and suitcase carrier, which is attached to the running board of a car by four screws, has just been placed on the market. The tread of the step is hinged, so that part of it can be raised, a strap passed through



Combined Auto Step and Carrier as It Appears When Mounted on the Running Board of a Machine and Holding a Suitcase

a special opening, and the suitcase or traveling bag held securely on the running board, while the machine is traveling at high speed or over rough roads.

McGregor, Iowa
Brinch Mfg. Co.

Chas. E. Es. Kingon,

416 *eras* POPULAR MECHANICS

Valley Calif
TREATMENT FOR ROOT FUNGUS
TO SAVE CITRUS TREES

963

Heroic treatment is sometimes necessary to save orange and lemon trees that have been attacked by root-fungus dis-



This Lemon Tree is Supported with Braces, and has Had Its Trunk and Remaining Roots Treated to Kill the Root-Fungus Germs

cases. In some cases, the taproot and lateral roots must be cut away to such an extent that the tree must be supported by staging and braces. The affected portions of the remaining trunk and roots are then thoroughly scraped and treated with powerful solutions to kill the fungus germs.

SOLID CORE WALL PREVENTS UNDERMINING OF LEVEE

969

The failure of protecting levees along rivers subject to excessive high water, has been traced, in some cases, to the activity of crayfish and other borers that burrow into the embankment and open

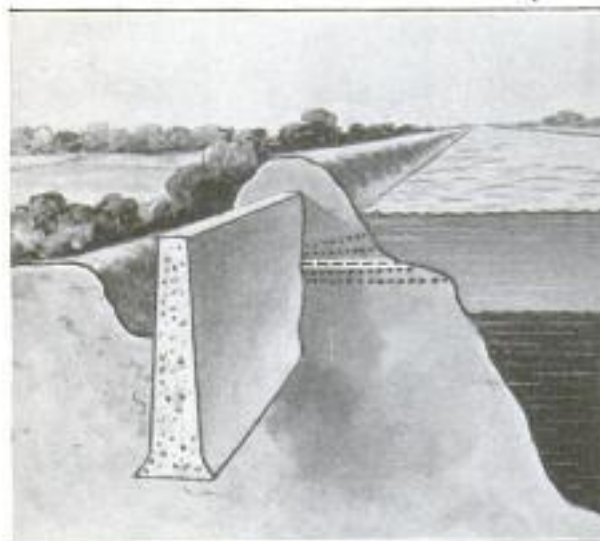

The Concrete Core Wall in This Levee Prevents the Borers from Opening Channels through Which the Water might Pass

Capt. Hugh Watson,
New Orleans, La.

channels through which the water may pass. To guard against this difficulty, a levee has been designed with a concrete core wall extending well below the bed of the river and reaching almost to the top of the levee. This wall stops the progress of the borers and prevents the undermining of the levee by water passing along porous strata of ground.

"ROMAN CHARIOTS" ARE MADE FROM WINE BARRELS

9542

Burlesquing the ancient Roman chariot races, members of a western motorcycle club entertained the spectators at one of their recent gatherings with an exhibition of extraordinary riding. The "chariots" were constructed of wine barrels which were cut obliquely in two, each half providing the body for one equipage. Automobile wheels were then mounted on the strange bodies, and to heighten the ef-



One of the Outfits Which Furnished Entertainment in the Burlesque Roman-Chariot Races Conducted by a Motorcycle Club

fect, the "charioteers" donned costumes reminiscent of the old Roman days. Hitched behind motorcycles, the chariots were towed at high speed around the arena, affording genuine excitement.

9729
WOOLENS MADE MOTH-PROOF BY NEW GERMAN PRODUCT

Of special interest to manufacturers of woolen goods is an announcement that a concern in Germany has placed on the market a product that makes wool immune to the attacks of moths. By its use, cleaners and dyers can give their goods, at a small additional cost, a moth-proof finish, and all woolen fabrics can be successfully treated. The goods are immersed in a cold solution of the product, and afterward rinsed,

Indian *cont.* Journal
April Copyrighted material

Calif.
Utahland
Idaho
Wyoming
Mont.
Wash.
Ariz.
Calif.
Tex.
Okla.
Ind.
Ill.
Mich.
Pa.
N.Y.
Conn.
Mass.
Vt.
N.H.
Me.
Wis.
Ohio
Mo.
Ark.
La.
Miss.
Ala.
Fla.
Georgia
South Carolina
North Carolina
Virginia
West Virginia
Del.
Maryland
D.C.

REMOTE-CONTROL BOOTHS FOR ARLINGTON STATION

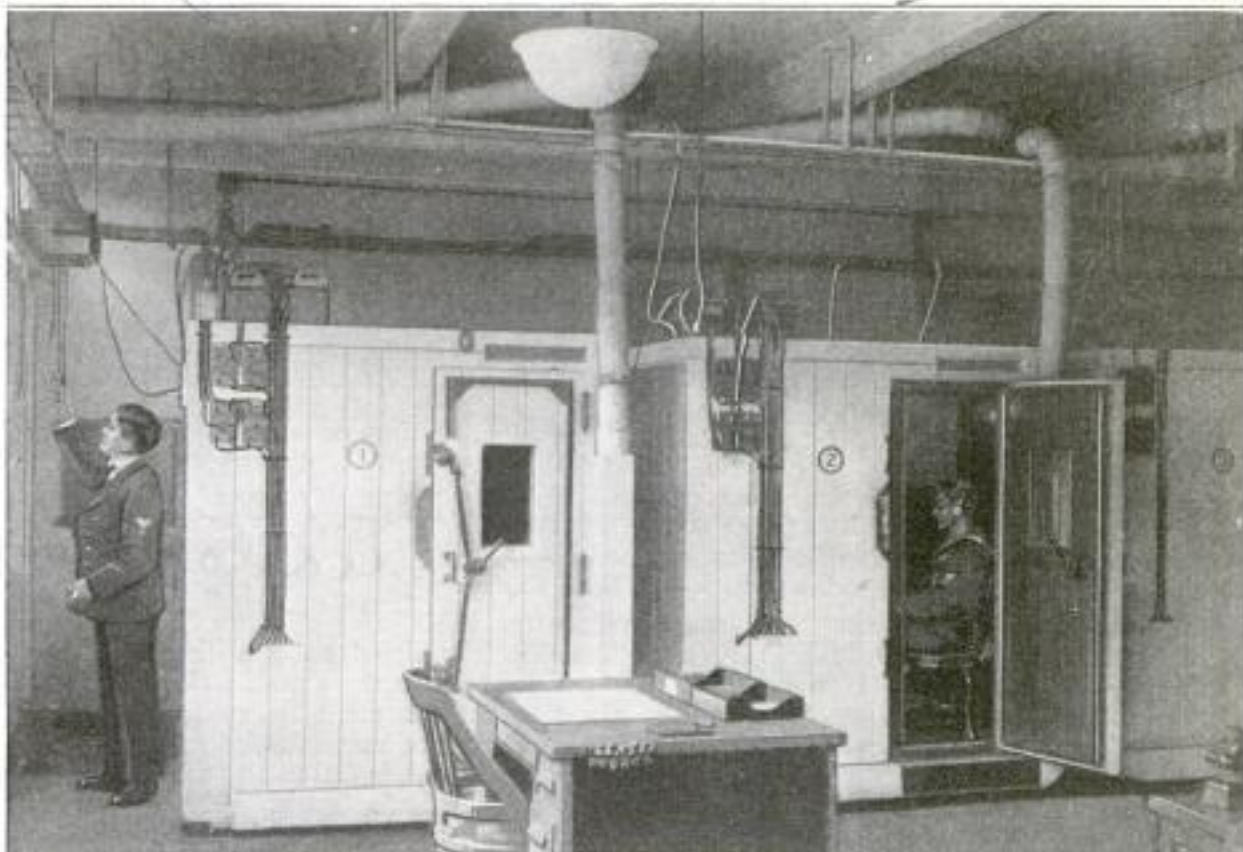

These Are the Remote-Control Booths for the Arlington Radio Station: They Have Double Walls to Make Them Soundproof, with a Grounded Copper Screen between the Walls to Absorb Stray Induction from Outside Electric Circuits. At the Extreme Left Are the Antenna Switches

Situated in the coastal radio room of the Navy Department Building, at Washington, are two small booths from which the transmitting apparatus of the famous Arlington radio plant, four miles away, is manipulated by remote control. An ordinary telegraph circuit is used between the control station and the sending station, and pressing a key in one of the control booths automatically sends the dots and dashes from the Arlington antenna.

Each of the control booths resembles, in general appearance, a refrigerator, and the construction is, in many respects, quite similar. The booth has double walls, with a copper screen between them, and completely surrounding the booth. The screening is grounded and serves to absorb any stray induction from outside electric wires and motors. The booths are of soundproof construction and are ventilated by fresh air drawn through large pipes from outside the building.

The batteries for the receiving apparatus are placed above the booths. There are two sets of batteries for each, and they are so connected that, while one set is in use, the other is being recharged.

Above the transmitting station at Arlington there are several antennae that radiate from a central tower, like the spokes of a wheel. The switches that make the connection with these antennae are located in the remote-control office. They are so arranged that when an operator wishes to tune in for any distant station, he selects the antenna that most nearly points toward that station, and throws in the proper switch. It is possible to work with any one of the antennae in either booth.

9746
EXPECT TO BUILD HUGE STEEL-MAKING PLANT IN INDIA

Plans are already well under way for the erection of a large-capacity iron and steel works and rolling mill in India. The plans call for the use of the most modern improvements and labor-saving devices. Iron ore of high quality, suitable fluxes, and excellent coking coal occur close together, and in large quantities. This condition, in connection with the low-priced labor available in India, should contribute to the production of steel at a remarkably low figure.

Indian For-life
 Journal 1/1922

England
 Sheffield,
 Laird & Co,
 17% Cannon, India
 Calcutta.
 United Steel Corporation of India Ltd
 % Bird & Co,

9612 d.w. J. W. Dowell, Dallas, Texas

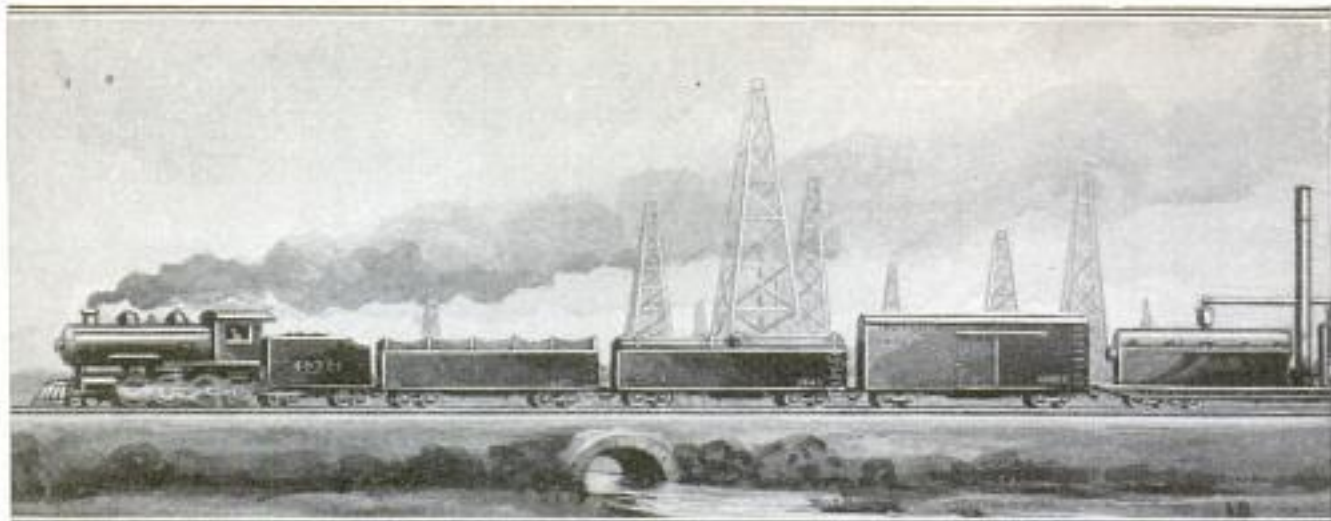

The Portable Oil Refinery as It will Appear When Moving to a New Oil Field: The Different Units are Built on Special Cars for the Operators. The Capacity of the

PORTABLE REFINERY FOR USE IN NEW OIL FIELDS

BY CURTIS VINSON,

*Dallas News
Texas*

A CRUDE-OIL refinery that moves on wheels from one field to another is the recent invention of an oil man of Dallas, Tex. The inventor has been in the business for years, being associated in the industry with his three brothers. Application for patent rights on the new invention has been made jointly by the four brothers.

The portable refinery is designed to meet the needs of new oil fields where pipe-line facilities are lacking. It will supply the pioneer producers with a mar-

ket for their oil while the big companies are laying lines to the field and independent refiners are building plants. Units of the portable refinery are built on specially constructed steel flat cars, 65 feet long and built to carry loads of 110,000 pounds each. These cars are mounted on six-wheel trucks and are specially constructed and insulated.

The first refinery of this type is now being built at East Chicago, Ind. This particular plant has three stills, with an estimated daily capacity of 4,000 barrels.

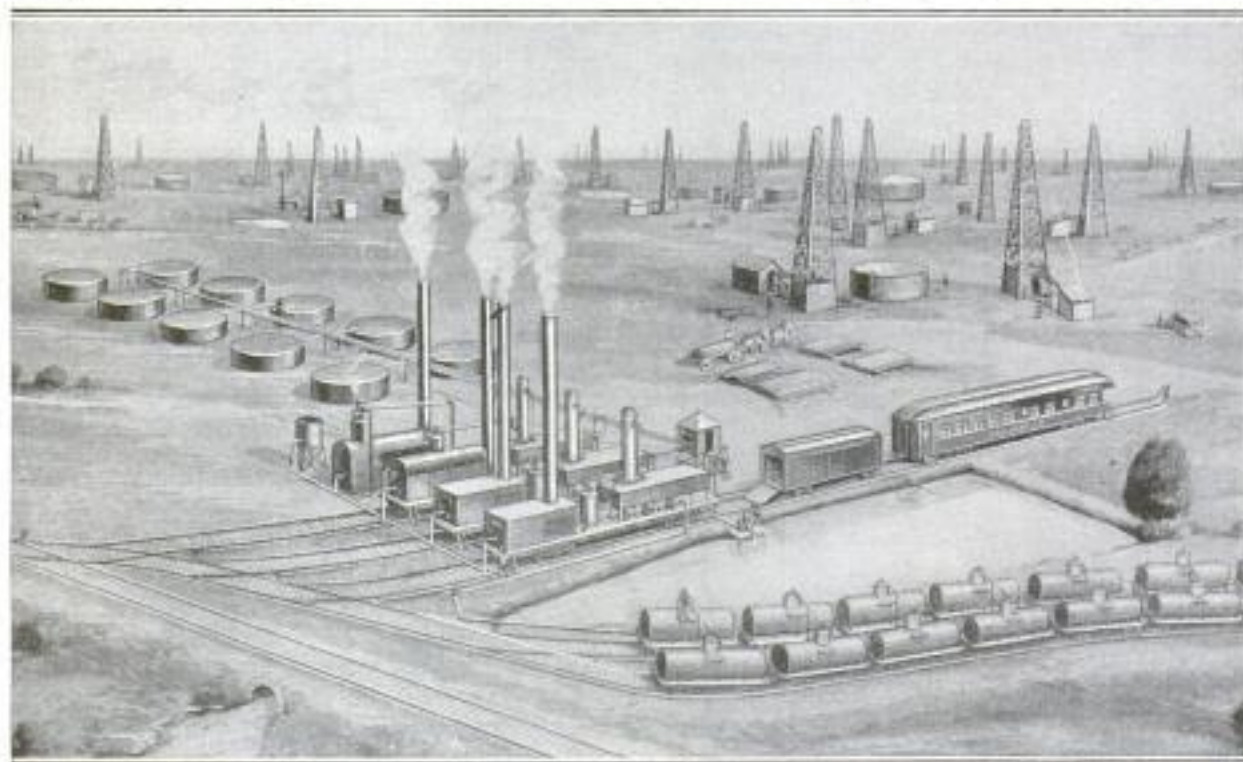

After Arriving at the New Oil Field, the Cars Carrying the Stills are Run on Parallel Switch Tracks and Connected Up, and the Refinery Is Ready for Business

9612

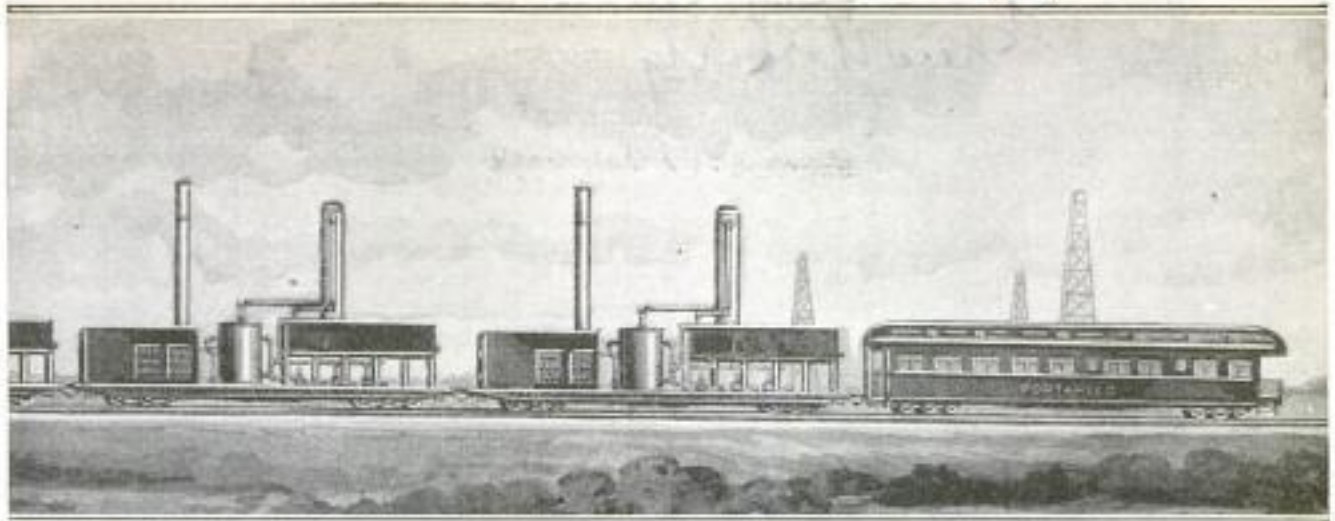

cial Flat Cars, and There Are Also Tool and Equipment Cars in Addition to an Office Car Arranged to Provide Living Refinery may be Easily Increased by Adding More Units

Each car is a separate unit, and plants of this type can be built to any required capacity by adding more units. In addition to the cars carrying the stills, the plant includes a tool car, and an office car, which latter is equipped with sleeping and dining quarters for the men who will operate the plant. A standard 60-horsepower boiler is used for supplying power to the plant when it is in operation. When set up in the oil fields, the stills are run on parallel switch tracks

and are then connected, and the work of extracting gasoline, kerosene, and other petroleum products begins. It is estimated that such a plant can begin operations in a new field within 10 or 15 days after oil is first found. When its activity in one field is finished, it can be readily moved to another field, thus eliminating the loss sustained by stationary refineries when they are forced to close down because of the exhaustion of the oil supply.

9644
PRIVATE WIRELESS STATION OWNED BY EIGHT FIRMS

Eight business firms of Minneapolis have decided to cooperate in the erection of one of the largest privately owned radio stations in the world, according to recently announced plans from that city. The broadcasting station will have a 500-watt transmitter and the biggest antenna to be found in the northwestern part of this country. An elaborate studio for the entertainers, connected to the broadcasting station by means of the usual microphone and cables, will also be included in the project.

9550
HEEL-PEDAL CONTROL PLACED ON ELECTRIC AUTOS

Heel pedals placed close to the front of the driver's seat are the latest addition to up-to-date electrical coupés, and were demonstrated at the recent auto show in New York City. By simply shifting the foot, which is usually kept on the forward control, to the heel pedal, the car is thrown in reverse without any danger of stripping the gears, thus making it a comparatively easy matter for an inexperienced driver to handle a car correctly.



COPYRIGHT, UNDERWOOD & UNDERWOOD

Electric Coupé with Door Open Showing, Close to the Seat, the Heel Pedal Which Reverses the Car without Shifting Any Gears, Thus Eliminating the Possibility of Stripping Them

Encl. George Smedal
360 6 Bearfield Ave
Minneapolis, Minn.

no data re number
Copyrighted material

The Harwin Machine Co.
Spring + Vanck St.
New York City
 420 POPULAR MECHANICS

9630
**INTERNAL-GRINDING MACHINE
 FOR QUANTITY PRODUCTION**

For the rapid and accurate grinding of straight, round holes of from 1 inch to 4 inches in diameter up to 4 inches deep, an internal grinder of original design has recently been placed on the market. Its outstanding

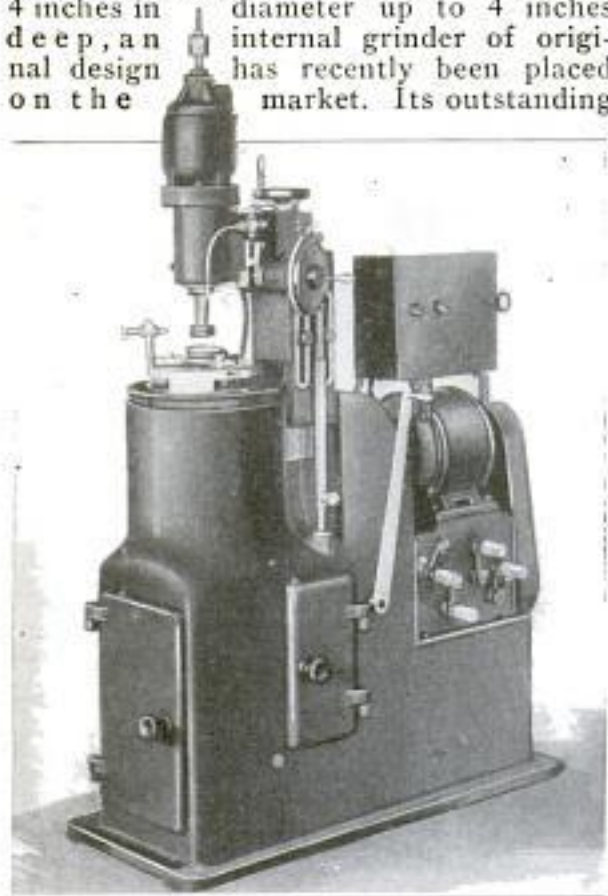

Internal Grinder for the Accurate Grinding of Straight, Round Holes on a Production Basis

feature is the revolving and reciprocating of the work-carrying spindle in one

bearing, thus eliminating the necessity of its exact alinement with other essential parts of the machine. The work spindle as well as the grinding-wheel spindle are vertical, and the latter, which is uppermost, is directly driven by a motor having variable speeds of from 7,500 to 12,000 revolutions per minute. A separate motor at the rear of the machine drives the work and the feed mechanism, which are under control of speed and stroke-change handles. The operating control of the machine by a hand lever is very simple, a single movement forward or backward throwing the machine into its work position or out of it. The machine occupies a floor space of 20 by 45 inches, and weighs 1,250 pounds.

9593 — *Germanis*
**GIANT HANGAR FOR AIRSHIP
 COMPLETED IN TEXAS**

The huge airship hangar at Brooks Field, Tex., has just been completed, but is without a tenant. The structure was intended for the ill-fated "Roma" that was destroyed in February of this year. The building has a clear height of 125 feet, and is 450 feet long by 125 feet wide at the base. Each of the sliding doors weighs 360 tons, and is supported on two six-wheeled trucks. A five-horsepower motor is used for opening and closing each door. The sides of the building are of corrugated asbestos with three rows of wire-ribbed glass panes for lighting. The roof is of gypsum base, covered with felt laid in asphalt. A solid concrete floor extends under the entire building.

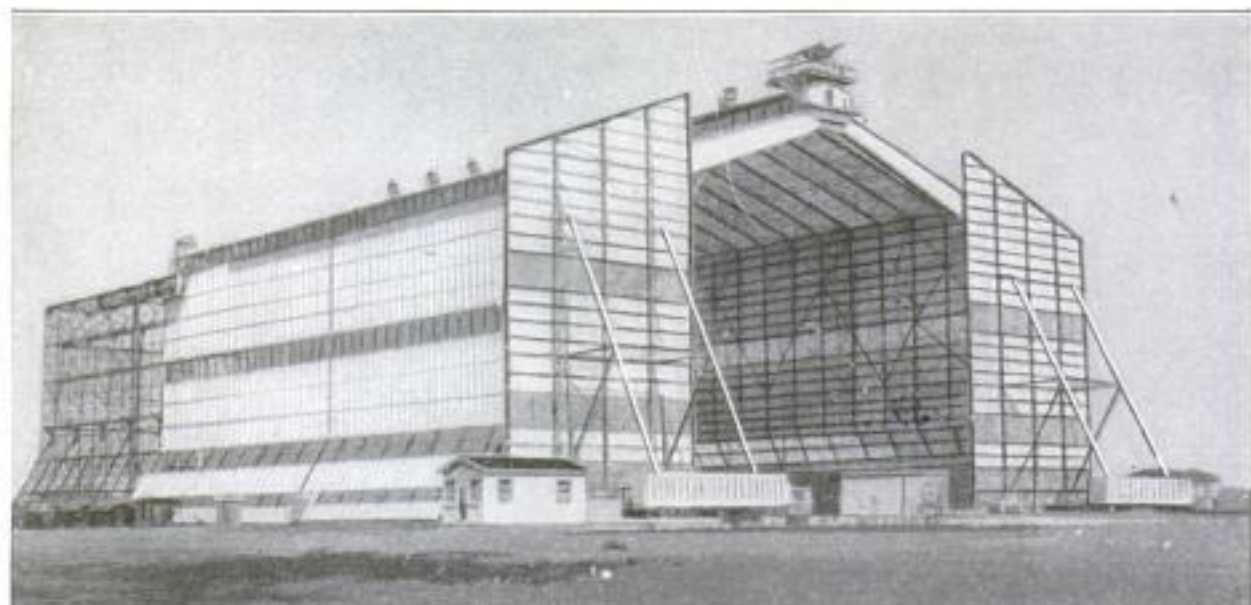

This Great Airship Hangar at Brooks Field, Texas, was Intended to House the Ill-Fated "Roma." The Building Is of the Most Approved Construction, and Has a Clear Height of 125 Feet

Emb. Miss. Hanora Vought, 528 E.
Essex St.
San Antonio, Texas
 Copyrighted material

9476



One of the Fireproof Dormitory Buildings of New York State's Great New Hospital: The Building Is of Brick, Steel, and Concrete Construction. Even the Floors Being of Concrete Covered with Linoleum. Large Airy Rooms, Wards, and Broad Screened Porches are Provided for the Patients

BUILDING A \$10,000,000 HOSPITAL

BY CHARLES MARTEL NILES, *Oriskany, N.Y.*

ONE of the largest and best equipped hospitals in the world is now under construction at Marcy, N. Y. The institution stands on a plateau overlooking the beautiful Mohawk Valley. It will be a city in itself, with its own water-supply system, power plant, streets, and sewers. This great hospital, which the state of New York is building at a cost of \$10,000,000, will accommodate from 3,000 to 5,000 patients, in addition to physicians, nurses, and other employes. Free treatment will be given to men and women who suffer from mental and nervous troubles.

Everything has been planned to promote the health, safety, and comfort of the patients in the most efficient and economical manner. The institution will comprise 48 different buildings, some of which will be connected by inclosed passageways. The three principal hospital units are of imposing size and massive construction. The main building, where the most severe cases will be treated, stands in the center of the group, flanked on the east by an immense dormitory for chronic male patients, and on the west by a similar building for chronic female patients. Behind each of the "chronic" buildings will stand a semicircular group of six "cottages," each of which will house 100 patients. There will be a separate dining hall for every three cottages. Food will be prepared in a large central kitchen.

In the rear of the main building will stand a large assembly hall for lectures and entertainments. The institution will

have a fully equipped laundry. There will be a nurses' home, and a home for the other employes. Two large shops will furnish occupation for the hands and minds of patients who are well enough to work. Separate dwellings will be erected for the superintendent, chief engineer, and steward. The mammoth power plant will be located in the rear of the other buildings, near a convenient railroad siding.

The hospital grounds cover more than a square mile and include a fine farm, which will supply fruits, vegetables, eggs, poultry, pork, and dairy products. Macadam roads and concrete walks will traverse the grounds.

All buildings will be constructed of brick, steel, and concrete, absolutely fireproof. Roofs will be of slate or tin. The main and chronic buildings will be three stories in height and measure 100 by 300 feet on the ground. They will contain large, airy, well-lighted wards, as well as cheery and comfortable private rooms. Each building will be provided with living quarters for the attendants, and an apartment for the resident physician. The floors will be of concrete, covered with linoleum. All heating and plumbing fixtures will be hung from the walls, leaving the floors unobstructed. Broad screened porches will adorn the front of the principal buildings, making a safe place for the patients to enjoy fresh air and sunshine.

An abundance of water will be procured close at hand. A massive concrete dam, 500 feet long and 40 feet high, has

marcy division, Utica State Hospital

9476

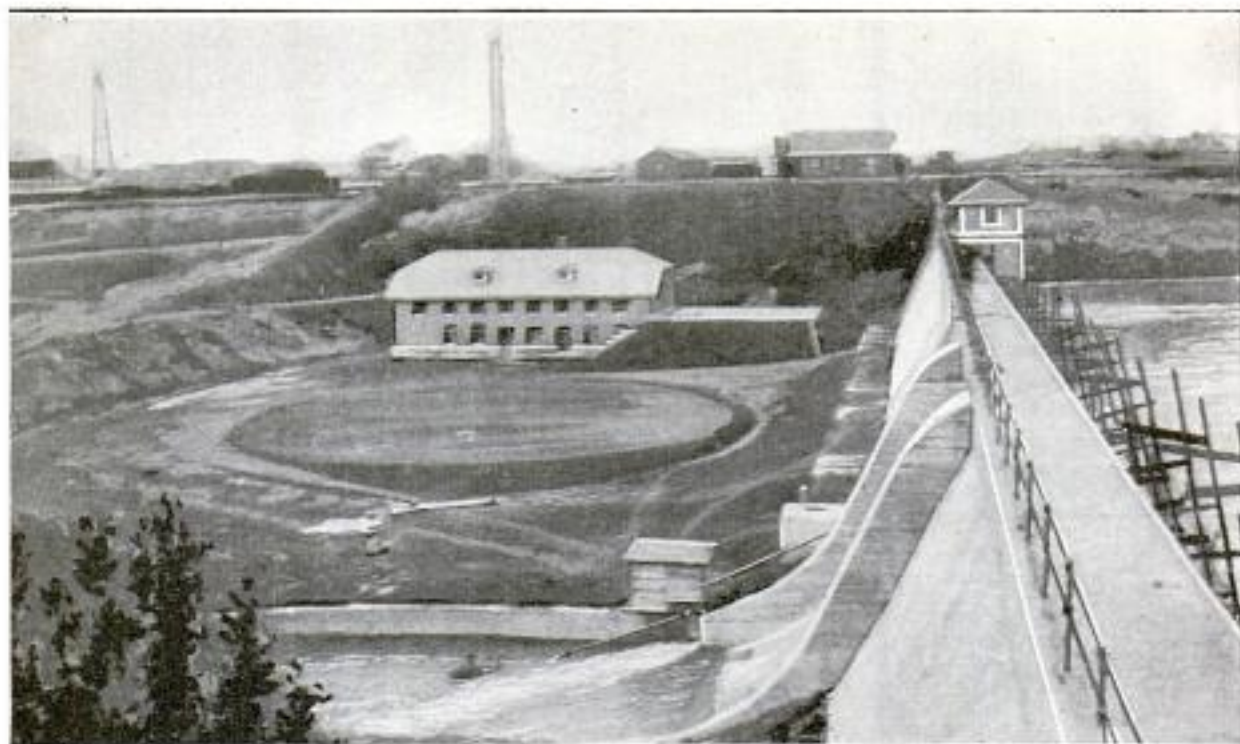

This Gives a Good Idea of the General Arrangement of the Institution's Water-Supply System; the Storage Reservoir Is at the Right with the Filter Beds and Pumping Plant in the Center. Powerful Pumps will Raise the Water to an Elevated Service Tank

been built across Crane Creek, which flows through the hospital grounds. The reservoir thus formed will impound about 45,000,000 gallons of water—three months' supply for the hospital. Before being used, all the water will pass through filter beds located in the gorge below the dam. Powerful pumps will lift the water to a tower tank, 160 feet above the highest point on the grounds. The tank has a capacity of 150,000 gallons.

The power plant will be a marvel of mechanical engineering. The big steel-

frame building will provide space for the installation of eight 500-horsepower watertube boilers. Coal will be dumped from railroad cars into a receiving hopper, from which a belt conveyor will carry it to the crusher. A bucket conveyor will elevate the coal from the crusher house to the top of the boiler room.

All the buildings of the institution will be heated from the power plant by means of a forced hot-water system. In addition, the power plant will be equipped with three dynamos having a combined

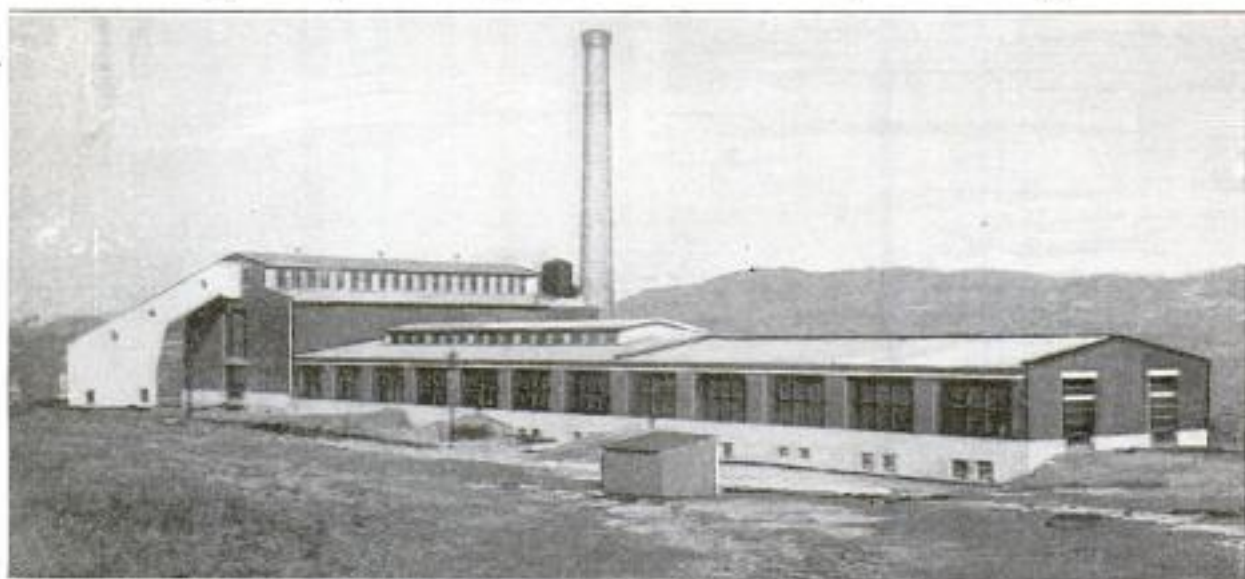

This Central Power Plant will Furnish the Big Hospital with Light, Heat, and Power. The Most Modern Mechanical Appliances will be Used for Handling the Coal and Ashes

capacity of 500 kilowatts. Power will be furnished for the refrigerating plant in the storehouse. Hot water for domestic uses will be piped from the power house to all buildings where it is needed. One end of the big building will be fitted as a machine shop and garage.

There will be over four miles of separate storm and sanitary sewers on the grounds. The sewage will be conducted to a disposal plant at the foot of the hill, where it will be treated by the most modern methods and converted into fertilizer as a source of saving or revenue.

The construction of this great institution has been in progress for over three years. At times the number of men employed exceeded 800. The present construction program will provide for the care of 3,000 patients, but the hospital can be expanded to accommodate 5,000 without much additional expense, as the principal service units have been designed with that object in view. The facilities and conveniences provided for the patients are almost innumerable. The Marcy Hospital will, indeed, be a splendid example of man's humanity to man.

9730

FLYING FISH FOUND TO HAVE BEST SOARING WINGS

By studying the wing structure of flying fish, a scientist, who is an authority on the flight of birds, has found that their wings are some four or five times as efficient, for soaring flight, as the wings of birds. He attributed this to the fact that the fin rays formed projected ridges on the under surface of the wings. By experimenting with models fashioned on similar lines, he found that the fin ray caused a sheltered area to appear back of the ray when the model moved through the air. His conclusion is that this sheltered area acts as a force to drive the wing ahead when soaring. It seems that the exact shape of the rear portion of the fin ray has little effect on the soaring ability. He also believes that atmospheric conditions largely govern soaring flight.

TWO METHODS TO PRESERVE DECAYING SANDSTONE

To preserve sandstone against decay, two methods have been suggested that have proved effective. If a piece of rotten sandstone is treated with certain chemical compounds of alcohol and silica and then exposed to moist air, the silica is deposited and forms a protective cement coating. Lime wash has also been found very effective for the same purpose.

9554

MODEL OF BRITISH FLAGSHIP ON AMERICAN AUTO TRUCK

In a recent naval parade in England, a well-known light American automobile, converted into a truck, was used to con-

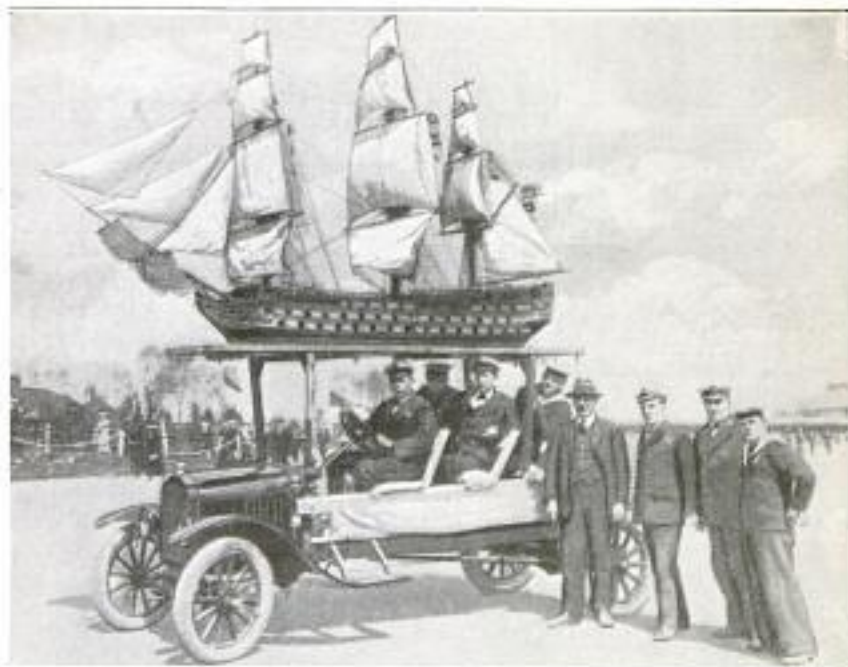

Full-Rigged Model of Lord Nelson's Famous Flagship "Victory," Conveyed by Auto Truck in a Naval Parade Recently Held in England

vey a model of Lord Nelson's famous flagship "Victory." The model was about the same length as the truck, and was supported by a platform above the heads of the passengers. It was a very complete reproduction of the ship, full-rigged, with sails set, and the flags flying that denoted Nelson's famous signal at the battle of Trafalgar, "England Expects That Every Man will Do His Duty."

The average time required by a ship to find its position by means of the present system of wireless telegraphy, is five minutes.

Christian Science Monitor 6/23/22

9469

The Engineer 6/16/22

*Col. William M. Myers
679 Bergen Ave
Jersey City, N.J.*

**STRONG SWIMMER TOWS BOAT
WITH SEVEN PASSENGERS**

9666 An English swimmer who is planning an attempt to swim the Channel, performs an unusual stunt, to show his power in



International
This English Swimmer, Who will Attempt to Swim the Channel, is Here Seen Towing a Small Boat Containing Seven Persons

the water and as a means of developing his endurance. Using a canvas harness and a short length of rope, he tows a small boat containing seven persons a distance of a mile. As a demonstration of strength and endurance the performance ranks high.

**SOUND MADE VISIBLE BY USE
OF RADIO VACUUM TUBE**

7737 One of the most remarkable developments growing out of the widespread interest in radiotelephony, is the construction of an apparatus for making sound vibrations visible. An adaptation of the vacuum tube is the basis of the new apparatus, and one of the most striking advantages is that it overcomes the lag occasioned by the mechanical inertia of devices formerly used for this purpose. The new tube is pear-shaped, about 8 inches long by 1 inch diameter at the socket end and 4 inches at the other end. The large end of the tube is covered with a fluorescent screen. The filament is about 1/4 inch long. Four platinum plates around the filament direct a beam against the fluorescent screen. The current fluctuations caused by sound vibrations cause this beam to move up and down the screen with great rapidity, and it is then possible to record these movements in the form of a moving-picture film.

9553
**TO EQUIP ALL FLYING FIELDS
WITH AERO AMBULANCES**

Because airplane ambulances have proved so efficient in transporting injured persons, the War Department has ordered all flying fields in the United States to be equipped with them. The type of ambulance chosen is the one that was shown and described in the November, 1920, issue of this magazine, at the time it was first tried out. There is room for two stretcher patients in the fuselage. The physician's cockpit is located just in front of this compartment, so that he can observe the patients at all times.

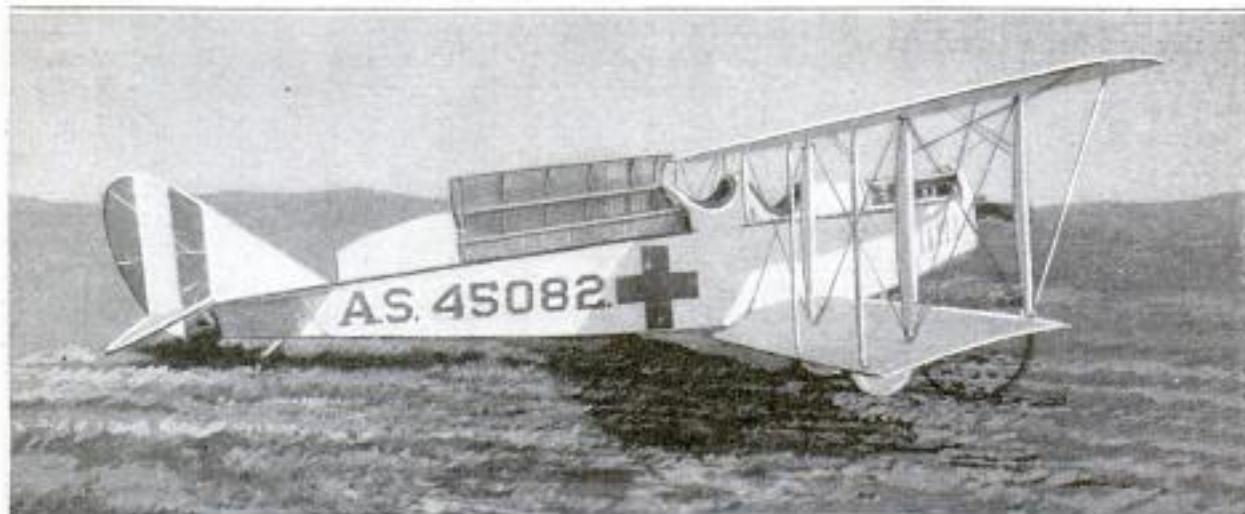

This Is the Type of Airplane Ambulance, with Room for Two Stretcher Patients, That has been Chosen by the War Department to be Used at All Flying Fields in the United States

*U.S. Army Air Service
Wilbur Wright Field Dayton, O.*

Copyrighted material

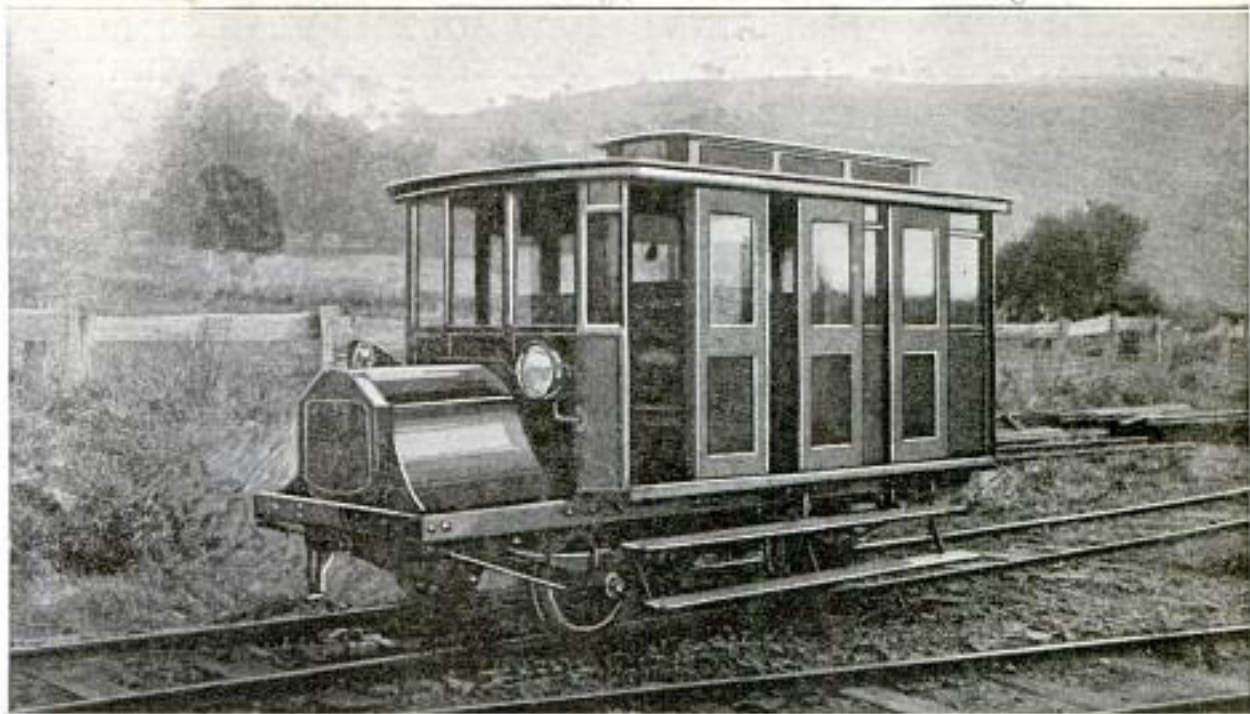

One of the Strange-Appearing Railway Cars That are to be Seen along the Rights of Way in Australia: These Conveyances, Which Resemble Oversize Toys, are Equipped with Special Gears to Enable Them to Climb Steep Grades with Ease

9510
**RAILWAY CARS IN AUSTRALIA
PRESENT STRANGE SIGHT**

Strange-appearing motor cars for handling passenger traffic are to be seen on some of the railways in Australia, one of these having a seating capacity of but 12 persons. Designed to negotiate steep grades, this odd conveyance, which is equipped with a 15-horsepower four-cylinder engine, chugs merrily along the right of way at the none too startling speed of 12 to 15 miles per hour.

9519
**FREE TELEPHONES INSTALLED
TO AID MOTORISTS**

No more will the distressed motorist in Pennsylvania be required to trudge wearily for miles back or ahead of his broken-down machine for the purpose of asking aid from the nearest garage. The Highway Emergency Service Company of that state has placed, at intervals of approximately one mile, telephones in special boxes which are mounted on poles at the roadside. These boxes are painted white, having in black lettering the distances in miles to the nearest towns, so that the traveler-tourist can see just where to call for help. Locks are placed on the boxes, the keys for which can be had by anyone at a small fee per year, or in the event of a stranger motoring through the state, a key can always be obtained at the house nearest to a box.

Harrisburg, Pa.

Long-distance calls can be made where the called party agrees to pay the charges, all other service being free within



Left: Close-Up of the Telephone Box, Showing the Lettering. Right: Box Shown Mounted on Pole at the Side of the Highway

the zone of the exchange making the connection.

Passengers in an automobile equipped with a concealed radio outfit, distinctly heard a musical concert and the returns of a prize fight while enjoying a ride along the boulevards of New York City recently. "Listening in" was accomplished with the usual head set and a loud-speaking horn, the absence of a visible antenna and ground being the principal features.

~~no information~~
as to maker.

Christian Science
Monitor - 6/22/22

426
9223

POPULAR MECHANICS
PORTABLE GRINDING MACHINE OPERATED BY ONE MAN
NEW HOUSING PLAN COMBINES LUXURY AND LOW RENTS

Ent. Es. C. P. Alfrey St. Louis, Mo.
Inventor

A portable grinding machine that can be handled by one man has an independ-

To relieve the housing shortage, and reduce the existing high rents in New

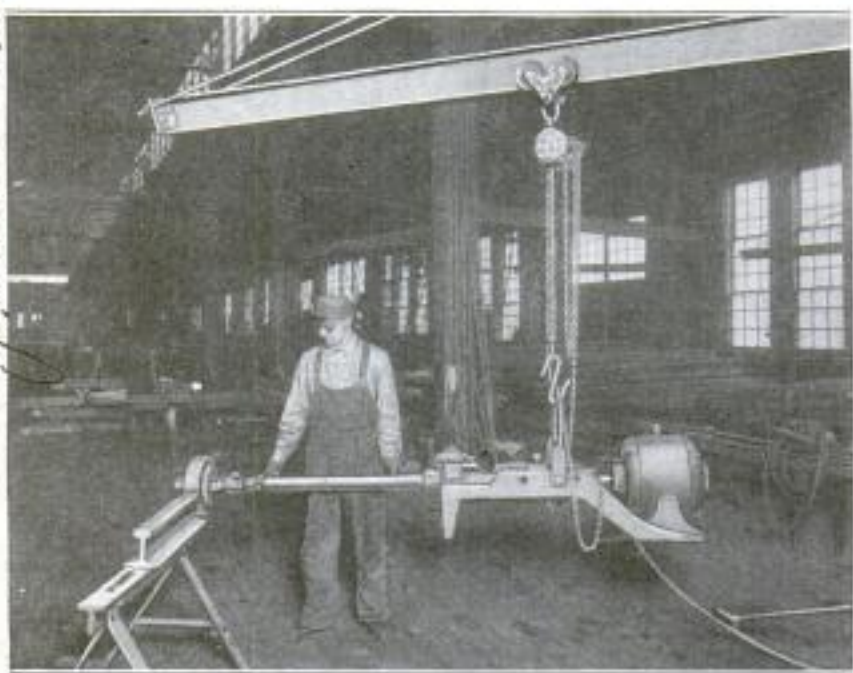

Portable Grinding Machine with Motor Attached, That can be Operated by One Man: It can be Moved and Used in Any Part of a Factory

York, a bill has recently been passed by the state legislature that permits insurance companies to invest up to 10 per cent of their assets in apartment-house construction. Taking advantage of this, the Metropolitan Life Insurance Company is about to erect three blocks of houses in Long Island City, and one in Astoria. The project is intended to combine beauty and comfort as well as economy. Each block of houses will have a large interior court, and every room will have an outside exposure. There will be interior gardens with a lawn common to all tenants. These first four blocks will house 1,950

ent motor at one end, and the grinding wheel at the other end, of a long horizontal frame. In connection with a trolley running on an overhead beam, is a block and tackle from which the grinder is suspended in balance, so that it can be raised or lowered, and swung into any position, thus proving a valuable and flexible arrangement for any factory.

families, in apartments of four, five, and six rooms and bath, and by the law the average rent of each room may not exceed \$9 a month.

There has recently been discovered near Dryden, Ontario, an extensive deposit of soapstone, which occurs on a low ridge only 500 feet from the railway.

9499

CLEVER WINDOW DISPLAYS FOR FISHING SEASON

Two clever window displays were shown recently by rival hardware merchants at Montrose, Colo., in advertising their camping and fishermen's supplies.

One was a representation of a mountain cabin made of spruce logs. In the cabin were the usual settings, including a stove, skillet, coffeepot, fishing supplies, camp stool, keg, and washbasin, firewood, hand ax, rubber boots, hunting knife, etc. On the walls were an alarm clock, a jumper, an old rifle, revolver with holster, dishpan and cloth, fish basket, deer-hide towel, and a calendar on which the opening day of the fishing season was circled with red crayon. A candle in a bottle was on a box near the stove, burned biscuits in a pan under the stove, a pan of nicely browned biscuits in the oven, and

eggshells, and other miscellaneous articles were strewn on the floor in a very realistic manner.

The other display showed a fishing scene along a mountain stream. In the distance were snow-capped mountain peaks, while the course of a mountain stream could be followed down a cañon, in which spruce and aspen trees were seen. An old cabin was visible through the trees, near a waterfall. In the foreground stood the effigy of a man with a fishing rod, in the act of pulling out a fine trout. The bank of the stream was strewn with sand and gravel.

The two displays created much attention and materially aided in stimulating the trade of the merchants who made them.

Lathrop Hardware Co., Montrose, Colo. Copyrighted

9499



Attractive Window Displays in Two Rival Hardware Stores at Montrose, Colorado, for Advertising Camping and Fishermen's Supplies: The One Above Represents a Log Cabin with All the Various Paraphernalia That Delight the Heart of a Camping Fisherman. That Below Shows a Fishing Scene at a Mountain Stream with Snow-Capped Peaks in the Distance



428
 9623

**GAS-FIRED MELTING FURNACE
 HAS THREE BURNERS**

For the smaller shops, a low-priced furnace for melting soft metals is now being



manufactured that has several noteworthy features. The removable cast-iron melting pot holds 150 pounds of metal, and is heated by three special gas burners. Each burner has a shut-off valve and pilot light, and no auxiliary blast or blower is required. Two burners develop sufficient heat for keeping the metal in a molten state. Regulators are provided that can be adjusted for different pressures or qualities of gas.

For the smaller shops, a low-priced furnace for melting soft metals is now being manufactured that has several noteworthy features. The removable cast-iron melting pot holds 150 pounds of metal, and is heated by three special gas burners. Each burner has a shut-off valve and pilot light, and no auxiliary blast or blower is required. Two burners develop sufficient heat for keeping the metal in a molten state. Regulators are provided that can be adjusted for different pressures or qualities of gas.

**OLD SHELLS FOUND USEFUL
 AT U. S. NAVAL STATION**

With partial naval disarmament assured, condemned shells are being put to a constructive use at many U. S. Naval Stations. At the Naval Proving Grounds, Indian Head, Md., 12-inch shells are

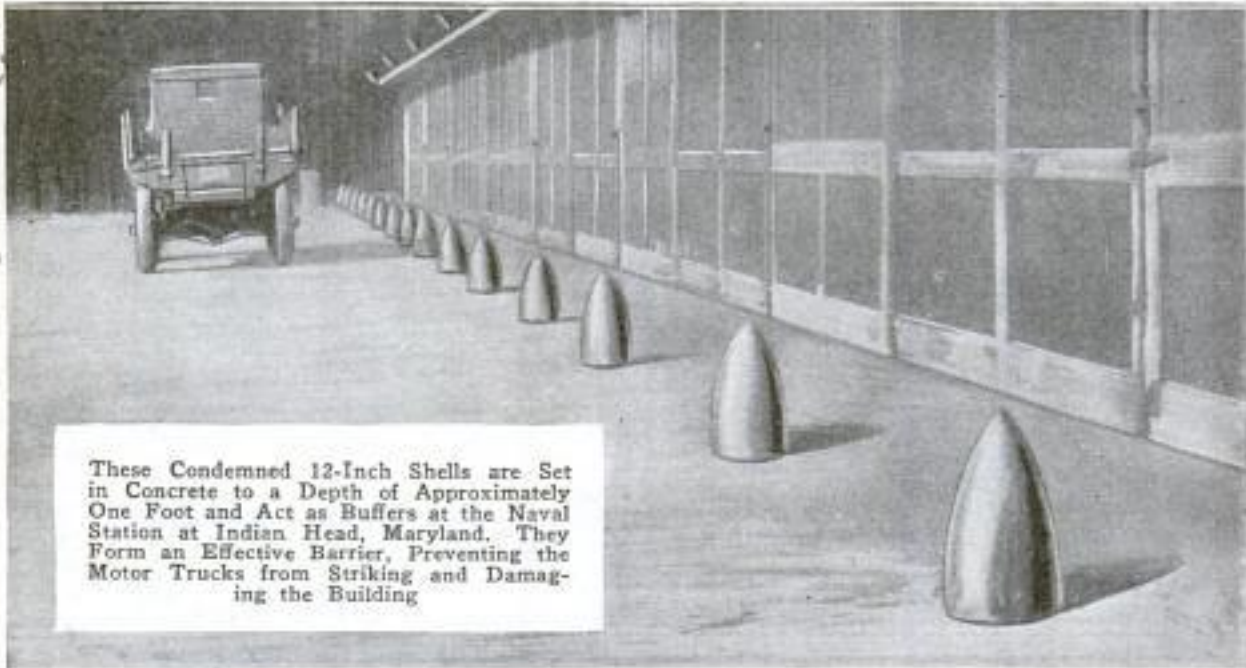

These Condemned 12-Inch Shells are Set in Concrete to a Depth of Approximately One Foot and Act as Buffers at the Naval Station at Indian Head, Maryland. They Form an Effective Barrier, Preventing the Motor Trucks from Striking and Damaging the Building

now used as buffer guides to keep trucks in the right path in entering the garage. As they are set to a depth of about a foot in concrete, there is little danger of a truck striking the building. At the same station, other shells are used at street intersections as curb markers to keep careless drivers from injuring the grass.

**SIGN MADE OF INLAID GLASS
 GIVES ARTISTIC EFFECT**

Representing a swan floating on the water, a sign constructed of inlaid glass



has been cemented into one of the stone pillars ornamenting the automobile entrance of the grounds belonging to a club at Schroon Lake, N. Y. The sign, the work of an artist, is made of varicolored glass in the same manner as the ornamental church window, and yields a beautiful effect.

Reckless auto drivers are to be called "flivver-boobs" according to the judges in the American Automobile Association's contest to pick the best name for the reckless driver.

Cmd. P. J. Charles Naval Proving Grounds Indian Head Md.

Cmd. Harry A. Blanchard 65 1st Ave on St. with telms 71 alle. h. h.

Cincinnati, Ohio

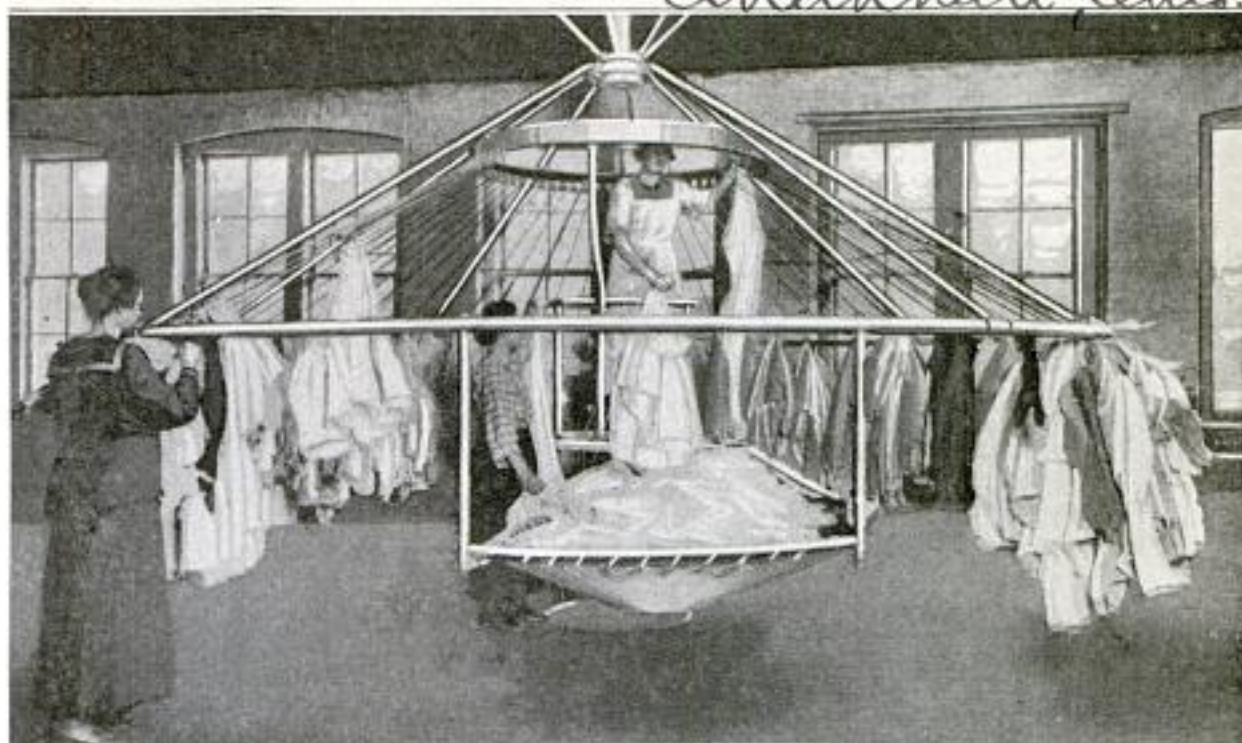

The Worker in the Center of the Reel Hangs the Identification Pin on the Proper Rod, and the Clothes Slide to the Outer Edge of the Reel to be Removed by the Checkers and Wrappers. This System Greatly Facilitates the Operation of Sorting, and Also Effects a Considerable Saving of Floor Space

9322

REEL FOR ASSORTING ROUGH-DRY WORK IN LAUNDRY

In laundries handling any quantity of rough-dry work, the problem of sorting the clothes for the different bundles is a serious one. To facilitate this work and also save floor space, an assorting reel has been devised in which the identification pins are slipped over inclined bars that carry the various garments to the outer edge of the reel, where they are removed by the checkers and wrappers. The worker doing the sorting stands on a circular raised platform in the center of the reel and can reach any of the inclined bars with but little moving about.

4285

ITALIAN LOCOMOTIVE SHEDS WITH ASBESTOS ROOFING

Protection against the destructive influence of smoke and gases from the locomotives is provided in a series of reinforced-concrete engine sheds recently built at Milan, Italy. The structure is 656 feet long, 314 feet wide, and is divided into five longitudinal bays, two on either side of the central one, which is 79 feet wide and 46 feet high. The roof framework, like the rest of the building, is of reinforced concrete, and the roof covering is composed of asbestos-cement sheeting, with steel-framed glazed lights.

Engineering Supplement 4/22/02

9615

TRAFFIC SIGNAL HAS SPIKES FOR CARELESS DRIVERS

Traffic signals mean nothing to some motorists, but one of these recently installed in Central Park, New York City, possesses numerous "pointed reminders." The usual red and green lights are incorporated in an artistic cement pedestal, in the base of which are set sharpened and protruding spikes that mean ruin to any tire driven against them.

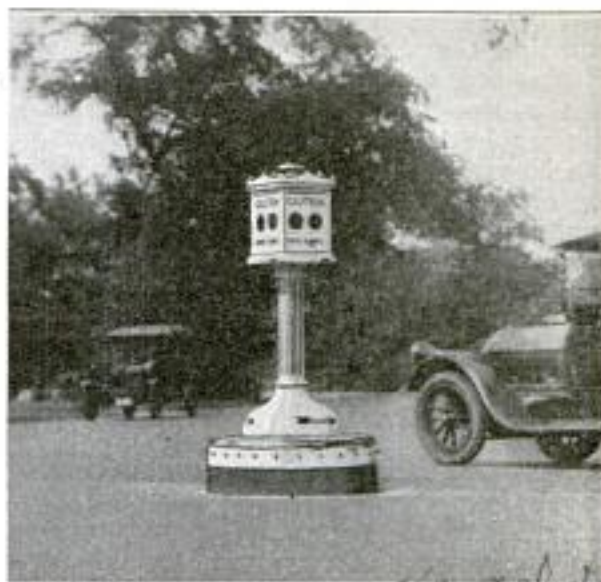

Traffic Signal Which Has Sharp-Pointed Spikes in the Base as a Reminder for Careless Motorists Who Disregard the Lights

Local Herald

*Cml. George F. Paul,
900 Ellsworth Bldg*

*Cml. Bogg + Ford
416 Union League
Bldg. Los Angeles
Calif*

**SHOWER BATH SPEEDS UP JOB
OF WASHING MOTOR BUS**

**COPPER HORSESHOES TO HELP
PREVENT FOREST FIRES**

9430 Because the patrons of motor busses insist that these conveyances be kept spick and span, the washing problem is

9601 Copper horseshoes as a means of preventing forest fires have recently made their appearance in several of the national

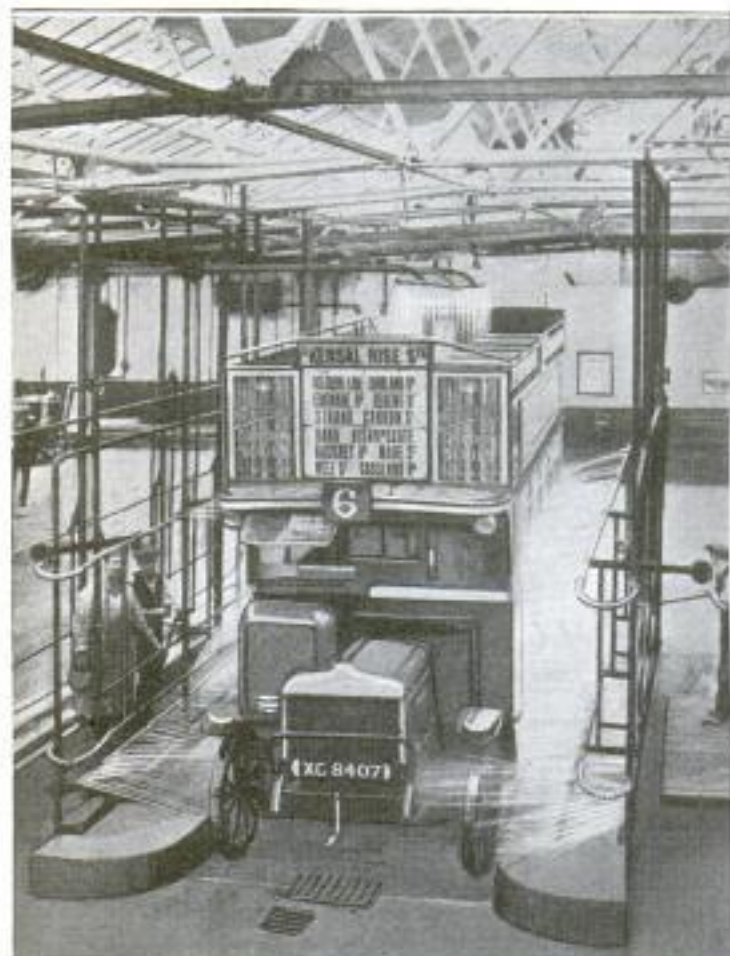

The Motor Bus is Driven into the Space between the Two Banks of Spray Pipes and Receives a Thorough Washing in a Few Minutes

one that cannot be ignored. As a means of speeding up this task, one of the London motor-bus companies has built a shower bath by means of which a bus can be washed very quickly. Spray pipes on either side direct streams of water against the bus, while a pipe above it can be lowered to wash the top.

forests of the West, and, if the plans of certain forestry officials are carried into effect, this metal will supplant steel upon the hoofs of all horses to be used on public domains, where there is any measure of fire hazard.

According to the supervisor of the Angeles National Forest, in southern California, steel horseshoes used in flinty mountainous regions may have been the cause of some of the mysterious fires that have started in the forest reserves. Heavy steel horseshoes striking against flint or hard granite may readily be the source of sparks, which, falling into dry grass or other inflammable material, would quickly cause it to burst into flames if fanned by a breeze.

The new horseshoes were given their first try-out recently in Calaveras County, Calif., when a motion-picture company sought permission to use the Calaveras National Forest as the background for making a film which called for the employment of a large number of horsemen. Permission to so use the forest was granted on condition that all the horses to be used should be shod with copper. The film was made, the horses being shod with shoes

made from copper alloyed with tin, to give the desired degree of hardness. This metal produces no sparks when struck against flint or other rock, and is said to wear quite as well as horseshoes of steel or iron. The cost, of course, is somewhat higher, but the prevention of one small fire more than offsets this.

9594

SINGING LEADERS SPEED CHINESE PILE DRIVERS

No visitor to China who once hears it ever forgets the chant of the pile-driver coolies. The lilting chorus that has come down through the ages and was sung by the toilers who built China's great wall, still is raised over every piece of construction work that brings into service this particular guild of workers. Ordinarily, contractors employ singing leaders

with each gang of pile-driver coolies, and while it is the particular function of these leaders to speed the work, they also extemporize words for the ancient chant, often at the expense of the foreign onlooker.

From the hammer of the human pile driver, which may weigh several hundred pounds, as many as a score of ropes run

*Cml. C. J. Laval, The China Press
Shanghai China*



These Coolies are Working on Shanghai's First Sewer System, Singing, as They Work, the Ancient Pile-Driver Chant under the Leadership of a Special Overseer

to as many workers stationed above on a staging. As the coolies heave in unison, lifting the hammer, the chant is begun by all the workers, and with each line of the song a blow is delivered as the hammer is dropped. Other coolies below control the movement of the hammer which rises and falls more and more rapidly until a swelling climax is reached with a shrill outburst from the throats of the workers.

FOUR-POINT CAR SUSPENSION CHANGED TO THREE-POINT

For converting a car with a four-point frame suspension into three-point suspension, an accessory that also acts as a compensating spring and a shock absorber, is now on the market. The device consists of a six-leaf semielliptical spring that is fastened by a shackle and auxiliary spring, at each end, to the front axle of any passenger car. Pivotaly attached to the center of the elliptical spring, and directly above it, is a cylindrical crossbar, the ends of which engage steel flanges



Three-Point Suspension Device: The Shackles on the Ends of the Spring Connect to the Axle, and the Cylindrical Crossbar Above Connects to the Car Body

projecting from each side of the base of the car body. This pivotal suspension of the front end of the body keeps the car

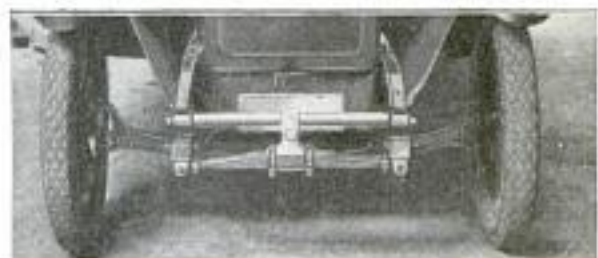

Three-Point Suspension Accessory as It Appears When Attached to the Front End of an Automobile

always level transversely, no matter what the position of the wheels may be, and the action of the shackle springs makes a shock absorber unnecessary.

USE ENAMELED UPHOLSTERING NAILS TO MAKE FLAG

An enterprising Minneapolis firm presented something new recently in the way of a flag display. The face of the United States flag was composed of 2,797 enameled upholstery nails. The gold fringe was made of 386 copper nails, placed on three sides. The 48 stars were represented by 144 white nails, and the blue field by 487 nails. The 13 stripes were composed of 841 white and 939 red nails. The nails were inserted into a fiber doormat which was used as a base for the flag.

% H.H. Blum, 2722 Prince St. Berkeley, Calif.

Medal for Warfield Co. Minneapolis, Minn. 2606

Christian Anderson, 2722 Prince St. Berkeley, Calif.

**NEW TYPE OF JOURNAL JACK
 IS SIMPLE AND COMPACT**

Designed for use in the inspection of journal boxes and the rebrassing of journals in all classes of railroad freight

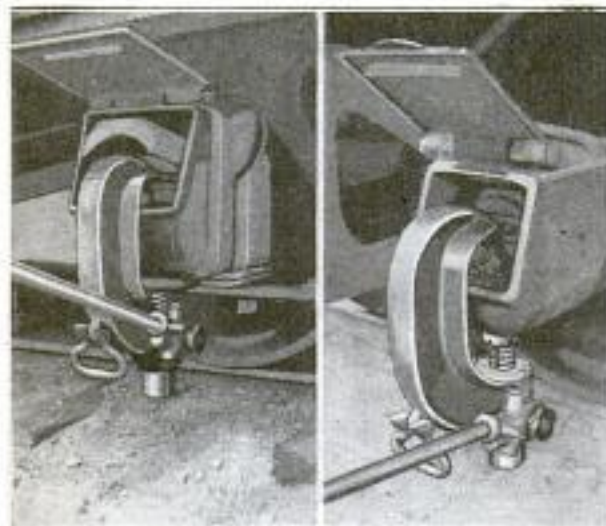

Two Views of Jack That does Not Touch the Ground: Its Head Clamp is Applied on the Journal Collar, and can be Used on Any Standard Journal

and passenger cars, a new clamp type of jack operates without having to touch the ground. It is applied on the axle collar, thus holding the wheel firmly down against the track. Only a short rise of the screw is required to lift the journal box sufficiently to remove and replace the brass, and only one size, as the head cap is adjustable and the jack can be used with any standard journal. The ratchet operates so easily that a 24-inch lever suffices to give the needed power, making it very handy at close quarters.

**SUPPORTING RIG FOR HORSE
 IN WEAKENED CONDITION**

After an exceptionally hard winter in North Dakota, a farm horse was reduced to such a condition that if it fell down



Four-Wheeled Rig Carrying a Strong Bellyband That Allows a Horse in a State of Exhaustion to Feed on the Prairie without Danger of Falling

Cmt. Wm. S. Neal,
The Tribune, Bismarck, N. D.

it could not get up again. It was thought that, after a few weeks' feeding on the prairie, the horse would recover its strength, so the farmer made a four-wheeled rig with a frame and supporting brackets that carried a strong bellyband, in which the horse was slung to prevent it from falling. The horse could get its mouth to the ground and could wander over the prairie at will.

9634
**AUTOMOBILE LOCK REPLACING
 TRANSMISSION-CASE COVER**

As a protection against automobile thieves, a positive lock is now available for use on a popular car. It replaces the regular transmission-case cover, and projecting from it, just above the floorboard near the brake pedal, is a small tube containing the keyhole. A quarter-turn of the key causes a steel forging, which is snugly housed below the cover, to slide so that teeth on its end mesh into the ring gear of the flywheel. At the same time an iron arm is caused to slide under

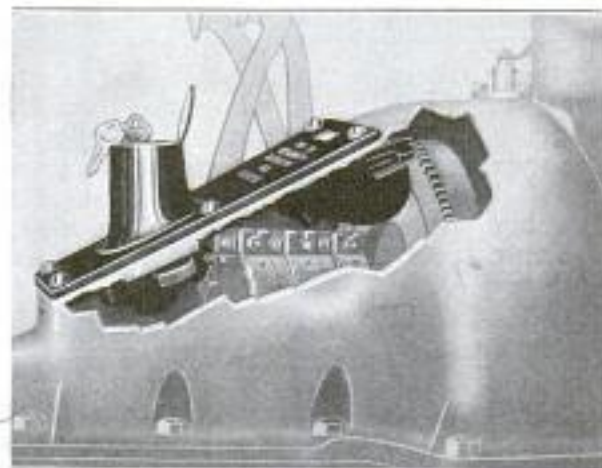

Lock That Replaces the Transmission-Case Cover on a Low-Priced Popular Car, and Blocks the Flywheel

the edges of the transmission case, making it impossible to remove the lock, even if its connecting screws are taken out.

Hercules Mfg. Co., Indianapolis
AMERICAN COAL-MINING FILM
TO BE SHOWN ABROAD

A motion-picture film, "The Story of Coal," made by the Bureau of Mines, is to be shown in Czecho-Slovakia and Jugo-Slavia. It has been exhibited extensively in this country, and was recently widely circulated in India. It seems destined to carry the story of American coal-mining methods to all parts of the world and should act as a trade stimulator for the sale of mining machinery.

916 4



Extracting the Oil of the Eulachan, That Is a Substitute for Butter among the Natives of British Columbia: At the Left Are the Bins in Which the Fish are Left to Soften. To the Right Are the Vats in Which the Oil is Extracted by Heat from the Softened Fish

THE FISH THAT TAKES COW'S PLACE

BY FRANCIS DICKIE

*Herbert Gray,
B. C., Canada.*

MARCH is the month when the Indians on the British Columbia coast put up their butter for the entire year—and it is gathered from a fish, which appears only once a year, for about three weeks' time. It sounds ridiculous to tell of a butter-giving fish, but that is actually what the eulachan, or candlefish, is, for the fats derived from it serve the Indians as an equivalent for the life-sustaining material which Anglo-Saxons get out of butter, and Italians and the people of the south of France out of olive oil.

The eulachan is the Indians' most precious fish, and is quite as mysterious in its ways as the much told-of salmon. Like the latter, it comes yearly from the unknown deeps of the Pacific and goes up fresh-water rivers along the Pacific coast. On the Columbia the run is in February; farther north, it lasts from two to three weeks in March. The eulachan of the Nass River is said to produce the best oil; but perhaps it is that the people there are more expert at extracting. The fish swim in a thin line, the first layer close to the bottom—a wonderful sight. Unlike the salmon, the eulachan goes back to sea after spawning; at least that is the supposition, since no dead fish are seen later, as in the case of the salmon. The eulachan is from 6 to 8 inches long, a silvery fish that is almost pure oil.

The Indians are on the lookout for the beginning of the run, and take millions of the fish in nets; some, too, are caught with a long pole with a line of very sharp thin spikes, like the teeth on a comb. This pole is passed through the water, as one would a paddle, and the fish are caught upon the sharp spikes.

The fish are dumped in great bins of cedar logs and left to soften. As the weather is usually cold at this time of the year, this softening process, though really a sort of decaying, has no bad effects on the product. It simply makes for easier rendering of the fat later. Of course, great care must be taken not to let the process go too far, which would result in rancid oil and grease. Eulachan grease, when well made, has no taint of fishiness.

When the eulachan have softened from a week to 10 days—or other periods, a great deal depending on the weather—they are transferred to great vats and boiled in hot water. The Indian method of heating the water is to drop hot stones into the vats; and though this is a much more laborious way than boiling in modern kettles, many of the Indians today, though they have adopted the white man's phonographs, drag saws, motor-boats, etc., still stick to this method. They claim that the grease produced in their own way is superior in flavor and

4164
434



Some of the Large Cedar Boxes into Which the Oil of the Eulachan, after Extraction from the Fish, is Poured: It Hardens into a Lardlike Substance, and Is Then Ready for Use or Shipment. Some of the Fish are Also Shipped after being Smoked and Dried

texture to that boiled in the white man's way. And this is true. A parallel may be cited in the old and modern ways of making maple sirup.

The oil is skimmed off and transferred to water-tight cedar boxes of remarkable make. The joining done on these is very fine work. Into the boxes the grease is poured and soon hardens, taking an appearance very much like good lard. It is also kept in the liquid state, and I have seen it used on porridge by many natives. The eulachan butter is used in cooking, as cow's butter is used by white people. And, be it noted, there is just as wide a variety of eulachan butter as there is of cow's. The best quality is pleasant-tasting, without rancidness, and keeps this way for 12 months. Strong eulachan

grease results from too much or too little boiling, or from leaving the fish too long in the sun. Among the Indians of British Columbia certain tribes were noted for their eulachan grease, and for hundreds of years they traded it with Indians of the interior for various products they did not themselves possess.

The fish are also smoked and dried; but it is as a producer of a staple fat they are most valuable, or rather invaluable, to the natives of the Pacific coast. Oddly enough, though these fish have been taken by the Indians for centuries, it is only in the last five years that the fish have been taken commercially by the white man, and as yet in very small quantities. Today they are sold fresh in small quantities in Pacific coast cities.

MAKING INDIVIDUAL ICE-CREAM BRICKS AS REQUIRED

9620

The popularity of individual bricks of dipped ice cream has resulted in the in-

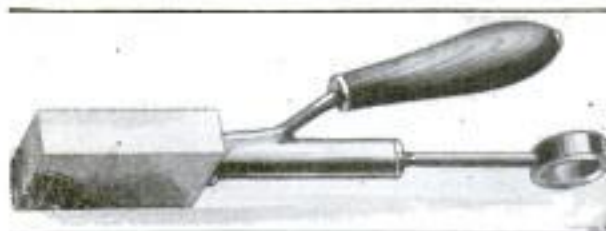

This Soda-Fountain Device, Forced into a Container of Ice Cream, Forms a Small Brick Ready to be Dipped

vention of a device for shaping the ice cream at the soda fountain as required. The forming case is forced into the ice cream and then withdrawn, and the small brick is then forced out of the case by a plunger and spring. It can then be dipped, wrapped, and handed to the customer, the entire operation taking only a few moments. One of the advantages of this system is that the customer may order any flavor of ice cream desired.

Our Bureau of Information will answer all questions regarding articles appearing in this magazine.

*Wm. James B. Garris,
Desandria, Ind*

Copyrighted Material

9728
 Science
 6/23/22
 P. 667

Hawaiian Dredger Co
 Honolulu, I. H.

POPULAR MECHANICS

435
 Hawaiian

AGENCY TO SEND LITERATURE TO RUSSIAN SCIENTISTS

Because of the many appeals that have come from Russian scientists for recent literature of a scientific nature, a committee has been formed in this country that will attempt to meet the requests of these men, who have been almost completely cut off from such literature since 1914. The committee will work in conjunction with the American Relief Administration and will collect and cause to be forwarded, scientific books and periodicals, authors' reprints, publications of scientific bureaus, and other technical information that has appeared in this and other countries since that year.

DREDGING OUTFIT CUTS CANAL ACROSS BOULEVARD

Cutting a canal across the picturesque and palm-lined Kalakaua Avenue at Hon-



Palm-Lined Boulevard in Honolulu as It Appeared After the Large Dredger had Partially Completed the Task of Cutting through the Pavement

9673
 MAKE FILTER FOR CATCHING FINE POWDERED GLASS

Annoyed by the clogging of the water pipes leading from the trough in which a manufacturing optician's grindstone revolved, a young mechanic of Sheboygan, Wis., has developed a filter that catches the finely powdered glass and stops the trouble. While no details of the construction can be given at this time, it is stated that the filter consists only of a



This Is a Block of Finely Powdered Glass, Caught by a Filter Placed in the Water Pipes Leading from an Optician's Grindstone

series of pipes and baffle plates. It has been found that the powdered glass that is trapped makes a good polishing agent for materials other than glass.

The engineer *W. J. ...*
 Word comes from Australia of the discovery of a process for the extraction of copper from low-grade ores. It is said that oxidized ore containing as little as two per cent copper can be treated at a profit.

olulu, in the Hawaiian Islands, was the unusual task recently assigned to a dredging company. The draining of marshes in the vicinity of Waikiki caused the waterway to be constructed through the beautiful boulevard, thereby interrupting all traffic, which, however, will soon be accommodated as usual by the erection of a temporary bridge.

9454
 COMBINED DRILL AND GRINDER HAS WIDE RANGE OF SPEED

A recently developed combination electric hand drill and grinder is so constructed that, with the use of one motor, the speed can be varied to suit either drilling or grinding. The 1/2-horsepower motor is of the universal type that can be operated by either alternating or direct current, and the speed change is of simple design. Its drilling capacity is 1/8 to 5/8-inch steel, and it has a 6-inch grinding wheel. The complete tool weighs 18 pounds.

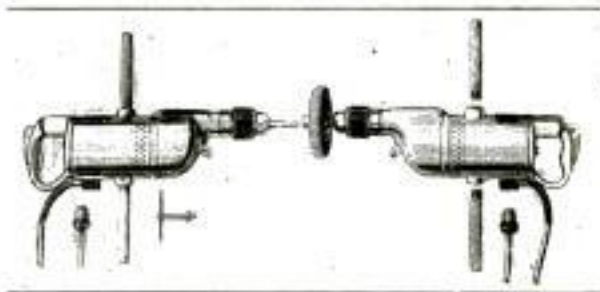

Combination Electric Tool, Shown in Use as Both a Drill and a Grinder: With One Motor Its Speed can be Changed to Suit Either the Drill or the Grinder

Recovery Bld
 Minerals
 Australia
 Super Separator Co., Perth

Woodach Electric Tool Corp.
 Chicago
 23 S. Jefferson

Eugene Pelkafer
 c/o A. & M. S. Co., Sheboygan, Wis.

Art Department.
Miss Peabody.

W.A.S. Electrical Mfg. Co.
402 Notre Dame Ave
Winnipeg, Canada

436

DAMAGED SIDEWALK REPLACED WITHOUT DISTURBING IT

9530

In laying a new cement sidewalk without removing the old one, a series of steel reinforcing rods, spaced a few inches

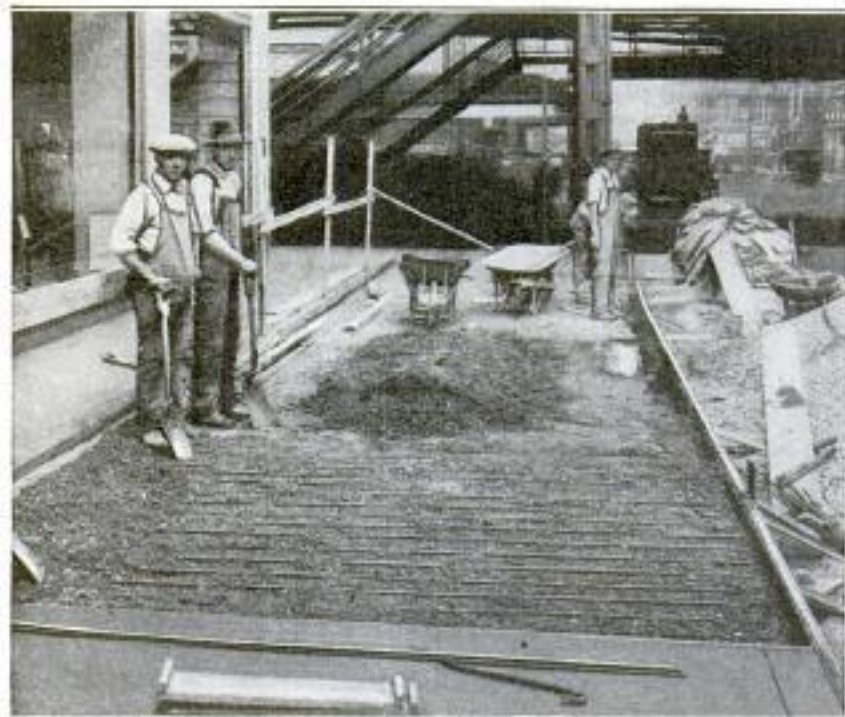

Laying a New Sidewalk on Top of an Old One: When the Steel Reinforcing Rods are Laid in a Thin Bed of Gravel, the Cement is Poured and Suitably Finished

apart, were laid across the top of the old sidewalk and buried in a layer of fine gravel. The cement was poured onto this and smoothed down to the required level, giving to the old sidewalk a new surface that will not crack and that is of a permanent nature.

TRANSATLANTIC TELEPHONY SOON TO BE ACHIEVED

9752

Telephone conversations between New York City and London, or Paris, are predicted as a common occurrence within a few years, due to the recent successful experiments with the electron tube. A set of these tubes of exceedingly high power is being installed in the great wireless station at Carnarvon, in Wales, England, while an even more powerful set is ready to be placed in the mammoth station at Port Jefferson, Long Island, in this country. These tubes will first be tested in wireless telegraphy as the dot-and-dash signals are the most simple sounds to transmit, and as their development progresses, they will be used in the attempt to send the varied tones of the voice across the thousands of miles of water.

N.Y. Times 6/30/22
P. 4

NEW LIGHTWEIGHT ELECTRIC STORAGE BATTERIES

9734

Almost simultaneously, two storage batteries have been invented, one in Winnipeg, Can., and the other in England, which, if the claims of the inventors are valid, mean something of a revolution in all the uses of electricity which require the storage battery. The Winnipeg battery is of the ordinary sulphate type, but by incorporating the insulation used with the positive plate, the plate is made so much stronger that only one-third of the inactive metal is required. It is claimed that this new construction makes it impossible for the active material to leave the grid. At the same time it provides for the free circulation of the electrolyte. The net result is that the weight of the battery, per unit of capacity, is reduced to one-third that of the ordinary battery. This

means that the electric automobile, with all its simplicity, cleanness of operation, and balancing of weight, may become common.

The claims made for the English battery are that the output is increased per unit weight 300 to 800 per cent; that it will not sulphate, that it can be charged in 15 minutes, and that it may stand idle any reasonable length of time without deterioration. This battery is now being tested by the experts of the national laboratory, London.

The inventors of both batteries claim that the construction and assembly of the parts are very simple, and the entire battery is not costly. The commercial development of these two batteries will be awaited with interest.

TRACTOR SPEEDS UP DIFFICULT TREE-REMOVING JOB

920

The erection of an addition to a bank building at Alhambra, Calif., recently, necessitated the removal of a large tree in the adjoining parkway. The tree could not be felled in the usual manner because it might damage surrounding property.

Winnipeg, Canada
Sibley, Leachman & Co., 187, West Winnipeg Road, S. D.

9207

Cmt. Hagg's Ford 476 Union League Bldg. Los Angeles, Calif 437
POPULAR MECHANICS



After Pulling the Tree Out by the Roots, the Tractor with a Single Mighty Heave Rolled the Stump and Trunk, Weighing Four Tons, onto a Sledge. It Then Towed the Whole Load to a Local Woodyard, Accomplishing the Entire Task in 20 Minutes

Accordingly, the branches were cut off and hauled away until nothing was left but the main trunk and roots. The disposal of this larger portion of the tree offered another problem. The trunk of the tree was about 20 inches in diameter, and, with the roots, weighed about four tons. The removal was greatly simplified by the use of a powerful endless-tread tractor. After workmen had dug around the roots to loosen the stump and trunk, the tractor was attached to the upper portion of the trunk with a heavy log chain. With a single mighty heave the tractor pulled the stump and trunk out, roots and all. The chain was then wrapped around the trunk, and by another pull of the tractor rolled upon a sledge previously placed for the purpose. The tractor then took the sledge in tow, and dragged the whole outfit to a local woodyard. The use of the tractor made the entire job the work of only about 20 minutes.

9751 — Subway

FLICKERING OF CAR LIGHTS REMEDIED BY NEW SHOE

Fitting some 200 of their subway cars with a special shoe, was the means employed by the Interborough Transit Commission of New York City, to eliminate the annoying flicker of the car lights. The new shoes contain a spring which keeps them in constant contact with the third rail, and thus insures a regular flow of current to the lamps.

N.Y. Times 6/30/22 P. 1

9613

ELECTRICAL SKINNING TOOL FOR PACKING HOUSES

Skinning a steer of ordinary size in the incredibly short time of five minutes is possible with the use of an electrical tool invented by a Frenchman and recently introduced in a Paris packing house. The appliance has three small blades of clover-leaf design mounted at the end of a flex-



Above: Close-Up of the Electrical Skinning Tool. Showing the Blades of Clover-Leaf Design Which are Revolved at a High Rate of Speed. Below: Skinning a Steer with the Electrically Driven Tool



ible driving shaft, which is turned by a motor at a speed of 2,800 revolutions per minute, thus yielding a seemingly solid cutting edge for the worker.

Copyrighted material
d no. M. Cercé Paris, France

no further information.

CIVIC FEATURES THAT PROMOTE THE COMFORT



COPYRIGHT, UNDERWOOD &
UNSCREWED

Above: This Picturesque Japanese Bridge is Located in the Tea Garden in Golden Gate Park, San Francisco, and is Only One of Many Artistic Features in This Beautiful Spot

Below: Because of the Dangerous Curve under This Bridge, the Base of the Retaining Wall has been Painted a Vivid Checkerboard as a Warning



Above: Located near New Oxford, Pennsylvania, on the Lincoln Highway, This Artistic Spring House is Not Only Useful but Ornamental as Well. The Concrete Base Effectually Protects the Spring, While the Structure Itself Blends Pleasantly with the Surrounding Landscape

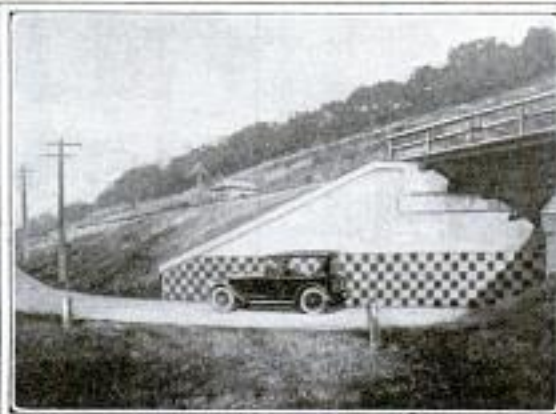

Above: This Type of Street Sign is being Erected in Detroit, Michigan, and Shows Not Only the Names of the Intersecting Streets but the Block Number Also. The Lettering is Large and Clear enough to be Easily Identified from a Passing Automobile

AND ENJOYMENT OF VISITORS AND RESIDENTS



Above: Scene at Pageant of Virginia, in Richmond, Which Represents the Landing of Captain John Smith, Portrayed by the Central Figure in Chains



Below: At Venice, California, These Concrete Blocks Containing Electric-Light Connections have been Erected So That Temporary Light Posts may be Placed on Them and Connected

To Combat the Fly Pest, Many Cities have Passed Ordinances Requiring That Flytraps be Placed on the Street in Front of Places of Business Where Flies are Likely to be Attracted. The Merchant is Obligated to Install and Care for the Trap at His Own Expense



This Apple Tree, Blooming in Its Wire Inclosure near Vancouver, Washington, is Supposed to Be the Oldest in the Northwest. The Story is That It Grew from a Seed Brought from England by One of the Captains of the Hudson's Bay Company, Nearly 100 Years Ago

opt
ur
hic
ent
o t
rap
be
riv
arp
hey
f a
n u
ile
old
ary

*Modern
carpenter*

AMATEUR WEATHER BUREAUS DO GOOD WORK

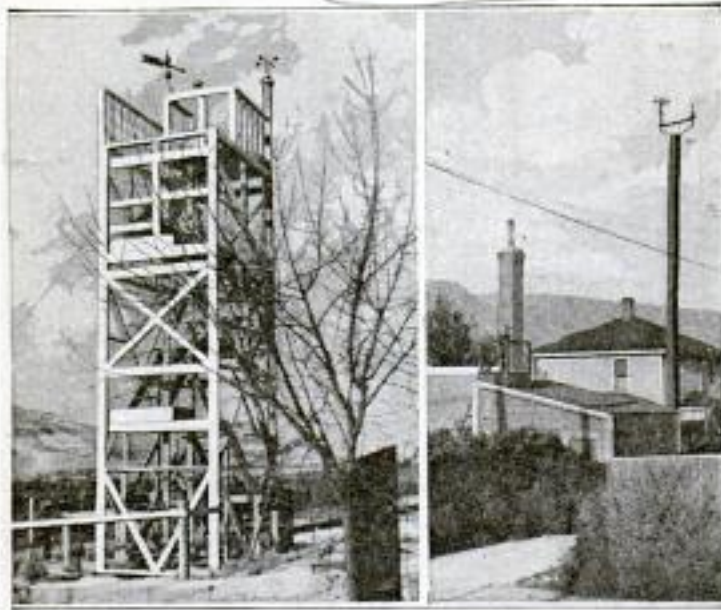

These Observation Towers have been Erected by Amateur Weather Prophets and Equipped by Them with Reliable Devices for Recording Atmospheric Conditions

Desire on the part of the owners to work with precise and delicate instruments as well as to compile useful and interesting data, with no other remuneration than the satisfaction realized in the accomplishment, has culminated in the construction of two well-equipped weather bureaus. Vanes, wind gauges, barographs, thermometers, sun meters, and rain gauges, all of the best quality, are part of the equipment. The amateur bureaus are located on suitably constructed towers and furnish local newspapers as well as the central weather bureau with reliable information. They form links in the continental system of weather bureaus, and all the records established are tabulated.

9365

EFFECTS OF HIGH ALTITUDES ON HUMAN BEINGS

The increasing migrations to high altitudes of men who have been accustomed to the conditions of the lower altitudes, has led to some interesting studies on the effects of the changed conditions. At an elevation of 14,000 feet, such as is found in the Andes of Peru, the oxygen tension is very much lower than at sea level. The first effect of this changed condition

on a person moving to this altitude, is the imperfect aeration of the arterial blood, causing quick fatigue and dizziness. It has been found, however, that once a person becomes acclimated he can perform a fair amount of mental work for long periods, but this does not hold true as regards sustained muscular effort. On the other hand, natives of these high altitudes can perform remarkable feats of work if allowed frequent periods of rest to make up the deficit of oxygen.

9426

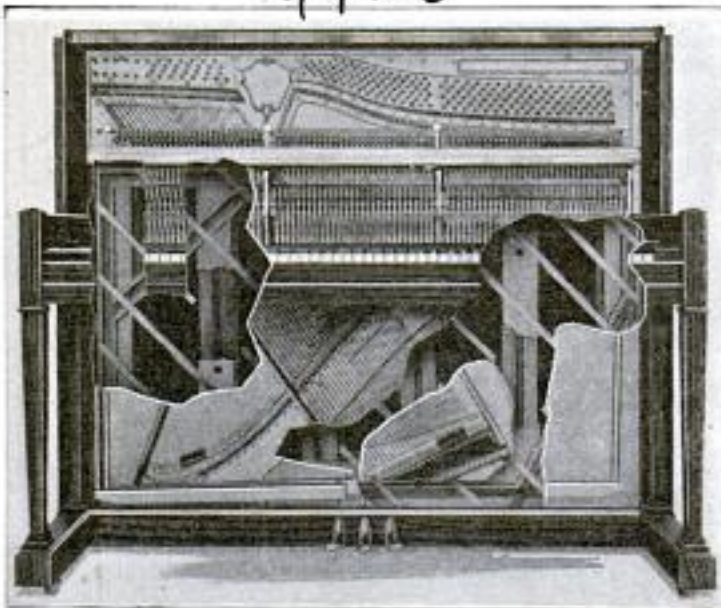

Tone Amplifier in an Upright Piano: Parts of the Plate and Soundboard are Cut Away to Show the Air Channels

UPRIGHT PIANOS FURNISHED WITH TONE AMPLIFIERS

Upright pianos are now being fitted with tone amplifiers that act somewhat in the same manner as the horn of a phonograph. A series of air channels extending through the various parts of the wooden frame of the piano, behind the soundboard, are so connected that they act like a single horn, having a length of some 50 or 60 feet. The effect of this method of amplification is said to improve the tone and increase its sustaining qualities 50 to 100 per cent. The construction can be used with good effect on player pianos as well.

*Journal American Medical Assoc.
 Vol. 78 No. 23, P. 1722, 6/3/22*

*United Piano Corp.
 20 W. 45th St. New York City*

*of Story & Clark Piano Co.
 J. A. Williams*

Baltimore, Md.

Copyrighted material

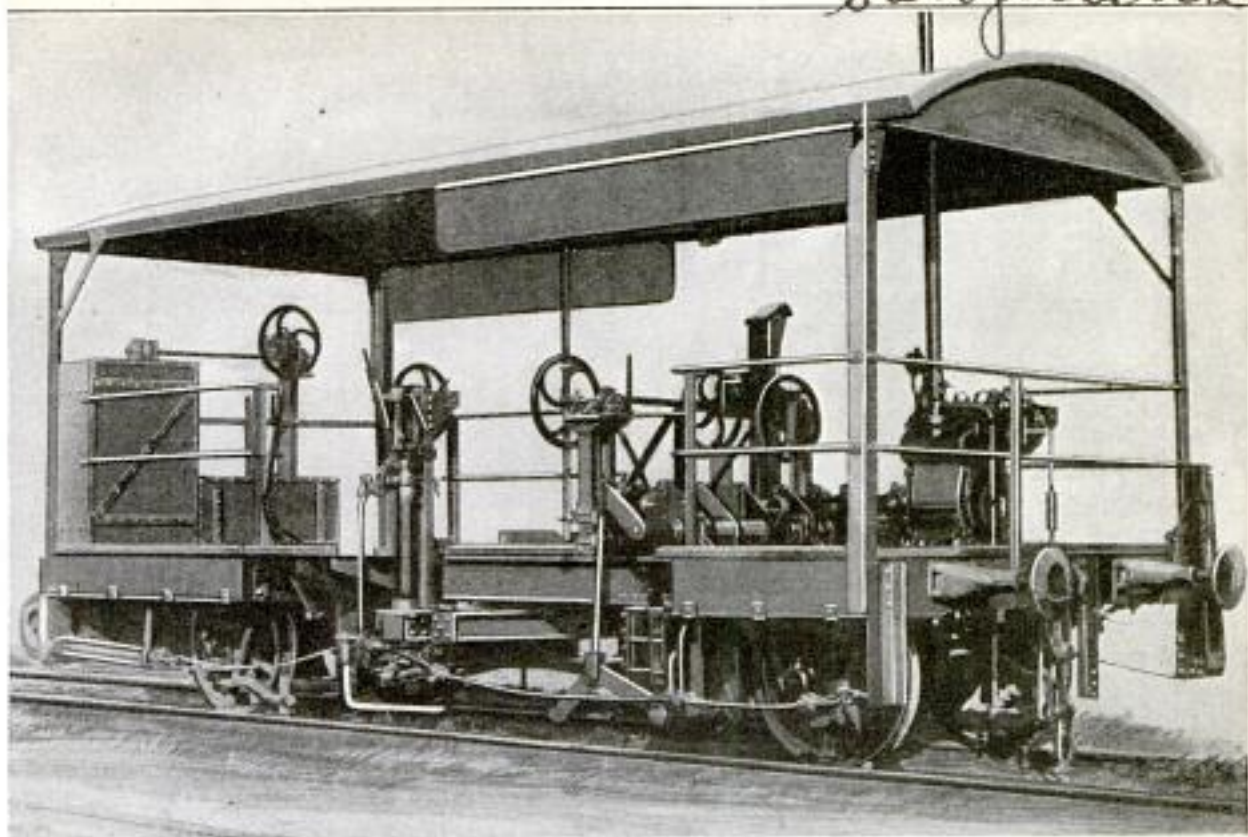

Machine for Uprooting Weeds on Railway Roadbeds: The Motor in Front of the Truck Operates Cutters beneath It, for Uprooting the Weeds in the Ballast between the Rails, as Well as Other Cutters outside the Rails. Brushes at the Rear Level the Ballast and Clean the Ties

9459
WEED-UPROOTING MACHINE OPERATES ON RAILROADS

A machine for ^{cutting} uprooting weeds or any vegetation from railway roadbeds is in operation in Switzerland, and is giving satisfactory results. The weeding devices are all attached to the frame of a truck that is mounted on railroad-car wheels. On the front part of the truck, under its frame, are a series of cutters, parallel with the railroad ties, which are operated by a motor. As the machine is pushed along by a locomotive at a speed of about four miles an hour, these cutters are driven into the ballast between the ties. At each tie the cutters are automatically lifted, and pass the tie without touching it. Similar cutters on another part of the truck are so constructed that they operate on the ballast outside the rails. At the rear of the machine are rotating brushes which level the ballast and clean the ties. The machine can be adapted to suit any gauge or roadbed.

Popular Mechanics Magazine does not publish the name of maker or seller of any device described in its pages, but this information is kept on file and will be furnished free by addressing our Bureau of Information.

9489
HAND-OPERATED HORN USED INSTEAD OF WHISTLE

Mailmen and traffic officers now have available a hand-operated horn which has been designed by a New Jersey man to take the place of the familiar whistle. Direct contact of the lips with dust and germs accumulated on the whistle, to say nothing of chapped lips in winter, may be avoided by the use of this small horn, which is sounded by pressure of the thumb and two fingers. Being small, the instrument permits the freedom of both hands while using it.

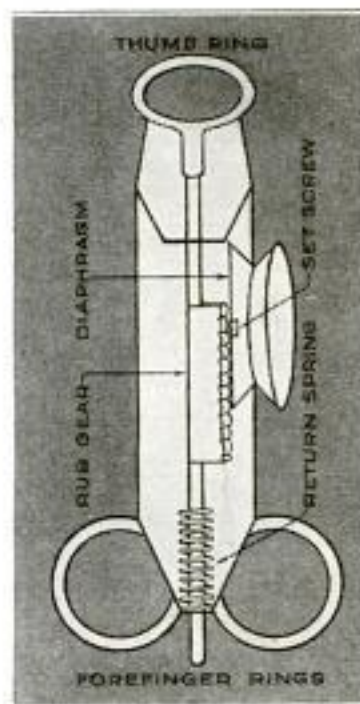

*Mr. H. E. Mende
 8790 S. 15th St.
 Newark N.J.*

9568

SOME NOVEL AND LITTLE-KNOWN ACCESSORIES



These Bathing Slippers are Made Entirely of Rubber and Have No Seams to Chafe the Foot. The Sole Is of Double Thickness for Protection from Sharp Stones



This Window and Mirror-Cleaning Bag, Filled with a Fine, Granular Substance, is Soaked in Water and Rubbed over the Glass



Safety Folding Ladder That cannot Collapse and Whose Sides Extend above the Top Step, Giving a Brace for the Limbs: It Weighs but 15 Pounds, Folds into a Space $23\frac{1}{4}$ by $7\frac{1}{2}$ by 52 Inches, and is Easily Hung on the Inside of a Pantry Door



Glass Salt Shaker Which Has Small Saw Blades Inside, to Cut Any Crust and Control the Flow of the Salt



Onions may be Cut and Chopped Freely without Causing Tears, or Staining the Hands, with the Use of This Glass-Covered Mincer

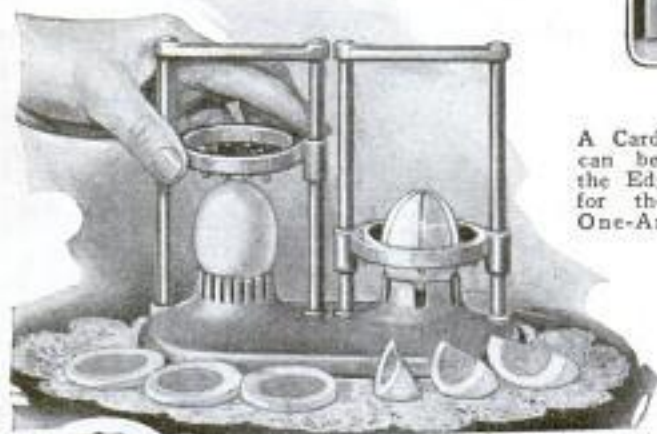

Egg-Cutter Which Slices the Egg Thin Enough for Sandwiches, or Cuts It into Six Parts for Garnishing Salads

A Card Holder That can be Fastened to the Edge of a Table for the Benefit of One-Armed Players



INTENDED FOR THE HOME AND ITS MEMBERS



A Fruit Strainer That Eliminates Burned and Stained Hands: The Hollow Hand Grip is Placed over the Bag and Merely Pushed Down as Far as It will Go



Knife or Scissors Sharpener with Two Steel Cutting Rolls between Which the Blades are Drawn



Kitchen Cabinet That is Compactly Built, Requiring but a Small Amount of Space: The Chair Slides Out like a Drawer, and the Seat is Curved to Conform with the Body. If Desired, a China Cabinet can be Mounted on the Top



Toothbrush Which is Handy for Travelers, Because the Paste can be Carried in the Handle of the Article



This Fruit-Jar Cap is Slotted for the Insertion of a Knife, Ice Pick, or Can Opener, to Aid in Turning the Cap in Tightening or Loosening It



Glass Cake Baker with Hole in Center, Which Permits Even Distribution of Heat to the Cake



Expanding Cuff Links Which Allow the Sleeves to be Pushed Quickly Up over the Elbow without Removing the Links from the Cuffs



This Clothes-Boiler Basket is Placed at the Bottom of the Boiler with the Clothes on Top of It. The Handles Permit Easy Removal of the Clothes

Dr. Hatcher Henry Eummelen,

444 Santa Ana, Calif. POPULAR MECHANICS

9260 HOLDERS SUPPLY CLEAN FOOD AND WATER TO PET BIRD

If the family is to be away from home for a day or two, the pet bird will not

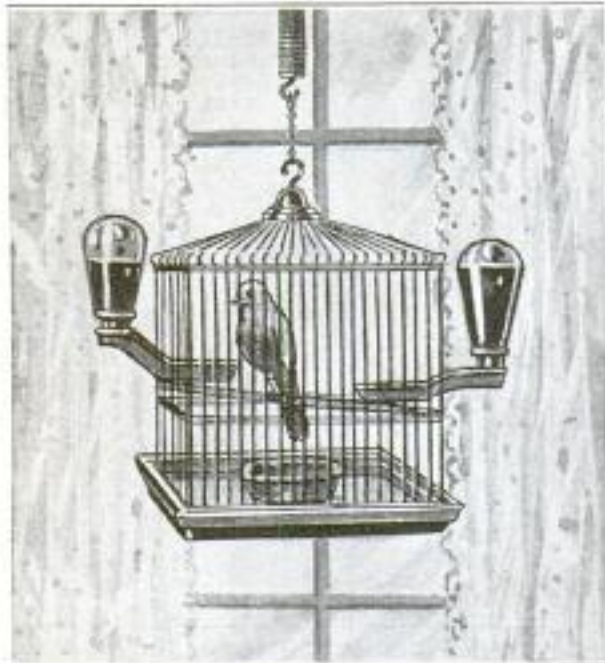

The Containers, Clamped to the Sides of the Cage, Hold Sufficient Food and Water for Nine Days and Supply These to the Bird as Needed

have to depend on the good memory of neighbors for his supply of fresh food and water, for a container has been devised which stores and distributes a supply sufficient for nine days. The containers are shaped like electric-light globes and connect with troughs extending into the cage. These troughs are narrow enough so that they cannot be fouled by the bird, and the seed trough is supplied with bars to prevent wasting of the food.

9555 BRAND REINDEER BY CUTTING NOTCHES IN THE EARS

When the native reindeer herder of Alaska wishes to brand the animals of his herd, he does not employ the branding iron with which we are all familiar. In-

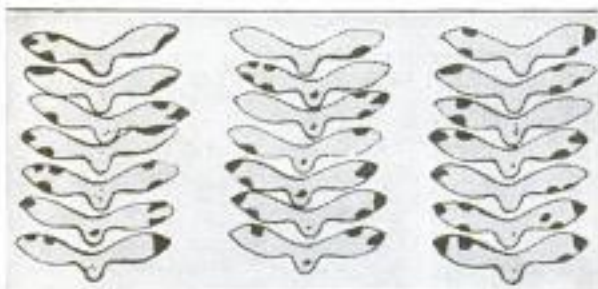

Ears of Reindeer: The Black Marks Indicate Notches Cut in the Ears as a Means of Branding the Animals

emb. a word or words, such as intelligence, strength, Wash.

stead, he cuts notches in the ears of the reindeer, the size, location, and arrangement of the cuts serving as a means of identification. By running his hand along the ears of an animal the herder easily determines to which herd it belongs.

9598 CEMENT SUCCESSFULLY USED AS A FIRE EXTINGUISHER

Recently a fire that had obtained a strong hold on some timber sheds and piles of lumber was prevented from spreading and was finally extinguished by means of cement. Piles adjacent to the fire were made fireproof by first coating them with dry cement, and then throwing water over them. Cement was also thrown over the timber that was ablaze, thereby preventing sparks from flying. Another use of cement as a fire extinguisher was in connection with a tank of 400 gallons of oil that was ablaze in the basement of a building, where sacks of dry cement thrown into the burning oil aided in reducing the damage.

The Engineer 6/2/22

9333 PADLOCK OF SAFE TYPE HAS NUMBERED COMBINATIONS

A padlock, recently patented, operates by any given combination of numbers in the same way as a safe lock. It consists

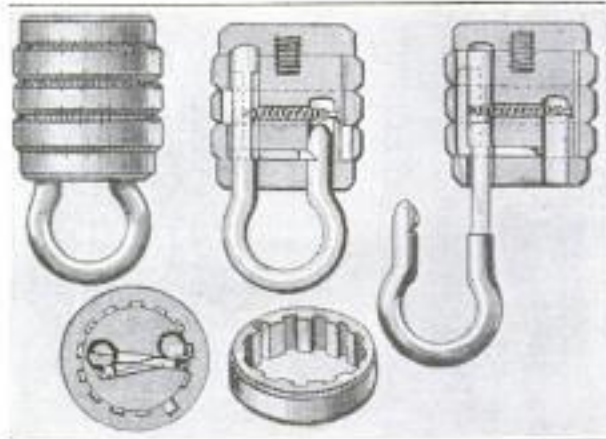

This Padlock Consists of Five Movable Metal Disks with Numbers on Their Outer Faces, and Operates like a Combination Safe Lock

of five superimposed disks wide enough to allow the inscription on their outside faces of a series of numbers and graduations. The top and bottom disks are somewhat smaller than the other three, which are in the nature of tumblers that can be rotated to bring any given series of numbers into line. With the required combination, a series of grooves are set in line so that a pull on the shackle of the

Dr. H. O. Nielsen
Redmond, Utah

*Civil. Norman C. McLeod,
1717 St. Paul St
Baltimore, Md.*

lock releases its latch, and allows the shackle to be withdrawn and turned in any direction.

ment from the smaller to the next larger step on the other cone. The belt tension

964 EXPECTED TARIFF REVISION REVERSES RAG TRADE

Recent consular reports indicate that the United States has become a heavy importer of woolen rags from England, whereas ordinarily the trade in this commodity has been in the opposite direction. At the present time, rags are admitted to this country free of duty, but it is expected that a duty will be established by the new tariff bill, and manufacturers of shoddy cloth appear to be accumulating a stock of woolen rags before the time this action is taken.

9538 FLUTED EXPANSION REAMER HAS AN ALINING PILOT

A recent addition to metal-cutting tools is a spirally fluted expansion reamer, with alining pilot, that is particularly adapted to the reaming of piston-pin bushings. The flutes are milled to a true spiral angle and give a smooth accurate hole without chattering. The alining pilot is slightly smaller than the size of the reamer, and is long enough



Spiral-Fluted Expansion Reamer, with an Alining Pilot, for Use in Reaming Piston-Pin Bushings

to bear in both bushings in the piston before the cutting begins, thus securing accurate alinement. At the front end of the pilot is a fluted cutter, to remove excess material in cases where the hole in the bushing is too small to allow the pilot to enter.

9486 NEW SPEED-CHANGING DEVICE ON HIGH-SPEED DRILLS

Drilling machines built in two types, bench and pedestal, and in combinations of from one to eight spindles, having three speeds of 5,700, 8,000, and 12,000 revolutions per minute, are now on the market. The outstanding feature of the machine is the speed-changing system. A turn of a handle automatically relieves the belt tension, shifts the belt first from the larger to the next smaller step on one cone pulley, and then by a similar move-

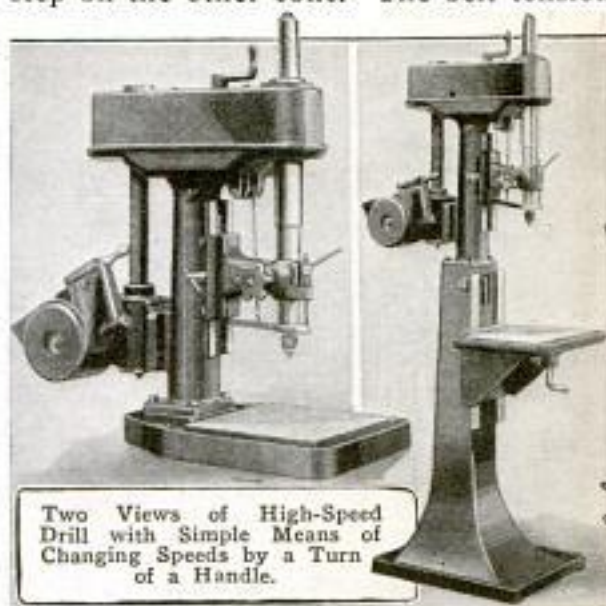

Two Views of High-Speed Drill with Simple Means of Changing Speeds by a Turn of a Handle.

is then automatically adjusted to the new position.

9264 LIGHT, COLLAPSIBLE STOOL FOR CARS OR OUTINGS

That extra seat in the automobile, or relief from the back-tiring effect of sitting on the ground during an outing trip, may be obtained by the use of a light, collapsible stool. The seat when collapsed is 13½ inches in length, 7 inches in width, 2¾ inches in thickness, and though weighing only 3½ pounds, is claimed to be strong enough to sustain a weight of 300 pounds.

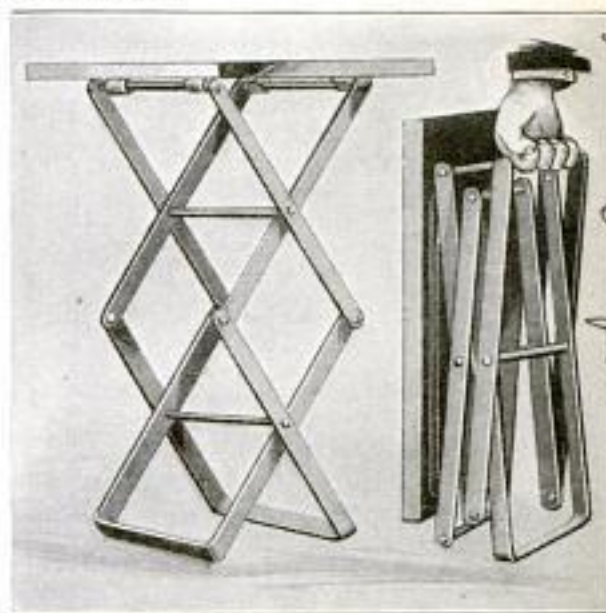

Light, Collapsible Stool, Extended, and Folded for Carrying: It may be Used in the Motor Car, at Picnics, or in the Camp

*Alford Reamer & Tool Co.
Millersburg, Pa.*

Alhambra, Calif.

*Box 463
Co.*

The Munchie

*Hosdick Machine Tool Co.
Cincinnati, O.*

Mr. E. W. Sawyer

446 POPULAR MECHANICS
North Anson, Maine

8997 ON AUTOMOBILE TOPS

In driving over a rough road in an automobile with the top up, the rebound of the springs is sometimes sufficient to

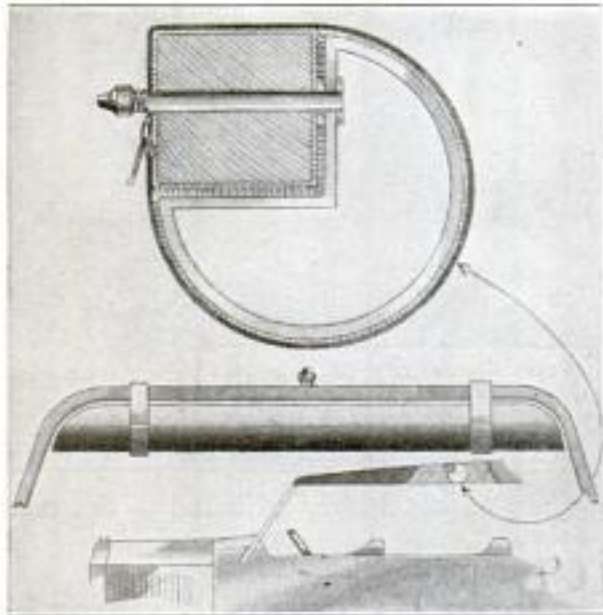

Inflated Rubber Tube Strapped to the Top Bow of an Automobile, to Act as a Head Protector: Above Are Two Detailed Views of the Device

bump the head of an occupant of the car against the hard top bow with force enough to cause severe injury. To guard against this danger, a new invention provides an inflated rubber tube that is strapped to the bow clear across the top of the car, and forms a cushion that will break the force of the severest blow.

9308
OILCAN THAT IS LEAK-PROOF FOR USE OF MOTORISTS

To avoid the annoying consequences of an upset oilcan, particularly in an automobile tool box, an oilcan has been devised that makes leakage impossible even if the can is reposing upside down. Fitted tightly in the brass spout of the can is a

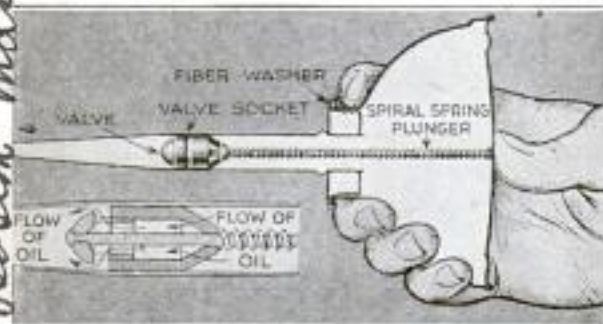

Leak-Proof Oilcan: Notations Explain Its Construction, and the Enlarged View Shows How the Oil Flows When the Valve is Opened

*Arthur Harding
Boston, Mass.*

*Carl S. Smedal
3506 Earfield Ave
Minneapolis, Minn.*

socket, with a valve which opens in the direction of the outlet of the spout and is normally held closed and oil-tight by a spring coiled on the valve stem. This extends to the bottom of the can, so that a little pressure opens the valve and allows the oil to flow down the spout.

9645
RUM RUNNERS USE ARMORED AUTOMOBILE

A rum-runner's armored car was wrecked recently near Canby, Minn., and one of the occupants of the car was killed. This machine had three gasoline tanks, which were connected separately with the carburetor, to guard against possible piercing of one of the tanks. Each tank was well protected with sheet-iron armor. Also there were special hoods of sheet-iron that were made to fit under the fenders, and could be dropped over the rear wheels by means of a lever, to protect the tires. The car carried a high-powered rifle and an automatic revolver. When captured, 280 quarts of whisky were found in the machine. The driver said he was paid \$150 a month to run between Winnipeg, Can., and Omaha.

9453
HOMEMADE STENCILS USED IN SELF-INKING STAMP

Stencils made at home can be used in a new self-inking stamp which resembles the ordinary hand rubber article, but instead of the usual wooden base a reservoir holding sufficient ink to print 1,500 copies is incorporated in it. The appliance was designed to afford an inexpensive means of obtaining a small stamp for return envelopes, letterheads, statements, shipping tags, labels of all kinds, short announcements, and similar articles.



To protect their messengers by making them as conspicuous as possible, is the scheme to be tried by New York brokerage firms. The messengers will wear bright-red coats and carry five-pound portable safes which will be chained around the waist, the chain being padlocked inside the safe.

*The Multi Stamp
232
Norfolk, Va.*

New York City
**STEEL GOLF CLUBS ALLOWED
BY WESTERN ASSOCIATION**

In the matter of steel-shafted golf clubs the United States Golf Association's disallowance of their use is meeting the same fate that was accorded the action of the association in barring Francis Ouimet from amateur competitions on the ground that he was engaged in the sale of golf supplies. Both rulings were ignored by the western association, and, in the former case, the famous Bostonian was allowed to compete for, and actually won, the western-championship title, while, in the latter, it has been declared that steel-shafted clubs may be used in the tournaments of the western association. It is thought that on more mature consideration the U. S. association will reverse its ruling, and allow the use of steel clubs in this year's national-championship tournaments.

9564

**ALL-STEEL RADIATOR COVERS
TO MATCH FURNITURE**

To convert the ordinary steam radiator into a window seat, cozy corner, or book-rack, an all-steel cover has been designed that is not only useful, but ornamental as well. It is substantially built, and there are no rough edges to catch and tear draperies or clothing. The cover can be tinted and grained to match the furniture or woodwork in a room. The efficiency of the radiator is not impaired,



This All-Steel Radiator Cover is Tinted and Grained to Match the Furniture or Woodwork in a Room

as a deflecting plate in the top of the cover directs the heated air to a series of large openings in the front.

**OLD-TIME CANNON NOW USED
AS QUEER FOG SIGNAL**

Built originally as a cannon for throwing a lead shell containing a charge of gun cotton, but abandoned after one trial, a queer old piece of ordnance was considered junk until some one proposed using it as a fog signal. The barrel of

the gun is about 2 feet in diameter and the metal is 1 inch thick. For its present use, on a pier at the Naval Proving Ground, Indian Head, Md., it is supported

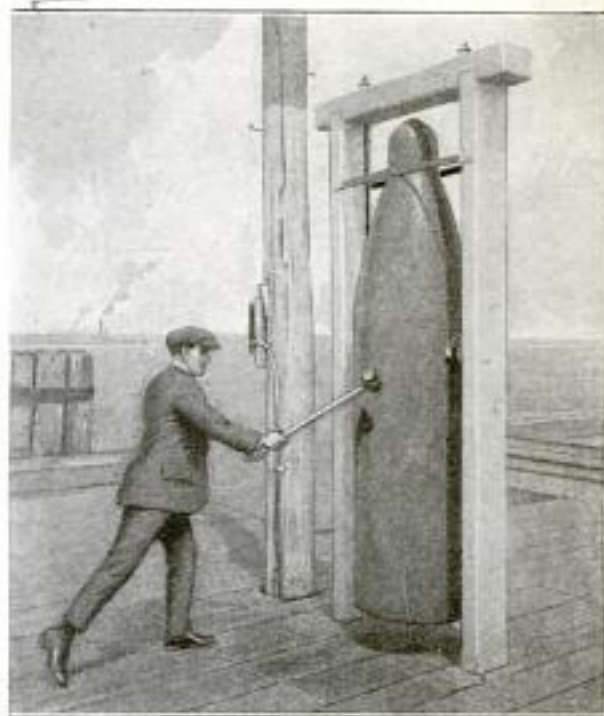

This Old Cannon is Now Used as a Fog Signal, and When Struck with a Sledge, Gives Out a Deep Resonant Tone, Audible at Great Distance

by its trunnions between two upright posts, and when struck with a sledge, gives out a deep resonant tone that can be heard a long distance. The sledge is kept hanging on one of the posts so that it is always at hand when needed.

9576

**NO SLIDING OR SIDESWAY
WITH NEW FISHING ROD**

A thorn in the side of the fisherman who depends upon casting for his amusement has been removed by the invention of a rod which eliminates sliding or sidesway at the pole joints. Because of this common annoyance the guides of the average rod are seldom in alinement. In the new pole, which is made of steel, the female joint is threaded at the lower end and the male joint has a loose ferrule,

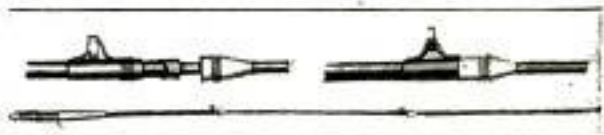

Above: Detail of the Improved Fishing-Rod Joint, Open and Closed; Below: The Complete Rod

which is screwed down onto the threads after the joints have been fitted together, making them absolutely immovable.

Holland Rod Mfg. Co.
St. Joseph, Mo.

Frank & Betts Co
Hammshnd Blvd.

9567

CHILDREN'S PICTURE-STORY DEPARTMENT



In Front of the New York City Hall, with Mayor Hylan Acting as Supervisor, a Tournament of Marble Players was Held to Select the Champion Who is to Play against the Champions of Baltimore and Philadelphia

COPYRIGHT UNDERWOOD & UNDERWOOD



Major Mite, 18 Years Old, 28 Inches Tall, Weighing Only 18 Pounds, Champion Dwarf of the World, Shown after His Arrival in Movie Land, at Los Angeles, Standing beside the 3½-Year-Old Baby Screen Star, Edwyn Hubbell



Above: Cake, Six Feet in Diameter, Six Feet High, and Weighing 1,200 Pounds, Made by the Baking Department of the Lane Technical School, Chicago, and Mounted upon a Float Made by the Students, Which in a Recent Boys' Parade in That City Won the Silver Loving Cup

Below: Two Views of Patent Scooter, ing the Spring Passenger Seat Unoccu Other with a Kiddie in the Seat and a at the Rear Doing the Propelling and The Car Runs on Roller-Skate

One Show-pied, and the Boy Friend Steering Wheels

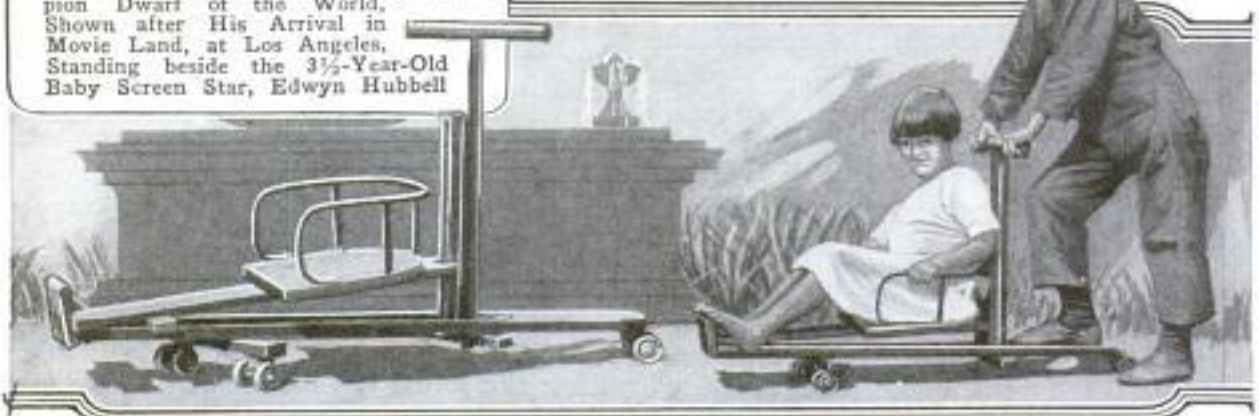

George F. Eastman
4021 Holmes St.
Kansas City, Mo.

OF MODERN ACTIVITIES AND INTERESTS



Squad of Native African Boy and Girl Scouts: Obviously, There Is Considerable Difference between Their Costumes and the Trim Uniforms of American Scouts. The Picture was Taken at Sierra Leone, and the Leaders are Seen Seated, with Their Silk-Hatted Chief Counselor behind Them



A Boy-Sized Clubhouse Built by Four Youngsters in a Huge Buttonwood Tree, near Hallam, Pennsylvania. Each Stair Riser Bears One Letter of Its Name "Brookleaf Nest"



This Little Cincinnati Girl does Not Allow Herself to be Handicapped by Physical Disability. With the Help of the Roller Skates and the Crutches She Gets About Just as Briskly as Her More Fortunate Companions. The Result Is That, Apart from Her Disabled Leg, She Is as Robust as Any Other Girl



This Team of Billy Goats will Celebrate the Opening of the New Road from St. Louis, Missouri, to Glacier Park, at Havre, Montana, by Hauling the Little Prairie Schooner the Whole Distance of 1,800 Miles

**STEAM SUPPLY IN RADIATORS
CONTROLLED AS DESIRED**

For regulating the heat of a steam radiator, so that it may be made suitable to varying weather conditions, a one-pipe installation connects to a supply valve at the top and to an automatic return valve at the base, on the same end of the radiator. At the supply valve is a lever handle by which the supply of steam can be controlled as desired. Any condensation flows out of the radiator through the



automatic return valve, and goes back to the boiler.

9561

**CHILDREN LEARN ARITHMETIC
FROM SPINNING TOP**

Children may be taught the different signs of arithmetic through the medium of a spinning top having on its surface two series of figures in circles above small holes. Inside the top, two small steel balls are rotated under the numbered holes, coming to rest, as the top stops, directly beneath certain of the openings. By means of an indicator which moves freely on the spinning handle, the indicated figures are then either added, subtracted, multiplied, or divided, as the case may be.

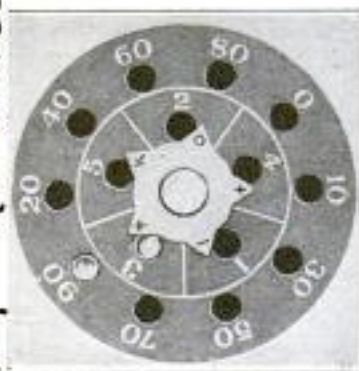

top stops, directly beneath certain of the openings. By means of an indicator which moves freely on the spinning handle, the indicated figures are then either added, subtracted, multiplied, or divided, as the case may be.

Our Bureau of Information is for your benefit. Use it as often as you please.

**NEW CAPTIVATING METHOD
OF CHILD PORTRAITURE**

A very charming method of child portraiture has lately come into vogue in England. The sitters are depicted in fancy costumes, actively occupied in some childish way, such as playing with toys, or petting "bunnies," all most delightfully colored. Several examples of these portraits, with fanciful settings, have been on exhibition in London galleries, and have been much admired.

9573

**ODDITY OF NAME MADE BASIS
OF ADVERTISING SLOGAN**

Profiting by the oddity of a name, an advertising club in the northwestern part of this country has adopted the following slogan: "Walla Walla, the Valley They Liked So Well They Named It Twice." This slogan will be placed on all products



of this country has adopted the following slogan: "Walla Walla, the Valley They Liked So Well They Named It Twice." This slogan will be placed on all products

from that section, on the windshields of all the motor cars in the locality, and on road-marking signs, and local business men will use it on their letterheads.

9560

**ANY TALKING MACHINE USED
AS RADIO LOUD SPEAKER**

Any talking machine can be utilized as a radio loud speaker by the addition of an easily adjusted attachment, introduced by an eastern concern. The innovation has three ends, or connections, one of which is attached to the arm of the machine



after the sound box has been removed. To the other two ends, the receivers are affixed, the sound coming out of the instrument in the usual manner, thus making use of the tone amplifier to secure a mellow and clear tone.

Mrs. Wm. A. Mills
103 Park Ave.
New York

Jay Ball Bearing Co
457 N. Racine, Chicago

Walla Walla Advertising Club



Refacing Old Pulleys and Flywheels

By J. S. HAGANS

WOODEN pulleys sometimes warp so that they do not run true, which causes the belts to flap, and causes a great deal of strain and vibration on the shaft. Aside from the mechanical disadvantages, such a pulley is unsightly. This condition, in the case of wooden pulleys, is usually caused by dampness and heat. Occasionally, also, a slipping pulley that has been tightened up a number of times will not run true. Pulleys in this condition can be trued without removing them from the shaft, by using the device illustrated in Figs. 1 and 2 of the drawing. The toolrest part of the fixture is made from a piece of flat iron, bent into the form of a "U," and drilled with a number of holes for attaching the supporting legs. In use, the device is clamped to the sides of a ladder, with the legs or brackets resting on one of the rounds. After the ladder has been placed in position firmly, the fixture is adjusted so that the front edge is close to the rim of the pulley and serves as a rest for the wood chisel, or turning tool, used to true up the wheel.

A similar dodge is used by shopmen engaged in the rebuilding and overhauling of old machinery, for refinishing the faces of flywheels and steel pulleys, to remove nicks and make them like new. Even were it possible to remove the wheels and do the work on a boring or turning mill, this would increase the labor cost, which, on this class of work, must be kept at the

lowest possible figure. If the work is done in a small shop where power is available, set up the engine near a lineshaft. Place a suitable pulley on the shaft to revolve the flywheel at a rate of about 30 ft. per minute; this will turn the wheel quite slowly, but the slow speed is desirable. A

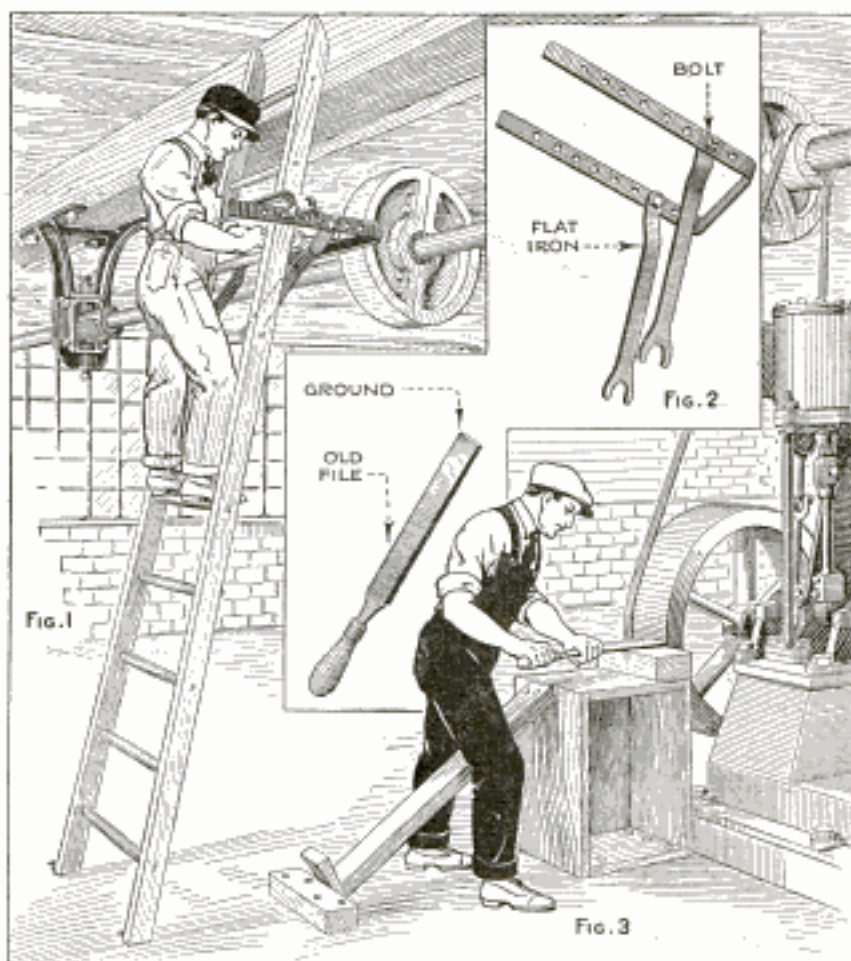

Fig. 1 Illustrates the Fixture Used to Turn Down Wooden Pulleys That have Warped. Fig. 3 Shows How the Faces of Steel Flywheels and Pulleys are Finished to Look like New

box is nailed to the floor near the rim of the wheel, and well braced, as in Fig. 3; this arrangement provides a rest for the tool. A narrow belt is then run on one side of the pulley, and wood strips are used to hold the belt near the edge.

Old files make good facing tools for

such work, and are ground as in the drawing, with a square end. By using such a file as a cutting tool and holding it so as to produce a minimum of clearance underneath, like a scraper, a cut can be taken across the face of the wheel that will remove all the surface nicks, paint, and rust, and give a bright new surface. When one side of the wheel has been finished, the

positions of the belt and box are reversed, and the operation repeated on the other half.

For finishing, the workman can use a regular mill file, or if an extremely high finish is desired, it can be obtained by using emery cloth tacked to a block of wood and pressed against the revolving wheel; a little oil should be used with the emery.

Hay Hook Used to Pull Staples

A rancher, finding it necessary to remove about four miles of old fence, tried several methods of pulling the old staples



Using a Hay Hook to Pull the Staples from Wire Fence Greatly Reduced the Labor Involved

without breaking the wire. It was found that a hammer or fencing pliers would not take hold of the staples, as they were deeply imbedded in the wood. As the wire had to be used again in a new fence, it was desirable that there be as few splices as possible. After trying several schemes, the idea of using an ordinary hay hook was hit upon. It was found that the point of the hook could be driven into the wood under the staple, the curve of the tool providing just the proper leverage. Using this tool as illustrated, no time was lost, no more wires were broken, and it was found that the staples could be pulled almost as fast as they could be driven.—W. W. Parker, Firestone, Colo.

Cleaning Platinum Filings

To remove dirt from platinum filings, spread them thinly in an iron pan, and heat to burn out the dust and other inflammable matter that may be present. After cooling, pass a magnet through the filings a number of times to gather up any fragments of steel and iron that are mixed with them. At this stage the filings can be washed before melting them into a button. As some of the metal may be lost in the melting process, it is suggested that the particles be reduced to a button of pure metal with an oxyhydrogen blowpipe.

A Rest for the Soldering Iron

Soldering irons, which are necessarily heavy, have a tiring effect on the user's arm when the job takes any great length of time; especially is this so when the work requires frequent turning, so that the tool must be lifted away from the seam repeatedly. The soldering-iron attachment shown in the illustration has a double use, as it forms a convenient means of holding the iron while it is being heated in the flame of a blowtorch, as well as a rest when in use. The device can be made in a few minutes by bending a piece of flat steel, about $\frac{3}{4}$ in. wide, into a semicircle and sawing out a slot in each end to clear the shank of the



This Attachment for the Soldering Iron Removes the Weight of the Tool from the User's Wrist and Serves to Support the Iron in the Flame

tool. The sides or ends of the slots are doubled over to take pins or screws, which hold the attachment to the iron, leaving the latter free to turn if desired. With this attachment, the full weight of the tool is removed from the arm of the user, the iron being raised or applied to the work by rocking the rest as required. As the rest is intended for repetition work only, it can be slipped on or off in a few seconds. Blocks of wood are used to raise the iron to a height most convenient for the work in hand.—Harry Moore, Montreal, Can.

Guard for Lathe Grinder

The illustration shows a simple sheet-metal guard, applied to a grinder used on the lathe. This is an attachment that is usually overlooked when grinding in the lathe, but it is a very necessary one, as it not only prevents injury to the operator's eyes, but keeps particles of the abrasive from lodging in the ways of the lathe. The grinder is simply a small bench

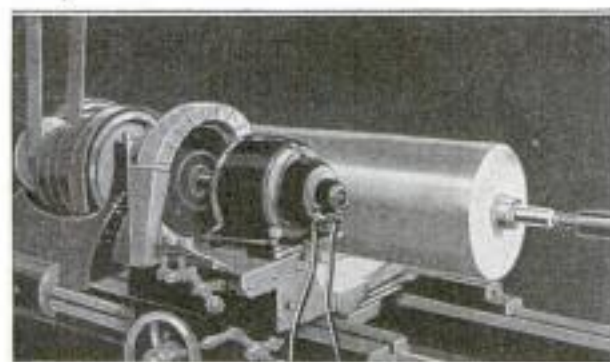

A Simple Sheet-Metal Guard Used When Grinding in the Lathe: A Clamp Holds It in Place, Making It Instantly Detachable

grinder, bolted to the cross slide, and the guard is attached to the cross slide by a clamp.

Steel Truck for Enameled Flywheels

The problem of handling 80-lb. cast-iron flywheels, after they have been enameled, and placing them in a drying oven, without touching the enameled surface, was solved by a large manufacturer by using the steel truck shown in the illustration. The flywheels are given a coat of black enamel, which is sprayed on in a spray booth, and must be carried from it to a baking oven, where they are baked for two hours at a temperature of about 250° F. The special truck designed to handle these flywheels is made from steel angles and will hold 30 wheels at one time, making a total load of about 2,400 lb.

Owing to the weight of each flywheel, it is necessary to handle them one at a time from the spraying booth, so uprights

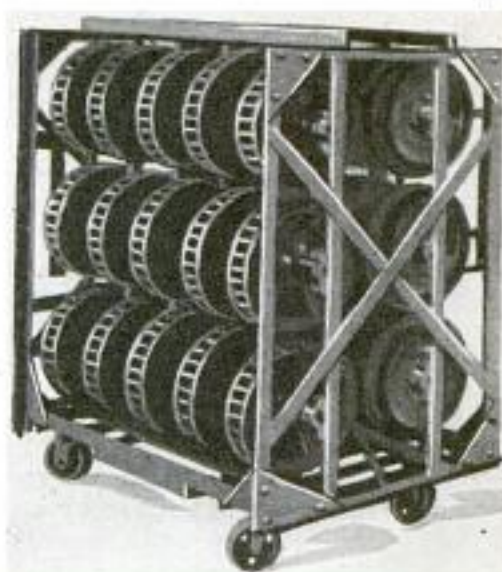

A Steel Truck Used in a Large Manufacturing Plant to Carry Enameled Flywheels from Paint-Spraying Booths to the Baking Oven

are placed in the framework of the trucks at the proper distance apart, and lugs riveted on to hold six rows of flywheels. Short lengths of 1-in. iron pipe are put through the shaft holes of the wheels before spraying, and the wheels are placed on the truck with the ends of the pipes resting on the lugs attached to the uprights. When the truck is full, it is pushed on its own casters to the baking oven. The casters have wheels about 6 in. in diameter.—Ed. H. Tingley, Dayton, Ohio.

Gauge for Marking Tubes

To facilitate the drilling of a circle of holes in tubing or cylindrical work, the marking gauge shown in the illustration will be found useful. Generally, if a shaft has to be drilled with any number of holes around the circumference, it is first "nicked" with a tool while it is running

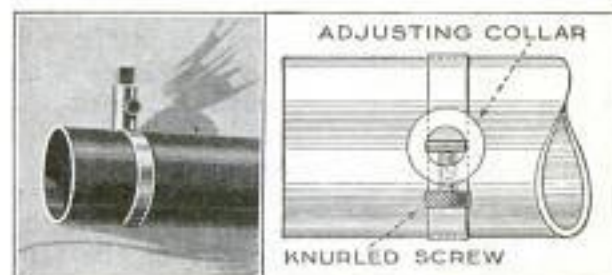

A Simple Gauge for Scribing a Line around Tubing or Other Cylindrical Work: The Device Consists of a Strip of Spring Steel and a Clamping Collar

between centers, but this method is not always possible in the case of tubing, as it may not run true enough.

To make this gauge, a piece of flat, flexible steel, long enough to fit around the various sizes of tube, is required. A long collar, of small diameter, is tapped in the side for a knurled tightening screw, and drilled in the center to take the double thickness of spring steel snugly.

In using the gauge, it is slipped over the work, the two ends of the steel band are pulled through the collar and the screw tightened. A scriber is then run around the work, the point bearing against the edge of the gauge, and if the gauge is properly made, this line will be exactly true and at right angles to the bore. It is apparent that the same gauge can be used for shafts as well as tubes, as, in many cases, the appearance of the former is spoiled by a mark such as made by a lathe tool.

Boring Out Pipe-Center Base in Lead Chuck

A pipe center that required boring out to take a new thrust bearing offered a rather difficult problem, as its shape made it hard to hold it true for machining in the lathe. To accomplish this, a lead

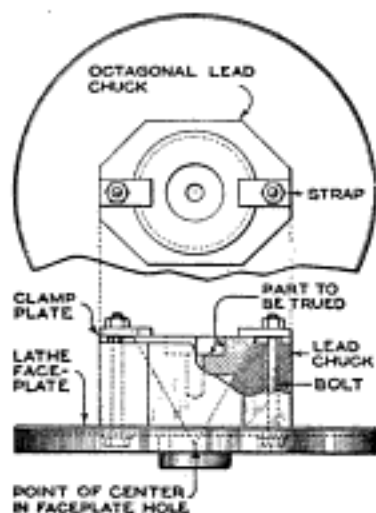

chuck was made, the center clamped in it, and the whole bolted to the faceplate. A roughly octagonal mold was built of wood, a little larger inside than the outer diameter of the center. This was placed on a flat, level board, the center placed within it, base down, and two bolts were driven into holes bored in the board to receive them. The top of the mold was finished level, so that when filled with lead both faces of the chuck would be approximately parallel and square with the center. A smooth board, with a hole for pouring and a small vent hole, was clamped over the top of the mold, with the point of the pipe center and the two bolts projecting, and the mold poured full of lead.

When cool, the mold was removed, the

pipe center driven out, and the chuck bolted to the faceplate and trued up as nearly as possible. Then a light cut was taken along the side of the cavity, using the compound rest, at the same angle as the face of the pipe center, until the center, when placed therein, was found to run true. It was then clamped in place by a couple of short straps, and the boring continued, taking light cuts so as not to throw the chuck out of true. The point of the center projected through the chuck and into the center hole of the faceplate.

Driving Nails to Prevent Splitting

French cabinetmakers have a simple method of preventing large or small nails, when driven close to the edge, from splitting the wood. The nails have their points blunted by tapping the ends lightly with a hammer while resting the heads on a piece of iron. Treated in this manner, the nail, when driven, pushes the wood fiber before it, preventing splitting, whereas the sharp-pointed nail pushes the fibers of the wood to the sides, causing a tendency to split.—Edson E. Shatto, Serena, Ill.

A Precision Testing Block

Many shops often feel the need of having something absolutely square for testing purposes, yet very few have facilities for machining a piece so accurately. The drawing shows a testing block that is made up of several parts, and is so constructed that it can be made in any shop, however meager the equipment. The round

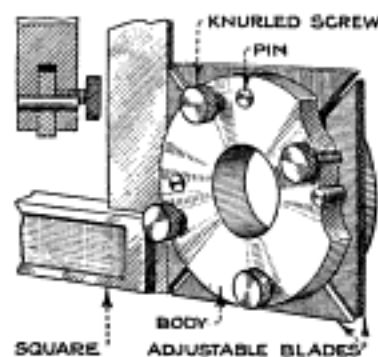

body is made of machine steel, a hole being drilled or bored through the center for convenience in handling, and a groove cut around the circumference to take the four adjustable blades. The latter, which should be made of tool steel, need not be accurate except on the outside edge, which should be perfectly flat. They are attached to the body, at right angles to each other, by snug-fitting pins through their centers, which allow them to rock against the bottom of the groove.

Each blade is tightened separately by a knurled screw, threaded into the body a little to one side of the pins. To set the block square, place the tool on the surface plate and bring an adjustable-blade square, bevel gauge, or similar device that is capable of being adjusted out of square, against one blade. With both pieces set approximately square, set the four blades alternately, adjusting them and the square or bevel until the block can be turned to all four positions, and the contact between blades and square is light-tight; then tighten all the screws. It will be seen that both the block and the other testing piece must be absolutely square when this result is reached, and that the fixture can be used to prove the squareness of any work, with confidence as to accuracy.

Cutting Oil Grooves in Pulleys

The drilling of an oil groove in the bearing of a loose pulley, or similar part, is a simple operation when a loose-fitted drill guide, of the type illustrated, is used.

The guide consists of a piece of round bar stock, of approximately the same diameter as the hole in the pulley, with a diagonal hole extending from the center through the side. A stop, to be clamped to the drill, has one edge beveled off to correspond with the angle of the hole in the guide, against which it bears. As the drill is fed forward, the bearing metal is cut away to form a V-bottomed groove. As the guide is free to move in any but a perpendicular direction, variations of the operation described make it possible to cut grooves in a variety of patterns.

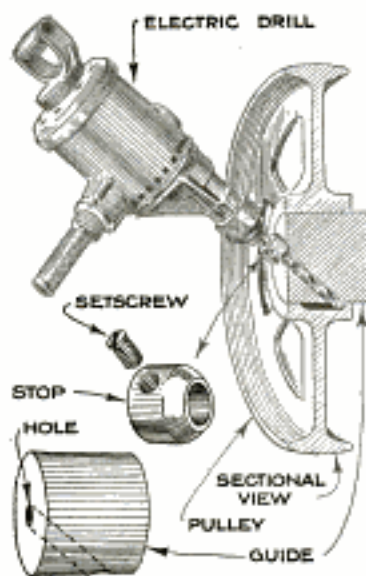

☐ To clean scale from gray-iron castings, pickle by immersing in water containing not more than one per cent of sulphuric acid and let stand for two or three hours; rinse in cold water, and scour with sharp sand and a fiber brush.

Supplying Lubricant to Drilling Head

To supply lubricating and cooling compound to the eight spindles of a drilling head, the arrangement illustrated was successfully used.

A hollow casting served as the lubricating ring. The holes through which the lubricant flowed were drilled entirely through the walls of the casting, the superfluous orifices in the outside diameter being closed with plugs. The completed lubricating ring was placed around the drilling head, and connected to the oil pump on the machine with pipe. In use, the lubricant is pumped through the holes and runs down the drills.

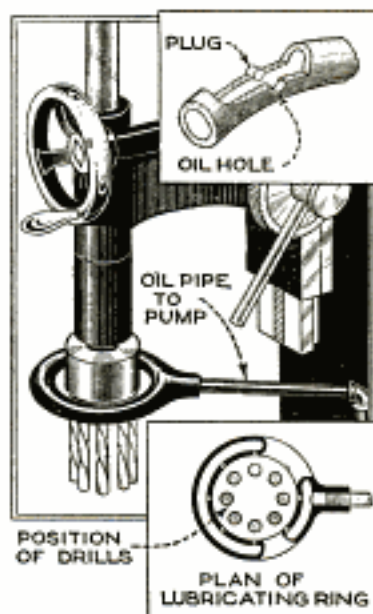

Roller Truck for Farm or Factory Yard

A truck, built after the style of a baggage truck, but with a long roller instead of wheels, is handy about the farm or factory yard for transporting tools, sacks of grain, and other heavy and bulky loads, the roller permitting use of the device on soft ground. The construction is simple

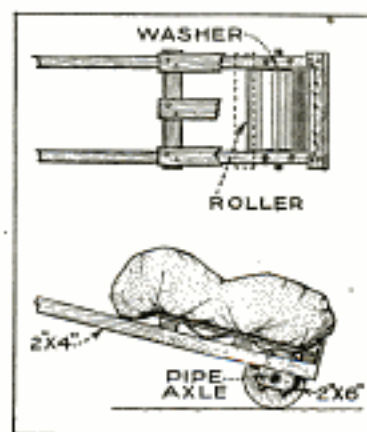

and may be modified to suit the particular use to which the truck is applied. The roller can be made from a piece of large-diameter pipe, provided with wooden ends, which are drilled to accommodate the pipe axle. For a more elaborate truck, a cold-rolled steel axle, running in cast-iron bearings, can be used to make the truck run easier. Washers should be placed on the shaft between the ends of the roller and the bearing blocks.

Cooling System for Hopper-Type Pumping Engine

A 1½-hp. gasoline engine with a hopper-cooled cylinder was used to operate a well pump that elevated water to a tank.

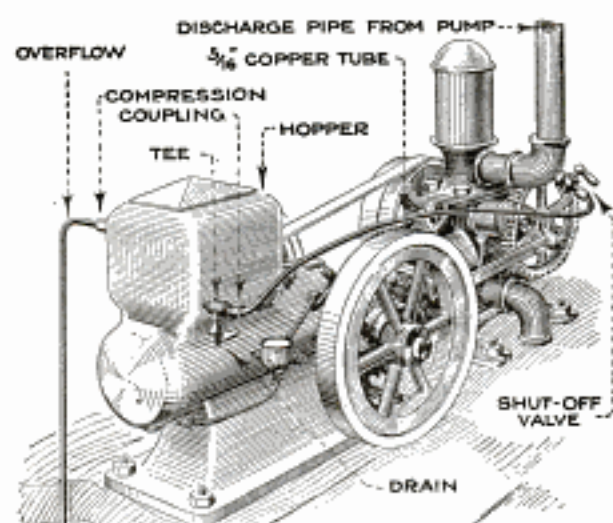

By Connecting a Hopper-Cooled Gasoline Engine to the Discharge Pipe of the Pump, It Operates by a Small Pipe Line. It Is Almost Impossible for the Hopper to Boil Dry

The hopper required periodical filling, and it was feared that this might sometimes be overlooked, so that dangerous overheating might develop. Accordingly, a continuous-flow system was installed by bringing a 5/16-in. copper pipe from the discharge pipe of the pump to the lower end of the water hopper. A shut-off valve was provided in the line, to cut off the supply of water or regulate its flow. A drain cock was also fitted, close to the hopper. Near the top of the hopper, a hole was drilled and tapped; a compression coupling was screwed into this hole, and another copper tube carried off the overflow. Of course, any other size of pipe and type of couplings can be used, but 5/16-in. pipe and fittings will generally suffice, as only enough make-up water is required to keep the hopper filled, the temperature of the water usually being kept close to the boiling point.

Annunciators for Group Machine Operators

Where a single operator is responsible for the output of a group of machines, such as screw machines, gear cutters, millers, and the like, an ordinary electric-annunciator and bell system can be used to call to the immediate notice of the workman the machine that requires attention, as when it runs out of stock.

Electrical contacts are arranged on the machines thus equipped, in such a man-

ner that, on the completion of a particular operation, the needle on the annunciator will point to the number of the machine to which it is wired. The contacts, in most cases, can be attached to the bed and table, to automatic stops, or to other parts of the machine. One of the contacts must be insulated from the machine by mounting it on a fiber block.

Micrometer Height Gauge

The height gauge, although a very useful tool, is beyond the reach of many mechanics by reason of its cost. However, a very serviceable instrument can be easily made from the tools found in most kits—a micrometer, square, and depth-gauge scale, held together by the attachment shown in the drawing. The clamping device for holding the micrometer to the perpendicular scale is made from a piece of ½-in. flat steel, slotted at the top for the micrometer frame, and at the rear for the square blade and scale. The slot at the rear is the same width throughout, as the blade of the square and scale will be alike, or nearly so, in thickness. Before this slot is cut, however, the attachment is tapped for the screw which holds the square and scale parts together. The micrometer is held to the attachment by a clamping screw which binds the instrument tightly. When the micrometer has been lined up squarely, a small hole is drilled and a pin inserted; thus, when the tool is to be assembled, it is only necessary to slide the micrometer

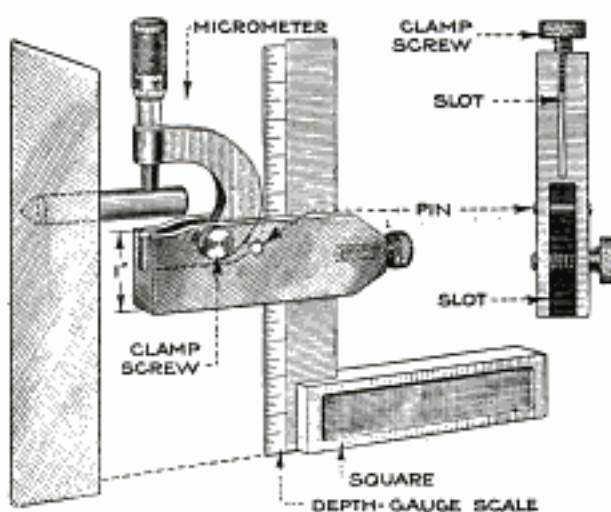

A Substitute for the High-Priced Micrometer Depth Gauge: The Mechanic can Make It Himself from the Tools That Already Form a Part of His Kit

along the slot until the frame touches the pin, when the screw is tightened.

The distance from the top of the micrometer anvil to the bottom of the clamp should be exactly 1 in. Then,

when measuring the height of a plug 4.560 in. from the surface plate, the attachment would be set so that the bottom was exactly on the 3-in. line of the scale; this, plus the 1-in. thickness of the attachment, gives 4 in., the height of the anvil face. The micrometer spindle is now raised .560 in., which is the correct height of the plug. If care is taken in reading the scale, accurate results will be had. However, if 1-in. measuring blocks are at hand, the insertion of three of these would give the highest accuracy much more easily.

An Improved Pipe Vice

When pipe is to be threaded or cut, and there is no pipe vise handy, a pair of pipe wrenches can be rigged up to serve the purpose. The wrenches are applied to the work so that they face in opposite directions, which prevents the pipe from turning either way; both the wrenches and the work are clamped to the bench with blocks.

Pipe to be cut or threaded can be held as securely by this method as in a regu-

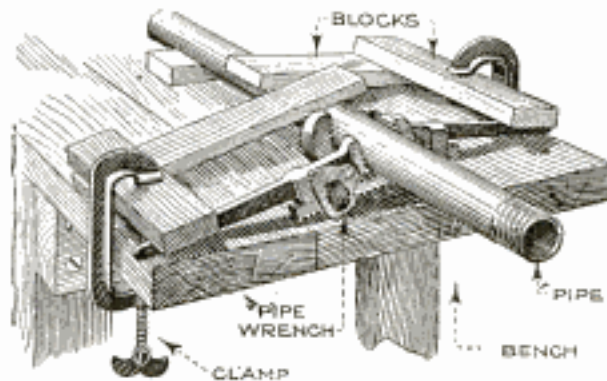

Threading and Cutting Pipe in an Improved Substitute for a Pipe Vise: Two Pipe Wrenches are Used to Hold the Work, the Whole being Clamped to the Top of the Bench

lar pipe vise, if the wrenches are properly secured and adjusted, although, of course, more time is required to clamp and release the work.

Hand Tapping on a Sensitive Drill

The drawing shows an arrangement for tapping by hand, with the tap held in the chuck of a sensitive drill, the spindle being turned by a handle attachment clamped to the upper end. This method insures a true start of the tap into the hole, especially if the hole is drilled and tapped at a single setting of the work; there is also less chance of tap breakage. If much repetition work is to be done, it would be well to cross either the main

drive belt or the speed-changing belt on the drill press so that the tap can be backed out by power.

The handle attachment may be either a

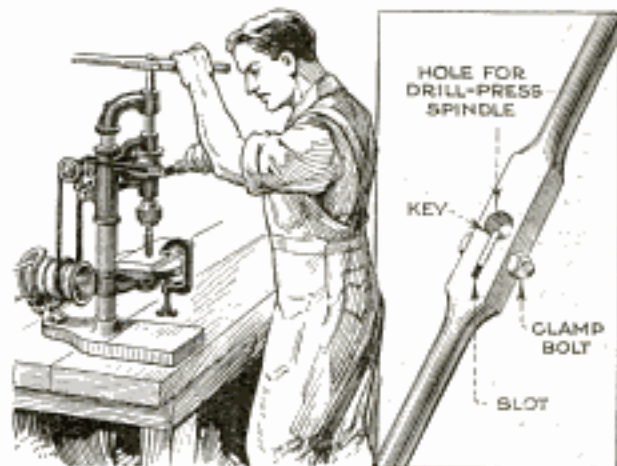

Holes can be Drilled and Accurately Tapped at a Single Setting of the Work in a Sensitive Drill. A Handle Attachment Clamped to the Spindle Makes the Tap Enter Accurately

casting or forging, or it may be turned from rectangular stock. A key is provided, which fits into the spindle keyway, and the slot in the handle into which this key fits also serves to secure it tightly to the spindle. In starting the tap into the work, pressure is applied to the feed lever with one hand, while the other hand is used to turn the handle. After the tap is started, the feed handle is allowed to work freely, and both hands are used.

A Combined Hammer and Drift

For the particular use of drill-press operators, the combination lead hammer and drift not only saves the operator's time, but he always has at hand the means of driving a drill firmly into its socket without damage. The taper key

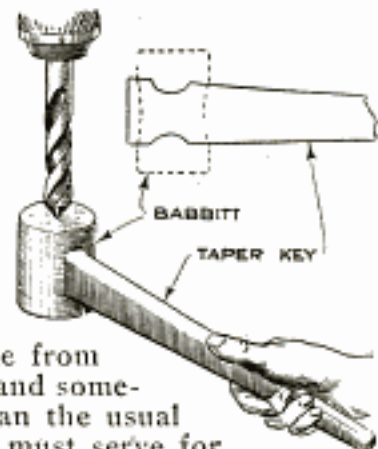

or drift is made from flat-steel stock and somewhat longer than the usual key, because it must serve for the handle of the hammer, as well. The lead or brass hammer head is cast around the large end of the key, which protrudes about $\frac{1}{16}$ in., to form a convenient projection to strike when the key is used for driving out the drill.—M. E. Duggan, Kenosha, Wis.



A CHEAP CONCRETE MIXER

By W. S. BETTS

THE farmer would use much more concrete construction than he does, were it not for the difficulty of mixing any large quantity by hand. A very satisfactory mixer, which should not cost more than \$15, may be made by following these plans; it will mix about two wheelbarrow loads at a batch.

The mixer proper is a lime-sulphur barrel, tar barrel, or any other heavy-stave barrel with one good head, that is, a head that is perfectly flat and is firmly attached to the barrel. This barrel rotates around its long axis in a frame that is arranged to tilt within another frame, thus dumping the batch.

The gears, sprockets and chain, shafts, bearings, etc., can be salvaged from a garage junk pile, or purchased from one of the junkmen who make a specialty of wrecking cars. There should be no difficulty in finding the materials, as they are all common automobile parts.

Obtain a bevel gear, about 12 in. in diameter, and its pinion; the pair should have a ratio of about 4 or 5 to 1. This gear will be in the form of a ring bolted to a flange. Remove the flange, and bolt the ring gear to the best head of the barrel, first knocking out the other head. Be very careful to center this gear exactly on the barrel head. From the plumber, get a 3-in. boiler flange union, a 3 to 1-in. bushing to fit the union, and a 1-in. long nipple. The flange union is in two identical members, fastened together by bolts. One member should be centered on the head of the barrel and bolted to the other member on the inside of the head, sandwiching the head between the two members, as in Fig. 4. The bushing and nipple may now be screwed in. It is well to smooth the surface of the nipple with a file, or to skim it in a lathe, if one is available, as it is to turn in a bearing.

Three 14-ft. and one 10-ft. 2 by 6-in. timbers will suffice for the entire frame. It is better to get these dressed on all four sides. The dimensions of the main-frame pieces are shown in Fig. 1, and the manner of framing in Fig. 2. The half-lap joints should be carefully cut, and the inside of each joint should be painted before bolting together. The crosspieces

E, F, and G, may be fastened by means of heavy lag screws if desired, although the method shown is the better. It will be necessary to strengthen the frame in front by two angle irons, shown in Fig. 2. The inside frame, which tilts within the main frame, is shown in Fig. 3. This is pivoted in the main frame, on the right side, by means of a heavy bolt turning in a piece of pipe, as shown in Fig. 7, but the left side is somewhat different. The pivot shaft must extend beyond the main frame, and be held fast, so that the pulley, shown in Fig. 5, may turn upon it. This is best accomplished by means of a flange through which the shaft passes, and by which it is rigidly held, the flange being securely bolted to the outside of the main frame. The hub of a discarded automobile wheel will furnish the flange, and an automobile axle the $1\frac{1}{4}$ -in. shaft. As the inside frame turns upon this shaft, it is well to use a piece of $1\frac{1}{4}$ -in. pipe for a bearing. The inside frame may now be put in place, when it will be found that the projecting end of the board M, Fig. 3, will strike on the back left-hand corner of the outside frame. Cut this corner off so that the inside frame will be nicely seated.

The pulley that takes the belt from the engine should be of such size that the mixer will rotate 40 or 50 times per minute. This is a simple calculation, as the gear ratio at the barrel head is known, and also the speed of the engine, and the size of its pulley. Simply multiply the speed of the engine by the size of the driving pulley, and by the number of teeth in the pinion. Divide this result by the product of the number of teeth in the bevel gear and the number of revolutions the barrel is to make.

For example, supposing that the engine makes 300 r.p.m., the engine pulley is 8 in. in diameter, the bevel gear has 40 teeth, and the pinion 10, and that the speed of the barrel is to be 40 r.p.m.: The speed of the engine, 300, is multiplied by the size of the pulley, 8, and by the number of teeth in the pinion, 10. The result is then divided by the product of the number of teeth in the bevel gear, 40, and the r.p.m. of the barrel, 40; the result is 15. This is

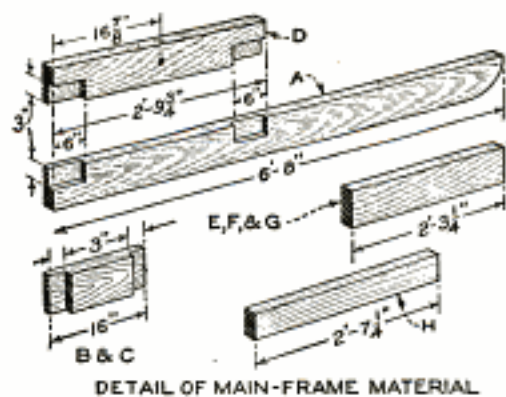

DETAIL OF MAIN-FRAME MATERIAL

Fig. 1

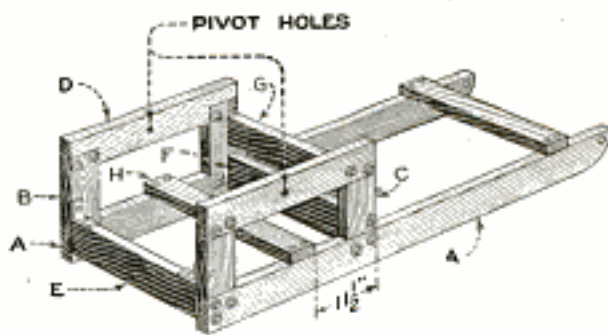

MAIN FRAME ASSEMBLED

Fig. 2

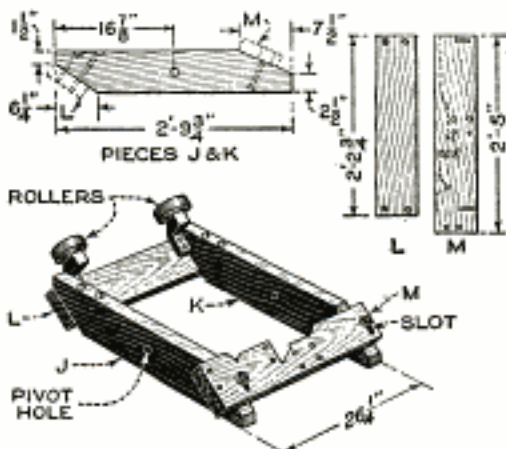

DETAIL OF INSIDE FRAME

Fig. 3

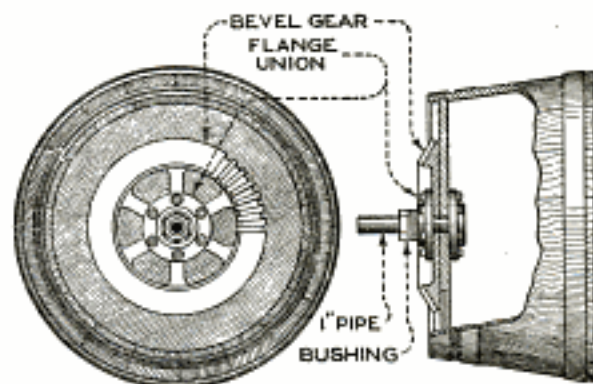

DETAIL SHOWING GEAR CONNECTIONS

Fig. 4

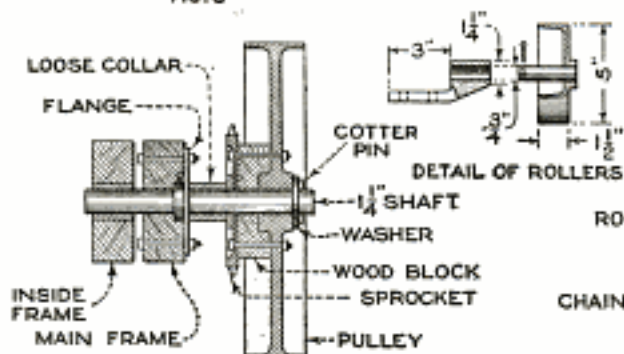

Fig. 5

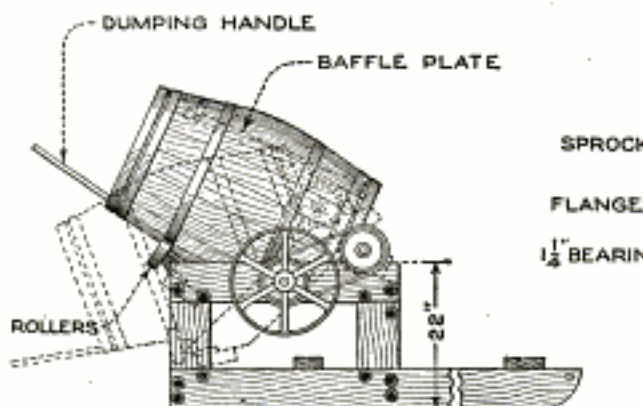

Fig. 6

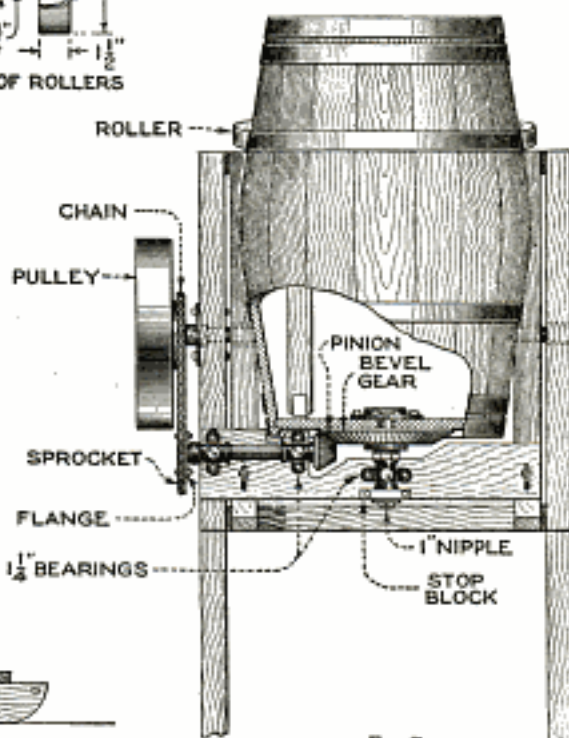

Fig. 7

Complete Details for the Building of a Cheap but Strong and Durable Concrete Mixer for the Farm: All the Mechanical Parts may be Obtained from the Automobile Junk Dealer, and the Necessary Lumber will Usually be Found around the Farm

the size of the necessary pulley, in inches. There is no reduction of motion in the sprockets, as they are of equal size. The pulley should be bored to take the $1\frac{1}{4}$ -in. shaft.

From the junkman obtain two sprockets, such as are used for chain-drive trucks, and about 5 ft. of sprocket chain. These sprockets are in the form of rings bolted to flanges. Remove the flange and bolt the ring to the belt pulley, as in Fig. 5. It will be necessary to block the sprocket out from the pulley, so that the chain may clear, and this is best done with a wood block. Bolt the sprocket through the wood to the spokes of the pulley. The pulley and sprocket may now be slipped onto the shaft, where they should turn easily, first inserting a collar of $1\frac{1}{4}$ -in. pipe and a washer for the pulley to bear against. Fig. 5 shows the complete details.

The builder is now ready to transfer the motion from the pulley and sprocket to the barrel. The motion is received from the pulley by the second sprocket, which is fastened to a $1\frac{1}{4}$ -in. shaft, at the other end of which is keyed the bevel pinion. This pinion engages the bevel gear on the head of the barrel. The details are given in Fig. 7. The shaft turns in two $1\frac{1}{4}$ -in. bearings, such as are used for automobiles. It will be seen that the board M, Fig. 7, is cut away to clear the barrel chine, gears, etc. No dimensions can be given for this, as the amount cut

will probably differ in every case. The best way to do this is to put the barrel in place with the nipple resting on board M. Block up the front of the barrel $2\frac{1}{2}$ in. from the board L, Fig. 3. Line the shafts up carefully, and cut away board M, so that the bevel gear may engage with its pinion. Bolt the shaft bearings into place, also the bearing for the nipple. A hardwood stop block, bored to accommodate the nipple, should now be bolted to board M, and a washer and pin inserted. This is to prevent the barrel from sliding forward when tipped.

The front end of the barrel is supported and rotates on two rollers, or casters, shown in Fig. 6. If two heavy discarded ball bearings can be obtained with the other parts, they will make splendid rollers, if protected from the cement and dirt; it will probably be necessary, however, to have these rollers cast in the nearest foundry. The cost should not be over \$3 each. The measurements are shown in Fig. 5. These rollers should be bolted to board L, so that the barrel will rotate between them, and so that they will keep the nipple at the head of the barrel central in its bearing.

A dumping handle bolted to the inside frame, and a baffle plate fitted inside the barrel, as indicated in Fig. 6, complete the machine. If the work has been carefully done, the machine should give as good service as commercial types costing five times as much.

Clamp for Squaring Ends of Belts

The successful use of any of the various devices intended for joining the ends of belts requires that the ends be perfectly



square. If a belt is repaired with its ends uneven, the strain will naturally be unequal, which tends to pull the belt more or less out of line and shorten its life. Many belt repairers use an ordinary square to mark off the broken ends and after-

ward cut down to the line, but it is a difficult job to cut straight across a belt,

the knife always showing a decided tendency to run off.

For such work, the spring clip illustrated is well worth making. The material used is heavy, flat spring steel, annealed and formed as shown, after which it is tempered lightly. It is apparent that no matter what thickness of belt is used the inner ends of the clip always lie flat against the sides. When in use, the belt is laid on one edge and the clip sprung over until the ends rest on the bench; the end of the belt is then sliced off, with the knife held against the side of the clip. Little time and no fuss are required to trim the ends of a belt in this way, as the clip can be sprung on or removed almost instantly.

Ⓞ Milling cutters with helical teeth are better for use on wide surfaces than straight-toothed cutters, as the former shave off the metal at an angle and less power is required; they also leave a more finished surface.



A Simple Method Used by a Swimming Instructor to Keep the Surface of an Open-Air Swimming Pool Free from Dust, Sticks, Paper, and Other Débris Blown into the Tank: Left, the Device in Use; Right, the Débris is Collected at a Corner of the Tank

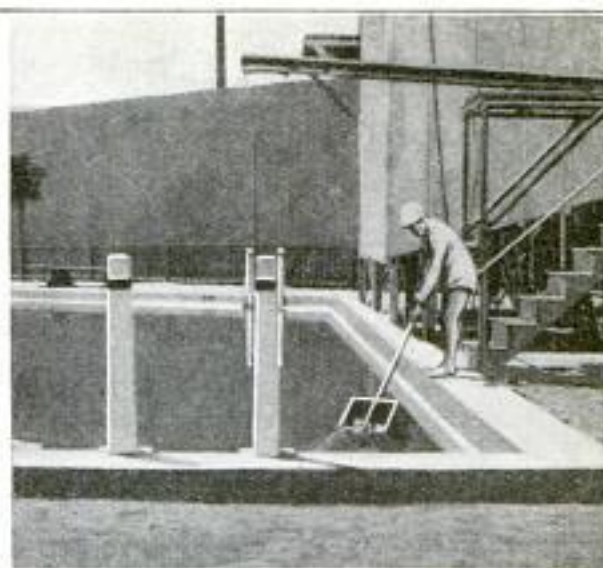

Keep the Surface of an Open-Air Swimming Pool Free from Dust, Sticks, Paper, and Other Débris Blown into the Tank: Left, the Device in Use; Right, the Débris is Collected at a Corner of the Tank

Skimming Flotsam from Surface of a Swimming Pool

At a California amusement park, the Hawaiian instructor at the big outdoor swimming tank has a clever system of keeping the surface of the water free of flotsam, such as dust, twigs, paper, and the like, blown into the pool by the wind. He does the work of cleaning the pool in a few minutes from the edge of the pool without the aid of a boat, and leaves the pond as clean as a sheet of polished glass.

He ties a long rope to the ends of a long stick or scantling, so that when he grasps the middle of the rope a triangle is formed. This allows him to keep the wooden base of the triangle constantly on the surface of the water as he draws it along by the apex, the flexibility of the rope allowing the user to keep ahead of the "drag" and remain on the edge of the pool. The stick always floats with most of its surface well above water, and if dragged at an angle to the sides of the tank, with its inside end in contact with the wall, and not too fast, a perfectly clean area is left behind. In this fashion the device is pulled to a corner of the pool, where the débris is easily and completely gathered up with a fine-mesh wire scoop, as shown in the right-hand photograph.—L. R. Perry, Berkeley, Calif.

Shelter for Small Engine

Many farmers, or dairymen, have a pump and small engine at some distance from the house, the engine being protected, if at all, only by a tarpaulin, or similar covering, to avoid the expense of

a pump or engine house. In such cases, a shelter of the type illustrated can be built at a trifling cost for time and materials, and will afford complete protection. The engine is bolted to a concrete-block base, and the box shelter is fastened to one side of the foundation with hinges,

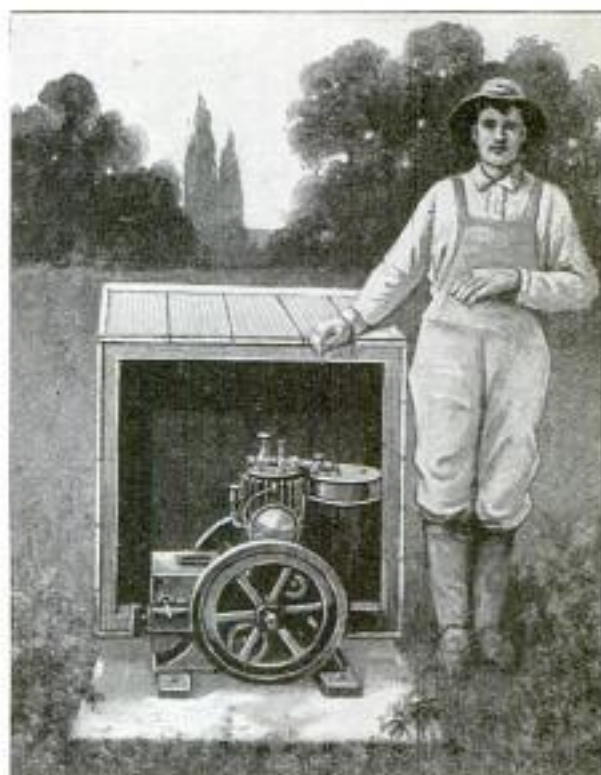

The Life and Usefulness of a Small Farm Gas Engine can be Greatly Increased by Providing Adequate Protection from the Elements

which are held by bolts set in the block. Thus, it is a very simple matter to cover or uncover the engine.—H. J. Engel, New Braunfels, Tex.

Small High-Pressure Pumps

The handicap of being unable to obtain small high-pressure liquid pumps often holds up the work of the experimenter;

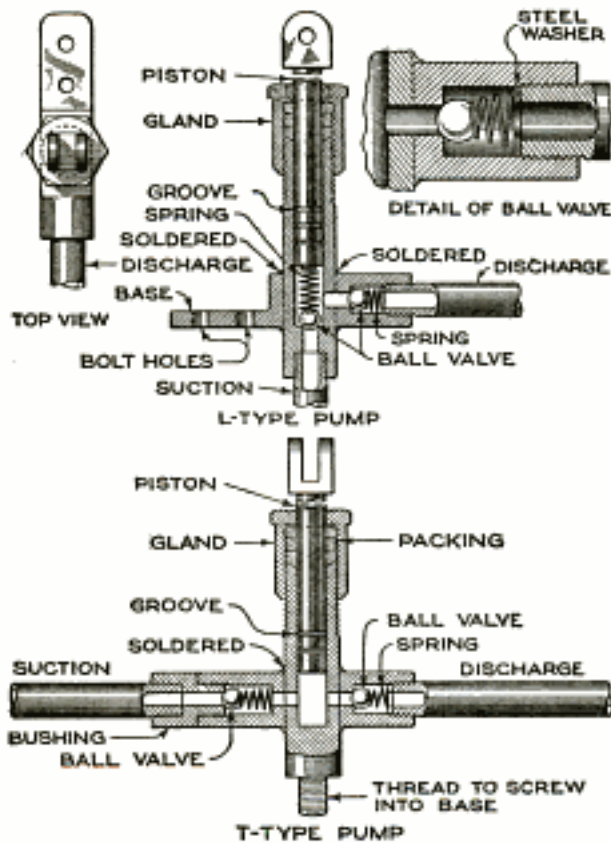

Two Forms of High-Pressure Pumps That will Meet the Requirements of the Experimental Mechanic: Of the Two Types, the L-Type Is the Simpler to Make

pumps of the styles shown, however, can be made at small expense. In these pumps, steel balls taken from ball bearings are used for the valves; where water is to be the element pumped, the use of brass throughout is recommended. The L-type pump is the simpler to make, as it requires a minimum of time and material. The pump cylinder is made of brass, with a carefully reamed hole for the bore. At the bottom of the bore is the suction-valve seat, on which the ball is held by a spring attached to the bottom of the piston. The discharge is through the side opening, which is fitted with a ball valve working outward. The cylinder and piece carrying the discharge valve are made separate, then assembled and soldered or brazed together, making a strong, tight joint; the discharge-valve piece is extended, as shown, to form a base for the attachment of the pump to the rest of the machine. The piston should make a snug fit in the cylinder, and should have two or three grooves cut in its lower end; these grooves hold the liquid and help to

seal the piston. A stuffing box at the upper end carries the packing, which can be adjusted to the proper tightness by screwing down the gland nut.

In the T-type pump, the suction is opposite the discharge, instead of at right angles to it as in the L-type, and in order to make the machining of the suction-valve seat an easy matter, it is cut in a bushing screwed into the valve body. The springs should be well fitted, with the end placed against the ball small enough to prevent it from slipping over the ball, and with the base large enough to center it in the cavity. To make a neat job of these spring seats, small steel washers, with holes in their centers, can be used to hold the springs in place. The pistons or plungers may be operated by eccentrics, cams, or small crankshafts.

Clamp Aids in Fitting Bearings

In all the larger repair or service shops for the most popular make of light automobiles, the bearings of the engine are "burnt in," or fitted with a machine. As these burning machines are quite expensive, the small shop must still use the time-honored method of hand scraping. After the babbitt in the cylinder block and in the bearing cap has been scraped to an approximate fit, the cap is bolted down and the crankshaft revolved. Often the cap bolts must be loosened and tightened several times before a correct fit is

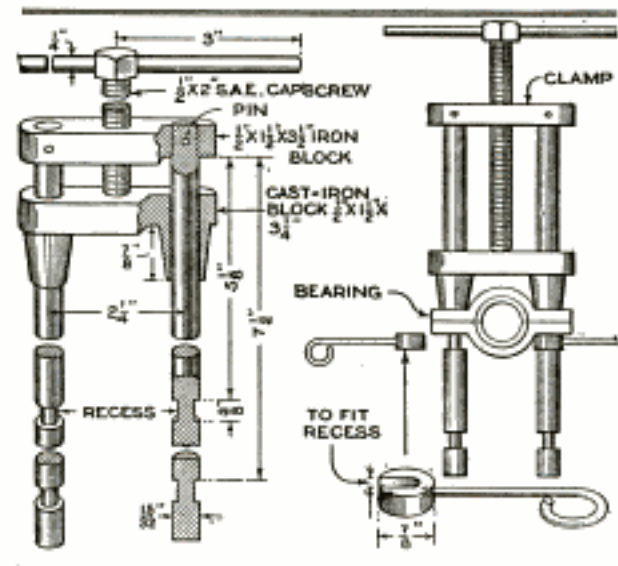

A Fixture for the Automobile-Repair Shop That Cuts Down the Time of Fitting the Main Engine Bearings of Light Automobiles

obtained or the proper number of shims inserted.

By using the tool shown in the draw-

ing, about two-thirds of the time used in fitting the shims can be saved. The two pieces of steel rod, each 9 in. long, are turned and assembled with the other parts, the form and dimensions of which are shown. Two washers are made from tool steel, slotted to fit neatly into the recesses on the rods, a handle is screwed into each, and the washers are then hardened.

To use, place the bearing cap in position, with the estimated correct number of shims under it, place the cast-iron block upon the cap so that the holes coincide, and slip the rods through the holes. If in the first, or center, bearing, the recess near the upper end will extend beyond the upper end of the hole about $\frac{1}{8}$ in. If in the rear bearing, the recess near the middle of the rods will be the one to use. Slip the slotted washers into the recesses in the rods, tighten the cap-screw, and try the shaft. If it needs more or less shims, loosen the setscrew, pull out the slotted washers and lift off the cap. Repeat the operation until the shaft is just right, then insert the proper bolts, tighten the nuts and insert cotter pins.—Vernon Orr, Pomona, Calif.

Auxiliary Tip for Micrometer

The drawing shows an attachment for micrometer calipers that will be found very useful when caliper narrow slots, or places that are not easily measured without their use. Either or both anvil and rod can be fitted with these caps, which are turned, hardened, and ground to the form shown. The inside diameter is a trifle smaller than the diameter of the parts they fit over, but by slotting them as shown,



fit over, but by slotting them as shown, they make a close fit.

Attachment Increases Usefulness of Test Indicator

The drawing shows a fast and accurate way to gauge the height of projecting parts with a familiar type of test indicator to which a simple little attachment is applied. The attachment is turned from machine steel, and taper-bored to fit over the stem of the indicator. If the device is to be used for gauging a large number

of parts, it would be advisable to case-harden the points of contact. The indicator is particularly useful for grinding

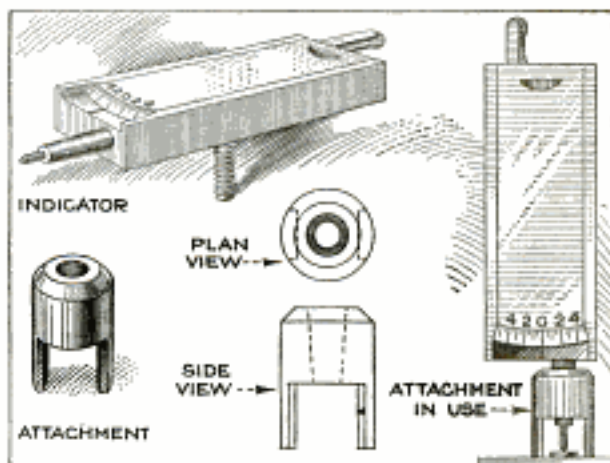

A Simple Attachment, That Slips over the Stem of a Test Indicator of a Familiar Type, Makes the Latter a Direct-Reading Height Gauge

operations. The great advantage gained by using this type of gauge is that the indicator shows how much more metal is to be removed.—T. Rod, Montreal, Can.

Drawbar for a 24-Foot Harrow

As generally equipped, the drawbars of tractor-drawn harrows have a tendency to pull the forward end of the implement either up or down. If the drawbar is made from a single heavy timber, the harrow can be made to run evenly. It is placed on steel-shod runners, which may be made of wood and shod with pieces of tire iron. The width and depth of the

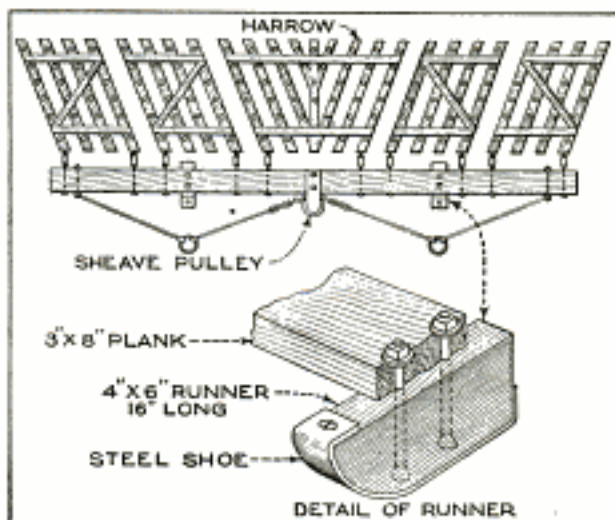

Preventing a Large Power-Drawn Harrow from Pulling Up or Down at the Forward End by Attaching the Harrow to a Single Heavy Timber Mounted on Iron-Shod Runners

runners will vary according to the character of the soil on which the outfit is used and the length of the drawbar. A little

experimenting may be necessary to get the right height, but after this is obtained, no further trouble will be experienced. The harrow is attached to the tractor drawbar by means of the equalizing arrangement shown attached to the forward edge of the beam.—L. A. Krider, Hatton, Wash.

Removing Cylinder-Head Plugs

Many types of automobile engines have plugs inserted into the cylinder head so that they can be unscrewed for inspecting, grinding, or removing the valves. Such plugs are usually made to be un-

screwed with a hexagonal key or wrench, and this is sometimes lost, broken, or otherwise unavailable when most needed. In such an emergency the plug can be

removed or screwed down by a simple method. A hexagonal nut, of a size that will fit into the wrench seat of the plug, is selected and put in place so that about half its thickness projects above the surface, providing a grip for a wrench.—Stephen Gladis, Forestville, Conn.

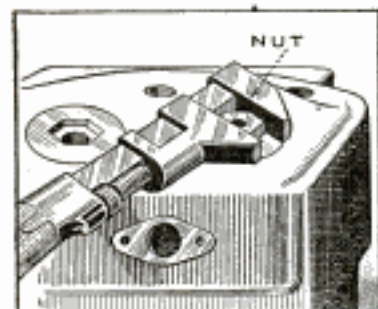

Rechambering a .22-Caliber Rifle

Those who have done considerable target shooting with a .22-caliber rifle have probably been annoyed at some time or other by the frequent sticking of the shell after it has been discharged. This occurs only in rifles that have been in long and continued use, and the sticking is due to the wearing of

the cartridge chamber from the lapping action of the copper on the steel barrel. This wears the forward end of the chamber a trifle larger, and as the fired shells expand to a tight fit, they will not eject on account of the taper in the chamber. The reamer shown in the drawing was

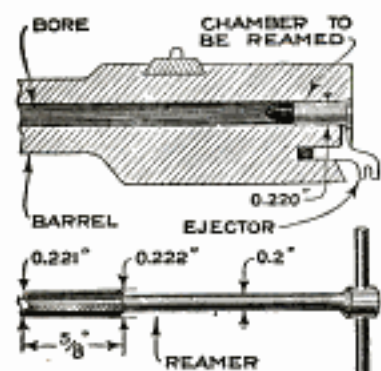

made for rechambering a rifle in which the trouble described had developed. Drill rod was used for the reamer, four flutes were milled out, and the shank turned to the dimensions given in the illustration. The original diameter at the rear of the chamber was .22 in. and the reamer was made .002 in. oversize at the back and .001 in. larger at the front. As the chamber was only 5/8 in. long, the reamer was limited to the same size. In using such a reamer, apply a little lard oil as a lubricant, and turn the tool slowly. The same idea can be applied to rifles of larger caliber when similarly worn.

The ejector is usually blamed when a shell sticks, yet, as often as not, in an old rifle, it is blameless, and the sticking can be traced to the cause assigned.—J. V. Romig, Allentown, Pa.

Vise for the Blacksmith's Anvil

Fitting into the hardy hole of the anvil, a vise such as the one illustrated makes it possible for the smith to do single-handed a variety of work that ordinarily requires the assistance of a helper. The body of the vise is provided with a series of notches along its horizontal extension,

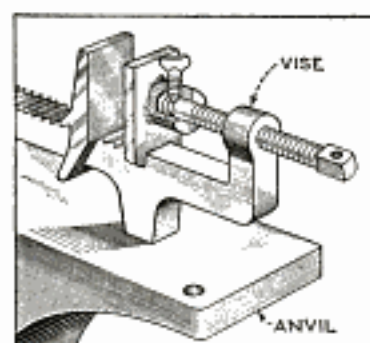

into which the tooth on the back of the rear jaw fits, making the tool quickly adjustable for work of different sizes. The vise screw is grooved on its inner end and is held to the

front jaw by means of a screw, the end of which fits in the groove.

A Lathe-Center Driver

The drawing shows an easily made convenience for tapping into place the live and dead centers of a large lathe. A hardwood block is commonly used for the purpose, but this soon splits up.

A heavy body is made up from either machine or tool steel, knurled if desired, and with one end drilled a drive fit for a brass plug, which is drilled and reamed out to fit the 60°

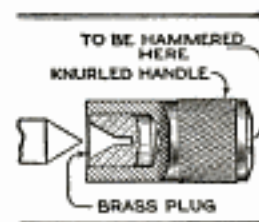

lathe centers. A large, combined center drill and reamer should be used for the purpose; in any event a hole must be drilled beyond the conical bore in order not to injure the point of the lathe center while driving it into the spindle. If the brass plug is set in slightly, as shown, it will help protect the center hole from accidental damage.—H. H. Parker, Oakland, Calif.

Chipping Tough Steel

Every mechanic knows the difficulty of cutting or squaring off the ends of keyways in a tough steel shaft. Also, he knows from long experience

that the ordinary cape chisel does not hold out long. The idea illustrated by the drawing shows how a short piece of high-speed steel may be used in a holder to make a thoroughly worthwhile chipping chisel.

The holder is made from a piece of cold-rolled rod, with a square opening broached in the end, into which the high-speed tool bit is inserted and held by means of a set-screw on the side.—John Aures, Buffalo, New York.



A Special Threading Arbor

Cutting an outside thread on work that is already provided with a thread inside, usually results in marring the outer

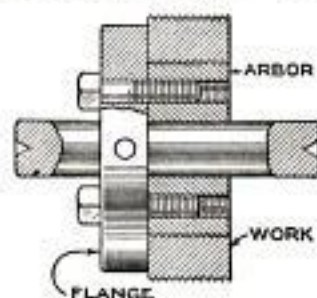

threads when attempting to remove the work from the arbor. With the arbor illustrated, when the cap screws are released, the work may be unscrewed with the fingers.

It consists of a flange, pinned to an arbor, and drilled for two or more cap screws. These cap screws hold to the flange a piece threaded to fit the internal screw on the work, bored an easy push fit on the arbor, and drilled and tapped for the screws.

The work is screwed on when the screws are tight; when the thread has been cut, the screws are loosened, and the work, being no longer screwed up tight against the flange, may be easily removed.—Harry Moore, Rosemount, Que.

Pencil Holder Made from Paper

Draftsmen, shopmen, and others who have occasion to use pencils for any length of time will appreciate the idea shown in the engraving, which allows short pencil stubs being used to give the utmost in service. The chief objection to the use of pencil stubs is the tight and tiring grip that must be used to hold them



in the fingers. This objection is overcome by rolling a cylinder of stiff paper around the short pencils, one in each end, and binding securely with cotton thread, tape, or an adhesive strip. If the paper is glued along the unbound edge of the cylinder, it will outlast a good many stubs before it must be thrown away.

Babbitt Ladle Made from Wagon Skein

As the illustration shows, an excellent babbitt ladle for use around the farm or lumber camp can be made from an old wagon skein

and a piece of iron rod, to serve as a handle. The larger end of the skein is cut square across, heated, and a lip or spout formed on the edge for convenience in pouring the metal. The lag-screw hole at the small end is filled up with a short bolt, with the head



inside and the outside end riveted. One end of the rod used for the handle is flattened, bent around the skein, and welded to the opposite side, making a continuous eye, and a small eye is turned in the other end by which the ladle is hung up when not in use.



A Homemade Utility Bench Grinder

By J. V. ROMIG

THE grinder illustrated and described in this article is an ideal type of machine for use in the experimental shop, small assembly department, or even the home workshop. The construction is simple, as the parts are easily obtained, and a minimum of machine work is required. Users of a grinder of this type have the benefit of two machines combined in a compact unit without sacrifice of strength.

The head of the machine requires two 1-in. pillow blocks as bearings for the grinding-wheel arbor; these bearings can be bought for a small sum from any machinery-supply house. The spindle, or arbor, is made of good tough steel, and grooves are turned in the bearing surfaces, as shown in Fig. 3. These grooves take the thrust, and prevent the shaft from moving endwise in its bearings. This feature of construction will, of course, make it necessary to reabbitt the boxes, to make the simplest and strongest bearing. The ends of the spindle are threaded with right and left-hand threads, as shown, for the wheel flanges that hold the grinding wheel to the shaft. The driving pulley is fastened to the spindle between the bearings, and oil cups of adequate capacity are fitted to the bearings to insure proper lubrication.

Four-inch pipe is used to make the pedestal of the machine; this pipe is turned down to an outside diameter of $3\frac{1}{16}$ in. and threaded at each end for screwing into the flanges. The flange at the bottom end of the pipe should be of the largest diameter obtainable, to make a solid base for the machine. The upper flange is shaped into rectangular form, as a base to which the two pillow blocks are bolted, and it may be necessary to have this cast.

In order to use the machine as a surface grinder, a special tee, fitted with an arm to carry the table, is added. A 4 by 4 by 2-in. tee serves as the body; it is chucked in the lathe, and the threads bored out to $3\frac{1}{16}$ -in. inside diameter,

making it a neat sliding fit on the turned pipe column. Ears, or lugs, are then welded to the rear side, as shown; these are drilled and tapped for the clamping screws, after which the lugs and tee are split, to make a clamp for holding the support at any position on the column. A section of 2-in. pipe is screwed tightly into the side of the tee; this horizontal piece of pipe is turned down to $1\frac{1}{16}$ -in. outside diameter. This arm must be perfectly square with the main column, when assembled, as it supports the pillow-block base of the pivoted worktable.

The worktable is made from a slab of flat steel, with pivot lugs welded to the underside of the rear end; the pivot arrangement for tilting the table is clearly shown. Holes are drilled and tapped through the lugs for taper-pointed screws, the points of which fit into 60° counter-sunk holes in the pillow-block base. Locknuts hold the screws, when tightened. This pivoting arrangement, together with the elevating screw shown, makes an accurately working mechanism. The weight of the table keeps it down tight and firm while grinding. The horizontal arm is made sufficiently long to allow the work to be moved laterally; the height of the pedestal is also sufficient to permit the use of jigs and fixtures. Since the table has no longitudinal travel, it is necessary to move the work itself, passing it back and forth under the wheel, feeding it in or across with each pass, until the whole area has been surfaced. Bent-wire frames are used to hold work that is too small to be fed by the hand, and on thin, flat stock, masks made of thin metal are used. Large work can be held and moved by C-clamps, as in Fig. 4, while a small toolmaker's vise comes in handy for holding many odd-shaped pieces of work.

As the work is slid back and forth under the wheel, it can readily be seen that the parallelism of the two surfaces must be exact. This feature is the most valuable characteristic of the machine, and makes for accurate quantity work.

For properly dressing and truing the grinding wheel, a diamond dressing tool is clamped in a small vise, held on the table, and brought against the wheel. The diamond point can be guided parallel

at a speed of about 2,500 r.p.m., which may be considered an entirely safe and efficient one.

An addition to the machine, which may be looked upon as a refinement,

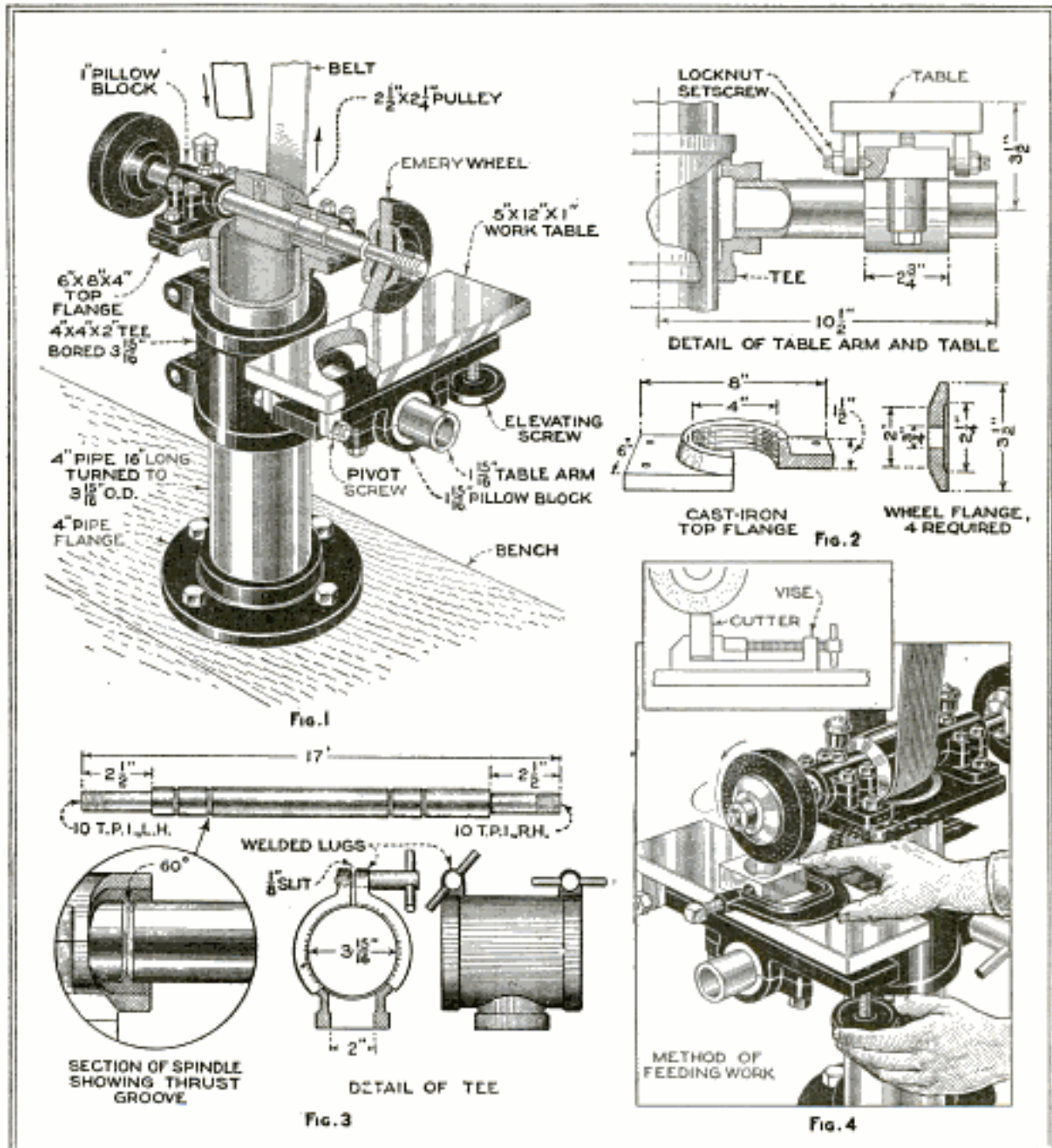

A Small Bench Grinder of a Very Convenient Type for the Small Workshop: All the Parts are Easily Obtained, and the Finished Grinder Is Capable of Accurate Work

with the wheel by clamping a steel square to the table.

Work must always be fed under the wheel from the rear, against the direction of rotation, as in milling-machine practice and for the same reason—to prevent the wheel or cutter from pulling the work in. A 6 by 1-in. grinding wheel is a suitable size for use with this machine.

The spindle or arbor should be driven

would consist of a vertical screw for adjusting the height of the table accurately. This would operate in exactly the same manner as those used for elevating the bed of a drill press. The addition of the screw would, of course, require that a lug be welded to the side of the tee and another to the flange base, the lug on the tee being drilled and tapped to serve as a nut for the screw.

Machine Anneals Parts Rapidly

The machine illustrated is used for annealing the ends of cas hardened shackle bolts, which are afterward inserted into

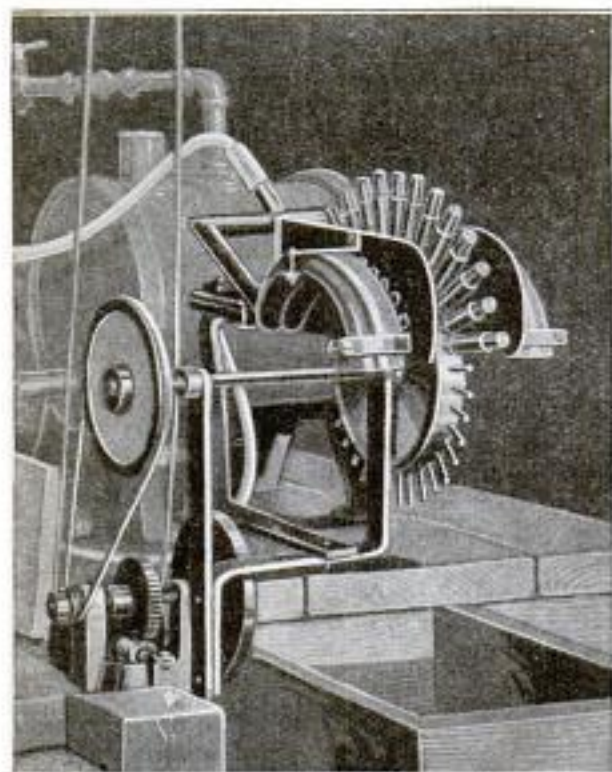

A Machine for Annealing the Ends of Cas hardened Shackle Bolts Used in Automobile-Spring Suspensions: The Bolts are Placed on the Radial Pins of a Slowly Revolving Disk and Pass between Gas Flames

the shackles and headed over in a punch press. The operation is practically automatic, and it is only necessary for the operator to place the bolts on the projecting pins of the revolving disk.

This disk is a casting, into the rim of which the pins are driven radially; these pins are just large enough to fit inside the hole drilled through the center of the parts to be annealed. The disk is driven at a slow speed by the worm reduction gear seen at the left in the illustration. Gas and air pipes are arranged at each side of the disk so that an intensely hot flame is directed against the ends of the pieces as they slowly revolve. The operator places the parts on the pins at the front of the disk, and only a few seconds are required to bring the parts to be annealed to a red heat, which is maintained for the period it requires to pass between the double flame.

As soon as the parts have passed below the center of the disk, at the rear, they drop off into a box, where they are allowed to cool.—J. Brandstetter, Chicago, Illinois.

Miscellaneous Uses for Linseed Oil

In the spring, before putting up the door and window screens, give the screens a very light coat of linseed oil on both sides. This treatment will add to the life of the screens by preventing them from rusting.

When there are so many coats of paint on tin roofs that the heat causes it to blister and peel, discontinue the painting and apply an annual coating of linseed oil; this applies also to tin valleys and gutters.

Galvanized-iron downspouts from the gutter troughs begin to rust first on the inside. To prevent this, pour a small amount of the oil into the top of each spout once a year, just after a rain and while the inner surface of the spout is still wet. The oil will distribute itself quite evenly over the wet surface and provide a rustproof coating.—Arthur Thornton, McKeesport, Pa.

Perforated-Pipe Lawn Sprinkler

Along the edge of the pavement, in front of the city hall of a small town, runs a $\frac{1}{2}$ -in. pipe that is practically invisible, being half buried in the earth of the parkway. Holes, at intervals of 1 ft., are drilled through the wall of the pipe at an angle of 45° to the pavement. The first



The Grass Plot along the Walk in Front of a City Hall is Kept Sprinkled during the Summer by a Perforated Pipe, the Water having First been Used to Test Water Meters

impression is that the arrangement is installed primarily for watering the lawn but the sprinkling system has another use. A pipe line runs from the basement of the building, where the water meters used within the municipality are tested. When a meter is to be tested it is inserted in the line, the connections tightened, and the water, which would otherwise be wasted, is used for sprinkling. During the winter months, the water from the meter-testing bureau is run into the sewer.—Dale R. Van Horn, College View, Neb.

Hardening Small Coil Springs

Small coil springs made of annealed steel wire should be hardened and tempered while held on an arbor. A process successfully used by jewelers is the following: The soft wire is wound on a threaded arbor of the proper diameter; two small holes are drilled through the arbor, at a distance apart equal to the length of the spring to be wound, and tapped and fitted with large-head screws. One end of the wire is fastened under one screw head, the wire wound on the arbor, and the other end is fastened as the first. The assembly is heated to a cherry red and quenched in cottonseed oil. To temper, the assembly is removed from the oil, held over a flame until the oil on it ignites and burns off, then quenched again.

To blue a spring after hardening, it should be polished thoroughly, and be free from grease or finger marks. It should then be placed, while on the arbor, on a small metal plate, copper being best for the purpose, and the plate placed over a flame. The spring is rolled back and forth until a deep-blue color appears, then quenched in water. The finished spring is removed from the arbor, washed in soap and water, and rinsed and dried in hot sawdust.

Case for Small Drills

Twist drills, especially those of the smaller or numbered sizes, are difficult to keep in proper order when dumped into a compartment of a tool box; besides, time is consumed in hunting for the size wanted, and the drills are liable to injury from contact with other tools. To make all the drills readily accessible, so that the proper size can be selected without hesitation, and prevent them from damage, the case illustrated provides a neat addition to the mechanic's tool kit.

It is made of sheet metal, to any dimensions desired, although the size indicated is convenient for the tool chest. The top and front flap of the case are hinged and provided with a small hasp so that a split ring, or lock, can be used to keep it closed. Two angle pieces are fas-

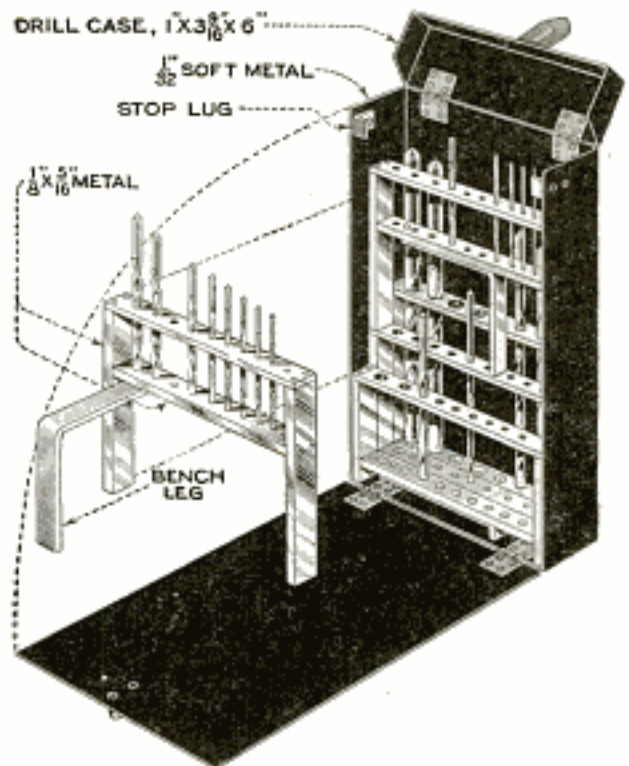

The Numbered, or Smaller, Sizes of Twist Drills are Kept in Order, So That the Proper Size can be Selected without Delay, and the Tools are Protected against Damage

tened to the sides, inside and near the top, to serve as stop lugs for the flap cover.

The drills are held in their proper order in a series of graduated drill benches, made of flat stock. Each of these benches is provided with a leg that folds underneath, so that a series of drill sizes can be taken from the case and stood on the bench. Five benches, as shown, will hold drills from No. 1 to 80, although the last bench, which holds the sizes from 56 to 80, can be dispensed with if extremely fine work is not done. The size of the drills may be stamped on the upper cross-pieces of the holders, or the numbers may be stamped on a piece of sheet metal to be attached a little below the top shelf.—P. A. Daschke, Astoria, L. I.

As a rule, timothy should be harvested for hay after the plants have passed out of full bloom, before any of the heads of the earliest plants have begun to turn brown, and before the seed has begun to mature.

Pinch Dogs Made from Nails

Inexpensive pinch dogs can be made from common nails by cutting off the head and end with a hacksaw, and bending

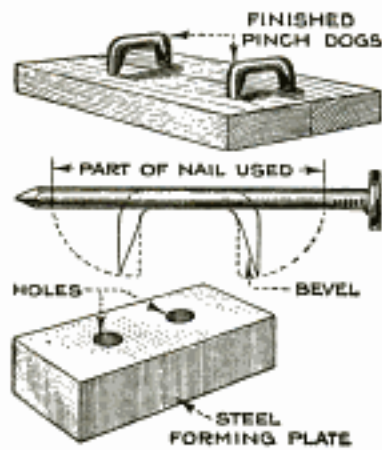

them into the desired shape and distance between the prongs. The prongs are filed on the inside to a flat sharp edge. Most pattern-makers desire their pinch dogs to be interchangeable, and in this case, a simple forming fixture can be made from a piece of flat steel. Two holes are drilled the desired distance apart and a little larger than the nail or rod used. The pinch dogs are then bent to the approximate size in a vise, after which the ends are placed in the holes of the fixture and driven down with a hammer.

Proper Angles and Dimensions for Steps and Stairs

Even the most casual observers have noticed that some stairways are much easier to ascend or descend than others, but why this is so, is not easily discovered. A stairway is only a man-made hill used to connect planes at different levels. By referring to the lower part of the accompanying drawing, it will be seen that the human leg swings in an arc, which necessitates a certain amount of "clearance" or drop to the incline or hill the person is ascending or descending. This principle, if applied to the building of steps, makes them easy to climb. A slant of $\frac{1}{8}$ in. given to the individual steps will be sufficient, and this is the secret used by expert stair-

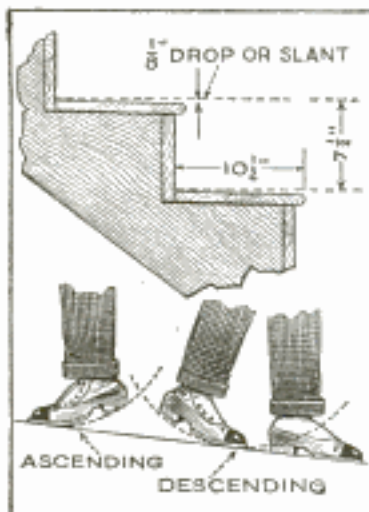

builders for producing what is known as an "easy tread." A flat, or perfectly level, step, or one having a slant toward the back, compels the person to lift the foot high to clear the front edge, and then lower it again to make contact for support. Besides being tiresome to climb, such a stairway is the cause of accidents due to tripping. Tripping is usually experienced on the descent, and the feeling of unnecessary fatigue on the ascent. The height of the steps is another important feature of a properly designed stairway. To be at their best, the steps should not be lower than $7\frac{1}{2}$ in. nor higher than $7\frac{7}{8}$ in. The width of the step, or tread, should be approximately $10\frac{1}{2}$ in. The pitch of all stairs should be governed by these dimensions when the layout or design is made.

builders for producing what is known as an "easy tread." A flat, or perfectly level, step, or one having a slant toward the back, compels the person to lift the foot high to clear the front edge, and then lower it again to make contact for support. Besides being tiresome to climb, such a stairway is the cause of accidents due to tripping. Tripping is usually experienced on the descent, and the feeling of unnecessary fatigue on the ascent. The height of the steps is another important feature of a properly designed stairway. To be at their best, the steps should not be lower than $7\frac{1}{2}$ in. nor higher than $7\frac{7}{8}$ in. The width of the step, or tread, should be approximately $10\frac{1}{2}$ in. The pitch of all stairs should be governed by these dimensions when the layout or design is made.

Powerful Shear Made of Bar Stock

The shears shown in the drawing were made in a sheet-metal shop, for cutting material too heavy for the usual cutters. The design is of special interest, as the method of supporting the fixed cutter

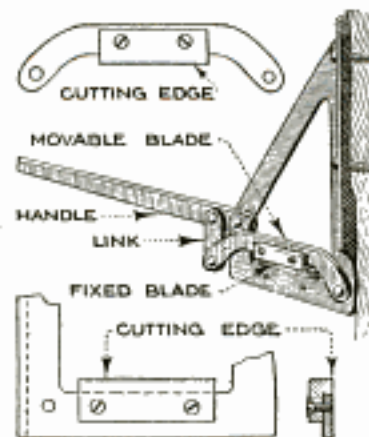

blade, and that of providing a powerful leverage with a simple linkage, are quite novel. The main frame is made from a triangular piece of structural plate, cut out to leave a diagonal support for the

outer end. The long side of the frame is bent at right angles, and drilled for lag screws, by means of which the device is attached to a post or other support. The movable blade is attached to a lever pivoted at the rear of the frame, while the hand lever is attached to the outside corner of the triangular frame; a link to connect the hand and blade levers completes the shear. The blades are made of tool steel, hardened and tempered, and are removable, so that they can be sharpened or replaced easily.—G. A. Luers, Washington, D. C.

Blueprints that have been slightly "burnt" can be brought out clearly by light sponging with peroxide of hydrogen.

Chuckling Thin Tubes without Distortion

Thin brass or copper tubes are often distorted when held in a three-jaw chuck for facing or threading the ends. For this reason many lathe operators turn up pieces of scrap stock to fit the bore of the tube; this takes the thrust of the jaws, but a better method is shown in the drawing, whereby tubes of any diameter, from 1 in. up, can be adequately supported with very little extra work.

The body of this support is a piece of 1-in. steel turned on one end to fit the taper in the headstock spindle. The front end is tapped for three $\frac{3}{8}$ -in. headless screws, the holes for which are tapped clear through the piece and are equidistantly spaced around the circumference, to suit the position of the chuck jaws. The device is set in the following manner:

A piece of tubing of the size to be turned is first gripped lightly in the chuck. The support is then held in the tailstock and advanced, each screw being set in turn to touch the inside wall of the tube. The piece is then removed

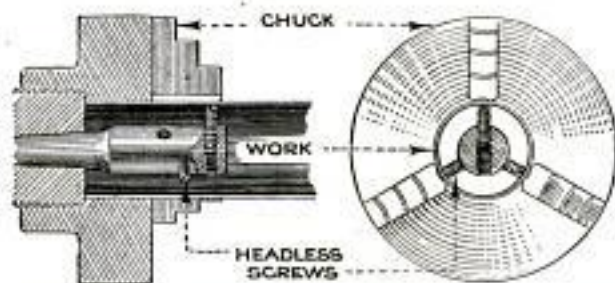

Support for Preventing the Distortion of Thin Tubing When the Jaws of the Lathe Chuck are Tightened Up

from the chuck, and the supporting device is placed in the headstock, after which it is necessary only to slip the work over the screws and tighten the chuck firmly. Care should be taken to have the three screws beyond the face of the chuck, so that large-size tubing, that will not enter the chuck bore, can be handled. Longer screws are used to support tubing of larger diameters.

Lathe Used to Saw Logs

A lot of back-breaking labor in sawing logs can be saved by harnessing the end of the crosscut saw to the faceplate of a lathe. The necessary attachment for the one-man saw is made by forging an eye on the end of a $\frac{3}{4}$ -in. rod, the opposite end of which is flattened and drilled to fit bolts for attaching it to the saw. A $\frac{5}{8}$ -in.

bolt is used to fasten the rod to the lathe faceplate, the bolt being an easy fit in the eye, to allow it to serve as a crankpin. The stroke of the saw can be adjusted by sliding the bolt closer to or away from



A Log-Sawing Attachment for the Engine Lathe That Relieves the Owner of a Lot of Back-Breaking Labor

the center, and its speed regulated in the ordinary manner; a weight, hung on the connecting rod, may be found necessary for rapid cutting.—Harry J. Bernhard, Pasadena, Calif.

Skid Used to Remove the Soil from Unbraced Excavation

When excavating material from a deep, unbraced sewer trench, two inclined poles were used to remove the soil to the surface. Planks were placed between the poles to form a smooth sliding surface for the drag scraper. The power for hauling the scraper was supplied by a team of horses hitched to the end of a rope; the poles served as guides for the scraper and supported the plank runway.



Skid Arrangement Used to Remove Excavated Material from an Open Sewer Trench: The Soil was Wheeled to the Bottom of the Runway and Dumped into a Drag Scraper, Which was Drawn to the Surface by a Team of Horses

The earth was wheeled to the foot of the skid in wheelbarrows and dumped into the scraper.—Allen P. Child, Kansas City, Missouri.

Blueprinting without a Frame

Good blueprints can be made without the use of a regular printing frame. It is



advisable to have at least one sheet of glass a little larger than the print, and another sheet of the same size for backing will make the job easier, although in its absence a piece of stiff cardboard can be used. A few paper clips around the edges of the glass will hold the im-

proved frame together and the blueprint paper in close contact with the tracing, or negative, whichever is used.—H. K. Randall, Chicago, Ill.

Disk-Grinding Pulleys

Instead of the slow method of turning flat-faced pulleys in the lathe, the drawing

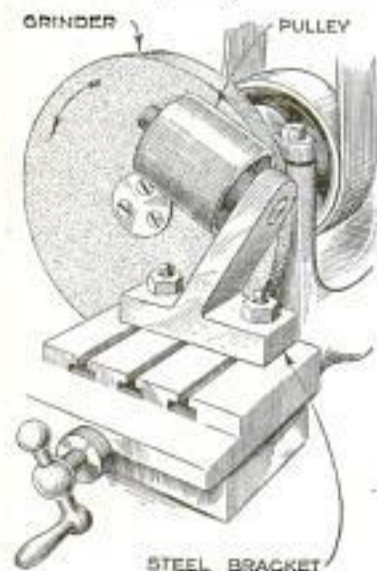

shows a quick and satisfactory method of doing the work that will equal the results obtained on the lathe. Place a steel bracket of the type shown, with a spindle onto which the pulley fits, upon the grinder table, fastening it so the pulley cannot come off

but can revolve freely in contact with the face of the grinder. When the machine is started, the table is fed in until the pulley makes contact with the wheel. The result is that the pulley revolves according to the speed of the abrasive disk and in a few minutes the work is done.

Loosening Sticking Screw Caps

The screw tops on cans, jars, and similar receptacles, have the bad habit of sometimes becoming so firmly stuck that force sufficient to damage the cap is necessary in order to remove it. If it is desired to take off the cap easily and without damage so that it can be used again, a simple method consists in soldering two pieces of wire, or nails with points and heads cut off, across the center of the cap about $\frac{1}{8}$ in. apart. This will produce a channel or groove, into which any straight-edged piece of metal can be inserted, so that sufficient pressure can be exerted to start the cap.—Leighton Powell, San Francisco, Calif.

Securing a Loose Valve Wheel

The usual method of fastening the valve wheel to a cast-iron valve is by means of a nut and washer, or a single screw on the end of the stem, but when either is ac-

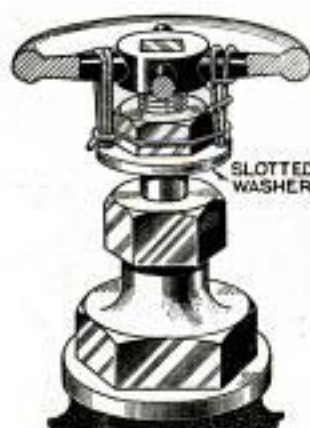

identally broken off or lost the wheel may roll off and possibly become lost when urgently needed. To make a proper repair, the valve should be taken down and the broken part machined, but as this is impracticable in many cases, the valve is either left "as is," or some

effort made to fasten the wheel. As shown, a nut and washer, and piece of wire can be used to make a serviceable repair. Run a thread-cutting die down the stem for a short distance; then file a slot on opposite sides of the washer and slip it on, followed by the nut. The wire is now twisted around one of the handwheel spokes, brought down through the slot on one side of the washer, up through the slot on the opposite side, and around a spoke on the other side of the wheel. These operations are then reversed, the wire pulled tight and twisted, after which the nut is given a turn or two to stretch the wire. The nut is then locked by a turn of wire around it.

☞ To find the pressure in pounds per square inch of a column of water, multiply the height of the column in feet by .434.



Amateur Mechanics

Information as to where to obtain any specified materials or parts for making objects described in the following pages may be had, on request, from our Bureau of Information.—Editor.

Combination Tent and Pack Cover

By C. S. TAYLOR

PORTSMEN and vacationists "roughing it," and carrying their own bed and board on their backs, or in a canoe, will appreciate the obvious advantages afforded by a tent that also serves as a cover for the owner's camp effects when not used as a shelter.

There are two methods of making the tent illustrated: One is to use a rectangular tarpaulin, or other suitable material, which is twice as long as the width. Make a strong hem around all edges and sew brass or iron rings, as indicated, at the ends of the dotted lines. The fly, or front flap, is made separately, from a square piece of material, the dotted lines showing the folds of the shelter when it is set up. It is unnecessary to do any cutting of material in making a tent of this type.

The alternative method requires more or less cutting of the material, which is cut along the dotted lines as a pattern. The separate pieces are sewed together, with the seam inside. This makes a regulation tent, and by making a few paper models of different sizes, it is an easy matter to get the right proportions

for a tent of different dimensions from that illustrated. The tent in the drawing is a good average size, and for making it, a piece of material 8 ft. wide and 16 ft. long is needed. It is not necessary to have the cloth in a single piece, but this is an advantage. In using yard-wide goods the strips are sewed together with heavy waxed thread, the seams running lengthwise of the 16-ft. piece. To reinforce the tent at the corners, where the greatest strain comes when the tent is pegged and the guys in place, it is a good plan to sew patches of cloth on both sides, where the rings are sewed on. The tent is amply large for two occupants, and when set up is 8 ft. wide, 6 ft. deep, 7½ ft. high at the front, sloping to a height of 2½ ft. at the back wall.

For a light summer tent a heavy grade of unbleached cotton cloth is a good choice, although if heavier material is wanted, regulation canvas duck of several weights can be used.

If a light nonwaterproof material is used, it can be processed and made to shed water by the following treatment: In 4 gal. of boiling soft water dissolve

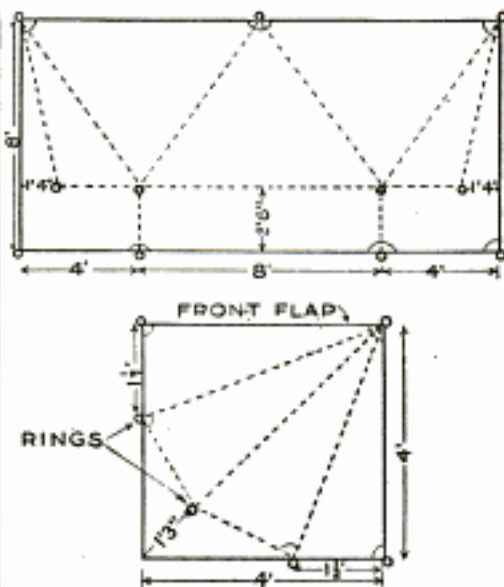

For the Sportsman or Vacationist "Roughing It" in the Woods or Traveling "Light" in a Canoe, the Tent Shown in the Drawing Not Only Provides a Shelter at Night, but Serves as a Cover for His Personal Effects

$\frac{1}{2}$ lb. of powdered alum; also dissolve $\frac{1}{2}$ lb. sugar of lead in another 4 gal. of water in a separate vessel, and when both chemicals are completely dissolved, pour the alum solution into a tub, and then add the lead mixture; let this stand for several hours, and pour off the clear liquid. This is used to saturate the tent material thoroughly. To make the cloth entirely waterproof, it is necessary to fix the acetate of aluminum in the fibers of

the cloth, and this cannot be done unless soft water is used. Finish the process by light rinsing in clean soft water, and hang up to dry. The sugar of lead used is a virulent poison, and should not be taken internally. Also, as some persons show a peculiar tendency to absorb poisonous lead salts through the skin, with accompanying bad effects, it is suggested that a stirring stick be used instead of the hands for saturating the cloth.

Novel Rubbish Box for Park

Receptacles for waste in public parks would not be such an eyesore as they usually are if made to represent animals,



like the one in the illustration. The outline of the animal is first drawn on a piece of wall-board, which is then used to mark the design on the sides of the receptacle. The sides are made of 1-in. boards, glued edge to edge,

and strengthened by flat-iron crosspieces. A good size for a receptacle of the type illustrated is 4 ft. high by 10 in. wide. The opening for rubbish is at the top, in the piece connecting the sides, and an opening, covered by a sliding board, should be cut in the bottom also, for convenience in emptying. Careful painting will add considerably to the effect of these novel boxes.

File for the Brief Case

An index file filler, of a size to fit the brief case, can be obtained from many stationers. This, when fitted into the case does not add appreciably to the weight, and letters, papers, and other documents are readily found under their proper index letter, and in perfect order, so that no time is wasted in hunting for what is wanted.

☐ A mark at the top of the automobile steering wheel to show when the wheels are straight ahead will be found of much assistance in maneuvering the car.

Replacing Cylinder-Head Bolts

The last two bolts on the light-automobile cylinder head are located directly underneath the dash, and must be in place while the head is inserted on the engine block. To push the head into place, with these bolts protruding, results in the gasket being bent, torn, or disarranged. The usual practice is to have a helper who holds the bolts while the cylinder head is being put on or taken off. A simple solution to this problem consists in stretching a rubber band, made by cutting a piece from an old tube, around the two bolts, underneath the heads.—A. W. Michener, New York City.

An Effective Cherry Picker

For picking cherries rapidly with a minimum of climbing, an effective implement can easily be made. A frame is

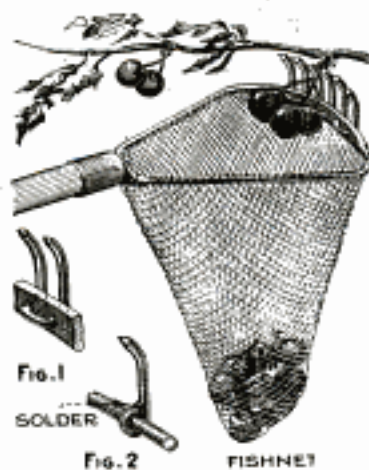

made of stiff wire or light iron rod, the ends being brought together and forced tightly into a handle of the proper length. On the front of the frame a series of picking fingers, or hooks, are fastened about $\frac{1}{4}$ in.

apart, so that the fruit cannot pass between them. Figures 1 and 2 illustrate two methods of attaching the hooks. Solder should be used in both cases, to make the fingers rigid. The device is completed by attaching a bag of close-woven fish netting to catch the fruit as it is plucked from the tree.—Wm. Melas, Philadelphia, Pa.

Auto Rim Incloses Flower Bed

To form an inclosure for a circular flower bed, a discarded automobile tire rim can be used. The rim is merely placed in the location desired, the central space filled with earth, and the seeds or plants put in. A larger flower bed of this character can be made by using the broad tires from wagons. By allowing about $\frac{1}{2}$ in. of space at the top, the rim will hold water until the soil inside absorbs it completely.

Trouble Light on the Auto

The headlamps of several makes of automobiles may be turned about on their brackets to illuminate the entire space underneath the engine hood, and make repairs or adjustments to the engine at night almost as easy as in daylight. If the light is so built that it is not braced to the body of the car, it is very simple to turn it around. This is done by loosening the lamp-bracket nut, and turning the whole assembly around, or by removing the two nuts that hold the lamp to the bracket, lifting it off,

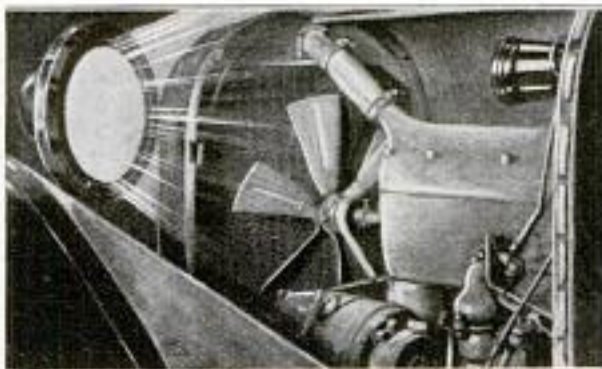

By Reversing the Position of One of the Headlamps of an Automobile, So That the Light Shines Backward, the Space under the Hood is Lighted

turning it around, and replacing it on the bracket. Of course, the method of mounting the headlamps will differ on various cars.

Homemade Garden Cultivator

A member of an Ohio garden club built the hand cultivator illustrated, at a total cost of a little over a dollar, obtaining with it results fully equal to those obtainable from the manufactured and higher-priced hand cultivators. Practically the only expense was the cost of having the cultivator shovels forged by a local blacksmith. The adjustable wooden frame that holds the cultivator shovels is arranged

so that the implement can be set for shallow, medium, or deep cultivation. The handles are $5\frac{1}{2}$ ft. long and 22 in. apart



For Use on an Allotment in a Garden Club, One of the Members Built This Efficient Cultivator

at the outer end. The wheel, which may be one taken from an old baby carriage, or, better, from an old wheelbarrow, should be lined up exactly midway between the handles.

Harrow Prevented from Injuring the Bark of Orchard Trees

Under some conditions of fruit culture, particularly in regions where rainfall is scant during the growing season, constant harrowing is necessary to maintain the moisture-preserving mulch. In order to make a good job, it is desirable to work as close as possible to the trunk of the tree, but in doing so, the bark is fre-

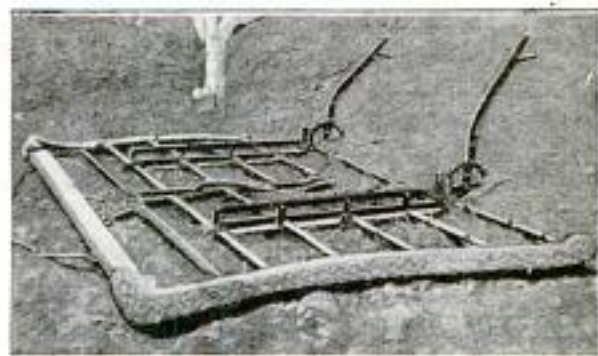

Old Automobile Tire Secured to the Sides of the Iron Harrow Frame, to Prevent It from Injuring the Bark of Fruit Trees

quently injured by contact with the harrow. The illustration shows the means used in one orchard to prevent this. Old automobile tires are cut and lapped over the sides and corners of the iron harrow frame, to which they are secured with wire.—W. L. Salvage, Beaumont, Calif.

Motorists' Folding Lunch Box and Table

For the automobile outing, when lunch is taken along, a compact and substantial combination lunch box and table can be

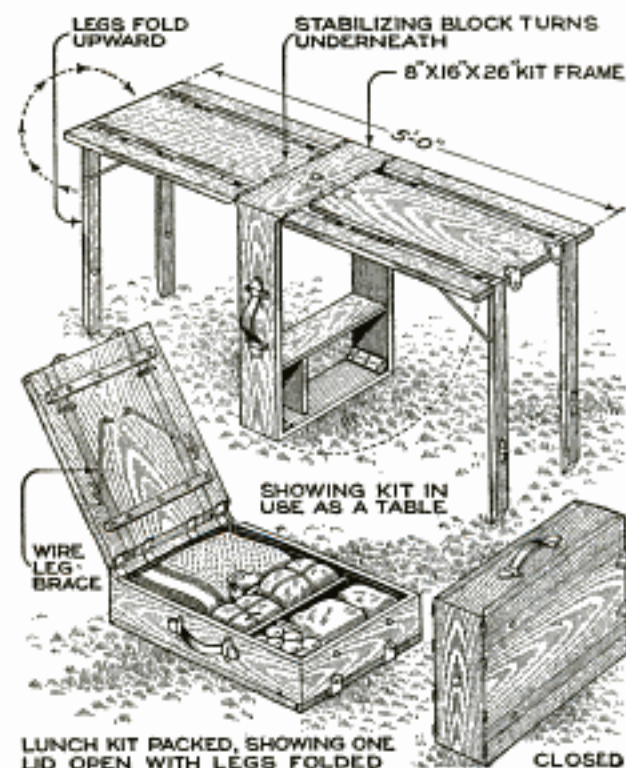

LUNCH KIT PACKED, SHOWING ONE LID OPEN WITH LEGS FOLDED
A Cleverly Designed Combination Table and Lunch Box for Automobile Excursions

made along the lines of the one illustrated. In use, the top and bottom hinged covers open horizontally, and a pivoted block, attached inside one end of the box frame, helps to stabilize the outfit. The legs are pivoted on a small iron rod and open downward; they are held rigidly vertical by means of wire braces, attached to the underside of the cover, the ends of the wires fitting into a hole on the outside edge of each leg. The legs are provided with buttons on the underside so that, when folded up in their slots, the buttons can be turned, locking the legs and forming a continuous cover.—Frank E. Leitch, Brooklyn, N. Y.

☞ To remove plaster and lime stains from floors and woodwork, wash with a solution made by adding 1 pt. strong vinegar to 1 gal. hot water.

Making Enamel Flow Easily

Our handy man taught me to keep the can of enamel in a pan of warm water when using, so that it would flow easily. Also, when enameling such articles as a bedstead, to do all of one rod or spindle at once, so that the finish will harden evenly. Fewer coats of the warmed enamel are required than by the usual method of thinning it to the desired consistency with turpentine. By keeping the enamel warm and doing the work in a warm room, the finish will flow more easily and smoothly, and the danger of getting a lumpy finish will be greatly reduced. In all cases, where enamel is applied, it will be found better to apply two or more thin coats than a single heavy one.—Mrs. James Doremus, Passaic, N. J.

An Automobile Burglar Alarm

An alarm that sounds when the automobile is started is easily made for the light car, provided the original magneto-operated horn is used. The end of the case on the steering column, which carries the horn button, is drilled on opposite sides to take two short pins, and the inner flange on the button is cut out to about one-half of its original thickness at two places, as shown. When the button is in the running position, the pins fit into the cut-out sections of the flange. In this position there is no electrical contact. When leaving his car, the driver presses the button and gives it a quarter-turn. This causes the pins to bear on the higher or thicker part of the flange, keeping it pressed in, and establishing an electrical contact. When the engine is idle and the button is depressed, as shown in the alarm position, the horn is not affected, since it receives no current from the magneto. As soon as the engine is started, the flow of current from the magneto to the horn will cause the latter to blow, notifying the driver that some one is tampering with his car.—R. H. Kasper, Philadelphia, Pa.

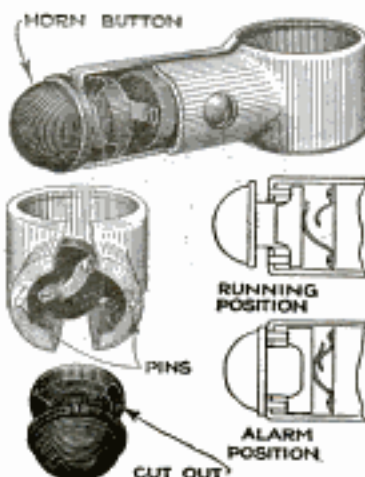

Applewood for Smoking Meats

As a rule hickory is preferred for smoking meats, but as this wood is rapidly growing scarce, and does not occur plentifully in all regions, maple, birch, and other hardwoods are widely and satisfactorily used. It is not generally realized that applewood produces excellent results. Either the trunks or boughs of the trees are used. Thus, when old trees in an apple orchard are cut out, they should be sawed up and laid aside for use in the smoke house. Applewood produces a smoke that has a tendency to sweeten the product treated, and gives an excellent flavor.

Harness from Auto Tires

Since no stitching is required, and the material used is part of a discarded auto-



mobile tire, the halter illustrated can be easily made. Only the fabric part of the tire is used, the rubber tread being peeled off. The material thus obtained is then cut into strips of the proper length and width. The metal parts can be obtained from any hardware store; the buckles and rings are riveted on. If bit straps are used in the metal loops on the cheeks of the halter, it can be used for driving or plowing. The appearance of the finished halter can be improved by a coat of black paint.—John Fowler, Regina, Can.

Connecting Rods for Model Machinery

Model builders and experimenters are often at a loss as to the best and easiest method of making the connecting rods and pitmen for models and machinery. To have them forged or cast is generally out of the question on account of the expense and time. The built-up connecting rod clears the way for quick work, and is not only strong and serviceable but it

also presents a good appearance. One of the simplest types of connecting rod is made by soldering or sweating tubing ends onto a notched shank. The design is laid out on paper and the exact dimensions found for the notched shank, or arm. Square or round stock, either solid or tubular, may be used. The notches in the end are of 90° and are made with a square file. To make sure of the squareness of the notches, lay the tubing pieces in them and square them up with the eye. To solder the three parts, fasten them together with wire as in the drawing, and

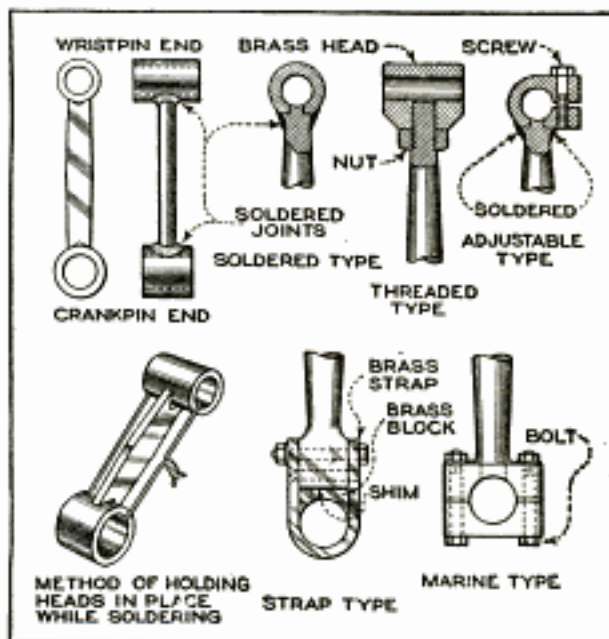

Methods of Making Small Connecting Rods for Model Machinery, from the Simplest Possible Type to the Exact Reproduction of the Original

then apply the solder, allowing it to fill up the notch and build up a fillet in the angle between the shank and the tubing.

When using taper-turned pitman rods, turn a small nub, or teat, on the rod ends and drill the bushings accordingly.

A rod that is adjustable for length can be made by using a threaded arm and solid brass heads; a locknut is used to hold the setting and keep the parts tight. A connecting rod with semisplit bearing ends, which are adjustable for wear, is made by sweating the brass ends to the rod arm, splitting the heads and placing a screw as illustrated. The strap form of connecting rod is much used for engine work and is strong and of good appearance. It is also adjustable, shims being laid between the solid-rod end and the half-bushing. The rod proper may be made of brass or steel, and the strap and bushing of brass. The strap is held to the rod end by two flat-head screws, the bushing and strap forming the whole cir-

cumference of the bearing. Where a solid and strong type of bearing is wanted, without regard for cost, a connecting rod is turned from rectangular stock and fitted with a lower cap, as shown for the marine-type bearing. This rod is adjustable for wear, shims being placed between the bearing halves, which are held together by bolts. When possible, it is advisable to insert two pieces of rod in the eyes of the bearing and square them up previous to soldering, in order to insure an accurate alignment of the bearings. If this is not possible, then check after soldering and bend until the eyes are square.

Auxiliary Radiator for Pipeless Furnaces

In houses that are heated by so-called pipeless furnaces, there is usually a spot,

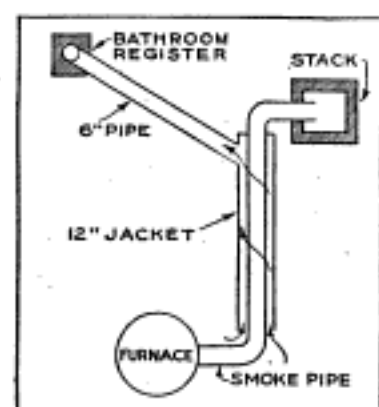

such as a bathroom, that fails to get its share of heat, and the diagram illustrates how an additional amount of heat can be conducted, under most circumstances, to that room.

A 12-in. jacket, around the furnace smoke pipe, has a 6-in. pipe joined to it near the upper closed end. The smaller pipe serves to carry the hot air to a register in the floor of the room it is desired to heat.—Jos. N. Parker, Richmond, Va.

Repair for Vacuum-Bottle Corks

The action of hot coffee and other liquids contained in a vacuum bottle will cause the cork to lose much of its spring,

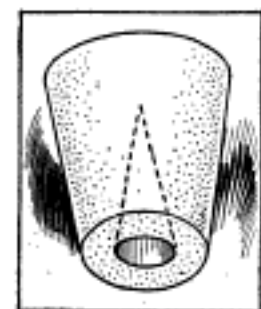

and allow the contents to leak after continued use. The old cork may be made as good as new by making a hole in the center of the small end with a six-penny nail, or pointed lead pencil; this will expand the cork and make it fit tightly inside the neck of the

bottle. A small wooden plug, driven into the hole, will make the repair permanent.—William Mallet, Olympia, Wash.

Watering Young Trees

Thousands of young fruit and shade trees are set out only to die every year, not through neglect, but killed by kindness. In one instance, a number of apple trees were planted at the same time, and under identical conditions, and perhaps half the number were within spraying distance of a hydrant. Naturally, these trees received plenty of water at all times. The remainder were so located that it was necessary to carry water to them, and this was obtained from a rain barrel. During a prolonged dry spell, I was greatly amazed to find that the trees nearest the hydrant did not thrive, regardless of the amount of water supplied, while those watered from the rain barrel showed no signs of withering. In due course the first trees died out, and the elderly gardener who came to aid in replacing them explained that they had been killed by the frequent applications of cold water. The water in the rain barrel was usually warm, and for that reason, the trees upon which it had been used thrived as from natural showers. It is not necessary that the temperature of the water be more than 65° or 70°; this may be obtained quite naturally during the summer by allowing a barrel of water to stand in a sunny place. If the barrel is refilled in the evening, the water will as a rule be ready for use the following afternoon.—G. E. Hendrickson, Argyle, Wisconsin.

Carrying an Automobile Tire

An automobile tire is not the easiest thing to carry for any great distance. Although the initial part of the trip may be made without undue strain on the hand or arm, the latter stages usually find the carrier casting about for ways and means to carry his load more comfortably and distribute the weight more evenly.

The drawing shows a method of carrying such a load conveniently and with a minimum of discomfort and fatigue. The idea is simple and consists in the mere insertion of a stick of suitable length and thickness inside the tire so that the ends will bear against the tire walls.—H. C. Rose, Newport, R. I.



An Improved Vertical Enlarger

By F. E. HINKLEY

BY using the essential features presented in a vertical enlarger that I had once seen, and supplementing them with others for convenience in working, I made an instrument almost ideal in its adaptability for varying kinds of work.

The enlarging cabinet is made of 1-in. well-seasoned pine, grooved, and with particular attention given to have the grain of the sidepieces exactly similar, so that the contraction and expansion will be all in the same direction. This will prevent cracking and warping. The door, and the back of the upper compartment, are paneled to allow for free expansion. The cabinet is 6 ft. 10 in. high, inside measurement. The upper and lower chambers are divided by a

straight-filament lamps, and a crown of seven sockets for concentrated-filament lamps at the top. This arrangement gives good distribution with whatever lamps used. I prefer, however, the concentrated-filament lamps.

In the wall directly back of the light frame are two flat brass springs, corresponding to two similar springs located in the frame. These sets of springs are for the purpose of automatically connecting the lamp circuit to the exterior wires,

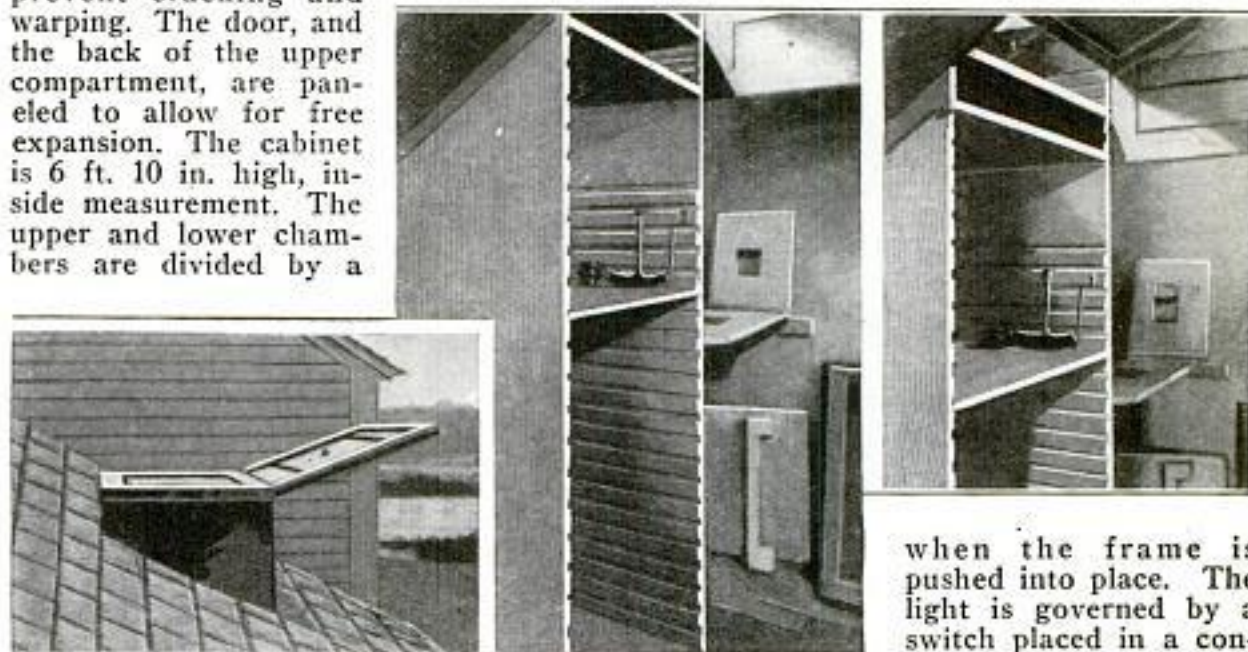

Left: The Light Hood on the Roof of the Laboratory. Center: A View of the Cabinet, Showing the Frame Grooves. Right: Interior View of the Roof Opening; Part of the Focusing Mechanism may be Seen on the Printing Frame

permanent shelf, 24 in. from the top of the enlarger.

The apparatus is erected in a low-roofed building, used as a laboratory, with the upper chamber joined to a short extension, leading out through the roof, as shown in one of the photos. I arranged for cutting off the light from the sky whenever desired, and, by means of a removable frame, holding electric lamps and placed in grooves at the top of the cabinet, am able to convert the enlarger into an instrument that can be used at night, and for purposes to which the daylight enlarger is not adapted.

This light frame, E, Fig. 2, occupies the grooves at the extreme top of the cabinet. It is made for the use of lamps in either a horizontal or vertical position, according to the kind available. There is a row of three sockets on either side of the frame, with one at the front and one at the back for regular 100-cp.

when the frame is pushed into place. The light is governed by a switch placed in a convenient position.

The next lower frame, D, Fig. 1, holding a 14 by 17-in. glass, ground on both sides, has also one fixed position in the center of the upper chamber, and is supported in grooves. By having the glass ground finely on both sides, I obtain good diffusion, and this also aids in cutting out undesirable reflections. The distance between the ground glass and negative frame is always sufficient to prevent the granulated appearance in the projected image that is observed when the ground glass is too near the objective focus. Between the frames E and D are some light-trapped holes to provide ventilation.

Three inches below the ground-glass frame, there are seven grooves, 1 in. apart, the last one being 3 in. above the permanent partition dividing the upper and lower chambers. These grooves accommodate the negative-adjusting frame C, Fig. 3. This frame is an assembly of three frames. The base frame has tongues on both sides to slide in the main grooves,

below the ground glass; it has also fixed guides at front and back, for holding in place the second thin frame, which moves from right to left. The latter has also fixed guides, at right angles to the first ones, for holding in place a third frame, which moves from front to back. The third frame has a rectangular opening for plates, or auxiliary frames, up to 8 by 10 in., and is self-centering by means of special spring clicks arranged to

shelf A, are cut at intervals of $1\frac{1}{2}$ in., beginning with No. 1, 13 in. from the top of the lower chamber, and extending to No. 31, at the bottom of the cabinet. The printing shelf, Fig. 4, is a plain, flat, parallel board, 1 in. thick, provided on one side with an adjustable frame working as follows: A brass bar, shown at the top, revolves on its axis by means of pins through lugs, or ears, at both ends. The two vertical arms, sliding on this

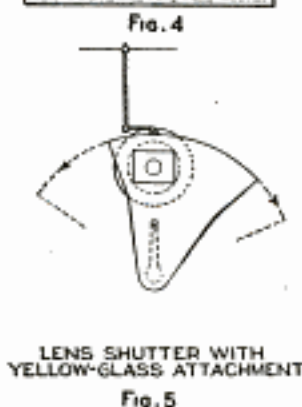
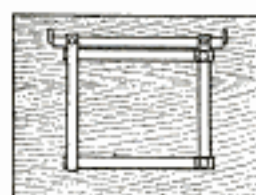
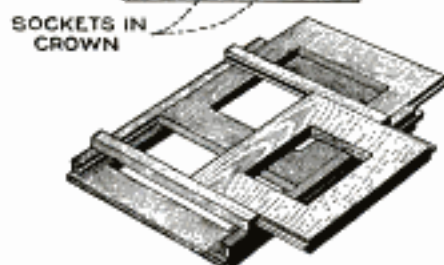
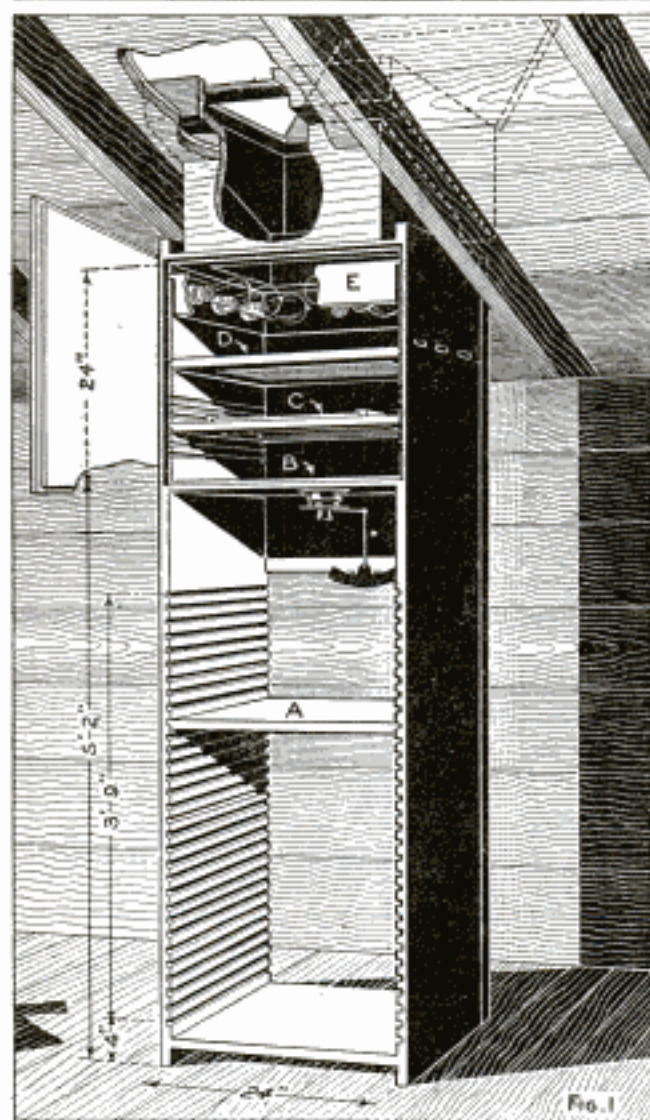
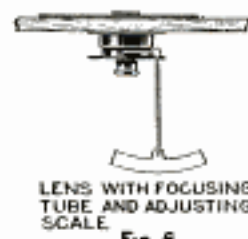

TABLE OF SETTINGS LENS $5\frac{1}{4}$ f			
MAGN. OR REDYN	NEG. SHELF	FOCUS SCALE	SHELF NUMBER
1 TO 1	e	.5	1
1 " 2	d	.5	5
1 " 3	c	.4	9
1 " 4	c	.8	12
1 " 5	b	.1	16
1 " 6	b	-.2	20
1 " 7	b	-.3	23
1 " 8	b	-.4	27
1 " 9	b	-.5	30



A Homemade Vertical Enlarger of Wide Range: The Construction of This Instrument Is Well within the Ability of the Earnest Amateur, and It Affords a Means of Making Very Accurate Enlargements and Reductions. By Means of Adjustable Printing Frames, Any Part of a Negative may be Brought into a Central Position for Enlargement

engage in notches. This whole arrangement is very convenient for bringing any selected portion of a negative into a central position for enlarging. The grooves in which the base frame slides are marked "a" to "g," from the lower one upward, for use in connection with the table of lens settings.

The grooves in the lower compartment, for the accommodation of the printing

bar laterally, and the two horizontal arms, sliding on the first pair, give an adjustment in all directions. These arms are locked in place by thumbscrews, and their own weight is the working pressure on the paper. The frame is adapted for 10 by 12-in. paper, and smaller; for other sizes, the shelf is reversed, and the paper held in position by thumbtacks.

In the center of the partition B, which

divides the upper and lower chambers, is set the objective, mounted in the smaller of two focusing tubes, which screw one inside of the other, with the screw threads common to focusing mounts and arranged to be held where wanted by a clamping screw. These tubes are approximately 3 in. in inside diameter, and give a lens movement of 1 in. The starting point being made at the center adjustment, there is an available focusing movement of $\frac{1}{2}$ in. in either direction. This movement, in connection with the movable negative shelf, in grooves "a" to "g," forms the means of focusing, and, with the focusing scale and table of settings about to be described, gives a simple and accurate means of obtaining any range of enlargement or reduction with certainty.

The front, or what becomes the lower end of the inner focusing tube holding the objective, carries a projecting flange on which revolves a small wheel, or roller, in connection with a pointer extending in front of the focusing scale, shown below partition B, at the back of the cabinet, and in Fig. 6. The construction is as follows: On a horizontal shaft extending from the lens to the back of the cabinet, are attached two arms at right angles to each other, forming a bell crank; the smaller arm carries the wheel, or roller, and the other, or pointer, ends just in front of the index scale below, at the back of the cabinet. The proportional length of the lever arms is very nearly 1 to 5, to facilitate reading, a movement of .01 in. in the objective being clearly indicated on the scale. A spiral spring, not shown in the drawing,

holds the wheel always against the lens flange when moved in either direction.

On top of partition B, above the lens, is located a shutter, Fig. 5, in a segment of thin tinplate, holding a frame containing a square piece of yellow glass. This is attached at the center of rotation to a pivot passing upward through the board, and at the lower end of this pivot is placed a hand lever, indicated by dotted lines in Fig. 5, which extends toward the outer edge to facilitate working. Three studs or stops are arranged on partition B, to limit mechanically the movements of opening and closing of the shutter, when focusing or exposing the lens.

The lens employed is one of $5\frac{1}{4}$ -in. focus, and the table of settings is arranged as follows: The first column gives in full numbers the magnification or reduction; the second gives the grooves for the negative shelf; the third gives the number representing the lens focus, obtained by turning the thumb flange of the focusing tube either to the right or left, until the proper number is reached on the scale below, and the fourth column gives the grooves numbered from one downward, in the lower chamber, for setting the paper shelf A in its proper position. By means of this table, the settings are made mechanically and with ease and certainty. When the necessary tests and adjustments of the figure on the scale have once been made, an error in focusing is impossible.

The arrangement of this enlarger permits almost endless variations in adjustments between "natural or same size," to enlargements or reductions from one to nine times.

Cleaning Soiled Leather

Soiled leather articles, such as puttees, shoes, traveling bags, and the like, can be cleaned by applying saddle soap with a moist sponge and rubbing with a clean, dry cloth. Oxalic acid, which is sometimes used alone and sometimes in preparations, for cleaning and bleaching leather, is injurious, and should not be used. Although it is almost impossible to remove oil or grease spots from leather, in some cases satisfactory results may be obtained by coating the spot with a thick and quick-drying rubber cement, then peeling off the coating when it is almost dry. It may be necessary to repeat this operation several times to clean the leather thoroughly.—A. C. Cole, Chicago, Ill.

Keeping Oars in Rowlocks

When the beginner goes rowing he usually has the unpleasant experience of pulling the oars from the rowlocks just at the time when it is most inconvenient. To overcome this and make learning to row easier, a heavy rubber band, cut from an old inner tube, can be placed across the ends of the rowlocks. These prevent the oars from jumping out, although the rubber will stretch considerably without coming off the horns of the rowlocks.

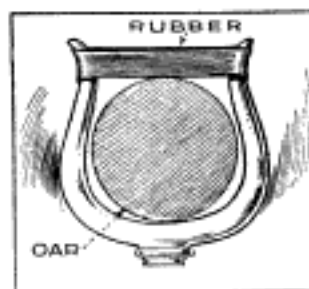

Mooring Boats in Tidal Waters

The square object hanging from the mooring post in the illustration is a wooden float. The post is driven into the

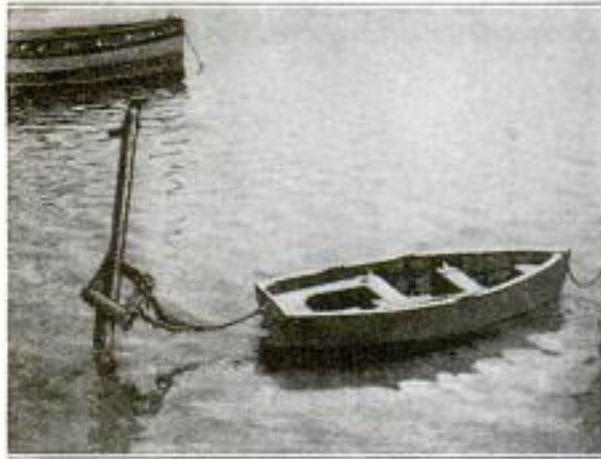

A Mooring for Small Boats in Tidal Waters: The Square Wooden Float Slides Up and Down on the Mooring Post as the Water Rises and Falls

bottom of a tide-water channel, and the float rises and falls with the tide, but is prevented from getting away by a cross-piece at the top of the stake. This arrangement provides a short-line mooring of constant length, serves better than the anchored buoy and rope for keeping small craft head-on to the wash of passing vessels, and is well adapted to places where wind and wave conditions are known to be quite regular.—L. R. Perry, Berkeley, Calif.

A Window-Ledge Guard

In many apartment houses it is the custom to set vegetables, milk, and other foods on the window ledge, particularly



when the weather is cool. It frequently happens that these articles are knocked or blown off. Even if the windows do not face a street where falling objects might hurt pedestrians, there is always the danger of breaking a skylight or other windows in their descent through a light well or court. To prevent this, a towel, or curtain, rod can be fastened in the window frame as shown in the drawing.

Killing Dandelions

While beautiful in itself, a dandelion is a nuisance in lawns where a close, green turf is desired. The removal of the dandelions by cutting off the roots is a laborious and expensive process where they are at all numerous, and may do more harm than good. The dandelion is a perennial, and perpetuates itself by means of a long deep-growing taproot. To cut this root off a few inches beneath the surface of the ground does but little damage to the pest, and within a few days new shoots will appear. The cutting is also very likely to split the crown, and two plants will appear where but one grew before. However, if a tablespoonful of salt, or a half cupful of gasoline is applied at the cutting point when each root is cut off, the eradication may be made complete. This method is impracticable where the dandelions are numerous.

If the dandelions are very thick, they can be controlled and practically eradicated by spraying them with a solution made by dissolving 2 lb. of iron sulphate or 2½ lb. of common salt in a gallon of water. The iron sulphate, which is known under a variety of other names, the commonest being copperas and green vitriol, comes in either granular or crystal form, and dissolves easily. One gallon of solution will spray 860 square feet.

On small lawns, the solution may be applied with a sprinkling can having very small perforations, care being taken to see that all plants are thoroughly wetted by the liquid. On large lawns or golf links, a hand spray pump, which is fitted with a nozzle for throwing a fine, mistlike spray, may be used. The fineness of the spray is important, as the finer it is, the better it will settle over all portions of the plant. Hand sprayers can be bought at varying prices, but the sprayer itself is not so important as the nozzle with which it is fitted. Insist on getting a nozzle that will give the necessary fine spray.

The spraying should be done after the dew is off, in the forenoon of a day when the weather indications show fair weather to be probable for 48 hours. Rain inside of 24 hours will undo the results, and make it necessary to spray again. Wait until three days after the lawn has been mown, as the iron sulphate injures new-mown grass. Do not sprinkle or mow the lawn for three days after spraying, but give the sulphate a chance to work. It may be necessary to spray

three or four times during the season, or even oftener, if the dandelions are very thick and have been allowed to go to seed once or twice. Scattering plants, which the spraying treatment has failed to kill, may be destroyed by placing a tablespoonful of the granulated iron sulphate on the crown of each plant.

Fertilizing the lawns to thicken the grass, and reseeding of the thin spots, will help to prevent reinfestation. Finely rotted barnyard manure is preferable as fertilizer, but the application of 100 lb. of sodium nitrate to 1,500 sq. ft. of lawn will be helpful.

The salt solution referred to has at least two distinct advantages over the sulphate solution; it is cheaper, and will not stain walks, fences, or clothing with which it comes into contact.

While this method of destroying dandelions has been found successful at the Wisconsin College of Agriculture, and has been shown, by seven years of investigation by the New York station, to be a dependable method, no permanent effects can be expected from spraying, so long as dandelions are allowed to go to seed unchecked on adjoining lawns, in fields, and along roadsides. It is undoubtedly true, that by community action in some form, either by agreement or ordinance, dandelions may be eradicated in an entire community, but it is useless for an individual to expect to keep the dandelions out of his lawn after the first treatment, unless he is willing to spray his lawn at least once in three years.—University of Wisconsin, Madison, Wis.

Testing the Vacuum System for Leaks

A small leak between the intake pipe of the carburetor and the filling chamber of the vacuum tank of an automobile is revealed by the difficulty experienced in maintaining the proper fuel level in the tank, especially on heavy pulls or when climbing hills. A small air leak is difficult to find because of the loud suction through the carburetor. To concentrate the suction at the point of leakage in the fuel-tank connections, a simple and positive means is to loosen the bolts connecting the carburetor to the engine and insert a piece of tin or sheet brass, large enough to cover the intake opening; then tighten the bolts to hold the tin in place over the intake. By turning the engine with the crank, the increased vacuum in the intake produces a positive sound at the point of leakage, so that the location is readily determined.

Muffler for Electric-Lighting Plant

The owner of an electric-lighting plant, located in the basement of his home, used the arrangement illustrated for muffling

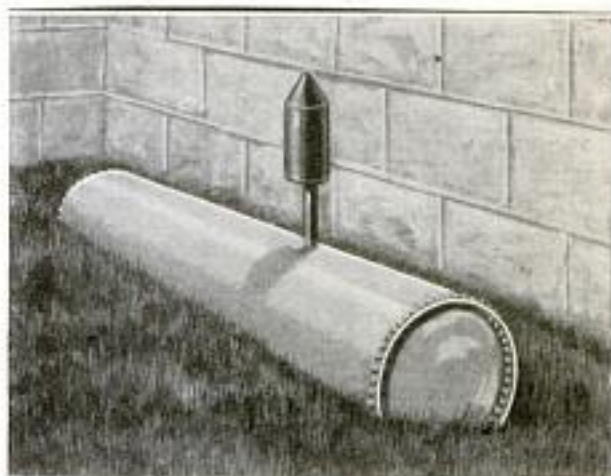

To Muffle the Exhaust from an Electric-Lighting Plant, the Owner Attached the Muffler of the Engine to a Discarded Water Tank

the exhaust from the small engine used to drive the dynamo. The exhaust pipe was led to the outside and screwed into one of the openings in a discarded water tank, the regular muffler that formed a part of the engine equipment being screwed on top of the tank, as indicated. To prevent possible explosion when starting, a two-way valve, or cut-out, is installed in the line; this is opened at first, allowing the gases to escape before they reach the tank. Then, after the engine is running smoothly, and no unexploded gas goes through it, the valve is turned, diverting the exhaust into the tank where it expands and passes, with little noise, to the air through the muffler.

Portable Feed Box

A teamster who is obliged to feed his horses at noon away from the barn uses the feed box illustrated, which can be slipped over the edge of the wagon box or a fence.



This box prevents the waste of grain attendant on the use of a nosebag, and does not occupy much more space.—Maggie A. Cromlich, Carlisle, Pa.

A Handy Laundry Cabinet

A cabinet in which all necessary washing materials, such as soap, bluing, soap powder, and the like, may be kept in one

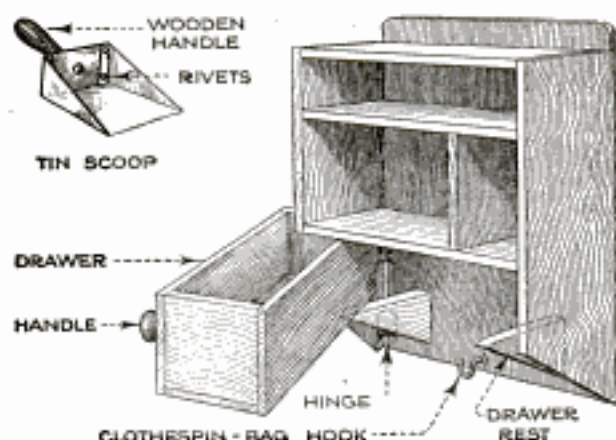

A Cabinet for the Laundry, in Which All Washing Materials are Kept Together

place will be appreciated by the laundress. The over-all dimensions of the cabinet illustrated are 5 by 12 by 20 in., and the swinging compartment, or drawer, which is used for soap powder or chips, is 4 by 5 by 10 in. If desired, a door can be fitted to cover the upper compartments. A hook is screwed underneath the soap drawer, from which the clothespin bag is hung. A simple scoop for handling the washing powder is easily made from a piece of tin and is kept in the drawer.

Jack Head Saves Blocking Car

Sometimes it becomes necessary to make tire or other repairs on the road when the car is standing on a slight slope, and, unless the brakes are in exceptionally good order, one is then obliged to find something to block one wheel while the other is jacked up.

To eliminate the need of scouring the roads and fields for a rock or piece of wood, and to prevent the car from moving and dropping off the jack, the special head shown was formed from a piece of steel bar and attached to the jack. The use of this attachment makes it possible, when making repairs on a sloping surface, to throw the center of weight ahead or back by placing the front or back part of the head under the axle.



Adjusting Vacuum Tubes to Voltmeter

If indicating instruments are used to adjust the filaments of vacuum detector tubes used in amateur wireless-receiving sets, a voltmeter should be used instead of an ammeter. Tungsten filaments show a decrease in current throughout their life, and if a constant current is maintained, rather than a constant voltage, the life of the tubes will be shortened, and the signals will be no better. The normal filament-terminal voltage for most standard tubes is from 5 to 5.4 volts.

Improving Pack-Sack Straps

The common method of carrying the hiker's shelter and provisions is in a pack sack. When light loads are carried, no great strain is imposed by the sack, but when the weight is upward of 75 or 80 lb., the pressure on the shoulders becomes quite irritating. An improvement that will make its carriage easier and less fatiguing is shown in the drawing. This consists in using a short strap with a har-



ness snap on one end. The short cross strap is riveted to one of the pack straps, and the snap hooks over a ring fastened to the opposite shoulder strap. Instead of the shoulders taking the whole strain, it is distributed over the entire upper part of the body. If desired, the cross strap may be left unfastened until the load begins to feel "heavy," when it can be snapped in place and the shoulders eased.—Robt. P. Lincoln, Minneapolis, Minn.

Blackening Brass

To blacken the brass work of cameras and similar fittings of the same metal, clean the pieces thoroughly, so as to free them entirely of grease, and dip into a solution composed of 200 gr. of copper nitrate to the ounce of water. After allowing them to remain for a few minutes in the bath, remove and heat until the desired color is obtained.

Preventing Jars from Cracking during Canning

Some of the least-known reasons why glass jars crack in canning, when the containers are placed in the boiling water, and their remedies, are:

Overpacking the jars; such products as corn, pumpkin, peas, lima beans, and sweet potatoes expand, so that if the jar is completely filled it will be almost sure to crack. Do not fill the jars quite full. Placing cold jars in hot water or vice versa; as soon as the jars are filled with hot sirup or water, place in the canner. If the top cracks during sterilization, the wire fastener used on some types of jars was too tight. In a steam canner, cracked jars are often the result of too much water; the water should not come above the platform on which the jars are placed. Cracking is also caused by allowing a cold draft of air to strike the hot jars.—Mrs. Mary F. Scott, Albany, N. Y.

Novel Pump Arrangement for Deep Wells

As the common pitcher pump will not pump water to a height of more than 20 or at the most 25 ft. above the water level, it is not generally known that such a pump can be used for pumping water

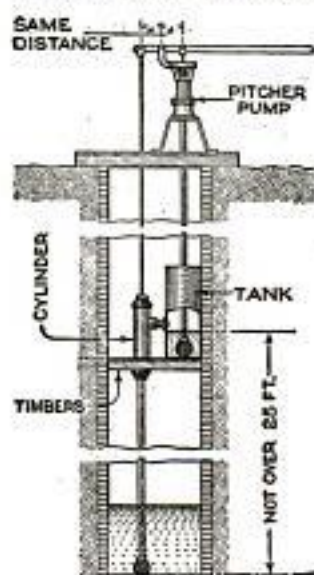

from a 50-ft. well by raising the water in successive stages. A pump cylinder, set half-way between the pump and water, is operated by the upper-pump lever and delivers the water into a tank set at the same level, from which it is drawn up in the usual manner by the upper pump. The tank is supported on timber crosspieces, and has one end open to admit the upper-pump suction pipe. The lower-pump cylinder is similar in bore and stroke to the upper one, and is attached to the upper end of the lower suction pipe. This is lowered into the well and connected to the tank. The plunger of the lower cylinder is connected to a rod fastened to the pump handle. In this manner, one cylinder discharges at each stroke of the handle.

Photographing Small Articles with a Folding Camera

Flowers, and other small articles that are to be photographed, generally must be supported in some manner, and the



Small Articles can be Photographed More Easily with the Camera Arranged as Shown

materials used to hold the object in a vertical position usually form an undesirable part of the picture unless blocked out on the negative. Practically all the trouble of arranging the articles can be avoided by placing them in the horizontal plane and making the photograph vertically, as in the illustration. The ends of the camera, the lens pointing toward the floor, are supported on the backs of two chairs, which should be of the same height. The object being photographed is placed on a cardboard background that is raised by a stack of books to the proper level for focusing.

"Swimming" in Wading Boots

Many fishermen have lost their lives by wading into water beyond their depth, and, burdened with wading boots, being unable to swim or keep afloat.

The drawing illustrates a method of keeping afloat used by a British sportsman. It should be learned by all fishermen, as very little practice is sufficient to master the idea so completely that it will be found possible to "shoot" rough waters.

Immediately the fisherman gets beyond his depth or trips, he should draw the

knees up to the body, face downstream, and assume a sitting posture in the water. While the head is kept above water, there is, naturally, no danger even in rough,



Method of "Swimming" for the Fisherman in Wading Boots Who Goes beyond His Depth

rocky water. To keep direction, paddle with the hands on either side under the water, and if a rock is struck, the first contact is made by the feet and lower part of the thighs. Don't struggle or change posture, for the wash off the rock will help the body to clear it. On no account try to swim, for if this is done, the head goes under and the legs will come to the surface, and unless there is aid at hand there is great danger of drowning. Paddle with the hands, always facing downstream, until shallow water or a landing is reached. This method should be practiced in a pool about waist-deep, that runs downstream into shallow water.

Holder for the Ice Pick

There is no particularly good reason for misplacing the ice pick if a holder is provided for it near the ice box. Since the instrument is a dangerous plaything for small children, it is essential that a holder be used that will keep the pick beyond their reach. Probably the simplest, yet most convenient, holder is one made from a window-shade roller bracket as illustrated. — Kenneth Coggeshall, Webster Groves, Missouri.

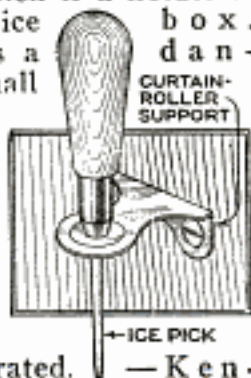

Why Films should be Soaked in Water before Developing

Exposed photographic films, particularly those in a strip or roll, should always be run through a dish of clean water before placing the negatives in the developing solution. The reasons for first washing the undeveloped negatives are good, and the operation will prevent many spoiled pictures. The amateur photographer generally makes the mistake of using too little developer, so that the film cannot be completely and uniformly immersed in the solution. Unless the developer is evenly distributed over the surface of the film, streaks are bound to result. However, if the negatives are first washed, a thin film of water will adhere to the surface, and this will retard the action of the developer, so that the person doing the work will have time enough to get the negatives uniformly covered with developer before development really begins. Dry materials placed in liquids generally cause the formation of air bubbles, and these, on sensitized materials, show up as circular transparent spots on the negative, which, in turn, show black on the prints. Both of these troubles are avoided by the preliminary washing.

Cooling City Drinking Water

Consumers of city water for drinking purposes are usually bothered by the high temperature of the water as it comes from the faucet during the summer months, which makes it almost unfit for drinking unless cooled with ice. In order to lower the temperature of the drinking water, and make it palatable without the use of ice, the idea illustrated was successfully used.

A spot was located directly beneath the faucet, and a small section of the flooring was removed. Then, with a post-hole auger, a hole was bored about 15 ft. deep. The hole was about 8 in. in diameter. An 8-ft. length of 4-in. pipe was connected into the water line as shown, so that the water entered at the

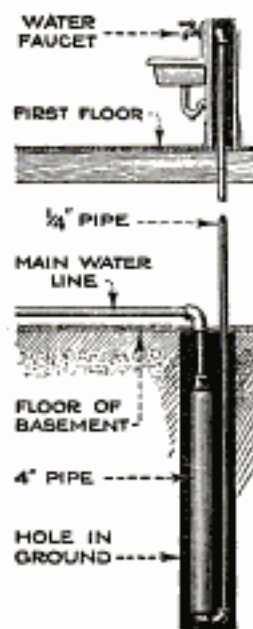

top of the large pipe and passed into the faucet connection at the bottom. After all connections had been made and tested, the hole was refilled with earth, and the flooring replaced. The coolest water is, of course, to be found at the bottom of the cooler, and is drawn off first. What little water is contained in the $\frac{1}{4}$ -in. pipe must be drawn off before the cooler water begins to come through the faucet; for this reason the small pipe is used, so that little water is wasted.—D. C. Stephenson, Augusta, Kan.

Homemade Three-Pole Double-Throw Switch

Needing a three-pole double-throw switch for a wireless set, at a time when a commercial one was not easily obtainable, a very satisfactory article was improvised, the materials being a spool with the flange on one end sawed off, three brass rods about 4 in. long, some

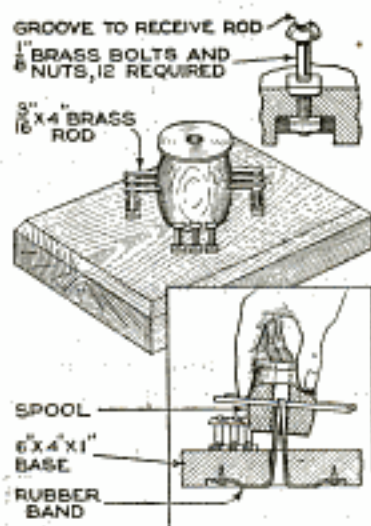

$\frac{1}{8}$ -in. brass bolts, a rubber band, two thumbtacks, and a piece of hardwood. Three holes, a little smaller than the diameter of the rods, were drilled in the spool, parallel with each other, and at right angles to the center hole, as shown. The brass rods were pressed into the holes so that about an inch of each end extended beyond the spool. In the center of the hardwood block, which was used as the switch base, a $\frac{1}{4}$ -in. hole was drilled. The rubber band was run through this hole, through the central vertical hole in the spool, and over the middle rod, the ends of the band being fastened to the underside of the base with the thumbtacks. This arrangement held the spool down tight, yet permitted it to be lifted and revolved through 90° . The brass bolts forming the contact points were set into the base in four sets of three each, opposite each other. The heads were a trifle higher than the rods in the spool, and semicircular grooves were filed as seats for the rods. The necessary connections were made on the underside of the base.

Blocks for Automobile Jacks

The handy pair of blocks shown in the drawing will more than repay the slight cost and trouble of making them, in the

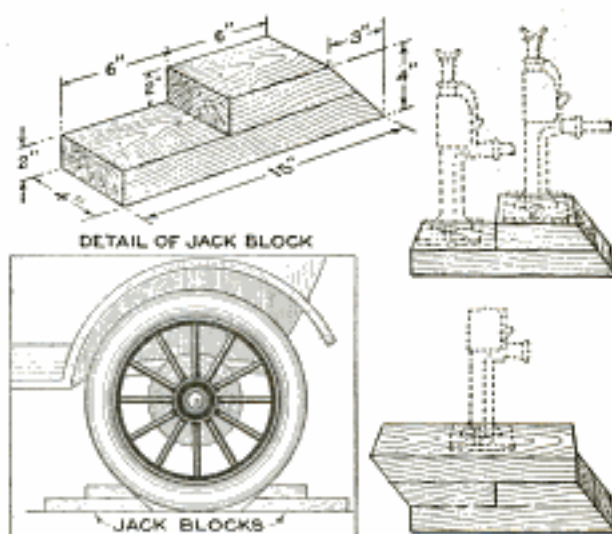

A Set of Jack Blocks, to Provide a Firm and Even Base for the Jack on Soft or Uneven Ground, and to Speed Up the Work

convenience that attends their application as indicated. The blocks can either be made from solid 4-in. timbers, or may be built up from 2-in. planks in the manner shown, and besides serving as a base for the jack on soft or uneven ground, they may be used for blocking the wheels of the car.—C. C. Spreen, Birmingham, Mich.

A Universal Hose Clamp

For simplicity, the hose clamp shown in the drawing can hardly be excelled, as it consists of nothing more than an ordinary cotter pin and a strip of sheet metal. It can be used on any size of radiator hose or wherever such a clamp can be applied. A strip of light sheet iron or other metal is cut to the proper length and provided with ears at the outer end, as shown; they may be soldered or not as preferred. The opposite end of the strip is inserted through the slot in the cotter pin and pulled through as far as possible, after which it can be drawn up as tightly as desired by means of a nail.

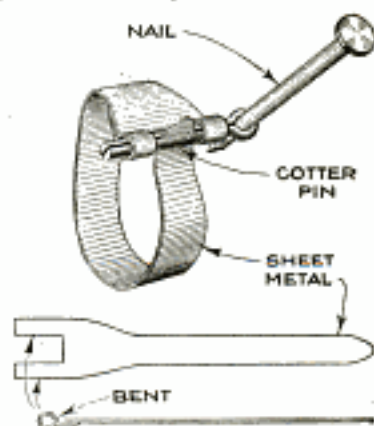

A Simple Radio-Transmitting Set

By F. L. BRITTIN

A SIMPLE spark-coil radio-transmitting set can be used where messages are to be sent over a short distance. The complete outfit can be put into a small suitcase, and is well adapted to the needs of outers in motor cars or boats, and for boy-scout field work.

The necessary instruments composing the set are the following: a high-tension jump-spark coil, of which different sizes can be purchased, good results having been obtained for distances up to 16 miles with the ignition coil from a standard light automobile; a key, an ordinary telegraph key answering the purpose, and a spark gap, which may be made from two zinc-battery electrodes mounted in two upright fiber posts. A condenser and helix will also be needed; the condenser stores up the energy, which is then discharged across the spark gap, and produces the oscillations that are thrown into space from the antenna in the form of waves.

The condenser can be made from a number of glass plates with sheets of tinfoil between them. Old 4 by 5-in. or 5 by 7-in. photographic negatives, from which the emulsion has been removed, will answer the purpose; the tinfoil sheets are cut $\frac{1}{2}$ in. smaller than the plates, and a tab, or ear, is left projecting for connecting the lead wires to each sheet. In assembling the condenser, the

tinfoil sheets are placed between the glass plates so that the tabs of alternate pieces will project from opposite sides. The condenser unit may consist of five sheets of foil and six glass plates. After assembling, bind the unit together and place in a cigar box, filling the surrounding space with melted insulating compound, or paraffin, to make a compact article for a portable set. If the transmitter is to be stationary, the condenser may be supported on wooden blocks in a pan, into which enough insulating or transformer oil to cover the unit is poured. Any desired capacity can be obtained by adding the proper number of condensers.

The helix consists of 45 turns of No. 14 bare-copper wire, which is wound around a grooved bakelite tube, 4 in. in diameter and 7 in. long. Spring clips are soldered to the wires from the aerial, ground, and spark gap, as shown in the diagram. Four dry cells give good results for short-distance work. When these are used, they may be connected in the series, as shown in the upper part of the drawing; another method of connecting them is in series-multiple, as shown in the insert. This distributes the load, and makes the battery last longer.

At the present price of materials, and assuming that all the parts are bought, the total cost of such a set will be about

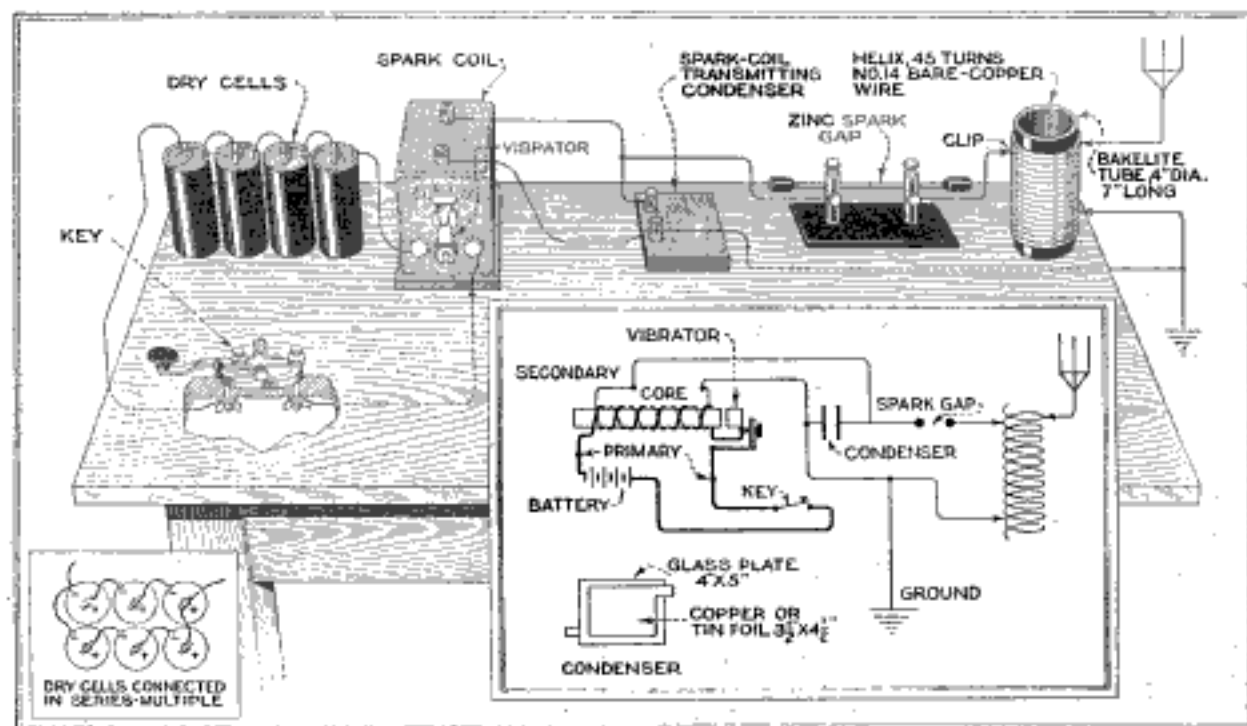

A Very Simple Transmitting Set for the Radio Amateur: It can be Packed into a Suitcase, Making It Suitable for Boy Scouts or Similar Organizations. All the Instruments may be Made at Home, if Desired, Making This a Very Cheap Set, and One Well Adapted to the Needs of the Beginner

\$15, but this amount can be considerably cut by using materials that are usually available around the average workshop.

The aerial should be well insulated from the ground, but not with porcelain cleats, which should not be used for the aerial of a transmitting set. Solder all wire connections and make all leads short. The ground is important; have the ground wire as short as possible, and fasten it to a water pipe, if convenient, first filing the pipe bright, and either

soldering the wire to it or using a ground clamp.

If the set is to be used in the house as a stationary outfit, a lightning arrester, or ground switch, must be installed on the outside, to prevent lightning from following the wire into the building.

To operate a transmitting station, an operator's license is necessary. Full details of the necessary examination can be obtained from the radio inspector of the district in which the builder resides.

Making Sure of a Sharp Focus

Many photographic exposures, which were apparently sharply focused, turn out to be more or less "fuzzy," because, in fact, they were not properly focused. A simple remedy for this, which makes it possible to focus the image as sharply as possible, consists in using a small magnifying glass, or strong spectacles. This idea can be applied to getting a better view of the subject in the finders of small box cameras, particularly on cloudy days when the image does not show clearly.—Mrs. A. K. Hinkley, Rowley, Mass.

Electric Light for the Refrigerator

Most refrigerators and ice boxes are so located that it is necessary to grope around in total or semidarkness to locate the article desired. All this can be easily overcome by fastening the socket for a miniature dry-battery lamp anywhere inside the food compartment. The light is turned on and off automatically by the simple contact shown in the drawing.

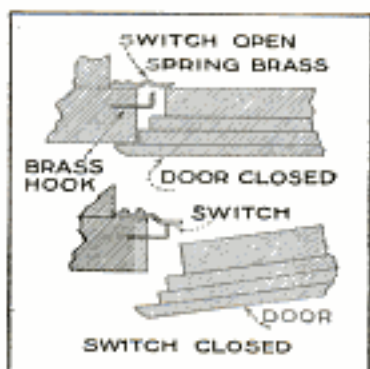

A piece of spring brass is fastened to the inside wall of the food compartment, and a brass hook is screwed into the edge of the door opening, in such a position that, when the door is closed, the spring contact will be separated from the hook, thus opening the battery circuit and turning off the light. As soon as the door is opened, the two parts of the contact come together and complete the circuit, causing the lamp to light.

Switch to Brighten Auto Headlights

On a light automobile where the headlights are supplied with current generated by the magneto, the lamps usually burn

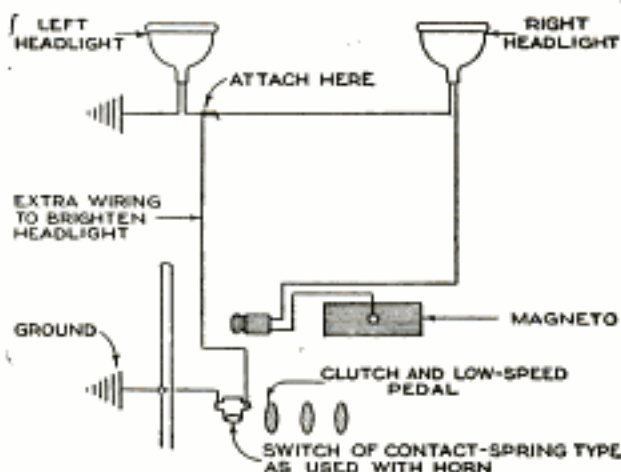

With This Wiring, One Headlight of a Light Car will Burn Brightly While the Car Runs at Slow Speeds

brightly when the car is running in high gear at slow speeds. For country driving, or wherever a bright light is desired with the car traveling at moderately slow speed, a simple arrangement for lighting one headlight brilliantly may be made by placing a push button, such as used for the horn, on the left side of the clutch pedal, running one wire from the button to a ground on the car frame, and another to the light, as shown in the diagram. When this button is pressed, the current flows only through the right lamp, causing it to burn brightly. The position of the button requires the use of the left foot to depress it, and consequently the car cannot be placed in low gear and the motor raced without releasing the pressure on the button, as otherwise the heavy current would burn out the bulbs.—G. A. Luers, Washington, D. C.

☛ A paper cone, slightly moistened inside the large end, can be used to remove small lamp bulbs that are difficult to grip with the fingers.

Pressing Pleated Skirts Easily

An easy way to press a pleated skirt, without the trouble of pinning, is shown in the drawing. Strips of tape are fas-

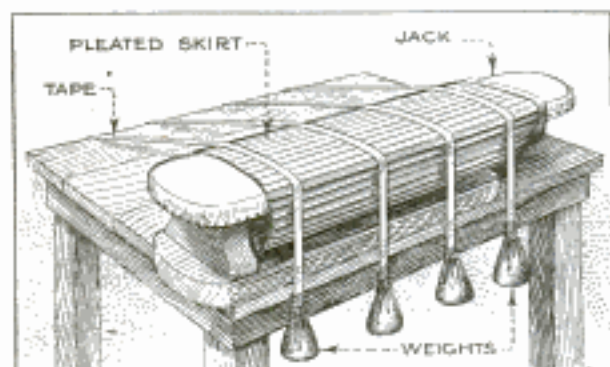

Pressing Pleated Skirts, Capes, and Similar Articles of Wearing Apparel, is Made Easy by Means of the Arrangement Illustrated

tened to the wall or edge of the table, at the desired distance apart, behind the pressing jack. A weight is fastened to the free end of each tape. The pleats are laid in order and held in place by drawing the tapes across the top, allowing the weights to hang over the edge of the jack. The iron can be run over the tapes. This method can be used successfully for either hand or machine pressing.—Alex Mackey, Powers, Ore.

How to Protect Lighting Fixtures When Using Vacuum Cleaner

Many a lighting fixture, to which a vacuum cleaner has been attached, has at some time or another been nearly pulled



from its fastenings because the machine was pushed farther than the wire would permit. The idea illustrated is designed as a "brake" on the wire, and to give warning to the user before any strain falls on the wire. A large rubber band is fastened across a loop made in the wire, 6 in. below the plug. The proper size to make the loop is found by stretching the rubber band as far as it can be done without breaking, and making the length of wire in the loop the same as the extended length of the band.—Mortimer V. Tessier, Nyack, N. Y.

Emergency Gasket Made of Lamp Cord

While on an automobile trip the owner was annoyed by the blowing out of the copper gasket between the exhaust manifold and exhaust pipe, so that the smoke and exhaust gases blew into the tonneau of the car. No stock gasket could be obtained, so a piece of flexible copper wire was used; this was braided into a circular gasket, and served well until a new copper gasket could be obtained.—Chas. H. Willey, Concord, N. H.

Tool Aids in Work on Overhead Automobile-Engine Valves

As the overhead valve with which certain makes of automobile engines are fitted drops down into the cylinder when

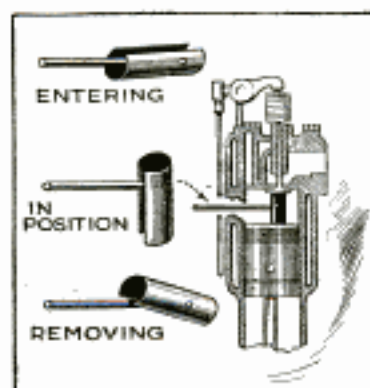

the valve spring is released, the usual practice is to unscrew the valve cage and do the work at the bench. But by using the little tool shown in the drawing, the cage need not be removed, as

the valve is held in place through the spark-plug hole; this makes it possible to remove weak or broken springs and replace them with a minimum of time and trouble. The tool is made from a piece of sheet brass, about 2½ in. long, rolled into an open-sided cylinder, pivoted near one end on a handle, so that when inserted through the spark-plug opening, it will fall into an upright position under the valve. The engine is then cranked by hand until the piston comes up and holds the tool against the valve. When the handle is turned upside down, the cylinder falls forward over the handle so that it can be withdrawn. A wooden handle is suggested to prevent injury to the threads of the spark-plug hole.

☞ Cut a hole in the side near the bottom of a wash boiler a trifle smaller than the hexagon on an ordinary faucet, and fasten the faucet to the boiler with solder. A locknut and washer on the inside will give additional strength. This arrangement makes it a very simple matter to empty the vessel.

PRIZE OFFERS AND ANNOUNCEMENTS

9843
DOUGHBOYS URGED TO RETURN SOUVENIRS TAKEN FROM RHEIMS CATHEDRAL

"Our doughboys went overseas with the sole and primary purpose of collecting souvenirs," laughingly declared a famous war veteran on his return from France. While the statement was made in fun, it is nevertheless true that great quantities of souvenirs were brought back. In an appeal to Yankee fighters, the American Legion requests every member of the Expeditionary Forces who may have "salvaged" a fragment of the Rheims Cathedral to send it back to Rheims. The French government has undertaken to reconstruct the historic church, but cannot replace the priceless bits of statuary and other elements which have been taken by souvenir hunters.

9647
HORSESHOE-PITCHING TOURNAMENT TO BE HELD THIS YEAR AT IOWA STATE FAIR

The annual National Horseshoe Pitchers' Tournament for the championship of the world will be held this year at the Iowa State Fair and Exposition, Des Moines. The men's national tournament will be August 29-September 1; the women's will be August 30, and the Iowa State tournament for men will be August 28-29. A cash prize of \$250, with trophies valued at \$850, and other cash prizes, down to \$20 for sixteenth place, are offered for the men's events. The women's prize list includes cash prizes from \$25 for first place, down to \$5 for eighth place, with trophies valued at \$300. All entries, accompanied by a fee of \$2 for men, and of \$1 for women, must be sent in not later than Aug. 24, 1922.

9527
STUDENTS OFFERED PRIZE FOR BEST ESSAY ON A HISTORICAL NOVEL

To promote a better knowledge of one of the greatest achievements in American literature, Kenyon College offers a prize of \$100 for the best essay, written by a student of any college or university in the United States or Canada, on "Gorgo, a Romance of Old Athens," by Charles Kelsey Gaines. Three typewritten copies of the essay, which must not be more than 4,000 words in length, must be submitted, and must reach Kenyon College, Gambier, Ohio, not later than Dec. 1, 1922.

9697
PRIZE OF \$5,000 TO BE AWARDED EVERY FIVE YEARS TO AN AMERICAN WOMAN

As a tribute to M. Carey Thomas, who is retiring from the presidency of the college, the Alumnae Association of Bryn Mawr College is founding a prize of \$5,000, which will be awarded every five years to an American woman who has achieved eminence in some line of work. The award will be known as the "M. Carey Thomas Prize." Address, Publicity Committee of Bryn Mawr College, Alumnae Office, Bryn Mawr, Pa.

U. S. CIVIL-SERVICE EXAMINATIONS FOR VARIOUS VACANCIES

Competitive examinations for assistant examiner Patent Office, will be held Aug. 23, 24, and 25, and Oct. 18, 19, and 20, 1922, in various cities and towns throughout the United States, Porto Rico, and Hawaii. Other vacancies in the Patent Office, with an initial salary of \$1,500 a year and a bonus of \$20 a month, with provisions for promotion to positions paying from \$1,650 to \$3,900 a year, will also be filled from this examination.

Examinations for valuation engineer and other vacancies on the technical staff of the income-tax unit of the Bureau of Internal Revenue, at \$3,600 to \$4,800 a year, are to be held in the near future. Applications for eligibility must reach Washington before Sept. 1, 1922.

The Langley Memorial Aeronautical Laboratory, Langley Field, Virginia, is in need of a wind-tunnel

mechanic. The position pays \$1,800. Receipt of applications closes Aug. 15, 1922.

Applicants for any of the foregoing positions should write at once for Form No. 1312, stating the title of the examination desired. Address Civil-Service Commission, Washington, D. C.

9850
COLORFUL PAGEANT WILL BE STAGED ON BOARDWALK OF ATLANTIC CITY

What promises to be a brilliant and colorful pageant will be staged on the boardwalk at Atlantic City, September 6, 7, and 8, according to plans approved by the local authorities.

"King Neptune"—to be acted by some one of international reputation—will be brought from the sea with his court of beauty, guard of honor, and slaves, on the first day in gayly decorated seaplanes. Among the many events on the program is a beauty contest, a bathers' revue, a rolling-chair parade, automobile road race, swimming meet, and a tennis, trapshooting, and golf tournament.

A statuette, representing a mermaid and wrought in solid gold, is the prize to be won by America's most beautiful bathing girl. The figure reclines on a bowlder of granite which is mounted on a bronze base, molded to represent ocean waves.

9843
INTERESTING PICTURES OF AUTOMOBILE WANTED BY MOTOR COMPANY

For the three most interesting or unusual photographs of the Chandler car, the Chandler Motor Company of Cleveland will pay cash prizes of \$100, \$50, and \$25. The contest closes before the end of the year, the exact date to be announced later. A short description of the scene should accompany each photograph submitted. All prints entered in the competition are to become the property of the motor company.

CONTESTS PREVIOUSLY ANNOUNCED

Medals, Diplomas, and Money Awards: Announced August issue, 1921; awards offered by the Franklin Institute.

For Service to City of Philadelphia: Prize \$10,000; announced September issue, 1921; awarded each year by Edward Bok, former editor of The Ladies' Home Journal.

One Million Francs for Best Motor: Announced January issue, 1922; closes June 1, 1923; address, Aero Club of France, Paris.

Man-Propelled Airplane: Prize 20,000 francs; announced April issue, 1922; closes September 13; address, Maison Peugeot, 80 Rue Danton, Levallois-Perret (Seine), France.

Best Lists of Uses of Shoe Polishes: Prizes \$500, \$300, \$200, 10 of \$25 each, 20 of \$15 each, 50 of \$5 each, 50 of \$2 each, and 100 of \$1 each; announced April, 1922; closes Aug. 31, 1922; address, F. F. Dalley Company of New York, 277 Military Road, Buffalo, N. Y.

Annual Commercial Airplane Contest for "Italy's Great Trophy": announced, July issue, 1922; address, Aero Club of Italy.

For Best Lists of Uses for "Sanlo": Prizes \$50, \$25, \$10, and three of \$5 each; announced June issue, 1922; closes Aug. 31, 1922; address, Contest Department, The Parker Sanlo Co., Inc., Rochester, N. Y.

Research Thesis by a Woman: Prize \$1,000; announced October issue, 1921; awarded annually; address, Dr. Lillian Welsh, Goucher College, Baltimore, Md.

Ideas for New Occupations for Shut-Ins: Prizes, \$100, \$50, and \$25; announced July issue, 1922; closes Nov. 1, 1922; address, Prize Editor, Popular Mechanics Magazine, 6 North Michigan Ave., Chicago.

American Legion National Essay Contest: Prizes, \$750, \$500, and \$250; announced August issue, 1922; closes Oct. 6, 1922; address, The American Legion, National Americanism Commission, Indianapolis, Ind.

Best Essay about Pasteur: Prize, 100 scientific books; announced August issue, 1922; closes, Sept.

*Thos. P. Endicott Director
General, Atlantic City Pageant
P. O. Box 13, City Hall*

1, 1922; address, Fédération de l'Alliance Française, 32 Nassau St., New York City.

Best Backyard Railroads: Prizes, 23, ranging from \$25 to \$2; announced August issue, 1922; closes Sept. 15, 1922; address, American Flyer Mfg. Co., 2219-39 South Halsted St., Chicago, Ill.

Fishing Contest: Prizes, Seven "Model 94" Win-

chester hunting rifles; announced July issue, 1922; no definite closing date.

Best Novel by an American Author: Prize \$2,000; announced August issue, 1922; closes March 1, 1923; address, Harper & Brothers, New York City.

Designs for Chicago Tribune Building: Prize, \$100,000; announced August issue, 1922.

In answering prize offers please mention Popular Mechanics Magazine

9327
FISHING THE ETHER

By George F. Staat

Every night on the stroke of seven,
I go fishing in the pond of heaven,
Hairlike hook and a crystal bait—
And I fish and I fish till the stroke of eight.

I cast a dozen miles from shore,
Cast again a dozen more,
With my thumb upon the reel,
Till a sound-fish bite I feel.

Nibble, nibble—here they come,
Till they make my tackle hum,
Sound fish, wonderful and fine;
Forty million on one line!

Opportunity
School,
Pasadena
Calif.

9394
CONFESSION

By James A. Sanaker

Not like one on the mountain top
Who, gazing down below,
Looks calmly at the shifting throng
Which rushes to and fro.

Not like the thinking man who plans
Each move to be just so,
Whose wisdom always bids him wait,
Whose watchword cries, "Go Slow!"

But, like a million other souls,
Quite thriftless here below,
I caught the latest fad and fell,
I bought my radio.

Missouri
Valley
Clara
St. San Francisco, Calif.

9712
**NEW BOX-TESTING MACHINE
AT FEDERAL LABORATORY**

The shaky rough-riding action of a freight car is imitated by a new box-testing machine in use at the Forest Products Laboratory, Madison, Wis. The boxes are placed on a heavy, low steel table, which is then operated by a series of motors "tuned" to reproduce faithfully

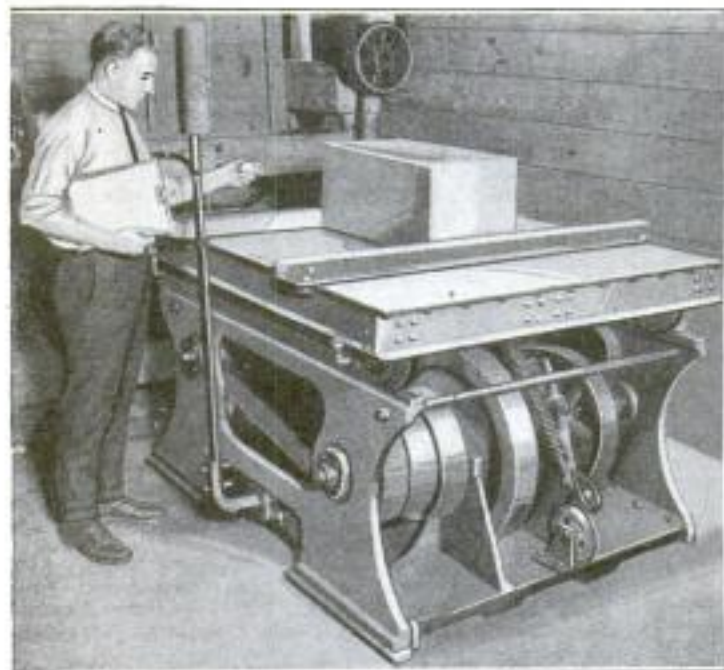

A Close-Up of the Box-Testing Machine: The Lever Controls a Series of Motors Which Give the Table the Shaky Motion of a Moving Freight Car

the vibrations of a moving freight car. The machine was designed by engineers of the Department of Agriculture.

9389
**WILL WIRE OFFICE BUILDING
FOR RADIO INSTALLATIONS**

For the first time in the history of Pacific-coast office-building construction, a 15-story skyscraper in San Francisco, erected by a navigation company, will be wired throughout for radiophone installation. Tenants wishing to put in a receiving set will only have to "plug in" to a wall socket, as for a desk lamp, to be connected with the antenna on the roof and receive broadcasting programs from stations in San Francisco and vicinity. Not only will the new building be completely wired as a convenience to tenants who are radiophone enthusiasts, but the company intends to install a powerful sending and receiving set, with which it is expected it will be possible to give orders to the captains of the company's nine freight and passenger ships, which maintain a weekly service between San Francisco and the Hawaiian Islands. Within the next year the company hopes to be able to talk by radiophone with its agencies in the islands.

Navigation
St. San Francisco
Market
Co. 120
A. E.

IN accordance with the editorial policy of this magazine never to accept compensation in any form for what appears in our reading pages, and also to avoid all appearance of doing so, we are obliged to omit the name of the maker or the seller of any article described. This information, however, is kept on file and will be furnished free, by addressing Bureau of Information, Popular Mechanics Magazine, Chicago. [Editor.]

Use it—and you will see the difference



Pocket sun dials tell time, yet you prefer an accurate watch, though it requires winding. Similarly, for 25c or less, you can buy a toy kind of clutch pencil with wobbly, uncertain point—but you prefer a finely made pencil of precision—like EVERSARP.

The principle of operation that makes EVERSARP write with satisfying smoothness and surety depends on the exclusive rifled tip that keeps the lead from slipping and wobbling. The success of this rifled tip is the success of EVERSARP—and no other pencil can use this rifled tip.

Supplementing the perfect EVERSARP tip are other excellent features that contribute dependability, convenience, beauty—all in every EVERSARP, regardless of what you pay.

Select your EVERSARP today—or get an extra one for your desk. Gold, silver and enamel finishes; priced from 50c to \$50. Sold everywhere.

Made in U. S. A. by
THE WAHL COMPANY, CHICAGO
Canadian Factory, THE WAHL COMPANY, Ltd., Toronto

EVERSHARP

REG. U.S. PAT. OFF.



EXCLUSIVE RIFLED TIP

The supreme point of efficient writing. Lead held firmly; cannot slip nor wobble.



HANDY ERASER UNDER THE CAP

Eraser free with every box of EVERSARP leads.



HOLDS 6 TO 12 LEADS

Sold completely loaded. Extra lead in the Red-top box, 15c everywhere. Seven grades of lead, also indelible.

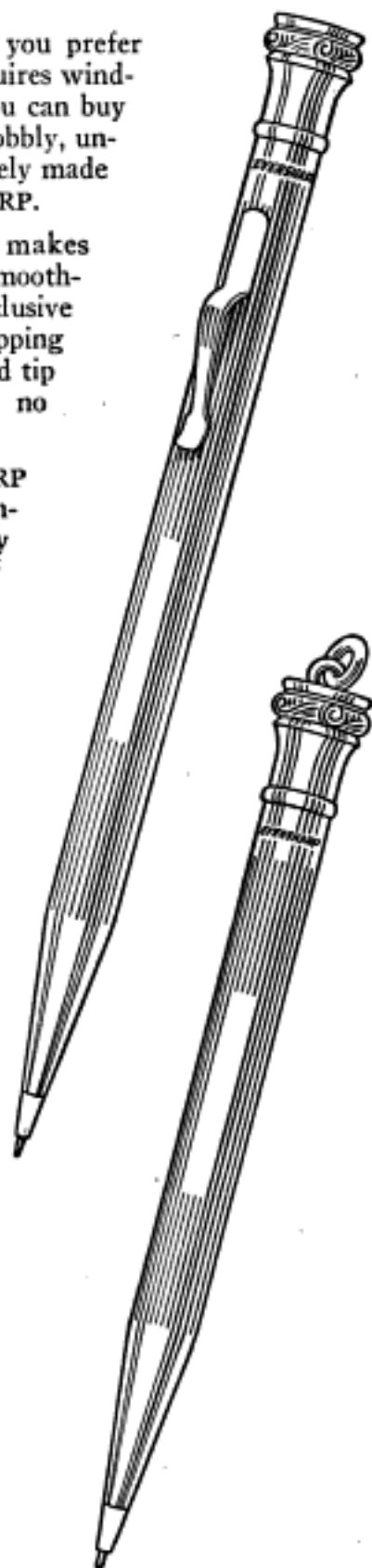



2400 telephone wires in a cable little larger than a man's wrist.

Science keeps down costs

When the Bell System installed its first successful telephone cable, fifty wires was the largest number that could be operated in a single cable without "cross-talk" and other interference. Today it would require 48 cables of the original type to accommodate the number of wires often operated in one cable.

Without this improvement in cable, the construction of new underground and aerial lines would have cost the Bell System upwards of a hundred million dollars more than has actually been spent. In addition, the cost of maintenance would have been greater by eighteen million dollars a year. These economies in the Bell System mean a saving in telephone rates to each individual subscriber.

In all branches of telephone practice

science has similarly contributed to economy. Even in such a comparatively small item as switchboard cords, improvements have reduced the cost of renewal by four million dollars a year.

Every new telephone added to the Bell System increases the usefulness of all telephones, but this multiplication tends likewise to increase the complications and the expense of service. The scientists of the Bell System, to offset this tendency, are constantly called upon to develop new devices which simplify complications and keep down costs.

By virtue of a united system the benefits of these improvements are shared by all subscribers—and the nation is provided with the best and cheapest telephone service in the world.



" BELL SYSTEM "

AMERICAN TELEPHONE AND TELEGRAPH COMPANY
AND ASSOCIATED COMPANIES

One Policy, One System, Universal Service, and all directed toward Better Service

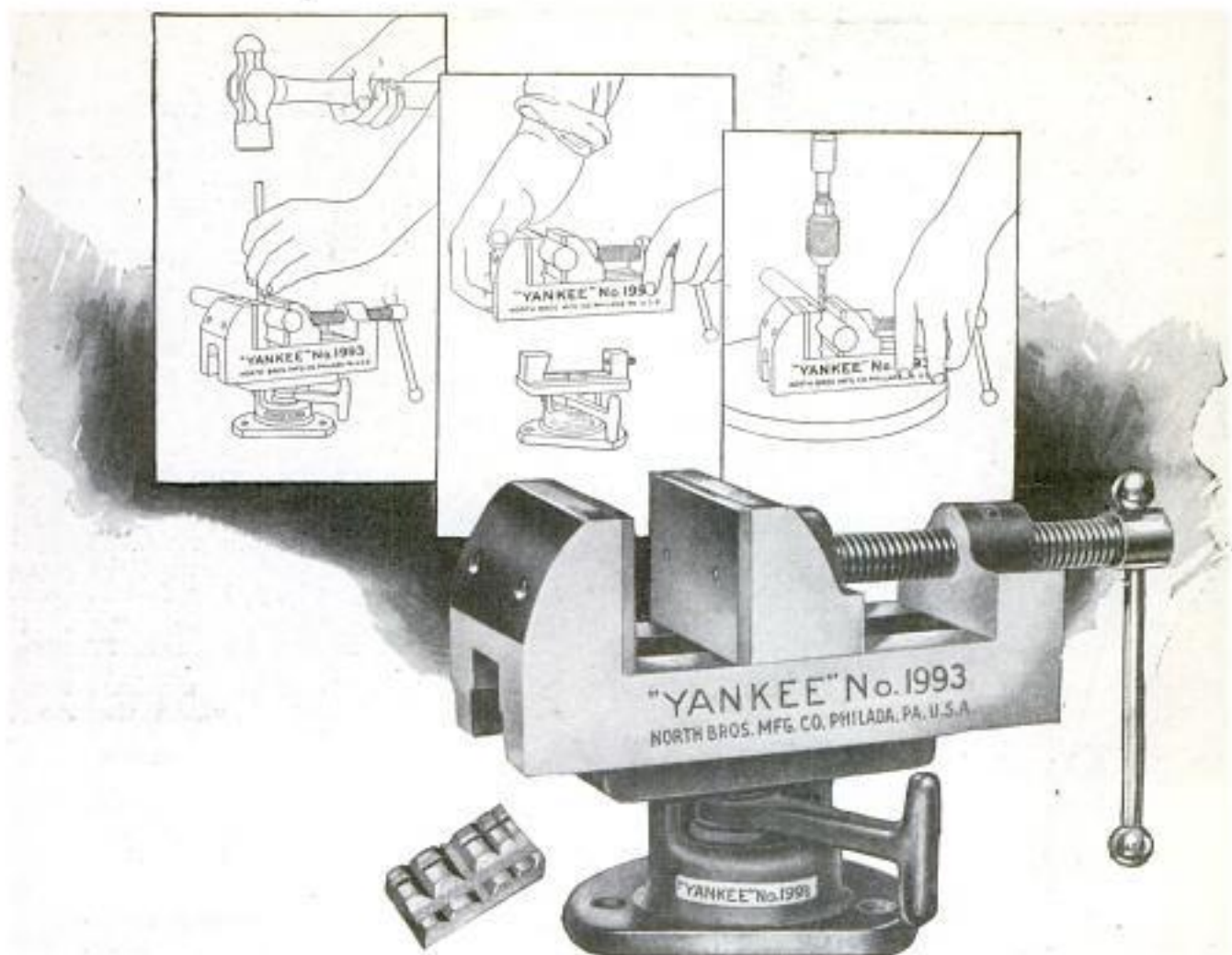

The "YANKEE" Vise stands by the job

Some other "YANKEE" Tools

Ratchet Breast Drills
Ratchet Hand Drills
Ratchet Chain Drills
Automatic Push Drills
Ratchet Tap Wrenches
Ratchet Bench Drills
Spiral Screw-drivers
Quick Return Spiral
Screw-drivers
Plain Screw-drivers
1½ to 30 in. blades

Dealers
everywhere sell
"YANKEE"
Tools

"When a job must go through quickly and be absolutely accurate, I lock it in a 'Yankee' Vise. The vise with work in it is detached from base. It goes from machine to machine and back to bench

in the original alignment." Sides, top and bottom of the vise machined true. Can be locked in any position. Removable steel block with V-shaped grooves holds round or irregular work.

"YANKEE" VISES with Swivel Base

No. 1991—Body 3½ in. long, 1½ in. wide, Jaws open 1½ in.; depth ¾ in.
No. 1992—Body 4¾ in. long, 2 in. wide, Jaws open 1¾ in.; depth 1½ in.
No. 1993—Body 7¾ in. long, 2¾ in. wide, Jaws open 3¾ in.; depth 1¾ in.
No. 1994—Body 10½ in. long, 4 in. wide, Jaws open 4 in.; depth 2¾ in.

Without Base

As above: Nos. 991, 992, 993, 994

Interesting Tool Book FREE, Illustrates and describes all the ingenious "Yankee" Tools for saving time and labor. Write today for it.

NORTH BROS. MFG. CO. Philadelphia



"YANKEE" TOOLS

Make Better mechanics



Teeth You Envy

Are brushed in this new way

Millions of people daily now combat the film on teeth. This method is fast spreading all the world over, largely by dental advice.

You see the results in every circle. Teeth once dingy now glisten as they should. Teeth once concealed now show in smiles.

This is to offer a ten-day test to prove the benefits to you.

That cloudy film

A dingy film accumulates on teeth. When fresh it is vis-

cus—you can feel it. Film clings to teeth, gets between the teeth and stays. It forms the basis of cloudy coats.

Film is what discolors—not the teeth. Tartar is based on film. Film holds food substance which ferments and forms acid. It holds the acid in contact with the teeth to cause decay.

Millions of germs breed in it. They, with tartar, are the chief cause of pyorrhea. Thus most tooth troubles are now traced to film, and very few escape them.

Must be combated

Film has formed a great tooth problem. No ordinary tooth paste can effectively combat it. So dental science has for years sought ways to fight this film.

Two ways have now been found. Able authorities have proved them by many careful tests. A new tooth paste has been perfected, to comply with modern requirements. And these two film combatants are embodied in it.

This tooth paste is Pepsodent, now employed by forty races, largely by dental advice.

Other tooth enemies

Starch is another tooth enemy. It gums the teeth, gets between the teeth, and often ferments and forms acid.

Nature puts a starch digestant in the saliva to digest those starch deposits, but with modern diet it is often too weak.

Pepsodent multiplies that starch digestant with every application. It also multiplies the alkalinity of the saliva. That is Nature's neutralizer for acids which cause decay.

Thus Pepsodent brings effects which modern authorities desire. They are bringing to millions a new dental era. Now we ask you to watch those effects for a few days and learn what they mean to you.

The facts are most important to you. Cut out the coupon now.

10-Day Tube Free 947

THE PEPSODENT COMPANY,
Dept. 171, 1104 S. Wabash Ave., Chicago, Ill.
Mail 10-Day Tube of Pepsodent to

.....
.....
Only one tube to a family.

Pepsodent PAT. OFF.
REG. U.S.

The New-Day Dentifrice

Endorsed by modern authorities and now advised by leading dentists nearly all the world over. All druggists supply the large tubes.



The Greatest Musical Catalog Ever Published

Over 3,000 Musical Articles—Every Known Musical Instrument Fully Described

For Professionals — Beginners — Amateurs

WURLITZER will send you any musical instrument known for a week's free trial in your own home. There is no obligation to buy. Not a penny cost to you unless you decide to keep it. You are the sole judge. Send the coupon for this catalog now. Read the details of this wonderful opportunity. This is your chance to buy any musical instrument you wish on *Free Trial*.

Any Known Instrument On Free Trial

Wurlitzer instruments have been used for three generations by famous artists, great bands and orchestras. Wurlitzer sends you any instrument on free trial. Many instruments come in velvet and plush lined carrying cases with all accessories, self-instructor, music, etc., all at factory prices, if you decide to buy. You get the entire outfit practically for the cost of the instrument alone.

Monthly Payments A few cents a day will pay for instrument and outfit if you decide after trial that you wish to keep it.

Send
for this
Catalog
Now!



The Rudolph Wurlitzer Co., Dept. 1776
117 E. 4th St. Cincinnati, O. 329 S. Wabash Ave. Chicago, Ill. 120 W. 42nd St. New York, N. Y.
250 Stockton Street, San Francisco, Calif.

Please send me your FREE 150-page catalog which features over 3000 articles of musical merchandise.

Name

Address

Instrument

(State instrument in which you are especially interested)

The Rudolph Wurlitzer Co.

Cincinnati

Chicago

New York

San Francisco

Dependable
Champions
For Every Engine Everywhere

**Insure
 Your
 Engine**



Type for Ford
 Champion X . . . now 60c
 Champion Regular now 75c

Champion accuracy in construction assures absolute uniformity of spark in each cylinder; consequently a more perfect timing of the engine

Ask your dealer to sell you a full set.

CHAMPION SPARK PLUG CO.

TOLEDO, OHIO



Your Home Is Within Your Reach When You Buy From Us

NOW is the time to build your Harris Home!

And here is a mighty organization of thirty great departments ready to serve you. Managed by expert material buyers, designers and practical builders. We have vast stocks bought at huge quantity price savings which are now at your command. Our sole aim and purpose is

To help you get a home that will prove entirely satisfactory at a price that will mean a substantial saving in actual dollars of your money.

The combined efforts of these great departments in experimenting and testing materials and methods of construction have produced for you a GUARANTEED home, expert machine cut, bundled and marked—the last word in building economy.

Not One Penny in Advance

So sure are we of the super-excellence of our material and our GUARANTEED Ready-Cut System that we will ship you any HARRIS HOME without the payment of one cent down. Our Plan Book explains our liberal terms fully.

FREE Plan Book

The latest edition is waiting for you, contains our FREE PLAN OFFER and photographic reproductions, with floor plans and specifications of 100 beautiful homes. Mail coupon today.

Building Material of All Kinds

For over a quarter of a century, thrifty wise buyers have realized that here is the "open door" to real economy, whether it be a brand new home or material for improvements or repairs. Our big stocks of brand new building material, all purchased in tremendous quantities at savings that are passed along to you are ready for quick and complete shipments.

"PRESTO-UP" Patented Bolt-together Buildings!

The wonder buildings of the age. Guaranteed buildings, for quick industrial housing. Individual Homes, etc., extra strong, practical and suitable for all year 'round habitation in any climate. 50 different plans. They come to you in easily handled sections—painted and stained, ready to bolt together and move in.

Plumbing and Heating!

Hot water and heating systems, warm air heating plants, pipeless furnaces and plumbing material of every kind—the product of America's leading makers. Our mammoth plumbing stock offers unlimited possibilities for you to save money. Our heating plants are guaranteed to heat your home in any weather with big fuel economy. Mail the coupon for our Plumbing and Heating Book and get the benefit of our Expert Engineering Service.

Department NM-7

HARRIS BROTHERS CO.
1349-1525 W. 35th St., CHICAGO

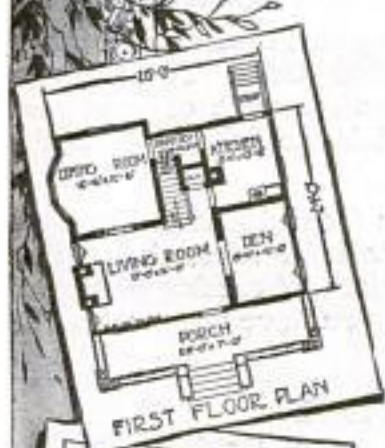

FIRST FLOOR PLAN

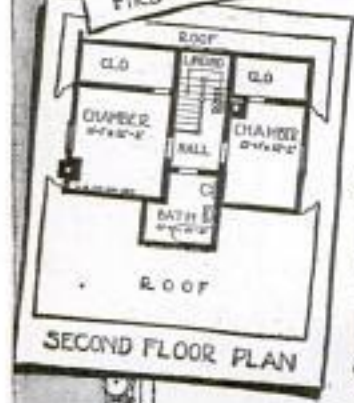

SECOND FLOOR PLAN



**FREE BOOK
of Plans**

HARRIS BROTHERS CO.
Dept. NM-7, Chicago

These books are FREE and sent post paid. Mark an "X" in the squares to indicate which ones you wish.

- Harris Home Book of Plans Book of "Presto-up" Houses and Garages
 Building Material Catalog Plumbing and Heating Book

Name.....

Address.....

GODELL-PRATT

1500 GOOD TOOLS



Calipers, Steel Rules and Surface Gauges in all the standard styles and sizes.

“Accuracy is my family name,” says Mr. Punch

You've got to buy measuring instruments and precision tools — micrometers, gauges, calipers and steel rules — largely on *faith*. The reputation of the maker is your best guarantee of *accuracy*.

The confidence and faith that mechanics, artisans, and other workmen have in the Goodell-Pratt 1500 Good Tools is *never misplaced*. Before you buy another steel rule, measure it up with a micrometer.

Exceptional accuracy—the result of taking pains

If you could see the infinite pains taken in the making of all Goodell-Pratt 1500 Good Tools — you would realize why so many thousands of workmen have such *faith* and *confidence* in the Goodell-Pratt Tools they use.

Your hardware dealer has Goodell-Pratt Tools or can get them for you. Talk to him. Meantime, write for a copy of our new machinist tool catalog picturing and describing the very tools you have always wanted to call your own. It's free.

Surface Gauge
No. 55
with Micrometer
Adjustment
Price, \$12.00

GODELL-PRATT COMPANY

Greenfield, Mass., U. S. A.

Toolsmiths

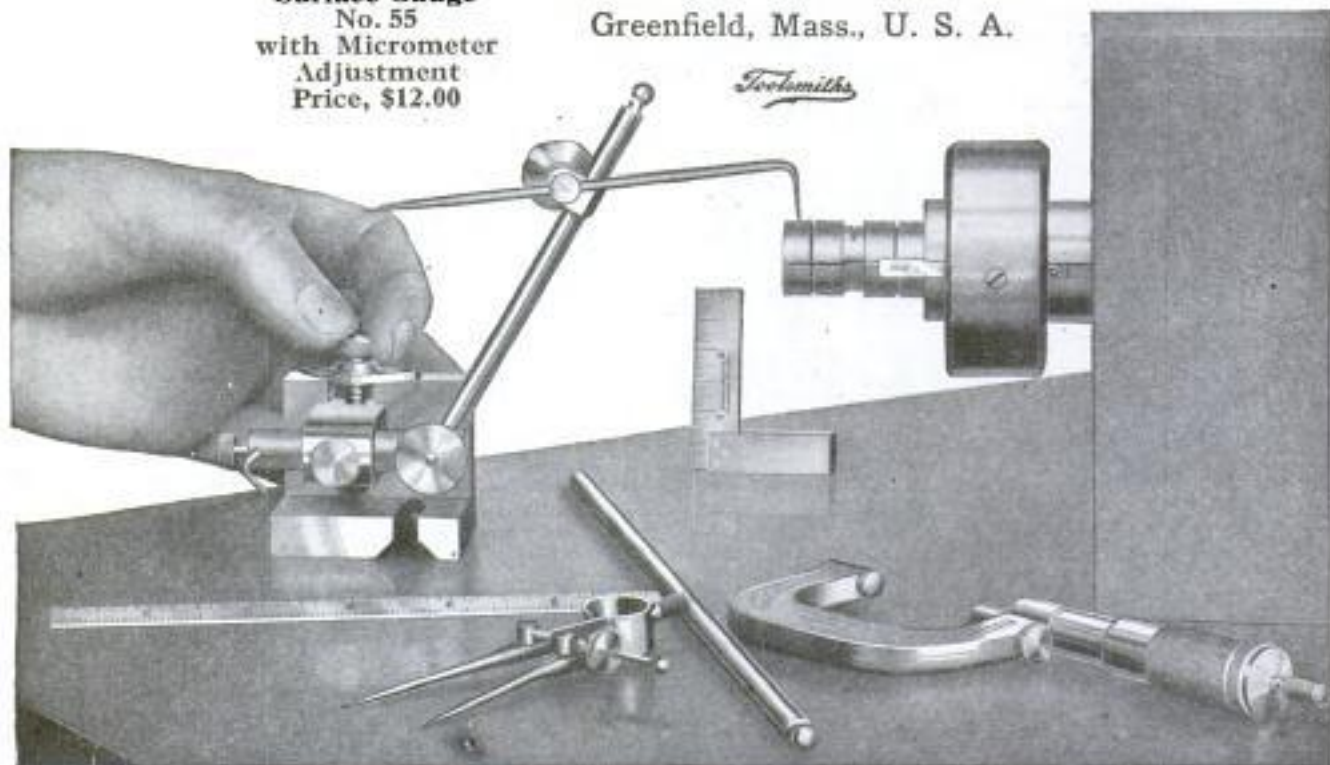

Sent on Approval No Money Down

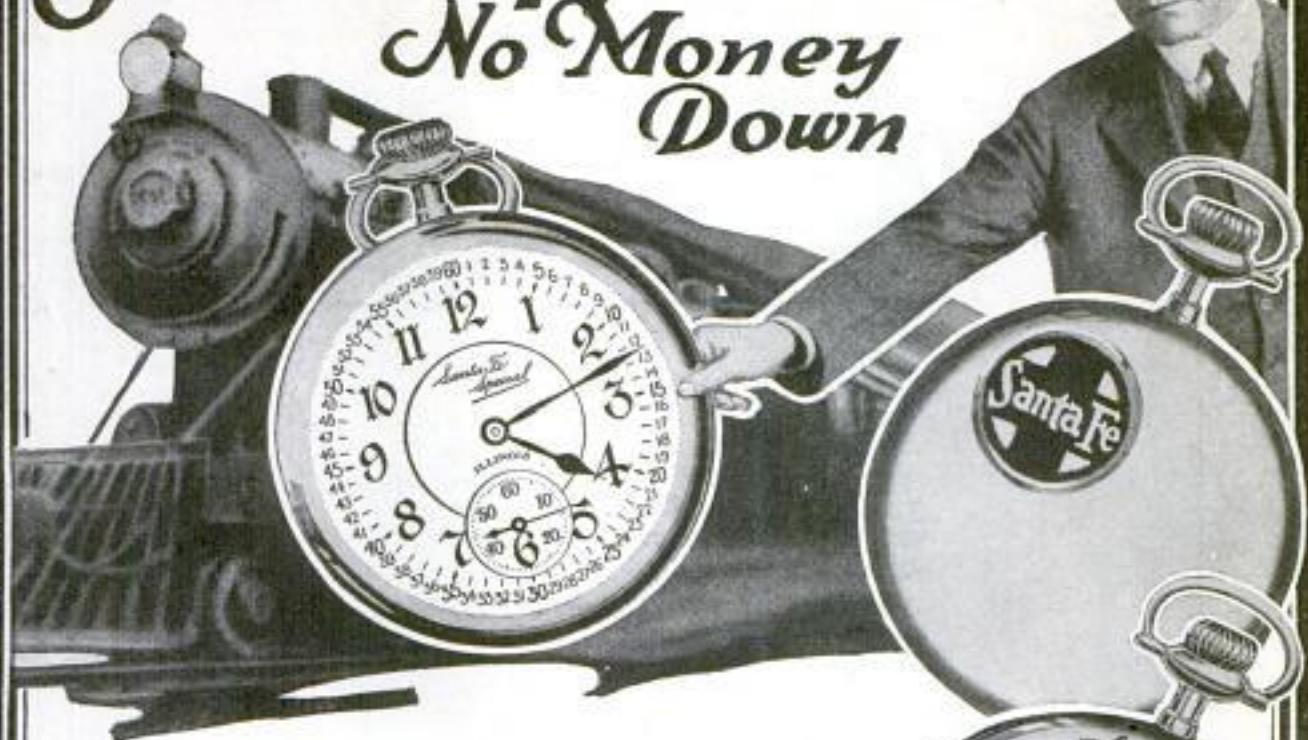

21 Jewel Santa Fe Special

21 Perfect Jewels
Adjusted to Positions
Adjusted to Temperature
Adjusted to Isochronism

Adjusted to the Second
New Models. Thin Cases
Montgomery Dial
25 Year Gold Strata Case

Without one penny of advance payment let us place in your hands to see, to examine, to inspect, to admire, to approve a real masterpiece in watch creation.

Our determination to this year double our sales of the world famous *Santa Fe Special* and *Bunn Special* Watches prompts this matchless offer.

While other watch dealers are raising their prices, asking you for larger monthly payments, and making payment terms harder for you to meet, we are offering you our new model *Santa Fe Special*, no advance in price, no money down, easier terms and smaller monthly payments. [WE realize the war is over and in order to double our business we MUST give you pre-war inducements, better prices, easier terms, and smaller payments.]

Page 12 of Our Watch Book is of Special Interest to You!

Ask for our Watch Book free—then select the watch you would like to see, either the famous *Santa Fe Special* or the 6 position *Bunn Special*, and let us explain our easy payment plan and send the watch, express prepaid, for you to examine. No money down.

REMEMBER No money down—easy payments buys a master timepiece—a 21 Jewel guaranteed for a lifetime at about half the price you pay for a similar watch of other makes. No money down—a wonderful offer.

SANTA FE WATCH COMPANY

96 Thomas Bldg.

Topeka, Kans.

SANTA FE WATCH CO.,
96 Thomas Bldg., Topeka, Kans.

Please send prepaid and without obligation your Watch Book free, explaining your "No Money Down" Offer on this *Santa Fe Special* Watch.

Name

Address



1880

1922

First among the things that explain the preference of two generations of skilled machinists for Starrett Tools is the fact that there are no "seconds." A man can rely on the unvarying accuracy of a Starrett Precision Tool as he can on the word of his best friend.

Write for Catalog No. 22AP and the Supplement describing the new Starrett Tools.

THE L. S. STARRETT CO.

The World's Greatest Toolmakers
Manufacturers of Hack saws Unexcelled
 ATHOL, MASS.



Micrometer Depth Gage No. 440
 With Three Measuring Rods
 For those who prefer a one inch movement of the screw. The 440 provides measurements of the depth of holes, grooves, etc., from 0 to 3 inches by thousandths of an inch.

Starrett Tools



42-392

I Want A \$5000 Man in Every Town

This is nothing more than a "Help Wanted" Ad—But it offers you the most amazing opportunity in years. You may not be the man I want—but if you are—I'll Show You How You Can Earn From \$5000 to \$7000 a Year



The Proposition

One of America's largest woolen mills, Taylor-Wells & Co.—for the first time in the history of woolen mill merchandising has decided to manufacture and sell directly from the mills to the wearer all wool products—overcoats, work-pants, bed-blankets, auto-ropes, raincoats and suits, fashioned from their own woolens. An organization of special representatives is now being formed to represent Taylor-Wells & Co. in exclusive territory. In view of the fact that this organization is to be composed of the best grade of men I can secure—I am going to be mighty particular about—

The Man

He need not have selling experience. But he must possess loyalty, honesty, sincerity and a good reputation in his community. I do not want every Tom, Dick or Harry. I want men of whom we will be proud—and who in turn will be proud of us and our merchandise. I know our products to be of the highest grade and I want men of a like calibre.

His Earnings

Conservatively estimated a special representative should earn from \$5000 to \$7000 a year. The demand for our products will be great. Selling direct from the woolen mills to the consumer—we can sell all wool merchandise at a price so low as to be astonishing. Our representative will practically build a business for himself in his territory. Customers who buy Taylor-Wells all wool products stay customers.

His Future

The sales organization now being formed is in its infancy. Within a short time District Managerships will be open. The men who join us now—and who "make good" place themselves immediately in line for a District Managership which should net him \$10,000 a year and more. The ambitious man with the determination to succeed will have no trouble in "landing" one of these openings.

Why You Must Act Quickly

This may be your one big opportunity. Do not delay! Write me immediately and use the coupon below for full details of this amazing opportunity. Territories will be going fast—so if you believe yourself the "right man"—hurry!

Take a Tip From Me

I've been in the selling game and sales promotion field for years—and when I tell you that this opportunity which is now offered you is **absolutely the most amazing selling plan I have ever seen**—I know what I am talking about.

You don't have to be a genius or a "star salesman" to "make good." If you've got grit and determination—you can't help but make good! I know it! Figure it out for yourself. Here is a gigantic woolen mills manufacturing high-grade merchandise from its own **woolens**—and selling them **direct to the wearer**. Can't you see the startling saving that the consumer gets?

I haven't the space to tell you all I want to say to you. But if you are the "right man"—mail the coupon—and let me give you the full details. They will surprise you!

G. H. LINDER,
Gen'l Sales Mgr.



TAYLOR-WELLS & CO.
Dept. 229, 2740 N. Paulina St., Chicago, Ill.
"From the Mills to the Millions"

TAYLOR-WELLS & CO.
Dept. 229, 2740 N. Paulina St.
Chicago, Illinois.

Attention, Mr. Linder: I am greatly interested in your proposition. Would like to represent you, and would appreciate your sending me full details of your remarkable selling plan.

Name

Address

City State

W. L. DOUGLAS

FOR MEN

\$5. \$6. \$7. & \$8. SHOES FOR WOMEN



WEAR W.L. DOUGLAS SHOES AND SAVE MONEY. THE BEST KNOWN SHOES IN THE WORLD

THEY ARE MADE OF THE BEST AND FINEST LEATHERS, by skilled shoemakers, all working to make the best shoes for the price that money can buy. The quality is unsurpassed. Only by examining them can you appreciate their wonderful value. Shoes of equal quality cannot be bought elsewhere at anywhere near our prices.

OUR \$7.00 AND \$8.00 SHOES ARE EXCEPTIONALLY GOOD VALUES. W.L. Douglas shoes are put into all of our 108 stores at factory cost. We do not make one cent of profit until the shoes are sold to you. It is worth dollars for you to remember that when you buy shoes at our stores

YOU PAY ONLY ONE PROFIT

SEE THAT THE NAME AND PRICE IS STAMPED ON THE SOLE. Do not take a substitute and pay extra profits. Order direct from the factory and save money.



Established 1876
Catalog Free

W.L. Douglas
President

W. L. Douglas Shoe Co.,
128 Spark St., Brockton, Mass.

Build and Fly Model Aeroplanes



Build your own Model Aeroplane; make trial flights and learn the principles of Aerostatics. With IDEAL Scale Drawings and Building and Flying Instructions you can easily build exact 3-ft. duplicates of Real Planes. Send now for the Plans for the one you want to build. Curtiss JN4D-2 Training Plane; DeHavilland Battle Plane; NC-4 Naval Seaplane; Curtiss Military Trainer; Bleriot, Nieuport or Taube Monoplanes; also Cecil Puller Racers; 25 cents each, postpaid.

"EVERY-BOYS" Airplane clips together without nails, wire or screws. Ready to fly in 2 hours. The newest idea. Send for catalogue and find out all about it.

Ideal Aeroplane & Supply Co., 119 Wooster St., cor. W. Houston St., New York City

Catalogue IDEAL Model Aeroplanes and Supplies, 5c postpaid

PLANS AND INSTRUCTIONS 25¢

SEND NO MONEY



Try this Portable Typewriter 10 Days FREE

Now you can buy famous, 9-pound National Typewriter direct from the factory, after 10 days' trial—absolutely free. You be the judge. Then we give you

10 MONTHS TO PAY

Same machine as used by thousands of doctors, lawyers, bankers, salesmen, students, writers and business men in 31 countries. Every feature of best, standard size machines. 28 keys.

84 characters. Brand new—not a rebuilt typewriter. Neat, compact carrying case free with every machine. Send today for our 10 Days' Free Trial offer and 10 Months' Easy Payment Plan.

NATIONAL TYPEWRITER CO.

Dept. 7-1.

Fond du Lac, Wis.

34 MILES on Gallon of Gasoline



Wonderful carburetor. Reduces gasoline bills one-half to one-third. Increases power of motors 30% to 50%. Starts easy in coldest weather.

Sent on 30 DAYS' TRIAL

Fits any car. Attach yourself. **Fords** make as high as 34 miles to gallon. Other cars show proportionate saving. Send make of car. Special 30-day trial offer. Agents Wanted.

AIR FRICTION CARBURETOR CO.

3580 Madison Street

Dayton, Ohio

Rider Agents Wanted

Select from the 44 Styles, colors and sizes of **Ranger Bicycles**. Ride and exhibit sample **Ranger** and make money. Delivered free, express prepaid, on Approval. Factory-to-Rider prices save \$10 to \$25.

12 Months to Pay on any **Ranger** if desired. Boys and girls easily save the small monthly payments. Parents often advance first payment.

Best quality, at factory prices, express prepaid. Lamps, wheels and equipment, low prices. Send

Mead Cycle Company
Dept. F108 Chicago

Write today for free **Ranger Catalog**, factory prices and marvelous easy payment terms



EXTRA—The American Duplex

a new Key cutting machine ready set to cut square, angular or round slots. For particulars, address

AMERICAN SHARPENING MACHINE CO.

Dept. 9, 184 W. Washington St.

Chicago

TIRE Agents Wanted

An auto owner in each locality to use and introduce

Mellinger EXTRA-PLY and CORD Tires Make big money part or full time. No capital or experience needed. Sample Sections furnished. **GUARANTEED**

8,000 and 10,000 Miles (No Seconds)

Hand made. Finest materials. Shipped prepaid on approval.

FREE Tires for Your Car to one user in each locality for taking a few orders. Be first to write quick for Special Agents Offer and Low Wholesale Prices.

MELLINGER TIRE & RUBBER CO.
510 North Oak Street
Kansas City, Mo.



Selling Motors Below Cost

because of cancellations



$\frac{1}{6}$ HP.
\$10

Delivers full 1-6 H. P. with liberal overload capacity. Made for 110 volts, 60 cycle current. (Also for 25, 30, 40, 50 cycle or 220 volts if desired at \$1.00 extra.) Just the thing for running washing machine, iron, dish washer, compressor, bench lathe, blower, fan, drill press, scroll saw or any small machine around house shop, garage.

Made and Guaranteed By Well Known House

ing. We had the parts all made when cancellations came. We're closing them out to get our money.

Sold on Money Back Guarantee

New motor or free repairs if anything goes wrong within one year. Parts always obtainable. Net weight 20 pounds, shipping weight 25 pounds. Easy means of reversing direction of rotation. 10 ft. cord with attachment plug, 50c. Pulleys, 1½ inch or 2 inch, 50c.

Send cash or order C. O. D. by express.

REYNOLDS
ELECTRIC COMPANY

2610 West Congress Street

CHICAGO, ILL.

MONEY IN MUSHROOMS

NOW TIME TO START
BIG DEMAND. HIGH PRICES BEING PAID
An uncrowded occupation. Exceptional opportunities for live men and women. Raised at home. Only small space needed. Small expenditure will start you in a practical money-making enterprise. Big profits. Booklet telling all free. Write Nat'l Spawn Co., Dept. 12, Brighton, Mass.

Try This Typewriter 5 Days FREE

\$3.00 Down — Balance \$5.00 Monthly
Any standard make. Perfectly rebuilt. Guaranteed satisfaction or your money back. Save \$25 to \$50. Pay while you earn. Try 5 days at our expense. Send postcard for special bargain price. Save July 14 to 15. Do it NOW!

WYNN TYPEWRITER EXCHANGE, 12 Reliance Bldg., Kansas City, Mo.

BALBA bouquet perfume

Let Our Money-Making Agency Offer
Balba Sales Machines
Make \$200 to \$1000 Monthly

This new plan of selling high quality perfume has taken the country by storm. Men everywhere are jumping at the opportunity to get into this big money-making field. See page 171 of March Popular Mechanics.

Over 500 Cities Already Taken
Remember the first who qualify get the exclusive sales rights. We do the local newspaper and national advertising. Get full particulars NOW.

BALBA CORPORATION of AMERICA, Inc.
Dept. 44, Adams and Jackson Sts.
TOLEDO, OHIO, U. S. A.

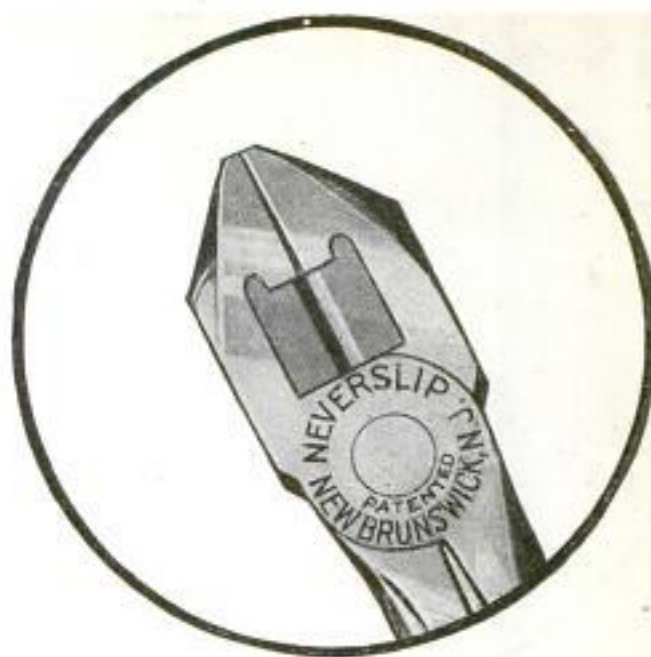

Here's why NEVERSLIP pliers will outcut and out- last any plier made

Most Pliers are made from one piece of steel — pliers and cutting edges all made at the same time. Is it any wonder that they dull quickly and soon have to be thrown away?

It takes time to make a pair of Neverslips. First we make the pliers. Then we make the cutting blades from special high carbon crucible steel. These cutting blades are renewable. When one set becomes accidentally nicked or broken, they may be quickly and easily replaced with a brand new pair.

And remember this: Neverslip Pliers are guaranteed to outcut and outlast any plier made.

Most hardware dealers sell them. Write for leaflet.

THE NEVERSLIP WORKS
New Brunswick New Jersey

NEVERSLIP side cutting pliers

Neverslip Pliers are furnished in six, seven and eight inch sizes.

If you use pliers you ought to read this interesting leaflet. It's mailed free upon request.



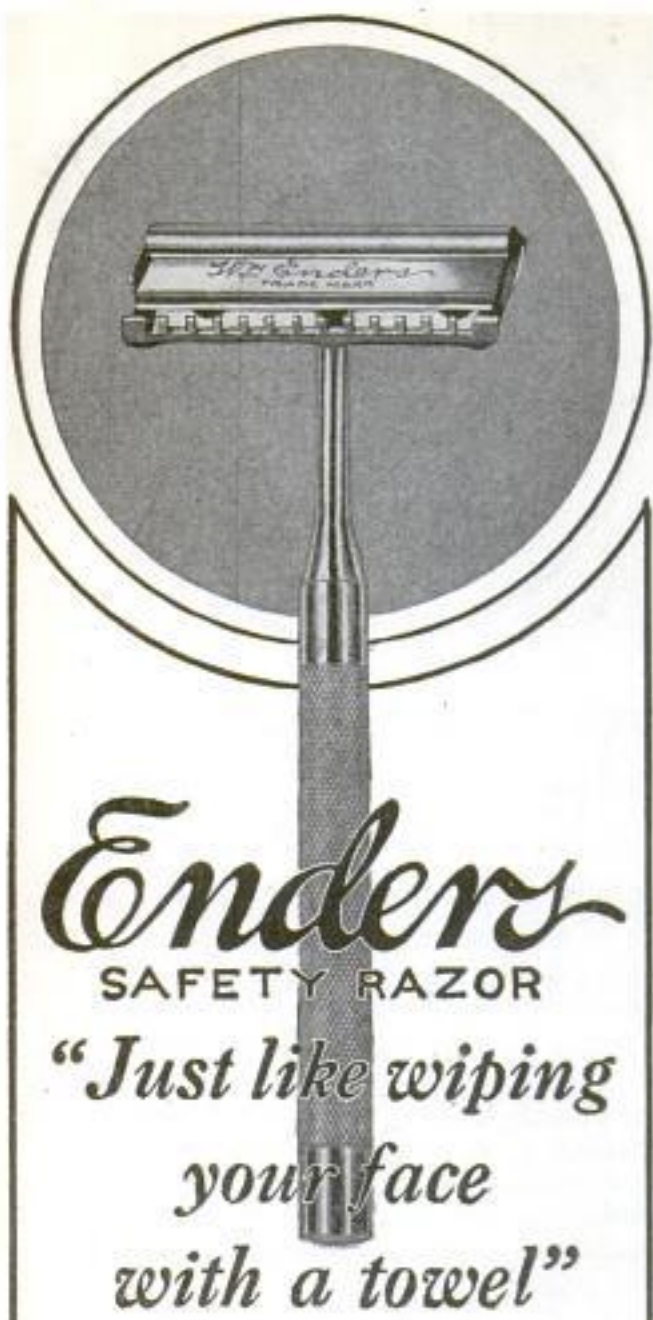

Enders
SAFETY RAZOR

*"Just like wiping
your face
with a towel"*

ENDERS SALES COMPANY
105-111 West 40th St. New York

ENDERS SELLS FOR \$1.00 with six blades of the best quality Swedish-base steel. Packed in black Keratol box, velvet lined. Extra blades, package of 5—35 cents. In Canada—Razor, \$1.50; Blades, 50c.

FOR SALE by All UP-TO-DATE DEALERS EVERYWHERE

Blades—Hand-stropped, Hand-tested



Please Mention Popular Mechanics

**Easy to Play
Easy to Pay**



BUESCHER

**True-Tone
SAXOPHONE**

Saxophone Book Free

Tells when to use Saxophone singly, in sextettes or in regular band; how to play from solo parts in orchestra and many other things you would like to know.



Easiest of all wind instruments to play and one of the most beautiful. You can learn the scale in an hour's practice and play popular music in a few weeks. You can take your place in a band within 90 days, if you so desire. Unrivalled for home entertainment, church, lodge or school.

(34) In big demand for orchestra dance music. The portrait above is of Donald Clark, Soloist with the famous Paul Whiteman's Orchestra.

Free Trial You may order any Buescher Instrument without paying one cent in advance, and try it six days in your own home, without obligation. If perfectly satisfied, pay for it on easy payments to suit your convenience. Mention the instrument interested in and a complete catalog will be mailed free.

Buescher Band Instrument Co.

Makers of Everything in Band and Orchestra Instruments

2534 Buescher Block, Elkhart, Indiana

NEW SINGLE PHASE A. C. MOTORS

1/4 H. P.—110 volt, 60 cycle, 1725 speed, complete with cord, plug and grooved pulley. \$13.00



1/4 H.P.	\$47.00
1/2 H.P.	58.00
1 H.P.	62.00
1 1/2 H.P.	76.00
2 H.P.	89.00
3 H.P.	108.00

Include pulley and base.

ONE YEAR GUARANTEE

1/2 H.P. and larger, 110/220 volt Rep. Ind. Type
Satisfaction guaranteed or money refunded
Illustrated Catalog of Motors and Supplies FREE
HYRE ELECTRIC CO., 615-H So. Dearborn St., Chicago



Buchstein's Fibre Limb

is soothing to your stump—strong, cool, neat, light. Easy payments. Braces for all deformities.
D. BUCHSTEIN CO.
113 6th St. S., MINNEAPOLIS, MINN.

THE AJAX EYELET FASTENER

BINDS AND INSERTS AJAX EYELETS IN PAPER, CARDBOARD, LEATHER OR CLOTH

It Saves Time by Punching the Hole, Feeding the Eyelet and Clinching It in One Operation.

Drop the eyelets into the magazine and go right ahead. Order from your stationer or direct.



PRICE WITH 1500 AJAX EYELETS, \$10.00 DELIVERED IN U. S. A.

Write for our catalogue of office tools
MACHINE APPLIANCE CORPORATION

351-353 Jay St.

Spec. Dept.

Brooklyn, N. Y.

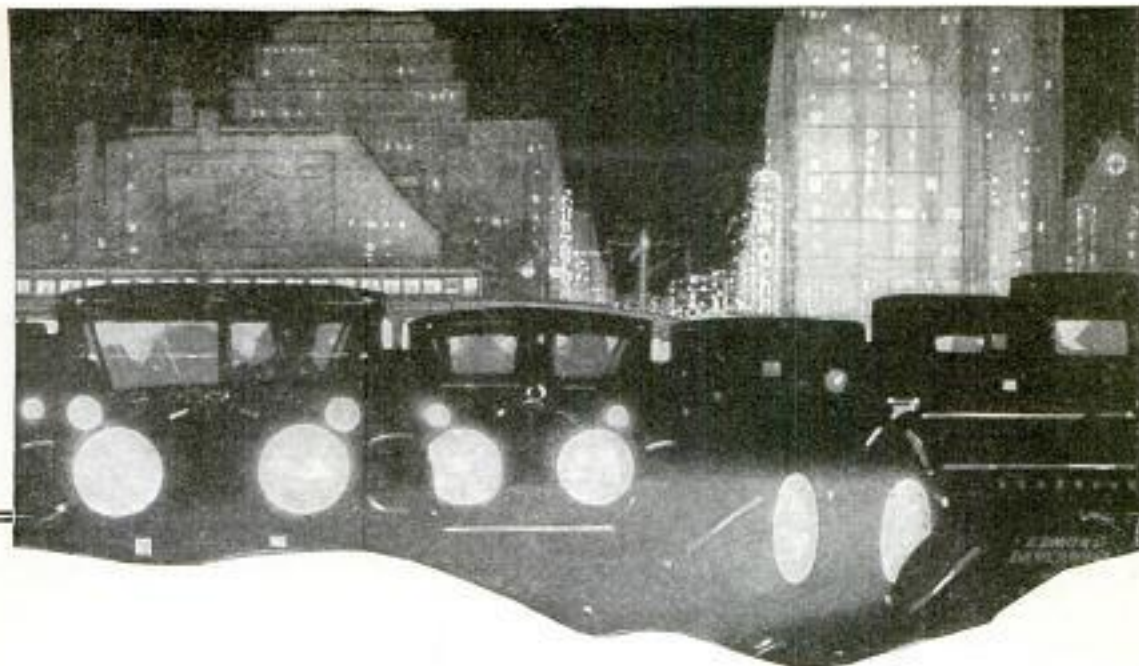

One quality—two designs

There is a battery built by Westinghouse for every car and purse. And you may be sure it is a good battery, or it would not bear the name Westinghouse.

Westinghouse Standard. The best battery Westinghouse can build! Oversize plate area—as much as 25 per cent; and warranted under a guarantee new in features and unequalled in liberality.

Westinghouse "Wubco" Special. For lighter weight cars. The best battery a man can buy for the money! Normal capacity. Rubber case. Quality construction. Lower priced.

WESTINGHOUSE UNION BATTERY CO., Swissvale, Pa.

WESTINGHOUSE BATTERIES

SELF-FILLING INK PENCIL "INDEPENDENT"

Meets all requirements. Self-filling, non-leakable, safety cap. Attached clip. Smooth writing gold style point.

Guaranteed Improved Fountain Pen. Eliminates fatigue. Promotes efficiency. Writes uniform. A business necessity.

\$2 By Mail

Your Name in Gold—25 Cents Extra

AGENTS WANTED

J. C. ULLRICH & CO., 161 Washington St., New York

FOR CAMP & SUMMER WEAR

Best quality, lowest prices. Our money back guarantee covers all purchases.

Army Shelter Tents.....	\$1.50
Folding Shelter Tent Poles.....	.25
Khaki Riding Breeches.....	.75
Khaki Trousers.....	2.25
Khaki Shirts.....	.95
Camp Cooking Grates.....	.30
Folding Mess Pans.....	.25
Athletic Shirts.....	.50
Army Folding Cots.....	4.00
Army O. D. Wool Blankets.....	2.75

Army tent's all sizes and 5000 other articles for camp or outdoor. Send 10c for big catalog 112

RUSSELL'S, INC.

245 W. 42d Street New York

Formerly Army & Navy Store Co.

Moore Push-Pins
Glass Heads—Steel Points

Moore Push-less Hangers
To hang up things

Ask your dealer to show them

Sold Everywhere **10¢** per packet

Moore Push-Pin Co.
Wayne Junction Philadelphia





It's a New Tool---

BROWN & SHARPE

Thickness Gauge No. 646

For Every Motor Mechanic

For Every Man Who Uses An Automobile

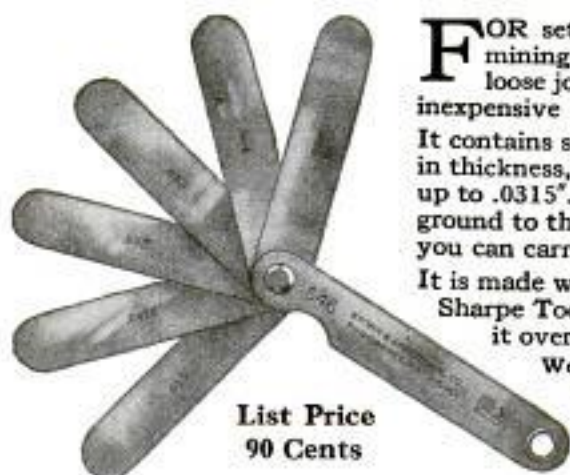

List Price
90 Cents

FOR setting tappets, distributor points, spark plugs, determining piston clearances, shims for steering knuckles or loose joints, etc., a broad range of uses. Affords a relatively inexpensive and accurate gauge.

It contains six blades, .0015", .002", .003", .004", .006" and .015" in thickness, which are used together or singly for measurements up to .0315". These blades are not rolled to size, but accurately ground to the correct thicknesses. It has an eyelet in one end—you can carry it on a ring or hang it up.

It is made with the same care and high accuracy of all Brown & Sharpe Tools. You will appreciate its fineness when you look it over at your dealer's.

We will be glad to send you pamphlet describing this handy gauge, together with our Small Tool Catalog No. 28.

Brown & Sharpe Mfg. Co.
Providence, R. I., U. S. A.



PLUMBING & HEATING

Buy Direct—Save 50%

\$66.95 Complete Bathroom Outfit \$66.95

Send NOW for our FREE Catalog "A" of Wholesale prices

Satisfaction Guaranteed

LAMPLOUGH BEAUMONT COMPANY
99 So. Portland Ave. Brooklyn, N. Y.



AUTOMOBILES

From Maine to California Bush Agents are making money. Mr. E. J. K., in Iowa, sold four in two weeks and got a Bush Car Free for his time, freight prepaid. Mr. Van E., in New Jersey, made \$400 in two weeks. Mr. K., in Maine, made \$200 in One Day. 1923 models now ready. Don't wait. No experience required. More agents wanted. Write for details.

BUSH MOTOR COMPANY, Dept. 9a, Bush Temple, CHICAGO

It's Easy to Build Things with a JUNIOR BENCH SAW



Does Ripping, mitering, grooving, rabbeting, tenoning, sanding, grinding and many other operations with ease and accuracy. Top 18" by 12". Saws 1 1/2" stock. Driven by 1/4 or 1-3/4 h.p. motor. Portable. Runs from any light socket. All metal construction. Extremely accurate. Descriptive circular tells many things of interest to workers in wood, fiber, bakelite and soft metals. **\$28.75**

Junior Bench Saw only, with guides and one 6" saw blade. Price complete with 1/4 h.p. Ball Bearing Motor \$60. Ball Bearing Motors are used exclusively on Bosc, Marbosc—another indication of their high quality. Cheaper because more durable and serviceable.

Ask about our Bench Jointers, 14" Bench Band Saws, larger motor driven Bench Saws, Bench Drills and 1/2 and 1-3/4 h.p. Ball Bearing Motors

W. & J. BOICE, 114 23rd Street, TOLEDO, OHIO



Buy Direct from Headquarters

Save from 25% to 40% on standard makes of new and rebuilt motors. Get the proper size and type of motor to suit your exact needs — and get it fully guaranteed by a motor merchandising house backed with 20 years of dependable service direct to users. Write today for catalog No. 70. It quotes prices on motors of every size and type.

Electrical Equipment Bought, Repaired or Exchanged.

THE FUERST-FRIEDMAN COMPANY

"Reliability Built In."

CLEVELAND

OHIO

TYPEWRITERS



\$50 buys a brand new Corona, the Personal Writing Machine. Fold it up, take it with you, typewrite anywhere! Write for free booklet No. 8.

Corona Typewriter Co., Inc.
GROTON, N. Y.



RAISE BELGIAN HARES

New Zealand Reds — Flemish Giants — American Blues.

BIG PROFITS, WE PAY \$1.50 TO \$8 EACH.

Also Carries, Mink, Skunk, Fox, Muskrat, Etc.

Easily raised anywhere. **FREE!**

page Catalog and Contract

Illustrated book "COMMON SENSE RABBIT

RAISING," quarterly journal, and copy of

America's leading small stock magazine, all for 10 cents. Address

Outdoor Enterprise Co., 1005 S. E. BLDG., KANSAS CITY, MO.



SAY!

Thousands have; why don't you improve your financial condition? Operate a Kingery Popcorn Popper, Peanut Roaster or Popcorn Fritter Outfit. 70 cents profit on every dollar. Many styles and sizes. Popping 40 quarts to 12 bushels per hour. Roasting 12 quarts to 5 bushels. Prices \$40 to \$550. Liberal terms. Catalog free.

KINGERY MFG. CO., Est. 1881
Dept. 242 CINCINNATI, OHIO

Only
\$15
Down

Play Well in
4 Weeks



—Eight Months to Pay

Latest C Melody Saxophone Outfit complete, only \$25—lowest price ever quoted. Sent on 5 days' trial. If satisfied, pay only \$10 a month for 8 months. No interest in pay—no extras. Outfit includes finest toned horn and richly lined Case, Instruction Book, Album of Popular Saxophone Songs, Music Lure, Carrying Strap, Mouthpiece and three fine Reeds.

"Masterbilt" Saxophones

Highest quality, built in perfect tune, assembled and tested by experts. Has all latest key improvements, light, quick action and beautiful finish. Order direct from this advertisement or write for Free Catalog Folder today.

The Saxophone Shop, 427 S. Wabash Ave., Chicago
Largest Exclusive Dealers in Saxophone Supplies in the World

21 Jewel Burlington



Adjusted to the Second 21 Ruby and Sapphire Jewels
Adjusted to Temperature 25 Year Gold Strata Case
Adjusted to Isochronism Your Choice of Dials
Adjusted to Positions (Including Montgomery H. H. Dial)
New Ideas in Thin Cases

Only \$100 Down

Only One Dollar Down will buy this masterpiece of watch manufacture. The balance you are allowed to pay in small, easy, monthly payments. The Burlington—a 21-Jewel Watch—is sold to you at a price much lower than that of other high-grade watches. Besides, you have the selection of the finest thin model designs and latest styles in watch cases. Don't delay! Write for the FREE Watch Book and our SPECIAL OFFER today.

Write While This Special Offer Lasts

Get the Burlington Watch Book by sending this coupon. Find out about this great special offer which is being made for only a limited time. You will know a great deal more about watch buying when you read this book. You will be able to "steer clear" of the over-priced watches which are no better. Remember, the Burlington is sent to you for only One Dollar down, balance in small monthly payments. Send the coupon for watch book and our special offer TODAY! Do not delay one minute!

Burlington Watch Company

Dept. 1356, 19th St. & Marshall Blvd., Chicago
Canadian Address: 62 Albert St., Winnipeg, Manitoba

Please send me (without obligations and prepaid) your free book on watches with full explanation of your \$1.00 down offer on the Burlington Watch.

Name _____

Address _____

Pick this Up

BAKELITE-DILECTO XX is the supreme Radio panel material. Use it to give your set thorough insulation, and smart, professional appearance.

Far superior to wood, hard rubber or marble. Uncle Sam proved that and has used it in the NAVY and SIGNAL CORPS over **eight years!** Tests highest in every count. Astonishing dielectric and tensile strength (proved constant 5.2). Resists water, heat and milder acids.

Absolutely Unequaled for Radio Panels and Wireless Insulations

Finished a sleek, everlasting black. Any dealer can get BAKELITE-DILECTO XX for you. CUT TO SIZE. For efficiency, economy and top-notch results, insist on BAKELITE-DILECTO XX for your Radio panels, frames, bases or partitions. Get started right NOW!

DEALERS—Get in now on the demand B. D. X. X. advertisements are creating. Price lists on sheets, rods, tubes, etc., and any other information sent on inquiry from

The Continental Fibre Company
of Newark, Del.

NEW YORK - 233 Broadway
ROCHESTER - 85 Plymouth Ave., S.
CHICAGO - 332 S. Michigan Ave.
PITTSBURGH - 301 Fifth Ave.
SAN FRANCISCO - 75 Fremont St.
LOS ANGELES - 411 S. Main St.
SEATTLE - 1927 First Ave., S.

Amateurs —
Write us direct for dealers' addresses

XX bakelite-dilecto!!



Agents

LARGE MANUFACTURER OF SHIRTS wants Agents to sell complete line of shirts direct to wearer. Exclusive patterns. Big values. No capital or experience required. Write for free samples.

MADISON SHIRT MILLS
507 Broadway New York, N. Y.

Rabbit Book FREE

Illustrated. Facts about the easy, profitable home industry — growing domestic hares for meat, fur, fancy. Little space—cheap equipment. Big demand. We buy all you raise at \$7 to \$18 per pair. Turn your spare time into cash. Book free — write now.

STANDARD FOOD & FUR ASS'N.
407B Broadway New York City

"I Would Not Part With It For \$10,000"

So writes an enthusiastic, grateful customer. In like manner testify over 100,000 people who have worn it. Conserve your body and life first.

The Natural Body Brace

Overcomes WEAKNESS and ORGANIC AILMENTS of WOMEN and MEN. Develops an erect, and graceful figure. Brings restful relief, comfort, energy and pep, ability to do things, health and strength. Does away with the strain and pain of standing and walking; replaces and supports misplaced internal organs; reduces enlarged abdomen; straightens and strengthens the back; corrects stooping shoulders; develops lungs, chest and bust; relieves backache, curvatures, nervousness, ruptures, constipation, after effects of Flu. Comfortable and easy to wear.

Costs You Nothing to Try It

Write today for illustrated book, free, with full information and measurement blank. Address

HOWARD C. RASH, Pres. Natural Body Brace Co.
223 Rash Building SALINA, KANSAS



For Children Also

SEND NO MONEY

If You Can Tell it from a GENUINE DIAMOND Send it back

To prove our blue-white MEXICAN DIAMOND cannot be told from a GENUINE DIAMOND and has come DAZZLING RAINBOW FIRE, we will send a selected 1 carat gem in ladies Solitaire Ring. (Cat. price \$5.25) for Half Price to introduce, \$2.63, or in Gentle Heavy Tooth Becher Ring (Cat. Price \$4.50) for \$3.25. Circled 1/2 Carat Filled settings. GUARANTEED 20 YEARS. SEND NO MONEY. Just mail postcard or this ad, State Size. We will mail at once. When ring arrives deposit \$2.63 for Ladies ring or \$3.25 for Gents with postman. If not pleased return in 2 days for money back less handling charges. Write for Free catalog. Agents Wanted. MEXICAN DIAMOND IMPORTING CO., Dept. E.T. Las Cruces, N. Mex. (Exclusive controllers Mexican Diamonds)

Please Mention Popular Mechanics

Look Prosperous!

WEAR DIAMONDS

FOR A FEW
CENTS A DAY

NO
MONEY
DOWN



18 kt.
White Gold,
7 perfect cut,
blue-white dia-
monds set in plat-
inum. Looks like 3
carat solitaire.

Special No. 61
Only
\$59.50



Premier Cluster,
7 carefully matched
blue-white diamonds
set in platinum.
Looks like 3 1/2-carat
solitaire.

Special No. 71
Only
\$69.50

Don't send a single penny. Ten days Free Trial. When the ring comes, examine it—if you are not convinced it is the **Greatest Bargain in America**, send it back at our expense. Only if pleased, send \$1.50 weekly—at the rate of a few cents a day. These Bargain Cluster Rings with 7 Blue-White Perfect Cut Diamonds can be yours. No Red Tape. No Risk. 8% Yearly Dividends Guaranteed. Also 5% Bonus.

Million Dollar **FREE** Send for it today. It Bargain Book pictures thousands of Bargains. Address Dept. 1776.

J.M. LYON & CO.
2-4 Maiden Lane N.Y.

In Business Nearly 100 years



"I MADE \$80 FIRST WEEK"



"From meagre wages to Big Paying Independent Business—Cleared \$80 first week—is my experience."—Geo. Cox. You can make **BIG MONEY** as our representative. Tremendous demand for our leader—rapid-fire seller—nothing like it. Complete line of Home Necessities means large sales—fine profits. All rapid repeaters.

Ask us how Cox and hundreds of others do it. Write now.

The Pioneer Soap Co., 35 St. Paul Ave., Dayton, Ohio



Does Your Camera Shutter Work?

Seneca, Kodak, Premo, Ansco or Ingento Shutters repaired and adjusted. Any style or size. Expert work done and guaranteed. Prompt Service. Reasonable Prices. Send your shutter in today.

Address Shutter Division
SENECA CAMERA MFG. COMPANY
Rochester, N. Y.

Play a Tune in One Hour

Many, without previous musical experience, have done it with a Conn Saxophone. You, too, can learn this popular instrument quickly. Pleasure and profit yours to command.

Conn Saxophone Supreme

Important improvements found on no other make. Built by world's largest producers of Saxophones. Used and endorsed by world's great musicians. Write now for details of Free Trial, Easy Payment Plan.

C. G. CONN, Ltd.
931 Conn Bldg., Elkhart, Ind.



CONN
WORLD'S
LARGEST MANUFACTURERS
OF HIGH GRADE SAXOPHONES
AND ORCHESTRA INSTRUMENTS



Tirro

The Ideal
Mending
Tape

FREE

Trial Strip
of Tirro.
Mail cou-
pon below

Make it safe

this new way



For a firm grip, safer driving, easier handling of your car, wrap the steering wheel with Tirro—the new water-proofed mending tape.



Tirro mends most anything, too. Garden hose, crockery, rubber gloves, leaky hot water bottles. Insulates electric wires. Mends some things temporarily, others permanently. You can color it to match the article mended.



It's a brand new idea in mending tape. Bauer & Black make it. All drug-gists have it. Costs nothing to try it.



Three Sizes: Small, 15c; Medium, 25c; Large, 50c
At Drug Stores

FM 9-22

Tirro

MAIL THIS
For Free Strip

BAUER & BLACK,
2500 Dearborn St., Chicago.

Mail me a strip of Tirro.

Name

Address

City State

Please Mention Popular Mechanics

SIMON'S POCKET-JERKIN

COPYRIGHT, 1922

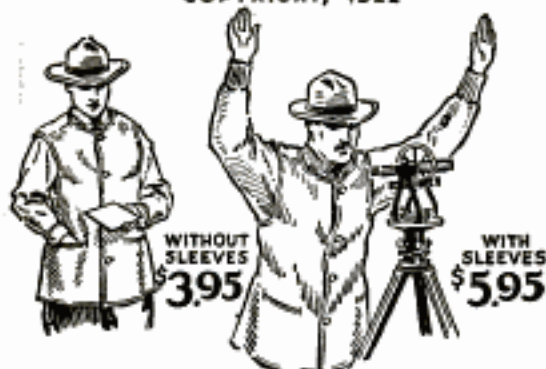

WITHOUT
SLEEVES
\$3.95

WITH
SLEEVES
\$5.95

Simon's Guaranteed POCKET JERKINS

Everything you want—sturdy, wind-proof, warmth, free arm-action, long wear, and two large pockets. Yet, when necessary, it may be worn comfortably under your regular overcoat.

Made of genuine sheep-skin leather, lined with heavy O. D. Govt. Melton, knit wristlets. Sizes 36 to 46, ready for you now. Just the thing for

Sportsmen	Golfers	Teamsters
Trainmen	Carpenters	Mechanics
Chauffeurs	Ice-men	Milkmen
Farmers	Motorists	Travelers
Freight handlers	Woodsmen	—and You!

Sent parcel post prepaid on receipt of price—\$3.95 sleeveless—\$5.95 with O. D. Melton sleeves. Money back if not entirely satisfied.

Send for our catalogue on Sheep-skin Coats

SIMON COAT CO., Mfrs.

144 Kingston St. Dept. A Boston, Mass.

"BOW LEGS and KNOCK-KNEES" UNSIGHTLY

SEND FOR BOOKLET SHOWING PHOTOS OF MEN WITH AND WITHOUT THE PERFECT LEG FORMS

PERFECT SALES CO.
140 N. Mayfield Ave., Dept. S, Chicago, Ill.

Percolates
Toasts

Boils
Fries

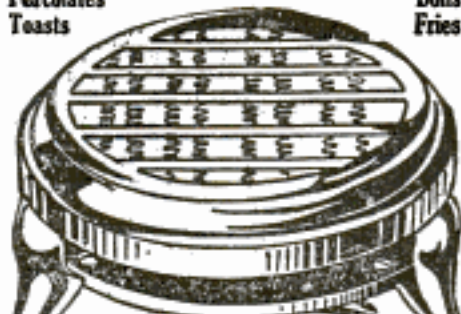

One Burner ELECTRIC STOVE

Strongly built. Handsomely nickel-plated. Fully guaranteed. 7 1/2" dia. 6 ft. cord with two-piece plug standard size. Many uses at home, office, shop. Bargain. **\$2.00**

Postage 35c. extra.

TWO BURNER STOVE

Heavily nickel-plated surface. 15" x 7 1/2". 6 ft. cord, standard plug and 2-point switch to regulate heat. Postage 60c. extra. **\$4.50**

CHAS. EMORY & CO.
120 N. 13th St. Dept. 90
Philadelphia, Pa.

Different from all others—the NEW BENJAMIN

AIR RIFLE

Made on a different principle from all other Air-Rifles. The Benjamin is really a strong air-pump used to compress the air in the air chamber to any degree of power desired. From one to six strokes of the pump give all the force necessary. Each additional stroke gives increased power. The Benjamin works on the same principle as all air-drills and air-hammers—with this difference:

You control the shooting force as you desire. Look at this block of hardwood. It shows how Benjamin power is regulated as you wish.

You can't have accidents with a Benjamin. It's safe, always, because you control the power. The Benjamin never loses shooting force, and has no springs to get out of order or shake your aim. Write us for an interesting folder about this wonderful air-gun.

For sale by all dealers.
Price **\$5.00.**

BENJAMIN
AIR-RIFLE & MFG. CO.
615 N. Broadway, St. Louis, Mo.

Ask your dealer for demonstration.



Are You All Primed?

We can supply you with Masonic books of reference, study, history, etc. Also fine aprons, regalia, novelties, jewelry and supplies.

Send for Free Catalogue P

REDDING & CO.

Publishers and Manufacturers

200 Fifth Avenue,

New York

Do Your PRINTING

Cards, circulars, labels, tags, book, menus, paper, Press, \$12. Larger \$35. Job Press \$150 up. Save money. Print for others, BIG PROFITS. All easy, rules sent. Write factory TODAY for press catalog, TYPE, cards, paper. **THE PRESS CO., D-37, MERIDEN, CONN.**

WINDOW SIGNS

AGENTS

\$60—\$200 a week. Free Samples GOLD SIGN LETTERS for store fronts and office windows. Anyone can put them on. No experience necessary. Big demand. LIBERAL OFFER TO GENERAL AGENTS.
METALLIC LETTER CO., 433B, N. Clark St., CHICAGO

SAVE HALF - INSTALL YOUR OWN PLUMBING AND HEATING BY OUR NEW EASY METHOD

Send for Our Big Handy-Man Plumbing and Heating Encyclopedia

It shows and explains our NEW EASY METHOD—how to save skilled labor, unnecessary material and heavy work. Any handy man can do the installing with our simplified systems and working plans. OUR NEW EASY METHOD saves much cutting, threading, time and material. Even if you are a plumber the big saving by using our products and NEW EASY METHOD will surprise you.

Big Book Saves Labor and Material

Every builder, mechanic, farmer, etc., needs this BIG INSTRUCTIVE PLUMBING AND HEATING ENCYCLOPEDIA. Besides being our wholesale catalog, it contains hundreds of floor plans, elevations, diagrams and installing sketches from the simplest to the most difficult systems, showing our EASY METHOD of installing your own plumbing or heating, gives hundreds of mechanical rules, kinks, receipts, short cuts, etc., how to lay out plumbing and heating, estimate costs, repair leaks, etc. It shows and describes over 10,000 FACTORY FITTED plumbing and heating fixtures and supplies with wholesale prices; helps you to select the best plumbing outfit, or heating plant, to meet your needs. Any handy man can do the installing with the aid of OUR HANDY-MAN PLUMBING AND HEATING ENCYCLOPEDIA.



Our Factory Fitted Plumbing and Heating

BATHROOM OUTFITS, TOILETS, LAVATORIES, BATH TUBS, SINKS, LAUNDRY TUBS, WATER SUPPLY SYSTEMS, WATER HEATERS, PUMPS, PIPELESS AND WARM AIR FURNACES, HOT WATER AND STEAM PLANTS, PIPE, FITTINGS, VALVES, etc. All outfits factory fitted for the handy man, with beauty, durability and EASE OF INSTALLATION built through and through.

SEND 25c FOR YOUR COPY TODAY



HARDIN-LAVIN CO. 50 YEARS AT 4547-57 COTTAGE GROVE AVE., CHICAGO

Enclosed find 25c. Please send me your HANDY-MAN PLUMBING AND HEATING ENCYCLOPEDIA with wholesale discounts, and mail me your monthly bulletin, "Service." 25c to be refunded to me with my first order.

Name _____

Street and No. _____

City _____

State _____

SQUAB BOOK FREE

Squabs are selling at the highest prices ever known. Breed them and make money. Write at once for free book, prices, etc. **Plymouth Rock Squab Co.** 634 Howard St., Melrose Highlands, Mass.

Beautiful HOUSES \$900 and BUNGALOWS

CAN BE BUILT FOR AND UP This and many others in my new book, Building Plans for Modern Homes, will save you hundreds of dollars. One of the most complete and comprehensive books of plans ever published by any architect. New edition just off the press. Nearly 500 floor plans and photographs of bungalows, Colonial houses, etc., costing from \$200 up; gives sizes and cost to build.



FREDERICK H. GOWING ARCHITECT

101 Tremont St., BOSTON, MASS.

Sent postpaid for \$2.00

Salesmen Sell our wonderful tailored to order \$29.50 virgin wool suits and o'coats direct to wearer—all one price—\$20 less than store prices. You keep deposit. Everything guaranteed. Big scratch outfit free; protected territory for hustlers. **J. B. SIMPSON, Inc., Dept. 125, 831 W. Adams St., Chicago**

KEITH'S \$2.50 OFFER

3 Plan Books, showing 100 designs of artistic bungalows, cottages, or two-story houses—in frame, stucco and brick—with floor plans and descriptions, and 8 months' subscription to Keith's Magazine, all for \$2.50.

Keith's Magazine for over 20 years an authority on planning, building and decorating houses—20c a copy on newsstands. With its help and Keith's Plans you can get the most distinctive, comfortable and satisfactory home with greatest economy. Set of 3 plan books (260 plans) and Keith's for 12 months—\$4.50 Keith Corporation, 565 Abbay Bldg., Minneapolis, Minn.



The Duncans will cure Two or Three times as many tires per day, as any other model. Will cure Two 3 1/2" or Three 4" or Two 4 1/2" tires at one time and will make a perfect cure with sand bag pressure as with air bag.

F. M. DUNCAN COMPANY 314-49 East Ohio Street, Department P., Chicago, U. S. A.

Earn \$600.00 a Month by Yourself with a DUNCAN Vulcanizing Plant

Includes every tool and vulcanizer for a high-grade repair business. Will handle the work of six men. Will cure either Cord or Fabric Tires in the same cavity, perfect to form and contour, without a reducing shell.

We teach you approved factory methods of tire repair, in your own home or in one of our many Schools FREE, when you purchase DUNCAN EQUIPMENT.

There is a big demand for high-grade shops and competent repairmen. We will start you in business for a small cash payment. Write today for all particulars of this really wonderful offer, and get started in this paying business for yourself.



The BEST LIGHT

Positively the cheapest and strongest light on earth. Used in every country on the globe. Makes and burns its own gas. Casts no shadows. Clean and odorless. Absolutely safe. Over 200 styles. 100 to 2000 Candle Power. Fully Guaranteed. Write for catalog. AGENTS WANTED EVERYWHERE.

THE BEST LIGHT CO., 324 E. 5th St., CANTON, O.

Electric Fireless Cooker

Gives every facility of electric range plus every advantage of fireless cooker at less cost than a good oil stove.

Automatic Rapid Electric Cooker New Invention Revolutionizes Cooking

Saves 50% to 75% fuel cost. Bakes, roasts, boils, steams, fries, toasts. Needs no watching. Shuts electricity off automatically. Attaches to any electric socket. No special wiring. Write for FREE Home Science Cook Book, 30-day FREE trial offer and direct factory prices.

WM. CAMPBELL CO. Dept. 64 Detroit, Mich. Georgetown, Ont.







WHITING-ADAMS BRUSHES

FAMOUS FOR THEIR QUALITY
Most extensive and best line of
Toilet Brushes in the world

Send for Illustrated Literature
JOHN L. WHITING-J. J. ADAMS CO.
Boston, U. S. A.
Brush Manufacturers for Over 113 Years and the
Largest in the World

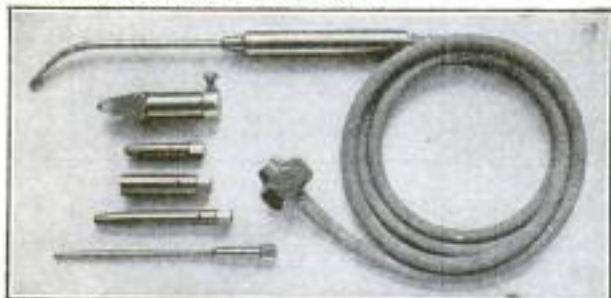

Add \$5 a Day to Your Profits WITH A TORIT ACETYLENE TORCH NO. 13
For radiator repairing, general welding, light bending, heating, battery recharging, etc. Produces instant hot flame, works rapidly. Fitted with 4 different tips and soldering copper, enabling you to do a wider range of work.



USES ACETYLENE GAS ONLY
A splendid use for discarded auto acetylene tanks. Many owners make the Torit No. 13 pay for itself in a single day. Torch with 4 different tips, soldering copper, 5 ft. tubing and connection for auto acetylene tank.....\$7.50
ORDER TODAY FROM YOUR JOBBER, OR
St. Paul Welding & Mfg. Co., 177 W. 3rd St., St. Paul, Minn.



TOOL CHESTS
For Machinists & Toolmakers
Every tool arranged in order. No up-to-date mechanic should be without one. A Gerstner Case costs no more than some tools, and will last a lifetime. Catalog free.

Gerstner Sons

717 Columbia Street DAYTON, OHIO



Dealers and Agents: Request Attractive Proposition
Adjusts Instantly to Any Length
Just slide it out. Gives exact inside or outside diameter. No folding. Accurate, strong, brass trimmed. Any length 2 to 8 feet. If not at dealer's, sent postpaid.

Master Rule Mfg. Co., Inc. "Interlox"
841-43 East 136th Street
NEW YORK CITY **MASTER SLIDE RULE**

ONE-HAND-Y ELECTRIC DRILL

For quick, accurate and easy drilling in wood or metal, the One-Hand-Y Electric Drill is unsurpassed.
It is a compact, serviceable electric drill for light work and saves time and labor.

Write direct to
Knight Engineering & Sales Company
30 W. Walton Place, Chicago

Price, \$52.40 Net
Weight, 3 lbs.
Capacity, 1/4"



Westinghouse
Universal Motor

210 W. Seventh Street, Los Angeles



It is the well known quality of **CRESCENT** machines that justifies you in selecting one of them each time you have need for wood working machinery. The **CRESCENT** line is better than ever and will always give you satisfaction in every particular. Ask today for catalog of hand saws, saw tables, jointers, shapers, planers, borers, planers and matchers, swing saws, disk grinder, cut off table, hollow chisel mortiser, variety wood worker, Universal wood workers.

THE CRESCENT MACHINE CO., 93 Columbia Street, Leontonia, Ohio



LATHES

9 to 18-inch Swing
List price \$165 and up according to size. When ready to buy send for Lathe Catalog and prices.
W. F. & John Barnes Co.
100 Ruby Street, ROCKFORD, ILL.

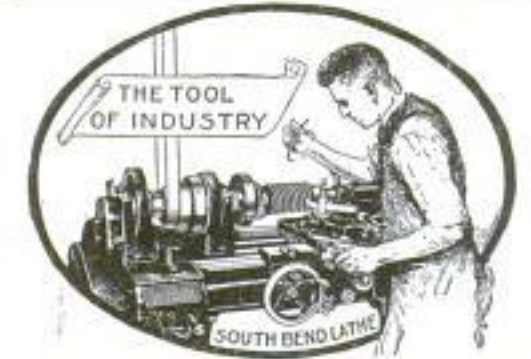

REDUCED PRICES

JUNE 1, 1922

SOUTH BEND LATHES

QUICK CHANGE GEAR

9'x3' Lathe.....	\$189.00	16'x 8' Lathe.....	\$436.00
11'x4' Lathe.....	233.00	18'x10' Lathe.....	649.00
13'x5' Lathe.....	301.00	21'x12' Lathe.....	905.00
15'x6' Lathe.....	367.00	24'x14' Lathe.....	1218.00

How to Run a Lathe:—New 80-page book, Revised Edition No. 24, for 10 cents postpaid, silver or stamps.

64-page Catalog No. 76 for 1922 sent free to any address
ESTABLISHED 1906
SOUTH BEND LATHE WORKS
625 E. Madison St. **SOUTH BEND, IND.**



CHASE trouble with Bernards. The pliers that make the odd jobs easy. Parallel jaws and outside cutting blades. Grip like a vise and cut with uncanny power. Hardware dealers.

MADE IN SEVEN SIZES

Send for illustrated Plier Booklet M



**BERNARD
PLIERS**

Wm. SCHOLLHORN CO.
NEW HAVEN, CONN.



PARALLEL JAWS

OUTSIDE CUTTER



The Midget "FIVE-IN-ONE" Slide Rule is a combination Mannheim, Log-Log, Add and Subtract, Polyphase and Binary Slide Rule. It will instantly add, subtract, multiply and divide any combination involving whole numbers, fractions, decimals and mixed numbers. Gives every possible root and power of every quantity. The graduations are printed on metal, coated with white enamel and are grease and waterproof. While it is the most versatile calculator ever invented, its operation is simple and easy understood. Diameter 4 inches. Price with 16-page Instruction Book, \$1.50. Leatherette carrying case 50c extra. Catalog free. Your money back if you are not satisfied. GILSON SLIDE RULE CO., Niles, Mich.

GUARANTEED

1/4 h.p. A.C. Motor

\$13⁵⁰

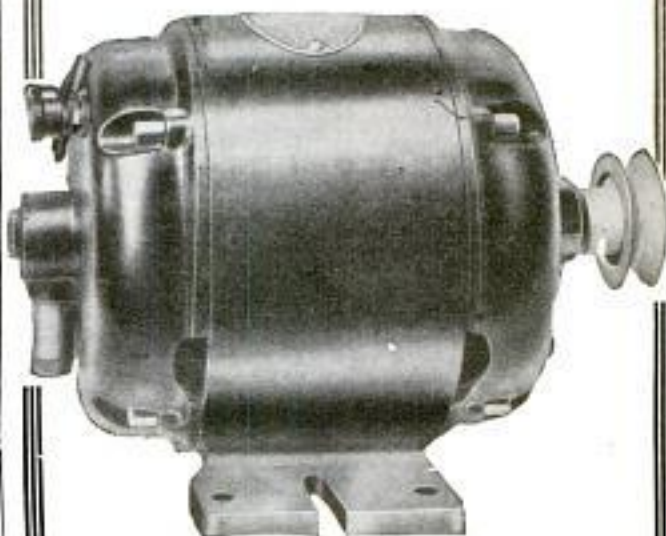

A sturdy, efficient, split phase 110 volt 60 cycle A.C. Motor, operating at 1740 r.p.m. Tested for 50% overload at factory. Guaranteed for 1 year by the makers. Best value ever offered for **\$13⁵⁰**

A hundred thousand of these motors are now in use giving satisfaction.

Grinder and Buffer

using above motor, 6 in. abrasive wheel and 7 in. Buff. Most makers charge \$50 or more **\$25⁰⁰**

Send cash with order.



\$25⁰⁰

NORTHWESTERN ELECTRIC CO.
408 S. Hoyne Avenue CHICAGO

Please Mention Popular Mechanics

Copyrighted material



Big Money

Made by agents selling our wonderful Facial Soap, Perfumes, Toilet Articles, Spices, Extracts, etc. Free cake of soap and agents' terms mailed to any address.

LACASSIAN CO., Dept. 455 ST. LOUIS, MO.

IT'S A METAL—



MOST WONDERFUL SOLDER EVER INVENTED 25c Per Tube

SOLDERS WIRES
SOLDERS RADIO CONNECTIONS
SOLDERS POTS & PANS
SOLDERS ALL METALS

Put up in Paste Form in Collapsible Tube Ready for Instant Use.

Sold By All Up-to-Date Stores Or Sent By Us Post Paid

SOLDERALL CO., Dept. P
129 Sussex Avenue NEWARK, N. J.



"Red Devil" Rapid Boring Auger Bits are 33 1/2% easier boring, have 10% greater clearance, and bore with or against the grain of any wood. Style 2400—10/16 in., shown here, 75c.

Red Devil

REG. U. S. PAT. OFF.

Snips



THE tinner's choice in snips is "Red Devil," for "Red Devil" Snips are designed and made to cut with the *least* effort and to *stay* sharp. Let his choice be your guide.

Made in every popular style and size for every need. "Red Devil" Snip No. 578 one of the many styles.

A Handy Household Tool

Whenever you have any rough cutting to do—from rubber washers to sheet iron—you have need for this practical snip. It will enable you to do things for yourself that you would otherwise pay to have done.

At reliable dealers everywhere—
or send \$1.00 for a pair

Mechanics' tool booklet free

"RED DEVIL" TOOLS
—AMERICAN MADE

SMITH & HEMENWAY CO., Inc.

Manufacturers of "Red Devil" Tools
260 Broadway, New York, N. Y.

"Red Devil" Glass Cutters—the glaziers' standard tools of the world. "It's all in the wheel."
Made in 40 styles. No. 024 shown here, 20c.



Please Mention Popular Mechanics

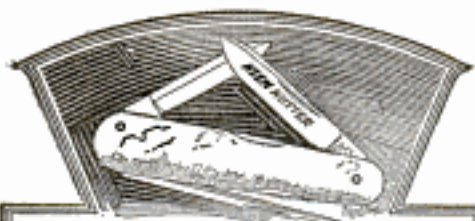

Pearl Handle! Those who are particular about details of appearance in all things truly appreciate Keen Kutter penknives—designs to suit personal preference.



Simmons Hardware Company

KEEN KUTTER

THE HANDIEST TOOL in the WORLD



OLSON
MAGAZINE
SCREW DRIVER
Large enough to hang a door,
Small enough to fit a bell.
Three blades, one set, guaranteed. Fits any
common screw and makes holes. Ask your
hardware store or send \$1.25, prepaid.

Olson Manufacturing Company
52 Commercial St., Worcester, Mass.

BURN YOUR NAME ON TOOLS WITH ARKOGRAF

Protect your tools from theft. Write any name, engrave any design on metal with electricity like writing on paper with pen or pencil. Complete outfit \$3.50, prepaid anywhere. Intercutting descriptive circular free. Write today. Agents Wanted. Arkograf Pen Company 1007 Yeon Building Portland, Oregon



To mend bandsaws so that they are stronger than before the break, use

Briggs' Silver Solder

1 oz. Tape—5 ft. long, 3/8 in. wide, 3/1000 in. thick, in non-waste, metal box..... \$1.25

J. BRIGGS & SONS CO., Mfrs.
67 Clifford St. Providence, R. I.

MYERS WONDERFUL SEWING AWL

Tools in Handle



A complete repair shop in itself. Sews anything heavy or light, leather, shoes, harness, buggy tops, covers, belts, etc. \$1.00 Postpaid.
C. A. MYERS COMPANY, 6329 Woodlawn Ave., Chicago, Ill.

HAWAIIAN IM. DIAMONDS



No. 2010
Special price \$2.98

The Greatest Discovery the World Has Ever Known. Just to advertise these famous Im. diamonds we will send you one of these 14K gold 1. ring, postage paid. When it arrives pay postman \$2.00 C.O.D. charge to cover cost etc. Only 10,000 rings given away. Money refunded if you can tell it from a genuine diamond. Send size of finger.

KRAUTH & REED
Dept. C
Masonic Temple Chicago



No. 2011
Special price \$2.98

DELTA ELECTRIC BICYCLE LAMP

AFTER DARK—

Going and coming from work—Delta Electric Bicycle Lamp lights the road ahead—spotting every danger—

Delta stands the "gaff," nothing to wear out, break, work loose; can't be bumped out of commission.

A brilliant, never failing light that is time-tried.

Ask your dealer, or model 27 (illustrated) fits any bicycle sent prepaid for \$2.25 complete, (less battery).

DELTA ELECTRIC COMPANY
100 Delta Block Marion, Ind.
Standard Makers of Electric Lanterns, Automobile Footlights,
Bicycle Lamps, Flashlights and all kinds of Dry Batteries.
New York Winnipeg San Francisco

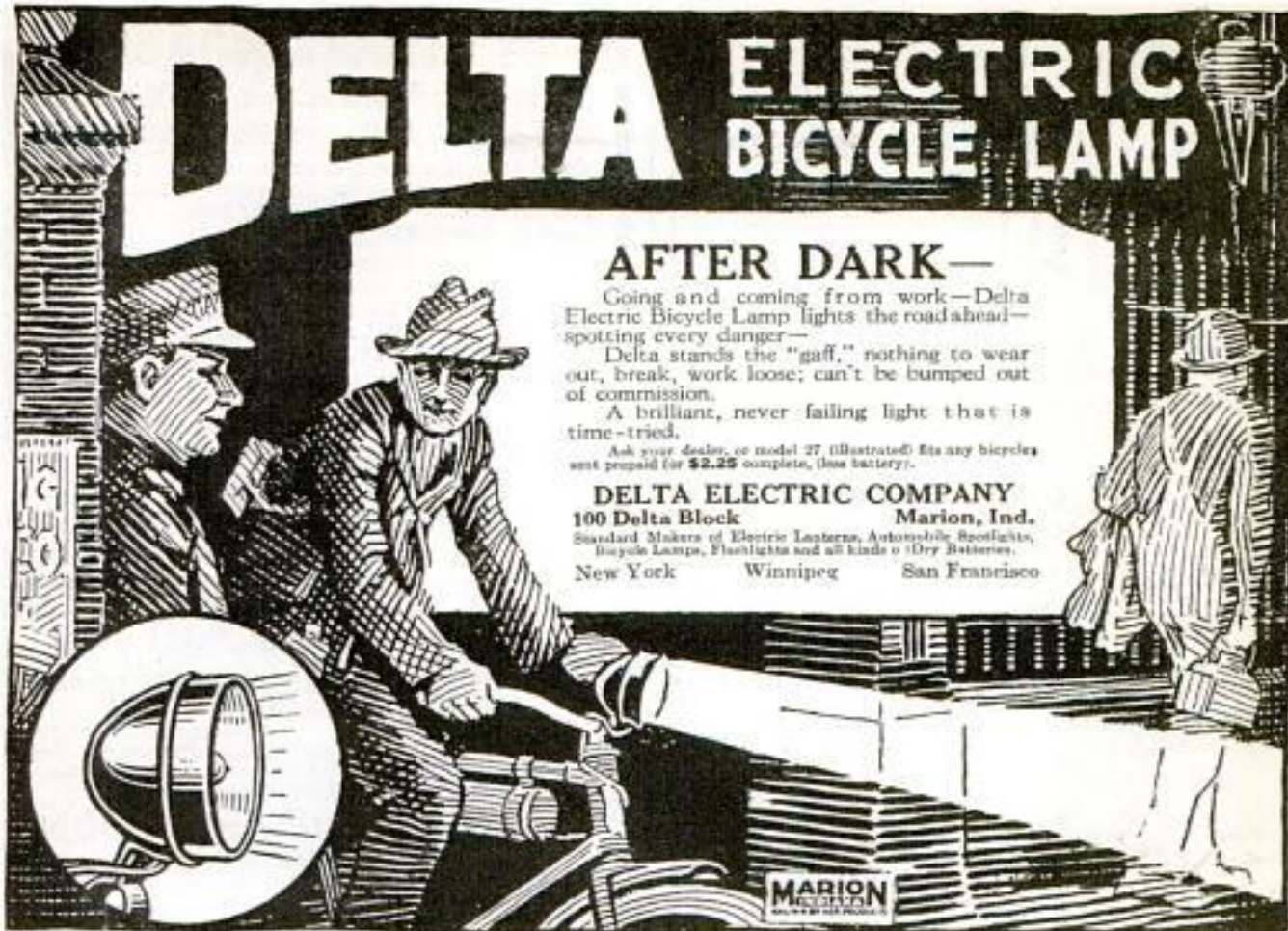

MAKE YOUR **FORD** INTO THIS **SPORT CAR** \$ **640** ONLY
Color types down to \$1.50. Famous new 81. *Roll-Roll* life-size patterned
and simple instructions show all details. You can easily convert your
Ford into this fast, easy Sport Car as
handlets have done with a few dollars worth of
material from the hardware
store. No need to lay up the
car. The "PAL" with optional
disc wheel pattern. Pressed
Metal Streamline Rear only
\$0.40 delivered. Built low,
rides wonderfully easy. Order
NOW while we can make good de-
livery. Send 25 cents for illustrated
prospectus of Sport Cars. "Jiffy"
Trade and "Gann" Woodville, Keokuk, Mo., 94 Keokuk Bldg., Galesburg, Iowa



MOTORCYCLE BARGAINS

Save 25% to 65%

on Slightly used and Rebuilt Motorcycles, Side Cars, Johnson Motor Wheels, Evans Power Cycles, Bicycles. Send for Free Bargain Bulletin and Money Saving Message, listing hundreds of Bargains in used, rebuilt and new machines, supplies, accessories, etc.

AMERICAN MOTOR CYCLE CO.
Dept. 914 2047 W. Chicago Avenue, CHICAGO



Try before you Buy

Your choice of 44 styles, colors and sizes in the famous Ranger line. Write for our marvelous prices and terms. Shipped on approval and 30 DAYS' FREE TRIAL, express prepaid.

12 Months to Pay You can get immediate possession and use of any Ranger bicycle on our liberal Easy Payment plan. Best quality at factory prices, express paid.

Tires, lamps, wheels, horns, equipment and repairs at unusually low prices.
Mead Cycle Company
Dept. F111 Chicago



Write today for free Ranger Catalog, factory prices and marvelous easy payment terms

MOTORCYCLES

RELIABLE STANDARD MAKES that you can **DEPEND** on.

Enjoy the glorious experience of going wherever you like—whenever you like. The price is within your means—35% to 50% less than others. These machines are slightly used, thoroughly overhauled or rebuilt. Send for catalogue.



MYEROW BROS.,
250 Columbus Ave., Boston, Mass.

FEDERAL

BICYCLE TIRES



QUALITY and "Extra Service" have made Federal exceedingly popular. Six different types to choose from, make it easy to match up with any other tire you are now using.

THE FEDERAL RUBBER CO.
of Illinois
Cudahy, Wisconsin

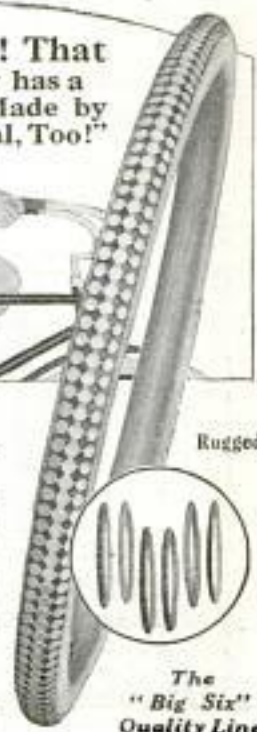

The
"Big Six"
Quality Line

GET FACTORY PRICES ON GALVANIZED ROOFING



EDWARDS "REO" Metal Shingles

Absolutely rust-proof—edges as well as sides. Not the space of a pin point exposed to weather. Also fire and lightning proof. Reduce insurance. Outlast building. Need no repairs—end all roofing expense. Easy to lay—one man can do the work—hammer and nails only tools needed. Lay over old shingles if desired. Patent Interlocking Device makes water tight seams—all nail heads covered—no rust or leaks possible.

Exclusive "Tightcote" Process
Put all Edwards Galvanized Roofing in a class by itself. Bend, twist, strike it with a hammer as much as you like—you can't loosen or scale off the galvanizing—due to our "TIGHTCOTE" process which practically makes zinc covering a part of the metal sheet. No other galvanized roofing can withstand this test.

FREE Roofing Book Don't buy roofing until you get our big free book, describing Edwards famous "Tightcote"



THE EDWARDS MFG. CO.
501-550 Pike St. CINCINNATI, O.



Corrugated



Patent Side Lock
No nail heads in sight or exposed to the weather



Brick Sliding

Roofings, Sidings, and Ceilings, and our lowest factory prices. We sell you direct and save you in-between dealers' profits. Write for Roofing Book No. 100.

Low-Priced Garages

Lowest prices on Ready-Made Fire-Proof Steel Garages. Get up any place. Send postal for Garage Book showing styles.



**FREE
Samples &
Roofing Book**



PAUL REVERE BICYCLE

A sturdy dependable Bicycle—all workmanship and parts absolutely guaranteed for five years—7 models to choose from—12 months to pay. Express charges prepaid. Beautiful Catalog free. Agents wanted.

MYEROW BROS.
260-262 COLUMBUS AVE.
BOSTON, MASS.

Men With Autos Wanted



to introduce and take orders for our **NEW PROCESS STORAGE BATTERY**. Plates cannot sulphate or buckle. No expert attention required.

One-half cup water every 3 months. Made for autos, radios, lighting outfits and all other battery purposes.

Guaranteed 2 Years

The biggest money maker and greatest business builder ever known. Write today for our exclusive proposition and low wholesale prices.

HARSHA BATTERY CO. Dept. 10.
21 East Van Buren St. CHICAGO

Car Owners Wanted!!

To sell and introduce the World's Best Automobile Tires

Great Exclusive processes that enable us to guarantee these Wonderful Tires for 12,500 MILES AGAINST: **RUT-WEAR RIM CUTS—STONE BRUISES and BLOWOUTS!**



An Agent wanted in each community to introduce these wonderful Tires at amazingly low prices.

FREE TIRES FOR YOUR OWN CAR!

Write for our Free Sensational Introductory Offer to one Agent in each locality.

Dept. 109

INTERNATIONAL RUBBER CORP.
Grand Rapids, Michigan

Over \$200 Profit Weekly Above Expenses

All over the U. S. and Canada, we are establishing vulcanizing service stations. We instruct you and furnish the most modern methods and equipment—

THE ANDERSON Known the World Over

We have 34 schools in U. S. and 4 in Canada. One is near you. School credits you \$5 per day while you learn vulcanizing if you buy Anderson equipment for your station. Small capital. Big profits.

Write for full particulars TODAY.

THE ANDERSON STEAM VULCANIZER CO.
Manufacturers of Modern Tire Repair Equipment
103 Williams Bldg. Indianapolis, U. S. A.

SEND for the INTERNATIONAL CATALOG

Factory to Consumer direct—

FOR FORD, CHEVROLET and DODGE.



Our net price list of auto bodies and body supplies at Wholesale Prices. Save big money by buying Direct from Factory

PRICES FROM \$27.85 UP
International Body Works 514 W. Ohio Street, Chicago, Ill. Dept. 7

CUSTOM TAILOR MADE To fit your individual car

Made in our custom shops after your order is received. We ship ordinarily in 2 or 3 parcels days. Perfect fit guaranteed Post Paid when correct name, year and model of car is given. You can easily apply it yourself. We furnish instructions and all necessary tools, wets and fasteners. Our catalog No. 10, with samples, is free for the asking.
LIBERTY TOP & TIRE CO., Dept. E-7, Cincinnati, O.

Auto Supplies
Knowing *HOW* to buy is merely knowing *WHERE*
This is Chicago's Great Wholesale House.
AUTO SUPPLIES AND MOTOR PARTS
WHOLESALE ONLY
Dealers send today for this big money-saving book
AKTELL AUTO ACCESSORIES COMPANY
3574 South Michigan Avenue
CHICAGO



2 TIRES FOR \$10²⁵

FREE TUBE WITH EACH TIRE

Sensational Cut In Standard Tire Prices!

Two used tires for less than the usual cost of one, and a free inner tube with each tire! No double treads or sowed tires. Our big volume means best tire values. Act now and cut your tire cost in two. Thousands of steady customers are getting full mileage out of these 12,000 MILES tires and you, too, can get it. You can see the mileage in our tires. Order and prove it—but order now! This is a special lot selected for record-breaking sale. Supply limited and going double quick.

Note the Bargain Prices on Two Tires of Same Size

Size	1 Tire	2 Tires	Size	1 Tire	2 Tires
28 x 3	\$ 6.95	\$10.25	32 x 4 1/2	\$13.45	\$21.45
30 x 3	7.25	11.45	33 x 4 1/2	13.95	22.45
30 x 3 1/2	8.25	13.65	34 x 4 1/2	14.45	23.45
32 x 3 1/2	9.45	15.45	35 x 4 1/2	14.95	24.90
31 x 4	10.65	16.90	36 x 4 1/2	15.45	25.45
32 x 4	11.85	18.90	36 x 4	14.95	25.95
33 x 4	12.45	19.85	37 x 5	15.90	26.45
34 x 4	13.25	20.85	37 x 5	16.45	26.95

SEND NO MONEY! Shipment C.O.D. express or parcel post. Examine tires on arrival and if not fully satisfied return same at our expense and your money will be promptly refunded. State whether straight side or clincher. **DON'T DELAY! ORDER NOW!**

ALBANY TIRE & RUBBER COMPANY
2721 Roosevelt Road Dept. 164K Chicago, Illinois

16,000 MILES without a Puncture

Wonderful invention. Insyde Tyres—Inner Armor for automobile tires. Positively prevent punctures and blowouts. Guaranteed to give double tire mileage, any tire—old or new.

Over 100,000 Satisfied Customers

Easily applied without tools. Just slip inside casing before replacing tube. Will not heat or pinch. Use over and over again. Old worn out casings will give 3 to 5,000 miles more service. Low priced. Agents wanted in every country.

American Accessories Co., B-1676, Cincinnati, O.

VITALIC Bicycle Tires

TRADE MARK REGISTERED
Tougher Than Elephant Hide

SAVE MIDDLEBURY'S 50 PER CENT

10,000 MILES GUARANTEED

CORDS \$10⁷⁵

30 x 3 1/2

Shipped C.O.D. if requested, direct from **FACTORY TO YOU**

32x3 1/2	\$15.60	34x4 1/2	\$26.40
32x4	17.95	35x4 1/2	27.00
33x4	18.95	36x4 1/2	27.60
34x4	19.95	33x5	31.20
32x4 1/2	25.05	35x5	32.25
33x4 1/2	25.85	37x5	35.00

B NUELLE RUBBER CO.
1223 So. Wabash Avenue
CHICAGO, ILL.

AGENTS WANTED

Please Mention Popular Mechanics



Miracle Number 5

Picnic party stalled for fifth time on sizzling hot day. Cause—leaky radiator requiring frequent refilling. Passerby suggested getting a can of liquid

RADIATOR NEVERLEAK

at next town. Suggestion adopted and contents of 75c can of Radiator Neverleak poured into radiator. Troubles over! Leak stopped almost instantly and did not recur again.

Save annoyance, time and expense! Carry can of Radiator Neverleak along for emergency. Cannot harm or clog radiator.

Guaranteed Satisfactory

At your dealers or sent post-paid for 75c.

Buffalo Specialty Co.

The Liquid Veneer People

357 Ellicott Street
Buffalo, N. Y.



10c. CHARGES RADIO & AUTO BATTERIES

FROM A LAMP SOCKET AT HOME OR BUSINESS WITH AN

F-F BATTERY BOOSTER, which is a FULL WAVE Magnetic Rectifier for 104-125 volt 60 cycle A.C. Leave Battery Just as it is in Your Car, Snap Charger Clips on Battery Terminals, Turn Switch, & Battery Will be Charged in the Morning. **AMMETER** Eliminates All GUESSES WORK.

A Complete Portable Automatic Charging Unit, with Insulating Cabinet, Rectifying Brushes, which Charge Unattended. No Skill is Required. A Fully Charged Battery Starts Car & Truck Quick, thus saves Expense Replacement Storage Batteries **MUST** be bought, when Kept Fully Charged: So It Costs Less to Buy & Recharge than to be without one. Do Not Think Your Battery is dead and worn out, simply because it will not start Your Car. Buy a BOOSTER. You'll like it with Life and Heavy Service Cars. **F-F Automatic, Full Wave, BATTERY BOOSTERS SAVE YOU MONEY and Last a Lifetime. PRICES:**

Type 4 charges "A" 6 volt Battery at 6 amperes \$15
Type B charges Radio "B" Batteries Up to 100 volts \$15
Type A-B charges Both "A & B" Radio Batteries \$20
Type 12 charges 12 volt Battery at 5 amperes \$15
Type 16 charges 6 volt Battery at 12 amperes \$24
Type 1612 charges 12 volt Battery at 7 amperes \$24
Type 1620 is a Combination of Types 16 & 12 \$34

The Larger Types are recommended for heavy Batteries, or where time is limited. Shipping Weights Complete with **AMMETER & BATTERY CLIPS:** 11 to 15 Pounds. Purchase from Your Dealer or Mail Check for Prompt Express Shipment. If for Parcel Post add Postage & Insurance. Charge. Or ORDER us to forward TYPE desired C.O.D. For Dependable, Economical **GROUP CHARGING, WRITE for FREE Descriptive 12 Battery, 8 Amperes, FULL WAVE, Automatic ROTARY RECTIFIER Bulletin 24-A. ORDER Now or WRITE Immediately for FREE Descriptive BOOSTER Bulletin 24. THE FRANCE MFG. CO., CLEVELAND, OHIO, U. S. A.** Canadian Representative: Battery Service & Sales Co., Hamilton, Ontario, Canada.

Fords Can't Burn

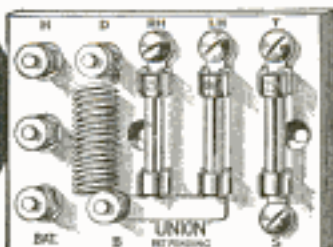

A grounded circuit won't start a fire when your lighting system is protected with "Union" Fuse Block. For then a fuse only blows, and it's easy to locate and repair the damage for a few cents. **It's dangerous to leave wiring unguarded.**

Flickering lamps, blown lamps and all other troubles caused by loose wires are impossible. Also permits using standard Mazda for both bright and dim lights, instead of expensive double filament bulbs. Best postpaid for \$1.50 if not at your dealers. Money back if not satisfactory. Booklet on request.

CHICAGO FUSE MFG. CO.

1503 W. 15th St., Chicago

Eastern Offices: New York.

LOFTIS BROS. & CO. Established 1858

DIAMONDS WATCHES CASH OR CREDIT



"SYLVIA" Diamond Ring
Blue white, radiant, perfect cut Diamond. The ring is 18-K Solid White Gold, carved and pierced. Extra special at \$100. Credit terms: **\$2.50 A WEEK**
Others at \$75, \$150, \$200 and up.

Genuine Diamonds GUARANTEED
Our Diamonds are distinctive in fiery brilliancy, blue white, perfect cut. Sent prepaid for your Free Examination, on Charge Account.

Send for Free Catalog
Everything explained. Over 2,000 illustrations of Diamond-set Jewelry, Furs, Watches, Wrist Watches, Mesh Bags, Silverware.



Wrist Watch \$2.25 A Month
Cushion Shape Gold filled, guaranteed 20 years. Ribbon bracelet with gold filled clasp. Special \$21

Diamonds Win Hearts
PRICES ARE DOWN
Our immense buying power for our Chain of Stores in leading cities and our large Mail Order House enables us to make lower prices than small concerns. We invite comparison. You will be convinced that you can do better with LOFTIS. Money back if not fully satisfied. **LIBERTY BONDS ACCEPTED.**



Wedding Ring
All Platinum \$25. Solid Gold Wedding Rings, \$5 up.

Every woman wants a Wrist Watch. Every high school girl should have one. Every wage-earning girl needs one. Open a charge account with LOFTIS. Any price you wish.
The beautiful Ring and Wrist Watch (illustrated) are only a few of a multitude of bargains shown in our large Catalog. Exquisite Diamonds from \$25 up. Send for Catalog Today. Don't Delay.

LOFTIS BROS & CO. EST'D 1858
THE OLD RELIABLE ORIGINAL CREDIT JEWELERS
DEPT. D-894
108 N. State Street, Chicago, Ill.
Stores in Leading Cities



"Lighting Fixtures"
READY TO HANG
(Direct from Manufacturers)
Completely wired, including glassware. New designs. Send for catalogue No. 24. Send for DEALERS' proposition.
ERIE FIXTURE SUPPLY CO.
STA. A. ERIE, PA.

\$34.50 3 Piece SUIT MADE TO ORDER SAVE



To prove our unbeatable values and get your steady trade, will make 3-piece suit consisting of coat, pants and vest to your measure for only \$34.50. Style shown in the picture or any one of 185 styles combinations to select from. One year's satisfaction guaranteed or every penny back—quick.
NO EXTRA CHARGES
You pay just what we say, not one penny of extra for anything. We even pay all postage and express. You save one-half—like before the war.
Earn \$60 Cash Weekly
You can take orders easy for these clothes in spare time and make \$3000 a year and up at home. Friends and neighbors buy on sight. Young Fred Green made \$174.00 in seventeen days. **SEND NO CASH.**
FREE—BIG SAMPLES
New samples show latest styles and 80 real cloth samples. Buy at inside Wholesale prices. Write now for Big Free Outfit.
WASHINGTON TAILORING CO.
Wholesale Tailors Dept. J-345 Chicago

DEAF?

Ask for Proof that you can Hear!



For fifteen years we have been urging every deaf person to try the Acousticon for ten days, absolutely free of cost or obligation—this because we are confident that our constant and expert effort has succeeded in keeping it more efficient than any other device. We again urge you to accept the

1922 ACOUSTICON
For 10 Days' FREE TRIAL
No Deposit—No Expense

If you learn of another hearing device which claims equal efficiency, ask for the same free trial which we offer and compare the two in your own home. We will be very happy to have you choose the one which suits you best and return the other. Let no one convince you but yourself.

DICTOGRAPH PRODUCTS CORP.
1307 Candler Bldg. 220 W. 42 St., N. Y. City

GET A RAZO!



This unique Razor-blade pocket knife is the handiest, safest general utility knife. Uses an old Gillette blade. Artists, writers, draftsmen, tailors, dressmakers, office men, women, school children all need RAZO. Send 25c for yours today. Great money maker for agents.

RAZO NOVELTY CO.
23 E. Van Buren St. Chicago

Only \$45.00 For This Job Complete

Save exorbitant freight rates and one-half original cost by buying Ford Speedster bodies knocked-down. Simple, complete instructions furnished, all parts cut to exact fit. Any one can assemble this job. Complete with hood, radiator, grill, instrument board, upholstery, metal parts, wood parts, springs, etc. Flat radiator shell furnished made up. Designed low with lack of wind resistance. Price set up \$60, further particulars on request.



Not Paper Patterns All Parts Complete
The Central Auto Supply Co., Eng. Dep. 120, Louisville, Ky.

MOTOR REPAIR BOOK FREE



Why spend dollars, when you can make perfect Automobile and Household repairs quickly and easily with SMOOTH-ON IRON CEMENT No. 1 at a few cents' expense? Write for this book and learn how—it's free.



Smooth-On No. 1 is sold in 6 oz., 1 lb., and 5 lb. tins by Hardware and Auto Supply Stores.
SMOOTH-ON MFG. CO.
Dept. 371 Jersey City, N. J.

SMOOTH-ON IRON CEMENT No. 1
For Motor and Household Repairs

LAUGH AT THE WEATHER



 with
"Wear Me"
 Windshield Wings

10"x20" Beveled Plate Glass.
 Clamped not Bolted. Hard-
 ware Strong and Rustproof.
 No interference with Side
 Curtains. Fully Guaranteed.

\$12.50 per
 set

Ford Special \$10.00 per set

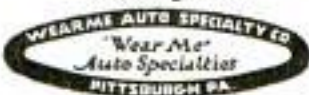
"The Kind You Have Been
 Waiting For"



Order from your dealer
 or direct

PRIDE—PLEASURE—PROFIT

Fast-
 speed
 Bodies
 3 New
 Models

16 Valve Heads
 Speed Differential
 Gears



Underslung Fixtures
 4-Speed Transmission

Crankshaft Counterbalance

Designed for discriminating purchaser whose taste demands class,
 Owners of FORDSPEED cars derive pride, pleasure and profit.
 TO INTRODUCE our new models, we offer a wonderful propo-
 sition. BIG opportunity for rider agents.

Specials for this month:

	Price	
Underslung Fixtures	\$15.00	\$8.00
3:1 Chrome Nickel Gears	12.00	7.00
24:1 Chrome Nickel Gears	18.00	10.00
Speed & Power Camshaft	20.00	9.00
Steel Wheel Discs (8)	12.00	6.00

Satisfaction or Money Back Guarantee: Turns 50% with order, balance upon delivery
 D. B. FORD SPEED & POWER EQUIPMENT MANUFACTURERS
 250 West 34th St., New York

**START YOUR OWN MONEY-MAKING
 BATTERY CHARGING BUSINESS \$20**

\$20 puts an HB Battery Charger in your shop. Pay balance out
 of your profits on long easy terms. Biggest season just starting.
 Get these profits. Sizes for 8, 10, 16 or 32 batteries. Sold on
 money-back guarantee. Write today for information.
 HOBART BROS. CO., Box M 99, TROY, OHIO

NEW AUTOMATIC ADDER, \$3.50

Makes adding easy. It's accurate, quick, durable and
 easily operated. Capacity 8 Columns. Saves time, beats
 work and errors. 65,000 pleased owners. Fully Guarant-
 eed. Price \$3.50. Delivered. With METAL OPERAT-
 ING BANDS, \$5. Delivered. Agents wanted. Imme-
 diate shipment made. Send your order now.

J. H. Bassett & Co., Dept. 215, 1458 Hollywood Ave., Chicago, Ill.

Our BUREAU OF INFORMATION will answer all ques-
 tions regarding articles appearing in this magazine.
 Address Bureau of Information, Popular Mechanics
 Magazine, Chicago.

Model
1-80 DRILL

A Powerful, Lightweight Drill

DOES the work better, quicker and easi-
 er. Ideal for drilling in hard-to-reach,
 out-of-the-way places. Simple to op-
 erate—economical to buy. Special, inter-
 changeable attachments make it capable of
 performing many jobs besides drilling.
 Grinds valves, removes carbon, buffs, etc.

Write for complete specifications
 and interesting booklet!

WISCONSIN ELECTRIC CO.
 RACINE, WISCONSIN
 Dept. D9

DUMORE
 Geared
 ELECTRIC DRILLS

THIS WONDERFUL INVENTION

converts any ordinary cook stove
 into a gas stove. OXO-GAS is
 made from kerosene and air.
 Cheaper, cleaner and more effi-
 cient than coal. Responsible dis-
 tributors wanted.

GLORIA LIGHT COMPANY
 114 N. May St.
 Chicago, Ill.

PHONOGRAPH OWNERS: GOOD NEWS!

No More Changing Needles! No More Scratched and Ruined Records!

The Everplay Needle cannot injure your records like the steel needles. Why?
 Because the playing point consists of a fine, soft, special alloy wire 9 inches long
 coiled within the needle. It is extended as used by a turned-in link-star lead.
 It exactly fits the record groove at all times, bringing out every note and vibra-
 tion without the surface noise and scratch. Cleans and polishes the groove;
 saves \$25 to \$40 in steel needles and much more in wear of records. Can
 be adjusted loud or soft. Will last a lifetime. Guaranteed to play 27,000
 records and the last as perfectly as the first. Adds to the appearance
 of your photograph. Price \$1.00—10c extra if C. O. D.

Money back if not satis-
 fied. Agents wanted
 everywhere

Everplay

Needle Co., Dept. 1
 McClurg Bldg.
 Chicago, Ill.

Actual size

7 Diamond Solitaire Cluster

\$5.00
 A
 Month

Special
 Price
\$55

Seven perfectly cut, blue white Diamonds are so closely set in Platinum, and so ex-
 quisite is the workmanship that the solitaire resemblance is actually startling. Looks
 like a single 2 ct. Diamond. Don't send us a penny—We'll send the Ring entirely
 FREE. If satisfied, pay \$5.00, then send the balance in ten months, \$5.00 a month.
 If not satisfied, return.

FREE

De Luxe Diamond Book
 showing over 2,000 Bargains in
 Diamonds, Watches and Jewelry
 —ten months to pay on every-
 thing. Write to Dept. 532-P

CAPITAL \$1,000,000

"THE HOUSE OF QUALITY"

L.W. SWEET INC.
 1650-1660 BROADWAY, NEW YORK

A Good Bookcase for the price of a good book!



\$1.75 Per Section
without Doors

With Disappearing
Glass Doors **\$2.75** Per Section

On Approval—Direct to User

Lundstrom

IT GROWS WITH YOUR LIBRARY
SECTIONAL BOOKCASE

Endorsed by Over 100,000 Users

Made for and universally used in the finest homes and offices throughout the country. Made in sections of different sizes, combining utility, economy and attractive appearance. Style shown above is beautifully finished in SOLID OAK. Price complete as shown with top, base and three book sections with **non-binding, disappearing, felt-cushioned glass doors** (Sections dust-proof) \$11.75. Price for same combination, without doors, \$9.75. Other styles in different grades and finishes at correspondingly low prices. **Shipped direct from factory ON APPROVAL** at a considerable saving TO YOU.

Write for new catalog No. 21.

The C. J. LUNDSTROM MFG. CO., Little Falls, N.Y.
Mfrs. Sectional Bookcases and Filing Cabinets

Light Fibre Legs and Arms



6311
Dean Bldg.
RAY TRAUTMAN Minneapolis, Minn.

Hand
Forged
Razor Steel
Blades, No. 57



A GENUINE \$2 KNIFE
FOR
\$1.18 POSTPAID

Direct at Factory Prices

This \$2 KNIFE \$1.18 Postpaid
Hand Forged Razor Steel Blades
Handy shaped Blade makes this
knife best for mechanics, sportsmen
and farmers; light but strong; re-
sharpened easily. Stag handle. Ger-
man silver finish; blades file tested,
hand forged from razor steel and
warranted.

Sample \$1.18 3 for \$3.00 Postpaid.

Send for our 100-page List and
"HOW TO USE A RAZOR"

FREE

MAHER & GROSH CO., 106 A St., Toledo, Ohio

Home
School
Club

MARVELOUS MOVIES

Church
Camp
Office

The most beautiful and best constructed motion picture machine for the price in the world. Shows the same clear, crisp movies the big theatres exhibit. Child or grownup can easily operate the **Paramount** without any previous experience. Do not confuse this machine with toys at the same price. The **Paramount** is **not** a toy. It is a real, wonderful, guaranteed machine made of best materials by skilled workmen.

Just attach the electric plug to any electric current and turn the crank and your show is on. The entire outfit, complete, weighs only twelve (12) pounds.

Our Film Service
Is Available

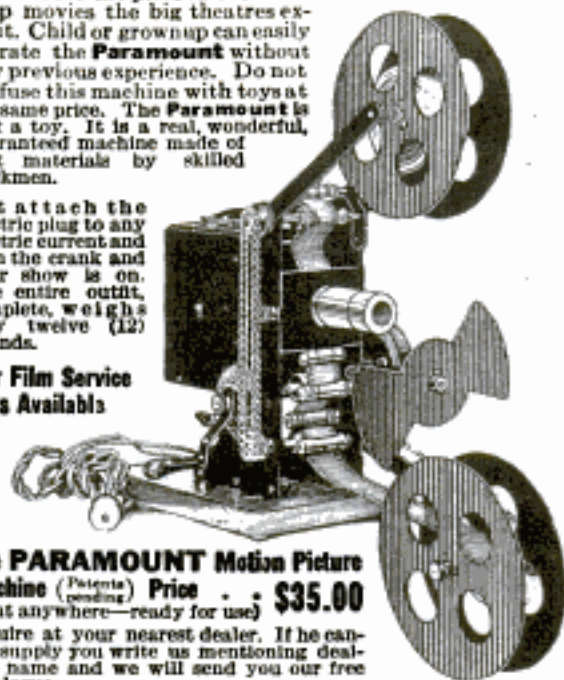

The **PARAMOUNT** Motion Picture
Machine (Patents pending) Price **\$35.00**

(Sent anywhere—ready for use)

Inquire at your nearest dealer. If he cannot supply you write us mentioning dealer's name and we will send you our free catalogue.

Remember there is no substitute for the **PARAMOUNT**
PARAMOUNT MFG. CO., Box 1371, Dept. M
BOSTON, MASS., U. S. A.

PATENTS

Protect your rights. Before disclosing invention write for booklet and blank form **EVIDENCE OF CONCEPTION** to be signed, witnessed and returned with rough sketch or model of your idea upon receipt of which I will promptly give opinion of patentable nature and instructions. **NO CHARGE** for preliminary advice. Highest references. Prompt, personal attention.

CLARENCE O'BRIEN

Registered Patent Lawyer, 798

Southern Building

Washington, D. C.

IVER JOHNSON

The **SAFE** Revolver

PATENTS TRADE-MARKS AND COPYRIGHTS

OUR OFFER—Free Opinion as to Patentable Nature

Before disclosing an invention, the inventor should write for our blank form "Record of Invention." This should be signed and witnessed and if returned to us together with model or sketch and description of the invention, we will give our opinion as to its patentable nature.

Our Three Books Mailed FREE to Inventors

OUR ILLUSTRATED GUIDE BOOK

HOW TO OBTAIN A PATENT

Contains full instructions regarding Patents, Trade-Marks, Foreign Patents, Our Methods, Terms, and 100 Mechanical Movements illustrated and described; Articles on Patent Practice and Procedure, and Law Points for inventors.

OUR TRADE MARK BOOK

Shows the value and necessity of trade-mark protection and gives information regarding unfair competition.

OUR FOREIGN PATENT BOOK

We have direct agencies in all the principal foreign countries and secure foreign patents in the shortest possible time and at the lowest cost. Write for our illustrated Guide Book on Foreign Patents, sent free to any address.

LIST OF PATENT BUYERS SENT FREE

Containing unsolicited letters from manufacturers and others who are constantly writing us regarding the purchase or leasing of meritorious patents. We endeavor to assist our clients in the commercial development of their inventions.

Specialization—Our Staff

The field of invention is so vast that it is impossible for any one man to become an expert in all the different classes of invention. For this reason Victor J. Evans & Co. employ a number of patent lawyers and mechanical experts who have been selected for their special knowledge and ability in certain lines of invention. Each case is placed in charge of experts in the classes to which the invention relates.

THE VALUE OF YOUR PATENT

will depend much upon the skill and care with which your case is prepared and prosecuted in the United States Patent Office. That every case intrusted to us receives our best efforts, and that our work is done consistently, skillfully, and thoroughly is evidenced by the many unsolicited letters of commendation that we receive constantly from our clients. We will furnish upon request lists of clients from any State in the Union for whom we have secured patents.

Our New York, Philadelphia, Pittsburgh, Chicago and San Francisco Offices

Owing to the growth of our business we have established for the benefit of our clients Branch Offices in New York City, Philadelphia, Pa., Pittsburgh, Pa., Chicago, Ill., and San Francisco, Cal. These branch offices being located in these large commercial cities together with our Main Office located near the U. S. Patent Office, in Washington, enables us to more promptly handle the business of our clients, particularly as the branch offices are in constant touch with the Main Office and fully equipped to handle patent business in all its branches.

Highest References — Prompt Attention — Reasonable Terms

—FREE COUPON—

VICTOR J. EVANS & CO., Patent Attorneys

NEW YORK OFFICES
1007 Woolworth Building

CHICAGO OFFICES
1114 Tacoma Building

PHILADELPHIA OFFICES
714-715 Liberty Bldg.

PITTSBURGH OFFICES
514 Empire Building

SAN FRANCISCO OFFICES
Hobart Building

MAIN OFFICES: 765 9TH STREET, N.W., WASHINGTON, D. C.

Gentlemen: Please send me FREE OF CHARGE your books as described above.

Name Address



PATENTS

IF YOU HAVE AN INvention which you wish to patent you can write fully and freely to Munn & Co., for advice in regard to the best way of obtaining protection. Please send sketches or a model of your invention and a description of the device, explaining its operation.

All communications are strictly confidential. Our vast practice, extending over a period of seventy-seven years, enables us in many cases to advise in regard to patentability without any expense to the client. Our Hand-Book on Patents is sent free on request. This explains our methods, terms, etc., in regard to **Patents, Trade Marks, Foreign Patents, etc.**

If you are a reader of the **SCIENTIFIC AMERICAN** you are probably aware of the fact that it has a special appeal to the inventor. Each issue contains a description of a large number of recently patented inventions. Pending patent legislation as well as the most recent rulings of the Patent Office and the courts are considered in its columns.

MUNN & CO.

SOLICITORS OF PATENTS

672 Woolworth Bldg., NEW YORK
 Scientific American Bldg., WASHINGTON, D. C.
 801 A Tower Bldg., - - CHICAGO, ILL.
 611 Hanna Bldg., - CLEVELAND, OHIO
 582 Market St. SAN FRANCISCO, CALIF.

RADIO

and other Electrical Inventions patented

MASON, FENWICK & LAWRENCE

Patent Lawyers

Washington, D. C.

Established 1861

We have with us four late members of the examining corps of the United States Patent Office.

Other offices: New York, Chicago, Denver, Seattle

Trade marks registered in United States and foreign countries

PATENTS

C. L. PARKER

Formerly Member Examining Corps, U. S. Patent Office

PATENT LAWYER

MCGILL BLDG.

WASHINGTON, D. C.

Patents, Trade Marks, Copyrights, Patent Litigation

Handbook for Inventors, "Protecting, Exploiting and Selling Inventions," sent free upon request.

PATENTS

TRADE-MARKS

COPYRIGHTS

Send for our free book of patent information.

Beale & Park 802 F St., Washington, D. C.
 16 S. Broad St., Philadelphia, Pa.

INVENTORS

who derive largest profits know and heed certain simple but vital facts before applying for

PATENTS

Our book Patent-Sense, for Inventors and Manufacturers, gives those facts: free. Write Lacey & Lacey, 646 F St., Washington, D. C.

ESTABLISHED 1869

PATENTS Secured

Prompt service. Avoid dangerous delays. Send for our "Record of Invention" form and Free Book telling How to Obtain a Patent. Send sketch or model for examination. Preliminary advice without charge. Highest references. Write TODAY. J. L. Jackson & Co., 327 Ourray Bldg., Washington, D. C.

Clear-Tone
 FOR
PIMPLES

Your skin can be quickly cleared of Pimples, Blackheads, Acne Eruptions on the face or body, Enlarged Pores, Oily or Shiny Skin. \$1,000.00 Cash says I can clear your skin of the above blemishes. WRITE TODAY for my FREE Booklet—"A Clear-Tone Skin"—telling how I cured myself after being afflicted for fifteen years.

FREE

E.S. GIVENS, 129 Chemical Bldg., Kansas City, Mo.

PATENTS

Booklet Free

Highest References

Promptness Assured

Best Results

Send drawing or model for preliminary examination

ALL BUSINESS GIVEN PROMPT AND PROPER ATTENTION

WATSON E. COLEMAN, Patent Lawyer, 624 F St., Washington, D. C.

Can You

think of a simple, practical idea that will fill one of the many requests we have on file for new inventions? It may mean a fortune for you. Thousands of things are needed right now. Your brains can help. Send today for our great new book—

"Inventions and Trade-Marks, Their Protection and Exploitation"

and learn more about making money from ideas than you ever knew before. It tells many things that are wanted, too.

**A postal will do—
It is free**

We Help Our Clients

without charge, to get the dollars out of their ideas—having facilities none others possess. Advice free. Don't delay—get the book at once.

American Industries, Inc.
200 Patent Dept.
WASHINGTON, D. C.

Patents Advertised For Sale Free

in Invention and Manufacturing Supplement

Published for the man with an idea. Send for free sample copy. One year's subscription, 50c.

PATENTS

To the Man with an Idea

I offer a comprehensive, experienced, efficient service for his prompt, legal protection and the development of his proposition.

Send sketch, or model and description, for advice as to cost, search through prior United States patents, etc. Preliminary advice gladly furnished without charge.

My experience and familiarity with various arts frequently enable me to accurately advise clients as to probable patentability before they go to any expense.

Booklet of valuable information and form for properly disclosing your idea free on request. Write today.

Richard B. Owen, Patent Lawyer
9-303 Owen Building, Washington, D.C.
2276-E Woolworth Bldg., New York City

PATENTS

If You Have an Invention and Desire to Learn How to Secure a Patent

Send for our Guide Book, **HOW TO GET A PATENT**, sent Free on request. Tells our terms, methods, etc. Send model or sketch and description of your invention and we will give our opinion as to its patentable nature.

RANDOLPH & CO.
600 F St., N.W., Washington, D. C.

NAME.....

STREET.....

CITY.....STATE.....

PATENTS PROMPTLY PROCURED TRADEMARKS REGISTERED

Send disclosure of invention, design, or trademark for actual search of U. S. Patents and novelty report. Validity and infringement investigations. Patent and trademark suits prosecuted and defended anywhere in the United States. Discriminating clients appreciate my efficient service. No literature will be sent you as this is a professional service, *individual and Personal*. Specific information and advice given regarding each individual case. Specialize in prosecution of pending cases that have been previously rejected by the Patent Office. Specialize also in unfair competition litigation before the Federal Trade Commission.

George P. Kimmel, Master of Patent Law
53-L Loan & Trust Bldg., Washington, D. C.



WRITE TODAY FOR FREE BOOK ABOUT PATENTS and "RECORD OF INVENTION" for establishing evidence of conception. The book tells how to proceed, the usual cost of obtaining a patent, and contains good sound practical advice every inventor should know. "RECORD OF INVENTION" should be filled out, signed and witnessed before you disclose invention to anyone. Send rough sketch or model and description for free report upon patentable nature and cost to Patent, etc. **Prompt, personal service.** Reasonable fees. Partial payment plan. Preliminary advice without charge.

J. REANEY KELLY
PATENT LAWYER

612-COLUMBIAN BLDG. WASHINGTON, D.C.



GEARS ALL KINDS SMALL

The most accurate made and prices reasonable. We carry a complete line of gears in stock for immediate shipment. Can also quote on special gears of all kinds. Send us your inquiries.

WRITE FOR CATALOGUE.

CHICAGO STOCK GEAR WORKS
105-109 S. Jefferson St., CHICAGO

U.S. PATENTS



SEND FOR
THIS FORM

DON'T LOSE YOUR RIGHTS TO PATENT PROTECTION

Before disclosing your invention to anyone send for blank form "EVIDENCE OF CONCEPTION" to be signed and witnessed. A sample form together with printed instructions will show you just how to work up your evidence and establish the same before filing application for patent. As registered patent attorneys we represent hundreds of inventors all over the United States and Canada in the advancement of inventions. Our schedule of fees will be found reasonable. The form "Evidence of Conception," sample, instructions relating to obtaining of patents and schedule of fees sent upon request. Ask for them—a post card will do.

PATENTS AND TRADE MARKS

LANCASTER & ALLWINE
D.C.

204 Ouray Bldg. Washington, D. C.
Originators of forms "Evidence of Conception."

INVENTORS AIDED. Ideas developed. Experimental Machinery Built. Individual Service.

RICHARDSON & ROGERS, 7 ALBEE, WASHINGTON

Practice in all Courts.

TRADE-MARKS. We seek the valid **PATENTS**

BATTERY CHARGING PAYS \$150 to \$300 Monthly Profits

Big demand NOW for reliable service recharging auto and radio batteries. \$20 cash brings you a money-making H-B Battery Charger. Your profits easily pay balance on easy monthly terms. No experience needed. H-B Outfits for charging 6, 10, 14 or 22 batteries at once. Send this ad for information to **HOBERT BROS. CO., BOX 495 TROY, OHIO**



Swear Off Tobacco

Tobacco Habit Banished Let Us Help You

Quick Results

Trying to quit the tobacco habit unaided is often a losing fight against heavy odds, and may mean a serious shock to your nervous system. So don't try it! Make the tobacco habit quit you. It will quit you if you will just take Tobacco Redeemer according to directions.

It doesn't make a particle of difference whether you've been a user of tobacco for a single month or 50 years, or how much you use, or in what form you use it. Whether you smoke cigars, cigarettes, pipe, chew plug or fine cut or use snuff—Tobacco Redeemer will positively remove all craving for tobacco in any form in a few days. Your tobacco craving will usually begin to decrease after the very first dose—there's no long waiting for results.

Tobacco Redeemer contains no habit-forming drugs of any kind and is marvelously quick, scientific and thoroughly reliable.

Not a Substitute

Tobacco Redeemer is in no sense a substitute for tobacco, but is a radical, efficient treatment. After finishing the treatment you have absolutely no desire to use tobacco again or to continue the use of the remedy. It helps to quiet the nerves, and will make you feel better in every way. If you really want to quit the tobacco habit—get rid of it so completely that when you see others using it, it will not awaken the slightest desire in you—you should at once begin a course of Tobacco Redeemer treatment for the habit.

Results Absolutely Guaranteed

A single trial will convince the most skeptical. Our legal, binding, money-back guarantee goes with each full treatment. If Tobacco Redeemer fails to banish the tobacco habit when taken according to the plain and easy directions, your money will be cheerfully refunded upon demand.

Let Us Send You Convincing Proof

If you are a slave of the tobacco habit and want to find a sure, quick way of quitting "for keeps" you owe it to yourself and to your family to mail the coupon below or send your name and address on a postal and receive our free booklet on the deadly effect of tobacco on the human system, and positive proof that Tobacco Redeemer will quickly free you from the habit.

Newell Pharmacal Company
Dept. 300 St. Louis, Mo.

Free Book Coupon

NEWELL PHARMACAL CO.,
Dept. 300 St. Louis, Mo.

Please send, without obligating me in any way, your free booklet regarding the tobacco habit and proof that Tobacco Redeemer will positively free me from the tobacco habit or my money will be refunded.

Name.....

Street and No.....

Town..... State.....



Tobacco Tosses
Nervous System



Tobacco Ruins
Digestion



Tobacco Stunts
Boy's Growth



Tobacco Robs
Man of Vitality



Tobacco Steals
from You the
Pleasures, Com-
forts, Luxuries
of Life



SMOKE—SIX—

EL VANDOMA CIGARS

ON YOUR APPROVAL

BUY DIRECT AND CUT YOUR CIGAR BILLS IN HALF. We save you the retailer's and wholesaler's profit. EL VANDOMA CIGARS are sold only on the "APPROVAL PLAN."

OUR OFFER: Upon receipt of your name and address we will send you a box of Fifty (50) EL VANDOMA CIGARS (Banker's Size—five (5) inches long) postage prepaid. Give them a thorough trial—smoke six (6) EL VANDOMAS. After you have smoked them and you find the box is not worth **Four (\$4.00) Dollars** return the balance of the cigars within ten days and you will not be out one cent. If you are pleased with the cigars, mail check or money order for **Four (\$4.00) Dollars.**

EL VANDOMAS are packed in special cedar chests. They are made of the finest quality imported Havana filler—mild, selected shade-grown wrapper of exquisite quality. These cigars are recommended for their rich, mild flavor.

SEND NO MONEY

Just your name and address on your business card or letter head. (If you prefer send check, money order or C.O. D.) State the quantity of cigars you desire. Remember you risk nothing. Try a box on our "APPROVAL PLAN."

EL VANDOMA CIGAR COMPANY
Dept. 60
290 Washington Street
Brooklyn, N. Y.

HAND MADE ACTUAL SIZE



Build Your Own PHONOGRAPH

IT'S EASY WITH OUR HELP

A few hours' interesting work saves over half and gives you a machine to suit your ideas. We furnish motors, tone arms, case material, blue prints and full instructions. Plays any record. Make fine profit building phonographs for your friends.

Write today for our **FREE** Blue print offer.

AGENTS wanted for Choraleon Phonographs.

CHORALEON PHONOGRAPH CO.
922 1st St., Elkhart, Ind.

SAVE OVER HALF



The Very

DEAF

Can Hear with the Marvelous New Invention of Earl C. Hanson, the

VACTUPHONE

Using the New Radio Vacuum Tube.

GLOBE PHONE MFG. CO.
Gen'l Offices and Factory, READING, MASS.

SALESROOMS:
Boston New York Philadelphia
Chicago San Francisco Los Angeles
Washington Cleveland

The Versatile

HAMMOND

Folding Portable
Typewriter

MULTIPLEX HAMMOND'S
Instantly changeable type
Many styles, many languages
Just Turn the knob to change

Hammond Typewriter Corp., 569A East 69th Street
New York City, N. Y., U. S. A.

RADIO RECEIVING SET

GIVEN Just as Shown

Genuine scientific instrument with Tuning Coil, Detector, Condenser, all on base. Can hear 15 to 25 miles under right conditions. Given for selling 28 pkgs. Bluine at 10 cts. a pkg.

BLUINE MFG. CO. 140 MILL ST., CONCORD JUNCT., MASS.



VIOLINS

SPECIAL LOW PRICE SALE

We can save you money on standard makes and models best quality, guaranteed violins. Biggest offers ever made by us. **SEND TODAY** for list of bargains and information.

JENKINS MUSIC COMPANY
(42 years in business—13 stores.)
931 Jenkins Bldg. Kansas City, Mo.



TOOTH No Bristle BRUSH

"ERASES THAT FILM"

For Tender Gums
Protects Against Pyorrhea

Made of Pure White Rubber. Will Clean Polish and Massage.

We guarantee this brush to outwear any bristle brush made. Clean—healthful—sanitary. Brush replaced if defective. At your dealer's or by mail postpaid 50c. Fine opportunity for agents.

THE NO BRISTLE BRUSH CO., 10 High St., BOSTON, MASS.



WANTED! BY MILLION DOLLAR COMPANY. A few high-class County and State Distributors to handle fast-selling automotive product, endorsed and used by thousands of motorists. Powerful newspaper advertising over distributor's name furnished to men who are qualified. Write, The Turbolator Corporation, Dept. 5, 2635 So. Michigan Ave., Chicago

DIAMONDS, WATCHES ON CREDIT

YOU SHOULD HAVE THE **JAMES BERGMAN WELBY BOOK** IN YOUR HOME. It is full of many bargains. Diamonds, Watches, Jewelry, Toilet Articles, etc. Select any article desired, have it sent to you, all charges prepaid. If satisfactory, send one-fifth of purchase price and keep it balance in TEN monthly payments. No interest charged. No security required. Write Today for Big Free Catalogue No. 9. It tells about Our Low Prices and binding guarantee.

JAMES BERGMAN
Est. 1891, NEW YORK CITY

411
\$3.00

381
\$4.00



Anyone Can Soon Learn to Operate The MONARCH Junior Lathe

THE MONARCH Junior 9 inch Engine Lathe is so simple and trouble proof that the beginner can soon turn out finished work—it is so accurate and completely equipped that it is preferred by the expert mechanic.

Inventors—Experimenters—Mechanics—Small shop owners—You will find that it pays to own this wonderful little lathe and do your own lathe work exactly as you want it done.

Monarch
Junior
Lathe
9-inch
swing,
2 1/4 ft.
bed.

Semi-
quick
change
gear
and bench
legs. Price

\$225

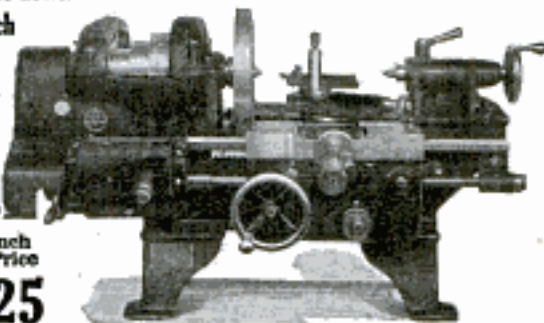

Also made in larger size, with 11-inch swing, at slightly higher price. Full details on request.

Sturdy and compact—economically operated—equipped with automatic safety devices—turns out any small work that any other lathe will do—accurate to 1-1000 of an inch—built of the best materials by

the leading lathe builders of the country. WRITE TODAY for our free catalog telling all about the MONARCH Junior Lathe as well as the complete line of MONARCH Lathes which are built up to 30 inches swing.

THE MONARCH MACHINE TOOL COMPANY

400 Oak Street - - - Sidney, O.

HOW TO MAKE MONEY WITH POULTRY

How to tell poor layers; how to cull; how to double egg yield; how to save feed. Over 1000 secrets and methods in 55 valuable lessons. Recommended by over 40,000 poultry raisers. Free Book "Dollars and Sense in the Poultry Business," outlines everything. Write for it today.



AMERICAN POULTRY SCHOOL
Dept. 185 Kansas City, Mo.

NO JOKE TO BE DEAF

—Every Deaf Person Knows That I make myself hear, after being deaf for 25 years, with these Artificial Ear Drums. I wear them day and night. They are perfectly comfortable. No one sees them. Write me and I will tell you a true story, how I got deaf and how I make you hear.



Address
GEO. P. WAY, Artificial Ear Drum Co. (Inc.)
80 Adelaide St., Detroit, Mich.



Medicated Ear Drum
Pat. Nov. 3, 1906

Harley-Davidson

World's Champion Motorcycle

Prices
Reduced

1/2

Rebuilt and Guaranteed
1915, three speed twin electric \$125; 1916, \$135; 1917, \$150; 1918, \$165; 1919, \$180; 1920, \$200. Shipped on approval. Catalog A free, describing Harley-Davidsons, Excelsiors, Indians, Smith Motors at \$40 and upwards. Liberty Bonds taken at full face value. Letters of recommendation from hundreds of satisfied owners. Refs: Banks and Harley-Davidson Motor Co. Rapid service on 1905 to 1922 Harley-Davidson parts. 100 page PARTS catalog 8.25 cents. Stamp or coin

WISCONSIN CYCLE SALES COMPANY

726 NATIONAL AVENUE
Oldest and Largest
Dealers in the
Northwest.

MILWAUKEE, WIS.
"Milwaukee—
World's Largest
Motorcycle Center"

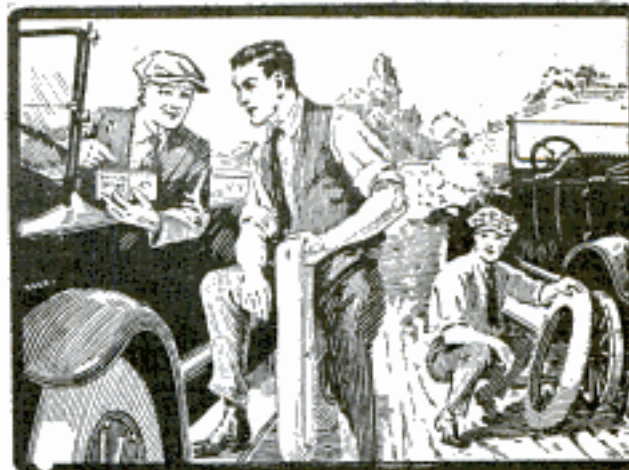

Try My Shaler!

No tool-kit is complete without a Shaler 5-Minute Vulcanizer. It is a necessity and the greatest convenience ever offered to the motorist.

Why take chances with cold patches when you can make a heat-vulcanized repair that will "stick"—even outlast the tube—in five minutes?

The Shaler 5-Minute Vulcanizer is easy to use—you need only a match. Always ready—never bothered by wind or storm. Cannot injure or burn the tube. No gasoline—no danger of fire.

Get a Shaler 5-Minute Vulcanizer from your dealer. It will soon pay for itself by the saving in time, trouble and tire repair bills.

\$1.50 at All Auto Supply Stores

Slightly Higher in Canada and West of the Rockies

The outfit includes the vulcanizer, 12 Patch-&-Heat Units (6 round for punctures and 6 oblong for cuts)—ready to use—with complete instructions. Extra Patch-&-Heat Units 75 cents a dozen.

C. A. SHALER CO.

2008 Fourth St.

Waupun, Wis.

SHALER

5 MINUTE VULCANIZER



Will YOU Get the Next Promotion?

TOBACCO slows up your mental activity—that, in addition to other physical effects. Tobacco makes you dull, unresponsive to the opportunities for advancement that are presenting themselves constantly.

Older business men look for the man whose mind is keen and alert, quick to catch mistakes and find opportunities for advancing his firm's interests.

You will not be the man selected if you keep your mental processes fogged by tobacco.

Quit it now! It is easy! Our tobacco treatment is pleasant to take, definitely effective and the result of years of research in our laboratories. Write us today for our booklet. It's free and confidential. Do it now.

The KEELEY INSTITUTE, Dept. P. M., DWIGHT, ILL.

The Keeley Institute, Dept. P. M., Dwight, Ill.

Please send me, without any obligation on my part, your free booklet which will tell me how to rid myself of the tobacco habit.

Name.....

Town.....

Street..... State.....

Health and Beauty

The marvelous effects of RenuLife Violet Ray treatments are easily within your grasp.

For rheumatism, neuritis, nervousness and many other ailments and for the complexion and hair, use

RenuLife
Violet Ray

Based on scientific truths these wonderful treatments are your opportunity to make yourself well physically and attractive in appearance.

Use the coupon

RenuLife Electric Company,

914 Newberry Bldg., Detroit, Mich.
(In Canada, Pitt St. E., Windsor, Ont.)

Please send your book "Health" and explain how I can have a generator for 10 days free trial.

Name.....
Address.....



10 Days
Free Trial

Send in the coupon for full information on our liberal trial offer. This entails no obligation on your part.



STOP USING A TRUSS

Do Away With Steel And Rubber Bands

FREE TRIAL



Inner surface is made adhesive to secure the PLAPAO-PAD firmly to the body, keeping the PLAPAO continually applied and the pad from slipping. No straps, buckles or springs attached. Soft as velvet—easy to apply.

It's the Non-Slipping, yet Non-Rigid Pad and What is Within It That Counts

FREE to 5,000 Truss Sufferers

To the extent of 5,000 sufferers who may apply I will send, ABSOLUTELY FREE, a sufficient quantity of the Plapao to positively convince them that this is the only logical, common-sense way of treating rupture. Plapao is a highly astringent medication placed within the Plapao-Pad and being absorbed through the skin, creates a wonderful feeling of relief and at the same time tends to strengthen the weakened muscles and thus permanently close the rupture opening. The process of recovery is natural, so you'll have no use for a truss—you can throw it away forever! Old and young have testified under oath that the Plapao-Pads cured their rupture—many of them long-standing, aggravated cases—without delay from work. Patent allowed in U. S. and foreign countries. Awarded Gold Medal at Rome and Grand Prix at Paris.

Send No Money—for a sufficient quantity of the Plapao is sent without charge to enable you to give it a thorough test; you pay nothing for this trial now or ever. Write for it and full information today. Address: Plapao Laboratories, Block 1427 St. Louis, Mo.

How to Get Rid of Moles



A simple, safe home treatment—15 years' success in my practice. Moles (Also BIG Growths) Dry Up.

Ask for Free Booklet of Full Particulars

WM. DAVIS, M. D.

124-5 Grove Ave., Woodbridge, N. J.

BATTERY CHARGING PROFITS 5150 to 5300 MONTHLY

Big profits easily made with an HB Battery Charger. Start your own money-making business charging auto and radio batteries. \$20 cash brings HB outfit, balance easy terms. Money-back guarantee. No experience needed. Instructions furnished free, discs for 5, 10, 15 or 22 batteries. Send postal for information.

HOBERT BROS. CO.

Box M98

Troy, Ohio



Are YOU Old at 40?

A very common cause of early old age is the disturbed condition of an important gland. Even big strong men are not exempt from this serious irregularity. Our plainly written, interesting educational

FREE BOOK

"Why Many Men Are Old at Forty" may bring a priceless message to you. It tells of a simple sensible way by which thousands have corrected this prostate gland condition. It tells how sciatica, backaches, foot pains, interrupted sleep, mental depression, etc., are so often due to this gland. Sold for over five years upon a money back-if-not-satisfied plan. Do not confuse it with massage, medication, violet rays, etc. No obligation. Write today.

The Electro Thermal Company Thermalaids
2113 Main St., Steubenville, Ohio



I Make Strong Men



That is my business. I make no other claims. But what I promise, I fulfill. I will increase your arm one full inch in 30 days and your chest in proportion. In three months I will make you a finished strong man. Are you interested? Read my book "Physical Perfection." It tells you how. All I ask is 10 cents to cover postage and wrapping. Don't put it off. Send today.

Arthur L. Hyson

198 Langdon Bldg. New York City

Don't Wear a Truss

Brooks' Appliance, the modern scientific invention, the wonderful new discovery that relieves rupture, will be sent on trial. No obnoxious springs or pads.



MR. C. E. BROOKS

Brooks' Rupture Appliance

Has automatic Air Cushions. Binds and draws the broken parts together as you would a broken limb. No salves. No lies. Durable, cheap. Sent on trial to prove it. Protected by U. S. patents. Catalog and measure blanks mailed free. Send name and address today.

BROOKS APPLIANCE CO., 126G State St., Marshall, Mich.

The WONDERFUL

ERICKSON PATENT LEG

Will not chafe, overheat, nor draw end of stump.



ERICKSON ARTIFICIAL LIMB CO., 38 Wash. Av. N., Minneapolis, Minn.

BUNIONS

PEDODYNE "Solvent." New way. Pain immediately vanishes. Acts like magic on worst Bunions. Hump gradually disappears.

SENT ON TRIAL

To introduce we will gladly arrange to send you a Box of "Solvent" to try for your own Bunions. Thousands are proving. Simply write and say: "I want to try PEDODYNE."

**KAY LABORATORIES, Dept. A 445
186 No. La Salle St., Chicago, Illinois**

NO MORE BALD HEADS



WHEN our VACUUM CAP is used a few minutes daily. We accept no pay until you have tried the Cap 30 days and are satisfied. The Vacuum Cap is an appliance that draws the blood to the Hair Roots and starts a new healthy crop of hair. It stops Dandruff, stops the hair from falling out.

Bought by Doctors and men who know that it is the only reasonable HAIR GROWER known to science. No Drugs Used. Write for application blank, testimonials, and booklet on "HAIR," sent sealed in plain envelope, FREE.

THE MODERN VACUUM CAP CO.

B 559 BARCLAY, DENVER, COLO.

Get Rid of Pimples

My Method is Guaranteed

No matter how long you have neglected your skin you can still get rid of pimples, blackheads, acne eruptions and other disfiguring blemishes. No matter how stubborn these pustules you can have the clear youthful complexion which you've always admired but never hoped to have.

A new scientific prescription has been discovered for getting rid of these terrible, unsightly blemishes.

Used Like Water

My Pimple Remedy is the prescription of a famous scientist, carefully compounded of soothing lotions. It is as easy to use as water. And the results are truly miraculous.



**No Grease
No Needles
Just Wash!**

That is all you do—just wash. No bother or fuss. Apply this healing lotion

for only a short time and you can almost see the pimples disappear. Decide now that you will get rid of these facial blemishes that embarrass you and keep you down in business and social life. Trade your old complexion for a new one. The clear, smooth skin of youth is yours for practically no effort on your part.



Money Back Guarantee

So confident am I that my Pimple Remedy will do all I claim, and more, that I guarantee satisfaction or money back. You are the sole and only judge. You can't possibly lose, because The Million Dollar State Bank of Philadelphia backs up my guarantee.

Send No Money

If you will give me a full description of your skin

trouble, your letter will have personal and confidential attention. As an introductory offer I will send you, in plain wrapper, my special \$4.00 Pimple Remedy with the understanding that you are to pay the postman only \$1.95 (plus a few cents postage) when the package is delivered. Don't delay. Write me your symptoms today. Banish every pimple and blackhead. Send no money—just the coupon below. You will be amazed and delighted with results. M. Sullivan, Dept. G, 269 So. 9th St., Philadelphia, Pa.

M. Sullivan, Dept. G,
269 So. 9th St., Philadelphia, Pa.

Please send to me at once your Pimple Remedy, regular price \$4.00. It is understood that I am to pay the postman only \$1.95 (plus a few cents postage) when he delivers the remedy to me. Although I am benefiting by your special reduced price offer, you agree to refund my money if I am not entirely satisfied with the results.

Name _____

Address _____

How long have you had pimples? _____ On what part of the body? _____

You may send cash if you prefer

Please Mention Popular Mechanics

Costs
\$300
Saves
Hundreds

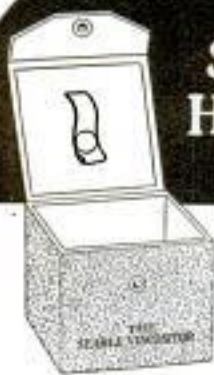

AGENTS
WANTED

Tells You When the Oil is Worn Out!

The Searle Viscositor, a scientific instrument, affords a feeling of confidence that only exact knowledge can give. Every car, truck, tractor, or fuel oil engine owner should have one.

SEARLE VISCOSITOR

Simple to operate. Reliable. Nothing to get out of order. Scientific method used by lubrication experts.

Fill cup with oil to be tested. Lay Viscositor on surface. If Viscositor floats in horizontal position, the oil is still of good body. If oil is worn out and of no further use as a lubricant, Viscositor will float in upright position.

Saves oil; prevents damage to engine; pays for itself quickly. Will last a lifetime.

Viscositor and testing cup in handsome case, with full directions, \$3, postpaid. Money back if not as represented. Order today. Stop guessing about oil!



Is this oil good?

Yes!

No!

Viscositor Co.

Dept. 192
238 Erie St.
Toledo, Ohio

AGENTS WANTED

You Can Easily Earn AMAZING PROFITS

Making CEMENT BLOCKS

YOU can make \$15.00 a day from the very start with one of these unique machines, which makes over 140 different styles and sizes of Cement Blocks. All you need is a very small investment. Pays for itself in less than 10 days.

10 Days FREE Trial

Get our big liberal 10 day FREE trial proposition. We absolutely prove to you that you can make big money. Write at once for our literature giving full details.



THE U. S. STANDARD MANUFACTURING CO.
137 West Railroad St. Columbiana, Ohio



\$2 Puts this
ELGIN WATCH
In Your Hands

No Red Tape, No Waiting

Simply send \$2.00 and receive watch. Full seven Jeweled Elgin in stylish Octagon Case. Thin model, guaranteed 20 years.

30 DAYS FREE TRIAL

Send only \$2.00 and watch comes charges paid. Carry for 30 days and if not satisfactory your deposit is returned. Pay balance \$2 a month for 10 months. Price only \$22.00. Send for FREE ROYAL BARGAIN BULLETIN, addressing Dept. 481.

ROYAL DIAMOND & WATCH CO.
35 Maiden Lane, New York



CORDS

@ 1/2 COST
of FABRICS

First quality new cord tires fully backed by our ironclad guarantee for 10,000 miles.

Tires	Tubes	Tires	Tubes		
30x3	\$7.25	\$1.10	32x3 1/2	\$19.10	\$1.75
30x3 1/2	8.95	1.30	34x4 1/2	20.15	1.50
32x3 1/2	11.50	1.35	35x4	21.95	1.90
31x4	12.75	1.40	36x4 1/2	24.30	2.00
32x4	13.95	1.45	37x5	26.50	2.15
33x4	14.85	1.50	35x5	27.50	2.25
34x4	15.50	1.50	37x5	29.00	2.50

Guaranteed
10000
Miles

Made in our factory of the best materials money can buy. These are rugged, sturdy Cords that run many miles over their guarantee.

SEND NO MONEY. Write and tell us the size of your tires and how many you want. Shipped C. O. D. Section unwrapped for your inspection.

CHARLES TIRE CORP., DEPT. 756
2812 WABASH AVE., CHICAGO, ILL.

TOBACCO

Habit Cured or No Pay

Any form, cigars, cigarettes, pipe, chewing or snuff Guaranteed. Harmless. Complete treatment sent on trial. Costs \$1.00 if it cures. Nothing if it fails. SUPERBA CO. E-41 BALTIMORE, MD.

DEAFNESS IS MISERY



I know because I was Deaf and had Head Noises for over 30 years. My invisible Antiseptic Ear Drums restored my hearing and stopped Head Noises, and will do it for you. They are Tiny Megaphones. Cannot be seen when worn. Effective when Deafness is caused by Catarrh or by Perforated, Partially or Wholly Destroyed Natural Drums. Easy to put in, easy to take out. Are "Unseen comforts." Inexpensive. Write for Booklet and my sworn statement of how I recovered my hearing.

A. O. LEONARD, Suite 226, 70 5th Avenue, New York City

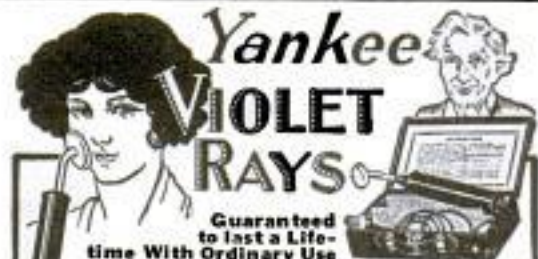

Guaranteed to last a Lifetime With Ordinary Use

Positively will give beneficial treatment for most ailments and increases blood circulation, stops disease destroying action and imparts a delightfully stimulating effect on the whole body.

SEND NO MONEY

Just your name and address, we will send Home Outhit by mail. \$12.00 collect—5 days' free trial. Money back if not satisfactory.

Its Beneficial Effects Have Been Acclaimed by the Foremost Physicians of the World. The prohibitive prices of other Violet Apparatuses ranging from \$35 to \$100 have deprived thousands of the benefits afforded through their use. The Yankee Violet Ray Outhit will last a lifetime and will pay for itself many times in its health giving benefits. Write for booklet—it's FREE.

YANKEE LABORATORIES, INC.
318 East 43rd Street New York, N. Y.

Fits on any furnace or boiler door



Let the CROWN Fuel Saver

pull you out of the rut

Make something of your sales ability. Establish a permanent, profitable business. Become exclusive distributor for the CROWN Fuel Saver, a simple scientific device that saves at least 1/5 the fuel. The principle is endorsed by the Government. Sells readily because the public appreciates and demands economy. Thousands in use.

We train our distributors, without cost, and aid them to sell the CROWN by result-producing advertising in local papers.

This is a legitimate opportunity to establish yourself in a paying business. Write or wire for exclusive distributor proposition. Good territory open. Don't delay.

CFSCO, 15 N. 10th St. Richmond, Indiana

WRITE TODAY for
Our 168-PAGE
FREE BOOK on

Deafness

and learn how Perfect Hearing is now being restored in every condition of deafness or defective hearing. Our "Little Wireless Phones for the Ears" require no medicine, but effectively replace what is lacking or defective in the natural ear drums. They are simple devices, which the wearer easily fits into the ears, where they are invisible. Soft, safe and comfortable.

WILSON EAR DRUM CO., Incorporated
1138 Inter-Southern Bldg. LOUISVILLE, KY.

FORD and CHEVROLET SPEED BODIES

Dealers:
Write for Accessory Catalogue

MAKE DRIVING
A PLEASURE



Equip your old Ford or Chevrolet Chassis with one of our new distinctively modern bodies. Up-to-date Roadster, Touring and Speedster designs. Ford bodies as low as \$29.50 and up. Territory open for live wire dealers and agents. Make real profits.

Buy Direct from Factory
FEDERAL MOTOR SUPPLY CO., Inc.
1424 S. Blue Island Ave. Chicago

CANADIAN DISTRIBUTORS
Federal Auto Body Co., Toronto, Ont.; Campbellton, N. B.

BIG MONEY MAKERS for AGENTS



SHOCK-PROOF LAMP, the new unbreakable mill type lamp, is fast replacing the old style. Stronger and gives many times the downward light. As I name implies, it is **SHOCK PROOF!** stands just and riding trucks so prevalent in GARAGES, FACTORIES, MILLS, SHIP YARDS, STEAMSHIPS, MINES—yes, even in the HOMES. Lasts longer and is sold for less money. Big money-saver.

FREE Send for our AGENTS PLAN and Booklets; fully explains how easy it is to sell SHOCK PROOF lamps.

Every GARAGE, FACTORY, MILL, RAILROAD YARD, STORE and HOME is looking for just this chance to get a better lamp for less money and it's a **BIG MONEY MAKER**. AGENTS everywhere are "coming in". This is YOUR opportunity. Don't let it get by. Grab it.

SEND FOR OUR AGENTS PLAN TODAY given to agents who qualify. Now is the time to get your share of **BIG MONEY** and **EXCLUSIVE TERRITORY**. GET THE AGENTS PLAN TODAY. IT COSTS YOU NOTHING.

MIDWEST LAMP CO., Dept. A, 143 W. Austin Ave., CHICAGO

1923 Models and FINAL PRICE REDUCTION

IMPROVEMENTS that set a new standard of motorcycle quality—and prices stabilized at lowered figures that will introduce thousands of new riders to "the greatest sport in the world."

This is Harley-Davidson's 1923 announcement to Outdoor America. In its new models, the Harley-Davidson stands out pre-eminent as the finest motorcycle ever produced. Yet priced as low as \$305.00 for the famous "World's Champion" Electric Twin!

—and 10 Improvements!

New double-acting brake that grips like a velvet vise, new roller-bearing driving hub for life-time service, new shock-absorbing tail lamp bracket, hinged mud guard, silchrome valves—these are a few of the features which the old rider will appreciate instantly. The new rider will simply sense the completeness, the amazing power and perfect control of this great motorcycle—the most economical form of rapid transit—the luxurious mount that delivers 50 miles of swift, unending travel for one dollar's worth of "gas", oil and tires!

See your dealer today for a demonstration
(or write us for literature).

Harley-Davidson Motor Co.
Milwaukee, Wis.

World's Largest Builders of Motorcycles

Harley-Davidson World's Champion Motorcycle



Please Mention Popular Mechanics



Choice of flowered
Tapestry or beautiful
blue Velour

Such Solid Comfort Only 20c a Day

Also Sofa and Chair to match. Made in our own great upholstering factory. 1200 other attractive furnishings and this comfy Rocker shown in our latest, big, 104 page guide to Better Homes. All on convenient monthly payments. Let this Book help you in furnishing one or several rooms. Thousands of home-lovers have profited. Check below offer interested in.

LOWER PRICES NOW ON

- Furnishings Symphonic Player Pianos
 Symphonic Pianos Symphonola Phonographs

(Check offer and mail ad Today)

Let us quote our money-saving Factory-to-Family prices on these Furnishings and famous Musical Instruments.

1 TO 4 YEARS TIME TO PAY

Mail this ad—check Offer—and give full name and address NOW for Big FREE Book.

Larkin Co Inc.

Desk FPM-522

BUFFALO, N. Y. Peoria & Chicago, Ill.

25c Brings Big 3 ft. Telescope

(in 5 Sections)
See people and objects miles away just like they were close, see Moon and Stars as you never did before. Brass bound, useful and interesting. "Could tell color of aeroplane 4 miles away."—Mrs. Terhough. "Watch my numbers on bus arrive at school."—Mrs. Horn. "I saw mountains on moon!"—A. C. Palmer. Thousands pleased.

SPECIAL OFFER—send only 25c with order. On arrival deposit \$1.25 with postman. If you prefer, send \$1.50 with order in full payment. Sent postpaid. Satisfaction guaranteed or money returned.

FERRY & CO., 6822 East End Ave., Dept. 1772 Chicago

A trained Weather Telescope on batteries 25 miles away, they looked to be 2 to 3 miles instead. —C. A. Shorey, Ft. Robinson, Neb.

DIAMONDS

10 MONTHS TO PAY 1/2 CARAT \$99⁰⁰

CASH VALUE \$165. 30 DAYS TRIAL

Genuine blue-white perfect cut diamonds now sold direct to you by DIAMOND IMPORTERS at wholesale prices on credit at 40% discount. 18Kt. solid, white, gold ring included free. 1/2 carat only \$49.00; 3/4 carat \$147.00; 1 carat \$195.00. If satisfied, pay 1/2 down and balance in 10 monthly payments. We guarantee to please you or refund your money. Order direct from this ad, or write for 128-page bargain catalog of other jewelry \$1,000,000 and 45 years' experience back our guarantees.

B. GUTTER & SONS
172 NASSAU STREET
6th Fl., 371, NEW YORK

You'll Get A Year's Wear or more

when you buy

Nu-Way
STRECH
SUSPENDERS

No rubber to rot. Phosphor Bronze Springs give the stretch. Nickel trimmed, 50c. Satin brass trimmed, 75c. Nu-Way Wide Web Garters, surprisingly easy and comfy, 50c. Ask Your Dealer for Nu-Way Suspenders, Garters and Hose Supporters. If he hasn't them, send direct, giving Dealer's name. Every pair guaranteed.

Nu-Way Stretch Suspender Co.
Dept. A. Adrian,
Mich.



AGENTS: \$6 a Day

taking orders for New Kerosene Burner. Makes any stove a gas stove. Burns kerosene (coal oil). Cheapest fuel known. Fits any stove.



\$40 a Week for Taking Only 2 Orders a Day

No experience necessary. No capital required. Work full or spare time. Easy to get orders on account of high price of coal. Get started at once. Big season now on. Write for demonstrating sample.

THOMAS MFG. CO. B-248 Dayton, Ohio

AGENTS Auto Given

and \$5 to \$10 a Day in Cash

We have territory open for willing workers—men or women—all or part time introducing our nationally advertised Pure Food Products, Toilet and Household Specialties. Over 350 articles. Even beginners make \$5 to \$10 a day. Ford Auto given, in addition to cash commissions. Write today for details.



American Products Co., 7069 American Bldg., Cincinnati, O.

DRIVE 100 TACKS AND SAVE \$25.00

Ford Roadster Top Re-covering \$5.20. Touring \$6.95, and \$9.95. Chevrolet, Dodge or Maxwell \$13.95. All other 5 passenger cars \$16.50 with plate glass lights. Regular Side Curtains \$5.95 up. Special Winter Side Curtains that open with doors \$11.90 up. Ford Seat Covers \$3.15 up. Ford Cushions \$5.75. All goods same as car mfrs. use. Quality the best and guaranteed to fit. Printed instructions given how to apply. Send for samples. Prices above include delivery at your door.

\$520 up
Delivered

AUTO EQUIPMENT CO., 32 Canal Street, Cincinnati, Ohio

Build This Phonograph Yourself

TREMENDOUS SAVING IN COST

Easy, fascinating work with our SIMPLIFIED PLANS. We furnish blue prints, diagrams, motor, cabinet pieces, ready-built horn, etc. You don't need to be a cabinet maker. A few hours assembling and you will have a fine instrument at one-quarter the regular retail price. **AGENTS MAKE MONEY** making and selling these instruments. Write today for full details and our FREE OFFER. Address:

MODERN PHONOGRAPH SUPPLY CO.
213 N. Morgan St. Dept. 700 CHICAGO, ILL.

STOP TOBACCO

If you cannot stop it, do you know why? Do you know its effect on efficiency? This subject discussed in common-sense manner in booklet written by one who conducted anti-cigarette clinic for L. A. Police Dept. for over a year. Treated thousands—all forms. Booklet free as long as they last. Write
Dr. T. H. Trinwith, Black Bldg., Los Angeles, Calif.



SHOP WORK with a

CARNES ARTIFICIAL ARM

FOR nearly ten years a Carnes Artificial Arm has kept Mr. Pahhe Yazze of Lawrence, Kan., on the payroll as a draftsman and machinist at a good salary. Thousands of other mechanics, artisans, office workers, farmers and laborers owe their independence to this improved arm.

Life-Like in Action and Appearance

The Carnes Arm cannot be detected from the natural except by close inspection. Its user can dress himself, use knife, fork, pen, pencil and keys; pick up large or small objects, carry grips—in fact, do virtually everything that was possible before. He can bend the elbow of the Carnes Arm, bend and turn the wrist and open and close the fingers at will, even if the amputation is at the shoulder.

192-Page Book FREE. A book of 192 pages, profusely illustrated with photographs showing what can be done with this remarkable invention, will be sent free to any person interested. Send for it now.

CARNES ARTIFICIAL LIMB CO.,
208 Carnes Bldg., Kansas City, Mo.

5 Master Keys

Only keys of their kind in existence. Open and test thousands of different locks. Tell you instantly if your door or padlocks are burglar proof. Serve in emergencies, too. Thousands of sets in daily use. Novel key chain FREE with each set. Send only \$1 today. Agents wanted. Mention if interested when ordering. **MASTER KEY CO.,** 2 Manhattan Block, MILWAUKEE, WIS.



Bam-Bee-Bo

Real Baseball Played on any table anywhere. Ask your dealer, or write **The Bam-Bee-Bo Sales Co., Dept. 692** Toledo, Ohio

Big ENGINE Sale

Prices Smashed Again!

Famous OTTAWA Engines back to 1914 priced New Improved Models. Better built for long, hard service. Direct-From-Factory Sales Plan saves you \$15 to \$150. Big surplus over rated H-P. Built in largest, most modern engine factory. Prices way down on all sizes.

2	H-P	\$38.50
2½	H-P	45.57
3½	H-P	54.50
4	H-P	75.95
5	H-P	97.50
7	H-P	115.15
10-12-16-22 H-P at Proportionally Low Prices		

OTTAWA 90 Days Trial 1922 MODEL ENGINES
stationary, portable or saw rig; gasoline or kerosene. Easy to start—easy to operate. Guaranteed for 10 years. Cash, or Easy Payments.
Write Today for book "How to Know Better Engines." Send at once while Sale is on.
Ottawa Mfg. Co., 933-F King St. Ottawa, Kans.



Free!



Vi-Rex Guide to Health

IN order that you may have complete and truthful information concerning the wonderful healing powers of VIOLET RAYS we will send you THIS REMARKABLE BOOK ABSOLUTELY FREE. It contains charts and diagrams of the nervous system, and organic locations, and fully describes the BUILDING OF PERFECT HEALTH with VI-REX VIOLET RAYS.

Keep well! It pays!

Don't be handicapped by aches, pains and ailments. KEEP PHYSICALLY FIT! Enjoy sparkling health! Increase your store of energy, revitalize your worn out cells, make every fibre in your body tingle with new vim and vigor.

Send today

10 days free trial proves all we claim

Demonstrate for yourself how Violet Rays will help YOU. Read what hundreds of users say of Vi-Rex, and the astonishing results obtained. Learn why it is the most economical and practical machine.

Vi-Rex Electric Co.

326 W. Madison St.
Dept. 29,
Chicago, Ill.

VI-REX ELECTRIC CO., 326 W. Madison St., Dept. 29, Chicago, Ill.
Please send me without any cost or obligation your free book describing your VI-REX Violet Ray outfit, and details of your free trial offer.

Name.....
Address.....
City.....
State.....



Putting the "howler" to sleep

THERE'S more than one "howler" to put to sleep these days. Your radio set can put on the greatest squalling and howling demonstration you ever dreamed of. The surest way to stop this howling and keep it peaceful is to add an Acme Audio Frequency Amplifying Transformer.

Most any amplifying transformer can magnify the incoming sounds but it also amplifies the howling and distortion of stray fields in the circuit. Acme Transformers with their specially constructed iron cores and coils eliminate this disagreeable feature—and it only takes five dollars to buy one.

Acme assures your receiving a large volume of sound that possesses the natural tones so lacking in the ordinary receiving set. Then, too, you will want the Acme Radio Frequency Transformer which costs the same as the Acme Audio Frequency Transformer. It can be used on both crystal detector and vacuum tube sets. It greatly increases the range of either.

You can buy either transformer at your nearest radio store or write the Acme Apparatus Company (pioneer transformer and radio engineers and manufacturers), Cambridge, Massachusetts, U. S. A. (New York Sales Office, 1270 Broadway). Ask also for interesting and instructive booklet on the use and operation of Amplifying transformers.

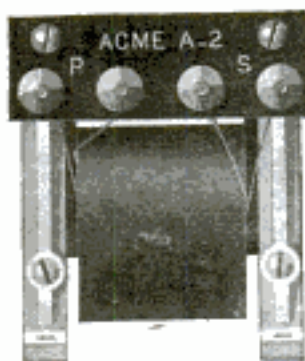

Type A-2 Acme Amplifying Transformer
Price \$5 (East of Rocky Mts.)

ACME

for amplification



A Lightning hold up

NIGHT and a storm—the sky's aflame. Your radio set is in grave danger without a Radisco Lightning Arrester. The high induced charges always present in your antenna wires during an electrical storm can ruin the delicate instrument. A Radisco Arrester holds up Lightning and sidetracks the induced charges to earth. Small, inexpensive, weatherproof. Two types, \$2.50 and \$3.00 at your dealers or RADIO DISTRIBUTING CO., NEWARK, N. J.

Write for catalog of radio supplies

RADISCO LIGHTNING ARRESTER

\$20 CASH STARTS Your Battery Charging Business
with an HB Battery Charger. Balance on easy monthly terms paid by your profits. Charge auto and radio batteries. Big demand, big profits. Charge auto and radio batteries. Big demand, big profits. No experience needed. HB outfit for \$8, 10, 16 or 32 batteries. Choose your size, then mail this ad with your name for information. Money-back guarantee.
HOBART BROS. CO., Box M 97, TROY, OHIO





RADIO
HEAD SETS, JACKS, PLUGS,
MICROPHONES
Manufacturers
American Electric
COMPANY
State and 64th Sts., Chicago, Ill.



S-C Loud Speaker Horn
Delivered at any door in U.S. for \$7.50
Largest Value on the Market
22½" High; 8¾" Bell
Made of soft brass of remarkable tonal quality, on correct, tested acoustic principles. Takes any radio receiver in universal receptacle. Handsome gold bronze finish, lacquered. Counterweight prevents tipping.
In the same high quality with low prices: Variometers, Variocouplers, Variable Condensers, Amplifying Transformers and other Radio parts. Pink-a-Tone Sets, \$25. Ask for Bulletin R.
S-C Products Company
1264 Nicholas Bldg. Toledo, Ohio

3000 OHM SETS, \$4.50

2000 OHM SETS, \$4.00 1000 OHM SETS, \$3.50

Plus 20c for Postage and Insurance
Satisfaction Guaranteed or Money Back.



We mail phones the day your order arrives. Every pair tested, matched, and guaranteed as sensitive as \$8 to \$10 phones. We have no agents or dealers. By ordering direct you save dealer's profits—circular free.

TOWER MFG. CO., Brookline, Mass.
35 Station St.

DUCK'S NEW No. 16, 256-Page Radio Catalog

All Other Catalogs in One

Our new catalog is truly the wonder catalog. You can spend more than a dollar for other catalogs and yet you will not have the equal of this catalog. There are over 50 pages of diagrams and data on wireless. As a radio book alone it is priceless. The complete catalog of the Radio Corporation of America, with circuits and information for making powerful wireless telephone transmitters, the Remler, Murdoch, Firth, and in fact all other catalogs are incorporated in this catalog, not to mention over 70 pages of our own goods.

Send 25c in coin carefully wrapped for this catalog today. Not sent otherwise.

The William B. Duck Company, 223-227 Superior St., Toledo, Ohio

LATEST IN RADIO

Sweeney's Line of Radio Supplies

Personal service, information and instruction for all radio users together with immediate supply of the most complete and very latest equipment. Keep in touch with newest scientific development by getting our catalog. Among new items: See the Variometer for \$5.50 and Variocoupler \$5.00; designed by electrical engineers and finished by instrument maker. Sweeney Battery, 80 Ampere hour, made of hard rubber, (can't leak) \$22.00. Variable condensers \$3.75. Phone condensers 35 cents; Grid condensers and leaks 50 cents.

SWEENEY RECEIVING SET—5 tube receiver (two stages of radio frequency amplification) detector and two stages of audio frequency amplification. Wave length 175 to 1000 meters. This is a wonderful set; price \$150. SEND 15c for illustrated instruction book, hook-up diagrams and complete catalog. Lowest prices and latest radio developments.

Write Dept. B

Sweeney
RADIO & ELECTRICAL CO.
UNION STATION PLAZA, KANSAS CITY, MO.

Please Mention Popular Mechanics

Machine-Shop Men can now Cash In On Radio

Practical hints in free book tell just how to profit big from nation-wide craze. Big new money-making field opened to machinists everywhere.



Huge Demand for Radio Panels

Every real radio-fan insists today upon one certain material for panelling his outfit; and cutting that material to dimensions is as profitable and practical a job as any machine-shop can ever make money doing. The makers of that material, wanting reputable machine-shops to cash in on this proper preference of radio enthusiasts, have prepared a handy little book which gives the machinist all the particulars he wants to open up for him this immensely profitable new field. A copy is yours for the asking.

Wonderful Money-Maker for Machinists

This supremely demanded material comes in sheets 38x38 inches, is miles ahead of every other known substance for panelling and insulating radio installations, and can be readily machined by any decently-equipped machine-shop. The difficulty the machinist will have will be in taking care promptly of the orders that will be forced upon him; and that, though it sounds almost too good to be true, is absolutely a FACT. The free book tells all about it, giving every fact the machine-shop man wants to know; and there is not one cent to pay for a copy of it, if you are legitimately a machinist with a plant fit for ordinary work. Send for your copy today, ride the wave of radio development to your own profit, and understand that you commit yourself to nothing whatever by asking for a copy. Ask The Continental Fibre Company, Newark, Delaware.



FROST-RADIO PROTECTOR

Listed by Underwriters' Laboratories under April, 1922, regulations. No interference with clear Radio receiving.

Never Grounds Mounts Indoors

Price \$1.50

Good deliveries on this approved device.



FROST-RADIO

Extension Cord and Plug

Comes in lengths from 10 to 100 ft. Loud speaker can be placed anywhere and connected with Radio set with FROST-RADIO Extension Cord.



OTHER FROST-RADIO LEADERS

Frost-Fones Frost-Radio Improved Plugs and Jacks
Frost-Radio Receiving Transformers Cunningham Vacuum Tubes
Remler Radio Apparatus

Inquire of your Local Dealer.



HERBERT H. FROST

NATIONAL FACTORY DISTRIBUTORS
TO THE ELECTRICAL-RADIO JOBBER
154 W. LAKE ST. CHICAGO, ILL.



BUILD YOUR RADIO

Save Money

Build Your Own At Home

Complete Standard Parts for Long Distance Radio Outfits. We do all machine work; you do the hand work; we tell you how. Immediate delivery. Also complete Radio Sets—all sizes at bargain prices. Write now for our big bargain catalog.

Colonial Radio Equipment Co., 4759 Calumet Avenue, Dept. 10 Chicago, Ill.

Radio Course \$1.97

Learn Radio in your own home! No long tedious hours of study. Our complete course—5 volumes—now for only \$1.97 teaches you to build your own radio set. Think what it means to listen to artists of world renown, concerts, lectures, news! Sit in your own home and bring the world to you through marvelous radio. Our complete Course praised by radio experts is simple, short, interesting! With it any boy can build his own radio set and secure a solid foundation of knowledge of radio—the most fascinating profession of our age.

Send No Money

The complete course of five volumes may now be yours for only \$1.97. See them for yourself before you decide. Just send your name and address and pay the postman \$1.97 and postage! If you are not more than satisfied, return the Course and we will refund your money immediately. Write today! Now!

RADIO COURSES, INC.

552 Seventh Avenue, Department 119, New York City

RADIO

Equipment



Big FREE Catalogue

THIS FREE catalogue tells you the kind of a Wireless Telephone to own, so that you receive in your own home all the latest news, music, church services, lectures—everything broadcasted throughout the United States.

Every home will soon have a wireless telephone outfit. We now offer complete outfits from \$15 up. Everyone interested in radio should see our low prices on parts and accessories. Write for this book. Learn about the miracle invention of the age. Easy to install, as simple to operate as a regular telephone.

One copy of this booklet is yours, FREE. Write for your copy.

Address Dept. R-5

Montgomery Ward & Co.

Kansas City Chicago St. Paul

"HOW I BEAT THE GAME"

The Inspiring Story of how one poorly paid garage mechanic won success, his own business and a big income. Tells how you can increase your salary from 100 to 500%. Send for it today FREE.

Ambu Engineering Institute

Dept. 110A 2632 Prairie Ave., Chicago, Ill.

RADIO For Everybody

Get into the new world—profession of unlimited opportunity. You can earn big money as a Certified Radio-trician. Learn by mail, in spare time how to design, construct, install, repair, maintain, operate, sell and demonstrate complete radio outfits. Write for our free book, "How to Learn Radio at Home."

National Radio Institute

Dept. 1203H,
1345 Pennsylvania Ave., N. W. Washington, D. C.



MOTORCYCLES

ONE YEAR TO PAY

Know the joy of owning—for business or pleasure—**HARLEY-DAVIDSON, EXCELSIOR, HENDERSON, INDIAN, CLEVELAND**, or any other standard make; thoroughly rebuilt in our own factory.

Write for Free Catalogue and Easy Payment Plan

HAVERFORD CYCLE COMPANY

America's Largest Cycle House
Established 26 Years

503 Market St., Philadelphia, Pa. Dep. P. M.

RADIO WIRE SHIPPED PROMPTLY--OVER 50 TONS IN STOCK

Size	Enamel			Single Cotton			Single Silk		
	1 lb.	1/4 lb.	1/8 lb.	1 lb.	1/4 lb.	1/8 lb.	1 lb.	1/4 lb.	1/8 lb.
22	.48	.28	.16	.95	.52	.30	.95	.51	.28
24	.55	.31	.18	1.05	.57	.32	1.07	.57	.31
26	.60	.34	.19	1.21	.65	.36	1.19	.63	.34
28	.64	.36	.20	1.36	.73	.40	1.44	.76	.40
30	.68	.38	.20	1.70	.89	.48	1.89	.88	.51

Send 5 cents to cover postage on our New Perpetual Catalog. No stamps accepted

I. R. NELSON CO., Bond St., Newark, N. J. Broadcasting Station W-A-A-M

POSTAGE EXTRA
Bank Wound Variocouplers—150 to 3000 Meter Range
\$6.00

YOU CAN MAKE \$18 DAILY PROFIT

With Our Great Introductory Offer
Giving These \$1.25 **FREE**



With each sale of our wonderful 11 piece Toilet Article Assortment for only \$1.75. TOTAL STORE VALUE \$4.60

\$18.00 a Day PROFIT on only TWENTY Sales



Lucky 11 Toilet Set—Retail Value \$3.35!

MY! HOW THEY SELL!

You get the attention with the free Shears. Walter Harris sold 800 boxes in six weeks. Profit over \$100 a week. You can do this too.

Act Now! Sell like hot cakes year round. A baby could sell Lucky 11. Don't wait a minute. Save time. Send \$1.75 for complete outfit including display case. At least write for circulars explaining our unique plans, including 30 other packages. **ACT NOW!**

E. M. DAVIS CO., Dept. 3356, CHICAGO, ILL.



\$1500 to \$3000 EASILY MADE Charging Batteries

Add that much and more to your yearly income with an HB Battery Charger. Only \$20 puts an HB outfit in your shop, balance easy terms more than covered by your monthly profits. No repairs, no renewals, no experience needed to operate. Tear out this ad and mail for information.

HOBART BROS. CO.

Box M 96, TROY, OHIO

Be A Floor Surfacing Contractor

New unworked field. Contractors prefer to sublet floor surfacing to Americans. Universal Contractors. Machine does work of 6 men. Works quickly, easily. We set you up in business of your own. furnish office loans, advertising, etc.

Make \$5,000 to \$15,000 or More—Yearly

Prepare for big building booms. Make new floors perfect, old floors like new. Every floor a prospect. Big money in old floors. No town too small. Beginners often pay for installation first month with profit besides. Get full information.

THE AMERICAN FLOOR SURFACING MACHINE CO.
523 So. St. Clair St. Toledo, O., U. S. A.

THE RONSON REPEATER



SHOOTs 5000 TIMES WITHOUT RELOADING
NO CAPS NO POWDER NO CARTRIDGES NO DANGER

The RONSON REPEATER brings you all the sport of a real automatic, with absolutely no danger. You not only hear it shoot, but you SEE it shoot, and see the smoke. It flashes—big, red flashes—every time you pull the trigger. These flashes make the Ronson Repeater look just like a real gun in action. But this gun is ABSOLUTELY HARMLESS. Shoot it anywhere and at anything in perfect safety.

We know every boy will want to know what makes the flash. But that is a secret, and we can't tell. Just keep pulling the trigger. You don't have to cock this gun—it's a real repeater. Reloaded in a jiffy with Ronson Redskin Reloads, each of which shoots 5,000 times.

The shape, grip and genuine gunmetal finish are just like a real automatic. The Ronson Repeater is made of pressed steel—it's strong and long lasting. Don't wait for your Ronson Repeater—get it now, and then you'll have it every. And don't forget to order several extra Reloads. You'll want 'em. PRICE of Ronson Repeater, loaded for 3,000 shots, ONLY 35 cents postpaid to any address in the world. Extra Reloads, 5 cents each postpaid.

JOHNSONSMITH & CO., Dept. 891, 3224 N. Halsted St., Chicago



Building Trades Need Men

The building trades are booming. Conservative estimates by Government experts indicate that more than four billion dollars (\$4,000,000,000) will be spent for construction in 1922. 1923 should be even bigger!

Don't you see what this means? It means good jobs at good salaries for thousands upon thousands of trained men.

There's a chance for you to get one of these good jobs at a salary of \$40 to \$100 a week if you really want it. Right at home, in the spare time that now goes to waste, the International Correspondence Schools will train you for success in Architecture, Drafting, Surveying, Civil Engineering, Structural Engineering, Concrete Building, Mechanical Engineering, or whatever it is that you have your heart set on doing.

Just fill out and mail the coupon printed below, and without cost or obligation on your part, let us tell you how the I. C. S. can help you get out of the rut and go upward to a better job and a bigger salary.

INTERNATIONAL CORRESPONDENCE SCHOOLS BOX 5669-C SCRANTON, PA.

Without cost or obligation, please explain how I can qualify in the subject before which I have marked an X:

- | | |
|---|---|
| <input type="checkbox"/> Architect | <input type="checkbox"/> Foreman Plumber |
| <input type="checkbox"/> Architectural Draftsman | <input type="checkbox"/> Sheet Metal Worker |
| <input type="checkbox"/> Contractor and Builder | <input type="checkbox"/> Civil Engineer |
| <input type="checkbox"/> Building Foreman | <input type="checkbox"/> Surveying and Mapping |
| <input type="checkbox"/> Concrete Builder | <input type="checkbox"/> Electrical Engineer |
| <input type="checkbox"/> Structural Engineer | <input type="checkbox"/> Electric Lighting and Rys. |
| <input type="checkbox"/> Structural Draftsman | <input type="checkbox"/> Electric Wiring |
| <input type="checkbox"/> Ship Draftsman | <input type="checkbox"/> Mechanical Engineer |
| <input type="checkbox"/> Plumber and Steam Fitter | <input type="checkbox"/> Mechanical Draftsman |
| <input type="checkbox"/> Heating and Ventilation | <input type="checkbox"/> Toolmaker |
| <input type="checkbox"/> Plumbing Inspector | <input type="checkbox"/> Machine Shop Practice |

Name.....

Street.....

Address.....

City..... State.....

Occupation.....

Persons residing in Canada should send this coupon to the International Correspondence Schools Canadian, Limited, Montreal, Canada.

Please Mention Popular Mechanics

WANTED!

\$1,000 REWARD

CONVICT 6138, escaped from the State Penitentiary; Name, Charles Condray; Age, 37; Height, 5 ft. 8 in.; Weight, 141 pounds; Hair, light brown; Eyes, gray.

Easy enough to identify him from his photograph and this description, you may say—but, Condray took the name of "Brown", dyed his hair, darkened his skin, grew a mustache, put on weight and walked with a stoop.

Yet he was captured and identified so positively that he knew the game was up and returned to the penitentiary without extradition. A Finger Print Expert made this identification and secured the reward.

MORE TRAINED EXPERTS NEEDED NOW!

There is a big chance for you in this uncrowded, fascinating profession. State, City, and Private Bureaus being established and expanded constantly. Trained men in great demand. Many earn \$3000 to \$10,000 yearly.

LEARN AT HOME IN SPARE TIME

Common school education, common sense and ambition, the only requirements. Many of the country's greatest experts learned their profession in this great school. A few hours' spare time a week soon fits you for a fine position as a Finger Print Expert.

**UNIVERSITY OF
APPLIED SCIENCE**
1920 Sunnyside Avenue,
Dept. 9356, Chicago, Ill.

Gentlemen:—Without any obligation whatever, send me your new, fully illustrated **FREE** Book on Finger Prints and your offer of a **FREE** course in Secret Service Intelligence and the Free Professional Finger Print Outline.

Name.....

Address.....

Present.....

Occupation..... Age.....

FREE! for a limited time. A professional Finger Print Outline—a course in Secret Service Intelligence. Also a complete book on Finger Prints sent at once if you will mail this coupon. Write today.

**UNIVERSITY OF
APPLIED SCIENCE**
1920 Sunnyside Ave.
Dept. 9356
CHICAGO, ILL.



Every Welder Should Have The Welding Encyclopedia

It is America's most complete and authoritative reference and instruction book on welding. It gives you a vast fund of expert knowledge on all forms of welding, conveniently arranged, fully illustrated by drawings and photographs and written in language you can understand. It has the approval of the leading manufacturers in the trade. You need this book in your shop.

326 Pages—375 Illustrations—Clothbound

Edited and Compiled by the Editors of the Welding Engineer with the help of many experts in the welding trade

CONTENTS

Illustrated encyclopedia covering all words, terms and trade names used in welding—Oxy-acetylene Welding—Aluminum, Steel, Cast Iron, Copper, Brass, Bronze, Full instructions for welding each of these metals—Electric Arc Welding—Electric Resistance Welding, includes Butt, Line, Percussion and Spot Welding—Thermit Welding—Use and Misuse of Oxy-acetylene Equipment—Boiler Welding—Heat Treatment of Steels—Rules and Regulations—Charts and Tables, including temperature color chart—Condensed Catalogs and Buyers' Index.

The Accumulated Experience of the
Welding Brains of America
Yours for \$5.00

Absolute Refund Guarantee:—If, after having ordered and examined this book, you are not satisfied with same, return it to us and your money will be refunded.

Popular Mechanics Book Dept.
6 N. Michigan Ave. Chicago

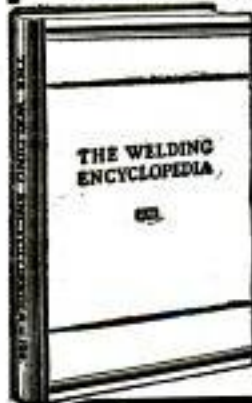

SELECT LIST OF HELPFUL

AUTOMOBILE BOOKS

Dyke's Automobile Encyclopedia Latest edition. Most widely used auto reference book on the market today. Covers every detail of construction, operation and repair. 940 Pages. 3362 Illustrations. Cloth, \$6.46. American Morocco, \$7.96

Automotive Wiring Manual 900 detailed blue prints showing the complete wiring system of all standard autos manufactured since 1912 up to and including this year models. **Price, \$15.00**

Starting, Lighting and Ignition Systems All the systems described and illustrated. Over 200 wiring diagrams. Trouble locating. Making repairs, etc. 800 Pages. 492 Illustrations. **Price, \$3.00**

The Modern Gasoline Automobile A complete, practical and up-to-date treatise. New enlarged edition. An incomparable reference book for home or school. 1032 Pages. 1000 Illustrations. **Price, \$4.00**

Automobile Repairing Made Easy Complete directions for making repairs to all parts of the motor car mechanism. Founded on thoroughly practical experience. 1056 Pages. 1000 Engravings. **Price, \$4.00**

The Model T Ford Car Its construction, operation and repair, including the Fordson Farm Tractor, F. A. Lighting and Starting System, Ford Motor Truck. 410 Pages. 153 Illustrations. **Price, \$2.00**

Ford Engine Chart Deals with location and correction of engine faults and troubles. **Price, 35 cents**

Storage Batteries Simplified Tells how to charge, care for and rebuild storage batteries and outlines industrial uses. 208 Pages. **Price, \$2.00**

The Modern Motor Truck Design, construction, operation and repair. A reference of great value. 800 Pages. 750 Illustrations. **Price, \$5.00**

Above Prices Postpaid

POPULAR MECHANICS BOOK DEPT.

6 N. MICHIGAN AVE., CHICAGO

\$375.75 IN ONE DAY WITH THIS GREAT MACHINE

Cash Business
Easy, Fascinating

Good times coming back. Conditions growing better. Make and sell Crispettes with this machine. Profits enormous. Demand phenomenal. Chances for quick success bright. It's the business for you.

Many are Successful

Many men making thousands. Ira Shook says: "Started with nothing, now have \$12,000. Took in \$375.75 in one day!" Kellogg writes: "Am \$700 ahead in two weeks!" Gibbs reports: \$50.00 profit the first night. Erwin's boy averages \$35.00 every Saturday afternoon. Master's letter states: "Sold \$40.00 in four hours." Turner did so well that he was

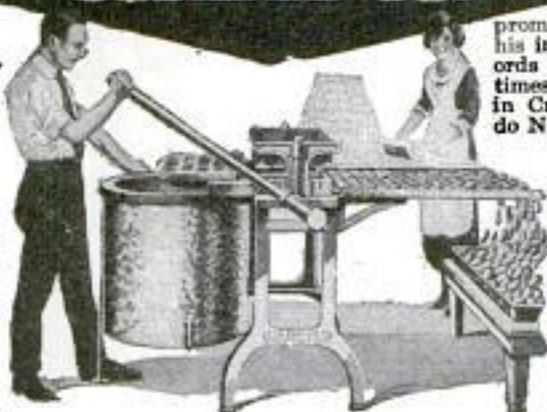

promptly offered \$700 profit above his investment to sell. All these records made during recent unsettled times. There is money—lots of money—in Crispettes. Think what you can do NOW! Splendid opportunities galore—start retail store or stand. Watch dimes pour in. Big possibilities wholesaling to druggists, candy stands, etc. Start right in your town. Good location not even necessary.

Success Anywhere!

Set machine up in own home. Wholesale from your kitchen. Nothing to stop you. Little capital starts you. Experience not necessary. I furnish everything. Raw materials plentiful and cheap. Nothing like Crispettes. A delicious confection made from secret formula. People never get enough. Always come back.

One-thousand Dollars Monthly Possible

Be first in your town to start. Send coupon—get my help. Learn the facts of this great business. Learn how others have succeeded. Read their letters. See pictures of their stores and stands. Find out all about my liberal proposition. Coupon brings complete details. Puts big 32-page fully illustrated book in your hands. Tells all you want to know. Shows how you can find your place. How you can get on road to quick success. It's FREE! Mail coupon NOW!

LONG EAKINS COMPANY

928 High Street

Springfield, Ohio

LONG EAKINS CO.
928 High Street,
Springfield, Ohio

Please send me full particulars of the Crispette business.

Name.....

Address.....

BIG PROFITS FROM POULTRY

We Teach You How; Easily Learned at Home; our guaranteed methods make success certain; write for free booklet: "How to Raise Poultry for Profit"

The National Poultry Institute, Inc., Dept. 31, Washington, D. C.

RADIO For Everybody

Make big money in Radio. Go into business for yourself, as a Certified Radio-trician. You can earn \$100 a week as an installation expert. Others are doing it—you can too! Amazing new course; prepares you quickly in spare time at home. Write for free book "How to Learn Radio at Home."

National Radio Institute

Dept. 1203C,

1345 Pennsylvania Ave., N. W.

Washington, D. C.

Broadcasting
over WWJ
Detroit
News,
October
14, 1922
8:30 to
10:00
P. M.



Listen
to
"Heirich
Gibson
Melody
Maid
Concert"

WWJ Detroit News Concerts are heard at great distances. Tune in on above date and hear the wonderful music possible on Gibson Instruments. You too will want to own a Gibson.

New friends, new pleasures, new and interesting experiences, invitations galore—dinners, dances, week-end parties, outings,—are some of the good things playing a Gibson brings into your life.

Gibson
Instruments

are easily learned in spare time without previous knowledge of music. A few weeks of pleasant, interesting study and you'll be able to play. And there's no other joy in life quite equal to hearing music you make on your own instruments.

\$5.00 Monthly buys a Gibson. The ultimate in construction, finish, tone quality and volume. Built like a violin. Adjustable bridge, non-warpable truss rod neck, 30 other exclusive Gibson features. **Guaranteed for life.** Non-Gibson instruments exchanged.

Make \$25 to \$200 weekly selling, playing, teaching. Own a high class, exclusive business. We furnish stock, advertise, help sell, carry accounts. Gibsons easily sold on conditional credit plan.

Send for FREE catalog, FREE music and information about Mandolin, Mandola, Mandocello, Mandobass, Guitar, Harp-guitar, Mandolin-bone, Tenor-banjo, Cello-banjo, Guitar-banjo. If interested in Agency, check here.....Teacher!..... Clip, check and mail this ad today.

Gibson Mandolin-Guitar Co.

1369 Parsons St.
Kalamazoo, Mich.

Foreign Dept.
25 Broad St., N. Y. City

AUTO OWNERS Make Big Money



Earn big money in your spare time introducing our splendid tires in your community. By our plan you can start a permanent, profitable tire business of your own. **Harrison Hand Made Tires** are positively guaranteed 10,000 miles, made by skilled workmen from finest materials. Easily sold at our low prices. Shipped on approval prepaid. No capital or experience necessary. Sample section **FREE.**

WRITE FOR SPECIAL OFFER

Our agency plan and confidential low prices to user agents sent you without obligation. **Write today.**

Harrison Tire & Rubber Co.
230 Indiana St. - Hammond, Ind.

Please Mention Popular Mechanics

Where Could Money Buy More?

NO matter where you buy your furnace, stove or range, someone must send your order to the factory. Why don't YOU do it yourself and save 25 to 40%? Just send for the new Kalamazoo Catalog and find out what a wonderful quality offer you can get at a low price in the new Kalamazoo pipeless furnace.

Many other attractive bargains in our catalog—a surprise on every page. Cash or easy payments. 30 day trial offer and money back guarantee.

Ask for Catalog No. 936

Kalamazoo Stove Co.

Kalamazoo, Mich.

"A Kalamazoo Trade Mark Registered Direct to You"



LATEST and BEST RADIO BOOKS

Construction of Radiophone and Telegraph Receivers for Beginners. By M. B. Sleeper. Fully Illus. - Price \$.75

How to Make Commercial Type Radio Apparatus. By M. B. Sleeper. Fully Illustrated - - - - Price \$.75

Construction of New Type Trans-Atlantic Receiving Set. By M. B. Sleeper. Fully Illustrated - Price \$.75

Radio Hook-Ups. By M. B. Sleeper. Price \$.75

Radio Design Data. By M. B. Sleeper. Price \$.75

A B C of Vacuum Tubes Used in Radio Reception. By E. H. Lewis. Fully Illustrated - - - - Price \$1.00

Wireless Telegraphy and Telephony Simply Explained. By A. P. Morgan. 154 Pages (5x7½), 156 Illustrations - - - - - Price \$1.50

Experimental Wireless Stations. By P. E. Edelman. 392 Pages; 167 Illustrations Price \$3.00

Above prices postpaid

POPULAR MECHANICS BOOK DEPT.
6 N. Michigan Ave. CHICAGO

Please Mention Popular Mechanics

THE INDEX TO VOL. 37, JAN.-JUNE, 1922 OF POPULAR MECHANICS MAGAZINE

Is now ready and will be sent to any address upon receipt of 10 cents in stamps

POPULAR MECHANICS, 6 N. MICHIGAN AVE., CHICAGO

MODEL MAKING

New 400-page book covering workshop practice, design and construction of models. The work described is real model engineering and not the construction of mere toys. 303 Illustrations. Cloth. Price, \$3.00 Postpaid.

POPULAR MECHANICS BOOK DEPT., 6 N. Michigan Ave., CHICAGO

RADIO FOR THE AMATEUR

Building, Installing and Operating Stations for Radio Communication are presented in convenient form in **Practical Amateur Wireless Stations**

An experience book containing the best suggestions of thirty-three experimenters compiled by the editor of Wireless Age.

It blazes a clear-cut trail to the practical achievement of an amateur wireless station.



Where a method is described, it is one which the author of the chapter has worked out and tried himself; and the same is true whether dealing with a single piece of apparatus or a complete station.

136 Pages—115 Illustrations
Size 6x5. Price 75c postpaid

Popular Mechanics Book Dept.
6 N. Michigan Ave. Chicago

Put this Parks band saw in your shop!

Constructed for real work. A fine, high-grade foot-power machine for the experienced mechanic. Sets firm and solid on any foundation. Runs fast and smoothly with little effort. 18-in. swing, cuts to center of 36-in. circle. Roomy table. Ball-Bearing disk saw-guide. Takes material up to 7-in. thick. Band saw wheel covered with endless rubber bands to prevent slipping. Takes saws 12 ft. long. This machine can be furnished with pulley drive at same price. Guaranteed 10 years. 30-days' trial. Price....\$40.00



Send for complete Parks catalog

THE PARKS BALL BEARING MACHINE CO.
1500-1540 Knowlton Street CINCINNATI, OHIO
Canadian Factory, 200 Notre Dame East, Montreal

PARKS

WOODWORKING MACHINES

FREE AIR SERVICE IN YOUR GARAGE \$28

Only \$28 puts an HB Automatic Air Compressor in your shop. Your profits on new trade gained from better service easily pay small monthly payments on balance. Money-back guarantee. Sturdy, dependable, keeps constant pressure 24 hours a day. Pleases old customers, brings new business. Send postal for information. **HOBART BROS. CO., Box M 92, TROY, OHIO**



THE BOOK YOU HAVE BEEN WAITING FOR

Gilbert Radio Telephone and
Broadcasting - 35c postpaid

The A. C. Gilbert Company, 312 Blatchley Ave., New Haven, Conn.



PATENTS

Send us sketch or model for patentability opinion and exact cost of patent. Our book "How to Obtain a Patent," Sent Free on request. It tells how to apply for Patents, Trade Marks, Foreign Patents, Copyrights, etc.; gives information on Patent Procedure; tells what every inventor should know. Thousands of inventors, who are our clients, are our references. **Chandlee & Chandlee, 25 Years Experience, 422 7th St. Washington, D. C.**

A REAL BOAT FOR REAL FISHERMEN



The MOTO-ROW \$250

MAKE your vacation a real outing by owning a Moto-Row. Here is the greatest boat value ever offered—a combination power and row boat of ideal design and construction for fishing, hunting and pleasure purposes at less cost than an outboard makeshift. Built of selected airplane spruce, copper riveted, and equipped with a dependable 2-H.P. motor protected from weather and theft beneath the stern deck, the Moto-Row offers you something distinctly new and practical. Dimensions 16 by 4 ft., speed 7 M.P.H., capacity six persons. Supplied with reinforced skeg which permits beaching without injury to propeller. Sals wasser equipment \$23 extra. Built by Sidney McLeuth, Marine City, Michigan. Write for illustrated catalog.

BELLE ISLE BOAT & ENGINE COMPANY

DEPT. 1

Builders of Belle Isle Boats

DETROIT, MICHIGAN



"You get the job"

"You have made yourself more valuable to this firm than any young man who ever came with us. You've shown an aptitude for our business that is little short of marvelous."

"We have a way, you know, of keeping a line on all our workers. And when we learned that you were studying with the I. C. S.—when your work showed that you were making a practical application of your studies—it wasn't a question of 'Shall we promote John Rogers?' but 'How soon can we find a place for him to use his growing ability?' So, beginning tomorrow, you are to take over Nicholson's work as manager of the department."

Do you wonder that John Rogers hurried home that night to tell the good news to his wife? Do you wonder that he is glad that he decided to make some profitable use of his spare time? He might still be a poorly paid clerk if he hadn't studied with the International Correspondence Schools.

Why don't you study some one thing and get ready for a real job, at a salary that will give your wife and children the things you would like them to have?

You can do it! Pick the position you want in the work you like best and the I. C. S. will prepare you for it right in your own home, in your spare time.

Just mark and mail the coupon and full particulars will come to you by return mail.

INTERNATIONAL CORRESPONDENCE SCHOOLS

Box 5665-C, Scranton, Penna.

Without cost or obligation, please send me full information about the subject before which I have marked an X in the list below:

BUSINESS TRAINING DEPARTMENT

- | | |
|---|---|
| <input type="checkbox"/> Business Management | <input type="checkbox"/> Salesmanship |
| <input type="checkbox"/> Industrial Management | <input type="checkbox"/> Advertising |
| <input type="checkbox"/> Personnel Organization | <input type="checkbox"/> Better Letters |
| <input type="checkbox"/> Traffic Management | <input type="checkbox"/> Foreign Trade |
| <input type="checkbox"/> Business Law | <input type="checkbox"/> Stenography and Typing |
| <input type="checkbox"/> Banking and Banking Law | <input type="checkbox"/> Business English |
| <input type="checkbox"/> Accountancy (including C.P.A.) | <input type="checkbox"/> Civil Service |
| <input type="checkbox"/> Nicholson Cost Accounting | <input type="checkbox"/> Railway Mail Clerk |
| <input type="checkbox"/> Bookkeeping | <input type="checkbox"/> Common School Subjects |
| <input type="checkbox"/> Private Secretary | <input type="checkbox"/> High School Subjects |
| <input type="checkbox"/> Business Spanish | <input type="checkbox"/> Illustrating |
| <input type="checkbox"/> French | <input type="checkbox"/> Cartooning |

TECHNICAL AND INDUSTRIAL DEPARTMENT

- | | |
|---|--|
| <input type="checkbox"/> Electrical Engineering | <input type="checkbox"/> Architect |
| <input type="checkbox"/> Electric Lighting | <input type="checkbox"/> Contractor and Builder |
| <input type="checkbox"/> Mechanical Engineer | <input type="checkbox"/> Architectural Draftsman |
| <input type="checkbox"/> Mechanical Draftsman | <input type="checkbox"/> Concrete Builder |
| <input type="checkbox"/> Machine Shop Practice | <input type="checkbox"/> Structural Engineer |
| <input type="checkbox"/> Railroad Positions | <input type="checkbox"/> Plumbing and Heating |
| <input type="checkbox"/> Gas Engine Operating | <input type="checkbox"/> Chemistry |
| <input type="checkbox"/> Civil Engineer | <input type="checkbox"/> Pharmacy |
| <input type="checkbox"/> Surveying and Mapping | <input type="checkbox"/> Automobile Work |
| <input type="checkbox"/> Mine Foreman or Engineer | <input type="checkbox"/> Navigation |
| <input type="checkbox"/> Steam Engineering | <input type="checkbox"/> Agriculture and Poultry |
| <input type="checkbox"/> Radio | <input type="checkbox"/> Airplane Engines |
| | <input type="checkbox"/> Mathematics |

Name.....
Street.....
Address.....

5-23-27

City..... State.....

Occupation.....

Persons residing in Canada should send this coupon to the International Correspondence Schools Canadian, Limited, Montreal, Canada.

Please Mention Popular Mechanics

FOUKE

Trappers: Wants your name and address if you are going to trap or buy FURS

Write Fouke today—prospects very good. For best results it's important to have constant up-to-the-minute market information. Fouke gives it. Get the jump on the other fellow.

SEND TO-DAY

FOUKE FUR COMPANY
241 Fouke Building, St. Louis, Mo.

Put my name on your books for Fouke Market Reports and "The Trapper's Partner," the new book on how to trap and grade furs, game laws, low prices on all supplies—all FREE.

Name _____
Town _____
State _____ R. F. D. _____ Box _____

60% of Market Price

Will Buy Diamonds Here

This 3/4-1/18 Ct. perfectly cut diamond, a stumpy, blasing solitaire, at \$42.65 among bargains to our lists. See the many big amazing values some as low as \$40 per Carat, other higher per Carat bargains. This is your oldest largest Diamond Bargain Store in all the world leads money on diamonds. Thousands of unpaid loans and other bargains. Must sell NOW.

Why Pay Full Prices

Costs Nothing To See. Any Diamond sent for absolutely free examination at our risk. No obligation. No cost to you. Latest Listings—Unpaid Loans. Sent Free. Describes Diamond Bargains in Detail, gives cash loan values guaranteed. Explains unlimited exchange privilege. Write Today. Postal card will do.

Joe. De Roy & Sons, 1930 De Roy Building, Pittsburgh, Pa.
Only Opposite Post Office



This Ring \$42.65
3/4 - 1/18
Carat
Perfectly
Cut



Pullman

Sleeper can be made of your car. Auto beds, stoves, tents, camp equipment.
Dep. 9. P. VANDERPOOL CO., Springfield, Ohio.



Fully Guaranteed

15 DAY FREE TRIAL

EASY MONTHLY PAYMENTS

Ride 15 Days AT OUR RISK

Faultless Bicycle or Motobike Coaster Brake

We'll send you a Faultless Motobike to ride at our risk for 15 days. Test it. Prove to yourself it's the best wheel you ever rode, or return it at our expense. It's yours to keep on EASY MONTHLY PAYMENTS.

Tested Frame of Seamless Steel Tubing. One piece Crank Hanger; Drop Forged Crown Forks; New Departure Coaster Brake; Roller Chain. Every device for Speed, Comfort. Perfect Control and Durability, including Channel Bar Stand.

Ask for illustrated circular and choose size, style and color you want to ride.

NATIONAL FARM EQUIPMENT CO., INC.
DEPT. 110-T 98 CHAMBERS ST., NEW YORK

FURS SKY HIGH!

FREE NEW SUPPLY-BOOK GUIDE AND HOW TO GRADE FURS

GET POSTED



WRITE **FUNSTEN** Big Season Ahead!

Get new Trapper's Bargain Catalog of Baits, Traps, Smokers, etc. Also Trapper's Guide, Game Laws and How to Grade Furs.

Best quality steel 13c FUNSTEN ANIMAL BAIT. Finest rapé as follows, each set in the world, per can, only \$1

FUNSTEN BROS. & CO.
111 Funsten Bldg., ST. LOUIS, MO.

TRAPS-GUNS

Hunting Search Lights, Animal Baits, and all Trappers' Supplies at lowest prices. Write for Trappers Guide, Catalog of Trappers Supplies, Game Laws, Fur market Information. All sent Free.

E. W. BIGGS & CO. 187 Biggs Bldg., Kansas City, Mo.

LUMINOUS PAINT

Make Your Watches, Clocks, Etc., Visible by Night

The very latest discovery in the scientific world. Hitherto, practically unobtainable except at an exorbitant price, we have at last succeeded in producing this remarkable LUMINOUS PAINT, which applied to the surface of any article, emits rays of white light, rendering it perfectly visible in the dark. THE DARKER THE NIGHT, THE MORE BRILLIANT IT SHINES. Quite simple to use. Anyone—you can do it. A little applied to the dial of your watch or clock will enable you to tell the time by night. You can coat the push buttons or switch plates of your electric lights, switch boxes, and innumerable other articles; make your own Luminous Crucifera, Luminous Rosaries, etc. Small bottle, price 25c. Larger sizes, 50c and \$1 postpaid.

Johnson Smith & Co., 3224 N. Halsted St., Dept. 811, Chicago

RADIO For Everybody

What do you want to know about Radio? Hook-ups, diagrams, laws, codes, code-work, definitions, testing instruments, use of equipment—everything you want to know fully explained and answered in the Radio Quiz Book. New edition now ready. Read this wonderful book for the best way to use your equipment, or to prepare for Government examinations for Operator's License, Etc., Etc. Price \$1.00. Money-back guarantee. Send for it today.

National Radio Institute
Dept. 1203A, 1345 Pennsylvania Ave., N.W., Washington, D. C.

LEARN TO PITCH

Lessons by "MATTY" WALSH, WHITE, JOHNSON, RUCKER, WOOD—PITCH THE FADE-A-WAY, SPITTER, KNUCKLER, SMOKE BALL, etc., clearly described and illustrated by 36 Pictures. Entire COURSE OF LESSONS sent p. p. for 25c.

J. C. DORN, 721 S. Dearborn St., Dept. 65, Chicago, Ill.

THIS PHONOGRAPH FOR YOUR BUNGALOW OUTING AND BOATING

An actual serviceable talking machine that plays all records up

to and including 10-in. (except Edison), Powerful Spring Motor, Universal Tone Arm and Reproducer. Wt. only 4½ lbs. Fully guaranteed by Manufacturer. Order today. Add 32c for postage.

\$2.48



A. W. POMEAN & CO. 1640 Germantown Ave. Phila., Pa.

Michigan Marine Motor



REPAIRS WITH FORD PARTS

MORE power, greater dependability, less weight, longer life, easier repairs, and lower cost—six salient points which make the Michigan Marine Motor the logical power equipment for your boat. Parts and repair service are available at any Ford garage in the world.

Michigan Marine Motor develops 4 hp., weighs 125 lbs., is of 4-cycle type, and is fully guaranteed for one year. Equipped with Bosch Magneto and impulse coupling \$20 extra. Built by Michigan Marine Motor Co. Write for special offer.

Belle Isle Boat & Engine Co.
Dealer of Sales and Rentals
West E. LITCHFIELD, MICH. DETROIT, MICH.

\$115

RADIO For Everybody

Radio broadcast stations need men as operators, technicians, engineers, repairmen, aids. Splendid positions waiting. Over 400 broadcast stations now in operation—more being erected. Prepare for a big-pay position in this new, big profession. New, easy instruction qualifies you quickly in spare time at home. Full details in our big free book, "How to Learn Radio at Home." Write for it today.

National Radio Institute

Dept. 1203F, 1345 Pennsylvania Ave., N. W., Washington, D. C.

The WEATHERJACKET

KEEPS YOU SNUG AND WARM
Defies Cold and Wind

All-wool, 1 piece, 2 pockets, Gray drab. Drawstring on hood; absolutely wind and cold-proof. Slips on like sweater; no buttons. Thoroughly tested by U. S. Gov't in North Seas. Keeps You Warm Without Bundling. Allows perfect freedom. Order immediately. Supply limited. Give chest measure. Semi postpaid anywhere in U. S. receipt check. **\$5.90**

(Actual Photo) currency or money order. Actual value \$12. Money back if not satisfied. **WEATHERJACKET DISTRIBUTING COMPANY,** Dept. 57, 321 L St., S. W., Washington, D. C.



SEND NO MONEY
-30 DAY TRIAL

\$1.00 RAZOR NONE FREE. Let us send you the famous K & K Razor—world's finest—guaranteed for 25 years. Thousands of these wonderful razors now in use in every home. Regular \$10.00 value—special price, while they last, \$1.95. If this razor does not give you more real satisfaction than any you have ever seen or used, you will not be out a single penny. **A \$1.00 Razor None FREE.** Send No Money! Just your name and address and razor will be mailed to you AT ONCE.

GREAT AMERICAN RAZOR WORKS
Dept. D-528, 1575 Ogden Ave. Chicago, Illinois

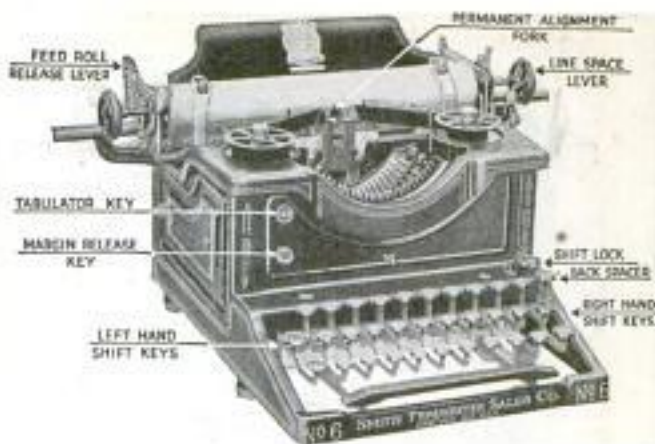

TYPEWRITER SENSATION!

Free Trial—Use as You Pay

Send us only \$4.00 a month until the low total price of \$48.85 is paid, and the machine is yours.

This is absolutely the most generous typewriter offer ever made. Do not rent a machine when you can pay \$4.00 a month and own one. Cash price \$44.00, just a little less than half its original price.

(STANDARD) SMITH Model No. 6

Perfect machines, Standard size, Keyboard of Universal arrangement, writing 84 characters. The entire line of writing completely visible at all times, has the tabulator, the two-color ribbon, the back spacer, in fact every late style feature and modern operating convenience. Comes to you with everything complete; tools, cover, operating book and instructions—nothing extra to buy. You cannot imagine the perfection of this beautiful reconstructed typewriter until you have seen it. We have sold thousands of these perfect late style machines and every one of these thousands of satisfied customers had this beautiful, strictly up-to-date machine on five days' free trial before deciding to buy it. We will send it to you F. O. B. Chicago for five days' free trial. It will sell itself, but if you are not satisfied that this is the greatest typewriter you ever saw, you can return it at our expense. You won't want to return it after you try it, for you cannot equal this wonderful value anywhere.

SEND NO MONEY Put In Your Order Now

\$4.85
AFTER TRIAL

When the typewriter arrives deposit with the express agent \$4.85 and take the machine for five days' trial. If you are convinced that it is the best typewriter you ever saw keep it and send us \$4.00 a month until our bargain price of \$48.85 is paid. If you don't want it, return it to the express agent, receive your \$4.85 and return the machine. We will pay the return express charges. This machine is guaranteed just as if you paid \$100.00 for it. It is standard. These typewriters are samples the manufacturer had at their branch offices throughout United States and have never been used except for demonstration purpose. Just like new but at extremely low price. **The supply at this price is limited, the price will probably be raised when next advertisement appears, so don't delay. Fill in the coupon to-day—the typewriter will be shipped promptly.** There is no red tape. We employ no solicitors—no collectors—no chattel mortgage. It is simply understood that we retain title to the machine until full \$48.85 is paid. You cannot lose. It is the greatest typewriter opportunity you will ever have. **Do not send us one cent. Get the coupon in the mails to-day—sure.**

SMITH TYPEWRITER SALES CO., 288, 218 N. Wells St., Chicago, Ill.

SMITH TYPEWRITER SALES CO., 288, 218 N. Wells St., Chicago, Ill. Ship me the Standard Visible Smith Model No. 6, F. O. B. Chicago, as described in this advertisement. I will pay you \$4.00 monthly as rent until the \$44.00 balance of the Special \$48.85 sale price is paid. The title to remain in you until fully paid for. It is understood that I have five days in which to examine and try the typewriter. If I choose not to keep it I will carefully repack it and return it to the express agent. It is understood that you give the standard guarantee.

Name

Street Address

City..... State.....

Occupation or Business.....

Ingersoll

WATERBURY
RADIOLITE

Tells time in the dark

\$5

The best watch
\$5 will buy



THE Waterbury Radiolite is a 4-jeweled watch, 12-size, the small, stylish size so in vogue, graceful from antique bow and crown to fine, open face in solid nickel case, with modified bridge construction. A mighty sturdy time-keeper. Guaranteed.

INGERSOLL WATCH CO., Inc.
New York Chicago San Francisco



Ingersoll Yankee

This is the reasonable, reliable, famous American Watch—the best known time-piece in the world.

\$1.50

Our BUREAU OF INFORMATION will answer all questions regarding articles appearing in this magazine. Address Bureau of Information, Popular Mechanics Magazine, Chicago.

Moore's Universal Assistant and Complete Mechanic

Contains 1016 Pages, 500 Engravings, and Over 1,000,000 Industrial Facts, Calculations, Receipts, Processes, and Trade Secrets for Every Business!



For Sterling Value, Elegance, and Low Cost, This Work Has No Compeer in the English Language

The Work contains 200,000 items for Gas, Steam, Civil and Mining Engineers, Machinists, Iron Founders, Plumbers, Metallurgists, Assayers, Miners, Builders, Metal and Wood Workers, Manufacturers, etc. Full details (with 500 Engravings) for constructing, operating, and repairing Mill and Steam Machinery of every kind, setting of Valves, Link and Valve Motion, Eccentrics, Indicator Diagrams, Injectors, Steam Boilers, Gauges, Machinists' Tools, Mechanical Movements, Tunnelling, Mining and Rock Drilling Machinery, Wheel Gearing, Gas Meters, Diagrams for Sheet Metal Workers, Views of Noted Buildings, Bridges, Plans of Mills, etc.

FULL INSTRUCTIONS TO ENGINEERS, FIREMEN, BOILER MAKERS, ENGINE AND CAR BUILDERS, ETC. Proportion of Engines, Repairing Locomotive Break-Downs on the Road, Boiler and Steam Pipe Covering, Cements—69 kinds, Bright Polish—4 kinds, Scale Preventives—10 kinds to Clean Waste, Details for Cotton, Woolen, and Fulling Mill Machinery; ditto, for Flour, Oatmeal, Saw, Shingle, Planing, Paper and Wind Mills, Grain Elevators, Sugar, Oil, Marble and Rolling Mills, Blast Furnaces, Gas Works, Water Works, Mill Dams, Water Wheels, Hydraulics, Cotton Presses, Speed of Wheels, Pulleys, Drums, Circular Saws, Woodworking Machinery, Horse Power of Streams, Belts, Strength of Metals, Timber, Building Materials, etc. Seasoning of Timber—12 ways, Growth of Forest Trees, Logging, Cost of Supplies, Stream Driving, Lumber Measurement and Surveyors' Tables, full and complete. Views of Lumbering Scenes, Saw Mills, Saw Filing, etc., etc.

PRICE ONLY \$2.00 POSTPAID
Popular Mechanics Book Dept.
6 N. Michigan Ave., Chicago

AUTO OWNERS Make \$60 Week!



Sell Automobile and Radio Storage Batteries! Get agency for

HAYWOOD HYPOWER BATTERIES

New. Different. Fully guaranteed for two years. Backed by \$400,000.00 concern. Sizes and styles for every car. Also Radio Batteries. Big demand. Write

quick for our wonderful proposition. Exclusive territory. Undersell competition.

ORDER DEMONSTRATOR FOR YOUR OWN CAR AT LOW FACTORY PRICE

We put ambitious hustlers into permanent, profitable business. Start as our agent. Sell to others. All or part time. Work into big paying profession. Own and manage a service station. We teach you how to build, repair and re-charge batteries. Furnish station for you complete. You buy supplies and materials direct from factory at rock bottom prices. There's big possibilities for men who sell Haywood Hypower Batteries. Write quick for our wonderful proposition. Address

HAYWOOD HYPOWER BATTERY COMPANY
1373 Capitol Ave. Indianapolis, Ind.

Conquer the TOBACCO OR SNUFF HABIT

quickly with simple, harmless preparation. No matter whether you smoke cigars, cigarettes, pipe, chew or use snuff, this preparation is guaranteed to quickly free you of the tobacco habit. **NO CURE, NO PAY.** Costs only \$1 if it cures—nothing if it fails. Full treatment sent on approval. Write today.

DR. C. M. SIMPSON CO.
213 W. 44th Street, Cleveland, Ohio

Ra-Tone The Electric Tonic

Treat Yourself For
Rheumatism
Neuritis
Anemia
Nervousness
Lumbago
Sciatica
Weak Eyes
Falling Hair
Insomnia
Skin Diseases
100 other Ailments

Rebuild Your Health at Home

Learn how to treat yourself for ailments caused by disordered nerves, impoverished blood and poor circulation. Build up cells and tissues to arrest activity, banish aches and pains and eradicate poisons. Regain your youthful energy and strength.

Ra-Tone Electric Co.
510 Park Place, West
Detroit, Mich.

Tells in a simple but scientific way of the cause and treatment of more than 100 disorders. A complete medical book that answers nearly every question about your health. Sent without obligation.

Write for It Today



The Perfected VIOLET RAY



High School Course in Two Years!

You Want to Earn Big Money!

And you will not be satisfied unless you earn steady promotion. But are you prepared for the job ahead of you? Do you measure up to the standard that insures success? For a more responsible position a fairly good education is necessary. To write a sensible business letter, to prepare estimates, to figure cost and to compute interest, you must have a certain amount of preparation. All this you must be able to do before you will earn promotion. Many business houses hire no men whose general knowledge is not equal to a high school course. Why? Because big business refuses to burden itself with men who are barred from promotion by the lack of elementary education.

Can You Qualify for a Better Position

We have a plan whereby you can. We can give you a complete but simplified high school course in two years, giving you all the essentials that form the foundation of practical business. It will prepare you to hold your own where competition is keen and exacting. Do not doubt your ability, but make up your mind to it and you will soon have the requirements that will bring you success and big money. **YOU CAN DO IT.**

Let us show you how to get on the road to success. It will not cost you a single working hour. Write today. It costs you nothing but a stamp.

American School

Dept. H 674, Drexel Ave. and 58th St., Chicago

American School

Dept. H 674, Drexel Ave. and 58th St., Chicago

Send me full information on the subject checked and how you will help me win success.

- | | |
|-----------------------------|---------------------------|
|Architect |Lawyer |
|Building Contractor |Machine Shop Practice |
|Automobile Engineer |Photoplay Writer |
|Automobile Repairman |Mechanical Engineer |
|Civil Engineer |Shop Superintendent |
|Structural Engineer |Employment Manager |
|Business Manager |Steam Engineer |
|Cert. Public Accountant |Foremanship |
|Accountant and Auditor |Sanitary Engineer |
|Bookkeeper |Surveyor (& Mapping) |
|Draftsman and Designer |Telephone Engineer |
|Electrical Engineer |Telegraph Engineer |
|Electric Light & Power |High School Graduate |
|General Education |Fire Insurance Expert |
|Vocational Guidance |Wireless Radio |
|Business Law |Undecided |

Name

Address

Please Mention Popular Mechanics



He makes that can hop every shot with his Stevens

It takes more than just skill to make a can hop, to plug a bull's eye, or to pick off a squirrel. It takes skill *and* an accurate firearm.

Hold a Stevens barrel up to the light and take a peep through it. Smooth, isn't it? Not a flaw—that barrel is accurate.

There's a good reason, too. When a Stevens rifle is drilled, the final reaming cuts away less than *one-half of a thousandth of an inch*.

For rifling, Stevens uses a special process: at each pass the cutter cuts away only *one thirtieth of a thousandth of an inch*.

It takes a long time to make a rifle that accurate—but a Stevens rifle shoots true.

And Stevens turns out these sturdy, accurate rifles at prices that you can afford. Ask at your dealer's or write for the interesting catalog describing our complete line of rifles and shot guns.

J. STEVENS ARMS COMPANY

Department J262, Chicopee Falls, Mass.

Owned and operated by the Savage Arms Corporation
Executive and Export Offices: 30 Church Street, New York

RETAIL PRICE Stevens "Favorite." 24-in. take-down; .22 long rifle, .22 short, .25 Stevens and .32 long rim-fire. A favorite for three generations. Other models ranging in price from \$5.40 to \$23.50



RETAIL PRICE including tax \$15.00 Stevens "Visible Loading." An accurate .22 caliber Repeater. You know when it is loaded—and when it is empty.

Please mention Popular Mechanics

Cartoonists!

The inspiration so necessary for success, as well as valuable hints regarding technique, methods of work and style will be yours if you equip yourself with portfolios of the work of the greatest cartoonists. Just such portfolios are the

BOUND VOLUMES OF CARTOONS MAGAZINE

Here you find the best cartoons of Darling, Cesare, McCutcheon, Carter, Kirby and scores of other master cartoonists of this and other countries.

PRICE \$2 PER VOLUME POSTPAID WITHIN THE REACH OF ALL

Think of it! These durable and attractively bound books (all new) each covering six months and containing 1200 cartoons, 900 pages (7 x 9½ in.) 3 in. thick will be sold separately as long as the limited supply lasts.

Make your selection from the following list and send in an order at once.

Vol. 11—January—June - 1917	} Part of World War Period
Vol. 12—July—December - 1917	
Vol. 13—January—June - 1918	
Vol. 14—July—December - 1918	
Vol. 15—January—June - 1919	
Vol. 16—July—December - 1919	
Vol. 17—January—June - 1920	
Vol. 18—July—December - 1920	

Address:

POPULAR MECHANICS BOOK DEPT.
6 N. Michigan Ave. Chicago

10,000 Practical Recipes

HENLEY'S

Twentieth Century
Book of
Recipes, Formulas
and Processes

Edited by

GARDNER D. HISCOX, M. E.

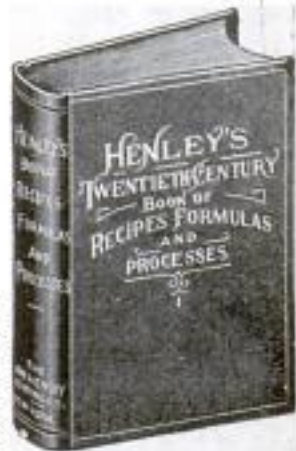

Contains over 10,000 Selected Scientific, Chemical, Technological and Practical Recipes and Processes, including Hundreds of So-Called Trade Secrets for Every Business. This book of 800 pages is the most complete Book of Recipes ever published, giving thousands of recipes for the manufacture of valuable articles for every-day use. Hints, Helps, Practical Ideas and Secret Processes are revealed within its pages. It covers every branch of the useful arts and tells thousands of ways of making money and is just the book everyone should have at his command. A book to which you may turn with confidence that you will find what you are looking for. A mine of information up-to-date in every respect. Contains an immense number of formulas that everyone ought to have that are not found in any other work.

Price \$4.00

Cloth Binding

Popular Mechanics Book Dept.
6 N. Michigan Ave., CHICAGO

Sweeping Victories

NOT content with winning nearly every outboard motor race of the year, the Evinrude Motor in most events has made a clean sweep—taking from the first three to the first eight places. Decisive victories at Peoria, Ill., Madison, Wis., Sandusky, Ohio, and at scores of lakes and river resorts throughout the country prove the Evinrude to be without question the speediest of outdoor motors.

But speed, alone, has not made the Evinrude the choice of America's sportsmen. That the sales of this powerful

little motor have passed the 140,000 mark, that it has become the pal of fishermen, hunters and campers everywhere, is largely due to its 12 year record for day-after-day dependability. *The Evinrude gets you there and back.*

There are two Evinrude models—the Standard for more rugged service, the popular 50-pound Lightweight for greater portability.

See these Evinrudes at your hardware or sporting goods dealer's. Or write for free catalog describing the Built-in-Flywheel Magneto, Tilt-up Attachment and other Evinrude features

Evinrude Motor Co.
725 Evinrude Bldg.
Milwaukee Wisconsin

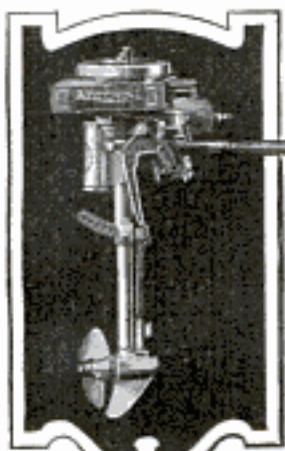

EVINRUDE Standard and Lightweight DETACHABLE MOTORS FOR WATERCRAFT

DISTRIBUTORS

69 Cortlandt St., New York, N. Y. 119 Broadway, Oakland, Calif.
780 Commonwealth Ave., Boston, Mass. 211 Morrison St., Portland, Ore.



Lost Your Keys?

One way to avoid this inconvenience is to supply yourself with a DEVIL'S COMBINATION MASTER KEY, which by actual test has opened and tested THOUSANDS of locks, and may serve you in an emergency. The most wonderful Combination of Master Keys in the world. By mail \$1.00.

B. URICH KEY CO.
232-3rd Street Milwaukee, Wis.
Largest Exclusive Key and Lock Shop in America



RADIO For Everybody

Go to sea as a Radio operator. Travel—see the world—meet interesting people, and make more money. Wonderful new course prepares you quickly in spare time as Government Licensed Radio operator. Four wonderful instruments free. Famous Radio experts help you. Write today for free book.

National Radio Institute

Dept. 1203E,

1345 Pennsylvania Ave., N. W. Washington, D. C.

PERFECT Ford CONTROL with a Stoner Footthrottle

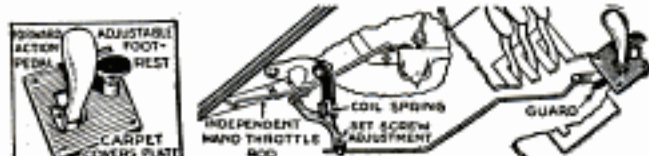

Install a **STONER FOOTTHRITTLE** and enjoy driving your Ford with the same comfort of a larger car. Lean back on the cushions—operate your Ford with your feet only, leaving both hands free for emergencies. Easily installed—no boring or drilling necessary. A mechanically perfect, beautiful device. Fits all models. Write for our **FREE** illustrated folder today.

Ask your Dealer about our special introductory offer of \$1.50. If he cannot supply you, mail \$1.50 today. Satisfaction guaranteed or money cheerfully refunded.

Dealers write for Special Proposition.

STONER EQUIPMENT CO. 326 W. MADISON STREET, CHICAGO, ILL.

OTTAWA LOG SAW
\$81.00

Fast Cutting

Try 30 Days



SAW 15 CORDS A DAY!

Beat the Coal Shortage!

The long drawn out coal and railroad strikes have resulted in a serious coal shortage. Prepare! Get an OTTAWA Log Saw at once! Have all the fuel you want at low cost. Be independent; be comfortable. Make extra money sawing and selling wood. Easy and quick with this dependable, fast-cutting power outfit. Use coupon below; get full particulars quick.

OTTAWA LOG SAW

Cuts Down Trees—Saws Logs By Power.

Cuts More Wood Faster. The OTTAWA is built to do dependable work. 2 H-P. Model saws 8-inch logs as well as 5-foot logs. Lightest Log Saw built. 4 H-P. Model falls trees; saws limbs. Fastest sawing; light weight; compact; wheel-mounted. 4-cycle engine assures plenty of power and fast cutting. Start or stop saw blade while engine runs on. A real one-man outfit.

Cash or Easy Payments. Don't worry about payments. Get our easy selling plan and see how easy it is to own this wonderful outfit. Sold direct by the makers—at Wholesale Prices; saving you all middle profits.

Quick Shipment From 10 Points. We save you time and freight by shipping the OTTAWA from our great factory at Ottawa, Kan., or from the nearest to you of these Branch Houses: Indianapolis, Ind.; Dallas, Tex.; St. Paul, Minn.; Pueblo, Colo.; Albany, N. Y.; Pittsburgh, Pa.; Atlanta, Ga.; San Francisco, Cal.; Portland, Ore. Address all communications to Ottawa, Kan.

30 Days' Trial—10-Year Guarantee. Every OTTAWA shipped on 30 Days' Trial. Must fulfill 10-Year OTTAWA Guarantee that it will do all the work claimed for it. Thousands of satisfied OTTAWA users everywhere.

FREE! A Valuable Book

Fill Out Coupon and Mail Today for my Big "Wood Saw Encyclopedia"; also complete information on OTTAWA Log Saws. Free to you. Learn how easy it is to save money and make money. Don't delay! Send the Coupon NOW!

H. C. OVERMAN, Gen'l Mgr.

OTTAWA MFG. CO.

1742-L Wood St., OTTAWA, KAN.

Free Book on Wood Sawing

MAIL TODAY!

H. C. Overman, Gen'l Mgr., OTTAWA MFG. CO., 1742-L Wood Street, Ottawa, Kansas.

Without obligation to me, send me your Wood Sawing Encyclopedia; also full information on OTTAWA Log Saws.

Name

Address

Please Mention Popular Mechanics

2 LIGHTS in 1



Makes out of doors
as light as day



Makes a perfect
Reading Lamp

Two Lights in One

Two hundred candle power—a powerful white light many times more brilliant than gas or electricity—at your service constantly—indoors or out. A handy lantern—a beautiful reading lamp with shade. Hang it up—set it down. Use it early and late for every "chore." Carry it in your ear—be ready for any emergency! Ideal for camping, fishing, etc.

The Combination HANDY LITE

Lights with matches—no torch. Burns common gasoline. Burns without flicker in strongest winds. No wick trimming. No smoking. No spilling or danger if tipped. Safe, simple, serviceable. Takes less space than an ordinary wick lamp and gives light of twenty! Nickel-plated brass—a beauty!

Special Agents Price

—to introduce into new territories. A big seller! Use spreads like wildfire. Sell it—use it. Send under money-back guarantee. Write quick for Agents Price. Address Dept. 33.

ENTERPRISE TOOL AND
METAL WORKS
126-128 So. Clinton St.
CHICAGO



LEARN JIU-JITSU

Know how to protect yourself and your loved ones against a bully or a ruffian. Muscle and weight are helpless before the marvelous science. Anyone can master it easily. Complete instructions in book entitled

JUDO (Improved Jiu-Jitsu)

by Sekisuke Yokoyama, Professor of Jiu-Jitsu in the Kodokwan Grading Athletic University in Japan. 300 pages. Illustrated with 90 actual photos.

Special Reduced Price Only \$2.00, Postpaid. (Class edition originally sold for \$6.) Money absolutely refunded within 5 days if not entirely satisfactory.

NISHODO BOOK COMPANY
512 Chamber of Commerce Bldg. Los Angeles, Cal.

Will ship
C. O. D.
anywhere
in U.S.A.
if desired.



Agents for fastest
selling 25c
article in years. Nation-
ally advertised "Adit" top.
Universal appeal. Send 25c
for sample and particulars.

ROGERS SALES CORP.
457 N. RACINE CHICAGO

DYNAMOS—SPECIAL



250 Watt 500 Volt 5
1700 R.P.M. Complete **23⁵⁰**
New High Grade

Also 30 to 500 Volt
up to 5 K. W.—Catalog.

STAR DYNAMO WORKS
Jefferson City, Mo., U. S. A.

THE TELEGRAPH INSTRUCTOR

By G. M. DODGE

New, revised edition, just published. A complete text on Morse (railway and commercial) telegraphy for the student or operator. Used by many schools.

PARTIAL CONTENTS

Telegraph—Student Codes—Electric Current—Key, Relay, Electro-Magnet, Sounder, Battery—Conductors and Non-Conductors—Switchboard—Ground Wire—Transmitting—Position—Movement—Alphabet—Correct Formation of Characters—Beginning Exercises—Receiving—Copying—Breaking—Penmanship—Circuit Regulations—Wire Signals—Abbreviations—Example Sentences—Definitions of Terms—Suggestions for Teaching—Duties of Railroad Employees—Rules for Movement of Trains—Train Orders—Block Signaling—Telegraph Block Signals—Block Signal Examination—Railroad Telegrams—Commercial Telegraph Rules—Commercial Telegrams—Service or Office Messages—Private Wires—Forms—Train Orders—Clearance Card—Train Sheet—Railroad, Commercial and Private Wire Messages—Grain, Provision and Stock Quotations—Abbreviations.

300 Pages—Cloth
\$1.75 Postpaid

POPULAR MECHANICS BOOK DEPT.
6 N. MICHIGAN AVE. CHICAGO

STAIR BUILDERS' GUIDE

Excellent treatise on construction of straight flight, platform, cylindrical and elliptical stairs.

256 Pages. 358 Figures. Cloth, \$2, postpaid.
Popular Mechanics Book Dept., 6 N. Michigan Ave., Chicago.

Amateur Electrical Experimenters

Here is the book you have been waiting for. It tells how to make things electrical, such as radio outfits, reading lamps, electric clocks, toasters and countless other useful appliances from materials easily obtainable. No previous electrical knowledge necessary. Clear directions, fully illustrated.

How to Make Things Electrical

427 pp. — 256 Articles — 353 Illustrations

4½x7 Cloth
Price \$2.60 Postpaid



Popular Mechanics
Book Dept.
6 N. Mich. Ave., CHICAGO

The Automobile Storage Battery Its Care and Repair

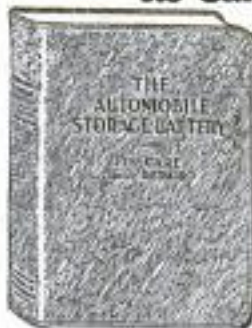

A new authoritative work upon the construction, repair and care of the storage battery used on the gasoline motor car.

Chapter Headings

Introductory—Batteries in General—Chemical Actions which Produce Electricity—How Chemical Actions Produce Electricity—Loss of Charge in an Idle Battery—The Discharge Phenomena—The Charge Phenomena—Capacity of Storage Batteries—Internal Resistance—Battery Diseases—Conditions of Operation—How to Take Care of the Battery on the Car—Manufacture of Storage Batteries—The Workshop—Analysis of the Condition of the Battery—Work on the Battery.

280 Pages—185 Illustrations. Bound in Flexible Leather. Price, \$5.00 postpaid.

POPULAR MECHANICS BOOK DEPT., 6 N. Michigan Ave., CHICAGO



Knowing how
Wins on
Pay Day

Pay-Raising BOOKS

Select From This List for
Free Use in Your Own Home

Automobile Engineering , 6 volumes, 2000 pages, 2000 pictures. Was \$45.00. Now	\$21.80
Carpentry and Contracting , 5 volumes, 2138 pages, 1000 pictures. Was \$37.50. Now	19.80
Civil Engineering , 9 volumes, 3900 pages, 3000 pictures. Was \$67.50. Now	34.80
Accountancy and Business Management , 7 volumes, 3000 pages, 2800 pictures. Was \$62.50. Now	29.80
Fire Prevention and Insurance , 4 volumes, 1500 pages, 600 pictures. Was \$30.00. Now	14.80
Electrical Engineering , 8 volumes, 3800 pages, 3000 pictures. Was \$60.00. Now	29.80
Machine Shop Practice , 6 volumes, 2300 pages, 2500 pictures. Was \$45.00. Now	21.80
Steam and Gas Engineering , 7 volumes, 3500 pages, 2500 pictures. Was \$52.50. Now	24.80
Telephony and Telegraphy , 4 volumes, 1728 pages, 2000 pictures. Was \$35.00. Now	14.80
Sanitation, Heating and Ventilating , 4 volumes, 1454 pages, 1400 pictures. Was \$30.00. Now	14.80
Drawing , 4 volumes, 1578 pages, 1000 pictures, blue-prints, etc., Was \$30.00. Now	14.80
American Law and Practice , (Including reading course,) 13 volumes, 6000 pages—illustrated, Was \$37.50. Now	49.80
Employment Management and Safety Engineering , 7 volumes; 1800 pages, 540 illustrations, charts and diagrams, Was \$32.50. Now	24.80

KNOWING HOW is the thing that puts the big pay in the pay-envelope. It's the thing that lifts men out of a poor-paying job into a man's size job with a man's size pay. *The man with the "know how" under his hat always wins out.* No matter what kind of work you are doing, or what you expect to do—you can learn more about that work and get more money for doing it. You don't have to go to school. Neither do you take any special training. One of these home study courses in book form gives you all the "know how" you need.

Some of the world's greatest experts prepared these books just to help ambitious men get ahead. They are written in plain, good old U. S. language that anyone can understand. No puzzling technical terms. Everything is explained. Thousands of pictures, plans, blueprints, diagrams, etc., in each set. Over 100,000 sets have been sold. Pick out a set in line with your ambition and send the FREE TRIAL coupon that brings the books without your sending any money in advance.



This picture shows the Automobile Engineering Books, five volumes closed and one open. The bindings will last a lifetime.

FREE Examination!

Don't send one penny. Just fill out the coupon and mail it. This will bring any set you select (the whole set, not a sample) by express collect. The books will be yours to use as you please for an entire week. You be the judge and decide whether or not they will do for you what they have done for thousands of other men. If you don't think they will help you, send them back at our expense and you won't owe a cent.

75 Cents a Week

Pay only \$2.80 within 1 week if you keep the books and send us \$3 each month until the special reduced price is paid. This amounts to about 10 cents a day. Mail coupon NOW. You'll be mighty glad you did when pay day comes 'round.

AMERICAN TECHNICAL SOCIETY, Dept. X-196, Chicago

AMERICAN TECHNICAL SOCIETY, Dept. X-196, Chicago, U. S. A.

Please send me set of for 7 DAYS' examination, shipping charges collect. I will examine the books thoroughly and, if satisfied, will send \$2.80 within 7 days and \$3.00 each month until

I have paid the special price of \$..... If I decide not to keep the books I will return them within a week at your expense.

Name

Address

Employed by

Please fill out all lines.



Means RADIO Satisfaction



Combination Detector and One Stage Amplifier

Made to allow for the greatest flexibility of operation with the maximum of efficiency. A genuine vacuum-tube detector, with great latitude of adjustment, and an amplifier that functions without annoying discord.

Radio equipment—whether you construct your own apparatus or buy the “custom-made” outfit—must be made right, or you cannot expect lasting satisfaction.

SIGNAL parts and sets are the product of a plant and an organization whose experience in making Radio equipment dates back to the earliest days of “wireless.”

There is seasoned knowledge and experienced handcraft built into every item of the SIGNAL line. Each piece will give you the service you have a right to expect.

Ask for SIGNAL when you want Radio parts or Radio sets and insure yourself against that “most embarrassing moment” when something goes wrong, just as you expect to entertain your friends.

For sale by dealers everywhere. Accept no substitutes.

SIGNAL Electric Mfg. Co.

1910 Broadway

Menominee, Mich.

33 S. Clinton St., Chicago

(1890)

THE SHAW MOTOR ATTACHMENT Makes Your Bike a Motorcycle

A high grade 2½ H. P. Motor attachment quickly clamped to any bike frame. Speed 4 to 40 miles an hour. 90 to 125 miles per gallon of gas.

Special Low Price Now! Write today for Complete Description and Special Low Prices on SHAW Motor Attachments and the Shaw Complete Motorcycle.

SHAW MFG. CO., Dept. 37, GALESBURG, KANS.



CATALOG No. 22 IS READY

Small Steam and Gasoline Engines, ¼ H. P. up. Pumps, gears, model makers' supplies. Sent postpaid (2 dimes preferred) or 20c stamps.

Modern Engine & Supply Co.
334 Menadneck Bldg., Chicago

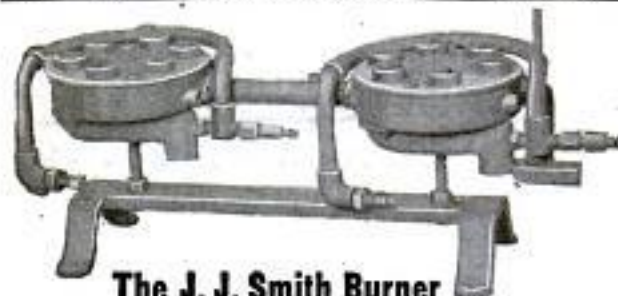

The J. J. Smith Burner

Burns Kerosene (Coal Oil) with a blue flame. Gives an intense heat. No wicks, smoke or dirt. Noiseless and economical in operation. Will not clog or backfire. Fits any cook stove. Has many unique features. Superior to any burner on the market. Guaranteed for one year. Write for a full description.

Agents Wanted.

Mfd. by E. J. ROBE, 620 W. Monroe Street, CHICAGO

THE PROPER AND MOST EFFICIENT WAY TO REPAIR FORD CARS TRUCKS AND TRACTORS

Here is a book that presents the information given in the Ford Service Course for Superintendents and Service Managers of Ford Agencies at the home plant in Detroit. It gives you information which cannot be secured otherwise outside the Ford plant. It describes for dealers, repairmen, garage mechanics and owners the proper and most efficient way to repair the products of the Ford factories.

Published April, 1922

FORD CAR, TRUCK AND TRACTOR REPAIR

By Alfred A. Good

Formerly Director, Ford Motor Company's Service School

220 pages, pocket size, flexible, 32 illustrations

PRICE \$2 POSTPAID

There have been a number of books written on the Ford car; but they only tell what the average Ford driver or mechanic already knows. This book gives you real practical information that shows you just how to locate troubles quickly and how to remedy them efficiently. It gives you a complete understanding of the mechanical principles underlying the operation of Ford cars, trucks and tractors—a thorough knowledge of the mechanical and electrical action of every unit of these machines—an explanation of how to get at the cause of the various troubles—and a step-by-step description of repair operations. The book covers the Ford car, truck and tractor in such a way that the mechanic who reads it is ready to answer any question concerning them which may be put to him by anyone.

Sent to any address postpaid upon receipt of price by

Popular Mechanics Book Dept.
6 N. Michigan Ave. Chicago



No Wonder Salesmen Make \$50 a Day With This Amazing Invention



\$215 in One Day
"Ye gods—some fellow
I made \$215 today!"—
T. W. Bember of Phila.

\$600 a Month
"Have averaged \$600
profit a month for last
six months."—A. M.
Russell, Conn.

**Berger—\$258.50 per
Week**
"Send following weekly
breakers: 10 No. 1; 4
No. 2; 4 No. 5."—R.
Berger, Ont.

\$1000 in 4 Weeks
"Am making \$1000 per
month. I have made big
money before, but did
not expect so much.
Your Burner is just the
thing."—J. Carnesey,
S. D.

Buya Car with Profits
"Have earned enough in
one month to buy me a
new auto."—S. W.
Knappen, Calif.

\$7 Profit per Hour
"I started out and made
\$21.50 in about 3 hours.
The Oliver does the
work. It certainly is
the real thing."—L.
Zucker, Ohio.

**"Sells Like Beer in a
Dry Town"**
"Am sending today for
7 Oliver's. This is one
day's orders (\$85 profit).
Selling like beer in a dry
town."—W. H. Dewey,
Michigan.

**Mr. T's 25th Order in
Six Months**
"Ship 52 Oliver's: 10 No.
2; 6 No. 1; 12 No. 2;
24 No. 4." (Mr. T's
profit on this order alone
is \$711.)—G. T. Ottawa,
Ont.

When a real idea comes along that does an important job and does it well depend upon it that every salesman or agent who ties up to it will clean up big. And this is one of them—a wonderful new device that saves housewives labor, mess, and drudgery. No wonder salesmen make the money they do (read the letters at the left) with this amazing invention.

THIS new device saves housewives from a roasting kitchen in the Summer, yet gives them three times more heat in Winter when they need it—and ready heat for changeable Spring and Fall. Just a turn of a valve instantly gives them as much or as little heat as they need. That's why the Oliver Improved Oil-Gas Burner is sweeping the country like wild-fire.

It isn't hard to sell a thing that everybody wants! You don't have to be a star salesman. You don't have to talk people into a sale. A short, clear-cut demonstration—and the sale is made.

Salesmen make big profits with the Oliver because it is not only timely, in these days of labor-saving devices and high priced coal and wood, but it is timely every season of the year. Agents clean up all year round. The Oliver Burner does away entirely with coal and wood and all worry about strikes, scarcity and high prices. Fits any cook stove, heater or furnace without change. It burns 95% air and 5% oil, the cheapest fuel there is.

Now that you know these things you can understand why agents make profits as shown in their actual letters on this page. There are hundreds of others. Here is your chance to "cash in" big too!

Coupon Brings Full Offer

Mail this coupon now for our offer. We are not making any extravagant claims about this. We do not have to. We believe that your common sense will indicate a good proposition to you when you know about it. We want to give you the facts. Won't you write us? By doing so quickly you can gain the opportunity of being allotted an exclusive territory with private selling rights.

The coupon will bring you the facts and will save you writing a letter. No obligation at all—just mail the coupon at once.

Oliver Oil-Gas Burner & Machine Co.

Oldest and largest manufacturers of Oil-Gas Burners
in the World.

2048-U Oliver Bldg. St. Louis, Mo.

Oliver Oil-Gas Burner & Machine Co.

2048-U Oliver Bldg., St. Louis, Mo.

Please send me full facts about how I can make big money representing you in my territory. Also your plan, if I wish to make big money in my spare time.

Name.....

Address.....

City.....State.....

"HOW IT WORKS" Series

By ARCHIBALD WILLIAMS

The How and Why of Mechanical Things in simple language. Cloth bound books with many full pages, plates, diagrams and text illustrations. 7 1/2 x 5 1/2 inches.

THINGS TO MAKE Just the book for an active boy that wants to make things for himself. This new volume will show him how to make dozens of useful, amusing or fascinating things that work.



HOW IT WORKS It deals in simple language with Steam, Electricity, Light, Heat, Sound, Hydraulics, Optics, etc.

Every properly constructed boy wishes at some time or other to cut open the bellows or to take his watch to pieces in order to see "how it works."

HOW IT IS DONE In this book the inquiring boy can learn how cycles, motor cars, paper, watches, locomotives, and a thousand other things are made. He can learn the secrets of the construction of a Dreadnought, a pin, a naval gun.

THINKING IT OUT This book is devoted to investigating in a simple manner the physical laws which meet us at every turn. Once you get a grip on the fundamentals you are equipped to think out and understand a multitude of things.

VICTORIES OF THE ENGINEER The building of the Mau-retaina, the erection of the Fourth Bridge, the construction of the Florida railway across miles of sea, for example, are romances of achievement by the side of which the average story pales its ineffectual size.

BOOK OF THE SEA A book which will instruct and delight the young mind that wants to know about the sea and its wonders.

Price \$2.00 per volume, postpaid

POPULAR MECHANICS BOOK DEPT.
6 N. MICHIGAN AVE. CHICAGO



Ever Get Stuck On a Job?

SHOP NOTES FOR 1922

The latest volume of Popular Mechanics series of year books tells

655 Easy Ways to Do Hard Things

of daily use to every mechanic. Among the many useful articles are Six Inch Bench Lathe—Electric Soldering Outfit—Contractor's Jib Crane—Pump Troubles—Farm or Road Roller—Small Bench Grinder—Small Bench Miller.

224 Pages—465 Illustrations
Price 50 Cents, Postpaid

Eight of the volumes of Shop Notes issued previously are also obtainable at 50 cents per copy postpaid.

POPULAR MECHANICS BOOK DEPT.
6 N. Michigan Ave., Chicago

forget

Your old conception of a gasoline engine and consider only

The Air-Cooled, Multi-Purpose
"New-Way"
5 Engines in 1



Compact as an electric motor—flexible, dependable and light in weight. Especially designed to operate portable machinery, semi-portable, traction and stationary.

Operates by direct power or generator electric motor driven units and tools in remote places.

Variable control, 2 to 5 horse power. Weight ready to mount on any equipment, 248 lbs. Write for Circular C-20.

THE "New-Way"
Motor Company
Lansing, Mich., U. S. A.
Eastern and Export Offices,
Woolworth Building
New York

Manufacturers and Dealers
Universalize your product with the "New-Way" Engine and sell to the world.

Our engineering staff has had wide experience in the application of power to machinery of all kinds. They will be glad to help you.

ATKINS

SILVER STEEL SAWS



Better for every use

Look for the name "Atkins" on the blade. It is a guarantee the saw will cut faster and easier—save you

time, labor and money for metal or wood cutting.

Get This FREE Book "SAW SENSE"

We'll mail you this useful book without charge—besides describing Atkins Saws for every cutting use, it is full of helpful facts on caring for saws and interesting facts on construction work. Just send your name and address and the use you make of a saw to—

E. C. ATKINS & CO., Inc.
Makers of "Silver Steel" Saws and Tools
Dept. P. Indianapolis, Ind.

FINE OLD VIOLINS

On Easy Payments 30 Days Free Trial



allowed, no matter where you live. If not more than pleased with our values return violin AT OUR EXPENSE—and no harm done. Ability to play the violin brings social and financial success. Get a violin with a rich, mellow tone and it will create in you a desire to master it.

Free! Magnificent Album-Catalog

containing portraits of the world's greatest violinists since Paganini's time, a half-tone of "Stradivarius in His Workshop," and the romantic story of The King of Musical Instruments. A postal brings all to you FREE—no obligations.

CREMONA VIOLIN SHOP
Dept. D41 Chicago

Our BUREAU OF INFORMATION will answer all questions regarding articles appearing in this magazine. Address Bureau of Information, Popular Mechanics Magazine, Chicago.

What's Wrong With YOU!



Pep, Nerve, Vigor—Gone?

Do you dare ask yourself why your strength and vitality are failing—why your life-forces are ebbing away? Look at yourself in the glass and ask what's wrong? Ask yourself why you are unable to achieve success and get the joy out of life. Do you realize that your ailments and weaknesses are dragging you down? Is it Catarrh, Constipation, Rupture, Nervousness, Indigestion, Rheumatism or Bad Blood? Are you Flat Chested, Round Shouldered, too Thin or too Stout? I want to help you—I can help you.

STRONGFORTISM—The Modern Science of Health Promotion will Banish Your Ailments and Revive Your Flagging Powers—no matter what your condition is, or what caused it. I guarantee it.

Mention the subjects on the free consultation coupon (write other subjects on extra line) on which you want special confidential information and send with 10c to help pay postage, etc., on my book—"Promotion and Conservation of Health, Strength, and Mental Energy." It's a man-builder and a life-saver. Send for my free book **Right Now.**

Strongfort
The Perfect Man

LIONEL STRONGFORT

Physical and Health Specialist

Dept. 959

Newark, New Jersey

~~~~~ Cut out and Mail this Coupon ~~~~~  
FREE CONSULTATION COUPON

Mr. Lionel Strongfort, Dept. 959, Newark, N. J.—Please send me your book, "PROMOTION AND CONSERVATION OF HEALTH, STRENGTH AND MENTAL ENERGY," for postage on which I enclose a 10c piece (one dime). I have marked (X) before the subject in which I am interested.

- |                     |                 |                     |
|---------------------|-----------------|---------------------|
| .. Colds            | .. Increased    | .. Poor Memory      |
| .. Catarrh          | .. Height       | .. Rheumatism       |
| .. Asthma           | .. Pimples      | .. Falling Hair     |
| .. Hay Fever        | .. Blackheads   | .. Weak Eyes        |
| .. Obesity          | .. Insomnia     | .. Gastritis        |
| .. Headache         | .. Short Wind   | .. Heart Weakness   |
| .. Thinness         | .. Flat Feet    | .. Poor Circulation |
| .. Rupture          | .. Stomach      | .. Skin Disorders   |
| .. Lumbago          | .. Disorders    | .. Dependency       |
| .. Neuritis         | .. Constipation | .. Round Shoulders  |
| .. Neuralgia        | .. Billiousness | .. Lung Troubles    |
| .. Flat Chest       | .. Torpid Liver | .. Steep Shoulders  |
| .. Deformity        | .. Indigestion  | .. Muscular         |
| .. (Describe)       | .. Nervousness  | .. Development      |
| .. Female Disorders | .. Weaknesses   | .. Great Strength   |
|                     | .. (Specify)    |                     |

Mention other ailments here.....

Name .....

Age ..... Occupation .....

Street .....

City ..... State .....

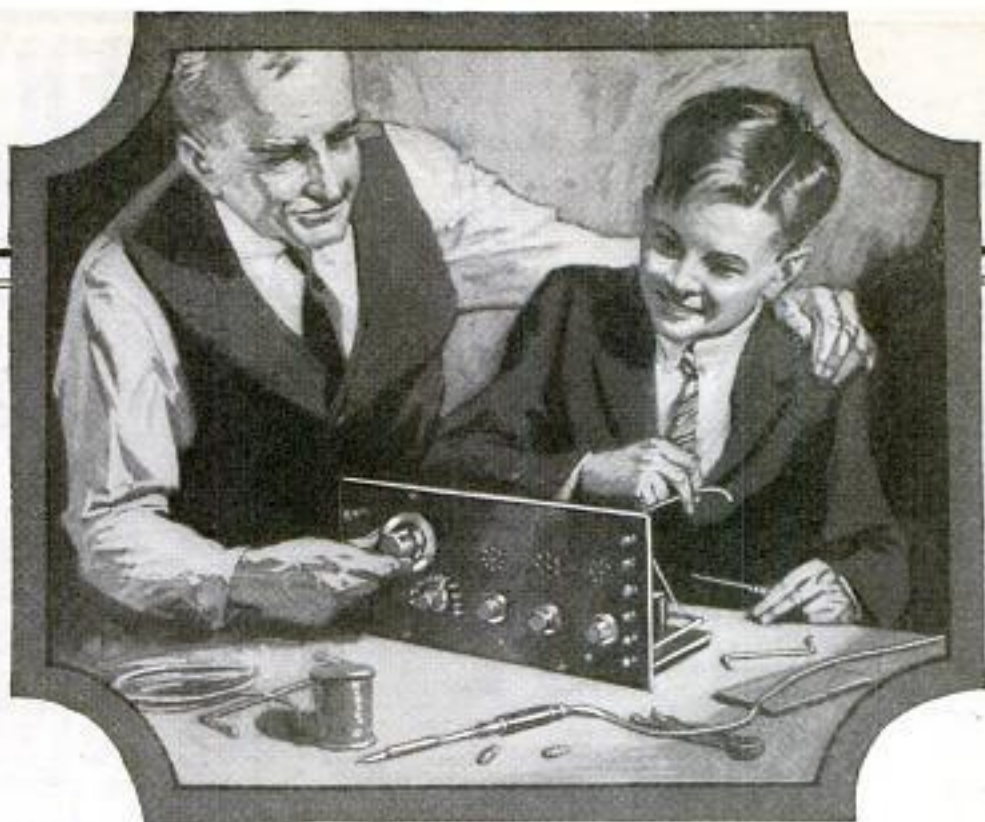

## "The fun in radio is— building your own"

**T**HERE is far more pleasure in building your own radio set than in just buying it ready-made. When you make it yourself you know the purpose of every part. Experimenting to get distant stations becomes an absorbing game.

The Sleeper Radio Corporation offers a wonderful series of construction sets. All the difficult work is done. The sets are packed ready for assembly with ordinary house tools and easily understood instructions specially prepared by M. B. Sleeper,

Editor of "Radio & Model Engineering."

The parts are all standard equipment and can be used again for different combinations. You can buy Sleeper Construction Sets from radio and electrical dealers at a fraction of the cost of finished sets.

Ask your dealer to show you the set listed below or write the SLEEPER RADIO CORPORATION, Dept. 12, 88 Park Place, New York City. Complete catalog of Sleeper Products sent on request.

### *Sleeper Construction Set, Type 2600*

**PRICE \$47.12.** Consists of long range tuning control, variometer for tuning plate circuit, detector and two-step amplifier, panels, and mounting for amplifier drilled and engraved, tuning unit assembled for mounting, including mahogany cabinet. Range 600-1400 meters. Only tools necessary are screw driver, pliers, and soldering iron. Only auxiliary articles needed are tubes, batteries and head phones. This set would cost you, if purchased completely assembled, at least \$150.00. You save the difference.

# SLEEPER

Radio

## CONSTRUCTION SETS

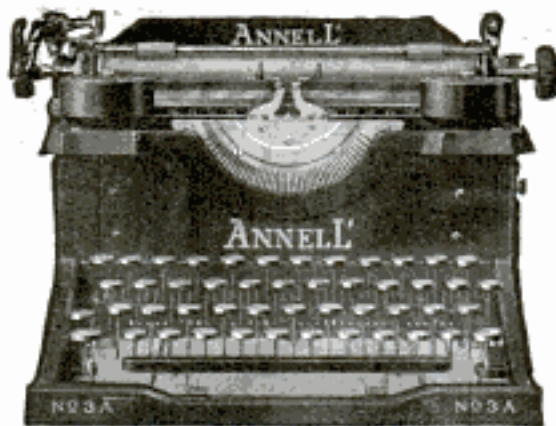

## BIG SAVING—FREE TRIAL

The Annell is Standard in size, appearance, construction and mechanical operation, with an action so smooth and a touch so responsive as to be a source of constant pleasure to the experienced operator, and making the progress of the novice immeasurably easier. It turns out beautiful work. The type is clear, clean-cut, hard; the alignment and spacing are utterly perfect. The speed is unlimited; no operator can crowd the Annell. Extremely simple in construction, it is trouble-proof, sturdy, and will last a business lifetime. It embodies the ideas and experience of mechanical geniuses who have been making typewriters and typewriter improvements for generations.

### Every Operating Feature

The Annell has every late-style feature and modern operating convenience — each letter completely visible as written (together with all the previous writing), Back Spacer, Tabulator, Two-Color Ribbon, Right and Left-Hand Shift Key, Shift-Lock, Margin Release, Adjustable Line Spacing, Adjustable Margin Stops, Paper Release, Automatic Line Spacer on Carriage Return, Adjustable Paper Fingers, etc., also the 42-Key, 84-character Universal Keyboard. Rubber cover and all extras shipped with each machine.

### Big Saving—Over a Year to Pay

We are the only company selling a Standard 42-Key, 4-Row, Brand-New Typewriter direct to the user by mail at practically the wholesale price of other high-grade typewriters. Our remarkably low price and monthly payment plan enable you to buy a brand-new typewriter easily and conveniently—over a year to pay.

### Fully Guaranteed

We protect you with an ironclad guarantee against any flaw in material or workmanship.

### No Risk—Ten-Day Free Trial

We will prove its high-grade quality by sending the Annell to you for ten days' trial. Use it on any of your work. If not satisfactory, return the machine to us. We will refund the express charges, and the trial will cost you nothing. You are the only judge. Could anything be fairer?

### Send for Information, or Send the Coupon

Send coupon or a postal today for full information about the greatest of all typewriter offers. Don't miss it. Act now.

## ANNELL TYPEWRITER CO.

680 No. 230 East Ohio Street, Chicago

### NOT AN ORDER—MAIL TODAY

ANNELL TYPEWRITER CO.

680 No. 230 East Ohio Street, Chicago.

Send me free catalog complete information about your wonderful typewriter offer. This places me under no obligation.

# MACHINERY'S Famous Books

## On SHOP PRACTICE and MACHINE DESIGN

### MACHINERY'S HANDBOOK

The one indispensable book for machine shop and drafting room. The greatest collection of practical mechanical data ever published covering the entire field of shop practice and machine and tool design. 1600 pages, 4 3/4" x 7", bound in black Korotek illustrated, indexed. Flexible bible paper, opens flat at any page. Price reduced from \$7.00 to.....\$6.00

### MACHINERY'S ENCYCLOPEDIA—7 VOLS.

A complete home study course in practical mechanical engineering. The greatest contribution to mechanical literature in 20 years. Complete and authentic data and information on every branch of mechanical engineering, practical mathematics, mechanics, machine design, machine construction, machine operation, electrical, gas, hydraulic and steam power machinery, metallurgy and many other subjects. 2045 pages and 25,000 items. Page size 8 x 11 inches. Finest quality paper and binding obtainable. Price per vol.....\$41.00

### ELECTRIC WELDING

A practical book on this important subject. 295 pages, 6 x 9 in., 213 illus., cloth.....\$3.00

### GAGE DESIGN AND GAGE MAKING

A comprehensive treatise on the development of gaging systems. 305 pages, 6 x 9 in., fully illus., cloth.....\$3.00

### GAGES, GAGING AND INSPECTION

Meets the requirements of interchangeable manufacturing practice. 295 pages, 6 x 9 in., 291 illus., cloth.....\$3.00

### AUTOMATIC SCREW MACHINES

A treatise on construction, design and operation. 342 pages, 6 x 9 in., 150 illus., cloth.....\$3.00

### ADVANCED GRINDING PRACTICE

On precision grinding methods and equipment. 244 pages, 6 x 9 in., 158 illus., cloth.....\$3.00

### HEAT TREATMENT OF STEEL

On hardening, tempering, annealing and casehardening. 276 pages, 6 x 9 in., illus., cloth.....\$3.00

### MECHANICAL DRAWING

Deals with actual methods used in well-managed drafting rooms.....\$3.00

### IRON AND STEEL

Treats the smelting, refining and mechanical processes of the iron and steel industry. 228 pages, 6 x 9 in., illus., cloth.....\$3.00

### SPIRAL AND WORM GEARING

Principles, dimensions, calculation and design. 274 pages, 6 x 9 in., 132 illus., cloth.....\$3.00

### SPUR AND BEVEL GEARING

Meets the practical needs of the machine-building trade. 306 pages, 6 x 9 in., 142 illus., cloth.....\$3.00

### THREAD-CUTTING METHODS

On the operation and use of various tools and machines for forming screw threads. 237 pages, 6 x 9 in., 211 illus., cloth.....\$3.00

### TOOLS, CHUCKS AND FIXTURES

Contains the most fundamental and complete descriptions of tools and devices for machining operations. 294 pages, 6 x 9 in., 184 illus., cloth.....\$3.00

### TURNING AND BORING

Most comprehensive treatise on lathe and boring mill work so far published. 307 pages, 6 x 9 in., fully illus., cloth.....\$3.00

### MECHANISMS AND MECHANICAL MOVEMENTS

Those originating new devices or perfecting machines now in use will find this book of utmost value. 310 pages, 6 x 9 in., 164 illus., cloth.....\$3.00

### MODERN TOOLMAKING METHODS

A complete, logically arranged and comprehensive treatise on toolmaking. 309 pages, 6 x 9 in., 178 illus., cloth.....\$3.00

### PRODUCTION MILLING

Deals with methods employed in progressive American shops for obtaining quantity production.....\$3.00

### JIG AND FIXTURE DESIGN

A treatise covering the principles of jig and fixture design, etc.....\$3.00

### DIEMAKING AND DIE DESIGN

A subject of great importance to every one interested in modern manufacturing methods. 329 pages, 6 x 9 in., 222 illus., cloth.....\$3.00

### SHOP MATHEMATICS

Teaches how to solve the problems arising in everyday shop practice. 275 pages, 6x9 in., fully illus., cloth.....\$3.00

### PATTERNMAKING

The making of patterns and core-boxes and the production of castings from patterns.....\$3.00

### MODERN DRILLING PRACTICE

On the use of various types of single and multiple spindle drilling machines. 225 pages, 6 x 9 in., fully illus., cloth.....\$3.00

### PLANING AND MILLING

On the use of planers, shapers, slotters and milling machines and their attachments. 306 pages, 6 x 9 in., 234 illus., cloth.....\$3.00

### OXY-ACETYLENE WELDING

Equipment and methods required for the oxy-acetylene welding of cast iron, malleable iron, steel, copper, brass, bronze and aluminum.....\$3.00

### SHOP MANAGEMENT AND SYSTEMS

Organization of machine building plants and methods essential to efficient administration. 207 pages, 6 x 9 in., 159 illus., cloth.....\$3.00

Above prices postpaid. Order any of these books under our plan of satisfaction guaranteed or money refunded.

**POPULAR MECHANICS BOOK DEPT.**  
6 N. Michigan Ave., Chicago

Please Mention Popular Mechanics

## Finest Instruments

FOR more than a quarter century King Brass Instruments have been built to the specifications of world-famous musicians. Every King Instrument has the latest improvements—is built by experts—and is thoroughly tested in our sound laboratory before being shipped. That's why every good musician praises the King.

### Perfect Instruments Easiest to Play

Whether you are just learning to play or are a finished musician you will find these wonderful King Saxophones, Trumpets, Trombones and Horns easier to play than any other make. The wonderful tone-quality is admired by everyone.

It's easy to own a King. You can now buy on easy payments direct from the factory, save middleman's profits, and get a brand new acoustically perfect laboratory-tested King Instrument. Every King is fully guaranteed. Write for free catalog.

### THE H. N. WHITE COMPANY

5240 Superior Avenue

Cleveland, Ohio



Rebuilt Instruments  
Write for list of bargains  
in rebuilt instruments.  
Lowest prices.



Ask for latest illustrated catalog of all King Instruments. Mailed free upon request.



BAND "KING" INSTRUMENTS



## "Look At Him Today!"

"Six years ago he started in here just as you are doing. Now he's General Manager and makes more in a day than he used to make in a week. The first week he was here he began to train for the job ahead by studying in spare time with the International Correspondence Schools. Inside of six months he got his first promotion. You've got the same chance he had, young man. Follow his example. Take up some I. C. S. course right away. What you are six years from now is entirely up to you."

This is the story of thousands of successful men. They did their work well, and in spare time, with I. C. S. help, trained themselves for advancement. That's the thing for you to do. Whatever your chosen work may be, there is an I. C. S. Course that will prepare you right at home for a better position with bigger pay.

More than 150,000 men are getting ready for promotion right now in the I. C. S. way. Let us tell you what we are doing for them and what we can do for you. The way to find out is easy. Just mark and mail this coupon.

### INTERNATIONAL CORRESPONDENCE SCHOOLS Box 5667-C, Scranton, Penna.

Without cost or obligation, please send me full information about the subject before which I have marked an X in the list below:

#### BUSINESS TRAINING DEPARTMENT

- |                                                         |                                                 |
|---------------------------------------------------------|-------------------------------------------------|
| <input type="checkbox"/> Business Management            | <input type="checkbox"/> Salesmanship           |
| <input type="checkbox"/> Industrial Management          | <input type="checkbox"/> Advertising            |
| <input type="checkbox"/> Personnel Organization         | <input type="checkbox"/> Better Letters         |
| <input type="checkbox"/> Traffic Management             | <input type="checkbox"/> Foreign Trade          |
| <input type="checkbox"/> Business Law                   | <input type="checkbox"/> Stenography and Typing |
| <input type="checkbox"/> Banking and Banking Law        | <input type="checkbox"/> Business English       |
| <input type="checkbox"/> Accountancy (Including C.P.A.) | <input type="checkbox"/> Civil Service          |
| <input type="checkbox"/> Nicholson Cost Accounting      | <input type="checkbox"/> Railway Mail Clerk     |
| <input type="checkbox"/> Bookkeeping                    | <input type="checkbox"/> Common School Subjects |
| <input type="checkbox"/> Private Secretary              | <input type="checkbox"/> High School Subjects   |
| <input type="checkbox"/> Business Spanish               | <input type="checkbox"/> Illustrating           |
| <input type="checkbox"/> French                         | <input type="checkbox"/> Cartooning             |

#### TECHNICAL AND INDUSTRIAL DEPARTMENT

- |                                                   |                                                  |
|---------------------------------------------------|--------------------------------------------------|
| <input type="checkbox"/> Electrical Engineering   | <input type="checkbox"/> Architect               |
| <input type="checkbox"/> Electric Lighting        | <input type="checkbox"/> Contractor and Builder  |
| <input type="checkbox"/> Mechanical Engineer      | <input type="checkbox"/> Architectural Draftsman |
| <input type="checkbox"/> Mechanical Draftsman     | <input type="checkbox"/> Concrete Builder        |
| <input type="checkbox"/> Machine Shop Practices   | <input type="checkbox"/> Structural Engineer     |
| <input type="checkbox"/> Railroad Positions       | <input type="checkbox"/> Plumbing and Heating    |
| <input type="checkbox"/> Gas Engine Operating     | <input type="checkbox"/> Chemistry               |
| <input type="checkbox"/> Civil Engineer           | <input type="checkbox"/> Pharmacy                |
| <input type="checkbox"/> Surveying and Mapping    | <input type="checkbox"/> Automobile Work         |
| <input type="checkbox"/> Mine Foreman or Engineer | <input type="checkbox"/> Navigation              |
| <input type="checkbox"/> Steam Engineering        | <input type="checkbox"/> Agriculture and Poultry |
| <input type="checkbox"/> Radio                    | <input type="checkbox"/> Airplane Engines        |
| <input type="checkbox"/> Mathematics              |                                                  |

Name.....  
Street.....  
Address.....  
City..... State.....

Occupation.....  
Persons residing in Canada should send this coupon to the International Correspondence Schools Canadian, Limited, Montreal, Canada.

Our BUREAU OF INFORMATION will answer all questions regarding articles appearing in this magazine. Address Bureau of Information, Popular Mechanics

**\$1500 to \$3000 PROFIT Yearly**  
Charging Batteries  
An HB Battery charger brings big profits charging auto and radio batteries. \$20 cash brings outfit, balance on easy monthly terms, more than paid by your profits. Money-back guarantee. Cut out this ad and mail with your name.  
HOBART BROS. CO., Box M94, TROY, OHIO

**AGENTS MAKE BIG PROFITS**  
selling our handy household device, sells on sight. An old soldier sold sixteen gross in five months. Write today for this big money making proposition.  
BENJ. P. FORBES CO., 488 Superior Ave., N. W., Cleveland, Ohio

**RADIO For Everybody**  
What do you want to know about Radio? Hook-ups, diagrams, laws, codes, code-work, definitions, testing instruments, use of equipment—everything you want to know fully explained in new, easy, home-study course. Qualify for Government First-Grade license in your spare time. Famous radio experts help you. Write for free book today.

National Radio Institute  
Dept. 1293M,

1345 Pennsylvania Ave., N. W. Washington, D. C.

## ANY BOY CAN BUILD THIS 20" CAT BOAT

with our complete  
Construction Set.

"Everything but  
the paint"

**\$5.00**

We have other boats, engines, boilers, etc.

Catalog Free

The H. E. Boucher Mfg. Co.  
154 Lafayette St., New York



## VICTORY Canary Songster



The Victory Canary Songster produces a more natural and effective warble than any we have seen. The imitation is wonderfully sweet and perfect. The sweet musical notes, the trills and warblings are perfectly and easily produced, and at the same time the automatic movement of the bill and tail lend a touch of realism. It will make dumb canaries sing and teach parrots to warble in a very short time. Handsomely finished in Canary Gold Color, with rubber tube and mouthpiece. Each in handsomely decorated box. PRICE ONLY 25 cents each postpaid.

**JOHNSON SMITH & CO., Dept. 891, 3224 N. Halsted St., Chicago.**

### STAGE MONEY



With a bunch of these bills, it is easy for each person of limited means to appear prosperous. By flashing a roll of these bills at the proper time and peeling off a genuine bill or two from the outside of the roll, the effect created will be found to be all that can be desired. Prices, postpaid: 15 Bills 10c, 50 Bills 25c, 125 for 50c, or \$3.50 thousand.

### WONDERFUL X-RAY TUBE



A wonderful little instrument producing optical illusions both surprising and startling. With it you can see what is apparently the bones of your fingers, the lead in a lead pencil, the interior opening in a pipe stem, and many other similar illusions. A mystery that no one has been able to satisfactorily explain. Price 10 cents; 3 for 25 cents; 1 dozen 75 cents. **JOHNSON SMITH & CO.**



### Good Luck Ring

Quaint and Novel Design

A VERY striking and uncommon ring. Silver finish, skull and crossbones design, with two brilliant, flashing eyes sparkling out of the eyes. Said by many to bring Good Luck to the wearer, hence its name, Good Luck Ring. Very strange ring that you will take a pride in wearing. **ONLY 25 CENTS.**

Address orders for all goods on this page to

## JOHNSON SMITH & CO.

Dept. 891 3224 N. Halsted St. Chicago

Our large catalog (300 Pages) of all the newest and best novelties, unobtainable elsewhere, free with every order.

## The Dying Pig



The most laughable novelty yet produced. Made of rubber, and you have only to blow it up and stand the pig on his feet, when he begins to squeal as he slowly collapses and finally lies down and dies in the most natural manner. You can blow him up as often as desired, and each time he will go through the same performance to the great amusement and delight of your friends. Price, 15 cents; 3 for 40 cents, one dozen \$1.25, mailed postpaid.

### Popular Watch Charms



Very pretty little curiosities and decidedly novel. Fitted with Magnifying Lenses they enlarge the pictures to a very surprising degree; in fact, it seems almost incredible that a clear picture could be possible in such a small compass, and how sharp and distinct they show up when you look through. Come in assorted views—Acrobats, views of Panama Canal, Lord's Prayer in type, etc.

Price 15c; 3 for 40c; \$1.35 doz.

### Mystic Skeleton

A jointed figure of a skeleton 14 in. in height, will dance to music and perform various grimaces and movements while the operator may be some distance from it.



### Serpent's Eggs

Box contains 12 eggs. When lit with a match, each one gradually hatches into a snake several feet long, which curls and twists about in a most life-like manner. Price per box, 15c postpaid.



### NEW BOOK ON ROPE SPLICING

Useful Knots, Hitches, Splices, etc.

A most practical handbook giving complete and simple directions for making all the most useful knots, hitches, splices, etc. Over 100 illustrations. All about wire rope attachments, lashings, blocks, tackles, etc. 27 Heraldic Knots illustrated. Of great value to mechanics, riggers, engineers, boatmen. Price 20c postpaid.



### MAGIC FLUTE

Wonderfully Sweet Toned and Musical



The Magic Flute, or Humanatone, is a unique and novel musical instrument that is played with nose and mouth combined. There is just a little knack in playing it which, when once acquired after a little practice will enable you to produce very sweet music that somewhat resembles a flute. There is no fingering, and once you have mastered it you can play all kinds of music with facility and ease. When played as an accompaniment to a piano or any other musical instrument, the effect is as charming as it is surprising. 25c postpaid.

## BLANK CARTRIDGE PISTOL



Well made and effective, modeled on latest type of revolver; appearance alone is enough to scare a burglar. When loaded it may be as effective as a real revolver without danger to life. It takes standard .38 & .45 Cal. Blank Cartridges originally recommended. Price 50c., superior quality \$1.00 postpaid. Blank Cartridges, by express, 50c per 100.

**JOHNSON SMITH & CO., Dept. 891, 3224 N. Halsted St. Chicago**

### DANCING BEAUTIES

Get a Kinetograph and see the picture move. France's latest sensation. A great surprise. Is worth twice what they cost. Are made of solid brass, highly nickel and very durable. Satisfactory or your money back. 50c Don't show your girl. Price 50c



**JOHNSON SMITH & CO., Dept. 891, Chicago**

**BOYS! BOYS! BOYS!**

## THROW YOUR VOICE

Into a trunk, under the bed or anywhere. Lots of fun fooling the teacher, policeman or friends.

**THE VENTRILO**  
a little instrument, fits in the mouth out of sight, used with above for Bird Calls, etc. Anyone can use it.

Never Fails. A 32 page book on ventriloquism, the Ventrilo, ALL FOR 10 CENTS

**1000 Silk Remnants** for patching Crazy Quilts, Sofa Cushions, Head Rests, Pin Pads etc. Large pieces, all colors and shades. Sure to delight you.

**For 10 Cents**, stamps, we send a large package and Book of quilt designs. 3 packages 35c. 1 pound makes a lovely large quilt. Price 10c postpaid. Our silk is the best.

**JOHNSON SMITH & CO., Dept. 891, 3224 N. Halsted Chicago**

## LOOK 50c Look

Wonderful instrument. Greatest thing yet. Nine separate articles in one. Everybody delighted with it. Odd, curious and interesting. Lots of pleasure as well as very useful. It is a double Microscope for examining the wonders of nature. It is also an Opera Glass, a Stereoscope, a Burning Lens, a Reading Glass, a Telescope, a Compass, a Pocket Mirror, and a Laryngoscope—for examining eye, ear, nose and throat. It is worth all the cost to locate even one painful cinder in the eye. Folds flat and fits the pocket. Something great—you need one. Don't miss it! Sent by mail, with 300 page Novelty Catalog, **ONLY 50c or 3 for \$1.25**



## Resurrection Plant

One of the most wonderful plants known. Possesses the strange power of turning in a few minutes from an apparently lifeless, dry herb to a beautiful living fernlike plant of a dark green color. Simply place the plant in saucer of water, it will open up and start to grow in 20 minutes. When taken out it will dry up and go to sleep until placed in water again. Fine house plant—summer or winter. 10 cents each or 3 for 25c. **AGENTS WANTED** post paid.

**JOHNSON SMITH CO., Dept. 891, 3224 N. Halsted, Chicago**



# Amazing Home Cleaning Invention Brings New Freedom to Housewives

Again invention has triumphed over labor in the home. A wonderful device that does all home cleaning by electricity—new freedom to housewives from the most arduous and wearing part of housework. This new invention is not limited to the sweeping of floor covering only; for without the use of extra, cumbersome, impractical attachments, all kinds of sweeping, cleaning and dusting about the house can be done. The new Air-Way is the ultimate and long sought for invention that is a practical and thorough house cleaner. It is of almost unlimited utility in keeping the household in perfect cleanliness.



## The New Air-Way

### Complete Electric Home Cleaner

This new appliance cannot be compared with any vacuum cleaner or sweeper that you have ever seen or heard about. It is fundamentally different, both in its design and its utility. The inventor has disregarded all the accepted standards of vacuum cleaner construction, and has created a device with a multitude of uses, which in addition is so light in weight and so easy to use that a child can carry it and use it from cellar to attic.

Not only does it clean carpets and rugs more thoroughly, quickly and easily, but you can just turn the machine around and clean a hundred different places through the hollow suction handle. Note illustration on the left and description of the amazing advantages derived from this single improvement. Then remember that in this new cleaning device there are four additional and just as revolutionary improvements. Everywhere this new machine is shown, women instantly recognize its multiplied advantages, because it

### Does All Extra Dusting and Cleaning Through Hollow Suction Handle

When you see the new Air-Way you will marvel at this great improvement which uses the handle for cleaning purposes. The Air-Way cleans carpets and rugs on the floor even more efficiently than the best old style electric vacuum cleaner. Yet this is only a small part of necessary house cleaning. With the Air-Way, when you finish the carpets and rugs, you just turn the machine about, reverse the suction, and do all kinds of cleaning through the hollow suction handle.

The marvelous light weight and perfect balance enables you to handle the new Air-Way as easily as you would point a broom handle. You don't have to climb on a step ladder to reach all the high spots, because you can comfortably hold and work the Air-Way at arm's length and clean things with the tip of the handle. With this ingenious improvement you get the dust from the picture frames, and from the tops of mouldings, and get the cobwebs from the corners, of eaves and dirt over door casings, around base-boards, under the radiators, down in the registers, and a hundred and one hard-to-get-at places. In addition you can clean all the upholstered furniture, draperies, tufts of mattresses, etc.

The suction power is just as great through the handle as through the floor nozzle. And it is always ready instantly, by the simple turn of the wrist, to take care of the scores of little cleaning tasks that would either be neglected in ordinary cleaning, or done with considerable extra effort.

Yet the hollow suction handle is only one of the five great Air-Way improvements, which give it universal utility in the home.

Space in this announcement is not sufficient for a description of all these improvements. Each, however, is as revolutionary as the hollow suction handle, multiplies the utility of this new device, and completes an invention that is desired by every woman no matter how she is now doing her house cleaning.

House-cleaning has always advanced through revolutionary stages. From the broom and dust pan to the carpet sweeper, then to the electric vacuum floor cleaner, and now to this great, revolutionary, complete home cleaner, which is offered at a nominal price, which every home can afford.

### Sweeps, Cleans, Dusts All Floors, Furniture and Furnishings Without Extra Attachments

In other words, the new Air-Way is a complete home cleaning appliance all in one unit—no extra attachments to buy or adjust or bother about. It is always ready for all kinds of cleaning throughout the house. Furthermore, it weighs less than half and costs less than other electric cleaners on the market, which are good for cleaning carpets and rugs only.

## WANTED Distributors, Local Agents and Salesmen

We have many splendid territories open which offer exceptional profit opportunities to competent distributors, local agents and salesmen. Men applying for distributorship must be financially able to carry the necessary stock of machines, and be competent to employ, train and manage salesmen. In every community there is a big cash profit opportunity for a responsible, honorable and energetic local agent or salesman. Appointments are now being made throughout the country, and applicants should give full details and references. Telegrams will hold territory if complete information is mailed. If you can qualify as agent, salesman or distributor this is an opportunity that will fulfil your greatest business ambition. For full particulars, address:



Complete Cleaner & Sweeper in One Unit

**AIR-WAY ELECTRIC APPLIANCE CORP., TOLEDO, OHIO**

# Twice the Heat in Any Stove

## Without Coal or Wood

### Instant-Gas

Cheaper than coal or wood, cleaner, no work, no dirt, no ashes, soot or smoke. No building of fires, no wood boxes or coal buckets. No shortage of fuel, no high prices and no strikes to worry about. No slaving with hatchets, axes and shovels. No dirt and ashes to make work for you.

### MAKES GAS IN ANY STOVE

Don't worry with dampers, flues and pokers. Don't interrupt yourself a hundred times a day just to keep the fires going. Don't be satisfied with a heat that is never what you want it. Use INSTANT-GAS

#### Turn on the Heat and Forget It

Have as much or as little heat as you need, twice as much as coal or wood if necessary. Instant-Gas is started, stopped and regulated with a simple valve. Better cooking and baking because you can have the heat you want. Better heating because it can be controlled. No ups and downs to ruin your cooking and give the family colds. Less work because all you have to do is to keep the reservoir supplied with kerosene.

#### Why Burden Yourself

with coal or wood fires when Instant-Gas is just as economical and saves all the work? Can be put in any heating or cooking stove in a few minutes at a cost of only a few dollars. No drilling, cutting or other damage to stove. Gas is made from

### AGENTS

Our free literature tells how others are making and how you can make tremendous profits as agent for the Instant-Gas.

Men and women—part time or all time. Write today for agency and sample.

coal oil or kerosene automatically. All you have to do is to start it—a mere matter of turning a valve, applying a match and then regulating the blaze to the proper heat. From then on you are FREE. The fire will take care of itself. Already giving satisfaction in thousands of homes.

#### THIRTY DAYS' TRIAL AT OUR RISK

You can try this wonderful burner in your own home without any risk whatever. We are anxious to prove to you at our own risk what a great time, trouble, labor and money saver it is. Write today for our thirty-day trial offer and special low price.

**INTERNATIONAL HEATING CO.**  
4553 North Broadway ST. LOUIS, MO.

## NEW WITTE

KEROSENE LOG SAW

**Runs Steadier  
Cuts Faster  
More Power  
EASIER To Handle  
Burns Kerosene  
or Gasoline**



Saws 'Em Down—Cuts 'Em Up—

**New Price**  
**\$89<sup>50</sup>**

F.O.B. K.C.  
From Pittsburgh \$96.00

**Built for Men Who Need A Rapid-Cutting Money-Making Log Saw**

Portable and Easy to Operate. Use engine also to pump, grind, buzz wood, or do other belt work. Comes all set up ready to use.

**Only Log Saw Sold On LIFETIME GUARANTEE—Cash or Easy Terms**

**See What You Get**—Special 4-cycle Log Saw Engine—More power than needed—Less weight—Lever controlled clutch—Double arm swing motion and other valuable WITTE improvements. Users say: "Cut 30 cords hard maple in 8 hours"—"Downed 50 trees in 7 hours"—"Best on market"—"Runs smooth"—"Works fine". If that is the kind of a rig you want, write us. **CATALOG FREE.**

**WITTE ENGINE WORKS**  
1741 Oakland Avenue, KANSAS CITY, MO.  
1741 Empire Building, PITTSBURGH, PA.



### WHERE ARE MY TOOLS

Left around somewhere? Lost? Damaged? Stolen? Not if you keep them in a Union Tool Chest. It often saves its cost the first month by keeping your tools safe and in order. Write for booklet describing more than fifty styles and sizes.

**UNION TOOL CHEST CO.**  
22 Mill Street Rochester, N. Y.

**\$28 Brings FREE AIR SERVICE**

Your profits on new business gained by reliable air service easily carry small monthly payments on balance in purchasing H.B. Automatic Air Compressor. Constant pressure of 140 to 150 pounds day and night. No repairs. Entirely automatic in operation. Brings new trade to your shop, pays for itself easily and shows a nice profit. Tear out this ad and mail for information.

**ROBERT BROS. CO. BOX M93 TROY, OHIO**



### World Batteries

FOR RADIO OR AUTOMOBILE

## SAVE YOU 50%

Buy direct from factory. Pay only one profit. Highest quality made.—lowest prices.

**WRITTEN TWO-YEAR GUARANTEE**

**AUTOMOBILE PRICES**

**6 Volt, 11 Plate - \$12.50**  
Ford, Chev., Mitch., Nap., Great, Elgin, Vels., Baxon.

**6 Volt, 13 Plate - 14.50**  
Overland, Buick, Geo., Paige, Hudson, Nash, Stude, and Dori.

**12 Volt, 7 Plate - 29.00**  
Maxwell, Dodge, Regal, Frank, Biscuit, and Crow-Elliott.

Give year and model of car.

We defy price competition, a glance at the prices below will convince you that the World Battery is the best buy on the market. Batteries shipped immediately. Express C. O. D. Begin now to get 100% battery service at one-half cost. Mail your order today.

**RADIO PRICES**

|                  |         |
|------------------|---------|
| 6 Volt, 40 Amps. | \$ 8.50 |
| 6 " 60 " "       | 10.00   |
| 6 " 80 " "       | 12.50   |
| 6 " 100 " "      | 14.50   |

**WORLD BATTERY CO.,** 1219 S. Wabash Ave. Dept. P., Chicago, Ill.

# 1923 Indian Motorcycle Prices down to

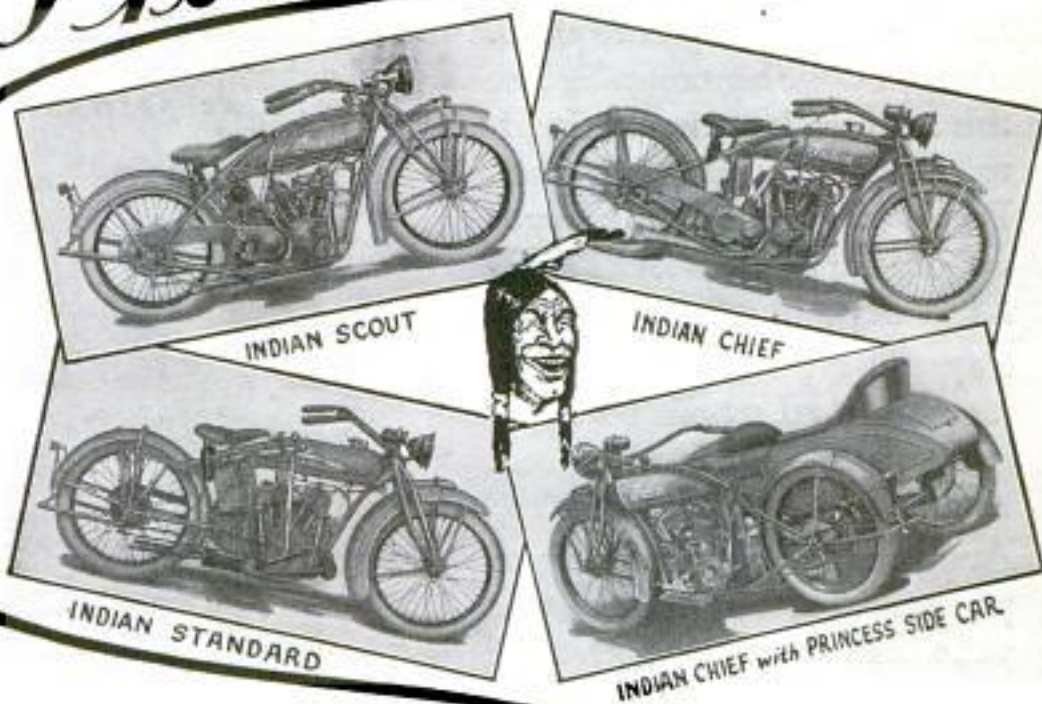

|                                  | BED   | ROCK  |       |
|----------------------------------|-------|-------|-------|
| INDIAN SCOUT - - - -             | 1923  | 1922  | 1921  |
| INDIAN SCOUT Electric - - - -    | \$250 | \$315 | \$400 |
| INDIAN STANDARD - - - -          | 285   | 345   | 440   |
| INDIAN STANDARD Electric - - - - | 275   | 335   | 440   |
| INDIAN CHIEF - - - -             | 310   | 370   | 480   |
| INDIAN CHIEF - - - -             | 325   | 435   |       |
| INDIAN PRINCESS SIDE CAR - - - - | 100   | 120   | 145   |

F. O. B. FACTORY

See the nearest Indian Dealer or write for information

## HENDEE MANUFACTURING COMPANY

Largest Motorcycle Manufacturer in the World

Dept. 37

SPRINGFIELD, MASS.

NEW PRICES GIVE NEW OPPORTUNITIES FOR MORE AGENTS  
VALUABLE TERRITORY OPEN—WRITE FOR PARTICULARS

# \$600 to \$5000 A YEAR FROM NEW-FOUND PROFIT!

**H**ERE'S how you can do it. Place a BUTTER-KIST Popcorn Machine in unoccupied space and sell popcorn and peanuts to hungry throngs. Any store has the small space required. You can make big profits because this machine is a winner. It actually draws trade to your store. People will go out of their way to get a bag of delicious BUTTER-KIST Popcorn.

Popcorn is an everyday seller, month in and month out. So are peanuts. The Machine sells both—lots of them!

And you can make profits! 60 to 70 cents out of every dollar's worth you sell is yours to keep! Think of it! That's why profits of BUTTER-KIST Popcorn Machines range from \$600 to \$5000 a year, depending on your location.

**HOLCOMB & HOKE MFG. CO.**

*World's Largest Manufacturers of Popcorn  
Machines and Peanut Toasters*

**2100 Van Buren St. Indianapolis**

HOLCOMB & HOKE MFG. CO.,  
2100 Van Buren St., Indianapolis, Ind.

Please send me, without obligation on my part, your free Butter-Kist book, "America's New Industry." I also want the Location Chart which I will fill out and return to you.

Name \_\_\_\_\_  
Address \_\_\_\_\_  
City and State \_\_\_\_\_  
Business \_\_\_\_\_

Let us send you a "Location Survey" that will help you to estimate your possible profits from this machine. Fill in and mail the coupon. It may mean the biggest thing you have ever done to increase the profits of your business.

**BUTTER-KIST Popcorn**  
"America's Oldest Treat"

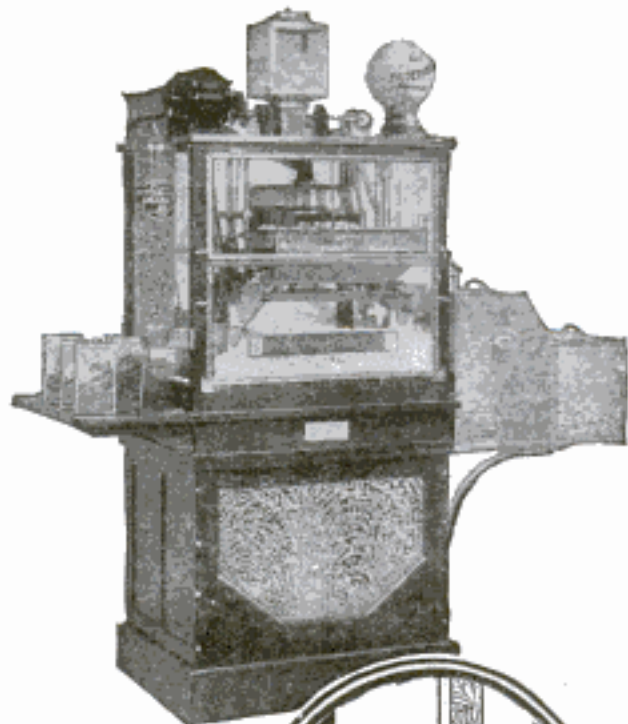

*The EASY PAY-  
MENT PLAN makes  
it easy for you to own  
one of these money-  
makers. Easy Pay—  
Easy Profits. That's  
the story. Send the cou-  
pon NOW.*

# BUTTER-KIST POPCORN AND PEANUT MACHINES

# These Men Earn \$10<sup>TO</sup> \$40 a Day!



## Demonstrating This Wonderful 300 Candle Power Light

*You have the same  
Opportunity!*



C. E. Hartley, one of our Ohio Representatives, has earned over \$1000 in a few months with The Diamond Light. His daily profits run between \$10 and \$40.



George U. Vivian, one of our Minnesota Representatives, who has found that \$39 profit for one day's effort is comparatively easy. He has made \$400 in 39 days with The Diamond Light sales plan.



James M. Connelly, a Pennsylvania Representative. He earned \$39 the first day he was appointed and in 23 days made over \$300 demonstrating The Diamond Light.

Never has a more practical and convenient light been designed. Its soft 300 candle power brilliance meets the need of millions of homes. Its simplicity, operating economy and beauty wins instant approval wherever it is shown. That is the reason hundreds of our representatives are earning from \$10 to \$40 a day by merely demonstrating The Diamond Light.

### Burns Gasoline or Kerosene

Its convenience and safety are unequalled. It lights with a match as easily as an old style wick lamp and burns gasoline or kerosene giving the same 300 candle power white light with either fuel. Only 4 per cent of fuel is consumed with 96 per cent of air. This saves more than the cost of The Diamond Light in a few months' time.

### Your Big Opportunity

You can do what these men shown here and hundreds of others are doing. It is no trick to make big money representing us. You have no competition. Each representative is given exclusive territory and The Diamond Light makes sales wherever it is demonstrated. You start making money immediately. H. I. Shumard, an Ohio man,

made \$30 his first day as representative; Leonard Leach, a Wisconsin man made \$75 in three days.

### No Sales Experience Needed

You do not need sales experience to make a success as our representative. We give you all necessary help and complete instructions. W. H. Everwine, was an electrician and increased his earnings \$200 a month; J. M. Connelly was a painter and earned \$39 his first day; George Vivian was a carpenter. Instructions are easy to follow and profits are certain.

You can devote either your spare time or your whole time to this proposition and increase your earning power. This is a real opportunity to develop a good paying business of your own.

### Send This Coupon Today!

Through our special sales and advertising plan you can make demonstrations by appointment. Business starts the first day. There is no peddling nor investing. You do not have to bother with collections or deliveries. Our plan is a simple straightforward money-earning opportunity. Fill in this coupon and mail it today. There is no obligation.

**COUPON**  
 THE AKRON LAMP CO., 109 Lamp Bldg., Akron, Ohio.  
 Gentlemen: I would like to know more about your sales plan and how I can earn \$10 to \$40 a day acting as your representative.  
 Name.....  
 Address.....

## The AKRON LAMP CO.

109 Lamp Bldg., AKRON, OHIO

Established 1898

# AUTO SUPPLIES

at the Latest Price Reductions  
in this **BIG FREE BOOK**

LOOK AT THESE LOW PRICES

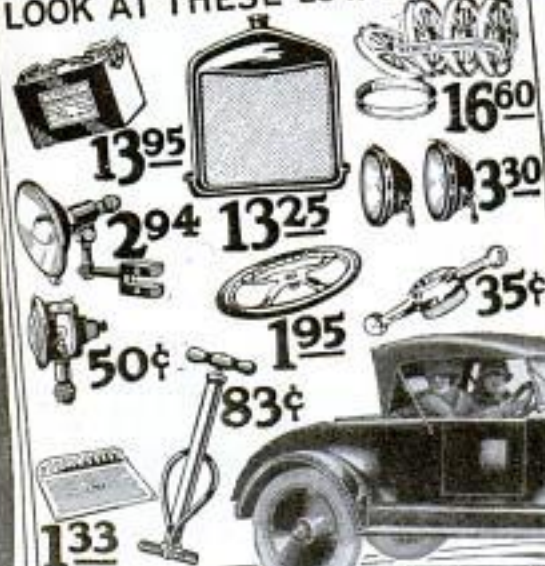

Radiators, batteries, headlights, spotlights —all kinds of repair parts and accessories for Fords and other cars are listed in this big book. Lowest prices anywhere—all parts standard quality.

### SPECIAL BODIES FOR FORD CARS

We make 12 different styles of special bodies for Fords and Chevrolets. Roadster, speedster, and classy touring bodies at bargain prices. Big free book tells all about them. Send for it today.

Bodies for Ford Cars

**29<sup>85</sup>**  
AND UP

NEMCO BARGAIN SUPPLY HOUSE

1017 W. Van Buren St., Chicago



## CARTER Oil Gauge

If your dealer can not supply you, send remittance, or order by parcel post C. O. D. Easy to screw gauge on instrument board, connect copper tube in place of lower petcock on Ford or Chevrolet. No oil passes thru gauge or tube.

**Accurate—Durable—Guaranteed**  
Order before cold weather; you will need it. It will save its cost many times in oil and wear on the engine.

*Buick Type ready Aug. 15, \$5.00*

**CARTER MOTOR ACCESSORIES, Inc.**  
340 Pearl Street Buffalo, N. Y.

**Ford  
Chevrolet  
Only \$3  
Buick \$5**

### \$15.00 TO \$50.00 PROFIT PER DAY

Outfit cleans, polishes, renews auto finish. Contains chemical duster, polishing mitt, cleansing and renewing liquid. Raises car resale value. Sells on sight. Exclusive territory. 100% profit. Fine street demonstration.

#### Free—Regular 50c Windshield Cloth

To introduce we give free regular 90c Windshield Cloth and spray charges on first order only. Outfit retails \$5.35. Need \$2.00 money order or bill, get complete outfit, FREE Cloth, agents' proposition. Act NOW.

**BARTELLE HAMILTON COMPANY, Dept. 38, Toledo, Ohio**

## RADIO For Everybody

Radio, the new wonder science offers you a glorious opportunity to travel all over the world as an operator on a ship and at the same time earn a fine salary. Wonderful new course prepares you quickly in spare time at home. Famous Radio experts help you. Four wonderful practice instruments free. Write for free book "How to Learn Radio at Home."

**National Radio Institute**  
Dept. 1203B,

1345 Pennsylvania Ave., N. W.

Washington, D. C.

## Great Diamond Ring Bargain

Perfectly cut, genuine blue-white Diamond held aloft on six white gold prongs. Gentleman's 14K Green Gold, hand-carved mounting, trimmed with artistic scroll designs of White Gold.

**Send No Money**—Ring sent FREE for your approval. If entirely satisfied pay only \$10, then \$5 a month, for ten months until the total price of \$60 has been paid.

**Free Gift Book** shows thousands of other bargains in Diamonds, Watches and Jewelry. Send for copy No. 62-P.

**\$5<sup>00</sup>**  
A Month



Buy Today  
10  
Months  
TO PAY

"THE HOUSE OF QUALITY"

**L.W. SWEET INC.**  
1650-1660 BROADWAY, NEW YORK.

ONLY  
\$ **3**  
DOWN  
and you  
keep this  
typewriter



DIRECT  
to you  
from our  
Factory  
Electric  
Desk Lamp  
FREE

## Yes, we will ship you this Genuine Underwood

Rebuilt in our own factory just like new for  
**ONLY \$3 down—NOT ONE CENT MORE**  
Until you have tried the machine 10 full days at our expense



Our Factory

**EVERY MACHINE** is fully guaranteed. New parts wherever needed. New enamel, new nickel, new lettering, new platen, new key rings—a complete, perfect typewriter. Impossible to tell it from a brand new Underwood either in appearance, durability or quality of finished work.

An up-to-date machine with two-color ribbon, back spacer, stencil device, automatic ribbon reverse, tabulator, etc. In addition we furnish FREE waterproof cover and special Touch Typewriter Instruction Book. You can learn to operate this Underwood in one day.

**Electric Desk Lamp  
FREE**



For a limited time only we offer this handsome flexible arm electric desk lamp free with a guaranteed Shipman-Ward Rebuilt Underwood. Lamp has flexible arm, can be moved in any position and comes complete with 6-foot cord, shade, plug, etc., but without bulb. You can have your choice of lamp in four finishes. Send in the coupon quick and learn about this great free offer. Remember, we have only a limited number of these handsome lamps. **Write Now**

**Shipman-Ward Mfg. Co.**  
"Typewriter Emporium"  
Montrose and Ravenswood Aves., Chicago

### Write Right Now

and learn how it is possible for us to ship you this Underwood Typewriter upon our free trial plan and our direct-to-you money saving methods. Get the full details now—just sign the coupon and mail today. Get all the facts—then decide.

### No Obligation

—to buy. You don't have to order. Just sign the coupon, send it to us and we will mail you our big catalog absolutely free, or we will ship the machine at once if you will check the coupon showing you want it without waiting for the catalog.

Send the  
Coupon  
Today

**10 Days'  
Free Trial**

You have ten full days in which to try the typewriter before deciding whether you want to keep it. Give it every test—see for yourself—make the Underwood prove its worth to you. Don't take our word for it—put the Underwood before you and see if you don't think it the greatest typewriter bargain ever offered.

This is the genuine Underwood Typewriter. We offer you the same three models of the Underwood Typewriter being made and sold by the manufacturers today. **Standard 4-row single shift keyboard. Absolutely visible writing—the full line of typewriting is visible at all times.** All the improvements and attachments that any high grade typewriter ought to have.

### Big Saving to You

Our plan of selling to you direct makes possible enormous savings, which are all for your benefit. **Send in the coupon and we will send you prepaid our big catalog, including "A Trip Through Our Factory."** This shows how the Shipman-Ward Rebuilt Underwood is the best that can be produced at our Special Price.

**You** don't have to do a thing except to fill in the coupon and send us only \$3, which will be returned to you

if you decide not to keep the typewriter and return it to us after the **10 DAYS' FREE TRIAL.**

**FREE TRIAL  
COUPON**

**SHIPMAN-WARD MFG. CO.**  
2126 Shipman Bldg., Chicago

Send me your big bargain catalog.  
 Enclosed find \$3. Send me the Shipman-Ward Rebuilt Underwood on 10 days' free trial. If I decide not to keep it I will return it at your expense and you will refund every cent paid by me. If I decide to keep it, I have the privilege of paying for it on easy monthly payments. **Mark the square with a cross.**

Name \_\_\_\_\_

Street \_\_\_\_\_

City \_\_\_\_\_ State \_\_\_\_\_

References \_\_\_\_\_  
This is not an order. You are under no obligation.



**"It's  
What You Get  
For Your Money  
That Counts"**

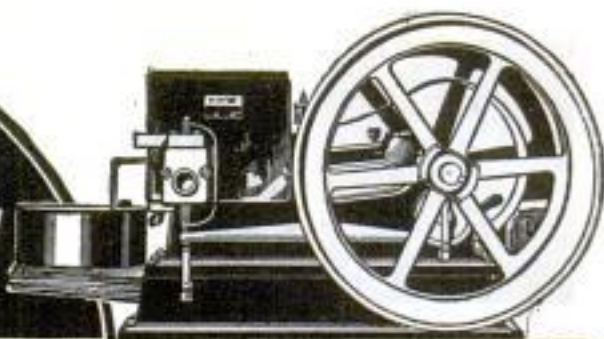

**2 H-P.** Chas. Beallien, Wla.: "Good as the first day I had it."

**3 H-P.** M. W. Kepceky, Tex.: "Easy to start—stop—regulate."

**4 H-P.** Geo. A. Noster, Va.: "Used it 7 years. Not a penny for repairs."

**6 H-P.** Wm. Mittelstadt, Iowa: "Had several makes, but Witte is best."

**8 H-P.** Ralph Milliken, Calif.: "Engine gives splendid service."

**12 H-P.** A. B. Treat, Ala.: "Runs smooth as a sewing machine."

**16 H-P.** J. C. Clark, Va.: "I like the 16 H-P. fine."

**22 H-P.** J. F. Brown, Ark.: "Engine is just what you told me."

**30 H-P.** T. E. Walton, Miss.: "It is surely a fine puller."

**Engine Value Depends On EASY OPERATION,  
LOW FUEL COST and DURABILITY**

Records for 37 years show that WITTE Engines not only stand up, giving long service, but they have big surplus power, operate easy, cost less to operate, and sell for less. No matter what size engine or power outfit you need or where you live, I can supply you direct at a saving—make Immediate Shipment—Cash or Easy Terms, as you wish—in sizes 2 to 30 H-P.—most any style you want.

**WITTE Engines** are sold on a **Straight  
Lifetime Guarantee**

This guarantee applies to every size and style outfit I make—Stationary, Portable, Portable Buzz Saw, Log Saw, Tree Saw, Stationary Cutoff Saws, Power Stump Borers and my New "Power-Lite" Engine used on electric light plant. I furnish this new light plant complete, with engine, generator and batteries ready to attach to your wiring, at a big saving in price. Use it for both power and light. If you need power for any purpose—write to WITTE—get an engine you know is time-proven, reliable and durable. Read what users say.

**WITTE ENGINE WORKS,** 1740 Oakland Avenue, KANSAS CITY, MO.  
1740 Empire Building, PITTSBURGH, PA.

**Tell Me What  
You Want**  
I Guarantee  
Safe Delivery  
Anywhere.  
**CATALOG  
FREE**

**"REEL EASY"  
VARIO COUPLER**

Our **BANK WOUND** Vario Coupler is  
**BUILT FOR YOU**  
Because We Feel it is  
**JUST THE THING**

We Absolutely Guarantee Satisfaction

**YOU ARE THE JUDGE**  
of Its Efficient Operation, Between 150  
and 3000 Meters

Price \$6.00 Shipping Weight 3 Lbs.  
Postage Extra

**I. R. NELSON CO.** BOND ST.  
NEWARK, N. J.  
RADIOPHONE STATION W-A-A-M

**TYPEWRITERS**  
We Save You 50%  
**FREE TRIAL—EASY TERMS**  
Your choice of all STANDARD MAKES,  
UNDERWOOD, ROYAL, SILENT, L. C.  
SMITH, self-starting, BIRMINGHAM, etc.  
Rebuilt by the Famous "Young Process."  
Guaranteed good as new. Lowest cash prices.  
Time payments or rentals with special pur-  
chase privilege. Largest stock in U. S.  
Write for special prices and terms.  
**YOUNG TYPEWRITER CO., Dept. 461 CHICAGO**

**Bowlegged Men**

Your legs will appear  
straight when you wear

**Straightleg Garters**

Combination hose-supporter and pantleg straightener  
— Quickly adjusted to fit various degrees of bow-  
legs; as easy to put on and comfortable to wear as  
any ordinary garter—no harness or padded forms;  
just an ingenious special garter for bowlegged men  
— improves appearance wonderfully. Wearers are  
enthusiastic. You will be too. Write for free booklet,  
mailed in plain envelope.

**S-L GARTER COMPANY**  
606 Davies Bldg. DAYTON, OHIO



**BIG PROFITS CHARGING BATTERIES**

Make \$150 to \$300 clear profit every month with an HB Battery Charger. Get into this money-making business NOW. Charge auto and radio batteries. Big demand, big profits, no experience needed to operate.

**\$20 Cash Brings HB Battery Charger**

balance easily paid from your profits on long monthly terms. Write today for information. Sizes for 8, 10, 16 or 32 batteries. Ask also about HB Automatic Air Compressor, Motor Grinders, Motors, Stock-Keeping Equipment. All sold on easy payments under money-back guarantee. Send postal for illustrated literature.

**HOBART BROS. CO.**

**BOX M91**

**TROY, OHIO**







# Electricity Needs You

## I WILL TRAIN YOU AT HOME

Stop right here. This is YOUR opportunity! Electricity is calling you, and the Electrical Business is in for a tremendous increase. But it needs more trained men—at big pay. By my Home Study Course in Practical Electricity I can train you for these positions.

### FREE!

#### BIG ELECTRICAL OUTFIT

A fine outfit of Electrical Tools, Instruments, Materials, etc., absolutely FREE to every student. I will also send you FREE and fully prepaid—Proof Lessons to show you how easily you can learn Electricity and enter this splendid profession by my new, revised and original system of Training by Mail.

#### Radio Course FREE!

Special newly-written wireless course worth \$45.00, given away FREE. Full particulars when you mail coupon below.

#### Earn Money While Learning

I give you something you can use now. Early in my Home Study Course I show you how to begin making money in Electricity, and help you get started. No need to wait until the whole course is completed. Hundreds of students have made several times the cost of their course in spare time work while learning.

### Earn \$70 to \$200 a Week

You've always had a liking for Electricity and a hankering to do electrical jobs. Now is the time to develop that talent; there's big money in it. Even if you don't know anything at all about Electricity you can quickly grasp it by my up-to-date, practical method of teaching. You will find it intensely interesting and highly profitable. I've trained and started hundreds of men in the Electrical Business, men who have made big successes. YOU CAN ALSO

### Be a Big Paid ELECTRICAL EXPERT

What are you doing to prepare yourself for a real success? At the rate you are going where will you be in ten years from now? Have you the specialized training that will put you on the road to success? Have you ambition enough to prepare for success, and get it?

You have the ambition and I will give you the training, so get busy. I am offering you success and all that goes with it. Will you take it? I'll make you an ELECTRICAL EXPERT. I will train you as you should be trained. I will give you the benefit of my advice and 20 years of engineering experience and help you in every way to the biggest, possible success.

#### Valuable Book Free

My book, "How to Become an Electrical Expert," has started many a man on the way to fortune. I will send a copy, free and prepaid, to every person answering this advertisement.

#### Act Now!

Good intentions never get you anywhere. It is action, alone, that counts. NOW IS THE TIME TO ACT.

L. L. COOKE, Chief Engineer

#### CHICAGO ENGINEERING WORKS

2154 LAWRENCE AVENUE  
Dept. 516 Chicago, U. S. A.

CHIEF ENGINEER  
COOKE

Chicago Engineering  
Works

Dept. 516, 2154 Lawrence Av.  
CHICAGO, ILL.

Dear Sir: You may send me entirely free and fully prepaid, a copy of your book, "How to Become an Electrical Expert," and particulars about your Home Study Course in Electricity and FREE Radio Course.

Name.....

Address .....

City.....State.....

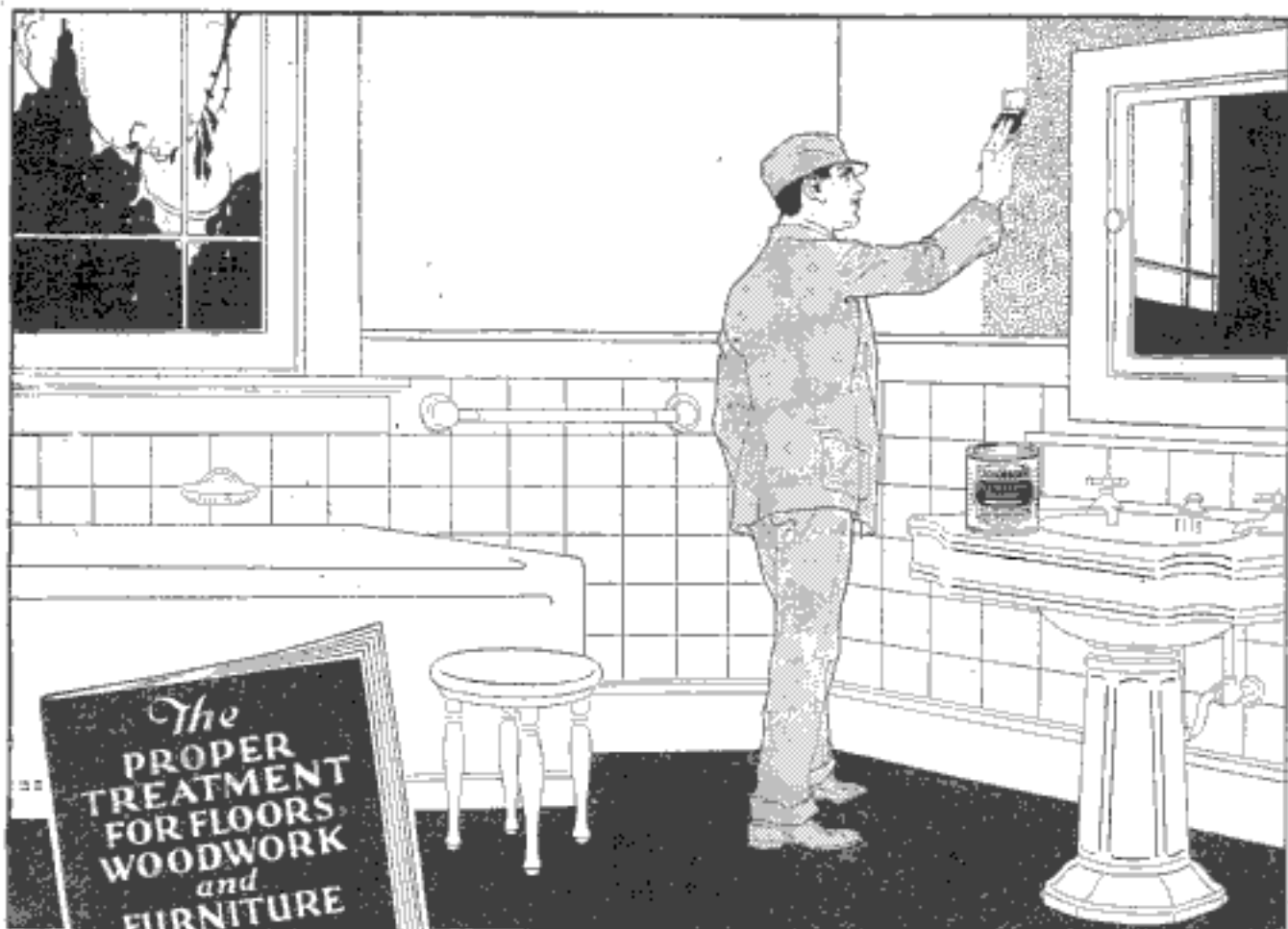

## This Beautiful Book on Wood Finishing FREE

**G**IVES complete instructions for finishing all wood—hard or soft, old or new. Explains just what materials to use and how to apply them. Tells how inexpensive soft woods may be finished so they are as beautiful and artistic as hard wood. This book is the work of experts—illustrated in color. Gives covering capacities, includes color charts, etc.

### JOHNSON'S ENAMEL

Johnson's Perfectone Undercoat and Enamel is the ideal finish for wood, plaster and metal. It will not chip, check, crack, peel or change its color. Gives a beautiful, germ-proof porcelain-like finish which is impervious to hot soapy water, iodine, ammonia, etc.

S. C. JOHNSON & SON, Dept. PA9, Racine, Wis.  
Please send me, free and postpaid, your Instruction  
Book on Wood Finishing. The best dealer in paints

here is.....

My Name.....

My Address.....

City and State.....

Fill out and mail coupon for a free copy of  
"The Proper Treatment for Floors, Wood-  
work and Furniture."

**S. C. JOHNSON & SON**

"The Wood Finishing Authorities"

Dept. PA9, Racine, Wis.

Canadian Factory—Brantford

# FREE TRIAL EASY TERMS

To introduce the latest in Olivers, we ship it to you for five days' free trial and inspection. In the privacy of your own office or home, you can put it through every test and make comparisons with other standard typewriters. You will realize quickly that the Oliver Speedster, our latest model, fulfills our policy of "the finest typewriter possible at the lowest price always."

## OLIVER

The Latest Model—No. 11

Celebrating the production of our millionth Oliver, we announce a wonderful new model, the climax of 27 years of development. Its advancements are many. Its superiorities are countless. No description in mere print can do this super-typewriter full justice.

That is why we send it to you. We let it prove its own case. And we send it to you without the slightest obligation on your part to buy.

To see this Oliver Speedster and to operate it is to experience a new sensation in typing. To the operator it brings many welcome surprises.

### No Longer \$100

While this is a standard \$100 typewriter, and while we sold Olivers at that price for years, we now ship direct from the factory to the buyer, eliminating many "in-between" expenses and extravagances.

This new plan of selling saves you \$35, for we price this Oliver Speedster at only \$65. If any typewriter is worth \$100 or more, it is this remarkable new model. Sold the old way we would have to charge \$100. Only by this new short-cut can we save you the \$35 which formerly went into a complicated selling system.

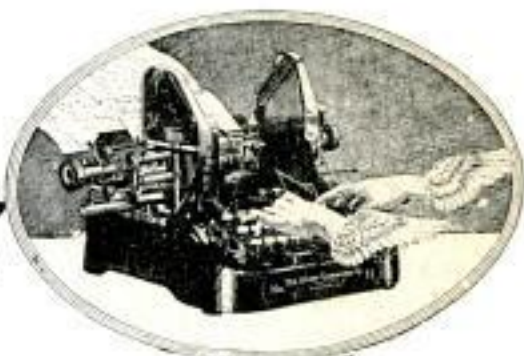

## Speedster

Remember we offer you a brand new Oliver—no second-hand, but our latest and finest model—speedier, quieter, more durable.

Here is our offer: We ship the Oliver to you if you mail us the coupon below. Try it for five days. Then if you agree that it is the finest typewriter, regardless of price, and want to own it, send us \$4 after trial and then \$4 per month.

If you prefer to pay \$100 for some other typewriter, ship the Oliver back at our expense.

That is all there is to our plan. The Oliver must sell itself. You must be the judge. No one need influence you. You deal direct with the manufacturer.

Thousands have bought this new way. Over 1,000,000 Olivers have been sold. It is the favorite of big businesses as well as individuals.

If you prefer further information before ordering, note that the coupon may be checked for EITHER a Free Trial Oliver or Further Information.

## SAVE \$35

Why pay \$100 for any typewriter when you can get our latest and finest for only \$65? Why rent? Why buy a second-hand typewriter? This Oliver offer is famous the world over. It set a new day in typewriter distribution. Mail the coupon at once.

The Oliver Typewriter Company

109C Oliver Typewriter Building

Chicago, Ill.



THE OLIVER TYPEWRITER COMPANY  
109C Oliver Typewriter Building, Chicago, Ill.

Ship me a new Oliver No. 11 Typewriter for five days' free inspection. If I keep it I will pay \$60 as follows: \$4 at the end of trial period and then at the rate of \$4 per month. The title to remain in you until fully paid for. If I make cash settlement at end of trial period I am to deduct ten per cent and remit to you \$58.50. If I decide not to keep it, I will ship it back at your expense at the end of five days.

My shipping point is .....

Do not send a machine until I order it. Mail me your book—"The High Cost of Typewriters—The Reason and the Remedy," the Speedster catalog and further information.

Name.....

Street Address .....

City.....State.....

Occupation or Business .....

# Take the first step - Get my free Catalog

## EARN BIG MONEY NOW IN AUTO, TRACTOR & RADIO BUSINESS



**E.J. SWEENEY**  
— PRESIDENT

### Big Free Catalog and Special Offer

The most important thing you can do today is to clip the coupon below and mail it right now. Get my big FREE 72-page catalog. It shows hundreds of actual photographs of men at work in my magnificent new school. I will gladly send you a copy beautifully illustrated. Also a copy of the Sweeney School News, a most interesting monthly school paper published here. **Get my contract for employment. My Free Radio Course. My offer to rebate your Railway Fare and special low cost tuition offer.**

**MAIL THE  
COUPON  
TODAY**

**Hundreds of good jobs paying \$50.00 a week and more are open to Sweeney Trained Men. You need no previous experience. I train you in 8 weeks with tools not books.**

Garages, repair shops, welding and vulcanizing shops, etc., have written the Sweeney School asking for competent mechanics. Sweeney Trained men are in demand everywhere—their practical training and experience in this great Million Dollar Trade School fits them to fill any position. I also can personally offer several thousand jobs for local branch managers. I will train you for this special work without extra cost.

What I offer the mechanically inclined young man is the COMPLETE COURSE personal instruction, the course that has made the Sweeney School famous the world over. This course includes Auto Mechanics, Welding, Vulcanizing, Battery work, and I have also added a FREE Course in RADIO to those who answer this ad.

## Sweeney System of Practical Experience

The Great Million Dollar School, world famous, and the success of my thousands of graduates are due to the Sweeney System.

That is what you get here and can't get anywhere else. I have taught nearly 50,000 men to be expert repair men, chauffeurs, tractor engineers, etc. I am proud of the fact that I was selected by the U. S. Government to train 5,000 men for mechanical work in the service. I teach by using tools not books. You learn as you do the real work with your hands.

The Sweeney School covers 12 acres of floor space. The building is ten stories high and every foot is devoted to teaching of Automobile and Tractor business. It is filled from top to bottom with tens of thousands of dollars' worth of gas engine equipment for you to work on and there are scores of expert instructors to help you learn. We even own a magnificent, fully equipped farm—our tractor farm—in order to exactly reproduce the conditions under which tractor engineers and farm machinists must work.

**THE SWEENEY BROADCASTING RADIO STATION**—Call WHB—talks all over the U. S. Students learn to build their own Radio sets.

### I PAY YOUR RAILWAY FARE

I want you to come now—not to wait and postpone—I am making it easy for you—I will help you—the first step is to send for my free catalog.

**GARAGE  
\$300**

**MECHANIC  
\$200.**

**WELDER  
\$140.**

**DO THE WORK  
YOU LIKE**

**VULCANIZER  
\$125.**

**DRIVER  
\$100.**

Maybe you have always wanted to work on the Automobile or Gas Engine, but never had the chance. WRITE ME. I have solved the trouble of 50,000 men. I am the "Daddy" of the business, although I am only 39 years old. I have taught more men the automobile business than any other man in the world. Thousands of men have written to me, told me their ambitions and have asked me to help them. Write me—tell me your ambitions. Do not waste your life—but be a LIVE ONE. BUCK UP! Get into a business that you are fitted for and that is one you like.

**Remember I pay your Railroad Fare to Kansas City**



**FOR BIG OFFER AND CATALOG  
MAIL THIS COUPON**

**EMORY J. SWEENEY, President**  
Dept. 1065, Sweeney Bldg., Kansas City, Mo.

Send me your offer of a Guaranteed position, your big Free Catalog and full details of the Sweeney eight weeks' course leading to an immediate money making opportunity.

Name .....

Address .....

**LEARN A TRADE -**  
**Sweeney**  
**SCHOOL OF AUTO-TRACTOR-AVIATION**  
1065 SWEENEY BLDG. KANSAS CITY MO