

July

25 Cents

POPULAR MECHANICS MAGAZINE

WRITTEN SO YOU CAN UNDERSTAND IT

REG'D TRADE MARK, GREAT BRITAIN, No. 410426

REG. U. S. PAT. OFF.



CHICAGO'S
UNION STATION
See Page 19

'Rahe AUTO and TRACTOR TRAINING Started Me on THE ROAD TO SUCCESS'

Thousands
of Men
NEEDED
\$2,400.00
to
\$10,000.00
A Year

BIG PAY
Jobs are
Waiting
Rahe
Trained Auto
Mechanics

I'll Pay Your
R. R. Fare to
My School

Be a Specialist

Send for My
Big Catalog
It Explains
Everything

IT'S FREE

*How 8 Weeks' Scientific Practice With Tools Lifted
Me From a Laborer's \$12.50 a Week To a Foreman-
ship at \$2,400.00 a Year*

MY ACTUAL EXPERIENCE

By Louis Beimer, Marlin, Texas

At the age of 20 years I was drawing \$12.50 a week—
laborer's pay.

At the age of 24 I am a foreman and my salary is
\$2,400.00 a year.

But it didn't take me four years to make the jump. I
qualified for the advancement by only eight weeks' sci-
entific practice with tools. Then, in two quick steps, I
reached my present position.

Those eight weeks were spent in one of Henry J. Rahe's big auto
and tractor schools. I earned \$50 a month before I went there.
On my return home, I went to work for \$150 a month and in
a very short time was made foreman at \$200 a month—a total
salary increase of \$150 a month, due entirely to Rahe training.

If you want to get ahead QUICKLY, take the quick, easy,
thorough course at a Rahe School.—Louis Beimer.



LOUIS BEIMER
who says Rahe training put him on
"Easy Street" in two months.

I'll Pay Your Railroad Fare

To CINCINNATI or CHICAGO

I'm going to start hundreds of men to QUICK success in the next few weeks, just
as I started Beimer. Be one of them and travel FREE to my nearest school. I'll
pay your railroad fare to my school nearest your home, no matter what part of
the country you live in.

Training Fee Reduced Again!

With large schools in two cities, I can now sell a complete Life Scholarship at the
lowest price ever quoted. Your total expense will be less than a good Rahe-trained
mechanic earns in three weeks.

Be a Specialist! Get out of the grind—out of the army of un-
skilled job hunters! My easy, practical course in motor-
maintenance engineering will make you an expert—a specialist—in just a few weeks!

Quick, Easy Training

No "book-learning" required—just easy, scientific practice with tools on engines,
cars, tractors. Master instructors tell you the "hows" and "whys." I furnish everything. And in
just a few weeks you'll be ready for BIG MONEY.

A Job Is Waiting For You!

This is a BIG year in the motor business. Thousands of Rahe-trained specialists
are needed. It's YOUR big opportunity. Let me prove it! Write me today.—

Be Sure to Address My Nearest School

Rahe Auto & Tractor Schools

CHICAGO
Michigan and Ontario

Dept. 893

CINCINNATI
Ninth and Walnut



There's a rhythm in Victor dance music that brings joy with every step

And no wonder! The best dance orchestras make Victor Records—Paul Whiteman and His Orchestra, The Benson Orchestra of Chicago, Club Royal Orchestra, Joseph C. Smith and His Orchestra, The Virginians, All Star Trio and Their Orchestra, Hackel-Bergè Orchestra, International Novelty Orchestra, and other favorite organizations. And such records played as only the Victrola can play them make dance music a perpetual delight.

Victrolas in great variety of styles from \$25 to \$1500.



"HIS MASTER'S VOICE"

Victrola

REG. U.S. PAT. OFF.

Important: Look for these trade-marks. Under the lid. On the label.

Victor Talking Machine Company, Camden, New Jersey

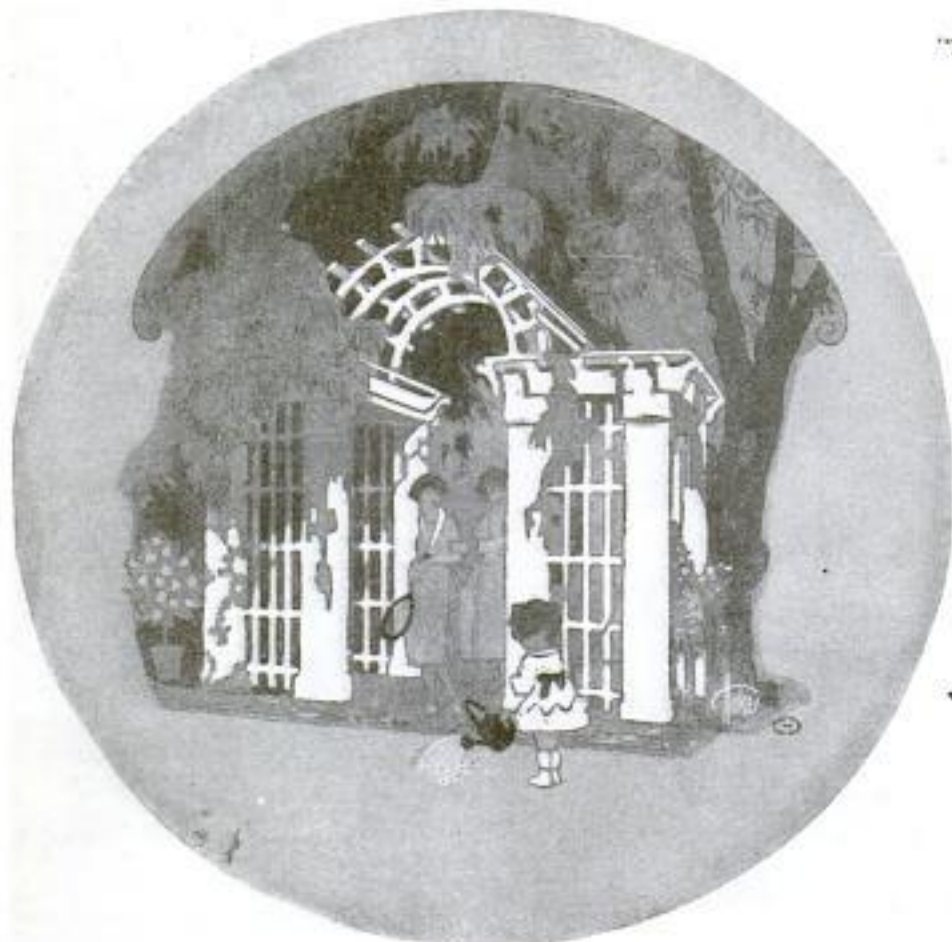

"THE WOOD THAT ALL
ITS USERS PRIZE,
THE WISE INVESTOR
SAFELY BUYS."

Tide Water
Cypress
"The Wood Eternal"

When the Baby is a Grown-up
and inherits the beautiful garden, the Cypress arbors and trellises and garden seats will be just about as perfect as they are today. She may, tho, have a few nails tightened up, and probably will want to add some new-style ideas in design—and, of course, the new things will be built of Cypress, "the Wood Eternal". Very likely she also will have the house remodeled or enlarged—with Cypress, "the Wood Eternal". But if it is of Cypress *now*, she will have practically no *repairing* to do then,—any more than you will between now and then. That's economy that really counts. Ask the lumberman to show you the Cypress trade-mark arrow (shown below) on every board or bundle.

Vol. 28 is the Trellis & Arbor Book. 68 pages. 28 pictures.
23 working plans with specifications. 2 valuable Vine Charts.
FREE on request. Write. (Also ask for Vol. 43, a surprise book.)

SOUTHERN CYPRESS MANUFACTURERS' ASSOCIATION



1219 Poydras Building, New Orleans, Louisiana
or 1219 Graham Building, Jacksonville, Florida



Popular Mechanics Magazine

6 N. Michigan Avenue, Chicago, U. S. A.

H. H. WINDSOR, Editor

London: Hachette & Cie,
16-17, King William Street, Charing Cross, W. C. 2

Paris: Hachette & Cie.
111 Rue Reaumur

Melbourne, Australia,
The Australasian News Co.

ISSUED MONTHLY

SUBSCRIPTION:

SINGLE COPY, 25 CENTS

In United States, and its possessions, Cuba, Mexico, and Canada, per year, postpaid - \$3.00

To all other countries in the Postal Union 3.50

All subscriptions are discontinued at expiration. Please examine the date printed on your wrapper.

Entered as Second Class Matter Sept. 15, 1933, at the Post Office at Chicago, Illinois, under Act of March 3rd, 1879.

Entered as Second Class Matter at the Post Office Department, Canada.

Published monthly by POPULAR MECHANICS CO.

Copyright, 1922, by H. H. Windsor.

Copyright in Australia.

Vol. 38

Contents for July, 1922

No. 1

Acetylene, Cyanide Solutions not Affected by.....	98	Corsage Shield, Feather.....	66
Aerial, New Transatlantic, Strung on Telegraph Poles, by Bernard G. Priestley.....	17	Crane, Clamshell, Used to Save Horse's Life.....	16
Aeromobile, Motorcycle Engine Drives.....	83	Crane, One Man Electric, Paper Handled by.....	103
Airplane Wings Tested by Flying.....	95	Crankcase Oil Dilution, Automatic Device Removes.....	99
Airship, New Design, to Use Nonexplosive Gas.....	9	Crutch, Rolling, with Chair Fastened to Framework.....	5
Alarm, Electric, Kills Man by Excessive Voltage.....	96	Crystal Detector Like Vacuum Tube.....	33
Alarm, Portable Burglar, Simple and Effective.....	122	Dam Project of Vast Proportions.....	58
Alloys Made Valuable by "Age Hardening".....	8	Dancer, Ballet, Performs on Typewriter Keys.....	4
Ambergris, Eighty Pounds of, Worth Small Fortune.....	95	Dew, Drinking Water for Cattle Obtained from.....	90
Amplifier, Universal, Aids Radio Communication.....	2	Ditch Digging, Machine Uses Water for.....	23
Automobile Body, Freak, Built for Comedy Picture.....	65	Doors, Fireproof Bulkhead, Made of Mahogany.....	72
Automobile Mud Rim Prevents Skidding on Slippery Roads.....	2	Dredging—Basin and Channel in Bahama Islands.....	112
Automobile Tire Chains with Vacuum Cups.....	53	Drill, Traveling Multiple, for Plates.....	46
Automobile Wheels, Steel Disk, Made in Light Weights.....	6	Drug Dissolving Appliance, Electrically Heated.....	22
Axle, Stub, for Emergency Towing.....	103	Dye, New, Colors Artificial Silk but not Cotton.....	22
Bag, Instant Heat, Chemicals Generate Heat for.....	94	Electricity—Rectifiers, Mercury-Arc, of Large Ca- pacity.....	10
Baggage Trailer for Motorist-Camper.....	63	Elevator, Wrecked, Rebuilding a Big Task.....	104
Balloons, Toy, Nonexplosive Gas Now Used for.....	53	Engines, Marine Oil, Remarkable Development in.....	118
Banjo Strings Made Snappy by Extension of Tail- piece.....	119	Exhibition, English, Publicity Demonstrated at.....	35
Bank Vault, Concrete, Mining Tools Used to Strip.....	64	Fan, Belt Driven Electric, Has High Speed Motor.....	82
Barley, New Variety, Has Striking Qualities.....	113	Fan, Diminutive Revolving, Operated by Hand.....	84
Battery Checking Voltmeter of Handy Design.....	6	Ferns, Hawaiian Tree, Source of Starch.....	74
Battery Opener, Electric, Simple and Practical.....	57	Ferryboat, Oil Electric, on Hudson River.....	5
Bayonets, German, Converted into Chopping Machines.....	122	Figs, Ripe, New Container for Shipping.....	108
Bear, Escaped, Novel Method of Capturing.....	8	Films, Industrial, Experts will Censor.....	109
Bearings, Connecting Rod, Machine Babbitts.....	103	Fire Department Truck Takes 12 Lines of Hose.....	57
Bees, Swarm of, Searchlights Used to Rout.....	118	Fire Engine, Demolished, Is Warning Sign.....	75
Binder, Loose Leaf, Largest Ever Built.....	79	Fire Fighting Unit, Motorcycles Used by.....	92
Boat, Giant Flying, Twenty-Seven Passengers Carried by.....	48	Fishing, Filipinos Use Net and Derrick for.....	71
Boat, Three Section, Easily Transportable.....	98	Flight Test Made at Night.....	99
Bridge "Boosting" a New Job for Dynamite, by H. S. Arbo.....	11	Flood—Devastated Town Offers Strange Sights.....	51
Bridge Building in Alaska, by George F. Paul.....	67	Flyhook Holder Made of Brass Spring.....	72
Bridge, Long Span Concrete Steel at Oregon City.....	97	Folding Machine, Speedy Electric, for Printing Shops.....	58
Broom Handle, Tubular, now being Made.....	8	Furnace, Attachment Is Fuel Economizer for.....	74
Building, Long Steel Columns Effect Saving in.....	93	Garage Roof Used as Auto Parking Space.....	39
Bungalow or Garage at Owner's Option.....	117	Garden, Italian, in America.....	45
Caisson for Delaware River Bridge, Launching.....	75	Gas Burner Cooks and Heats Water at Same Time.....	34
Camera, Aerial, Extremely Efficient High Speed.....	36	Gauge, Micrometer Caliper, Useful for Inspectors.....	53
Cameras, Two New Airplane, Developed.....	23	Grass Mower, Motor Driven, Cuts and Rolls Lawn.....	56
Can, Fuel Oil, for Use in Garages.....	62	Grate, Auxiliary, for Burning Low-Grade Coal.....	52
Canoes, South Pacific Islanders Make.....	81	Gravel, Road Building, Device Tests Hardness of.....	93
Capitol Building, Nebraska, Work Begun on.....	6	Guitar, Hawaiian, Shaped to Rest on Lap of Player.....	83
Capitol Building, State, Carved in Wood.....	46	Gun, Antibandit, in Demonstration, by Eric A. Dime.....	41
Cat-Tail Growths Proved Beneficial for Hogs.....	4	Gun Sight, New Design, Easy to Manipulate.....	112
Check Book Stub Holder Leaves Both Hands Free.....	61	Hair Drier, Simple, Proves Effective.....	113
Children's Picture Pages.....	120	Hayrakes on Motor Truck Function Efficiently.....	35
Chisel, Long Handled, Used as Tree Pruning Tool.....	94	Hedge Trimming Machine Operated by One Person.....	9
Civic Features.....	110	Hobs, Recently Developed, Sprocket Teeth Cut with Hoist, Electric, and Overhead Conveyor Combined.....	44
Civic Improvement, Chicago's Program of, by Cleve- land Gaines.....	19	Horses, Fire, Last Run Feature of Parade.....	35
Civilization, Ancient and Modern, Where They Meet.....	109	Hospital Garment Easy to Remove.....	40
Cliff, Rock, "Devil's Postpile," by John L. Von Blon.....	54	House Decorations, Interior, of Fiji Islanders.....	22
Coal Briquetting Plant in Western China.....	164	House on Stilts, Two Story, Has Elevated Basement.....	76
Coffee Made and Bottled by Centrifugal Machine.....	50	Household Devices.....	114
Comment and Review, by H. H. Windsor.....	29	Hydrogen, Escaping, Discover Cause of Ignition of.....	22
"Concrete Lumber," Two Types of, by Frank B. Howe.....	100	Ice Carrier, Simple and Convenient, for Motorists.....	119
Concrete Pipes, New Hydrostatic Apparatus Tests.....	6	Icebergs, Coast Guard Cutter Passing between.....	76
Cork Extractor, Pneumatic, Acts with Air Pressure.....	79	Indians, Pacific Coast, Fighting to Retain Ancient Rights, by Francis Dickie.....	87

[Continued on Page 4]

THIS ONE



KDY8-FQY-XWFS

[Contents—Continued]

Lathe, Cylinder Grinding Machine Attaches to.....	44	Sugar Cane Mill, Small, Large Water Wheel Drives.....	65
Lifeboat, Large Motor, Has Cabin Accommodations..	62	Tea Wagon, Electric Steam Radiator Heats.....	2
Lock, Adjustable Auto, for the Steering Wheel.....	4	Tears, Bacteria Destroyed by Strange Substance in..	33
Lock, Auto, Exhaust Passage Closed by.....	94	Telephone Camouflaged in Wall of Café.....	93
Locomotive Sand Boxes, Improvement of.....	117	Telephone Mouthpiece, New, Prevents Eavesdropping	6J
Locomotives, Swedish, Ready for Delivery to Russia..	49	Telescope Reflector, Largest, Cast in America.....	10
Logs, Continuous Tread Traction System for Hauling	79	Theater Foundations Rebuilt While Players Perform	25
Meals, Warm, Tractor Hauls to Patients.....	84	Timing Mechanism, Electric, for Various Uses.....	72
Memorial, Lincoln, Dedicated.....	2	Tire Carrier, Spare, Lifts Heavy Wheels.....	86
Metal Sheets, Thin, Machine Tests Workability of...	61	Tire Chains, Automobile, Bag for Carrying.....	106
Milk, Remade, Devise Test for Detecting Presence of	78	Tire Press Bracket Hoist, Time and Labor Saved by	37
Molybdenite Found to Give Photonegative Reaction..	9	Tobacco Gathering Machine Saves Hand Labor....	85
Motion Pictures, High Power Portable Light for....	48	Toboggan, Water Slide, a New Summer Sport.....	1
Motion Pictures, Home, Shown by Using New Pro-		Ton, Weight of, Suggest Term to Designate.....	116
jector.....	62	Tractor, Gasoline, Pulls Four Mowers at Once.....	60
Motion Pictures, Speaking, Voices Registered on Film		Tree, Japanese Pine, Trained in Form of Boat.....	28
for.....	83	Trees, Unightly Trimmed, on Lincoln Highway....	14
Motorboat, Special Compartments Make Nonsinkable		Tripod Head, Tilting, Motion Picture Man Aided by..	18
Mud Is Valuable Accessory in Drilling Oil Wells...	46	Truck, Highway Maintenance, Complete Equipment	
Nail, Driving End of, Made Self Clinching.....	116	on.....	102
"Oats, Canned," Army Horses Fed.....	30	Truck, Scraper Attachment on, for Road Maintenance	
Organist, Divided Seat for.....	66	Tunnel, Wind, New Type for Airplane Testing, by	
Packing, Metallic, for Stuffing Boxes.....	96	Bernard G. Priestley.....	77
Paper Making Experiments in Western Australia....	66	Typewriter, Child's, Letters and Pictures Printed by	
Paper Weight Is Magnifying Glass.....	107	Valve Stem, Tiny Oil Cup Inside of Spring Lubri-	
Pears, Machine Tests Ripeness of.....	82	cates.....	116
Peat, Water Jets and Pumps Used in Treatment of..	48	Valve Stems, Poppet, One Piece Spring Retainer for	
Pen, Iodine, Antiseptic.....	44	Wallboard Fastener, Self-Clinching.....	63
Pencil Sharpener with Tool Steel Blade.....	84	Watch, Old, World's Fair Medal Won by.....	18
Photography—Developing Outfit, Compact, Carried in		Waterfall, World's Highest, Seldom Visited.....	65
Pocket.....	32	Winch on Tractor, Heavy Labor Performed by.....	39
Piano, Miniature Upright, Has Pedal Keyboard.....	40	Wireless Equipment, First Commercial Vehicle to Use	
Pier Decking Constructed with Safety Openings....	60	Wireless Messages, Invention Promises Secrecy for..	37
Pipe, Concrete, Standardization of Methods Improves		Wireless Service, Directional, of Short Wave Length	
Pipe Wrench, One Hand, Simple and Strong.....	122	Wires, Single Crystal, Foreign Scientist Produces...	102
Platform Truck and End Dumping Body on Rollers..	78	Woodworking Machine, New, of Multifarious Uses...	113
Players, Strolling, Auto Bus Used by.....	33	Wreck, Train, in India, the Result of a Plot.....	52
Plumber's Tool, Handy, Has Automatic Jaws.....	116	Wrench, Auto Rim, Has Sockets of Four Sizes.....	58
Poison Fumes in One Apartment Kill in Another....	4		
Polo Goal Post Made Harmless by Hongkong Polo			
Club.....	32		
Poultry Drinking Fountain Operates Automatically..	119		
Prayer Wheels in India Operated by Electricity....	86		
Prize Offers and Announcements.....	163		
Pulley, Simplified Split, Has No Bolts or Nuts.....	116		
"Push-Ball" Game Played with Automobiles.....	81		
Radiator Valve Leak-Proof without Packing.....	72		
Railroad Car, Gasoline Motor Driven, for Short Trips			
Railroad Cars, Gasoline Driven, Cut Operating Costs.			
Railroad Cars, Impact Device Records Rough Hand-			
ling of.....	80		
Railroad Cars, Safety Toe Board Aids Truckmen on.			
Rawhide Used in Fan Belts and Tire Patches.....	117		
Reamer with Motor Drive, Self-Contained.....	72		
Reflectors, Crystal Glass, for Use in Spotlights....	112		
Rheostat, Filament, Made of Carbon Disk.....	38		
Ribbon, Colored, Machine for Drying Strips of.....	107		
Road Repair Patrol System for Province of Quebec..	76		
Roads, Concave Concrete, of English Design.....	64		
Roofing, Corrugated, of Asbestos and Cement.....	71		
Sandwiches, Machine Vends and Keeps Fresh.....	70		
Saw Bench, Tilting Arbor, Direct Motor Driven....	92		
Saw, Swing, Automatic Safeguard Operates with....	85		
Saxophone Holder, Self-Supporting Adjustable.....	122		
Scale for Weighing Cargo through a Ship's Draft..			
Scaling Tool, Motor Driven, Cleans Metal Surfaces..			
School in India, Technical, for Apprentices.....	92		
Scissor Blades, Triplicate, Buttonhole Shears on....	106		
Seaplanes Equipped with Kite to Carry Radio Antenna			
Semaphores, Interurban, Public Operate.....	85		
Shingle Package, New, Reduces Shipping Loss.....	56		
Ship, Concrete, Wreck of, Shows Great Endurance..	15		
Ship Lookout Telegraph for Use as Direction In-			
dicator.....	64		
Ship "Lusitania," Expedition for Salvaging.....	53		
Ship—World's Largest Ocean Liner.....	42		
Shovel, Automatic Counters on, Record Each Shovel-			
ful of Coal.....	66		
Shrine, Miniature Model of, Hindu Monks Make....	99		
Soda Fountain and Oil Tank Truck Combined.....	61		
Sound in Telephone Circuit, Remarkable Speed of..	82		
Spraying Machine Strainer Prevents Clogging.....	112		
Stamp Invoicing Appliance for Rapid Accounting....	49		
Stand, Sanitary Display, Fruit Preserved with.....	80		
Statue, New York, on Trial for Public Opinion.....	14		
Stove, Portable, New Fuel Used in.....	104		
Street Car Stops, Color Scheme Used to Control....	24		
Submarine Chasers, Mother Ship and Brood of.....	38		
Suck Hole Leakage in Rock Filled Dams, Method of			
Stopping.....	86		
Sugar Cane Mill Made Entirely of Wood.....	108		

SHOP NOTES

Air Compressor, Homemade.....	126
Arbor, Self-Gripping.....	137
Blueprints, Timing Test for.....	142
Boxes, Fiber, Strength of.....	128
Building Dimensions, Reproducing without Plans...	141
Bushings, Oversize, Shrinking.....	126
Bushings, Solid, Taking Up Play in.....	135
Caliper Leg, Auxiliary.....	123
Casting without Rolling the Flask.....	125
Clamp, Planer, for Awkward Places.....	123
Concrete, Maximum Strength, Making.....	123
Drill Plate, Handy.....	137
Facing Tool, Novel.....	134
Garage, Handy Spot Remover for Use in.....	142
Hammer and Chisel, Self-Contained.....	127
Holder Protects Cutting Tools.....	126
Hose Streams on Charged Wires, Danger of.....	138
Index Centers, Miller, Grinding.....	140
Iron Bars, Twisting.....	123
Ladder Extension, Safe.....	141
Lathe, Six-Inch Turret, Building.....	129
Micrometer Attachment for Measuring Tapers....	140
Nut Locking Device, Quick.....	135
Pencil Marker, Useful.....	140
Plane Adjustment, Made Easy to Reach.....	136
Pulleys, Loose, Oiling.....	134
Pump, Siphon, for Heavy Liquids.....	136
Reamer and Gauge Holder, Combined.....	133
Saw, Crosscut, Filing.....	133
Scriber for Marking Patches.....	124
Signs, Business, Perforated Sheet Metal.....	125
Soldering Flux, Keeping Handy.....	135
Soldering Iron, Electric, How to Make.....	139
Thresher Grain Spout, Automatic Shut-Off for....	142
Toolholder, Box, Is Accurate.....	141
Tractor Front End, Increasing Weight of.....	134
Umbrella Ribs, Tools Made from.....	137
Waterline, True, Drawing.....	138
Welding Rod, Double, Holder for.....	136
Wheel Dressers, Resetting Diamonds in.....	127

AMATEUR MECHANICS

Airplanes, Model, How to Build.....	149
Amplifier, Two Step Audio-Frequency.....	157
Automobile Springs, Assembling and Replacing....	144
Basket, Hanging, How to Line.....	153
Bathroom, Portable.....	160
Boat Engine, Attaching Generator to.....	155
Boat Hoist, Simple.....	148
Bushings, Worn Spring, Replacing.....	146
Cartridges, Broken, Extracting.....	161

DRAKE'S PRACTICAL MECHANICAL BOOKS

THEY WILL RAISE YOUR PAY— ORDER ON 5-DAY TRIAL

The books listed below will perfect you in your chosen trade — pave the way to the big positions. Written in non-technical language—easy to read and understand. *Every book covers its subject completely. An entire course of instruction condensed into one volume.* Your choice sent postpaid — you benefit 5 days — money refunded in full if not entirely satisfactory. Order direct from this page.



Automobile Books

- Automobile Ignition, by ManlyLeatherette \$2.00
 Automobile Starting and Lighting, by Manly.....Leatherette \$2.00
 Brookes' Automobile Handbook.....Leatherette \$2.00
 Ford Motor Car, Truck and Tractor, by Manly.....Cloth \$1.50
 Starting and Lighting Troubles, Remedies and Repairs, by ManlyLeatherette \$3.00
 Automobile Battery, Care and Repair, by Manly.....Leatherette \$2.00
 Automobile Catechism and Repair Manual.....Leatherette \$1.50
 Tires and Vulcanizing, by TuffordCloth \$2.00
 Gas and Oil Engine Handbook.....Cloth \$1.50
 Automobile Upkeep and Care, by Manly.....Cloth \$1.50
 Motorcycle Handbook, by ManlyCloth \$1.50

Shop Practice Books

- Sheet Metal Workers' Manual.....Leatherette \$2.00
 Oxy-Acetylene Welding and CuttingLeatherette \$1.75
 Souded WeldsCloth \$2.00
 Slide Rule and Logarithmic TablesLeatherette \$2.00

- Handbook for Millwrights.....Cloth \$2.00
 Modern Blacksmithing.....Cloth \$1.25
 Machine Shop Practice.....Cloth \$2.00
 Mechanical Drawing and Machine DesignCloth \$2.00
 Pattern Making.....Cloth \$1.50

Carpentry Books

- Cloth Binding
 Modern Carpentry, 2 vols.....\$3.00
 The Steel Square, 2 vols.....\$3.00
 Wooden Boat and Shipbuilding.....\$1.50
 Modern Estimator\$1.50
 Timber Framing\$2.00
 Builder's Architectural Drawing.....\$2.00
 Concrete\$1.50
 Practical Bungalows\$1.00
 Low Cost Homes.....\$1.00
 Roof Framing\$1.50
 Stair Building and Hand Railing\$1.50

Electrical Books

- Practical Applied Electricity.....\$2.00
 Alternating Current\$1.50
 Electric Motor Control Systems.....\$1.50
 Wiring Diagrams and Descriptions\$1.50
 Electrical Tables and Data.....\$1.50
 Armature and Magnet Winding.....\$1.50
 Modern Electrical Construction.....\$1.50
 Modern Electric Illumination.....\$1.50
 Electricians' Operating and Testing\$1.50
 Motion Picture Operation.....\$1.50
 Drake's Electrical Dictionary.....\$1.50
 Electric Motors, D. & A.\$1.50
 Electrical Measurements and Meter Testing\$1.50
 Drake's Telephone Handbook.....\$1.50
 Modern American Telephony.....\$2.00
 Easy Electrical Experiments.....Cloth \$1.25
 Wireless Telegraph and Telephone Handbook.....Cloth \$1.25
 Telegraphy Self-Taught.....Cloth \$1.25

Steam Engineering

- Swingle's Handbook for Steam Engineers and Electricians.....Leatherette \$4.00
 Examination Questions and Answers for Marine and Stationary Engineers.....Leatherette \$2.00

- Steam Boilers.....Leatherette \$2.00
 Swingle's Catechism of Steam, Gas and Electrical EngineeringLeatherette \$1.50

Painting Books

- Scene Painting and Bulletin ArtCloth \$4.00
 A Show at Sho' Cards.....Cloth \$4.00
 Sign PaintingCloth \$4.00
 Strong's Book of Designs.....Leatherette \$4.00
 Strong's Art of Show Card WritingCloth \$4.00
 Signalist's Alphabets.....Cloth \$1.50
 Modern Painter's Cyclopedia.....Cloth \$2.00
 Automobile Painting.....Cloth \$1.50
 Estimates, Costs and Profits, Painting and Decorating.....Cloth \$1.50
 New Hardwood Finishing.....Cloth \$1.50
 The Amateur Artist.....Cloth \$1.50
 New StencilsCloth \$1.25

Farm Books

- Farm Mechanics.....Cloth \$1.25
 Farm Buildings.....Cloth \$1.25
 Farm Engines.....Cloth \$1.25
 Traction Farming.....Cloth \$1.50

Business and Reference Books

- Better Business Letters.....Leatherette \$1.50
 Better Business English.....Leatherette \$1.50
 Better Advertising.....Leatherette \$1.50
 Finger Prints Simplified.....Cloth \$2.00
 Practical Bricklaying.....Cloth \$1.25
 Practical Instruction for DetectivesCloth \$1.00
 Practical PlumbingCloth \$1.50
 Hot Water Heating.....Cloth \$1.50
 Elementary Chemistry.....Cloth \$1.50
 Courses in Civil Service.....Cloth \$1.50
 Cyclopedia of Recipes.....Cloth \$1.50
 American Star Speaker.....Cloth \$1.50

Modern Languages

- By Prof. P. S. Allen, U. of Chicago
 French without a Teacher.....Cloth \$1.25
 Spanish without a Teacher.....Cloth \$1.25
 German without a Teacher.....Cloth \$1.25
 Everyday French.....\$1.25
 Everyday Spanish.....\$1.25

ORDER DIRECT FROM THIS PAGE—ON OUR MONEY-BACK PLAN

The books listed above are only a few of the many in our catalogue, which you will receive promptly after filling out and mailing us the attached coupon. For quick action order direct from this page—cross name of each book wanted and send in with price quoted. We prepay postage and send the books on our money-back plan.

FREDERICK J. DRAKE & CO.

PUBLISHERS

1008 Michigan Ave., Chicago

Drake Books Are For Sale at All Book Stores

Mail Coupon For Free Catalogue
Your Guide to Home Study

FREDERICK J. DRAKE & CO.
1008 Michigan Avenue
Chicago, Ill.

GENTLEMEN:—Please send me free, postage paid, your illustrated catalogue which lists and describes over 100 Practical Mechanical Books for Home Study.

My name is

and my address

Mrs. Thompson Tells How She Did Away With Her Hot Summer Kitchen

Every housewife dreads having her hot range going in roasting Summer weather. At least she THINKS she must do that! But I discovered a way that gives plenty of heat when you want to cook a meal or bake and leaves the kitchen cool when you don't need heat. This wonderful device does away with all the mess, perspiration and drudgery that comes with coal and wood. Just turn a little valve and—presto!—there you have plenty of heat. Turn the valve again and the heat is off. There is no red hot stove to drag you down when the weather is hot enough already.

This device saves me money too. It burns 95 per cent air and 5 per cent kerosene. It is absolutely safe and I installed it in my cook stove in one minute without a single change. Its inventor, Mr. B. M. Oliver, 2014-G Pine St., St. Louis, will send anyone an Attractive Booklet FREE that tells all about it. He is now making a special Low Price Offer including a Thirty-Day Free Trial. Why don't you write him as I did? He is also looking for good live distributors and will tell you how to earn \$500 a month if you are interested in his sales plan.—Adv.



Hotels Need Trained Executives

Nation-wide demand for trained men and women in all departments of hotels, clubs and apartment houses. Uncrowded field: fine living, quick advancement in the big hotels of the United States—now America's Fourth Largest Industry. Statistics show that ONE IN EVERY TEN HOTELS WILL HAVE AN OPENING FOR A MANAGER THIS YEAR. Thousands of other positions also open to those who qualify through training.

The Lewis School guarantees to give you the valuable knowledge that is taken course of the most successful hotel men years to obtain—men who are now making \$5,000 to \$50,000 a year. All of your training will be under the personal direction of Clifford Lewis—a hotel expert of national reputation. A few spare-time hours a week given to the simple, plain lessons of the course will open the way to a good position, a fine living and a handsome salary. The training will in no way interfere with your present activities.

Send today for FREE BOOK, "Your Big Opportunity." Don't wait a minute—you may lose the opportunity of a lifetime. Mail the coupon NOW. Your whole future may depend on it. Founded 1916.

LEWIS HOTEL TRAINING SCHOOL
Clifford Lewis, Pres.
Room 319
Washington, D. C.

Free Coupon

LEWIS HOTEL TRAINING SCHOOL

Room 319
Washington, D. C.

Send me without obligation the FREE BOOK "Your Big Opportunity."

Name..... Please Print Name

Street.....

City..... State.....

[Contents—Continued from Page 4]

Closet, China, Making Room in.....	162
Dark Box for Photographers.....	146
Electric Bulb Filaments, Repairing.....	161
Electric Light Fixture, Cheap Indirect.....	156
Films, Cut, Simple Hanger for.....	152
Fishhook, Novel Attachment for.....	146
Fishing—Binding Hook to Leader for Salt Water.....	162
Flashlight Bracket for Bed.....	155
Glass, Drilling Large Holes in.....	147
Glass, Writing on.....	148
Grass Seed on Terraces, Protecting.....	156
Hair Drier, Electric Toaster and Vacuum Cleaner Make.....	145
Hoe Cleaner, Novel.....	162
Lamp, Trouble, Installed under Dash.....	154
Language Study on Phonograph.....	147
Lawn Edger Made from Shovel.....	153
Lawns and Walks, Concrete Blocks Protect.....	161
Mechanics, Home, Square, Plumb and Rule for.....	154
Mirror, Watch Crystal.....	148
Motorists, Eye Protection for.....	162
Mower Attachment for Cutting High Grass.....	144
Oilcan, Spigot for.....	147
Pails, Stencil Color, for Painters.....	153
Phonograph, Used for Winding Yarn.....	154
Photography—Timing Snapshot Exposures.....	156
Rake Teeth, Clothespins Replace.....	145
Screwdriver with Extra Leverage.....	147
Spraying Outfit, Wheelbarrow.....	143
Strawberry Runners, Cutter for.....	155
Table, Breakfast Nook, Improved.....	146
Teakettle, Safety Vent for.....	153
Tire Valves, Leaky, Testing.....	152
Vacuum Cleaner, Clothes Cleaned with.....	155
Ventilators, Registers Used as.....	152
"Water Skate," How to Make.....	161
Window, Bedroom, Wind Scoop for.....	162
Wireless Rheostat Mounting, Novel.....	153
Wireless Sound Amplifier Made from Phonograph.....	145
Wires, Neat Tips on.....	152



Violin, Hawaiian Guitar, Ukulele,
Guitar, Mandolin, Cornet, Tenor Banjo or Banjo

Wonderful new system of teaching note music by mail. To first pupils in each locality, we give a \$20 superb Violin, Mandolin, Ukulele, Guitar, Hawaiian Guitar, Cornet, Tenor Banjo or Banjo absolutely free. Very small charge for lessons only. We guarantee success or no charge. Complete outfit free. Write now. No obligation.
SLINGERLAND SCHOOL OF MUSIC, Inc., Dept. 104, CHICAGO, ILL.

RADIO For Everybody

Make Radio a profession instead of a plaything. You can earn big money as a Radio-trician. Learn by mail, in spare time, how to design, construct, install, repair, maintain, operate, sell and demonstrate complete radio outfits. Write for free 32-page catalog describing our course entitled, "How to Learn Radio at Home."
National Radio Institute, Dept. 1164, Washington, D. C.

ELECTRICITY LEARN AT HOME

Send for catalog which tells how Burgess Home Training enables men and boys to get good jobs and keep them.
Burgess Electrical School, Dept. P-7, 744 E. 42nd St., Chicago

EARN MONEY AT HOME

LEARN Show Card Writing by our new, simple Directograph system and earn money in your spare time at home. No canvassing or soliciting. We guarantee to supply work and pay you cash for the work you do. Write for full particulars and free booklet.

WEST-ANGUS SHOW CARD SERVICE
76 Colborne Building Toronto, Can.

Let These Guides

Solve Your Problems



Electricity at your finger ends

HAWKINS ELECTRICAL GUIDES IN TEN VOLUMES

3500 PAGES

4700 PICTURES

\$1 A VOLUME

\$1 A MONTH

Send No Money—Send Only This Coupon

Know the facts in Electricity. They mean more money and better position for you. Hawkins Guides tell you all you need to know about Electricity. Every important electrical subject covered so you can understand it. Easy to study and apply. A complete, practical working course, in 10 volumes. Books are pocket size; flexible covers. Order a set today to look over.

LEARN ALL ABOUT

Magnetism—Induction—Experiments—Dynamoes—Electric Machinery—Motors—Armatures—Armature Windings—Installing of Dynamoes—Electrical Instrument Testing—Practical Management of Dynamoes and Motors—Distribution Systems—Wiring—Wiring Diagrams—Sign Flashers—Storage Batteries—Principles of Alternating Currents and Alternators—Alternating Current Motors—Transformers—Converters—Rectifiers—Alternating Current Systems—Circuit Breakers—Measuring Instruments—Switchboards—Wiring—Power Stations—Installing—Telephone—Telegraph—Wireless—Bells—Lighting—Railways. Also many Modern Practical Applications of Electricity and Ready Reference Index of the ten numbers.

SHIPPED FREE

Not a cent to pay until you see the books. No obligation to buy unless you are satisfied. Send Coupon now—today—and get this great help library and see if it is not worth \$100 to you—you pay \$1.00 a month for ten months or return it.

THEO. AUDEL & CO.,
72 Fifth Ave., New York City

Please submit me for free examination, HAWKINS ELECTRICAL GUIDE, (Price \$1 a number). Ship at once prepaid, the 10 numbers. If satisfactory, I agree to send you \$1 within seven days and to further mail you \$1 each month until paid.

Name

Occupation

Employed by

Home Address

Reference

PM JULY 25



A Big Raise in Salary!

Is Very Easy to Get, If You Go About It in the Right Way

You have often heard of others who have doubled and trebled their salaries in a year's time. You wondered how they did it. Was it a pull? Don't you think it. When a man is hired he gets paid for exactly what he does, there is no sentiment in business. It's preparing for the future and knowing what to do at the right time that doubles and trebles salaries.

Remember When You Were a Kid

and tried to ride a bike for the very first time? You thought that you would never learn and then—all of a sudden you knew how, and said in surprise: "Why it's a cinch if you know how." It's that way with most things, and getting a job with big money is no exception to the rule, if you know how.

We Will Show You How

Without loss to you of a single working hour we can show you a sure way to success and big pay. A large number of men in each of the positions listed are enjoying their salaries because of our help—we want to help you.

Make check on the coupon against the job you want and we will help you to get it. Write or print your name on the coupon and send it in today.

AMERICAN SCHOOL

Dept. G-B74, Drexel Ave. and 58th St., Chicago

AMERICAN SCHOOL, Dept. G-B74, Drexel Ave. and 58th St., Chicago, U. S. A.

I want job checked — tell me how to get it.

..... Architect.....	\$5,000 to \$15,000 Lawyer.....	\$5,000 to \$15,000
..... Building Contractor.....	\$5,000 to \$10,000 Mechanical Engineer.....	\$4,000 to \$10,000
..... Automobile Engineer.....	\$4,000 to \$10,000 Shop Superintendent.....	\$3,000 to \$7,000
..... Automobile Repairman.....	\$2,500 to \$4,000 Employment Manager.....	\$4,000 to \$10,000
..... Civil Engineer.....	\$5,000 to \$15,000 Steam Engineer.....	\$2,000 to \$4,000
..... Structural Engineer.....	\$4,000 to \$10,000 Foreman's Course.....	\$2,000 to \$4,000
..... Business Manager.....	\$5,000 to \$15,000 Photoplay Writer.....	\$2,000 to \$10,000
..... Certified Public Accountant.....	\$7,000 to \$15,000 Sanitary Engineer.....	\$3,000 to \$5,000
..... Accountant and Auditor.....	\$2,500 to \$7,000 Telephone Engineer.....	\$2,500 to \$5,000
..... Draftsman and Designer.....	\$2,500 to \$4,000 Telegraph Engineer.....	\$2,500 to \$5,000
..... Electrical Engineer.....	\$4,000 to \$10,000 High School Graduate.....	In two years
..... General Education.....	In one year Fire Insurance Expert.....	\$3,000 to \$10,000

Name..... Address.....

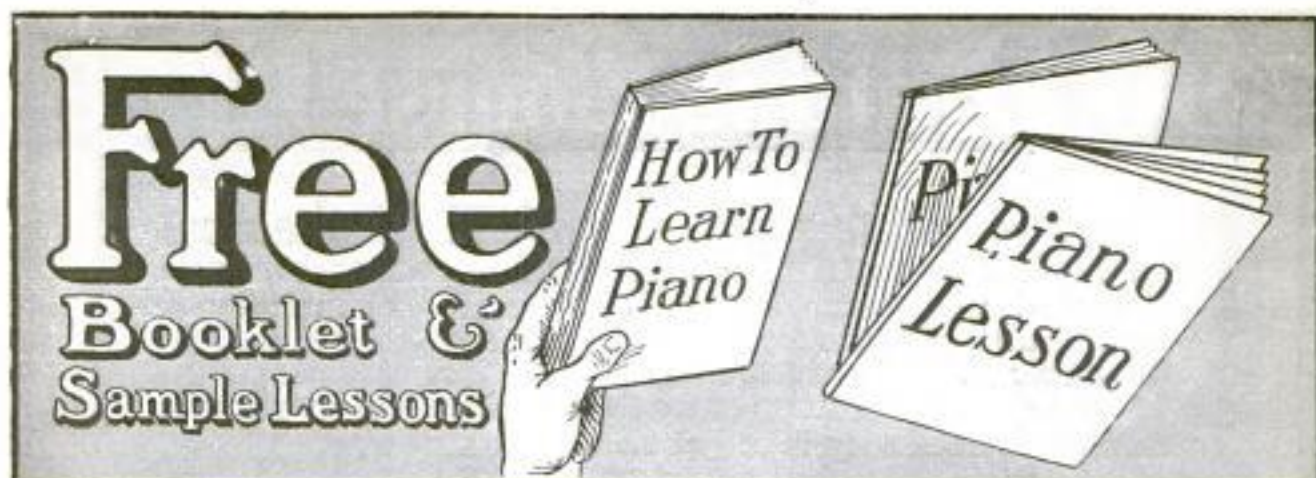

Stop Wondering How I Teach Piano; I'll Show You, FREE



YEAR after year you've seen my advertisement in all the leading publications, offering to teach you piano in *quarter* the usual time. Year after year my school has grown and grown until now I have far more students than were ever before taught by one man. In 1921 over a thousand students *graduated* from my Piano or Organ course and received their diplomas.

Yet when I first started giving piano and organ lessons by mail in 1891 my method was laughed at. Could my conservatory have grown as it has, obtained students in every state of the Union and in fact practically every civilized country of the world unless it produced very unusual and satisfying RESULTS for its students? See for yourself what it is that has brought my method so rapidly to the front. Write for free booklet and sample lessons.

Now, for the first time, you can obtain sample lessons without charge. In the past I have always been opposed to sending out free lessons, even to persons who were seriously interested in my course. But my friends have insisted that I give everybody a chance to see for themselves just how simple, interesting and DIFFERENT my lessons are, and I have consented to try the experiment for a short time. Simply mail the coupon below or write a postcard, and the 64-page booklet and sample lessons will go to you at once absolutely free and without obligation.

Within four lessons you will play an interesting piece on the piano or organ, not only in the original key, but in all other keys as well. Most students practice months before they acquire this ability. It is made possible by my patented invention the Colorotone. Another invention obtainable only from me is my hand-operated moving picture device, Quinn-dex. By means of Quinn-dex you actually see my fingers in motion on the piano, and can learn just how to train your own fingers.

When I say that I can teach you piano in *quarter* the usual time, do not think that this is too good to be true. Modern inventions and improved methods have accomplished just as great wonders in other branches of education. You at least owe it to yourself to *investigate*. Send coupon or postcard at once, before the offer of free sample lessons is withdrawn.

Please send me, without cost or obligation your free booklet, "How to Learn Piano or Organ," free sample lessons, and full particulars of your method.

Name.....

Address.....

Quinn

Conservatory,

**Studio PM 47,
598 Columbia Road,
Boston 25, Mass.**

\$80 Drafting Course Free

There is such an urgent demand for practical, trained Draftsmen that I am making this special offer in order to enable deserving, ambitious and bright men to get into this line of work. I will teach you to become a Draftsman and Designer, until you are drawing a salary of \$250.00 a month. You need not pay me for my personal instruction or for the complete set of instruments. All that is necessary is to get two other students.

\$250 a Month

Starting salary according to my agreement and guarantee. Draftsmen's work is pleasant and profitable. Positions are open paying \$3,600.00 a year in the best surroundings. They are open everywhere. Thousands of men are needed who have just the kind of training I will give you. You can get this training during spare time in your own home.

Mail the Coupon

for my valuable book — "Successful Draftsmanship." It explains how YOU can become a Successful Draftsman in a short time. The book is free at present, so write **AT ONCE**.

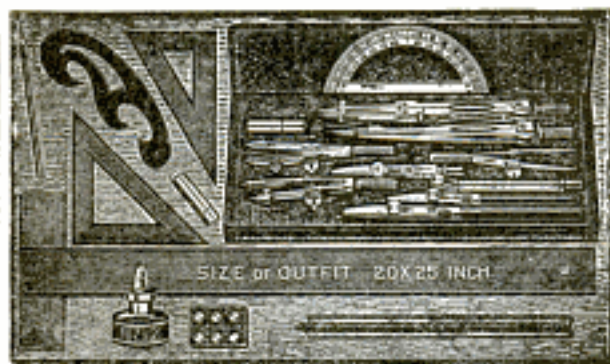

Free Course Offer Coupon Chief Draftsman Dobe

4001 Broadway, Div. B-135 Chicago
Without any obligation to me please mail your book, "Successful Draftsmanship" and full particulars of your liberal "Personal Instruction" offer to a few students. It is understood I am obligated in no way whatever.



Name _____

Address _____

Chief Draftsman Will Train You Personally

on practical Drafting-room work Until you are competent and Until you are in a permanent position at a salary paying at least \$250 per month. This is an exceptional opportunity for a few selected ambitious men, between the ages of 16 and 50 whom I will train personally.



Send the Coupon

or a letter and let me tell you how you can become a Draftsman in your spare time and earn a good salary. Don't delay — send the coupon at once.

I Guarantee

To instruct you until competent and in a permanent paying position at a regular Draftsman's salary of at least \$250 per month and guarantee to furnish you free complete Draftsman's working outfit at once from the start.

FREE—this \$25.00 Draftsman's Working Outfit

These are regular working instruments, the kind I use myself. I give them free to you if you enroll at once. Send the Free Coupon today.

Earn While Learning

You can be earning a handsome income while learning at home. This is a special offer I am making. Absolutely no obligations of any kind in sending coupon. But you must write at once, as I limit the number of my students.

Mail the FREE Coupon at once for my book — "Successful Draftsmanship," also list of open positions and for the free offer to be earning good money at once while learning at home. This offer is limited and in order to benefit thereby — act at once.

Chief Draftsman Dobe
4001 Broadway, Div. B-135 Chicago, Ill.

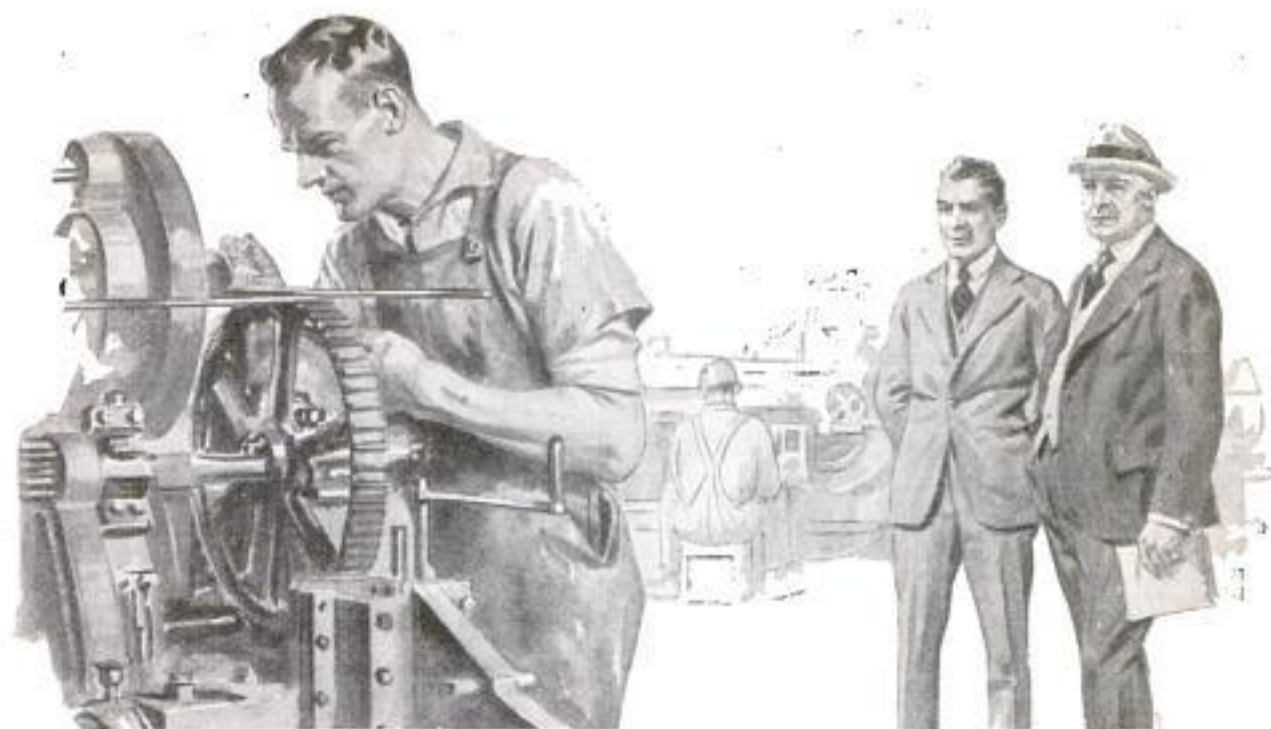

“He’s Already Patented Four Inventions”

FUNNY thing, too When he first came here he was just an ordinary worker. For a time, when things were slack, I even thought that we might have to let him go.

“Then, gradually, I noticed an improvement in his work. He seemed to really understand what he was doing.

“One day he came into my office and said he had worked out a new arm for the automatic feeder. I was a little skeptical at first, but when he started explaining to me, I could see that he had really discovered something. And when I started questioning him, I was amazed. He certainly did know what he was talking about.

“So we sat down and talked for over an hour. Finally, I asked him where he had learned so much about his work. He smiled and took a little book from his pocket.

“There’s no secret about it,” he said. “The answer’s right here. Four months ago I saw one of those advertisements of the International Correspondence Schools. I had been seeing them for years, but this time something inside of me said, ‘Send in that coupon.’ It was the best move I ever made—I knew it the minute I started my first lesson. Before, I had been working in a sort of mental fog—just an automatic part of the machine in front of me. But the I. C. S. taught me to really understand what I was doing.”

“Well, that was just a start. Three times since he has come to me with improvements on our machines—improvements that are being adopted in other plants and on which he receives a royalty. He is certainly a splendid example of the practical value of I. C. S. training.”

Note the word *practical*. No one word describes the courses of the International Correspondence Schools better than that.

For the lessons and textbooks take up problems that you meet every day in your work. And every lesson is so fully illustrated and is written in such plain, simple language that you just can’t help understand.

Every mail brings letters from students of the I. C. S. telling of advancements and larger salaries won through spare-time study. There’s still a chance for you, if you will only make the start.

No matter where you live, the I. C. S. will come to you. No matter what your handicaps or how small your means, we have a plan to meet your circumstances. No matter what career you may choose, some one of the 300 I. C. S. courses will surely suit your needs.

Just fill out and mail the coupon printed below and without cost or obligation, get the full story of what the I. C. S. can do for you. Today—not Tomorrow—is the day to take that first step toward Success.

TEAR OUT HERE

INTERNATIONAL CORRESPONDENCE SCHOOLS, BOX 5649-C, SCRANTON, PENNA.

Without cost or obligation on my part, please send me full particulars about the subject before which I have marked an X in the list below:—

- Automobile Work
- Gas Engine Operating
- Airplane Engines
- Radio
- Electrical Engineering
- Electric Lighting
- Mechanical Engineer
- Mechanical Draftsman
- Machine Shop Practice
- Railroad Positions

- Civil Engineer
- Surveying and Mapping
- Mine Foreman or Engineer
- Marine Engineer
- Architect
- Contractor and Builder
- Architectural Draftsman
- Structural Engineer
- Chemistry
- Pharmacy

- Business Management
- Industrial Management
- Traffic Management
- Business Law
- Banking and Banking Law
- Accountancy (including C.P.A.)
- Nicholson Cost Accounting
- Bookkeeping
- Business English
- Business Spanish

- Salesmanship
- Advertising
- Stenography and Typing
- Teacher
- Civil Service
- Railway Mail Clerk
- Common School Subjects
- High School Subjects
- Illustrating
- French

Name.....Street Address.....

City.....State.....Occupation.....

Persons residing in Canada should send this coupon to the International Correspondence Schools Canadian, Limited, Montreal, Canada.



\$100 FOR ONE DRAWING

Illustrators, Cartoonists, Commercial Artists, make big money. You can earn \$25 to \$100 a week and more. Learn at home in spare time under personal direction of one of America's most famous newspaper, magazine, advertising artists of 30 years' successful experience.

WASHINGTON SCHOOL OF ART, Inc.
Room 1859, Marden Bldg.
Washington, D. C.
Send me particulars of FREE ARTIST'S OUTFIT offer and free book, "How to Become an Artist."

Be An ARTIST

Delightful, fascinating profession. Wonderful new home-study method makes drawing easy! Send coupon or postal today for amazing offer—complete Artist's Outfit given.

FREE! to new students. Write for handsome book, "How to Become an Artist." Don't delay—write or send coupon at once. Address

Name.....
Address.....
City..... State.....
Washington School of Art, Inc.
Room 1859, Marden Bldg.
WASHINGTON, D. C.

PLAY PIANO BY EAR

**No Note Reading—No Music
Play Ragtime Easily and Quickly**



The only course teaching Piano Playing solely by ear. No musical experience necessary. As easy as learning to play a game. Instructive—interesting. Learn to play for pleasure or profit.

Send 50c for first lesson or \$1.00 for first two lessons with full instructions.

COMPLETE COURSE 10 LESSONS \$6.00
DAVID PIANO COURSE 323-7 N. Michigan Ave.
CHICAGO, ILL.
ELEVEN YEARS SUCCESSFUL TEACHING

Cartoonists!

The inspiration so necessary for success, as well as valuable hints regarding technique, methods of work and style will be yours if you equip yourself with portfolios of the work of the greatest cartoonists. Just such portfolios are the

BOUND VOLUMES OF CARTOONS MAGAZINE

Here you find the best cartoons of Darling, Cesare, McCutcheon, Carter, Kirby and scores of other master cartoonists of this and other countries.

**PRICE \$2 PER VOLUME POSTPAID
WITHIN THE REACH OF ALL**

Think of it! These durable and attractively bound books (all new) each covering six months and containing 1200 cartoons, 900 pages (7 x 9½ in.) 3 in. thick will be sold separately as long as the limited supply lasts.

Make your selection from the following list and send in an order at once.

Vol. 11—January—June - 1917	} Part of World War Period
Vol. 12—July—December - 1917	
Vol. 13—January—June - 1918	
Vol. 14—July—December - 1918	
Vol. 15—January—June - 1919	
Vol. 16—July—December - 1919	
Vol. 17—January—June - 1920	
Vol. 18—July—December - 1920	

Address:
POPULAR MECHANICS BOOK DEPT.
6 N. Michigan Ave. Chicago

SELL US YOUR SPARE TIME

You can earn money writing show cards in your own home. No canvassing—A pleasant, profitable profession easily and quickly learnt by our new simple graphic block system—Artistic ability not necessary—We teach you how, and supply you with work—Distance no object. Full particulars and booklet free.
Wilson Methods, Ltd., Dept. M, 64 Richmond East, Toronto, Canada.

"HOW I BEAT THE GAME"

The Inspiring Story of how one poorly paid garage mechanic won success, his own business and a big income. Tells how you can increase your salary from 10% to 500%. Send for it today FREE.

Ambu Engineering Institute
Dept. 17 2632 Prairie Ave., Chicago, Ill.

WANTED—RAILWAY MAIL CLERKS

\$135 to \$190 a Month for Life

Every second week off with full pay—no "lay offs" because of strikes, poor business, etc.—sure pay—rapid advancement to higher positions. City and country residents stand same chance. Common sense education sufficient—no political influence. Examinations likely in every city very shortly.

CANDIDATES PREPARED FREE

Write for free schedule of coming examination places. Every day's delay means so much less coaching—so write at once.

FRANKLIN INSTITUTE, Dept. E176, Rochester, N. Y.

Mail This Coupon

Write Plainly
Use It Before You Lose It

COUPON

FRANKLIN INSTITUTE, Dept. E176, Rochester, N. Y.

Kindly send me, without any obligation whatever on my part and entirely free of charge, (1) a full description of the position checked below; (2) Sample examination questions; (3) Free copy of copyrighted book "Government Positions and How to Get Them"; (4) A list of U. S. Government Jobs now open; (5) Schedule showing dates and places of all coming examinations.

.. Railway Mail Clerk (\$1600 to \$2300) .. Customs Positions (\$1100 to \$2000)
.. Postoffice Clerk (\$1400 to \$1800) .. Internal Revenue (\$1100 to \$2000)
.. Postoffice Carrier (\$1400 to \$1800) .. Rural Mail Carrier (\$1100 to \$2000)

Name.....

Address.....

NOTE:—This announcement answers two questions that big employers repeatedly ask, viz: (1) What makes LaSalle men so practical? (2) Why don't more men train with LaSalle for the high pay positions in business?

The LaSalle Problem Method

—and how it successfully condenses a lifetime of experience into a few months of study

A question has blocked action on the part of many thoughtful men who were and are sincere in their desire to qualify in high salary fields. They have asked themselves whether training gained at home by correspondence might not prove to be mere "book-learning"—impractical—unmarketable.

We have no fault to find with this question—it is a natural one. The burden of our criticism rests on the man who permits the question to be its own answer, and to block and stop him in his upward climb without seeking further enlightenment.

For when more than three hundred thousand men have trained with LaSalle and found bigger, better things thru this training there must be sound reasons for their success.

There are reasons. They lie in the LaSalle Problem Method of imparting—not "book-learning"—but real, practical, usable business experience.

A knowledge of principles is one thing. The ability to apply and use principles—actually do the work at hand, is another—and the gap between the two is bridged by one factor and one only—*Experience*.

That's why business men place such a premium on experience—it safeguards them against costly experiments.

Suppose you decided to take up as your life work—accountancy, say.

Now stretch your imagination a trifle.

Suppose that thru the offices of an influential friend, arrangements were made for you to step in and immediately occupy the position you intended training to fill—right in the organization of a big corporation—with a complete department under your orders.

Say that by your side were placed, as your instructors and guides, several high grade accountants—men of national reputation—their sole duty being to train and equip you.

With these men instructing you in proper principles—then, you yourself exercising your own judgment in handling transactions and solving problems as they arose in your daily work—do you get the idea? You would be acquiring *experience* right along with the bed-rock fundamentals of the profession.

Sitting in the chair of authority—dealing with actual business—learning by applying what you learned—with experts correcting your errors, commending good work, guiding you aright through the ramifications, routine and emergency situations of the entire accounting field and making you make good every step of the way—mind—not in a class-room, but right in a business office where you would be actually doing the work you were training for—

wouldn't you, at the end of a year or so in *this* situation be much farther ahead than men who had spent years seeking the same knowledge in the old, hard, "find-out-for-yourself" way?

You can answer these questions—your good sense tells you that the situation described would make you a practical man—sure, certain and confident—able and capable of holding down any situation the accounting field offered.

And that is why the LaSalle Problem Method makes practical men. Simply because the procedure outlined above is followed—exactly.

True, you do your work at home. True, the experts who help you are located here in Chicago.

Nevertheless, under the LaSalle Problem Method you are actually occupying the position you are training to fill, whether it be in the accountancy field, or traffic or business management, or law, or correspondence—irrespective of what you are studying you are acquiring principles and applying them in actual business under the watchful eyes and helpful guidance of men big in your chosen field.

And when you have completed your LaSalle work, you can truthfully say that you are not only a thoroughly trained man, but an *experienced* man—you know the bed-rock principles and you have used them all—they are familiar tools in your hands.

A LaSalle man can walk in anywhere with confidence. He does not feel the uncertainty and fear that arise when one faces the new and unknown. Under the Problem Method he has explored his chosen field on his own feet—the questions, the problems, the difficulties—he has met, faced and conquered them all.

His experience makes him know that altho he may be assuming a new position at higher pay, the duties of that position are an old, familiar story.

Experience is cash capital in business.

There are only two ways to get it.

One is the old, slow, uncertain way. The man who chooses to learn a branch of business by picking it up bit by bit as he goes along, finds the years slip by faster than he thought and sometimes his progress not as sure as he had anticipated. For all the "bits of knowledge" he sought may not have come his way.

The other road is short, sure and certain. It lies thru the Problem Method, distinctive with LaSalle Extension University.

This way condenses into months experience which it takes most men a lifetime to gain.



The LaSalle Problem Method gives you self-confidence—practical, usable knowledge—because it makes you an experienced man.

J. Choplin
President LaSalle Extension University,
of Chicago, Illinois

LaSalle Extension University

The Largest Business Training Institution in the World

If you are in earnest when you say to yourself that you must do something to permanently increase your earning capacity—then—check the coupon below in the square opposite that training which appeals most to you. It is a step you will never regret. And it is a step that is one hundred times as hard to make tomorrow as it is to take today. Where's that pen—never mind—a pencil will do just as well.

INQUIRY COUPON

LASALLE EXTENSION UNIVERSITY

Dept. 764-R

CHICAGO, ILLINOIS

Please send me catalog and full information regarding the course and services below. Also a copy of your booklet, "Ten Years' Promotion in One," all without obligation to me.

- Business Management: Training for Official, Managerial, Sales and Executive positions.
- Salesmanship—Principles and Practice: Training for Sales and Advertising Executives, Solicitors, Sales Promotion Managers, Salesmen, Manufacturers' Agents and all those engaged in retail, wholesale or specialty selling.
- Higher Accountancy: Training for positions as Auditor, Comptroller, Certified Public Accountant, Cost Accountant, etc.
- Traffic Management—Foreign and Domestic: Training for positions as Railroad and Industrial Traffic Manager, etc.
- Law: Training for Bar; LL. B. Degree.

- Railway Accounting and Station Management: Training for Railway Auditors, Comptrollers, Accountants, Clerks, Station Agents, Members of Railway and Public Utilities Commissions, etc.
- Industrial Management Efficiency: For Executives, Managers, Office and Shop Employees and those desiring practical training in industrial management principles and practice.
- Modern Business Correspondence and Practice: Training for Sales and Collection Correspondents; Sales Promotion Managers; Credit and Office Managers; Correspondence Supervisors, Secretaries, etc.
- Banking and Finance.

- Modern Foremanship and Production Methods: Training in the direction and handling of industrial forces—for Executives, Managers, Superintendents, Contractors, Foremen, Sub-Foremen, etc.
- Personnel and Employment Management: Training for Employers, Employment Managers, Executives, Industrial Engineers.
- C. P. A. Coaching for Advanced Accountants.
- Commercial Law.
- Expert Bookkeeping.
- Business English.
- Commercial Spanish.
- Effective Speaking.

Name..... Present Position..... Address.....

Is Your English a Handicap?

This Test Will Tell You

Thousands of people make little mistakes in their everyday English and don't know it. As a result of countless tests, Sherwin Cody found that the average person is only 61% efficient in the vital points of English. In a five-minute conversation or in an average one-page letter, five to fifty errors will appear. Try the test shown below, now. See where you stand on these 30 simple questions.



Sherwin Cody

Try This Test Now

Correct answers shown in panel below

1. Would You Write—

Between you and I	or	Between you and ME
I HOPE it would come	or	I WISH it would come
WHO shall I call	or	WHOM shall I call
It's just AS I said	or	It's just LIKE I said
How MANY are there	or	How MUCH are there
I WOULD like to go	or	I SHOULD like to go
The FIRST TWO lessons	or	The TWO FIRST lessons
He sat AMONG the three	or	He sat BETWEEN the three
The wind blows COLD	or	The wind blows COLDLY
You will FIND ONLY one	or	You will ONLY FIND one

2. How Do You Say—

erasing	or	EV-ning	or	ee-ning
ascertain	or	as-CE-tain	or	ah-SEE-tain
hospitable	or	hos-PI-ta-ble	or	hoh-PEE-ta-ble
abdones	or	ab-DO-men	or	ah-DO-men
mayorally	or	MAY-or-ally	or	may-OR-ally
accessible	or	a-NE-na-ble	or	a-MEN-able
ac-crete	or	ac-CL-i-mate	or	ac-CL-i-mate
professed	or	PRO found	or	pro-FOUND
beneficiary	or	ben-e-FISH-ary	or	ben-e-FISH-ary
culinary	or	CUL-i-nary	or	CU-l-i-nary

3. Do You Spell It

superCede	or	supercede	or	replition	or	replition
re-ceive	or	re-ieve	or	re-plite	or	re-plite
re-ieve	or	re-ieve	or	re-plite	or	re-plite
donKEYS	or	donkEYS	or	traFFICK	or	traFFICK
factorIES	or	factorYs	or	ac-CEssible	or	ac-CEssible

New Invention Improves Your English in 15 Minutes a Day

Mr. Cody has specialized in English for the past twenty years. His wonderful self-correcting device is simple, fascinating, time-saving, and incomparably efficient. You can write the answers to 50 questions in 15 minutes, and correct your work in 5 minutes more. You waste no time in going over the things you already know. Your efforts are automatically concentrated on the mistakes you are in the habit of making, and through constantly being shown the right way, you soon acquire the correct habit in place of the incorrect habit. There is no tedious copying. There is no heart-breaking drudgery.

FREE Book on English

Your English reveals you as nothing else can. When you use the wrong word, when you mispronounce a word, when you misspell a word, when you punctuate incorrectly, when you use flat, ordinary words, you handicap yourself. Write for our new book, "How to Speak and Write Masterly English." Merely mail the coupon, and it will be sent by return mail. Learn how Sherwin Cody's new invention makes it easy to gain command of language in 15 minutes a day.

SHERWIN CODY SCHOOL OF ENGLISH
57 Searle Building - Rochester, New York

SHERWIN CODY SCHOOL OF ENGLISH
57 Searle Bldg., Rochester, N. Y.

Please send me at once your Free Book, "How to Speak and Write Masterly English."

Name.....
Address.....
City.....State.....

Answers

1
Between you and me
I wish it would come
Whom shall I call
It's just as I said
How many are there
I should like to go
The first two lessons
He sat among the three
The wind blows cold
You will find only one

2
EVE-ning
as-CE-tain
hos-PI-ta-ble
ab-DO-men
MAY-or-ally
a-NE-na-ble
ac-CL-i-mate
pro-FOUND
ben-e-FISH-ary
CU-l-i-nary

3
supercede
re-ceive
re-ieve
donkeys
factories
restitution
separate
accommodate
trafficking
accessible

BE AN ARTIST

We can teach you **DRAWING** in your own home during your spare time.

Our 18 years of successful teaching prove our ability. 10 Courses in Commercial and Illustrative Drawing. Teachers Normal and Applied Art. Endorsed by high art authorities. Students trained by members of our Faculty are filling high-salaried positions. Artist's Outfit **FREE** to Enrolled Students. Write today for Art Year **FREE** Book.

OUR HANDSOME ART YEAR BOOK
"FREE" to Enrolled Students.

SCHOOL OF APPLIED ART
APPLIED ART BLDG. NO. 2 BATTLE CREEK MICH.

Learn Chemistry at HOME

Chemistry offers the greatest opportunities to-day of any profession. If you want to know how you can learn chemistry at home, in your spare time, write to one of the foremost authorities on Chemistry, Dr. T. O'Connor Sloane, care Chemical Institute of New York, Home Extension Division 7, 140-P Liberty St., New York City. Dr. Sloane will send you full information **FREE**, by return mail.



I, Charles L. H. Wagner,

Principal of the Wagner School of Sign and Show Card Writing, **POSITIVELY GUARANTEE** to teach you to become a successful sign and show card writer by my original **Blue Print Method**. ALL I expect from you is application. I have proven this with others, I can do the same for you. Let me tell you how. Write me today for P. M. Booklet of my course.

Wagner-Sprague Correspondence School
131 Columbus Avenue, Boston, Mass.

BE AN EXPERT Penman

Write for my **FREE BOOK**, "HOW TO BECOME AN EXPERT PENMAN." It contains specimens and tells how others became expert writers. Your name written on a card if you enclose stamp.
T. M. TEVIS, Box 25K, CHILLICOTHE, MO.

LAW

IN YOUR SPARE TIME
Learn law with only institution giving same course by correspondence as was given for years at resident classes of this college. **DEGREE OF LL. B. CONFERRED**. One year business law course prepares you for success in business. Law trained business men in demand. Three year university course covers preparation for bar examination. Money back guarantee if not satisfied. Low fee, easy terms, includes complete 1921 thirteen volume library, text material and all expenses. Write for **FREE BOOK**.
Hamilton College of Law 431 South Dearborn St., Dept. 67 Chicago

BECOME A RAILWAY MAIL CLERK

Examinations soon. \$1600 to \$2300 a year. No strikes or lockouts. Common education sufficient. No "pull" necessary. Mail coupon for Catalog.

Patterson Civil Service School
Dept. 87, Rochester, N. Y.

Sirs:—Send me without charge your Catalog, describing this and other fine U. S. Government positions.

Name.....
Address.....

Dept. 87
Patterson Civil Service School
Rochester, N. Y.

How to Read Blueprints and Plans

How to Use the Steel Square Successfully.

What You Should Know About Carpentry and Building.

How to Build a Frame or a Brick Structure.

What You Should Know About Sheet Metal Work.

How to Be a Successful Building Superintendent.

What You Should Know About Heating and Ventilating.

How to Write and Read Building Specifications.

What You Should Know About Water Supply and Drainage.

How to Estimate the Cost of a Building.

What You Should Know About Plastering and Painting.

How to Know Material and Select the Best.

How to Build of Concrete and Steel.

How to Care for Tools.

A Thousand Things You Ought to Know

EVERY day in your work you get up against new problems—sometimes it is only some old “sticker” coming in a new way. Just the same, though, it takes a lot of time to figure them out. **Don't do it.** Here's everything worked out for you. Every problem, big or little, that you will meet in a day's work. Hundreds of new ideas and better ways of doing things. Hundreds of ways the other fellows are making money. Hundreds of ways **you** can make more out of the same work you are doing now.

CARPENTRY AND CONTRACTING

Five great big volumes flexibly bound in genuine American Morocco with 2,138 pages and more than 1,000 blueprints, plans, pictures and diagrams. It is the newest, most complete, most practical work of its kind ever published. Twenty-five well-known experts prepared these great books, gathering the material from hundreds of different sources. Every man in the shop and on the job should have them. Written in such plain language that anyone can understand them.

7 Days' FREE Examination

Send the coupon for these great Carpentry and Contracting books TODAY. You can't afford to be without them and you don't take any risk at all. The coupon brings the whole set by express collect for a week's free examination. Use the books a week and notify us to get them back if they don't please you. If you like them, send us only \$2.80 and \$3.00 each month thereafter until \$19.80 is paid. If you prefer to pay cash with order, send only \$17.80. The return privilege holds good just the same. Send the coupon NOW. Remember—sending for the books does not obligate you to buy.

AMERICAN TECHNICAL SOCIETY, Dept. G-19b, Chicago



**American Technical Society,
Dept. G-19b, Chicago**

Please send me the five-volume Cyclopaedia of Carpentry and Contracting, shipping charges collect. I will send you \$2.80 in seven days and \$3.00 each month thereafter until \$19.80 has been paid, or return the books at your expense.

Name

Street and No.

City and State

Reference

(Please fill in all lines)

How I Earn \$15 to \$25

a Week at Home
in my Spare Time
By Wm. S. Coulthard



I needed money. I had a lot of time on my hands in the evenings, Saturday afternoons, etc.—for I had no hobby—and besides my expenses had been mounting fast—so you will see the receptive mood I was in when I saw your little ad, "MAKE MONEY AT HOME."

I sent for your free booklet.

I read it.

Your plan looked good to me—your guarantee so liberal—and on investigation I found you were reliable, so I accepted your offer. If others could make money by your plan, I could. That was less than a year ago.

Now I am earning \$15.00 to \$25.00 a week, each week, writing show cards in my spare time. In addition to this, I still hold my regular job, and my salary has been increased there, too. I believe my spare time work has made me better satisfied with life, and so I'm doing my regular work better.

I have been offered positions writing show cards, but I am not interested, as my present position is perfectly satisfactory, but I certainly am glad I enrolled in your school—my spare time money is exceedingly attractive. Besides, I find show card writing an interesting occupation that fills in those evening hours that used to drag so. In fact, it is really a hobby now with me—and a profitable one, as you can well imagine. Only last week I received a check from your school for \$70.00 for work done over the last three weeks. Of course, you'd have paid me regularly each week if I'd bothered about it, but I was too busy to tell you the amount of work I'd finished.

There are times, however, that I feel show card writing by your simple method is almost too good a thing—that's when I have so many orders ahead that I cannot see my way clear to finish them—and have to turn down work.

Your system of supplying work to your students has certainly helped me, but sometimes you send too much—I'm only working at it in my spare time, you know. Please note this, and don't try to overload me too much.

By the way, I think you'll be interested to know that previous to enrolling in your school I had never tried my hand at any work of this nature.

I'm glad to thank you for what you've done for me—and you can certainly use my name and tell prospective students, for I feel I'll be doing any one a real good turn if I can help them get started in this profitable work.

Yours sincerely,

WM. S. COULTHARD.

NOTE:—The above is the story of Mr. Coulthard. It tells of facts, for Show Card Writing offers a marvelous opportunity to both men and women, either for spare time or full time work. What Mr. Coulthard has done and is doing, you can do. Colbran, Dusenberry, Wendt, Blade, Poulson, Charles, Wright, Babineau and many other men have proved it. Mrs. Litherdale, Mrs. Lush, Mrs. Le Moine and dozens of housewives have added to the family income in this way. Girls like Misses MacDonald, Clegg, Bordreau and Hoyle are but a few of those who have bettered their positions in this pleasant way. All these owe their success to the American Show Card School method of training—the old established school which has trained hundreds to make money in SHOW CARDS. The American Show Card School will gladly send you full particulars if you but send your name and address to them.

Use this
Coupon.

Name.....
(Print your name plainly)

Address.....
(In full)

State.....

TEAR OFF HERE AND MAIL TO-DAY.
American
Show Card
School
2030 Ryrie Bldg.
Toronto, Can.
Send me your Free Booklet on Show
Card Writing, and show me how I can
make money at home—without invest-
ing or soliciting. It is understood that this
places me under no obligation of any kind.



A Wonderful Book on Finger Prints FREE to You!

FULL of thrilling, True Stories of crime mysteries solved through Finger Print Evidence by some of America's greatest Finger Print Experts. Gripping illustrations. Greatest book ever published on the subject. Send for your FREE copy today.

Big Money to Experts!

You can learn the Finger Print Profession easily at home in spare time. Great demand for Experts. Professional fees are high. This book pictures the wonderful opportunity awaiting you.

Big Special Offer open now. Write at once. Get full details, Big surprise in store for you. A splendid field for professional work never even dreamed of.

UNIVERSITY OF APPLIED SCIENCE
Dept. B135, 1920 Sunnyside Ave., Chicago, Ill.

Learn Photography at HOME

Make \$75.00 a Week on the Side

Establish yourself as a Photographic Expert quickly—during your spare time—under a leading photographer. I'll show you how to start your own business—on commission—a large salary. Send (no money) offer—its your temporary. Act at once. A postal will do. H. R. VANT.
INTERNATIONAL STUDIOS, Inc.
Dept. 119 B, 3601 Mich. Ave., Chicago, U.S.A.



DO YOUR OWN \$ ELECTRICAL WORK

Anyone with the aid of Electrical Kinks can do wiring and repairing of door bells, burglar alarms, garages, electric irons, vacuum cleaners, washing machines, table lamps, etc. In fact, most anything electrical in the home. 131 pages, 75 illustrations. Cost is only \$1.00 postpaid. Money back if not satisfied. Send today—you may need the book tomorrow.

HOME BOOK CO., 389 ARCADE BLDG.
CLEVELAND, OHIO



NAVIGATION TAUGHT BY MAIL

Hundreds of Ship Officers needed in Merchant Marine and Navy. Salaries up to \$412 monthly and living expenses. You can qualify through Captain Warren Sheppard's Home Study Course on Navigation. Chance of a lifetime to see the world as a ship's officer at a big salary. Write for free Book, "Your Future is on the Seven Seas."

World Technical Institute, Dept. 100A, Fuller Building, Jersey City, N. J.



SHORTHAND IN ONE MONTH

Boyd—the Wonderful, New, Easy System. Writers hold World's record. 100 to 150 words a minute in 30 days guaranteed. New Principles—dictation first week. Best for Court Reporting and Secretaries. Also Typewriting, Bookkeeping and Commercial Law. Send today for Catalog and Money-Back Guarantee.
CHICAGO HOME STUDY SCHOOLS, 802 Reaper Block, Chicago, Ill.



"BECOME A LIGHTNING TRICK CARTOONIST"

MAKE MONEY CHALK TALKING. SEND \$1.00 FOR SHARPLY PROGRAM OF TRICK DRAWINGS WITH INSTRUCTIONS BY A PROFESSIONAL CARTOONIST. SATISFACTION GUARANTEED. CIRCULAR FREE. BALDA ART SERVICE, 61 OSHKOSH, WIS.

RADIO For Everybody

Make Radio a profession instead of a plaything. You can earn big money as a Radio-trician. Learn by mail, in spare time, how to design, construct, install, repair, maintain, operate, sell and demonstrate complete radio outfits. Write for free 32-page catalog describing our course entitled, "How to Learn Radio at Home."

National Radio Institute, Dept. 1164, Washington, D. C.



An Amazingly Easy Way to Earn \$10,000 a Year

Let Me Show You How FREE

TO the average man the \$10,000-a-year job is only a dream. Yet today there are a surprising number of men earning five figure salaries were merely dreaming of them a short while ago. The secret of their success should prove a startling revelation to every ambitious man who has ever aspired to get into the \$10,000-a-year class.

There is nothing "different" about the man whose salary runs into five figures. He is made of the same stuff as you and I. For example, take J. P. Overstreet, of Dallas, Texas. A few short years ago he was a police officer earning less than \$1,000 a year. Today his earnings are in excess of \$1,000 a month—more than \$12,000 a year. C. W. Campbell, Greensburg, Pa., was formerly a railroad employe on a small salary—last month his earnings were \$1,562.

Why Don't YOU Get into the Selling Field?

Read These Amazing Stories of Success

Earned \$524 in Two Weeks
I had never earned more than \$40 a month. Last week cleared \$300 and this week \$218. You have done wonders for me.—Geo. W. Kearns, Oklahoma City, Okla.

I Now Earn as High as \$100 a Day
I took your course two years ago. Was earning \$15 a week working. Am now selling many of the largest firms in the U.S. I have earned more than \$100 in a day. You secured me my position. Our Sales Manager is a graduate of yours.—J. L. DeBelle, Chicago, Ill.

Earned \$1562 in Thirty Days
My earnings for the past thirty days are \$1,562.00, and I won Second Prize in March, although I only worked two weeks during that month.—C. W. Campbell, Greensburg, Pa.

Earned \$1,000 in Six Weeks
My earnings for March were over \$1,500 and over \$1,300 for the last six weeks, while last week my earnings were \$254.00. I traveled eleven months out of the year, working 5 days each week. The N. S. T. A. dug me out of a rut where I was earning less than \$1,000 a year and showed me how to make a success.—J. P. Overstreet, Dallas, Texas.

Mr. Overstreet, Mr. Campbell, and the others whose letters you see on this page are all successful salesmen. They have stepped into the \$10,000-a-year class—and they never sold goods before! It is hard to believe that such big success could come so quickly and easily. Yet it was all amazingly simple! Ask them the secret of their sudden success. They will tell you they owe it to the National Salesmen's Training Association. This is an organization of top-notch salesmen and sales managers formed expressly for the purpose of training men to sell and helping them to good selling positions. It has taken hundreds of men from all walks of life and

made them Master Salesmen—it has lifted them out of the rut and shown them the way to magnificent earnings, to fascinating careers and big selling positions.

We Train You and Help You Land a Job

What these men have done you can do! In your spare time at home you can easily master the secrets of selling that make Star Salesmen. Whatever your experience has been—whatever you may be doing now—whether or not you think you can sell—just answer this question: Are you ambitious to earn \$10,000 a year? Then send me your name quick! I will prove to you without cost or obligation that you can easily become a Star Salesman. I will show you how the Salesmanship Training and Free Employment Service of the N. S. T. A. will help you to wonderful success in Selling.

Free Book on Salesmanship

Just mail the coupon or write for our great illustrated book, "Modern Salesmanship," which we will send you free. Let us prove to you that regardless of what you are doing now you can quickly become a Star Salesman. Let us show you how you, too, can step into the ranks of the big money makers of business. See how easily you can learn this fascinating, big pay profession at home in your spare time. Learn what we have done for others and what we stand ready to do for you. Don't put it off until tomorrow—write us today. Mail the coupon at once.

National Salesmen's Training Association
Dept. 12-H, Chicago, Ill., U. S. A.

National Salesmen's Training Association
Dept. 12-H, Chicago, Ill., U. S. A.

Please send me, without any obligation on my part, your free book, "Modern Salesmanship," and full information about the N. S. T. A. system of Salesmanship Training and Employment Service. Also a list showing lines of business with openings for salesmen.

Name.....
Street.....
City..... State.....
Age..... Occupation.....



"Don't tell me you never had a chance!"

"Four years ago you and I worked at the same bench. I realized that to get ahead I needed special training, and decided to let the International Correspondence Schools help me. I wanted you to do the same, but you said, 'Aw, forget it!' You had the same chance I had, but you turned it down. No, Jim, you can't expect more money until you've trained yourself to handle bigger work."

There are lots of "Jims" in the world—in stores, factories, offices, everywhere. Are you one of them? Wake up! Every time you see an I. C. S. coupon your chance is staring you in the face. Don't turn it down.

Right now over one hundred thousand men are preparing themselves for bigger jobs and better pay through I. C. S. courses.

You can join them and get in line for promotion. Mark and mail this coupon, and find out how.

INTERNATIONAL CORRESPONDENCE SCHOOLS Box 5651-C, Scranton, Penna.

Without cost or obligation, please send me full information about the subject before which I have marked an X in the list below:

BUSINESS TRAINING DEPARTMENT

- | | |
|---|---|
| <input type="checkbox"/> Business Management | <input type="checkbox"/> Salesmanship |
| <input type="checkbox"/> Industrial Management | <input type="checkbox"/> Advertising |
| <input type="checkbox"/> Personnel Organization | <input type="checkbox"/> Better Letters |
| <input type="checkbox"/> Traffic Management | <input type="checkbox"/> Foreign Trade |
| <input type="checkbox"/> Business Law | <input type="checkbox"/> Stenography and Typing |
| <input type="checkbox"/> Banking and Banking Law | <input type="checkbox"/> Business English |
| <input type="checkbox"/> Accountancy (including C.P.A.) | <input type="checkbox"/> Civil Service |
| <input type="checkbox"/> Nicholson Cost Accounting | <input type="checkbox"/> Railway Mail Clerk |
| <input type="checkbox"/> Bookkeeping | <input type="checkbox"/> Common School Subjects |
| <input type="checkbox"/> Private Secretary | <input type="checkbox"/> High School Subjects |
| <input type="checkbox"/> Business Spanish <input type="checkbox"/> French | <input type="checkbox"/> Illustrating <input type="checkbox"/> Cartooning |

TECHNICAL AND INDUSTRIAL DEPARTMENT

- | | |
|---|--|
| <input type="checkbox"/> Electrical Engineering | <input type="checkbox"/> Architect |
| <input type="checkbox"/> Electric Lighting | <input type="checkbox"/> Contractor and Builder |
| <input type="checkbox"/> Mechanical Engineer | <input type="checkbox"/> Architectural Draftsman |
| <input type="checkbox"/> Mechanical Draftsman | <input type="checkbox"/> Concrete Builder |
| <input type="checkbox"/> Machine Shop Practice | <input type="checkbox"/> Structural Engineer |
| <input type="checkbox"/> Railroad Positions | <input type="checkbox"/> Plumbing and Heating |
| <input type="checkbox"/> Gas Engine Operating | <input type="checkbox"/> Chemistry |
| <input type="checkbox"/> Civil Engineer | <input type="checkbox"/> Pharmacy |
| <input type="checkbox"/> Surveying and Mapping | <input type="checkbox"/> Automobile Work |
| <input type="checkbox"/> Mine Foreman or Engineer | <input type="checkbox"/> Navigation |
| <input type="checkbox"/> Steam Engineering | <input type="checkbox"/> Agriculture and Poultry |
| <input type="checkbox"/> Wireless <input type="checkbox"/> Airplane Engines | <input type="checkbox"/> Mathematics |

Name.....
Street.....
Address.....

City..... State.....

Occupation.....

Persons residing in Canada should send this coupon to the International Correspondence Schools Canadian, Limited, Montreal, Canada.

Learn to Write

I Teach by Mail

I CAN make a good penman of you at your home during spare time, no matter where you live or how poorly you now write. My simplified system has shown thousands of others the way to good penmanship during the past twenty years—it can and will do the same for YOU!

Beautifully Illustrated Book
"How to Become a Good Penman"

It contains general information, with testimonials and beautiful specimens of penmanship showing what others have accomplished by the Tambllyn System. (Your name elegantly written on a card if you enclose stamp for postage.) WRITE TODAY. Address

F. W. TAMBLYN
418 Ridge Bldg., Kansas City, Mo., U. S. A.

F. W. Tambllyn



HOW TO BECOME PROFESSIONAL PHOTOGRAPHER

Earning \$35 to \$125 a week

An interesting illustrated booklet on choosing a vocation, the except opportunities Photography offers you and how to avail yourself of these advantages.

Motion Picture—Commercial—Portraiture

Three to six months' Practical course. Modern equipment. Day or evening classes. Easy terms. Call or write for Catalog No. 49.

N. Y. INSTITUTE OF PHOTOGRAPHY
NEW YORK CHICAGO BROOKLYN
141 W. 36th St. 630 So. Wabash Ave. 505 State St.

STAMMER

If you stammer attend no stammering school till you get my large FREE book entitled "STAMMERING, Its Origin and the Advanced Natural Method of Cure," bound in cloth and stamped in pure gold. Ask for special tuition rate and a FREE copy of "The Natural Speech Magazine." Largest, best equipped and most successful school in the world for the cure of stammering, stuttering, etc. No sing-song or time beat. Write today. The North-Western School, 2317 Grand Ave., Milwaukee, Wis.

WHY not spend Spring, Summer and Fall gathering butterflies, insects? I buy hundreds of kinds for collections. Some worth \$1 to \$7 each. Simple outdoor work with my instructions, pictures, price list. Get posted now. Send 25c (NOT STAMPS) for my Illustrated Prospectus. Mr. Siasche, Dealer in Insects, Dept. 6, Ocean Park, Calif.



Music Lessons

UNDER MASTER TEACHERS

At Home

Any Instrument Write passing course you are interested in: Violin, Cornet, Mandolin, Guitar, Banjo or Reed Organ—and we will send FREE CATALOG. SEND for it NOW!

University Extension Conservatory, 622 Siegel-Myers Bldg., Chicago

Boxing - 5¢ a lesson!

80 Lessons \$3.85

Lessons in fundamentals—

- (1) Hitting. (2) Guarding. (3) Ducking. (4) Feinting. (5) Clinching.

Advanced Boxing—

- (1) Psychology of the ring. (2) Breaking ground. (3) The Crouch. (4) Feinting. (5) Judging distance and timing. (6) Advanced ducking. (7) Advanced clinching. (8) Right-hand boxing. (9) In-fighting. (10) Side-stepping and back-stepping. (11) Boxing a taller opponent. (12) Generalship.

Blows and Guards—(13)

- Left-hand lead for body. (14) Guard for same. (15) Right-hand body blow. (16) Guard for same. (17) Cross-parry. (18) Guard for same. (19) Straight left-hand blow for head. (20) Guard for same. (21) Right-hand cross counter for head. (22) Guard for same. (23) Left-hand counter for head with guard. (24) Stopping a straight counter for head. (25) Swinging left-hand blow for head. (26) Guard for same. (27) Swinging left-hand blow for jaw, and guard. (28) Swinging left-hand blow for body and guard. (29) Stop for all blows. (30) The left-hand uppercut and guard. (31) Right hand uppercut and guard. (32) Pivot blow. (33) Corbett swing. (34) Jack Dempsey Triple. (35) Benny Leonard Triple. (36) Fitzsimmons Shift. (37) Kid McCoy Corkscrew Blow. (38) Dal Hawkins Hook. (39) Stanley Ketchel One-Two Blow. (40) Donovan Leverage Guard.

Shadow Boxing—(41) Round

- 1-5 blows. (42) Round 2-7 blows. (43) Round 3-7 blows.

Training—(44) Training.

- (45) Bridging. (46) Dipping. (47) Chinling. (48) Foot exercise. (49) Leg exercise. (50) Colon exercise. (51) Synthetic breathing.

Mass Boxing—(52) Straight

- blows. (53) Swinging blows. (54) Guarding. (55) Ducking. (56) Foot Work. (57) Upper-cutting. (58) Drill.

Jiu-Jitsu and Wrestling—

- (59) Arm Twist. (60) The hand grip. (61) Arm lock. (62) Gun releases. (63) Defense against dagger. (64) Wrist release. (65) Throat release. (66) To stop a kick. (67) Releasing neck hold. (68) Releasing a waist hold. (69) Throwing an opponent over your head. (70) Head and cross buttock. (71) Arm and cross buttock. (72) Rolling with the arm of opponent. (73) Crotch hold. (74) Head in chancery hold. (75) Throwing an opponent grasping from behind. (76) The Back Heel Hold. (77) Standing chancery hold. (78) Standing crotch hold. (79) The toe hold. (80) Scissor hold.

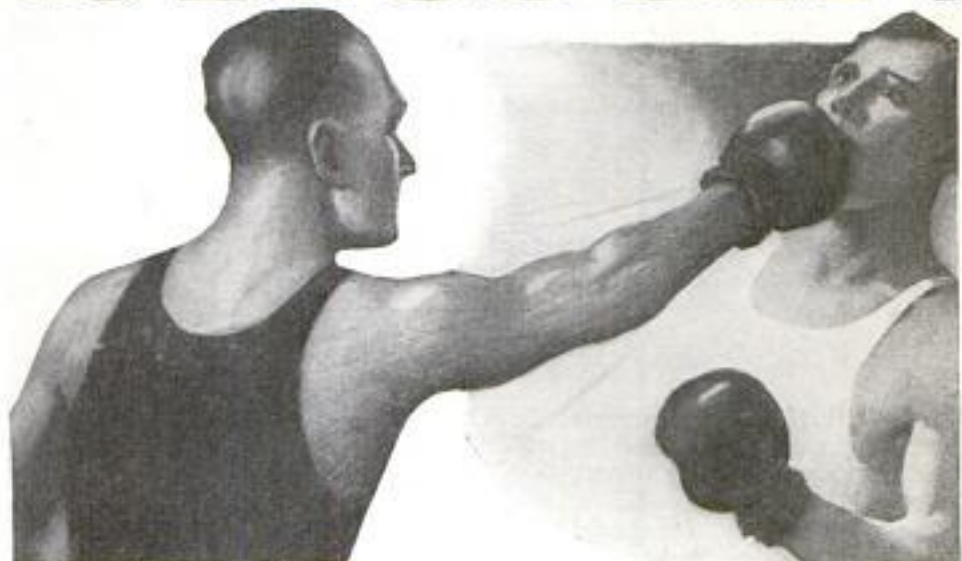

Thousands of red-blooded men all over the United States will take advantage of this stupendous offer—a new "short-cut" method of learning self-defense *right in your own home*—at only 5 cents a lesson.

In a few weeks you'll master the fundamentals of scientific hitting, guarding, feinting, ducking, clinching, countering, etc.

Next you will learn the blows and guards used by top-notchers—the Benny Leonard Triple Blow, the Fitzsimmons Shift, the Jack Dempsey Triple, footwork, generalship, etc.

Marshall Stillman, friend and pupil of Mike Donovan, teaches you by a brand new method—*The Mental Suggestion Method*.

You don't have to know a thing about boxing to begin with. Fifteen minutes a day will make you a good boxer in a short time.

You start with simple movements you are already familiar with, such as holding out your hand for a coin, the breast stroke in swimming, etc. Then step by step Marshall Stillman leads you into similar movements in boxing—hitting, ducking, guarding, side-stepping, etc., until you go through these motions almost without thinking about them. You are not pounded, confused or bewildered by a more experienced opponent.

To complete your training in self-defense, you're taught 15 jiu jitsu and bone breaking

holds, and releases, and 14 of the best wrestling holds—the Gotch Toe Hold, Stecher Scissor Hold, the Head Lock, etc.

And to improve you physically you're given a complete set of health and muscle-building exercises.

There are 80 lessons altogether, 381 pages, 246 illustrations. When Marshall Stillman first produced the course it sold for \$10. And now we offer it to you on approval at less than 5 cents a lesson—\$3.85 for the complete course.

Free History of Boxers—Every one who accepts this liberal offer will receive without extra charge a History of Famous Boxers, with their pictures—Jack Dempsey, John L. Sullivan, Benny Leonard, Carpenter, etc., with inside stories seldom heard outside professional circles.

SEND NO MONEY

We'll send you the complete course for 10-day examination. When you receive the course, hand the postman a temporary deposit of \$1. Try the course out for 10 days. At the end of that time, send us \$2.85 more or return the books, and we'll send your dollar back. Mail the coupon now to Marshall Stillman Ass'n, Dept. 1222-G, 42nd St. and Madison Ave., New York.

MARSHALL STILLMAN ASSOCIATION,
Dept. 1222-G, 42nd St. and Madison Ave.,
New York.

You may send me on approval the complete Marshall Stillman Course, price of which is \$3.85. Upon its receipt, I agree to pay the postman \$1 as deposit. It is understood that I am to pay the balance (\$2.85) or return the course within 10 days after I receive it. If I return it you are to refund my dollar.

Note: Canadian or foreign orders must be accompanied by cash (\$3.85) subject to money back if not satisfactory.

Name

Address



AN ambitious salesman of Louisiana realized that in order to get along he must become master of his job. He enrolled for the United Y. M. C. A. Schools' course in Salesmanship. His employer wrote "We observed that he was applying salesmanship principles to his work and getting effective results."

This young man stepped into a larger opportunity after only eight weeks' studying and his commissions the first month in this new job amounted to \$500.

Few could expect such a quick or large return, but every ambitious young man can fit himself for larger responsibility and earnings through spare-hour study with the United Y. M. C. A. Schools.

Send for an inspiring booklet, "Head and Shoulders Above the Crowd—How to Get There," tell us your age, occupation and ambition, and get our friendly counsel free.

The "Six Reasons" for studying with the United Y. M. C. A. Schools will appeal to you.

Tear Out and Send This Slip

United Y. M. C. A. Schools' Correspondence Courses, or positions for which they afford training

Accountant	Highway Engineering
Advertising Man	Machine-Shop Practice
Agricultural Courses	Leadership Courses
Architect	Locomotive Operator
Auto Mechanic	Mathematical Courses
Banking	Mechanical Engineer
Better Letters	Own-Your-Home Course
Bookkeeper	Plumber
Building Construction	Poultry Husbandry
Business English	Radio Operator
Business Law	Radio Engineer
Business Organization	Railroad Engineering
Civil Engineer	Salesman
Civil Service	Secretarial
Concrete Engineer	Shorthand and Typewriting
Dairy Farming	Steam Engineer
Draftsman	Structural Drafting
Electrician	Surveyor
Electrical Engineer	Tool Designing
Factory Management	Tractors and Farm Machinery
Farm Management	Traffic Management
Foreign Languages	Use of the Slide Rule
High School Subjects	Are You an ex-service Man?
Foremanship	

United Y.M.C.A. Schools

375 Lexington Ave.
New York City.

Without obligating me, please advise regarding the course in

Age and Occupation.....

Name.....

Full address.....

74-37

(Please write plainly.)



THE PRACTICAL Automobile, Wagon, House and Sign Painter

By W. F. White
Postpaid, \$1.00

This book is written for the man who wishes to paint his automobile, or his home, or wagon. It will tell the inexperienced just how to do it, and it will tell him how to mix paints. It also contains many painters' recipes and trade secrets of great value. Bound in Cloth—157 pages—Size 5 x 7 1/2.

Postpaid \$1.00

SHREWSBURY PUBLISHING CO.
5525 West Lake Street Chicago, Illinois

Earn \$35-\$125 a Wk



Your Opportunity in MECHANICAL DENTISTRY

Ambitious men of all ages can rise above small salaried positions into this profession of unlimited possibilities.

Taught by actual practice—day or evening. Three months' course. Modern laboratories. No previous knowledge or experience required. No charge for tools or equipment. The men we train are in demand. Established 30 years. Catalog free.

Address your inquiry to Dept. 2

BODEE SCHOOLS OF MECHANICAL DENTISTRY

NEW YORK
436 W. 52 St.

PHILADELPHIA
1515 and Walnut Sts.

BROOKLYN
15 Flatbush Ave.

PIANO JAZZ

By note or ear. With or without music. Short Course. Adult beginners taught by mail. No teacher required. Self-Instruction Course for Advanced Pianists. Learn 67 styles of Bass, 180 Syncopated Effects, Blue Harmony, Oriental, Chime, Movie and Cafe Jazz, Trick Endings, Clever Breaks, Space Fillers, Sax Slurs, Triple Bass, Wicked Harmony, Blue Obligato, and 247 other Subjects, including Ear Playing, 110 pages of REAL Jazz, 25,000 words. A Postal brings our FREE Special Offer. Waterman Piano School, 259 Superba Theatre Bldg., Los Angeles, Calif.

LEARN WATCHMAKING

and become independent. Good-paying positions secured.

Easy to learn. Send for FREE CATALOG.

ST. LOUIS WATCHMAKING SCHOOL, Dept. 5, ST. LOUIS, MO

40,000 Opportunities in Hotels

Nation wide demand for high salaried men and women; past experience unnecessary; we train you by mail and put you in touch with big opportunities. Big pay, exciting, interesting work, quick advancement; permanent. Write for Free Book, "Your Big Opportunity."

LEWIS HOTEL TRAINING SCHOOL, Room 328, Washington, D. C.



MAIL CLERKS

COMMENCE

\$135 Month

Raise to \$195 Month

Send coupon today sure

Men, Boys—Over 17

LIFE JOB

FRANKLIN INSTITUTE
Dept. E, 171, Rochester, N. Y.

Sirs:—Send me at once, free of charge, Sample Railway Mail Examination questions, list of other U. S. Government positions now open and free book describing them.

Name.....
Address.....

FREE RAILROAD FARE

**Learn
Electricity
in 3½
Months**

**Earn
\$150
to
\$400
per
Month**

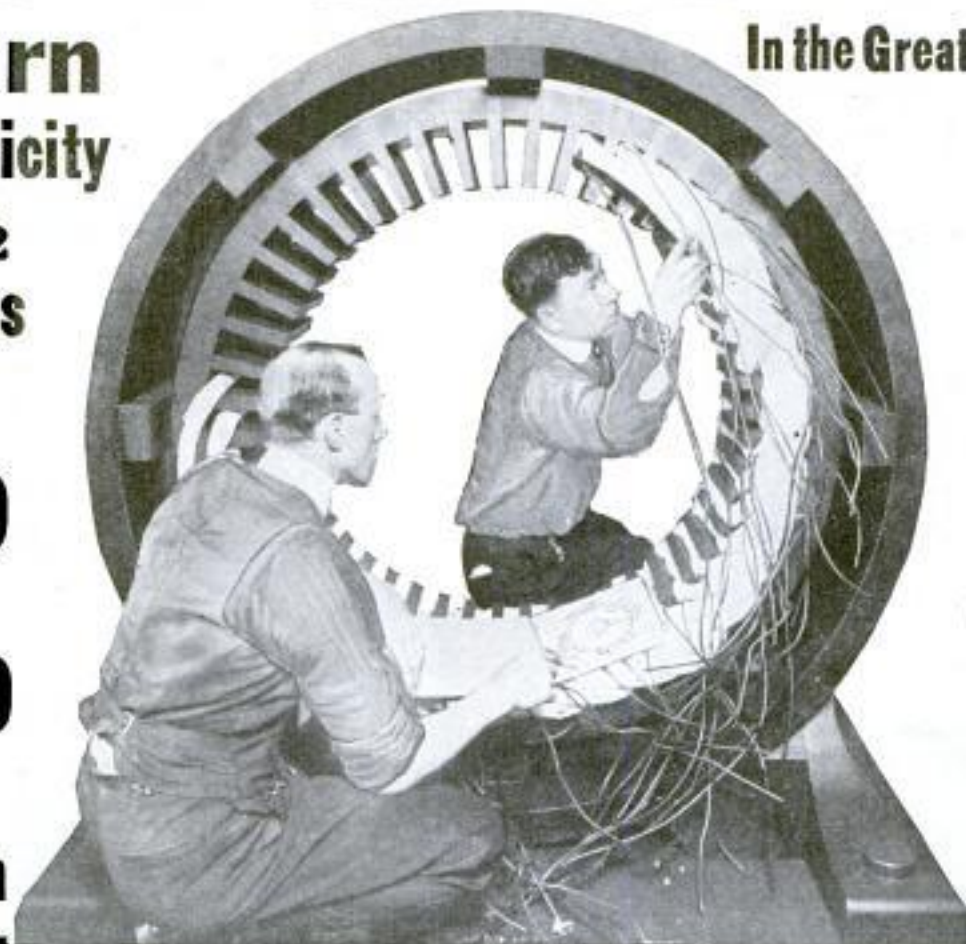

In the Great Shops of

COYNE

Student Winding Stator

Make this the most profitable and enjoyable summer of your life. Come to Chicago, the greatest summer resort city in the country on beautiful Lake Michigan, and the greatest electrical center in the world. We pay your railroad fare from any place in the United States. See the country at our expense. Become a skilled electrical expert in the great shops of Coyne.

Complete Electrical Training in 3½ Months

No books or useless theory—everything is practical. You are trained on \$100,000 worth of electrical equipment. Everything from door bells to power plants. You work on motors, generators, house wiring, autos, batteries, radio, switchboards, power plants—everything to make you an expert ready to step right into a position paying from \$45 to \$100 per week. A Coyne trained man is trained completely. He can take his place any-

where in the electrical world. Auto ignition and battery experts make from \$3,000 to \$20,000 a year. Hundreds of our graduates are making big money and you can do the same if you grasp this opportunity. Send the coupon today!

Radio Course FREE

Besides paying your railroad fare, we include free a course in Radio—the marvel of the age. Also, a complete course in auto, truck and tractor electricity and storage batteries. Greatest outlay of auto electrical and battery equipment in the country.

Earn While You Learn

Our employment department helps you get a job to earn a good part of your expenses.

Send Coupon NOW!

This is the greatest offer ever made by a school and it is for a limited time. Don't delay a single minute. Send the coupon in right away for our big free catalogue and full particulars of this wonderful offer. Act now!

B. W. COOKE, Pres.

COYNE TRADE & ENGINEERING SCHOOL

Dept. 17, 39-51 E. Illinois St., Chicago, Ill.

Dear Sir:—Please send me free your big catalog and full particulars of your special offer of free railroad fare and 2 extra courses.

Name.....

Address.....

Chicago, on beautiful Lake Michigan, is the Nation's summer playground. Free bathing beaches, beautiful parks, excursion boats and the great Municipal Pier, zoo, ball parks. Coyne is near the Lake and bathing beaches.



B. W. COOKE, President

COYNE TRADE & ENGINEERING SCHOOL

39-51 E. Illinois Street

Dept. 17

CHICAGO, ILL.

Do You Like to Draw?

Here Is a Simple, Easy Way
to Draw a Comic Face

TRY IT



Make a square with pencil, then add to it with pencil as shown in the small squares above. Erase all pencil guide lines after the drawing is completed.

We will not give you any "grand prize," if you draw this picture. Nor will we claim to make you "rich in a week." But if you are anxious to develop your talent with a **successful cartoonist**, so you can **make money**, send a copy of this picture with six cents in stamps for portfolio of cartoons and sample lesson plate, and let us explain more in detail. Some of the **most successful cartoonists** are former students of this school. It is not hard to learn to draw **originals** when you are shown how in a **practical way**,



THE W. L. EVANS SCHOOL OF CARTOONING
"The School That Has the Reputation"
821 Leader Bldg. CLEVELAND, OHIO

LEARN BY DOING
Every phase of all branches of
ELECTRICITY
Taught by Actual Practice
In America's foremost and oldest institution for trade training.
No Books Used Individual Instruction Start Any Day
A SPECIAL and SEPARATE Course in Ignition, Auto Lighting and STARTER Systems. Write for FREE 64-page catalog.
THE
NEW YORK ELECTRICAL SCHOOL
44 West 17th Street NEW YORK CITY

LEARN WATCH REPAIRING

Be a watchmaker—you can learn this profitable trade by correspondence in a few weeks in your own home by the DeSelm's Chart System. After you complete the course you will know a watch from A to Z. You will know just what the matter is and how to repair one. When you graduate you will be a practical watchmaker and repairer and competent to fill any position. Positional or our graduates.

Ask for our Free Book, it explains our system and terms
THE DeSELMS WATCH SCHOOL
23 Perry Street ATTICA, INDIANA



Wonderful, new device, guides your hand; corrects your writing in few days. Big improvement in three hours. No failures. **Complete outline FREE.** Write C. J. Ozment, D-34, St. Louis, Mo.

STAMMERERS

For 55 years we have successfully corrected stammering by our simple and natural course of individual lessons. Attend no school until you have read our free booklet, "How To Stop Stammering."
SAMUEL A. ROBBINS, Director,
Boston Stammerers' Institute
246 Huntington Ave. Boston 17, Mass.

Wrestling Book FREE

Be an expert wrestler. Learn at home by mail. Wonderful lessons prepared by world's champion Farmer Burns and Frank Gotch. Free book tells you how. Secret holds, blocks and tricks revealed. Don't delay. Be strong, healthy. Handle big men with ease. Write for free book. State your age.
Farmer Burns, 817 Range Building, Omaha, Neb.

Ride A Ranger

The finest bicycle ever built. 44 Styles, colors, sizes; made in our new factory. **SAVE \$10 to \$25** by direct from the factory purchase.
Delivered free on approval, express prepaid, for **30 Days' Free Trial. 12 MONTHS TO PAY**, if desired.
Tires best quality at factory prices, express paid. Lamps, wheels, horns, equipment and repairs at unusually low prices. **Send No Money, do business direct with makers.**
Mead Cycle Company
Dept. F105 Chicago

Write today for free Ranger Catalog, factory prices and marvelous easy payment terms

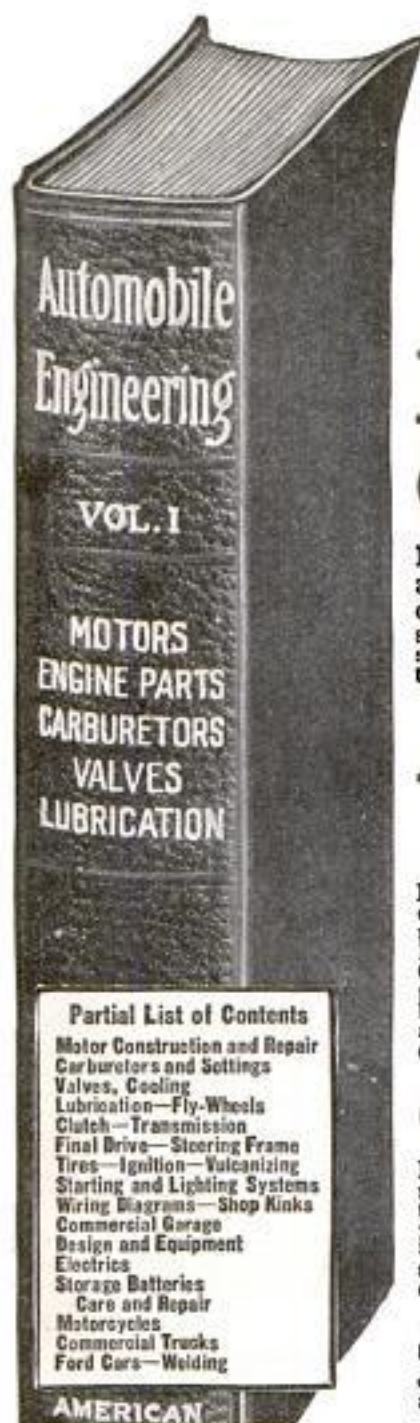

Partial List of Contents

Motor Construction and Repair
 Carburetors and Settings
 Valves, Cooling
 Lubrication—Fly-Wheels
 Clutch—Transmission
 Final Drive—Steering Frame
 Tires—Ignition—Vulcanizing
 Starting and Lighting Systems
 Wiring Diagrams—Shop Kinks
 Commercial Garage
 Design and Equipment
 Electrics
 Storage Batteries
 Care and Repair
 Motorcycles
 Commercial Trucks
 Ford Cars—Welding

AMERICAN

NAME	POSITION	SALARY
John	AUTOMOBILE ENGINEER	\$125 A WEEK
	REPAIR MAN	\$50 A WEEK
	CHAUFFEUR	\$40 A WEEK

Put Your Name On this Pay-Roll

Men like you are wanted for big-pay positions in the fascinating field of automobile engineering. We have made it easy for you to fit yourself for one of these positions. You don't have to go to school. You don't have to serve an apprenticeship. Fifteen automobile engineers and specialists have compiled a spare time reading course that will equip you to be an automobile expert without taking any time from your present work.

AUTO BOOKS 6 Volumes Shipped FREE

Now ready for you—at a big reduction in price—an up-to-the-minute six-volume library on Automobile Engineering, covering construction, care and repair of pleasure cars, motor trucks, tractors and motorcycles. Brimming over with advanced information on Lighting Systems, Garage Design and Equipment, Welding and other repair methods. Contains everything that a mechanic or an engineer or a motorcyclist or the owner or prospective owner of a motor car ought to know. Written in simple language that anybody can understand. Tastefully bound in flexible covers and gold stamped, 2700 pages and 2400 illustrations, tables and wiring diagrams. A library that cost thousands of dollars to compile but that comes to you free for 7 days' examination.

Only 10 Cents a Day

Not a cent to pay in advance. First you see the books in your own home or shop. Just mail coupon and pay express charges when books arrive. You can read them and study them for seven whole days before you decide whether you want to keep them or not. If you like the books send \$2.80 in seven days and \$3.00 a month until the special price of \$21.80 has been paid. (Regular price \$45.00.) Along with the set goes a year's membership in the American Technical Society, including consulting privileges and free employment service.

Send No Money Now

Don't take our word for it. See the books without cost. There is so much profit in this offer for you, that we urge you not to waste a moment in sending for the books. Put the coupon in the mails today. SEND NO MONEY—only the coupon.

American Technical Society

Dept. A-19B

Chicago, Illinois

American Technical Society, Dept. A-19B, Chicago

Please send me a set of Automobile Engineering books in 6 volumes by express collect, for a week's free use. At the end of a week I will either send the books back at your expense or send you \$2.80 as first payment and \$3.00 each month thereafter until a total of \$21.80 is paid. I understand that I will get a membership in your society, including consulting privileges and free employment service if I purchase the books.

Name

Address

City

State

Reference

Mail The
Coupon For
These Books



"Blake is the Man!"

"I told Hartley he was a 'comer'—and this confirms my judgment! Listen to this letter:—

Dear Sir:

You will no doubt be glad to know that James H. Blake, one of your employees of whose excellent work as a student we have been advising you each month, has completed his course and has been granted a diploma.

International Correspondence Schools

"That settles the manager question. The man who cares enough about his future to invest some of his spare time in training is the kind we want in this firm's responsible positions.

"That \$5,000 salary will mean a lot to Blake and his family. I'll send for him now! It's a pleasure to promote a man who *deserves* it."

There is a job ahead of you that some man is going to be picked for. And your boss can't take chances. He is going to choose a trained man. Why don't you put yourself in line for that promotion?

One hour a day spent with the I. C. S. in your own home will bring you bigger money, more comforts, more pleasures, all that success means. Don't let another single priceless hour of spare-time go to waste! Without cost or obligation of any kind, let us prove that we can help you. Just mark and mail this coupon.

INTERNATIONAL CORRESPONDENCE SCHOOLS Box 5653-C, Scranton, Penna.

Without cost or obligation, please send me full information about the subject before which I have marked an X in the list below:

BUSINESS TRAINING DEPARTMENT

- | | |
|---|---|
| <input type="checkbox"/> Business Management | <input type="checkbox"/> Salesmanship |
| <input type="checkbox"/> Industrial Management | <input type="checkbox"/> Advertising |
| <input type="checkbox"/> Personnel Organization | <input type="checkbox"/> Better Letters |
| <input type="checkbox"/> Traffic Management | <input type="checkbox"/> Foreign Trade |
| <input type="checkbox"/> Business Law | <input type="checkbox"/> Stenography and Typing |
| <input type="checkbox"/> Banking and Banking Law | <input type="checkbox"/> Business English |
| <input type="checkbox"/> Accountancy (including C.P.A.) | <input type="checkbox"/> Civil Service |
| <input type="checkbox"/> Nicholson Cost Accounting | <input type="checkbox"/> Railway Mail Clerk |
| <input type="checkbox"/> Bookkeeping | <input type="checkbox"/> Common School Subjects |
| <input type="checkbox"/> Private Secretary | <input type="checkbox"/> High School Subjects |
| <input type="checkbox"/> Business Spanish <input type="checkbox"/> French | <input type="checkbox"/> Illustrating <input type="checkbox"/> Cartooning |

TECHNICAL AND INDUSTRIAL DEPARTMENT

- | | |
|---|--|
| <input type="checkbox"/> Electrical Engineering | <input type="checkbox"/> Architect |
| <input type="checkbox"/> Electric Lighting | <input type="checkbox"/> Contractor and Builder |
| <input type="checkbox"/> Mechanical Engineer | <input type="checkbox"/> Architectural Draftsman |
| <input type="checkbox"/> Mechanical Draftsman | <input type="checkbox"/> Concrete Builder |
| <input type="checkbox"/> Machine Shop Practice | <input type="checkbox"/> Structural Engineer |
| <input type="checkbox"/> Railroad Positions | <input type="checkbox"/> Plumbing and Heating |
| <input type="checkbox"/> Gas Engine Operating | <input type="checkbox"/> Chemistry |
| <input type="checkbox"/> Civil Engineer | <input type="checkbox"/> Pharmacy |
| <input type="checkbox"/> Surveying and Mapping | <input type="checkbox"/> Automobile Work |
| <input type="checkbox"/> Mine Foreman or Engineer | <input type="checkbox"/> Navigation |
| <input type="checkbox"/> Steam Engineering | <input type="checkbox"/> Agriculture and Poultry |
| <input type="checkbox"/> Wireless <input type="checkbox"/> Airplane Engines | <input type="checkbox"/> Mathematics |

Name.....
Street.....
Address.....

City..... State.....

Occupation.....

Persons residing in Canada should send this coupon to the International Correspondence Schools Canadian, Limited, Montreal, Canada.

Please Mention Popular Mechanics

BECOME A LAWYER



Study At Home. Legally trained men win high positions and big success in business and public life. Greater opportunities now than ever before. Be a leader. Lawyers earn

\$3,000 to \$10,000 Annually

We guide you step by step. You can train at home during spare time. Let us send you records and letters from LaSalle students admitted to the bar in various states. Money refunded according to our Guarantee Bond if dissatisfied. Degree of LL. B. conferred. Thousands of successful students enrolled. Low cost, easy terms. We furnish all text material, including fourteen-volume Law Library. Get your valuable 120-page "Law Guide" and "Evidence" books free. Send for them today.

LASALLE EXTENSION UNIVERSITY
Dept. 764-L Chicago

Keystone Institute "The Service School"

A fully equipped school with expert instructors, organized to give intensive instruction in

2-Year Courses
Electrical Engineering
Mechanical Engineering
Accounting and Business Administration
16 weeks' course in Automotive Engineering

Day and Night Classes. Graduates are sought by large and small industrial establishments and are filling important positions in all sections of the country. Write for information on subject that interests you to Keystone Institute. Address The Vice President, 133 North 4th Street, Reading, Penna.

WRITE NOW FOR Dyke's FREE Booklet

A NEW IDEA OF TEACHING BY MAIL tells how you can learn at home—spare time—and Become an Auto Expert on repairing and electrical systems.

DYKE'S SCHOOL OF MOTORING, Box 300 Granite Bldg., St. Louis, Mo.
A department of the Firm: A. L. Dyke, Publisher. Original and only system of its kind. Endorsed by leading motor authorities of the world.

Learn Drafting Increase Your Income

Expert Draftsmen earn from \$60 to \$150 a week and are in line for promotion to executive positions. You can become an expert by the Chicago "Tech" Method. Train by mail in spare time and put yourself in the high salaried class.

Free Trial Lesson

Send for Free Lesson which shows how easily you can get this practical training at little cost and on easy terms. Write today.

CHICAGO TECHNICAL COLLEGE
730 CHICAGO "TECH" BLDG., CHICAGO, ILL.

MUSIC LESSONS FREE

 IN YOUR OWN HOME
You can read Music like this quickly

Piano, Organ, Violin, Mandolin, Guitar, Banjo, etc. Beginners or advanced players. One lesson weekly. Illustrations make everything plain. Only expense about 5¢ per day to cover cost of postage and music used. Write for FREE booklet which explains everything in full.

AMERICAN SCHOOL OF MUSIC, 51 Lakeside Building, CHICAGO

TRI STATE COLLEGE OF ENGINEERING

Makes you a Civil, Mechanical, Electrical or Chemical Engineer in two years, 48 weeks each. No entrance examinations. High School Diploma not required. Compact courses made up of essentials only. Expenses low. For catalog address
100 "M" STREET, ANGOLA, IND.

LEARN WATCH REPAIRING

 You can learn by our modern and original system of instruction every part of the Watch Repairing Trade at home as good or better than at a shop. You can earn money while learning and secure a well paying position or start in business after completing our course of instruction. Good watch repairers are always in demand and earn from \$80 to \$70 per week. For particulars apply to the WISCONSIN SCHOOL OF WATCH REPAIRING
166 Mason St., MILWAUKEE, WIS.

Thousands Who Don't Dream They Can Write Really CAN!

By ELINOR GLYN

Author of "Three Weeks," "Beyond the Rocks,"
"The Great Moment," Etc., Etc.

YOU may consider the above a broad statement. But is it? Is writing a magical art set aside as the special province of certain gifted dreamers?

I do not think so. I think that the vast majority of stories and photoplays are made up of characters, emotions, and reactions that you and the rest of the world know all about. I have discussed this subject to great lengths with a number of persons. Invariably, they have agreed with me that fiction, in its sensible phases, is nothing more than an interesting picture of certain characters revealing themselves by their actions and their words. Thus, when a writer has certain characters to write of, he merely makes them do things that will show clearly and interestingly what kind of people they are.

The life of the most commonplace individual is chock-full of stories. A woman, in reporting to a friend the little rumors, anecdotes, and gossip she has heard, has at her finger-tips plots and ideas for any number of interesting stories and photoplays. There is something interesting about every man and woman. Our daily existence is a history of blunders, hopes, surprises, privations, meetings, partings, adventures, journeys, accidents, romance, thwarted hopes, burning desires, and the like without end. Any of these phases of life can be made into splendid stories and photoplays. And, by certain methods that have just come to light, great numbers may now learn how to turn their knowledge, ideas, and experiences into salable stories and photoplays far easier than they ever dreamed it could be done.

I have enjoyed the privilege of considerable travel, and as a consequence have had the opportunity of meeting hundreds of aspiring writers. And always I have been eagerly asked for advice. How do I do it? What are the secrets of my success? Who started me off? Did I have a pull? How do I know what to write about? And the like in many varieties.

And always I answer: The art of writing is not such a horribly complicated thing as you seem to think. I myself am merely a receptive medium upon whose mind life, experiences and characters make certain impressions. I then put these impressions into stories, novels, articles, and photoplays. Your instincts, emotions, joys, and tribulations are not greatly different from those of myself or any well-known author, for that matter. Then, most assuredly, your impulses, impressions, and the ideas peculiar to you and your life should be made into stories and photoplays. You know how you have acted under certain circumstances. Why can you not put story characters in like situations and make them do the same?

You perhaps are not aware that the greatest stories and photoplays have been based upon the simplest, most primeval

passions and emotions brought up-to-date and arranged in such a manner as to create suspense. When a story or photoplay is thus based on truths and elements of human nature that are the very essence of homely, every-day existence, it is no more difficult to drive home a convincing and sincere effect than it is for water to run down hill. You know your niche of life, your occupation, your surroundings, your friends, and all the elements of your existence, far better than anyone else knows it. And, if you have taken the time and trouble to become interested in the people and the world about you, you certainly ought to write a far stronger story or photoplay of that life than anyone else could.

The fiction which I have written has been successful because it has been about the life that I know—and I feel assured that hundreds would obtain equal success if they would only stick to picturing phases of existence with which they are thoroughly familiar.

I have pointed out this very truth to struggling writers in past years, and I have been greatly amazed at the speed with which they have progressed when thus fortified with the confidence that in their little world were myriad plots which they and they alone were capable of digging up, brushing off, and presenting to the public.

The reason so many ambitious writers fail is because they struggle too hard to attain what is not half so difficult as it is made to seem. So many aspirants puff and fret and cast about frantically in hidden places for the secrets of success which all the while fairly stare them in the face. Their work is rejected because it is too obviously manufactured for the occasion, like a country boy attired for a city dress ball. They overstrain, they overstep. Had they written naturally of real life as they know it, they might have astonished the world.

Perhaps I have brought a new light to bear upon this subject of story and play writing. If so, I am very, very thankful. There is more to be said, however—some vitally interesting things concerning writing and writers that I would like to tell you if the space permitted. But it doesn't, so I have arranged with my publishers, The Authors' Press, of Auburn, N. Y., to send you a book which tells you a great many more things about my methods and secrets of writing, how to get ideas, how to succeed, and so on. It is a delightfully engaging little book and will be mailed free of charge to anyone really interested in learning how to write stories and photoplays by newly revealed methods that make writing so very much easier. This little book is named, "The Short-Cut to Successful Writing." It is very aptly named. I can assure you that its pages reveal the promised short-cuts in a very charming manner. I know you will be vastly pleased and instructed after having read it. It contains information that it is a shame to have kept from the public so long.

Simply fill out the coupon below, mail it to The Authors' Press. "The Short-Cut to Successful Writing" will be sent to you by return mail—ABSOLUTELY FREE.

THE AUTHORS' PRESS, Dept. 103, Auburn, N. Y.

Send me ABSOLUTELY FREE, "The Short-Cut to Successful Writing." This does not obligate me in any way. (Print your name and address plainly in pencil.)

Name.....

Address.....

City and State.....



Elinor Glyn

BE A RAILWAY TRAFFIC INSPECTOR

Position GUARANTEED

or Money Refunded

EARN up to \$250 per Mo., Expenses Paid

Pleasant, outdoor work. Travel or remain near home. Hundreds of men are wanted for this fascinating profession.

Many excellent opportunities for advancement. Work brings you in contact with big railway officials. Any average man can qualify.

Prepare In Spare Time

Start at \$110.00 per month, expenses paid. Prepare in three months' spare-time study at home. Advancement rapid with experience.

YOU TAKE NO RISK

Our Guarantee is that if we do not obtain for you a position paying at least \$110 a month and expenses, your enrollment fee is returned in full.

Send coupon today for full particulars and free booklet. Don't delay, investigate NOW while more men are wanted than are trained.

**STANDARD BUSINESS
TRAINING INST.**

BUFFALO, N. Y.



Standard Business Training Inst.,
Buffalo, N. Y.

Send me, entirely free, Booklet No. D-722, giving full particulars about course in Railway Traffic Inspection.

Name

Street

City

LAW High-Grade Instruction

Prepares You for
the Bar—Est. 1892
University Methods.

Standard Text-Books. Approved by Bench and Bar. Graduates practicing in every state. Send today for Free Catalog. Chicago School of Law

520 Reaper Block

Chicago, Ill.



WE TEACH COMMERCIAL

ART

Properly trained Artists Earn \$100 a week and up. Meyer Both College—a Department of the Meyer Both Company—offers you a different and practical training. If you like to draw, develop your talent. Study this practical course—taught by the largest and most widely known Commercial Art Organization in the field with 20 years' success—which each year produces and sells to advertisers in the United States and Canada over ten thousand commercial drawings. Who else could

give you so wide an experience? Commercial Art is a business necessity—the demand for commercial artists is greater every year. It's a highly paid, intensely interesting profession, equally open to both men and women. Home study instruction. Get facts before you enroll in any school. Get our special booklet, "Your Opportunity"—for half the cost of mailing—4c in stamps.

**MEYER BOTH COLLEGE
of COMMERCIAL ART**
Michigan Ave., at 20th St.
Dept. 16 CHICAGO, ILL.

STAMMER NO MORE

Kill the fear of stammering. Re-education the key. The widely famed Hatfield Method fully outlined in an accurate, dependable, worth-while book—"HOW TO STOP STAMMERING." It has inspired thousands. Free copy today.

THE HATFIELD INSTITUTE, 109 N. Dearborn, Chicago, Ill.

AVIATION INFORMATION FREE

Send us your name and address for full information regarding the Aviation and Airplane business. Find out about the many great opportunities now open and how we prepare you at home, during spare time, to qualify. Our new book "Opportunities in the Airplane Industry" shipped free if you answer at once.

AMERICAN SCHOOL OF AVIATION:

Dept. 119-B 3601 Michigan Ave. CHICAGO

Learn Autos and Tractors



Wonderful opportunities constantly offered trained men; we train you thoroughly to start your own business or make good money as motor expert, driver, shop foreman, etc.

7,000 Graduates making good. Catalog Free

Cleveland Automobile School, 1814 E. 24th St., Cleveland, O.

YOUR CHANCE! BARGAIN PRICE!

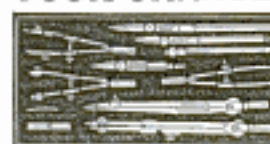

5 1/4" Drawing Sets Complete
Compass, Finest black cloth, pocket book case - Green Velvet lined. Pen and pencil attachments and lens-cleaning bar. Hair Spring Divider, Bow Spacer, Bow Pencil, Bow Pen, 2 Ruling Pens, Box for leads. \$6.00 Post-paid

Order Today and get yours.
KOLESCH & CO., 138 E. Fulton Street, New York

"THERE'S MONEY IN IT"

AT HOME LEARN TELEGRAPHY AT HOME MORSE AND WIRELESS

TEACH YOURSELF

in half usual time, at trifling cost, with the wonderful Automatic Transmitter THE OMNIGRAPH. Sends unlimited Morse or Continental messages, at any speed, just as an expert operator would. Adopted by U. S. Government, and leading Universities, Colleges and Telegraph Schools. 3 styles. Catalog free.

OMNIGRAPH MFG. CO.

16-22 Hudson St., NEW YORK



Are You Satisfied with Your Appearance?

Are you as strong and healthy as you wish to be?

Do you feel the fire and vim of youth surging through your veins?

Do you have a well developed, powerful physique, a pleasing appearance and a strong personality?

Ask yourself frankly, "Am I a real man?"

How Do Your Measurements Compare with These?

Height.....	5 feet 9 inches
Weight without clothes.....	158 pounds
Neck.....	17 inches
Biceps.....	16 $\frac{1}{2}$ inches
Chest.....	47 $\frac{3}{4}$ "
Waist.....	32 "
Forearm.....	13 "
Thigh.....	23 $\frac{1}{2}$ "
Calves.....	15 $\frac{1}{2}$ "
Wrist.....	6 $\frac{1}{2}$ "

Look in your mirror this very night and see what it tells you. Would you be proud to have your picture produced in these columns? How does it compare with the illustrations and measurements shown herewith? Your outward physical appearance reflects your internal condition. If you do not show a daily improvement outwardly, you must not be deceived. Your body is being consumed and you are clogging up like the stagnant pool. Stop then where you are. Get a grip on yourself this very minute. Let this be the start of new life and physical perfection, for it is yours if you will accept it.

You can easily obtain these proportions and perhaps better than if you really set your mind to it. Many of my pupils are stronger and have larger measurements than I have. Why not give me a chance to help you make the most of yourself? I have developed thousands of boys and men, taken many of them when they were physical wrecks—more dead than alive—and trained them into powerful athletes. Wouldn't you like me to do the same for you? No matter what your condition is at present, **I CAN DO IT**—now it is up to you to let me.

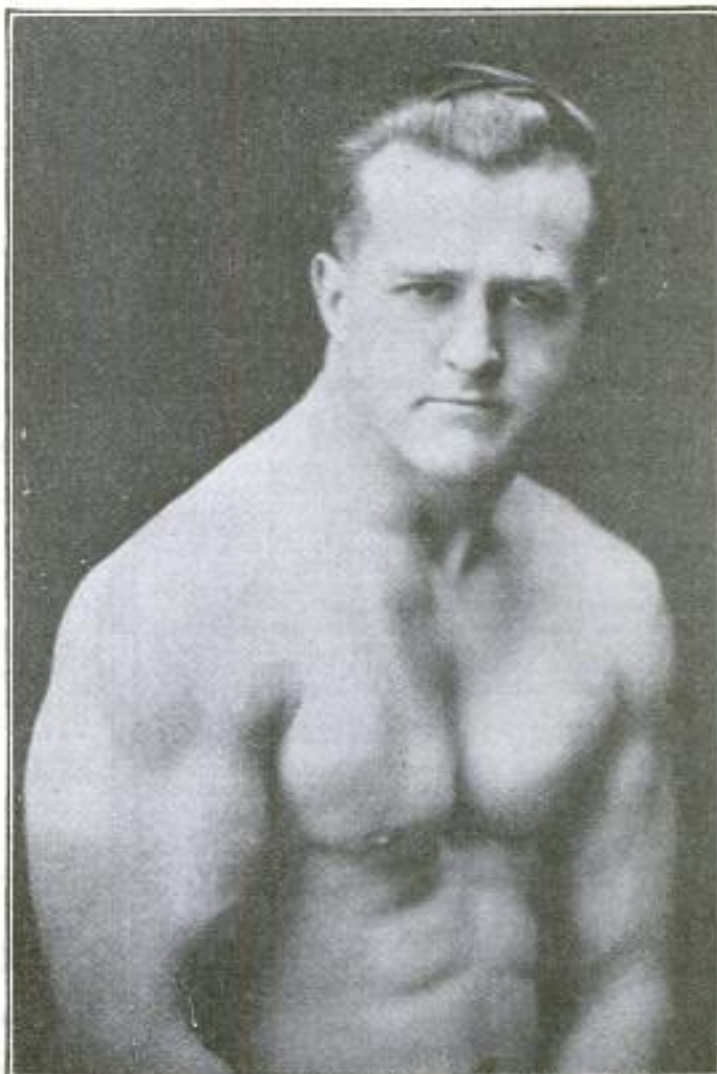

Latest photograph of Earle E. Liederman taken February, 1922

You are Judged by Your Appearance

Look strong and feel strong and have a strong personality. Be a man of power! Broaden your shoulders, deepen your chest, make your arms thick and muscular, straighten your neck, develop your legs and obtain the energy and "pep" that only an athlete knows.

Why put things off? Every day you put off is a day wasted which could be spent in beautifying your body.

The eighth edition of my latest book

"MUSCULAR DEVELOPMENT"

is just off the press. It contains 26 full page photographs of myself and some of the athletes I have trained. This book is bound to interest you and thrill you. It will be an inspiration to you. There is not another book like it on the market. I want every man and boy who reads this page to send for a copy. **IT IS ABSOLUTELY FREE.** Remember, this does not obligate you in any way. I want you to have it, so it's yours to keep. All I ask you to cover is the cost of wrapping and postage—10 cents. Now, do not delay one minute. This may be the turning point of your entire life. Tear off the coupon and mail at once while it is on your mind.

EARLE E. LIEDERMAN
Dept. 2007, 305-309 Broadway, New York City

EARLE E. LIEDERMAN

Dept. 2007, 309 Broadway, New York City

Dear Sir:—I enclose herewith 10 cents for which you are to send me, without any obligation on my part whatever, a copy of your latest book, "Muscular Development." (Please write plainly.)

Name.....

Street.....

City..... State.....



High School Course in Two Years!

You Want to Earn Big Money!

And you will not be satisfied unless you earn steady promotion. But are you prepared for the job ahead of you? Do you measure up to the standard that insures success? For a more responsible position a fairly good education is necessary. To write a sensible business letter, to prepare estimates, to figure cost and to compute interest, you must have a certain amount of preparation. All this you must be able to do before you will earn promotion.

Many business houses hire no men whose general knowledge is not equal to a high school course. Why? Because big business refuses to burden itself with men who are barred from promotion by the lack of elementary education.

Can You Qualify for a Better Position?

We have a plan whereby you can. We can give you a complete but simplified high school course in two years, giving you all the essentials that form the foundation of practical business. It will prepare you to hold your own where competition is keen and exacting. Do not doubt your ability, but make up your mind to it and you will soon have the requirements that will bring you success and big money. YOU CAN DO IT.

Let us show you how to get on the road to success. It will not cost you a single working hour. We are so sure of being able to help you that we will cheerfully return to you, at the end of ten lessons, every cent you sent us if you are not absolutely satisfied. What fairer offer can we make you? Write today. It costs you nothing but a stamp.

AMERICAN SCHOOL

Dept. H-B74, Drexel Ave. and 58th St., Chicago

AMERICAN SCHOOL

AMERICAN SCHOOL

Dept. H-B74, Drexel Ave. and 58th St., Chicago

Explain how I can qualify for position checked:

...Architect	\$5,000 to \$15,000	...Lawyer	\$5,000 to \$15,000
...Building Contractor	\$5,000 to \$10,000	...Mechanical Engineer	\$4,000 to \$10,000
...Automobile Engineer	\$4,000 to \$10,000	...Shop Superintendent	\$3,000 to \$7,000
...Automobile Repairman	\$2,500 to \$4,000	...Employment Manager	\$4,000 to \$10,000
...Civil Engineer	\$5,000 to \$15,000	...Steam Engineer	\$2,000 to \$4,000
...Structural Engineer	\$4,000 to \$10,000	...Fireman's Course	\$2,000 to \$4,000
...Business Manager	\$5,000 to \$15,000	...Sanitary Engineer	\$2,000 to \$5,000
...Certified Public Accountant	\$7,000 to \$15,000	...Telephone Engineer	\$2,500 to \$5,000
...Accountant and Auditor	\$2,500 to \$7,000	...Telegraph Engineer	\$2,500 to \$5,000
...Draftsman and Designer	\$2,500 to \$4,000	...High School Graduate	In two years
...Electrical Engineer	\$4,000 to \$10,000	...Fire Insurance Expert	\$5,000 to \$10,000
...General Education	In two years		

Name..... Address.....

VALPARAISO UNIVERSITY

Founded 1873



VALPARAISO, INDIANA

The Fiftieth Year Will Begin September 19, 1922

Known for Democracy, Economy, Hard Work

Departments—Education, Arts and Sciences, Engineering, Pharmacy, Law, Pre-Medicine, Home Economics, Public Speaking, Music, Manual Training, Preparatory, High School, Commerce, Stenography and Typewriting.

This university is governed by a board of trustees—all of whom are influential men with the welfare of the students at heart. Because Valparaiso is not operated for profit, because sound business principles are applied to its management, you get the benefit of an exceedingly

Low Cost of Living

The most satisfactory accommodations for board and room may be had from \$54 to \$90 per quarter of 12 weeks. Tuition, \$30 per quarter of 12 weeks or \$115 per year of 48 weeks, if paid in advance. If the entire tuition is paid in advance for a year, it includes instruction in all departments except Law, and private lessons in Music. Valparaiso University is beautifully situated forty miles from Chicago.

For Free Catalog Address President
Box 11 University Hall, Valparaiso, Ind.

ELECTRICAL ENGINEERING IN ONE YEAR

men with training are in demand. For more than a quarter of a century this school has been training men of ambition and limited time, for the electrical industries. Condensed course in Electrical Engineering enables graduates to secure good positions and promotions. Theoretical and practical Electricity, Mathematics, Steam and Gas Engines, Mechanical Drawing. Students construct dynamo, install wiring and test electrical machinery. Course with diploma, complete.



Thoroughly equipped fireproof dormitories, dining hall, laboratories, shops. Over 3000 men trained.

Write for catalog. 30th year begins Sept. 27, 1922.

BLISS ELECTRICAL SCHOOL

404 TAKOMA AVENUE, WASHINGTON, D. C.

TIME IS MONEY ROPP'S CALCULATOR



Saves Both.

Shows prices, quantities, weights, etc. of familiar commodities in any business.

Desk Size, \$1.50

Pocket size, leatherette, 1.00

Pocket size, cloth, .50

paper, .35

Postage free anywhere

WELLS & EDWARDS

Dept. A

852 George St. Chicago, Ill.

Send for free book catalog

Genuine \$20.00 Imported **VIOLIN** Will Be Given To You **FREE**

Help me introduce this beautiful Violin in your district. Be first to show how easy it is to play with help of three new inventions and my scientific instructions. You can play it in one week.

10,000 Students Found Easy to Learn Violin Playing

You can learn as easily as others. Surprise your friends. My three new inventions make it very easy. Have been teaching 37 years. Write your name and address on bottom of page and send for free violin offer and three new violin inventions.

PROF. A. HINCHCLIFFE, 233 Broadway
Woolworth Bldg. Dept. 50-7 NEW YORK



Be An Expert Accountant

—The Man Who Directs

Everywhere in business there is need for the man who knows Higher Accounting. To meet the competitive conditions that exist today, waste must be eliminated, accurate cost systems must be installed, economies must be put into effect

and the management must have the whole situation charted and shown in figures whenever wanted. To analyze a business a man must be more than a detail worker—he must be to accounting what the highly trained lawyer is to the legal aspects of commerce.

Over 500,000 American concerns today need the services of men of this type. That fact shows where opportunity is—it shows you the straight road to advancement in a highly paid, important profession.

Learn Higher Accounting by Mail

Enrolled with LaSalle you train by mail under the personal supervision of Wm. B. Castenholz, A. M., C. P. A., former Comptroller and Instructor, University of Illinois, former Director of the Illinois Society of Certified Public Accountants, and of the National Association of Cost Accountants, assisted by a large staff of Certified Public Accountants, including members of the American Institute of Accountants.

The underlying principles and modern methods of Business Analysis and Organization, and the Principles of General Accounting, Cost Accounting, Auditing, Commercial Law and

Scientific Management all made clear by the famous LaSalle Problem Method of instruction. You get your training by actually handling the same problems which the expert accountant meets in his daily work—the most practical course of training ever devised. You will be given special preparation for the C. P. A. examinations, and made ready to command a higher salary or to enter business as a Consulting Accountant.

You can get all this in your spare time while you hold your present position. No large fee—and you can pay on easy terms—a little each month if you wish.

LaSalle Students and Graduates With Leading Corporations

Actual investigation shows that practically every great commercial corporation and railroad company in the United States has LaSalle trained men in responsible positions. As many as 50 to 2,000 are to be found in each of such organizations as Standard Oil Co., Ford Motor Co., U. S. Steel Corporation, Swift & Co., Pennsylvania R. R., International Harvester Co., Armour & Co., Baltimore & Ohio R. R.

Employers have come to realize that LaSalle training makes seasoned, efficient men—the kind of men who can make decisions based on accurate knowledge of correct principles and modern methods. And men ambitious to rise are seeing that such training as this opens the way to the utmost possibilities for advancement in position and salary.

More than 350,000 men in active business life, including a large number of corporation officials, have been enrolled and are reaping the benefits of LaSalle training and service. Over 60,000 new students now enroll annually. The LaSalle organization consists of 1,600 people, including a staff of 450 business experts, professional men, text writers, special lecture writers, instructors and assistants.

Mail the Coupon

Make the knowledge of these LaSalle experts yours. At least send for information about this course which has helped so many men to rise quickly to positions of greater profit and prestige and which you can easily master by home study. We will also send valuable book, "Ten Years' Promotion in One." Mail coupon now.

LASALLE EXTENSION UNIVERSITY

The Largest Business Training Institution in the World
Dept. 764-HR Chicago, Illinois

Please send me catalog and full information regarding the course and service I have marked with X below. Also a copy of your book, "Ten Years' Promotion in One," all without obligation to me.

Higher Accountancy { Training for positions as Auditor, Comptroller, Certified Public Accountant, Cost Accountant, etc.

Other LaSalle Training Courses

LaSalle is the largest business training institution in the world. It offers training for every important business need. If more interested in any of these courses, check here:

- | | |
|--|--|
| <input type="checkbox"/> Business Management | <input type="checkbox"/> Modern Business Correspondence and Practice |
| <input type="checkbox"/> Salesmanship | <input type="checkbox"/> Modern Foremanship and Production Methods |
| <input type="checkbox"/> Traffic Management | <input type="checkbox"/> Personnel and Employment Management |
| <input type="checkbox"/> Railway Accounting and Station Management | <input type="checkbox"/> Expert Bookkeeping |
| <input type="checkbox"/> Law—Degree of LL. B. | <input type="checkbox"/> Business English |
| <input type="checkbox"/> Commercial Law | <input type="checkbox"/> Commercial Spanish |
| <input type="checkbox"/> Industrial Management Efficiency | <input type="checkbox"/> Effective Speaking |
| <input type="checkbox"/> Banking and Finance | <input type="checkbox"/> C. P. A. Coaching |



Name.....
Present Position.....
Address.....



"The Best Hunch I Ever Had!"

"I was feeling pretty blue. Pay-day had come around again and the raise I'd hoped for wasn't there. It began to look as though I was to spend the rest of my life checking orders at a small salary!

"I picked up a magazine. It fell open at a familiar advertisement, and a coupon stared me in the face. Month after month I'd been seeing that coupon, but never until that moment had I thought of it as meaning anything to me. But this time I read the advertisement twice—yes, every word. And this time I tore out the coupon!

"That was the turn in the road for me. The Schools at Scranton suggested a course that would give me a real understanding of our business and they worked with me every hour I had to spare.

"In six months I was in charge of my division. In a year my salary had been doubled! And I've been advancing ever since. Today I was appointed manager of our Western office at \$5,000 a year. Tearing out that coupon three years ago was the best hunch I ever had."

You, too, can have the position you want in the work you like best. No matter what your age, your occupation, your education or your means—you can do it.

All we ask is the chance to prove it. Just mark and mail this coupon. It takes but a moment, but it's the most important thing you can do today. Do it right now!

INTERNATIONAL CORRESPONDENCE SCHOOLS Box 5652-C Scranton, Penna.

Without cost or obligation, please send me full information about the subject before which I have marked an X in the list below:

BUSINESS TRAINING DEPARTMENT

- | | |
|---|---|
| <input type="checkbox"/> Business Management | <input type="checkbox"/> Salesmanship |
| <input type="checkbox"/> Industrial Management | <input type="checkbox"/> Advertising |
| <input type="checkbox"/> Personnel Organizations | <input type="checkbox"/> Better Letters |
| <input type="checkbox"/> Traffic Management | <input type="checkbox"/> Foreign Trade |
| <input type="checkbox"/> Business Law | <input type="checkbox"/> Stenography and Typing |
| <input type="checkbox"/> Banking and Banking Law | <input type="checkbox"/> Business English |
| <input type="checkbox"/> Accountancy (including C.P.A.) | <input type="checkbox"/> Civil Service |
| <input type="checkbox"/> Nicholson Cost Accounting | <input type="checkbox"/> Railway Mail Clerk |
| <input type="checkbox"/> Bookkeeping | <input type="checkbox"/> Common School Subjects |
| <input type="checkbox"/> Private Secretary | <input type="checkbox"/> High School Subjects |
| <input type="checkbox"/> Business Spanish <input type="checkbox"/> French | <input type="checkbox"/> Illustrating <input type="checkbox"/> Cartooning |

TECHNICAL AND INDUSTRIAL DEPARTMENT

- | | |
|---|--|
| <input type="checkbox"/> Electrical Engineering | <input type="checkbox"/> Architect |
| <input type="checkbox"/> Electric Lighting | <input type="checkbox"/> Contractor and Builder |
| <input type="checkbox"/> Mechanical Engineer | <input type="checkbox"/> Architectural Draftsman |
| <input type="checkbox"/> Mechanical Draftsman | <input type="checkbox"/> Concrete Builder |
| <input type="checkbox"/> Machine Shop Practice | <input type="checkbox"/> Structural Engineer |
| <input type="checkbox"/> Railroad Positions | <input type="checkbox"/> Plumbing and Heating |
| <input type="checkbox"/> Gas Engine Operating | <input type="checkbox"/> Chemistry |
| <input type="checkbox"/> Civil Engineer | <input type="checkbox"/> Pharmacy |
| <input type="checkbox"/> Surveying and Mapping | <input type="checkbox"/> Automobile Work |
| <input type="checkbox"/> Mine Foreman or Engineer | <input type="checkbox"/> Navigation |
| <input type="checkbox"/> Steam Engineering | <input type="checkbox"/> Agriculture and Poultry |
| <input type="checkbox"/> Wireless <input type="checkbox"/> Airplane Engines | <input type="checkbox"/> Mathematics |

Name.....

Street.....

Address.....

City..... State.....

Occupation.....

Persons residing in Canada should send this coupon to the International Correspondence Schools Canadian, Limited, Montreal, Canada.

Please Mention Popular Mechanics

"RADIO TELEPHONY FOR AMATEURS"

By **STUART BALLANTINE**

Formerly Expert Radio Aid U. S. N.

is the book that tells the how and why of radio telephony. Written so you can understand it fully. The biggest help to the amateur operator. 200 pages, fully illustrated.

\$1.50 net, by mail \$1.65

Send for your copy

DAVID McKAY COMPANY, Philadelphia



THIRTY-FIVE EASY LESSONS IN RADIO 50c

A systematic course of elementary principles written in a simple and concise lesson course, easily understood. Thousands have taken up Radio for entertainment and are operating their own amateur sets.

This book embodies all the principles and application of everyday radio for the home and in business. Paper cover.

Price postpaid 50c

SHREWSBURY PUBLISHING CO.
5525 West Lake Street Chicago, Ill.

Taxidermy Book FREE.



Stuff Beautiful Birds. Learn by mail to stuff and mount

all kinds of birds, animals, fish and game heads, make rugs, tan skins.

Mount your own specimens and make money preserving for others.

Men, women and boys learn easily and quickly. Success guaranteed or no tuition. Write today for our wonderful FREE book "How to Learn to Mount Birds and Animals. N.W. School of Taxidermy, B177 Elwood Bldg., Omaha, Neb.

Write Today.

Learn Watchwork, Jewelrywork and Engraving. A fine trade commanding a good salary, and your services are always in demand. Address **HOROLOGICAL**, Dept. P, Bradley Institute, Peoria, Ill., for our latest catalog.

BE AN ARTIST

Comics, Cartoons, Commercial, Newspaper and Magazine Illustrating, Pastel, Crayon Portraits and Fashions. Our simple method quickly develops your talent in spare time. By Mail or Local Classes. Write for terms and list of successful students. **ASSOCIATED ART STUDIOS** 87-B Flatiron Building, NEW YORK

BIG PAYING HOTEL JOBS OPEN

to trained men and women; we train you by mail; get 20 years' hotel experience in few months; earn \$3,000 to \$10,000 a year; fine living; work is fascinatingly interesting; quick advancement. Send for FREE BOOK today!

LEWIS HOTEL TRAINING SCHOOL, Room 329, Washington, D. C.

FREE LESSONS EXPERT AUTO and MOTOR WORK

Men — Boys, 15 and over, can easily learn Expert Motor and Auto operation and construction during spare moments

IN 10 WEEKS
Auto and Motor Experts frequently earn

\$40 to \$90 a week

Send Coupon Immediately

COUPON MAIL AT ONCE TO
Franklin Institute
Dept. E433, Rochester, N. Y.

Kindly send me absolutely free, sample lessons in MOTOR AND AUTO OPERATION AND CONSTRUCTION. Tell me also how I can take up this work and earn while learning.

Name..... Address.....

Draftsman's Complete Outfit

FREE



Everything Used by Expert Draftsmen Given You Absolutely FREE

Outfit includes "professional" complete set of fine drawing instruments with double set of compasses and dividers all in velvet lined case. Drawing board, T square, two triangles, protractor, universal curve, triangular, standard scale, water-proof ink, pens, pencils and all accessories—furnished you free in this expert's complete outfit.

Draftsmen Make \$225.00 to \$500.00 a Month

There is a tremendous demand for trained draftsmen. Now is the time to start. Draftsmen get good pay from the start and can work up to \$500 a month *and more*. Draftsmen are needed everywhere. Once you are trained you can choose your own business and work in any part of the country you please. Coyne training makes everything easy for you. Coyne student, L.T. Dubendorf, writes:

"Immediately after completing Coyne course I went to work for Armour & Co. Work was easy for me. Five months later I accepted a position in New York at a large increase in salary."

3 Months' Course at School You can qualify as an expert draftsman by 3 months' intensive training at the school in Chicago. Living

cheap. Possibilities of earning way while studying. If you prefer to come to school instead of the "Home Study" course, check coupon and send it for complete information.



B. W. Cooke

President

COYNE

HOME STUDY DEPT.

TRADE & ENGINEERING SCHOOLS

Recognized Producer of Successful Men

39-51 E. Illinois St., Dept. B177, Chicago, Ill.

Easy to Learn at Home from Great School Known all over the World

The Coyne Home Study course guarantees to train you. Remember, the Coyne Trade and Engineering Schools are recognized by educators all over the world. Students come from all over the *world* to get Coyne training. Why? Because of the Coyne school's long established, tremendous reputation for successful teaching by its great staff of experts. Coyne is not a "one man" school, but a great educational institution, 22 years old, an acknowledged leader and originator. Coyne originated the "Learn by Doing" method now endorsed by educators everywhere. Coyne has graduated thousands of successful, prosperous men all over the world. You can't make a mistake if you write for the Coyne free book. Coyne students say every minute of the course was enjoyable. Some students took *good positions three months before their course was finished.*

Send for FREE Book

Mail this coupon for our interesting book, "Drafting, the Foundation of Industry," sent you free. It explains all about the Coyne home study method and shows you how to become a draftsman in the quickest and easiest way. You want to know all about this great institution. Don't put it off. Send for this book now. It's absolutely free, no obligation. It contains the most valuable information you will ever get in your life. Send the coupon now.

Check Coupon Below and Mail Now!

Coyne Trade and Engineering Schools,
Department B177 39-51 E. Illinois St., Chicago, Ill.

Dear Sirs:—Please send me, absolutely free, without obligation, your book, "Drafting, the Foundation of Industry," also full information about the Course in Drafting. (Check which course you prefer.)

Home Study Course School Course

Name

Address

City.....State.....

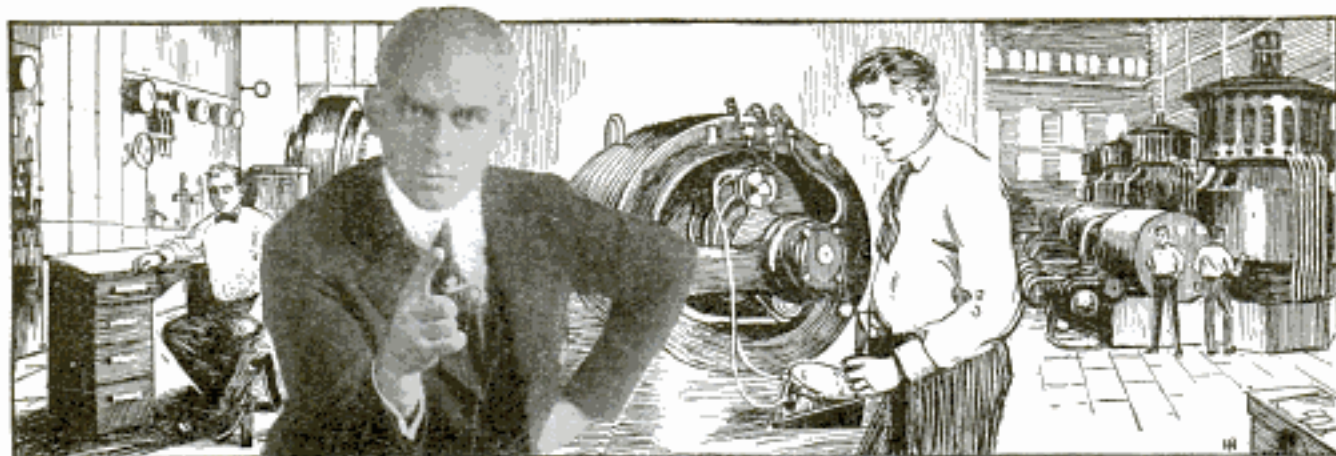

Electricity Needs You I WILL TRAIN YOU AT HOME

Stop right here. This is YOUR opportunity! Electricity is calling you, and the Electrical Business is in for a tremendous increase. But it needs more trained men—at big pay. By my **Home Study Course in Practical Electricity** I can train you for these positions.

Earn \$70 to \$200 a Week

You've always had a liking for Electricity and a hankering to do electrical jobs. Now is the time to develop that talent; there's big money in it. Even if you don't know anything at all about Electricity you can quickly grasp it by my up-to-date, practical method of teaching. You will find it intensely interesting and highly profitable. I've trained and started hundreds of men in the Electrical Business, men who have made big successes. **YOU CAN ALSO**

Be a Big Paid ELECTRICAL EXPERT

What are you doing to prepare yourself for a real success? At the rate you are going where will you be in ten years from now? Have you the specialized training that will put you on the road to success? Have you ambition enough to **prepare** for success, and get it?

You have the ambition and I will give you the training, so **get busy**. I am offering you **success** and all that goes with it. Will you take it? I'll make you an **ELECTRICAL EXPERT**. I will train you as you should be trained. I will give you the benefit of my advice and 20 years of engineering experience and help you in every way to the biggest, possible success.

**CHIEF ENGINEER
COOKE**
Chicago Engineering
Works
Dept. 1-b, 2150 Lawrence Av.
CHICAGO, ILL.

Dear Sir: You may send me entirely free and fully prepaid, a copy of your book, "How to Become an Electrical Expert," and particulars about your **Home Study Course in Electricity**.

Name.....
Address.....
City.....State.....

Valuable Book Free

My book, "How to Become an Electrical Expert," has started many a man on the way to fortune. I will send a copy, free and prepaid, to every person answering this advertisement.

Act Now! Good intentions never get you anywhere. It is action, alone, that counts. **NOW IS THE TIME TO ACT.**

L. L. COOKE, Chief Engineer

**CHICAGO
ENGINEERING
WORKS**

2150 LAWRENCE AVENUE
Dept. 1-b Chicago, U. S. A.

FREE! BIG ELECTRICAL OUTFIT

A fine outfit of Electrical Tools, Instruments, Materials, etc., absolutely **FREE** to every student. I will also send you **FREE** and fully prepaid —Proof Lessons to show you how easily you can learn Electricity and enter this splendid profession by my new, revised and original system of Training by Mail.

Radio Course FREE!

Special newly-written wireless course worth \$45.00, given away **free**. Full particulars when you mail coupon below.

Earn Money While Learning

I give you something you can use **now**. Early in my **Home Study Course** I show you how to begin making money in Electricity, and help you get started. No need to wait until the whole course is completed. Hundreds of students have made several times the cost of their course in spare time work while learning.

CLASSIFIED ADVERTISEMENTS

WORLD'S BEST WANT AD MEDIUM

Advertisements in this section, 25 cents per word, each insertion, minimum 10 words, payable in advance. To be inserted under proper classification in August issue, copy should be in our office June 25th.

AUTOMOBILE SUPPLIES

AUTOMOBILE Parts, guaranteed new, for all cars. Save money; get parts direct at wholesale. We ship immediately from stock, transmission and differential gears, bearings, shafts, gaskets, flywheel gear rings, pistons, rings and other parts for any car. When necessary we make gears special from old samples. Get our wholesale prices today. Wire or write us when you need parts in a hurry. State make of car, model and parts wanted. We refund your money, including transportation charges, if parts are unsatisfactory. Mechanics Gear Works, 3768 North Halsted Street, Chicago, Ill.

INSIDE Tyres inner armor for automobile tires. Positively prevent punctures and blowouts. Guaranteed double tire mileage. Any tire. Enormous demand. Low priced. Write for particulars. Agents wanted. American Accessories Co., B-778, Cincinnati, Ohio.

AIR compressor automatic, buffers, motors, battery chargers. Attractive terms. Profits pay. Write needs on postal. Hobart, Troy, Ohio.

TOP Covers, etc., especially made for your car. Write now for samples. Comfort Auto Top Co., 1629 Germantown Ave., Philadelphia, Pa.

BEAUTIFUL Flower Vase for your automobile. \$1.95; satisfaction or money refunded. Simon Supply Company, 207 North Seventh Street, St. Louis, Mo.

2,000 EXTRA miles from any tire, guaranteed. Costs 10c. Takes five minutes. Send \$1. Gillespie Bain, Ladysmith, B. C., Can.

BIG Profits Battery Charging. \$20 starts you. Profits pay balance. Send postal. Hobartsons, Troy, Ohio.

AMERICAN Garage & Auto Dealer publishes each month interesting and helpful suggestions and information on sales, merchandising, advertising, business management, accounting, welding, cutting, brazing, practical and progressive hints for office and shop for "small-town" automotive dealers, garagemen, repairmen, mechanics. Subscription price \$1.00 per year. Sample copy on request. American Garage & Auto Dealer, 1044 Lake View Bldg., Chicago.

PROTECT Your rights. Write for Record of Invention which contains form to establish evidence of conception of your invention. Prompt personal service. Preliminary advice without charge. J. Reaney Kelly, 612-G Columbia Bldg., Washington, D.C.

PASCO Wire Wheels—economical, safe, beautiful, strong, and serviceable. Price \$65.00 set five for Ford, \$70.00 for Chevrolet. Optional color. Order from your dealer or direct. Circulars free. Maryland Metal Products Company, Hagerstown, Md.

GARAGE Men, Small-town dealers. Make and sell 17 auto specialties. 500% profit. Information free. Nite Mail Order & Supply Co., 609 27th St., Denver, Colo.

OIL Tanks, all sizes. Oil Stations, Garages, Repair Shops, Small Stores, all of steel. Lowest prices. J. O. Dickson, Hammond, Indiana.

AREND Piston Rings—Patented Sept. 27, 1921. Adjustable. Send for circular. John Arend, Mankato, Minn.

AUTO Parts—Save 25-50%. New gears, axles, bearings, springs, radiators, magnetos—1,000 models. Bankrupt supplies, retopping outfits. Brightman Auto Exchange, 321 Windsor Ave., Hartford, Conn. Largest in the East.

ELECTRIC Service and Battery Stations send your jobber's name for booklet entitled "The Testing and Repairing of Automotive Electrical Equipment as a Profitable Business." Electric Machine Corporation, Indianapolis, Ind.

AIR Compressor with Tank and Hose \$50. With Motor \$72.50. Suitable for private or public garage, tire shop, painting or cleaning. Also Motor in the Head Buffer. Home size \$18.50, Shop size \$25. Garage size \$108. Battery charging outfit, home or garage size \$14. Send for our large 100-page catalogue, describing all kinds of Air Compressors, Vulcanizers, Garage and Battery outfits. Equipment Co., 21 Canal St., Cincinnati, Ohio.

STOP! Forget carbon troubles! Magic remover guarantees results, satisfaction, or money refunded! \$1.25 can. Send now! Oregon Auto Accessories Company, Box 4268, Portland, Oregon.

AUTO Top Roof Covers easy to put on. You drive 100 ticks and save \$15 to \$40. Ford Roadster \$5.20, Touring \$6.95 and \$9.95. Chevrolet, Dodge or Maxwell \$13.95. All other cars \$16.50 with plate glass lights. Ford regular size Curtains, \$5.95 up. For other cars \$11.50 up. Ford Seat Slips, Roadster \$8.15, Touring \$6.25, or tailored, Roadster \$6.20, Touring \$9.90, other cars \$1 to \$32. Ford Cushions \$5.95. All goods same as car manufacturers use and guaranteed to fit. Printed instructions given how to apply. Send for samples. Prices delivered at your door. Equipment Co., 30 Canal, Cincinnati, Ohio.

AUTO Owner Tire Agent wanted each locality to use and take orders for hand-made Mellinger extra ply and cord tires; guaranteed by bond for 8,000 and 10,000 miles (no seconds); shipped prepaid on approval; get your tires free; no capital or experience required; make \$100 to \$300 weekly. Write for wholesale prices and sample section. Mellinger Tire Co., 929-K Oak, Kansas City, Mo.

AIR Compressors—Genuine Brunner Compressors, new, on very attractive terms; send post card. Brunner Mfg. Co., Dept. A, Utica, N. Y.

AUTOMOBILE Owners, Garagemen, Mechanics, Repairmen, send for free copy of our current issue. It contains helpful, instructive information on overhauling, ignition troubles, wiring, carburetors, storage batteries, etc. Over 140 pages, illustrated. Send for free copy today. Automobile Digest, 505 Butler Bldg., Cincinnati.

SAVING fuel and oil, stopping oil pumping, decreasing carbon deposits is accomplished by Zelco, the zinc-coated piston ring, price 45c each; peened by special process. If your dealer doesn't handle, order of Zelco Piston Ring Division, Zelnicher, St. Louis. Distributors wanted.

"HOW To Sell Patents" free. Patent News, F. Washington, D. C.

VULCANIZING and Repairing is a paying business. Forty million tires need repairing every day. Make big profits in tire repair. Easy to learn. Instructions free. No hard times. Always busy. Get into this money-making business quick! Plants \$200 up. Write for free catalog. Equipment Co., 1 Canal, Cincinnati, Ohio.

AUTOMOBILES

DYKE'S Automobile Encyclopedia contains the greatest array of automobile facts ever published in one volume. Several separate books containing the same information would cost in the neighborhood of \$21.00. New, enlarged edition, 348 pp., 3362 illus.; cloth, \$6.46; American Morocco, \$7.96, postpaid. Popular Mechanics Book Dept., 6 N. Michigan Ave., Chicago.

AUTOMOBILE Electrical Systems are fully treated in the new edition of the book entitled "Automobile Starting, Lighting and Ignition Systems." Over 250 complete wiring diagrams, 800 pp., 492 illus. \$3 postpaid. Popular Mechanics Book Dept., 6 N. Michigan Ave., Chicago.

AUTOMOBILE Repairshop Shortcuts—Over 1500 time and labor saving kinks from more than 1000 of the best Repairshops in the U. S. 256 pp., 1500 figs. Price \$3.50 postpaid. Popular Mechanics Book Dept., 6 N. Michigan Ave., Chicago.

AUTO Owners make big money. Represent us in all or spare time. Take orders for Akron Quality cord and fabric tires. Low prices. Save auto owners money. Get your own tires without cost. Federal Rubber Goods Company, Akron, Ohio.

AUTOMOBILE Owners, Garagemen, Mechanics, Repairmen, send for free copy of our current issue. It contains helpful, instructive information on overhauling, ignition troubles, wiring, carburetors, storage batteries, etc. Over 140 pages, illustrated. Send for free copy today. Automobile Digest, 505 Butler Bldg., Cincinnati.

PATENTS—Write for our free illustrated Guide Book and Evidence of Conception Blank. Send model or sketch and description of your invention and we will give our opinion of its patentable nature. Highest references. Prompt service. Reasonable terms. Victor J. Evans & Co., 185 Ninth, Washington, D. C.

FOR FORD OWNERS

FORD Car Repair Book sent free. This complete, well illustrated, valuable book explains in a simple way the Causes and Cures of Overheating; Repairing Ford Timer; Curing Piston Ring Troubles; Carburetor Adjustments and Repairs; Connecting Rods; Transmission Troubles; Care and Repair of Rear Axle; Stopping Axle Grease Leaks; also covers practically every other phase of Ford Car Repairing. Send 25c coin for three months' trial subscription and get the valuable repair book free. Ford Owner and Dealer Magazine, 519 Montgomery Bldg., Milwaukee, Wis.

DON'T Get Out of your car to fill your gasoline tank. Know at all times how much gas you have. Forbes Filler and Gauge does it. Easily installed on Touring, Roadster, Sedan or Coupe. Only Five Dollars, Circular free. Forbes Filler & Gauge Company, 1313 Engineers Bldg., Cleveland, Ohio.

\$6.00 WILL make your Ford Thief-Proof. For that amount we will send you a Venn Manifold Lock, prepaid. The best lock for Ford cars on the market. Quickly and easily installed. Money back if dissatisfied. Taylor-Shantz Co., 478 St. Paul St., Rochester, N. Y.

GASIFIER saves gasoline, prevents carbon; applied ten minutes; no changes. Special price Fords \$2.65. Write for information. Detroit Gasifier Co., 743 Book Building, Detroit.

WILMO Manifolds for Fords—\$3.75 with order. United Supply Co., Inc., Dallas, Texas.

FORD Repairing—New valuable book explains use of all up-to-date tools and shop equipment, describes methods of performing work on all different mechanical parts of car, 250 pp. fully illus. Leatherette. Price \$2.50 postpaid. Popular Mechanics Book Dept., 6 N. Michigan Ave., Chicago.

ATTENTION, Ford owners! Marvelous invention ends lighting troubles. Money back guarantee, 10 day trial. Particulars, Oregon Auto Accessories Company, Box 4268, Portland, Oregon.

CONVERT Ford into one ton Truck. Complete Auxiliary Springs \$20. Unwin, 265 Broadway, New York.

FORD Owners—15% to 40% Guaranteed saving gasoline consumption after installing Kreitner's Automatic Air Valve on Fords. Installed in 5 minutes. Retail \$4.50. Agents wanted in every town. Write quick. Address, Kreitner Mfg. Co., 1017 Title Guaranty Bldg., St. Louis, Mo.

STOP your engine from overheating. The Auxillo does it. Prepaid for 75 cents. With new fan belt, both one dollar. Send for literature. Agents wanted. Burnham-Cote Co., Holyoke, Mass.

FORD Owners. Stop your Ford from Chattering by installing Bredar's Ball Shim, Price \$1.10. Write for information and Agency proposition. Nic Bredar's Son Mfg. Co., Rock Island, Ill.

FORD Sport Model Fenders. Very classy. Description free. Star Supply Company, Edms. Ohio.

JULES Oil Circulator stops any Ford from pumping oil, doubles oil mileage. Guaranteed. \$4.00 each. Special introductory price, \$2.00. C. O. D. Money back if dissatisfied. Electric Machine Corporation, Indianapolis, Ind.

SPEEDSTER Fans. Don't fail to see "Red-I-Kut" ad. Page 133.

LACEY Patent Senses. See page 142.

MOTORCYCLES, BICYCLES AND SUPPLIES

I SELL Motorcycles, in all parts of the U. S. On Easy Payments. All Makes. All Models. Send stamp for Big Free List 31. Floyd Clymer, Largest Motorcycle Dealer in West, Denver, Colo.

'19 INDIAN 3 Speed \$85.00. '20 Indian 3 Speed \$100.00. '21 Indian 3 Speed \$150.00. Howard A. French Company, Baltimore, Md.; Washington, D.C.

NEW "Rogers" Sidecars \$69.50; used Motorcycles, Sidecars, Engines, Parts, get our List. Erickson, 8039 Parnell, Chicago.

BICYCLES \$10 up. Racers \$17.50 up. Tandems (coaster) \$25 up. McDougald, 300 N. Wells St., Chicago.

INDIAN "Powerplus" twin; fine shape, \$75. Geo. Laatch, Altamont, Ill.

SMITH Flyer \$50.00. Smith Bicycle Motor \$35.00. Wagle's, Marshall, Mo.

SEND for big list of slightly used motorcycles on our easy payment plan. Howard Cycle Co., 152 N. Broad St., Trenton, N. J.

USED parts for all motorcycles cheap. State wants. Schuck Cycle Co., 1922 Westlake, Seattle, Wash.

USED and new parts, Indian, Excelsior, Harley, Reading, Thor, Henderson, Yale. Get our price lists. Kingshighway Cycle Co., 1166 North Kingshighway, St. Louis, Mo.

DON'T buy a Bicycle Motor Attachment until you get our catalogue and prices. Shaw Mfg. Co., Dept. 27, Galesburg, Kan.

NEW motorcycles have been reduced 10%. Our prices have been reduced 35%. Send for big bargain list of rebuilt motorcycles. Western Supplies Co., 359 Hayutin Bldg., Denver, Colo.

USED motorcycles, new and used parts; write us, Mahowald Cycle Co., Mankato, Minn.

BOYS, build your own cycle car! Send 25c for building plans and list of parts. We can supply motor with clutch and all parts at low prices. Shaw Mfg. Co., Car Dept., Galesburg, Kan.

MOTORCYCLE Cylinders reground, fitted with new piston rings, \$6.00. Guaranteed. Muncie Piston Co., Muncie, Ind.

AVIATION

REAL aeronautical bargains—turnbuckles, 20c; aero cloth, 30c; shock absorbers, 5c; Gnome motors, \$150.00; tubing, 5c per ft.; aeroplane sheet steel, 5c per lb.; tape, 3c; sparkplug, 25c; high tension wires with terminals, 20c; wheels 20x1, \$6.00; brass screws, 40c per gross; plywood, 20c; aircraft nuts, 1/2c. Many other bargains. Sale sheet, 2c. Heath Aeroplane Co., Chicago, Ill.

LEARN to fly! Lieut. Harold Peterson (transomed aviator), formerly U. S. army instructor, now head of own school, equipped with safe airplanes, teaches you; moderate cost; wonderful opportunities. Enroll now for summer course. Booklet free, 203 Metropolitan Life, Minneapolis, Minn.

"CURTISS" Passenger Biplane, Niury horsepower, \$850. Plans for building Ford motor biplane, \$2.50. Motorcycle Engine Monoplane Plans, \$1. Aviation Engineering Co., Lawrence, Kan.

HEATH propellers represent the most efficient method of aerial drive. Each propeller individually designed for the particular work to be done, as laid out by America's oldest aeronautical engineers. Propeller catalog 4c. Heath Airplane Co., Chicago, Ill.

AERODRIVE Boat Blueprint 75c. Set Motorcycle Airplane Wings \$25. Fuselages \$100. Everything Aeronautical. Ostergaard Aircraft Works, 4289 N. Narragansett, Chicago.

FOR Sale, light-weight aviation motor; aeroplane wings. Write Alfred Sorenson, Morgan, Minn.

A WONDERFUL opportunity to learn to fly by our new method, includes three hours' instruction in the air and one month intensive shop course, complete at \$100.00. Heath Airplane Co., Chicago, Ill.

HIGHEST, best catalogue Model Aeroplanes, Parts and Supplies; 5c postpaid. Ideal Aeroplane Co., 67 1/2 West Houston, New York.

INVENTORS desiring patents should write for our Free Illustrated Guide Book and Evidence of Conception Blank. Send model or sketch for our opinion of its patentable nature. Highest references. Prompt service. Reasonable terms. Victor J. Evans & Co., 187 Ninth, Washington, D. C.

WELDING

IT'S easy to solder aluminum. All you need is a clean soldering iron and a bar of Everstick Aluminum Solder. No flux necessary. Behind this product stands the 30 years' reputation of this organization. Highest Dun's and Bradstreet's rating. Order today and judge for yourself, \$2.50 a pound, delivered. Trial bar 50c postpaid. Great Western Smelting & Refining Co., 3102 N. Broadway, St. Louis, Mo.

DON'T scrap aluminum parts. Save with So-Laminum. Great welding solder, stronger than aluminum; perfect substitute for acetylene welding, 3/4 time and cost. Use gas torch or soldering iron. No flux required. Booklet on request. Sample bar \$1. Endorsed by United States, England and Japan. So-Laminum Manufacturing Co., 1634 Broadway, New York, N. Y.

ACETYLENE Brazing and Soldering Torches, \$2.00. Light welding and lead burning torches, \$7.00. Postage prepaid upon receipt of price. Marshall Mfg. Co., Kansas City, Mo.

BOOKS AND PERIODICALS

HEALTH! "Vitalic Breathing" explains a marvelous tonic system that makes living a joy. Requires no apparatus; takes little time; arms against fatigue, premature old age, disease. Insures mental and physical fitness. 235 pages, illustrated, cloth bound, \$2.00. Reilly & Lee Co., 1006 So. Michigan Ave., Chicago.

"MAGIC." Edward M. Massey. Just published. 36 entirely new and original effects, clearly described. Illustrated with 25 full-page plates and 11 smaller illustrations. Attractively bound, elaborate gold stamping 8"x5 1/2". \$3.00 postpaid. Spou & Chamberlain, 120 P. M. Liberty Street, New York, N. Y.

TRUTH Received through Vibratory Force of Mind—Christ's Message, 30c, Prof. James', 10c. Barbara Rigler, 2122 34th Ave., Chicago.

RADIO Outfits, etc. Radio receiving sets, how to make and operate; illustrated book, 25c. Western Puzzle Works, St. Paul, Minn.

1,000,000 INDUSTRIAL Facts, Calculations, Receipts, Processes and Trade Secrets for every business are contained in the 1016 page book "Moore's Universal Assistant and Complete Mechanic," 500 engravings, cloth. Price \$2 postpaid. Popular Mechanics Book Dept., 6 N. Michigan Ave., Chicago.

AMATEUR Electrician or Toy maker book, 64 pages, illustrated. Postpaid 10c each. Western Puzzle Works, St. Paul, Minn.

OUR new catalogue listing over five hundred carefully selected practical books under eighty different subject groupings will be sent free upon request. Popular Mechanics Book Dept., 6 N. Michigan Ave., Chicago.

"THE Truth About Henry Ford," a revealing, human document about the most talked of living American; the story as told to the author by Mrs. Ford; the first authentic narrative about this master of millions. Illustrated, 222 pages, cloth bound, \$1.25. Reilly & Lee Co., 1006 So. Michigan Ave., Chicago.

CONCENTRATION. Learn how to keep your mind upon one subject despite interruptions. Wonderful possibilities through psychology of thought control. Book 50c. Another book, "How to Conquer Fear," shows how to avoid worry, doubt, nervousness, gain contentment, 50c. Both \$1. Satisfaction or money back. Centre Publishing Co., 108 West 34th St., ZB, New York.

"THE Potygraft Album"—a volume of old-fashioned family pictures with humorous comments on each, by Rebecca Sparis Peters, aged eleven, as shown by her to the new neighbor. A laugh on every page. Handsomely bound. \$1.00. Reilly & Lee Co., 1006 So. Michigan Ave., Chicago.

BOOK Bargains. Select any six subjects. History, Physics, Chemistry, Business English, Letter Writing, Physiology, Literature, Spanish, French, German, Grammar, Rhetoric, Agriculture, Arithmetic, Algebra, Geometry, Calculus, Mechanical Drawing, Psychology, Geography, Eloquence, Logic, Ethics, Anatomy, Biology, Latin, Greek, Art, Commercial Law, Short-hand. Six books value over \$18.00, sent postpaid for \$2.00. Follett's Book Store, 708 South Wabash Ave., Dept. M, Chicago, Ill.

"EATING To Live Long"—Don't poison your system by eating the wrong food. This book tells how to restore and maintain health. It tells the kind of food that is suited to Your system and the kind that poisons You. Eat right and you will enjoy health and long life. Endorsed by leading physicians. Cloth bound, 245 pages, \$1.50. Reilly & Lee Co., 1006 So. Michigan Ave., Chicago.

ELECTRICITY Taught by experts; earn while you learn at home; electrical book and proof lessons free; your success guaranteed and position secured. Chicago Engineering Works, Dept. 51-B, 2144 Lawrence Ave., Chicago.

LEARN Shoe Repairing at home; good money in it; our book of instruction teaches you every detail, only \$1 prepaid. American Bench Shoe Makers, Dept. 2, Aurora, Ill.

"CONCRETE"—big monthly magazine about all kinds of concrete work. Articles written in plain English, \$2.50 per year. Concrete, 1809 East Grand Boulevard, Detroit, Mich.

MONEY-MAKING Secrets Exposed. The newest book published, revealing important money-making secrets. Postpaid 50c. Address Thomas Game, Box 154, Highland Park, Mich.

"MIND-READING"—Any distance. Wonderful "Hypnotism" Controls others—25 easy lessons \$1.00. "Hypnotic Wonders" free. Science Institute, PM72-1014 Belmont, Chicago.

INTERESTING vest pocket books, 10c each. Write for list. Address Record, Van Horn, Iowa.

RADIO books, Automobile books. Lists free. Wells & Edwards, X852 George, Chicago.

BOOKS. All Kinds. Lists. Higene's, A2441 Post Street, San Francisco, Calif.

STUDY Human Nature, know people, make more money. Send 10 cents for "Personal Power," a little book that points the way. Address, Progress League, C-31 Union Square, New York, N. Y.

"36 ACCOUNTING Problems Solved by C. P. A." Cloth bound, loose leaf, new, original, up-to-date, valuable. Prepaid, \$1.00. Walhamore Company, Lafayette Bldg., Philadelphia, Pa.

THIRTY-FIVE Cent Electrical and Mechanical Books. Fully illustrated. Other popular subjects. Send for list. Spou & Chamberlain, 120 P. M. Liberty St., New York.

AMBITIOUS Writers send today for Free copy America's leading magazine for writers of photoplays, stories, poems, songs. Instructive, helpful. Writer's Digest, 603 Butler Building, Cincinnati, Ohio.

LIGHTNING Cartoonist's Book, Secrets, Tricks, \$1.00. Christman, 2925 Euclid, Kansas City, Mo.

PLANS for Poultry Houses. All styles, 150 illustrations; secret of getting winter eggs, and copy of "The Full Egg Basket." Send 25 cents. Inland Poultry Journal, Dept. 74, Indianapolis, Ind.

INDUSTRIAL Alcohol, Wright's book everybody wants. Full directions for making with drawings of necessary apparatus, \$2.50 postpaid. Spou & Chamberlain, 120 P. M. Liberty Street, New York, N. Y.

INSTRUCTION Book (for shop use) on vulcanizing auto tire, boots and shoes, \$1 bill. Equipment Co., 3 Canal, Cincinnati, O.

PICTURES AND POSTCARDS

POCKET mirrors—Send Kodak picture or photo, with 50c. Will tint, mount—beautiful mirror. "E. R." Studio, 3122 5th Ave., Chicago.

TEN beautiful views Niagara Falls, all different, 25 cents. Return for mailing. James Malone, Box 422, Buffalo, N. Y.

TWELVE beautiful Photographs of the Canadian Rocky Mountains, \$1.00 postpaid. "Studio," 1053 Laird St., Regina, Canada.

JOIN Live Postcard club; Sample paper, list, catalog, 10c. Harvey Teeple, Decatur, Ind.

NOVELTIES

"**BOLIVIAN** Lucky Beans," something original; each bean everlasting, natural, brilliant, scarlet and black; for earrings, brooches, watch chains, rings, bangles, etc., \$2.50 per dozen. Address: Woods, Chacabuco, 430 Valparaiso, Chile, South America.

GAMES AND ENTERTAINMENTS

VENTRILOQUISM taught almost anyone at home. Small cost. Send 2c stamp today for particulars and proof. George W. Smith, Room M-288, 125 N. Jefferson Ave., Peoria, Illinois.

MIND-READING Made Easy. Clever Parlor Trick; Mysterious, yet Easy to Learn. Makes you Most Welcome Guest. Price, 25c. Wright, 272 E. 119th St., New York City, N. Y.

67 TRICKS, 400 Jokes, Riddles, Toasts, Fortune Telling Secrets, Funny Readings and big catalog, 10c. Ideal Book Shop, 5591NC, North Robey, Chicago.

MAGIC Checkerboard—Tells fortunes as you move. Advertising sample for 12c in stamps. Magic Checkerboard Co., Fort Wayne, Ind.

ENTERTAINING Books, Puzzles, Tricks, Jokes. Catalog free. Andco, 4049-P, North Whipple, Chicago.

AMERICA'S greatest puzzle, postpaid 25c. Everlasting Entertainment, Miller, 728 Racine St., Milwaukee.

\$7,000 STOCK magical goods. Catalogues 15c. Address: Gilmagico, Morgan Park, Ill.

BASEBALL fans! Play game at home. Marvelously interesting. Greatest game on market. Send 25c coin. E. Kubler & Co., Clifford Ave., Springfield, Ill., N. Y.

TRICKS, Puzzles, Jokes, magical apparatus, plays, stage supplies, mind-reading acts, and sensational escapes. 160-page illustrated professional catalogue, 10c. Oaks Magical Co., Dept. 548, Oshkosh, Wis.

200 KINDS iron, wood and wire puzzles. Leader and illustrated list 10c. Western Puzzle Works, St. Paul, Minn.

MAGIC—Tricks, Books and Supplies. For Amateurs as well as the great professionals. Anyone can learn through our instructions. Feature Acts in Mind Reading, Spiritualism, Rope Ties, etc. Large Illustrated Professional Catalog, 10c. Chicago Magic Co., Dept. B, 140 S. Dearborn St., Chicago, Ill.

250 MAGIC Tricks 25c. Big Catalog 2c. Harvey Teeple, Decatur, Ind.

STAMP COLLECTING

SNAPS—150 different stamps, 18c; 60 different United States Stamps, 12c. With each order we give free our price list of sets, packets, albums, etc., and our pamphlet which tells "how to make a collection properly." Queen City Stamp Company, Room 36, 604 Race, Cincinnati, Ohio.

150 DIFFERENT, 18c; 500 good mixed stamps, all over world, and magazine three months, 30c. Harvey Teeple, Decatur, Ind.

42-PAGE Album, 10x10 1/2, containing 504 poster stamps, all neatly mounted, \$1.15. Agents wanted. Fred J. Funk, Box 252, Killdeer, N. D.

SPECIAL—To introduce our Star A approvals, we will send selected stamps, guaranteed values at 30c, for only 10c! Paxton Stamp Co., 2207 E. 67th St., Chicago, Ill.

10 DIFFERENT Latvia free! (2c postage) to applicants for 60% discount approvals. 1,009 varieties \$2.50. Morrey, 183 10th Ave., Columbus, Ohio.

BEAUTIFUL, Bosnia Commemoratives 1917, complete set unused 10c postpaid. Price List free. Address: Midwest Stamp Company, Kemper Building, Kansas City, Mo.

"**GEE WHIZ**" Collection 100 Roumania, 55c. War Issues approvals. Free Lists. Broadway Stamp Co., 115 Nassau St., New York.

SOUTH and Central American stamps: 150 different, \$1.00; 25 different, 10c. Nickles, 123 Florida Ave., Washington, D. C.

STAMP Cataloging over 50c, not junk, with 50% approvals, 3c. Address: Goodman, Wilson Block, Los Angeles, Calif.

ZAMBESIA, Abyssinia, Herzegovina, Holkar, Ukraina Stamps, Menagerie Pack-ets, 250 Hinges, 10c. Liberty, 3974 Arsenal, St. Louis, Mo.

CHINESE Commemorative Set Complete. Also 100 different stamps for 30c. Jacob Fischer, 1538 North Lawler, Chicago.

FREE—Eight Egypt to approval applicants enclosing postage. Emory, 567 Oakwood Ave., Toronto.

\$1.00 WORTH of stamps for only 10c. Hull, 12 West 101st, New York.

30 DIFF. Sweden, 8c; 50 diff. Austria, 17c. Lester Hansler, Pomona, Calif.

14 UKRAINIA 20c. Fine Approvals, Cassell, 331 Lumber Exchange, Minneapolis, Minn.

125 DIFFERENT Stamps, 10c. Nickles, 123 Florida Ave., Washington, D. C.

1,000 STAMPS from 15 countries, 10c. Alvin Johnson, Hawarden, Iowa.

200 DIFFERENT Stamps 15c. Lists Free. Michal, 5602 Prairie, Chicago.

LIBERAL Offer: 500 mixed U. S., 1,000 hinges, 100 diff. foreign, Bargain Stamp paper 6 months for 25c. Weatherly, Medina, Ohio.

FREE, 100 different stamps to applicants for approvals sending 2c. Richard P. Lamprocht, Valparaiso, Ind.

FREE, 7 beautiful French Colonials to new approval applicants, Frank Hadley, Plainfield, N. J.

STAMPS—50 different Jamaica, Venezuela, etc., only 7c; 100 all diff., 10c; 1000 all diff., \$2.50; 100 diff., U. S., 25c; 1000 Hinges, 10c; 50 per cent approvals with every order. List free. I buy stamps. Write L. B. Dover, Dept. A, Longmont, Colo.

100 FOREIGN Stamps sent free. Cornish Company, Schenectady, N. Y.

STAMPS Free—War Stamps, Surcharged, Unused, Pictorials, British, French Colonials 2c postage. Midland Stamp Co., Toronto, Canada.

158 GENUINE Foreign Stamps—Mexico War Issues, Venezuela, Salvador and India Service, Guatemala, China, etc., only 10c. Finest approval sheets, 50 to 60%. Agents Wanted. Big 72-p. Lists Free. We Buy Stamps. Estab. 29 yrs. Hussman Stamp Co., Dept. 54, St. Louis, Mo.

BEST one-cent approvals in America. F. P. Hand, 1117 So. 69th St., Philadelphia, Pa.

FREE, 25 U. S. stamps with 60% approvals to reliable parties, 100 different U. S. 25c. C. Seidenberg, Meiton, Wis.

FRENCH Colonies Free—Beautiful Picture set, including Native Chiefs, Tigers, Pictorials, 2c Postage. Empire Stamp Company, Toronto, Canada.

3 NYASSA Giraffe stamps free to approval applicants. Wilmar Edgar, Cherokee, Iowa.

STAMPS, 50 Varieties, Africa, Brazil, Peru, Cuba, Mexico, etc., 10c. 50 different U. S., 25c; 1,000 mixed, 40c; 1,000 hinges, 10c. List free. C. Stegman, 5948 Cote Brillante, St. Louis, Mo.

FREE! Sectional Loose Leaf Postage Stamp Album at the rate of 8 pages each month given with subscription to our monthly Journal. Send two-cent stamp for prospectus. United Stamp Co., 140 S. Dearborn St., Chicago, Ill.

BIG Variety Packet Foreign Stamps free for 2c postage. Gray Stamp Co., Station E., Toronto, Canada.

STAMPS sent on approval at 70% discount. Reference required. Emory Benoit, Hanover, Pa.

STAMPS Free—Ask for money-saving approvals. John P. Borresen, Cedar Falls, Ia.

24 VARIETIES Cuban stamps, 10 cents. List of 6,000 low-priced stamps free. Address: Chambers Stamp Co., 111P, Nassau St., New York City, N. Y.

105 CHINA, etc., stamp dictionary, list, 2c. Album (500 illustrations), 3c. Bullard, Sta. A, Boston.

20 UNUSED stamps free. All different. Postage, 2c. Fisk Stamps, Toledo, Ohio.

PACKET of 23 stamps, no two countries alike. Packet hinges. Set of \$1 and \$2 U. S. Rev., all for 5c. Mention paper. Miami Stamp Co., Toledo, Ohio.

STAMPS, 20 unused, all different, free. Postage 2c. Mention paper. Quaker Stamp Co., Toledo, O.

FREE 10 different Scandinavian, millimetre scale, gauge, book, lists, etc., to all sending 10c for 57 different Stam, Ceylon, Guatemala, etc. 200 different, 25c; 300 different, 60c; 100 different U. S., 25c. Hawkeye Stamp Co., Cedar Rapids, Ia.

RARE COINS

GET large old U. S. copper cent nearly as large as half Dollar, curious and interesting and large 50 page illustrated Coin Catalog for Ten Cents—just as a "got-acquainted offer." Send for one now. Some \$25,000.00 worth of coins in stock. Get on my list for fine catalog free to my customers. B. Max Mehl, Numismatist, Mehl Bldg., Dept. K., Fort Worth, Texas. Largest Rare Coin Establishment in the United States.

CALIFORNIA gold, 3/4 size, 27c. 3/8 size, 53c. 3c piece and catalogue, 10c. Address: Norman Shultz, Colorado Springs, Colo.

\$2 TO \$500 Each paid for hundreds of old coins. Keep all old money. Send 10 cents for Illustrated Coin Value Book, 4x6. Guaranteed Prices. It may mean your Fortune. Address: Clark Coin Company, Ave. 2, Le Roy, N. Y.

OLD coins wanted—Have you an odd or old coin or bill? It may be worth several dollars. Get posted. Send 4c for Coin Circular. May mean much profit to you. Send now. Numismatic Bank, Dept. H, Fort Worth, Texas.

CALIFORNIA Gold, Quarter size and Colombia nickel coin only 30c. Italy 20 cents and catalog 10c. Homer Shultz, King City, Mo.

OLD coins, large Spring selling catalogue of coins for sale, free. Catalogue quoting prices paid for coins, ten cents. William Hesslein, 101B Tremont St., Boston, Mass.

FOR BOYS

MOUTH-ORGAN Instructor, 25c. Learn in one hour. G. Eisen, Bowling Green, Ohio.

BOYS!—You who like gripping, thrilling stories of achievement will want to read "Victories of the Engineer," a book that tells in a way you can understand it how the great feats in railroad engineering, building great bridges, ships, dams, canals, harbors, tunnels, mining, etc., have been accomplished. By A. Williams, 487 pp., 259 illus. Price \$2.00 postpaid. Popular Mechanics Book Dept., 6 N. Michigan Ave., Chicago.

MODEL Boats and Engines. Complete boats ready to run. Also K. D. ready to put together. All difficult work done. 36" and 38" hulls. Circular. Free Miniature Boat & Engine Co., New Orleans, La.

ELECTRICITY Taught by experts; earn while you learn at home; electrical book and proof lessons free; your success guaranteed and position secured. Chicago Engineering Works, Dept. 51-B, 2144 Lawrence Ave., Chicago.

BOYS, Get flying model aeroplane free. Write to Aero Shop, 3050 Hurbut Ave., Detroit, Mich.

BOYS!—Build Things. Our three books, The Boy Mechanic, 1, 2, and 3, tell you in a way you can understand how to make such things as Boy's Motor Car, Houseboat, Model Monoplane, Water Toboggan and Slide, Aerial Cableway, Ski Sled, Sailing Canoe, Searchlight, Electric Locomotive, etc. Each book is complete in itself and has 480 pages and upwards of 800 articles and illustrations. Description of each book sent on request. Price \$2.50 per vol. postpaid. Popular Mechanics Book Dept., 6 N. Michigan Ave., Chicago.

CAMERAS AND PHOTO SUPPLIES

JUST Published—Our new complete 128-page catalog and bargain book of new and used cameras and supplies. Our goods are guaranteed finest quality obtainable. We have thousands of satisfied customers. Write at once for this bargain bulletin, just hot from the press. Address Central Camera Co., 124 S. Wabash Ave., Dept. E 59, Chicago, Ill.

TRIAL Offer—20c for developing any film or 6 negatives any size, including 6 prints. Other charges proportionate. 24-hour service. Splendid work. \$20,000 plant. Roanoke Photo Finishing Co., 209 Bell Ave., Roanoke, Virginia.

KODAK Finishing! Lowest prices. Best work. Send 10c stamps for booklet telling you how to make better pictures. Price list included. Address Photographic Institute, Wedgway Building, Schenectady, N. Y.

FADED Pictures, Tintypes, Daguerreotypes restored and enlarged. New Process. Perfect results. Reasonable costs. Roanoke Photo Finishing Co., 512 Bell Ave., Roanoke, Va.

FILMS Developed 5c; Prints 2c. Postcards 5c. Prize Photo free. Order today! J. B. Christopherson, Box 1051, Salt Lake City, Utah.

PHOTO Mounts for Amateurs. We are the only manufacturers selling direct to amateurs exclusively. Therefore, all mounts and folders purchased from us are of unexcelled quality and artistic perfection, at a price most pleasing to you. Send stamps, five cents, for sample and prices. (State Brown or Gray.) We know your decision will be an order. L. P. C.-Universal Corporation, 270-276 Hudson Ave., Albany, N. Y.

CAMERAS, Lenses, Binoculars lowest prices. Take shotguns, revolvers in trade. National Camera Exchange, 29 Washington Ave., So. Minneapolis, Minn.

ROLL developed and six prints 25c. Old reliable. Address National Photo Co., Westport Station, Kansas City, Mo.

KODAKERS, send us your roll and get six prints 25 cents coin. Maggard Studio, Ashland, Ky.

To Show You Our Exquisite Photograph finishing with rounded corners, hairline border, high gloss, we will develop and print one roll or six negatives for 10c. Kyograph, 148 N. Seventh St., Philadelphia, Pa.

KODAK Finishing—Kodak, camera repairing. Developing and printing for amateurs. One-day service. Complete line of photo supplies. Write Radium Studio No. 21, 847 Belmont, Chicago.

ESTABLISH yourself—at home—as an expert photographer and train with R. Vant, director International Studios, 343-B—8601 Michigan Ave., Chicago.

KODAKS, Cameras, Lenses, Photo Supplies, Radio outfits. Ask for bargain list. Hyatt's Supply Co., 417 N. Broadway, St. Louis, Mo.

BETTER Pictures—Your kodak film developed 4c—prints 4c each. Cameron Photo Company, P-3418 Burch Ave., Cincinnati, Ohio.

FILMS developed 5c—prints 3c each. Photo Shop, Dept. A, Station D, Cincinnati, Ohio.

BIG Money Saved on Photographic Lenses and Apparatus—goods exchanged; repairing done. Ralph J. Golsen, 1128 Argyle St., Chicago, Dept. P.

BASS Camera Bargains are known the world over. Write your needs. Largest stock of Graflex, Kodaks and Motion Picture Cameras in the world. Bass Camera Company, Mail Order Division, Chicago, Ill.

KODAK films developed and finished with attractive margin designs 25c. Something new. New England Photo Service, Box 1202, Boston, Mass.

HAVE You a Camera? Write for Free sample of our big magazine, showing how to make better pictures and earn money. American Photography, 790 Camera House, Boston, 17, Mass.

SEND your next Roll Film and 20c or six Film Negatives, one hand-tinted free. Address, Az-U-Lyk-M, Dept. C, Bristol, Vt.

MOTION PICTURES

HAVE fifty reels, 1,000 ft. each, recent news weeklies, mostly of Chicago and vicinity, all live, new subjects. Price \$5.00 per reel. Fresh film. Bass Camera Company, 109 No. Dearborn St., Dept. P, Chicago, Ill.

MOTION Picture Operation, Stage Electrics and Illusions—the only practical handbook and guide published for motion picture operators, theatre electricians and managers. Pocket size, cloth, 393 pp. fully illus. Price \$1.50 postpaid. Popular Mechanics Book Dept., 6 N. Michigan Ave., Chicago.

MOVIE Camera, F. 3.5 lens, \$55. Tripod with panorama and tilt, \$25. National Home Projector, 1,000-foot standard reels, \$45. Cosmograph, motor-driven, \$75. Film cement, extra lenses, extra reels. Sateen screens, 9/12. Ray, 326 Fifth Avenue, New York.

BIG Money Nightly—Get my installment figures Complete Moving Picture outfit before buying. Also have excellent complete Movie Camera outfit \$98, description application. Ralph J. Golsen, 1128 Argyle St., Chicago.

WE buy used portable suitcase and professional moving-picture machines. Highest prices paid. What have you for sale? Monarch Theatre Supply Co., 724 So. Wabash Ave., Chicago, Ill.

EARN Money Writing Photoplays. Beginners' plan free. Los Angeles Photoplay Co., Los Angeles, Cal.

AMERICA'S Greatest Fortunes have been made in the Moving Picture Business. Small investment needed. We furnish complete theatre equipment. Easy payments. Openings everywhere. Catalog free. Monarch Theatre Supply Co., Dept. F, 724 So. Wabash Ave., Chicago, Ill.

\$35.00 PROFIT nightly. Small capital starts you. No experience needed. Our machines are used and endorsed by government institutions. Catalog free. Atlas Moving Picture Company, 482 Morton Bldg., Chicago.

JUST Out! Send for one at once! The Complete Cinema Hand Book. A complete course in motion-picture making from raw film to the projected image. 508 pages crammed full of authoritative information. Postpaid to any part of the world on receipt of \$3.00. Everything in Motion Picture Apparatus. Cameras from \$20.00 to \$1500.00. Write for information to the World, Bass Camera Company, Dept. 114, 169 No. Dearborn St., Chicago, Ill.

CLEARANCE Sale—500 reels high-grade film. Two to six reel subjects Famous Movie stars. Special \$3.50 per reel only while they last. Stock up now. List free. Monarch Theatre Supply Co., Union and Fourth, Memphis, Tenn.

BUY direct from Manufacturers—New or rebuilt Moving Picture Machines for Homes, Schools, Lodges, Churches, Traveling Shows and Theatres, Manda—Arc or Gas complete outfits—Film and Supplies. Dept. X, Monarch Theatre Supply Co., Memphis, Tenn.

FILMS for Toy and Professional Machines. All famous movie stars. \$3.00 per reel and up. Machine bargains also. Write for big list free. Monarch Theatre Supply Co., Dept. P. M., 724 S. Wabash Ave., Chicago, Ill.

FILMS For Sale—\$2.50 per Reel up. Address Queen Feature Service, Birmingham, Ala.

MAKE money writing photoplays; details free to beginners. No correspondence course. Producers League, 230 Wainwright, St. Louis.

FREE to Writers—A wonderful little book of money-making hints, suggestions, ideas; the A B C of successful story and play writing. Absolutely Free. Just address Authors Press, Dept. 12, Auburn, New York.

SCENERY TO RENT

SETTINGS for Opera, Plays, Minstrels, Flax Drops. Catalog. Amelia Grain, Philadelphia.

EDUCATIONAL AND INSTRUCTION

BECOME a Laboratory Expert. Earn \$300 per month up. Learn Interesting and Profitable Profession of Bacteriology, Microbiology, quickly, at home. Enjoy high Social Standing and Financial Independence. We teach the above sciences including Blood Analysis, Detection of Poisons and Blood Stains—Serology and Wasserman tests thoroughly. Extension and Residential Courses. Diplomas and Degrees granted. Help you secure position. 46 Piece Urinalysis outfit free to Students. Write today for 34 Page Prospectus and description of free outfit. College of Microbiology, 955 Belden Ave., Chicago, Ill.

WORLD-Romic System, Masterkey to All Languages. Six Textbooks, \$1.75; French Chart, 37c; Spanish, 37c. Pronunciation-Tables, 78 languages, 30c each. Languages Publishing Company, 8 West 40th St., New York.

BOOKKEEPING in a week. Dukes, 1857-9 Walton Ave., New York.

ROFF'S Calculator and Short-Cut Arithmetic shows the answer as quickly as a watch shows the time to all problems likely to occur in office, store, shop, bank, farm or factory. Price, pocket size, paper 35 cents, cloth 50 cents, leatherette \$1. Desk size, cloth \$1.50 postpaid. Popular Mechanics Book Dept. 6 N. Michigan Ave., Chicago.

CARTOONISTS—Improve your style by following the work of the greatest cartoonists found in the bound volumes of Cartoons magazine. Eight volumes, each covering six months, Jan.-June, 1917, to July-Dec., 1920, inclusive. 1,200 cartoons, 900 pages to a volume, 7 by 9½ in., 3 in. thick. New books; durable and attractive binding. Sold separately at \$2 per vol. postpaid. Supply very limited. Send at once Popular Mechanics Book Dept., 6 N. Michigan Ave., Chicago.

HAVE a business of your own; the most fascinating, best paying business profession in the World, a foot correctionist; easy terms for training you at home in a few weeks, a new protected system that has enabled men and women to rise in one step to greater earnings than they ever thought possible; no capital required or goods to buy, no agency or soliciting. Address, Stephenson Laboratory, 1 Back Bay, Boston, Mass.

ARTIFICIAL Marble, sanitary flooring instructions, ornamental casting, concrete plaster, papier-mache decorations, garden furniture, statuary, Rubber-moulds, Electro-metallurgy, particulars and 250 illustrations free. Chris Mahler, Box 122, Huntington, N. Y.

STUDY Bacteriology—become a laboratory expert. Course interesting, can be mastered in few months at home or in school. Good paying positions open. Degree granted our graduates. School 13 years old. Send for Announcement, American College of Bacteriology, 2923 S. Michigan Ave., Chicago, Ill.

SUCCEED Home Shorthand, \$2.50. Send money order. We are responsible. Byrne Publishing Company, Tyler, Texas.

WANTED: Information exchanged about commercial uses for air compressors. Address Engineering Dept., Brunner Mfg. Co., Utica, N. Y.

AMBITIOUS writers—send today for free copy America's leading magazine for writers of photoplays, stories, poems, songs; instructive, helpful. Writers Digest, 708 Butler Bldg., Cincinnati.

WRITE articles, stories, news, in spare time for newspapers and magazines. Big pay. Copyright book free. Press Syndicate, 552, St. Louis, Mo.

DOUBLE Entry Bookkeeping mastered in 40 hours with 8 keys; guaranteed; Diplomas International Bookkeeping Institute, Dept. 8, Springfield, Mo.

"WHAT to Invent for Profit" free. Patent News, N. Washington, D. C.

DOUBLE Entry Bookkeeping mastered in 40 hours with 8 keys; guaranteed; Diplomas International Bookkeeping Institute, Dept. 8, Springfield, Mo.

WHAT'S Your Future? Develop winning personality, be popular. Higher business positions, social acquaintances, and larger earning capacity. Success depends largely on personality, no matter what business you are in or have studied. It's a wonderful thing. Free literature. Write today. Personal Service Bureau, Box 235, West Palm Beach, Fla.

INVENTORS—Write for our Illustrated guide book and Evidence of Conception; Blank. Send model or sketch and description for free opinion of its patentable nature. Highest references. Prompt attention. Reasonable terms. Victor J. Evans & Co., 167 Ninth, Washington, D. C.

LEARN Advertising by mail in spare time—pays big salaries, requires little effort. \$2 starts you; balance as you proceed; \$30 in all; no other expenses; no books to buy; easily mastered. Curtis Newton, Dept. P2, 5145 Wentworth Ave., Chicago.

LINCOLN-JEFFERSON University. Home study in Academy, College, Theological, Law, Music, Pharmacy, Business and Graduated Schools, leading to degrees. Box W, 64 W. Randolph St., Chicago.

TELEGRAPHY

TELEGRAPHY—Morse and Wireless—taught at home in half usual time and at trifling cost. Omnigraph Automatic Transmitter will send, on Sounder or Buzzer, unlimited messages, any speed, just as expert operator would. Adopted by U. S. Gort. and used by leading Universities, Colleges, Technical and Telegraph Schools throughout U. S. Catalog free. Omnigraph Mfg. Co., 18 Hudson St., New York.

TELEGRAPHY (both Morse and Wireless) and Railway Accounting taught quickly. Big salaries. Great opportunities. Oldest and largest school; established 46 years. All expenses low—can earn large part. Catalog free. Dodge's Institute, H St., Valparaiso, Ind.

RADIO OUTFITS AND SUPPLIES

SEND ten cents for our new large \$2-page catalog describing our course entitled "How to Learn Radio at Home." National Radio Institute, Dept. 1328, 1345 Penn. Ave., N. W., Washington, D. C.

GALENA Crystals. 50c pays for a lump of "Cascade" Galena—enough for 6 or more detectors. Also supplied in bulk or granules. Discount to dealers. Harry G. Allen Co., 508-A Post St., Seattle, Wash., Distributors for Kilbourne & Clark Radio Equipment.

BUILD your own Radiophone. Instruction book ten cents. Radio Service Inst., U. S. Bank Bldg., Washington, D. C.

GALENA—The world's famous super-sensitive, double tested Vit O Ray. Doubles the efficiency of crystal receiving sets. Used, recommended and endorsed by some of the largest Radio manufacturers. We are sole American Distributors for Vit O Ray. Send \$3.50 now for a sample pound by prepaid Parcel Post. K P K Radio Manufacturing Company, 31st and Downing St., Denver, Colo.

RADIO for the Amateur-Building. Installing, Operating Stations for Radio Communication treated simply in "Practical Amateur Wireless Stations," a 136-page book compiled by Editor of Wireless Age, 115 Ills. and diag. Size 6x9 in. Price 75c postpaid. Popular Mechanics Book Dept., 6 N. Michigan Ave., Chicago.

BUILD your own Radio Receiver for \$5.00 and hear the concerts nightly. Our bulletin No. 149 explains all. Price \$1.00. Experimenters Information Service, 220 West 42nd, New York City.

NEW Radio Books—Construction of Radiophone and Telegraph Receivers for Beginners, 75c—How to Make Commercial Type Radio Apparatus, 75c—A B C of Vacuum Tubes Used in Radio Reception, \$1. Prices postpaid. Popular Mechanics Book Dept., 6 N. Michigan Ave., Chicago.

DO you know anyone who is not interested in radio outfits and equipment? In 11 days we received 393 inquiries concerning radio outfits—and every mail brings many others. These inquiries, in most cases, could be converted into actual orders, so you see what you are missing by not advertising in this column. Send us your copy and remittance for our August issue, forms for which close June 25th. Get the business. J. Roy McClellan, Manager Classified Advertising, Popular Mechanics Magazine, Chicago.

RADIO—The Radio Telephone simply and fully described. How to construct and operate your set, and its cost. Send \$1.00 today. Radiorite Co., 321 Mid-City Bank Bldg., Chicago, Ill.

TRIO Radio Receiving Sets, complete with serial and full instructions. Special design for receiving news, music, reports, etc. Genuine Fibre panel, handsomely mounted with nickel-plated parts, substantial cabinet. No batteries needed, costs nothing to keep up. Will last a lifetime. Requires no experience to install or operate it. Money back if not satisfied. Price complete with single phone anywhere in U. S. A., \$12.50 C. O. D. Price complete with double phone anywhere in U. S. A., \$15 C. O. D. Trio Radio Laboratories, 9916-9920 E. 14th Street, Oakland, Calif.

RADIO Amateurs: You must solder your connections for best results. The "Wonder" is a complete Self-Heating Soldering Iron. Use it anywhere without stove. The most efficient Soldering Iron for Radio work. Put up with solder and solder-paste. Only \$2 in U. S. Send money order or cash. Dealers, this is a live seller. Write for proposition. North Shore Radio Works, 810 Davis St., Evanston, Ill.

MOST Complete Crystal Radio Receiving Set on the market; can be set up and ready to use one hour after you receive it. A finely finished instrument with double headset radio headphones, 2,000 ohms high sensitivity. No additional parts to be bought. Full instructions with each set. Price \$20. Address Nite Mail Order & Supply Co., 609 27th St., Denver, Colo.

MAKE Your Own Radiophone receiver. It's easy when you have simple directions and diagrams to follow. You can do it at small expense. Our new copyrighted book tells you how. Well bound, attractive, complete with circuits of receiving sets, definitions, symbols, parts of sets, etc. Sent postpaid for 75 cents. Radiophone Service Bureau, 1431 Clifton Street N. W., Washington, D. C.

RADIO Apparatus and supplies; standard makes. Westinghouse, General Electric, Radio Corporation products. Amrad and Pink-A-Tone. Quick delivery. Universal Radio Equipment Co., 20 East Jackson Blvd., Chicago, Ill.

BOYS, build complete crystal radio set with 4x8 coil. Price of parts, necessary wire and instructions for building \$1.50 postpaid. Circular free. Aero Shop, 2650 Hurlbut Ave., Detroit, Mich.

ORDERS filled same day. Catalog and bulletins for stamp. Address Hancock Radio, Austin, Texas.

GET your Radio Set practically without cost; make easy money selling friends. No stock to carry. Leading makes; all types. Address Wheeler-Thomas Radio Company, Holland, New York.

EIGHT 2 bearing motor generator sets. Will wind generators for 500 to 1,000 volts. 200 watts. E. A. S., 1126 Jones St., Ft. Wayne, Ind.

RADIO receiving sets; all parts and blue print plans for building. Send stamp for circular and price list. General Radio Supply, 5056 Broadway, Chicago.

MAKE a Radio, Book \$1. Galena crystals 20 cents. Send cash. Address H. J. Davis, 200 Ridgewood Ave., Brooklyn, N. Y.

RADIO—Build your own loud speaker. Blue prints, instructions, \$1. Wolverine Radio Engineering Co., 1207 Jackson St., Albion, Mich.

VARIOCOUPLER, 10 taps \$2.50. Guaranteed. Other prices for 2c stamp. S. S. Pokal, 2124 7th Avenue, N. Y. City.

B-M RADIO Receiving Set \$7.50. Write for description of set. Busch-Murphy, 105 Mason St., Rochester, N. Y.

RADIO apparatus at cut-rate prices. Crystal receiver, \$6.50. Address Ray, 326 Fifth Ave., New York.

THE Home Radio—How to make and use it. At last! A simple explanation of the making and use of a home radio outfit. Every step in construction is carefully directed and illustrated with numerous working diagrams. Bound in cloth. Postpaid for 75c. "Broadcasting Guide," 25c. Radio Educational Service, 209 5th Ave., R-416, New York City.

CRYSTAL Set that gets radio concerts. Build it right, boys. Plans and full instructions for building at small cost, high-grade, fine adjustable Crystal Receiving Set, fifty cents postpaid. Dept. 27-B. Shaw Mfg. Co., Galeburg, Kans.

THE Best in Radio. Write for circular. Howard Lindsey, Sacandaga, N. Y.

WRITE for catalog showing complete line of Elenco Shielded Radio Apparatus, tuners, detectors, amplifiers, transformers and sockets. Electric Machine Corporation, Indianapolis, Ind.

BUSINESS OPPORTUNITIES

MAIL Order Business is your opportunity. Brenner's Famous Handbooks teach how to start small, grow big. Sell merchandise, service, ideas; enormous profits. Spare time to begin. Get complete set, 11 books, \$3.00, and be posted. Brenner, 535 Walnut, Philadelphia. Descriptive Catalog and big batch interesting mail order information, 25c. None free.

GET into the specialty manufacturing business. Amazing profits. We will send you free book explaining our system. Write immediately. A wonderful opportunity awaits you. Thos. D. Steel, President, 624 Main, Richmond, Va.

MAKE Money at Home making Toys—We show you how. Send \$1 for complete working drawings and instructions. Dekalb Designing Co., Dept. 6, Decatur, Ga.

MAKE Rubber Stamps. We furnish Everything. Big profits. Enormous demand. Write now. Sears, Ashland, Ohio.

UNLIMITED Possibilities; Formula, Trade Secret Business, Particulars Dime. Co-operative Service Bureau, Kokomo, Ind.

SLOT Machines; Headquarters for Premium Machines, 1016 Germantown Ave., Philadelphia.

LEARN about "Business Service." H. L. Woodward, 712 9th St., Washington.

FREE—Formula Catalog, S. & H. Laboratories, Boylston Building, Chicago.

ATTENTION!! Go into business for yourself. Establish and operate New System real estate; business brokerage, and Insurance Agency in your community. Office at home; earn \$5,000 year. Representatives wanted everywhere; send stamp for booklet. Hayes Realty Association, Cincinnati, Ohio.

PIES and Profit are synonymous when you work the Smith way. I help you start baking pies, the home-made kind, delicious and satisfying; in demand everywhere at fancy prices. Also teach how to sell to cafes, lunch rooms, and private consumers. Can start home and earn a few dollars weekly at beginning, gradually working up to hundreds profit. Ask me about this. Address F. N. Smith, 447 Huntington, N. Y.

PATENTS—Trademarks. Before disclosing an invention, the inventor should write for my blank form Evidence of Conception. This should be signed, witnessed and returned to me with sketch or model, upon receipt of which I will promptly render opinion as to patentable nature and send booklet on Patents. Highest references. Prompt attention. Reasonable terms. Address Clarence B. O'Brien, Registered Patent Lawyer, Southern Bldg., Washington, D. C.

PATENTS Procured—Trade Marks Registered—A comprehensive, experienced, prompt service for the protection and development of your ideas. Preliminary advice gladly furnished without charge. Booklet of information and form for disclosing idea free on request. Richard B. Owen, 30 Owen Bldg., Washington, D. C., or 2276 R. Woodworth Bldg., New York.

BUSINESS Prospects Review, offers opportunities for Business, Profit, Increased Income for Manufacturers, Mechanics, Homeworkers. Agents all over the World. Contains latest Novelties, Inventions, Money-Making Ideas. Sample Copy free. Business Prospects Review, Box 42, West Farm Station, New York.

IF you have \$1,000 and capable of organizing sales force to sell articles needed in every home, this is new, and \$10,000 a year or more can be made. Address Heigh Mfg. Co., 203 State St., Rochester, N. Y.

PROTECT Your Rights. Write for Record of Invention which contains form to establish evidence of conception of your invention. Prompt personal service. Preliminary advice without charge. J. Reaney Kelly, 612 G. Columbia Bldg., Washington, D. C.

ELECTRICITY Taught by experts; earn while you learn at home; electrical book and proof lessons free; your success guaranteed and position secured. Chicago Engineering Works, Dept. 518, 2144 Lawrence Ave., Chicago.

NICKEL plate automobile accessories, hardware, electrical parts. Big profits. Requires no capital. Simple battery process. Write today. Webster Engineering Co., Webster Groves, Mo.

START business of your own, big profits, exchanging Rolls and Records, write us. Standard Music Co., 183 North Wabash, Chicago.

MANUFACTURE Extracts, and other necessities, 200% profit; we tell you how. Write White Manufacturing Drug Co., Box 322, Cincinnati, O.

PROFITABLE sales by mail come by using authentic, reliable mailing lists, 20,000-600 accurate names. Martinecke Company, Corona, N. Y.

"BUSINESS Opportunities" for you! Particulars free. Sell Rite Co., Box 2, West Fort Sta., Detroit, Mich.

MAKE money with your camera. Information for stamp. Address Lancaster, 409B Wright-Caldender Bldg., Los Angeles, Calif.

\$3,000 TO \$6,000 Yearly. Want it? Others are making it. Send check or money order today for our invaluable books "How to Sell Real Estate," \$3.00—and "How to Conduct Real Estate and Insurance Business," \$1.50. Absolute satisfaction guaranteed. Free catalogs. Realty Book Co., Dept. 52, Cleveland, Ohio.

THE new concrete street and railroad tie, patent 1,399,123, patented Dec. 6, 1921, for sale—\$1,000 and 5% royalty; safer than any railroad tie at the present time. Pete Jarnowski, Lombard, Ill.

START Profitable Mail Order Business at Home. We teach you by successful method. Particulars free. Walhamore Company, Mail Order Dept., Lafayette Bldg., Philadelphia, Pa.

BECOME a Battery Manufacturer. Write for particulars to Lavender Battery Mfg. Co., Webster City, Iowa.

ENTER a new business. Earn \$3,000 to \$6,000 yearly in professional fees making and fitting a foot specialty, openings everywhere, with all the trade you can attend to; easily learned by anyone at home in a few weeks, at small expense; no further capital required, no goods to buy, job hunting, soliciting or agency. Address Stephenson Laboratory, 11 Back Bay, Boston, Mass.

"WHAT To Invent for Profit" free. Patent News-C, Washington, D. C.

START manufacturing imitation Moerschmump pipes. An expert can't tell it from a genuine. Send \$2 money order for details. Address G. Hiescher, 111 W. Main St., Seattle, Wash.

CASH business if interested in conducting your own profitable business, capital \$125 to \$1,000. Call or write for free booklet. Paul Kaye, 149 Broadway, New York, N. Y.

NO money needed if you are responsible or have excellent reputation; big commissions; prefer men calling on power plants, railways, large factories. You can make plenty of money if you are right; have a real article. We are nationally known and highly rated in Dun's and Bradstreet's. Manufacturers, 1660 Kingsland Ave., St. Louis.

DOLLARS yearly in your backyard. No Mushroom dope. Particulars free. Metz, 313 East 89th, New York, N. Y.

SELL or finance your business or invention. Write Box 474, Cleveland, Ohio.

BECOME Master Dealer—Learn Secrets Real Estate Success. Be Independent, Big Profits Either Sex. Special Offer Free. Stephens System, 618 Wyss, Muncie, Ind.

GOOD money easily earned at home, spare time silvering mirrors; no capital. Free instructive book tells how. Patterson & Co., Brookville, Ky.

If you have about \$1,000 and capable of organizing sales force, to sell article needed by every merchant, wholesaler and retailer, which should net you \$10,000 profits first year, write Sales Director, 828 Reaper Block, Chicago.

I MADE \$30 a week home. French bread-making, 15 years' experience; free booklet tells. Ashbrook, 67, Marengo, O.

BE Independent. We teach by mail how to manufacture unexcelled Toilet Preparations. Earn while you learn. Results guaranteed. Particulars Free. School of Cosmetics, Box K, Omaha, Nebr.

"HOW To Sell Patents" free. Patent News-H, Washington, D. C.

LEARN the collection business. Good income, quick results. Interesting booklet, "Skillful Collecting," free. National Collectors Assn., Long St., Newark, O.

START a Paying Business of Your Own. Be a business man. Any location. 8,000 new Tire Vulcanizing and Repair Stations needed. Business always good. Are you ambitious? \$200 will start you. Write at once. Wonderful opportunity. Equipment Co., 11 Canal, Cincinnati, Ohio.

MARBLE mixing instructions, covering wood or cement flooring 1/4 inch thick, fireproof, waterproof, low cost, sanitary, all colors. Particulars, 209 illustrations free. Chris Mahler, Box 123, Huntington, N. Y.

SILVERING Mirrors! My exclusive French Tartaric method opens enormously profitable business. Booklet free. H. Barstow, 514 23d Street, Oakland, Calif.

EXCEPTIONAL Opportunity for Sales Manager capable of handling state distribution. Marvellous new Adding Machine. Retail \$15. Work equals \$350 machine. Tremendous possibilities. Unlimited profits. Write quick for details. Lightning Calculator Co., Dept. B, Grand Rapids, Mich.

\$100,000 CORPORATION wants capable man; open office; manage sales for High Class New Device. Every Home a Prospect. Big money-making possibilities for the right man. Opening in every city. Cost \$2.00, retails \$5.00. \$500 to \$2,000 necessary to finance exclusive agency. Scott Corporation, 82 W. Washington, Desk G, Chicago.

RESPONSIBLE Corporation wants general sales managers to open branch office, manage salesmen. \$500 to \$5,000 necessary; expenses allowed to Baltimore if you qualify. Address Manager, 603 N. Eutaw St., Baltimore, Md.

We Start You in Business, furnishing everything; men and women, \$30.00 to \$100.00 weekly operating our "New System Specialty Candy Factories" anywhere. Opportunity lifetime; booklet free. W. Hillier Hagsdale, Drawer 4, East Orange, N. J.

"SCHEMER Magazine," Alliance Ohio, prints big profit schemes; one subscriber making \$25,000 from three; another \$10,000 from one. Try your luck. Year, only \$1.00; three months, 25c.

CHEMICAL Expert will furnish Formulas and Trade Secrets. All lines. Lists Free. W. L. Cummings, Ph.D., 228 Gordon Ave., Syracuse, N. Y.

FORMULAS AND TRADE SECRETS

FORMULAS of the better sort. Write for our free catalog. Thos. D. Steel, President, 624 Main, Richmond, Va.

1,000,000 FORMULAS, Trade Secrets, \$2.00 postpaid, Co-operative Service Bureau, Kokomo, Ind.

10,000 SELECTED scientific, chemical, technological and practical recipes and processes including hundreds of so called trade secrets for every business alphabetically arranged in one large volume of 800 pages. Price \$4 postpaid. Popular Mechanics Book Dept., 6 N. Michigan Ave., Chicago.

FREE—Formula Catalog. S. & H. Laboratories, Boylston Building, Chicago.

SOAP Formula—Make your own soap for family use. Garages, Mechanics. A grease and dirt lifter; get all material at grocery for making; no lye or grease used. Formula \$1. Cropper Mail Order House, Dept. 1, Marysville, Utah.

500 FORMULAS, 20c. Luminous paint—Resilvering Mirrors—Renewing dry batteries—Mechanics' Soap—Gas Tonic—Carbon remover. Puncture Plugger, 20c each. Entire collection, 50c. Ideal Book Shop, 5501FG, North Robey, Chicago.

350 RARE Formulas for 25c (coin). We can furnish any formula wanted for 50c. Catalog Free. Allen's Enterprises, 1227 Milwaukee Ave., Chicago, Ill.

COMET cleans auto bodies, fenders instantly. Little work, wonderful discovery. Formula \$1. Address Comet Company, 407 West Capitol, Little Rock, Ark.

1,000,000 FORMULAS, Trade Secrets, for Every Business, \$2.00. Ideal Book Shop, 5501MG, North Robey, Chicago.

ABSOLUTELY any formula. Satisfaction guaranteed. \$1.00. Robert Tyler, 256 Park St., Newton, Mass.

3,000 FORMULAS, Trade-Secrets, 400 pages. \$1. Andco, 4049-F, North Whipple, Chicago.

FORMULAS—Catalogue free. "Clover," 5501C, North Robey, Chicago.

FREE Formulas—Write quick. "Restovall," 4049-P, North Whipple, Chicago.

"500 THINGS to Sell by Mail!" A valuable up-to-date compilation of fast selling suggestions, plans and methods. Prepaid, \$1.00. Walhamore Company, Lafayette Bldg., Philadelphia, Pa.

ABSOLUTE Money Getters!—New catalog of novel, startling propositions free; postal will do. Fitzgerald Laboratory, Box 48-B, Stapleton, N. Y.

500 SUCCESSFUL money-making formulas and trade secrets for 50c. Postpaid. Rudolph Bjerggaard, Rollag, Minn.

1,000,000 FORMULAS and recipes—1016 pages, \$2.00. Englewood Book Shop, 7021A, South Winchester, Chicago.

AGENTS WANTED

A BIG Money Maker and a Pleasure for Men, Women and Children You can make the most beautiful Marble, Turquoise, Agate, Tile and art work from common Portland Cement, also beautiful pictures, picture frames and scenery. I will also tell you how you can make from twenty-five to one hundred dollars in an hour's time after learning how to do the work. Will pay five dollars if you cannot do the work by following instructions. My twenty-five-dollar course of instructions for twenty-five cents silver. Based on 40 years' experience. B. F. Spencer, Instruction Dept., Elsinore, Calif.

AGENTS, Men or Women, full or spare time, earn \$25.00 to \$100.00 a week and be your own boss representing the Ho-Ro-Co Mfg. Co., manufacturers of the wonderful Ho-Ro-Co Tonic, the great blood purifier and system builder; some profit-maker. Ho-Ro-Co Medicated Skin and Scalp Soap for the baby, toilet, bath, skin and scalp; a repeater. Over 100 other fast-selling specialties, toilet preparations, perfumes, flavoring extracts, spices, medicinal preparations and household specialties. Every item a fast seller and a big profit-maker. Don't fail to ask for our free sample case offer. We furnish advertising matter and samples free of charge. Ho-Ro-Co representatives are successful. Write today, Ho-Ro-Co Mfg. Co., 154 Locust St., St. Louis, Mo.

WHIRLWIND money-maker for agents—sample free. Sell powdered Hanslick, an absolutely new, non-competitive, and unbeatable hand cleanser. Removes grease, grime, ink, paint, etc., without slightest injury to skin. Its use spreads like wildfire. Cheaper than all others. Sells in cans (or bulk with dispensers) to garages, autoists, mechanics, factory and office folks, to housewives, hardware stores and to auto supply houses. Huge quantities used weekly by mercantile houses. (Names on request.) Big repeat business assured. Exclusive agencies, crews working for you, fast sales, splendid profits and a permanent business for hustlers. Live ones can clean up \$500 a month. Send 2c stamp for postage on Free sample. Complete sales plan goes with it. Write quick to Solar Products Company, 124 W. Lake St., Chicago, Ill.

500% PROFIT—Quick, easy seller. Klean-Rite, New Clothes Washing Compound, No rubbing. Women simply amazed. Free premiums make sales easy. Fast repeater. Distributing samples free. Everybody grabbing for territory. Write quick. Bestever Products Co., 1941-K7, Irving Park, Chicago.

AGENTS: Sell full line of guaranteed hosiery for men, women and children. Must wear 12 months or replaced free. All styles, colors and finest line of silk hose. Often take orders for dozen pairs in one family; permanent customers and repeat orders make you steady income. Write for sample outfit. Thomas Mfg. Co., Class 462, Dayton, Ohio.

OUR New Angora Cleaning Mitt for Autos, Stores, Offices and Household. A big seller at good profit. Send \$2.00 for sales outfit and proposition. If you sell the Auto Trade, our Strait-Jacket Belting Service will surely interest you. It is new and offers a wonderful opportunity. F. Rantville Company, 249 Pearl Street, Grand Rapids, Mich.

AT Last—World's Greatest Adding Machine. Almost human. Retail \$15; work equals \$300 machine. \$500 monthly easily made, demonstrating to stores, offices, garages, factories. Simple, easy; adds, subtracts, multiplies, divides, automatically. Speedy, accurate, durable handsome. Five year guarantee. Tremendous demand; amazing profits. Liberal trial offer. Protected territory. Write quick. Lightning Calculator Corp., Dept. F, Grand Rapids, Mich.

\$31.00 PROFIT—You Make With Only \$1.50 Selling Pure Gold Leaf Monograms for Automobiles, Trunks, Bags—Window and Wagon Letters. Applied instantly. No experience necessary. No. 1 Outfit brings you \$32.50—cost only \$1.50—you make \$31.00 profit. Get colored catalog. Full particulars—free samples (36 designs). "Hurry". Nullife Auto-Aid, Hartford, Conn.

\$75 A WEEK: Legitimate business agency for the fastest selling Ford necessity on the market—The Spad Magneto Timer. Price \$2.50. Quick sales, big profits. Nationally advertised in Motor Age, Ford Owner and Dealer, American Automobile Digest. Write Dept. A, Spad Mfg. Co., Inc., 44 West 39th St., New York City.

AGENTS—\$5 to \$15 daily—Introducing new style guaranteed hosiery—latest modes and shades—nude, camel, silver, etc. Big profits. Repeat orders bring you regular income. You write orders—we deliver and collect. Experience unnecessary. Outfits contain all colors and grades, including silks. Mac-O-Chee Mills Co., Desk 107, Cincinnati, Ohio.

WHY work for others? Make and sell your own goods. We show you how. Enormous profits. Write quick for free book explaining everything. Thos. D. Steel, President, 624 Main, Richmond, Va.

WHY Buy Your Goods. Use Miller's Guaranteed Manufacturer's Reliable Formulas for Manufacturing Agent-Specialty Salesman's Big Selling Specialties—all lines. Free Descriptive Literature Concerning Non-Thermic Ice Cloths, Grape-Ola, and Flavors for all beverages, New Food Specialties, Launderite and New Laundry products. All latest Automobile Specialties including 686 Polish and Amazon Rubber Repair and many other meritorious sellers which can be manufactured in your home, store or office without machinery. Make your start now. Stamp brings valuable information. Miller, Chemist, Tampa, Fla.

LARGE manufacturer wants agents to sell guaranteed made to measure raincoats, Gaberdines and Reversible top and raincoat combined. Make \$75 to \$100 weekly. Profit in advance. We deliver and collect. Outfit free. Standard Raincoat Co., 163 West 21st Street, New York, N. Y.

AGENTS—Ten to Fifteen Dollars daily. Every car owner wants initials on side doors of automobiles. Applied while waiting. Sale \$1.50. Profits \$1.38. Write for agency. Free samples. Transfer Monogram Co., Desk 30, 10 Orchard St., Newark, N. J.

AGENTS—Crew men, novelty men, Gloo-Pen, a 5c mucilage fountain pen; everybody buys on demonstration; sample 25c; big profit plan free. Gloo-Pen Company, 55-FF Pine Street, New York.

AGENTS and Dealers: New patent-improved flat curtain rods. Special exclusive features. The best at a lower price. Full information. H. O. Wolff, 2111 Roscoe St., Chicago, Ill.

AGENTS wanted everywhere. Something new, fastest seller on market, enormous profit. Write for sample and factory prices. Flo Mfg. Co., 2530 Drake Ave., Chicago.

YOU can make \$10.00 daily taking orders for caps, made to order. Underwell stores. Be first. Armstrong Cap Factory, 395 Marion Bldg., Cleveland, Ohio.

AGENTS—Big profits selling "Wanrub Polish" for Furniture, Woodwork, Autos, Etc. Cleans and Polishes. Fritch's Laboratories, 6431 Magnolia, Chicago.

FIELD manager wanted; \$40.00 a week and expenses; man with Ford car preferred. Write, Protecto Manufacturing Co., Brantwood, Wis.

RUMMAGE Sales make \$50 daily. Representatives wanted everywhere. Permanent business. We start you. Crosby Co., 609 Division, Chicago.

FREE—Formula Catalog, S. & H. Laboratories, Boylston Building, Chicago.

SOMETHING New, \$9.00 value for fifty cents. Send for sample. Address Box 342, New Haven, Conn.

NUT Cracker. Twist of the wrist cracks pecans and other nuts. Gets kernels out whole. Nut bowl, cracker, and one pound pecans—all for \$2, postpaid. Selling like minting money. Rush your order. Process Nut Cracker P.M.M. Co., Salina, Kans.

SALES Agents. Men or women, \$200 a month. Year round position. No layoffs. Take orders for Jennings New Style Hosiery. Written guarantee of satisfaction or new hose free. Write for outfit. Jennings Mfg. Co., Dept. 268, Dayton, Ohio.

SELL the American Constitution to Americans. Do a patriotic service at a profit to yourself. "The Short Constitution," by Wade & Russell, tells what the Constitution means. Every American should have it. Every school should use it. Write for proposition. American Citizenship Society Press, 381 Shepard Building, Grand Rapids, Mich.

ATTENTION, Men and Women: Geo. Cox made \$80 the first week with our new selling proposition. No competition on rapid-selling leader. Complete line of household necessities that are repeaters. Quick sales. Large profits. Great opportunity. Write today. The Pioneer Soap Co., 35 St. Paul Ave., Dayton, Ohio.

CENTRAL Indiana Manufacturers now marketing an entirely new auto accessory that makes night driving safe, eliminating glare from approaching headlights. Want general sales managers to open branch office, handle exclusive territory and manage salesmen. Some investment necessary. Profit possibilities practically unlimited. Ray Auto Filter Co., Marion, Ind.

\$195 EARNED by Schleicher in first twelve hours. Self-selling proposition establishes new money-making records. Automatic hot or cold running water bath equipment, without plumbing or waterworks, only \$7.50. Exclusive territory. Investigate. Send no money. Terms. Write today. Allen Mfg. Co., 678 Allen Bldg., Toledo, O.

AGENTS—\$15 a day—Easy, quick sales—Free Auto—Big weekly bonus—\$1.75 premium free to every customer. Simply show our beautiful, 7-piece, solid aluminum handle cutlery set. Appeals instantly. We deliver and collect. Pay daily. New Era Mfg. Co., 803 Madison St., Dept. 21-A, Chicago.

SPOON-N-FORK—Fastest selling specialty ever produced for the kitchen. 100% profit. Every woman buys on sight. A necessity wherever food is cooked. Send 25c for sample or \$1.50 for dozen. Act now for exclusive territory. At Last, 860B Woolworth Building, New York.

AGENTS, Wireless Umbrella. I am paying \$2 an hour, taking orders for this newest invention. Send for 5-part outfit. Six-inch midget demonstrator free. Parker Mfg. Co., 378 Dike St., Dayton, Ohio.

ANY man handy with paint brush or light tools can start new mechanical business on nearly nothing; needed everywhere; nearly all profit; experience not required. John Braceland, 1457 So. Ninth, Philadelphia, Pa.

WHY work for others? Make and sell your own goods. We show you how. Enormous profits. Write quick for free book explaining everything. Thos. D. Steel, president, 624 Main, Richmond, Va.

AGENTS—Whole or part time; build substantial business selling article that steadily repeats. Tremendous summer business assured. Write for particulars today. The Zeila Company, Inc., Dept. 18, 1819 Broadway, New York.

\$12 DAILY and cash bonus. Beautiful Cutlery Set, Genuine Cocobolo handles; sells everywhere. New sales plan. We deliver and collect. Spare time satisfactory. Address, Eastern Kewware Co., Franklinville, N. Y.

ALUMINUM Brush Agents. Aladdin Polish for aluminum and other metals; highly profitable side line. 38c-\$1.00 sizes for homes and public places. Sample 5c. Address Teaply Co., Somerville, N. J.

AGENTS—Sell necessities like tea, coffee, baking powder, flavors, soaps, perfumes and other products. Used every day in the year. Repeat over and over again. Every home a customer and regular user. The smart and experienced agents handle this line, why not you? Write today for Money-Making Plan. Don't delay. Territory going fast. American Products Co., 5887 American Bldg., Cincinnati, Ohio.

AGENTS and distributors wanted to sell our Radio-Gaslighters. 25 cent sellers, 300% clear profit. Universal demand. Write for proof. Ignition Products Company, Inc., 12E Union Square, New York.

AGENTS Wanted—Hand made solid leather link belt; big profit, fast seller, sample \$1.00; any size or color. H. S. O'Brien, 1334 W. Van Buren St., Chicago, Ill.

\$45.00 IN three days with Nu-Lustre Cloth; cleans, polishes all metals. Sells everywhere; big repeater. Sample free. Shef Mfg. Co., 80 Station D, Dept. 1, New York.

TEN dollars daily easy selling Kleenzall. Washes clothes without rubbing. 300 per cent profit. Sale first order guaranteed. Free samples. Quality Products Co., Altoona, Penna.

WANTED—District Purchasing Agents. \$250 per month. Steady employment and exclusive territory. Write now. Experience unnecessary. National Instrument Company, 4794 North Hamilton, Chicago, Ill.

WHY work for others? Make and sell your own goods. We show you how. Enormous profits. Write quick for free book explaining everything. Thos. D. Steel, President, 624 Main, Richmond, Va.

AGENTS. Big money selling our Blue Bird. Wonderful demonstrator, sure repeater. Particulars free. Sample 25c. Blue Bird Manufacturing Co., 719 Portage St., Dept. A, Kalamazoo, Mich.

LATEST, niftiest, simplest folding automobile and camping stool ever devised. Sells also like wildfire at parades, public gatherings, etc. 100% profit. Mincke, Alhambra, Calif.

SELL Pudding Powders—Delicious dessert. Fast sellers; quick repeaters; big profit. Send for terms and sample. C. H. Stuart Co., 74 Broadway, Newark, New York.

"TURNME"—It's a scream! Big dime seller; three different samples 25c. Gross \$4.10. Novix Specialty Company, Dept. 7, 39 East 27th Street, New York.

GUARANTEED Hosiery, lowest prices, manufacturer's complete line direct to wearer. Samples without charge. We deliver. Part time acceptable. Joseph Bros., 311-H Broadway, New York City.

EVERYBODY uses extracts. Sell Duo Double Strength Extracts. Complete line household necessities. Big repeaters. Write today. Duo Co., Dept. E1, Attica, N. Y.

\$150.00 WEEKLY. Start automobile repainting, retrimming business. Easily learned without experience or capital; many positions now being advertised. Automobile Finishing Co., Sheboygan, Wis.

A BUSINESS of your own: Make sparkling glass name plates, numbers, checkerboards, medallions, signs. Big illustrated book free. E. Palmer, 511, Wooster, Ohio.

AGENTS—Sell Skimit Kitchen Cream Separator; nationally advertised; sells on sight; attractive terms; big profits; retails \$1. Skimit Mfg. Co., Oshkosh, Ia.

AGENTS Coining Money! Wonderful seller; 48c profit every 50c sale. Saves purchaser \$1.00. License unnecessary. Sample free! Frost, Box 67, San Diego, Calif.

SUCCESSFUL plan appeals to all theatre managers; nets you \$50 weekly. Theatre Bulletin Co., Washington Building, Los Angeles.

"SALES organization operating Quebec District and Eastern Canada desires several additional responsible lines. Marveu & Thibodeau Reg., 39 St. Paul St., Quebec."

YOU can make good durable paint and varnish 40c gallon. Write Dept. 2. Emmelmann Bros. Mfg. Co., Indianapolis, Ind.

\$210 MONTHLY, expenses, premium auto to agents selling our poultry and stock remedies. Sunflower Poultry Farm, A78, Parsons, Kans.

\$3.00 MERCHANDISE package, \$1.50 seller. Sample, 50c. New York State Trading Goods Co., 53 East Houston St., New York City.

SOFT Drinks; sell like wildfire; big money-makers. Write quick. Bestever Products Co., 1941-87, Irving Park, Chicago.

WHY work for others? Make and sell your own goods. We show you how. Enormous profits. Write quick for free book explaining everything. Thos. D. Steel, President, 624 Main, Richmond, Va.

AGENTS Wanted. If you want to make money, write Americus Sharpening Co., Americus, Ga.

MEN Only. Sell New Novelty. Sample 25 cents. Howard Eddy, Meriden, Conn.

QUICK profits! Permanent Business. Moustour proposition offered to agents to handle our Sanitary Aluminum Soap Dispenser. At the same time create a substantial and permanent income. We manufacture a milk powdered soap, highly scented for the machines, costing agents 15c per pound and selling for 50c. Agents establish themselves in permanent business by selling the machines to hotels, office buildings, private homes, and physicians. All future orders for soap would be supplied by agents. This soap dispenser means absolute cleanliness. One turn of the handle discharges sufficient for a washing. Consumers save 100% and avoid using sloppy contaminated unsanitary piece of soap. Don't miss this great opportunity to establish yourselves in a business making from \$5,000.00 to \$10,000.00 income per year. National Milling & Chemical Company, Fox Chase, Philadelphia, Pa.

AGENTS: We've got a wonderful line of all-wool tailored to order suits and overcoats to retail at \$29.50. They're all one price and \$20.00 cheaper than store prices. You keep deposits; we deliver and collect. Protected territory for hustlers. This is a powerful easy selling line and we are interested in men who believe in a square deal to their customers. Hustlers write J. B. Simpson, Inc., Dept. A-118, 831 West Adams St., Chicago.

AGENTS: Make \$75.00 a week selling our strictly All-Wool made-to-measure suits at \$28.50. You collect profits in advance and keep them. We supply finest selling outfit in America. Many exclusive money-making features. Tailoring, raincoat and side-line men, part or full time, get in touch with us immediately. Address Dept. 106, Goodwear, Inc., 843 W. Adams St., Chicago.

\$15.00 DAILY Easy selling the New Amheroid Unbreakable Combs; kind you can hit with a hammer; saw wood with the teeth. They are top-notch sellers at fairs, with agents, streetmen, etc. Many of our street workers selling over \$100.00 worth on a Saturday afternoon and evening. You can do as well. Write for wholesale prices and proof. Oliver Gandy, Cristfield, Md.

TO Sell—Milburn Puncture Proof Inner Tubes. Positively puncture proof. Inflated like ordinary tube and costs little more. Fearlessly guaranteed. Sold only through agents. Be in business for yourself. 100% profit. Live wires are making \$100 to \$200 weekly. Write quick for territory. Milburn Puncture Proof Tube Company, Dept. K-6, Milburn Bldg., 330-335 West Forty-Seventh St., Chicago.

AGENTS Wanted—Something New—Fire Fighter sells easily. Makes a spectacular demonstration—car owners, homes, factories, stores practically buy on sight. Our men make \$10 to \$30 a day—exclusive territory. If you wish to establish a business of your own with unlimited possibilities for making big money, write us today. Fry-Fyter Co., 163 Fry-Fyter Bldg., Dayton, Ohio.

TERRITORY Salesmen: First popular price Fire Extinguisher ever made. Retail \$5. Others cost \$15. Every home, office or factory can be sold. One man sold 12,000 in Dayton. Peck cleaning up in Detroit. \$90 a week. No capital. No experience. Territory going fast. Write Thurston Mfg. Co., 178 Foe St., Dayton, Ohio.

BIG Money Makers. Large factory offers you big profits on 150 fast sellers. Toilet gift sets, flavoring extracts, remedies, soaps being you \$8.00 to \$25.00 daily. Howe of Illinois makes \$4.00 an hour. Sample outfit free to workers. Lincoln Chemical Works, Dept. 155, 2956 No. Leavitt, Chicago.

AMBITIOUS agents are coining money manufacturing and selling Orange Blossom Shampoo. Pleases particular customers. Repeat orders assured. Materials obtainable anywhere. Machinery unnecessary. Interesting booklet and convincing proof mailed free. Address Normand M. Ovi, East San Diego, Calif.

MAKE \$50 Daily. Something new! 400% profit. All business, professional men need it. Sells \$5. Costs \$1. Brooks, Texas, sold 20 first day, profit \$80. Big weekly repeater. Sells quickly. Experience unnecessary. Write today for territory wanted. Sample outfit free. Federal Association, 71-K Asylum St., Hartford, Conn.

SUCCESSFUL consumer salesman can build up permanent, increasing business everywhere; representing America's finest spark plug "Liberty." Can demonstrate plug instantly, and compel attention. Wonderfully attractive seller. Only five sets a day earn \$90 weekly. Real salesman write. A. L. P. Co., 169 Mass. Ave., Boston, Mass.

HOW Would You Like to Make \$25 in two days? That's what one new agent made selling "Simplex Ironing Board Covers." Remarkable new invention; housewives buy on sight. If you want big money write today. W. J. Lynch, Springfield, Ill.

SCIENTIFIC headlight deflector greatly multiplies lighting distance ahead; big, broad, long white light. No glare. No competition. Easily shown. Quickly sold. Agent's sample and sales plan \$1. Regular price \$2. Exclusive territory. Multi-Ray Sales, Dept. 342, Toledo, Ohio.

AGENTS: Make big money selling fountain pen with perpetual calendar built into cap. \$3.75 each. Send \$5.00 for samples. Money refunded for samples returned. Literature free. Associated Supply Company, Box 363, City Hall Station, New York.

AGENTS—\$5 to \$10 daily selling Snow Dust Washing Compound. Washes clothes without rubbing. Women wild about it. Big repeater. Free samples boost sales. Exclusive Territory. 300% Profit. Sample Free. Norman E. Conrad, Wabash, Ind.

PROTECT Your Rights. Write for Record of Invention which contains form to establish evidence of conception of your invention. Prompt personal service. Preliminary advice without charge. J. Beane Kelly, 612 G. Columbia Bldg., Washington, D. C.

LIVE Agents, 300% Profit. New imported novelty. Opera glass, microscope, stereoscope, compass and laryngoscope combined. Folds and fits vest pocket. Sample 50c. Nite Mail Order & Supply Co., 609 27th St., Denver, Colo.

AGENTS: See our display advertisement on page 127 in this magazine, then write us immediately. Wide awake agents need no other line. Address, Sales Dept., The Kazo Company, Cambridge, 29, Mass.

AGENTS—Patented Automatic Nickel Ejector Cigarette Case. Sells on sight 150% profit. Live wires only. Big money for hustlers. Make real cleanup. Superior Lamp Co., 150 West 52nd St., New York.

INTRODUCE Whiz, delicious beverage. Great demand, Big repeater. Hundred other fast sellers. Fine profit. Write at once for terms and sample. Address Newton & Co., 61 Main St., Newark, N. Y.

H & B LOCK for Milk Boxes: new. Agent's Sample 35c. C. O. D. More than 100% on each sale. Address Heigh Mfg. Co., 203 State St., Rochester, N. Y.

AGENTS, Crew men, Novelty men. Gloo-Pen, a 50c mucilage fountain pen; everybody buys on demonstration; sample 25c; big profit plan free. Gloo-Pen Company, 56-FP Pine Street, New York.

100% PROFIT each 50c sale. Why not make this for yourself? Snap for hustlers. Sell to Auto Owners and Chauffeurs. Territory valuable. Quick action. Perkins, 250 Broadway, New York.

HIP-Suspenders (health way), stop dangerous pressure, creeping shirt, sagging trousers. Thousands endorsing. Tiny "Alumite" pair; featherweight, indestructible outfit. Enormous seller; agents 50c. Woods, 501 North Seventh, St. Louis.

AGENTS Make Easy Money. Represent us in your town and vicinity and start business yourself with our specialties. J. R. Wolf Co., 216 E. Pearl St., Cincinnati, Ohio.

BIG money selling our Auto Specialties. Olin Russell sold one day \$185.00; others did equally well. Free sample and particulars. Jackson Mfg. Co., B 2097, Denver, Colo.

AGENTS: Get into a good repeat proposition. Sell our high-grade flavoring extracts. Build up steady income. Liberal terms. Acme Extract Co., 320 West Broadway, New York.

MEN—Women: Sell Yarborough hair products. Quick sales, large profits. Write today. Colored agents preferred. Territory going fast. Address Yarborough Mfg. Co., Winston-Salem, N. C.

Oh! My sweetie, tender, sore feet: relieved by using the Sims Shoe Ventilator. Agents wanted everywhere. Particulars. W. B. Sims, 315 Mason St., Portland, Ore.

SELLS Like Hot Cakes; big profits; new ironing wax pad and asbestos rest; clamps board; perfumes clothes; outfit 10c; Yankee Mfg. Co., 380 Atlantic Ave., Brooklyn, N. Y.

ORIENTAL Pearls Undrilled for mounting rings, pins, etc., sell like wildfire, 500% profit. No competition. Sample 30c postpaid. Address McCallister, importer, Phelan Bldg., San Francisco, Calif.

AGENTS—Literally coining money applying monograms on automobiles. You charge \$1.50, profit \$1.40. Ten orders daily easy. Free samples. Worcester Monogram Co., Worcester, Mass.

AGENTS double your money. Polmet Polishing cloth cleans all metals. Retail 25c. Sample Free. A. A. Gale Co., 17 Edinboro St., Boston, Mass.

AGENTS: Make Big Money, sell the "Stick-On" Window Lock. Sample with full particulars 10c. Louis Otto, 120 Dover St., Joliet, Ill.

EARN \$10 daily silvering mirrors, plating and refinishing metalware, autos, chandeliers, bedsteads, reflectors. Outfits furnished. E. Decie Laboratories, 1133 Broadway, New York, N. Y.

AGENTS: Repeat order household necessity, whole or part time, man or woman. Shur-Klean-Zit Co., 1618 N. 6th St., Sheboygan, Wis.

PREPARE and Sell Your Own Products—Formulas by experts. Trade secrets, manufacturing processes. Catalog free. Address B. Thaxly Co., Washington, D. C.

HOME employment evenings. Start little Mail Order business anywhere. Everything furnished. Stamp brings Instructive Booklet. R. Pier, 72 Cortlandt Street, New York.

FISHER Safety Steering Device "Makes a Ford drive like a Packard." State and county agents wanted. Fisher Sales Co., Lincoln, Nebr.

AGENTS—Make big money selling the Wizard Self-Heating Flat Iron. Investigate. Wizard Mfg. Co., 1608 Fulton St., Chicago.

"BLADEKNIFE" means genuine pocket knife from any discarded razor blade. Sample 25 cents. Address, L. L. Martin, Patterson, N. J.

NEW automobile accessory. Recently Patented. Wonderful seller. No installing. Over 100% profit. Exclusive territory. Box 2071, Denver, Colo.

TWENTY—Big Money-making opportunities Free. Three quick action samples 25 cents. Lawrence Products Company, Dept. M, Beaver Dam, Wis.

SWIFT, easy, sure selling necessities; exceptionally profitable; exclusive business. Samples free. Peninsular Specialty Co., 15303 E. Jefferson, Detroit.

METAL Toy Soldiers \$3.00 per 1,000. Samples 25c. Edwin H. Eppley, 328 N. Queen St., York, Penna.

PICTURE Men: Prices are smashed. Bromide prints 20 cents. United Service Art Station D, Chicago, Ill.

\$1.00 BRINGS 24 boxes Reoline Silver Polish. Real profit. Lester Hagel Co., Peoria, Ill.

GOOD prices paid for butterflies, insects. See Sinclair's Display Advertisement, page 18.

AGENTS—Earn \$50 to \$100 a week selling Marquette Tire Tool. Simple demonstration sells it. Removes tires in a jiffy. Every owner wants it. Thousands in use. Exclusive territory going fast. Agent's sample \$1.25, retails at \$2.50. Write for full particulars or send \$1.25 for sample and particulars. Marquette Mfg. Co., Dept. A, 218 S. Wabasha Ave., St. Paul, Minn.

AGENTS Wanted—Brand new article with wonderful sales possibilities. Applicants must be big enough to handle County rights on exclusive basis. Our contract assures you a permanent and substantial business. Sample fifty cents. Money refunded if we do not connect. Dept. 21, Bethlehem Utilities Co., Bethlehem, Pa.

"THE Mucilage Fountain Pen"—Carry in pocket with your fountain pen. No sticky fingers. Lasts lifetime. Never dry. Handy office or home. Sample 50c U. S. stamps. Agents wanted. Liberal terms. Jax Co., Box 292 Steger, Ill., U. S. A.

300% PROFIT—Every Home, Store, Office and Garage Needs. Easily carried, quickly sold. Free sample. Address Chapman Company, 829 Dwight Bldg., Kansas City, Mo.

AGENTS—Send for sample "Fretnot"—the washday wonder. Be convinced you can do a whirlwind business. You can clear at least \$20 to \$100 weekly, according to spare or whole time. You don't have to talk; if she doesn't buy at sight, leave sample; she will be looking for you long before you are able to make the rounds again. Samples furnished free. Premiums for your customers. Exclusive territory guaranteed to agents who can produce. Credits given. Don't call. P. M. Motter & Sons, 20 E. Jackson Blvd., Chicago.

IMMEDIATE Commissions—no investment—no delivering—no collecting. Pay-day every day. Profits larger than usual. That's our proposition No. 1. For the agent that buys to resell—our proposition No. 2 would instantly appeal. 100% profit and Free Goods. High grade guaranteed aluminum cooking utensil specialties and staples. Our Free Goods Offer is unusually interesting. We maintain a 24-hour shipping schedule. Exclusive territories granted and protected. Get yours before it's too late. Perfection Aluminum Mfg. Co., Desk A., Lemont, Ill.

WOULD \$18 an hour interest you? Clarke made this selling amazing windshield cleaner; for autolets, motormen, engineers; works like magic; one rub cleans glass clear 24 hours; cleans entire windshield; works while you drive; chemical-felt sheds water like a duck's back; snappy metal holder fits pocket; guaranteed year; sells \$1; Sweet sold 2,000 few days; amazing details free. Security Mfg. Co., Dept. 622, Toledo, Ohio.

PORTRAIT Agents—Earn big money selling our Photo Medallions. Everybody buys. You charge \$3.00; make \$2.40 each sale. \$10 daily easy. Big variety designs. 4-day service. Perry Photo Novelty Corporation, Section 16, 360 Bowery, New York.

STARTLING Agents Proposition—\$100 weekly selling Rolly's Washday Wonder. New Chemical Dirt Solvent. Harmless. Cleans without rubbing. Enormous profits. Repeat orders assured. Experience unnecessary. Territory going fast. Samples free. Rolly Chemical Co., Al. Hastings, Neb.

PORTRAIT Agents—\$50,000 is what "Picture Man Friedman" made canvassing. Free circular "Profits in Portraits" tell how. 24-hour service prints, finished portraits, frames. Samples free. "Picture Man Friedman," Dept. 8, 127 N. Dearborn St., Chicago.

MANUFACTURE something new with our guaranteed solid metal outfit; makes article 1 1/2x3 costing 1c, sells 10-25c, outdoor and indoor, like wildfire; price \$7.50 with instructions; sample 25c. New Jersey Specialty Co., 16 Bergen Sta., Jersey City, N. J.

MOST Wonderful Seller. 96c profit every dollar. No stock to carry. License unnecessary. Sample free. Mission, 2421-MP, Smith, Detroit.

CALIFORNIA Rosebuds selling like hot cakes. Agents coinng money; new stuff. Big profits. Catalog free. Mission, 2421-FM, Smith, Detroit.

TAILORING agents wanted to sell guaranteed tailor-made suits and overcoats. We ship free prepaid, large traveling sample outfit, 250 all-wool fabrics at \$15.00 and up for guaranteed suit or overcoat. Write today for fall and winter samples. Jay Rose & Co., 411 S. Wells St., Chicago, Dept. 500P.

AGENTS—Men and Women—We start you in a permanent business without any investment. Whole or spare time. Big line, easy sales everywhere. Handsome profits. No experience necessary. Write now. National Mfg. Co., B-23 West Hoboken, N. J.

SALES Agents for exclusive county representation on Dico spark plugs. Buskers make \$60.00 and better weekly. Every car and tractor user a prospect. Write quick. Dayton Ignition Co., Dayton, Ohio.

MEN'S shirts. Easy to sell. Big demand everywhere. Make \$15.00 daily. Undersell stores. Complete line. Free samples to workers. Chicago Shirt Co., 9 So. Clinton, Factory 295, Chicago.

WIRE twisted sanitary Brushes—Mops, Dusters, Automobile Brushes, etc., are the leaders in specialties. Restricted territory for live wires. Steelcut Brush Co., 487 Broadway, N. Y. City.

MANUFACTURERS Agents—District Managers—Crew Managers—Get immediately our proposition. Mother Goose Wringer Mop—New, Patented, Perfect. Saves the back—Housewife stands erect to do all scrubbing—Hands never touch the water. Retail \$1.50. More than 100% profit. Sample prepaid \$1.00. We had to double size of factory last year to handle the orders. You can make a small fortune. The Alline Company, 6523 Euclid Avenue, Cleveland, Ohio.

AGENTS—Enormous profits selling Genuine Gold Leaf sign letters. Guaranteed not to fade. Establish a permanent business or travel. Anybody can do it. Free samples. Guarantee Sign Service, A 430 South California Ave., Chicago.

"HOW to Sell Patents" free. Patent News-O, Washington, D. C.

WORLD'S Fastest Selling Auto Accessory! County Distributors wanted; write today. G. L. W. Spring Oiler Co., San Diego, Calif.

AGENTS Wanted—Big money in selling artificial flowers. Lotus Manufacturing Co., 1734 N. Halsted St., Chicago.

SELL Ladies' Art Embroidery Needle. Sample 50 cents. Eugene Marquis, 5200 North Keystone, Indianapolis, Ind.

EVERPLAY Phonograph Needle plays 27,000 times. Better tone and reproduction. Preserves records. Fits all phonographs like ordinary needle. Not a jewel. Point renewed as used from 9 inches of soft special alloy wire coiled within the needle. Saves \$40. Retail \$1.00. No dealers to buck. Big profits. Everplay, 1 McKay Bldg., San Francisco, Calif.

MOTOR Ignition Amplifier—A Wonder Invention! Gives new power to an old motor and more power to the new. Sell to garages, accessory dealers and users. Quick action, big money and satisfaction. Write for prices and literature. Motor Ignition Corporation, Mfgs., Albany, N. Y.

AGENTS coinng money with our women's household aprons and other rubberized goods; children's aprons, pinafores and sunbonnets, utility bags, etc. Best goods made at least prices. Write for catalog 11. The Schafuss Corporation, 466 Broome St., New York, N. Y.

SALES Representative wanted every county to give all or spare time. Position worth \$1,200 to \$3,000 yearly. No previous experience or capital necessary. Write for full particulars. A. A. Silver-Chamberlin Co., Clayton, N. J.

AGENTS—Sell Our Marvel Can Opener. Make \$4 on every \$2 invested. Our tip—your opportunity. Write us now. Staples Mfg. Co., Mt. Vernon, Ind.

AGENTS Make \$1.50 on every shirt order from manufacturer direct to wearer. Menzies Shirt Co., 3843 3rd Ave., New York City.

\$10 DAILY Easy with my specialty. 500% profit. K. Home, 1957 Warren, Chicago.

AGENTS: Men and women, in spare or full time, make big money selling household necessity. Every home a prospect. Quick sales, big profit. Territory open. Write for particulars. Judd & Leland Manufacturing Company, Box 21, Clifton Springs, N. Y.

AGENTS—Sell Patented Cigar Lighters and Cigar-Case Moisteners. Big Profits. Start making money at once. Write for circulars, cuts and sales plan. Drake Mfg. Co., Dept. M., Milwaukee, Wis.

AGENTS—Sell Electric Body Batteries for Nervous Diseases and Rheumatism. Nealeigh & Co., Indianapolis, Ind.

SIGNS for stores and offices. Entirely new. \$50 week easily made. Chicago Sign System, F150 W. Austin Ave., Chicago.

AGENTS Sell Neverfall Iron Rust and Stain Remover. Huge profits. Big line. Sample. Write today. Sanford Beal Co., Inc., Newark, N. Y., Dept. 6.

AGENTS—Advertising Pencils, ready sellers, excellent sideline. Write for proposition. North American Pencil Works, 310 So. Canal St., Chicago.

WANTED—Agents and Salesmen to handle Europe's Famous Wonder Glass, the newly imported Prism "Binoculette." For theatre, hunting, yachting, races, touring, aviation, etc. This is the smallest and of its size the most powerful Glass in the world. Can be carried in vest pocket or ladies' bag. Retail at \$25.00. Confidential wholesale price to agents \$12.50. Send money with order to George Mayerle Optical Co., General Importers, established 1894, 969 Market St., San Francisco, Calif. (Send for catalog.)

AGENTS—\$40-\$200 a week. Free Samples. Gold Sign letters anyone can put on store windows. Liberal offer to general agents. Metallic Letter Co., 431-C N. Clark St., Chicago.

GALLAGHER made \$328.00 in one week selling guaranteed Collection Systems, used by all business men. Sayers Mfg., 2815 Sheffield Ave., Chicago, Ill.

FREE Sample "Rain Shield Wiper." Retail \$1.00—Costs You 25 Cents (300% Profit). Every Autoist Buys Quickly. No Cloth. No Paste. No Mechanical Attachment. (1) Rub keeps Windshields clear 48 Hours against Rain, Snow Storms. Invention Just Out. Prevents Accidents. (Williams makes \$12 Hour.) Experience Unnecessary. Wonderful Pocket Sideline. Write Quick for Your Free Sample. Nu-Life (B) Corporation, Hartford, Conn.

100% PROFIT selling our felt rugs to homes, hotels, offices, etc. Everybody buys. We are manufacturers, not jobbers. Prices defy competition. \$75 week easy. Newark Felt Rug Company, 56-C Bergen Street, Newark, N. J.

SOFT Drinks In Powder; ten kinds. Just add cold water and sugar; no trouble. Fine for the home, picnics, parties, dances, etc. Many make \$10 to \$50 day. Tea-glass package, best drink you ever tasted, and particulars 10c postpaid. Morrissey Company, 4463-11 Madison St., Chicago.

AGENTS: 1922's Greatest Sensation. 11-piece toilet article set selling like blazes at \$1.75 with \$1.00 dressmaker's shears free to each customer. Line up with Davis for 1922. E. M. Davis Co., Dept. 506, Chicago.

PLYMOUTH Bags. We are selling this popular bag in green, black, blue and brown leatherette, cretonne lined. \$6-\$8.50-\$1.20 and \$10 per dozen. Sample 65c prepaid. Write for free samples of material. E. Condon, Mfg., 12 Pearl St., Boston, Mass.

LIVE Agents make \$10 Day selling Eureka Strainer and Splash Preventor for every water faucet. Takes on sight. Widely advertised and known. Get details today. A. B. Seed Filter Company, 73 Franklin, New York.

MAKE 600% Profit. Free Samples. Lowest priced Gold window letters for stores, offices. Anybody can do it. Large demand. Exclusive territory. Big future. Sideline. Acme Letter Co., 2860-D, Congress, Chicago.

SELFOLITE—Agents, Streetmen—Selfolite lights any fire while user sleeps, or any time. Performs surprising stunts. Newly patented. Sample 25c, postpaid; money back. Particulars. Kaytow Mfg. Co., C195 Station A, Boston, Mass.

AGENTS: Big Profits. Genuine Gold Leaf Window Letters anyone can put up. Scripts and 57 varieties. Chicago Agency Co., 842 Altgeld St., Chicago.

AGENTS—Big Profits. Gold Sign letters easily applied, samples free. Liberal offer to General Agents. Dept. C Interstate Sign, 2620 No. Halsted St., Chicago.

EARN Big Money Fast applying Lithogram Initials to automobile doors. Every owner buys. \$1.35 Profit on each sale. Full particulars mailed. Address, Lithogram Company, 17-B East Orange, N. J.

AGENTS wanted to sell "Havana Treat" 5c cigars to Smokers and Stores. Havana Treat Cigar Co., Utica, N. Y.

GOOD income, spare time, refinishing chandeliers, brass beds, automobiles, etc., by new method; producing amazing results; every household possible customer; experience unnecessary; simple plan of manufacturing at home starts you in big money-making business. Write for free samples, showing finishes, etc. Gunmetal Finish Co., Ave. H, Decatur, Ill.

GOLD Leaf Sign Letters; make and sell; profits exceed 1,000%; immense demand; particulars free. Johnston Co., Quincy, Ill.

AGENTS make 500% profit handling Auto Monograms, New Pictures, Window Letters, Transfer Flags, Novelty Signs. Catalog Free. Write Hinton Co., Star City, Ind.

PORTRAIT Agents, who want good work and prompt service and who desire to purchase their frames at factory prices, should write us at once for catalog and price list. W. G. Hannan Co., Dept. A-5, 57 E. 18th St., Chicago, Ill.

AGENTS—New patented curtain rod, necessity in every home; big profit; 4 to 10 sales at every house. Write for free sample. Home Curtain Rod Co., Providence, R. I.

LARGE shirt manufacturer wants Agents to sell complete line of shirts direct to wearer. Exclusive patterns. Big values. Free samples. Madison Mills, 503 Broadway, New York.

AGENTS—Clever Invention! Inkspoon makes every pen a fountain pen. Fast office seller; big profit, demand increasing everywhere. Exclusive territory offered. Sample free. H. Marul Company, Tribune Bldg., New York, N. Y.

AGENTS: Big Money Monogramming By Transfer Method. Catalogue Showing Over 50 Styles and Particulars Free. Motorists' Accessories Co., Mansfield, Ohio.

\$200 WEEKLY. Free samples. Sell gold sign letters to stores, offices. No experience. Big future guaranteed. Can travel. Exclusive territory. Become our general agent. Acme Letter Co., 2804D Congress, Chicago.

MAKE \$25 to \$50 Week representing Clows' Famous Philadelphia Hosiery, direct from mill—for men, women, children. Every pair guaranteed. Prices that win. Free book "How to Start" tells the story. George Clows Company, Desk 31, Philadelphia, Pa.

YOU can letter Automobiles, Doors, Trunks etc., without any previous experience by Transfer Process. Make \$27.50 on \$2.50 outfit. Auto Monogram Supply Co., 16 Green St., Newark, N. J.

BEST Proposition on Earth. Kitchen Specialty Every Woman Wants. Nothing like it in existence. 200% profit. Best Novelty Mfg. Co., Dept. C, 169 N. Wells, Chicago.

WE Start You Without a Dollar. Soaps, Extracts, Perfumes, Toilet Goods. Experience unnecessary. Carnation Co., 201 Olive St., St. Louis.

AGENTS and portrait men. Crew managers. We give you more for your money. Better and quicker service. Lowest prices on frames and glass. Rejects credited. Catalog free. The Pioneer Corporation, 1259-A West 63rd St., Chicago.

AGENTS—Stamping names on Pocket Key Protectors; sample Check with your name and address, 25c. Stamping Outfits, Emblem Checks, Check Fobs, Name Plates. Hart Mfg. Co., Desk 2, 303 Degraw St., Brooklyn, N. Y.

YOU can be your own boss with our Key Check outfit. Good for \$5 a day stamping names on pocket key checks, fobs, etc. Sample check with your name and address, 20 cents. Pease Die Works, Dept. M, Winchester, N. H.

PATENTS—Write for our free illustrated guide book and Evidence of Conception Blank. Send sketch or model for our opinion of its patentable nature free. Highest references. Prompt attention. Reasonable terms. Victor J. Evans & Co., 163 Ninth, Washington, D. C.

PORTRAIT Agents: Our goods will make you big profits. Delivery guaranteed. Rejects credited. Prompt shipments. Send for latest catalog and prices. Adam J. Kroll & Co., 602 Blue Island Ave., Chicago, Ill.

AGENTS—Best seller: Jem Rubber Repair for tires and tubes; supercedes vulcanization at saving of over 800%; put it on cold, vulcanizes itself in two minutes, and is guaranteed to last the life of the tire or tube. Sells to every auto owner and accessory dealer. For particulars how to make big money and free sample, address Amazon Rubber Co., Amazon Bldg., Philadelphia, Pa., Dept. 505.

AGENTS: Big profits. Best and cheapest window letters made. Easily applied. Dime brings five samples. Particulars free. Stainite Co., 1115 Second Ave., New York.

AGENTS—If you are making less than \$300 a month our proposition on Sentinel Burglar Alarms for windows and doors will interest you. Many agents earn \$20 daily. Brand new inventions. No wires, batteries or nails. Instantly attached to any door or window. Handsomely nickel plated. Sell on sight. No competition. Provides cheap burglar insurance. Big money makers. Write today for extremely liberal terms to agents. Sentinel Alarm Co., 140 S. Dearborn St., Chicago, Ill.

MAKE \$2 an Hour. Article that removes iron rust, grass, medicine, fruit, mildew stains. Cleans Panama and Straw Hats. Bleaches clothes. Sells Every home. Write for free demonstrating outfit and start taking orders at once. Christy, 81A Union, Newark, N. Y.

AGENTS: Big Returns, fast office sellers; particulars and samples free. One Dip Pen Co., 2 Daily Record, Baltimore, Md.

AGENTS make a dollar an hour. Sell Mendets, a patent patch for instantly mending leaks in all utensils. Sample package free. Collette Mfg. Co., Dept. 404-B, Amsterdam, N. Y.

BIG money and Fast Sales. Every owner buys Gold Initials for his auto. You charge \$1.50; make \$1.35. Ten orders a day easy. Write for particulars and free samples. American Monogram Co., Dept. 40, East Orange, N. J.

OUR Ex-Cel Luminous Crucifix shines brilliantly in the dark. Churches, hospitals and individuals are only waiting for a demonstration before buying. Agents make handsome profits. W. G. Hannan Co., Dept. B, 57 E. 18th St., Chicago.

EASY, pleasant work for Mechanics, Shop Men, Clerks, during spare hours; will add many dollars to their salaries. Also want persons who can give full time. Big wages assured. Novelty Outley Co., 67 Bar St., Canton, O.

IF you need good live agents—fellows who can get the business—ask me how others are doing it. I'll gladly render the necessary assistance. J. Roy McClellan, Mgr. Classified Advertising, Popular Mechanics Magazine, Chicago.

AGENTS make 140% profit. Iridium (luminous) crucifix shines in the dark. Sells for \$2.00. Costs 84c. Complete line religious articles, crucifixes, bulbs, switch plates, house numbers and match boxes. Novel Ornamental Useful! Every home a prospect. Big sales. Get free demonstrating outfit. The Pioneer Corporation, 1259 W. 63d St., Chicago, Ill.

AMERICO Booster auxiliary water carburetor makes autos burn water. Eliminates carbon. Low cost; liberal profits; details free. Americo Co., Dept. 178, Cincinnati, Ohio.

SELL Necessities. Everybody needs and buys the "Business Guide." Bryant cleared \$300.00 in July. Send for sample. It's free. Nichols Co., Box 4-B, Naperville, Ill.

HIGH-GRADE SALESMEN WANTED

OUR Florida "Go Getter" has sold \$3,500 in motion-picture service since joining our organization sixty days ago, and he is going strong. The same opportunity exists for you, right in your own locality, selling motion-picture publicity to bankers and merchants. Our live and aggressive organization builds Men and Character as well as a superb quality product. Make us prove it! Address Alexander Film Co., 1151 Main Ave., Spokane, Wash.

A BUSINESS of your own. Aggressive, ambitious men who seek new and larger business opportunities and expect to scratch and hustle to build real prosperity. Such men can secure factory sales connection and exclusive wholesale distribution on high-grade automobile necessities becoming well-known through national advertising. More than sales job; an opportunity to build permanent and profitable business with "Money back" merchandise that sells and repeats. Must have references, financial standing, evidence of past success and business promotion experiences outlined. Waste no time on postal cards or letters that do not state particulars requested. Correspondence with new, wide-awake specialty distributors solicited. Write Robert Bowes Company, Indianapolis, Ind.

SALESMEN sell "Ratskyl." Our non-poisonous Rat and Mouse Exterminator. Wonderful new discovery. Ready for use, no mixing, no bait required. Harmless to man, poultry, cat, dog and other animals. Rodents die outside premises. No odor. Call on hotels, restaurants, bakeries, groceries, department stores, mills, etc. Good salary and commission. Empire Specialties Co., 1549 N. Wells, Dept. 301, Chicago, Ill.

200% PROFIT. Sell automobile and furniture polish. An attractive self-selling display box of 24 cans costs you only \$2.40. Retail price 30c per can. Write today for particulars. Hy-Gen-Oil Laboratory, Spring Valley, N. Y.

CAR owner Representative. \$125.00 weekly, demonstrating guaranteed air filled Puncture Sealing Inner Tubes. Inexpensive. Enormous profits. Free sample. H. Weststone Co., 3025 Indiana Ave., Chicago.

MINUTES pay dollars demonstrating world's greatest specialty. Wonderful new three-pound Adding Machine. Retail \$15. Work equals \$300.00 machine. Adds, subtracts, multiplies, divides, automatically. Speedy, accurate, durable, handsome. Five-year Guarantee. Tremendous demand everywhere. Amazing profits, main or sideline. Experience unnecessary. Write quick for liberal trial offer and protected territory. Lightning Calculator Co., Dept. G, Grand Rapids, Mich.

DISTRIBUTORS, here's your chance! Want it? Nifty Clever Little "Cataract" Washer; cleanses autos quickly. Attaches to Garden Hose. All Brass—can't rust. Won't mar finest varnish. Everybody your customer. Three Styles—No. 1, \$2.50; No. 2, \$1.75; No. 3, \$1.35. Alluring profits. Quick shipments. Cataract Auto Washer Co., Topeka, Kan.

NOVELTY Salesmen: Increase your earnings selling "French" Perfumed Cards, Parisian Novelty Cards with colored sketches, and French post cards with beautiful designs. 84 different subjects. Assortment by mail 25 cents. A. Lob, Sole Distributor, 688 Hudson St., New York.

MANUFACTURER and patentee of a new necessity of sound commercial value; fully guaranteed. Want first-class general agents and salesmen to introduce through house salesmen. Apply Dundee Mfg. Co., Inc., 17 Edinboro St., Boston, Mass.

SALESMEN—Given protected territory to sell Doublewear Shoes direct from factory to wearer. Our new measure board insures perfect fitting. Write for particulars and list of open counties. Doublewear Shoe Co., Minneapolis, Minn.

SIDE-LINE Salesman wanted to sell coal to your trade in carload lots. Earn a week's pay in an hour. For particulars write, Washington Coal Co., 3537 So. Racine, Chicago.

SALESMEN—Side line men—our new big box Toy Balloon assortment is whirlwind seller; quality, price, assortment right. Huron Rubber Co., Willard, O.

SIX Live Patented auto accessories: Oil gauge, windshield cleaners, hose clamp, etc. No investment. Big commissions. Address Sales Mgr., 52 Sta. C, Omaha, Nebr.

SALESMEN—Zim's Peerless Collection System "brings home the bacon." Special, exclusive collecting features help sale. Sells \$7.50. Creditors' Association, 312 McKnight Bldg., Minneapolis, Minn.

SALESMEN make good side money selling small acetylene torch to garages and shops. Easy to sell. St. Paul Welding & Mfg. Co., St. Paul, Minn.

NEW Automotive accessory eliminates acknowledged defect, all cars and trucks. Exclusive territorial agents wanted. Continuous demand. Unusual profits. Address Fulco Engineering Corp., Irvington, N. J.

SALESMEN calling on garages and accessory dealers to sell high-grade spark plugs. 15% commission. Address Roman Spark Plug Co., Rome, N. Y.

AGENTS. Distributors. Salesmen wanted in every city to handle Arctic Cow Ventilation for all makes of cars. Easy to install; sell on sight; practical necessity for all-season driving. \$50-\$100 weekly in this for you. Send for Our Income Plan. National Aluminum Co., Dept. 6, Racine, Wis.

MAKE \$50 Daily. Something New! 400% Profit. All Business. Professional Men Need It. Sells \$5. Costs \$1. Brooks, Texas, sold 20 first day, profit \$80. Big weekly repeater. Sells quickly. Experience unnecessary. Write today for territory wanted. Sample outfit Free. Federal Association, 71-D Asylum St., Hartford, Conn.

ONLY one policy a day means \$130 per month profit; same on renewals. Policy pays \$5,000 death; \$25 weekly benefit for injury or sickness. Premium \$10 yearly. Full or spare time. Easy seller. Write quick for territory. Underwriters, Dept. K-31, Newark, N. J.

SALESMEN. Make big money. \$100 per week and up. No experience or capital necessary. Take orders for guaranteed Akron quality tires, cord and fabric. Sell below dealers prices. Save auto owners money. Dignified, profitable work. Federal Rubber Goods Co., Akron, Ohio.

SALESMEN with Ford cars to sell Kreitner's Automatic Air Valve for Fords. Guaranteed saving 15% to 40% Gasoline. Installed in 5 minutes. List \$4.50. Large commissions. State territory you cover. Address Kreitner Mfg. Co., 1017 Tilde Guaranty Bldg., St. Louis, Mo.

IF you think in terms of \$4,000 the first year, write me personally. Strong line for retail stores. Nationally advertised. Liberal weekly advance to producers. W. T. Morgan, Sales Manager, 1920 Euclid, Cleveland, Ohio, Dept. 300.

SALESMEN Can make \$5.00 a day selling our Calendars, Pencils, Signs, Advertising Novelties, Yardsticks, Whistles, etc. Liberal terms. Sells entire year. Fine side line. Local and traveling agencies. Model Calendar Co., Dept. 226, South Bend, Ind.

SALESMEN: For our newly patented "Check-Protector" fountain pen; a wonderful and practical invention, sells easily to every business and professional man. Is backed by five year written guarantee. See Display Advertisement page 146.

AGENTS to sell Roxwitch brand new auto accessory. Operates headlights and horn button from steering wheel, any car. No competition. Big profit. Get particulars today. Patton MacGruyer Company, Providence, R. I.

PRONTO Series Gap Mica Spark Plugs. Guaranteed life of motor. Positively shoots through oil. 100% Government Air Mail Service test. Real dealers and distributors write. Pronto Mfg. Co., Omaha, Neb.

SALESMEN. Be your own Boss. Largest commissions paid selling Sanitary twisted in wire Brushes. Write for our proposition. Address Sanitary Wire Grip Brush Co., 29 Mercer St., New York City, N. Y.

SOMETHING New, a necessity. All business and professional men need it. Sells \$7.50, costs you \$1.40. Big repeater. Write for sample. Merchants Assn., Minneapolis, Minn.

DEMONSTRATE Cycle "Modified Vapor" System with your Ford and make \$3.50 on every sale. Most powerful of all hot-spots. Cycle Manifold Co., Akron, Ohio.

SALESMEN to sell Bank Supplies. Every Bank, Building and Loan and Savings Society possible customers. Choice Side Line. Liberal Commissions. Buckeye Passbook Company, Springfield, Ohio.

THOUSANDS of Climax Oil Burners in use. Very successful in residence furnaces. Liberal proposition. Address E. L. Miller Mfg. Co., Kansas City, Mo.

SALESMEN can sell our tools to every hotel, because they pay for themselves first time used. Address J., 1040 Georgia St., Los Angeles, Calif.

MANUFACTURER offers employment saleslady each town. Pay check weekly. Exceptional position. References. Address, Temple Company, Mason City, Iowa.

MAKE big money selling new, self-adjusting Robert Wrench. Most wonderful tool on market. Sells for \$1.35. You make almost 100% on each. No free samples. Robert Wrench Co., 71-C Murray St., New York.

CALIFORNIA Rosebuds selling like hot cakes. Agents coining money. Absolutely new. Big profits. Catalog free. Mission, 2421-SP, Smith, Detroit.

EASY to sell Groceries, Paints, Automobile Oils, Roofing, Stock Food to consumers from samples, no capital or experience necessary; steady, profitable work. Commissions advanced. Satisfaction guaranteed. 50 years in business. Write for full particulars. Loverin & Brown Co., Wholesale Grocers, 1775 S. State Street, Chicago, Ill.

MAKE \$50 to \$100 per week selling direct to wearer our \$20, \$24, \$28 line of Virgin wool made-to-measure Suits and Top Coats. You get your profit the minute sale is closed; experience not necessary. We teach you how and furnish everything to do business with; no extra charges for double breasted or fancy coats, extra sizes or skeleton linings. House of Campbell, Campbell Building, 456 South State St., Chicago, Ill.

BEST Seller: Jem Rubber Repair for tires and tubes; supersedes vulcanization at saving of over 800%; put it on cold, vulcanizes itself in two minutes, guaranteed to last life of tire or tube; sells to every auto owner and accessory dealer. Get particulars how to make big money and free sample. Amazon Rubber Co., Philadelphia, Pa., Dept. 510.

ASKO—Salesmen to sell Auto Acc. as side line; can carry sample in vest pocket; sells on sight. Big comm. Write for sample. Allen Specialty Co., 2721 West Lake St., Chicago.

57 MILES per gallon made with new patented gasoline Vaporizer. Write for particulars. Vaporizer Co., Pukwana, S. Dak.

EVERYBODY Eats Every Day. You can handle Sugar, Flour, Canned Goods, Dried Fruit, Coffee, and entire line of groceries, as well as Paints, Roofing, Aluminum Ware and Automobile Oils, with no rent to pay; no money invested; take large orders from samples. Goods are guaranteed and proven quality. Selling experience not necessary. Steady, profitable work for "workers." Address Hitchcock-Hill Co., Dept. 260, Chicago, Ill. Reference: Any Bank or Express Co.

AGENTS—\$50-\$200 a week. Free samples. Gold sign letters anyone can put on store windows. Liberal offer to general agents. Metallic Letter Co., 431-E N. Clark St., Chicago.

HELP WANTED

100 SALESMEN wanted immediately by one of the largest raincoat manufacturers in New York to sell our guaranteed custom made Gabardines, Raincoats, Topcoats, etc., \$75 to \$150 weekly easily earned. Write at once for further information and free outfit. Universal Raincoat Co., 607 Broadway, New York.

\$5-\$10 HOURLY during spare or full time laying Stameco Marbleized Flooring. No experience necessary. Indestructible, noiseless, waterproof. Most substantial and ornamental interior flooring for homes, public buildings, etc. All colors, easily prepared and applied. One job brings many. Enormous profit. Field unlimited. Write for full particulars and sample. Stameco Products, F2412 Ogden Ave., Chicago.

\$133-\$192 MONTHLY. Become Government Railway Mail Clerks. Men over 17. Common education sufficient. Steady. List positions free. Write immediately. Franklin Institute, Dept. F21, Rochester, N. Y.

BE a Finger Print Expert. Particulars Free. Write J. Ganor, St. Louis.

YOU Are Wanted. Men—Women. Government Jobs. Commence \$95 month. List positions free. Write immediately. Franklin Institute, Dept. F21, Rochester, N. Y.

WRITE for particulars. Real Estate men make \$5,000 to \$10,000 yearly. We show you how without capital. Alliance Realty Bureau, Milwaukee, Wis.

WANTED—Men over 17. Railway Mail Clerks. \$133-\$195 month. List positions free. Franklin Institute, Dept. F21, Rochester, N. Y.

MEN wanted to qualify for Firemen, Brakemen. Transportation furnished. Write W. Boggs, St. Louis.

WANTED—Railway Mail Clerks. \$133-\$195 month. List positions free. Franklin Institute, Dept. F21, Rochester, N. Y.

START a pressing, cleaning and dyeing shop, splendid field, excellent profits. We tell you how. Write for booklet. Ben-Vondo System, Dept. C, Charlotte, N. C.

WHAT is it worth to you? Distributor—District Manager—Salesman or Agent, to have the agency for the best line of Rubber Specialties on the market? Hot Water Bottles, Bathing Caps, Combination Shopping Bags, Pure Rubber and Rubberized Aprons, Rubber Gloves, and forty other fast selling articles needed in every home. Profits range from 100 to 150 per cent. Write B. & G. Rubber Mfg. Co., 618 Penn Ave., Pittsburgh, Pa., Dept. 168.

WANTED—Honest and sincere men to handle electrical necessity—thousands sold; no competition. Write quick. A. B. C. Company, 200 W. 72nd, New York.

WOMEN—Girls. Learn Dress Designing. \$35 week. Learn while earning. Sample lessons free. Franklin Institute, Dept. E-394, Rochester, N. Y.

FIREMEN, Brakemen, Baggage-men, Sleeping car, train porters (colored). \$140-\$200. Experience unnecessary. 810 Railway Bureau, East St. Louis, Ill.

BECOME Automobile experts. Hundreds vacancies. \$45 week. Learn while earning. Write Franklin Institute, Dept. E-401, Rochester, N. Y.

DISTRICT Managers—Big Profits. Men capable organizing and managing crews of lady solicitors can easily clear \$100 to \$200 per week with the R. & G. Protector, the original and best Protector on the market. Every woman needs and buys it. Two grades. R. & G. Rubber Co., 618 Penn Ave., Dept. 167, Pittsburgh, Pa.

MEN—Women, over 17. Get U. S. Government positions. \$92-\$192 month. Quick sure raise. Steady work. No "layoffs". No strikes. Sure pay. Life positions. Paid vacation. Common education sufficient. Influence unnecessary. List positions easily obtained—free. Write today sure. Prompt action advisable. Franklin Institute, Dept. F3, Rochester, N. Y.

BETTER Positions More Earnings. Constant demand everywhere. Trade Commissioners, Purchasing Agents, Investigators, Traffic Managers; Inspectors—Canneries, Dairy Products, Factories, Fisheries, Food, Immigration, Weights, Measures, Industrial knowledge prospectus free, without obligation. International Technological Institute, Dept. W, Box 595, Adelaide, Toronto, Canada.

LOCOMOTIVE Firemen, beginners \$150, later \$250 monthly, for railroads nearest their homes, everywhere in United States and Canada. Address Railway Association, Desk M-1, Brooklyn, N. Y.

WE can place you as a Motion Picture Operator. We teach you how and give you a job when competent. Write today! Box 38, Sioux Falls, So. Dak.

BIG money selling Upholstered Furniture from your home—buy from manufacturer—wholesale prices. Photos, information for stamps. Grogg Upholstery, 312 North Western Ave., Springfield, Ohio.

WANTED: Railway Mail Clerks—\$1,600 to \$2,300. Exams everywhere. Write today for full information. Patterson, Civil Service Expert, Box 4925, Rochester, N. Y.

EARN \$10 daily silvering mirrors, plating and refinishing metalware, autos, chandeliers, bedsteads, reflectors. Outfits furnished. E. Dele Laboratories, 1133 Broadway, New York, N. Y.

HOME employment evenings. Start Little Mail Order business anywhere. Everything furnished. Stamp brings Instructive Booklet. M. Pier, 72 Cortlandt Street, New York.

EARN \$50.00 weekly anywhere cleaning and adjusting Typewriters by Our System; details Free. Address today! Gainesville Typewriter Co., Gainesville, Fla.

GOVERNMENT needs Railway Mail Clerks, \$133 to \$192 month. Write for free specimen questions. Columbus Institute, E-2, Columbus, O.

MEN, women, over 18, desiring Government positions write immediately. Chicago Civil Service College, A-1 Kesner Building, Chicago.

MANUFACTURER offers employment **salaried** each town. Pay check weekly. **Exceptional position.** References. Address Temple Company, Mason City, Iowa.

GOOD prices paid for butterflies, insects. See Sinclair's Display Advertisement, PAGE 18.

GOOD pay for your friends' names. John David Black, Los Angeles, Calif.

GOVERNMENT positions. Men, women, 18, over. Wanted for railway mail, post-office, other government positions. Examination soon. Salary \$1400-1800 year. Experience not required. Particulars free. Write Columbia School of Civil Service, 411 Pope Bldg., Washington, D. C.

START Silvering Mirrors, Auto Headlights, Tableware, etc. Plans free. Clarence Sprinkle, Dept. 28, Marion, Ind.

"**WHAT** to Invent for Profit" free. Patent News-B, Washington, D. C.

SALESMEN—Become Independent. Own your business; experience unnecessary; selling our \$7,500 Accidental Death, \$50 Accident, \$25 Sick Weekly Benefits; \$12.50 yearly; other amounts proportionate. Guaranteed steady income from renewals. \$250,000 deposited Insurance Department. Registration Dept. A, Newark, N. J.

SIGN Letter Agents and Painters: 500% Profit. Gold and Silver Sign Letters for Stores and Office Windows. Anyone can put on. Big demand. Free Samples. Metallic Letter Co., 431D N. Clark St., Chicago.

ALL men—women over 17, willing to accept Government Positions \$135 (Traveling or Stationary), write Mr. Ozment, 101 St. Louis, Mo.

SILVERING mirrors, French plate taught. Easy to learn, immense profits. Plans free. Wear Mirror Works, Excelsior Springs, Mo.

UNITED States Government Wants Men. Excellent positions at attractive salaries. Railway Mail Clerk Examination soon. Let our expert (former United States Civil Service Examiner) prepare you for this and other fine positions. Write today for free catalog PM, Patterson Civil Service School, Rochester, N. Y.

BE a Railway Traffic Inspector! \$110 to \$250 monthly; expenses paid after 3 months' spare-time study. Splendid opportunities. Position guaranteed or money refunded. Write for free booklet CM-46, Stand. Business Training Inst., Buffalo, N. Y.

STORIES, poems, plays, etc., are wanted for publication. Good ideas bring big money. Submit manuscripts or write Literary Bureau, 523, Hannibal, Mo.

START a Paying Business of Your Own. Be a business man. Any location. 8,000 new Tire Vulcanizing and Repair Stations needed. Business always good. Are you ambitious? \$100 will start you. Write at once. Wonderful opportunity. Equipment Co., 175 Canal, Cincinnati, Ohio.

WRITE Articles, stories, news, in spare time for newspapers and magazines. Big pay. Copyright book free. Press Syndicate, 553, St. Louis, Mo.

MAKE money writing Photo-plays; details free to beginners. No correspondence course. Producers' League, 230 Wainwright, St. Louis.

INVENTORS desiring to secure patents should write for our book, "How to Get Your Patent," tells our terms and methods. Send sketch for our opinion of its patentable nature. Randolph & Co., Patent Attorneys, 620 F. Washington, D. C.

OUR genuine gold window sign letters are an excellent money-making proposition for handy men. Stann Sign System, St. Antoine St., Detroit, Mich.

PARTNERS WANTED

PARTNER wanted—exploit valuable invention. "Momentum Operated Brakes." Write Coutinho, 150 W. 14th Street, New York, N. Y.

FOR ADVERTISERS

ADVERTISE. 25 words, 126 magazines, \$1.00. Hill, 4293 Elati, Denver, Colo.

FOR Sale—A novelty, Advertising Postal Card. Will advertise any company. F. C. Morton, 2114 Clinton Ave., Minneapolis, Minn.

CUTS, make 'em yourself method \$1. Address Mac Clark, Ottawa, Kansas.

PERHAPS Fred Luther Kline, Kline Building, Kent, Ohio, can enliven your business if you sell direct or through agents or salesmen. Established sixteen years. Clients everywhere.

THOUSANDS maintain New York addresses. Why? How to increase your advertising results. Free. D. C. Way, 55 New St., New York.

ADVERTISERS get our lists. Jacobus Advertising Service, Irvington, N. J.

ADVERTISE in 24 Big Sunday Newspapers, 25 words \$15.00. Catalog listing 1,000 leading Dailies, Weeklies, Magazines, 4c stamps. Union Advertising, Baltimore Bldg., Chicago.

INCH Display Advertisement 161 Magazines Thrice \$15. Year \$50. Page \$100. Wood's Popular Services, Atlantic City, N. J.

ADVERTISE your ad in 100 magazines for 5c per word. Sample copy 10c. Harley Snell, 1921 State Ave., Cincinnati, Ohio.

MAILING LISTS

5,000 LEADING purchasing agents United States, \$10. **3,000** Chicago manufacturers, \$6. **3,212** South American merchants. Wonderful Opportunity, \$25. Cottrell, Box 239, Chicago.

20,000,000 ACCURATE names! Authentic, reliable lists are profitable order getters. Martineke Company, Corona, N. Y.

1,000 NAMES Progressive, Texas Farmers and Business men, \$3.00 per M. Geo. M. Hight, Ridgeway, Texas.

100 AGENTS' names \$2.00. Send for list of classifications. Pennell Company, Covington, Ky.

TYPEWRITERS AND SUPPLIES

TYPEWRITERS. All Makes. Save one-half. Thoroughly Rebuilt in our factory by the famous "Young Process." Fully guaranteed. Free trial. We handle all standard makes. Cash or sold on easy terms. Write for Catalog. Young Typewriter Co., Dept. 321, Chicago, Ill.

UNDERWOOD Typewriters at far less than manufacturers' price; rebuilt, all worn parts replaced, guaranteed good as new. Cash, installment payments. Write for Catalog B 151. Typewriter Emporium, estab. 1892. Montrose and Ravenswood Ave., Chicago, Ill.

ALL Makes, \$100 used typewriters, \$10 up. Guaranteed. Free trial. Write for illustrated Bargain List 287. Northwestern Typewriter Exchange, 329 Goethe St., Chicago.

AGENTS make \$50.00 to \$100.00 weekly selling our rebuilt typewriters. All standard makes \$15.00 up. Guaranteed five years, one month free trial. Send for agents' proposition. Typewriter Exchange, Wholesale Dept., Fordham, N. Y.

BETTER Ribbons for less Money. New, Black, Visible Models. 33c-\$3.50 Doz. You will order again. Typewriter Supply, 7927-29 Colfax Ave., Chicago.

BUSINESS SERVICE

CHEMICAL Analysis honestly and correctly done by L. E. Tenney, Colton, N. Y.

SOUTH Carolina, Rock Hill, Collections, Legal Business. J. H. Foster.

INCORPORATE. Our lawyers do the work, saving you time, annoyance and money in incorporating under the most liberal laws of Arizona. Laws and forms free. Southwestern Securities & Investment Co., Box D488, Phoenix, Ariz.

DUPLICATORS AND DEVICES

YOU can make 50 to 100 copies of a letter, notice, etc., on three cents' worth of Hoyer Quality Compound. Write for free catalog and samples. The Hoyer Duplicator Co., 162 N. Wells St., Chicago.

WANT a "Modern" Duplicator to print Typewritten or Pen Written Letters, Drawings, Lessons, Music, Bids, Menus, Maps, Specifications or anything in one or more colors? Prints two a minute, \$2.25 up. Special sale on; 30 Days Free Trial. Booklet Free. J. E. Durkin-Reeves Co., Pittsburgh, Pa.

ADDING MACHINES

NEW \$2.50 Automatic Adding Machine. Adds, Subtracts, Multiplies. Absolutely accurate. Capacity 999,999.99. Fully guaranteed. 75,000 pleased users. Makes adding easy, positive, quick. Eliminates Mistakes. Saves Time. Postpaid, \$3.50. Bassett Co., 1458-H, Hollywood Ave., Chicago.

FREE Trial. Marvelous new Adding Machine. Adds, Subtracts, Multiplies, Divides, automatically. Work equals \$350.00 machine. Price only \$15.00. Speedy, durable, handsome. Five-year guarantee. Used by largest corporations. Write today for catalog and free trial offer. Lightning Calculator Co., Dept. E, Grand Rapids, Mich.

PRINTING, ENGRAVING AND MULTIGRAPHING

100 LINEN finish note sheets and 100 envelopes to match, neatly imprinted your three line address \$1.00 prepaid. Samples of quality printing for stamp. Model Company, Manchester, Iowa.

250 LETTERHEADS, 250 white envelopes, printed and mailed, \$3.00. Samples printing free. Address Sunco, Mohawk, N. Y.

ALL Printing Prices Smashed. 5,000 Letterheads or Envelopes \$13.85. Samples. Quality Printshop, Marietta, Ohio.

LOWEST prices on advertising-pencils in quantity. Sample, with your ad imprinted in Gold, 10c. S. Musial & Co., 423 Walnut St., Yonkers, N. Y.

1,000 LETTERHEADS or Envelopes, \$3.00, sent prepaid. Samples Free. Moonite Press, Morrisville, Pa.

STATIONERY and Card Printing. Write for list. G. H. Rodebeaver, Braddock, Pa.

REDUCED prices for better printing. 1,000 Bond letter-heads, \$5.00; 1,000 good envelopes, \$4.25; 1,000 four-page folders, 3½x8¼ inches, \$12.00. Catalogues, circulars, booklets our specialty. All printing at reduced prices. Samples free. Fantus, 525 S. Dearborn St., Chicago.

QUANTITY Users save 30%. Wolf Roll Labels, Sta. E, Philadelphia.

PRE-USED Printing Presses, Type and supplies. List for stamp. Popular Bargains, Richland, Pa.

EMBOSSED business, personal stationery. Samples, stamp. Daniels Co., Pittston, Pa.

250 GOOD Bond Letterheads or Envelopes printed and mailed \$1.50, or 1,000 for \$4.50. Address Hatton Printing Co., Hatton, N. Dak.

WE print anything. Circulars, stationery, Catalogs, Samples. Commercial Press, Batavia, Ohio.

PRINTING Outfits—Presses, type supplies, type novelties. Send stamp for catalogue. Model Press, York, Penna.

RAZORS AND BLADES

FREE—Two Safety Razor Blades sharpened free to show our work. St. Louis Safety Razor Sharpening Co., 61, St. Louis, Mo.

BLADES Resharpened 3c. Free cake Williams Shaving Soap every Dozen. Standard Safety Razor Corporation, Pittsburgh, Pa.

BLADES resharpened 2c single edge; double 3c. James Murrell, Druid Station, Baltimore, Md.

BLADES, resharpened, one edge 2c; double 3c. New York Edge Co., Glen Cove, N. Y.

FOR MEN

TOBACCO Conquerer Tablets quickly overcome tobacco habit, or money back. Write today. Peerless Pharmaceutical Co., 140 Syracuse, N. Y.

FOR SMOKERS

CIGARS—You save \$2.15 per 100 by buying direct from factory. Londres shape, foil wrapped, best quality throughout. Box 50, \$1.50; 100, \$2.85, postpaid. Cash with order or pay postman on delivery. Quality and delivery guaranteed. H. & H. Cigar Co., Bealville, Ohio.

PURE Red Leaf Tobacco, quality guaranteed. Best chewing, 4 lbs. \$1.25, 10 lbs. \$3.10. Mild smoking, 4 lbs. \$1.00, 10 lbs. \$2.10, delivered. O. D. Collier, Agent, Martin, Tenn. "Collier is absolutely honest and reliable." Martin Bank, Raymer, Cashier.

HOMESPUN Smoking Tobacco, Mild and Mellow—16 lbs. \$1.50; 20 lbs. \$2.75; delivery guaranteed. We furnish free recipe for preparing. Smoking Tobacco Exchange, Sedalia, Ky.

GUNS, SPORTING GOODS, ETC.

LUGER, Mauser, Mannlicher arms. Circular ten cents. Pacific Sales, Ltd., Moscow, Idaho.

LEFEVER, 12-30 hammerless double barrel shotgun, brand new. Nitro Special barrel, modified choke, \$25, sent subject inspection, \$5 deposit. National Camera Exchange, 20 Washington Ave., So. Minneapolis, Minn.

BOATS AND LAUNCHES

16'-ROWBOAT, 12½'-Rowboat, 12'-Folding Rowboat. Easily made. Construction blueprints 30c each. Wee-Sho-U Co., West Market, Detroit, Mich.

PALMER four-cycle motor for Rowboats, Yacht Tenders. Price \$98.00. Also two and four-cycle to seventy-five horsepower. Catalogue free. Palmer Bros., Cos Cob, Conn.

"HOW to make your boat leakproof." Send for booklets. L. W. Ferdinand & Co., 152 Kneeland St., Boston, Mass.

WEARING APPAREL

MATCH your worn or torn trousers with a new pair. Arme Panta Matching Co., 20 West Jackson Blvd., Dept. A, Chicago. Mail vest or sample.

DIAMONDS, WATCHES AND JEWELRY

A **BEAUTIFUL** Mexican Opal set in a solid gold ladies' ring or man's scarf pin sent for \$2.50 in stamps. Guaranteed genuine Mexican opal set in solid gold. Satisfaction or money back. The Mexican Gem Co., Box 54, Saltillo, Mexico.

ANTIQUES AND WAR RELICS

FOR Dens. Collected from Europe's Battlefields. Catalogue 10c. War Photographs, actual warfare, 275 different \$5.00. Sample set 14 views, 25c. Lieut. Welsh, 50 Fort-greene Place, Brooklyn, N. Y.

FOR THE HOME

MAKE Inexpensive Iceless Refrigerator. Blueprint 35c. William Quemore, Camden, New Jersey.

PHONOGRAPHS AND RECORDS

BUILD Your Phonograph and save half. Use genuine "Perfection" motors, tonearms, etc. Also Radio equipment. Lowest wholesale prices. Catalog free. Federal Supply Company, Indianapolis, Ind.

BUILD a genuine Choraleon phonograph and save over half. Big profit building and selling. We furnish motors, tone-arms, full instructions and all necessary parts. Send for catalog and free blueprint offer. Choraleon Phonograph Co., 722 11th St., Elkhart, Ind.

AMERICAN Phonograph Parts are best and lowest priced. Write for catalog today. American Phonograph Co., 3515 North Crawford, Chicago.

BUILD your own Phonograph. Write for prices of Cabinets, Motors and Tone Arms. Arthur Davis, Livingston, Ill.

BUILD your own phonographs. We can supply you with motors, tone arms and all accessories at wholesale prices. Write for catalogue AX. Pleasing Sound Phonograph Co., 204 East 113th Street, New York, N. Y.

BUILD your phonograph. Quality Phonographs. Highest quality spring and electric Motors, Tone Arms, Reproducers, Amplifiers, Case Material and Accessories. Free Blue Prints and Building Instructions. Big saving. Wonderful results. New catalog mailed for ten cents. Hoosier Manufacturing & Supply Co., Phonograph Supply Department, 313 Baldwin Block, Indianapolis, Ind.

MUSIC AND MUSICAL INSTRUMENTS

LEARN to play the Saxophone free. Complete course by mail on latest popular music free. Some learn in four weeks. Jack Regan Saxophone Studios, 166 North Mentor Ave., Pasadena, Calif.

VIOLINS—Deep, Mellow, Soulful—on credit. Easy terms for wonderful instrument. Get details today. Gustaf F. Henning, 2424 Gaylord St., Denver, Colo.

TROMBONISTS—Lubricate your slides with "Gills" (a liquid jelly). Postpaid 35c. No stamps. Chester C. Loomis, 457 Brainard St., Detroit, Mich.

SONG Writers—Have wonderful proposition for poem or melody writers. Ray Hibbler, D110, 4040 Dickens Av., Chicago.

"**MUSIC** Composed" to words. Bauer Bros (formerly of Sousa's Band), Oshkosh, Wis.

CORNETISTS—Trombonists—Saxophonists—Clarinetists. Send for "Free Pointers." Name instrument. Virtuoso School, Buffalo, New York.

WRITE Songs. Big money and reputation. Write for information. J. Gordon Pub. Co., 201 N. Hayes Ave., Chicago.

I WANT song poems. Casper Nathan, Garrick Theatre Building, Chicago.

PATENT ATTORNEYS

INVENTORS: Send sketch or model of invention for advice. Write for Evidence of Disclosure form and Book on Patents. Free. Prompt Service, Merton-Roberts & Company, 151 Mather Building, Washington, D. C.

PATENTS promptly procured. Personal, careful and efficient service. Highest references. Moderate fees. Send sketch or model for actual search and advice. George P. Kimmel, Master of Patent Law, 54-J, Loan and Trust Bldg., Washington, D. C.

PATENTS, Trade-marks—30 years of confidential service; expert advice, prompt action, reasonable fees. Send for free book. Edgar Tate & Co., 245 Broadway, New York, 635 F St., N. W., Washington, D. C.

PATENTS—Trademarks. Before disclosing an invention, the inventor should write for my blank form "Evidence of Conception." This should be signed, witnessed and returned to me with sketch or model, upon receipt of which I will promptly render opinion as to patentable nature and send booklet on Patents. Highest references. Prompt attention. Reasonable terms. Address Clarence B. O'Brien, Registered Patent Lawyer, Southern Building, Washington, D. C.

PATENTS Procured—Trade-Marks Registered—A comprehensive, experienced, prompt service for the protection and development of your ideas. Preliminary advice gladly furnished without charge. Booklet of information and forms for disclosing idea free on request. Richard B. Owen, 30 Owen Building, Washington, D. C., or 2276R Woolworth Bldg., New York.

PATENTS—"How to Obtain a Patent" is the name of a book which every inventor should have. It will be sent free upon request, and will tell you what you want to know about patents. It contains the whole story. It describes the different parts of the application and explains in simple language the prosecution before the Patent Office. It tells about joint applications, releases, assignments, assignments, licenses, interferences, infringements, process patents, design patents, trade-marks, and prints and labels. If you are interested in patents either as an inventor, manufacturer or owner of a patent you will enjoy reading this book which was written by a lawyer who has had twenty-five years' experience in patent matters. If you have an invention and will send us a sketch, model or photograph of it we will promptly make a search of the Patent Office records and advise you whether or not, in our opinion, your invention is patentable, our charge for the service being \$5.00. We feel that our experience of twenty-five years has fitted us to render prompt and efficient service which will merit your confidence. Write today. Talbert & Talbert, 463 Talbert Building, Washington, D. C.

MILLIONS spent annually for ideas! Hundreds now wanted! Patent yours and profit! Write today for free books—tell how to protect yourself, how to invent, ideas wanted, how we help you sell, etc. Address 590 Patent Dept., American Industries, Inc., Washington, D. C.

PATENT your invention. But note: a patent is no better than its claims. Be sure your patent is as good as your invention. Patent claims skillfully drafted by Lamb & Co., Patent Attorneys, 1419 G Street, Washington, D. C.

PATENTS—Trademarks. Thirty-five years' experience. Send model or sketch for opinion as to patentability. Free "Inventors Guide." Highest references and personal attention assure best results. Franklin H. Hough, 522 Washington Loan & Trust Bldg., Washington, D. C.

PROTECT your rights. Write for "Record of Invention" which contains form to establish evidence of conception of your invention. Prompt personal service. Preliminary advice without charge. J. Heaney Kelly, 612 G, Columbian Bldg., Washington, D. C.

PATENTS—Prompt, personal efficient service by an attorney-at-law, skilled in all branches of Patent Practice. Over 12 years' actual experience; full information upon request. B. P. Fishburne, 331 McGill Bldg., Washington, D. C.

PATENTS, Trade-Marks, Designs and Copyrights. Registered firm of attorneys-at-law. Careful, prompt personal service assured. Moderate fees. Full information free upon request. Gross & Collins, 664 Ouray Building, Washington, D. C.

PATENTS and Trade-marks obtained. Prompt service. Write for our new book on patents. Established in 1889. D. Swift & Co., 369 7th St., Washington, D. C.

PATENT applications filed on partial payment plan. Trade-marks, copyrights, etc. Milo B. Stevens & Co., 685 F St., Washington; 352 Monadnock Bldg., Chicago. Estab. 1864.

INVENTORS—Send for form "Evidence of Conception" to be signed and witnessed. Form, fee schedule, information free. Lancaster and Allwine, 221 Ouray Building, Washington, D. C.

INVENTIONS Patented; Trade-marks Registered; reasonable charges; prompt service; plain advice; request detailed information. Jaynes & Jaynes, 700 Kellogg, Washington, D. C.

SHREVE, Crowe & Gordon, Attorneys and Counsellors at Law, Patent and Trade-Mark Practice. Correspondence Invited. Address, Fendal Building, Washington, D. C.

I REPORT if patent obtainable and exact cost. Send for circular. Herbert Jenner, Patent Attorney and Mechanical Expert, 624 F St., Washington, D. C.

MONROE MILLER, Ouray Building, Washington, D. C., patent attorney, mechanical and electrical expert. Best quality of work and results. Moderate charges.

PATENTS, Trademarks. Moderate fees payable in installments. Preliminary advice free. Eugene Stevens, Jr., 315 Barrister Bldg., Washington, D. C.

"**INVENTORS' Guide.**" free on request; gives very valuable information and advice. Write Frank Ledermann, 15 Park Row, New York, N. Y.

PATENTS. Have you an idea to patent? Write for "Inventors Record" and Instructions for its use. Terms and advice sent immediately upon request. Address, Wm. H. Mulligan, 134 Woodward Bldg., Washington, D. C.

WOODWARD. New Book. Submit your ideas. H. L. Woodward, 714 9th St., Washington.

PATENTS. Booklet free. Highest references. Best results. Promptness assured. Send model or drawing for preliminary examination. Watson E. Coleman, Patent Lawyer, 624 F Street, Washington, D. C.

ROBB, Robb & Hill offer a strictly professional service to manufacturers and inventors in patenting inventions and registering trade-marks, a service which is the result of 20 years' experience. Write for free booklet and names of prominent manufacturers and inventors represented by us. Send sketch for preliminary advice, 311 McLachlen Bldg., Washington, D. C.; 1343 Hanna Bldg., Cleveland, Ohio.

PATENTS—Trademarks— Write for our free illustrated guide book and Evidence of Conception Blank. Send model or sketch and description and we will give our opinion of its patentable nature free. Highest references. Prompt attention. Reasonable terms. Victor J. Evans & Co., 166 Ninth, Washington, D. C.

INVENTORS! Send sketch or model of your invention for opinion concerning patentable nature and exact cost of applying for patent. Book, "How to Obtain a Patent," sent free. Gives information on patent procedure and tells what every inventor should know. Established twenty-eight years. Chandlee & Chandlee, 426 Seventh St., Washington, D. C.

PATENTS—Herbert Jenner, patent attorney and mechanical expert, 622 F St., Washington, D. C. I report if a patent can be had and its exact cost. Send for circular.

PATENTS—Trademark, copyright; folder free; results procured. Write Metzger, Washington D. C.

INVENTORS Aided. Ideas developed. We seek the valid patents. Richardson & Rogers, 7 Albee Building, Washington. Experimental machinery built. Practice in all courts.

FOR INVENTORS

PATENTS. If you have an invention which you wish to patent you can write fully and freely to Munn & Co. for advice in regard to the best way of obtaining protection. Please send sketches or a model of your invention and a description of the device, explaining its operation. All communications are strictly confidential. Our vast practice, extending over a period of seventy-seven years, enables us in many cases to advise in regard to patentability without expense to the client. Our Handbook on Patents is sent free on request. This explains our methods, terms, etc. In regard to Patents, Trade Marks, Foreign Patents, etc. "Scientific American" contains Patent Office News. Decisions of interest to inventors, and particulars of recently patented inventions. Munn & Co., Solicitors of Patents, 623 Woolworth Bldg., New York; Scientific American Bldg., Washington, D. C.; 891 A Tower Bldg., Chicago, Ill.; 611 Hanna Bldg., Cleveland, Ohio; Hobart Bldg., San Francisco, Calif.

PATENTS Secured. Prompt service. Avoid dangerous delays. Send for our "Record of Invention" form and Free Book telling how to obtain a Patent. Send sketch or model for examination. Preliminary advice without charge. Highest references. Write Today, J. L. Jackson & Co., 242 Ouray Bldg., Washington, D. C.

INVENTORS: Send sketch or model of invention for advice. Write for Evidence of Disclosure form and Book on Patents. Free. Prompt Service. Merton-Roberts & Company, 182 Mather Building, Washington, D. C.

PATENTS—"How to Obtain a Patent" is the name of a book which every inventor should have. It will be sent free upon request, and will tell you what you want to know about patents. It contains the whole story. It describes the different parts of the application and explains in simple language the prosecution before the Patent Office. It tells about joint applications, interferences, infringements, process patents, design patents, trade-marks, and prints and labels. If you are interested in patents either as an inventor, manufacturer or owner of a patent you will enjoy reading this book which was written by a lawyer who has had twenty-five years' experience in patent matters. If you have an invention and will send us a sketch, model, or photograph of it we will promptly make a search of the Patent Office records and advise you whether or not, in our opinion, your invention is patentable, our charge for the service being \$5.00. We feel that our experience of twenty-five years has fitted us to render prompt and efficient service which will merit your confidence. Write today, Talbert & Talbert, 464 Talbert Building, Washington, D. C.

900 MECHANICAL Movements and 50 Perpetual Motions illustrated and explained in my book, *Inventor's Universal Educator*, 5th Edition—Tells how to procure and sell patents. Government and other costs. Covers the matter from A to Z—160 pages—Elegantly bound. Contains noted decisions of U. S. Supreme and State Courts on Patent cases. Mechanical Movements greatly assist inventors—suggest new ideas that might prove of great aid in perfecting inventions. Tells how to select an Attorney. Has valuable information regarding Patent Sharks, Selling Agents and promoters. Price, \$2. Postage free everywhere. Fred G. Dieterich, 621 Ouray Bldg., Washington, D. C.

MODEL Making and experimental work; Modern Shop; expert workmen. Manufacturing. Lamson Model and Experimental Works, 625 W. Jackson, Chicago.

I SELL Patents. Established 1900. Address, Charles A. Scott, 773PM Garson Avenue, Rochester, N. Y.

PATENTS. Write for free illustrated guide book. Send model or sketch and description for free opinion of its patentable nature. Highest references. Prompt attention. Reasonable terms. Victor J. Evans & Co., 157 Ninth, Washington, D. C.

HAVE You an Invention? If so, write for our free book, "How to Get Your Patent," tells our terms and methods. Send model or sketch for our opinion of its patentable nature. Randolph & Co., Dept. 144, Washington, D. C.

GET your own patent. Complete instructions \$1. Cutting Sons, Campbell, Calif.

PATENTS—Trademarks. Before disclosing an invention, the inventor should write for my blank form Evidence of Conception. This should be signed, witnessed and returned to me with sketch or model upon receipt of which I will promptly render opinion as to patentable nature and send booklet on Patents. Highest references. Prompt attention. Reasonable terms. Address Clarence B. O'Brien, Registered Patent Lawyer, Southern Bldg., Washington, D. C.

INVENTORS and Manufacturers. For developing your invention, designing and constructing Automatic Machinery, Labor-saving Devices for all purposes. Coin-Controlled Beverage and Food-Dispensing Machines. Consult John Frick, Mechanical Engineer, 1105 Arch St., Philadelphia, Pa.

INVENTORS—If you have an idea, before spending unnecessary money for a patent, write Inventors' & Engineers Consulting Co., P. O. Box 344, Washington, D. C.

PATENTS Procured—Trade Marks Registered—A comprehensive, experienced, prompt service for the protection and development of your ideas. Preliminary advice gladly furnished without charge. Booklet of information and form for disclosing idea free on request. Richard B. Owen, 39 Owen Bldg., Washington, D. C., or 2276 B. Woolworth Bldg., New York.

PROTECT Your rights. Write for Record of Invention which contains form to establish evidence of conception of your invention. Prompt personal service. Preliminary advice without charge. J. Beany Kelly, 612G Columbia Bldg., Washington, D. C.

"**INVENTORS' Guide.**" free on request; gives very valuable information and advice. Write Frank Ledermann, 15 Park Row, New York, N. Y.

PATENTS. Have you an idea to patent? Write for "Inventors Record" and Instructions for its use. Terms and advice sent immediately upon request. Address, Wm. H. Mulligan, 135 Woodward Bldg., Washington, D. C.

INVENTORS: Before applying for patent on any invention, be sure it is worth while. Write for information, Charles A. Scott, 773PM Garson Avenue, Rochester, N. Y.

SEND sketch for search report. Get my latest book on patents. H. L. Woodward, 711 9th St., Washington.

PATENTS FOR SALE

PATENTS secured. Prompt service. Avoid dangerous delays. Send for our "Record of Invention" form and Free Book telling how to obtain a Patent. Send sketch or model for examination. Preliminary advice without charge. Highest references. Write today, J. L. Jackson & Co., 242 Ouray Bldg., Washington, D. C.

MILLIONS in it—must sell basic mechanical invention—fortune in its promotion and manufacture. Controlled by government during the war—best offer takes it; from one thousand dollars up considered. Investigate today! Address Louis Willard, 617 W. Fourth Avenue, Pine Bluff, Ark.

PATENT 1,110,334. Can Opening Mach., for sale. Can be used in hotels and restaurants anywhere. Will sell cash or royalty basis. Address Joseph Moran, 83 Wyckoff St., Brooklyn, N. Y.

FOR Sale—Patent on convertible freight car. Will sell outright or half-interest. Will bear investigation. Address today! N. Fender, 608 Harrison St., Gary, Ind.

STREET Register or Indicator—12,222-1; Baby Swing—13,048-1; Match Scratching Attachment for Lamps—13,433-1. Talbert & Talbert, Talbert Bldg., Washington, D. C.

OUTRIGHT or Royalty. Self-locking device for cabinets, etc. Circulars. Address, Leo O. Miller, 9341 Pontiac St., Detroit, Mich.

OUTRIGHT or Royalty. Pipe Cutter. Will stand the acid test. J. G. Keatley, 430 West 12th Ave., Denver, Colo.

FOR Sale—Patent Expandible Steel Rim Split pulley. J. Muller, 1843 Norman St., Brooklyn, New York.

CASH or Royalty; U. S. Patent 1,412,343. Machine for boring post holes. Edward Decker, Center, Mo.

WILL sell cheap. Piano record patent. Also valuable pending application. Box 263, Davenport, Iowa.

OUTRIGHT or royalty—Automobile cook stove. Cooks from exhaust of any motor car. Connected by means of a cut out; placed on running board when in use. Small, but efficient, doing away with making fires, etc. C. A. Parker, Jr., & Co., Columbia, Tenn.

PATENT for Sale: Hallomax Recorder—keeps accurate check on each day's events. Promotes thrift and efficiency—indispensable for professional men. Investigate; this is a winner. Hallomax Company, 2718 Farragut Road, Brooklyn, N. Y.

FOR best cash or royalty offer I'll sacrifice my Motorcycle-Tractor patent for plowing, cultivating, farm machineries, wagon. For working B. P. write Rev. Jno. Pribula, 514 Chestnut St., Johnstown, Pa.

AIRCRAFT—Sell outright, patent co-ordinating Helicopter, that may be deflected forward or backward, with wing surfaces and gas bags. James Whalen, 1642 North Monticello Ave., Chicago, Ill.

PATENT Improved Auto signal with right-left turn Stop and Red light. Sell outright. Big profits for mfg. John B. Eger, 3743 Narragansett Ave., Chicago, Ill.

NEW book on patents. H. L. Woodward, 713 9th St., Washington. Submit your ideas.

FOR Sale! U. S. and Canadian Patents. Pop Corn Heater; keeps pop corn delicious and palatable. L. H. Bulbee, 405 Palmer, Emmetsburg, Iowa.

U. S. AND Canada Patent: Pliers for belt mending or lacing. For particulars address A. Michal, Orange, N. J.

ROTARY spark gap, greatly simplified; amateur demand; high merits; cash, royalty; information, pictures. Teall, 529 W. 7th, Cincinnati, O.

OUTRIGHT or Royalty: Gear Shift Indicator; only Manufacturers on future Automobiles; patent pending. Anthony Balch, Kemmerer, Wyo.

FOR Sale—Patent on quickly adjustable lock wrench. For information write to C. E. Vandenberg, Cherry Grove, Pa.

PATENT: Prepare for Christmas with new toy; will sell reasonable. H. Linder, 6319 Wayne Ave., Chicago.

PATENT pending. Automobile Electrical Lock. Cash or Royalty. Floyd Bagley, 73 Pleasant Ave., Woodford, Maine.

FOR Sale, Outright—Hardware Specialty; big market through dealers. Geo. L. Bachelder, Cedar Rapids, Iowa.

PATENT for Sale. Self-tightening drill chuck. Richard Knebel, New Britain, Conn.

DON'T buy or manufacture without book by H. L. Woodward, 701 9th St., Washington.

PATENTS For Sale: To sell, buy or obtain patents write Patent News—P. Washington, D. C.

YOU have a worth-while patent, haven't you? Why don't you tell our two million readers about it? Most of them are specially interested in patents and new inventions. Ask me to tell you how other inventors successfully sold their patents. J. Roy McClellan, Manager, Classified Advertising, Popular Mechanics Magazine, Chicago, Ill.

PATENTED cattle dehorner for sale outright, royalty or partnership. Make offer. Van Amber, 7326 Princeton Ave., Chicago.

MODELS AND MODEL SUPPLIES

PUNCH Press work, tool and die making, model and special machine work wanted. Completely equipped with new machinery of the latest type. Prompt delivery, reasonable prices guaranteed. Quality Hardware & Machine Co., Dept. A, 6154-56 N. Clark St., Chicago.

TURNER, SCOTT & FINCH, Box 11, South Bend, Indiana. Consulting Mechanical Engineers. Model and Tool designing. Mechanical Drawings. Valuable advice regarding inventions. Everything strictly confidential. Write us regarding your problems, before spending money elsewhere.

PRACTICAL model steam engines, boilers, blowlamps, fittings, pumps. Send 5c in stamps for a new catalogue. Model Machine Shop Co., 415-17 E. 71 St., New York City.

MODELS, dies, tools, machinery, designed and built. Ideas developed. Engelmann, 3929 Portmann Ave., Cleveland, Ohio.

MODEL making. Foundry and Machine Shop Work. M. C. Suttle, Vincennes, Ind.

MODEL Making and experimental work; Modern Shop expert workmen. Manufacturing. Lamson Model and Experimental Works, 625 W. Jackson, Chicago.

MODELS and Patterns made. Light manufacturing. Address H. W. Hathorn, Mason City, Iowa.

WE make working models for inventors and do experimental work and carry a complete stock of brass gears and model supplies. Send for catalogue. The Pierce Model Works, Tinley Park, Ill.

INVENTORS—Write for our free illustrated guide book and Evidence of Conception Blank. Highest references. Prompt attention. Reasonable Terms. Victor J. Evans & Co., 165 Ninth, Washington, D. C.

FOR MANUFACTURERS

MODEL making and experimental work; Modern Shop expert workmen. Manufacturing. Lamson Model and Experimental Works, 625 W. Jackson, Chicago.

WANTED—Metal Stamping and Model work taken on contract basis. We are ideally located and equipped to develop patents. Meyers Company, Box 263, Bedford, Ind.

EXPERT Drafting and Engineering Service. Designs furnished. Rates reasonable. Pelishek Engineering Company, Clintonville, Wisconsin.

MANUFACTURING

WANTED—Wood, steel, brass or aluminum specialties to manufacture whole or in part. Nickel plating. Tell us what you want done and let us quote. Seneca Camera Mfg. Company, Dept. X, Rochester, New York.

WE design and build special machinery, make models, dies, stamping tools, do general machine work and light manufacturing. Marshall Mfg. Co., Kansas City, Mo.

WE are equipped to manufacture all kinds of wire and light metal goods. Stampings, Dies and Tools, Punch press work. Patented articles wanted. Safety Wire Gas Globe Company, Columbus, Ohio.

LET us be your machine shop! We build models and will do your manufacturing. Victor Eng. Co., 2524 W. Chicago Avenue, Chicago.

MODEL making and experimental work; Modern Shop expert workmen. Manufacturing. Lamson Model and Experimental Works, 625 W. Jackson, Chicago.

EXPERIMENTS developed, dies, models and manufacturing, machine designing. Estimates and information promptly given. Address Schroer Bros. Machine Works, 512 East 25th Street, Kansas City, Mo.

IF you want dies and metal stampings, write us. Lyons Machine Works, Lyons, Ia.

SPECIAL Devices and Machinery developed and built at reasonable rates. Jigs and fixtures designed and built for interchangeable and economical manufacturing. Punches and dies made for all kinds of metal stamping. Machine work to order. Simplex Tool Company, Woonsocket, R. I.

WIRE Goods, all kinds made to order. Cooley Mfg. Co., 524-530 N. Western Ave., Chicago.

DRAWING INSTRUMENTS

BARGAIN price. 5/8" Compass Drawing Set, with pen and pencil attachments and lengthening bar. Bow Spacer, Bow Pencil, Bow Pen, 2 Ruling Pens, Box for Leads. Cloth pocket-book case, velvet lines, complete. Send for particulars. Kolesch & Co., 135 B Fulton Street, New York.

SURVEYING INSTRUMENTS

NEW and used surveying instruments direct from factory. Satisfaction guaranteed or money refunded. Wissler, 619 Broadway, St. Louis.

MACHINERY, TOOLS AND SUPPLIES

TOOLS, Dies, Stamping, Light manufacturing. A. Timmerman, 419 Kimball, Danville, Ill.

FOR Sale—Model D Moline Tractor, fully equipped with self-starter, extension rims and two 14-inch plows. Used three seasons. Price reasonable. Inspection invited. Bettie Ellen Stock Farms, Branchville, N. J.

CONCRETE Building Block Machines and Molds. Catalogue free. Concrete Machine Co., 303 South Third St., St. Louis, Mo.

WANTED: Information about new air compressors. Write for free manual. Engineers Dept., Brunner Mfg. Co., Utica, N. Y.

PULLEYS, Grooved and Motor. Reducing Gears. Light Transmission Machinery. Send for catalog. Winfield H. Smith, Buffalo, N. Y.

12-TOOL Handy Set, made of best steel. The most useful and practical tool on the market. Postpaid \$1.25. National Specialties, 32M Union Sq., New York City.

OTHERS have successfully sold their machinery through our columns—so can you. Ask me for proof. J. Roy McClellan, Manager, Classified Advertising, Popular Mechanics Magazine, Chicago.

ENGINES, MOTORS AND DYNAMOS

TWIN Excelsior Engine, \$20. Sunderland Cycle Co., Canon City, Colo.

STANLEY, Steamer Owners, get "List," Armo Boilers, Burners, vaporizers, superheaters; everything for Steam Automobiles. "Doc" Paine, 1238 Santa Fe, Denver, Colorado.

AUTOMOBILE Owners, Garagemen, Mechanics, Repairmen, send for free copy of our current issue. It contains helpful, instructive information on overhauling, ignition troubles, wiring, carburetor, storage batteries, etc. Over 140 pages, illustrated. Send for free copy today. Automobile Digest, 507 Butler Bldg., Cincinnati.

ALTERNATING and direct current motor bargains. New and rebuilt. All guaranteed for one year. Special prices. Get our price list before buying. Motors exchanged and repaired. Hyre Electric Co., 633-RM South Dearborn St., Chicago.

ELECTRICAL

BALL bearing motors save power. Furnished on easy payments. Send postal. Hobart Motors, Troy, Ohio.

ALL electricians need and should carry a Sparkler Screwdriver. Coil in handles for locating opens, shorts, grounds, on 90-500 volt lines, alternating or direct. Excellent safety device. Increases efficiency. Postpaid \$2.25. Money back if not satisfied. Electrician agents wanted. Sparkler Electric Co., Medford Block, Akron, Ohio.

ELECTRICITY Taught by experts; earn while you learn at home; electrical book and proof lessons free; your success guaranteed and position secured. Chicago Engineering Works, Dept. 51-B, 2144 Lawrence Ave., Chicago.

ELECTRICITY For 10c Per Hour. Moseco Auto Generator. Operates on any make automobile. Produces electricity for Moving Picture Machines, Theatres, Schools, Churches, Homes, Etc. Write for free particulars. Monarch Theatre Supply Co., Dept. AG 724 South Wabash Ave., Chicago.

POWER Attachments for Ice Cream Freezers, \$7.50. Can be attached to any hand freezer. Gives the right reduction between motor and freezer. Winfield H. Smith, Buffalo, N. Y.

ELECTRIC motors and supplies, including sockets, wire conduit, cleats, loom, rosettes, switches. New revised wholesale prices. Illustrated Catalog free. Hyre Electric Co., 633-GH, South Dearborn St., Chicago.

FOR MECHANICS

SELF-VULCANIZING rubber dough, put on cold, supersedes vulcanization. Formula \$5.00; sample for 10c. Souza, 82 Potomack St., New Bedford, Mass.

IF you have an idea to patent write for free book "Patent Advice" and full instructions for proceeding. Address, Wm. H. Mulligan, 133 Woodward Bldg., Washington, D. C.

PATENTS—Write for our free illustrated guide book and Evidence of Conception Blank. Send model for sketch and description of the invention for our opinion of its patentable nature free. Highest references. Prompt attention. Reasonable terms. Victor J. Evans & Co., 154 Ninth, Washington, D. C.

BLACKSMITHS

BLACKSMITHS, Contractors, Inventors: Here's what you've been looking for. New powerful Iron Bender, Bends Eyes, U's, and Angles. Bends cold up to 3/4"x3" bars, or 1 1/4" pipe. Price only \$15. Send for circular. Little Giant Bender Co., Box 134, Lewiston, Minn.

BLACKSMITHS, Listen: Any Handy man can make more money doing hard jobs easy. Forging and welding solid, with Toy's Modern Methods of Blacksmithing. Hardening and tempering to a standard with colored tempering charts. All for one dollar. Samples Free. W. M. Toy, Sidney, O.

FOR THE SHOP

SHOP Notes for 1922—Bench Lathe, Electric Soldering Outfit, 3lb Crane, Pump Troubles, Road Roller, Bench Grinder, Bench Miller, are among the 635 articles in this new volume. 224 pp. 50 cents postpaid. Popular Mechanics Book Dept., 6 N. Michigan Ave., Chicago.

FOR SALE—MISCELLANEOUS

\$17.50 GENUINE Carl Zeiss Field, Marine and Aviation Glasses, eight power, adjustable focus and eye pieces; cost \$38.00 with carrying case. Sent C. O. D. subject to examination. Money refunded. We have other Glasses, Binoculars and merchandise. Weil's Curiosity Shop, 20 S. 2nd St., Philadelphia, Pa.

VALVE and valve gear for Steam Engine. William Smith, Cartersville, Mo.

AIR Compressor with Tank and Hose, \$50. With Motor, \$72.50. Suitable for private or public Garage. Tire Shop, Painting or Cleaning, also Motor in the Head Buffer. Home size, \$18.50. Shop size, \$25. Garage size, \$106. Battery Charging outfit. Home or Garage size, \$14. 6 Tools in one. Forge, Vice, Anvil, Pipe Vise, Drill Press, Emery Grinder, \$25.00. Send for our large 100-page catalogue, describing all kinds of Air Compressors, Vulcanizers, Garage and Battery Outfits. Equipment Co., 187 Canal, Cincinnati, Ohio.

ADDRESSOGRAPHIS, Letter Folders, Multigraphs, Envelope Sealers, Duplicators, less than half price. Guaranteed. Pruitt Co., 112-B N. La Salle, Chicago.

REAL ESTATE AND FARM LANDS

\$5.00 DOWN; \$5.00 monthly; Five acres fruit; poultry, fur farm. Riverfront; Ozarks; \$100; hunting, fishing, trapping. Address Harvey Hubbard, 1973 North Fifth, Kansas City, Kans.

ATTENTION! "Get Acquainted." Cash for your property. Farm, Hotel, or Retail Store, no matter where located; confidential service. Hayes' Business Agency, Cincinnati, Ohio.

EASTERN Farms—mild climate, productive land, near best markets. New York, Phila., Atlantic City, many stocked, prices \$1000 up, easy terms. Illustrated cat. free. New Jersey Farm Agency, 154PM Nassau St., N. Y. C., N. Y.

I WANT Farms for cash buyers; will deal with owners only. R. A. McNow, 312 Wilkinson Bldg., Omaha, Neb.

SELL your property quickly for cash, no matter where located. Don't pay big commissions. Particulars free. Real Estate Salesmen Co., Desk B, Lincoln, Neb.

FLORIDA Oranges are most profitable as well as most delicious. Grow your own in a land of sunshine, away from winter blizzards and coal bills. Money you'll not miss will buy you land for a grove in a high, rolling, lake-jewelled land of many golden groves. If you mean business, write today for Book of Facts and Photos, Lake County Land Owners' Association, 93 Arbor Avenue, Fruitland Park, Fla.

\$10 TO \$50 Down! Starts you on a 20, 40 or 80 tract near thriving city in one of Michigan's best agricultural counties. Balance long time to meet your circumstances. Prices now only \$15 to \$35 per acre. Investigate this opportunity to get a farm home and business of your own. Write today for big illustrated booklet giving full information. It's free. Swigart Land Co., P-1259 First National Bank Building, Chicago, Ill.

13,000 ACRES Wyoming for irrigation. Ideal colonization project, \$12.50 acre, 10,210 acres Florida muck, no richer land in the world, \$15 acre. 8,500 acre Colorado, highly improved equipped ranch, \$20 acre. Unusual bargains. A. M. Riedesel, Denver Col.

\$750 SECURES 250-acre farm, 10 cows, poultry, horses, implements, crops included; near town; 10-room house, 50-ft. barn. All \$3,500, only \$750 cash. Page 36. Free catalog, Street Farm Agency, 150P Nassau St., New York City, N. Y.

HOMESEEKERS: Send for Virginia farm list; best climate. Dept. 50, Emporia, Va.

WANTED—MISCELLANEOUS

MAIL old gold, unused postage, war and thrift stamps, Liberty bonds, silver, platinum, diamonds, jewelry, watches, false teeth, magnet points, etc., new or broken. Cash immediately. Held ten days, returned if unsatisfactory. Ohio Smelting Co., 205 Lennox Building, Cleveland, Ohio.

CASH Paid. Mail us your discarded jewelry, gold crowns and bridges, watches, diamonds, silver, platinum, War Savings Stamps and old false teeth. Highest prices paid. Money sent by return mail. Packages held 4 to 12 days and returned at our expense if our offer is refused. United States Smelting Works (The Old Reliable), Dept. 71, Chicago, Ill.

SEEDS, PLANTS, TREES, ETC.

GOLDEN Seal seed and plants for sale; \$5,000 to \$10,000 worth can be raised on one acre of ground. Beaver Run Gardens, Warsaw, Ohio.

DOGS, BIRDS, POULTRY, PETS

ARKANSAS fox, coon, deer, bear, opossum, rabbit hounds sent on 10 days' trial. Stamp for list. W. B. Caraway, Alma, Ark.

SILVERBLACK Foxes \$300, Skunks \$10. Airedale; traps; Time Payments; booklet dime. Arthur Schumacher, Lockland, O.

BREED Squabs. Book free. E. Rice, Melrose Highlands, 77 Massachusetts.

DOG Owners' Text Book Free. An expert guide for dog owners on proper training, feeding and care of dogs. Sent free with three months subscription to Sportsman's Digest. Send 25 cents (coin or stamps) today. Sportsman's Digest, 307 Butler Bldg., Cincinnati, O.

BELGIAN HARES, GUINEA PIGS, ETC.

RAISE guinea pigs. Pay better than poultry or rabbits; easy to raise; little space required. We guarantee market. Particulars and booklet how to raise free. Cavies Distributing Co., 3102 Grand Ave., Kansas City, Mo.

PERSONAL

COMPLETE life reading, give birthdate, 35c. Palmistry, 35c. J. Wambaugh, Goshen, Indiana.

ST-STU-T-T-TERING and stammering cured at home. Instructive booklet free. Walter McDowell, 46 Potomac Bank Bldg., Washington, D. C.

CIGARETTE habit positively cured or money back. Scientific method—no drugs. State number of cigarettes used daily, enclosing one dollar. Address The Antinine System, 503 Benson Street, Camden, N. J.

BE Wise! Be Cheerful! Be Prosperous! New way plan brings wonderful results. Valuable pointers and your personality revealed for 10c and birthdate. Thomson-Haywood, Dept. 985, Chronicle Bldg., San Francisco, Calif.

YOUR Horoscope covering full year for 25c. Includes an extensive reading, valuable daily guide, large pictorial chart and special forecasts for each month. Scientific, complete. Try it! Money back if dissatisfied. Give birthdate. Address, H. Daniels, Flatbush St., Box 32, Brooklyn, N. Y.

TOBACCO Kills Manly Vigor—Quit easily. Cigarettes, chewing, smoking, snuff, conquered or no charge. Small sum if satisfactory. Stops craving; harmless. Full treatment on trial. Perkins Co., 34A, Hastings, Nebr.

FREE—Stop using tobacco. We will give free information how to conquer habit easily and permanently. Results guaranteed. Anti-Tobacco League, Box K, Omaha, Nebr.

TOBACCO or Snuff Habit cured or no pay. \$1.00 if cured. Remedy sent on trial. Superba Co., TP., Baltimore, Md.

MISCELLANEOUS

5 MASTER Keys. Work like magic in emergencies or prove whether your home is burglar-proof. Test and open thousands of locks. Send \$1 today. Novel key chain free. Master Key Co., 133 Manhattan Block, Milwaukee, Wis.

WANTED—Stamping work for power presses. The W. & P. Toy Mfg. Co., Lawrence, L. I., N. Y.

RUN Mail Order Business? Will furnish formulas, write literature. Gladly send particulars. Andy Stokes, Mohawk, Fla.

HYPNOTISM easily learned by practical lessons. Send 4 cents stamps for booklet explaining how to obtain the system. Fernando, Department 27, Springfield, Mass.

FOR Sale—the best Bank Protection that ever was. Not a press-button or trap affair. Wm. H. Friedrich, Dyer, Ind.

MAKE big money Opening Safes and Setting Combinations. Wayne Strong, Box 1130, Los Angeles, Calif.

GOOD prices paid for butterflies, insects. See Sinclair's Display Advertisement, page 18.

ARMY binoculars, cheap. Enterprise Co., 8 East Third, Cincinnati.

LOCKSMITHS: Send \$1.00 for valuable chart for cutting tumbler padlock keys. Globe System, 278 Washington St., Newark, N. J.

CUTS anybody can make. Simple, cheap process. \$1. Specimens, particulars. 2c stamp. M. Day, Windfall, Ind.

SAVE incorporating expenses and excess profit taxes and avoid personal liability by organizing your company on the Common Law Plan under a Declaration of Trust. Anyone, anywhere, can fill in Demaree Standard Forms, issue shares and begin doing business same day. Pamphlet B-53 free. C. S. Demaree, Legal Blank Printer, 613 Walnut, Kansas City, Mo.

ARTIFICIAL Eyes, \$3. Booklet free. Denver Optic, 359 Barclay, Denver, Colo.

INFORMATION

RELIABLE information furnished on any subject or money refunded, 75c. Co-Operative Service, Times Plaza, Box K61, Brooklyn, N. Y.



Joe Phillips Clears the Tracks for a \$5,200 Job

'Just a clerk'—that was Joe Phillips' "title" less than two years ago. Today he signs himself "Manager of the Traffic Department," and draws a salary of \$5,200 a year.

For five years Joe Phillips had been just a routine clerk—first in a railroad office, then in the shipping department of a big manufacturing concern.

One day he read, just as you are reading now, that thousands upon thousands of dollars are lost or wasted by concerns that do not have trained traffic men in charge of shipping and transportation.

He realized that the firm for which he worked had no traffic manager. He investigated, and found that there was a practical way whereby he could fit himself for that bigger job—could learn all about freight classification, rates, law of carriers, procedure before the Interstate Commerce Commission, express service and rates, ocean traffic and trade—all in his spare time, without interference with his daily work.

He hadn't been at his studies a month before he found his opportunity.

His firm's product (a kitchen utensil) was being shipped in individual boxes. He recommended a slight redesigning of the product so as to permit half a dozen to be shipped in the same package. Nested together, they took up less space—and were straight-way accorded a more favorable freight rate.

Thus at a single stroke Joe Phillips saved his firm from five to six thousand a year—and cleared the tracks for the fifty-two-hundred-dollar job which he swings today. * * *

Just an average fellow—Joe Phillips—merely one out of hundreds of earnest, energetic men who have won their way to important traffic positions thru the LaSalle Problem Method of home-study training.

"By applying the principles embodied in your Traffic Management training," writes J. G. Innet, of the Northern Pacific Railroad, "I was enabled to establish a system of handling fuel accounts that saved our company \$25,000 a year." "Saved our company \$7,000," writes another, "and will probably save \$33,000 more this year." Still another, a former rate clerk, reports the recovery of more than \$200,000 in cash for one of the big packers, simply by proving a correct rate of \$1.53 a hundred-weight on certain shipments as against the rate of \$1.60 which the company had been paying. That man is now traffic manager for the largest cement company in the world.

No wonder that men who have the necessary training are everywhere making good in the field of "Traffic" and are rapidly advancing to positions paying attractive salaries.

* * *

Why step *aside* while other men step *ahead*—to the big-pay jobs? Why content yourself with the slender earnings of the routine man, when right in your own home by the LaSalle Problem Method you can get the special training which will qualify you for an important position?

Send today for our booklet, "Skillful Traffic Management," which tells all about the opportunities in this attractive field. Investigate—*get the facts!* The coupon will promptly bring you complete information, together with details of our convenient-payment plan; also your copy of that inspiring book, "Ten Years' Promotion in One."

It takes but a moment to decide—yet the kind of a decision you are making now has meant for thousands of men just the difference between a meagre pay-envelope and a worth-while income. Mail the coupon NOW.

—INQUIRY COUPON—

LaSalle Extension University

*The Largest Business Training
Institution in the World*

Dept. 764-TR Chicago, Ill.

Please send me catalog and full information regarding the course and service I have marked with an X below. Also a copy of your book, "Ten Years' Promotion in One," all without obligation to me.

Traffic Management—Foreign and Domestic:

Training for positions as Railroad or Industrial Traffic Managers, etc.

Other LaSalle Training Courses

LaSalle is the largest business training institution in the world. It offers training for every important business need. If more interested in any of these courses, check here:

- | | |
|--|--|
| <input type="checkbox"/> Business Management | <input type="checkbox"/> Banking and Finance |
| <input type="checkbox"/> Salesmanship | <input type="checkbox"/> Modern Foremanship and Production Methods |
| <input type="checkbox"/> Higher Accountancy | <input type="checkbox"/> Personnel and Employment Management |
| <input type="checkbox"/> Railway Accounting and Station Management | <input type="checkbox"/> Expert Bookkeeping |
| <input type="checkbox"/> Law—Degree of LL.B. | <input type="checkbox"/> Business English |
| <input type="checkbox"/> Commercial Law | <input type="checkbox"/> Commercial Spanish |
| <input type="checkbox"/> Industrial Management Efficiency | <input type="checkbox"/> Effective Speaking |
| <input type="checkbox"/> Modern Business Correspondence and Practice | <input type="checkbox"/> C. P. A. Coaching |

Name.....

Present Position.....

Address.....





An Easy Way to Learn PHARMACY AT HOME

Graduate pharmacists are always in demand. The work is interesting and pleasant and salaries are good. Many young men open drug stores of their own and become independent.

There's an easy way to learn pharmacy right in your own home in spare time, without losing a day or a dollar from your present work.

The International Correspondence Schools course in Pharmacy supplies the knowledge which it will be necessary for you to have in order that you may pass your State Board Examination.

Just mark and mail the coupon printed below to the International Correspondence Schools, Box 5655-C, Scranton, Pa., and full particulars about the Pharmacy Course or any other work of your choice will come speeding to you by return mail.

INTERNATIONAL CORRESPONDENCE SCHOOLS Box 5655-C, Scranton, Penna.

Without cost or obligation, please send me full information about the subject before which I have marked an X in the list below:

TECHNICAL AND INDUSTRIAL DEPARTMENT

- | | |
|--|---|
| <input type="checkbox"/> PHARMACY | <input type="checkbox"/> Civil Engineer |
| <input type="checkbox"/> Chemistry | <input type="checkbox"/> Surveying and Mapping |
| <input type="checkbox"/> Automobile Work | <input type="checkbox"/> Mine Foreman or Engineer |
| <input type="checkbox"/> Navigation | <input type="checkbox"/> Steam Engineer |
| <input type="checkbox"/> Agriculture and Poultry | <input type="checkbox"/> Gas Engine Operating |
| <input type="checkbox"/> Mathematics | <input type="checkbox"/> Wireless <input type="checkbox"/> Airplane Engines |
| <input type="checkbox"/> Electrical Engineering | <input type="checkbox"/> Architect |
| <input type="checkbox"/> Electrician | <input type="checkbox"/> Contractor and Builder |
| <input type="checkbox"/> Mechanical Engineer | <input type="checkbox"/> Architectural Draftsman |
| <input type="checkbox"/> Mechanical Draftsman | <input type="checkbox"/> Concrete Builder |
| <input type="checkbox"/> Machine Shop Practice | <input type="checkbox"/> Structural Engineer |
| <input type="checkbox"/> Railroad Positions | <input type="checkbox"/> Plumbing and Heating |

BUSINESS TRAINING DEPARTMENT

- | | |
|---|---|
| <input type="checkbox"/> Business Management | <input type="checkbox"/> Salesmanship |
| <input type="checkbox"/> Industrial Management | <input type="checkbox"/> Advertising |
| <input type="checkbox"/> Personnel Organization | <input type="checkbox"/> Better Letters |
| <input type="checkbox"/> Traffic Management | <input type="checkbox"/> Foreign Trade |
| <input type="checkbox"/> Business Law | <input type="checkbox"/> Stenography and Typing |
| <input type="checkbox"/> Banking and Banking Law | <input type="checkbox"/> Business English |
| <input type="checkbox"/> Accountancy (including C.P.A.) | <input type="checkbox"/> Civil Service |
| <input type="checkbox"/> Nicholson Cost Accounting | <input type="checkbox"/> Railway Mail Clerk |
| <input type="checkbox"/> Bookkeeping | <input type="checkbox"/> Common School Subjects |
| <input type="checkbox"/> Private Secretary | <input type="checkbox"/> High School Subjects |
| <input type="checkbox"/> Business Spanish <input type="checkbox"/> French | <input type="checkbox"/> Illustrating <input type="checkbox"/> Cartooning |

Name.....
Street.....
Address.....

City..... State.....

Occupation.....

Persons residing in Canada should send this coupon to the International Correspondence Schools Canadian, Limited, Montreal, Canada.

Please Mention Popular Mechanics

I Make Strong Men



That is my business. I make no other claims. But what I promise, I fulfill. I will increase your arm one full inch in 30 days and your chest in proportion. In three months I will make you a finished strong man. Are you interested? Read my book "Physical Perfection." It tells you how. All I ask is 10 cents to cover postage and wrapping. Don't put it off. Send today.

Arthur L. Hyson
191 Langdon Bldg. New York City

RADIO For Everybody

Make Radio a profession instead of a plaything. You can earn big money as a Radio-trician. Learn by mail, in spare time, how to design, construct, install, repair, maintain, operate, sell and demonstrate complete radio outfits. Write for free 32-page catalog describing our course entitled, "How to Learn Radio at Home."

National Radio Institute, Dept. 1164, Washington, D. C.



LEG TROUBLES—VARICOSE VEINS
Swollen limbs, weak ankles, open sores, phlebitis, fallen arches and oedema. The new improved

CORLISS LACED STOCKING
gives immediate relief and perfect support. Cheapest and best stocking made, contains no elastic. Adjustable, light, cool, real comfort, thousands in use.

Special Home-treatment for all leg sores.
Send today for free booklet No. 24.

CORLISS LIMB SPECIALTY CO.
164 Washington St. Boston, Mass.

DEAFNESS IS MISERY



I know because I was Deaf and had Head Noises for over 30 years. My invisible Antiseptic Ear Drums restored my hearing and stopped Head Noises, and will do it for you. They are Tiny Megaphones. Cannot be seen when worn. Effective when Deafness is caused by Catarrh or by Perforated, Partially or Wholly Destroyed Natural Drums. Easy to put in, easy to take out. Are "Unseen comforts." Inexpensive. Write for Booklet and my sworn statement of how I recovered my hearing.

A. O. LEONARD, Suite 226, 70 5th Avenue, New York City

TOBACCO

Habit Cured or No Pay

Any form, cigars, cigarettes, pipe, chewing or snuff Guaranteed. Harmless. Complete treatment sent on trial. Costs \$1.00 if it cures. Nothing if it fails. SUPERBA CO. E-41 BALTIMORE, MD.



Clear-Tone
FOR
PIMPLES

Your skin can be quickly cleared of Pimples, Blackheads, Acne Eruptions on the face or body, Enlarged Pores, Oily or Shiny Skin. \$1,000.00 Cold Cash says I can clear your skin of the above blemishes. WRITE TODAY for my FREE Booklet—"A Clear-Tone Skin"—telling how I cured myself after being afflicted for fifteen years.

FREE
E.S.GIVENS, 129 Chemical Bldg., Kansas City, Mo.



If He Had Passed It Up

He Would Still be a Laborer at \$2 a Day. No Money, Nothing Ahead but Hard Work, Longer Hours—and Regrets. But He Didn't Pass It Up

He decided to learn Mechanical Drawing. He buckled down to work with the Columbia School of Drafting. When he had a quiet half hour to spend he spent it—as a wise man spends money—to get full returns.

MADE \$275 EXTRA IN 3 DAYS. He recently received \$275 for one drawing that only took him three days to draw.

NOW HOW ABOUT YOU? Are you working up hill or down? Count the money in your pay envelope next pay day. You'll find the answer there.

MAKE \$35 TO \$100.00 A WEEK. We will train you to be an expert Draftsman in your spare time at home by mail. There's lots of room for you if you act now.

PROMOTION IS QUICK. WE'LL QUALIFY YOU for a high-salaried position in the drafting field and keep you in touch with openings for Draftsmen in the big machine shops, industrial plants and United States Government departments. Men who start as

Draftsmen are often advanced to Chief Draftsmen, Chief Engineers, Production Managers and so on.

GET THE RIGHT TRAINING. Mr. Clafin, the founder and director, stands personally in back of the Columbia School of Drafting. You spend no time in long-winded theories—useless and expensive to you. You start on actual drawing work the day you receive your first lesson.

YOU NEED NO PREVIOUS TRAINING. The course is easy to understand and easy to follow. Many students are qualified even before they complete the course.

SUCCESS CALLS MEN OF ACTION ONLY. If you are a man of action clip the coupon now and show that you are a man of action. Keep right on top of this opportunity to make real money. Don't go looking for a pair of scissors. Tear the coupon off and mail it right now. We have a special offer for those who reply promptly. Get started now.

What We Give You

PRACTICAL PROBLEMS. You are carefully coached in practical Drafting work.

WE HELP YOU GET A JOB. We help you get a position as a practical Draftsman as soon as you are qualified.

PERSONAL INSTRUCTION AND SUPERVISION THROUGHOUT THE COURSE. You receive the personal instruction and help of Roy C. Clafin, president of the Columbia School of Drafting and a practical Draftsman of many years' experience.

DRAFTSMAN'S EQUIPMENT. We furnish you with a full set of Drawing Equipment and Drafting Instruments as shown in the picture below when you enroll. You keep both sets on completing the course.

CONSULTATION PRIVILEGES. You are free to write us at any time for advice and suggestions regarding your success.

DIPLOMA. The diploma we give you on completing the course attests to your proficiency as a Draftsman. It is an "entering wedge" to success.

FREE SUBSCRIPTION TO DRAFTSMAN'S PUBLICATION, "THE COMPASS." You are given free a subscription to our helpful, inspiring publication, "The Compass."



**Drafting
Outfit
Free**

FREE We give you free with our course this professional Drafting outfit. It is yours to keep when you complete the course.

U. S. Civil Service Commission Needs DRAFTSMEN

The following are a few of the many positions open in Government Departments from time to time. The salaries are starting salaries, subject to increase. Practically all of them carry a bonus of \$240 a year additional.

Architectural Designer \$4,000
Chief Draftsman (Aeronautical) Naval Aircraft Factory, per day . . . 15.04
Aeronautical Draftsman—Field Service of Navy Department, \$5.20 per day to \$12 per day.

FREE BOOK Send in this coupon today. Immediately on receipt of it we will send you our book, "Your

Future in Drafting," which tells you all about our new method of teaching Mechanical Drawing and gives full details of our special offer to those who reply promptly.

THE COLUMBIA SCHOOL OF DRAFTING

Roy C. Clafin, President

Dept. 1764, 14th and T Sts., N. W., Washington, D. C.

—Free Book Coupon—

COLUMBIA SCHOOL OF DRAFTING,
 Dept. 1764, 14th and T Sts., N. W., Washington, D. C.

Enter my name for a free subscription to "The Compass" and also send me without charge your illustrated book on Drafting, telling me how I can secure your complete Home Study Course and your help in securing a position as Draftsman.

Name Age

Address

City State

\$150 to \$400 a Month for YOU As an Expert Auto Mechanic



EASY TO LEARN HOW In 6 to 8 Weeks' Time

Come down to Washington—the Nation's Capital. Drop in at the American Motor Schools. Go all thru our big new \$250,000 building. Watch the young men who are learning, by actual practice, every detail of auto construction and repair, auto electricity, battery building, vulcanizing, tire repairing, and welding. Lots of these fellows will soon own their own garages

and be making from \$5,000 to \$10,000 a year. Many of them will soon be holding down good jobs paying from \$150 to \$400 a month.

You too can get your start towards success in the Auto business with the help of the American Motor Schools.

FREE CATALOGUE

Fill in and send the following coupon and we will send you free our illustrated catalogue telling about your opportunity in the auto business and how we will help you to make good. By acting promptly you can save \$50. Mail the coupon NOW.

**American Motor Schools, Inc.,
Dept. 281 16th & You Sts. Washington, D. C.**

Send the Coupon

The American Motor Schools, Inc.,
16th & You Sts., N. W.,
Dept. 281, Washington, D. C.

Please send me, free of charge, illustrated catalogue and information regarding your Auto Mechanics Course.

Name

Address

City, State

LEARN The BUSINESS of Advertising



QUICKLY BY MAIL

We guarantee to teach you. It's easy to learn—and easy to get into! Make the start *this week*. This free book tells how.

\$75 to \$100 a Week

—frequently paid beginners. There is *no limit* to opportunities which men and women trained in advertising meet on every hand.

FREE This interesting book on advertising is sent free. Tells just the things you want to know about getting into this fascinating field. Full of facts.

PAGE-DAVIS SCHOOL, Dept. A19, Page Bldg., Chicago

Gibson Instruments

Mandolin, Mandola, Mando-Cello,
Guitar, Tenor-Banjo, Mandolin-
Banjo, Cello-Banjo, Guitar-
Banjo, Harp-Guitar,
Mando-Bass —



Easy to Play Easy to Pay

Select your Gibson now. You can soon be playing the music of the day. Your friends will be surprised and delightfully entertained. Let us help you organize a Gibson Orchestra in your community. You can increase your popularity, income and pleasure by playing for Concerts, Entertainments, Church Affairs, etc. A small down payment and then \$5 a month will soon pay for a Gibson and will furnish you with wholesome, year-'round entertainment. If you have an old instrument we will make liberal allowance on a Gibson. Write for Free Book, Catalog, Free Trial Offer, information about Wm. F. Rice, Jr. Book and Instrument 95% prefer.

GIBSON MANDOLIN-GUITAR COMPANY
1257 Parsons Street Kalamazoo, Mich., U. S. A.



Learn Photography

Good-paying positions in the best studios of the country await men and women who prepare themselves now. For 28 years we have successfully taught

Photography, Photo-Engraving and Three-Color Work

Our graduates earn \$35 to \$100 a week. We assist them to secure these positions. Now is the time to fit yourself for an advanced position at better pay. Terms easy; living inexpensive. Largest and best school of its kind. Write for catalog today.

ILLINOIS COLLEGE OF PHOTOGRAPHY
Le Grand A. Flack, Pres., Box 472, Effingham, Illinois

LEARN ENGINEERING

Courses, 3 months to 3 years practical-technical training under experts. Not a Trade School, but a practical-technical college teaching electricity, steam, gas, auto-electric, armature winding, drafting. Extensive laboratory and shop equipment. Degrees awarded. Day and night sessions. Enroll any time.

FINLAY ENGINEERING COLLEGE
1021 Indiana Avenue Kansas City, Mo.

LEARN WATCHMAKING and ENGRAVING

Earn while learning. Most practical watch school. Individual instructions. Graduates in great demand. Book free. Chicago School of Watchmaking, Dept. 20, 4840 Lincoln Ave., Chicago

\$100 a WEEK for DRAWING

How would you like to make \$100 a week as a commercial artist? If you like to draw, you are indeed fortunate—well-trained artists are always at a premium. They readily earn \$75, \$100, \$150 a week, and even more, and beginners with practical ability soon command \$50 a week.

LEARN QUICKLY AT HOME IN YOUR SPARE TIME

Develop your talent—put your natural ability to its best use. The Federal "Master" Course, endorsed by high authorities, teaches you by mail in your spare time. No experience needed, each step is clearly explained.

You receive individual personal criticisms on all your lessons.

Send for "Your Future," a splendid book showing work of Federal Students, telling all about this remarkable course, and pointing out opportunities that will surprise you. If you are in earnest and 16 years old or more, write today for this free book, kindly stating your age.

FEDERAL SCHOOL OF COMMERCIAL DESIGNING, 678 Federal Schools Bldg., Minneapolis, Minn.

Swear Off Tobacco



Tobacco Tells on Nervous System



Tobacco Ruins Digestion



Tobacco Stunts Boy's Growth



Tobacco Robs Man of Vitality



Tobacco Steals from You the Pleasures, Comforts, Luxuries of Life

Tobacco Habit Banished Let Us Help You

Quick Results

Trying to quit the tobacco habit unaided is often a losing fight against heavy odds, and may mean a serious shock to your nervous system. So don't try it! Make the tobacco habit quit you. It will quit you if you will just take **Tobacco Redeemer** according to directions.

It doesn't make a particle of difference whether you've been a user of tobacco for a single month or 50 years, or how much you use, or in what form you use it. Whether you smoke cigars, cigarettes, pipe, chew plug or fine cut or use snuff—**Tobacco Redeemer** will positively remove all craving for tobacco in any form in a few days. Your tobacco craving will usually begin to decrease after the very first dose—there's no long waiting for results.

Tobacco Redeemer contains no habit-forming drugs of any kind and is marvelously quick, scientific and thoroughly reliable.

Not a Substitute

Tobacco Redeemer is in no sense a substitute for tobacco, but is a radical, efficient treatment. After finishing the treatment you have absolutely no desire to use tobacco again or to continue the use of the remedy. It helps to quiet the nerves, and will make you feel better in every way. If you really want to quit the tobacco habit—get rid of it so completely that when you see others using it, it will not awaken the slightest desire in you—you should at once begin a course of **Tobacco Redeemer** treatment for the habit.

Results Absolutely Guaranteed

A single trial will convince the most skeptical. Our legal, binding, money-back guarantee goes with each full treatment. If **Tobacco Redeemer** fails to banish the tobacco habit when taken according to the plain and easy directions, your money will be cheerfully refunded upon demand.

Let Us Send You Convincing Proof

If you are a slave of the tobacco habit and want to find a sure, quick way of quitting "for keeps" you owe it to yourself and to your family to mail the coupon below or send your name and address on a postal and receive our free booklet on the deadly effect of tobacco on the human system, and positive proof that **Tobacco Redeemer** will quickly free you from the habit.

Newell Pharmacal Company
Dept. 300 St. Louis, Mo.



Free Book Coupon

NEWELL PHARMACAL CO.,
Dept. 300 St. Louis, Mo.

Please send, without obligating me in any way, your free booklet regarding the tobacco habit and proof that **Tobacco Redeemer** will positively free me from the tobacco habit or my money will be refunded.

Name.....

Street and No.....

Town..... State.....

LEARN CARTOONING the Right Way



1.

Have your ability trained by the school that has developed many famous cartoonists.

If you like to draw—if you find pleasure in picking up a pencil and paper and trying to make sketches or cartoons, don't regard it merely as a hobby. Have your ability developed and earn a good income as a cartoonist.



2.

Hundreds of nationally known cartoonists, such as Branner of the Chicago Tribune; Blosser, who draws "Freckles and His Friends"; Gene Byrnes, creator of "Reg'lar Fellers"; Thiele of the Sioux City Tribune; Fung, of the Seattle Times and others equally well known, took the Landon Course at home, in their spare time, and fitted themselves for their present positions at salaries ranging from \$50 to \$200 and more per week.



3.

Have YOUR talent developed by the same method

What the above mentioned boys did you can do, with the same training. The Landon method of teaching makes cartooning easy to learn. By means of an extensive series of Big picture charts all the necessary details of ORIGINAL drawing are explained step by step, in a clear and simple manner.



4.

FACTS that determine the superiority of the Landon School:

1. Landon School Students are securing the best cartooning positions which open up everywhere.
2. The picture chart method of instruction was originated and is used exclusively by the Landon School.
3. From the very beginning, the Landon Course teaches ORIGINAL drawing. No copy work.
4. Individual attention and criticism of student's work. Personal coaching whenever necessary.
5. Specialized instruction on how to originate cartoon ideas. This is an exclusive feature of the Landon Course.
6. Practical assistance in securing positions for students and help in marketing their work.
7. The price is within reach of everyone who is ambitious to succeed. Easy payments can be arranged.



5.

Write today for full information about the Landon Course, and sample chart by means of which you can test your own ability. Find out what the possibilities are for YOU in this interesting profession. Please state your age.

The Landon School
1138 National Bldg. Cleveland, Ohio

Make Your Bike a MOTORCYCLE

Make your "foot-power" bike a dependable, easy-running, light-weight motorcycle at small cost. You can do it yourself with the

SHAW MOTOR ATTACHMENT

Compact. Easy to attach. No special tools required. Battery or magneto. Thousands in use. Write at once for free book, prices, terms; also about Shaw Motorbicycle.

Write for
FREE
Book

SHAW MFG. CO.
Dept. 375
Galesburg, Kans.



95 to 125
Miles per
gallon!

BLANK CARTRIDGE PISTOL

PRICE
\$1.00



Well made and effective; modelled on latest type of Revolver; appearance alone is enough to scare a burglar. When loaded it may be as effective as a real revolver without danger to life. Does not shoot real bullets but takes standard .22 Cal. Blank Cartridges, obtainable everywhere. A Great Protection Against Burglars, Tramps and Dogs. You can have it lying about without the danger attached to other revolvers. PRICE \$1.00 Postpaid. Blank Cartridges .22 Cal., shipped express, 50c per 100. JOHNSON SMITH & CO., Dept. 856, 3224 N. Halsted St., CHICAGO



Deafness

For over 25 years Perfect Hearing has been restored in nearly every condition of deafness by the use of our "Little Wireless Phones for the Ears."

The Wilson Common-Sense Ear Drums effectively replace what is lacking or defective in the natural ear drums; require no medicine; are simple little devices easily fitted into the ears, where they are invisible. Soft, safe and comfortable to wear.

Write today for FREE book, explaining the causes of DEAFNESS, and giving experience of hundreds whose hearing has been happily restored.

WILSON EAR DRUM CO., Incorporated
938 Inter-southern Bldg. LOUISVILLE, KY.



LEARN TO PITCH

Lessons by "MATTY" WALSH, WHITE, JOHNSON, RUCKER, WOOD—PITCH THE FADE-A-WAY, SPITTER, KNUCKLER, SMOKE BALL, etc., clearly described and illustrated by 56 Pictures. Entire COURSE OF LESSONS sent p. p. for 25c.

J. C. DORN, 721 S. Dearborn St., Dept. 65, Chicago, Ill.

THE INDEX

TO VOL. 37, JAN.-JUNE, 1922 OF
POPULAR MECHANICS MAGAZINE

Is now ready and will be sent to any address upon receipt of 10 cents in stamps
POPULAR MECHANICS, 6 N. MICHIGAN AVE., CHICAGO

You Can Play the Hawaiian Guitar Just Like the Hawaiians!

Because Our Native Hawaiian Instructors Will Help You

OUR STUDENTS SAY

Kenneth School,
314 So. Franklin St.,
Chicago, Ill.

First Hawaiian Conservatory of
Music, Inc.

I shall certainly be very glad to
recommence your course whenever
the pleasure is mine to do so. Mr. W.
R. Johnson has not phoned me yet,
and if he does not phone in a day or
so, will write him. Am sending a letter
to Miss Helen Sivik today which
I think may help to secure her enroll-
ment, and I shall be glad at any time
to write a personal letter to anyone
whom you may suggest.

Your former student,
W. L. Walker.

Sam Quentin, Calif.

First Hawaiian Conservatory of Music,
903 Woolworth Building, N. Y. City.

Dear Sirs:—

Lessons 18 and 19 came last evening
and I was pleased to see that they are
beginning to get hard, or at least a
little bit more to learn in them. I
have a great deal of spare time to put
in on the Guitar and I enjoy it. Your
course is the simplest and most interest-
ing I have ever tried to learn. I
am getting along fine and can play
very easily up to the last one and
I can readily see that when I have
finished with all of the lessons I will
be able to play most anything and
play it good. I am, in appreciation,
Yours truly, J. K. FERGUSON.

P. S. If at any time you wish to
use my name as a reference for your
course you may do so, as I think that
any one who takes it up will derive a
great benefit from it and never regret
it.

Our improved method of teaching is so **simple, plain and easy** that you begin on a piece with your first lesson. **In half an hour you can play it.** Thousands of successful students prove this to be true.

ONLY 4 MOTIONS We have reduced the necessary motions you learn to only four, and you acquire these in a very few minutes. Then it is only a matter of a little practice to acquire the weird, fascinating, tremolos, staccatos, slurs and other effects that make this instrument so delightful. **The Hawaiian Guitar plays any kind of music,** both the melody and the accompaniment.

FREE Just think of it. 52 lessons on this wonderful guitar. You get a beautiful large sized **Genuine Hawaiian Guitar absolutely free as soon as you enroll for the lessons.** All the necessary picks, the steel playing bar and 52 pieces of music are included **without cost to you.**

Special Arrangements for Lessons if You Have Your Own Guitar

Play Any Music

In half an hour after you get the free Hawaiian Guitar and the first lesson, **you can play Hawaiian Melodies.**

In a very short time after a little practice you can play any kind of music as well as Hawaiian, both the melody and accompaniment.

[TEAR OUT COUPON]



Tear Off and Mail Today

First Hawaiian Conservatory of Music, Inc.
233 Broadway (Woolworth Bldg.), New York City

Please send me full information about your 52 easy lessons and **FREE GUITAR OFFER.**

NAME.....

ADDRESS.....

TOWN..... STATE.....

Print name and address clearly. P.M.7

Whatever Your Question;—be it the pronunciation of Bolsheviki, the spelling of a puzzling word, the location of Murman Coast—the meaning of blighty, ace, lank, ukulele, etc., this Supreme Authority—

WEBSTER'S NEW INTERNATIONAL DICTIONARY

contains an accurate, final answer 400,000 Words, 2700 Pages, 6000 Illustrations.

Regular and India-Paper Editions.

G. & C. MERRIAM CO., Springfield, Mass.

Write for specimen pages, prices, etc. and **FREE Pocket Maps per Popular Mechanics**



IVER JOHNSON

The **SAFE** Revolver

How to Get Rid of Moles



A simple, safe home treatment—
15 years' success in my practice.
Moles (Also BIG Growths) Dry Up.

Ask for Free Booklet of Full Particulars

WM. DAVIS, M. D.

124-5 Grove Ave., Woodbridge, N. J.

MURDER

WILL OUT

Write for FREE reports telling uses of finger prints and how to learn this profitable profession. POSITION GUARANTEED.

U. S. SCHOOL OF FINGER PRINTS, Room 938, 7003 N. Clark St., Chicago, Ill.

Police Dept., factories, banks, industries adopt finger print method of identification to find originals. **BE A FINGER PRINT EXPERT.** Train at home in spare time.

A FILE

MAKE YOUR MIND NOT A FILE



A classified index from which you select facts, figures, names, faces. Develop concentration, self-control, overcome bashfulness, forgetfulness. Write today for FREE memory and concentration test and illustrated booklet "HOW TO REMEMBER," 21 years' success.



PROF. HENRY DICKSON
Dept. 1041-N Evanston, Ill.

WANTED

RAILWAY MAIL CLERKS

\$1600 to \$2300 Year

MEN—BOYS OVER 16 SHOULD

SEND COUPON IMMEDIATELY

Steady Work No Layoffs Paid Vacations

Common education sufficient

Send coupon today—SURE



Franklin Institute, Dept. E177, Rochester, N. Y.

Sirs: Send me, without charge, (1) sample Railway Mail Clerk Examination Questions; (2) schedule showing places of all coming U. S. Government examinations; (3) list of many Government jobs now obtainable.

Name.....

Address.....

Treat yourself at home

Vi-Rex VIOLET RAYS

Used successfully for the treatment of

Asthma	Falling Hair	Neuralgia
Boils	Hay Fever	Paralysis
Blackheads	Headache	Pimples
Catarrh	Insomnia	Rheumatism
Colds	Lumbago	Skin Diseases
Eczema	Nervousness	Sore Throat

and other ailments

Complete Outfit **\$12⁵⁰**



If you have less than perfect health you are sub-normal! If you will take the advice of thousands of leading medical men and famous beauty specialists, you will revitalize and tone up the muscles, nerves and tissues of your body through VI-REX VIOLET RAY treatments. VIOLET RAY TREATMENTS will preserve or restore for you these choicest gifts of Nature.

Free Trial

Because the VI-REX is the most scientific, most effective and best built machine made, we know that it will give you the MAXIMUM RESULTS obtainable from the use of VIOLET RAYS. In ten days you will be thoroughly convinced. Make this experiment ENTIRELY AT OUR RISK, we will give you a full 10-days free trial of our machine on request.

Wonderful book
FREE

Learn why your vitality is low, why you have pains, aches and list. Remarkable book just published contains charts of nervous system, organic locations, and describes beneficial results of VI-REX VIOLET RAY TREATMENTS. Clip this coupon and mail it today.

Vi-Rex Electric Co.

326 W. Madison St.

Dept. 27

Chicago, Ill.

VI-REX ELECTRIC CO., 326 W. Madison St., Dept. 27, Chicago, Ill.
Please send me without any cost or obligation your free book describing your VI-REX Violet Ray outfits, and details of your free trial offer.

Name.....
Address.....
City.....
State.....

SHOP WORK with a

CARNES ARTIFICIAL ARM

FOR nearly ten years a Carnes Artificial Arm has kept Mr. Pahhe Yazze of Lawrence, Kan., on the payroll as a draftsman and machinist at a good salary. Thousands of other mechanics, artisans, office workers, farmers and laborers owe their independence to this improved arm.

Life-Like in Action and Appearance

The Carnes Arm cannot be detected from the natural except by close inspection. Its user can dress himself, use knife, fork, pen, pencil and keys; pick up large or small objects, carry grips—in fact, do virtually everything that was possible before. He can bend the elbow of the Carnes Arm, bend and turn the wrist and open and close the fingers at will, even if the amputation is at the shoulder.

192-Page Book FREE. A book of 192 pages, profusely illustrated with photographs showing what can be done with this remarkable invention, will be sent free to any person interested. Send for it now.

CARNES ARTIFICIAL LIMB CO.,
208 Carnes Bldg., Kansas City, Mo.

NO JOKE TO BE DEAF

—Every Deaf Person Knows That I make myself hear, after being deaf for 25 years, with these Artificial Ear Drums. I wear them day and night. They are perfectly comfortable. No one sees them. Write me and I will tell you a true story, how I got deaf and how I make you hear.



Medicated Ear Drum

Pat. Nov. 2, 1906

Address
GEO. P. WAY, Artificial Ear Drum Co. (Inc.)
80 Adelaide St., Detroit, Mich.

The WONDERFUL

ERICKSON PATENT LEG

Will not chafe, overheat, nor draw end of stump.



ERICKSON ARTIFICIAL LIMB CO., 35 Wash. Av. N., Minneapolis, Minn.

NO MORE BALD HEADS



WHEN our VACUUM CAP is used a few minutes daily. We accept no pay until you have tried the Cap 60 days and are satisfied. The Vacuum Cap is an appliance that draws the blood to the Hair Roots and starts a new healthy crop of hair. It stops Dandruff, stops the hair from falling out.

Bought by Doctors and men who know that it is the only reasonable HAIR GROWER known to science. No Drugs Used. Write for application blank, testimonials, and booklet on "HAIR," sent sealed in plain envelope. FREE.

THE MODERN VACUUM CAP CO.

Z 559 BARCLAY, DENVER, COLO.

10,000 Practical Recipes

HENLEY'S

Twentieth Century
Book of

Recipes, Formulas
and Processes

Edited by

GARDNER D. HISCOX, M. E.



Contains over 10,000 Selected Scientific, Chemical, Technological and Practical Recipes and Processes, including Hundreds of So-Called Trade Secrets for Every Business. This book of 800 pages is the most complete Book of Recipes ever published, giving thousands of recipes for the manufacture of valuable articles for every-day use. Hints, Helps, Practical Ideas and Secret Processes are revealed within its pages. It covers every branch of the useful arts and tells thousands of ways of making money and is just the book everyone should have at his command. A book to which you may turn with confidence that you will find what you are looking for. A mine of information up-to-date in every respect. Contains an immense number of formulas that everyone ought to have that are not found in any other work.

Price \$4.00
Cloth Binding

Popular Mechanics Book Dept.
6 N. Michigan Ave., CHICAGO

LATEST and BEST RADIO BOOKS

Construction of Radiophone and Telegraph Receivers for Beginners. By M. B. Sleeper. Fully Illustrated. Price \$.75
How to Make Commercial Type Radio Apparatus. By M. B. Sleeper. Fully Illus. Price \$.75
Construction of New Type Trans-Atlantic Receiving Set. By M. B. Sleeper. Fully Illustrated. Price \$.75
Radio Hook-Ups. By M. B. Sleeper. Price \$.75
Radio Design Data. By M. B. Sleeper. Price \$.75
A B C of Vacuum Tubes Used in Radio Reception. By E. H. Lewis. Fully Illus. Price \$1.00

Above prices postpaid

POPULAR MECHANICS BOOK DEPT.
6 N. Michigan Ave. CHICAGO

POPULAR MECHANICS SHOP NOTES FOR 1922

VOLUME XVIII

224 PAGES — 655 ARTICLES
465 ILLUSTRATIONS

Six-Inch Bench Lathe—Electric Soldering Outfit—Contractors' Jib Crane—Pump Troubles—Farm or Road Roller—Small Bench Grinder—Small Bench Miller are among the many useful articles in this volume.

PRICE 50 CENTS, POSTPAID

POPULAR MECHANICS BOOK DEPARTMENT
6 N. MICHIGAN AVE. CHICAGO

HOW CAN I ENJOY RADIO at home?

What is the best way for me to listen to the daily concerts, news, government reports, sporting results, etc.? What kind of set will I need? How shall I put up my aerial? Just what are the different pieces of apparatus for?

Lefax Radio Handbook is the one recognized authority on every phase of radio. The authors of the Lefax Handbook are Dr. J. H. Dellinger, Chief of the U. S. Bureau of Standards Radio Laboratory and L. E. Whittemore, Alternate Chief, with the unlimited resources of the Government at their command. Technically correct in everyday language. Lefax

knows all—tells how
never grows old!

New pages, covering new events as fast as they happen, will be sent free to every owner up till July 1st, 1923. Only by using Lefax Handbook and Lefax Service, can you have a complete radio library in handy form always at your fingertips, that never goes out of date.

The price is \$3.50 including a handsome six-ring binder. Considering the time, trouble and money Lefax will save you—the expert results it will help you get—the satisfaction of having the cream of radio research always at your fingertips—Lefax is the best radio investment you could possibly make.

Get your copy now for a full year of Lefax service free. At your dealer's or send \$3.50 direct to

LEFAX, Inc.

75E South Ninth St., Philadelphia

Lefax \$3.50
LOOSE-LEAF PAGES
RADIO HANDBOOK



SAVE YOUR BODY

Conserve Your Health and Efficiency First

"I Would Not Part with it for \$10,000"

So writes an enthusiastic, grateful customer. "Worth more than a farm," says another. In like manner testify over 100,000 people who have worn it.

The Natural Body Brace

Overcomes WEAKNESS and ORGANIC AILMENTS of WOMEN AND MEN. Develops erect, graceful figure.

Brings restful relief, comfort, ability to do things, health and strength.

Wear It 30 Days Free at Our Expense

Does away with the strain and pain of standing and walking; replaces and supports misplaced internal organs; reduces enlarged abdomen; straightens and strengthens the back; corrects stooping shoulders; develops lungs, chest and bust; relieves backache, curvatures, nervousness, ruptures, constipation, after effects of flu. Comfortable and easy to wear.

Keep Yourself Fit Write today for illustrated booklet, measurement blank, etc., and read our very liberal proposition.

HOWARD C. RASH, Pres. Natural Body Brace Co.
223 Rash Building SALINA, KANSAS



For Boys and Girls Also



Play "JAZZ" on the Saxophone

Become musician so quickly as to astound everyone. Learn by playing real music,—instead of tiresome "exercises." You'll soon become the most popular person in your "set."

NEW EASY METHOD

Is a revelation. Nothing else like it for thoroughness and rapidity. So simple that young and old find it easy to play with amazing skill. No "trick music"—but actual notes, learned quickly right in your own home.

FREE BOOK

offers this wonderful musical opportunity. Send for it today before copies are exhausted. You'll be astounded, thrilled, fascinated, at this easy, rapid way to become a veritable master of your favorite instrument. Name below the instrument you are particularly interested in.

LEARN TO PLAY ANY INSTRUMENT

Piano	Mandolin
Organ	Drums and Traps
Violin	Harmony and Composition
Banjo	Sight Singing
Clarinet	Ukulele
Flute	Piccolo
Harp	Trombone
Cornet	Saxophone
Cello	Voice and Speech Culture
Guitar	Automatic Fingering Control

U. S. SCHOOL OF MUSIC, 77 Brunswick Bldg., New York City
Send me your amazing free book, "Music Lessons in Your Own Home." This does not put me under any obligation. (Please write plainly)

NAME

ADDRESS

INSTRUMENT

STOP USING A TRUSS

Do Away With Steel And Rubber Bands

FREE TRIAL



Inner surface is made adhesive to secure the PLAPAO-PAD firmly to the body, keeping the PLAPAO continually applied and the pad from slipping. No straps, buckles or springs attached. Soft as velvet—easy to apply.

It's the Non-Slipping, yet Non-Rigid Pad and What is Within It That Counts

FREE to 5,000 Truss Sufferers

To the extent of 5,000 sufferers who may apply I will send, ABSOLUTELY FREE, a sufficient quantity of the Plapao to positively convince them that this is the only logical, common-sense way of treating rupture. Plapao is a highly astringent medication placed within the Plapao-Pad and being absorbed through the skin, creates a wonderful feeling of relief and at the same time tends to strengthen the weakened muscles and thus permanently close the rupture opening. The process of recovery is natural, so you'll have no use for a truss—you can throw it away forever! Old and young have testified under oath that the Plapao-Pads cured their rupture—many of them long-standing, aggravated cases—without delay from work. Patent allowed in U. S. and foreign countries. Awarded Gold Medal at Rome and Grand Prix at Paris.

Send No Money—for a sufficient quantity of the Plapao to give it a thorough test; you pay nothing for this trial now or ever. Write for it and full information today. Address: Plapao Laboratories, Block 1427 St. Louis, Mo.

Popular Mechanics Books

EACH one of the following books has been published by Popular Mechanics and is characterized by the same careful editing and authoritative presentation of the subject matter as is the magazine itself. All are unusually good values for the prices asked.

THE BOY MECHANIC—BOOK ONE 480 Pages—700 Articles—800 Illus.	\$2.50
THE BOY MECHANIC—BOOK TWO 480 Pages—1000 Articles—995 Illus.	2.50
THE BOY MECHANIC—BOOK THREE 480 Pages—800 Articles—802 Illus.	2.50
MISSION FURNITURE, HOW TO MAKE IT, PART 1 128 Pages—30 Designs, Illus.50
MISSION FURNITURE, HOW TO MAKE IT, PART 2 128 Pages—32 Designs, Illus.50
MISSION FURNITURE, HOW TO MAKE IT, PART 3 128 Pages—36 Designs, Illus.50
WOOD-WORKING FOR AMATEUR CRAFTSMEN 128 Pages—125 Illus.50
ARTS-CRAFTS LAMPS, HOW TO MAKE THEM 96 Pages—16 Designs, Illus.50
LAMPS AND SHADES IN METAL AND ART GLASS 128 Pages—18 Designs, Illus.50
METAL WORK AND ETCHING 96 Pages—Illus.50
ELECTROPLATING 112 Pages—62 Illus.50
PRACTICAL COURSE IN MECHANICAL DRAWING 160 Pages—157 Drawings.50
HEAT 128 Pages—Illus.25
KINGDOM OF DUST 128 Pages—40 Illus.50
HOW TO MAKE DEVICES FOR OUTDOOR WINTER SPORTS. 64 Pages—Illus.25
SHOP NOTES FOR 1922 224 Pages—655 Articles—465 Illus.50
SHOP NOTES SERIES 11 Vols.	5.50
PATTERN MAKING 224 Pages—312 Illus.	1.00
POWER GAS AND THE GAS PRODUCER 192 Pages—Illus.	1.00

Above prices are postpaid.

POPULAR MECHANICS BOOK DEPT.
6 N. Michigan Ave., Chicago

DYKE'S AUTOMOBILE ENCYCLOPEDIA

Will Teach You How to Become:

- (1) An Automobile Repairman.
- (2) Engine Expert. (3) Electric Trouble Shooter. (4) Ignition Expert. (5) Tire Repair Expert. (6) Storage Battery Expert. (7) Carburetor Expert. (8) Tractor Expert. (9) Truck Expert. (10) Operator and Radiator Repairman.

968 Pages, 6½x9¾ in.
3,362 Illus.

Price Prepaid, Cloth, \$6.46
American Morocco, \$7.96

POPULAR MECHANICS BOOK DEPT.
6, N. Michigan Ave., Chicago



LATHE WORK for BEGINNERS

By R. F. YATES

A book for those interested in lathe work in wood and metal. It will prove a valuable aid to the young machinist or apprentice who intends to make lathe work his occupation. It foresees all his questions, and its answers go to the heart of his difficulty. Shows how to set up the lathe, explains the various tools and the correct way of using them, and makes plain the different lathe attachments and their applications. The lessons range from the turning of a brass cup to the completion of a model rapid-fire gun, and milling, gear-cutting, thread-cutting, sawing and grinding are set forth. Chapters are: Choosing a Lathe.—Setting up and Driving the Lathe.—The Lathe and Its Parts.—Lathe Attachments and Their Use.—Measuring Tools and Their Use.—A Lesson in Metal Turning.—Advanced Lathe Work.—Screw Cutting.—Wood Turning.—Metal Spinning.—Building an Amateur's Metal Turning Lathe.—Building a Simple Wood Turning Lathe.—A Model Rapid-Fire Naval-Gun.

240 Pages (5x7½), 167 Illustrations.
Cloth Binding. Price \$1.50 Postpaid.

Popular Mechanics Book Dept. 6 N. Michigan Ave. CHICAGO



Tune up and listen in
on the July special
RADIO issue of

THE AMERICAN BOY

"The Biggest, Brightest, Best Magazine for Boys
in All the World"

Facts that every boy needs in order to start right in radio; a wonderful article on radio construction that makes the building of a receiving set as easy as A B C; articles that tell you how to get the most satisfaction out of your radio set.

There is a "fact" story of a young fellow who, beginning with the simple experiments every boy tries, *used his brains* and became one of the most famous (and one of the richest) radio inventors in the world.

In July we will publish the best radio yarn we have seen yet, "The Devil Code," by Kenneth Payson Kempton.

July also contains the announcement of a special radio contest open to every boy. Prizes and everything.

Tune in on this great July radio number of **THE AMERICAN BOY**.

The wave length is 20c at all news-stands, or \$2.00 for a full year's subscription, delivered. Subscribe for a year or leave a standing order at your news-dealer's.

The American Boy

The Biggest, Brightest, Best Magazine for Boys in All the World

THE SPRAGUE PUBLISHING CO.
No. 375 American Bldg., Detroit, Mich.

Herewith send \$2.00. Please send **THE AMERICAN BOY** for one year, beginning with the current issue, to

Name.....

Address.....

Please Mention Popular Mechanics

Get Into This

10,449,785
Automobiles in U.S.

50,000,000
Tires to be repaired.

10,000,000 Batteries,
10,000,000 Ignition
Systems and only
38,000 Garages.

You Can

Follow in the lead of Bradley, shown on the opposite page, and scores like him who have taken advantage of the amazing money-making possibilities in the automobile, truck and tractor business. Here is a chart of facts—authentic figures which point out the opportunities. If you are ambitious and seeking a money-making opening, here's your chance—a chance to cash-in to a degree that will satisfy your highest aims.

Thousands of competent garages, battery shops, auto electrical shops, tire and welding shops are needed now. Trained men can run them.

tire and welding shops are

Learn Autos, Trucks and Tractors in the Heart of the Industry

Without any previous experience—just a liking for mechanics—you can learn the auto business from A to Z in a few weeks at the Michigan State Automobile School—the factory endorsed school in Detroit—the heart of the industry. Then step out, equipped with knowledge and training, to a future of certain, big money making. You have distinctive advantages, learning the business here. It's the fountain head of the automotive industry. You are taught under factory endorsed methods. You learn both theory and practice on latest equipment. You visit the great auto factories—learn their methods first hand—and it all means greater opportunities and more certain success.

Learn in a Few Weeks--Start Now

A thorough training in Detroit, at the M. S. A. S., is the thing that fattens the pay envelope if you are working for others, or puts more profit in business for yourself. You can take a full Automotive Course, or specialize in any one of its money-making branches, you can be an Auto Electrician; a Tire Expert; a Battery Service Man; a Repair-Man; a Welder; a Machinist; or specialize in motorized farming, with truck, tractor and farm electric-lighting and farm engine training. Classes are always open. You need make no special arrangements—you can start at once—now—and that's the thing to do.

Life Scholarship Your enrollment entitles you to a life membership, with privilege of our service any time you want it. Many students come back to brush up on latest automotive ideas and new equipment. It doesn't cost a penny extra. The position of the M. S. A. S. (The Detroit Auto School) in the heart of this industry, insures most thorough, most practical, systematic training, at a cost so low and terms so easy that any man, anywhere, can afford it.

Earn While You Learn If necessary we can assist students to secure part time work to earn a small amount each week. Or students who wish to take our evening course will be assisted to full time day jobs. Ask for details, and in writing, please explain your circumstances fully.

MICHIGAN STATE AUTOMOBILE SCHOOL

The Factory Endorsed School



Read What Factories Say:

MAXWELL MOTOR SALES CORPORATION AUTOMOBILES DETROIT, MICH.

"We heartily recommend to you the Michigan State Auto School. We consider this one of the best in the country and their instruction will give you a complete education in motor car mechanics. There is an immense demand for properly trained men in this business."



BUICK MOTOR COMPANY

"We believe the MICHIGAN STATE AUTO SCHOOL, Detroit, would best meet your requirements, as its course of technical training is most thorough and complete in every detail."

THE STUDEBAKER CORPORATION OF AMERICA

"We do not know of a better automobile school than the MICHIGAN STATE."



HUDSON MOTOR CAR COMPANY

DETROIT, MICH., U.S.A.

"This school is thought very highly of by the automobile men of Detroit, and is considered one of the best equipped and most efficient schools in the country. You will make no mistake in attending the M. S. A. S."

Big Money Business

Have Success Like This

Here is Bradley—merely one of thousands of M. S. A. S. students who have achieved success far beyond their fondest hopes. What these men have done you can do. The opportunities are now greater than ever. There are more autos—more trucks—more tractors and every year adds to the money-making possibilities. You have ambition—you want success. Success is certain if you are willing to work for it. You can have independence—be your own boss—stop the plodding and get into work you like. You can earn big money, be prosperous, happy and independent. Bradley is no exception, we have graduates who have made as high as \$10,000 in less than a year. These records may seem amazing, but they are only ordinary. It is all done through head and hand training at the M. S. A. S. Decide now to give yourself the training that will pay you big and establish you in a successful life work.

Detroit-Trained Auto Men Earn More Money

Detroit-trained men are preferred. Your diploma from the M. S. A. S. is a valuable money-making asset—an advantage that you can get from no other school. The Michigan State Automobile School is known the world over. Wherever autos are used—Detroit-trained men get the best jobs, highest pay. Auto, truck, tractor factories employ M. S. A. S. graduates. Leading factories, dealers, service stations, garages, shops and farms want men who have trained their heads as well as their hands—the M. S. A. S. Detroit-kind.

Good Positions Open Right now the demand for men who know automotive mechanics and electricians is greater than the supply. We have more calls than we can fill. The years ahead are predicted to be the biggest years of the industry. Every Detroit plant has increased its production. Most are working over-time. All are behind on orders, and that means certain money-making advantages to men who start in the business now.

Mail This Coupon

Get all the interesting facts from our new big catalog. It's a book of information concerning **your future** that you must not fail to get. It gives complete information about all courses, which makes it easy to decide. It's alive with photos of classes, school, equipment and graduates. It tells you how you can get a good paying job—how you can go into business for yourself with little capital. Let us send it to you **FREE** without obligation. Mail the coupon or send us a postcard today. Write now.

Radio Included All students of our Complete Auto and Tractor Courses, until further notice, are entitled to our course in Radio Telegraphy and Telephony, without extra charge.

A. G. ZELLER, Pres. and Gen. Mgr.

307 Auto Bldg., 3729 Woodward Avenue
DETROIT, MICHIGAN

**From \$12⁰⁰ a Week
to
\$500⁰⁰
a Month**



H. S. Bradley

Read Bradley's letter below. It's his own story of the credit he gives to M. S. A. S. for his success. The success you can enjoy, too, if you accept this opportunity.

BRADLEY GARAGE
Distributor Vesta Storage Batteries
ALEMITE LUBRICATOR SERVICE
Automobile Repairing

Michigan State Auto School,
Detroit, Mich.

Gentlemen: I wish to state that before going to your School I was employed as shipping clerk with a well-known concern at the enormous salary of \$12 per week. Incidentally, this included over-time. I knew absolutely nothing about an automobile. I couldn't even drive one and didn't know the difference between a carburetor and a wheel-base; in fact, I didn't know they had a wheel-base.

After leaving the School I worked as service repairman for the Oakland Motor Company of Pontiac, Michigan. I left the Oakland to accept a position as night service foreman for the Studebaker Company of Detroit and was later connected with such firms as the Northway Motor and Manufacturing Company, and the Continental Motor Manufacturing Company. I have since been service manager for two large concerns—one in Detroit and one in Cleveland. The salary mounted all the time—the last position paying me \$300 per month.

I then decided to go in business for myself, which business I have successfully built and maintained up to the present time and expect to maintain for a long time to come. I estimate the present earnings of my business at \$500 per month clear and growing all the time.

I believe that the M. S. A. S. is by far the best School of its kind in the country. For the man who will apply himself to the work and to the studies, I can safely say that the Michigan State Auto School is the best place to learn the automobile business.

Yours very truly,
H. S. BRADLEY.

FREE

CATALOG
MICHIGAN STATE
AUTO SCHOOL

Mail Coupon To Day

MICHIGAN STATE AUTO SCHOOL
307 Auto Bldg., Detroit, Mich.

Gentlemen:—Send **FREE** and without obligation, your big catalog, and Auto School News, giving complete information and showing the opportunities and advantages of a Detroit-Training to make the most money.

Name.....

Street or R. F. D.

City..... State.....



"Harris is the man for the Job"

"He thinks ahead. He puts in his spare time studying."

A group of executives were conferring about the filling of an important position.

It wasn't strange that they picked for the place an employe who had the foresight to prepare for bigger responsibility. The vote was unanimous. And yet they did only what employers usually and gladly do for the man who gets ready for opportunity.

Be a man like Harris! If you have the ambition, the United Y. M. C. A. Schools will furnish the way, no matter where you live or what your working hours are. Let us tell you about the new type of correspondence instruction that brings the student the most up-to-date courses and the most personal kind of service at a very reasonable cost.

Marking and mailing the coupon below will not obligate you but will bring a copy of a stimulating booklet, "Head and Shoulders Above the Crowd—How to Get There," and our friendly counsel.

Tear Out and Send This Slip

United Y. M. C. A. Schools' Correspondence Courses,

or positions for which they afford training:

Accountant	Factory Management	Salesman
Advertising Man	Farm Management	Secretarial
Agricultural Courses	Foreign Languages	Shorthand and Type-writing
Architect	High School Subjects	Steam Engineer
Auto Mechanic	Foremanship	Structural Drafting
Banking	Highway Engineering	Surveyor
Better Letters	Machine-Shop Practice	Tool Designing
Bookkeeper	Leadership Courses	Tractors and Farm Machinery
Building Construction	Locomotive Operator	Traffic Management
Business English	Mathematical Courses	Use of the Slide Rule
Business Law	Mechanical Engineer	Are You an ex-Serviceman?
Business Organization	Own-Your-Home Course	
Civil Engineer	Plumber	
Civil Service	Poultry Husbandry	
Concrete Engineer	Radio Operator	
Dairy Farming	Radio Engineer	
Draftsman	Railroad Engineering	
Electrician		
Electrical Engineer		



United Y.M.C.A. Schools

375 Lexington Ave.
New York City.

Without obligating me, please advise regarding the

..... COURSE.
Age and Occupation.....
Name.....
Full Address.....
2-3y (Please write plainly)

A PROFESSIONAL TONED INSTRUMENT FREE



Teaches Quickest

For Violin, Mandolin and Mandolin Banjo

Become a Musician

I teach you personally with my course of music instructions on phonograph records—instant results. Anyone can learn to play these three instruments in a few days and can learn to teach and make big money in sixty days.

This Simplified System covers the first two years of study as taught in all the leading music colleges and schools in the United States and Europe. The name Schneider is linked with the leading concert artists and teachers of the country. The first lesson will teach you to read music in fifteen minutes and it will not cost you a cent if you do not go ahead with the study. I will send the first lesson, on reading notes, on a full size phonograph record, also an instruction chart free, and will give you complete particulars about the entire course. Just enclose check or money order for \$1.00 to cover packing and the record (which can be used on any phonograph) and chart are yours to keep whether you take course or not. If you return the record, your money will be refunded. Address **F. M. Schneider, Director, SCHNEIDER SCHOOL OF MUSIC 238 Vermont Street, Blue Island, Ill. (A Suburb of Chicago)**

Work while learning Electricity

Set of tools given to producers. Write

S & H ELECTRICAL WORKS.

Dept. G. 1, 368 So. Green St., CHICAGO

How I Improved My Memory In One Evening

I used to have a wretched memory, now I can retain and recall at will any number of facts, figures, names, addresses, telephone numbers, points I want to recall when making a speech, or selling, statistics, anecdotes, stories—in fact whenever I commit anything to my memory it is never lost and I can always recall it. I learned the amazingly simple method in one evening through the

Roth Memory Course

This wonderful method teaches through "mental movies." Simple, interesting, and quick-to-learn—yet so practical and accurate that in a short time any poor memory can be quickly changed to one performing startling feats. This method is mailed anywhere FREE. Keep it for 5 days and if not perfectly satisfied return it and owe nothing. If you decide to keep it, as you surely will—send only SPECIAL PRICE of \$3. 200,000 people have paid \$5 or more for same course. No money now, just write letter or post card and course will be instantly mailed. You do not risk one cent. Pay after 5 days ONLY if satisfied.

Independent Corporation, Dept. R-457, 22 West 19th St., New York.

Amateur Electrical

Experimenters

Here is the book you have been waiting for. It tells how to make things electrical, such as radio outfits, reading lamps, electric clocks, toasters and countless other useful appliances from materials easily obtainable. No previous electrical knowledge necessary. Clear directions, fully illustrated.

How to Make Things Electrical

427 pp. — 256 Articles — 353 Illustrations

4 1/2 x 7 Cloth

Price \$2.50 Postpaid



Popular Mechanics
Book Dept.
6 N. Mich. Ave., CHICAGO

RECEIVE the sporting news, concerts, children's stories and lectures. Free to the world.

ANEW type of crystal receiver, simple in construction yet giving marvelous results.

DETAILED in my book, "Specifications for Radio Telephone Type CRR."

IT COVERS complete instructions, from the erection of the aerial to the finished machine.

ONLY 50c for this illustrated book, with international code, symbols used in radio, etc.

RAYMOND J. HENDRICKSON

118 Springfield Ave. Westerleigh, Staten Island, N. Y.

BIG PROFITS FROM POULTRY

We Teach You How; Easily Learned at Home;

our guaranteed methods make success certain; write for free book, "How to Raise Poultry for Profit," Free. Don't delay; write today.

The National Poultry Institute, Inc., Dept. 312, Washington, D. C.



LEARN AUTOMOTIVE ENGINEERING

A business for "live wires." There is a constant demand for trained Repairmen, Chauffeurs, Truck Drivers, Demonstrators, Automobile Salesmen, Garage Managers, etc.

COURSES \$25 AND UP

Positions secured for all competent graduates without charge. Diplomas granted. Write for free booklet.

GREER COLLEGE OF AUTOMOTIVE ENGINEERING
2057 Wabash Ave. Chicago, Illinois

Factory to Rider

Saves \$10 to \$25 on the Ranger Bicycle you select. You can have your choice of 44 Styles, colors and sizes. Delivered free on approval, express prepaid, for 30 DAYS' FREE TRIAL.

12 Months to Pay If desired, Possession and use at once on our liberal year to pay plan. Parents often advance first payment.

Best quality, at factory prices, express prepaid. Tires, lamps, wheels and equipment, low prices. Send No Money, do business direct with makers.

Mead Cycle Company
Dept. F108 Chicago

Write today for free Ranger Catalog. Factory prices and marvelous easy payment terms.



How to Box 40c

By Terry McGovern, James J. Corbett, J. Gardner Smith, M. D., Arthur P. Keeley and Gus. E. Keeley.

How to Box to Win, How to Build Muscle, How to Punch the Bag and How to Stand, Walk or Run.

This interesting book written by experts is known also as "The Book of Health and Strength." It will greatly assist everyone in keeping fit, in putting them in condition to master a strenuous undertaking either physical or mental.

43 illustrations. Size 4 1/2 x 7 1/2 in. Paper copy. 135 pages
SHREWSBURY PUBLISHING CO.
5523 West Lake Street, Chicago, Ill.

Don't Wear a Truss

Brooks' Appliance, the modern scientific invention, the wonderful new discovery that relieves rupture, will be sent on trial. No obnoxious springs or pads.



MR. C. E. BROOKS

Brooks' Rupture Appliance

Has automatic Air Cushions. Binds and draws the broken parts together as you would a broken limb. No salves. No lies. Durable, cheap. Sent on trial to prove it. Protected by U. S. patents. Catalog and measure blanks mailed free. Send name and address today.

BROOKS APPLIANCE CO., 126C State St., Marshall, Mich.

The Letter That Saved Bob Johnson's Job

—and paved the way for a better one!

IT was written to his employer by the International Correspondence Schools. It told how "Robert Johnson had enrolled for a course of home-study and had received a mark of 94 for his first lesson."

Bob answered the summons to the Chief's office with just a little fear and trembling, for a lot of men were being dropped—a lot more were having their pay reduced.

But as Bob came in, his employer did a surprising thing. He got up quickly from his desk and grasped Bob warmly by the hand.

"I want to congratulate you, young man, on the marks you are making with the I. C. S. I am glad to see that you are training yourself not only for your present job but for the job ahead.

"We're cutting the pay-roll. Until I received this letter, I had you in mind as one of the men to be dropped. But not now. Keep on studying—keep your eyes open—and pretty soon there'll be a better job for you around here. We're always looking for trained men."

Won't you let the I. C. S. help you, too? Won't you trade a few hours of your spare time for a good job, a good salary and the comforts that go with it? Then mark the work you like best on the coupon below and mail it to Scranton today. That doesn't obligate you in the least, but it will be your first big step towards success. *Do it now!*

INTERNATIONAL CORRESPONDENCE SCHOOLS Box 5650-C, Scranton, Penna.

Without cost or obligation, please send me full information about the subject before which I have marked an X in the list below:

BUSINESS TRAINING DEPARTMENT

- | | |
|---|---|
| <input type="checkbox"/> Business Management | <input type="checkbox"/> Salesmanship |
| <input type="checkbox"/> Industrial Management | <input type="checkbox"/> Advertising |
| <input type="checkbox"/> Personnel Organization | <input type="checkbox"/> Better Letters |
| <input type="checkbox"/> Traffic Management | <input type="checkbox"/> Foreign Trade |
| <input type="checkbox"/> Business Law | <input type="checkbox"/> Stenography and Typing |
| <input type="checkbox"/> Banking and Banking Law | <input type="checkbox"/> Business English |
| <input type="checkbox"/> Accountancy (including C.P.A.) | <input type="checkbox"/> Civil Service |
| <input type="checkbox"/> Nicholson Cost Accounting | <input type="checkbox"/> Railway Mail Clerk |
| <input type="checkbox"/> Bookkeeping | <input type="checkbox"/> Common School Subjects |
| <input type="checkbox"/> Private Secretary | <input type="checkbox"/> High School Subjects |
| <input type="checkbox"/> Business Spanish | <input type="checkbox"/> Illustrating |
| <input type="checkbox"/> French | <input type="checkbox"/> Cartooning |

TECHNICAL AND INDUSTRIAL DEPARTMENT

- | | |
|---|--|
| <input type="checkbox"/> Electrical Engineering | <input type="checkbox"/> Architect |
| <input type="checkbox"/> Electric Lighting | <input type="checkbox"/> Contractor and Builder |
| <input type="checkbox"/> Mechanical Engineer | <input type="checkbox"/> Architectural Draftsman |
| <input type="checkbox"/> Mechanical Draftsman | <input type="checkbox"/> Concrete Builder |
| <input type="checkbox"/> Machine Shop Practice | <input type="checkbox"/> Structural Engineer |
| <input type="checkbox"/> Railroad Positions | <input type="checkbox"/> Plumbing and Heating |
| <input type="checkbox"/> Gas Engine Operating | <input type="checkbox"/> Chemistry |
| <input type="checkbox"/> Civil Engineer | <input type="checkbox"/> Pharmacy |
| <input type="checkbox"/> Surveying and Mapping | <input type="checkbox"/> Automobile Work |
| <input type="checkbox"/> Mine Foreman or Engineer | <input type="checkbox"/> Navigation |
| <input type="checkbox"/> Steam Engineering | <input type="checkbox"/> Agriculture and Poultry |
| <input type="checkbox"/> Wireless | <input type="checkbox"/> Airplane Engines |
| <input type="checkbox"/> Mathematics | |

Name.....
Street.....
Address.....

City..... State.....

Occupation.....

Persons residing in Canada should send this coupon to the International Correspondence Schools Canadian, Limited, Montreal, Canada.

THE SCIENTIFICALLY BUILT WATCH

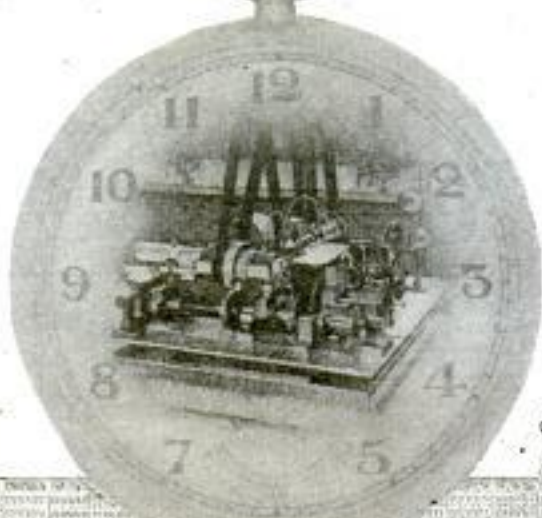

MECHANICAL

PERFECTION



Small Thimble
Holds 47,000 Screws

Forty-seven Thousand Screws In a Small Thimble

AND every one a tiny, shining piece of perfection—and every one made automatically by the marvelous screw machine (illustrated above) invented and developed by Waltham mechanical genius for this important unit in the works of a watch.

One half turn, one way or another, of a certain screw in your watch, would make the time vary ten seconds a day.

For years, all watch screws were made by hand, which caused variable time in most watches.

It was Waltham achievement that overcame this universal problem, and the screws made by this truly wonderful machine are so perfect that any one can be used in place of another in that part of the watch in which they are used.

This standardized interchangeability in Waltham Watches is responsible for their world-famed dependability, their life-long service to the owner, and it is also a positive assurance of the lowest up-keep cost.

A Waltham Watch is an investment—it provides many reasons why a lady or gentleman is wise to insist upon this master time-piece in preference to all others.



Waltham 7½ Ligne

Carved Case, Green or White Gold
Price \$210.00

Makers of the famous Waltham air-friction quality Speedometers
and Automobile Time-pieces used on the world's leading cars

WALTHAM

THE WORLD'S WATCH OVER TIME

Where you see this sign they sell Waltham Watches

GIFTS THAT LAST

draws. - info. J. Willard Sherman H. M. Catron Sulphur Springs Swimming Pool Sulphur Springs Fla. Park.

Popular Mechanics Magazine

REGISTERED IN U. S. PATENT OFFICE

WRITTEN SO YOU CAN UNDERSTAND IT

Vol. 38

JULY, 1922

No. 1

9130

Water-Slide Toboggan New Summer Sport

FASHIONED after the slides erected for the children at the beaches and parks, a water toboggan slide has been built at Sulphur Springs, near Tampa, Fla., which is claimed to be a real thriller. The chute is 45 ft. high and 125 ft. long, and ends in a gradual curve at the surface of the water. Bathers using the slide sit on wooden toboggans large enough for two persons, which are released by an attend-

ant at the top of the slide. The toboggans slide on tracks that are lubricated with water, and attain a speed of 80 miles an hour by the time they reach the bottom of the chute. After leaving the chute, the toboggans often glide a distance of 200 ft. over the surface of the pond, and may be guided as one would guide a sled on the snow. The toboggans are returned to the top of the slide by an elevator.

Wm. Catron + Sherman, Sulphur Springs Park, Fla.



The Toboggans Used on This Water Slide Are Large Enough to Accommodate Two Passengers, and Travel on Wooden Runners Which Fit into Wooden Guide Tracks Kept Lubricated with Water Pumped to the Top of the Tower by Electric Pumps

Above: The Water Toboggan Slide Is 45 Feet High and the Bathers Ride Down on Wooden Toboggans Which are Released by an Attendant at the Top of the Slide. The Slide Curves Gently to a Horizontal Position near the Bottom, and Ends at the Water's Edge, a Speed of 80 Miles per Hour being Attained When Leaving the Slide. Right: Stairs are Provided at One Side of the Slide for the Bathers, While the Toboggans are Raised by an Elevator at the Back

**ELECTRIC STEAM RADIATOR
HEATS TEA WAGON**

9208

Serving tea from a copper-covered tray placed on a five-coil radiator heated by electricity, the whole being mounted on

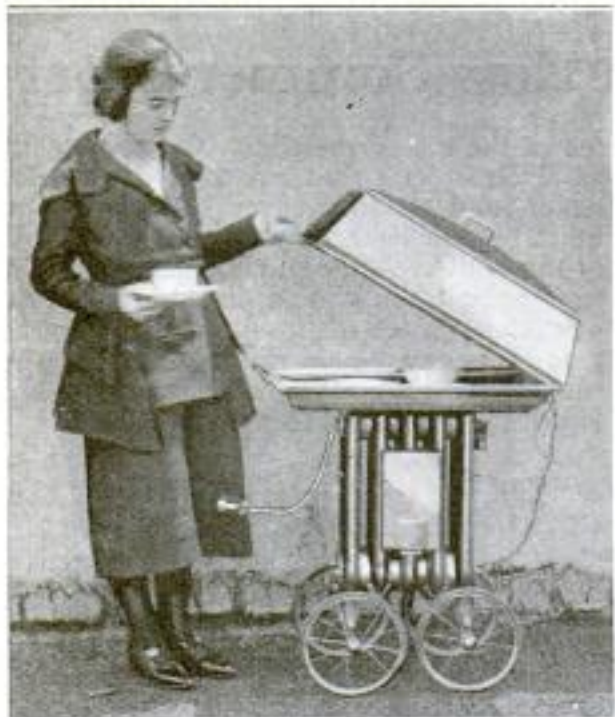

Tea Wagon and Copper-Covered Tray, the Contents of Which are Heated by an Electric Steam Radiator

rubber-tired wheels, is the latest innovation in this line. The heating element is submerged in water in the bottom of the coils, and has the usual cord and plug for connection to any light socket. The outfit possesses a thermostatic attachment which regulates the steam pressure by switching the current off and on at certain temperatures, and with the apparatus electrically disconnected entirely, the food will remain for a half hour in a proper condition for serving.

**UNIVERSAL AMPLIFIER AIDS
RADIO COMMUNICATION**

Universal amplifiers for radio communication have lately been successfully tested by the Bureau of Engineering of the Navy Department, according to an announcement by Secretary Denby. A six-stage apparatus has been constructed which yields practically the same amplification over a range extending from a wave length of some hundred meters up to one in the vicinity of 20,000 meters.

**MUD RIM PREVENTS SKIDDING
ON SLIPPERY ROADS**

Slippery dirt roads, the bane of motorists, have been safeguarded against by the production of a metal mud rim, which is fastened to the tire in a manner somewhat similar to that used with the common chains. With this accessory, which can be attached in two minutes, the driver can travel safely over muddy roads, turn in and out of deep ruts at will, and always have the car under complete control, since skidding is practically impossible.

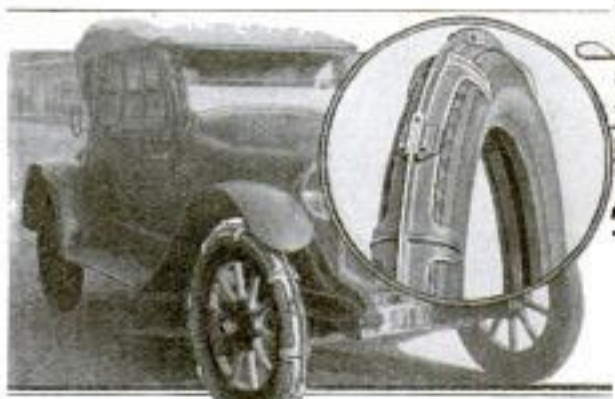

Metal Mud Rim Fitted to Automobile Tire for Prevention of Skidding on Muddy Roads: The Insert Shows How the Rim is Attached to the Tire

STATELY LINCOLN MEMORIAL DEDICATED

9211

It seems particularly fitting that Memorial Day should have been chosen for the dedication of the Lincoln Memorial in Potomac Park, Washington. Plans and preparations have been going forward for more than 10 years, and the result is worthy of the time and patient effort expended, for the beautiful and impressive structure reflects in its simple strength the character of the man in whose honor it was erected. Standing as it does near the Potomac River, and harmonizing with its beautiful surroundings, the memorial is isolated from other buildings, but is yet

easy of access for visitors. The structure is 156 ft. long by 84 ft. wide, and is situated on a terrace, so that its height is 122 ft. above the roadway grade. The central chamber contains only the heroic statue of the immortal Lincoln, seated, facing toward the capitol. The side rooms, separated from the main chamber by columns, contain large tablets on which appear the texts of his Gettysburg and second-inaugural speeches, while mural paintings, 12 by 60 ft., show in allegory the subjects "Emancipation" and "Reunion."

W. J. Miller, Research Laboratory
 Radio, Washington, D. C.

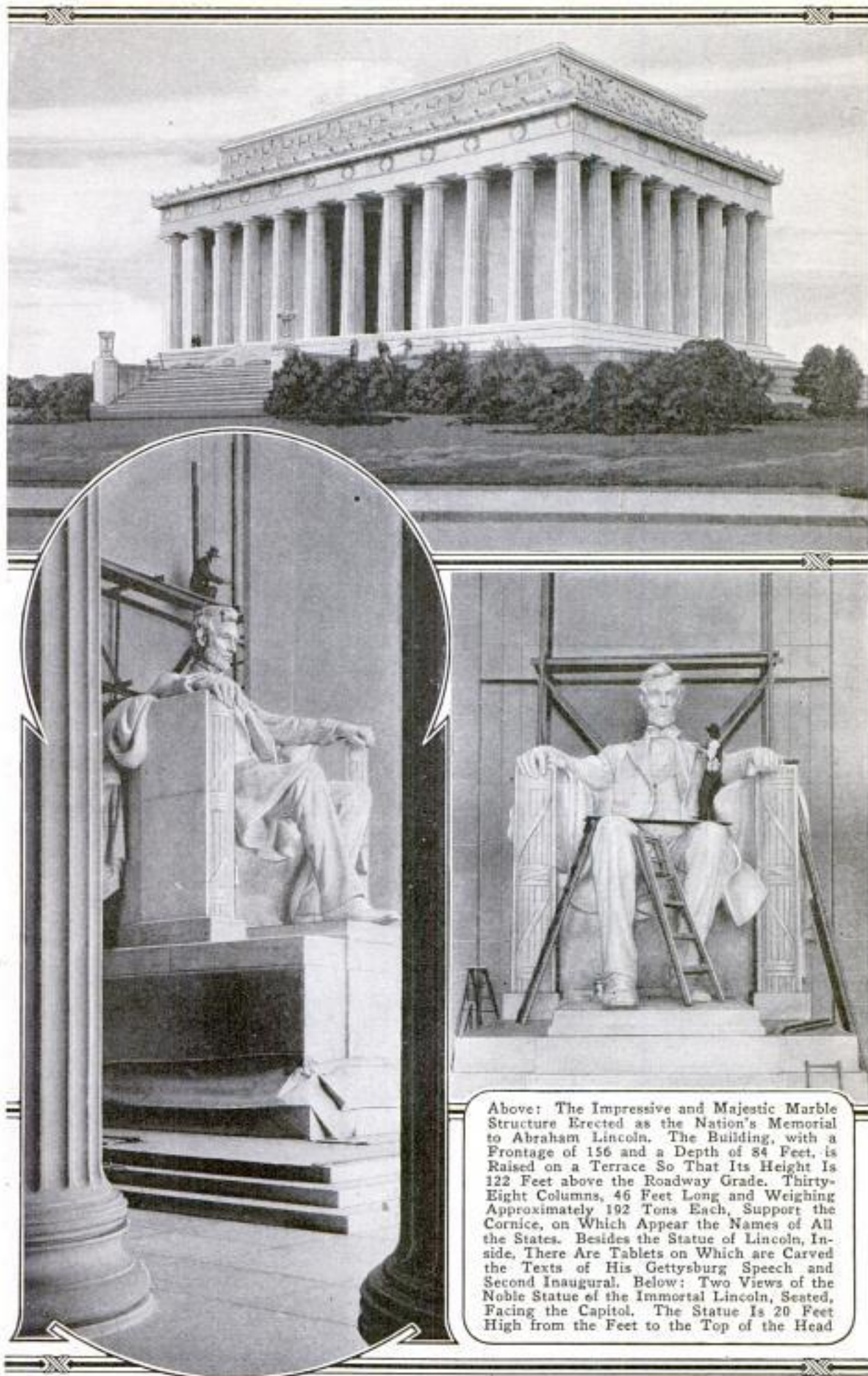

Above: The Impressive and Majestic Marble Structure Erected as the Nation's Memorial to Abraham Lincoln. The Building, with a Frontage of 156 and a Depth of 84 Feet, is Raised on a Terrace So That Its Height Is 122 Feet above the Roadway Grade. Thirty-Eight Columns, 46 Feet Long and Weighing Approximately 192 Tons Each, Support the Cornice, on Which Appear the Names of All the States. Besides the Statue of Lincoln, Inside, There Are Tablets on Which are Carved the Texts of His Gettysburg Speech and Second Inaugural. Below: Two Views of the Noble Statue of the Immortal Lincoln, Seated, Facing the Capitol. The Statue Is 20 Feet High from the Feet to the Top of the Head

N.Y. Times 5/3/22 p. 10
Col. 2.

49048

POPULAR MECHANICS

BALLET DANCER PERFORMS ON TYPEWRITER KEYS

Operating the keys of a typewriter with her toes is the accomplishment of a

POISONED IN ONE APARTMENT BY FUMES FROM ANOTHER

One morning, a short time ago, the bodies of a man and his wife, both over 70 years of age, were found lying on the bathroom floor of their apartment in a Brooklyn hotel. An autopsy proved that both had been poisoned, and yet there was no trace of any kind of poison within the apartment. There were no conditions existing that suggested the possibility of either suicide or murder. It was finally discovered that the rooms immediately below the apartment had been fumigated just before the death of the couple, and investigation showed that apertures for steam and water pipes extended upward into the fatal apartment. There was reason to believe that the fumigating drug was some form of prussic acid, and that the fumes had reached the bathroom above through these apertures, and thus poisoned the aged couple. Similar cases have occurred elsewhere.



Left: Ballet Dancer Balancing with One Toe on Roller Carriage of Typewriter, with the Other Free to Tap the Keys. Right: Beginning the Dance

talented ballet dancer now appearing on one of the vaudeville circuits in this country. Balancing with one toe on the roller carriage of the machine, the performer gracefully sways and gestures in perfect time with the music. With the other toe, as she bends low in rhythm with the melody, she lightly and accurately taps certain keys and the space bar. At the conclusion of her entertainment, amidst the customary admiring applause, the dancer usually tosses the neatly written note which reads, "I thank you," to some person in the audience as a souvenir.

CAT-TAIL GROWTHS PROVED BENEFICIAL FOR HOGS

Hogs, to the number of 60 head, were recently turned into a three-acre cat-tail swamp by a New Mexico farmer as an experiment to determine the practical value of this growth as a food for these animals. At the end of three months when the hogs were examined, it was found that all had received sufficient nutriment to keep them in good flesh, and none was discovered to be suffering from any illness or digestive disturbance.

ADJUSTABLE LOCK AVAILABLE FOR STEERING WHEEL

Safeguarding an automobile against thieves is aided by the introduction of a combined steering wheel and lock of case-hardened steel. The accessory is easily installed, and said to be immune from being "picked," and as an added feature,

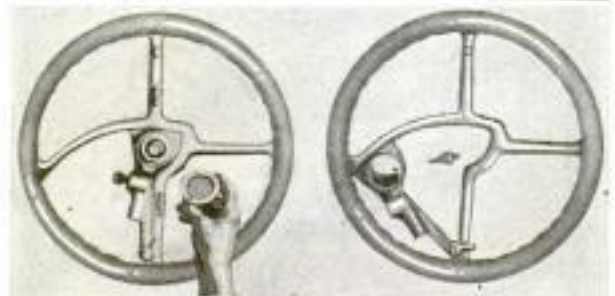

Left: Adjustable Steering Wheel Ready for Driving. Right: Wheel Swung Aside for Driver to Alight

it can be swung aside several inches, so that the driver has more space when getting in or out of the machine.

Stout's Mfg. Co. Inc.
Lockport, N.Y.

Emb. Hogg & Ford 416 Union League Bldg
Los Angeles, Calif.

Science
4/28/22

9273

9024

Auto Area

9118

Westinghouse Electric + Mfg. Co.

POPULAR MECHANICS

East Pittsburgh, Pa.

5

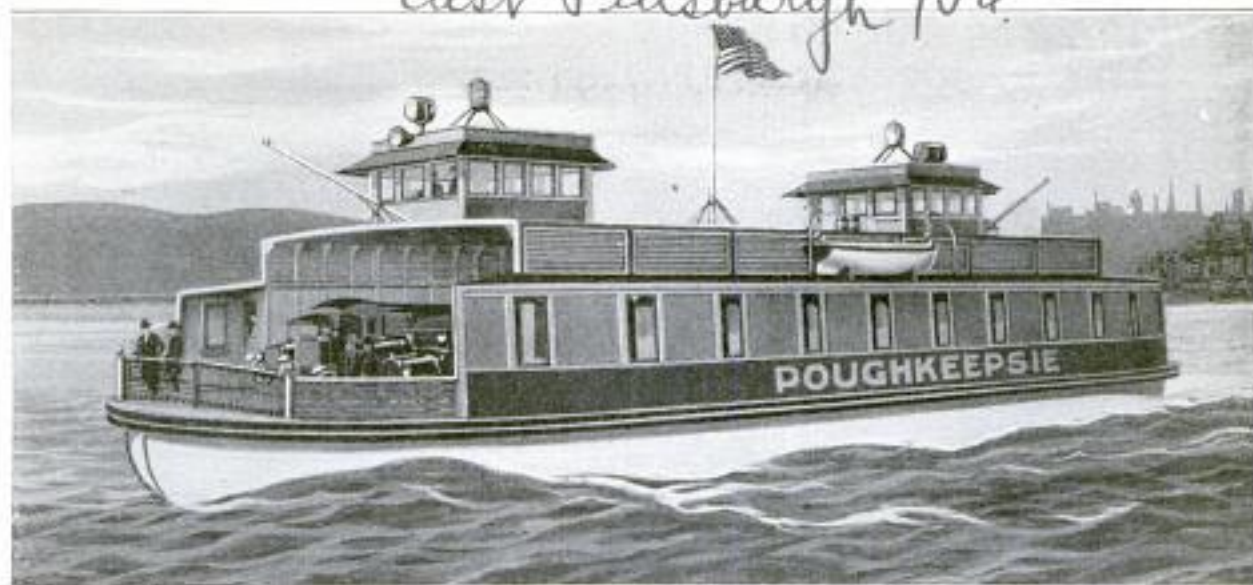

Ferryboat to Be Ready for Service, This Summer, across the Hudson River, between Poughkeepsie and Highlands: There Is Neither Smokestack nor Engine Room above the Main Deck

9118

OIL-ELECTRIC FERRYBOAT ON THE HUDSON RIVER

Motorists crossing the Hudson River between Poughkeepsie and Highlands, N. Y., this summer, will find at their service a new ferryboat that will excel anything of the kind they have ever seen before. The vessel, now under construction, will be of exceptional capacity, and will be electrically propelled. The generators are to be driven by heavy-oil engines, and the whole power plant is to be installed in the hull beneath the main deck. Consequently, there will be no engine room or smokestack to interfere with this deck, which will be housed in, and have four uninterrupted driveways for automobiles, giving a car-carrying capacity about double that of a similar steam-driven vessel. The entire control of the motors will be in the pilot house, where the pilot will run the ferryboat much in the same way as a driver runs an electric street car. The control of the electric propelling system is so flexible that it will be possible to stop and reverse the vessel in a few seconds.

Like horses, which were superseded by the automobile, the hurdy-gurdy is now being displaced by radio in New York City. A receiving set mounted on a motor truck is said to be attracting larger crowds than ever stopped to listen to the familiar old instrument.

9093

ROLLING CRUTCH WITH CHAIR FASTENED TO FRAMEWORK

Invalids and cripples have been benefited by the introduction of a rolling crutch which has a chair fastened to the



Rolling Crutch with a Chair Fastened to the Framework on Which the Patient Rests While being Wheeled to or from the Place Chosen for Exercise

framework. The contrivance is constructed of the lightest steel tubing, has ball-bearing, rubber-tired wheels, and is narrow enough to pass through the ordinary door. Thus the patient can be placed in the chair and wheeled to the spot chosen for exercise, after which the afflicted person again rests on the seat while the apparatus is taken back inside of the hospital, sanitarium, or home, with only a minimum of effort.

M. W. Scott 600 S.
Tremont St., Newane, N. Y.
U.S. + maker of it.

Detroit Mich
**VOLTMETER OF HANDY DESIGN
FOR BATTERY CHECKING**

Rapid checking of batteries to ascertain their voltage is aided by the employment of a voltmeter of handy design, which is



manufactured in Detroit. Instead of having two flexible wires, or leads, to connect with the battery, the new appliance possesses a pair of rigid studs, or contacts, and a convenient handle. The mechanic can thus quickly test the different cells, using only one hand, and writing down the readings with the other. A scale with its zero at the center eliminates the danger of reversing the instrument, as the indicating needle swings in either direction.

ings with the other. A scale with its zero at the center eliminates the danger of reversing the instrument, as the indicating needle swings in either direction.

928
**DISK WHEELS OF STEEL MADE
IN LIGHT WEIGHTS**

Disk wheels of steel, heretofore found much too heavy for use on the common makes of light motor cars, are now being manufactured in weights that total but a few ounces more than the corresponding sizes in wood. Light-gauge metal is used in the construction of the wheels, which are radially corrugated and made either with or without hubs and are welded into standard felloes for taking either straight-side or clincher rims.

WORK ON NEW NEBRASKA STATE CAPITOL BEGUN

Work has been started at Lincoln, Neb., on the new state capitol, which is to be one of the most remarkable buildings of the kind in the country. Its dominating feature will be a tower, soaring 400 ft. into the air, of substantial proportions and capped with a graceful dome. Around this tower the building is disposed in the form of a square, flanked by terraces, each side being 437 ft. long. This part of the building will be only two stories high,

9281
**NEW HYDROSTATIC APPARATUS
TESTS CONCRETE PIPES**

Hydrostatic tests on single lengths of concrete pipes are now being made, in California, without the use of false ends and tie-rods. The apparatus consists of two aluminum cylinders fitting one inside the other and each having flanged ends with a space between the flanges for a tubular gasket. These flanges fit tightly into the interior of the pipe under test, and water pressure is supplied to the gaskets and the space between the outer aluminum cylinder and the interior of the pipe. Up to the present 150 lb. per square inch is the safe limit for the apparatus. Improvements will raise this limit considerably.

9212
**MOTOR-DRIVEN SCALING TOOL
CLEANS METAL SURFACES**

An electrically driven scaling tool for effectively removing rust and scale from



metal surfaces, now in use in England, is in the form of a handle large enough to be grasped by both hands, with a head at one end in which a revolving scraper is driven by a flexible shaft coupled to it at the other end. The tool is

used for cleaning boilers, for scaling ships' bottoms, and for other work of the same nature.

*Frank Silman
Mfr. Birmingham England.*

with an entrance building considerably higher that is fronted by a flight of stairs of ample width leading from the terrace to the street level. To expedite construction, a railway is being built through the city to the capitol grounds, so that no transshipment of the building material will be needed. An electric motor car will haul the freight cars on this railway. The new capitol will cost \$5,000,000, and will take five years to build.

9218

928

*9 Motor Wheel Corp
Lansing, Mich
9/162*

Cont: Renabelle Kirkland 1324 H St.
9162 Lincoln, Nebr.

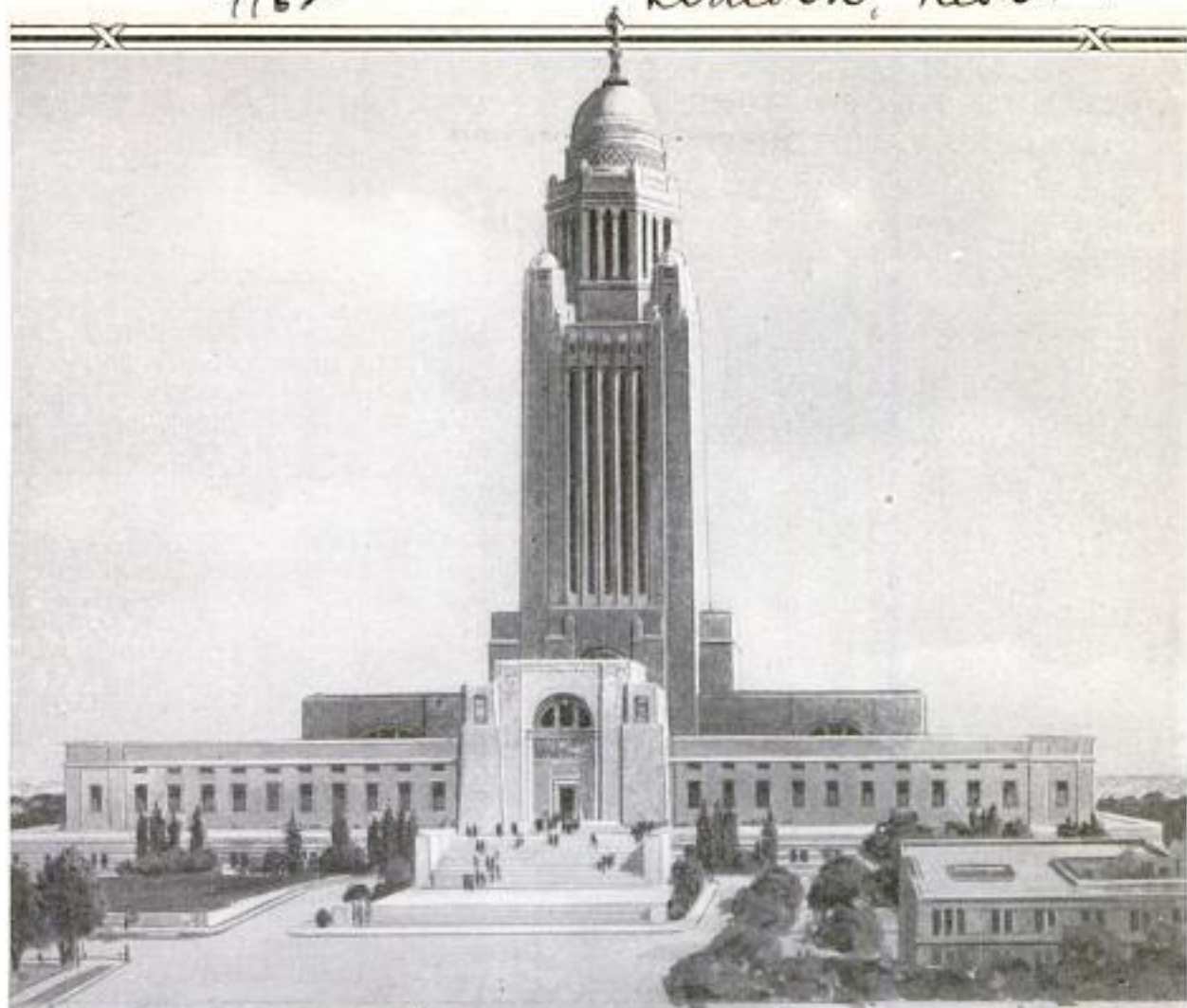

Above: Perspective View of the New Nebraska State Capitol, Now under Construction at Lincoln, Which It will Take Five Years to Complete. The Dome-Capped Tower in the Center of the Quadrangular Building is 400 Feet High. Each Side of the Building is 437 Feet Long. Below: Electric Motor Car That Hauls from Three to Five Freight Cars on the Railroad That has been Specially Built to Facilitate Transportation of Materials



Above: Old State Capitol, in Another Part of Capitol Square, Which will Not be Torn Down Until the New Building is Completed. Around the Square is a Railroad Track Specially Built to Connect with the Track to the Main Railroads



Above: Looking down H Street, Where the Track is being Laid to Connect with the One around Capitol Square. The Property Owners Objected Strenuously to the Prospect of Having Freight Cars Rumbling past Their Windows, but without Effect

Kadel + Herbert

Cmt. Harold B. Say
of Portland Telegram

Cmt. C. A. Briggs
1521 Oak St. N.W.,
Washington,
D.C.

POPULAR MECHANICS

Oregon

NOVEL METHOD OF CAPTURING
ESCAPED BLACK BEAR

"AGE-HARDENING" MAKES
ALLOYS VALUABLE

9135 A big black bear in one of the parks of
Portland, Ore., escaped from his cage
recently and caused considerable excite-

9064 Important and very interesting facts
have recently been announced respecting
the "age-hardening" of certain light alloys
of aluminum, of which the well-known
duralumin is one. These alloys have en-
joyed increasing use and value in the arts
and industries on account of the combina-
tion of lightness and strength which is
found in them. Unlike most nonferrous
alloys, the alloys of aluminum can be heat-
treated like steel, to the great improve-
ment of their physical properties. After
undergoing this process, these alloys have
the curious property of being soft im-
mediately after quenching at a tempera-
ture of 500°C. (932°F.), but the hardness
increases with time, and the maximum
hardness and strength is practically
reached in two or three days. This
phenomenon of increasing hardness with
time is known as age-hardening.



After Spending a Day in the Top of This Tree, the
Escaped Black Bear Slid Down into the Cage

ment in that portion of the city. He
finally climbed high up in a fir tree, and
all efforts to induce him to descend failed.
At last a cage was built around the foot
of the tree, and after a day of waiting,
the bear changed his mind about remain-
ing in the air and slid down the tree into
the cage. Park attendants waited pa-
tiently until the bear was in the cage,
when it was a simple matter to return him
to his place in the park.

According to an announcement just
made, it appears that this age-hardening
is produced by silicon, which previously
has been regarded more or less as an
impurity. It is now found that, when the
alloys are quenched, a compound of
magnesium and silicon is retained in an
unstable condition, which in a few days
changes to a more stable form, believed
to consist of particles of magnesium sili-
cide highly dispersed throughout the
aluminum. These particles are so fine
that they cannot be seen under the high-
est-power microscope available, but they
give to the alloys their valuable charac-
teristic of increasing in hardness and
strength after quenching to a point where
they are valuable for many structural pur-
poses. It has been determined that the
hardness reached depends upon the
amount of magnesium silicide present, up
to a certain point, beyond which further
amounts of this compound will not give
increased age-hardening. New alloys
have also been produced, some of which
may be of practical value.

925 MAKE BROOM HANDLE TUBULAR
INSTEAD OF SOLID STICK

In an effort to improve that standard
household utensil, the common broom, an
inventor, using a patented machine, has
succeeded in making a tubular wooden
handle which is much lighter than the
solid stick and yet is strong and straight.
The tube is made of veneer joined with
waterproof glue, and is 1 1/8 in. in diam-
eter, with walls 1/8 in. thick.

Dr. J. H. Proctor
Andover, Mass

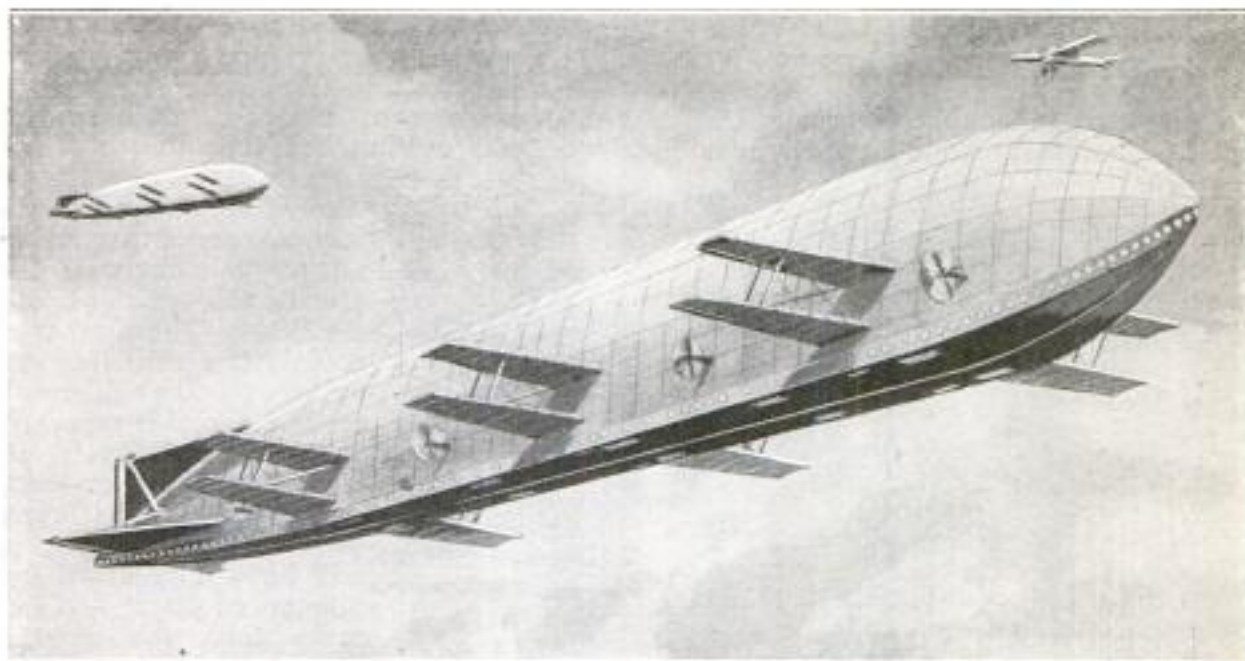

This Passenger and Freight-Carrying Airship has been Designed for Use with the Newly Discovered, Noninflammable Gas in Connection with "Vertical Lift" Devices Placed in Each Pair of Side Wings

9145 **NEW DESIGN OF AIRSHIP WILL USE NONEXPLOSIVE GAS**

As was to be expected, the discovery of a new nonexplosive, noninflammable gas for airships—mention of which was made in the June issue of this magazine—has led to the formulation of plans for the construction of a number of airship carriers for freight and passenger service. In design, the ships will differ from other forms of air craft, as they will be supplied with a central rigid frame and will have wings at the sides. The number of wings, motors, and propellers will depend on the size of the ship. In each pair of wings will be inserted a "vertical lift" device, claimed to be much more efficient than the ordinary propeller, and making it possible for the airship to rise and descend vertically. The noninflammable character of the gas used for lifting makes possible many improvements in design and construction. The new gas has a lifting power almost equal to hydrogen and is said to be cheaper than helium.

9226 **MOLYBDENITE FOUND TO GIVE "PHOTONEGATIVE" REACTION**

Some substances, like selenium, when exposed to the light, decrease in electrical resistance, but it has been found that samples of molybdenite connected with a battery and exposed to green, blue, or yellow light, show higher resistance than when kept in the dark. This is called a "photonegative" reaction. Tests have

Bureau of Standards
 J. N. B. 61

been performed on samples of molybdenite in an effort to determine if the action is reversible, and it has been found that a small electric current is generated when the samples are exposed to light.

9134 **HEDGE-TRIMMING MACHINE OPERATED BY ANYONE**

Trimming hedges, usually a tedious task and one requiring considerable skill, has been simplified by the introduction of a machine for this purpose. This innovation, weighing but 15 lb., is suspended from the shoulders by a strap, the operator steadying the apparatus with one hand and with the other turning a crank which is geared to the high-grade steel cutting bar. The outfit is manufactured in two sizes, one making a 40-in. and the other a 60-in. cut.

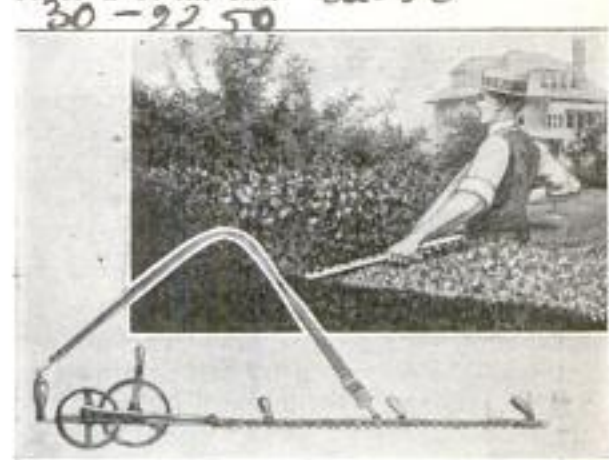

Above: Hedge-Trimming Machine as Used When Cutting the Top. Below: Close-Up of Machine

John C. Uettra
 Machine Co.,
 Lake Mont, Pa.

*Com. L. W. Pedrose
Hinckley Bldg*

POPULAR MECHANICS

9117

Seattle, Wash.

MERCURY-ARC RECTIFIERS
OF LARGE CAPACITY

REFLECTOR CAST IN AMERICA
FOR LARGEST TELESCOPE

Compared in simplicity and reliability with the ordinary transformer, the mer-

Announcement has been made of the successful casting and annealing at Van-

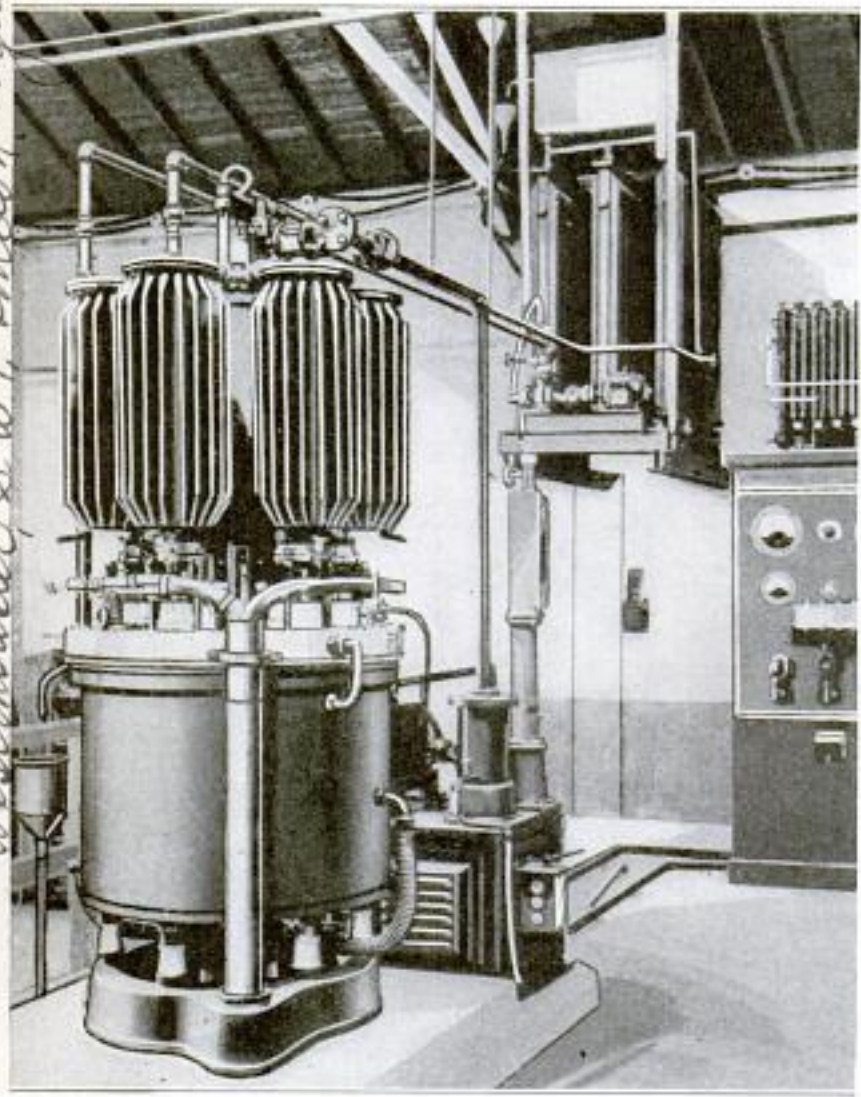

Mercury-Arc Rectifier Which has Recently been Installed in Paris, France, Showing the Piping of the Water-Cooling Apparatus and Also the Necessary Switch Gear and Controlling Panel Board

couver, B. C., of a 10-ton disk for the world's largest reflecting telescope which will be erected this year at Seattle, Wash. The glass was made from sand imported from five different countries, and is reported to have cost \$360,000. It is the largest ever cast, and when it has been ground and silvered, it will have a practical diameter of 10 ft.—19 in. more than the present largest telescope, located at Mount Wilson, California.

The Mount Wilson disk was cast at the St. Gobain works in France. The war hindered the work considerably, and more than three years were required to produce the great block of flawless glass needed. It was said no American glass works would take the contract for the Seattle mirror, and those in Europe were ruined by the war. Finally an astronomer and student of glass processes attached to the Dominion meteorological service accepted the contract to produce the glass in one year.

The huge new reflector was shipped to Seattle on an especially constructed barge and so packed with mattresses and springs that it could not suffer damage. The site for the observatory has not yet been chosen, but it will be in or near Seattle. The project is being built by a local capitalist, and when completed will be known as the Frye Observatory. This will give the Pacific coast the three largest astronomical telescopes in the world, including the Mount Wilson instrument and the Dominion government 72-in. reflector located at Sanich, British Columbia.

ⓂAbout 170 vessels are to be built in Belgium for transporting coal from the Ruhr district on the river Rhine.

cury-arc rectifier has been improved upon until stationary direct-current substations are now a practical possibility. Overcoming serious difficulties, an English concern has developed the rectifier for the satisfactory performance of heavy power work. Units with ratings of 300, 600, and 1,000 amperes, have been standardized for manufacturing purposes at any voltage up to 750, and, with slight modifications, will successfully handle 1,500 volts. These machines can be advantageously operated by connecting two or more units in parallel, and due to their noiseless operation, will no doubt be acceptable in various localities where the sound of the familiar rotary converters would be objectionable.

Brown, Boveri & Co. Ltd. 9 Alder Queens St. Westminster, S.W. 1, London England.

1936
9056

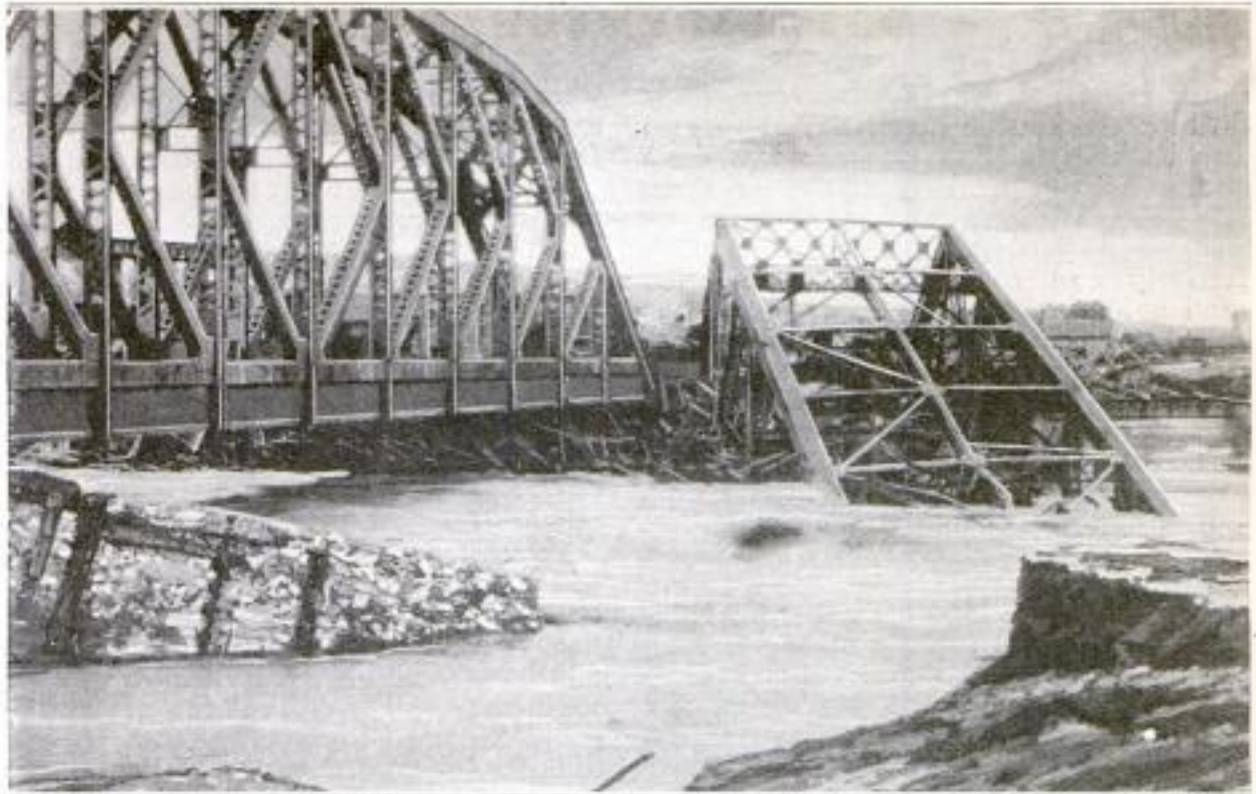

Wreckage of the Denver and Rio Grande Western Bridge at Pueblo, Colorado, the Result of a Flood in the Arkansas River: About 25 Feet Away from the Wrecked Bridge Another, Seen Standing, Carries the Traffic of Four Railroad Lines In and Out of Pueblo

BRIDGE "BOOSTING"—A NEW JOB FOR DYNAMITE

BY H. S. ARBO,

4943 Grand Blvd
Chicago

MANY a time when Nature and man come to grips, all-powerful Nature defies the best efforts of man to overcome her. But in most instances man with ingenious application of his modern resources is the victor. This was the case when Nature and the Arkansas River refused to succumb to ordinary salvage methods, and seemed determined to hold the Pueblo bridge which the swollen, raging torrent had buried deep in the sand and débris at the river bottom.

At the time of the flood last year, the rushing Arkansas River undermined the piles of the bridge of the Denver and Rio Grande Western Railroad, at Pueblo. The piling gone, the great bridge sank deep into the sand and settled there. Then followed a period when the swift current, carrying a quantity of débris, consisting of logs, lumber, mud, and all kinds of drift, piled it high over the fallen structure, imbedding it deeper in the sands and threatening to cause serious damage by damming up the river channel.

Most of the superstructure of the bridge was cut off with oxyacetylene torches and carried to the bank by cranes. The surface driftwood was cleared away by hand. The trouble came

when the salvage engineers were confronted with the problem of removing the heavy girders and uprights which were imbedded deep in the sand, and of getting rid of the débris which had been thrown over the structure by the current.

This was not a simple task. The first method attempted was to blast out the débris and at the same time to loosen the sand around the bridge and partly raise it by firing off several charges of high explosive simultaneously under the buried deck of the bridge. It was necessary to place the explosive under the bridge deck, for if it were placed above that point, it would only throw the water about without doing any work of value on the bridge itself. Furthermore, as the bridge was within 25 ft. of a standing steel bridge over which all the traffic of four railroad lines passes in and out of Pueblo, extreme care in placing and firing these charges was necessary. So, in order to place the charges in the desired position, 4-in. pipes, pointed at one end, were driven into the river bed under the bridge deck. Eighty-per-cent gelatin dynamite was then loaded into these pipes, and the contents of all the pipes fired simultaneously with electric blasting caps. Be-

cause of the depth of the water, very little of the blasted material was thrown any distance, and no damage was done except for the breaking of two or three telephone wires. Two multiple blasts were fired, getting rid of the debris effectively and somewhat loosening the sand holding the bridge.

But even after the blasts the bridge was so firmly anchored that it was impossible to get chains and tackle strong enough to pull it out. Two steam cranes and two hoists, exerting a joint pull of over 300 tons, easily snapped the 1½-in. cables and the chains with links 1½ in. thick, even though they were doubled and quadrupled.

While the wrecking crew was busy endeavoring to find a chain strong enough to lift the bridge, another flood came along, piled on more debris again, and shifted the bridge into an even more difficult position in the sand. To raise the bridge even after it was loosened now seemed impossible.

The ingenuity of man was not exhausted, however. It was decided that the part of the bridge under water but above the river bed should be blasted into sections and carried to the bank piecemeal. The swift current of the river made difficult the accurate placing of the explosive around the bridge members. So pipes were resorted to again. These

were driven down into the river, to be cut off and fired simultaneously as before. As the bed was now too solid and hard to drive the pipes by hand, a special pile driver was improvised. A 15-ft. guide was erected on a raft anchored by ropes. The weight was placed in this guide and attached to a rope running over a pulley at the top of the guide. The weight was raised and lowered by six men pulling on the rope and then suddenly letting go. When the pipes were in position they were loaded with charges of from 200 to 400 lb. of dynamite and then fired simultaneously.

In this manner, all the superstructure of the bridge above the river bottom was eventually cut to pieces and taken to the banks by cranes and hoists. The deck and floor structure of the bridge was left until the river had subsided so that it could be more easily taken out. It was not absolutely necessary to remove this, however, because the superstructure constituted the real menace, as it caught the drift and was likely to dam up the river channel.

For the whole work 1,200 lb. of dynamite, costing \$360, was used, thereby saving the railroad several thousands of dollars which would have been spent had the bridge been removed by mechanical means—if it could have been done at all in that way.

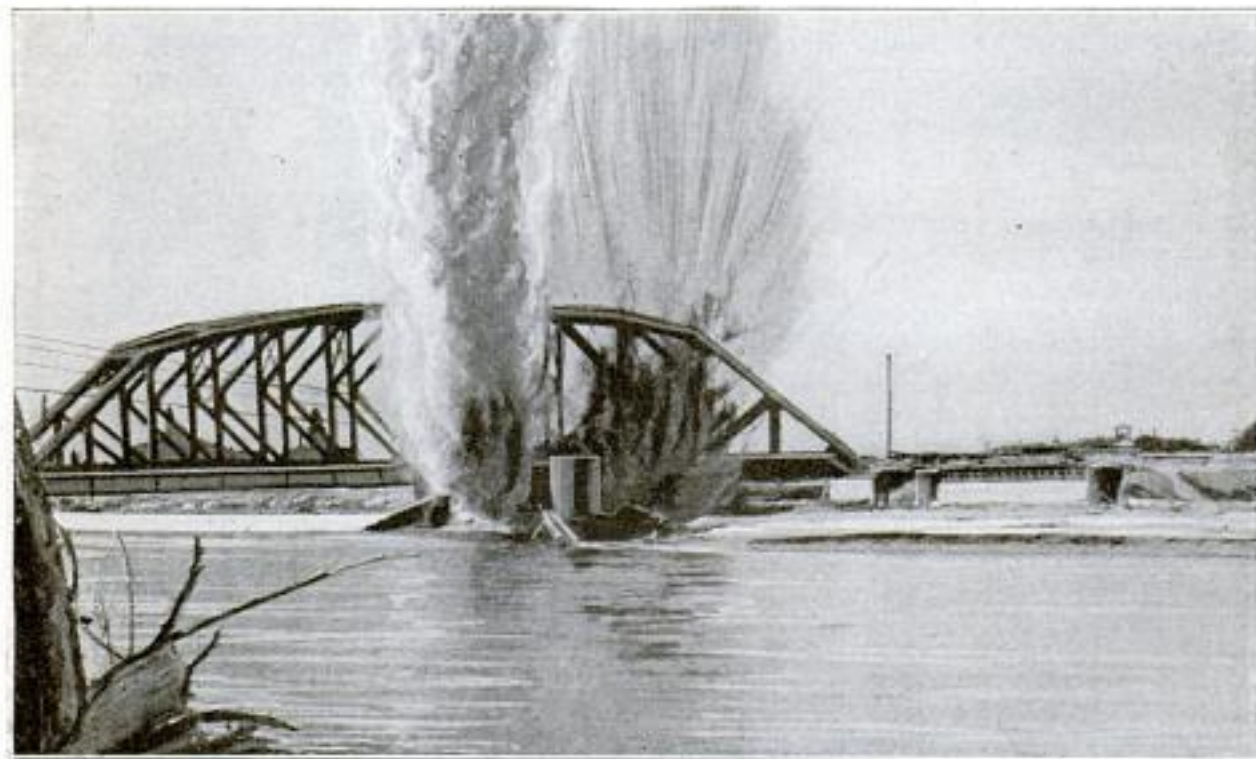

In Order to Break Up the Wrecked Bridge, a Number of Four-Inch Pipes, Pointed at One End and Loaded with Dynamite, were Driven into the River Bed under the Bridge Deck. Here is Seen the Result of the Firing of One Group of These Pipes

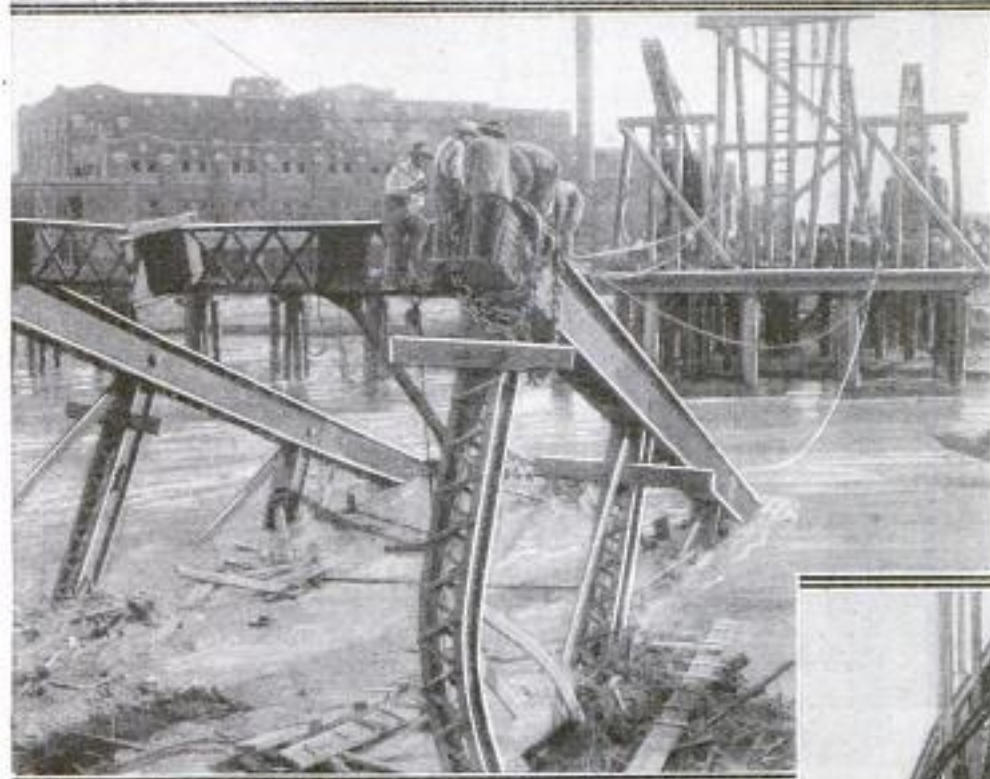
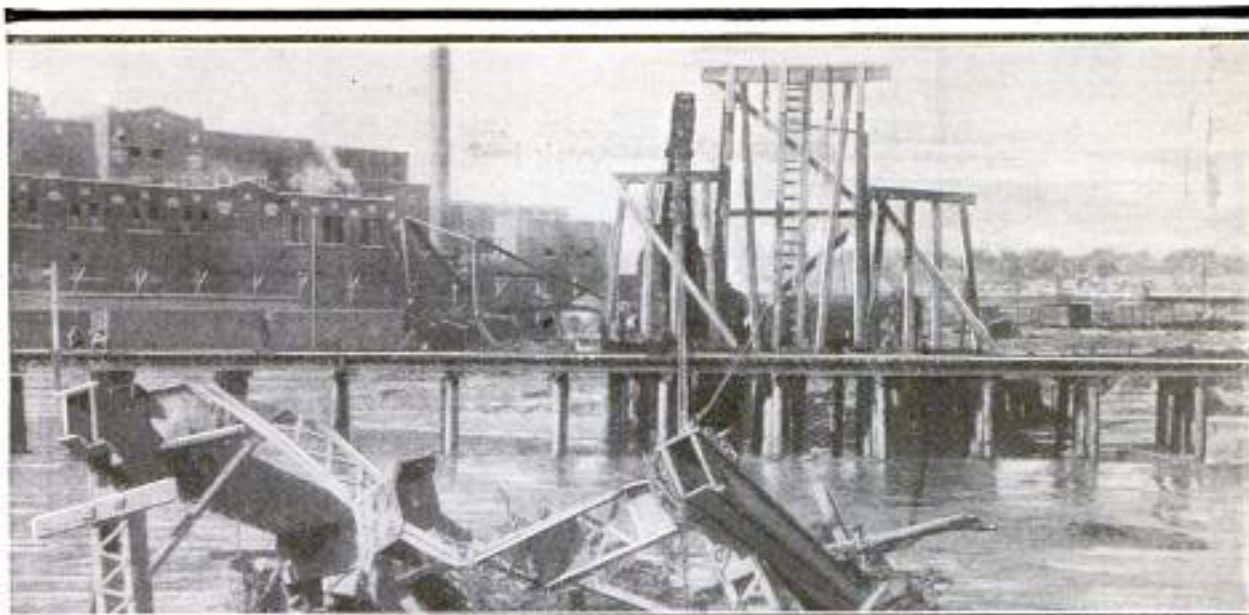

Above: Result of a Second Flood That Left the Wrecked Bridge in a Still Worse Condition than That Caused by the Previous Flood. Left: Parts of the Bridge That Remained above the Water being Cut Off with Oxyacetylene Torches and Then Hauled Ashore by Cranes. This Was the Easiest Part of the Work in Connection with the Removal of the Wreckage

Right: Cables from the Cranes and Hoists Attached to the Neighboring Bridge That Remained Standing. Two Steam Cranes and Two Hoists Exerted a Combined Pull of Over 300 Tons. To the Left are Seen Men Loading Dynamite into Pipes that have been Driven by the Pile Driver. Electric Blasting Caps were Then Connected to the Pipes

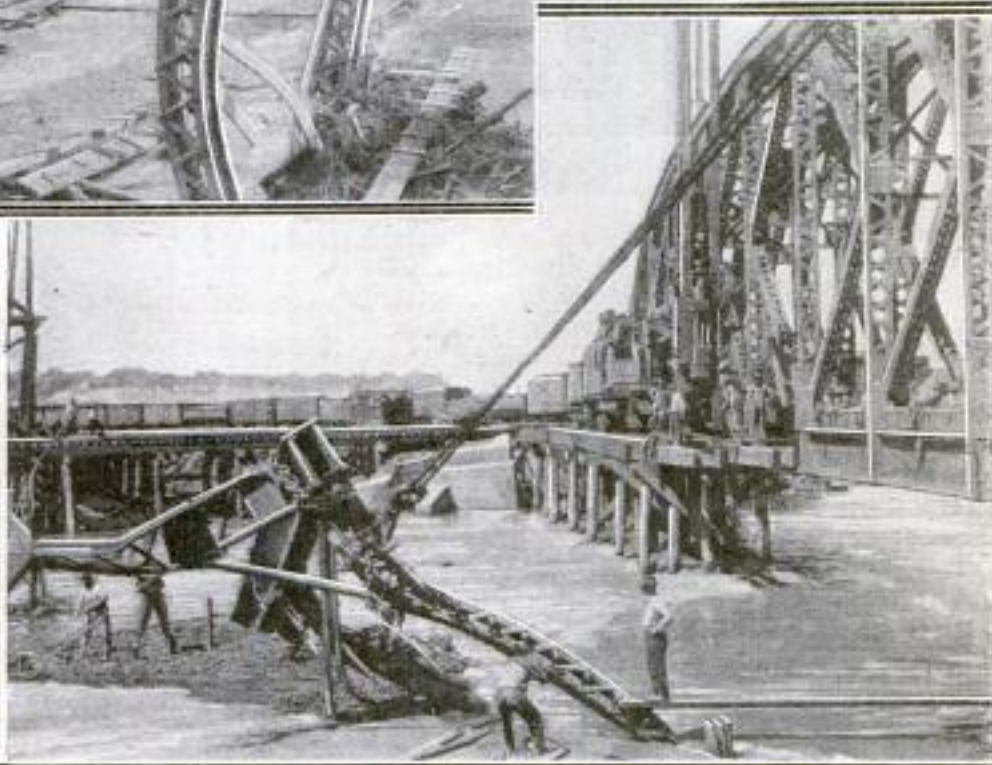

14 9/18 7

NEW YORK STATUE ON TRIAL
BEFORE PUBLIC OPINION

A piece of statuary in New York City, that has caused more comment and controversy than the 18th amendment, is



Marble Statue Named "Civic Virtue" in City Hall Park, New York, Which has been Much Criticised

called "Civic Virtue," and stands on guard at the new fountain pool in City Hall Park, over which the 57-story Woolworth Building casts its afternoon shadow. "Civic Virtue" is by MacMonnies, the noted sculptor who has been so successful with his statues of Lincoln and other famous men, but this latest work has received no end of both criticism and commendation since its recent installation. It represents the triumph of Virtue over Vice. Because the leading figure is a man trampling underfoot female figures representing evil sirens, the statuary has received especially severe criticism from many of the women of the city. Before being brought from the sculptor's workshop, "Civic Virtue" was given a thick coat of plaster to protect it from possible

damage. It required several hours to remove this protective covering after the work had been set on its pedestal. While the statue has been accepted by the city-park authorities, the public still continues its criticism and favorable comment, many of the remarks being rather humorous. "It ain't art to have a guy stepping on a girl's neck that way," said a youthful on-looker. "Huh, those women represent vice—the man doesn't. That's why the women are kicking about it," replied his companion. "If that fellow only had a baseball bat in his hand we would all like him," remarked another. Even visitors to the city are joining heartily in the big jury that is trying to decide whether "Civic Virtue" is a good or bad piece of workmanship.

9/16

UNSIGHTLY TRIMMED TREES
ON LINCOLN HIGHWAY

Trees are usually considered obstacles by the telephone and telegraph companies, who invariably sacrifice the beauty of any such growth to add to the efficiency of their lines. A graphic instance of this can be seen on the Lincoln Highway near Thomasville, Pa., where characteristic mutilations have been effected. Evergreen trees, growing so as to interfere with the free stringing of telegraph wires, have had great "bites" taken from their graceful contour. These now present a curious sight to passing motorists, who doubtless must wonder why commercial ways are thus permitted to spoil the beauties of nature.



Tree on Lincoln Highway, Showing the Unsightly "Bite" Taken from Its Contour to Permit the Free Stringing of Telegraph Wires

Cont. Alice Crowell H. H. Mas
1383 W. Poplar St.
York, Pa.

Cmd. J. Benjamin
7 auct 40 2 Parkside Ave.
Brooklyn, N.Y.

WRECK OF CONCRETE SHIP SHOWS GREAT ENDURANCE

AT night, in February, 1920, during a blinding blizzard and amid great cakes of floating ice, the steamer "Polias," without cargo, mistook floating beacons and struck on a submerged ledge off Port Clyde, Me. The ship, which was 250 ft.

aboard found their trust in the ship vindicated. The ship lies broadside to the sea, exposed to heavy waves and swells at all times, for the tides, which rise 13 ft. at this point, surge over the hidden ledges with tremendous force even in

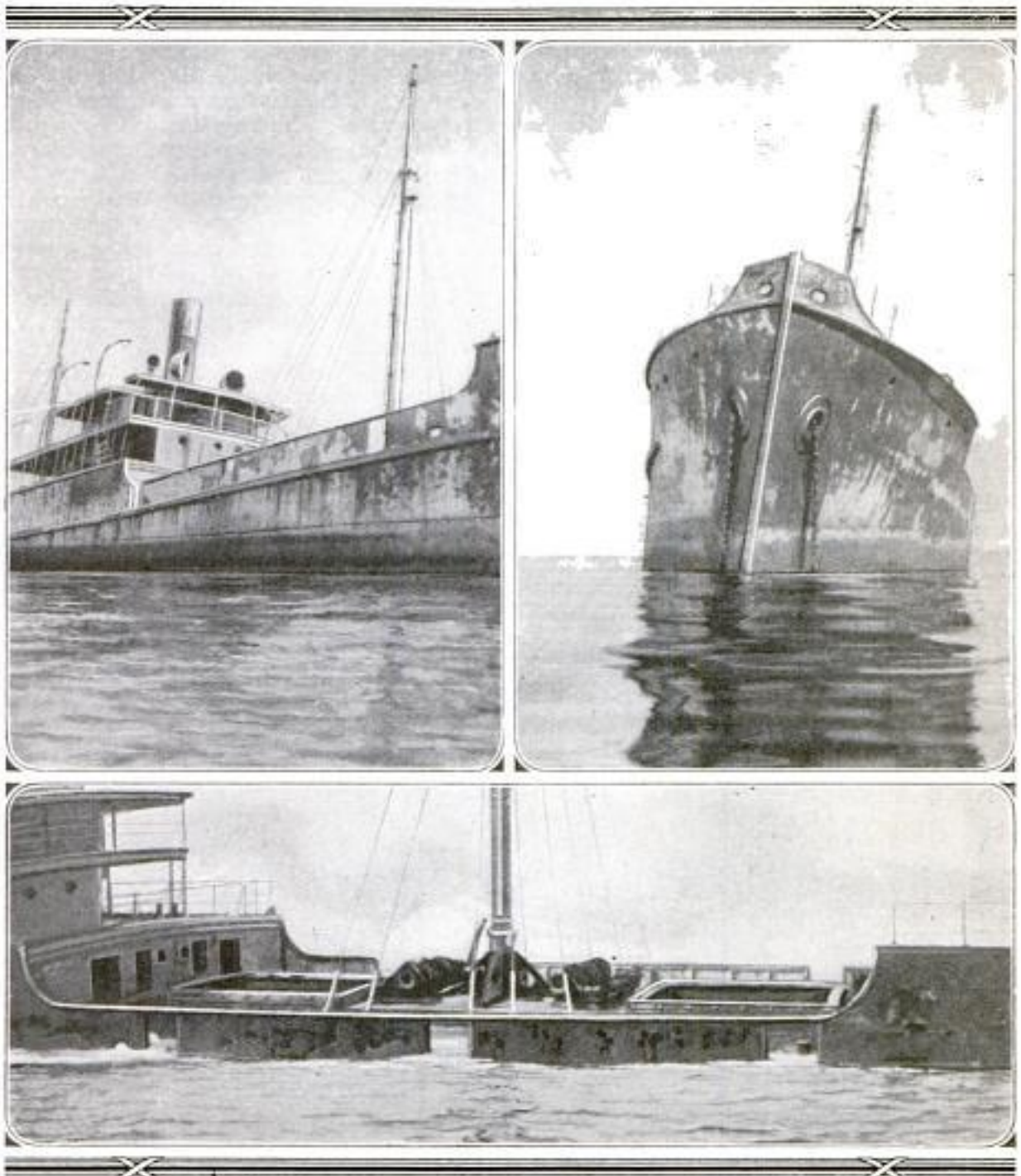

Three Views of the Concrete Ship "Polias," Grounded on a Submerged Reef off the Coast of Maine: Lying Broadside to the Open Sea and Exposed to the Pounding Waves and Tides, the Ship Shows Few Signs of Going to Pieces, Even after 28 Months of Severe Buffeting

long, did not differ from a type largely constructed during the war, except that the hull was of concrete. Eleven of the crew who left in small boats were drowned, while those who remained

calm weather. An inspection of the ship in July, 1920, revealed no damage whatever, except a hole in the bottom and water in the hold. Otherwise the hull, decks, and bulwarks, all of concrete, did

not show even a small crack. Standing on the main deck, or bridge, one no more felt the pounding seas than on land.

Efforts to raise the ship, which cost upward of \$2,000,000, proved unsuccessful, however, and a second visit in August, 1921, disclosed little change in its condition. Some of the upper works, which were built of wood, had begun to wash away, and the paint was gone in spots, from the sides; otherwise it appeared as solid as the rock on which it rested. The chief of the salvage crew stated that a steel or wooden vessel in the same position could not have endured the seas three months. The accident was in no way due to the concrete construction. According to latest advices, the hulk is still safe and sound, after defying the elements for 28 months.

914² CLAMSHELL CRANE USED TO SAVE HORSE'S LIFE

The roundhouse on the first division of the Canadian National Railway west of Edmonton, is built right over a muskeg. A short while ago it was found necessary to make a five-stall extension to it, and in excavating for the laying of the concrete a great deal of trash, such as old roots, etc., was dug up. A homesteader was engaged by the contractor to haul this stuff.

To get to the place where he was allowed to dump the stuff, the homesteader was obliged to cross a number of tracks, so, in order to save time, he used the locomotive turntable whenever it was idle.

This worked nicely for a while, and then on one trip, as he was returning, one of his horses broke through the planking on the turntable and its hind leg caught between two beams. In less time than it takes to tell it, half a hundred men were on the scene. The only thing they could do, however, was to hold the horse down, as it would surely have broken a leg by struggling. For some time no one could think of a feasible way of getting the animal out, and then the clamshell engineer appeared on the scene. Without saying much, he turned back to his outfit where he was digging ashes out of the pits and loading onto cars, and ran the crane up to the edge of the turntable pit. By making a sling of ropes around the horse and attaching the crane hook, the quick-witted engineer was able to hoist the animal carefully so that others could get its leg free, after which he swung it clear of the turntable to the ground.

Ⓢ A stone-cutting circular saw, of unusual proportions, is 100½ in. in diameter, ¾ in. thick, and weighs nearly 900 lb. Around its periphery are 210 diamonds, and at a speed of about 600 r.p.m. it cuts through a 6 by 3-ft. stone slab in 15 minutes.



Clamshell Crane Shown in the Act of Hoisting the Horse from the Large Hole Seen in the Planking, Preparatory to Swinging the Unusual Load Clear of the Turntable to the Ground, Thus Avoiding the Necessity of Shooting the Imprisoned and Struggling Animal.

Capt. Raymond Thompson Edson, Alberta Canada.

NEW TRANSATLANTIC RECEIVING AERIAL STRUNG ON TELEGRAPH POLES

By BERNARD G. PRIESTLEY, 291 Washington St.
Melrose Mass.

ORDINARY telegraph poles support an antenna stretching cross-country for eight miles, that is now being used for the reception of transatlantic wireless messages from England, France, Germany, and Norway, at the receiving station of the Radio Corporation of America at Chatham, Cape Cod, Mass. Running less than 30 ft. from the ground, this antenna is a decided departure from the old type strung between towering pylons commonly used for intercepting wireless messages coming from long distances. The new aerial replaces one consisting of several wires, strung between an iron mast 320 ft. high and steel towers more than 100 ft. high. In one respect particularly is the new antenna an advancement over the old. The wires can be used for receiving an unlimited number of messages at the same time, provided a separate receiving set is employed for each message. Fifteen messages have been received simultaneously on this type of aerial without interference. Four receiving sets at the station are constantly taking messages over this single antenna today. The results have led to discontinuance of high aerials at the station.

The lower cost of construction and maintenance of the new antenna as compared with the old gives the former a decided advantage over the latter. The new type has demonstrated its superiority over the old in three important respects, in addition to its ability to pick up an unlimited number of messages at the same time: First, its arrange-

ment enables it to eliminate interference by messages not intended for the station; second, the wires are so arranged as to give double signal strength, making relatively easy the task of catching messages that, under very unfavorable atmospheric conditions, it would be most difficult if not impossible to receive with the old type; and third, the antenna is so low that it reduces to a minimum the heavy charges of static which are picked up and magnified on high aerials.

The eight-mile antenna, stretching from Chatham to South Dennis, goes through woods much of the distance. A clearing, about 30 ft. wide, has been made

through the woods. The aerial points toward the land transmitting stations in Europe from which messages are most commonly received at the Chatham station. The wires are strung on glass insulators on the arms of the telegraph poles in precisely the same way that telephone and telegraph lines are put up. There are two arms on each pole, and a wire running on either side of each arm. The wires are paired and joined outside the receiving station, those on the same side of the pole forming a pair. Thus, two wires instead of four run into the receiving sets inside the building.

The paired wires act in the same way as would a single wire except that they double the signal strength of the incoming messages. The arrangement of the wires—in

two sets of two wires running opposite and parallel with each other—practically prevents interfering wireless waves from



At the Right is Seen One of the Telegraph Poles That Carry the Eight-Mile Receiving Antenna. The Upper and Lower Wires on Each Side are Joined near the Station



Four Tiers of Receiving Sets in the Station can Receive Messages from the Telegraph-Pole Antenna at the Same Time without Interfering with Each Other

crossing the wires from either side. Special devices at the end of the aerial near the station deflect interference from that end, so that only messages coming from the east, or ocean end, of the antenna have free access to it. The long aerial really picks up the messages and transmits them over the wires to the receiving units. With the receiving sets tuned for various wave lengths and stations, they are able to take the messages from the wires without the slightest interference with each other.

A second aerial of the new type has been put into use at the station for receiving messages from ships at sea. But this is only 1 1/2 miles long, and it is in-

tended for work of a much shorter range than the longer antenna. The marine aerial has one set of opposite and parallel

wires, one wire strung along on each side of the single arm on each telegraph pole.

Messages received at the station are, immediately upon their receipt, transmitted over private telegraph wires to Boston and thence to the headquarters of the radio company in New York City. Messages to be

transmitted come back over the same route, but pass through Chatham station and on to Marion, Mass., 50 miles farther, before they are transmitted. Transmission is controlled from New York, more than 400 miles distant from the transmitting aerials.

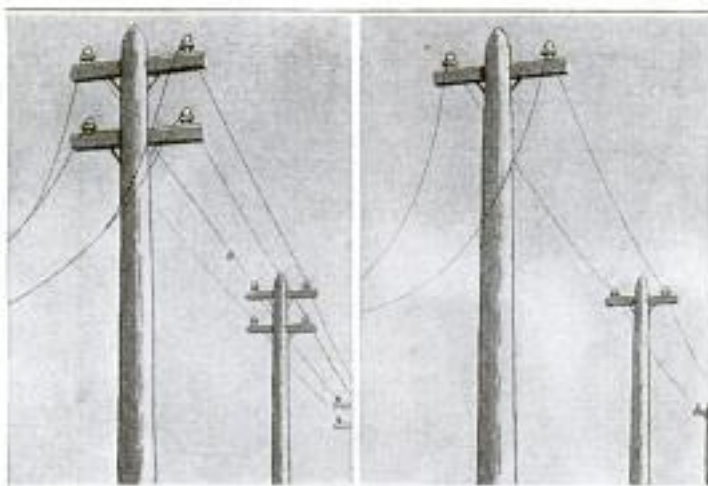

Left: At the Station End of the Eight-Mile Transatlantic Antenna the Two Wires on Each Side of the Pole are Connected, Giving Double Signal Strength. Right: The Station End of the Shorter Aerial, 1 1/2 Miles Long, Used for Receiving Messages from Ships

9234 **TILTING TRIPOD HEAD AIDS MOTION-PICTURE MAN**

Taking motion pictures at unusual angles is possible with a tripod head

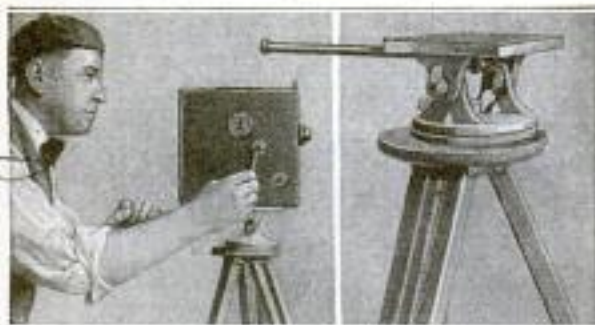

The Operator can Tilt the Tripod Head with the Long Lever and Crank the Camera at the Same Time. Right: Close View Showing Construction

which can be tilted up or down with one hand, leaving the other free to turn the crank. The appliance possesses a long tillerlike handle for operation, is made of aluminum, and is adaptable to any standard tripod. The tilting does not interfere with the cranking mechanism, and this outfit is said to be particularly adapted for those not skilled in this form of photography.

9239 **OLD WATCH OF CURIOUS MAKE WON WORLD'S-FAIR MEDAL**

Dating back more than half a century to the world's fair at Paris in 1867, where it was awarded a gold medal, is the record of a hand-made watch produced by a jeweler of Copenhagen, Denmark. The strange timepiece possesses a dial divided into the so-called "universal," or decimal, time of 10 hours, 100 minutes, and 100 seconds.

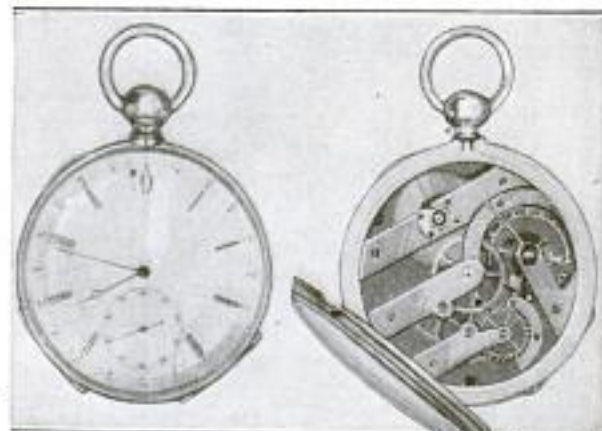

A Watch Which Keeps Time on the Decimal System, in Which There Are 100 Seconds to the Minute, 100 Minutes to the Hour, and 10 Hours to the Day

Henry Freund & Pro.
65 Nassau St. New York.

5127 -
 Amnia Mfg. Co.,
 Los Angeles
 4th Ave. California

9192 Architects } P. P. Friedstedt Co. 1633 Tribune
 } 1549 Chicago
 } Abraham Anderson
CHICAGO'S PROGRAM OF CIVIC IMPROVEMENT

BY CLEVELAND GAINES Probst & White
 80 & Jackson
 Blvd. Chicago

Construction Progressing on the New Union Station; Plans for a New Central Station, and an Improvement of the River Front and Modernizing of South Water Street

FOR many years, a group of far-sighted Chicago men have been striving for an ideal in city planning, and developments have now progressed to a point where it seems possible that their dreams may be realized. Three great projects within the city are either under construc-

tion, or have reached a point where work will soon be started. railroad terminals has held an important place, with special reference to the new Union Terminal and the proposed Central Station. Of the former, there will soon be visible evidence of the years of careful planning and preliminary construction. Work on

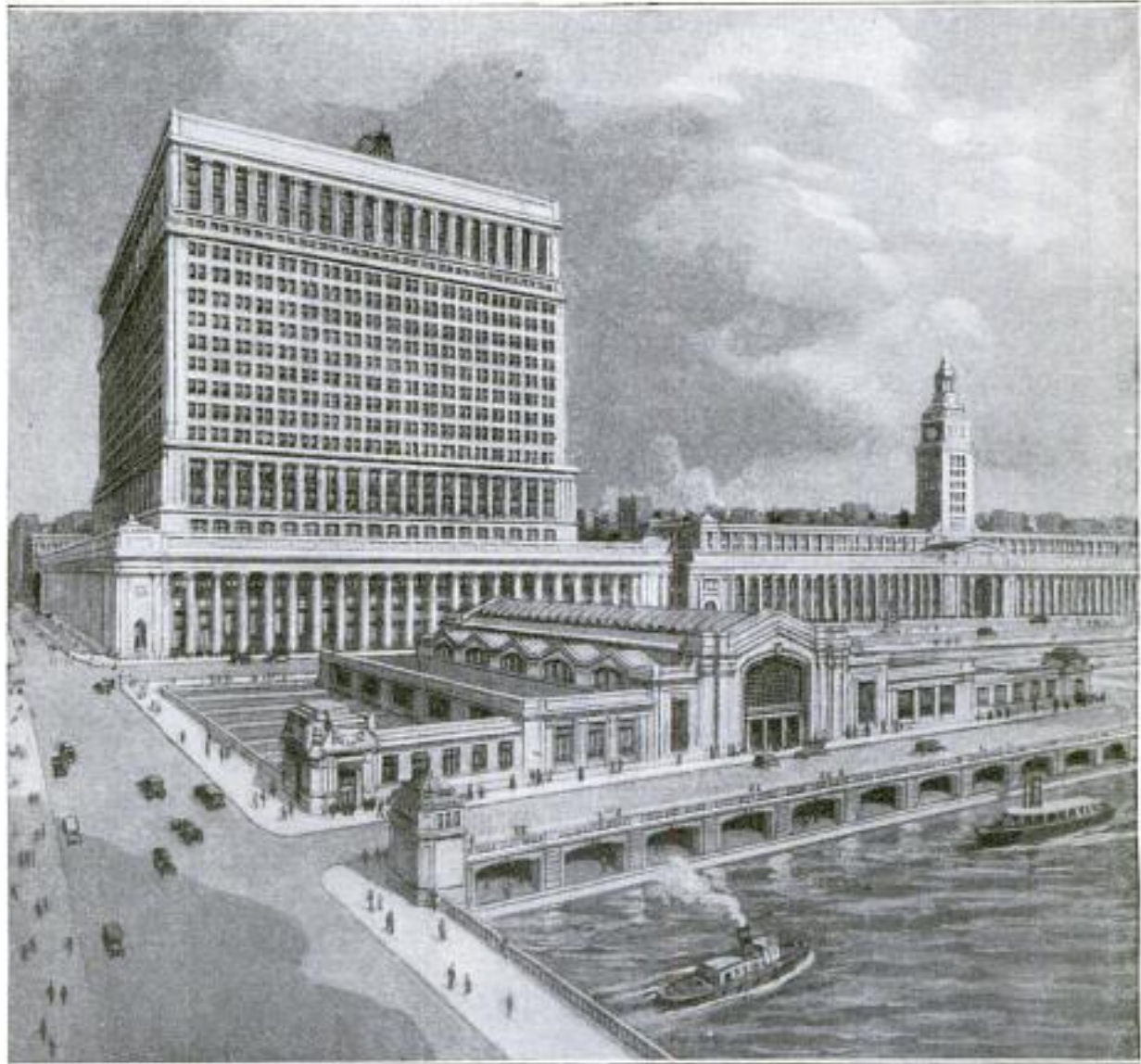

The New Union Station as It will Appear When Completed: The Train Concourse is Located under the Building in the Foreground; the Office Building at the Rear will House the Station Proper, Connected with the Concourse by a Passage. The Proposed United States Post Office and Federal Building Appears at the Right

tion, or have reached a point where work will soon be started. In any city, the visitors' first impressions are gained from the terminal facilities, so it is only proper that these should have first consideration in any plans for civic betterment. In all the work of the Chicago Plan Commission the question of

various parts of the project, including extensive street alterations and viaduct approaches to the river bridges, has been in progress for several years, but the station proper is yet to be built. When completed, this station will occupy an entire city block and will be surmounted by a 20-story office building. The station itself

9192
20

POPULAR MECHANICS

is of the twin, or double-end, design, with a transverse concourse-between two sets

common facilities for handling passengers and baggage. The tracks have been depressed to about 4 ft.

above water level in the river, and the streets have been raised and widened to provide adequate approaches. There will be 14 tracks in the south trainshed and 10 in the north, all arranged singly and separated by platforms. Alternate platforms will be assigned for handling baggage coming from the baggage room under the concourse.

The station facilities, such as waiting room, ticket office, lunch room, etc., will be located under the main building, and will be connected with the train concourse by passages under the street. For the use of cabs and baggage wagons, inclined ramps at the sides of the building will lead from the street to the track level. The exterior of the station, office-building, and concourse entrances will be of buff stone.

The plans for the Central Station have not as yet progressed as far as the Union Terminal, but are fast approaching a point where action will result. This station will be located near the lake front,

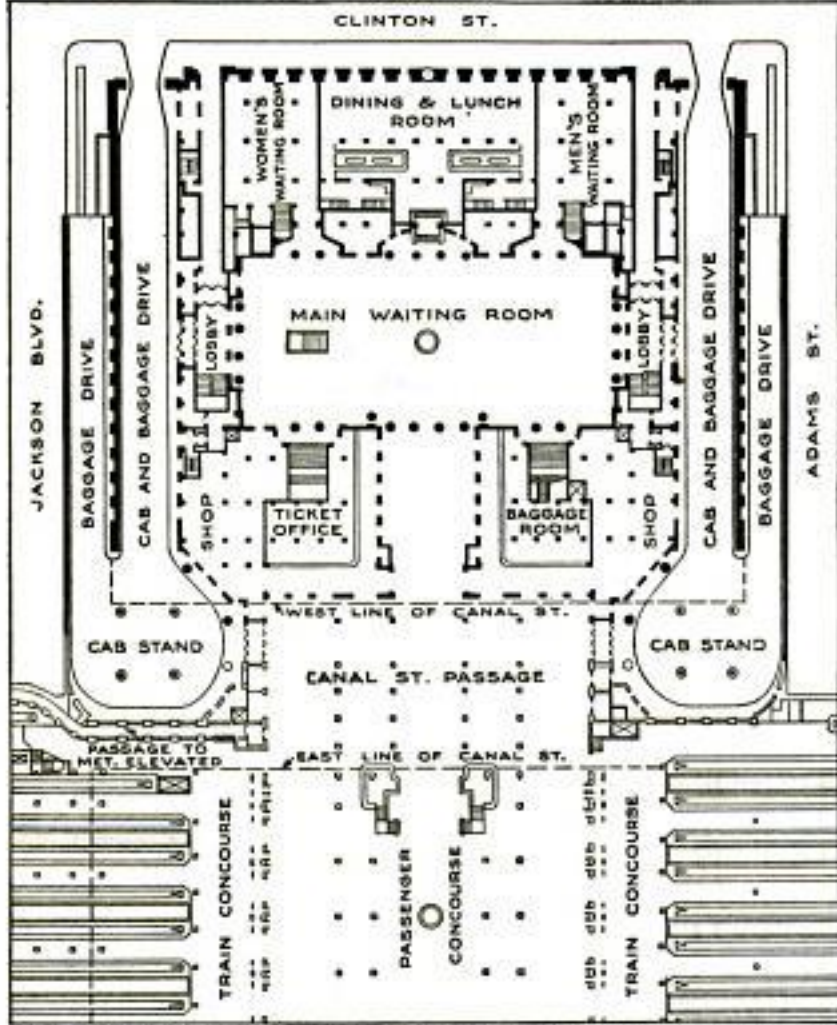

Ground Plan of the New Union Station, Showing the Convenient Grouping of the Ticket Office, Baggage Room, and Waiting Room: A Passage under Canal Street Connects the Station with the Train Concourse, the Full Width of Which is Not Shown

of stub tracks. Railways will enter from the north and south, respectively, with

point where action will result. This station will be located near the lake front,

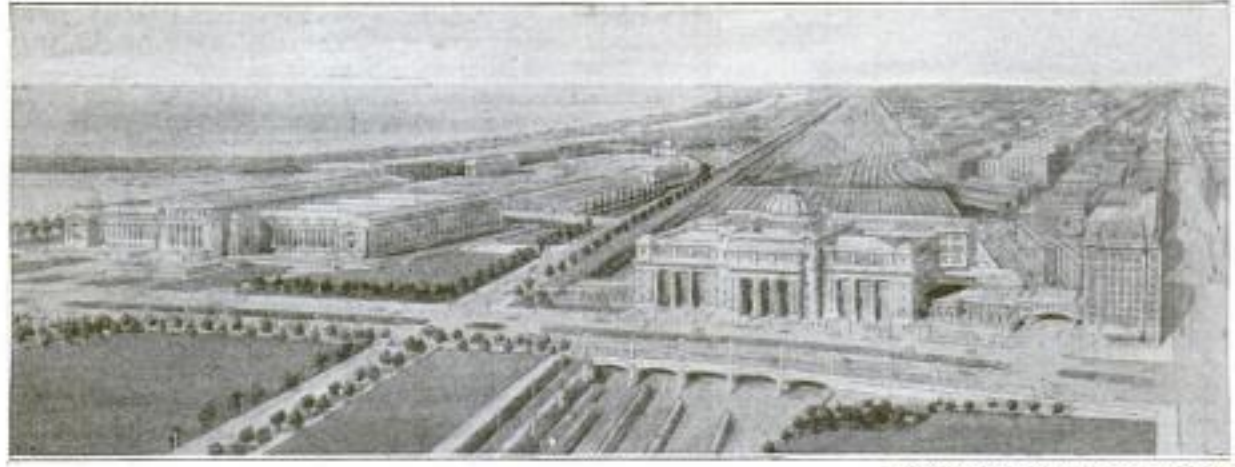

A Bird's-Eye View, Looking South, of the Central-Station Project as It will Appear When Completed: The New Field Museum Appears at the Left, and behind It the Proposed Athletic Stadium. The Central Station, at the Right, is Located Just South of Roosevelt Road and East of Michigan Avenue, at the Extreme Right. The Illinois Central Right of Way is Seen Extending Almost Due South

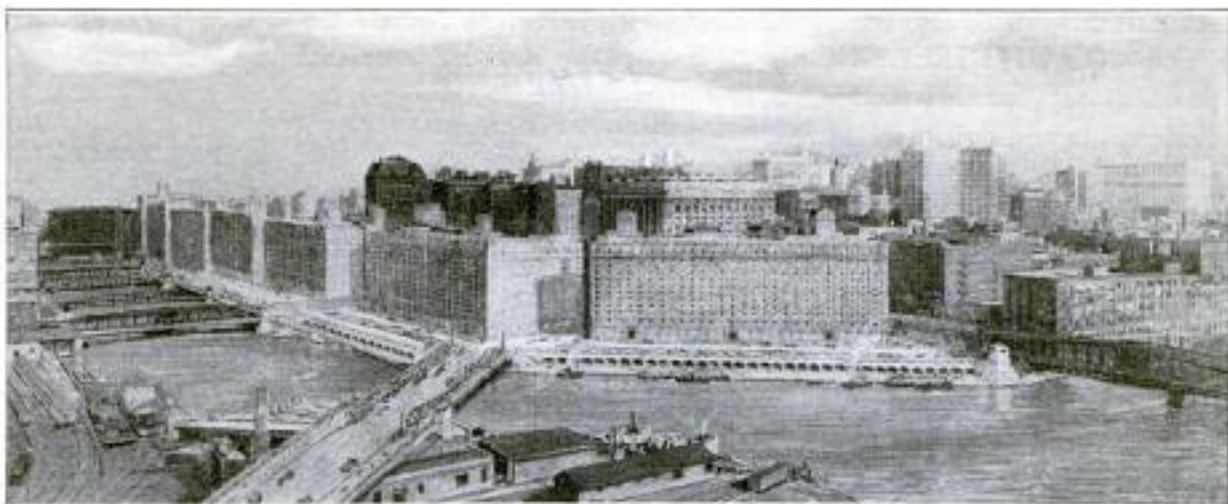

BY COURTESY OF THE CHICAGO PLAN COMMISSION
The South Water Street Improvement as It is Planned: The Upper Level of the Viaduct will Be a Boulevard, While the Lower Level will be Given Over to Trucks and Wagons

on Roosevelt Road, and will be particularly favored as regards approaches. It will contain all modern and necessary conveniences, and will be of a dignified style of architecture in harmony with its surroundings. The through service and suburban service will be entirely segregated, the suburban tracks passing through a tunnel under the station. This plan will allow the system to be linked with the subway system when built.

The third great project, while still in a tentative stage, deals with the improvement of the river front and the modernizing of South Water Street. This plan calls for the widening and double-decking of approximately a mile of city streets and the razing of six acres of buildings.

The present street will be lowered to a point 5 ft. above lake level, with the upper level, or viaduct, 20 ft. above the lake. All intersecting streets will rise on easy ramps to this upper level, affording approaches to the bridges over the river. The lower level will be used for heavy traffic and will provide space for three lines of trucks moving in each direction, with additional space for backing up to a continuous 8-ft. loading platform adjacent to the buildings. North of the driveways will be a 25-ft. space along the river for boats to load or discharge passengers and freight. The viaduct floor will be of reinforced-concrete flat-slab construction, supported on columns which will rest on caissons extending to the hardpan, 60 to 80 ft. below lake level.

The plan contemplates an extensive ventilaticn system for changing the air in the lower street level. The bad air will be collected in ducts and expelled by fans into the upper air.

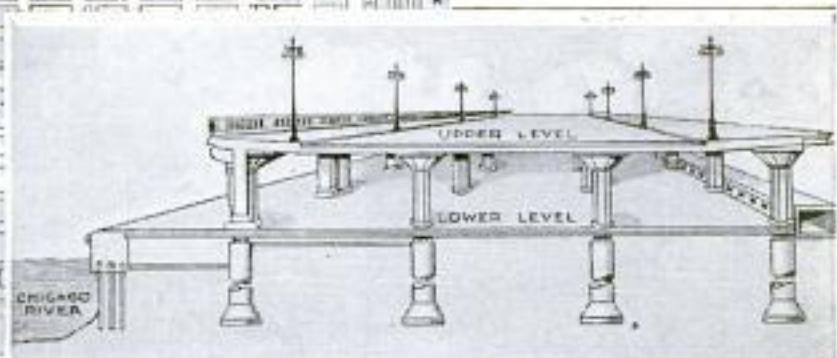
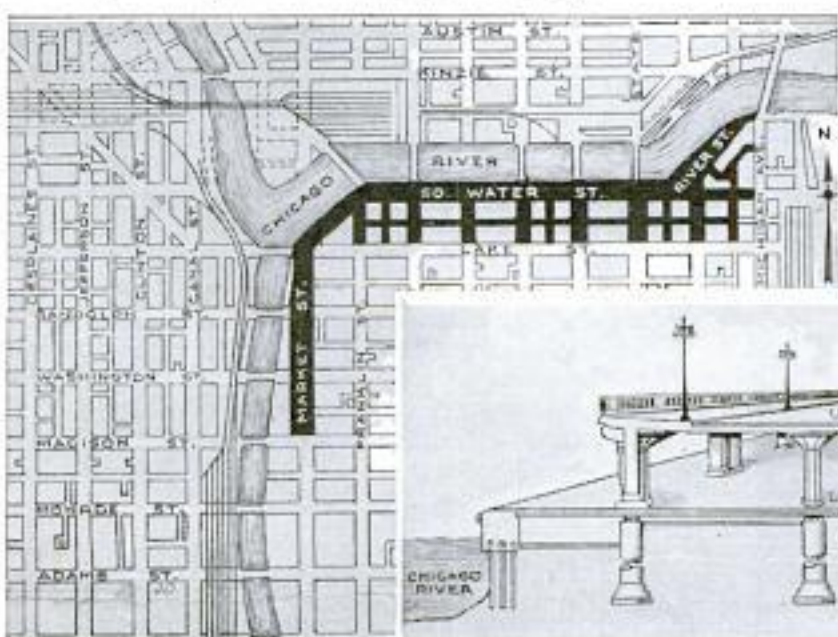

Left: The Black Lines Show the Location of the South Water Street Improvement, Extending from Michigan Avenue to Market and Madison Streets. At the Right is a Sectional View of the Two-Level Roadway. There is Space along the River for Unloading Boats, and a Loading Platform Adjacent to the Buildings

Cont. Thos. McMahon, 90 V. Yabsley, Eng.
 Bank of Australia, Market Place
 Sydney, Australia

Engineering
 4/21/22

POPULAR MECHANICS

INTERIOR HOUSE DECORATIONS
 OF FIJI ISLANDERS

DISCOVER CAUSE OF IGNITION
 OF ESCAPING HYDROGEN

9078

The natives of the Fiji Islands build comfortable and substantial dwellings and

9284

There have been so many cases of spontaneous ignition of hydrogen gas



The Walls and Ceiling of This Fiji House are Decorated with Strings of Coconut Fiber Plaited into Various Artistic Designs and Dyed in Black and White

take great pride in their decoration, showing a high degree of artistic taste in this direction. The interior decorations are mostly of coconut-fiber strings plaited into various designs, black and white dyes being used to produce artistic effects.

when charging balloons that an investigation has been carried on to determine the cause. Various experiments were performed, such as allowing the gas to escape under pressure through different kinds of orifices, to determine if friction were responsible for ignition, but these experiments gave negative results. Finally, by observing in the dark a jet of hydrogen escaping through a pipe flange, it was found that a brush discharge of static electricity was plainly visible. When the pipe was tapped, to stir up the dust, an explosion occurred. From the investigation it would seem that the spontaneous ignition was due to the friction between the hydrogen and the dust of iron rust and to the brush discharge of static electricity from the electrified particles.

9282

NEW DYE COLORS ARTIFICIAL
 SILK BUT NOT COTTON

It seems probable that the discovery of a new dye by a British concern will have an important influence on the dyeing industry, for this dye has the peculiar property of coloring artificial-silk fabrics without affecting cotton. Should a mixed fabric of cotton and silk be dipped in this dye, the silk will take the color. The cotton in the fabric may then be colored by washing in a dye that affects only cotton. This combined dyeing makes it possible to produce a party-colored effect in mixed fabrics after they are woven.

DRUG-DISSOLVING APPLIANCE
 ELECTRICALLY HEATED

Dissolving drugs for the aid of dentists and doctors who avail themselves of the

use of local anesthesia, has been simplified by the invention of a small electric heater. This appliance is adapted for 110-volt alternating or direct current, and eliminates



the handling of matches and alcohol, thus doing away with the often objectionable odor of the latter.

Experiments are being conducted at the Forest Products Laboratory of Canada to find a means of preventing decay in stored wood pulp used in making news print. Storage of the pulp in water has given such favorable results that a trial will be made on a commercial scale.

9151
 Ketch Mfg. Co. Inc.
 202 E. 46th St. New York

British Dye-stuffs Corp.
 Imperial House, 17 Langs Way
 E.C. 2, London, England

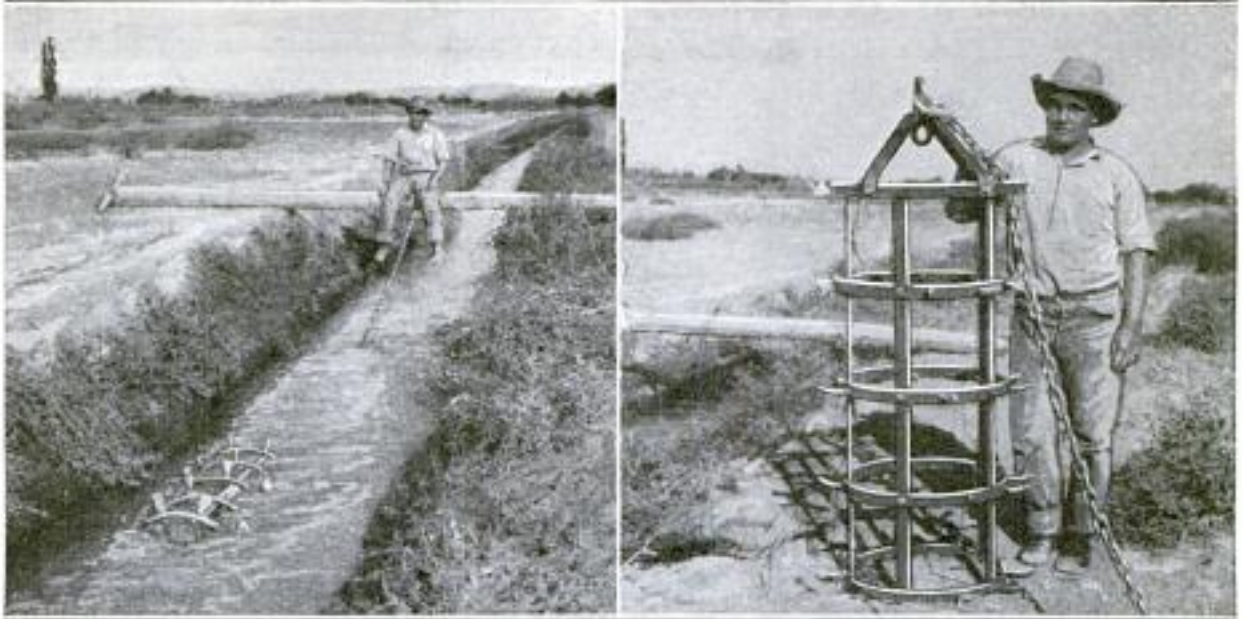

Left: In Operation, the Slucing Machine is Dragged Back and Forth along the Ditch and Stirs Up the Soil, Which is Carried Away by the Water. Right: The Device Is of Simple, Sturdy Construction, and Has Blades for Loosening the Soil along the Ditch

**HANDY MACHINE MAKES WATER
DO THE DITCH DIGGING**

Digging drainage ditches with water at a cost that is but a fraction of the usual amount has been accomplished near Vale, Ore. This feat was made possible by the invention of a slucing machine by one of the farmers of the community, working at the suggestion of the Oregon Experiment Station.

To dig a large main drain by this method, a few furrows are plowed along the line of the proposed ditch. Then a large head of water is turned in at the upper end, and the slucing machine is dragged back and forth along the bottom of the ditch by means of a horse at either end of a cross pole. The machine is built much on the order of an overgrown threshing-machine cylinder, and is heavy enough to dig up the bottom of the ditch and allow the water to wash away the soil thus loosened. Ditches, 6 and even 7 ft. deep, have been dug with entire success by this method, the only requirement being that there be plenty of water available and that the soil be anything but the heaviest clay.

**TWO NEW AIRPLANE CAMERAS
DEVELOPED BY EXPERTS**

Camera experts at McCook Field, near Dayton, Ohio, have recently developed two airplane cameras that are of unusual interest. One type, which is used for extreme high-altitude photography, has

Mr. A. W. Durka,
Air Service, Washington, D. C.

an over-all length of 5 ft., and, on account of its unusual focal length, can be used at heights where the regulation camera would be useless. The other type is a



The Huge Camera at the Left, Due to Its Unusual Focal Length, can be Used at Very High Altitudes. At the Right Is the Triple-Lens Camera for Mapping

triple-lens camera which can be used at lower altitudes for mapping work, and is of more conventional size. It can be used in standard airplanes for checking hydrographic surveys or similar work.

Engineering Division
Copyrighted material
L. C.

9224
1924
A
M
C
S
P
R
O
V
E
R
S
E
S
O
N
S
I
T
I
O
N
S
S
E
R
I
E
S
O
F
A
I
R
P
L
A
N
E
C
A
M
E
R
A
S

Shepard Electric Crane
+ Hoist Co., 412 Schuyler Av.

24 POPULAR MECHANICS
Montour Falls, N.Y.

**COMBINATION ELECTRIC HOIST
AND OVERHEAD CONVEYOR**

9242

A combination electrically driven hoist and overhead traveling-trolley conveyor that runs on the bottom flange of a

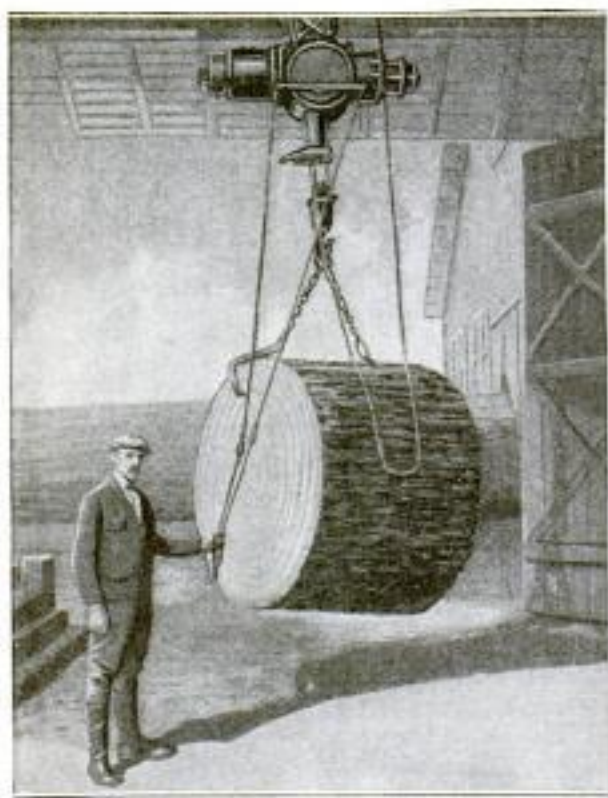

Combination Electric Hoist and Overhead Trolley Handling a Six-Foot Section of a Redwood Tree between the Mill and a Steaming Vat: The Control Is in the Operator's Left Hand

standard I-beam, is now on the market. The hoist, controlled by suspended cables, lifts loads up to 2,000 lb., and by means of another suspended cable, a single operator can move these loads from place to place. The working parts of the hoist are inclosed in an oil-tight case, so that they are at all times thoroughly lubricated. The hoist can be equipped with single or variable-speed control, the latter having 11 speeds. All parts are easily accessible by the removal of a few bolts. The trolley is adjustable to fit any standard I-beam, and the wheels are mounted on roller bearings.

9256

**TRY CONTROL OF STREET-CAR
STOPS BY COLOR SCHEME**

Some novel suggestions for improvements in street-car service are contained in an invention that has been submitted to the Toronto transportation committee and which will be given a trial. The principal feature of the invention consists in so marking and arranging the cars that

Chas. E. R. Symmes
301 Lister Bldg.
Hamilton, Ont. Canada

successive cars stop at progressively different points. The cars on any particular route are designated by means of numbers, signals, or otherwise, in groups of two, three, four, or more, as required, and the stops designated accordingly. Thus, if there are three forms of cars designated by a color scheme of red, green, and yellow, the stops will be arranged in the same way, and a car will stop only at the station carrying a corresponding designation—red car at red stop, green car at green stop, and a yellow car at a yellow stop. The public will know that like cars will stop only at like stations. A man may not be able to stop just at the street he desires, but with a three-color system he can be only one block away from the street at which he desires to alight. The inventor claims that his scheme will allow faster speed, as practically two-thirds of the time wasted in stopping will be eliminated, and that a great annual saving in cost will accrue to the transportation commission, while congestion of ordinary vehicular traffic will be in a great measure relieved, which is something to be greatly desired in the larger cities.

9001

**SHARK-FISHING APPLIANCE
HAS INDICATING FLOAT**

Shark fishing is a profitable occupation, due to the many uses to which the bodies of these sea monsters may be put, and a Florida man is the originator of a new method of catching them. His outfit consists of a float in which a quantity of blood may be placed and ejected one drop at a time, and which has an indicating ball, pivotally mounted, at one end. At the other end of the float, a chain with the baiting hook upon it, is attached, this chain also being suspended from the indicator by a piece of twine. When the shark seizes the bait, the pulling force breaks the twine and allows the indicator to swing to a horizontal position, thus giving visible evidence of the catch.

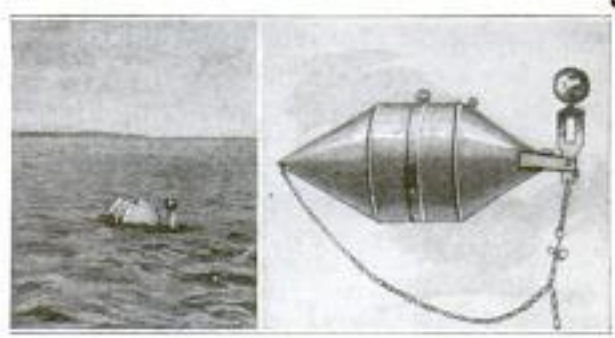

When a Shark Takes the Bait, the Buoy Changes Position and the Indicating Ball at the Right Signals the Fisherman

Chas. E. R. Symmes, Miami, Fla.

FOUNDATIONS FOR NEW THEATER PLACED WHILE PLAYERS PERFORM

By EVERETT J. LOVETT

EVEN in a time when the extraordinary has become the commonplace, some feat will stand out as being worthy of more than passing notice. In this class belongs the task of placing the foundations for the new theater that is to replace the old McVickers building in Chicago. Probably none of those who enjoyed the performances in the theater during the early part of this year realized that the solid and substantial building in which they sat was resting on temporary foundations of steel and wood, while deep in the ground below men were digging down to the solid bedrock to place the foundations for the new building.

Before the actual work started, careful and precise calculations were made to determine the proper method of placing the beams that would support the building during the time the excavations were being made. Some idea of the magnitude of this task alone can be gained when it is recalled that twice each day some 2,000 persons were admitted to the theater, and that they constituted what is called a "moving load," of first importance in all calculations both from an engineering and a safety standpoint.

When the actual work started, a chute was cut from the basement of the building to the freight tunnel which passes along Madison Street about 40 ft. below the surface. All material excavated was handled through this chute and dumped into cars waiting in the tunnel. After the supporting beams were brought in

and placed in position, the excavations were started, and permanent piers built up. Excavations were made under the walls, and the footings for the new walls were poured and placed. When these had set sufficiently, jacks were placed below the standing walls, and this weight was used to settle the new foundations until no movement could be noticed, after

which the new walls were built up to the ground level. During this time the caissons were being sunk to the limestone bedrock, 100 ft. below. These caissons were 4 and 5 ft. in diameter and were filled with concrete, forming solid pillars upon which the new theater building will rest. The pouring of the concrete in each of these caissons was done continuously, the material being delivered from the alley at one side of the building. The delivery of this material was the only hint the public



The Old McVickers Theater Building, Where for More than Four Months, Daily Performances were Given While Workmen Toiled Far Below Placing the Foundations for the New Building

had of the work that was going on below. The proscenium wall and steel curtain, weighing together some 700 tons and extending to the sixth floor, were carried on an individual set of shoring and jacks, and the new proscenium wall, about 20 ft. back of the old one, was constructed without interfering with the performance. Because of the difference in elevation, it was possible to build the new stage almost directly below the rear of the old stage, and all this was done before the playhouse closed its doors.

The foundation work went forward 24 hours per day, being divided into three shifts. Care was taken in so planning

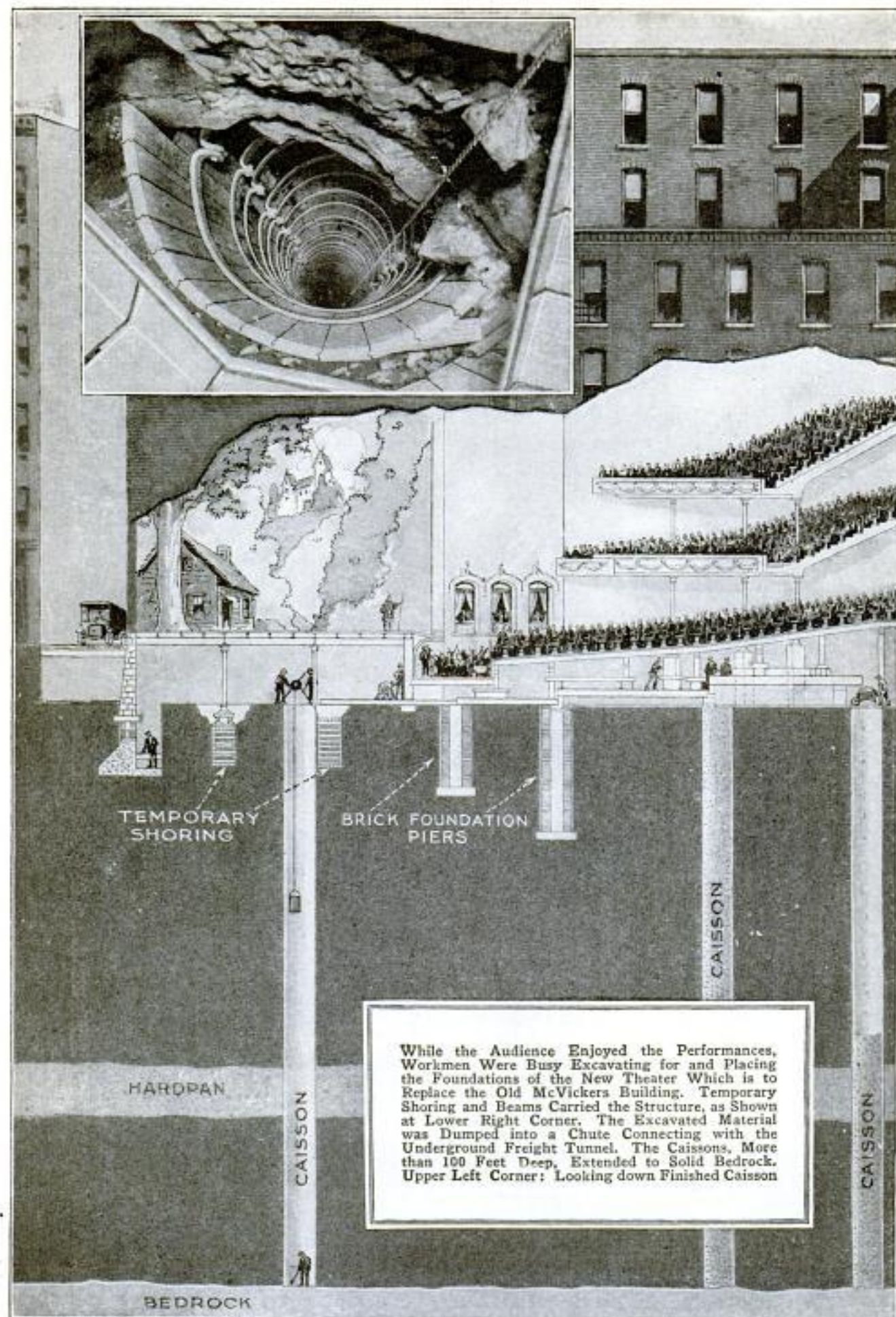

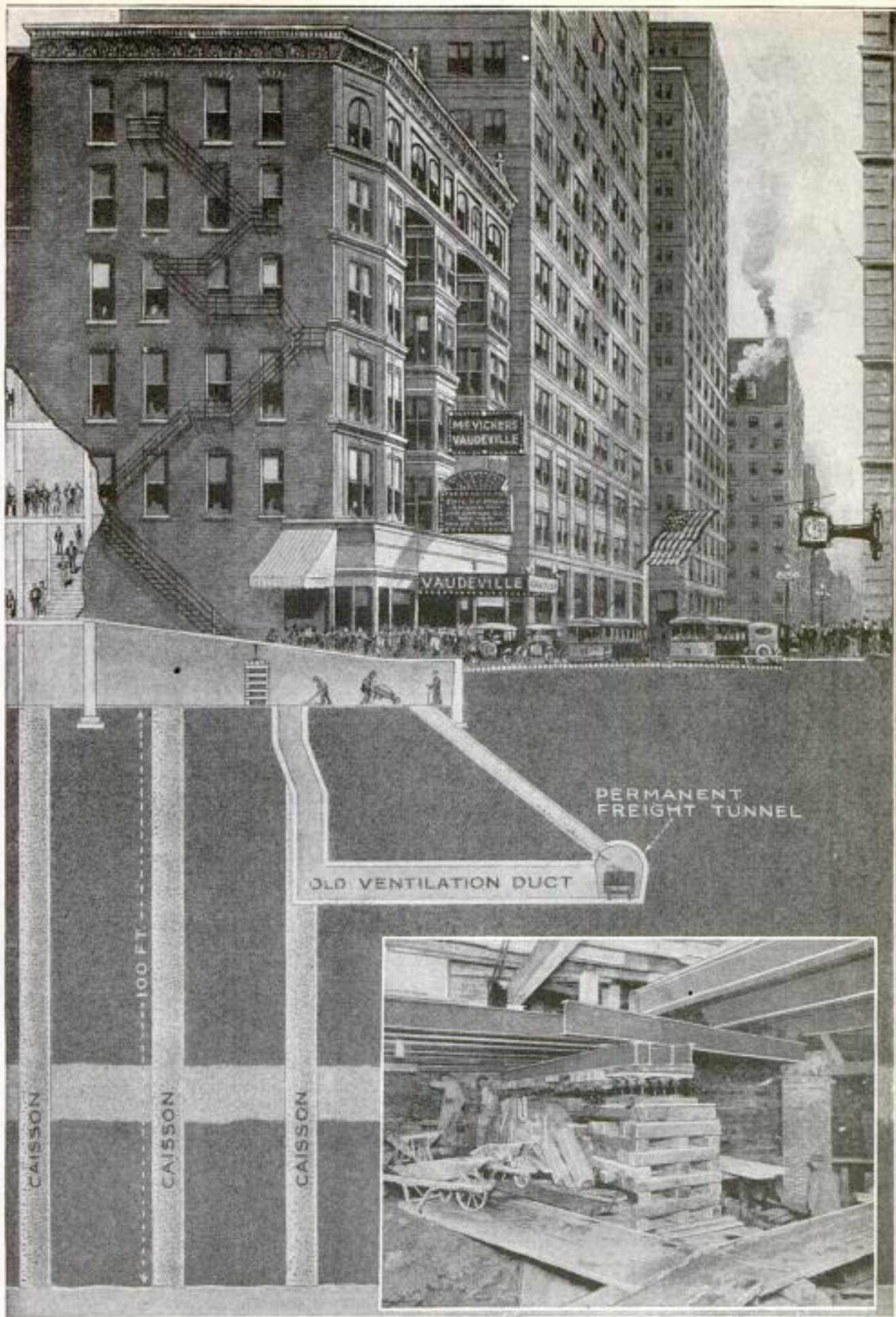

L. P. FINESTEDT COMPANY

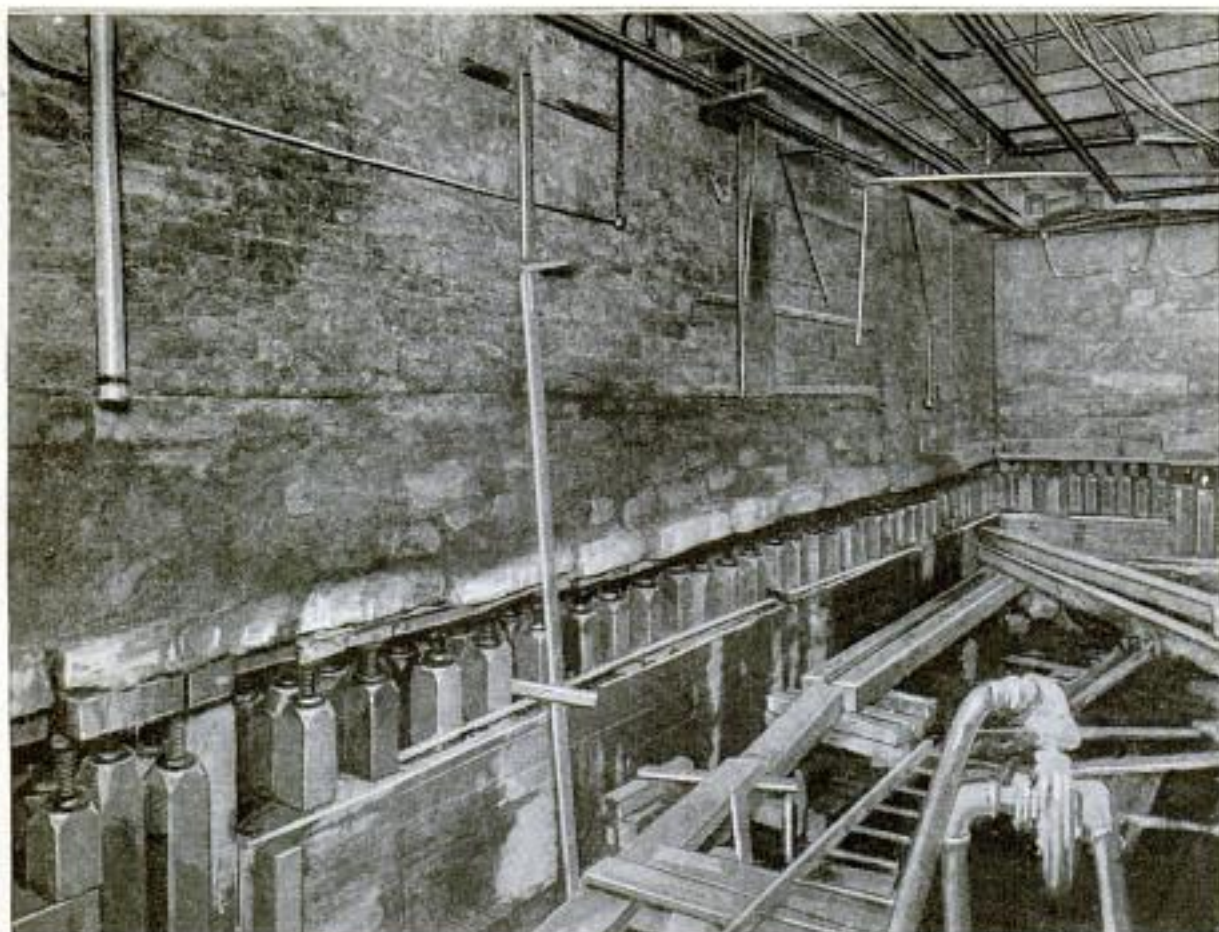

The Foundations for the New Walls were Built Some 12 or 15 Feet below the Old Foundations, and by Using Jacks, and Checking with Precise Leveling, the Weight of the Old Walls was Used to Settle the New Foundations Until No Movement was Noted, and Then the Jacks were Removed and the Space Bricked Up

the operations that all pounding or noisy work should be done between midnight and 10 o'clock in the morning in order not to disturb the performance above.

As soon as the final curtain was rung

down, the wreckers started to tear down the old building, and when this is accomplished, construction will start immediately on the new structure. No serious accidents marred the dangerous job.

JAPANESE PINE TREE TRAINED TO FORM A BOAT



This Sacred Japanese Pine Tree, 600 Years Old, has been Trained on a Trellis and Grows in the Form of a Japanese Sampan

The Japanese have accomplished some wonderful results in the training of trees, in one case, by the use of a trellis, even causing a pine tree to assume the form of a Japanese sampan. The tree is a sacred pine, more than 600 years old, growing in the grounds of one of the temples. The trunk of the tree represents the mast of the sampan, the upper branches being trained to simulate the sail, while the lower branches carry out the idea of a hull of the boat.

Cmt. A. E. Thomas,
 911 Wunchley Ave., Portland, Ore.

9382

COMMENT AND REVIEW

[These pages were printed May 26, 1922.]

PARENTS have come to regard with disfavor any further additions to the already overloaded courses of study in public schools, some of which are more ornamental than useful. They will, however, favor the Ohio plan, which makes instruction in fire prevention compulsory by law in all public schools of the state, beginning with the kindergarten classes.

Fire Prevention Taught

In addition to the customary fire drill, scholars are taught the location and operation of fire-alarm boxes and how to send in a fire alarm; all about hand fire extinguishers, why and how they work, and how to use them; when to use water to put out a fire and when not to use it, and the proper, handy substitutes, like flour or sand; also instructions in the many ways to avoid fires, especially in and around the home.

The result of this training begun in childhood will enable even those of quite early age to know just what to do when a fire starts, and instead of going into a panic, which renders one helpless, they will be enabled to keep their head, because the mind will be occupied with doing the necessary and appropriate thing. The instruction will commend itself as extremely practical, and in years to come will result not only in much saving of life, but should tend to decrease the present fire loss in this country of half a billion dollars yearly. The city of Toledo has given the new course the name of "Citizen Training," and its Public Safety Committee has provided appropriate medals in recognition of unusual proficiency and accomplishment. The idea is so simple and practical that its adoption generally throughout the country should promptly follow.



WHILE no cement ships are under construction at present in this country, neither are there many steel or wood hulls being built. Steel and wooden shipbuilders continue strong in their disapproval of a "stone" ship, and constructing engineers are still divided in their views.

The Cement Ship

The cement ships built by the government during the war may fairly be classed with "Eagle" boats and wooden and steel hulls, many of which will never carry a cargo. On the other hand, the "Faith," the first cement ship built in this country, is in excellent condition and at present engaged in carrying cargoes.

It must be acknowledged the cement ship possesses wonderful strength. The tanker "Selma," which went on the rocks at Tampico, Mexico, was raised and towed to Galveston, a distance of 455 miles. It is true that for reasons largely local, it was found impractical to make the necessary repairs, and the ship was finally left in an out-of-the-way place by the Shipping Board, but beyond the hole in her hull the ship was as strong as ever.

Another example of the unusual endurance of these craft may be seen in the steamer "Polias," which in a blinding snowstorm went on a submerged ledge in February, 1920, three miles off Port Clyde light, Maine. The wreck lies broadside to the heavy waves which continuously come in from the open sea. In July of that year I went aboard and carefully inspected the entire vessel. The ship was as solid as the rock on which she rested; not a break or crack above or below decks, except where a sharp rock came through the bottom. Standing on the bridge 40 feet above the waterline, I could feel no tremor when the heavy seas struck her. An inspection a year later showed the same conditions, except that the paint was beginning to wash from her sides. The superintendent of the wrecking company declared either a steel or wooden hull in the same position could not have withstood the seas three months. Efforts during two summers to float her with air, however, proved a failure, and after removing the machinery, etc., other salvage was abandoned. It will be interesting to note how many years the hull will last.

While the experience with cement ships has not yet demonstrated a final success—for the accidents to the two ships mentioned would have happened had they been steel or wooden—their strength seems to have been completely established. It is also only fair to consider that these vessels were built during war times and for the first time. With a well-organized shipyard, the cost, which was

something less than steel, would be still further reduced; and early efforts, like the locomotive and automobile, are always somewhat crude. Possibly, with a resumption of shipbuilding later on, it may be found practical greatly to reduce the weight and make other modifications to advantage. The present state of the art of the cement ship, therefore, may be regarded as neither a positive success, nor yet a demonstrated failure, with the balance more in its favor than otherwise.



RADIO, which is probably better understood by more boys and young men than by adults, has swept the country with a rapidity and intensity beyond precedent. Tonight probably no less than two million listeners will receive the concerts, lectures, and other forms of entertainment, broadcast from two score or more sending stations. The number of receiving sets in use in this country today is estimated at about three quarters of a million. As a stimulus to the study of electricity, it has already accomplished in six months more than all the textbooks in years. Factories turning out radio apparatus are running night and day, and are weeks behind on orders. Radio has become what is termed a "craze," for it has attracted

Radio

both young and old.

Radio outfits as built today work with less efficiency during hot or humid weather; hence we may expect something of a let-down during July and August, but with the return of cooler weather people will return to it with new interest.

Like new gold and oil fields and boom towns, many extravagant claims are being put out for what radio will do, and thousands rush in during the first period of excitement. Then, gradually, there is a falling off for one reason or another, and the proposition gets down to fundamentals. The practical, commercial uses are increasing rapidly and already have reached a point where a Federal commission has been appointed to regulate the use of the air for transmission purposes in order to avoid chaotic confusion. So, at last, even the air is no longer wholly free. Improvement in construction and operation will, of course, come as time goes on; but like everything else mechanical, radio has certain limitations. What these limitations are no one knows as yet.

While we hear most of radio as an absorbing source of entertainment, its practical use for commercial purposes is already very large. A vast amount of press, business, and government work is now passing hourly across oceans, and a larger number of messages between cities than is generally known is being handled. In Europe its use in the home is much less than here, but regular service is maintained commercially between many cities.

In navigation its service has from the first been of paramount value, especially in bringing assistance to disabled vessels. The saving in both ships and human life at sea has been enormous, and on the Great Lakes, where ships are never more than a few hours from land, their operation is being still further safeguarded by the establishment on shore of naval radio-compass stations. In times of fog, the signals from these stations reach farther from land than light or foghorns, and are more accurate. By this means vessels are able to avoid danger points, and during fog to travel in lanes which cannot be widened, and proceed and pass with far less danger to themselves and other craft.

If the efforts being made to transmit pictures by radio are successfully worked out, it will put a great advantage into the hands of the authorities of the law, and the likeness of known criminals, at least, can be shot through space even faster than the high-speed automobiles in which they now so easily make their escape.

Its use commercially in this country will eventually, in all probability, be its larger function. Already some country banks and stores have installed sets for the purpose of receiving market reports for their farmer customers. This feature is still scarcely developed. Stranger things have happened, but it seems unlikely, however, that it will ever displace the wire circuits of city and long-distance telephones where both privacy and certainty of operation are indispensable.

It is interesting to watch the development of these new things, all of which seem automatically to be immediately drafted into military service. As soon as one nation devises something new in the way of attack, others quickly study out a method of making it ineffective—hence, armor plate to resist heavy gunfire, anti-aircraft guns, masks for gas, and so on; and now "radio scrambling" is announced to render the communications of the enemy unintelligible. Thousands

of people are being entertained; others instructed; the blind, bedridden, and infirm now have concerts, lectures, and sermons brought to them. It is doing a great work, which doubtless has far from reached its limits.



SOME timid mothers, on reading the reported death of three children in a burning house, and knowing less of radio than their small boys, have allowed themselves to worry unnecessarily over the receiving sets in their own homes. With the hundreds of thousands of installations made by amateurs, whose chief aim in life was to get their receivers working at the earliest moment, and with a cheerful indifference to any possible danger, the wonder is there have not been scores of incipient fires. That there is some element of risk where installations are improperly made, is indicated by the recommendations now announced by the National Board of Fire Underwriters, and an observance of the few simple suggestions

made should insure complete immunity from fire risk.

Aside from a possible attraction of lightning to outside antennæ—against which a simple lightning arrester placed out of doors will safeguard—the chief risk seems to be in the careless stretching of wires across or near wires carrying more than 600 volts, and specially the high-voltage lines of street-railway and other public-utility wires. Warning is also given not to experiment with lighting circuits, and to avoid poorly connected or cross leads from storage batteries; the latter have caused several fires. Outside antennæ should be constructed in a substantial manner to avoid contact by accidental sagging or swaying in the wind, and all joints should be securely soldered. Inside antennæ are not subject to these dangers. Lead-in wires should enter a building through a noncombustible bushing and should not be smaller than No. 14 B. & S. gauge. Experience has shown that more than once even six-volt batteries are capable of starting fires, and special stress is laid on not charging batteries from the electric-light current in the home, nor to receive messages via the house-lighting circuit.

It will be seen from the above that the precautions are really very few and simple, but should be followed to insure payment on a fire-insurance policy in case of fire. With any receiving set the principal danger comes from lightning brought in over the equipment. Where there is no exterior antenna, this hazard is removed. If in doubt, ask any insurance man. Radio is too good to be made the goat of careless or ignorant installation.



MORE and more our manufacturers are coming to recognize the growing demand on the part of the public for a higher standard of art in manufactured products. Thus far there has been comparatively little consistent effort to train an army of artists, designers, and craftsmen beyond the elemental stage. Each manufacturer has practically had to train artists for his own particular need, or, as has been done to a large extent, copy from foreign manufacturers or import artists from abroad. Naturally the successful operation of a large plant is what appeals first of all to the producer, and in most cases the ability to manage a large business does not carry with it an equal ability to train designers. In other words, the two

processes, while most intimately connected in producing an article, are actually very different things in execution. To teach designers requires facilities and instructors that are just as complete and competent in their line as the manufacturing process must be complete, with its choice of most efficient machinery and the best possible arrangement of it to prevent lost motion as the raw material is carried through to the finished product. We have paid great attention to efficiency in these matters, but have neglected a constant supply of new art designs of the best and highest order. Obviously no better pattern will emerge from a loom than is given the loom to weave.

For a long time some method for improving conditions has been talked of and is now about to materialize. In Chicago, a strong association of manufacturers has been organized for the purpose of establishing a training school for artists, designers, and craftsmen. Also, another is forming at Newark, N. J. It is the intention to gather from all parts of the world notable examples of cloths,

*Radio
Fire Risk
Avoidable*

*Art
in
Industry*

tapestries, laces, jewelry, all forms of interior decoration, and specimens of all kinds of work that has to do with industrial art. Instructors will be carefully selected for their special fitness in each of the many varieties, and students will be taught not only the general principles of the arts, but will be encouraged to select some one line for which they show special inclination and aptitude, and to specialize in that particular branch. This will not only open up new avenues of occupation for the artistically inclined, both men and women, but in a few years will provide the manufacturer with carefully trained artists who are not merely artists, but who have been taught how to combine art with the practical uses of production, and who are expected to bring to their work that initiative which is so greatly prized. And when the plan is well in operation, our standard of industrial art should be raised to a level which will not only be appreciated in the home markets, but largely increase export sales.

This country possesses one great advantage over others in such efforts, in the fact that Americans are so adaptable, and not likely to handicap themselves by hidebound traditions; and wherever efficiency permits, make short cuts to the final result toward which an effort tends.

H. H. WINDSOR

GOAL POST MADE HARMLESS AT HONGKONG POLO CLUB

To protect both horse and man from the obvious danger that must exist in the game of polo from the liability of collision, the goal post on the grounds of the



Polo Goal Post Made Entirely of Bamboo Baskets, and So Constructed That It is Knocked Over in Case of Collision, without Injury to Horse or Rider

polo club at Hongkong, China, was built of delicately constructed bamboo baskets, so that in case of collision it would be easily knocked over. A particular inducement to adopt this harmless kind of goal post was the visit to the club of the Prince of Wales.

Because of the decreasing value and unsatisfactory character of the mark as a medium of exchange, the people in some parts of Germany are reverting to the ancient principle of trade by barter.

COMPACT DEVELOPING OUTFIT CARRIED IN POCKET

Developing outfits are numerous, but one of recent introduction has several features incorporated in it for the benefit of the tourist-traveler and vacationist. The complete kit weighs only 1 lb. and measures $1\frac{1}{4}$ by $4\frac{1}{4}$ by $6\frac{1}{2}$ in. when folded in the case, so that it can be carried in the pocket. All roll film from the "vest-pocket," eight-exposure type, up to and including the $3\frac{1}{4}$ by $5\frac{1}{2}$, six-exposure size, are quickly and easily developed by the aid of this outfit in broad daylight.

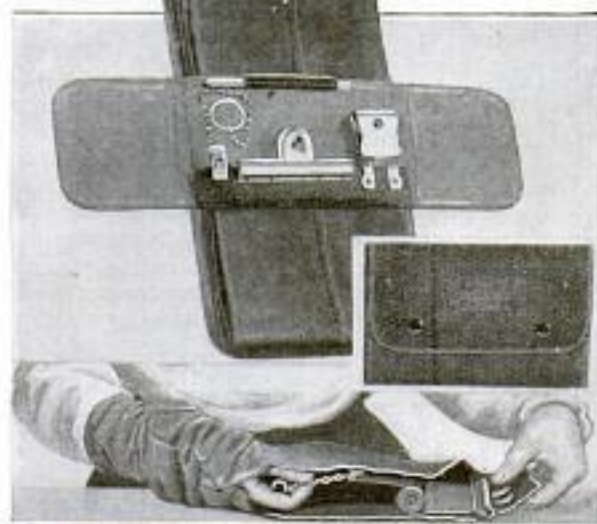

Above: Developing Kit with the Case Shown Open and Closed. Below: Bag Cut Open So That the Two Hands can be Seen Unrolling the Film

Burke + James, Inc.
240 E. Ontario St. Chicago

Cmd. Roy C. Bennett, 1208 N. 57th St. Philadelphia, Pa. 9248

9266

6.00

9210 Cmt. Howard C. Kegley
1349 Larveta Terrace, Los Angeles
Calif



The Traveling Stock Company of Players and Their Auto Bus Ready to Leave for One of the Near-By Towns Where They will Give a Performance: After the Show They Return to the Home Town for a Good Night's Rest

9210

STROLLING PLAYERS USE AUTO-BUS FOR TRAVELING

The combination of gasoline and good roads is accomplishing wonders for the theatrical business in several of the south-western states, for the motor bus has stepped in and made it possible for showmen to form "wheels" in suburban cities

and **country** towns which could not be played by stock companies a few years ago because of the poor transportation facilities prevailing.

One well-known eastern theatrical man has been using a truck in Los Angeles

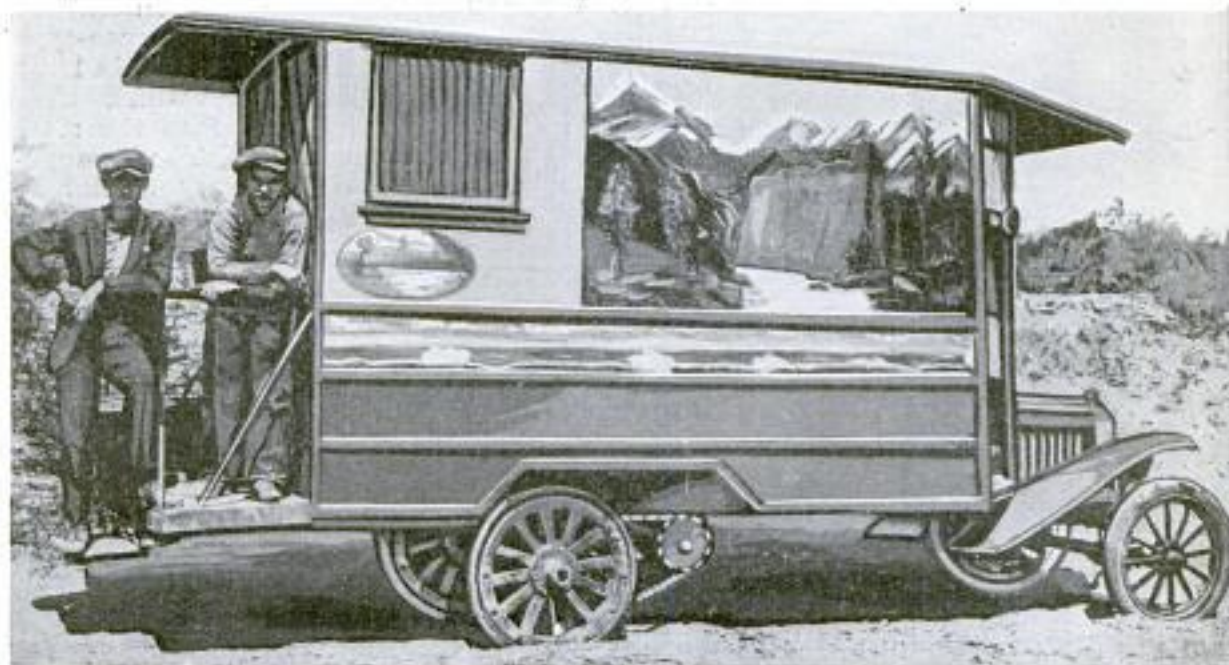

Auto Truck Used by a Traveling Vaudeville Troupe Playing the Smaller Towns in Arizona and Texas: Scenic Paintings on the Sides of the Truck Serve to Call Attention to the Show

and Orange counties, California, with marked success. He has a staff of 15 members, 11 of whom are players, and with this troupe he plays around a wheel each week, giving Anaheim, Santa Ana, Corona, Whittier, Orange, and La Habra good shows at fair prices. Two nights a week the company plays in Anaheim. It plays one night a week in each of the other towns. Corona, 40 miles away, is the most distant point. The company drives over there from Anaheim in the afternoon, gets set for the night show, puts on a performance, and hikes back to Anaheim in an hour and a half after the curtain goes down. Every night it plays a new town, but always it gets home to Anaheim to sleep in a comfortable bed. This eliminates the discomfort of hotel beds in country towns.

The company carries all the scenery and baggage it needs on a trailer. The truck has a bus body with seats to accommodate the entire troupe. In the matter of handling scenery, the company enjoys great advantage when traveling by truck, because it can take the "drops" right with it to the theater door, eliminating drayage cost, and getting away from the trouble of checking baggage. I say

nothing of the saving in wear and tear by doing away with four extra handlings.

Only a few weeks ago a vaudeville company, playing country towns, especially through Arizona and Texas, where "big time" vaudeville is hard to get because of poor transportation facilities, was seen touring the country between Phoenix and Imperial Valley in an auto with a delivery body. The sides of this body were covered with canvas, and these canvas areas were covered with scenic paintings which attracted considerable attention, and served, in some degree, to advertise the company as it journeyed along.

In southwestern Colorado there is a motion-picture showman who has a wheel of motion-picture theaters in country towns about 50 miles apart. After billboarding one show as he goes along with another, he takes a new release and starts over his circuit, making one town a day till Saturday night. He drives home Sunday, picks up the film for next week's show, and makes a new start over the circuit, stopping at billboards along the roads each day to paste up a few "three-sheets" announcing next week's show, for the information of his scattered patrons.

GAS BURNER COOKS AND HEATS WATER AT THE SAME TIME

It will no longer be necessary to have a separate unit for heating water in the

storage tank, if a newly designed gas-range burner is adopted. The burner is supplied with an annular space around the flame, and this space is directly connected to the hot-water tank. When the range is in use, the heat that would ordinarily be wasted in the open-type burner is absorbed by the water, which then circulates into the storage tank. The arrangement is very similar to the standard waterback of the coal range. The operation of the burner for cooking on top of the stove does not differ from the regular open-type burner.

Submarine pipes from the Sarawak oil wells carry the oil out to depths that will accommodate the largest vessels. One of these pipes is 14,555 ft. long, and believed to be the longest of its kind in the world.

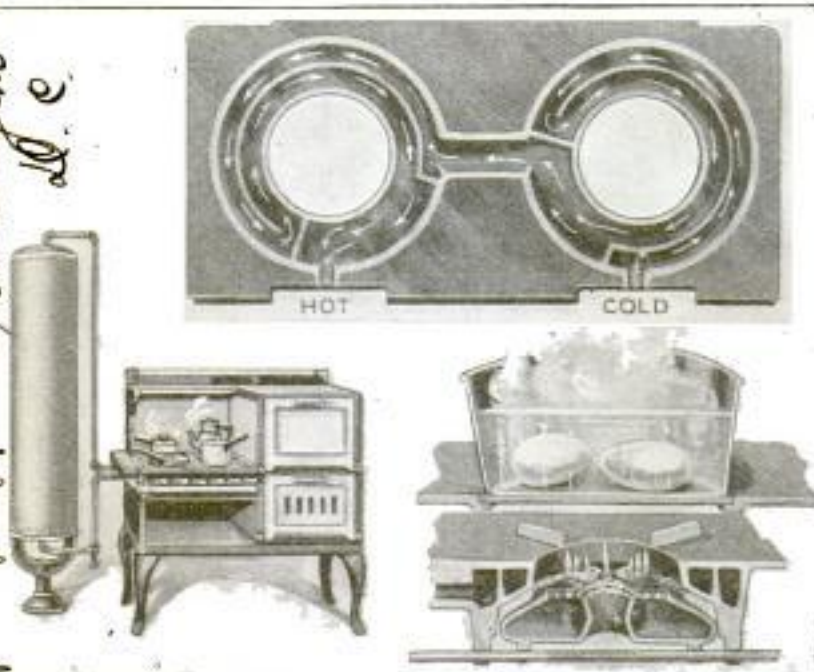

Above: The Arrows Show How the Water Circulates in the Space Surrounding the Burners. Below: The Gas Range Connected to the Hot-Water Tank, and a Section of the Two-Purpose Burner

H. P. Updegraff, Scott Press Appliances Co., Washington, D. C.
 5 Thomas cycle N.W. Washington, D.C.
 34 Board Bldg.

9257



The Horse-Drawn Fire Engine Making Its Last Appearance in a Parade to Signalize the Complete Motorization of the Detroit Fire Department: With Bell Ringing and Whistle Blowing, the Apparatus Drawn by the Magnificent Team Led the Procession. The Team at the Right Also Took Part in the Procession

9257
FIRE HORSES MAKE LAST RUN AS FEATURE OF PARADE

Making their last spectacular run, teams of fire horses dashed down one of the main thoroughfares of Detroit, recently, before thousands of spectators who had gathered to witness a parade of the city's fire-fighting equipment. Complete motorization of the Fire Department is responsible for the passing of the faithful animals. They have been turned over to the park commissioner for use on light hauling work.

8915
HAYRAKES ON MOTOR TRUCK FUNCTION EFFICIENTLY

Two hayrakes attached to a frame which is suspended from a platform, that in turn may be placed on an ordinary

motor truck, constitute the invention of a Kansas man. The rakes are of equal size, normally self-balanced, and being positioned close to the ground, they function efficiently in rapid loading of the hay.

9283
PUBLICITY IS DEMONSTRATED AT ENGLISH EXHIBITION

Publicity, that necessary adjunct of successful business, had its worth practically demonstrated in an original manner at an English exhibition recently. A miniature railway system, operated by electricity, was installed and served to direct attention to the many commodities that could be profitably transported in the cars. Likewise were illustrated numerous kinds of advertising signs and posters which could be erected in stations, along the right of way, on fences, and on bridges.

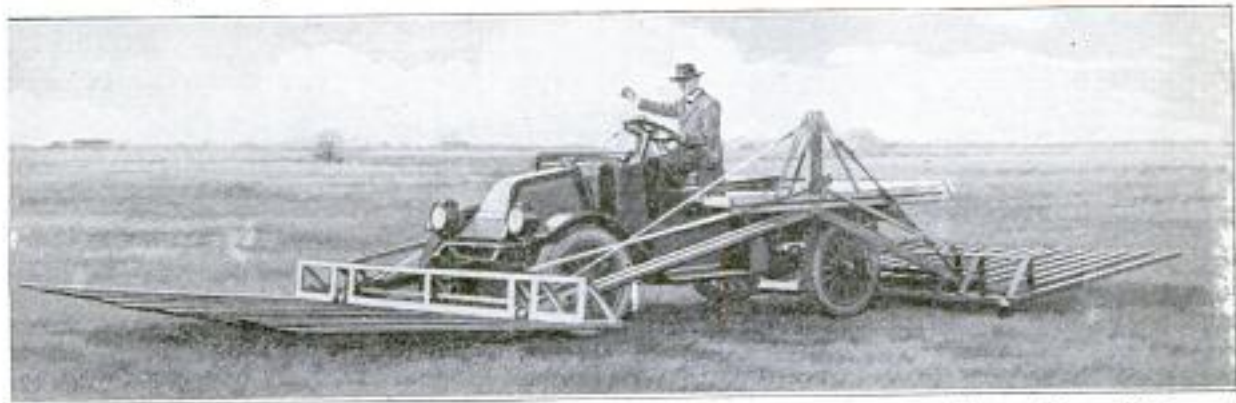

The Rake Attachment Which may be Suspended by a Frame from the Body of an Ordinary Motor Truck and, Because of the Low Position, Functions Efficiently as a Rake, and Permits Rapid Loading of the Hay

Chas. Wesley Kouns, Salina, Kans.

London Times Weekly 4/27/12
Exhibitions Division, Department Overseas Trade, 2 South Collyer St. London

7961 Fairchild Aerial Camera Corp.
136 W. 52nd St. New York

Dr. Sherman M. Fairchild

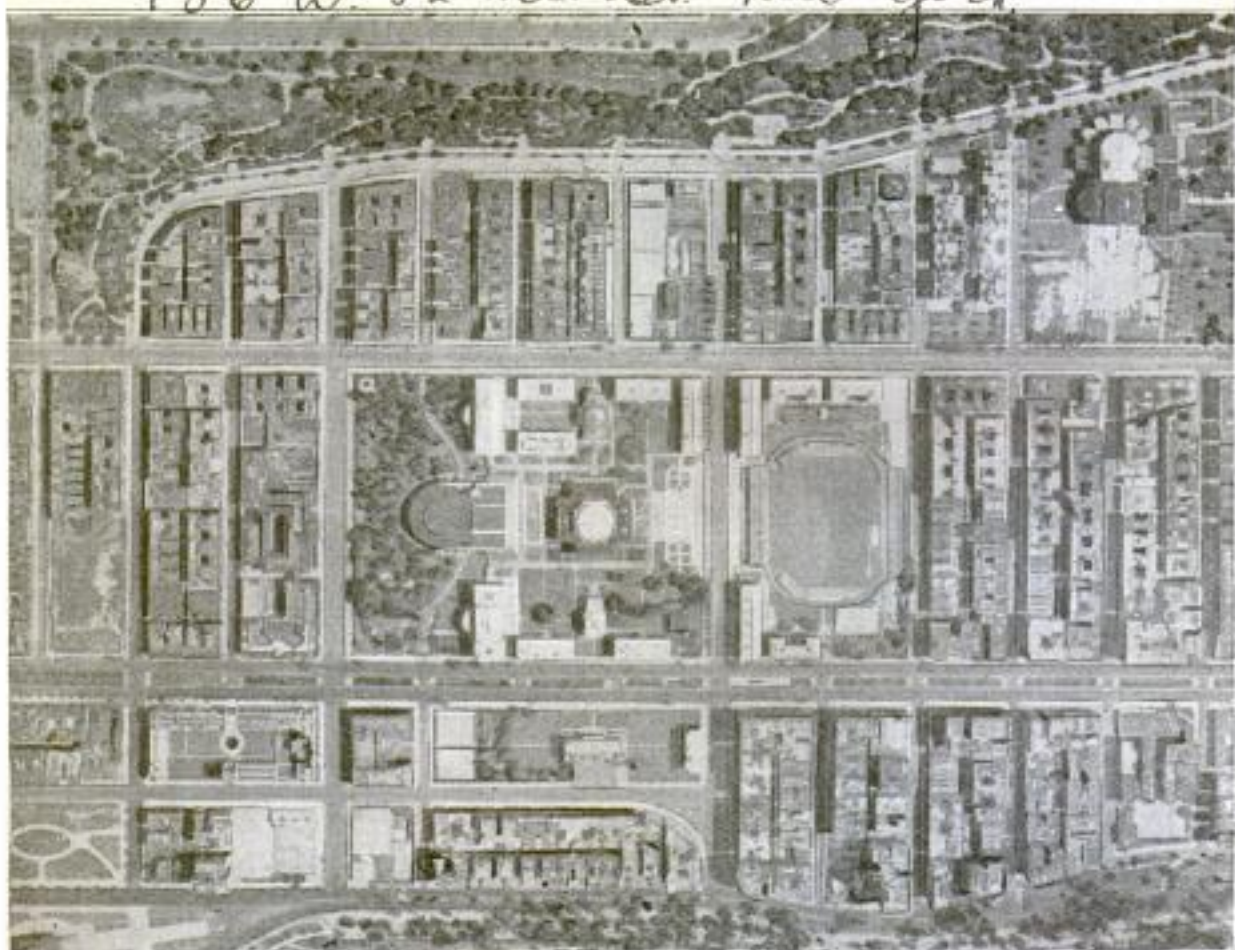

Part of the Photographic Mosaic Map of Manhattan Island: The Circular White Spot in the Center Is the Dome of Columbia University Library. Along the Top of the Picture Is Morningside Park. In the Upper Right Corner Are the Seven Chapels of St. John the Divine, with the Foundation of the Cathedral Just Below

EFFICIENT HIGH-SPEED AERIAL CAMERA

Aerial photography has been greatly developed since the war, when it was first put into practical use, and a notable instance in connection with this development is a new aerial camera which has recently given a remarkable demonstration of efficiency in the production of a photographic mosaic map of Manhattan Island. A hundred exposures taken at an altitude of nearly two miles resulted in a map, 8 1/2 ft. long and 28 in. wide, showing more than 32 square miles of New York City, with every object, even to the pedestrians, plainly portrayed.

The machine that



Large High-Speed Aerial Camera, with the Lens End Below, and Above, the Spools on Which the Film is Wound by the Electric Motor Seen on the Left Side

made this possible is a large camera, weighing 36 lb., which uses a film similar to that of any ordinary camera, though very much larger, and having an electric timing device that regulates the exposures in proper relation to the speed of the airplane from which the camera is operated. Inaccuracy that would result from the continuous movement of the airplane is prevented by the use of a new kind of shutter that operates between the two lenses of the camera, and exposes the entire plate in 1/500 second—such a short period that the exposure is entirely unaffected by the movement of the airplane.

The new camera is equipped with an automatic device for regulating the intervals between exposures in accordance with the speed of the airplane. By means of another innovation the roll film is held without vibration.

9309

INVENTION PROMISES SECRECY FOR RADIO MESSAGES

Considering the wonderful advance that has been made in radio communication during a comparatively limited time, it is only logical to expect some development that would insure secrecy for radio messages. It is now announced that one of the foremost radio experimenters of this country has produced a simple device which prevents any but authorized stations from receiving broadcast messages. Several messages may be sent at the same time on a single wave length, and the apparatus reduces the possibility of accidental interference and also the effects of static disturbances.

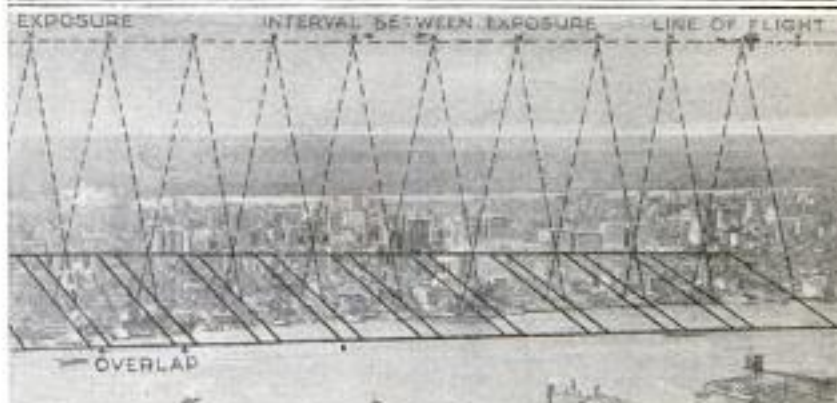

COPYRIGHT, FAIRCHILD AERIAL CAMERA CORPORATION
Diagram, Showing How 32 Square Miles of Manhattan Island were Plotted and Photographed in 69 Minutes with a Modern Aerial Mapping Camera: Above Is a Plan of the Area, Showing Route of Airplane and Successive Exposures. Below Is a Diagram Showing the Method of Procedure

8707

TIRE-PRESS BRACKET HOIST SAVES TIME AND LABOR

By means of a bracket hoist, recently developed in San Francisco, one man can operate a press for the heaviest solid truck tires in less time than it could be done by two men in the ordinary way. The hoist is self-adjustable, and can be applied to any size or type of hydraulic press. It consists of a swiveled bracket connected to the side of the press, and fitted with a small winch. This is operated by a crank handle that winds up a

chain from which the wheel is suspended. The tire is first centered on the wheel, which is then hoisted to the proper height, swung under the press, and lowered onto the platen. Then the press is started.

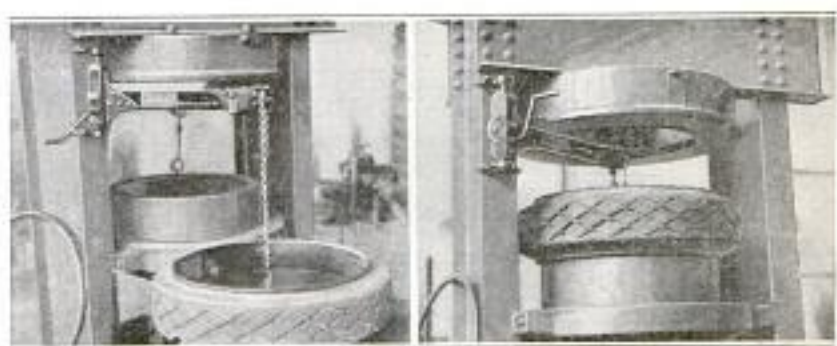

Left-Hand View Shows How the Tire is Centered on the Wheel before Swinging It onto the Press, and at the Right It is Shown in Position Ready for the Press to be Started

Reliance Trailer & Truck Co
30.8th St. San Francisco, Calif

Dr. John Hays Hammond, Jr. Leicester, Mass

Randell Wireless Co,
9 Central Ave.

24 Times
5/18/22 P. 7

38
910
NEWARK N.J.
POPULAR MECHANICS
CRYSTAL DETECTOR APPEARS
LIKE VACUUM TUBE

Resembling a vacuum tube in appearance, a new crystal detector is now being



manufactured and placed on the market by an eastern company. The detector and fixed contact are inclosed in a glass case to prevent interference by moisture and dirt, and should prove popular with persons interested in receiving radio broadcasting from near-by stations.

STRANGE SUBSTANCE IN TEARS
9023 DESTROYS BACTERIA

A British scientist has made the remarkable discovery that human tears contain a substance that has the peculiar property of readily destroying microbes and bacteria. A small portion of tears introduced into a test tube containing countless bacteria quickly dissolved them. While the substance has not yet been isolated, it is known to exist in nearly all tissues of the body and also in some vegetables.

9194
FILAMENT RHEOSTAT MADE
OF CARBON DISKS

Two small columns of carbon, or graphite, disks inclosed in a porcelain con-



tainer, constitute the essentials of the latest filament rheostat. An adjusting knob, or screw, is provided for controlling the pressure on the disks, thus changing the resistance of the columns and thereby raising or lowering the amount of current flowing through the filament. The circuit is controlled by an internal switch that opens the battery circuit when the screw is released.

9227
MOTHER SHIP AND HER BROOD
OF SUBMARINE CHASERS

The submarine chasers, because of their small size, can carry only a limited supply of fuel oil, and have no facilities aboard for making repairs or renewals, and this has led to the development of the mother ship, used as a base of supplies. When the commander of a subchaser finds it necessary to replenish his supply of fuel oil, he ties up alongside the mother ship, from whose tanks the oil is pumped. It is not unusual for ten or more of the subchasers to be taking supplies at the same time.

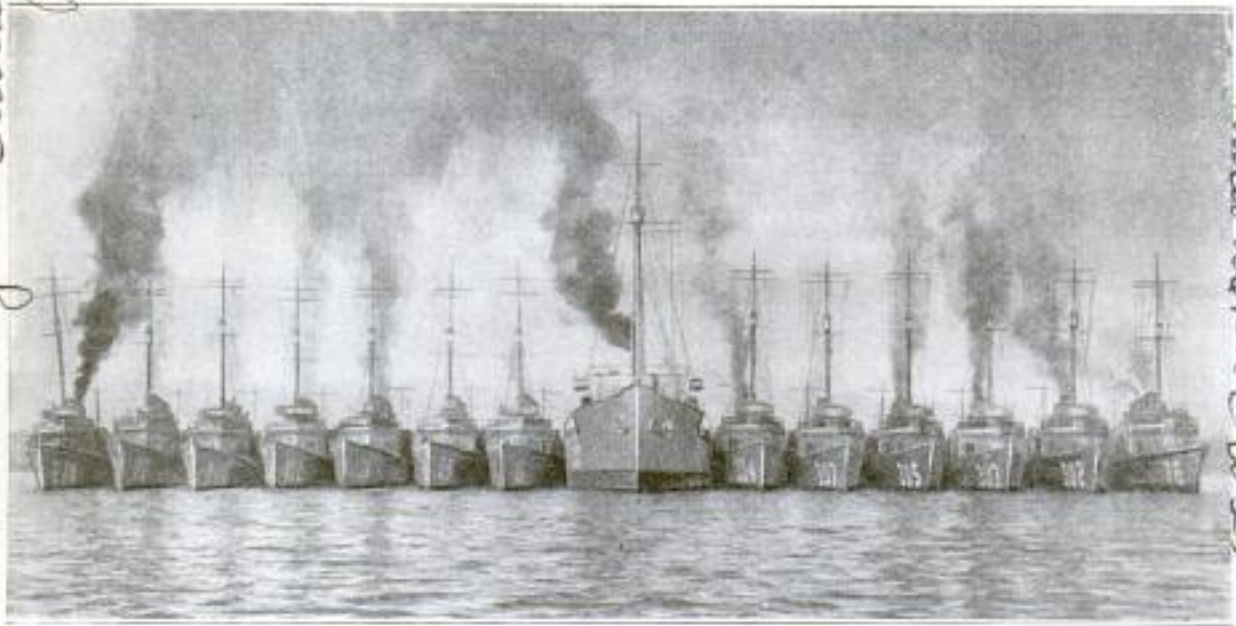

Like Chickens Gathered around the Old Hen, These Little Submarine Chasers Gather around the Mother Ship, from Which They Receive Their Supply of Fuel Oil

Allen Bradley Co., 288 Greenfield Ave
Mentor, Ohio

No. 4. Beatty, 1604 Consumers Bldg.
Chicago

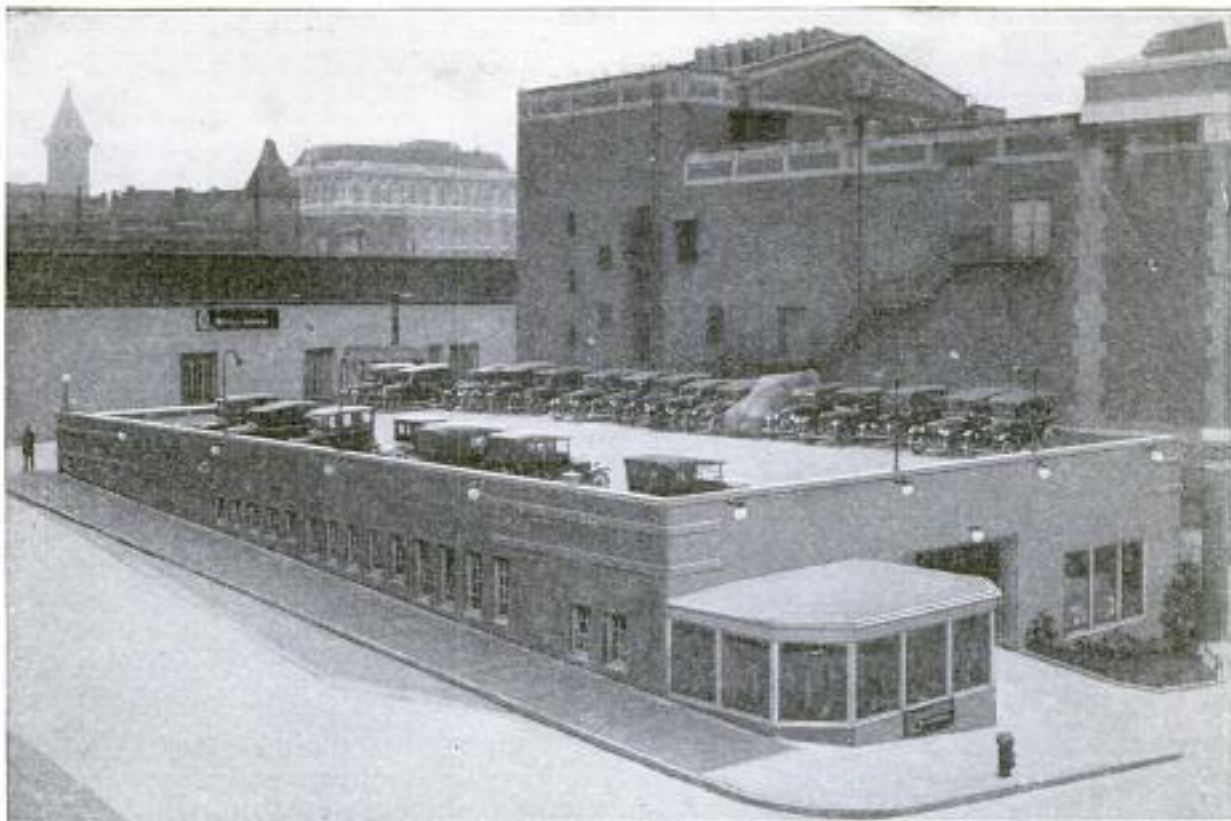

The Roof of This One-Story Garage in Seattle has been Made a Source of Revenue by Constructing It in Such a Way That It can be Used as an Outdoor Parking Space for 200 Automobiles

9108
**USING THE ROOF OF A GARAGE
 AS AUTO-PARKING SPACE**

As a means of utilizing the down-town space to best advantage, the owner of a one-story garage in the city of Seattle, Wash., has made the roof into an outdoor parking space. Advantage is taken of the hilly nature of the ground by making an inclined driveway from the side street to the roof of the garage. There is room for 200 cars in this unusual parking space.

9090
**WINCH ERECTED ON TRACTOR
 PERFORMS HEAVY LABOR**

Heavy labor of various kinds can be performed with the use of a winch which has been constructed on a common type of tractor, although the outfit was originally designed for service in the oil fields. The winch is mounted on the differential housing of the implement, the drum being driven direct from the pulley shaft by means of an easily attached

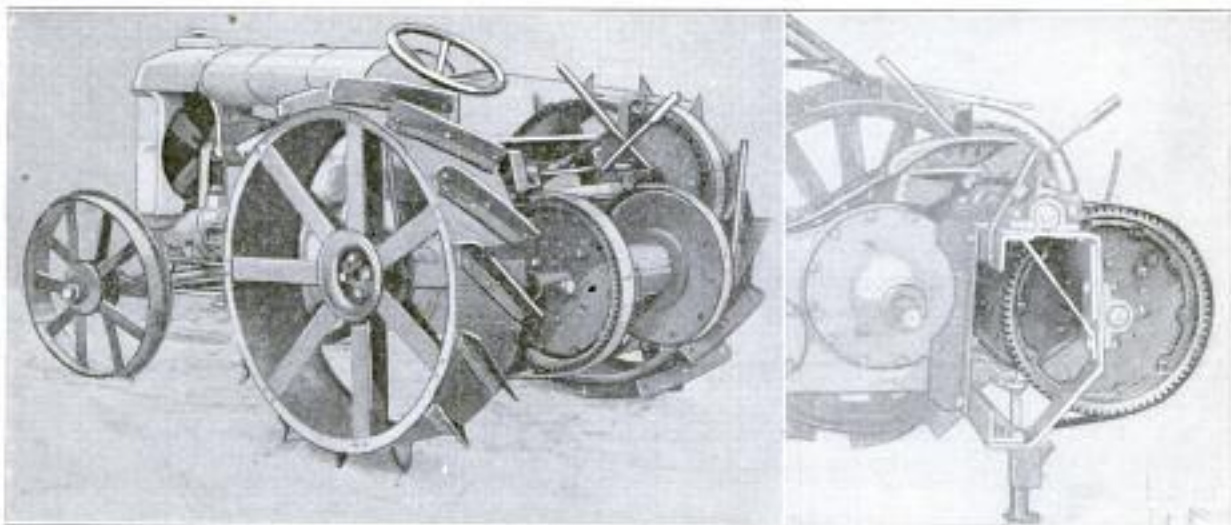

Left: Winch Mounted on the Differential Housing of a Tractor. Right: Traction Wheel Removed, Showing How Winch is Attached; It is Controlled by a Special Clutch Lever Independent of the Operation of the Tractor

A. W. C. K. Meyers, Franklin, Pa.
Hardson Copyrighted material

Robert Reis & Co.,
19th + Broadway
New York City

sprocket, chain drive, and gears. The tractor transmission is thereby left idle, and all wear thereon is eliminated while the winch is in operation, all of which is accomplished without in any way interfering with the different maneuverings of the machine. The pulling capacity of the contrivance is six tons, direct pull, and 15 to 25 tons with the aid of a block-and-tackle arrangement. The drum holds 3,000 ft. of 3/8-in. steel cable.

CHILD'S TYPEWRITER PRINTS LETTERS AND PICTURES

9243

The education that children receive through games comes easily and without

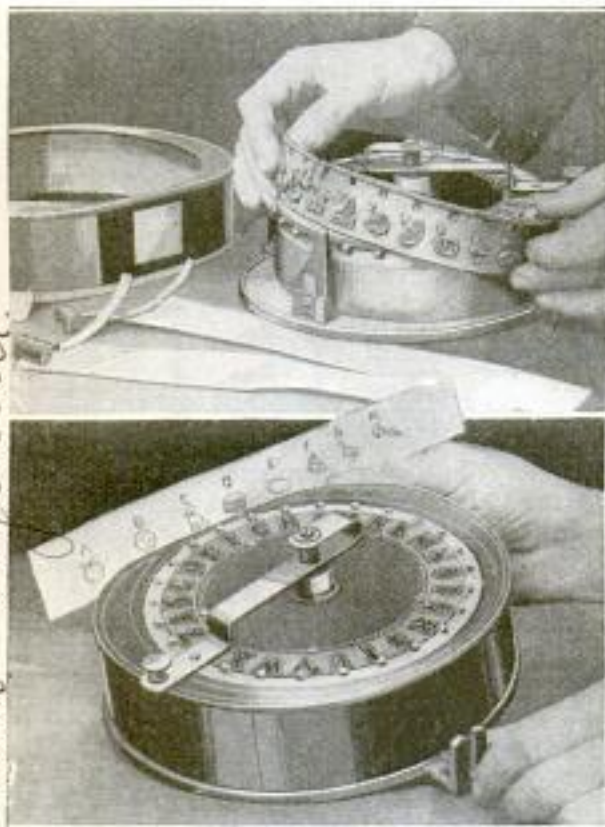

A Child's Typewriter Which Prints the Letter and a Picture of Some Object Whose Name Begins with That Letter

apparent effort, and, working along these lines, an English inventor has developed a typewriter that should take much of the drudgery out of learning to write and spell. The machine has a circular keyboard showing the letters of the alphabet. When one of the keys is pressed the letter is printed on a slip of paper and beside the letter a small picture of some common object whose name begins with the letter printed. The machine is designed to use interchangeable signs, so that progressive lessons in reading and spelling may be given.

Warmley's, 8.9 Hill,
Allendale Road, Denmark,
London, England.

HOSPITAL GARMENT IS MADE TO BE EASILY REMOVED

9320

To overcome the annoyance and pain occasioned when bedridden patients must be moved or examined, a garment has been devised which can easily be removed without disturbing the patient in the least. The back and front of the garment are made in two parts held together with snap fasteners, and the sleeves are also fastened in the same way. If the garment is made in the form of pajamas, the legs are held in the same manner. Garments made in this form permit ready access when examinations are to be made or wounds dressed. Also, in case one arm or leg of the garment becomes soiled, it can be detached and sent to the laundry separately.

Dr. Geo. George Thompson,
162 E. 61st St.
New York City

MINIATURE UPRIGHT PIANO WITH PEDAL KEYBOARD

8856

While the hands are busy with a violin, or other musical instrument, the feet are free to operate a miniature piano designed for that purpose by an inventor in Omaha, Neb. The little piano, weighing only about 30 lb., is 34 in. high, 24 in. wide and 3 in. thick, with a keyboard, including its 18 pedals, 14 in. wide. Of the 18 notes, nine are treble and nine bass, and it has an arrangement by which these can be played in nine different keys. It can be played by the hands as well as the feet, and it is said that it will perform any ordinary music. It has a harp-like tone, and is easily mastered.



Miniature Piano Played by the Feet, While the Hands Are Free to Perform on Any Other Instrument

Dr. Fred C. Ingersoll,
1609 Burt St. Omaha,
nebr.

9326 d no. Isew. Jno. J. Thompson, U.S.A.
(Retired) Washington, D.C.

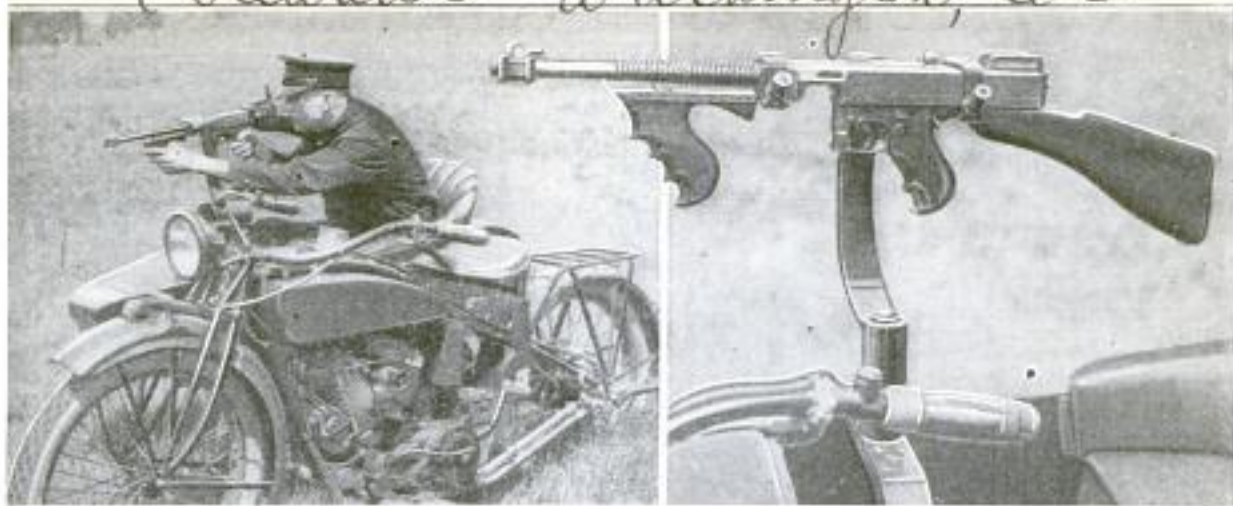

The Thompson Submachine Gun Mounted on a Motorcycle Sidecar Provides an Effective Means of Fighting Automobile Bandits. The View at the Right Shows the Substantial Mounting of the Gun on the Frame of the Sidecar

9326

AN ANTIBANDIT GUN IN DEMONSTRATION

BY ERIC A. DIME

159 W. 33rd St.
New York City

THAT the Thompson submachine gun is an effective weapon against automobile bandits was demonstrated at the Sportsman's Service Station, Tenafly, N. J., on the 10th of last month. The gun, which was first described in the November, 1920, number of Popular Mechanics, is the lightest automatic gun in existence. It weighs only 9½ lb. and can fire .45-caliber bullets at the rate of 1,000 per minute. It can also be used as a single-shot rifle.

The reason why bandits, after committing a holdup or a robbery, are able to escape in automobiles lies in the fact that a police officer equipped with only a regulation pistol and in pursuit of the crooks, finds it difficult to shoot straight and "wing" the bandits. During the demonstration at Tenafly the submachine gun showed its effectiveness. The weapon was mounted on a motorcycle sidecar and operated by a policeman. The motorcycle pursued an automobile containing dummies representing thugs attempting to make a get-away. The auto was towed by another car some 25 or 30 ft. ahead. The submachine-gun operator opened fire on the "bandits' car, and shot its tires full of holes, so that the machine had to come to a halt. As a matter of fact, the rapid fire would have killed any one sitting in the automobile.

Later it was demonstrated what this antibandit gun can really do to a motor car when the latter becomes the target of automatic firing. Three of these weapons blazed away simultaneously on a seven-passenger touring car, and in less than a minute reduced the car to a pile of junk. The tonneau was perforated till it looked

like a Swiss cheese. The radiator was torn to shreds, the gas tank resembled a nutmeg grater, and the steering gear was turned into an indescribable mass of kindling wood and twisted metal. An incendiary bullet was finally fired into the spilled gasoline, and instantly the machine was a mass of flames.

In densely populated districts, birdshot cartridges are used with the gun. The birdshot afford severe punishment without causing mortality. A 4 by 5-ft. target at which automatic fire of birdshot was directed for five or six seconds was peppered so full of holes that it looked like the face of a man having suffered from a severe case of smallpox. The firing was done at a range of 30 ft., and there was not a spot on the entire target big enough for the smallest mouse to escape death or injury.

The gun will fire a magazine of 20 cartridges containing 120 No. 8 birdshot in 1½ seconds, or 2,400 birdshot in a "burst" of 20 shots. No more than 20 birdshot cartridges are placed in a magazine, so it requires four minutes to shoot 1,000 birdshot cartridges containing 120,000 birdshot. There is no other gun in the world that shoots both ball and birdshot cartridges. With ball cartridges, a policeman can fire 42 shots at six bandits armed with automatics containing seven shots each and, shot for shot, have 58 shots without reloading when the automatics are empty. The gun has an accurate range of 2,000 ft. when military high-power cartridges, such as are employed in wars, are used, and with police ammunition, the accurate range is 1,500 feet.

8959

WORLD'S LARGEST OCEAN LINER

By HENRY S. WHITE

A Floating Edifice with Accommodations for the Population of a Small Town, and with the Luxurious Fittings of a Great City Hotel

Majestic

ALLOCATED by the treaty of Versailles to the British government, and sold by it to the White Star Line, the former German steamship "Bismarck" has been converted into the liner "Majestic," very suitably named, for it is the world's largest ship, and in many ways the most luxuriously fitted vessel afloat. This ocean-borne palace is 956 ft. long, 100 ft. broad, its hull is 102 ft. deep, and its tonnage is 56,000. It has nine decks, with a total area of 7 1/2 acres, and its main deck is 75 ft. above water. It has accommodations for 4,100 passengers and a crew of 1,000. Its power installation is the largest ever fitted in a passenger vessel, consisting of four huge turbine engines, each weighing 375 tons, for forward driving, and four reversing turbines. With 48 boilers, it is fitted with a modern oil-burning system, and consumes about 5,700 tons of liquid fuel in a single crossing. The total horsepower is 100,000, and its normal speed is 28 miles an hour. Passengers can



take their daily walks in any kind of weather, for the promenade deck is more than 50 ft. above the sea, and is inclosed for a great part of its length with glass panels. On this deck are a restaurant, a palm court, and a lounge. From a grand foyer is an unbroken sweep of 250 ft. down the center of these apartments. Provision is made for outdoor sports in a special section of the boat deck.

Two public rooms of special interest, by reason of their size and location, are the library and the smoking room. Contrary to custom, both are situated at the forward end of the passenger decks, one above the other. The library, on the same deck as the lounge, has shelf capacity for 4,000 volumes. The room affords facilities for personal correspondence, or any kind of literary work.

Besides the luxuriously furnished first-class accommodations, the ship has second and third-class quarters which correspond in character with the other parts of the ship.

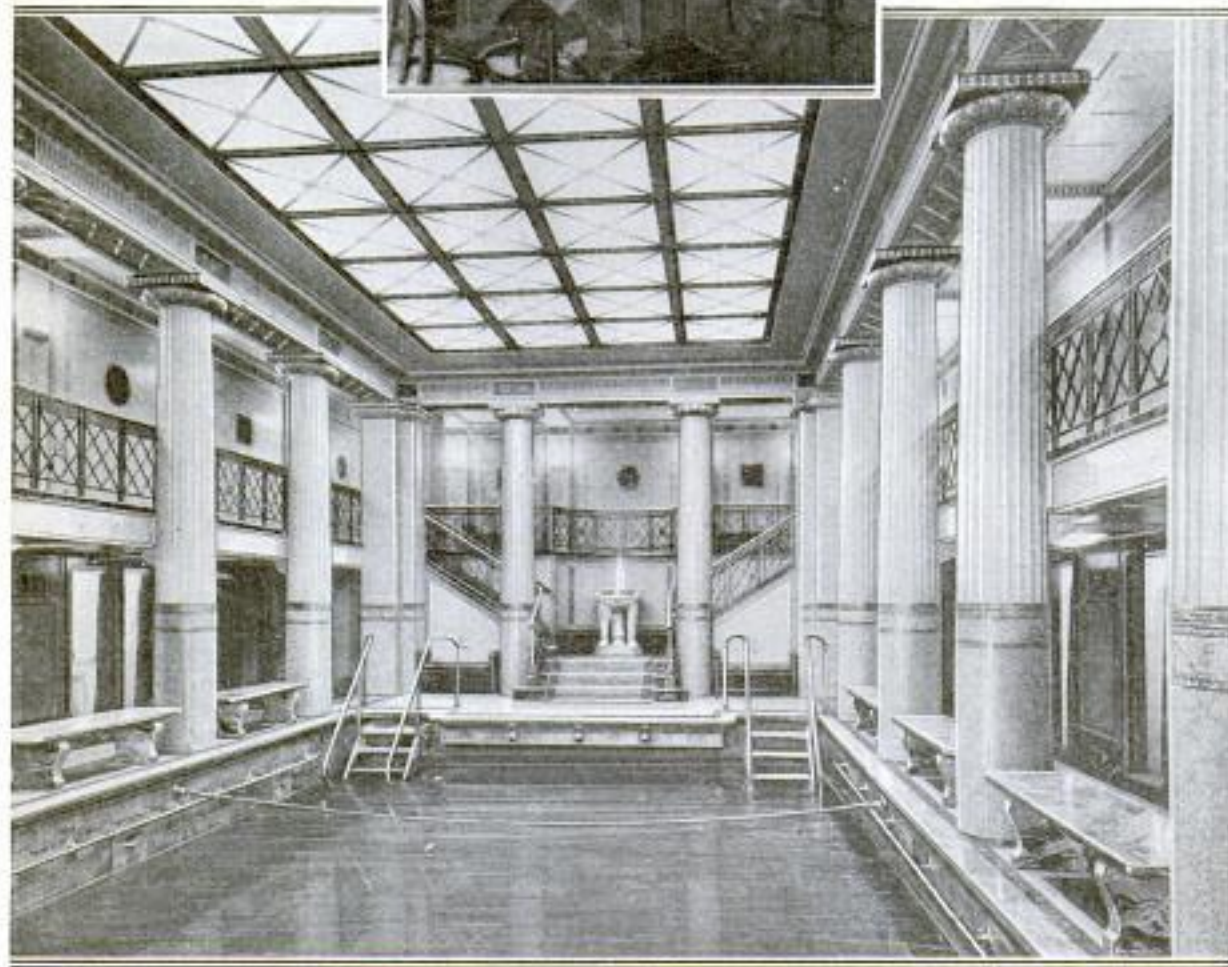

Swimming Pool with an Area of 820 Square Feet: There Are 30 Dressing Rooms and a Gallery for 300 Spectators; Turkish and Electric-Ray Baths Adjoin the Pool. Above is Shown the Dining Room with a Domed Ceiling, 31 Feet High, the Loftiest Apartment Ever Constructed in a Ship. It Seats 652 People

White Star Line, 1 Broadway, New York City

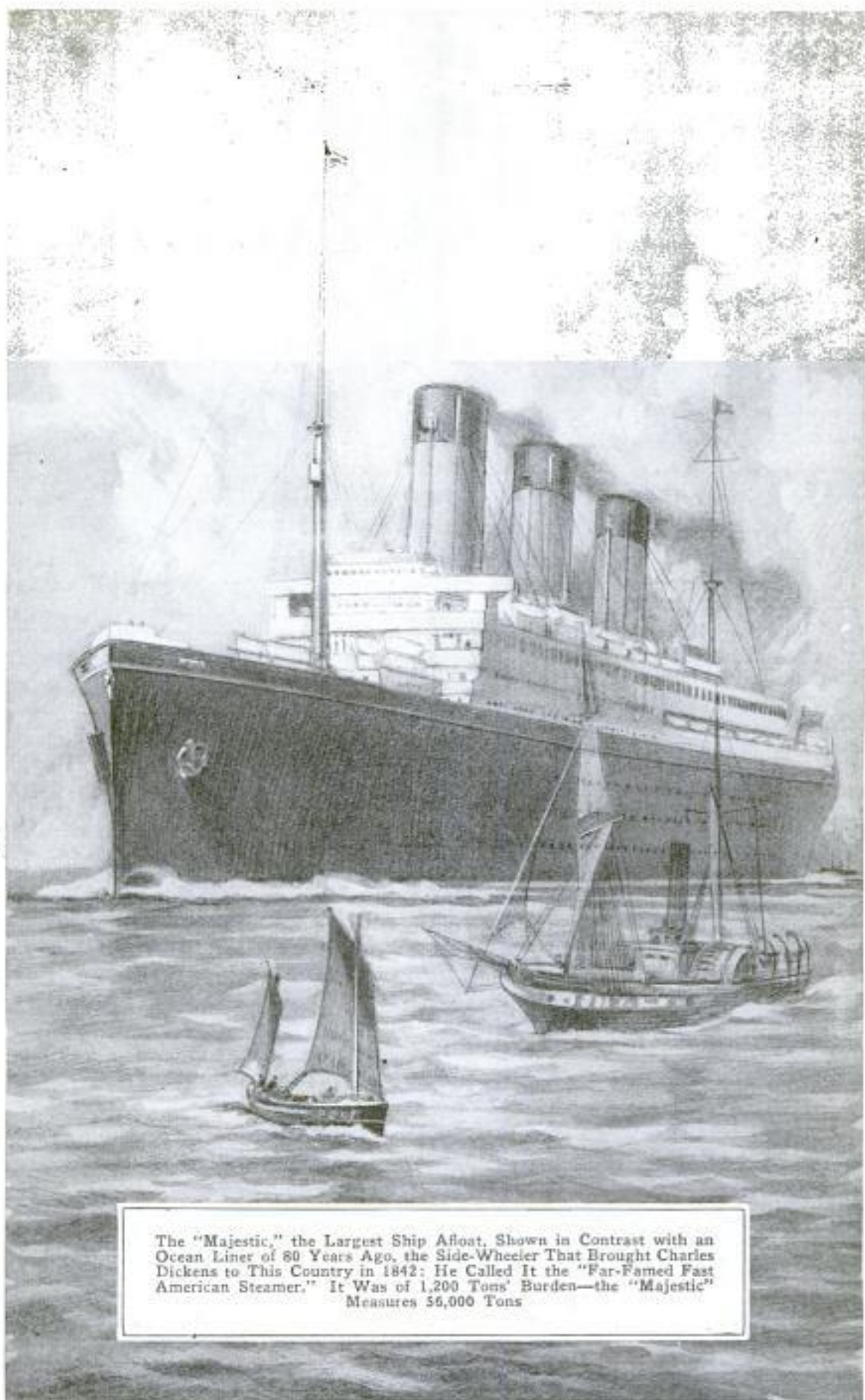

The "Majestic," the Largest Ship Afloat, Shown in Contrast with an Ocean Liner of 80 Years Ago, the Side-Wheeler That Brought Charles Dickens to This Country in 1842: He Called It the "Far-Famed Fast American Steamer." It Was of 1,200 Tons' Burden—the "Majestic" Measures 36,000 Tons

RECENTLY DEVELOPED HOBS
TO CUT SPROCKET TEETH

Instead of being hobbled, sprocket teeth are cut almost entirely by the ordinary rotary cutter, the reason being

that it has been generally supposed that the range of teeth that could be correctly cut by a single hob is necessarily limited, and that therefore a large number of hobs would be required properly to equip a shop for sprocket cutting. There has now been developed in an Indiana factory a set of hobs, each of which is capable of cutting any number of sprocket teeth of a given pitch and roller diameter. A single one of these hobs, it is said, will do the work that has hitherto required a set of from six to nine cutters. These hobs are designed to cut sprocket teeth of the new American-standard tooth form, which has been approved by the principal engineering societies, and by manufacturers of roller-transmission chains.

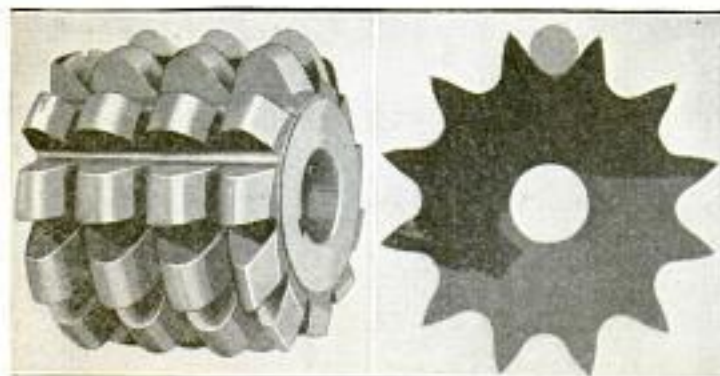

Left: A Set of Hobs, Each Capable of Cutting Any Number of Sprocket Teeth of a Given Pitch and Roller Diameter. Right: The Form of Sprocket Tooth Which has been Approved

ANTISEPTIC IODINE PEN HAS READY SUPPLY

A nonleaking iodine pen has been developed which is equally well adapted for home or office use. The supply of iodine is held in the lower part of the glass tube, and is fed through a valve to the brush, as required. The flow of iodine can be regulated by partially opening or closing the hole in the glass



The Supply of Iodine is Held in the Glass Reservoir and is Forced into the Brush by Pressing the Glass Pen Downward

pen. The end of the brush may be cut off after using if desired.

Universal Products Corp. Jackson Bldg. Providence, R. I.

CYLINDER-GRINDING MACHINE ATTACHES TO LATHE

To facilitate the regrinding of automobile cylinders there has been produced a

special attachment for lathes of 14-in. swing and larger. The attachment is self-contained, and has its own driving motor of 1/2 hp. which will run by connection with an ordinary lamp socket. A cylinder block of any size is held on an angle plate, with an up-and-down attachment, mounted on the lathe carriage, which feeds it to the grinder. This is mounted on the lathe, and its motor drives the grinding-wheel spindle, and also at its other end, through sprockets and a silent chain, the carriage-feed gearing. Thus the whole machine is operated independently of any power in connection with the lathe. Different feeds are provided for, and the wheel spindle is driven at 5,600 revolutions per minute. The attachment weighs about 500 pounds.

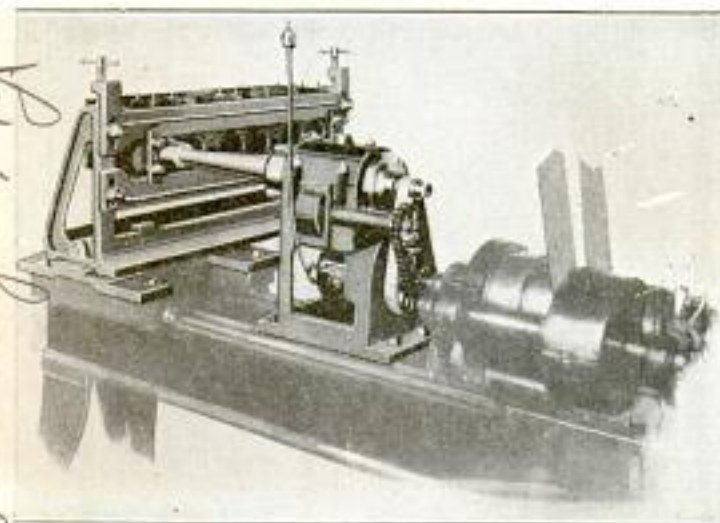

Cylinder-Grinding Attachment for Lathes: It is Operated by Its Own Motor Which Drives the Grinder and Also the Feed Gearing of the Lathe Carriage on Which the Cylinders are Mounted. The Attachment Weighs About 500 Pounds

Liberty Tool Co., Inc.
Crawfordsville, Ind.

8657

9188 Cont. E. K. Hampton 4548
Campus Ave., San Diego, Calif
AN ITALIAN GARDEN MADE IN AMERICA

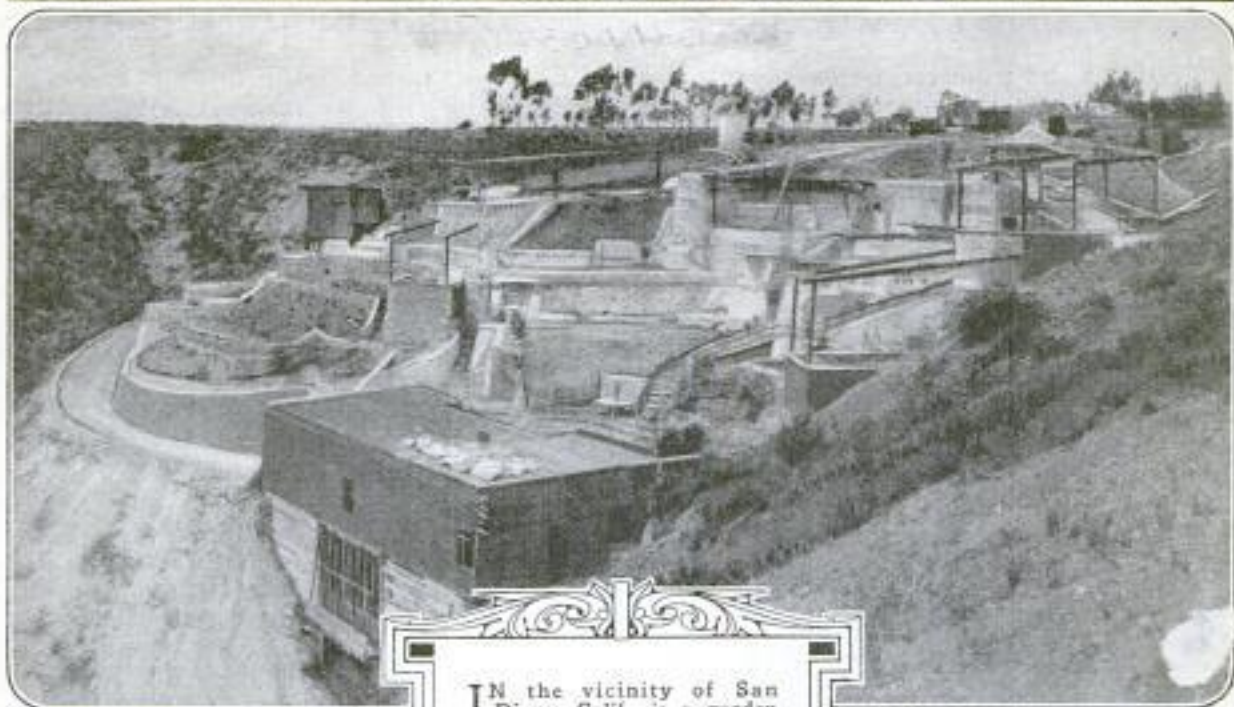

IN the vicinity of San Diego, Calif., is a garden that was ruined by the war, like many a garden in Italy, and that is almost as Italian as they were, for it was the product of an eminent Italian sculptor whose ambition was to reproduce there the famous hanging garden in the Villa Farnesina at Naples. Circumstances connected with the war forced him to abandon his garden when it was only half finished, and subsequent neglect has made it a ruin overgrown with grass and weeds.

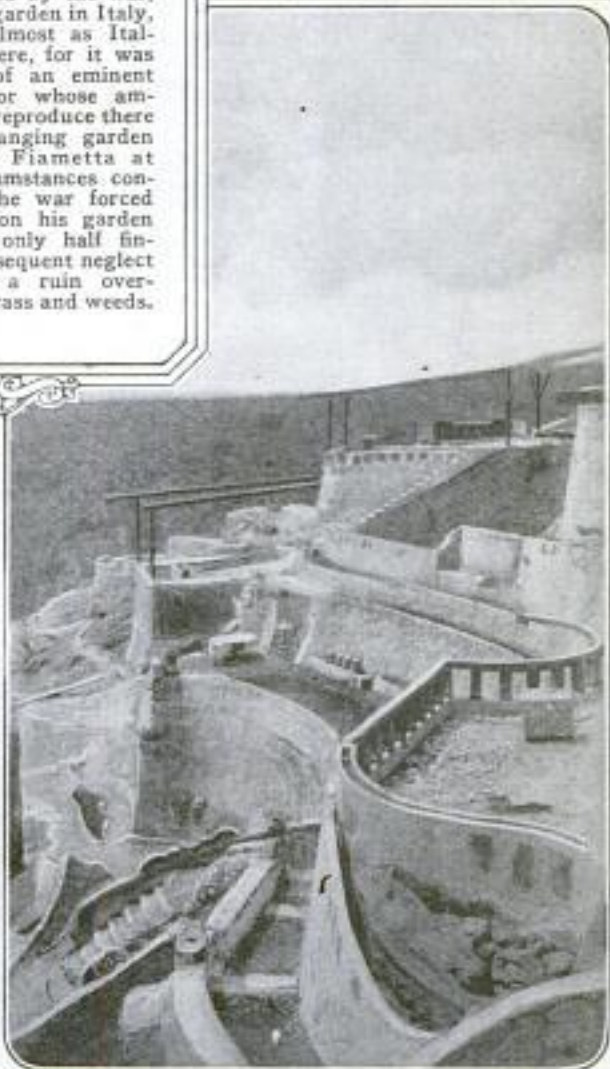

maker. Frank A. Hayward
385 Linner St.

46
8999 *Boston, Mass.*
STATE CAPITOL BUILDING
CARVED IN WOOD

Faithfully reproduced in every detail, a replica of the state capitol building has been carved in wood and presented to

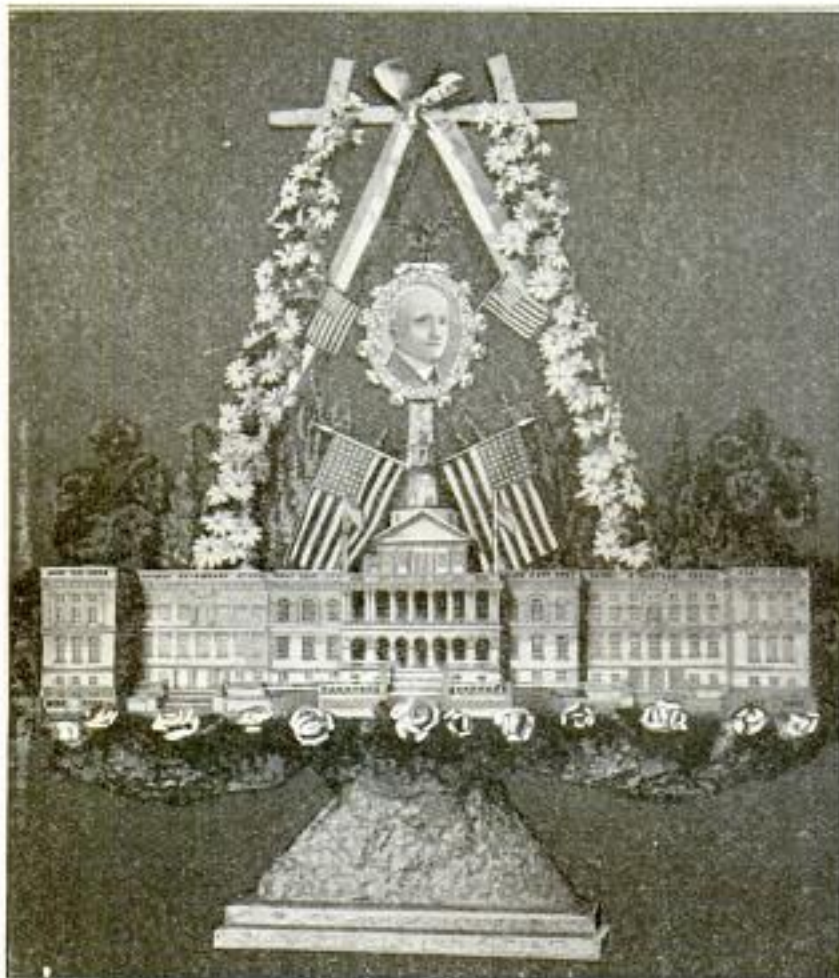

Replica of the State Capitol Building Presented to Ex-Governor McCall of Massachusetts: Carved Entirely Out of Wood, It Stands Four Feet High. Above the Dome Is a Framed Photograph of the Ex-Governor

former Governor McCall of Massachusetts. The work is supported by a pedestal of carved wood, and is surmounted by a frame of wooden daisies.

9253 **MUD IS VALUABLE ACCESSORY
IN DRILLING OIL WELLS**

Mud—ordinary mud—is as precious as gold in the oil fields of California, for this gray substance is found in the Montebello oil fields and scarcely anywhere else in the state. So valuable is it that it can be neither bought nor sold, but is rented on condition that it be returned the moment its mission is fulfilled. This peculiar mud is almost indispensable in drilling for oil. At first, it is used as a primer to start the rotary drill; then, as the drill penetrates the earth, it is necessary to force the mud into the hole between the drill and the walls in order that the latter may not cave in. The mud must not be permitted to harden and clog operations, and so it is kept in circulation. To accomplish this, it is drawn from the hole and sluiced into a vessel or box and allowed to settle. The top, or lighter, mud is then forced back into the hole. Seeing it in trucks being transported to other fields, one would marvel at the careful handling of it. Never a lump is lost. If any falls from the truck, the team is

halted and the pieces carefully gathered up and replaced in the truck. Renting this mud has proved a profitable business to the man upon whose land it is found.

Comr. John Hamilton, 245 W. Palm St.

9304 **TRAVELING MULTIPLE DRILL FOR PLATES**

A multiple drilling machine, of exceptionally large proportions, for drilling, countersinking, and tapping steel plates has been constructed in New York. The multiple drills, 13 in number, are mounted on a cross-rail casting that is suspended from two double-webbed plate girders, supported 8 ft. 10 in. above the floor by two heavy cast-iron uprights, each mounted on two wheels running on rails 44 ft. apart. The cross rail is suspended from a wheeled carriage that runs on

tracks above the bottom flanges of the girders, and under this carriage the cross rail and its drills are pivoted. A constant-speed reversible motor is provided either for revolving the cross rail and drills, or for driving the wheeled carriage the whole length of the girders. The drill spindles are adjustable, and have a minimum center to center distance of 8 in., the maximum distance between outside spindles being 12 ft. 8 in. The spindles are 2 in. in diameter at the driving point.

Wiley. Cement-Pond Co., New York
111 Broadway, New York

9304

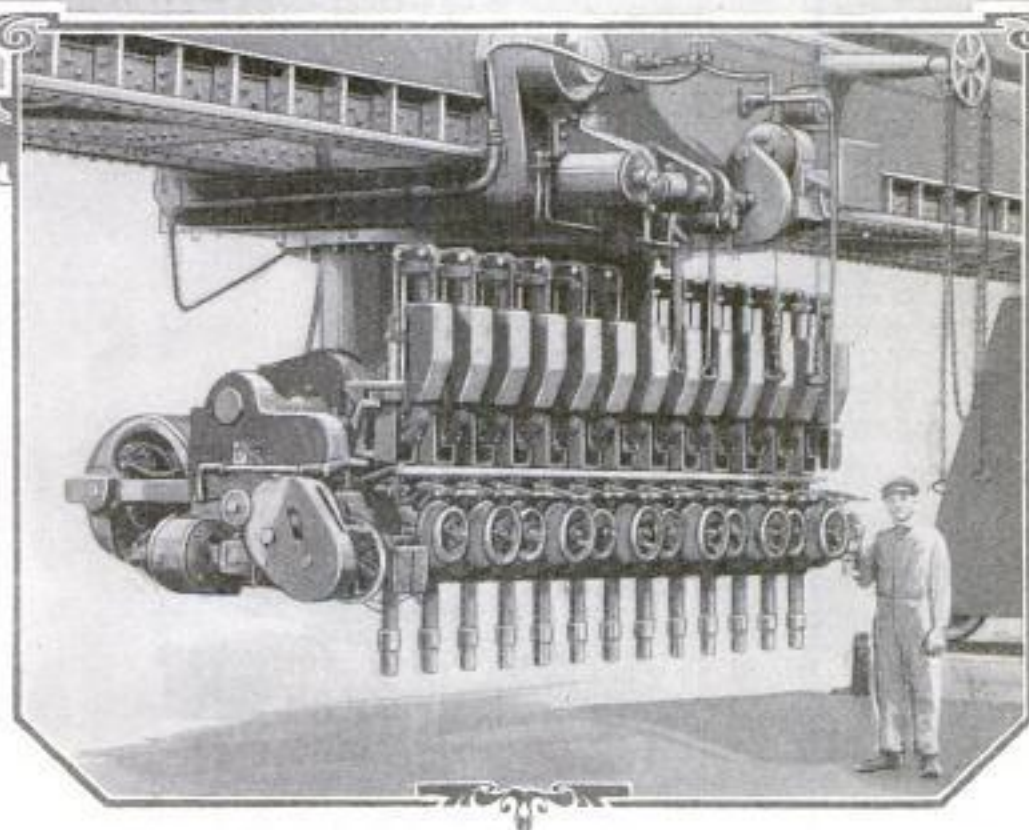
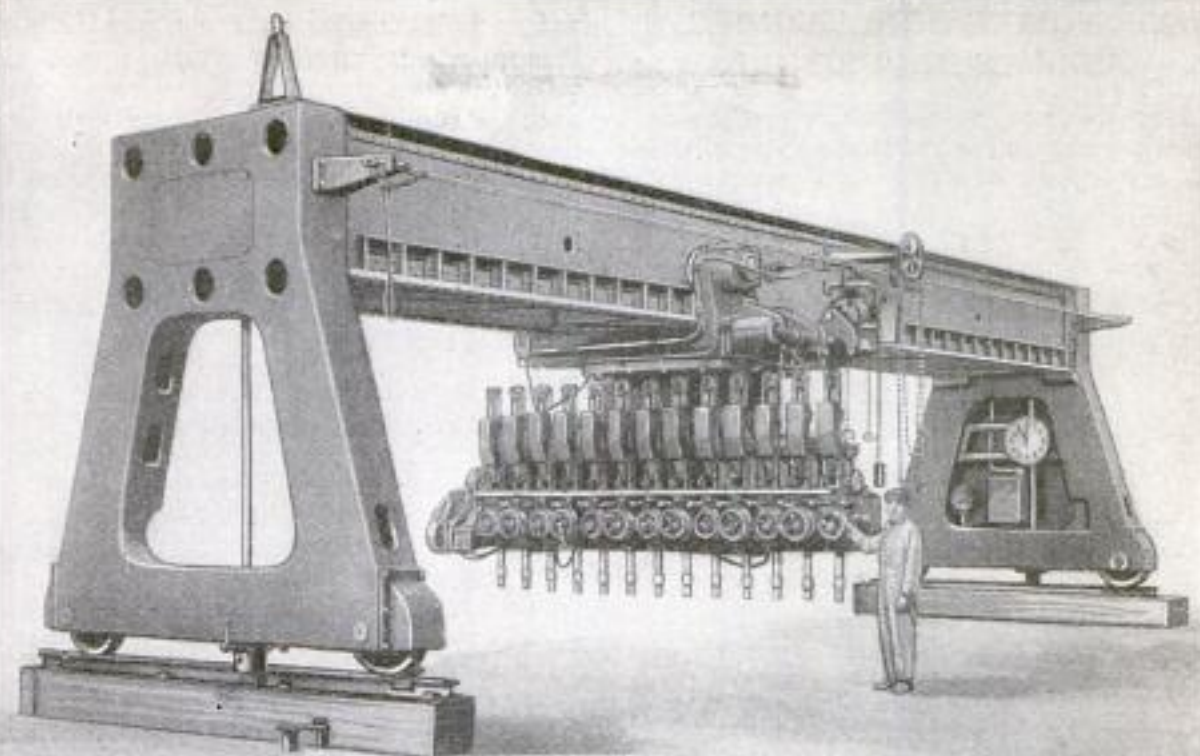

Traveling Multiple Drilling Machine with 13 Drill Spindles, and with a Span of 44 Feet between the Rails that It Travels On: Above is a General View of the Machine, Showing the Revolving Cross Rail at Right Angles to the Supporting Girders. The View Below Shows in Greater Detail the Cross Rail Carrying the Drilling Heads. They are Driven by the 50-Horsepower Motor Seen at the Left

Dealer - Daniel J. Esoff
 320 Wrigley Bldg
 Chicago

HIGH-POWER PORTABLE LIGHT FOR MOVING PICTURES

For the use of the news-reel camera man who must "shoot" his pictures under all conditions of light, or even at night

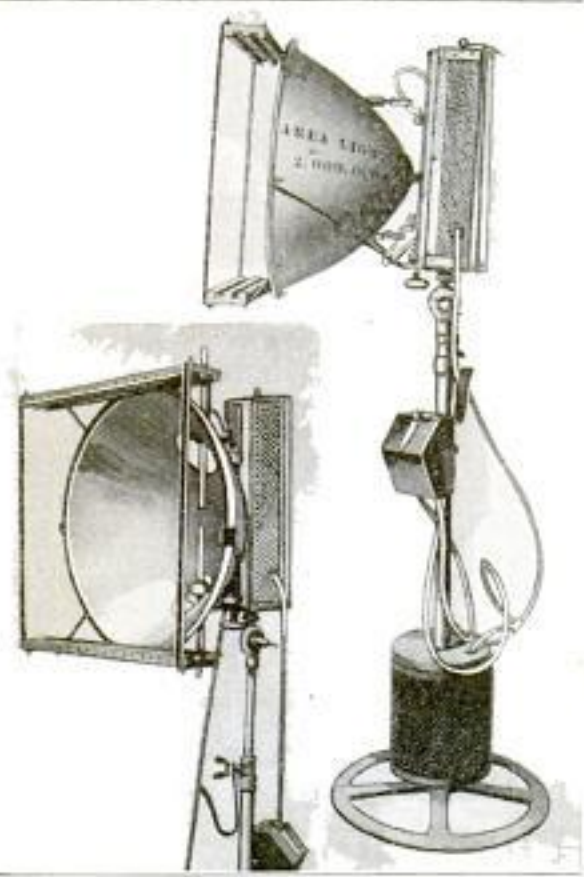

This Lightweight Portable Arc Light, with a Parabolic Reflector, is Designed for Taking Moving Pictures at Night

if the occasion demands, a portable arc light has been constructed which is light enough to be carried by one man. It is equipped with a parabolic reflector and uses a remarkably small amount of current considering the intensity of the light.

926 **WATER JETS AND PUMPS USED IN TREATMENT OF PEAT**

Peat is now being mined, in Finland, by means of powerful jets of water, driven into the bog, working it up into a homogeneous liquid mass, freed from the roots and stumps that make mechanical digging difficult. The liquid is then sucked up by a turbine pump that has cutting blades adjusted to cause minute subdivision of the peat mass. Means are provided to prevent the entrance into the pump of any large solid substance, and if, in spite of this, hard objects are drawn in, they cause the fracture of several

safety bolts, and stop the pump. Above this pump is another which forces the peat through a pipe line to the drying area. The pumps with their driving motors are suspended from the boom of a crane mounted on a car, and can be raised or lowered to suit the level of the peat in the bog.

9267 **GIANT FLYING BOAT CARRIES TWENTY-SEVEN PERSONS**

A new record for passenger carrying is claimed to have been established for flying boats when the air cruiser "Mendoza" recently flew from Keyport, N. J., to the Eighty-Second Street pier on the Hudson River, New York, carrying 27 passengers. The air distance covered was 30 miles, and the time for the flight was 21 minutes. The "Mendoza," which has a wing spread of 104 ft. and is propelled by two 400-hp. Liberty engines, is equipped with a spacious, electrically lighted, glass-enclosed cabin, furnished with comfortable seats.

9230 **STAMP-INVINCING APPLIANCE FOR RAPID ACCOUNTING**

Postage stamps can be invoiced rapidly with a contrivance consisting of a reel incorporating 12 spools, on which stamps of different denominations are wound, after first being numbered on the mucilage side. A glance at these numbers offers a ready indication, at any time, of the amount remaining on the spool, or of the quantity sold. The wheel may be removed from the standards and placed in the vault at night.

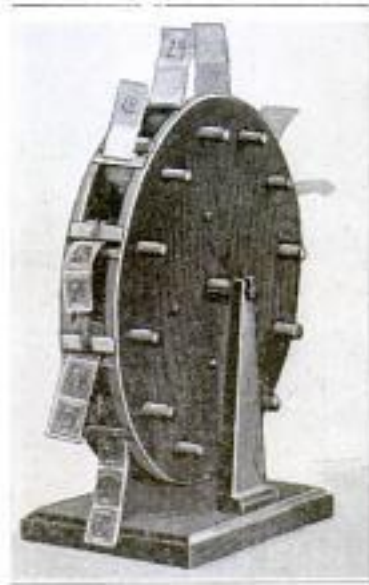

Inv. J. H. Muesey, Des Moines, Iowa

Ⓢ A New Zealand steamship company is converting a former hulk into a modern coal-handling plant at a cost of \$485,000. The converted hulk will be capable of bunkering steamships at the rate of 120 tons an hour.

London Times
 Eng. & Shipbuilding
 4/22/22



SWEDISH LOCOMOTIVES READY FOR DELIVERY TO RUSSIA *Wide World Photos*

AS an indication of the attempt of Soviet Russia to reestablish her railroads on an operating basis, contracts have been let to Swedish locomotive works for 200 railroad engines to be delivered in 1922 and 250 per year for the three following years. Fourteen of these engines have been completed and are ready for delivery.

8965 machinery

TRUCK FOR ROAD MAINTENANCE HAS SCRAPER ATTACHMENT

For the maintenance of gravel roads, a truck fitted with a scraper attachment is now being manufactured in Michigan. The scraper consists of a blade mounted diagonally below the truck on the outside ends of four spiral

steel springs, each 6 in. wide and very strong. The inside ends of the springs are connected to a hollow bar which is adjustable by means of a chain and ratchet post. The bar is bracketed to a

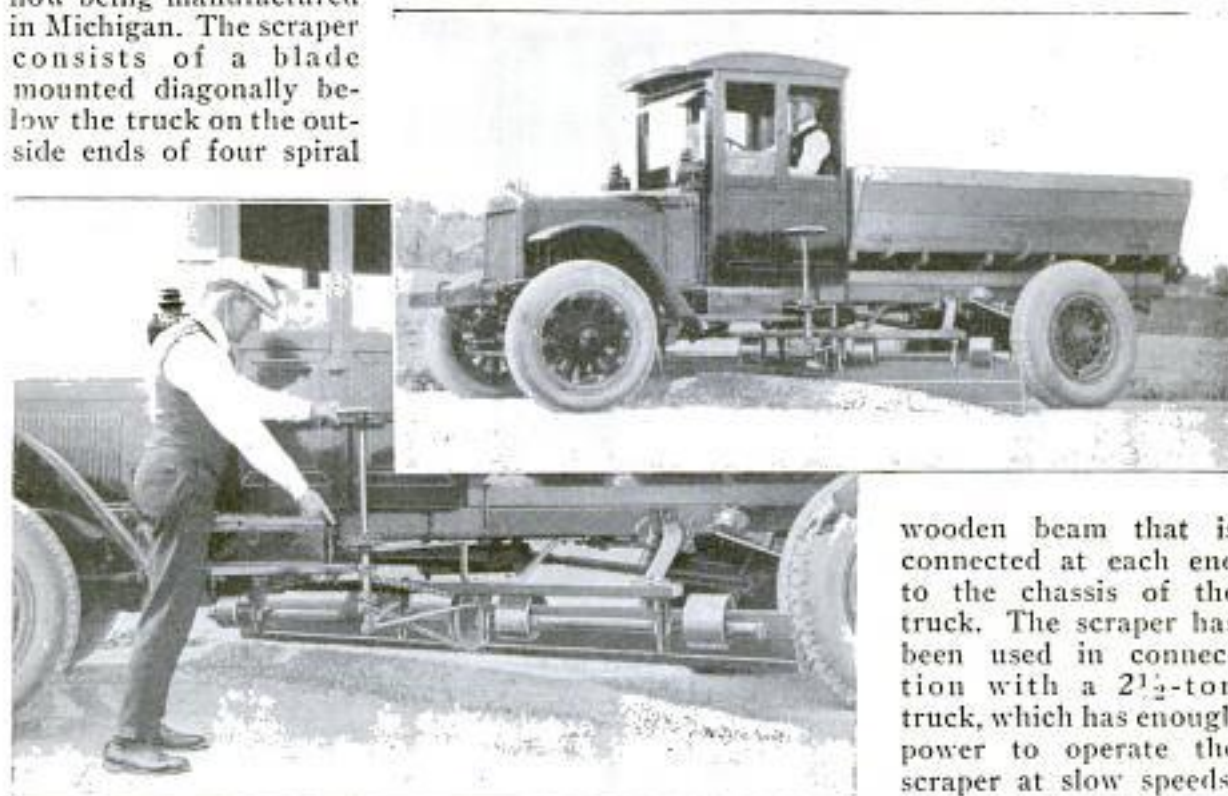

Above: Road-Maintenance Truck with Its Scraper Attachment Shown in Operation. Below: Close-Up of the Mechanism for Operating the Scraper

wooden beam that is connected at each end to the chassis of the truck. The scraper has been used in connection with a 2½-ton truck, which has enough power to operate the scraper at slow speeds, and enough weight to hold it down firmly.

Republic Truck Sales Corp., Alma, Mich.

912⁵⁰

CENTRIFUGAL MACHINE MAKES COFFEE AND BOTTLES IT

For making coffee in large quantities rapidly a mechanical coffee infuser and bottle filler is now being installed in a

Manthey Form Laboratories Co., Cleveland, Ohio

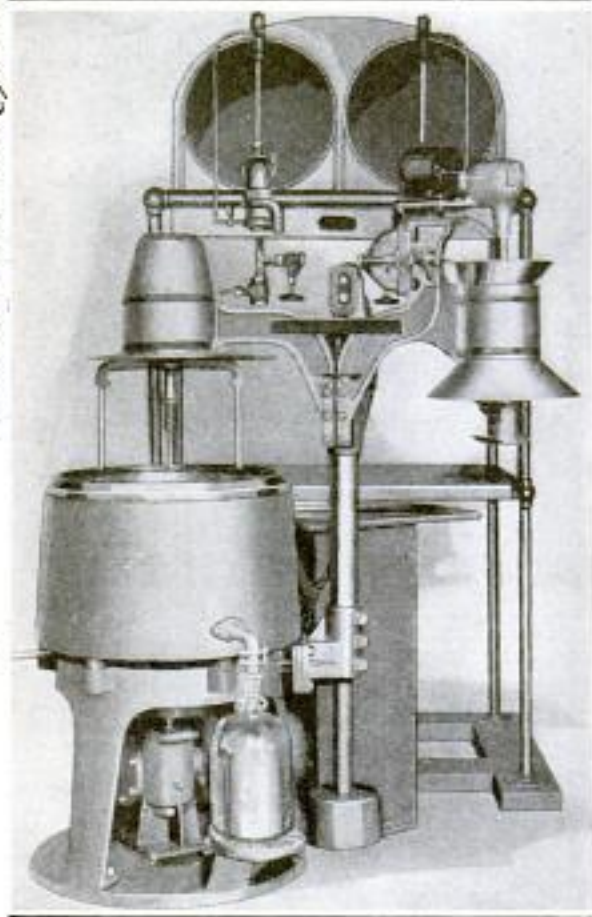

Coffee Infuser and Bottle Filler with the Water Container in Position for Feeding Boiling Water into the Infusing Bowl and Thence into the Bottle

number of restaurants and large hotels. The machine operates centrifugally, somewhat on the same principle as a cream separator. Mounted on a skeleton base is a metal bowl which incloses a basket made of fine wire mesh and lined with filter paper. This basket is rotated at a speed of 1,200 r.p.m. by an electric motor which, with its gear box, is within the base and beneath the bowl. By the side of this is a vertical post which carries above the bowl a two-armed pivoted bracket, with a ground-coffee container at the end of one arm, and a hot-water container at the end of the other. In the coffee container is a stirrer that is revolved at a very high speed by a second small motor, by which means, through a distributing propeller beneath the container, the coffee is thrown against the inside wall of the whirling basket. The machine operates in connection with two

boilers above it, from which boiling water is fed into the hot-water container. When the wall of ground coffee has been formed in the basket, the bracket is swung round so that the water container takes the place of the coffee container above the whirling basket, into which the water is fed so that it is forced through the wall of coffee. It then issues through an outlet spout into a bottle-filler tank, from which it is siphoned into bottles. The product is a coffee extract strong enough to make at least four times its quantity of drinking coffee.

9141

SAFETY TOE BOARD FOR CARS AIDS RAILROAD TRUCKMEN

Trucking freight into or out of railroad box cars has been facilitated by the introduction of a safety toe board which is constructed of 3/16-in. steel. The board is slightly curved to equalize any difference in elevation between the cars and the loading platform, so that both ends may rest flush on the floor. A flange on each side acts as a guide for the truck wheels, and bosses are provided along the center to insure a safe and sure footing under any conditions which may confront the truckmen, such as rain-soaked or ice-covered platforms.

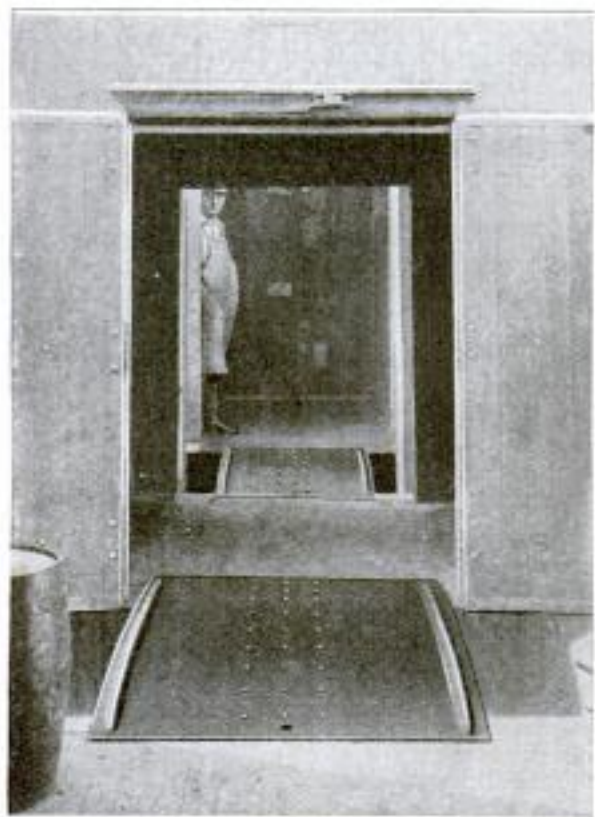

Safety Toe Board, Showing the Flanged Sides and Metal Bosses Which Prevent Accidents during the Loading or Unloading of Freight

The Viche Safety Toe Board Co. (No street number) Duluth Minn.

9141 Cont. N. Baker, % Tangley Co
Muscatine, Iowa.

FLOOD-DEVASTATED TOWN OFFERS STRANGE SIGHTS



Views of the Recent Flood at Beardstown, Illinois: At the Top is Seen One of the Poster-Carrying Boats Which Were the Only Means of Reaching the Polls on Election Day. In the Center is Shown the Torrent Pouring over a Break in the Levee, through the Tracks of the Chicago, Burlington, and Quincy Railroad. Below, a Funeral is being Conducted under Unusual Circumstances. The Wide Flatboat is Carrying the Casket and Mourners Away from the Church Seen at the Left, on Their Journey to the Distant Burial Ground



9185⁵²



Wide World Photos

TRAIN WRECK IN INDIA THE RESULT OF A PLOT

A TRAIN was wrecked recently while traveling at a speed of 50 miles an hour near Madhupur, India, on one of the great trunk-railway lines. The wreck was the result of a fiendish plot, the object of which was to wreck both the up and down mail trains, which usually pass each other at this point. After removing the fish-plates, a loose rail had been laid across the track, with the result that the locomotive and six cars were hurled down the 50-ft. embankment. Six people were killed and many more were injured.

9067

AUXILIARY GRATE FOR BURNING LOW-GRADE COAL

As the available areas of high-grade coal are mined out, the problem of burning the lower-grade coals and lignites be-

with a movable chain grate. The auxiliary grate is driven from the main grate and pushes the partly ignited coal forward upon the strong burning fire which is carried forward by the chain grate. Arrangements are also made to conduct draft of air under and through this auxiliary fire grate if necessary, to insure dehydration and complete combustion.

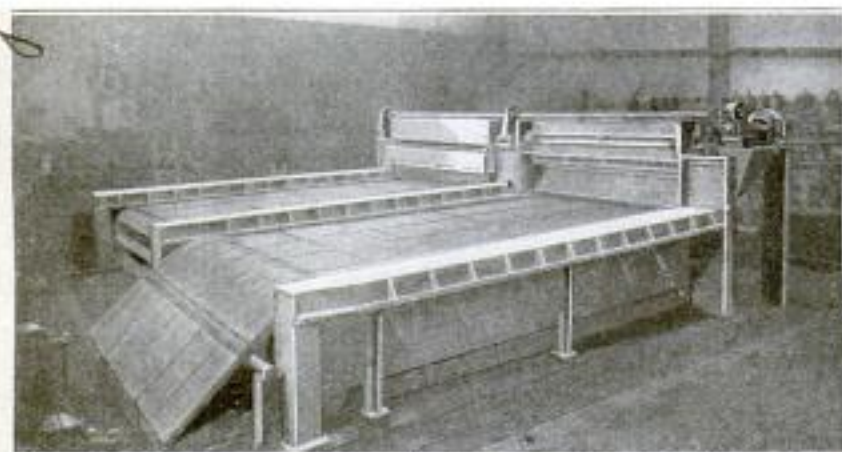

Rear View of the Special Grate for Burning Low-Grade Fuel

comes more urgent and is leading to experiments that will eventually find the solution. It has been found that the lower-grade coals can be burned successfully if a strong base, or starting, fire is maintained, and to accomplish this automatically, an auxiliary fire grate has been evolved for use in combination

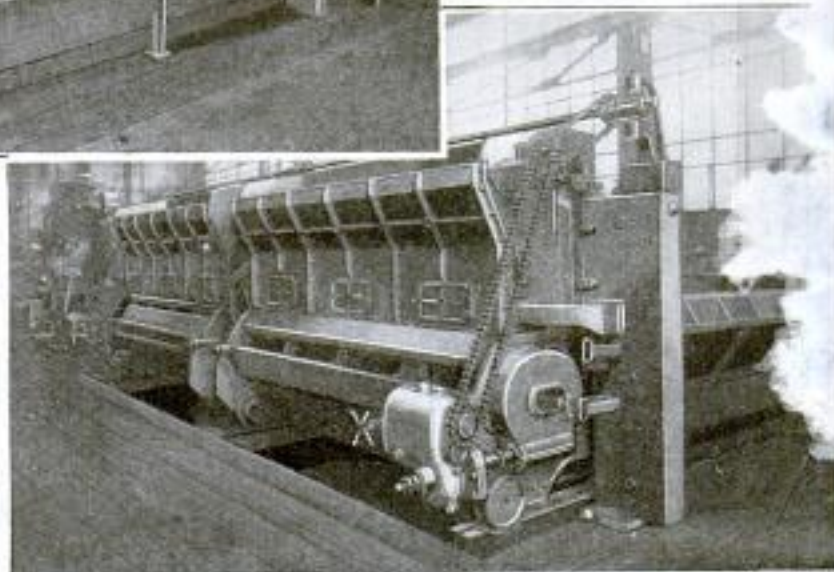

Front View of the Grate Setting: The Fuel is Fed into the Hopper and Drops onto the Auxiliary Grate Which is Driven by Chains

Conl. E. H. Wernery, Foreign Patent
 Exchange, 21 E. Van Buren
 Chicago, Ill. 804, Drabell Bldg. 21
 Letter
 recd.

N.Y. Times 5/10/22
P. 11, Col. 3.

9232

POPULAR

issos. Curranium
Int'l International Co.
Transportation. nyc
Los Angeles Calif

Curranium
issos. White & Hall

EXPEDITION FOR SALVAGING HULL OF THE "LUSITANIA"

It is reported that a salvaging company in Philadelphia is about to send an expedition for the purpose of attempting to raise the "Lusitania," and other vessels that have been wrecked during the last few years. In the case of the "Lusitania," much doubt is expressed, in England, as to the possibility of success. It is pointed out that this huge vessel, of such enormous weight, lies under 360 ft. of water. This means that the hull has been subjected to a pressure of 155 lb. per square inch for about seven years, and that now the hull may be disintegrated.

9196
AUTOMOBILE-TIRE CHAINS WITH VACUUM CUPS

An automobile-tire chain, recently patented, is designed to give an extra-strong grip upon the surface of the roadway without sacrificing its strength and wearing quality, and also to eliminate the necessity for the circumferential side chains common to such devices. These are replaced by flat, close-fitting members similarly located on the sides of the tire,



Cross Chains for Automobile Tires: Two or Three Links on the Tire Tread Have Each a Vacuum Cup That Grips Firmly and Resists Wear

but made of a flexible fibrous material. Around their outer circumferences are a number of eyelets in which are clamped the end hooks of the cross chains. These are formed of two or three steel links, each carrying a flat vacuum cup which may be of hardened metal or of tough fiber, best suited to withstand gripping and grinding wear, independently of the tensile strains which are taken care of by the parts of the links that hold the cups.

9147
NOW USE NONEXPLOSIVE GAS TO FILL TOY BALLOONS

An unexpected development following the discovery of a nonexplosive balloon gas is the use of this gas for filling toy balloons in place of the more dangerous hydrogen gas. Some cities have already

passed laws prohibiting the sale of hydrogen-gas toy balloons because of the danger of fires, but there should be no objection to balloons filled with the new



Left: Street Vender — with Conspicuous Cigarette — Selling Noninflammable Gas Balloons. Right: Showing How the Escaping Gas Blows Out a Candle Flame

gas. Tests have shown that if a lighted candle is permitted to burn through the envelope, the escaping gas will extinguish it.

9184
MICROMETER CALIPER GAUGE USEFUL FOR INSPECTORS

Measuring the walls of hollow cylindrical forms accurately is often an awkward and difficult job, and a micrometer caliper gauge has recently been marketed that will make this easy, and will be particularly handy for inspectors. The gauge is furnished with two anvils, and by means of a micrometer attachment measures by thousandths of an inch up to 2 in. With this gauge it is said to be as easy to measure cylindrical walls as flat material. It can also be done as rapidly.

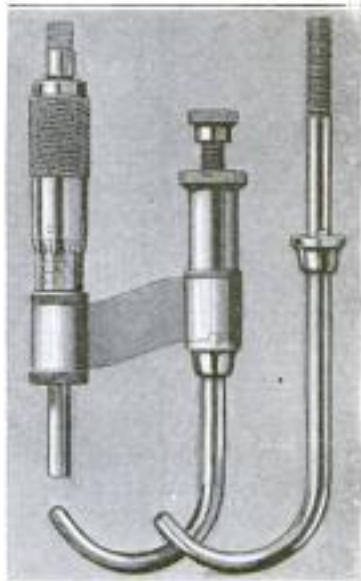

City Comptroller
Chicago
V. Benoit,
Chicago
Mrs. M. S. Benoit,
Chicago

Int'l International Transportation
nyc
Los Angeles Calif

Dealer: Paul Henrich
311 E. 3rd St. (Intersect)
Los Angeles, Calif.

The L. S. Starrett Co.
Athol, Mass.
Copyrighted material

8967



An Unusual Cliff of Columnar Basalt, Found in the Sierra Nevada Mountains: The Broken Pieces in the Foreground have Fallen Away from the Cliff. Note the Relative Size of the Men Shown in the White Circle

THE DEVIL'S POSTPILE

By JOHN L. VON BLON,

Los Angeles Athletic Club, Los Angeles, Calif.

THOUGH set apart by the president a decade ago, recognized as the best example extant of its peculiar type of columnar basalt, and readily accessible in summer, "The Devil's Postpile" remains virtually unknown and unseen. Perhaps only one out of every 10,000 Americans has beheld it or could tell its location, while foreign governments and institutions send their scientists to study the splendid tower of long, dark, glistening prisms. This natural wonder is located in the high Sierra Nevada Mountains, on the middle fork of the San Joaquin River, and is within easy driving distance of Los Angeles or San Francisco. The "pile" is a mile long, half as wide, and 400 ft. high. The odd formation

whence its appellation is derived is not everywhere in evidence, cropping out only in certain places. The most striking columns constitute more than 1,000 ft. of its western face. They rise over 100 ft. above the talus—a vast heap of broken "posts" accumulated through the process of weathering. How far downward they extend is a matter of conjecture. The columns in this amazing bluff are arranged in rows as regularly as the pipes of an organ. Almost perfect prisms, they are fitted together like cells in a honeycomb, and really look as if carved by human hands. These columns range from 14 in. to more than 3 ft. in diameter. Most of them are pentagonal, whereas elsewhere the general



Looking Down on the Upper Ends of the Columns Which are Polished Smooth and Give the Appearance of a Giant Mosaic Floor

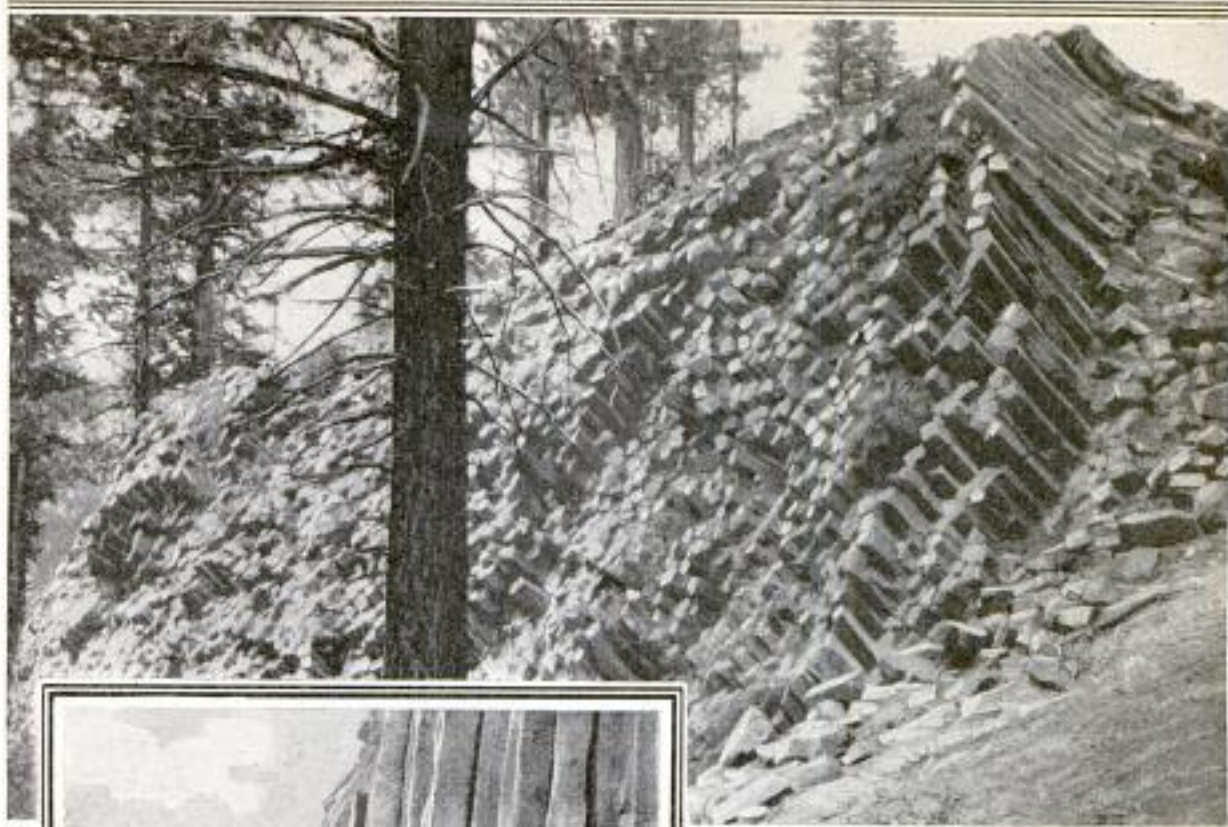

Above: On the Far Side of the Cliff the Formation has been Bent Over, Until the Columns, Instead of Standing Vertically, Are Nearly Horizontal and Resemble a Giant Wood Pile. They Glisten in the Sun with Almost the Brilliance of Precious Stones

Left: Giving Some Idea of the Prismatic Formation of the Columns. The Man at the Base of the Columns Is Six Feet Tall

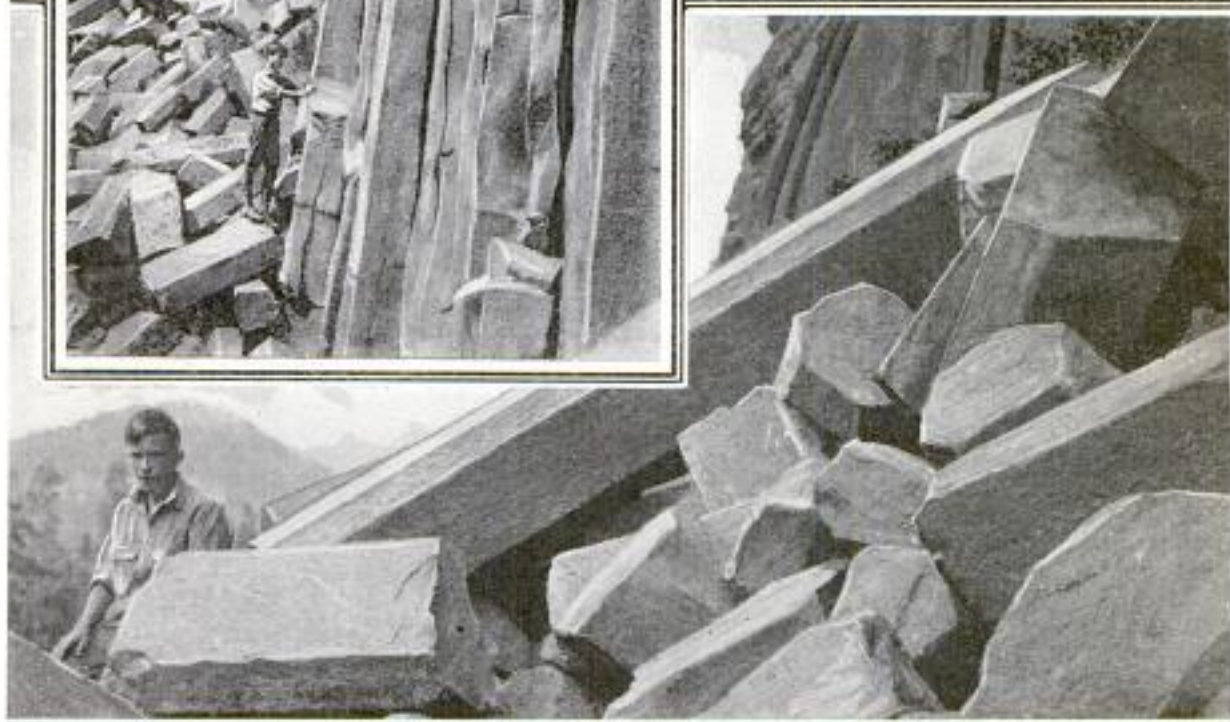

A Section of the Fallen Column Which Stood Alone for Many Years but was Struck by Lightning and Fell: This can be Seen Standing Almost in the Center of the Picture on the Opposite Page, and Was One of the Finest Specimens of This Peculiar Formation

shape is hexagonal. The Devil's Postpile affords strange deviation in this respect, some of its immense columns being eight-sided, many seven-sided, and the remainder hexagons. In one extensive section they are straight as sawed timbers and perpendicular. In another they lean and are gracefully curved, and the individual prisms are twisted and fluted, resembling sticks of pliable candy. At one

point they have the wavy appearance of flowing water. At the southern, upper end they project almost horizontally and resemble gigantic railroad ties or evenly corded wood on a hillside.

For many years the handsomest of all the columns, tall and symmetrically tapered, was separated from the body and stood upright and alone, but unfortunately, it was recently struck by lightning.

9109
NEW PACKAGE REDUCES LOSS
IN SHIPPING SHINGLES

That the older method of packing shingles for shipment resulted in much

damage and loss, has led to the development of a new container for use particularly in export shipments. The new package has box ends and corners and is bound by strapping or wire. Each case contains 500 shingles and can be handled with hooks without damage.

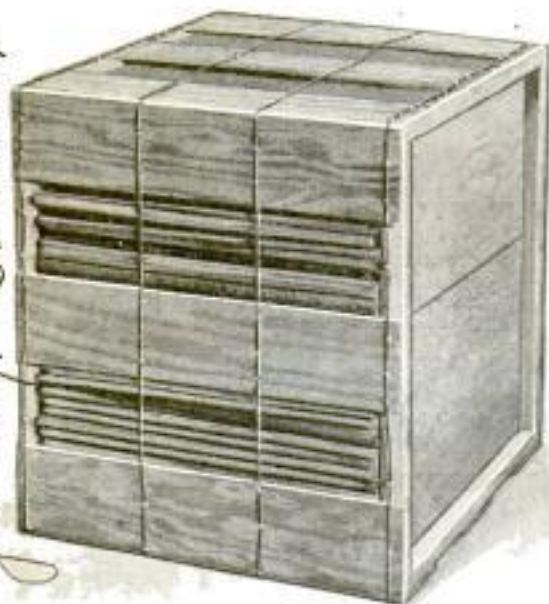

This Packing Case for Shingles Has Box Ends and Corners to Reduce Loss from Breakage

9123
MOTOR-DRIVEN GRASS MOWER
CUTS AND ROLLS LAWN

Mowing and rolling golf courses, lawns of large estates, parks, cemeteries, etc., may be accomplished efficiently with a motor-driven mower produced by an Illinois manufacturer. The outfit possesses a powerful six-cylinder engine which draws five 30-in. cutting units attached to a triangular floating frame, each unit arranged so as to overlap another, the whole cutting a swath 11½ ft. in width. A two-ton roller can also be added to the machine without affecting the operation or maneuvering. The mowing attachment may be removed in a few minutes, so that the implement can be utilized for pulling wagons for field or road uses, or equipped with a belt pulley for pumping or other stationary power work.



The Front View of the Motor-Driven Mower, at the Left, Shows the Triangular Arrangement of the Five Cutting Units on the Floating Frame. At the Right Is a Rear View Which Reveals the Extreme Length of the Steering and Control Apparatus

Avery Co., Peoria, Ill.

Mrs. E. D. Hamilton, Rite-Road & Shingle Ave. Wash.
 Henry Bldg. Seattle.

9191 A. J. Morse + Son

211 High St.

POPULAR MECHANICS

Boston Mass.

57

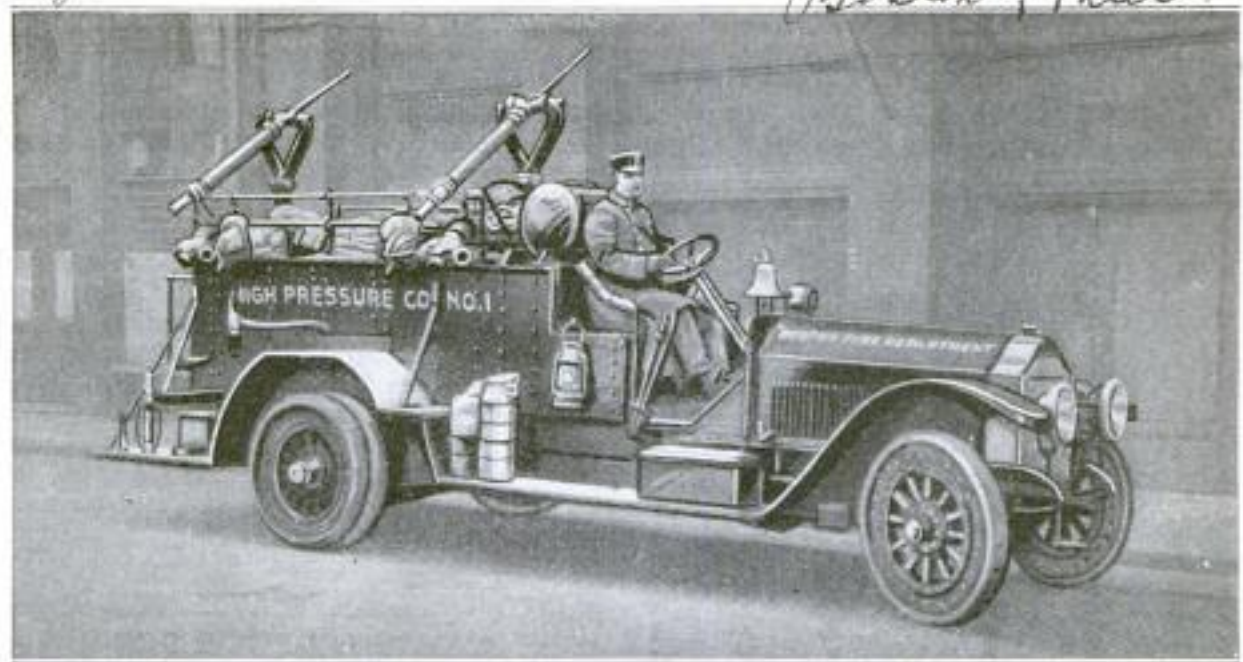

"Water-Gun" Machine, Showing the High-Pressure Nozzles, Mounted on the Top: Two of the Four Connections, Capable of Taking Three Lines of Hose Each, can be Seen Projecting over the Side

"WATER-GUN" MACHINE TAKES TWELVE LINES OF HOSE

Taking the water from 12 lines of hose simultaneously and throwing it in two concentrated streams at extremely high pressure, is possible with a new "water-gun" machine recently added to the Boston Fire Department. Various nozzles are used in conjunction with this apparatus, measuring from 1½ to 2½ in. in diameter, depending upon the pressure or height of stream desired. The pressure per square inch at the nozzles ranges from 200 to 300 lb., and the machine has a total capacity of delivering 1,850 gal. of water per minute.

DIRECTIONAL-RADIO SERVICE OF SHORT WAVE LENGTH

Directional wireless, the absolute contrast of the methods now employed wherein anyone possessing a receiving set that is tuned to the proper wave length can "listen in," is being rapidly developed. By recent experiments, according to Signor Marconi, it has been demonstrated that 20-meter wave lengths are capable of providing point-to-point directional commercial service over very wide ranges. Service of this nature would be considered comparatively secret, in comparison with the broadcasting type of radio transmission which is at present so much in vogue in this country as a means of furnishing both entertainment and valuable instruction in the home.

N.Y. Times 5/6/22
p. 10, Col. 8

ELECTRIC-BATTERY OPENER SIMPLE AND PRACTICAL

Opening batteries with the aid of an electric-heating appliance is the principal feature of an accessory now being manufactured by a Minnesota company. The outfit consists of an insulated metal box, 26 by 15 by 14 in. in size, in which the batteries are placed, and the compound softened by the radiation from heating elements. By this method, the electrolyte is never diluted with water, as is common with various steam openers, and acid-saturated cases can be thoroughly dried for reassembling and painting.

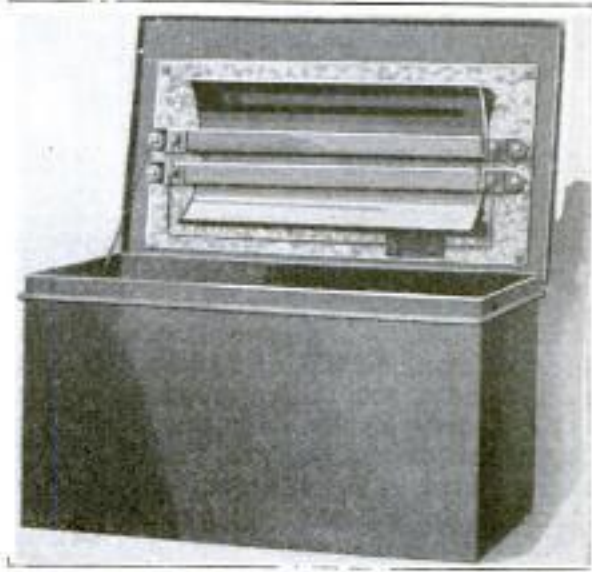

Electric-Battery Opener with the Cover Raised, Showing How the Heating Element is Fastened to the Lid of the Appliance

J. E. Schraeder Co
Crookston, Minn

9197 **SPEEDY ELECTRIC FOLDER
FOR PRINTING SHOPS**

Parallel folds at the rate of 10,000 to 20,000 per hour are possible with the use

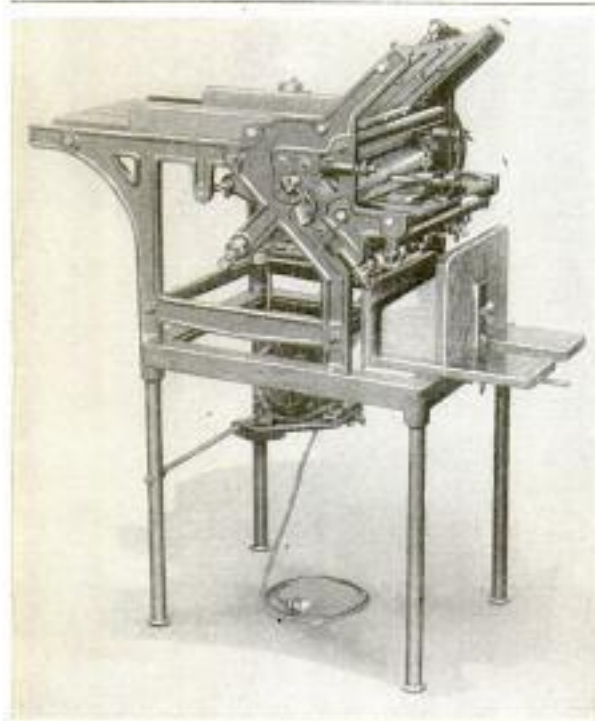

Electric Folding Machine Which Makes One or Two Parallel Folds at One Feeding and cannot be Fed Out of Time

of an electric folding machine now being distributed by a Chicago sales company. The mechanism is tapeless, and by the simple shifting of a gauge and the adjustment of thumb screws, various sizes of standard and accordion folds are produced. The rolls are of solid steel, turned and knurled to absolute accuracy, are driven by machine-cut gears, and mounted in oilless spring-cushioned bearings in a heavy, double-ribbed gray-iron frame.

9000 **WATER-IMPOUNDING PROJECT OF VAST PROPORTIONS**

Industrial expansion was responsible for the launching of a vast water-impounding project at Decatur, Ill., two years ago, which undertaking has been completed but recently. Engineers had estimated the cost at \$2,000,000, and at first this was considered a prohibitive amount, because the city was legally empowered to issue bonds for only \$500,000. Finally a plan was evolved to form a company and sell stock to the citizens, pay seven per cent dividends on this, and then turn the receipts from water rentals over to the company for payment of the interest and principal. The people generously responded,

**LATEST TUNGSTEN ARC LAMP
HAS ONE-POINT LIGHT** *Excelsior*

Tungsten arc lamps, particularly adapted for projection, microscopy, and general laboratory uses, are now being manufactured and placed on the market by an Eindhoven, Holland, concern. These new lamps are so constructed that they give virtually a one-point source of light, by means of an arc discharge which takes place between two small tungsten spheres placed in an atmosphere of rare gas. The distance between the spheres and the glass walls of the lamp may be very small, so that a short-focus condensing lens can be employed when the lamp is wanted for projection purposes.

9127 **AUTOMOBILE-RIM WRENCH HAS
SOCKETS OF FOUR SIZES**

For use on rims of automobiles, a wrench with a quadruple revolving socket head of four different sizes, is now on the market. It is equivalent to four ordinary wrenches, for in order to change the size of the socket all that is necessary is to give the socket head a quarter turn, when the handle and socket become locked securely, and the wrench is ready



Automobile-Rim Wrench with a Revolving Socket Head That Has Sockets of Four Different Sizes

for use with any one of the four different-sized sockets.

*American Grinder Mfg. Co.,
Milwaukee, Wis.*

subscribing \$1,200,000 worth of stock, after which the water-rental rates were increased until they yielded \$135,000 per year. With these funds, a huge dam, 1,600 ft. in length, was built across the Sangamon River, forming a lake $\frac{1}{2}$ mile wide and 13 miles long, which held approximately 8,000,000,000 gal. The lake submerged 4,200 acres of land. This was immediately purchased by the company, which also was required to elevate several bridges and accompanying approaches, because of the 12-ft. rise in the water. The present industries in the city are now adequately provided for.

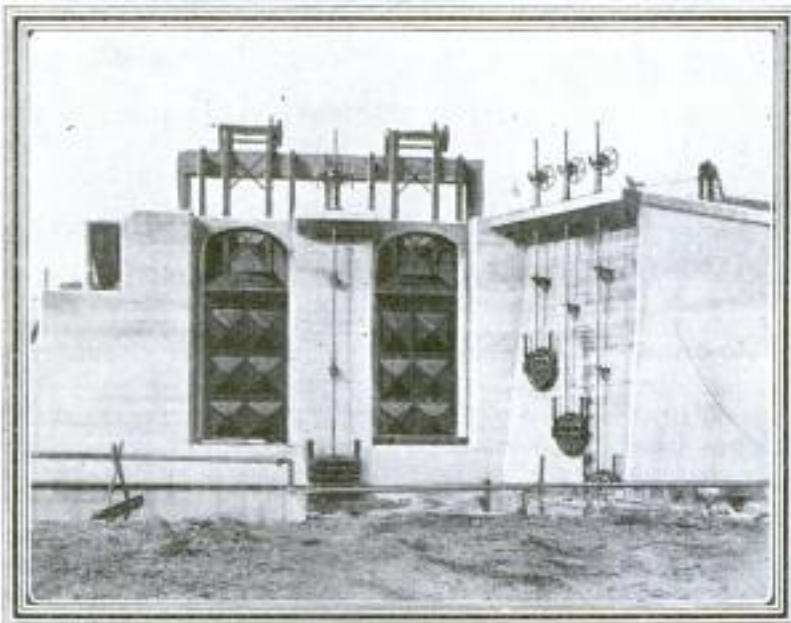

Above: Dam of Recently Completed Vast Water-Impounding Project as It Appears during the High-Water Period, and Which was Constructed as a Means of Advancing Industrial Development

At the Left are Seen the Huge Hydraulic Gates with Which the Water-Impounding System is Controlled So That There Is Now a Great Reserve of Water to Provide against Any Emergencies

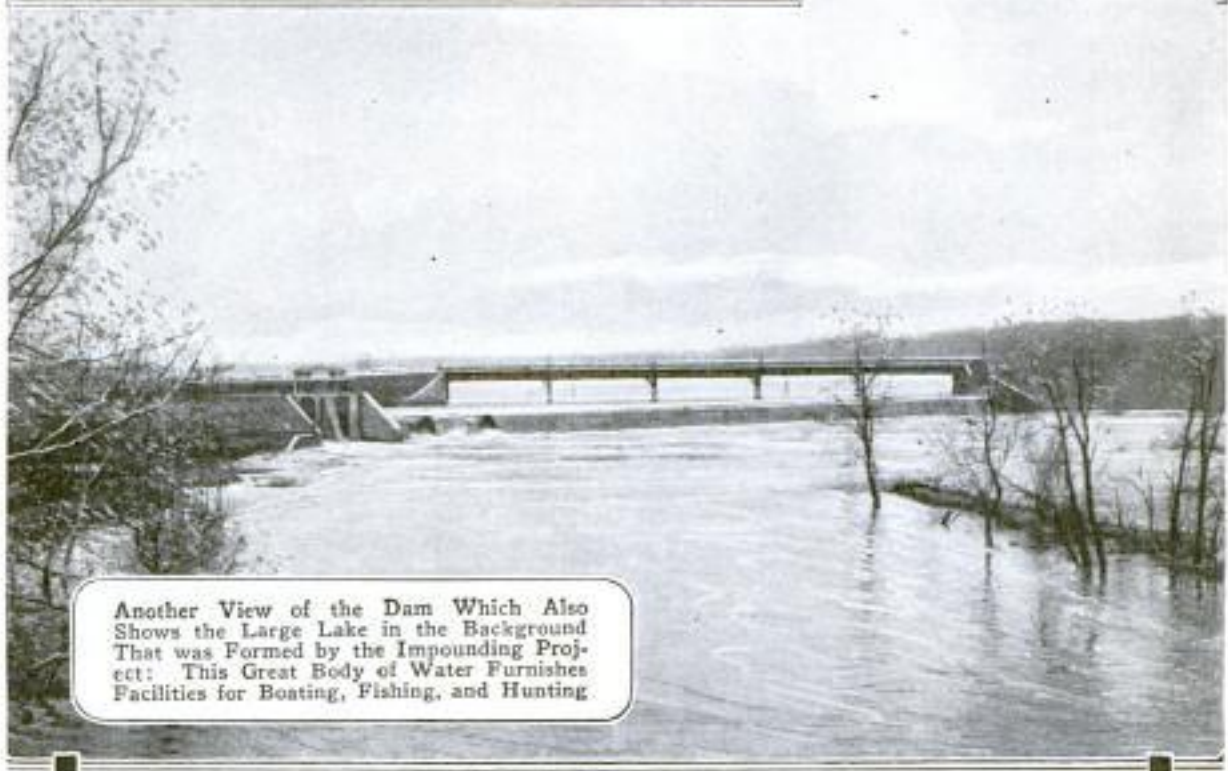

Another View of the Dam Which Also Shows the Large Lake in the Background That was Formed by the Impounding Project: This Great Body of Water Furnishes Facilities for Boating, Fishing, and Hunting

Com. M. Drol, 4, Rue Richer,
Paris, (IXe). France

London Times
Eng. Supplement
4/22/22

POPULAR MECHANICS

64
9158

SCALE FOR WEIGHING CARGO
THROUGH A SHIP'S DRAFT

An ingenious cargo-weighting device, a recent French invention, for use in the hold of a ship below the waterline, consists of a pipe vertically suspended from the beam of a small scale of great precision, that is mounted on top of a conical support inclosing the pipe. By means of a flexible hose the pipe can be placed into communication with the water in which the ship is floating, so that the amount of water in the pipe will vary with the draft of the ship, and consequently with the weight of the cargo. The scale is graduated so that the weight of the water in the pipe will give readings corresponding to the weight of the cargo at any draft of the ship.

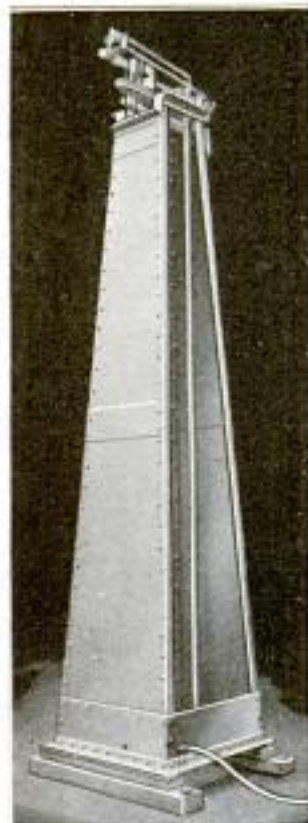

COPYRIGHT, M. DOL

readings corresponding to the weight of the cargo at any draft of the ship.

PIER DECKING CONSTRUCTED
WITH SAFETY OPENINGS

8839

To resist the exceptionally heavy seas that prevail there, a concrete pier in Manila Bay has been constructed with a special form of open decking, solid decking being considered unsafe. The pier carries two railway tracks and consists of reinforced-concrete beams supported by precast concrete piles, and the framework of the pier presents a series of openings to the sea below. For the convenience of pedestrians these openings are covered with a decking of 3-in. planks, held down by their own weight alone, so that, in case of heavy seas, they are free to be washed away, offering no resistance to the water. This construction has proved its worth, and the pier has withstood the most destructive typhoons that prevail in the China Sea.

9095
ONE GASOLINE TRACTOR PULLS
FOUR MOWERS AT ONCE

Where the farmer of a generation ago was content to use one mower and a team of horses when cutting his hay, his successor of the present day applies more modern methods, and speeds up the job by hitching four mowers behind his tractor. The draft gear is arranged so that each mower is offset from the one preceding it. This system results in a more uniform cutting and curing of the hay, and, consequently, a better product.



Modern Methods Applied on a Large Hay Farm: One Gasoline Tractor Draws Four Mowers Arranged So That Each Mower is Offset from the One Ahead. There Is One Attendant for Each Mower

J. d. Case Threshing Machine Co.
Racine, Wis.

Copyrighted material

Invention of a Frenchman

8993 Cmt. Chas W. Iseiger
 Powell + Sutter St, San Francisco
 POPULAR MECHANICS
 Calif. '61



Combination Soda-Fountain and Oil-Tank Truck Which was Employed by an Advertising Company to Feature Its Display at a Recent Auto Show: Officials of the Company are Seen Partaking of Refreshments

COMBINATION SODA-FOUNTAIN AND OIL-TANK TRUCK

Installing a complete miniature soda-fountain on an oil-tank motor truck was the means employed by an advertising company to feature its display at a recent auto show in San Francisco. The equipment, such as compressed-air cylinders, water containers, and sirup receptacles, was concealed in the large oil tank at the top, while below were placed faucets for drawing the beverages.

9150

MACHINE TESTS WORKABILITY OF THIN METAL SHEETS

That tests of the tensile strength of thin metal sheets do not give complete information as to their ability to stand drawing and stamping, has led to the development of a machine which tests this quality. A sample of the sheet is held between two dies and a hemispherical ball is forced against the sheet until fracture occurs. The depth of impression necessary to cause fracture is read directly on a micrometer-screw.



*Chas. A. W. Erichsen
 England (1)
 data lost.*

HOLDER FOR CHECK-BOOK STUB LEAVES BOTH HANDS FREE

8839

Anyone who has done posting from the stubs of a commercial check book knows how they have a tendency to slip out of

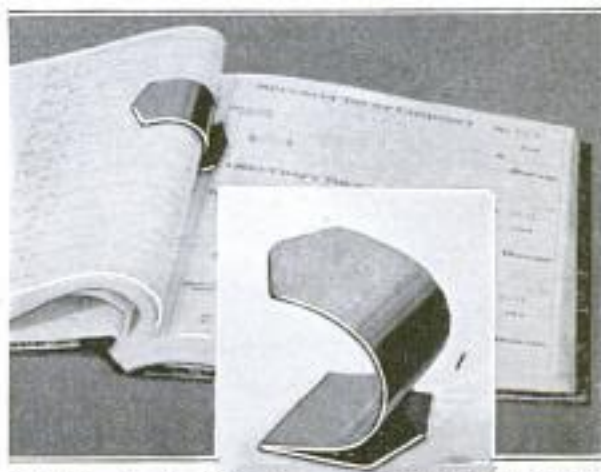

This Handy Clip, Forced against the Stubs, will Hold Them Out of the Way When Posting from Stubs to Ledger

control at the most inopportune times. To overcome this difficulty, a handy little holder has been devised which can be slipped against the stubs to be held back and will hold them securely in place.

☐ The thickest coal seam in the world is being developed in Queensland, Australia. Its maximum thickness is 93 ft., free from clay bands from top to bottom.

*Arlando, Fla.
 C. S. Hamblin, Fla.*

Weaver Mfg Co,
 62 Springfield, Ill.

National Life
 Boat Institution

**FUEL OR OIL-SERVICE CAN
 FOR USE IN GARAGES**

To furnish a convenient, safe, and economical means of handling fuel and lubricants in public and private garages,



Right, Service Can with Hose as Connected When Not in Use, and Above, When Filling an Auto Tank

a can is now being manufactured that is easy to manipulate, and that has connected to its discharge opening a flexible steel hose which will reach any gas-tank opening, no matter how inconveniently located. Thus there is never any need of special funnels, which are easily forgotten or mislaid. When not in use, the nozzle on the flexible hose is inserted in a vent

in the cap of the can, rendering it perfectly air-tight, and preventing evaporation of its contents.

**LARGE MOTOR LIFEBOAT HAS
 CABIN ACCOMMODATIONS**

There is now building in England a motor lifeboat that will go far toward robbing shipwrecks of much of their terror. The new boat is 60 ft. long with 15-ft. beam, and has a displacement of 40 tons; it will be driven by two 75-hp. motors housed in separate water-tight compartments. There will be two cabins for passengers, with accommodations for 50, while the total capacity of the boat will be more than 150. One unusual piece of equipment will be a life-saving net to be stretched across the boat, amidships of it, so that passengers may jump into it from vessels.

**SHOW HOME MOVING PICTURES
 USING NEW PROJECTOR**

For industrial pictures, for use in hospitals, or for moving-picture shows at home, a new projecting machine has been devised which can be operated by electric dry batteries or from the regular house-lighting circuit. In place of the usual strip of film, the pictures are made on round disks similar in appearance to phonograph records. These disks are noninflammable and unbreakable, and are equal to 100 ft. of ordinary film. The disks may be changed readily, and can be run in either direction or stopped to show titles, as there is no danger of their catching fire.

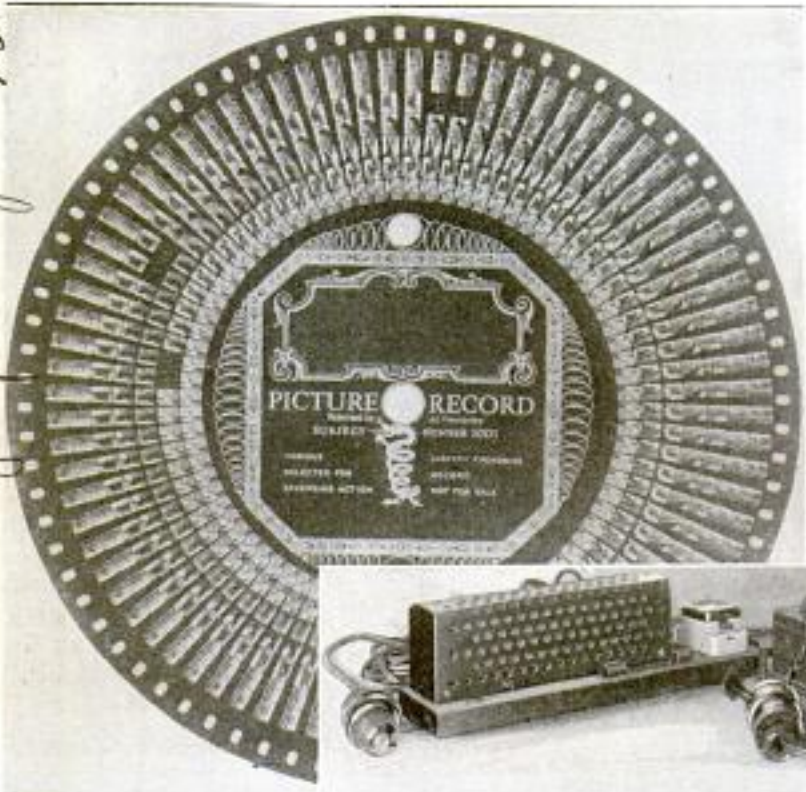

This Lightweight Moving-Picture Projector Operates on Dry Batteries or from the House-Lighting Circuit. The Pictures are Made on Noninflammable Disks, Similar in Size to Phonograph Records

Dealer - Daniel J. Scott, Chicago
 320 Wrigley Bldg., Chicago 75-68

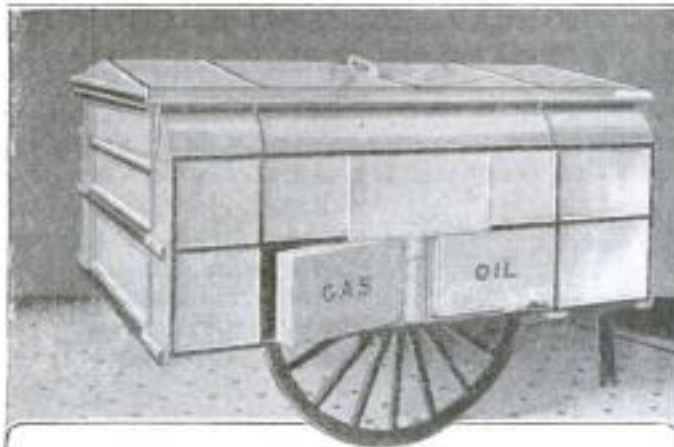

Above is Shown the Baggage Trailer Ready for Attaching to the Rear of an Automobile. The Cylinder in Which is Contained the Coil Spring, can be Seen Just above the Center of the Wheel. The Tanks for Gasoline and Oil Are Also Visible. At the Right is Shown the Manner of Raising the Top of the Trailer When Temporary Sleeping Quarters are Desired

BAGGAGE TRAILER AVAILABLE FOR MOTORIST-CAMPER

Automobile tourists and campers now have available a baggage trailer which possesses special wheel bearings, each wheel being carried independently on a coil spring in a cylinder. The trailer is connected to the towing machine by double spring-steel bands, so adjusted that they hold the baggage container directly behind the car in turning or backing. An added feature is a shelf, the width of a full-sized bed, which is placed above the load, for sleeping or for use as an emergency ambulance.

9139
FASTENER FOR WALLBOARD IS SELF-CLINCHING

In attaching wallboard to studding, a new self-clinching fastener makes unnecessary the use of nails, which are objectionable because either the heads must be left exposed or they must be countersunk, which is a tedious and expensive job.



The fastener, which is made of steel, is about an inch square and has five sharp prongs bent at right angles from one side of it. It is attached to the studs, and the prongs clinch into the wallboard from the back without penetrating it, so that they are invisible from the front surface.

NEW TELEPHONE MOUTHPIECE PREVENTS EAVESDROPPING

A telephone mouthpiece has been invented which gives to the ordinary desk phone all the privacy of a booth phone. It not only transmits whispering sounds, but effectually screens the voice so that a person standing near the speaker is



This Mouthpiece Screens the Voice So That a Person Standing Near By Hears Only a Low Murmur

unable to distinguish the words spoken, hearing only an indistinct murmur.

The Upson Co., Lockport, N.Y. % d.no. - Mr. Benedict
 manufacturers Patents
 520 Fifth Av. New York

Cont. Es. E. Palfrey,
Esplanade Bldg.

64 St. Louis, Mo. POPULAR MECHANICS

MINING TOOLS USED TO STRIP
BANK VAULT OF CONCRETE

9206

When it was found necessary to move a bank vault from the first floor to the basement, mining methods were used for re-



When Removing the Protecting Concrete from This Steel Vault, Holes were Drilled with a Compressed-Air Drill, and the Concrete Broken Away by Driving Steel Pins into the Holes

moving the protecting concrete around the steel shell. Holes were drilled with a compressed-air drill, and workmen with sledges drove steel pins into the holes, splitting away the concrete in large blocks. No explosives were used.

LOOKOUT TELEGRAPH FOR USE
AS DIRECTION INDICATOR

In common practice, the lookout man in the crow's-nest of a ship, when he observes an object, notifies the officer on the bridge by shouting to him, or at best by means of a speaking tube, and he has to call out the direction. There is now in use in England a much better means of doing this electrically. On the crow's-nest is a transmitter that has a circular dial graduated to degrees and minutes, on which is mounted a revolving eyepiece. When this is trained on an object, the exact position of it to port or starboard is automatically indicated on a similarly graduated dial of a receiver that is mounted on the bridge.

London Times Eng
Supplement

POPULAR MECHANICS

4/22/22

CONCAVE INSTEAD OF CONVEX
ROADS OF ENGLISH DESIGN

A new system of concrete-road construction is proposed in England, in which the under surface of the concrete slab, as

well as the surface of the roadway, would slope down from the sides to the center, instead of being crowned in the conventional manner. It is argued that when the concrete expands sideways under the influence of heat or moisture, if the slope is downward to the center instead of from it, this expansion of the concrete outward will be resisted by its own weight, instead of being assisted by it, as in the other condition. The structural weakness of the concave form is to be compensated by additional steel reinforcement. In a road 30 ft. or more wide, it is proposed to make the sides of the concrete slab slope downward at 1 in 16 to a central level portion, 6 ft. wide. Above this would be the steel reinforcement, with the road surface above finished to a 1-in-40 slope. Beneath the lowest point of the concrete slab, at its center, would be the drainage system.

ward at 1 in 16 to a central level portion, 6 ft. wide. Above this would be the steel reinforcement, with the road surface above finished to a 1-in-40 slope. Beneath the lowest point of the concrete slab, at its center, would be the drainage system.

At each of these instruments is a bell, by means of which the lookout man signals the officer, and vice versa. The dial of the receiver shows the bearing transmitted to within 1° of arc.

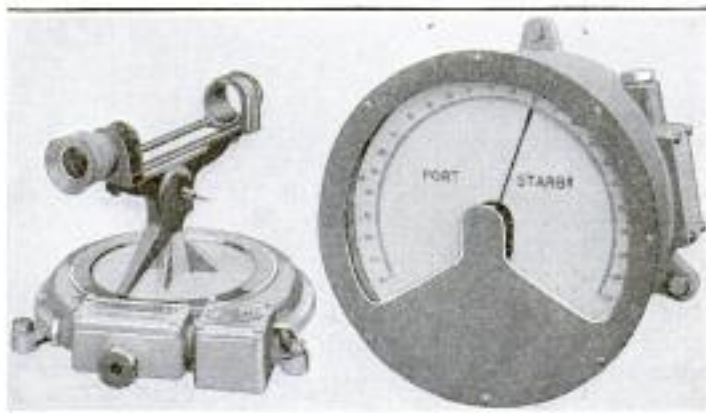

Left: Transmitter That is Mounted on the Crow's-Nest. The Eyepiece is Trained on Any Object, and Indicates Its Bearing on the Receiver on the Bridge, Shown to the Right

Mess
Acton
Evershed & Vigor's Ltd.
Lane Works, Chisholm, London, U.K
England

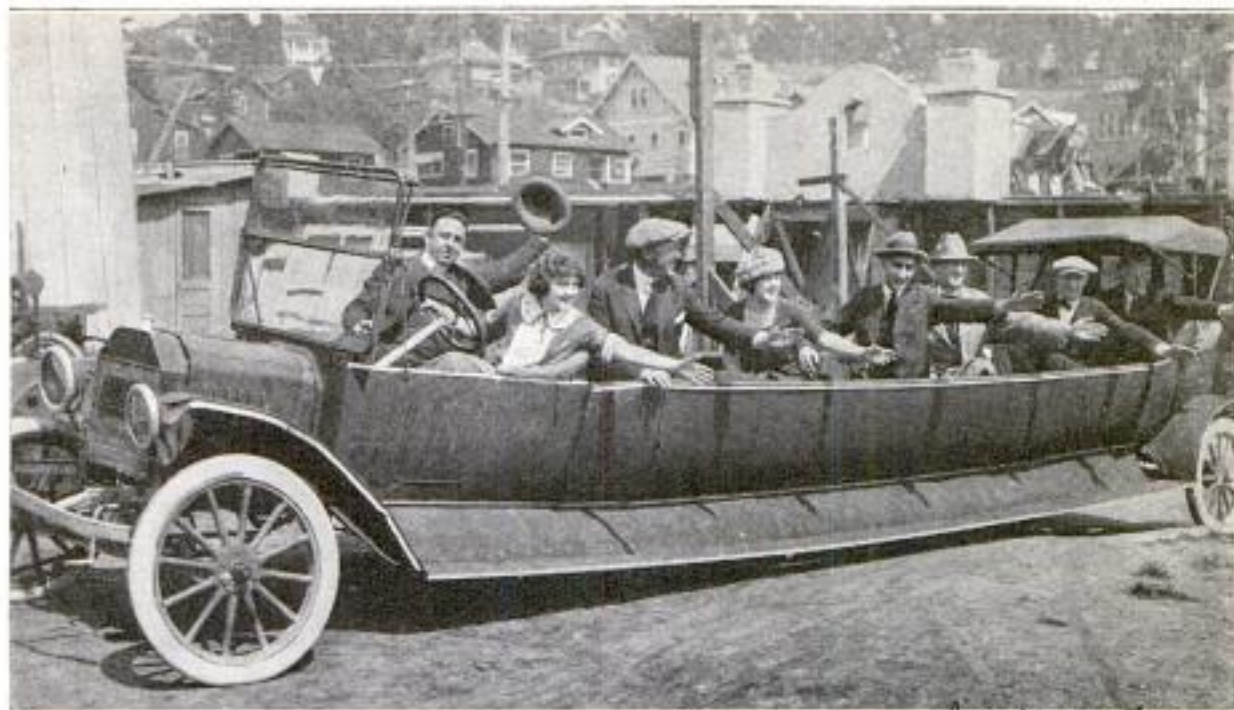

FREAK AUTOMOBILE BODY BUILT FOR COMEDY PICTURE

COMEDY motion-picture producers go to great expense to evolve new and absurd situations in which the cast perform, and the elongated automobile shown in the accompanying photograph is a late instance of this. An old car of well-known make has been transformed into an imitation motor bus, whose excessive length of wheelbase and the sagging, or bouncing, effect seen when the machine is moving, tend to create a ridiculous impression. However, these and other details have been obtained at a cost which is considered trifling, provided the finished picture accomplishes the desired end—that of making the people laugh.

WORLD'S HIGHEST WATERFALL 9178 IS SELDOM VISITED

Although Kaieteur Fall, in British Guiana, is by far the most powerful waterfall in the world, exceeding both Niagara and Victoria Falls by several hundred feet in height, it has seldom been visited. It was discovered over fifty years ago, but, on account of its inaccessibility, not much is known about it. Recently it was fully photographed by an expedition exploring the Guianas for the American Museum of Natural History. Kaieteur Fall is on the Potaro River, a tributary of the Essequibo. The fall is 741 ft. high, and in width varies from 120 ft. in dry weather to 400 ft. in rainy seasons. The river for about 200 yd. above the fall is about 400 ft. wide, and flows noiselessly along, without a ripple, its surface as smooth as a plate-glass mirror, until it reaches the rocky ridge, where it bends to a right angle and falls in a perpendicular mass that maintains for a distance of 350 ft. its solid appearance, and then dissolves into clouds of vapor before reaching the bottom of the abyss, whence rises a thundering, incessant roar. The fall and the river are surrounded by dense virgin forests, the whole scene being wonderfully imposing.

American Museum of
Natural History
New York City

LARGE WATER WHEEL DRIVES 9025 SMALL SUGAR-CANE MILL

In the Philippine Islands water power is used wherever possible, even if the amount of power available is small. In



In This Small Sugar-Cane Mill a Small Stream has been Diverted and the Water Wheel is Used for Driving the Rollers of the Mill

some cases it is used for driving small sugar-cane mills, the stream being diverted and the water wheel directly connected to the rollers which crush the cane. The mill has small capacity, but that does not concern the owner.

Cont. Roy C. Benneth,
Victoria Hotel, Shanghai,
Canton, China

Mr. Ralph Howard
Dubuque, Iowa.

Mr. William
Le Camp, 121 E. Water
St.
Chillicothe, Ohio.

7619
AUTOMATIC COUNTERS RECORD
EACH SHOVELFUL OF COAL

8445
DIVIDED SEAT FOR ORGANIST
MAKES PLAYING EASIER

Considerable physical effort is required of a pipe organist in reaching the various

In firing a locomotive, the economy of the coal consumed depends a great deal upon the way it is fed into the firebox. Some firemen will get the same results with less fuel than others, and so as to be able to compare the work of different firemen, a coal shovel has been invented that registers on counters every shovelful of coal thrown into the firebox. The shovel has a sleeve over the bottom part of the handle. This sleeve is so constructed that it moves sideways each time a shovelful of coal is lifted, and by the action of a trigger pushes up a rod, in the center of the handle, that operates a series of numbered counters that are inserted

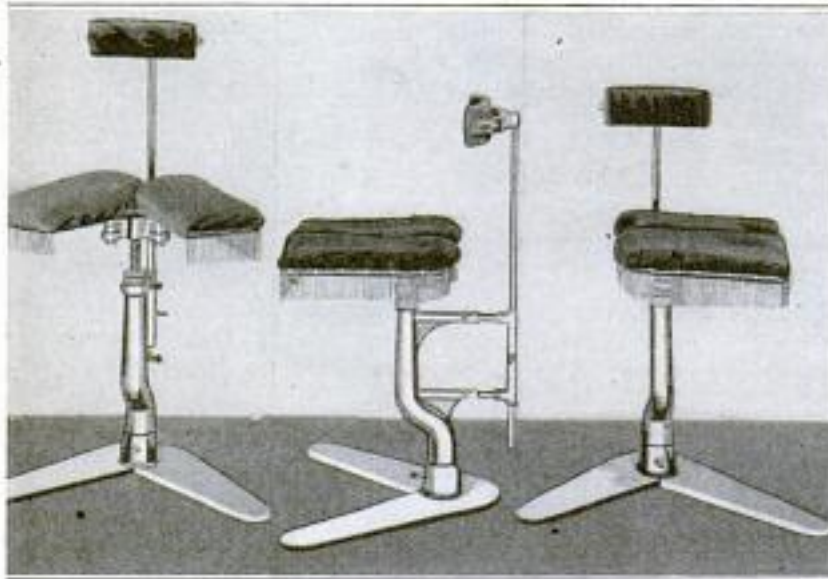

Left: Organist's Divided Seat Shown with the Two Halves Spread Apart. Center: Side View of the Seat, Showing How the Backrest is Attached. Right: Illustrating the Free Movement of the Seat

pedals, and to lessen this exertion an Iowa man has constructed a divided seat. When playing, instead of sliding back and forth on the usual bench, the organist can sit on either half of the revolving seat and easily touch the farthestmost pedals. The seat can be raised or lowered five inches, be placed any desired distance from the organ, and has a backrest with a spring arrangement, which constantly adjusts itself to the different positions of the player.

in the widened part of the handle. When the coal is discharged from the shovel a spring on the pushrod returns it, ready to register another shovelful. The resist-

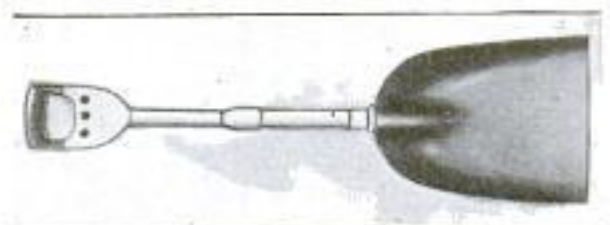

Coal Shovel That Registers on Counters in Handle Each Shovelful of Coal Thrown into the Firebox

ance of this spring keeps the pushrod inactive until the shovel is loaded.

9171
PAPER-MAKING EXPERIMENTS
IN WESTERN AUSTRALIA

Experiments are to be made in western Australia to ascertain whether it is possible to produce paper pulp from Australian timber. Contributions of funds from the western Australian and the Federal governments, as well as from private sources, will provide equipment and salaries for carrying out these experiments, and a laboratory will be built.

Recent prospecting has shown the existence of radium-bearing minerals on the island of Madagascar.

FEATHER CORSAGE SHIELD
IS COLORFUL NOVELTY

Brides-to-be and debutantes now have available a feather corsage shield which is

being manufactured in white, pink, Nile green, yellow, blue, and lavender. Placed on a background of ostrich feathers, are artificial flowers of varicolored hues, the



whole being tied with a length of gold ribbon and presenting a most attractive appearance.

Mr. H. Baynes Dorfer & Co.
1129 Arch St.
Philadelphia

Commerce Reports 4/24/22

8996 Cont. George F Paul 900 Ellsworth
Railroad Bldg, Chicago

BRIDGE BUILDING IN ALASKA TESTS ENGINEERING SKILL

By George F. Paul



Here Are the Dog Teams Carrying Mail to the Northern Points along the Railroad. In Some Parts of Alaska This Is the Only Feasible Method of Handling the Mail during Six Months of the Year

8996
IF any one were to start out to hunt the steel railway bridge farthest to the northwest on the American continent, he would find it when he reached a point 284 miles north of Seward, Alaska. Here is located the famous Hurricane Gulch, as treacherous as its name is ominous,

and over this yawning chasm has now been thrown an arch of steel that tells the triumph of American resourcefulness. Here at this last outpost of railroad life a mighty bridge has been built with an arch span 384 ft. long. Three hundred feet below the rails is the bottom of the



At Some Points along the Railroad, Freight and Supplies could be Handled by Tractors Drawing Wagon Trains, and This Method was Adopted Whenever It Was Practicable

gulch. Nearly 1,000 tons of steel went into the arch proper, to say nothing of the 530 additional tons that were needed to build the approaches to the arch. The entire structure is 914 ft. long. At either end of the arch is a deck span 120 ft. long. At the south end is a plate-girder span 50 ft. long, and at the north end a steel viaduct 240 ft. long.

Well might an engineer hesitate when he stood at the edge of this great gash and looked across to the other side where the track would have to strike, if it ever struck that far. He could see that if the arch was to be built by the cantilever method it would be necessary for each half to be built out from the shore and held back by steel backstays. Now it was apparent that it would not be so very difficult to erect the south half of the arch, for the track of this new Alaskan railway ran right up to the south edge of the gulch, and there a construction yard could be established, but the real difficulty would be in getting structural materials across to the north side of the gulch. It

was not at all practical to move these materials down through the gulch. To bring them in from the north was out of the question. Cableway transfer was considered, but not adopted for the heavy members. Instead, the final decision was to lower the members to the bottom of the gulch by a locomotive crane standing on the outer end of the south half of the arch. An A-frame derrick was made ready on the north side. Its load falls were lowered to the bottom of the gulch and hitched to the member. Then both sets of falls were taken up at the same time. This brought the member up along

the slope until it was just beneath the position that it was to occupy permanently. Then the locomotive crane falls were released and the A-frame derrick lifted the member up to its place. The maximum gap between the erecting units was 192 ft., but this method put no more strain on each boom than when either boom had to carry the whole load vertically.

As far as possible, the material was riveted at the yard. The center of gravity for each bottom-chord member was figured out carefully in the drawing room.

Then when the hitches were made, they were applied at such points that the chords would hang in practically their permanent position while they were being placed.

Great care was taken to get the shoes of the arch set at the proper distance apart. A 500-ft. steel tape was used; it was corrected for temperature. The maker of the tape had marked it to measure the distance of 384 ft. while supported only at the zero and 384-ft. marks under a tension of 50 lb. The real test came when the

halves of the arch were lowered to position—they fitted accurately.

Backstay bars connected the anchorages to the 120-ft. approach spans. These were telescopic in action. Two pairs of backstay bars were provided at each anchorage. A 500-ton hydraulic jack was inserted in the telescopic joint of each pair. During the erection work the ends of the arch halves were slightly elevated at the middle of the structure. Steel shims in the telescopic joints held them in this position.

At the proper time pressure was applied to the hydraulic jacks, the shims were



This Shows Work Progressing on One of the Tunnels along the Route. In Some Cases It was Deemed Advisable to Drive Tunnels Rather than to Make Deep Open Cuts through the Rock. The Formation at This Point Is Hard Slate

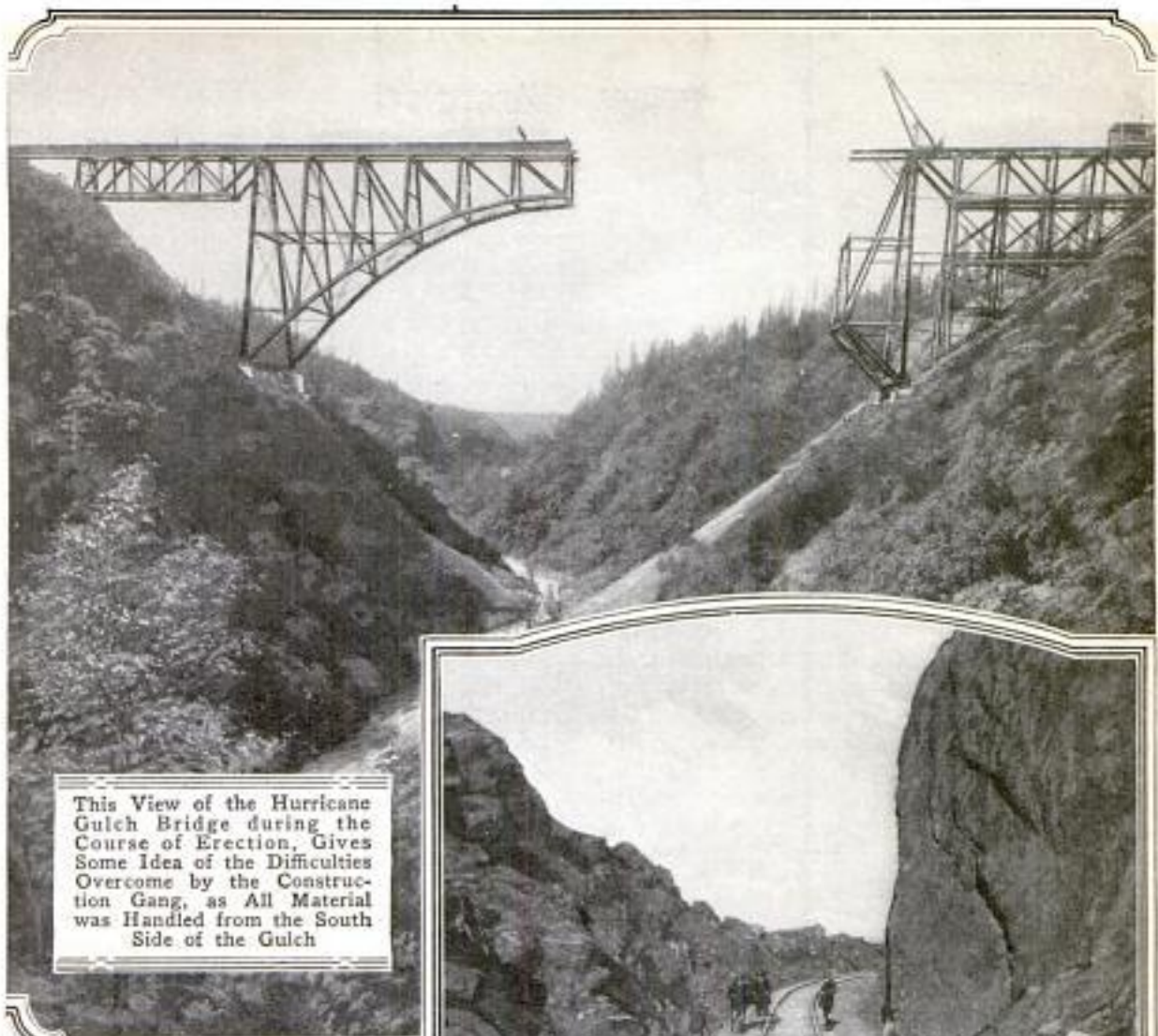

This View of the Hurricane Gulch Bridge during the Course of Erection, Gives Some Idea of the Difficulties Overcome by the Construction Gang, as All Material was Handled from the South Side of the Gulch

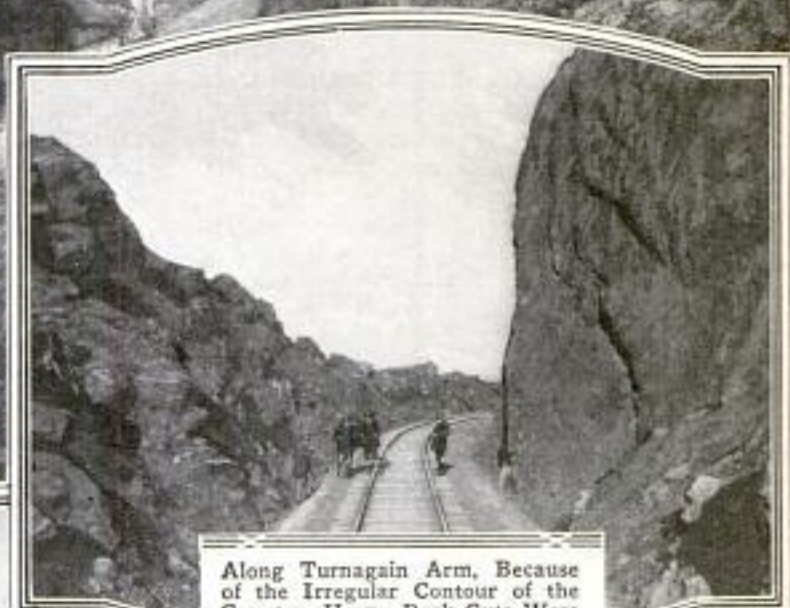

Along Turnagain Arm, Because of the Irregular Contour of the Country, Heavy Rock Cuts Were Necessary through Walls of Hard Slate

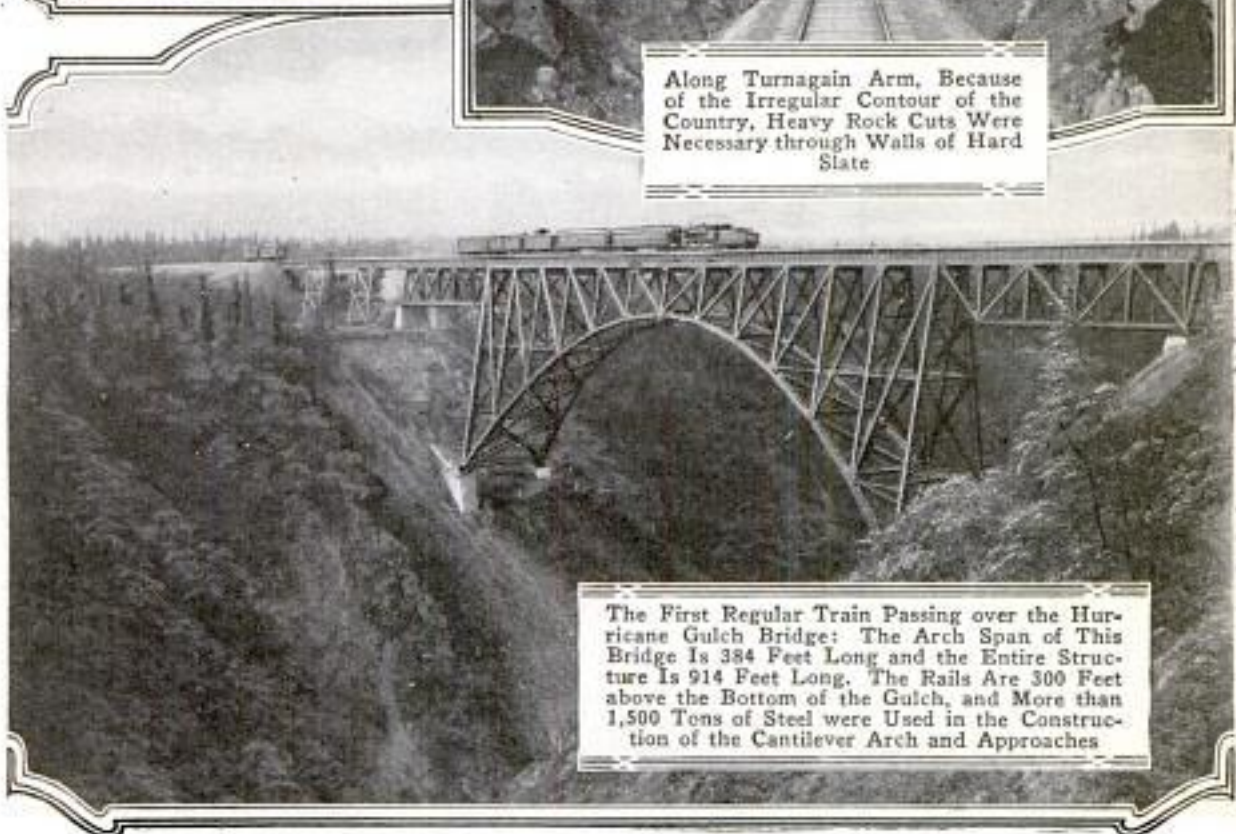

The First Regular Train Passing over the Hurricane Gulch Bridge: The Arch Span of This Bridge Is 384 Feet Long and the Entire Structure Is 914 Feet Long. The Rails Are 300 Feet above the Bottom of the Gulch, and More than 1,500 Tons of Steel were Used in the Construction of the Cantilever Arch and Approaches

loosened and withdrawn, and then the halves of the arch were lowered to a bearing on a pin in each bottom chord at the center.

This new railway being built by the United States government is to connect the Matanuska coal fields with tidewater. Railroad building presents endless difficulties in Alaska. In some inland parts the working season is cut short by the heavy snowfall that starts in early. In the spring the work is also delayed, because of the deep snow.

The work that was done between Seward and Anchorage along Turnagain Arm, a branch of Cook Inlet, is typical of the difficulties encountered. For the greater part of this distance the line had to be cut in on heavy slopes. The contour of the country is very irregular. Deep embankments and gulches occur in many cases, and in order to save expensive cuts in the precipitous rock bluffs it was necessary to make heavy fills. The rock is mostly of a hard slate. More than 2,000,000 cu. yd. of excavation was necessary along Turnagain Arm, about half of which was through solid rock. At several points on this line truss bridges were necessary over the larger streams. It is estimated that about 8,000 ft. of snowsheds will be required in this district.

Anchorage is 114 miles north of Seward. It is at the head of Cook Inlet, and consequently can be reached by ocean steamers. Here the government proposes to build a wharf 80 ft. high. This great height is necessary to take care of the 42-ft. change of water level and to provide six fathoms of water at low tide. This wharf, which will be 1,000 ft. long, will have wings running back to the shore from either end, one of them wide enough to carry three standard-gauge railroad tracks, out to the coal bunkers on the wharf. Here Matanuska coal will be stored and delivered to vessels. As Anchorage is much nearer the coal fields it will be more convenient for coal to be handled from this point. However, in the winter season, it may be found a better plan to have the coal shipped south to Seward and loaded on boats there.

The railroad work done in Alaska impresses a person with the vastness of the country and with the tremendous resources that Nature has stored there in lavish abundance against the day when the coal and the wood and other riches of mountain and valley would be needed and men would have the means and the energy to prepare a great highway along which these resources could be shipped to places where they are needed.

8706

MACHINE VENDS SANDWICHES AND KEEPS THEM FRESH

There have for a long time been machines that deliver one or more sandwiches in response to the insertion of a coin, and now there is one that also keeps the sandwiches fresh and cool. The main boxlike body of the machine is a refrigerating cabinet with a central compartment for holding ice. Around this, at each corner of the cabinet, is a rack on which the sandwiches are piled. With

each insertion of a coin, this pile is raised sufficiently to deliver one sandwich to the depositor of the coin. To extract a sandwich, a knob is pulled, which is normally locked until released by the coin. The sandwiches are visible, and when all have been delivered, the sign "empty" becomes visible instead of a sandwich, and the coin slot closes. The machine can, of course, be used for other articles, provided they are of approximately the size of a sandwich. It may also be designed for articles of other shapes.



Left: General View of Sandwich-Vending and Refrigerating Machine. Center: Two Top Views, the One at Right Showing Device at Each Corner for Delivering Sandwiches, the Other Showing Two of These Open, with Sandwich Piles Raised. Right: One of the Racks in Which Sandwiches are Piled

Mrs. W. R. Tweede, Rochester, N. Y.
 no street address letter 10-11

8985

Johns. Manville Co.,
Westinghouse Bldg., Pittsburgh
POPULAR MECHANICS Pa. 71

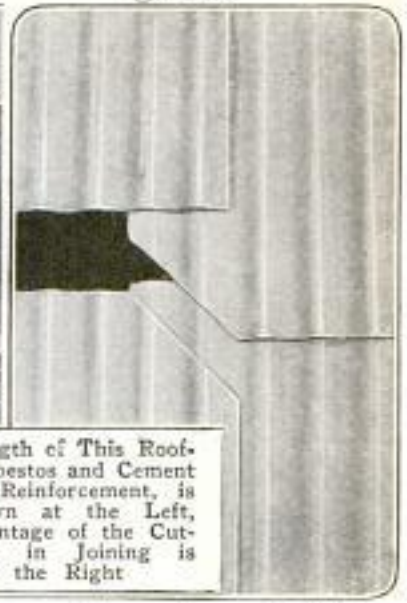

The Great Strength of This Roofing, Made of Asbestos and Cement without Metal Reinforcement, is Strikingly Shown at the Left, While the Advantage of the Cut-Corner Feature in Joining is Shown at the Right

STRONG CORRUGATED ROOFING OF ASBESTOS AND CEMENT

The exacting requirements of the chemical, gas, oil, and allied industries demand an unusual roofing, one that resists not only weather and time, but fire, condensation, and corrosive vapors as well. In answer to this need, a new roofing is now being manufactured that is made of asbestos fiber and Portland cement and molded under great hydraulic pressure into dense, tough, and structurally strong sheets that are inert to the destructive elements encountered in boiler rooms, chemical plants, refineries, refrigeration plants, fertilizer plants, and other places where chemical fumes and fires must be guarded against.

This corrugated, artificial stone roofing is furnished in sheets 8 ft. long, 42 in. wide, and 1/4 in. thick, and weighs 3 1/2 lb. per square foot. Due to the inside and outside radius of the corrugations being similar, the nesting of the sheets is perfect, a great aid in making the roofing more weatherproof and water-tight, and because of its unusual structural strength this newly developed roofing can be laid on spans of 45 in., thus affording a substantial saving in the supporting framework.

Another exclusive feature is the bevel-cut corners which permit the sheets to nest tightly at the joints. These cut corners not only avoid unnecessary extra thickness at the joints, but eliminate the wedge-shaped openings which permit wind and rain to enter the building. Another advantage of the cut corners is that, in the application of this new roofing, sheets can be laid in straight, con-

tinuous, horizontal, and vertical lines, greatly improving the appearance of the finished job. No metal reinforcement is used in this roofing material.

9026 FILIPINOS USE LARGE DIP NET AND DERRICK FOR FISHING

When the natives of the Philippine Islands go fishing they do not have the conveniences of the modern fisherman, but they manage to get the fish with the material at their disposal. They use a large dip net supported from a bamboo derrick on a raft of the same material. The net is lowered to the bottom of the stream



This Is the Style of Bamboo Raft and Derrick That is Used by the Native Fishermen of the Philippine Islands

and the raft moved ahead. The net is then raised and the captured fish fall to the center of the net and are dipped out.

Two flying boats, for passenger service, broke existing records recently, by making the trip from New Orleans, La., to Chicago, Ill., in 13 hr. 10 min. actual flying time.

Cmd. Roy C. Bennett, Victoria Hotel, Iloilo, Zamboanga, Cebu, Manila, Cebu, China

George H. Blottner Co., The Engineer
 1401 W. Jackson Blvd. Chicago
 POPULAR MECHANICS
 4/14/22

72
 9112 REAMER WITH MOTOR DRIVE
 WHOLLY SELF-CONTAINED

Reaming by hand is rapidly being superseded by power-driven tools. An entirely self-contained machine of the kind consists of a sturdy pedestal that carries a 3/4-hp. electric motor, and, beside it, a small assembling bench. The motor is belted through a three-speed cone to a self-locking worm-gear reduction above it, and this rotates a chuck that holds the reamer horizontally, and at a convenient height for the operator. The machine can be run



from any lighting circuit. It has a capacity up to 1 1/2 inch.

9095 ELECTRIC TIMING MECHANISM
 FOR VARIOUS USES

Whenever the element of time enters into a manufacturing process, the use of a new timing instrument will be found to be valuable. The appliance has a dial graduated into seconds, and an indicating hand which may be set at the predetermined interval, in seconds, from "zero." The mechanism is



then connected to the ordinary lighting circuit, and the small synchronous motor within accurately tolls off the time as the hand moves back to zero.

Stromberg Electric Co., Chicago
 223 W. Erie

9170 FIREPROOF BULKHEAD DOORS
 MADE OF MAHOGANY

Ships' bulkhead doors are now being made, in England, of mahogany fireproofed by a timber fireproofing system that, in itself, is not new, though its application for this purpose is of recent date. On the new Cunarder "Samaria," these doors are 7 ft. high, 4 ft. wide, and 1 7/8 in. thick. Several other large vessels, now being built in England, are to be fitted with similar doors.

8896 RADIATOR VALVE LEAK-PROOF
 WITHOUT ANY PACKING

A radiator valve that is proof against any leakage, without the use of packing,

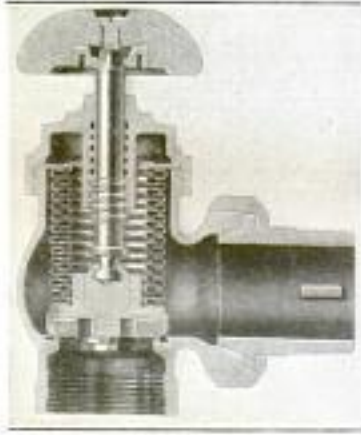

is fitted above its valve disk and around its stem with a brass bellows that expands and contracts as the valve is opened or closed, and at the same time always forms a barrier to the passage of steam, water,

or air from the steam piping to the exterior. There is no friction on the bellows, and nothing to cause wear excepting its expansion and compression, which occurs so seldom that the life of the valve should be practically equal to that of the radiator.

American Radiator Co., Buffalo, N. Y.
 9085 CONVENIENT FLYHOOK HOLDER
 MADE OF BRASS SPRING

Any fly fisherman who has had occasion to search through his book just as the fish started to strike will appreciate a new patented holder that can be fastened to a soft hat and holds twenty or more flies in a brass spring, in such a way that they may readily be detached when wanted.

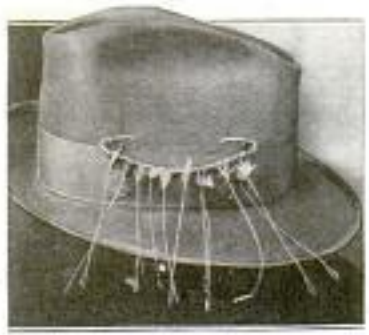

mfr. W. R. Davis, Wallace, Idaho.

9037 Wichita Motors Co, Wichita
Hills, Texas.

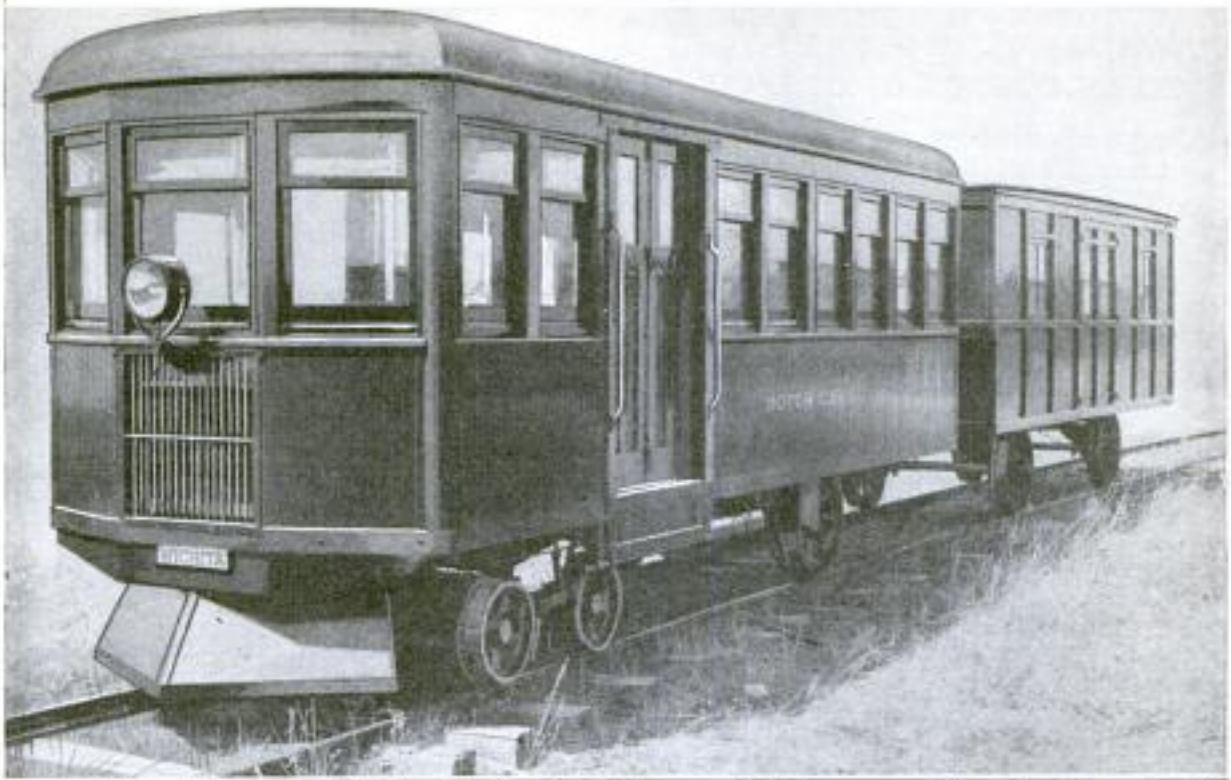

Gasoline-Driven Rail Car and Trailer Built for the Jefferson and Northwestern Railway in Arkansas: The Front Axle of the Car has been Replaced with a Four-Wheel Truck Pivoted in the Center. The Front Wheels Are 20 Inches, and the Other Wheels Are 30 Inches in Diameter

9037

GASOLINE-DRIVEN RAIL CARS CUT OPERATING COSTS

Gasoline-driven cars have been introduced on two more railroads in this country, namely, the New York and New Haven, and an Arkansas short line, called the Jefferson and Northwestern. The former road employs a car that has a seating capacity of 78 persons, a speed of 40 to 50 miles per hour, and is said to lower the operating costs by half. The car recently finished for the Jefferson and Northwestern, carries 30 people and 3,000 lb. of baggage, besides a trailer for freight, and attains a speed of 45 miles per hour

with a 40-hp. engine that burns either gasoline or kerosene. These new carriers are completely equipped with all the conveniences found on the latest passenger trains, and railroad officials who



Gasoline-Driven Rail Car Operated by the New York and New Haven Railroad as It Appeared When Leaving the Yards on the Final Test Trip



Another View of the New York and New Haven Car, Showing the Hood Raised, Exposing the Ordinary Gasoline Motor Similar to Those Installed in Trucks

have witnessed demonstrations of this departure in transportation, have unanimously declared themselves satisfied with the results.

International Motor Co.
West End Ave. & 64th St. New York

Mack Bulldog Rail Cars

9099 *Cont. R. M. Clutterbuck*
Box 3461, Honolulu, H.I.

HAWAIIAN TREE FERNS FOUND TO BE SOURCE OF STARCH

Always admired as a thing of beauty, and marveled at because of their great size, the tree ferns of the Hawaiian



These Tree Ferns of the Hawaiian Islands have been found to be a potential source of starch, equal in quality to the best of the corn starches

Islands have been considered as of no commercial value, but an accidental discovery indicates that they may become the source of large revenue. The tree ferns grow abundantly on the sheltered portions of the islands, the trunks often being as large as a man's body and more than 10 ft. high. When the outer bark is chopped away and the thin inner bark removed, there remains a core, about 6 in. in diameter, which is almost pure starch. When this is ground, screened, and thoroughly washed, it produces a pure white starch claimed to be fully as good as the corn starches or more expensive arrowroot. The tender young fronds of the tree fern may also be cooked as a vegetable, and, when so used, resemble cauliflower in taste.

LAKE LEVELS NOT PARALLEL WITH SEA LEVEL

The northern end of a quiet lake whose top surface is not given a slant by wind or currents, is nearer parallelism with sea level than its south end. The larger the lake and the higher it is above the sea, the greater is this effect. In Lake Michigan

it would amount to a little more than three inches.

This condition arises from the facts that the earth is not a perfect sphere and is turning about its axis so that a centrifugal force is developed which opposes its attraction, an effect which has its maximum at the equator. If the sea were raised by the addition of water, the level would increase slower at the poles than at the equator, and a change of elevation at the poles of 1,000 ft. would be accompanied by a rise of sea level at the equator of 1,005 ft. In other words, level surfaces at different heights are neither parallel with the surface of the sea nor with each other, and at the equator they would be the farthest distance apart. This has to be taken into account in the precise surveys made by the Coast and Geodetic Survey. For instance, in a line of levels from San Diego to Seattle, which runs much of the way over high ground, the correction is 1 1/4 meters, or about 50 in., an amount which is far from negligible.

ATTACHMENT FOR FURNACES

8898 IS FUEL ECONOMIZER

Already in extensive use, and highly recommended by the users, is a new scientific device that is guaranteed to reduce fuel consumption in furnaces 25 per cent or more. The device is automatic, and is inclosed in a steel drum that can be fitted to any smokepipe between the furnace and the chimney. It acts as a carburetor to the furnace, drawing live, oxygen-laden air from the outside, superheating it, and spraying it back over the fire. It is claimed that besides economizing fuel consumption, it also reduces largely the amount of ash and the volume of smoke, and that it increases heat efficiency.

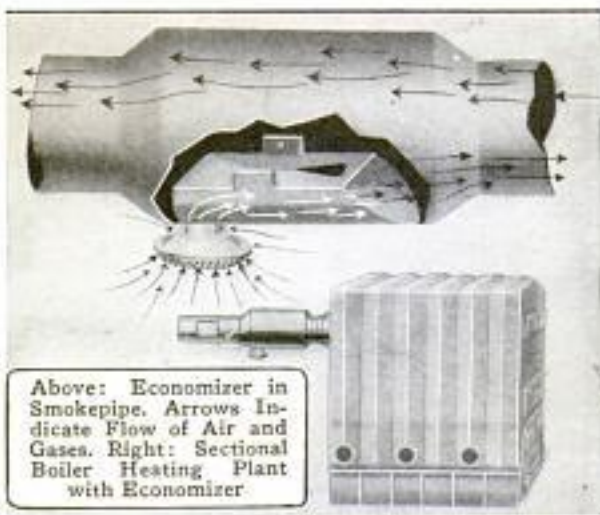

Above: Economizer in Smokepipe. Arrows Indicate Flow of Air and Gases. Right: Sectional Boiler Heating Plant with Economizer

Letter retd 11/10/24

Royal Burnall Fuel Saver, Inc., 140 Nassau St. New York City

Miss Sloty + Co., Hilo, Hawaii

9080

Cont. C.A. Briggs, 1521 Oak St. N.W., Washington, U.C.

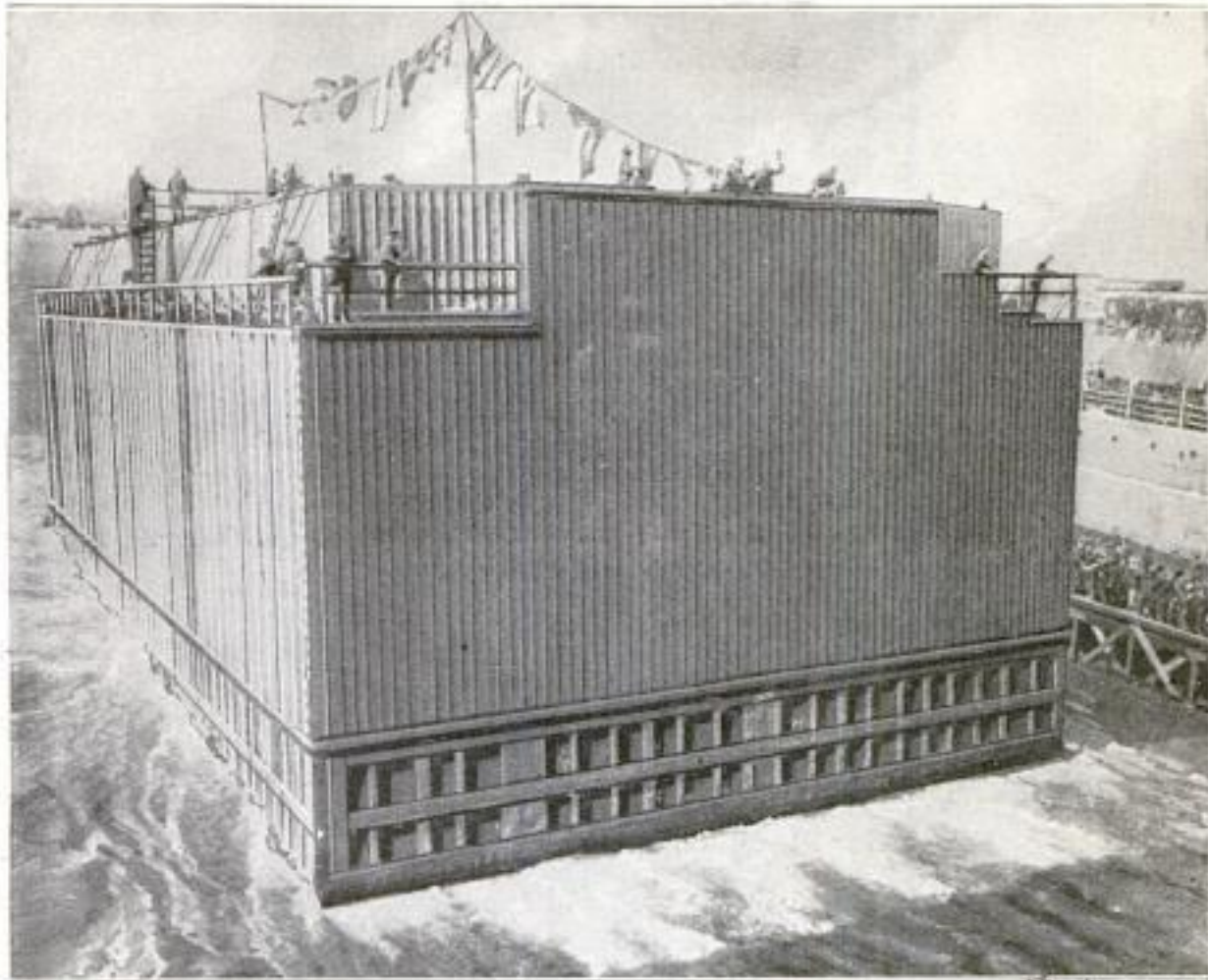

LAUNCHING A CAISSON FOR THE DELAWARE RIVER BRIDGE

*Photogram
New York
City*

THE largest caisson ever built, 143 ft. long, 70 ft. wide, 65 ft. high, and weighing 1,600 tons, to be used in the construction of the Delaware River Bridge, is shown in the act of being launched at the yards of the New York Shipbuilding Corporation, Camden, N. J. Six hundred thousand feet of lumber were used in the building of the caisson. It is called "Caisson A," and is for use in building the pier at the Philadelphia side of the river.

9042

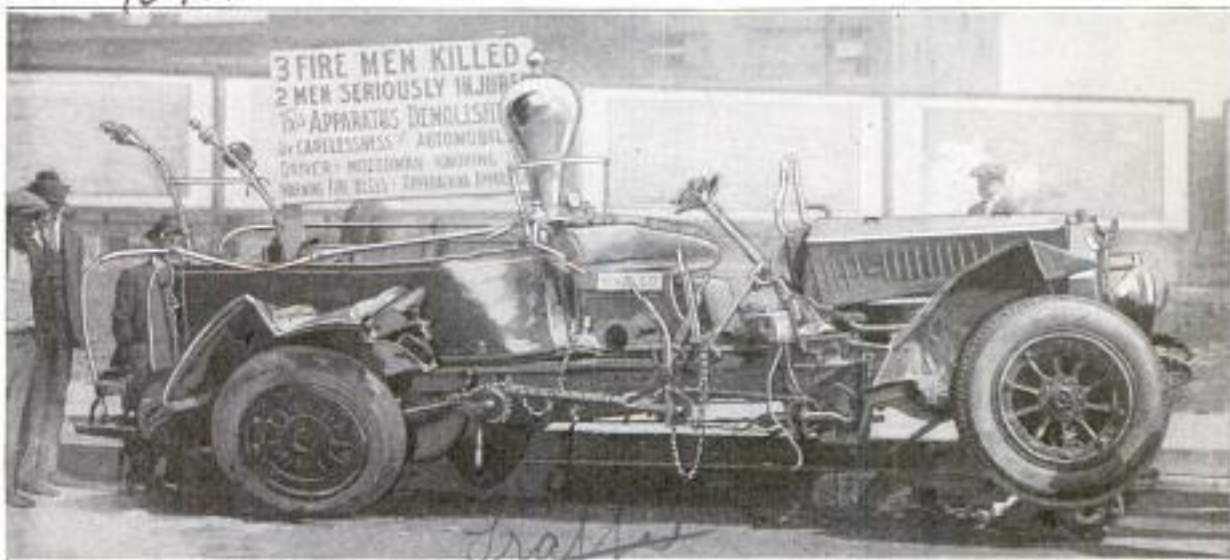

A WARNING SIGN THAT CANNOT BE IGNORED

IN the effort to prevent a recurrence of similar accidents, this demolished piece of fire apparatus was used as a warning sign in St. Louis, Mo. The sign placed over it tells briefly the story of the accident, and points out the reason it occurred. Surely, such a warning should bring home to every driver of an automobile the necessity for observing the warning signals of approaching fire apparatus rushing to the scene of a fire.

*Chas. E. & Palfrey, 514 Esplanade Bldg
St. Louis, Mo.*



COAST-GUARD CUTTER PASSING BETWEEN TWO ICEBERGS

Wide World Photos

WHEN these giant masses of ice break from the northern glaciers and drift southward into the north Atlantic Ocean, they become a serious menace to navigation. Some idea of the size of the bergs may be obtained by comparing them with the size of the coast-guard cutter "Seneca," remembering that icebergs float with only one-ninth of their total bulk above the water. Fortunately these floating danger spots melt rapidly when they encounter the warmer air and water found in the more temperate zones.

H. W. ...

8958 **TWO-STORY HOUSE ON STILTS HAS ELEVATED BASEMENT**

The city of Prince Rupert, B. C., is situated on very hilly ground, and in some instances houses were built before



This House was Built before the Land was Graded, and While the First Floor Is at Street Level, the Basement is Supported on Stilts at a Considerable Height above the Ground

the grading operations were completed, which has led to many unusual sights. In one case a house was built with the first floor level with the street, but the ground was so far below the street level that it was necessary to support the basement on long timbers. A narrow wooden bridge leads from the sidewalk to the first floor of the house.

9768

ROAD-REPAIR PATROL SYSTEM FOR PROVINCE OF QUEBEC

Plans are under way in the province of Quebec, Canada, for the establishment by the Department of Roads of a patrol system

which will keep in repair all the improved highways of the province, 4,000 miles in extent. An organization is to be established which will enable the Minister of Roads to know with exactitude the condition of each section of road, the road mender in charge, and the amount of repairs being done. Under the new plan, while the municipalities will be under less expense, it will be necessary for them to work in harmony with the provincial government by passing by-laws permitting the minister to take care of the roads. As a result of this system it is

expected that before the end of this year all roads in the province will be in good repair.

Christian Science Monitor

At the Croydon Air Station, near London, an airplane "taxi," seating three passengers, is maintained ready for immediate flight, the rate being a flat charge of less than 50 cents per mile.

4/12/22

9058
9058
Cont. Bernard G. Priestley
271 Washington St., Melrose, Mass

NEW-TYPE WIND TUNNEL FOR AIRPLANE TESTING

BY BERNARD G. PRIESTLEY

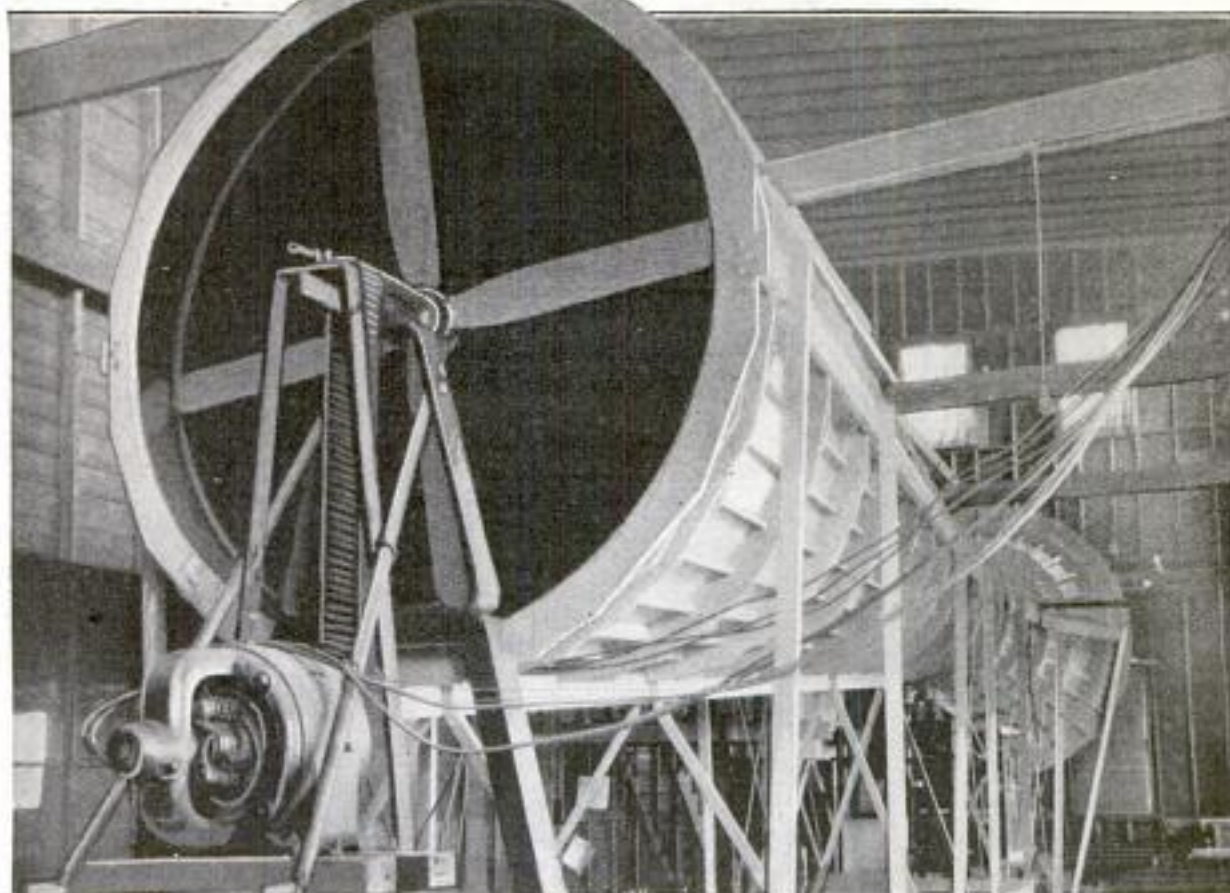

New Type of Wind Tunnel for Testing Models of Airplanes at the Massachusetts Institute of Technology, about 40 Feet Long and with Four Feet Inside Diameter: At the Opening is Seen the Motor-Driven Propeller Fan That Sets Up a Wind Velocity of from Two to 65 Miles an Hour.

An entirely new form of wind tunnel for the testing of model airplanes has been put into operation at the Massachusetts Institute of Technology. Because of its efficiency and ability to develop a high wind velocity, this tunnel is proclaimed by aeronautical engineers as the best constructed in the comparatively short time that tunnels of such type have been in use.

Unlike the square-shaped older tunnels, this one is circular in construction. Heretofore the most common practice in constructing these tunnels has been to use wood entirely. Sheet-iron or wooden frames, lined with fabrics,

have been tried, but have not proved wholly satisfactory. Part of this tunnel—the end through which the air enters—is

made of plaster, worked to form by hand, then varnished and polished. The remainder is made of built-up wooden frames covered with thin sheets of veneer. The new methods of construction made the tunnel comparatively inexpensive, besides reducing its weight to a minimum consistent with greatest efficiency.

The tunnel is about 40 ft. in length and 4 ft. inside diameter. It runs lengthwise inside a building, and is mounted about 12 ft. from the floor on



PHOTO COPYRIGHT, FRANK S. LINCOLN
Two Observers Taking Readings from the Wind-Tunnel Balance: The Model being Tested Is above the Opening in the Tunnel Floor, over the Balance Stand

a wooden scaffold reinforced by adjustable iron rods that lessen vibration when the air is forced through the tunnel.

Wind velocity is developed in the tunnel by means of a large propeller fan driven by an electric motor. The wind speed is kept constant by an automatic regulating device. The maximum velocity obtainable is 65 miles per hour and the minimum, two miles per hour. In the old square tunnel that the new one replaces, the same input of power would develop a maximum wind velocity of only 40 miles an hour.

In the floor of the tunnel, midway of its length, is an opening through which is projected the model airplane to be tested. The model is supported on a balance used in much the same way as any pair of scales. This balance, however, has a much greater range of adjustment and is considerably more complicated than ordinary scales. It permits accurate weighing of the lift and resistance of the models. These weighings enable calcu-

lating the speed at which the full-size plane must fly in order to maintain itself in the air, and the horsepower that will be required to drive it at the necessary speed.

The tunnel is used largely to test models of new types of airplanes. Models have about a 2-ft. wing spread, but their dimensions are comparatively the exact dimensions—down to one-five-hundredth of an inch—of the full-size plane. It costs as much as \$1,000 to make a model. Wind tunnels afford the only way of investigating air forces, steadiness of motion, and effectiveness of control, without trying the full-size airplane in the air—a most dangerous procedure in experimenting with new types.

Uses of the tunnels are by no means confined to testing of airplane models. They can be used to test the wind pressure on buildings, the wind resistance of motor cars, and for various other tests in which the element of wind velocity figures.

907³ **END-DUMPING BODY MOUNTED ON LEGS OR ROLLERS**

Bulk materials, such as sand, coal, ashes, etc., can be handled efficiently with a combined end-dumping body and elevating platform truck, which is manufactured by a Cleveland concern. The body possesses steel legs, to which wheels or casters may be attached, has a capacity of 27 cu. ft., or 2,700 lb., and a special rocker arrangement for dumping from the elevating platform. This platform has a lift of 96 in., so that it is convenient to raise the loaded body and empty it into a wagon, motor truck, or other vehicle used for hauling purposes.

9190 **DEVISE TEST FOR DETECTING PRESENCE OF REMADE MILK**

Because of the increased use of remade milk, manufactured from powdered or condensed milk and sweet-cream butter, it has become necessary for chemists to devise some test that will indicate its presence in milk products. If the curd from remade milk is dissolved in sodium hydroxide, it shows a characteristic yellow color, after standing, while natural products or products containing only a small percentage of remade milk, do not show this color. As little as 10 per cent of remade milk can be detected by this test when carefully made.

Rept. of Agriculture Exp. Sheet # 2002
5/8/22

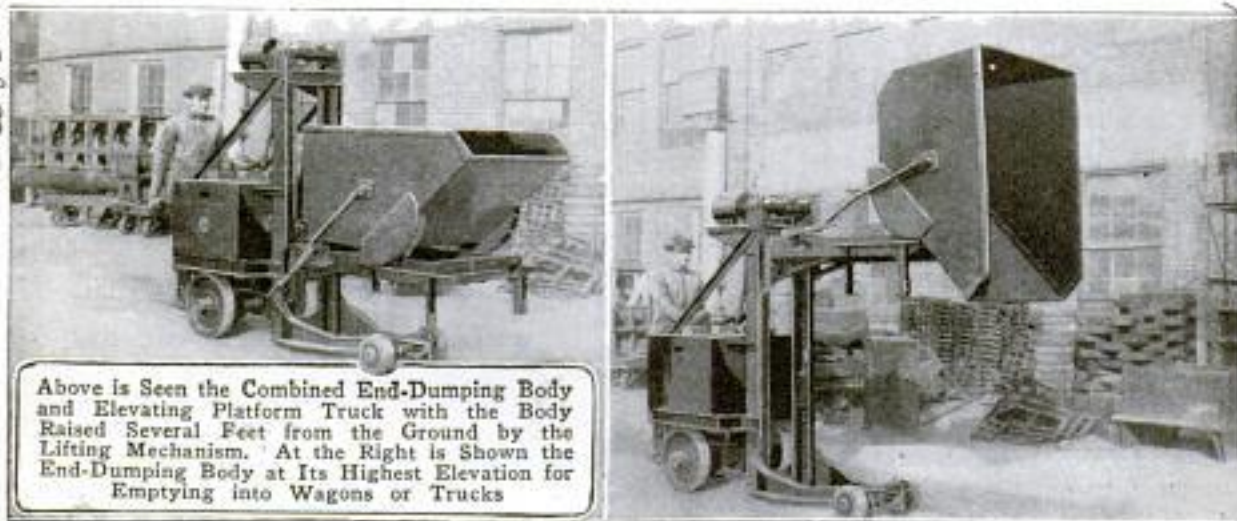

Above is Seen the Combined End-Dumping Body and Elevating Platform Truck with the Body Raised Several Feet from the Ground by the Lifting Mechanism. At the Right is Shown the End-Dumping Body at Its Highest Elevation for Emptying into Wagons or Trucks

The Lakewood Engineering Co., Cleveland, Ohio



Huge Log being Hauled with Its End Supported on a Dolly, or "Bummer," That Has a Truck Fitted with Continuous-Tread Traction Wheels Similar, on a Smaller Scale, to Those of the Tractor That is Hauling. This System of Traction Allows the Tractor to Haul Heavy Loads over Soft Ground

8934
CONTINUOUS-TREAD TRACTION SYSTEM FOR HAULING LOGS

The continuous-tread system, similar to that used on ordinary tractors, is now being used in skidding logs in the logging sections of the Pacific Northwest. In place of the usual dolly with a pair of round wheels, on which one end of a heavy log is mounted, a truck with continuous-tread traction wheels is used. On the front of this truck is a tongue to which is hitched a tractor for hauling it. This dolly known as a continuous-tread "bummer," is pushed under one end of the log, and enables the tractor to haul much greater loads over soft ground than is possible with ordinary round wheels.

8922
PNEUMATIC CORK EXTRACTOR ACTS WITH AIR PRESSURE

Quite a novel method of extracting a cork from a bottle is to blow it out by



Extracting a Cork by Air Pressure: The Hand Pump Forces Compressed Air into the Space between the Bottom of the Cork and the Contents of the Bottle

air pressure. A bowed, thin, hollow air conductor is inserted between the cork and the neck of the bottle. Outside the bottle this is

the Patent Welt 3/22
Berlin, S.W. 19, Benthstr 4/5
Germany.

being at right angles and leads to a small pipe, to which is connected an air pump that forces air into the space in the bottle between its contents and the bottom of the cork. The device is of German origin.

9086
MAMMOTH LOOSE-LEAF BINDER LARGEST EVER BUILT

Being a veritable "Goliath" in size when compared with their usual product, a

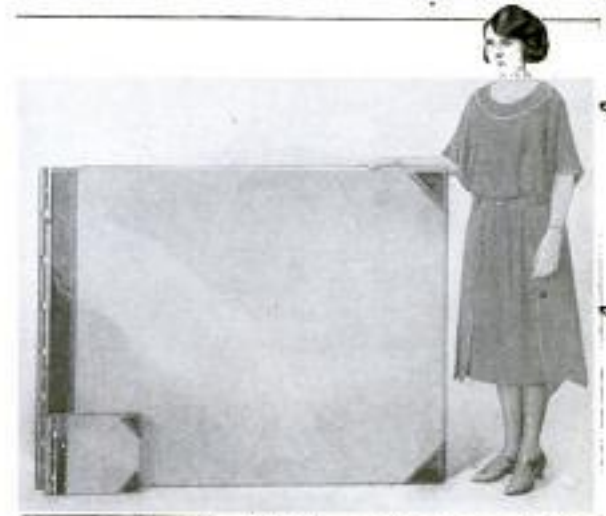

Mammoth Loose-Leaf Binder as It Appears in Comparison with a Binder of the Size Commonly Seen

mammoth loose-leaf binder was delivered recently by a Michigan firm to a Texas customer. The huge article, said to be the largest ever built, measures 41½ by 54 in., making it 9 ft. wide when open. It weighs 100 lb. empty, and 500 lb. when filled with its capacity of 11 in. of sheets.

Holt Mfg. Co., Stockton, Calif.

Kalamazoo Loose Leaf Binder Co. Mich.

9144

**IMPACT DEVICE RECORDS ANY
 ROUGH HANDLING OF CARS**

The annual claim made against the railroads for goods damaged by rough handling in shipment, runs into staggering figures (\$2,000,000),

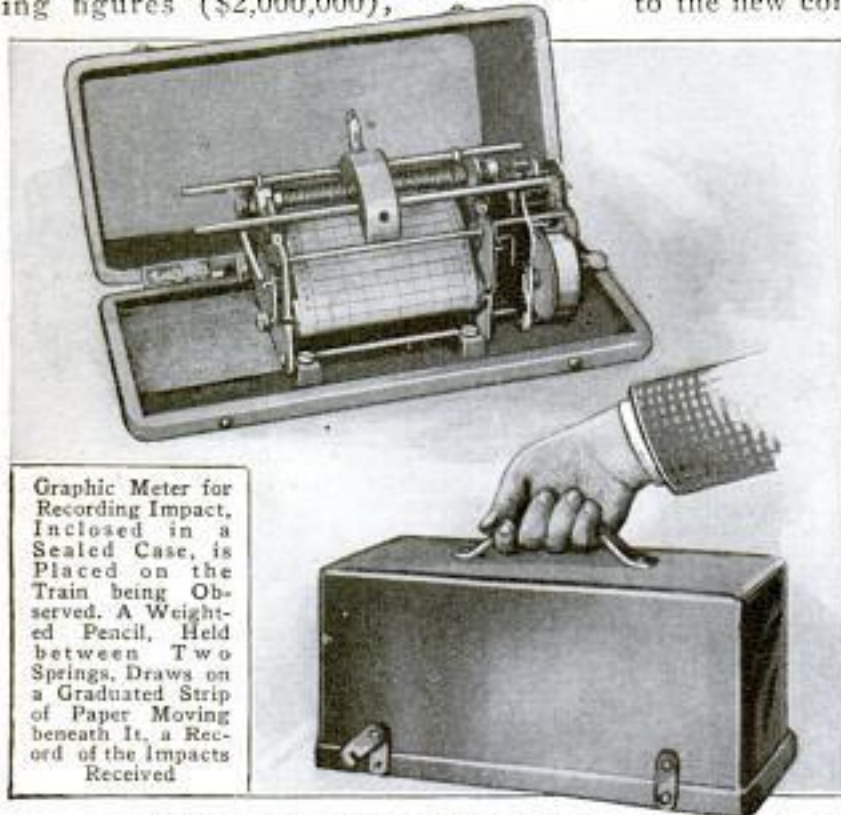

Graphic Meter for Recording Impact, Inclosed in a Sealed Case, is Placed on the Train being Observed. A Weighted Pencil, Held between Two Springs, Draws on a Graduated Strip of Paper Moving beneath It, a Record of the Impacts Received

some of which can be charged to careless handling when cars are coupled. In any effort to reduce this loss, an impartial record of the way cars are handled is necessary. To accomplish this, a compact machine has been devised in which a weighted pencil, held between springs, draws on a moving strip of paper the record of the way the car is handled. The impact register is placed on the train to be observed, and is sealed to prevent persons tampering with the mechanism or the record. It has been found that cars coupled at a speed of more than three to four miles per hour constitute a case of rough handling, in which car and contents may be damaged.

9116 **"CANNED OATS" FED ARMY
 HORSES SUCCESSFULLY**

Compressed forage, composed of pure oats and other grains, pressed into bricks made with a binder of molasses, has been successfully developed at Camp Lewis. The bricks are 12 in. long, 6 in. wide, and 1 1/2 in. thick. Perforations make it possible to break up the bricks by hand if only portions are to be fed to

Camp Lewis, Wash.
 Quartermaster Corps

the army horses or mules. With the new compressed feed, it is pointed out, a horse can go into battle carrying its rations like the soldier carries his own.

Tests were made on fifty animals at Camp Lewis, and all but four took readily to the new compressed feed, according to

the report of the chief camp veterinarian. With the exception of two of the animals, all gained weight and maintained their working efficiency. No sickness was observed. One stallion gained 46 lb. in thirty days.

The mules disliked the ration at first, but soon became fond of it. For a number of years, army officers state, efforts have been made to solve the problem of easily transporting horse feed during campaigns. The British supply officers in Egypt who were confronted with heavy obstacles in forwarding supplies during their recent expedition against the Arabs, evolved a type of compressed feed by using cotton baling presses to

reduce the bulk, but this was not very satisfactory, since the weight was not reduced. The new type of compressed feed developed at Camp Lewis is intended to take the place of the oat ration only.

**SANITARY DISPLAY STAND
 9096 PRESERVES FRUIT**

Fruit and vegetables of all kinds may be preserved in perfect freshness for many weeks by the use of a sanitary, metal display stand, or basket, invented by a New Mexico man.



The basket is lined with burlap saturated with an antiseptic solution, the evaporation of which cools and gives the proper amount of humidity; and at the same time the lining acts as a cushion to prevent the bruising of the contents.

Everfresh
 Basket Co., 212 S. High St.
 Albuquerque, N.M.

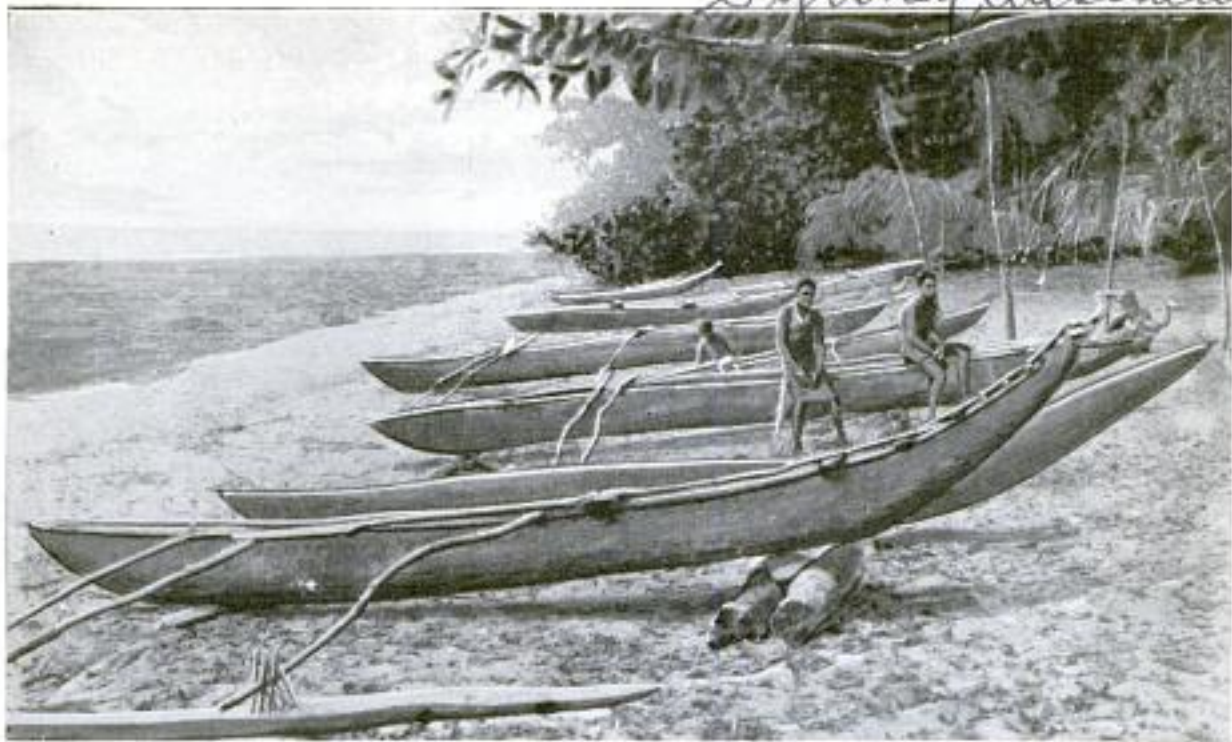

CANOES MADE BY SOUTH PACIFIC ISLANDERS

IN MAKING canoes, similar in some respects to the well-known American Indians' dugouts, the natives of the islands of the New Hebrides, in the south Pacific Ocean, always select trees that have been bent by the wind. This enables them to make a canoe with an upturned prow like the Malay proa, which it further resembles by having an outrigger float.

9041

"PUSH-BALL" GAME PLAYED WITH AUTOMOBILES

"Push ball," a game which is usually played by men on foot, was enjoyed recently by the drivers of six automobiles and numerous interested spectators. The cars were stripped of windshields and tops, lined up at opposite ends of the field, and, at a given signal, furiously charged the large inflated ball. Although the sport was

necessarily rough, considerable skill was evidenced by the different drivers in avert-

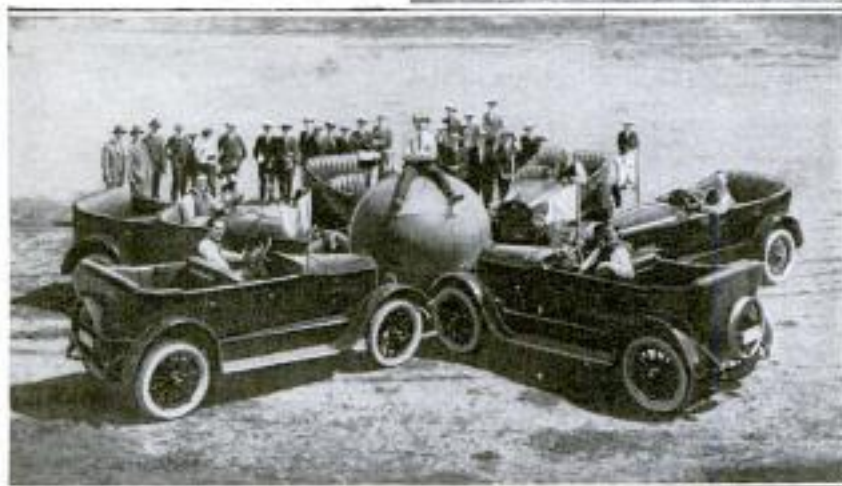

Above is Shown the Huge Ball in the Center of the Field, with the Six Automobiles Waiting for the Referee to Give the Signal for the Opening Charge. At the Left are Seen the Participants at the Finish of the Game

ing mishaps, and when the game was finished, it was found that none of the machines had suffered the slightest damage in any way.

Comd. Chas. W. Seiger, Powell & Suttler Sts.
 San Francisco, Calif.

Monsoon Cooling Systems, Inc.
1476 Broadway
New York City

POPULAR MECHANICS

**BELT-DRIVEN ELECTRIC FAN
WITH HIGH-SPEED MOTOR**

9028

When ventilating fans are direct-connected to the motor that drives them, as

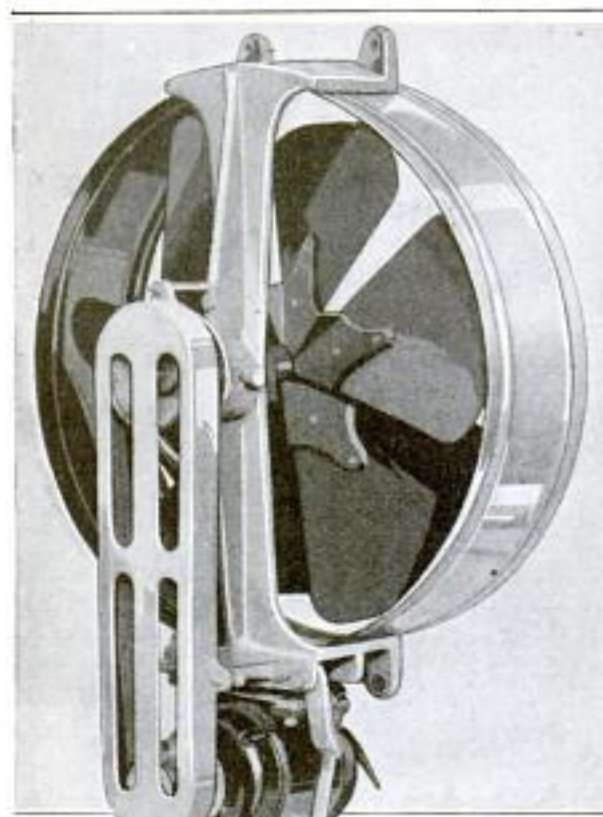

Belt-Driven Electric Fan with Relatively Higher Speed than That of the Fan; Adjusting Screw beside the Motor Regulates the Belt Tension

they usually are, because of the relatively low speed of the fan comparatively large motors are required to drive them. A new belt-driven fan is now being built, in sizes from 16 to 48 in., which, having a much larger pulley on the fan than on the motor, permits the use of small high-speed motors, of much smaller size than if the fan were direct-driven. The motor is adjustable on the fan frame, so that the belt tension can be regulated, and the pulleys are self-cooling, preventing overheating of the belt or pulleys.

**REMARKABLE SPEED OF SOUND
9199 IN TELEPHONE CIRCUIT**

A rather interesting comparison of the speed of sound over telephone circuits and through the air, was brought out in a recent long-distance telephone test. In this trial, there was made what is probably the longest telephone circuit ever established, starting from Havana, Cuba, up the Atlantic coast to New York, across to San Francisco, down the Pacific

coast to Los Angeles, and then to Catalina Island. The connection was approximately 5,600 miles long and the transmission of the voice from one end of the circuit to the other required only the tenth of a second. If it had been possible for the sound to have traveled over the same course through the air, it would have taken in the neighborhood of seven hours for the sound to reach its destination.

984

**HANDY MACHINE FOR TESTING
RIPENESS OF PEARS**

Because the juicy pears that one buys from the grocer or fruit stand must be picked green and allowed to ripen, it is a difficult matter to tell just when the crop is ready to harvest, as the green pears are extremely hard. A simple testing machine has now been devised, consisting of a scale, plunger, and handle, by which the exact hardness of the fruit may be gauged. Selected samples of the crop are tested from time to time by pressing the plunger and noting the force required to dent the fruit, and thus the fruit can be picked at the proper time to insure its reaching the market in prime condition.

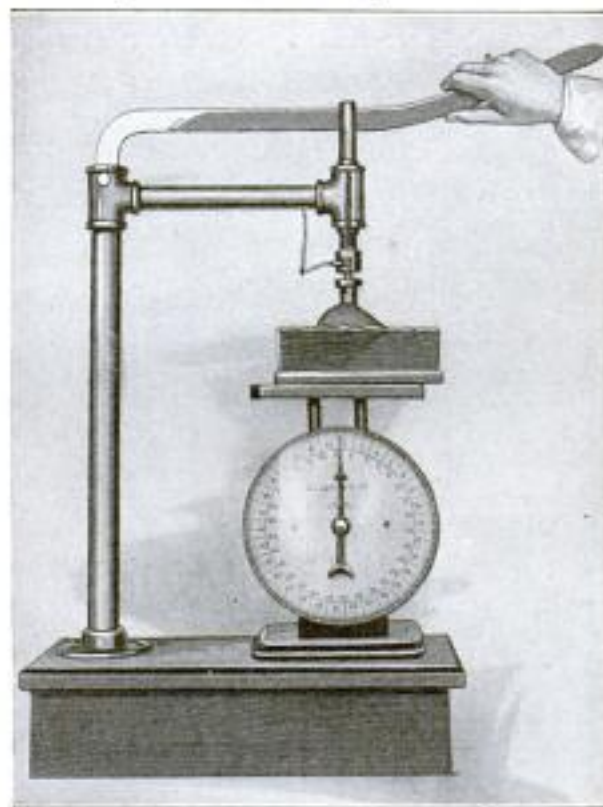

By Pressing the Plunger Down on the Sample of Fruit on the Scale and Noting the Force Required to Make a Dent, Its Exact Hardness can be Gauged

After being picked, the fruit is allowed to stand six hours before testing.

Journal of Western Society
of Engineers, May, 1922
Chicago Vol. XXVII #5

Oregon Agricultural
College, Corvallis,
Oregon.

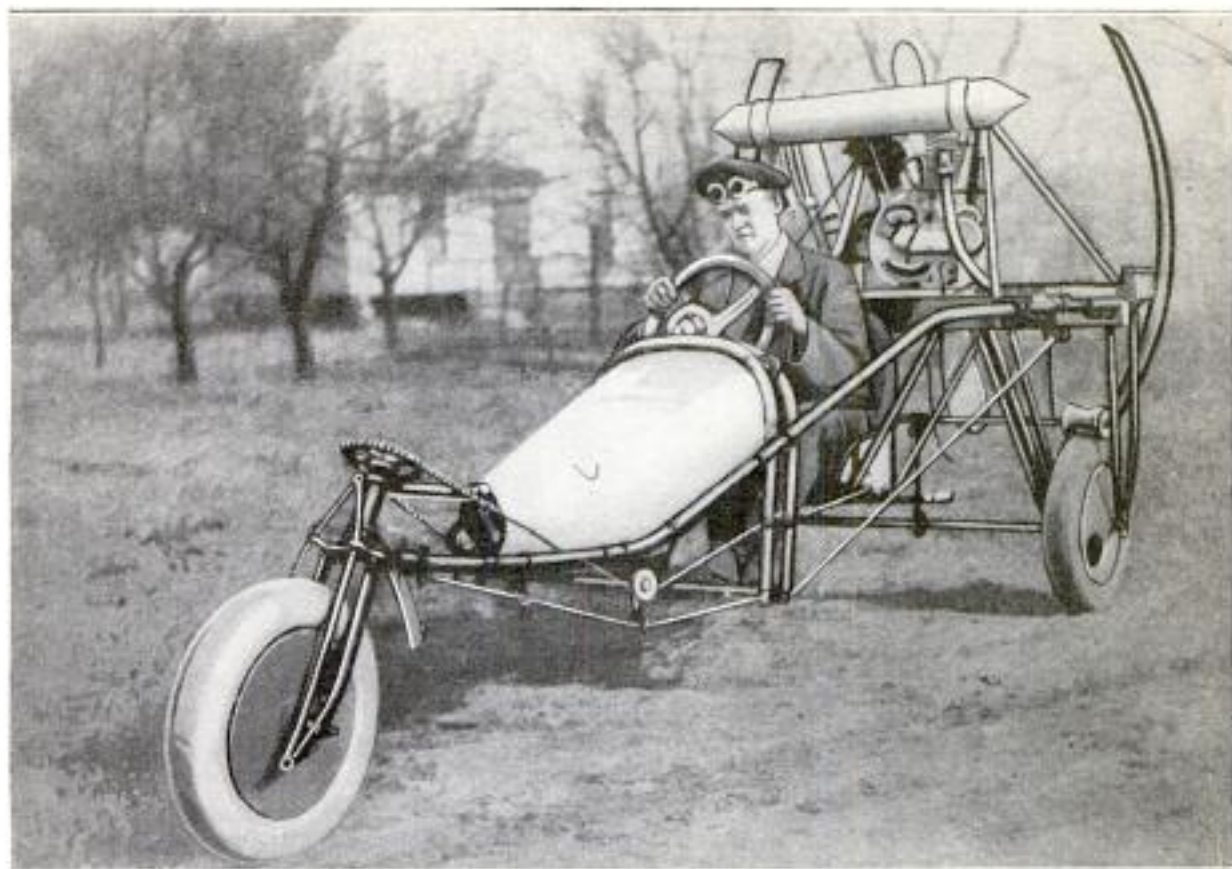

This Little Aeromobile is Constructed Almost Entirely of Airplane Parts, and, Driven by a Motorcycle Engine and Propeller, Makes Good Speed over Smooth Roads, Using Little Gasoline

9060
NEAT AEROMOBILE IS DRIVEN BY MOTORCYCLE ENGINE

What appears, at first glance, to be an airplane without wings, is, in reality, a road vehicle driven by a motorcycle engine and propeller. Airplane parts have been used for nearly all of the construction, and on smooth roads the little machine is capable of good speed. Braking is accomplished through two hardwood reels that are pressed against the two rear wheels. The construction, while light, is strong, and the machine has stood severe tests over rough country roads.

9175
VOICES REGISTERED ON FILM FOR SPEAKING MOVIES

Registering voices simultaneously with the action of a motion-picture film is an invention recently announced by Lee De Forest, pioneer in the wireless research field. The voice, according to the inventor, is registered on the narrow margin of the film by light action, the margin thus bearing a veritable picture of the vocal effort. Through the medium of a special attachment on the projection machines, the spoken words are reproduced in synchronism with the motion picture.

N.Y. Times 4/22/22

9131
NEW HAWAIIAN GUITAR RESTS FIRMLY ON PLAYER'S LAP

A new musical instrument bearing some resemblance to a zither and played like a Hawaiian guitar has been devised by a young woman of Honolulu. The hollow sound box extends under the entire length of the strings, and the lower surface is shaped to rest securely across the lap of the player.



The Hollow Sound Box of This New Musical Instrument Extends under the Full Length of the Strings, and Fits the Lap of the Player

*Miss Lolita Smith
 Honolulu, Hawaii.*

1440 Palalo St.

9040
84

Pittinger's Sanitarium, Monrovia, Calif.

POPULAR MECHANICS

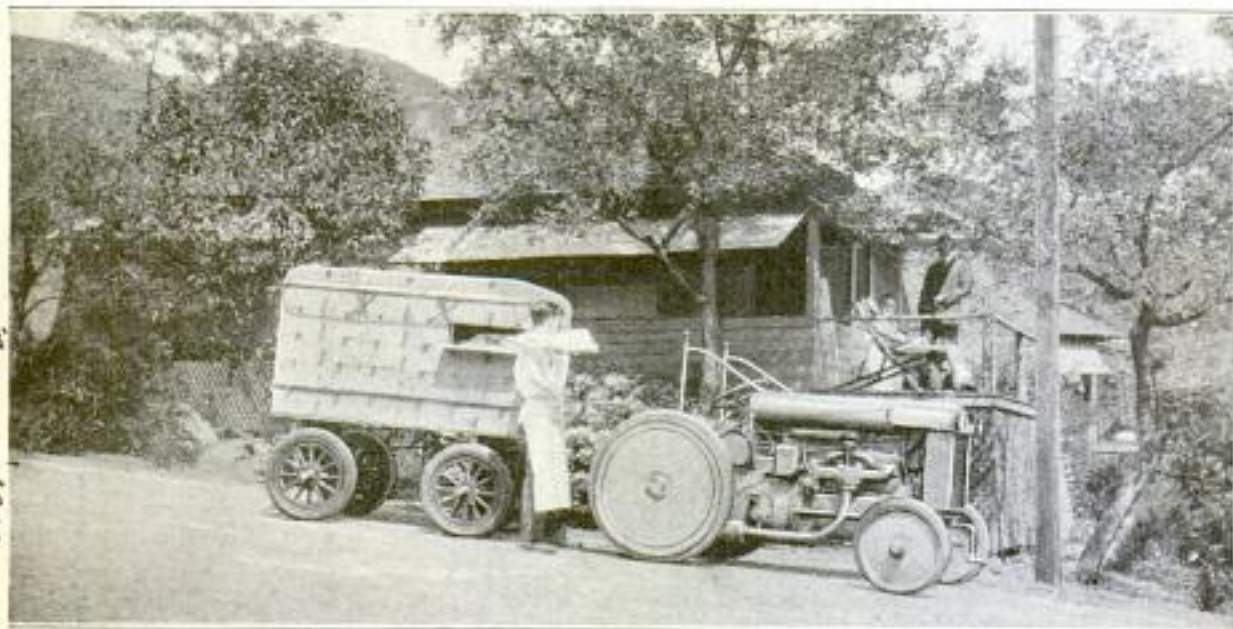

Tractor-Trailer Outfit Which is Used to Haul Steaming-Hot Meals to the Patients at a Tuberculosis Sanitarium: With This Outfit, All the Meals are Delivered to the Inmates of the Widely Scattered Bungalows by the Employment of a Driver for the Tractor, and One Waiter Who Carries in the Trays

PENCIL SHARPENER PRODUCED WITH TOOL-STEEL BLADE

Simplicity of design and practical arrangement for being kept in good condition, are the chief merits of a pencil

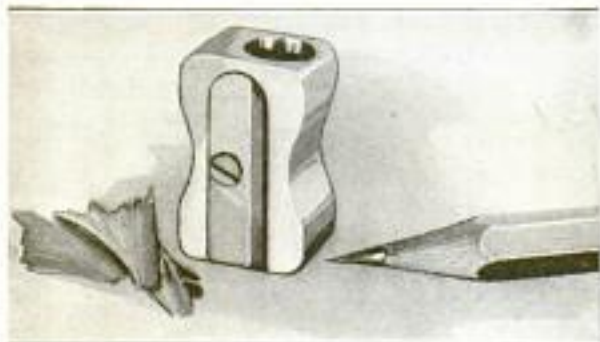

Pencil Sharpener with Tool-Steel Blade: The Shavings and the Sharpened Pencil Are Evidences of the Keen-Cutting Edge

sharpener made in Germany. The appliance is 1 by 1/2 by 3/8 in. in size, easily fitting into a vest pocket or handbag, and has a renewable, tool-steel cutting blade.

a small-size tractor engine mounted on rubber tires, and three trailers of special design, and likewise fitted with rubber tires. The trailers are virtually all-metal cupboards, equipped with tiers of shelves for holding the trays, each of which has an individual door. Steampipes are installed throughout the interior of the trailers, with a valve at the rear whereby a connection is made with the kitchen heating plant while the trays are being placed in the queer conveyance.

DIMINUTIVE REVOLVING FAN 9016 OPERATED BY HAND

Diminutive revolving fans, operated by hand, are the latest novelty, and are now being manufactured and placed on the market by a Chicago company. In using this toy, the blades are caused to revolve rapidly by means of a trigger arrangement, worked by the thumb. When not in use, the blades are folded and concealed in the case, which is small enough to be carried conveniently in a vest pocket or a handbag.



Left: Diminutive Revolving Fan Inclosed in Case. Center: Blades Out and Thumb on Trigger Ready for Use. Right: Fan being Closed

WARM MEALS FOR PATIENTS HAULED BY TRACTOR

Steaming-hot meals are carried three times each day to the patients at a tuberculosis sanitarium in California, the delivery being made with a tractor-trailer outfit. This plan was inaugurated as a means of preventing the mingling of the inmates, who are accordingly housed in separate bungalows which are scattered over a large area. The outfit consists of

Dealer: Roman Avat., 3131 Meldrum Ave. Detroit Mich. 9092

Importers - George L. Lusk & Co., 145 W. 45th St., New York City
Geo. W. Fan Co., 501 N. La Salle, Chicago

Ypsilanti, Mich
SEMAPHORES ON INTERURBAN OPERATED BY PUBLIC

Seeking to eliminate all danger and give the public better service, an electric railway in Michigan has installed semaphores on all of its small crossroads stations. An ordinary light bulb is constantly burning at these places, and serves for illumination when not used for signaling purposes. When the would-be passenger arrives at one of these stations, he waits until the car approaches and then pulls a wire which places the green-disked semaphore in front of the lamp. Since the inauguration of this system, the company claims to have had fewer accidents, and also a greater amount of praise from its patrons.



Semaphore on Interurban Station Which is Operated by Would-Be Passenger Pulling a Wire

8350

TOBACCO-GATHERING MACHINE SAVES HAND LABOR



Tobacco-Gathering Machine That Strips the Leaves from the Lath When It is Inserted in the Hole Seen above the Table

8784

In curing tobacco, the leaves are strung in bundles along wooden strips or lath, which are hung in the drying sheds, and a machine has now been designed for gathering the strips from the lath rapidly, when the curing process is complete. Behind a table is a vertical frame in which are mounted two pulleys which are rotated by a gasoline engine beside the frame. In the frame in front of the pulleys is a small hole through which the lath is fed between the pulleys, which pull it through the hole, pushing off the tobacco.

AUTOMATIC SAFEGUARD OPERATES WITH SWING SAW

A novel safeguard for a swing saw, in use at a New York factory, consists of an automatic guard for the front of the saw that incloses that part of the saw after it has passed through the sawn material. In connection with this guard is a rod that prevents the saw from moving any farther forward, after it has done its work. When the saw is swung backward, this movement is limited to the proper position by a stop, and in connection with this is a latch that automatically prevents

the saw from moving forward while material is being placed in position for saw-

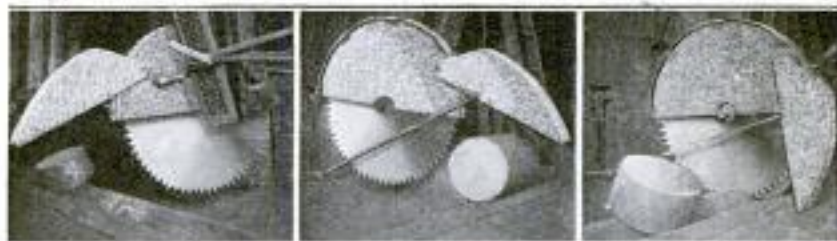

Left: Swing Saw in Its Backward Position, with Automatic Guard Raised Ready for Cutting. Center: Other Side of Saw, Showing Rod That Actuates the Guard. Right: Position of Guard after Saw is Moved Forward

ing. A light on the saw illuminates the cutting edge, and a counterweight transmits cutting pressure to the saw.

*Acheson Esraphite Co,
Niagara Falls, N.Y.*

*E. Windsor Hill Conn.
Clapp, Box 15,
Dudley A. Leander B. Coe*

Lawrence Carrier Corp.

86

208 Lake St.

POPULAR MECHANICS

Chicago

9038

SPARE-TIRE CARRIER LIFTS HEAVY METAL WHEELS

Lifting heavy wheels containing spare tires, from the ground to the carrier, is a difficult task for a woman, and to lighten this effort an extra-tire carrier has been produced which has a lever attachment.

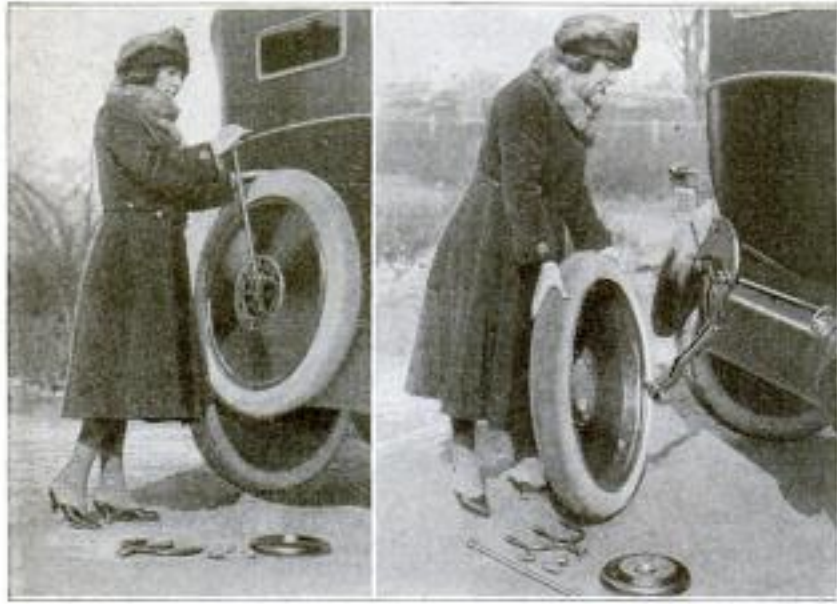

Left: Lever Attachment being Applied to the Spare-Tire Carrier Preparatory to Lowering the Heavy Wheel to the Ground. Right: Ready to Roll the Wheel Around to the Front of the Automobile

This lever is fitted to the center of the carrier, with the handle projecting through the wheel. The spare member is then easily lowered to the ground and the damaged wheel put in its place, all of which is executed with but a minimum of exertion.

STOPPING SUCK-HOLE LEAKAGE IN ROCK-FILLED DAMS

9010

Enormous losses in water power are readily evident in many sections of the country during dry seasons. In some cases the trouble has been traced, after many attempts to locate sources of water loss at dams, to the presence of so-called suck holes, sometimes far removed from the dam itself and the sheeting adjacent thereto.

As these losses were confined principally to plants where the rock-filled type of dam was used, or dams without deep foundations, methods had to be devised not only to trace underground leaks but to remedy them. Such leaks may, in time, form a regular subterranean tunnel and drain great quantities of water.

The methods of locating these suck holes and filling them without employing costly diving apparatus are interesting.

Two men in a boat, hitched to a cross-river rope, work their way back and forth from one bank to the other. For the exploration work, the boat is equipped with an electric light of about 200 watts. The lamp, incased in a waterproof marine socket, is lowered from one side of the boat until it nearly touches the river bed.

The man on the other side of the boat watches, through a marine telescope, for traces of eddy currents. The process is continued until the entire area above the dam has been explored. After the leak is found, it remains to determine its shape and size. The material used for filling the hole depends on the size of the subterranean tunnel. For small channels, small field stones or small boulders are sufficient. In larger tunnels it becomes necessary to lower sacks of cinders and sometimes concrete into the orifice.

The best and most permanent method of stopping these leaks is to first

let down small stones, loaded in tin cans, and, if necessary, force brush and other objects into the opening, until observation determines that the obstructions are actually lessening the flow. A few sacks of cement or cinders on top of these will finally eliminate the suction. The whole should finally be sealed over with a 2 or 3-ft. covering of concrete, spread over an area of at least twice that of the leak.

NOW OPERATE PRAYER WHEELS IN INDIA BY ELECTRICITY

Motor-driven prayers have become popular with the Buddhist priests of Simla, the summer capital of India. Formerly the limit of invention allowed lazy priests to tack pieces of paper, on which were written the perpetual prayers, onto great prayer wheels. The power for turning these wheels was supplied from the many small mountain streams about the capital. When a firm of British engineers came with a proposal to divert these little streams and merge them into a water-power project, the priests incited the people against them until finally an item was included in the franchise stating that electric motors and power were to be supplied to perpetually turn the prayer wheels.

Capt. Frank H. Jones
15 Rowe St.
Auburndale, Mass.

← same

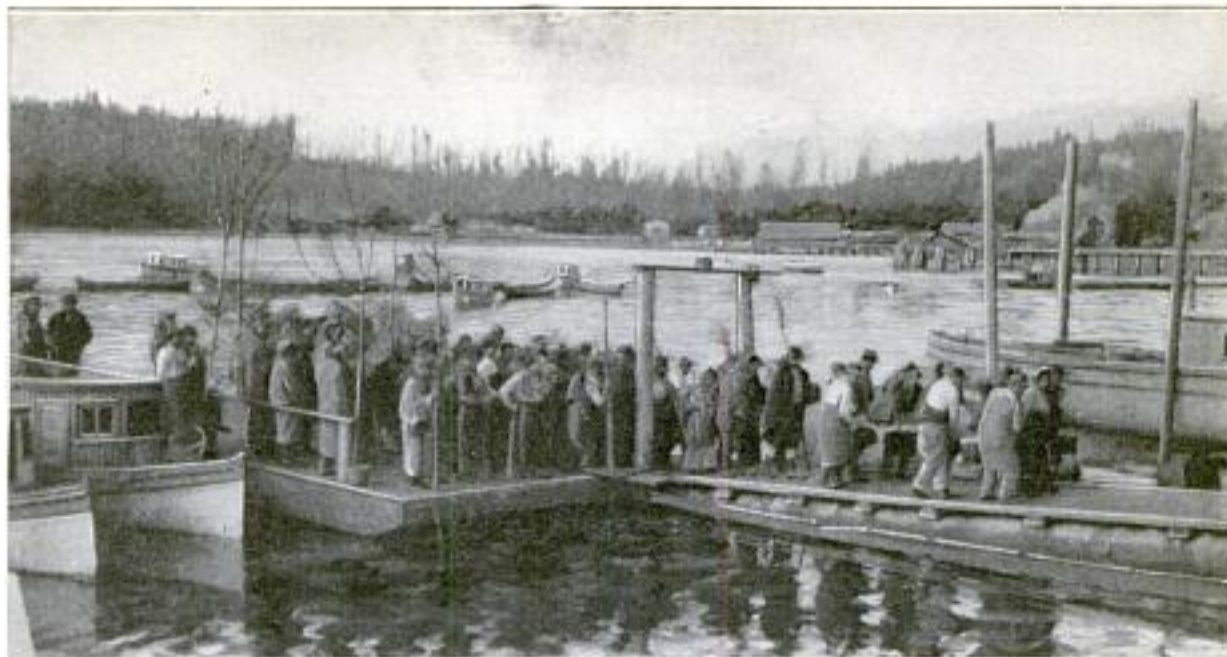

Bringing the "Wild Men" Ashore: These Men Are Members of the Tribe Giving the "Potlatch," and are Dressed in Masks and Costumes. After the Guests are Seated at the Feast, the Wild Men Entertain Them with Dances

PACIFIC-COAST INDIANS FIGHTING TO RETAIN ANCIENT RIGHTS

BY FRANCIS DICKIE.

Heriot Bay, B. C., Canada.

ONE of the most unusual legal battles in Canadian history has just been staged on the Pacific coast of British Columbia, where some forty of the Kwakiutl tribe have been convicted of holding a "potlatch," and some of them sentenced to two months' imprisonment. Among those convicted was a squaw, the first in the history of British Columbia.

In defense of their ancient primitive rights, the Indians hired the best legal talent obtainable in the country, and though the Court of Appeal decided against them, the Indians are continuing the fight by way of a petition to the Governor-General, Lord Byng, and Council, asking that the law against the potlatch be modified. Though the fight has largely centered around a few members of the Kwakiutl tribe at the famous Indian village of Alert Bay, all the coastal Indians are affected by the enforcing of the law, as the potlatch feast is one of the most important things in the social organization of all the coast tribes of British Columbia and also Alaska; a social organization vastly complex, and understood by very few white men. Those few white men fully conversant with the social organization of the Indians are mostly in sympathy with the red men, and a good many to date have put their signatures to the petition.

The writer of this has given consider-

able time and study to the Pacific-coast Indians, traveling on various occasions in many regions with a member of the anthropological department of the Geological Survey of Canada, and getting as thorough an insight into the social organization, myth, and legend of the various tribes as is possible, short of a lifetime of research.

The potlatch is one of the outstanding events of life among the Indians of the Pacific coast, but very little has been written of it, and this mostly without understanding of the deep social significance of the feast, dancing, ceremonies, and gift-giving which are a part of the event called potlatch.

On the part of the government, a law against the holding of potlatches was passed in 1884 (Statutes of Canada, Chapter 27, Section 3). But the Indians continued their ancient customs without prosecution, until 1897, when there was, as far as I can find, only one prosecution, the Indian not defending himself. In 1918 the law was amended so Indians could be tried by the Indian agent. Since then numerous prosecutions have been made and many convictions have been registered against the Indians, ending with the prosecution of no less than forty in the first months of 1922. The fight was centered mostly around the famous Indian village of Alert Bay, once the most picturesque

8861
88

of its kind in North America, with its wonderful collection of totem poles and immense potlatch houses, but now, due largely to the interference of white men, losing its ancient charm. In the first week in March, 1922, the last of the magnificent totem poles were sold—a rare thing for Indians to do. Two of the poles went to Portland where they will figure in a coming exposition, and the third to the "historic Indian village" that is being erected in Stanley Park, Vancouver.

The government's placing restraining laws against the holding of potlatches was on the ground that Indians on these occasions impoverished themselves by giving away all their earthly possessions, often the savings of years; for when an Indian gave a potlatch, he did give away everything he owned to members of his tribe whom he had invited. In some cases, where a very great chief gave a potlatch, people of other tribes, often hundreds of miles away, were invited. In the years before the white man came, such feasts lasted from ten days to a month.

But though the government was partly right in its claim, the potlatch presents a paradoxical situation, for in giving away all he possessed an Indian was at the same time acquiring a vested interest—the potlatch was nothing less than a life-insurance premium, old-age pension, and endowment fund all rolled into one. In fact, the Indians had in operation a mutual-benefit system long before the white man.

Within the limited space permitted a magazine article, the best way to set forth the unique and peculiar workings of the Indian system which centered around the potlatch will be to tell of one, and the events leading up to it. From the many tales of such familiar to the writer, the story of Saix, a famous Tsimshian chief living a hundred and fifty years ago, is given as perhaps being the best example.

One day Saix, while walking to his canoe, slipped and fell. On arising, he noted that his accident had been witnessed by two other chiefs. Now, though this was an unavoidable accident, he was still, in the Indian way of thinking, "subjected to ridicule" by these men having witnessed his fall. To wipe it out, a feast had to be given some months later, as soon as preparation could be made. At this feast were the two chiefs and most of the others from the region, and the headmen of the tribe.

The feast, or potlatch, the correct term for which is "yowk," was of lesser importance, only food being given away. But every guest was given far more than he could eat, so that much was carried away. The food presents consisted of cedar boxes filled with eulachon grease, bags of berries preserved in eulachon grease, dried salmon, pressed cakes of seaweed a foot long, dried deer meat, and herring eggs on kelp, a prime delicacy; dried salmon was the *pièce de résistance*.

Shortly following this feast Saix' nephew reached an

age when he could assume his name in the tribe. The Indian descent is maternal, so a man gives more attention to his nephews and nieces than to his own children, and they in turn aid him in any undertaking such as a preparation for a feast. Thus Saix, when he gave his food feast, was assisted by his brothers, nephews, and nieces. He did not have to repay this, except that he was in duty bound to serve any of the helpers in the same way if he should ever be called upon to do so. Similarly, his maternal relatives helped him prepare for the feast which celebrated the nephew taking his name as a member of the house. This last feast was of great importance and had been prepared for several years in advance. All the chiefs and headmen of the region were there. As they filed into the great house



At This Potlatch Given at Alert Bay, British Columbia, Kitchen Utensils and Furs were Given Away. The View Shows the Gifts Displayed for Inspection



Above: Sewing Machines, Furniture, and Dresses were Given Away at This Potlatch, Where the Gift-Giving Was Lavish

of Saix some of Saix' relatives saw them seated in order of rank, a very important thing, a mistake being the most serious slight that could be offered. Following this, "wild men" in masks and costumes danced, and singers related in chants the heraldic feats of the Saix clan.



Left: A Kitchen-Utensils Potlatch. The Totem Pole Shows by Symbols Various Feats of Skill Performed by One Tribe

Then Saix gave away some 300 furs of otter, beaver, mink, and marten; two great dugouts of cedar, and two copper shields, these last the most important item of wealth in coast Indian history. The copper shields were first made of the raw copper beaten out by Coppermine



At a Shoes and Clothes Potlatch: Enormous Quantities are Given Away to the Guests, the Givers Often Making Themselves and Members of Their Family Bankrupt in Their Efforts to Excel All Previous Potlatches, Preparations Sometimes Going Forward for a Period of Three or Four Years

886⁹⁰
 Indians nearly 1,500 miles away, and by various bartering tribes were passed on to coast Indians. Later the Hudson's Bay Company, getting wise to the enormous valuation placed upon them by Indians, began manufacturing them at Victoria about 1815. Turned out, they cost about \$2. Recently one was sold for \$10,000 by one Indian to another, though only \$1,400 was made as a first payment. The shield was worth only about \$2 in white man's money, but it represented some vested interest, in the Indian social organization, of sufficient value to make its acquiring worth while to the purchaser.

At any rate, at the Saix feast this abundance of wealth was given away. During this and the previous feast, at which some twenty of Saix' maternal relations were present, these relations kept track of everything given. In the weeks and months following the feast they often talked the facts over to keep fresh in mind all that had been given and to whom, both of food and more expensive things; for every one of these gifts had to be repaid, doublefold, by the person accepting them. In the case of great chiefs, the gifts were often returned four and fivefold. The laws regulating all the bases of return are too intricate and would require too much space to give in detail. Suffice it that Saix now had a nice little income due him, of food, furs, canoes, and coppers. The feasts were usually returned within three years' time at the outside. Should any guest fail in due time to return the feast, Saix and his relatives would then subject him to ridicule by spreading tales of his poverty, the worst insult possible to give an Indian of the coastal regions. Seldom did a man fail to return a feast and repay doubly or trebly, or fivefold, the things received. In instances where he was unable, through lack of hunting, fishing, or ability in war, to get the wherewithal to repay, the man would be so subjected to ridicule he would leave the tribe.

Now, in the instance of Saix (to show the working out of this mutual-benefit system), shortly after the last feast he fell

sick and was unable to hunt for over a year. Yet he and his family were fully supplied with food by reason of all the food coming in at various feasts given him by way of return for the one he had given. Similarly he began to get returns on his second feast in the way of furs, etc. But Saix died about a year after the giving of the last feast. However, unlike the white man's way, where death usually wipes out personal obligations, Saix' income from the feasts did not stop, but had to be repaid to his nephew.

After the coming of the white man, the potlatches changed considerably. Instead of furs the Indians began giving blankets, flour, guns, and ammunition bought from the Hudson's Bay Company. As time went on they took full advantage of all the wonders of the white man, so in recent years potlatches have presented one of the most incongruous sights perhaps the world has ever seen. There came into existence sewing-machine, and furniture, and gramophone potlatches; potlatches of cooking utensils and clothes; boots and clothes; frequently furs and some of these articles. But the chief potlatches in recent times have been gramophone, furniture, and utensils. The writer has been fortunate in obtaining the most recent photos of what may be perhaps the last potlatches ever held. These photos also show the march of the wild men to the great ceremonial hall.

Should the potlatches be stopped forever it is hard to foretell what will be the effect on the Indians. It is a fact that quite aside from the vested interest acquired by giving a potlatch, the giving of such gave the giver immense prestige. It was the highest peak of social ambition for a coast Indian, striven for as eagerly as a nouveau riche trying to break into New York's "four hundred." Looked at from this point of view, the taking away of it may rob the Indians of initiative and ambition to earn money to hold one—another paradox in view of the government passing a prohibitive law because the potlatch impoverished the giver.

DRINKING WATER FOR CATTLE OBTAINED FROM DEW

9061
 For collecting a supply of drinking water for cattle, a catch basin that takes advantage of the dewfall as well as the rainfall, thus greatly increasing the supply, has been constructed on a farm in England. That it really is a dew reservoir, and not merely a rain catcher, is proved by the fact that it collects more than

twice as much water, by actual measurement, as it could by the rainfall alone. The dew in England is heavier than in most parts of this country, and the results here would not be so great as indicated in a dew reservoir built in England, that was 30 ft. square, and that collected an average daily supply of 120 gal. during the

S. B. Russell, Isosmore, Hitchin,

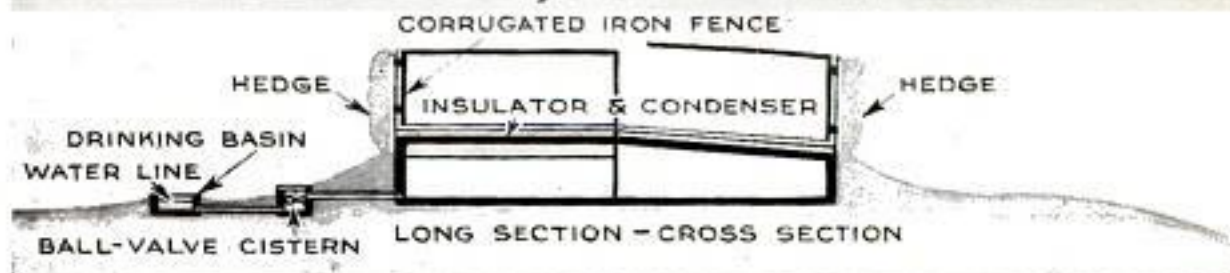
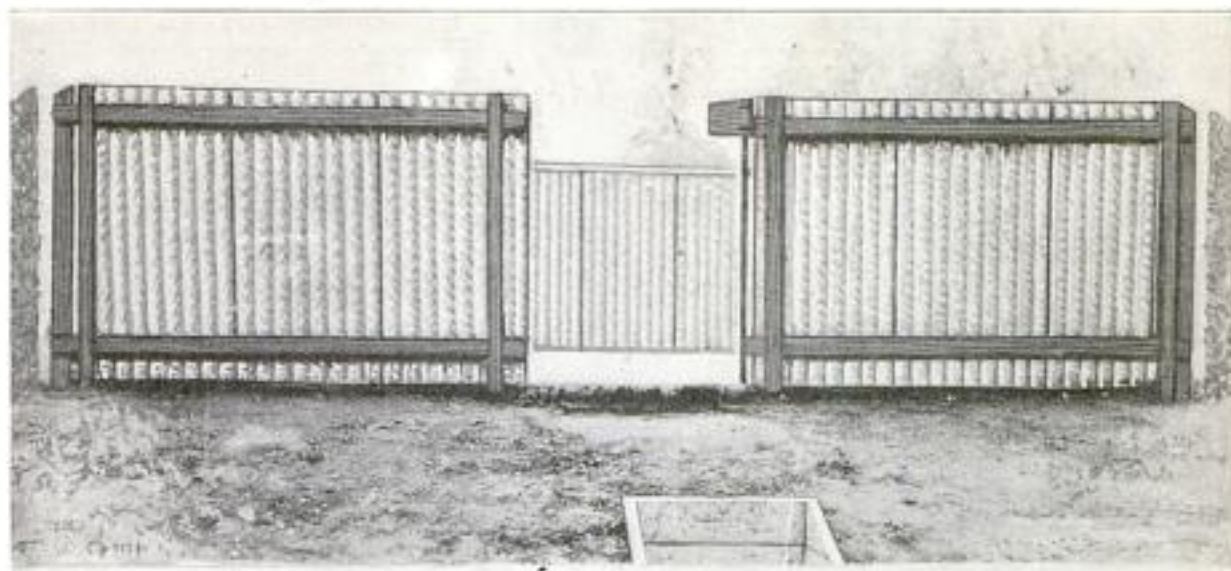

Above: Dew Reservoir Seen through the Opening in the Fence That Surrounds It. Below, the Reservoir is Shown in Section, the Left Half Longitudinally and the Right Half Transversely. The Reservoir Is 30 Feet Square and Five Feet Deep, and the Corrugated Iron Fence Is Eight Feet High

hot summer months, and 50 gal. daily during the rest of the year.

The dew reservoir consists of a concrete cistern about 5 ft. deep, built upon the surface of the ground and having a sloping roof, which acts as an insulator and condenser. The sides of the cistern are banked with earth up to the roof, and above this the whole is inclosed with a corrugated iron fence about 8 ft. high, which aids in collecting the vapor and shields it from the wind. This fence is made still more effective by surrounding it with a hedge. A pipe conducts the drainage from the low part of the roof into the interior of the cistern. To one side at a lower level is a concrete drinking basin, into which the water is piped after passing through a small container where a ball valve controls the supply.

9018 DEVICE CHANGES KETTLEDRUM TO MUSICAL INSTRUMENT

The demand for new musical sounds in the "jazz" orchestra has led to the development of a device that permits the rapid tuning of the kettledrum to a point where it ranks as a musical instrument. All the tuning handles are connected by a shaft with universal joints, and this shaft is

*Inv. Adolph Wiedoff
c/o Cinderella Roof*

in turn, connected to a pedal wheel by which the drummer raises or lowers the



By Turning the Pedal Wheel of This Device, the Drummer Turns All the Tuning Handles, and Changes Rapidly the Pitch of the Drum

pitch of the drum by changing the tension of the head.

Yellow taillights may replace those of the usual red hue, the advisability of the plan now being under consideration by the Society of Automotive Engineers, who claim that confusion of these with the red warning signals used on highways has resulted in many serious accidents.

*6th + Olive St
Los Angeles, Calif*

92
8903

SPECIAL FIRE-FIGHTING UNIT SPEEDS ON MOTORCYCLE

Because of the ease with which it can be driven through the heavy traffic of

TECHNICAL SCHOOL IN INDIA FOR APPRENTICES

9164

As the result of the recommendations contained in a report of a committee appointed in 1919 by the Bengal government in connection with the establishment, in Calcutta, of a part-time technical school for apprentices, a piece of land, several acres in area, has been purchased at a cost of about \$250,000, as a site for the erection of a school building. As soon as the ground has been cleared, the first story of what will eventually be a three-story building, will be completed, and will be used as a school, pending the completion of the upper stories. This temporary school will accommodate about 300 apprentices, and during its

erection about that number, both European and native, will receive part-time training at the Calcutta Evening Technical School, which receives a yearly grant from the Indian government. The government allows free use of rooms in the School of Art for these classes.



This Special Unit is Used by the Paris Fire Department for Fighting Small Fires, Because It can Make Better Speed through the Heavy Traffic When Responding to an Alarm

Paris streets, the fire department of that city has adopted a special motorcycle unit for use in fighting small fires. A motorcycle and sidecar are used and the crew consists of three firemen. A box mounted behind the driver contains extinguishers and other necessary tools.

erection about that number, both European and native, will receive part-time training at the Calcutta Evening Technical School, which receives a yearly grant from the Indian government. The government allows free use of rooms in the School of Art for these classes.

Date: Caj. P.E.E. de la
marce cachemaille 20 An
Pareure a Demers France
8633

TILTING ARBOR SAW BENCH DIRECT MOTOR DRIVEN

A tilting arbor saw bench with the saw at an angle of 45 degrees, and with direct motor drive, is now on the market. The saw operates in a slot in the table, 38 by 47 in. in size, the underside of which is ribbed to eliminate all possibility of warping. The machine is equipped with ball bearings in well-lubricated housings. The base of the machine is a one-piece casting in pedestal form, in which all the working parts are inclosed in such a manner that the sawdust cannot reach them. In connection with the base is a yoke that supports a sliding bracket on which the motor is mounted, and that has means for its adjustment. Fully graduated gauges are provided as well as a splitter guard that covers the rear half of the saw, which is inclosed in a dust spout furnished with a door. The

motor is controlled by an inclosed safety switch on the outside of the housing.



Tilting Arbor Saw Bench with Direct Motor Drive, and Saw at an Angle of 45 Degrees: Motor on Bracket at Left Is Adjustable

The Sannewity Works, Grand Rapids, Mich.

Copyrighted material

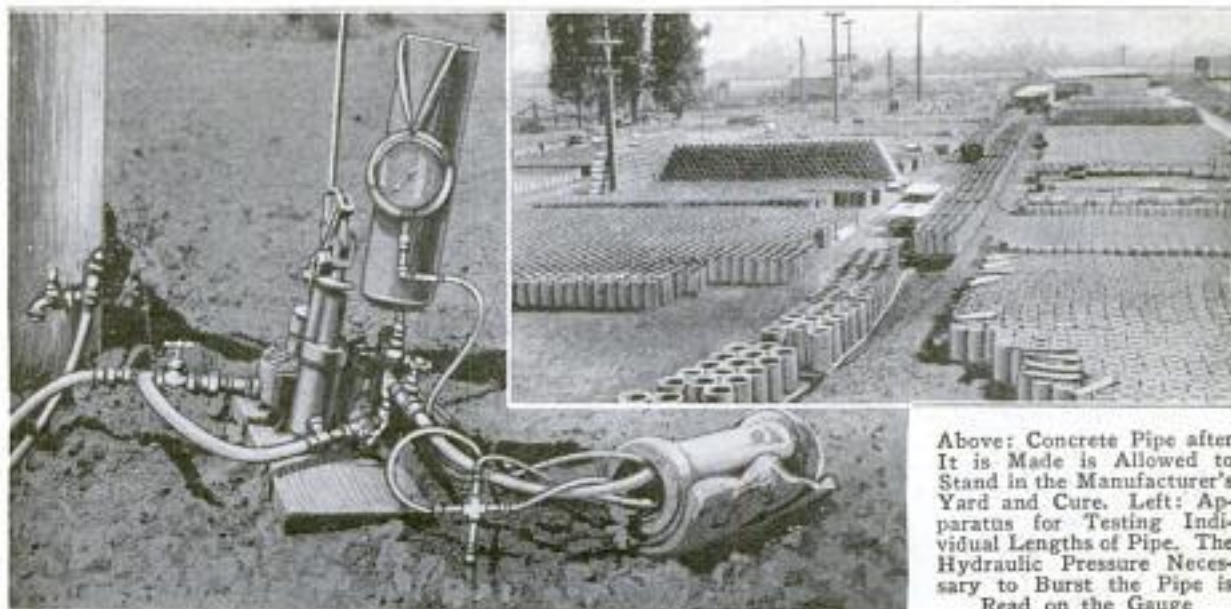

Above: Concrete Pipe after It is Made is Allowed to Stand in the Manufacturer's Yard and Cure. Left: Apparatus for Testing Individual Lengths of Pipe. The Hydraulic Pressure Necessary to Burst the Pipe is Read on the Gauge

9071
STANDARDIZATION OF METHODS IMPROVES CONCRETE PIPE

Because, in many localities, concrete pipe, when properly made, cured, and laid, is more economical and durable than other forms, investigations have been made to determine the best methods of manufacture. One result of this investigation has been the development of a device for testing individual lengths of pipe without the use of bulkheads, joints, and connecting rods. The tester consists of an aluminum cylinder supplied with rubber tubes near the ends for making a tight joint. The tester is inserted in the pipe, and water pressure in the tubes seals the joints, and is then increased until the pipe is broken. Other tests are also made and have resulted in the standardization of manufacturing methods, thereby producing a concrete pipe of materially better qualities.

9203

LONG STEEL COLUMNS EFFECT SAVING IN BUILDING

In the erection of a five-story office building in California recently, the use of long steel columns above the second floor resulted in a considerable saving in the time of erection. The columns used were standard commercial 60-ft. lengths, and while heavier than necessary for the upper stories, the extra cost was offset by the saving in shop cost and erecting time. Another advantage of the use of long columns is that it eliminates the necessity of repeated raisings of the lifting derrick.

Engineering News-Record
 5/4/22

9103
NEW DEVICE TESTS HARDNESS OF ROAD-BUILDING GRAVEL

To aid local contractors in determining the suitability of gravel for road-building purposes, a portable testing apparatus has been designed by which the hardness may readily be gauged. The specimen of gravel to be tested is supported on a steel ball, and another steel ball is allowed to fall upon it from varying heights. The movable ball is supplied with a scale for recording the height of fall necessary to

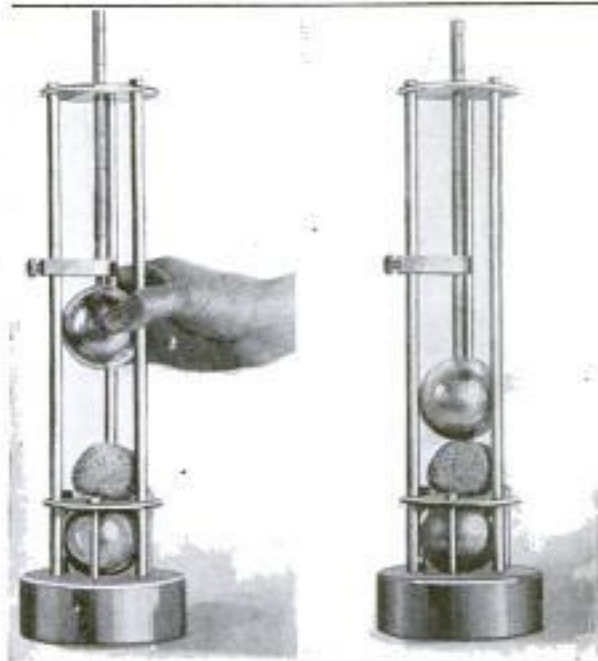

In This Hardness-Testing Device, the Movable Steel Ball Falls on the Sample Supported on Another Steel Ball, and the Height of Fall is Shown by the Scale

fracture the sample and thus determine its ability to withstand traffic conditions.

Bureau of Public Roads,
 U. S. Dept. of Agriculture
 Washington, D. C.

Mr. W. H. Watts,

94 Kerrmoor Pa. POPULAR

LONG-HANDLED CHISEL USED AS TREE-PRUNING TOOL

Trimming the small branches from trees can be easily and rapidly accomplished by using a long-handled chisel,



Tree-Pruning Chisel Which can be Fitted with a Long Handle, Thus Enabling the Workman to Trim Small Trees without a Ladder

which is the product of an eastern orchard owner. The chisel, a keen-edged blade affixed to the end of a pole having a plunger attachment, is first placed against the limb to be cut off. The plunger is then drawn back to its full extent and driven sharply forward, hitting a "cushion" of sole leather, the impact forcing the sharp tool through the branch.

CHEMICAL INSTANT-HEAT BAG FOR MANY PURPOSES

The well-known fact that certain chemicals give off heat when moistened with water has been put to practical use in the development of a heat bag recently introduced. Certain harmless chemicals are placed in a bag of heavy canvas, about the



When an Ounce of Water is Poured on the Chemicals in This Bag, Heat is Generated. This Heat will Last for Several Hours and can be Renewed

Exhaust Lock Co.
201 Chamber of Commerce
Indianapolis, Ind.
MECHANICS

size of the regulation hot-water bottle, and when it is desired to heat the bag, it is only necessary to pour an ounce of water into the bag and the chemical action immediately starts. Either hot or cold water may be used and the amount of chemicals in the bag would about fill an ordinary drinking glass. The heat generated is moist and nonirritating, and a temperature of 200° F. is attained.

The addition of water will cause heat to be generated for a period of several hours. If further heat is required, more water may be added until the heat-generating properties of the chemicals are exhausted. One charging of chemicals will produce about 200 hours of heating effect, and fresh chemicals may be secured at nominal cost.

9103

AN AUTO LOCK THAT CLOSSES THE EXHAUST PASSAGE

Brought out specially for a well-known small car, but applicable to any car, an auto lock has been devised which prevents the operation of the engine. A butterfly valve is inserted in the exhaust pipe and connected with a lock set flush with the

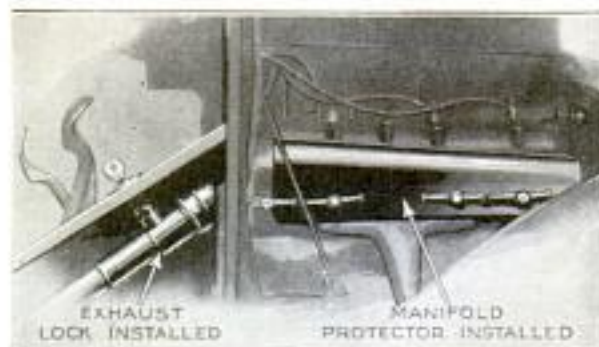

This Auto Lock Sets Flush with the Floor Boards and Closes a Butterfly Valve in the Exhaust Pipe

floor boards. When the lock is closed, there is no vent for the exhaust gases, and the engine will not run. *Price, \$10.00*

TO DEVELOP IRON RESOURCES BY STEEL PLANT IN AFRICA

In the effort to reduce the large imports of steel and steel products into South Africa, it is proposed to erect a steel plant there, capable of supplying a substantial portion of the local demand. Investigation has shown that there are important deposits of first-class iron ore and an abundance of coal located within a reasonable distance of each other. Ore reserves sufficient for fifty to sixty years have been proved.

Commerce Reports

The Catalytic Co. Inc. 10/15/34
2000 Michigan Ave.

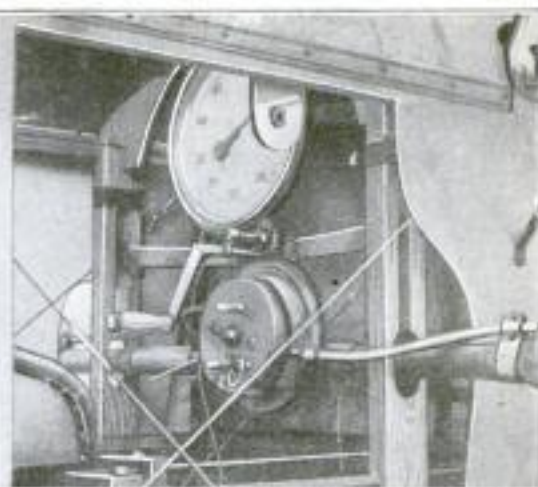
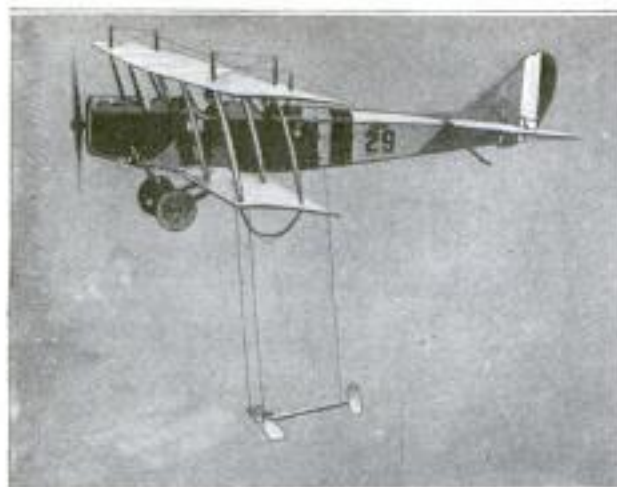

Left: When the Airplane has Reached a Proper Altitude, the Test Wing is Lowered on Three Wires and Its Behavior Noted. Right: The Winch and Recording Apparatus are Located in the Fuselage of the Airplane

8983
METHOD OF TESTING AIRPLANE WINGS BY FLYING IN AIR

The fact that wind tunnels and other means of testing small models of airplane wings have not given dependable results, has led to the development of a method of testing large-size wings under actual flight conditions. A wing is suspended in an inverted position below an airplane that is capable of flying at a speed of 75 to 100 miles per hour. When the airplane has reached a sufficient altitude, the test wing is lowered about 25 ft. on three steel wires, and instruments in the cockpit of the testing plane record the reactions of the test wing at different speeds, altitudes, and angles of incidence. Before landing, the test wing is reeled up, clear of the landing gear, directly below the testing plane. By this method of testing, any defects can be noted under actual flying conditions and more dependable results obtained.

9100
EIGHTY POUNDS OF AMBERGRIS WORTH A SMALL FORTUNE

Ambergris is an ash-colored waxy substance found floating on the seas frequented by sperm whales, supposed to be an internal secretion from these animals. It is used in certain fragrant drugs and ointments, and is of great value. Recently, on the island of Hawaii, a lighthouse keeper while wandering on a lonely beach saw a mass of mysterious-looking white stuff floating some distance out at sea. He waited all day for it to be washed ashore. He picked it up, having no idea what it was, but imagining that it must be of some value, though never dreaming that it was worth about twice its weight in gold. It was, however, for although

the whole of it weighed only 80 lb., its value was over 40,000 dollars.

Another man who found about 90 lb. of ambergris on the beach at Laysan Island, a few hundred miles from Hawaii, was not so fortunate. Judging from its appearance that it must be of some use, he took it to his shack and kept it there until one day when painting the shack, he ran short of oil, and thanked his stars that at last he had found some use for the waxy substance. He melted the amber-



Piece of Ambergris Picked Up on the Beach on the Island of Hawaii, That Weighs Only about a Pound and Is Worth at Least 500 Dollars

gris, and finished the painting of his shack with a mixture that was worth about \$45,000. It would have been more economical to have gilded the shack.

By using a special dynamometer, the Bureau of Standards, among other things, has been able to determine the power loss in automobile tires. It was found that an average 4-in. fabric tire under normal conditions will absorb .90 hp. due to rolling resistance at a speed of 25 miles per hour.

Cont. R. M. Clutterbuck
Honolulu, Hawaii

96
 9051

ELECTRIC ALARM KILLS MAN BY EXCESSIVE VOLTAGE



Argentine Workman Who was Electrocuted by His Alarm-Clock Arrangement While Sleeping: Wires Leading from the Light Circuit, by Way of the Clock, can be Seen on His Wrists

Combining electricity with an alarm clock as a means of rousing himself from sleep, was the idea of an Argentine workman in Buenos Aires. The clock, alone, failing to awaken the heavy sleeper, he had conceived the plan of connecting the electric-light circuit to his wrists, with wires. Then, when the predetermined time arrived, the turning of the alarm handle closed a contact, causing a current to pass through his body. For some little time the contrivance operated successfully, but one morning a defect in an outside line transformer permitted an excessive voltage to enter the residence wiring, killing the sleeper.

8946

EQUIP SEAPLANES WITH KITE TO CARRY RADIO ANTENNA

Because, heretofore, seaplanes have been equipped only with trailing antenna, it was possible for them to keep in radio communication with shore stations only when in flight, as the trailing antenna was useless after the plane had settled on the water. To remedy this condition, some planes have been equipped with small "fin antennæ," but their range is very limited. The practical solution seems to have been reached in using kites to carry aloft the antenna in case the plane is forced down. Canvas screens on the plane direct the wind stream

from the propeller against the wind-driven radio generator. Using this system, the sending range from the water is even greater than when the plane is using the trailing antenna in flight.



If the Seaplane is Forced Down and Needs Assistance, the Kite Carries Aloft the Wireless Antenna, While the Wind Stream from the Propeller drives the Radio Generator

cht.

3

al

METALLIC PACKING FOR USE IN STUFFING BOXES

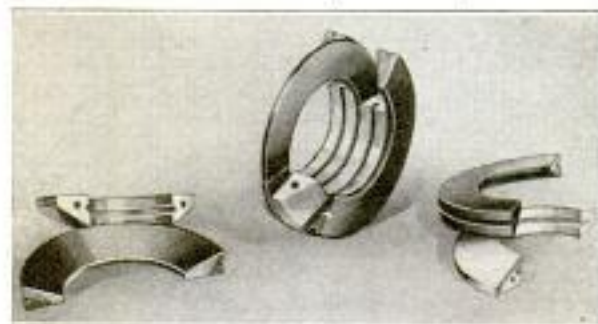

Metallic Packing for Stuffing Boxes, Consisting of Alternate Split Rings of Brass and Babbitt Metal of Wedge-Shaped Section That are Arranged in Pairs, Presenting Parallel Faces When Assembled

In order to overcome the annoyance of frequent replacements of the usual forms of packing used in the stuffing boxes of engines, an inventor has designed a metallic packing that, in trials, has given exceptionally good results. It consists of split rings of alternate brass and babbitt metal, so formed that when the gland nuts are drawn up, the babbitt metal rings are compressed against the piston rod. The ring segments are of wedge-shaped section, presenting parallel faces on opposite sides. This feature makes it possible to use as many ring sections as desired.

E. H. Werner Foreign Patent Exchange
 A. 804, Esabella Bldg. 21 E. Van Buren Chicago
 Letter recd

Wide World Photos
 A & H Journal 3/25/22

8963 Cont H. E. Thomas,
 911 Blanchley Ave
 POPULAR MECHANICS
 Portland, Ore. 87



Above: As This Artistic Bridge will Appear When Completed. The Steel Work is Covered with Concrete as a Means of Protection and to Make It Harmonize with the Balance of the Structure



During Construction: Showing How the Cables of the Old Suspension Bridge were Used in Transporting Material for the New Structure

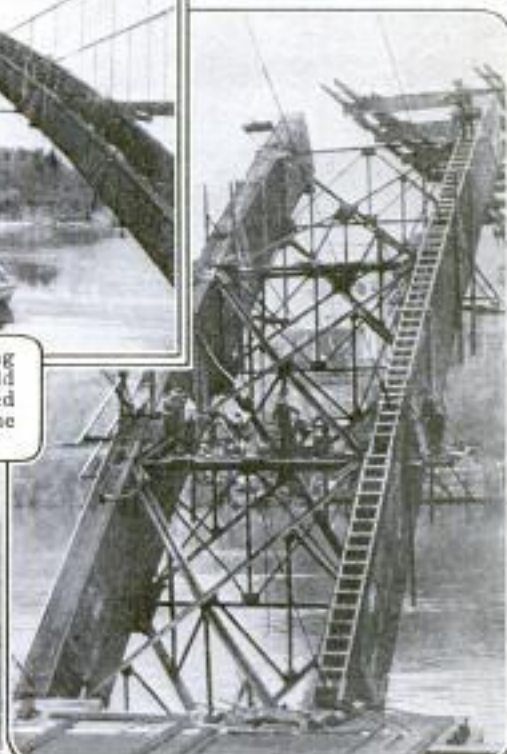
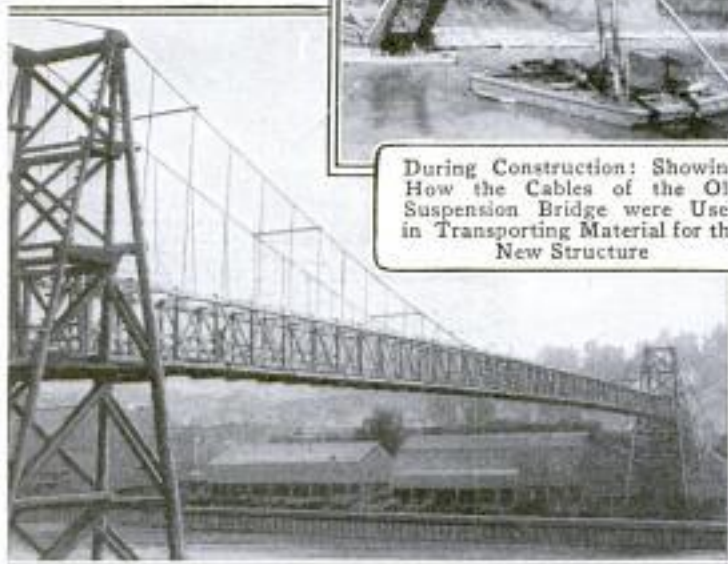

Left: This Temporary Suspension Bridge was Built to Accommodate Foot Traffic during Construction of the New Bridge. Right: Work Progressing on the Erection of the Main Arch That Has a Span of 350 Feet across the Willamette River

LONG-SPAN CONCRETE-STEEL BRIDGE AT OREGON CITY

Construction is now well under way at Oregon City, Ore., on what is said to be the longest single-span bridge in the West. This bridge was briefly mentioned in the November, 1919, issue of this magazine at the time when its erection was first proposed. It will have a total length of 850 ft. with a central span of 350 ft. across the Willamette River. The immense steel girders forming the arch are now in place, and work is progressing on the superstructure. When completed, the bridge will have the appearance of solid concrete, as the steel frame will be covered with this material, not only as a means of protection, but in order that it

may harmonize with the other parts of the structure, the whole blending with the naturally beautiful surroundings.

KAOLIANG BRAN UTILIZED IN DYE MANUFACTURE

9/65

Kaoliang, or sorghum bran, is now being utilized in the manufacture of various dyes, principally black, brown, and blue-black. This bran may be obtained in practically unlimited quantities in Manchuria, where it is delivered at the railroad stations for approximately 1.80 yen (about 75c) per 100 kin (about 132 lb.). In the production of these dyes, the kaoliang product is mixed with soda, sulphate, and the like, for which process a patent has been granted.

Commerce Report
 Copyrighted material
 4/19/22

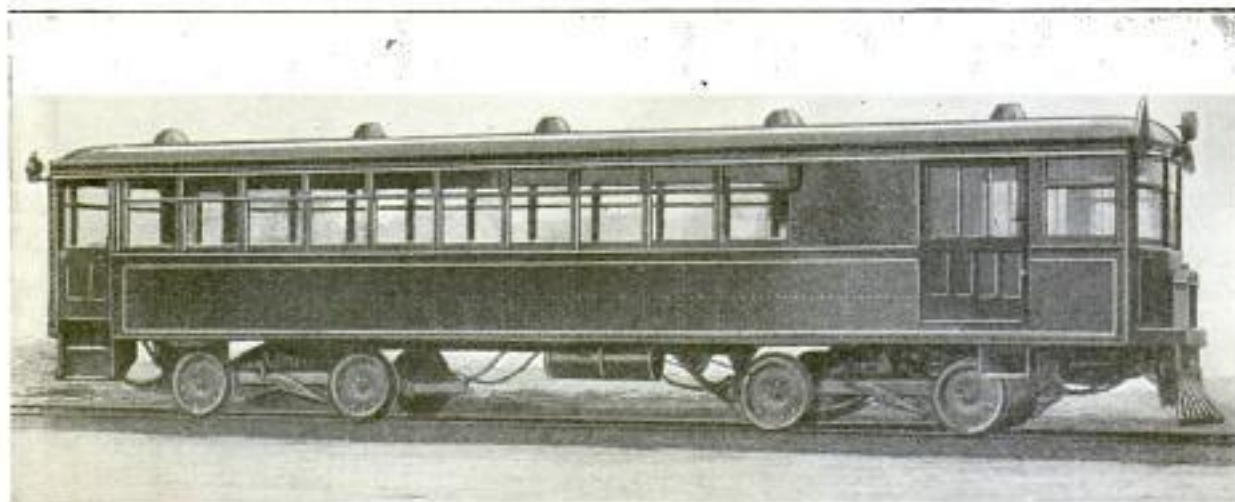

Gasoline-Motor-Driven Coach with Seats for 44 Passengers and a Large Baggage Compartment: Its Weight Is 27,000 Pounds, and Its Maximum Speed 46 Miles an Hour. The Drive Is in Connection with the Front Truck

88 72 **GASOLINE-MOTOR-DRIVEN CAR FOR SHORT RAILWAY TRIPS**

For short hauls on railroads, a gasoline-motor-driven coach, designed and built in Indiana, has met with much success, and gives promise of becoming the pattern for many cars of this type. The coach accommodates 44 passengers, and has a large baggage compartment. It weighs 27,000 lb., and has a maximum speed of 46 miles an hour. The motor and driving wheels are in connection with the front truck. In trial trips, it has made as much as 145 miles on 27½ gal. of gasoline and less than 1 qt. of oil. Thus, it averages over five miles per gallon of gasoline. The first coach built has attracted a great deal of attention from railroad officials in this country and Canada.

9043 **ACETYLENE DOES NOT AFFECT CYANIDE SOLUTIONS**

It has been supposed that acetylene acted as a precipitating agent when introduced into cyanide solutions containing

silver, and, in fact, a patent had been granted for such a process. Recent investigations by the Bureau of Mines, however, have shown this to be a fallacy. It is not the acetylene that acts as the precipitant, but small quantities of hydrogen sulphide generated from the sulphur compounds which are present in the calcium carbide as impurities.

895 **BOAT IN THREE SECTIONS EASILY TRANSPORTABLE**

Long and narrow, in appearance somewhat like an outriggered racing shell, is a boat built in three sections, which can be separated to facilitate transportation. The midship section is 10 ft. 6 in. long, and the bow and stern sections are each 7 ft. 6 in. long. The three sections can be put together in less than five minutes, and when disassembled, are easily packed for transportation. The boat has outriggered rowlocks, and stationary thwarts for the oarsmen. It has an ordinary rudder, but very little keel. It is light, and very neat in appearance.

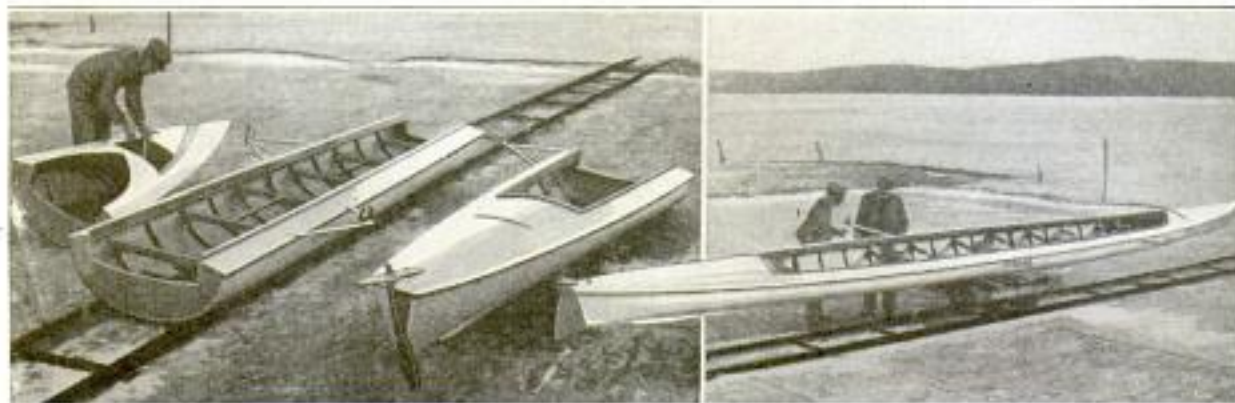

Boat Made in Three Sections, Shown at Left Disassembled to Facilitate Its Transportation Overland: The Midship Section in the Center Is 10 Feet 6 Inches Long, and the Other Two Sections Are Each 7 Feet 6 Inches Long. Right: The Three Sections are Shown Assembled Ready to be Launched

Bureau of Mines, Serial No 2346
4/1/26

no data on maker

W. F. Parush, 2010 Peoples
Isas Bldg. Chicago.

Office Appliances

POPULAR MECHANICS

10/1921

99

9044 **AUTOMATIC DEVICE REMOVES
CRANKCASE-OIL DILUTION**

All autoists are painfully familiar with the trouble caused by the dilution of their crankcase oil with gasoline, and other matter from the motor cylinders. This dilution causes the mixing together of the heavy hydrocarbons of the lubricant with those of higher boiling point from the fuel. These two can be separated by heat, however. Upon this principle a method has been developed for automatically removing the gasoline and water dilution from crankcase oil, and filtering the sediment composed of carbon, sand, and metallic particles. This method removes all the present difficulties in the lubrication of internal-combustion engines. The apparatus consists of four main units: a heating element, a filter, a refiner, and a cooler. The entire outfit is very simple, light in weight, and occupies about the same space as a vacuum fuel system. It does not interfere with the existing lubricating system of the engine.

8579 **MINIATURE MODEL OF SHRINE
MADE BY HINDU MONKS**

Time is a negligible quantity with a large portion of the population of India, and in some cases this condition leads to

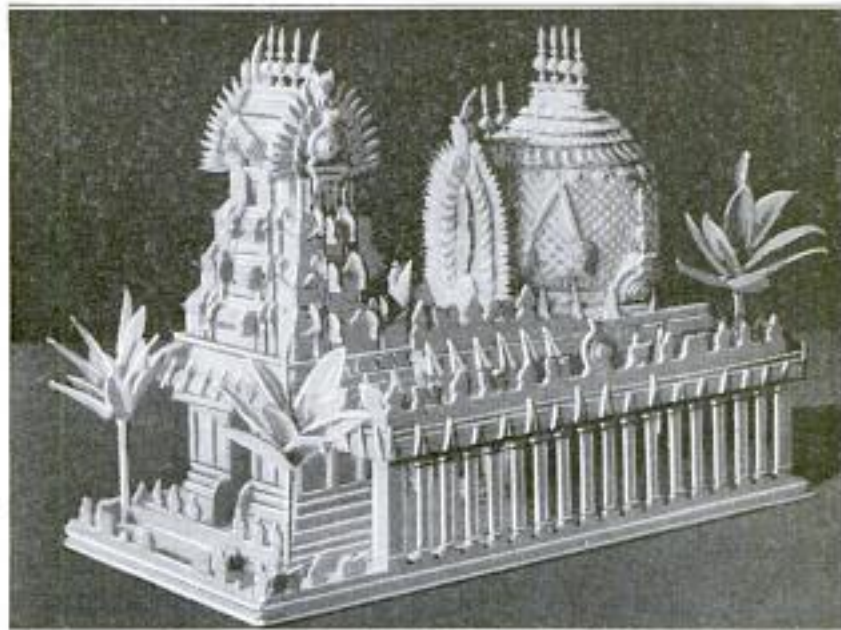

Miniature Brahmanic Shrine, the Result of Many Years' Work by Hindu Monks: It Is All Hand-Carved Out of One Piece of Bleached Marrow of Teakwood, and Weighs Only Two and Three-Fourths Pounds

achievements that would be impossible in the western world, where universally time is money. A notable instance is a miniature reproduction of a Brahmanic shrine by Hindu monks, as a result of probably about ten years' labor. The model is perfect in all its elaborate details of columns, carvings, dome, steps, and palm trees. It is carved from a single piece of the bleached marrow of teakwood, which is soft and lends itself to delicate tracery. This wood is also extremely light, and the model weighs only 2 lb. 9 ounces.

**TELEPHONE IS CAMOUFLAGED
9089 IN WALL OF CAFÉ**

Camouflaging the telephone is a method used by the proprietor of a café in Los Angeles, Calif., to provide service at any



time to those acquainted with the secret. The exterior of the building being of concrete blocks, an imitation block having a spring door has been made of wood. Persons familiar

with the location of the counterfeit member can press a tiny button on its end and have the door swing open, exposing the instrument.

**MAKE TEST FLIGHT AT NIGHT
ON CONTINENTAL ROUTE**

9202 In order to test the wireless and lighting arrangements on the air route between London and Paris, a flight was made recently, starting at about 9:30 p. m. and lasting until nearly midnight. The flight started from Croydon field, and a landing was made at Lypne field after a short flight off the coast, during which the aerial lighthouses on the French coast were easily distinguished. Leaving Lypne at 11:30, the fliers returned to Croydon, the lights along the route being readily picked out. It is thought there should be no difficulty in commercial night flying between London and Paris.

Pink Oal Cafe
Alvarado + W. 7th Sts.
Los Angeles Calif.

cont. Chas. H. Loddard, 5626
Chvington Palace
Los Angeles, Calif.

Aerial Age 5/1/22
Copyrighted material

mfr. { F. M. Sawyer 325 Citizens National
 Bank Bldg. Los Angeles, Calif.
 Concrete Lumber Co. Black Stg. Los Angeles
 Calif.
 8825

TWO TYPES OF "CONCRETE LUMBER"

BY FRANK B. HOWE, 412 Mason Opera
 House Bldg. Los Angeles, Calif.

IT has commonly been predicted for some time that concrete as a building material would eventually take some form which would enable easier handling and faster construction than is possible under the customary method of handling that material at present.

Fully in line with this prediction, and with the peculiar coincidence which inventors in all lines know only too well, two men in the same city have announced at practically the same time the successful invention and use of what may be termed "concrete lumber"—material which may be purchased in the same manner as ordinary lumber; erected in similar fashion without need of elaborate forms or molds, and giving a finished result that equals that achieved by the pouring method.

One style of this lumber consists of standard "boards" which are furnished in a variety of sizes. They are made by pouring concrete over special reinforcement consisting of iron rods and heavy-mesh wire. This is aged a little over a month before being sold. Hence when the purchaser buys it, he can erect his

concrete building without the least delay. The boards are tongue-and-grooved and finished with a "beam" at each edge. In construction, these pieces fit snugly together, an iron clamp, or tie, is slipped around the adjoining beams, and the joint is made, a little wet cement having first been used to insure the absolute tightness of the connection.

To permit wooden inside finish, or lathing, and simple installation of wooden window casing and door frames, provision has been made for nailing wooden material directly into the concrete where so desired. The peculiar construction of the tongue-and-grooved joint enables one to drive a nail directly and without difficulty into the joint at any point. There is no danger of this forcing the joint apart. Thus, wooden or plaster finish can easily be applied.

Oddly enough, for supposedly brittle concrete, these boards are surprisingly resilient, owing to the nature of the reinforcing used. The inventor's pet demonstration of this quality of the material is to support a board on two horses and let men jump upon it, and while it gives as



These Concrete "Boards" are Reinforced with Special Wire Forms and Develop Great Strength, as Shown in the Upper Views. Because of the Shape of the Boards, Regulation Wooden Studding and Laths can be Used on the Interiors, the Nails being Driven into the Joints, as Shown in the Lower Views

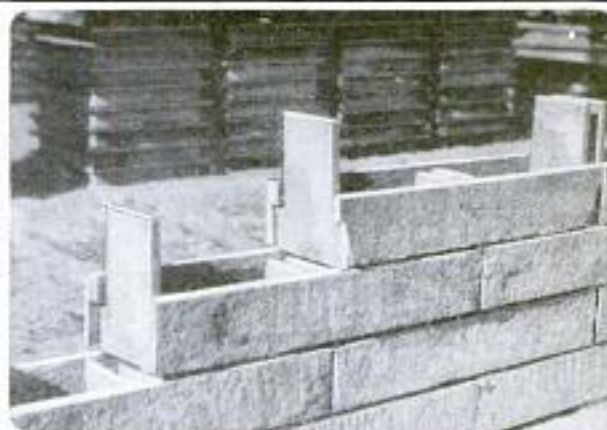

Three Views Showing a Form of "Concrete Lumber" in Which the Boards are Cast with Special Grooves in the Ends That Lock around Key Plates Set in the Wall: Built Up in This Way, the Wall Is Similar to Hollow Tile and is Then Washed Over with Wet Concrete That Joins the Boards into a Solid Wall

much as an inch under the force of the jump, no cracks have, so far, developed. Houses have already been built of this material and thoroughly tested, and have been satisfactory in every way. The wide air space in the wall, provided by lumber of this type, effectually prevents dampness.

The other type of concrete lumber has



two basic types of construction—one for walls and one for floors. The wall type consists of small concrete boards, at the end of which are grooves, into which key plates, also of concrete, fit. In building up the wall, two of the boards are set parallel and about 6 in. apart, the ends are locked with the keys, and the following sections similarly added with the joints staggered. Wet concrete is then poured between the keys to bind the wall together.

The floor sections consist of square troughlike plates, which, when placed with



Illustrating a Type of Floor Construction in Which the Boxlike Concrete Blocks Rest on the Joists, Leaving Spaces between That are Filled with Wet Concrete, Forming a Solid Floor: A Floor 14 Feet Square Sustained a Weight of 100,000 Pounds without being Damaged, as Shown in the Lower View

Dr. E. O. von Karman
Institute for Aeronautics
Chemistry, Berlin, Germany
Engineering
4/14/26

their open sides together, form a hollow slab. The adjacent squares are laid 2 in. apart. A steel rod is then inserted in the opening and the space filled with concrete, solidifying the whole floor into one piece, and providing the necessary reinforcement. The strength of this type of construction has been demonstrated by a recent test, in which 100,000 lb. of cement were piled on one of these floors, which measured 14 ft. square, without caving it in. This type of concrete lumber

has also been successfully used in actual construction and proved entirely practical, the floors showing good insulating properties due to the dead air space inclosed between the hollow slabs.

Probably these two systems are but forerunners of improvements and modifications that may eventually provide an ideal system under which the prospective builder will order his concrete building material in precisely the same way as he now orders lumber.

DRAW FINE WIRES COMPOSED OF A SINGLE CRYSTAL

By means of a special drawing apparatus a foreign scientist has succeeded in producing fine metal wires that are believed to represent a single crystal of the metal. These single crystal wires have shown peculiar properties under tests. A zinc wire, drawn slowly, at a temperature 25 degrees above the melting point of the metal, has a ductility far above that of ordinary zinc. If the wire is drawn more quickly, at a slightly increased temperature, a brittle wire is produced. Experiments are being made with wires drawn from many other metals, including aluminum, tin, lead, bismuth, and others.

HIGHWAY-MAINTENANCE TRUCK HAS COMPLETE EQUIPMENT

A highway-maintenance truck has been put into operation in California which would seem to be the last word in complete equipment. It carries a concrete mixer and combination material bin for cement, sand, and gravel. Also an air compressor and air tank which can be used for driving a rock drill for road work, or can be used in connection with a water-supply tank as a spraying outfit or fire extinguisher. There is also a centrifugal pump which can be used for filling the water tank or for pumping out cisterns or caissons. The truck engine furnishes all necessary power for driving

the auxiliary equipment at various speeds through a special transmission. Flanged wheels may be substituted if so desired.

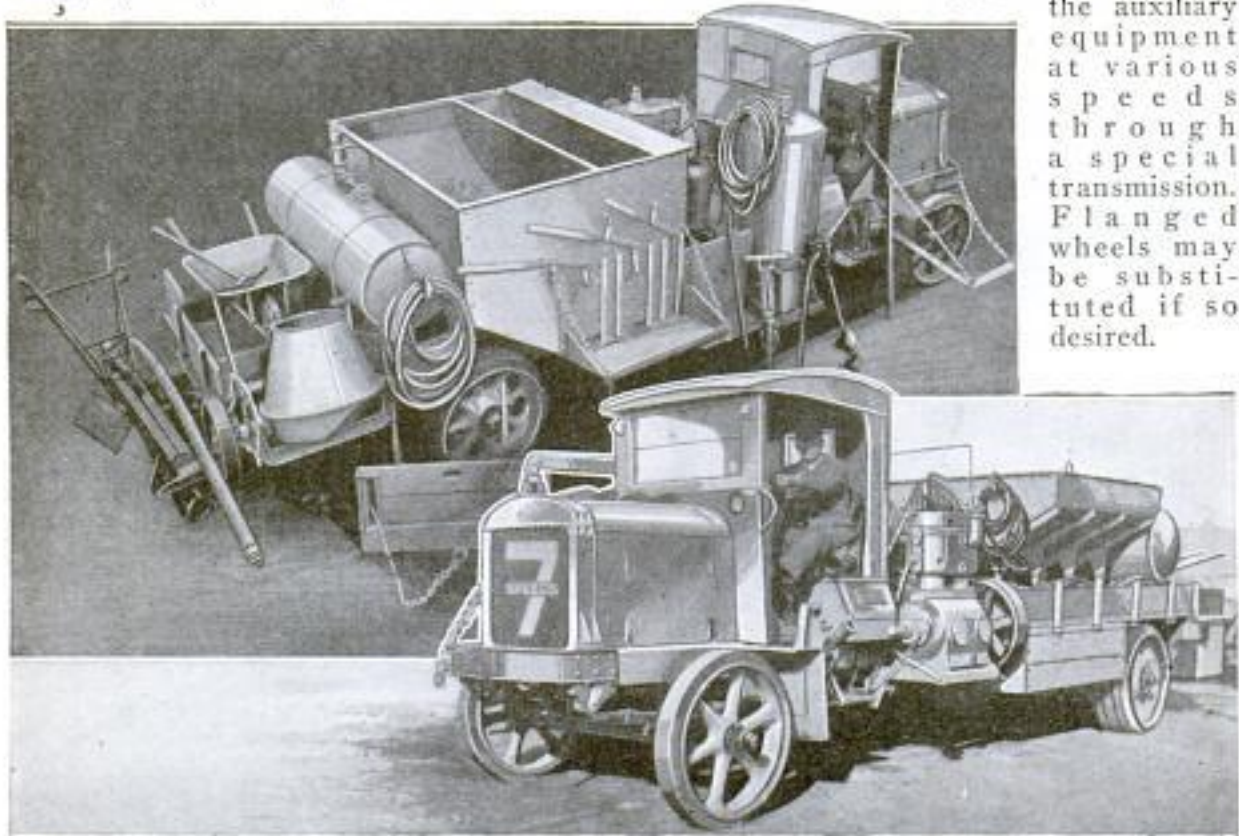

For Highway-Maintenance Work, This Truck Carries Equipment for Almost Any Job That may be Encountered. All Auxiliary Equipment, Including Concrete Mixer, Air Compressor, and Centrifugal Pump, is Driven by the Truck Motor through a Special Transmission

Frageol Motors Co
Oakland, Calif.

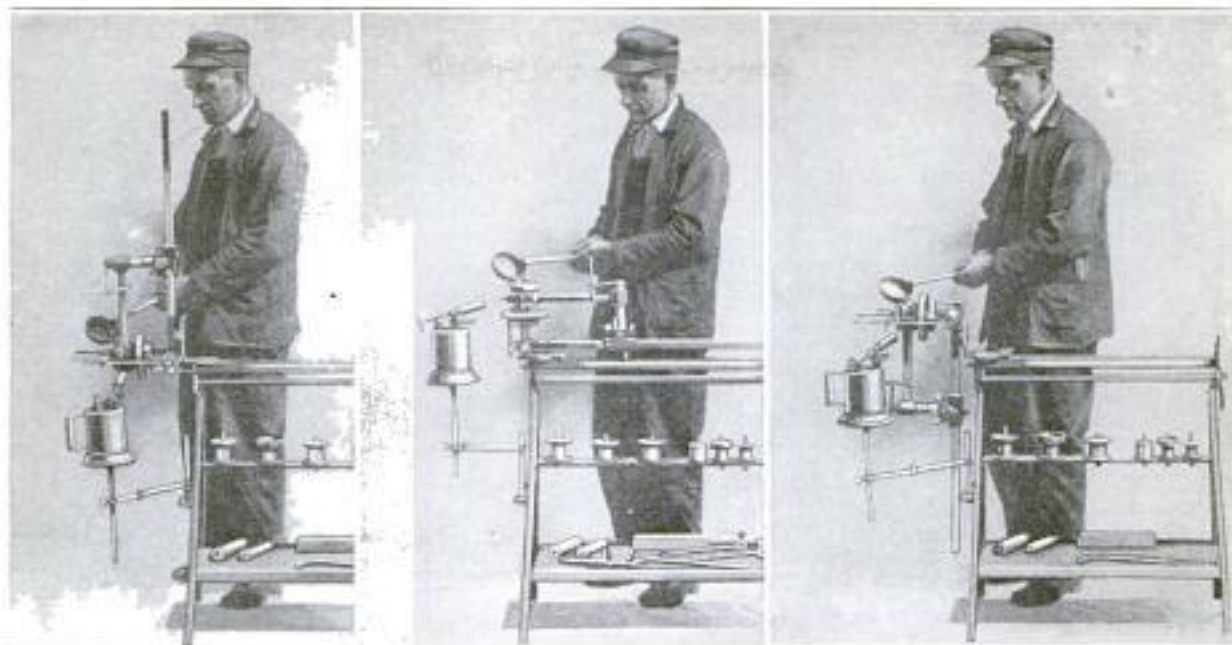

Machine for Babbitting Connecting-Rod Bearings. Left: With Connecting Rod Standing Upward, Babbitt is Poured through the Oil Hole. Center: With Connecting Rod Held Horizontally, Babbitt is Poured through the Shims. Right: With Connecting Rod Hanging Downward, Babbitt is Poured through the Oil Dip Hole.

MACHINE BABBITTS BEARINGS

8789 IN CONNECTING RODS

As equipment for shops where babbitting is done, a newly developed connecting-rod babbitting machine should be a time and labor saver. Although other kinds of babbitting work can be done with it, the machine is constructed specially to handle connecting rods from 6 to 24 in. long. On a stand, at a convenient height for the operator, is a faceplate with an arbor for the crankpin end of the connecting rod, and an adjustable carrier for the wristpin end, beneath which is a pointer that indicates on a measuring bar the correct length for centering the two bearings. When set up correctly, the connecting rod and its fixtures can be swung as a unit on a swivel, so that the babbitt can be poured with the connecting rod standing upward, hanging downward, or placed horizontally from the front or the side. Thus the bearing can be poured either through the oil hole in the top, the oil dip hole in the bottom, through the shims on either side, or through either side elsewhere, according to what best suits the construction of the connecting rod. The machine is also fitted with an alining device, and six arbors of different sizes are furnished with it, but special arbors can be made to fit any connecting rod.

☛Buds from an apple tree which produced seedless apples will be used by the Department of Agriculture in an attempt to propagate a new variety.

DESIGN SEPARATE STUB AXLE FOR EMERGENCY TOWING

To meet the demand for a device that makes it possible to tow an automobile that has a broken rear axle or differential, a separate stub shaft has been designed. In order to move the disabled car, one rear wheel is removed and the emergency stub axle is clamped to the brake-drum housing. This furnishes an axle upon which the wheel can revolve freely and, because of the construction of the driving mechanism, releasing one

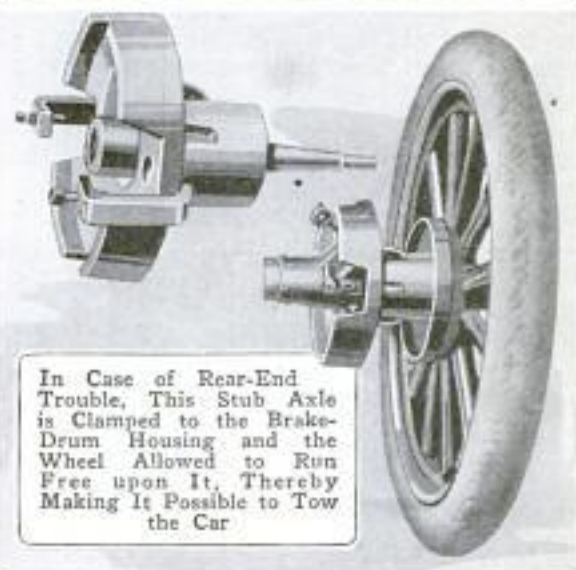

In Case of Rear-End Trouble, This Stub Axle is Clamped to the Brake-Drum Housing and the Wheel Allowed to Run Free upon It, Thereby Making It Possible to Tow the Car

wheel allows the other to turn, and the car can then be towed to the repair shop without the use of a dolly.

Chas. J. E. Woodson
Collage Iron, Oregon

9039

NEW FUEL USED IN STOVE OF PORTABLE DESIGN



Left: Portable Stove Which Burns New Kind of Fuel, Shown Accommodating a Coffee Percolator. Right: The Stove Fitted with Oven Attachment

Portable cookstoves and heaters are now available that burn a new kind of fuel derived from a process of expanding denatured alcohol. This fuel is manufactured under government supervision and requires a special burner, or converter, which is made of copper and brass and is claimed to last several years. An oven attachment is provided for the stoves, which are produced in numerous sizes, the smallest of which can easily be carried in a bag when traveling. Thus tourists can make use of the convenient little article.

8966

REBUILDING WRECKED ELEVATOR IS BIG TASK

The task of rebuilding and fireproofing the giant elevator of the Chicago and Northwestern Railway, at South Chicago, Ill., wrecked on March 19, last year, as recorded at the time in this magazine, was found to be such a big problem that it took experienced engineers some time to determine the proper methods of procedure. The elevator, with a capacity of 10,000,000 bu., was constructed of reinforced concrete. So vast were the piles of debris, so numerous the engineering difficulties to be surmounted, so elaborate the plans for rendering the new structure explosion-proof, that even with the employment of specially devised methods and a large force of workmen, the task of restoration seems slow and laborious.

In cases where the surfaces had to resist a terrific stress, it has been found necessary to provide an overlapping of the new steel reinforcement upon that remaining in the parts left standing. It was thought better to obtain this overlap by cutting away enough of the concrete to expose the old reinforcement than by drilling holes into the standing concrete so that the ends of the new reinforcing bars could be inserted. The original plan was followed in laying the new steel reinforcement, forms were built up and the concrete poured. This plan was also followed in making great gaps in the bin walls grain-tight. In going over small cracks in outside walls, a thin cement mixture known as "eyewash" was used.

In small cracks, where reinforcing had been snapped off, it was necessary, in order to reach the steel, to enlarge the cracks to a width of 6 to 8 in., and then

fill in with concrete. By having the filling opening at a higher level, the upper part of the aperture was compactly filled and no tamping was needed.

Greater precautions have been taken in this rebuilt terminal to fight the dust menace than in any other large elevator. Two separate dust-collecting systems are to be installed. The units of each system can be operated independently. All the dust will be piped directly to 15 collecting bins on the roof of the track shed, and then carried to collectors over dust houses outside of the elevator.

There will also be a special equipment for removing dust from floors, walls, and ceilings. At every 45 ft. about the large plant an inlet valve will be provided. Here can be attached metallic hose that will enable the operator to pick up grain and dust from the floors, ceilings, and walls at any point within 50 feet.

The new drier house will be separate from the working house. All drier fans are to be chain-driven, and dust-proof housings will inclose all these chains. The fans of the dust-collecting system are to be installed in a separate fireproof building. Compressed air will also be used for blowing dust out of motors and motor bearings of electrical appliances. All electrical panel boards will be erected in separate dust-tight rooms. To protect the electric lights, double vapor globes and heavy wire guards will be provided. It is hoped and expected that these precautions will prevent a repetition of the explosion that was powerful enough to lift from the supporting pillars the storage bins containing 6,000,000 bu. of grain.

Fixed -
kustal gas.

Com. George F. Paul 900. Ellsworth
Bldg., Chicago

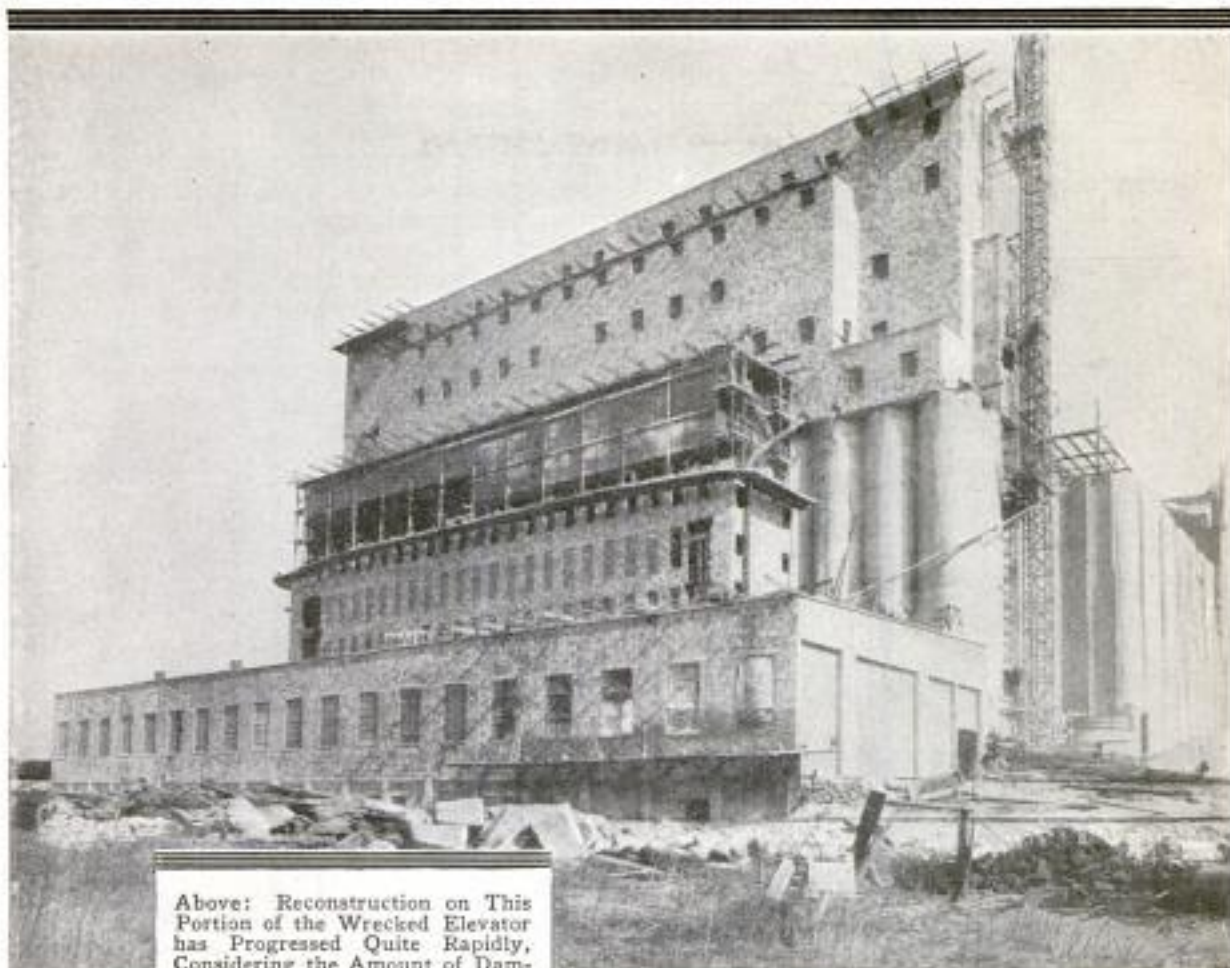

Above: Reconstruction on This Portion of the Wrecked Elevator has Progressed Quite Rapidly, Considering the Amount of Damage Which It Suffered. The New Construction Is of Six-Inch Hollow Tile Instead of Cement Concrete. Below: A Portion of the Wrecked Elevator as It Appeared after the Débris had been Cleared Away. All Portions of the Standing Structure are Carefully Examined for Evidence of Weakness or Injury, and will be Repaired and Strengthened before the Destroyed Parts are Replaced



Dr. E. L. Arthur
Pembroke, Va.

807¹⁰⁶4

POPULAR MECHANICS

HANDY BAG FOR CARRYING
AUTOMOBILE-TIRE CHAINS

When tire chains are removed and thrown loose into the tool box of an automobile,



they cover everything they touch with mud, and the next time they are wanted they are found tangled with wrenches, screwdrivers, and spare parts. The use of a new chain bag avoids all this. A long narrow bag is fitted with a top ring and, just below it, a collar ring.

When the top ring is twisted down over the collar ring, the bag is closed. A single twist will open it when the chains are wanted.

SPECIAL COMPARTMENTS MAKE
MOTORBOAT NONSINKABLE

Anyone who has watched speedy motorboats racing knows how prone they are to suddenly take a nose dive and sink, particularly if the water is at all rough. This tendency to go under the water instead of over it, has been one of the hazards of motorboat racing, but now seems to have been overcome by a Los Angeles enthusiast. He has constructed a

boat with four water-tight bulkheads made of 3/8-in. plywood which divide the boat into five compartments. The two Liberty motors of 450 hp. each are in one compartment and are completely inclosed when the deck is folded over. All compartments except the operator's are water-tight and afford buoyancy in case the boat sinks. Besides these compartments, there are 100 air-tight bags made of balloon cloth, which are shaped to fit the available waste spaces in the boat and designed to add buoyancy in case of accident. In a recent trial this boat struck a wave and dived beneath the water, but the air-tight compartments brought it back to the surface as soon as the engines stopped.

9053-

TRIPPLICATE SCISSOR BLADES
HAVE BUTTONHOLE SHEARS

TriPLICATE scissor blades which include buttonhole shears, are incorporated in the



recent invention of an eastern man. The third and smaller member is so arranged that it may be operated with either of the larger blades, and the user is thus provided with

two kinds of scissors which are incorporated in but one instrument.

When you want anything and do not know where to get it, write Bureau of Information, Popular Mechanics, Chicago.



Left: When the Deck is Folded Over, the Two Liberty Motors of 450 Horsepower Each are Entirely Inclosed. Above: The Nonsinkable Motorboat on a Trial Run. During One Trial the Boat Sank, but as Soon as the Momentum had been Overcome the Water-Tight Compartments Exerted Their Buoyancy and Brought the Boat to the Surface

Builder - Frank A. Barbutti,
Los Angeles, Calif.

Dr. John H. Byers, Artanna, Pa.

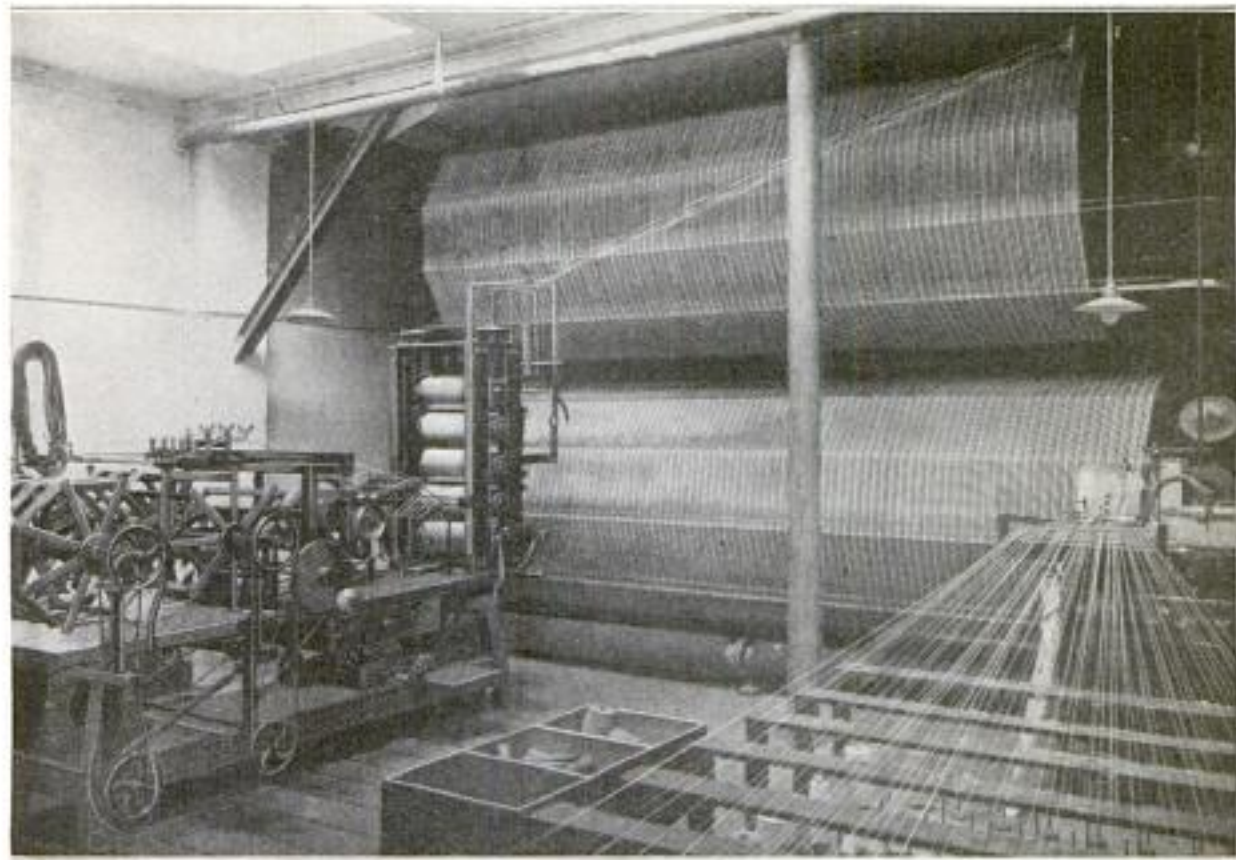

On These Large Reels for Drying Colored Ribbons or Tapes after They have been Dyed, the Strips are Carried on Metal Bands Passing between Metal Disks Supported at the Ends of the Reels

MACHINE FOR DRYING STRIPS

8982 OF COLORED RIBBON

A machine for drying strips of colored tape or ribbon after it has been dyed, was patented recently by a Swiss inventor. It consists of a set of four large reels, each having disks at the ends mounted on a central shaft. Attached to these disks at right angles are other smaller disks over which extend metal bands running the length of the reel. The outer edges of these metal bands provide the supporting means over which the colored ribbons or tapes are wound in spiral fashion. After the strip of tape or ribbon has been wound on one reel, it is wound onto the next, and successively over the remaining two reels. As the reels are made very large, a great quantity of strips can be dried on the machine in a relatively short time, the capacity being about double that of former machines of equal size.

☐ Wireless payments may now be made at any time on board the Cunard liners "Mauretania," "Aquitania," and "Beren-garia," according to recent announce-ments of New York and London banking interests. Also, through branch banks on these ships, passengers can order pay-ments made to persons in this country.

NEAT PAPER WEIGHT IS ALSO

9054 A MAGNIFYING GLASS

For the examination of small-scale drawings, currency, or illegible print, it will not be necessary to go searching for a magnifying glass if one's office is supplied with a new magnifying paper weight which has just been placed on the market. It consists of a cube of optical glass, the upper surface of which is ground and polished in the form of a convex lens. It is not necessary to focus this lens, as it is in proper position for magnification when the paper weight is placed on the object to be enlarged.

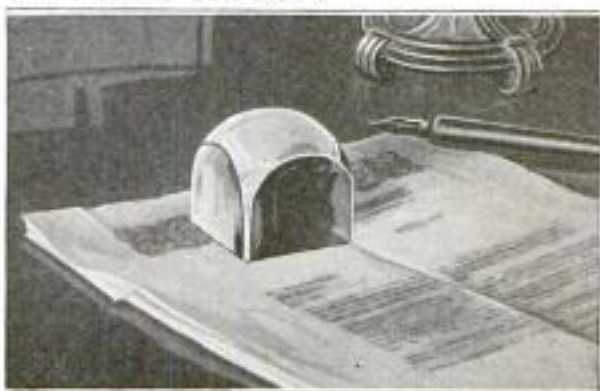

The Upper Surface of This Paper Weight Is a Con-
vex Lens for Magnifying Drawings, Printing,
or Currency Placed under the Weight

Buffalo Optical Co

574 Main St N. Y.

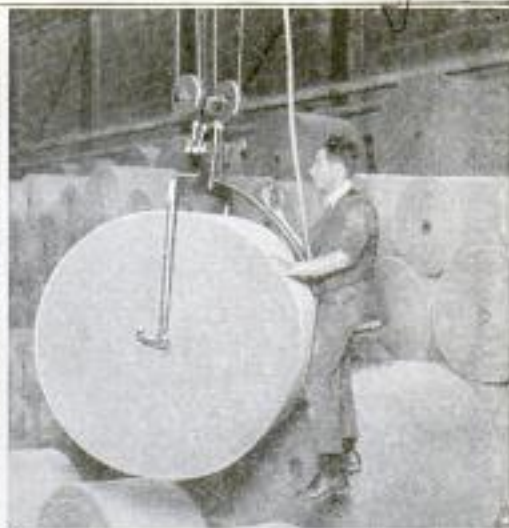

Left: One-Man Electric Crane Handling a Large Roll of Paper in the Warehouse. Overhead can be seen the I-Beam Tracks and the Electric Panel Which is Controlled by the Push-Button Switch in the Hand of the Operator. Right: Close-Up of the Crane, Showing the Saddlelike Seat

902
 PRIMITIVE CANE MILL MADE ENTIRELY OF WOOD

Even today, in the Philippine Islands there are found primitive mills made entirely of wood, for squeezing the juice

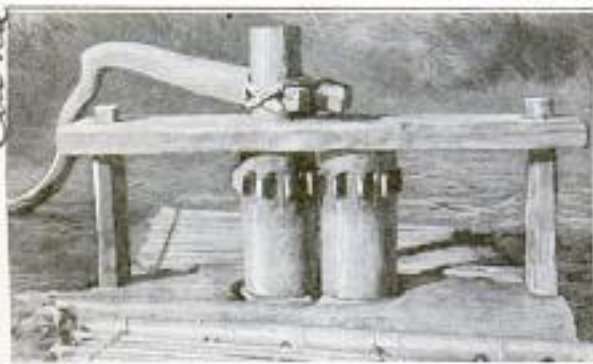

This Old-Fashioned Mill is Constructed Entirely of Wood and is Used in the Philippines for Squeezing the Juice from Sugar Cane

from sugar cane. The rollers are cut from hardwood logs and are driven by wooden cog teeth set in the rollers. A carabao, or water buffalo, hitched to a crooked wooden sweep, furnishes the motive power to turn the rollers. The capacity of the mill is small,

8992
 ONE-MAN ELECTRIC CRANE FOR HANDLING PAPER

Handling large rolls of paper and felt with a one-man electric crane, is the method employed by a western company in their storage warehouse. The crane is provided with a pair of jaws, or tongs, which fit into the core of the roll and

which are manipulated by a lever attachment. A saddlelike seat is furnished for the operator, who has a push-button switch that controls the raising, lowering, advancing, and reversing of the overhead mechanism. An elaborate system of I-beam tracks is installed for the outfit to travel on, as well as numerous safety appliances for the prevention of accidents.

906
 NEW CONTAINER FOR SHIPPING RIPE FIGS WITHOUT INJURY

Few people, except those living in the states where they are grown, have ever enjoyed eating ripe figs, as it has been impossible to ship them in quantities with any assurance of their arrival in good condition. This difficulty seems to have been overcome now by the development of a container in which the figs are held apart by perforated cardboard strips. This method of packing prevents injury by abrasion and yet insures sufficient ventilation to keep the delicate fruit from heating and spoiling, as often happens when the figs are wrapped individually.



Emb. Roy C. Bennett,
 Victoria Hotel, Shamney, Calif.

Emb. Frank H. Jones
15 Rowe St, Auburndale,
Mass

Emb. C. H. Thomas, 120 Broad
St.

POPULAR MECHANICS

109

Kenneth Square,
Pa.

900 INDUSTRIAL FILMS WILL BE
CENSORED BY EXPERTS

8916 FIRST COMMERCIAL VEHICLES
USING RADIO EQUIPMENT

Pa.

With the great increase in the number of subjects being shown on the screen that are prepared and taken in a wide range of industries, there comes the need of making certain that all scenes are technically correct in every detail. Especially is this true of the more scientific subjects, where the moving-picture camera is to record processes of manufacture or scenes taken in conjunction with research problems, the results of which are to be shown before a great many critical observers. A board of censorship has been set up by the Bureau of Mines, in conjunction with the Department of Commerce. It consists of three members, one representing the Bureau of Mines, and one from the Department of Commerce, while the third member is a representative of the industrial activity with which the picture deals. This board will do much to eliminate errors and correct technical details often overlooked.

Equipping its delivery trucks with wireless outfits, so as to keep constantly in



Delivery Truck Showing the Aerial for the Wireless Messages Which Enable the Manager of the Company to Keep in Constant Touch with the Drivers: Note the Receivers on the Man's Ears

touch with the drivers, is the original method employed by a Philadelphia company. Since the installation of the apparatus, the travel of the machines over the routes has been greatly facilitated.

9128



WHERE ANCIENT AND MODERN CIVILIZATIONS MEET

IN the oil fields west of Tampico, Mexico, is an ancient Aztec burying mound, on the top of which the natives have erected a shrine. At the base of the mound, on either side, there are oil-rig towers, standing where wells have been drilled, appearing as fitting symbols of the modern civilization, while between them lies a village cemetery.

Emb. E. M. Rowley
Tampico, Mexico

Copyrighted material

CIVIC FEATURES THAT PROMOTE THE COMFORT

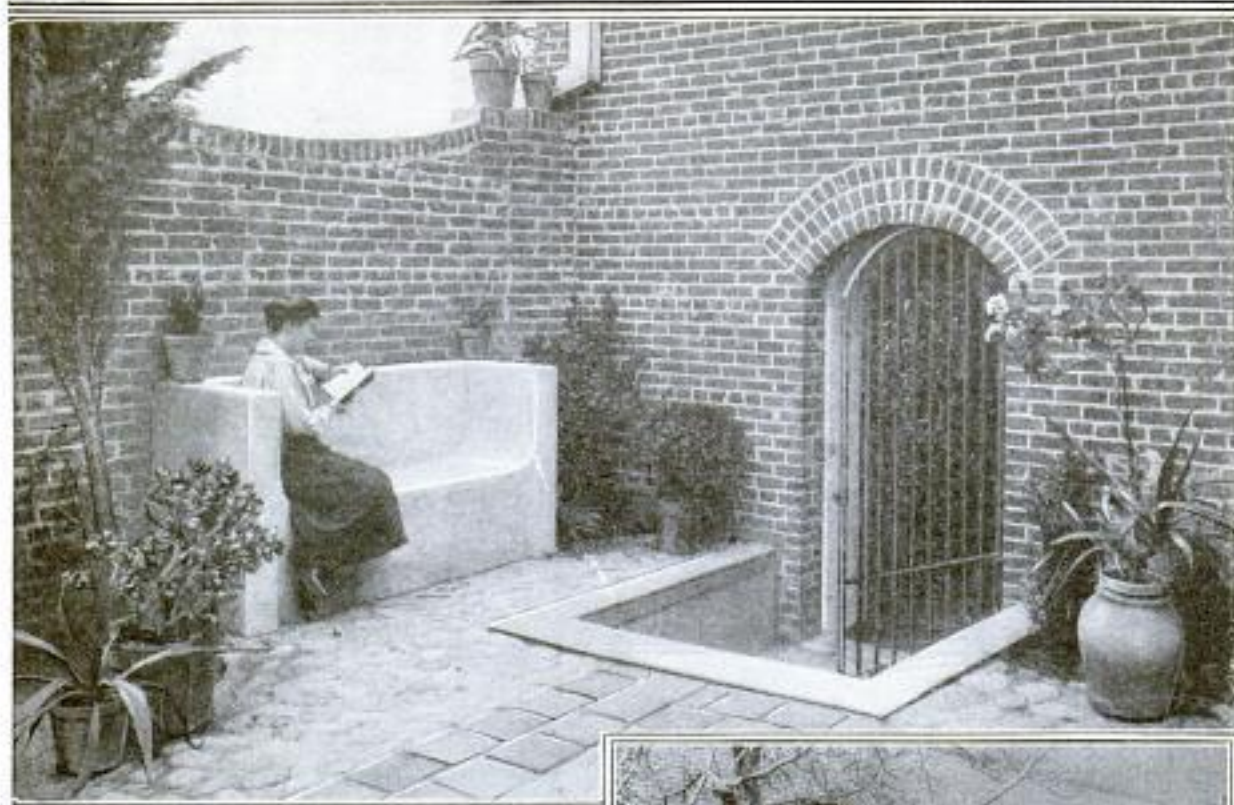

Above: Recreation Spot at the Rear of a Bookstore in Pasadena, California, Which was Designed after the Type of Spanish Courtyards of the 17th Century. Right: Another View of Courtyard, Showing the Ornamental Fountain



Overcrowding of a School in Ottawa, Illinois, Caused This Tiny One-Room House to be Erected for the Teaching of the Kindergarten Pupils

REST HOUR

Signs of This Description are Employed by a Hospital in Alexandria, Louisiana, to Notify Motorists and Truck Drivers of the Patients' Rest Period



Over the Waimea River in Waimea, Kaula, Hawaiian Islands, is Hung This Strange-Appearing Bridge Which Serves Pedestrians in Crossing the Stream. Note the Unusual Approaches to the Structure

AND ENJOYMENT OF VISITORS AND RESIDENTS

Sanitary Outdoor Dining Place Maintained by the Playground Commission of Los Angeles, California, in the Angeles National Forest: A Concrete Floor under, and a Wall around the Tables, Keep the Remainder of the Place from Being Littered

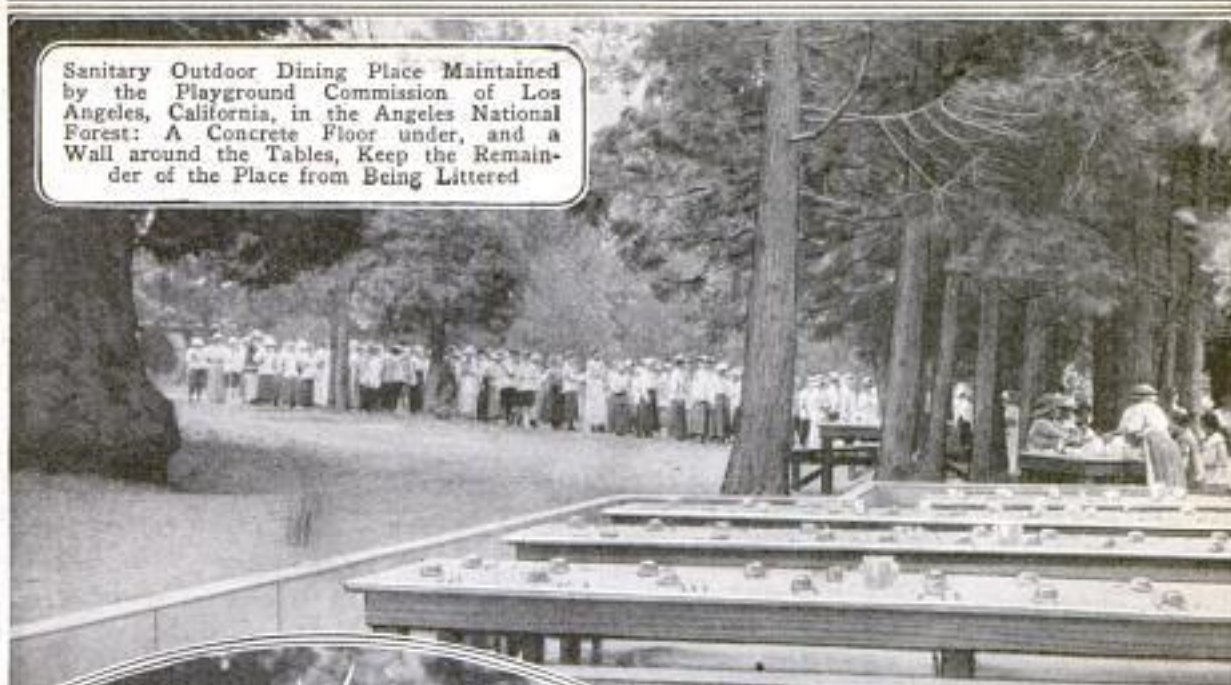

Ancient Japanese Battle Accouterments Presented to the Vanderbilt University at Nashville, Tennessee



Automobile Drivers in Columbus, Ohio, are Thus Graphically Reminded of the Danger in Speeding through the Streets of the City

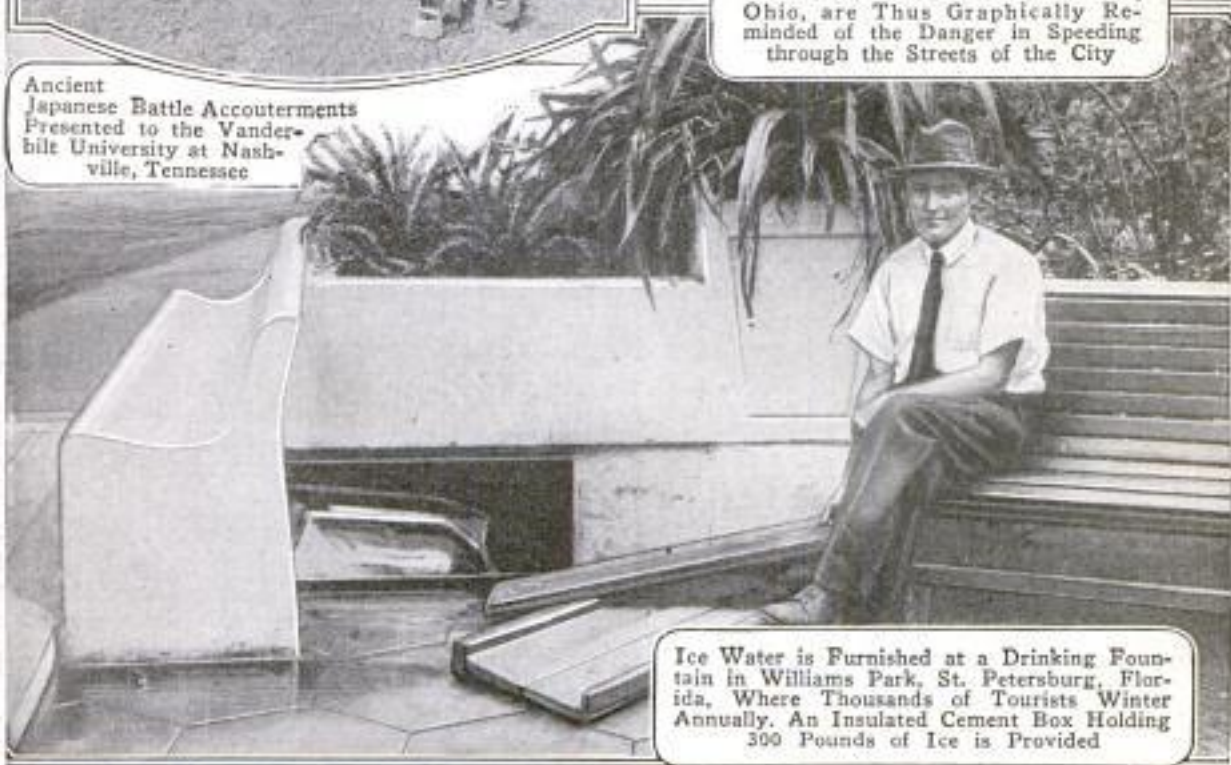

Ice Water is Furnished at a Drinking Fountain in Williams Park, St. Petersburg, Florida, Where Thousands of Tourists Winter Annually. An Insulated Cement Box Holding 300 Pounds of Ice is Provided

Mr. H. H. Crawford,
305 Broadway,
New York City

112 POPULAR MECHANICS

9036 SPRAYING-MACHINE STRAINER PREVENTS CLOGGING

Spraying solutions for whitewashing, tree spraying, water-color painting, etc., invariably contain certain gritty ingre-

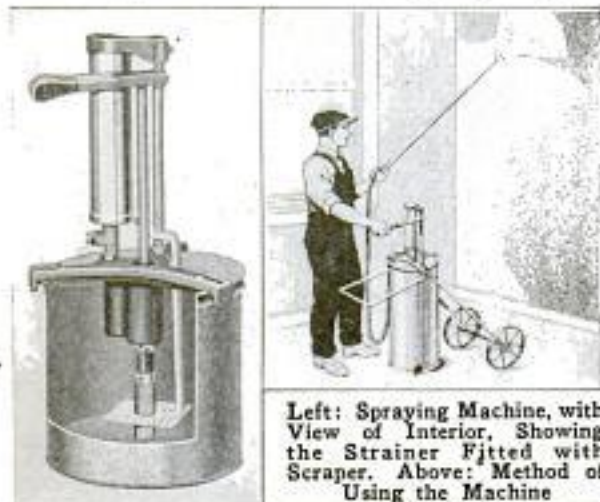

Left: Spraying Machine, with View of Interior, Showing the Strainer Fitted with Scraper. Above: Method of Using the Machine

dients which tend to clog the nozzle of the apparatus used. To alleviate this nuisance, a nonclogging machine has been perfected which has a self-cleaning strainer, fitted snugly over the end of the suction pipe. On the outside of the strainer is an agitator, or scraper, that moves up and down with the action of the pump handle, thoroughly cleaning the strainer with every stroke. Since there are smaller perforations in the strainer than are found in the nozzle, it is apparent that any particles passing through the former will be ejected from the latter.

9057 CRYSTAL-GLASS REFLECTORS FOR USE IN SPOTLIGHTS

For all kinds of spotlights, reflectors are now being made from crystal glass in molds which are under water, the red-hot



glass being blown into them and turned continuously. When taken from the molds the glass is annealed, chemically cleaned, treated to a hot process of silvering, and finished with a gutta-percha paint that is absolutely impervious to dust and moisture. The result is a reflector with the lasting qualities and bril-

liancy of a silvered plate-glass mirror. These reflectors are being made in sizes from 3-in. diameter for flashlights to 18 in. for locomotive headlights.

9172 DREDGE BASIN AND CHANNEL IN BAHAMA ISLANDS

The removal of more than a million cubic yards of rock and sand in the dredging of a mooring basin and channel, is the announced intention of the government of the Bahama Islands. The basin will be 600 ft. square and 25 ft. below the depth of low-water level, while the channel will be approximately 5,600 ft. in length, at a depth of 25 to 27 ft., and will range from 250 to 400 ft. in width.

9053 GUN SIGHT OF NEW DESIGN EASY TO MANIPULATE

Gun sights for long-range shooting are usually rather complicated, but a set of these, lately invented by a western man, are very simple and efficient. The front

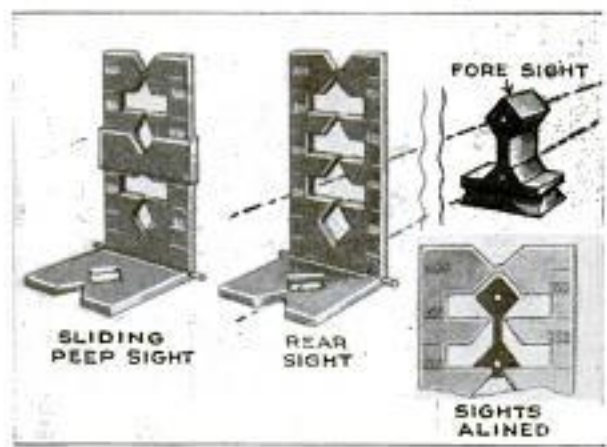

Gun Sights Which Enable the Hunter to Secure the Proper Range without Adjusting Complicated Apparatus

sight is diamond-shaped, and that in the rear has openings of the same pattern in it. Graduations representing 25 yd. each, and extending to 450 yd., are marked on the rear sight, and due to the design of the whole, the slightest canting, elevating, or lowering of the gun, is at once perceptible to the marksman.

Ⓐ Apart from the plans of the U. S. Government, in connection with the Brazilian Centennial Exposition, to be held in Rio de Janeiro, this year, for which an appropriation of \$1,000,000 has been made by Congress, an "unofficial" American building will be erected there. The contract for this building has already been awarded to a New York concern.

Mrs. Julia E. Wray 506 S. Montana St.
 Butte, Mont.

The Standard Corp.
 Columbus Ohio

8891 - Invented by: J. M. Mack, Calif.
 allbrook, Calif. 113

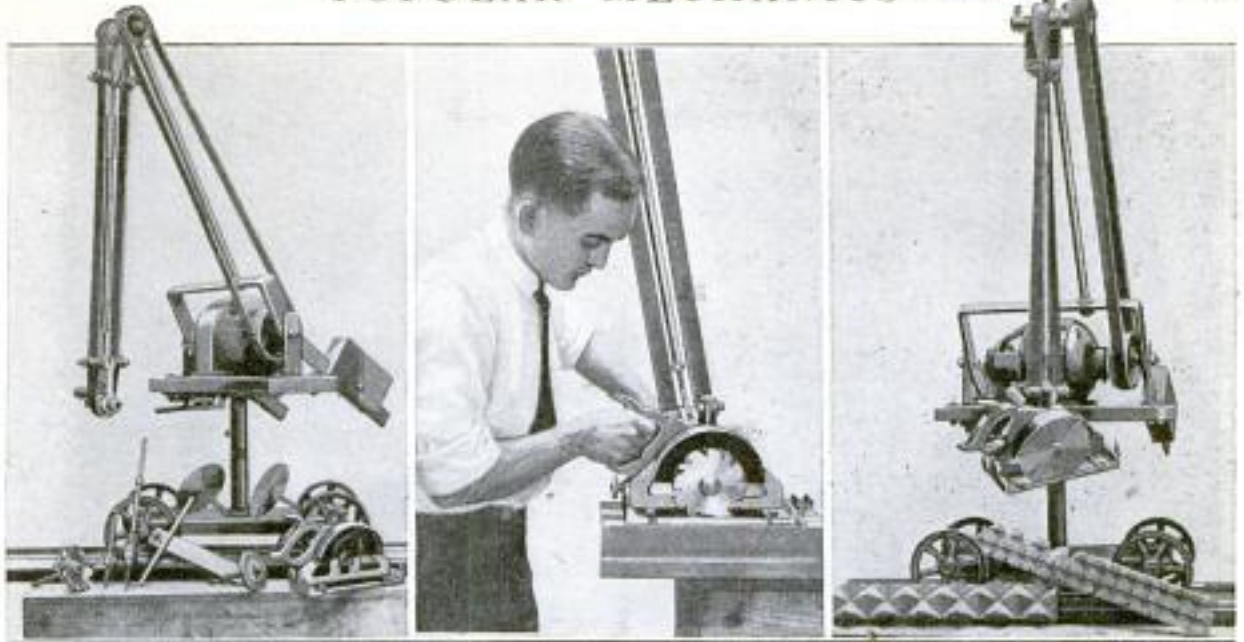

Electrically Operated Woodworking Machine That is Mounted on Four Wheels That Run on the Bench Track Seen at Left, Where Various Tools Used with the Machine are Shown: At Center, the Machine is Shown Dadoing, and at Right Making Angular Saw Cuts

NEW VARIETY OF BARLEY HAS STRIKING QUALITIES

Growing in a field of wheat mixed with much barley, what is evidently a new variety of barley has been discovered which is possessed of many unusual qualities. Instead of the usual three to seven nodes, the new barley has from 10 to 30 nodes, with the striking capacity to produce roots at any of these nodes. It also has the property of being able to branch at any node, with the further capacity for secondary and later branching. This new variety is not of practical agricultural interest as yet, but is being studied because of its scientific interest.

Science 4/7/22 P. 397
NEW WOODWORKING MACHINE OF MULTIFARIOUS USES

An electrically operated machine that will do almost anything done in wood-working, is the recent development of a Cincinnati manufacturer. The machine is mounted on four wheels, adapted to run on a track on the back of a carpenter's bench. Mounted above the wheel frame is a 1½-hp. motor, and adjustably connected to its support is an arm, at the end of which are belt pulleys and a suspended rod. At the lower end of this rod is another belt pulley, which drives a hollow spindle, into which can be inserted mandrels for operating various tools. This operating point of the machine hangs over the front of the bench, and can be moved into any position most suitable for the work in hand.

The P. L. Sellingsley Co.
 424 Elm St.
 Cincinnati, Ohio

Supplied with the machine is a cutter head that will do any simple molding, beading, tonguing, grooving, and splining, and there is also a boring mandrel that does the work of a brace and bit.

HAIR DRIER OF SIMPLE MAKE — PROVES VERY EFFECTIVE

Drying hair in a simple and effective manner is possible with the use of a lately introduced and long needed domestic appliance, which operates safely and at small cost. The drier consists of a funnel-shaped piece of galvanized-tin, having a long narrow neck, which terminates in a bell-shaped end. Placed over any common alcohol, kerosene, or gas burner, the funnel throws a hot blast of air for a distance of three feet. The outfit weighs only 1½ lb., is claimed to be absolutely smokeless or odorless in operation, and requires but 15 minutes to dry the heaviest head of hair thoroughly.



Mrs. Laurette Hunley-Chaffer.
 2508 S. Dearborn, Chicago

SOME NOVEL AND LITTLE-KNOWN ACCESSORIES



This Electric Boudoir Lamp Has Six Different Intensities of Light



Electric Alarm Clock Which Automatically Switches On a Light in the Room When the Alarm Goes Off



Sanitary Milk Box That is Placed on the Wall of the Porch as a Protection against Thieves, Animals, and Insects



Match Scratcher Which is Designed to be Attached to the Inside of a Coat by Means of Safety Pins

This Serviceable Bathroom Stool is Combined with a Shoe-Shining Convenience. The Front Side Drops Down So That the Person can be Seated While Polishing the Shoes, and the Footrest is Adjustable as to Height and Position



Aluminum Pie Pan That Has a Juice Catcher Incorporated in It to Keep the Bottom of the Oven Clean



Portable Refrigerator, Specially Adapted for Small Families, Nurseries, and Hospitals, Which Contains Unusual Insulation against Heat

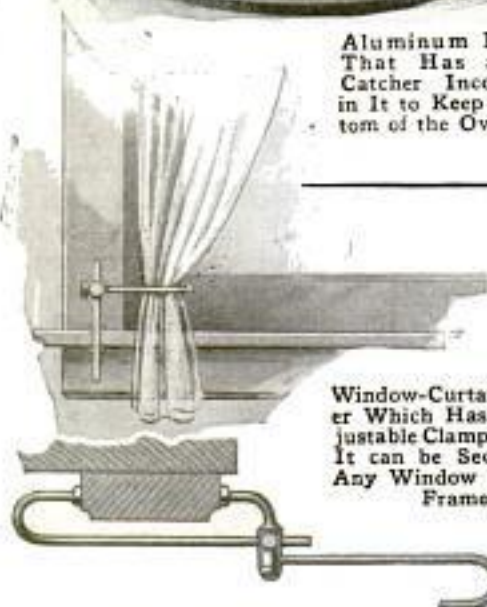

Window-Curtain Holder Which Has an Adjustable Clamp So That It can be Secured to Any Window or Door Frame

8289

INTENDED FOR THE HOME AND ITS MEMBERS



This Self - Wringing Mop Eliminates the Placing of the Hands in Dirty Water. The Mop is Wrung by Pulling the Wringer Handle Back and Forth

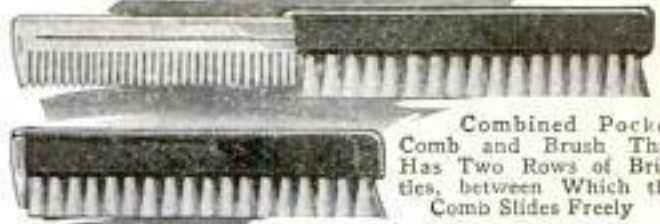

Combined Pocket Comb and Brush That Has Two Rows of Bristles, between Which the Comb Slides Freely



Combination Chair, Bed, and Writing Desk Which Has Waterproof Cushions That Are Reversible. One Arm Swings Back, Permitting an Invalid to be Lifted Easily into the Chair



This Window Shade Has a Patented Covering That Gives It the Appearance of a Lace Curtain from the Inside, and That of an Ordinary Shade from the Outside



Tea Set of Heat-Resisting Iridescent Glassware Which can be Placed in the Oven or Exposed to the Extreme Cold without Danger of Breakage



Toothbrush Which is Made Entirely of Rubber Instead of Having the Usual Bristles, and Which can be Sterilized in Boiling Water without Injuring the Composition

Deodorizer for Refrigerators That Automatically Absorbs All Odors Arising from Meat and Vegetables by Neutralizing Them



This Handy Sprayer Fits into the Cork of a Bottle and can be Used for Spraying Plants, Dampening Laundry, Settling Dust When Sweeping, and Other Household Purposes



8970
Right

TINY OIL CUP INSIDE SPRING LUBRICATES VALVE STEM

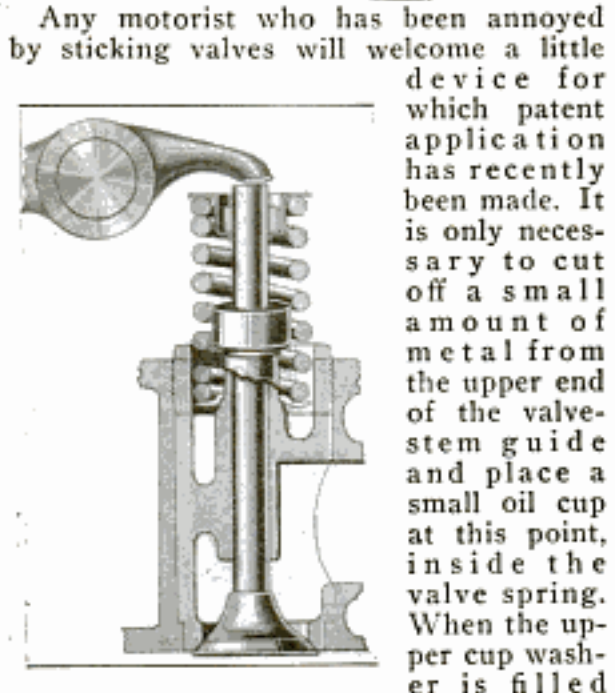

Any motorist who has been annoyed by sticking valves will welcome a little device for which patent application has recently been made. It is only necessary to cut off a small amount of metal from the upper end of the valve-stem guide and place a small oil cup at this point, inside the valve spring. When the upper cup washer is filled

DRIVING END OF ANY NAIL MADE SELF-CLINCHING

A self-clinching nail, recently patented, has a slot cut near the driving end of the nail in such a manner that it leaves a sharp arrowlike point on the shank of the nail. When driven into wood any withdrawal of the nail causes this sharp point to stick into the wood, and thus resist such withdrawal.

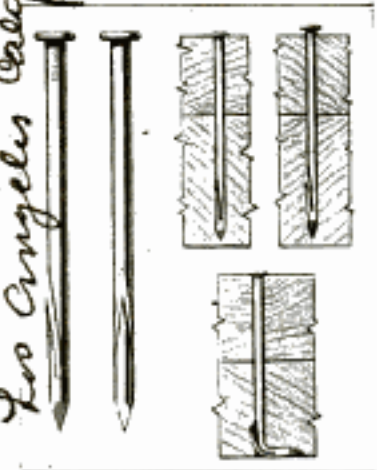

Should the point of the nail strike anything hard it will bend easily, and the sharp point will act in the same way as when not bent to resist withdrawal.

Our Bureau of Information will answer all questions regarding articles appearing in this magazine.

done **William H. Frost**
 1757 *2* **Gerrans Ave.**
Los Angeles Calif.

SUGGEST TERM TO DESIGNATE WEIGHT OF TON MEANT

While references to the ton weight in America is accepted as meaning 2,000 lb., some countries still use the short ton of 2,000 lb. and the long ton of 2,240 lb., and as a means of preventing misunderstanding, it has been suggested that identifying terms be adopted by manufacturers. Unless circumstances demand it, the term "ton" shall mean 2,000 lb. In special cases "S-ton" shall be used. The weight of 2,240 lb. shall be designated as "L-ton" as a positive means of identification.

HANDY TOOL FOR PLUMBERS HAS AUTOMATIC JAWS

Another tool for the plumber has been introduced as a means of facilitating the removal of basin nuts, ball cocks, valve tubes, or for working on small pipes. This appliance, which has automatic jaws that need no adjustment to make them grip, is 8 in. in length and weighs about one pound.

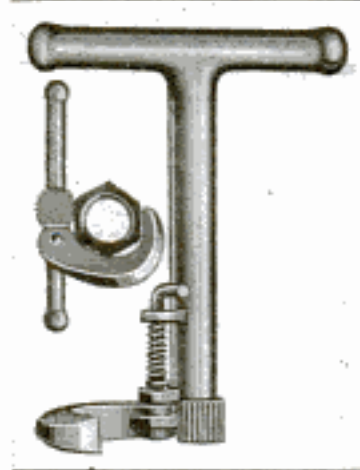

SIMPLIFIED SPLIT PULLEY HAS NO BOLTS OR NUTS

A split pulley that can be put in place on a shaft by simply driving in two steel wedges, supplied with the pulley, with an ordinary hammer, is now on the market. The rim of the pulley is of hardwood, and the central part is cast iron. A key-seat is not needed in the shaft. This simplicity makes it possible to put the pulley in place very rapidly and easily.

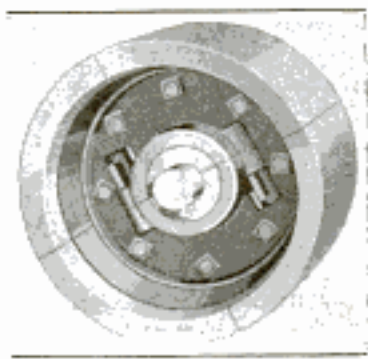

Lewis Tool Factory Ltd.
Lewis, P. I., Canada.

Chas. H. House
Engl. Co.
1209 Harmon St.

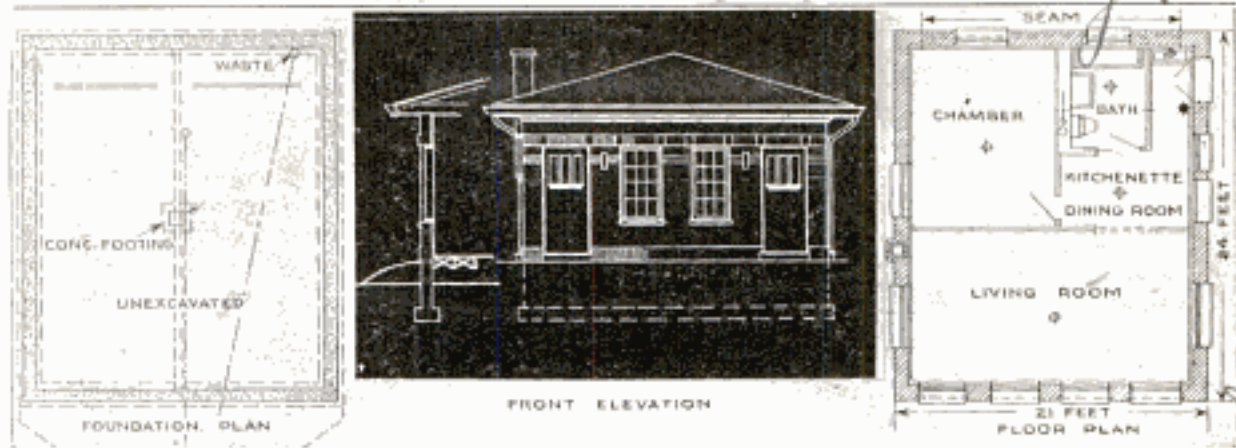

EDWARD GEORGE MC CLELLAN, ARCHITECT
 Plans for Combined Bungalow and Garage, Called a "Garlow": The Foundation Is All Concrete, and the Outside Walls Are Pressed Brick, with Stone Door and Window Sills. The Partitions Shown in Floor Plan, as Well as the Rear Wall between the Two Seams, Are Easily Removable for Conversion of the Bungalow into a Garage

EITHER BUNGALOW OR GARAGE AT THE OWNER'S OPTION

A novel form of residential structure, called a "garlow," as its name implies, is a combined bungalow and garage; that is to say, it starts out by being the former and ends up by being the latter. It is very useful to the purchaser of a city or suburban lot, who is going to build a good home, but for lack of either time or money must begin on a small scale. First then is built this garlow in the form of a modest bungalow, with partitions that can easily be taken away, and part of the rear wall removable, to be replaced later by a large garage door. It is on a concrete foundation, with outside brick walls, and doors as well as windows which are permanent in all walls except the rear one. It is built on the rear of the lot where the garage would naturally be, and is drained to a catch basin in the yard, which will also be used later for drainage of the permanent residence. This, of course, will be built on the front of the lot, and when it is finished the garlow will become a garage.

RAWHIDE USED IN FAN BELTS AND BLOWOUT PATCHES

For blowout patches for tires, and for making fan belts, a new fabric is being made by subjecting rawhide to a process that makes it nonelastic, and then covering it with heavy rubber-frictioned cotton duck. The toughness of the rawhide makes the material very puncture-proof and durable when used on tires, and for this purpose it is made in the form of a patch with two strong flaps that tighten over the beads and hold the patch in place. When used for fan belts, its non-

stretching property causes it to grip all the tighter when subjected to heat, instead of expanding and slipping, as with the common leather belt.

IMPROVEMENT OF SAND BOXES USED ON LOCOMOTIVES

The simple box used on locomotives and elsewhere for sanding the rails to prevent slippage has been considerably elaborated in an invention recently patented in England. Inserted through the closed top of the box is a sprinkler rose on the end of a pipe that leads to a water container. In this pipe is a valve that is connected by a swiveled rod and bell-crank arrangement to another valve in a pipe below the sand box that conveys the sand to the rail. These two valves, in this manner, open or close simultaneously, so that whenever sand runs down the sand pipe, water is sprinkled on the sand in the box, in order to keep it moist. A pipe from the boiler runs in at the top of the sand box, out at the bottom, and then along the length of the sand pipe so that whenever necessary, steam can be turned on to keep the sand warm. A screen is also fitted in the sand box for preventing pebbles, or anything of that nature, from reaching the opening to the sand pipe.

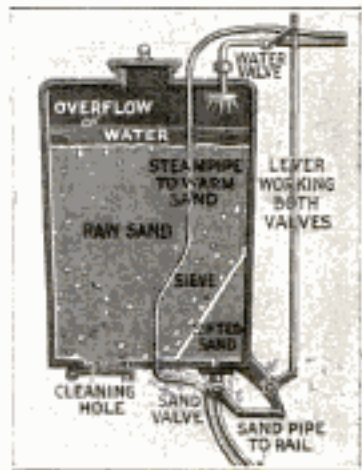

Rawhide Products Distributing Co.
 7, W. 22 nd St. New York City.

James Southworth, 46, Woodhouse Lane, Wigan, England.

The Engineer 2/17/22

118
838

P. 180

POPULAR MECHANICS

33 Norfolk St., W.C.2, London, England

35 Bedford St
Strand London
E. C. England

REMARKABLE DEVELOPMENT IN MARINE OIL ENGINES

There are now being installed in a new twin-screw liner, after several years of experimental work, two late types of the British heavy-oil engine that utilizes the heat of the exhaust gases, and the cylinder water jacket, invariably wasted

the Diesel principle, and this boiler has a burner for generating steam for starting the engine, or for taking care of an overload when running. Normally the boiler acts as a receiver for the steam derived from the waste heat of the exhaust gases

by water-jacketing the exhaust pipe, which connects the working cylinder with the boiler, and from a feed-water heater, to which the exhaust gases are also piped. By means of a pump the feed water is circulated through these heaters, and then passed to the cylinder jacket of the engine, where it gains more heat and is then returned to the boiler, where the heat is sufficient to generate steam for one end of the power cylinder. Thus, the waste heat is utilized for adding power, without consumption of extra fuel, and a further advantage is that, on account of the high temperature of the cylinder-cooling water, the compression pressure for combustion of the fuel can be considerably lower than in the ordinary Diesel engine. In connection with the steam end of the power cylinder is a condensing plant. It will be obvious that the engine operates, on its combustion side, upon the two-stroke port-scavenging principle, with no valve except that for the fuel injection. On the steam side are, of course, inlet and exhaust valves. The combustion and steam operate alternately, so that the engine is double-acting, though naturally the power developed on the steam side is considerably less than that developed on the combustion side. Although as yet

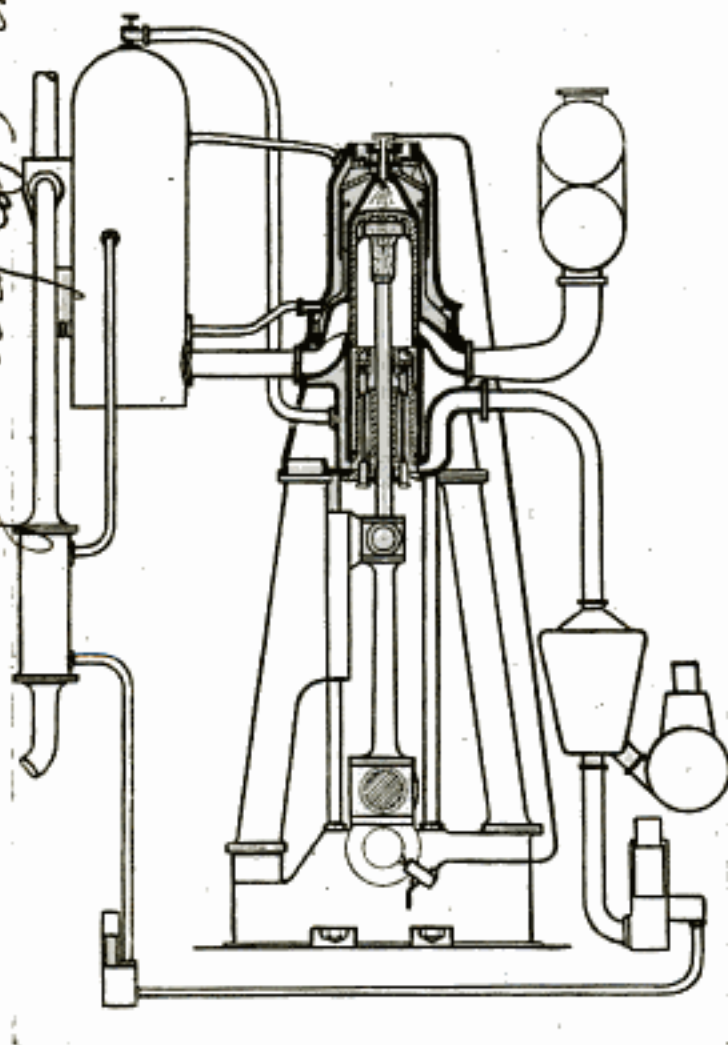

Combined Steam and Internal-Combustion Engine with Cylinder in Section, Showing Combustion Chamber above Piston, and Steam Cylinder with Inlet and Exhaust Valves below It

in other types of internal-combustion engines. This engine was mentioned, when first invented, in the August, 1915, issue of this magazine. Its fundamental principle is the recovery of waste heat, and its conversion into power through the medium of steam. This type of engine is, in fact, a combination of the steam and the internal-combustion engines, for steam acts on one side of the piston, and oil combustion takes place on the other side in the same cylinder. A very small boiler—not much larger than the engine cylinder and its jacketing—is part of the installation. The combustion of the oil is by means of compression on

this remarkable engine has been applied only for marine service, the possibilities for land work are considerable. Its high efficiency would make it specially suitable for use at central power stations.

SEARCHLIGHTS USED TO ROUT SWARM OF BEES

Bees are seldom respecters of human rights when they find a new queen and decide to swarm. Accordingly they are often a source of "stinging" embarrassment to persons who are compelled to work in the vicinity of a location chosen by the bees for swarming purposes. An

9046
Carl Hogg & Ford Bldg.
416 Union League Bldg.
Los Angeles Calif.

Steel Engine Co. Ltd. S. coast Shipbuilding & Engineering Co. Ltd. S. coast Shipbuilding & Engineering Co. Ltd. S. coast Shipbuilding & Engineering Co. Ltd.

POPULAR MECHANICS

*Info. A. H. Lerover
180-13th St.
9029 Long Island City
BANJO STRINGS MADE SNAPPY
BY EXTENSION TAILPIECE N.Y.*

incident of this kind occurred at Universal City, Calif., recently when a swarm of bees chose an outdoor motion-picture "set," upon which several cameras and a corps of actors and actresses were working. In a few minutes the bees became so annoying that chaos reigned, and it seemed necessary to stop the production of the picture for the rest of the day—obviously at heavy loss to the producers.

Seeking some means of driving the bees away, the director of the picture be-thought himself of the powerful electric searchlights. Half a dozen of these were hurried to the "set" from the "electric stage," and the battery of lights were turned upon the swarming bees. In less than a minute the bees began to scatter, and in five minutes more every bee had been driven away.

9005 — Aut. (1922)
**ICE CARRIER FOR MOTORISTS
SIMPLE AND CONVENIENT**

Carrying a cake of ice on, or in, an automobile is a rather difficult and dirty task, and to simplify this, a Texas company has produced a neat carrier. This article, made of a 5 by 10-in. plate of galvanized iron, contains perforations having rough edges which prevent the ice from sliding, and is fastened by four screws to the running board of the car.



8997
**ONE-PIECE SPRING RETAINER
FOR POPPET-VALVE STEMS**

For use on poppet-valve stems, there is now on the market a one-piece spring retainer that can be assembled with one hand, there being no pin to insert. Two small flexible arms on top of the spring retainer slide over the end of the valve stem, and when the retainer is pushed upward by the spring, these arms are automatically engaged in a groove in the stem, and hold the retainer in place.



*Master Premier Co.
130 Larned St.
Detroit, Mich*

A new extension tailpiece for a banjo is so constructed that pressure is brought to bear on the strings just behind the

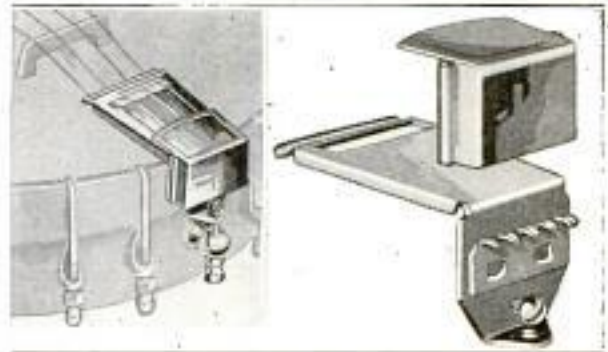

Left: Extension Tailpiece on a Banjo. Showing How Pressure is Brought to Bear on the Strings Just behind the Bridge. Right: the Tailpiece Disassembled

bridge, and it is claimed that this results in a louder and snappier tone. In connection with the extension is an attaching device, from which the strings pass along the extension through a slot near its end, finally under a beveled bar and up over the bridge.

8977
**POULTRY DRINKING FOUNTAIN
OPERATES AUTOMATICALLY**

Improvised drinking fountains for poultry may be seen in any barnyard, and one of these, of unusual construction, has lately appeared on the English market. This fountain consists of a three-gallon container placed in a small pan or tray, the whole of which is made of zinc. An air-tight cap in the top permits filling, and a tiny hole in the bottom allows the water to trickle out into the tray.



(Names and addresses of manufacturers of articles described in this magazine will be furnished free by our Bureau of Information.

*H. Welsh Co. Box 256,
El Paso, Texas*

Kingdon & Co., Allen, Hunts, England.

8987

CHILDREN'S PICTURE-STORY DEPARTMENT

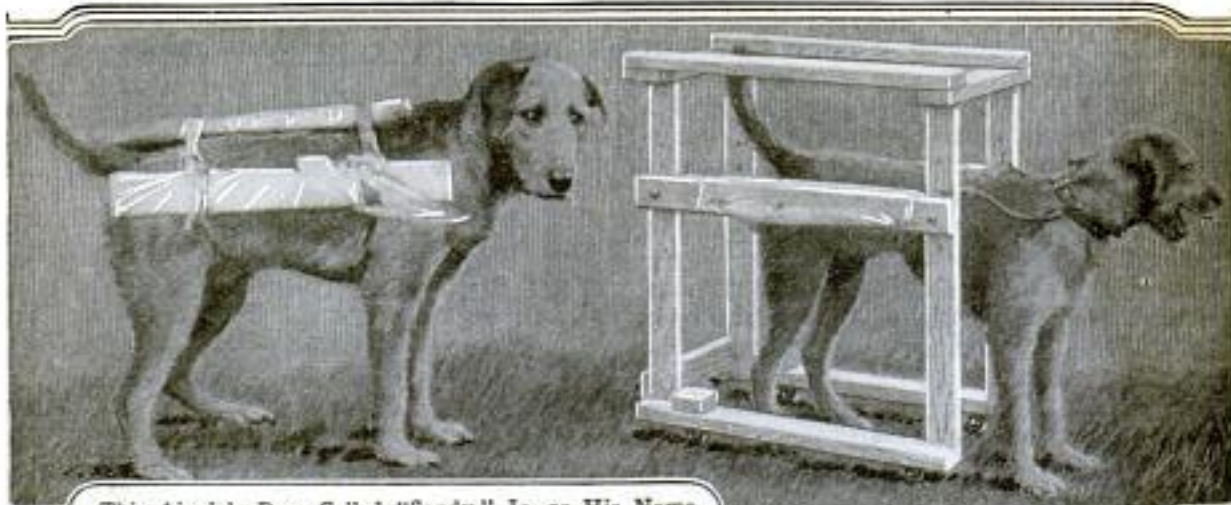

This Airedale Pup, Called "Sandy," Is, as His Name Implies, Scotch, but Was Not "Canny" Enough to Avoid an Auto Which Broke His Back. A Veterinary Put Him in Splints, as Seen at the Left, and 17 Days Later "Sandy" was Going About with the Aid of the "Crawler," Seen to the Right. Two Weeks Later "Sandy" Was as Active as Ever

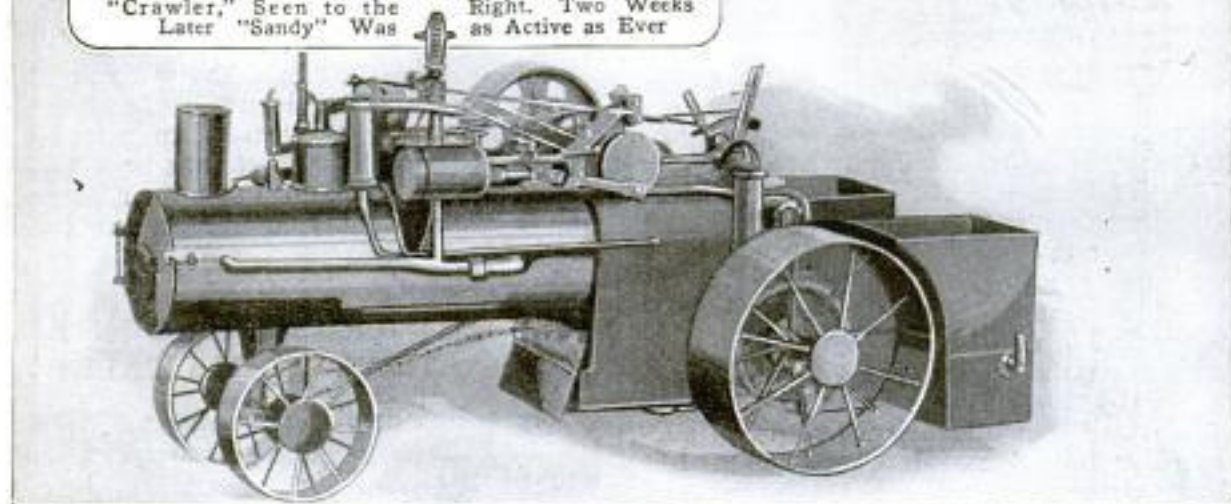

This Looks like a Regular Full-Sized Steam Tractor, but It Isn't. It Is Only a Little Model of One, 30 Inches Long, 14 Inches Wide, and 16 Inches High, Designed and Fabricated Single-Handed by an 18-Year-Old Boy, Alfred Getz, in His Father's Welding Shop at Kalispel, Montana. It is Completely Equipped in Every Respect, and Has a Reversible Engine Which Develops One-Eighth Horsepower. The Boiler Stands 80 Pounds' Pressure

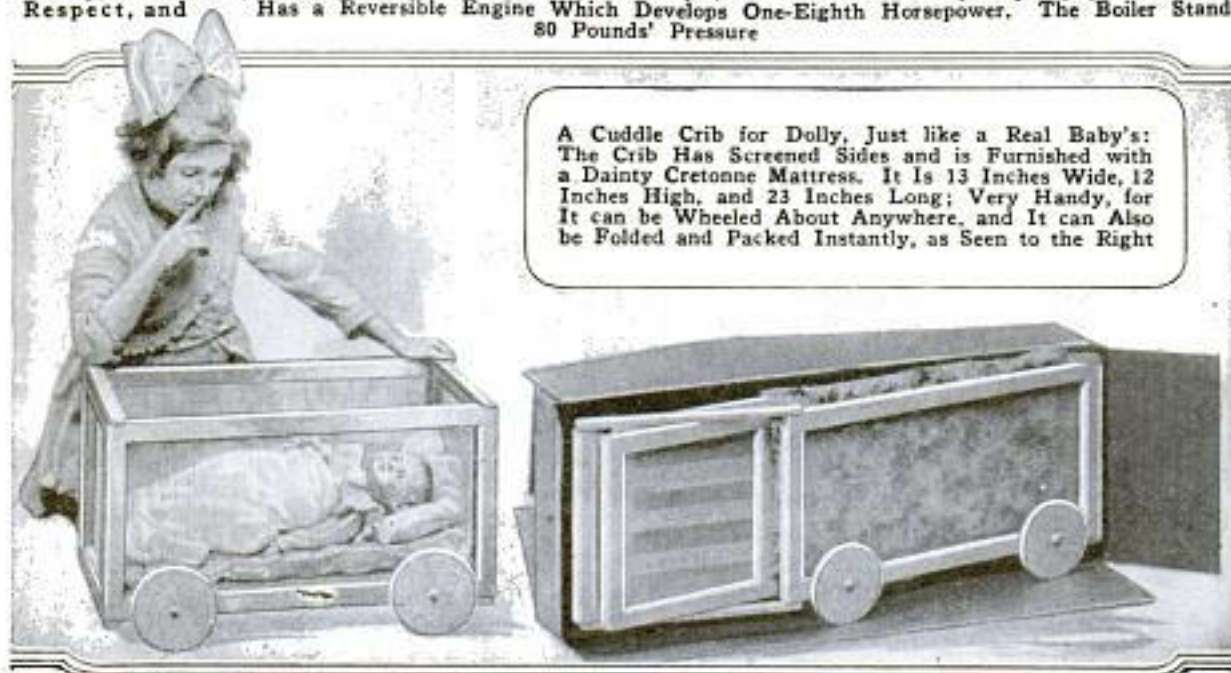

A Cuddle Crib for Dolly, Just like a Real Baby's: The Crib Has Screened Sides and is Furnished with a Dainty Cretonne Mattress. It Is 13 Inches Wide, 12 Inches High, and 23 Inches Long; Very Handy, for It can be Wheeled About Anywhere, and It can Also be Folded and Packed Instantly, as Seen to the Right

OF MODERN ACTIVITIES AND INTERESTS

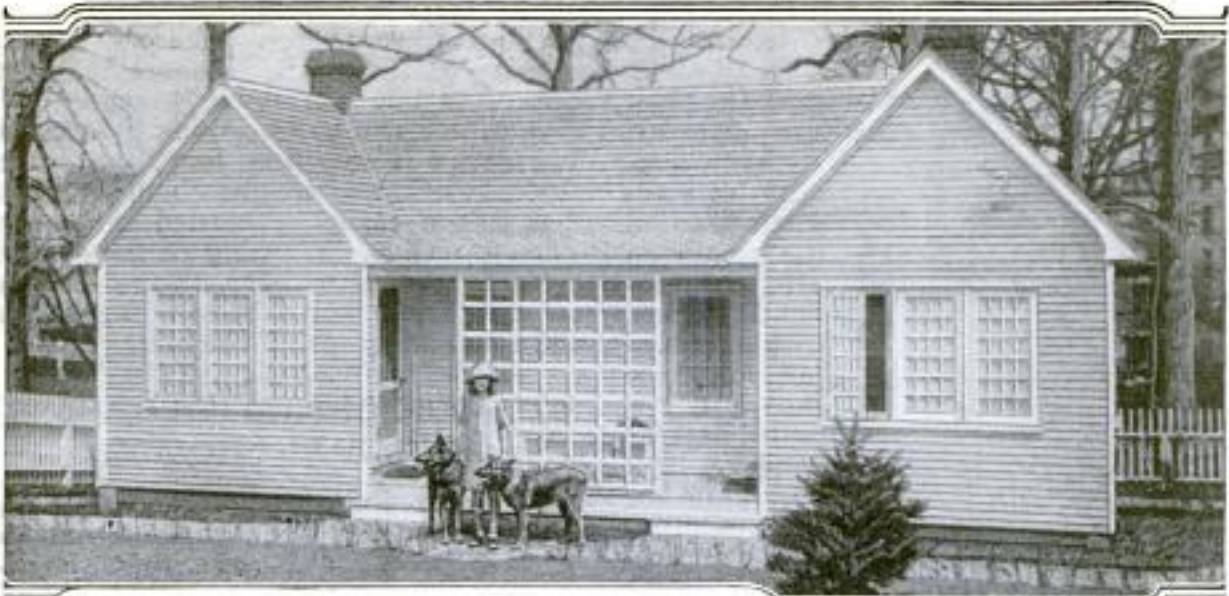

On the Porch, between the Two Big Dogs, Each of Which Probably Weighs as Much as She Does, Is the Little Girl Who Was the Designer of This Playhouse, Probably the Youngest Architect in the Country. Her Name Is Helen, and She Is the Daughter of Harry Wardman of Washington, District of Columbia. The House Has Three Rooms, Electrically Heated and Lighted, and is Appropriately Furnished



Left: The Youngest Boy Scout in Panama, but Not Too Young to Take a Solitary Hike Clear across the Isthmus from the Atlantic to the Pacific. He may Not Be a Man in Years, but He Is "Mann" by Name—Timothy Mann, Brother of Alma Mann, the Water Nymph, Who has Won Much Renown as a Swimmer. Right: This Gray Squirrel, Snapped on the Grounds of the Capitol at Harrisburg, Pennsylvania, is Evidently Not Afflicted with Any Excessive Timidity. He Stands Up like a Little Man, and Careses the Big Hand with His Paws and Snout Eagerly. There Is a Reason—in the Hand Is a Tasty Nut



A Practical Auto Wagon for Boys, Easily Steered and Propelled, with a Seat in Front for a Passenger, and Lots of Room for Baggage—Very Handy for Delivering Newspapers



Left: The Youngest Boy Scout in Panama, but Not Too Young to Take a Solitary Hike Clear across the Isthmus from the Atlantic to the Pacific. He may Not Be a Man in Years, but He Is "Mann" by Name—Timothy Mann, Brother of Alma Mann, the Water Nymph, Who has Won Much Renown as a Swimmer. Right: This Gray Squirrel, Snapped on the Grounds of the Capitol at Harrisburg, Pennsylvania, is Evidently Not Afflicted with Any Excessive Timidity. He Stands Up like a Little Man, and Careses the Big Hand with His Paws and Snout Eagerly. There Is a Reason—in the Hand Is a Tasty Nut

Coleman Railway Supply Co
30 Church St.

122 8901 POPULAR MECHANICS
New York City
NEW ONE-HAND PIPE WRENCH
IS SIMPLE AND STRONG

A new make of pipe wrench that has an unusually tight grip on a pipe, and that



is to some extent self-adjusting, is in the form of an all-steel one-hand wrench, with one fixed jaw, and the movable jaw pulled back by hand. A light spring in the handle slides this jaw forward. The two jaws make a three-point contact with the pipe, and the greater the pressure on the handle, the greater is the grip on the pipe. The movable jaw

is in the form of a small serrated wheel, and the wrench is released from the pipe by simply pushing the handle forward instead of pulling it backward, as when turning the pipe.

902³ PORTABLE BURGLAR ALARM
SIMPLE AND EFFECTIVE

Protection against burglars is provided by the use of a simple but effective alarm which consists of a bell and battery outfit placed inside a metal case with a hard-rubber cover. By means of specially arranged contacts, the alarm can be ad-

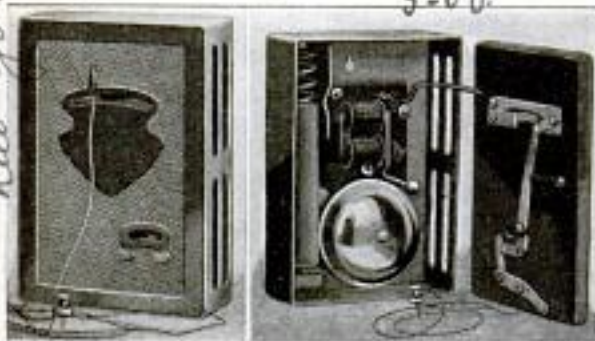

Left: Exterior of Portable Burglar Alarm. Right: Interior, Showing Bell, Battery, and Alarm Contacts

justed and held in tension by a thread, or string, the touching of which causes

the bell to ring. Thus with the thread stretched across open windows, or attached to windows and doors that are closed, anyone attempting to enter will sound the alarm by disturbing the thread. The device is only 6 in. long, 4 in. wide, 1½ in. thick, and weighs about 2 lb., so that it can easily be carried for safety when traveling. Warning of fire is also given by the contrivance, as the burning of the thread would release the spring and accordingly set off the alarm.

SELF-SUPPORTING SAXOPHONE
861 ADJUSTABLE HOLDER

To the tired musician a practical holder or supporter for the saxophone will be of great assistance, as these instruments, particularly the large, bulky ones, held by a small strap around the neck, become very burdensome when carried continuously for two or three hours. This new holder is strong and rigid, with a telescoping top that can be adjusted to fit any saxophone, and also to suit the height of any player. The whole



weight of the saxophone is supported, and the musician's hands are entirely unencumbered, and have more freedom of action in operating the keys.

GERMAN BAYONETS CONVERTED
INTO CHOPPING MACHINES

9113 For use in the provinces of Germany where wood is the principal fuel, wood-splitting machines, made from reclaimed war bayonets, have been introduced. The machines have become very popular and are quite simple, operating on the leverage principle. Their further importation, however, is forbidden, as the bayonets can easily be detached and could be used for war purposes.

U The farthest-north church in the world was recently completed, according to a wireless report from Advent Bay, Spitzbergen, close to 80° latitude.

Handley & Son, 819-6th Ave. New York City

Alarm Corporation,
68 William St. New York City

Janney Portable Burglar & Fire



Making Concrete of Maximum Strength

By A. J. R. CURTIS

ALTHOUGH concrete is already recognized as having more diversified structural uses than almost any other material, some of its important characteristics have still to be thoroughly investigated.

The principal ordinary ingredients of concrete are Portland cement, sand, pebbles (or stone), and water. Early in the history of concrete the conclusion was reached that the quality of the product could be controlled largely by constant tests, to insure the quality of the binding element—cement. Further study revealed the equal necessity of testing and rectifying the defects in the "aggregates," the latter term being used to designate the sand, pebbles, stone, or other nonmetallic minerals united by the cement. In good practice the aggregates usually compose from two-thirds to four-fifths of the concrete mass.

For many years these tests were supposed to provide about all the scientific data required with respect to the concrete mixture. The water

amount of cement present are vital considerations so far as the strength of the resulting concrete is concerned. The curve shown in Fig. 2 illustrates diagrammatically the manner in which similar concrete mixtures develop greater strength with the use of more water up to a certain point, beyond which an addition of water causes

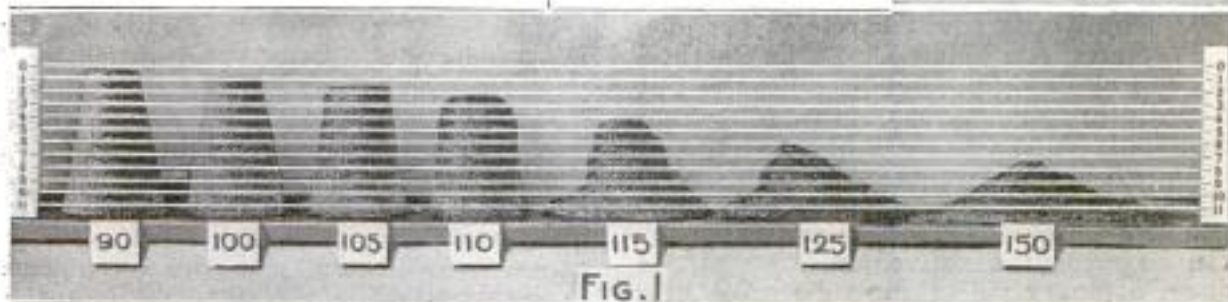
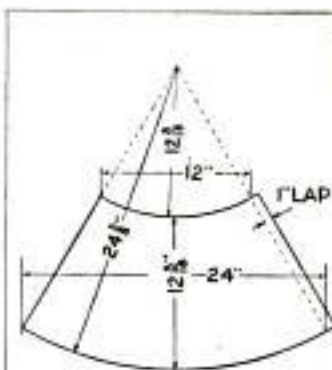

Lower Illustration: "Slump"-Test Specimens Made with Varying Amounts of Water. Notice How the Piles on the Right have "Slumped" from Their Original Height. Upper Left: Plan for Galvanized-Iron Form for Making the Slump Test. Upper Right: Removal of the Slump-Test Mold by a Steady, Vertical Pull

present was considered merely a lubricant, to be used in the mixture in almost any quantity found convenient. It is only recently that the staff of the Structural Materials Research Laboratory, Lewis Institute, Chicago, of which Prof. Duff A. Abrams is chief, discovered that the plasticity of the concrete mixture and the relation of the amount of water to the

the strength to diminish. This curve is a composite of many similar curves, plotted from results obtained by adding various amounts of water to mixtures of different proportions, using various typical concrete materials.

The amount of water required to produce a concrete mixture of greatest strength is designated in this diagram as

100 per cent. It may be noted from the curve that a 10-per-cent reduction of water from the 100-per-cent point produces at least a 25-per-cent reduction in strength; an increase of 10 per cent in

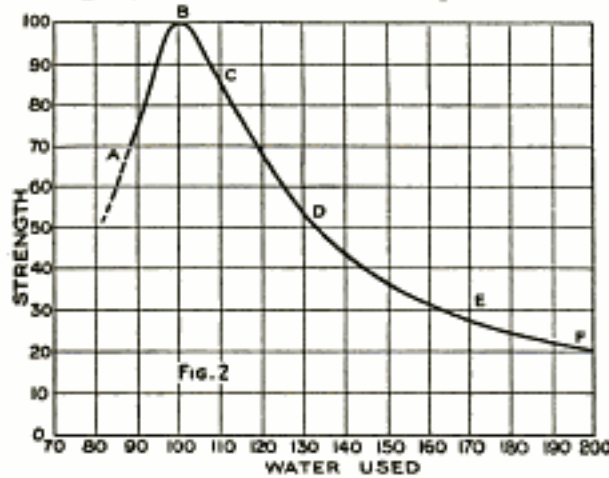

Diagram Showing Varying Strengths of Concrete Mixtures Due to Variation in the Amount of Water Used

water above the 100-per-cent point produces a 15-per-cent reduction in strength. These are, of course, average figures, but show clearly that there is one consistency for every mixture which produces greatest strength, and that deviations from it are accompanied by a sacrifice in strength.

Compare this curve with the illustration in Fig. 1. The latter shows a number of piles of concrete made of identical materials, in identical proportions, but with various amounts of water. The pile marked 100 represents the consistency designated as 100 per cent in the diagram, and the other piles represent corresponding percentages from 90 to 150. The wetter the concrete in the pile, the greater the "slump." This method of determining consistency, although but recently introduced, has come to be used commonly in scientific laboratories, and is known as the "slump test."

Slump-test cones are made 12 in. high, and the extent of the slump in inches can be measured conveniently by means of an ordinary rule equipped with a sliding crossbar. Fig. 1 shows a plan for a galvanized-iron form for producing specimen batches for the test.

The form is placed on a smooth, level floor, or substantial table, and the concrete is deposited in it in four or five small batches, each batch being tamped briskly with a $\frac{1}{4}$ -in. round rod before the next batch is deposited. When the mold is filled with the mixture, the top is struck off level. The mold is then withdrawn by a steady vertical pull without vibra-

tion. After a few minutes the amount of the slump is measured, and comparison is made with the illustration in Fig. 1 or a corresponding table. The result will reveal whether the mixture is too dry or too wet for maximum strength. In some cases the probable reduction in strength on account of too much or too little water can be judged approximately. Owing to the variation in methods of handling concrete for the many uses to which it is put, the employment of the consistency that will give maximum strength is frequently impracticable, it being more economical to use a little more material than to use the ideal consistency. In all cases it is desirable to use the proportion of water that gives the greatest strength within the practical limits of the handling methods employed. It is also desirable to know the probable approximate reduction in strength caused by limitations of handling methods, so that this may be taken into proper account in the design.

Scriber for Marking Patches

For locating and scribing setscrew holes, oil holes, or slots at any point, on a patch or ring that has been shrunk over

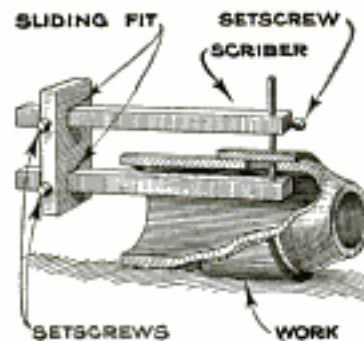

the hole or slot, the scriber shown will save considerable time. As an examination of the drawing will show, the device is extremely simple, consisting of only

a square steel block and two movable arms, the latter sliding through holes in the block, and locked, when adjusted, by means of setscrews. The lower arm is fitted with a locating pin driven tightly into a hole drilled near the outer end of the arm, while the upper arm has a scribing point fitted near its end, a setscrew making the scriber adjustable for different thicknesses.

When a hole is to be located, it is only necessary to insert the arms into the work, until the locating point on the lower arm enters the opening; the scribing point is then adjusted and the device manipulated until the location of the hole has been scribed on the surface of the ring or patch.—Leon Yacoby, New York City.

Casting without Rolling the Flask

Ordinarily, in casting a steel annealing box, having three ribs on the bottom, a wooden bottom board would be placed on the foundry floor. Then the pattern, bottom down, would be laid on this board, and sand would be filled in and rammed in the usual manner. A roll-over board would be placed on top, and flask hooks would be put around the outside to clamp the bottom board to the flask and the roll-over board, and then the whole thing would be turned over ready to receive the cope. This method would be perfectly satisfactory in casting one or two pieces, but when 25 or 30 are to be produced, not every foundry is equipped with the necessary number of boards.

By a simplified method, illustrated in the drawing, all these boards, the clamping hooks, the rolling of the flask and the extra labor are eliminated, the molds being made in a few minutes by a laborer. The first operation is the filling in of the bottom or drag flask with sand, which is rammed and then struck off; the next is the filling, ramming, and striking off of the pattern, which is then inverted and placed on the sand bed at about the cen-

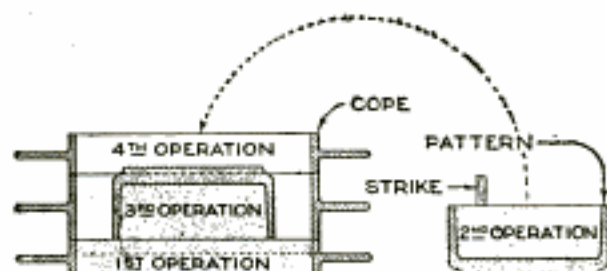

Method of Making Molds for a Number of Cast-Steel Annealing Boxes, in Which Bottom and Roll-Over Boards, Clamping Hooks, and Rolling of the Flask are Eliminated

ter of the flask; the pattern is settled down by a few strokes of a hammer on the bottom, and the cheek of the middle flask is put on the drag, filled with sand, rammed, and struck off flush with the bottom of the pattern. The cope flask is next placed on the cheek flask, and sand is filled in, rammed, and vented in the usual way. Afterward the cope is lifted, the pattern drawn out, and the cope replaced, thus finishing the mold. The molding of this pattern can be done in a two-part flask, cope, and drag by filling in about enough sand to bring the pattern flush with the top of the drag, as shown by the lower dotted line.

Under no conditions should acetylene be used where the pressure is greater than 15 lb. per square inch.

Perforated Business Signs of Sheet Metal

The drawing shows a neat type of small sheet-metal sign on which the letters, instead of being painted, are cut out. Sheet

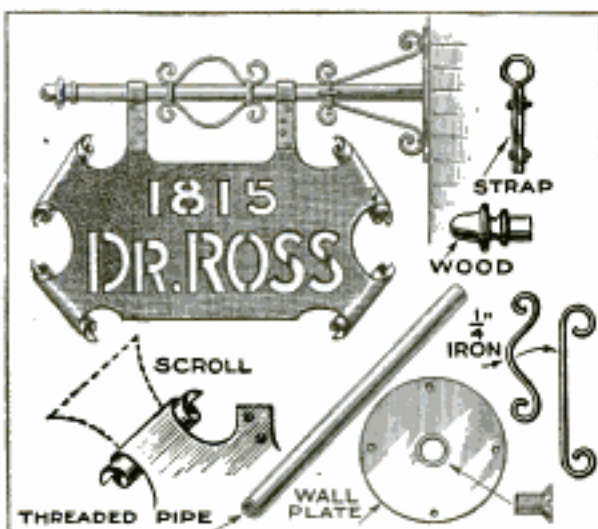

Effective by Night as Well as by Day, a Sheet-Metal Sign with Cut-Out Letters Is Attractive, Is Not Hard to Make, and is Easily Read

brass is preferable for such signs, although black iron will answer. The letters may be cut out with a chisel or with a jeweler's metal-cutting saw. The sign is supported on a horizontal bracket, made of pipe, to which it should be rigidly attached, as a swinging sign becomes very noisy. The advantage of a sign of this type is that it is effective by night as well as by day, as any light from the opposite side will cause the letters to stand out distinctly.

Planer Clamp for Awkward Pieces

In order to clamp down irregularly shaped work quickly and firmly, the fixture shown in the drawing was made, reducing materially the time formerly required to set up the pieces on the planer. Two clamps of the shape shown were made and bolted to a special holding block. The work rested on the short pins, and the ends of the clamps were machined to fit over it. When the bolts were tightened, the work was held with an even pressure on both sides. The fixture was bolted to the bed of the planer in the usual manner.

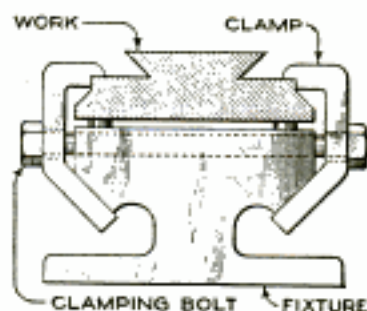

Homemade Air Compressor

Where a small volume of air under pressure is wanted, as for operating blowpipes or inflating tires in a bicycle shop

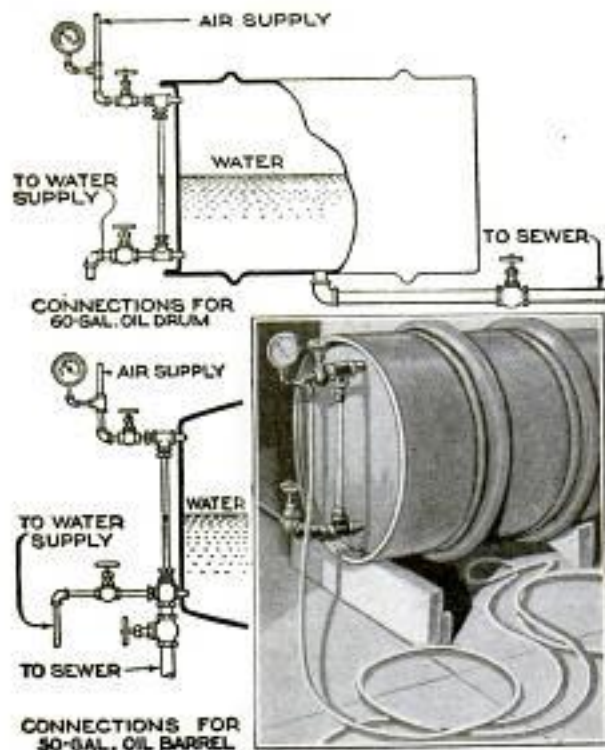

Air under Pressure for Blowpipe Work or for Other Purposes, is Furnished by a Simple Air Compressor Made from an Empty Oil Drum

or private garage, a serviceable air compressor can be made from a steel oil drum or barrel that is free from leaks. It should be placed in a horizontal position with the large 2-in. side opening, or bung-hole, down, in the case of the drum. There are also two openings tapped for $\frac{3}{4}$ -in. pipe in the head of a 60-gal. drum. The lower opening is connected to the water system, using a suitable valve for regulating the flow of water. The bung-hole is the drain, and is connected to the sewer. To operate, the water is let into the drum, forcing the air out under the same pressure as that in the water system. When the drum is nearly filled, the water is shut off, the air valve opened, and the drum drained, ready for repeating the operation. A pressure gauge and gauge glass can be added, as illustrated, although neither is necessary.—H. C. Rowell, Hudson, N. H.

☛ A broach should only be used in work for which it is designed. If the broach is to be used for work of varying length, the broach maker should be given this information. Then, if the variation is not too great, the broach may be designed to meet the conditions.

Shrinking Oversize Bushings

Frequently, in lapping hardened steel bushings, the hole is accidentally lapped too large. It may also happen, after lapping to size, that the hole has not cleaned up, and the bushing must be scrapped. However, by the method of rehardening described, the hole can often be shrunk sufficiently to make a new bushing unnecessary. Turn up a piece of machine steel in the lathe, about .004 or .005 in. under the size of the hole in the bushing. Leave a shoulder on one end of the turned piece, place the bushing over the small end and reharden, quenching the shoulder end first. The water or quenching solution cools the outside of the bushing first and shrinks the hole several thousandths, allowing more stock for re-lapping.

Holder Protects Cutting Tools

The practice of throwing tool bits into a pile in the most convenient place is admittedly bad, but the lack of some simple yet efficient holder is, in most cases, responsible. The type of holder adopted in many shops is an oblong or square wooden block drilled with rows of holes, in which the tools are placed. Most lathe operators grind tool bits on both ends to save time, and this custom makes it necessary to lift each tool from its hole when searching for some particular type or shape, which may be concealed on the bottom end of a bit. Another objection to a holder of this kind is that, when filled with tools, it presents a dangerous surface, bristling as it does with sharp-pointed tool bits, which may cause severe cuts on the arms and hands of the operator when reaching across the tray.

The holder illustrated is as cheap to make as that described above, and it has the double advantage of being perfectly safe and of presenting both ends of the tools to view at the same time. A piece of hardwood is turned to a diameter of about $4\frac{1}{2}$ in., one end is hollowed out, and a groove is machined near the bottom. About a dozen $\frac{1}{2}$ -in. holes are drilled, as shown, to accommodate the $\frac{3}{8}$ -in. square tool bits, and the holder is



complete. The depth of the holder should be greater than the longest tool bit used. It will be apparent that, with the upper ends of the tools protected by the edge of the holder, injuries due to contact with the sharp edges and points are impossible, and that both ends are clearly visible as the holder is revolved.

Resetting Diamonds in Wheel Dressers

In tool and grinding rooms, where diamond-pointed emery-wheel dressers are extensively used, it is not an infrequent occurrence that a diamond becomes loose in its holder; it should be reset at once to prevent it from coming out entirely, with the possibility of its becoming lost.

One of the best methods of resetting such a diamond is illustrated by the drawing. A piece of standard-size drill rod is obtained, and a hole the size of the diamond is drilled in the end to a depth of about $\frac{1}{8}$ in. Next, crosscuts are made with a hacksaw, as shown in the drawing, to a depth of about $\frac{3}{8}$ inch. The diamond is then placed in the hole, and the edge of the hole is slightly riveted over, to prevent

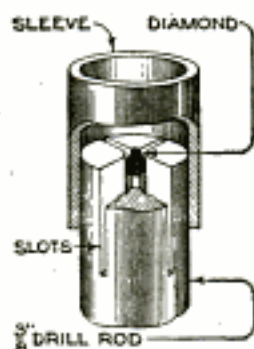

the stone from coming out. A machine-steel sleeve is made to fit tightly over the end of the drill rod; this sleeve is made long enough, so that when pressed in place it will cover up the hacksaw slots and extend beyond the end for about $\frac{1}{2}$ in. The diamond is now ready for brazing in, and the sleeve is filled with borax and spelter; when heat is applied, this melts and flows down, packing solidly around the diamond. Add more spelter until the sleeve is full, and be sure to keep it at a good heat for about a minute after the sleeve has been filled. Then the sleeve and surplus spelter can be turned off in a lathe.—Chas. Homewood, Ontario, Calif.

Self-Contained Hammer and Chisel

There is nothing quite so unhandy to hold and work with as a small chisel. Many and hard are the knocks the workman receives on the fingers and knuckles when chipping in confined places and difficult corners. Even on work easily reached by hand, it is a ticklish job to chip a slot or small keyway if the chisel

must be held by hand. The "hand gun" illustrated was designed to overcome this, and is extensively used on fine tool and die work. With it, there is less abuse of the tools, and by using bent and shaped

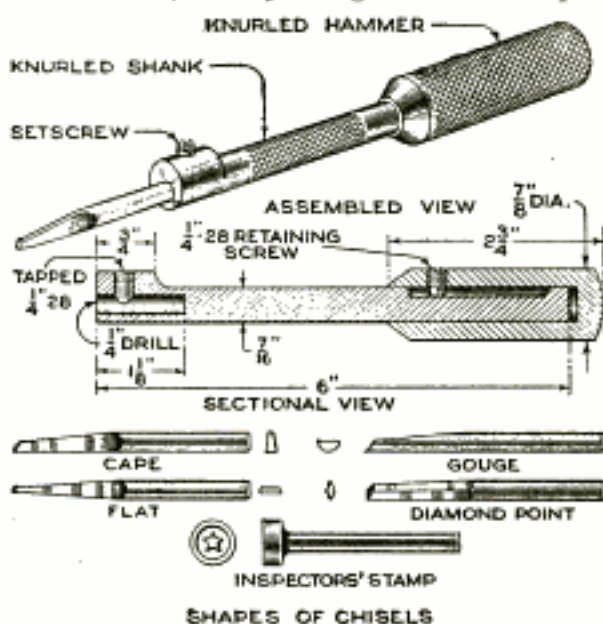

A Combination of Hammer and Chisel That Makes Chipping and Tooling in the Confined Corners of Tool and Die Work Comfortable

chisels, some work can be done that would otherwise be considered impossible.

The shank of the tool is made of drill rod, turned to the dimensions shown, the center is knurled for a good grip, and a flat is filed, or a groove cut, near the rear end. The hammer sleeve slips loosely over the end of the shank, on which it is retained by a small screw; this part is also knurled and has a polished round end.

In use, the chisel is fastened in the head, and the shank of the tool is held by the left hand. The sleeve is drawn back, and then brought sharply forward, with the desired degree of force. Any weight of blow can be obtained, though for light work it is sometimes desirable to provide a smaller and lighter hammer sleeve. The chisels are made of $\frac{1}{4}$ -in. drill rod, ground or filed to shape, and of various widths and sizes to suit the work in hand. Inspectors' stamps can also be made up to fit the tool, and, so used, will save time and trouble. Commonly, either the stamp or the hammer is mislaid, and holds up the inspection; with both combined into one tool, this is not likely to occur.

Scissors sharpened with too much bevel will not hold their edge, but if sharpened to an angle of 30° or 35° , the edge will hold for a long time.

An Auxiliary Caliper Leg

An extra leg on a pair of inside calipers is handy in many instances, as it enables the user to obtain two measurements with the same tool. The leg is made of flat stock, of the same thickness as the caliper legs, bent over at one end, as shown, and clamped in place with a

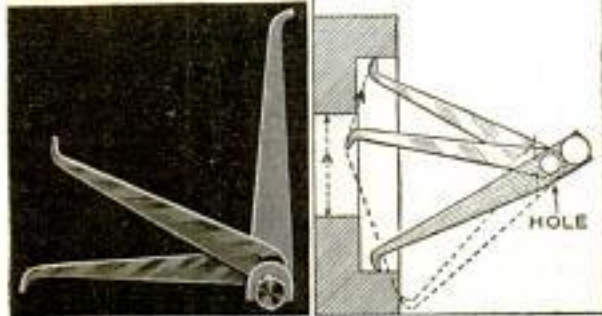

Two Measurements can be Taken at the Same Time with One Pair of Calipers by Attaching an Easily Made Auxiliary Leg

knurled screw and nuts. The leg is drilled to fit over the joint washer, upon which it swivels. In the illustration, the calipers are shown set for two inside dimensions, but they can be used also for inside and outside measurements by turning the auxiliary leg around. In use, the calipers proper are set first, and the auxiliary leg afterward. As an effective means of reducing the number of tools required on a job or as a handy method of finally testing dimensions before removing a piece of work from a machine, the auxiliary caliper leg is worth the time required to make it.

The Strength of Fiber Boxes

The direction in which the fibers run in fiber-board boxes has been found to have a considerable effect upon the life of the boxes. Fiber-board does not tear as easily across the grain as with the grain; it may have two or three times as much strength in one direction as in the other, the difference varying with manufacturing conditions. This excess strength may be used advantageously to reinforce the weakest points of the box and so produce a more perfectly balanced construction.

The weakest parts of fiber boxes are the scores, or folds, forming the edges of the box. It is impossible to have the fibers running perpendicular to every

score, but usually they may be made to run perpendicular to the scores that receive the hardest usage, or that tend to break open first. The location of the scores most likely to fail, of course, varies with the shape of the box and the nature of the contents, and can be best determined by test.

In a test on fiber boxes, some were packed with 2 doz. food cans, and some with 4 doz. tall milk cans. It was found that the first break nearly always occurred in the horizontal end scores. By making up the boxes so that the fibers ran vertically instead of horizontally, on the sides and ends, the first break in the horizontal end scores did not occur until the boxes had been under test almost twice as long as before, and the horizontal side scores, which received the next hardest usage, were so strengthened that they never failed until some other part had first given way.

The gain in strength of the horizontal scores was, of course, accompanied by a weakening of the vertical scores. But since the upright scores are not ordinarily under as great strain as the horizontal scores, and in these tests were not as likely to come in contact with the sharp edges of the cans, they were able to stand a reduction in strength and yet not become the point of first failure.—U. S. Forest Products Laboratory, Madison, Wis.

Twisting Iron Bars

The occasional worker in ornamental iron often finds it difficult to twist two round bars, or a square one, so that the



resulting piece will be straight and the pitch of the twists uniform. By applying the idea illustrated, however, excellent results may be obtained. One end of the bar to be twisted is clamped in a vise and a close-fitting piece of pipe is slipped over it as shown, allowing the upper end of the rod to project beyond the pipe. This end is seized in a wrench, which is used to twist the rod.—W. Norman Fox, Atlantic City, New Jersey.

Refer inquiries for castings to
J. V. Romig, Route # 5,
Box 181, Allentown,
Pa.

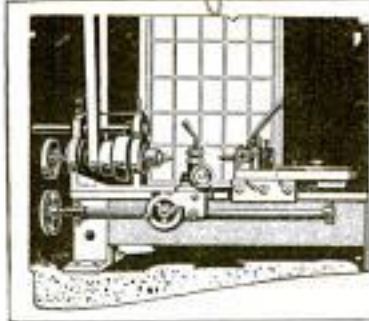

BUILDING A SIX-INCH TURRET LATHE

By J. V. ROMIG

Mr. Romig died Jan. 1924.
castings not furnished

[Arrangements have been made to supply the necessary castings for this lathe, at a low figure, to any one interested. This magazine has no financial or other interest in this beyond that of service to the reader. The name and address of the maker will be furnished, upon request, by the Shop Notes Department.—Editor.]

WHILE the turret lathe is essentially a tool for the production of work in large quantities, a 6-in. lathe of the type described in this article will be found exceedingly useful in the small experimental shop. With a center held in the main turret, the machine may be used as a simple engine lathe, and when a number of similar pieces are to be turned out in a hurry, the work may be performed in almost as expeditious a manner as on a commercial turret lathe.

This machine was built and used by the author in his own workshop, on fine precision work, and many accurate jobs have been done with it very quickly. Most of the work of building can be done in a workshop equipped only with a vise and bench drill, with the necessary small tools, as flat cold-rolled steel is used for the ways, carriage, and other parts of that character; it will be necessary, however, to have certain things, such as the machining of the headstock and the cutting of the feed screw, done in a machine shop, but this is a small item.

The headstock is made of gray iron, and is fitted with an overarm steadyrest, which allows the carriage to travel the full length of long work, as the work is supported from the top and rear. The spindle is carried, at the rear, by a double-row ball bearing, .75 in. wide, of the combined axial and radial-load type, and at the front by a single-row bearing, .629 in. wide. Both of these bearings have an outside diameter of 2.441 in., and an inside diameter of 1.181 in. Care must be taken to bore the bearing housings a push fit for the bearings, and to have all faces square and parallel with each other.

The spindle should be made of a good grade of steel, of about .3-per-cent carbon content, and is hollow. It is best to bore

the spindle first, then re-center and finish the outside. The nose is taper-bored to take the collets, and threaded eight threads per inch, U. S. standard, to fit the faceplates and chucks. The taper seat for the collets should not be finished until the lathe has been completely assembled; it should then be machined with tools held in the toolpost of the lathe itself.

The inner races of the ball bearings should be a good fit on the flat threads on the rear of the spindle, and on the outside of the spindle at the front. Bearing-

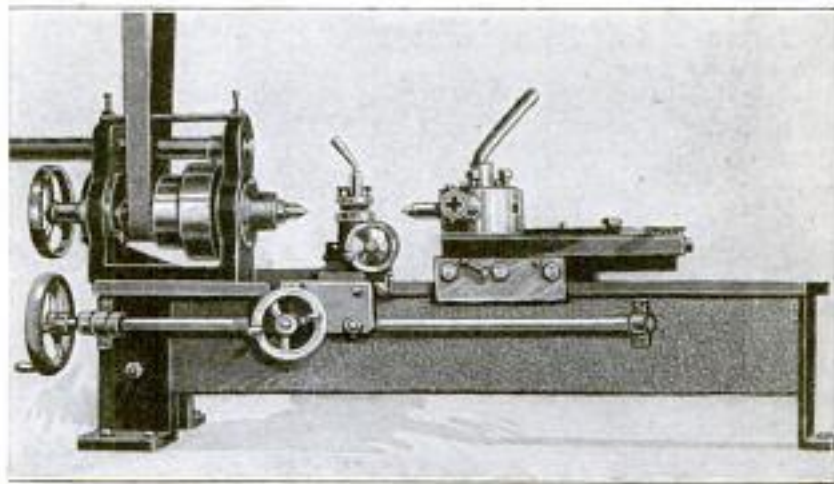

Photograph of the Completed Lathe as Used in the Author's Workshop: It Is Capable of Performing Both Fast and Accurate Work

retaining rings are fitted at the rear, clamping the outer race of the bearing firmly, and taking up the end thrust. These are fitted with felt dust rings, bearing on the collars on the spindle; the rings at the front are also fitted with dust rings, running on the spindle, but these rings do not clamp the single-row bearing, which is permitted to float.

When the headstock is assembled, the bearing housings should be packed with a good grade of vaseline, which will last a long time; see that the vaseline supply is at all times sufficient for good lubrication. Spindles fitted in this manner are far superior to those fitted with plain bearings, as they consume less power, are free from vibration, and allow of accurate as well as heavy work. The writer has

taken a $\frac{1}{8}$ -in. cut on a piece of $\frac{1}{2}$ -in. cold-rolled steel at a distance of 5 in. from the collet, the reduced diameter being very accurate as to size.

The drawbar for the collets is a tube, the outer diameter of which fits the bore of the spindle. It is threaded at the front to fit the collets, and is fitted with a hand-wheel at the rear. A tiebar at the top of the headstock keeps the two arms stiff and rigid. The cone pulley is fastened to the spindle by a setscrew, spotted into the spindle; two cone pulleys, of the same size, should be cast and machined, one being used on the countershaft. The arm for the steadyrest is a length of 1-in. cold-rolled steel; it is clamped in position by $\frac{3}{8}$ -in. capscrews, which compress the slotted headstock arms. The headstock is fastened to the bed by two $\frac{1}{2}$ -in. bolts, running up through pieces of pipe cast into the bed; by this means no strains are put on the cement.

The construction of the bed is somewhat of a novelty, although it has been thoroughly tried out by the writer in this

and other machines, and found to be very satisfactory. This method of making the bed eliminates the hardest work of making a small lathe, as it does away with the bed casting and the necessary machining.

A piece of $\frac{1}{2}$ by 4-in. cold-rolled steel, 30 in. long, is used for the shears. This is first drilled and tapped for a number of $\frac{3}{16}$ -in. stove bolts, of varying lengths, which are used to anchor the shears to the cement, also drilled and countersunk for the leg screws and for the $\frac{1}{2}$ -in. headstock bolts. It is next carefully straightened and scraped to a true surface on top and sides, testing the width throughout with a micrometer, and using a knife-edge straightedge on the surfaces; these

must be as true and straight as it is possible to make them, as upon their truth depends the accuracy of the lathe. When trued, all surfaces should either be frosted or polished.

The shear anchor bolts should now be screwed home, the pipes, leg and rear leadscrew-bearing bolts placed in position, and a wooden form made to fit closely around shears and legs, in which to pour the cement. The cement used is a mixture of one part Portland cement to three parts clean, sharp sand, mixed with just enough water to enable a handful of the mixture to be picked up and squeezed and to leave the impression of

the fingers in it. This cement is tamped down firmly in the form, poking it around the screws and into the corners with an ice pick, or some similar tool. When the concrete has set thoroughly, the boards are removed and the cement thoroughly wetted twice a day for about a week; this will temper the cement, and is a very important part of the work. The resulting bed is as strong as anyone could wish. Reinforc-

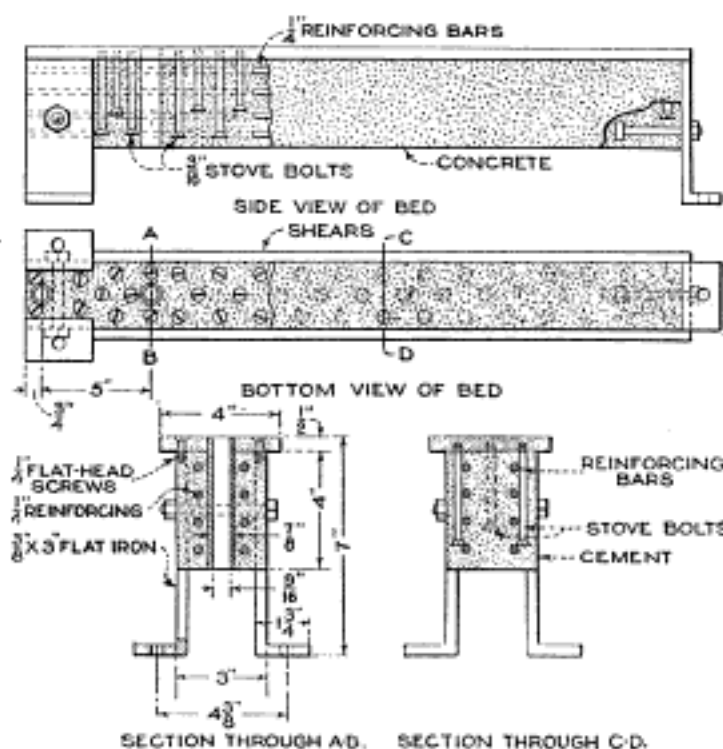

Method of Making the Bed: The Bolts for the Rear Leadscrew Bearing are Not Shown, but should be Cast In like the Leg Bolts

ing rods may be laid down in the cement, as it is being placed, or wires twisted throughout the bolts, adding further to the strength of the bed.

The main member of the carriage is made of cold-rolled steel, $\frac{1}{2}$ by 5 by $5\frac{1}{4}$ in. in size, machined as shown in the carriage-detail drawing. A piece of $\frac{1}{4}$ by 2-in. cold-rolled steel, 7 in. long, is fastened to the top of the main member by $\frac{3}{16}$ -in. screws; on this piece the cross slide runs. The cross slide is also made of steel, machined as shown, and is fitted with a turret toolpost. The cross slide is held to its ways by means of angle pieces, as shown in the front view of the carriage. The turret is made of steel, and is casehardened; four tools can be

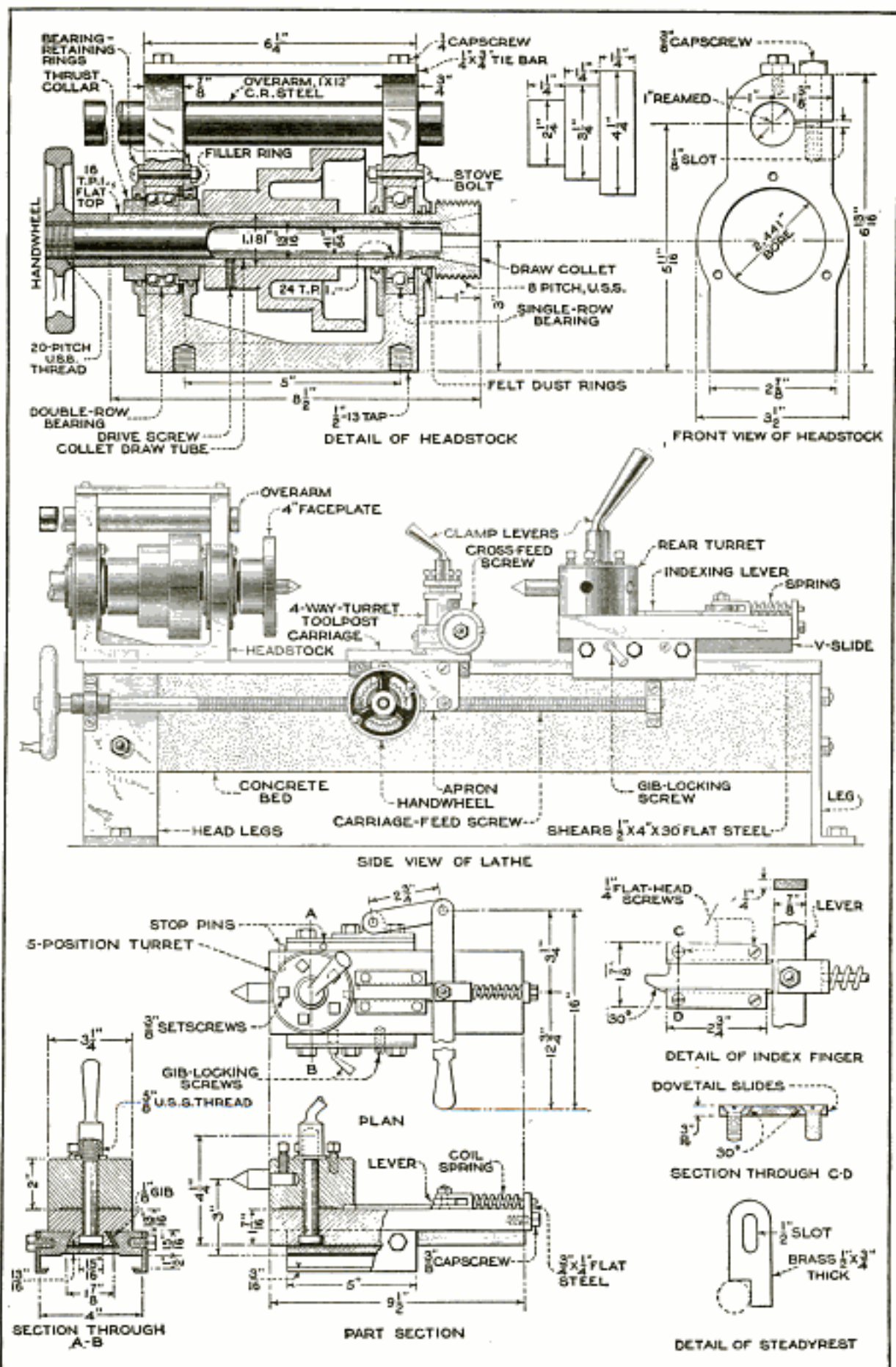

Details of the Headstock and Main Turret, and Side Elevation of Completed Lathe: When a Center is Used in the Turret, as Shown, and the Gib-Locking Screw Tightened, the Tool can be Used as an Ordinary Bench Lathe, for Turning Work between Centers. Five Tools can be Used in the Main Turret, and Four in the Toolpost Turret, Making for Speed in Production

mounted in this at once. On the boss of the cross slide is mounted a small index post, into the countersunk top of which the elevating screws fit, allowing each tool to be adjusted to its correct cutting height. A spring pushes the turret upward when the clamping handle is loosened, allowing the turret to be turned to bring another tool into cutting position. A $\frac{1}{4}$ -in. square-thread screw operates the cross slide, and the tools are held in the toolpost by $\frac{1}{4}$ -in. square-head setscrews.

The apron of the carriage is made of steel, 2 in. wide, and is fastened to the main carriage member by flat-head machine screws. The front angle piece of

against the edge of the shears. Brass shims, or wearing pieces, $\frac{1}{32}$ in. thick, are set in the ends, to take the wear on the filler piece. The rear angle is plain, machined as shown in the drawing.

Behind the apron is fitted a bronze nut; this rotates in a bearing fastened to the apron, and is screwed into one of a pair of miter gears, which, in turn, are driven by 3-to-1 spur gears; the larger gear is pinned to the handwheel, and the smaller is pressed onto the hub of the second miter gear, which runs in the apron. The handwheel runs on a stud screwed into the apron; this stud is fitted with a knurled friction nut, so that, if

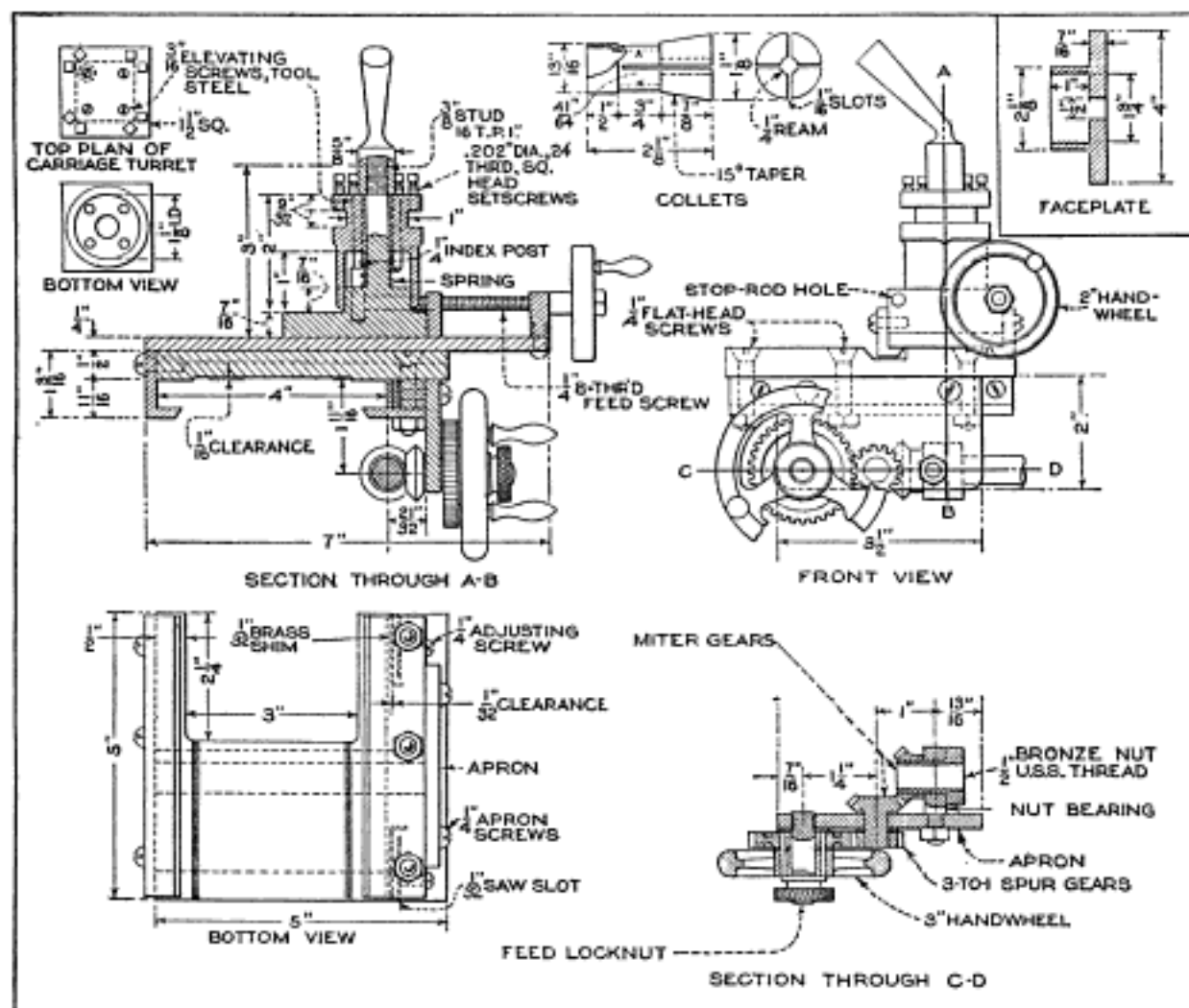

Full Details of the Carriage and Apron Mechanism: Note the Employment of the Small Index Post and Elevating Screws in the Toolpost to Secure the Correct Height for Each Tool. The Post is Set in the Inner Left-Hand Corner of the Turret Base

the carriage is built up, as shown, the filler piece being slit at each end, so that wear may be taken up as it develops, by tightening the adjusting screws. The holes for these screws do not go clear through the filler piece, but stop at the slits, so that, by screwing the screws in, the inner ends of the filler are pressed

change gears are fitted to the lathe or it is desired to feed by means of the handwheel on the end of the leadscrew, the nut can be tightened and the whole assembly of spur and miter gears and nut locked firmly.

The rear, or main-turret, base and slide are made of cast iron, a dovetailed slide

being used, fitted with a $\frac{1}{8}$ -in. gib. The front gib-adjusting screw is fitted with a handle and is used to lock the turret in position for plain turning operations. The turret pivot pin, of cold-rolled steel, casehardened, is $\frac{5}{8}$ in. in diameter, with a $\frac{5}{8}$ -in. U. S. standard thread cut on the upper end, and fitted with a clamping handle. The turret is made of steel, undercut as shown in the drawings, and has five equally spaced slots milled around the lower surface for the index finger. One side of each slot is radial, the other being tapered, and the index finger is made to correspond. By making the finger and slots of this form, the radial side does the actual locating, and the tapered side moves the turret to position; only the radial side need be of great accuracy, while the wear is chiefly on the inclined side, where it does no harm.

The holes for the tools should not be bored until the indexing mechanism has been assembled and the lathe set up; then, by boring the holes with a tool held in the chuck, and correctly supported, the greatest degree of accuracy is obtained. The details of the indexing device are so complete that little description is necessary; care should be taken, however, to see that the coil spring is heavy enough to prevent the index finger from being withdrawn from the turret until the stop pin on the back of the turret base strikes the pin on the slide; the backward movement of the lever will thus move the whole turret back until the stop pins engage; further movement disengaging the index finger, and allowing the turret to be revolved to the next position. The index finger slides between beveled strips of $\frac{1}{16}$ -in. steel, and must be a good fit; both slides and finger should be casehardened to insure long life.

The speed of the lathe, and the arrangement of the countershaft, will be determined by the work to be undertaken and the shop conditions. A reversing countershaft should be fitted if tap and die work is to be performed on the lathe. A quadrant and stud can be fitted on the head end, and a set of change gears provided, if the lathe is to be used for screw-cutting; in this event, no care should be spared to secure an accurate leadscrew.

The builder of this lathe will have a very efficient machine, one that could not be purchased for many times the cost of building.

☐ A round file and a monkey wrench make an excellent pipe wrench in an emergency.

Combined Reamer and Gauge Holder

For various reasons an adjustable reamer may cut larger or smaller than the size to which it has been set. This demands careful gauging to avoid a number of spoiled pieces with a consequent loss in time. In the drawing is shown a holder that gauges the work as it is finished. The expansion-shell reamer shown is $1\frac{1}{2}$ in. in diameter, and is used to ream out cast-iron rings that vary from 2 to 5 in. in width. The reamer is held in the ordinary manner, and two sleeves, or rings, are made a running fit on the holder. One sleeve, used as the "go" gauge, is left plain, the other, or "not go," is tapped for two knurled-head screws. The go gauge is always held in a position just behind the reamer, but the not-go gauge can be set by means of the knurled screws to various positions to suit the width of the rings. When the work is reamed, the go gauge enters before the reamer passes through and shows that the hole is above the low limit, and if the not-go gauge fails to enter, the hole is right. Being loose on the holder, the gauges cannot score the work, as they revolve with it. The shank of the holder as well as the gauges should be casehardened and ground to size.

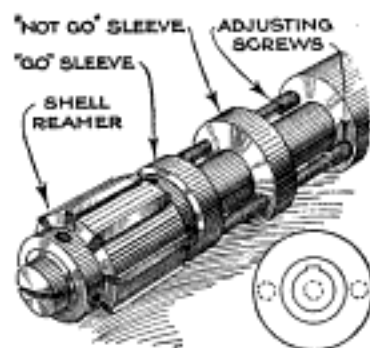

Filing the Crosscut Saw

The drawing shows a new method of filing a crosscut saw in such a manner as to make a bevel on each side of the drag tooth, similar to that of the cutting tooth. When filed in this manner, the drag quality is not impaired, while the cutting speed is considerably increased. When filing the teeth in this manner, the drag should be almost as long as the cutting tooth, but never set as the cutting teeth are.—Elmer Hufferd, Rushville, Ind.

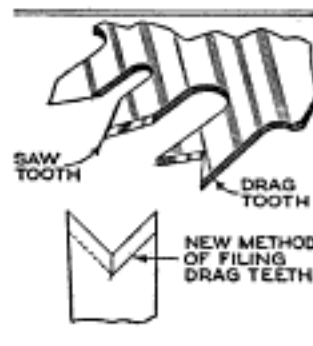

Oiling Loose Pulleys

Inadequate lubrication of loose pulleys causes excessive wear on countershafts and necessitates frequent rebushing of the pulleys, and to keep the ordinary loose pulley well lubricated requires considerable more attention than can be given it in the average shop where no oiler is employed.

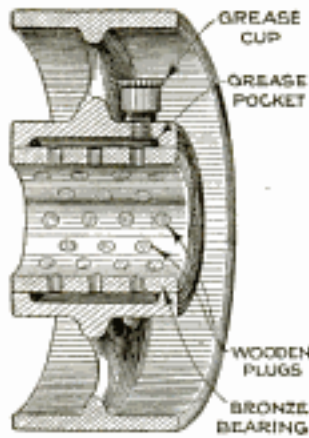

The drawing shows a method of lubricating that has been adopted by a large shop. The pulleys are bored for an oversize bushing, and recessed to form a grease pocket around the hub. Bronze bearing metal is used for the bushings, which are pressed into the hub. Before taking the finishing cut on the bushings, $\frac{3}{8}$ -in. holes are drilled in them, as shown, and plugged by driving in hard-maple pins; the finishing cut turns these flush with the bearing surface. After placing the pulley on the shaft, the annular pocket is filled with a good grade of light grease. The pulleys are well oiled when first placed on the shafts; afterward the grease works down through the plugs and good lubrication is insured.—Lowell R. Butcher, Des Moines, Ia.

Increasing Weight of Tractor Front End

My first experience with a tractor was in the days when the designs were created more by guess than by practical experience, and my first tractor would act more like a balky horse than most of the present-day tractors do. Not that it refused to go so often,

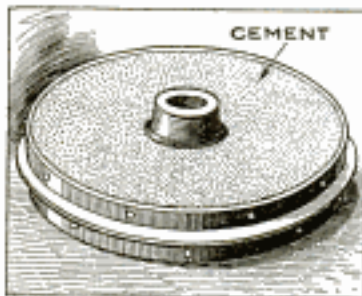

but when it was overloaded, it tried to turn a back somersault. I decided to break it of this habit, and found that I could do so by filling the front wheels with cement. To do this, the wheels were removed and placed over a concave depression scooped out of the ground to the form desired, and a place was also

provided for the hub to lie in. Then the space between the rim and hub was filled with a mixture of one part cement to four parts sand, and troweled off on top. The extra weight amounted to about 350 lb., and was sufficient to hold the front end down. Making the front wheels solid in this manner not only provided the extra weight required, but made it easier to turn in loose ground and to steer.—G. G. McVicker, North Bend, Neb.

A Novel Facing Tool

Every shop has a collection of soft arbors, usually well decorated with cuts and small burrs, all along the surface, caused by careless operators who dig into them with the tool when facing work. This uneven surface is very apt to seize the work as it is being driven off, with the result that the hole will be roughed up and probably spoiled. Hardened arbors do not suffer in the same way, but they

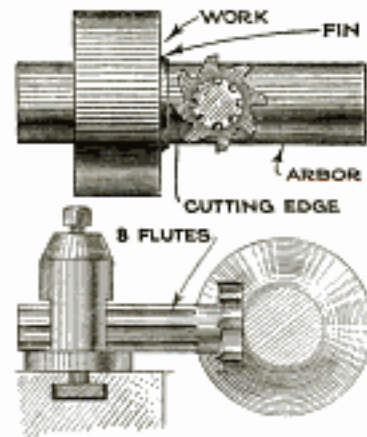

dull the tool immediately if the operator feeds it in a little too far. The facing tool illustrated can neither dig into a soft arbor nor be dulled by contact with a hard one, and once made, will last a long time, as it possesses eight cutting edges. The drawing shows clearly the shape of the tool; it is made somewhat like an ordinary milling cutter, but the front face is left perfectly flat, only the backs and faces of the teeth being backed off. Milled along the shank are eight half-round grooves, the centers of which are in line with the cutting edges. The work should be roughed down with an ordinary round-nose tool until close to the desired length; this will leave a rough fin to be removed by the facing tool. The tool is gripped lightly in the toolpost, the point of the toolpost screw entering one of the grooves in the shank, which brings one of the cutting edges in the right position. The tool is then moved in until it touches the arbor and lies flat against it, when the former is tightened up. The fin is removed in one side cut, and the tool fed outward in the final finishing cut. It will be seen that the tool cannot dig in

or be dulled by contact with a hardened arbor as the wide, plain face prevents this, and since it involves only one change of tools, as with the ordinary tool, it is worth making as a saver of arbors.

Quick Nut-Locking Device

Two nuts, locked together on a threaded bar, are used on many machines as a means for holding some part at a required setting; some makers of milling machines use this method to set the travel of the table, while on many hand-screw machines, turrets and cross slides are set by the same method. The use of two wrenches is required to tighten or release two ordinary hexagon nuts, with

the danger of slipping or altering the setting by unequal pressure. The device shown enables two nuts to be locked together with one wrench easily and without fear of the setting being disturbed while

so doing. Instead of the usual hexagon, the nuts are made circular, one being drilled and tapped on the outside, while the other has a slot cut into its circumference. A piece of drill rod is threaded to fit the tapped hole in the first nut and bent over as shown, to fit into the slot of the second. The following method will determine where the slot should be cut: Screw both nuts onto the bar on which they will be used; tighten them up, face to face, until they move freely together, and then scribe a line through the center of the tapped hole and across the other nut to mark the center of the slot. When this is cut, as shown, and the bent drill rod put in place, both will, of course, screw onto the bar in the same position; they can then be moved to any adjustment by hand and tightened with a single wrench by moving the bent rod as shown. The nuts are released by moving the U-shaped drill rod in the opposite direction.

☛ When milling aluminum, use kerosene as a lubricant.

Keeping the Soldering Flux Handy

When using the blowtorch for heating the soldering iron, or for soldering electrical connections, the worker often mislays the soldering flux, so that just when it is needed, it cannot be found, and time must be spent in hunting for it at the risk of "burning" the copper bit. This can all be avoided by attaching a small container between the handle supports of the torch. The flux container can easily be made removable, but the best plan is to make it a permanent part of the torch, as it is never in the way, and is very convenient.



Taking Up Play in Solid Bushings

Frequently, when the solid bushings of machine parts become too worn, they are discarded and new ones fitted. In cases where it is found impossible to get new bushings at once, a handy way to "doctor up" the old ones is shown in the drawing. A hole is drilled and tapped in the journal box right over the point of greatest wear, where the bore will be oval, in line with the pull of the belt. Allow the drill barely to spot the brass, and use a bottom tap to finish tapping the hole. After this operation, the shaft being withdrawn, slit the bearing with a hacksaw blade, holding the

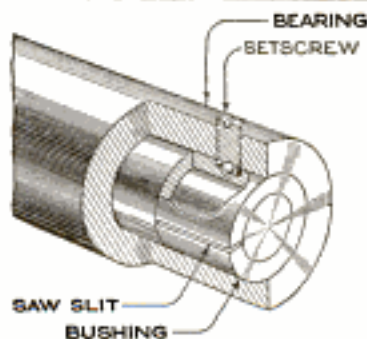

saw with the fingers if the frame cannot be used. Then drop a $\frac{1}{16}$ or $\frac{1}{8}$ -in. steel ball into the hole, and screw in a cup-pointed setscrew. Pressure applied to the bushing by the screw will enable the worn part of the bearing to be brought into contact with the shaft and take up the play. The ball fits nicely between the bottom of the setscrew and the bottom of the hole, and keeps the bearing from turning. Where the bearing bushing is long, place two or more such screws along its length.

Double Welding-Rod Holder

Acetylene welders will find many uses for the welding-rod holder illustrated. When a single-rod holder is used, the welder must lay down the rod he is using and grope around for the other as the

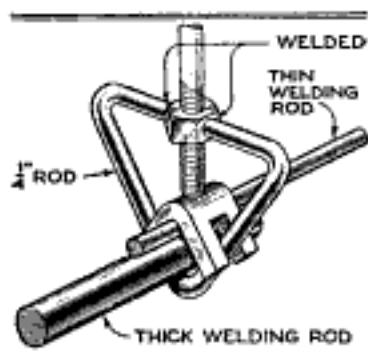

work progresses. This can be avoided by holding the thick and thin welding rods in the same holder, and the one described can be made from scraps. An iron rod $\frac{1}{4}$ in. in diameter, is heated and bent to form one jaw of the clamp, the other being made from a piece of flat stock, bent and sawed out on the sides to clear the rod. An iron-pipe nut is welded between the ends of the $\frac{1}{4}$ -in. rod, and a piece of pipe is used to tighten the welding rods in the holder and serve as a handle. The different sizes of rods extend in opposite directions, so that it is only necessary to turn the holder around to bring either rod into use.

Making the Plane Adjustment Easy to Reach

The drawing shows how a woodworkers' plane of a familiar type was rearranged to bring the adjusting screw

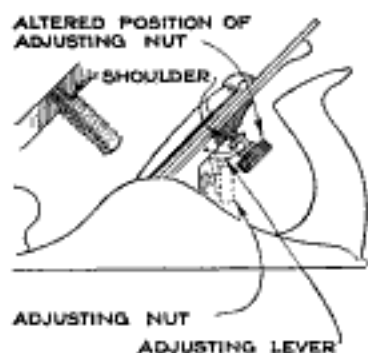

within easy reach of a short-fingered workman. The screw was removed from its original position, as shown by the dotted lines, and a shoulder was turned and threaded on one end, as in the detail. The pin holding the lateral adjusting lever was driven out, and a hole drilled and tapped for the shouldered screw. The end of the screw should project a trifle and be riveted over. In reassembling, the adjusting lever is reversed to fit into the nut, as shown. The job is a simple one, and when completed, the adjusting nut is right at the user's finger tips, so that he need not remove his hand to set the plane.
—M. E. Duggan, Kenosha, Wis.

Siphon Pump for Heavy Liquids

A pump, suitable for oils and similar heavy liquids, that is self-operating when once started, can be made from ordinary pipe fittings.

The barrel, or other container, is elevated from the floor about 2 or 3 ft., and the cap or bung is drilled to take a $\frac{3}{4}$ -in. pipe; this vertical length of pipe should extend almost to the bottom of the container and project about 4 in. from the top. An elbow and a horizontal length of pipe with another elbow is fitted to the first pipe, then a second vertical pipe, the

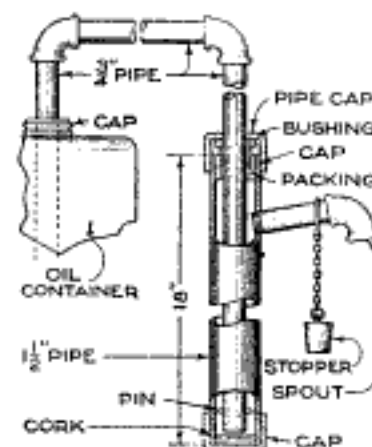

end of which must come level with the bottom of the container, is screwed into the outer elbow. This last pipe is rubbed off with emery paper to make it smooth and round. A small hole is drilled through the

lower end and a metal pin driven into it that will project about $\frac{1}{4}$ in. on each side. The vacuum chamber, which starts the siphon, is made from an 18-in. length of $1\frac{1}{2}$ -in. pipe. Cap one end, which is the bottom, first lining the inside of the cap with a piece of cork. The top end contains the gland. This, as shown in the drawing, is made by first forcing a pipe cap down inside the end of the pipe and brazing the edges together. Drill a hole to fit the $\frac{3}{4}$ -in. pipe in the center of the cap. Next, grind off the outside threads of a $\frac{3}{4}$ by 1-in. bushing, so it can be easily forced inside the cap. The outside flange of the bushing should not project over the outside edges of the pipe. Finally, drill a hole to fit the $\frac{3}{4}$ -in. pipe in the center of a $1\frac{1}{2}$ -in. pipe cap, and screw that down over the pipe. With packing under the bottom of the bushing, the screwing down of the outside cap will force it outward and around the $\frac{3}{4}$ -in. pipe, so that some effort will be required to move this vacuum chamber up and down on the pipe. The smoother the pipe and the better the packing is adjusted, the easier the chamber can be operated to produce the vacuum necessary to start a flow of liquid.

A spout, consisting of a short length of $\frac{3}{4}$ -in. pipe, and an elbow, is screwed

into the side of the chamber, about a fourth of the distance from the top; this is given a slight upward angle to prevent dripping. Keep a cork stopper near by, to hold the vacuum in the chamber by closing the spout when not in use. Make all joints in the piping air-tight, and steady the line from swaying and undue vibration.

With the bottom of the vacuum chamber against the bottom of the pipe and the spout closed, pull the chamber down slowly until the fluid in the container is sucked into it. If the first stroke does not suffice to start a flow of the liquid, open the spout, push the chamber back up, close the spout and repeat until the liquid begins to flow. With the flow once started, the spout can be left open as long as desired, and the flow will continue until the container is exhausted. To stop the flow, it is only necessary to push up the chamber until the bottom of the pipe touches the cork. Only the liquid remaining above the spout will then flow out.—L. B. Robbins, Harwich, Mass.

A Self-Gripping Arbor

A simple self-gripping arbor that is especially useful in facing up the bosses of brackets, links, or any work of a similar character, is shown in the drawing.

One end is turned to fit into the lathe spindle, while the opposite end is turned to the diameter of the hole in the work. Next, the slot is cut with a V-cutter and a wedge made to fit into it; the wedge is shaped as indicated, and should be of such width that, when the work is placed on the arbor, the wedge can just be felt when in the position shown in the lower view.

When the lathe is started, the work and wedge will move in the direction of the arrow, and the more pressure exerted against the work, the tighter the grip. To loosen the work, pull forward in the direction opposite the arrow.

☛ In milling steel, use oil liberally; the cutter will do better work and remain sharp longer.

Tools from Umbrella Ribs

The ribs of an umbrella frame are generally made of a good grade of steel, to give them elasticity and the ability to keep the covering tightly stretched, even in a wind. Excellent small tools for special purposes can be made from pieces of the ribs, and, as they can be hardened and tempered, may be made into small tools for the jeweler and engraver. A very good eraser for the draftsman can also be made from one of the ribs.

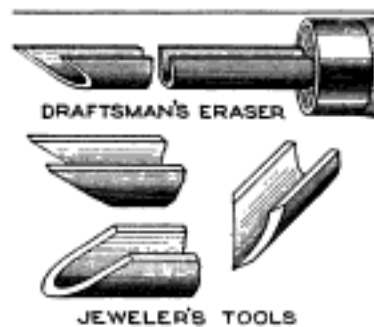

A Handy Drill Plate

Many times work is drilled on a heavy drill press because there is no sensitive drill available, or because the work requires clamping to the table. In such cases, and a variety of others, the drill plate illustrated can be placed on the table of the heavy drill press, clamping the work, and saving the table from becoming pitted when the drill breaks through the work. The plate is made of cast iron, and the shank is turned to fit the hole in the table, the outside diameter being tapered slightly, to facilitate the removal of the plate. Two pins are driven into the plate, engaging the T-slots of the table to prevent the plate from turning, and a $\frac{1}{2}$ -in. hole is drilled through the shank. As the plate is cheaply made, holes can be tapped in any position desired, and when its surface becomes too deeply pitted, the plate can be scrapped and a new one substituted. Hexagon screws with larger heads than standard are handy as clamps, as they not only prevent flat pieces from flying around when the drill breaks through, but also stop the work from climbing up the drill, as it very often will if only a pin or stud, set into the drill-press table, is used as a stop.

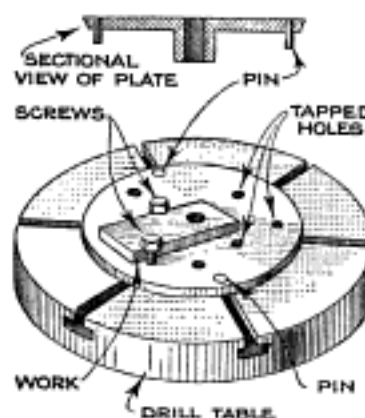

Drawing a True Waterline

After the height of the waterline has been determined at bow and stern, plumb

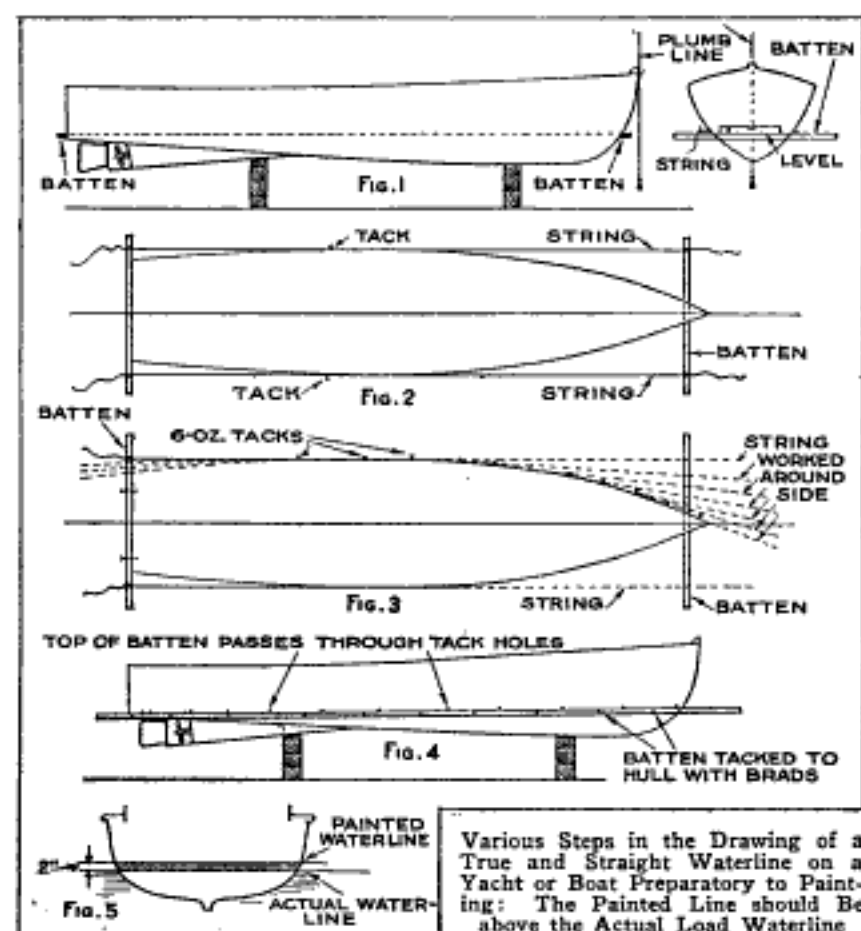

the boat by hanging a plumb line directly in front of the stem, and aline the stem with this. Place a batten at right angles to the bow and stern at the proper height, level these with a spirit level, as indicated in Fig. 1, and fasten them securely. Tie the end of a chalk line to one end of the after batten, so that, when the line is carried forward, it will just touch the widest part of the hull, as in Fig. 2. At the point where the string strikes the planking, stick a small tack into the hull, directly under the line, and with one man carefully moving the forward part of the line inboard, or toward the hull as in Fig. 3, continue to insert tacks into the hull as the string strikes it, at intervals of about a foot. The string must not be moved too fast, as it will tend to follow the form of the hull, and crowd under. Continue in this manner until the stem is reached, and then work from amidships aft, repeating the operation on the opposite side.

The line of small holes made by the tacks should be plain enough to serve as a guide for the fastening of light battens

on each side of the hull, as shown in Fig. 4. This batten should be in one piece, the whole length of the boat if small, about $\frac{1}{4}$ or $\frac{3}{8}$ in. thick by $\frac{3}{4}$ in. wide, and planed so as to have at least one true edge and face. By tacking this batten with the true edge just "splitting" the tack holes, a straight waterline can be drawn. A hard pencil is good for marking the waterline along the top edge of the batten. The writer has used this method many times and has found it to be both simple and accurate.

It has been my experience that, on small boats, from 25 to 50 ft. in length, it is always best to plan the painted waterline from 1 to 3 in. above the actual waterline, as this will keep the paint on the sides above the line from becoming fouled with dirt or growths of any kind. With this in view, the small-boat builder, if painting, say, 2 in. above the actual load waterline, as in Fig. 5, has a margin of about 40 per cent of the displacement of his boat to come and go on. With fair judgment, there is very little danger of getting this line too high.—J. Arthur Stevens, East Boothbay, Me.

Danger in Directing Hose Stream onto Charged Wires

Recognizing the danger present when a stream of water is directed onto a heavily charged electric wire, a power plant in Washington, D. C., has marked the location of all high-potential wires and conductors with green lights. These burn continuously as a warning to firemen, in case a fire should break out, that the hose should not be used without observing the precaution of wearing heavy rubber boots and gloves. The significance of the green lights has been explained to the fire department and the information has been distributed to the several fire stations. This is an idea well worth copying in any plant where the same danger is present. The water serves as a path for the current to the ground.

How to Make an Electric Soldering Iron

By CURTIS RALSTON

MAKING an electric soldering iron, using a coil of resistance wire as a heating element, is, for several reasons, not a simple matter, yet if the right methods and materials are used, it is entirely possible to make a tool that will give very satisfactory service.

The drawing shows a sectional view of the iron. The dimensions given are not to be adhered to with any great accuracy, as the materials used will depend largely upon what is available. The heating element is intended to be wound with wire known to the trade as "No. 193 alloy," which can be bought from or through any electrical-supply house. The figures given for the resistance wire are based on the use of a coil about $\frac{3}{4}$ in. in diameter by about 3 in. long, so that if the

quicker. An excellent heating element can be made by winding the resistance on a piece of quartz tubing. A piece of old clay pyrometer tubing is also good material, and even a piece of hard-glass tubing, such as is used for water-gauge glasses, will serve the purpose.

About 85 turns of No. 28 bare wire of the kind mentioned will be required, spaced about 28 to the inch, so that some kind of automatic feed will be found advisable for spacing the turns uniformly. This winding is designed to consume about 150 watts at 110 volts, which means a current of 1.36 amperes. Electric heating devices operate equally well on direct or alternating current.

In connecting the heating element to the lead wires, the suggestions given in

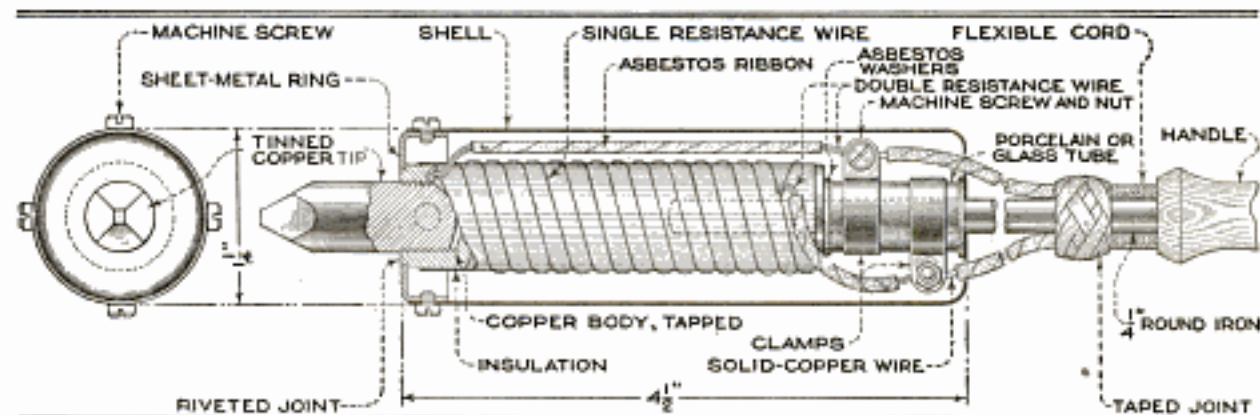

An Electrically Heated Soldering Iron That is Provided with Means for Using Interchangeable Copper Tips for Different Kinds of Work: Such a Tool can be Used on Any 110-Volt Alternating or Direct-Current Circuit with Very Satisfactory Results

copper body varies from the dimensions given, the amount of wire used will have to be changed accordingly.

The main heat reservoir formed by the copper body is tapped out at one end so that copper tips can be screwed into it, making it possible to use a variety of tips.

Insulating the hot wire from the copper body is one of the biggest problems, since the insulation must be proof against the 110-volt electrical pressure, even at very high temperatures, and must also conduct heat easily from the wire to the copper body. The best insulator for the purpose is $\frac{1}{2}$ -in. asbestos ribbon, which can be bought from electrical-supply houses. Wind the copper body tightly with one or two layers of the ribbon, and then the resistance wire directly on it. A much better job will result if a little water glass (sodium silicate) is used as a cement on the asbestos. Besides providing mechanical firmness, the cement will greatly improve the heat conductivity of the asbestos, making the tip heat up

the drawing should be closely studied. The ends of the resistance wire are brought out to two screws on insulated clamps; these are shown fastened around a piece of porcelain or glass tubing, but if plenty of asbestos tape is at hand, it will be just as well to wind some of it around the iron-rod stem of the tool directly and fasten the clamps on it. If the piece of tubing is used, some asbestos washers should be made and inserted between it and the copper body and steel shell, to prevent rattling.

It is important that the resistance wire should be brought out double to the clamp screws; otherwise it will get very hot at the ends as well as in the portion wrapped around the body. Doubling the wire provides a path of twice the conductance and reduces the energy loss in the leads. These doubled portions of resistance wire, as well as the copper leads brought in, should be wound with asbestos tape. Do not use rubber-insulated lamp cord for the leads into the shell, as the rubber

will burn off. Use No. 16 or 18 solid-copper wire, and solder it to the flexible cord at a point well back from the hot shell. This point must be far enough back so that the shell can be slid off without striking the taped joint, when the four small screws fastening it to the ring are removed.

It should be noted that the winding data given are not to be considered final; they are suggested only as a starting point in making the first heating element. So many factors enter into this question that it is impossible to say, without repeated trials, just how many watts can be safely drawn by a soldering iron. If it

is found that the iron does not get hot enough to melt solder in less than 10 minutes, fewer turns of the wire should be used or some of the windings short-circuited. If the tip gets hot enough to melt solder in less than three minutes, or the element burns out, or if the water glass seems to be acting chemically on the resistance wire, then too much energy passes through it, and more turns or smaller wire must be used.

In using any electrical heating device, care must be taken not to leave the current turned on when not in use, and some kind of stand or rack should be provided on which to set the iron down when hot.

Micrometer Attachment for Measuring Tapers

Measuring tapers with a micrometer is always an awkward job, owing to the unsatisfactory surface presented to the flat faces of the measuring tool. To urement, and the piece a tance to test taper in that still more less some



the measur- take a meas- then advance definite dis- the amount of distance, is awkward, un- more or less

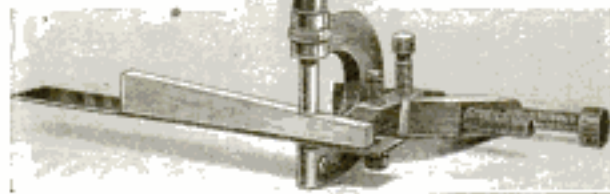

Measuring Tapered Work with a Micrometer is Greatly Simplified by the Method Shown, Which Requires Nothing but a Few Tools Always Included in the Machinist's Equipment

expensive device is used. The illustration shows a method that gives very accurate results without requiring any addition to the machinist's tool equipment. To obtain correct alinement, a rule is clamped to the top of the micrometer anvil in the following manner: The micrometer spindle is first brought down until the scale is held between spindle and anvil, exactly as though the scale were being measured. A small clamp is then pressed close to the side of the micrometer and tightened on the scale, a second clamp being used to hold the first to the micrometer. In this way the scale is held flat on the face of the anvil and at right angles to the spindle.

To measure the work for the amount of taper per inch, either end is placed upon some even inch of the scale and

a reading taken, after which the piece is moved to the next inch graduation and measured again, the difference between the two readings being, of course, the amount of taper per inch. By this arrangement both hands are left free, as the clamps may be arranged to support the micrometer in a vertical position.

Grinding Miller Index Centers

Difficulty in getting the head center of an index head to run true is overcome by using the following method of grinding in a surface grinder. Bolt the head to the auxiliary plate, which comes with the grinder. Place on the table of the grinder, swing to 30° and bolt it down. Turn the index crank and move the table in and out until the desired amount of metal is removed from the center. A center ground in this manner will be perfectly true with the spindle, something that is nearly impossible if the center is removed for grinding.—Louis M. Steffen, Dayton, Ohio.

A Useful Pencil Marker

Draftsmen and others using several grades of pencils will appreciate the merits of the pencil marker illustrated, which, besides indicating the hardness of the lead at a glance also prevents the pencil from rolling. These markers are easily made in a few minutes by whittling down an ordinary thread spool, the hole in which is usually the right size to fit the pencil.



Reproducing Building Dimensions without Plans

On many occasions it is desired to duplicate a home, store, warehouse, or other building, the plans of which are not available. If the original building is of brick, a competent brick mason can very accurately determine the dimensions from photographs showing all four sides. These photographs should have sufficient detail to permit counting the number of courses of brick, which will enable the mason to obtain the approximately correct proportions, and place doors and other openings in their correct positions. This procedure holds good for either standard-size brick, concrete blocks, or special-sized brick, but if either of the last two is used, the dimensions of the face of one of these are necessary to obtain the corresponding over-all dimensions.

A Safe Ladder Extension

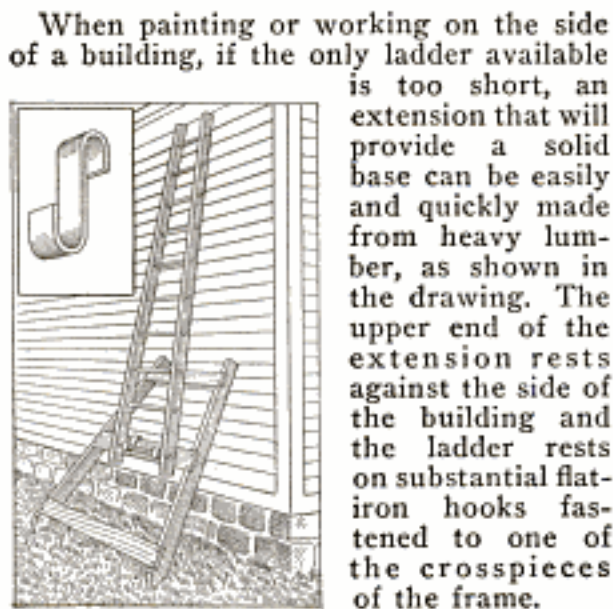

When painting or working on the side of a building, if the only ladder available is too short, an extension that will provide a solid base can be easily and quickly made from heavy lumber, as shown in the drawing. The upper end of the extension rests against the side of the building and the ladder rests on substantial flat-iron hooks fastened to one of the crosspieces of the frame.

An Accurate Box Toolholder

The box form of toolholder has one great disadvantage when used for finishing work smoothly and accurately. The work being so well piloted in the bore of the holder, it is prevented from springing away from the tool when the latter is withdrawn after a cut, and a slight spiral groove is left in the work if the holder is withdrawn quickly; if withdrawn slowly, the tool removes a shaving of metal and reduces the diameter. For this reason, on accurate work, a slight allowance is made to be filed off later.

The box toolholder illustrated over-

comes this objectionable feature by releasing the tension between tool and work when the latter has finished the cut. It is, of course, used as a finishing tool only, the work having previously been roughed down to within $\frac{1}{64}$ in. of its fin-

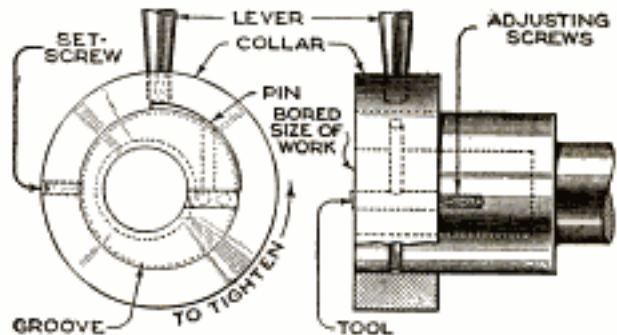

Box Toolholder for Finishing Work That does Not Cut When Withdrawn Because the Cutter is Released from Contact with the Work

ished size. The body of the holder is turned on the shank to fit the turret hole and bored at the front to the size of the finished work. The hole is bored eccentric, to permit the use of lighter stock. Next a collar is made to fit the front part of the body, drilled and tapped in one place for a lever, and at an angle of about 90° to this, for a headless setscrew. This screw bears in a groove cut in the body and serves to hold the parts together. A slot is cut in the front of the body, on the heavy side, to take the tool, and two holes are drilled and tapped in the back of the slot for adjusting screws. A hole is then drilled in the body at right angles to the slot, to take a loose tightening pin, which is filed on the top to conform to the radius of the cam surface filed inside the collar. When using the holder, push over the lever until the collar reaches the position shown in the drawing. It will be seen that the end of the tool is now backed up by the collar, while, at the same time, it is held down on the face by the pin. Before withdrawing the holder, pull the lever down until the end of the cam portion strikes the pin, which forms a convenient stop. The act of pulling back the lever relieves the pressure on the tool and also, as the tool is slightly tapered on the top so that the pin forces it back against the collar, allows it to slip back a little against the cut-away cam surface. The tool is ground on the front only, the adjusting screws at the back of the slot being used to keep it always slightly ahead of the holder.

☛When preheating a large casting for welding, always use a soaking heat.

Automatic Shut-Off for Thresher Grain Spout

When operating a thresher, it is much more convenient to have a team hitched

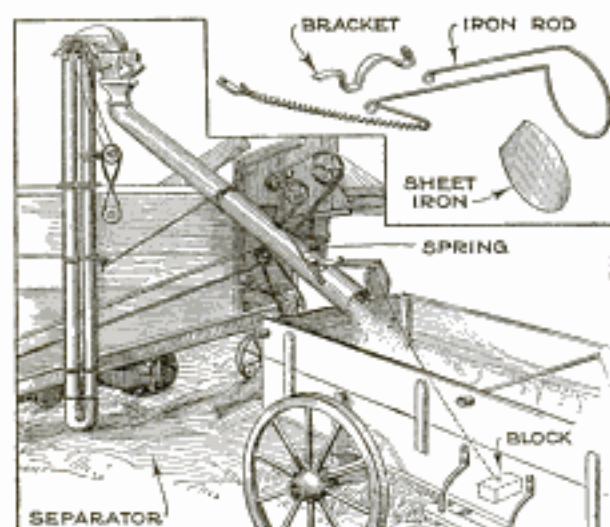

An Automatic Shut-Off for the Spout of a Grain Separator, That Acts as Soon as the Team Begins to Pull the Wagon Away

to each of the grain wagons than to unhitch the horses from the wagon being filled, but there are times when the horses will pull the wagon from under the grain spout before the attendant can reach them. To prevent the waste of grain that results from this, an automatic cut-off for the grain spout, that operates as soon as the wagon begins to move, can easily be made. A flat iron bracket is riveted to the spout; this has upturned ears, to which the iron-rod support for the shut-off is pivoted with bolts. The shut-off consists of a piece of sheet metal that closes down over the spout opening. A spring, fastened to a hook riveted on the spout, holds the shutter up until a cord, attached to the shutter, which is tied to a 3-in. square block of wood placed in the bottom of the wagon, starts the shutter to close; the spring then quickly closes it over the end of the spout. The block on the end of the spring is allowed to remain in the wagon box, and the grain covering it causes a pull when the team starts.

A Handy Mixture for the Garage

I have found that a mixture composed of equal parts of benzol and denatured alcohol is very handy in the garage or repair shop; it is kept in a bottle and called "remover." This mixture removes spots from fabric without injury or stain. It will also remove paint; simply apply a little of it to the painted surface, and in

a few minutes the paint will soften up so that it can be scraped off easily. It is good to remove carbon; in this case an ounce of the fluid is poured into each cylinder and allowed to stand for from 2 to 12 hours, loosening the carbon so that it will be blown out through the exhaust when the engine is started. Finally, the mixture is excellent for cleaning the hands of grease and grime.—Ralph Hanenkraft, Northville, N. Y.

Timing Test for Blueprints

Anyone who has made blueprints knows that the print must be given just the right exposure in order to get the best results, and that the length of the exposure will vary greatly, according to the quality of the sensitized surface, and of the tracing cloth, and the intensity and actinic value of the light used. When printing by natural light, the time necessarily varies according to the hour of the day and atmospheric conditions. Therefore, when starting to make prints, it is always best to make a test to determine the proper exposure, for each condition of light, etc. The easiest and most thorough method of doing this is to use a special tracing for the purpose, marked and lettered somewhat after the manner of the one shown in the drawing.

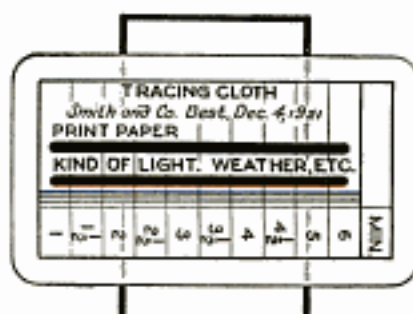

The test print is made from the special tracing in this way: Mount it in the frame as usual, and cover with a heavy card held in the hand. At a given time by the watch, say, 9:54 a. m., for instance, expose the 6-minute strip to the light. At 9:55, move the card down to expose the next strip; in another half minute uncover the 4½-minute strip and so on. At one minute before the hour, remove the card entirely and at 10:00 o'clock take the print out and wash as usual. The resulting print will form a graphic record showing exactly what exposure will produce best results. Data can be written, if desired, on the white spaces provided for the purpose.

Send your radio inquiries to our Bureau of Information.



A Wheelbarrow Spraying Outfit

By L. B. ROBBINS

A COMPACT and serviceable spraying outfit for use in the small orchard can be made for a few dollars. It is mounted on an ordinary wheelbarrow, so that it can be wheeled to any location, ready for work.

The most important part of the apparatus is the tank, which is made from a hot-water heating - system expansion tank. A tank with a capacity of about 20 gal. can be obtained from

pump to the tank. A piece of pipe, long enough to reach almost to the bottom of the tank, is threaded for its entire length, screwed into the other gauge hole, locked with a pipe nut, under which a soft-rubber gasket and a washer are placed, and an elbow, two short nipples, and a shut-

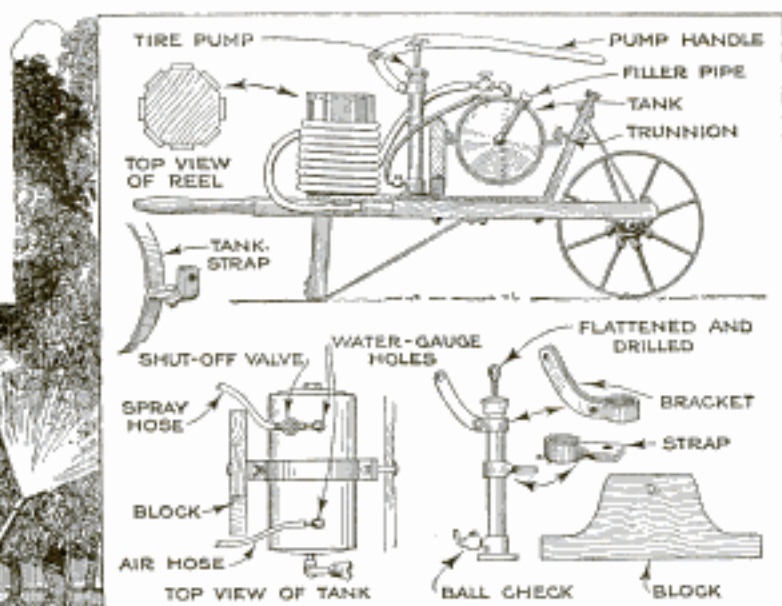

A Compromise between the Extremes of Heavy and Expensive Spraying Equipment and the Light Knapsack Outfits is Struck by This Homemade Apparatus. It is Mounted on a Wheelbarrow, So That It may be Transported Easily Wherever It is Needed

hardware dealers or plumbing contractors; it comes equipped with a water gauge and fittings, which, as they are unnecessary for the spraying outfit, are removed and discarded. After the gauge glass and fittings are removed, an elbow and two short nipples are screwed into one of the holes, for use in connecting the

off valve are screwed on for the spray-hose connections. The pipe opening in one end of the tank is plugged, and the one in the other end fitted with a filler pipe, kept closed by an ordinary pipe cap, to which a sheet-metal wing is soldered for ease in opening and closing. A leather or rubber disk should be placed inside the

filler-pipe cap to prevent the air inside the tank from leaking.

A two-piece clamp is made of flat iron, and bolted around the middle of the tank so that the latter will balance when mounted on the trunnions, which are ordinary bolts. This arrangement makes it possible to keep the spray mixture agitated by rocking the tank, so that the ingredients do not settle to the bottom. A wooden block, bolted to the bed of the wheelbarrow, serves as a support for one of the trunnions, while the end of the barrow carries the other. An automobile-tire pump, preferably a three-stage one, is bolted to the floor of the barrow; the end of the plunger rod is either flattened

or fitted with a yoke, so that it can be attached to the curved pump handle, which is made of either wood or iron. The pump handle is fastened to the cylinder by a curved bracket that clamps around the barrel just underneath the cap. A ball-check valve must be provided between the pump and tank.

A hose reel, similar to the one shown, may be fastened to the unoccupied space on the floor of the wheelbarrow, to carry the necessary hose, or the hose may be coiled inside of a box fastened to the bed. Bolts should be used to fasten all of the apparatus to the wheelbarrow, so that when the sprayer is not in use, the tank, pump, and fittings may be removed.

Assembling and Replacing Springs

One of the frequent troubles experienced with the light automobile is breakage of the front-spring leaves. The draw-

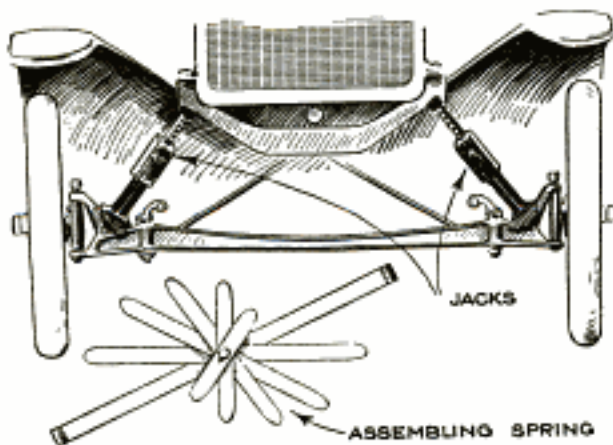

Methods of Elevating the Front of a Light Automobile for Removing or Replacing a Front Spring, and of Assembling the Leaves without Clamping

ing illustrates methods that facilitate the replacing or removal of a broken leaf, and the assembly of the leaves without clamping. The leaves are assembled star-fashion, as shown, about the center bolt. The nut is easily screwed on a thread or two, after which the leaves are brought into their proper position and the nut tightened.

In lifting the car frame above the axle, to remove or replace a spring, two jacks are placed, one on either side, with their bases resting against the axles, their heads resting under the lamp brackets on each side. The wheels are blocked so that they cannot rock. This affords a quick method of lifting, and one that gives a clear working space. In cases where the center bolt of the spring does not aline with the slot in the frame, by simply raising one jack and lowering the other, the body will shift

enough to make them line up. The same method can be applied to lifting the rear of the car above the rear axle, although the lift will necessarily be greater on account of the considerably greater deflection of the rear spring.—G. A. Luers, Washington, D. C.

Mower Attachment for Cutting High Grass

After the lawn has been neglected and allowed to grow for more than a week, it is generally hard work to make a good job of mowing, as great exertion is required to push the mower into the tall growth.

The photograph indicates a way out of the difficulty. It consists in attaching to the mower a revolving blade, or fan, which pushes the tall grass into the cutter so that it can be cut off instead of being pushed over by the advancing lawn mower and rolled flat on the ground. Two pieces of flat-iron stock are drilled at one end to take a light shaft, and the opposite ends are drilled to fit under nuts on the mower-wheel housing. A piece

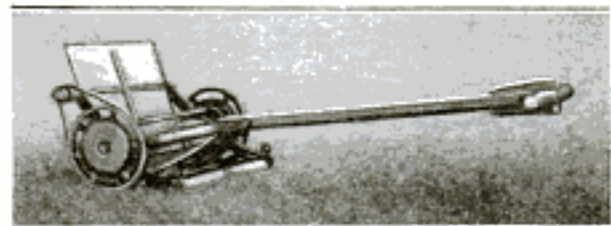

An Attachment for the Lawn Mower Which Makes It Possible to Mow Grass of Tall Growth Easily

of stiff sheet metal, or light board, is mounted on the shaft between the bearings, one outer end of the shaft being provided with a small pulley in line with the mower wheel. A belt around the

wheel of the mower and the pulley causes the fan to revolve when the implement is pushed forward, the grass being pushed into the path of the revolving cutters.—Maurice Staller, Fowler, Ind.

Radio Sound Amplifier Made from the Phonograph

Every night thousands of radio enthusiasts are receiving the musical programs that are broadcast at certain hours. When dependent on ordinary phone receivers the size of the audience is limited to the number of headsets available. However, without spending much money, an ordinary phonograph can be used to amplify the sounds so that all within hearing can enjoy the program. An old phonograph reproducer, or sound box, of a type suited to the phonograph used, is procured, and its back is cut off and fastened to the cap of a telephone receiver, using a piece of felt between the metal and cap. It can then be slipped onto the tone arm of the instrument in place of the regular reproducer. This arrangement in no way interferes with the use of the phonograph for its regu-

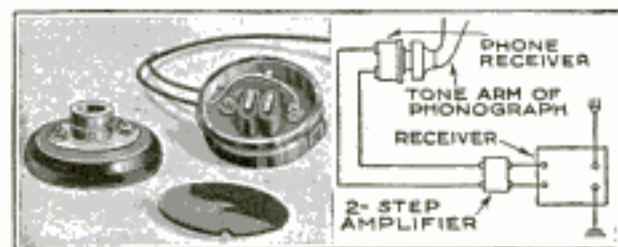

The Back of an Old Phonograph Reproducer Fastened to the Cap of a Telephone Receiver, and Slipped onto the Tone Arm of a Phonograph, Makes an Excellent Amplifier for Entertaining an Audience

lar purpose, as it is only necessary to remove the telephone receiver and replace the reproducer, which, in most types of instruments, is simply a matter of a twist of the wrist.—Edward Thomas Jones, New Orleans, La.

Clothespins Replace Rake Teeth

About half of the original wooden teeth of a lawn rake were broken, and as a result the rake was practically useless for any purpose until the missing teeth were replaced.

Clothespins were used for the purpose, and in order that all the teeth would be uniform, the old teeth were first removed. The clothespins were fitted for their new duty by dressing the heads down to fit the holes in the bar.—Gregor H. Glitzke, Kansas City, Mo.

Hair Drier Made from Electric Toaster and Vacuum Cleaner

A simple but effective apparatus for drying the hair with a blast of warm air,



Drying the Hair by Means of Heated Air Furnished by an Electric Toaster and an Electrically Operated Vacuum Cleaner

or for other purposes where a supply of heated air may be required, is easily made from an electric toaster and a vacuum cleaner. A wooden box, large enough to contain the toaster, is lined with sheet asbestos, sodium silicate (water glass) being used to paste the asbestos paper to the wood. Openings are cut through opposite ends of the box and metal tubes inserted, over which the air tubes are fastened with light twine. The short air tube, or hose, can be made by sewing together the edges of a strip of closely woven cloth to form a pipe; the longer one is usually supplied with the cleaner. Another piece of tubing, which may be cardboard, is used at the outlet end.

The vacuum cleaner is placed on a sheet of clean cardboard, the nozzle elevated on one or two strips of wood, and the dust bag is removed, so that one end of the short tube can be slipped over the dust-bag nozzle and fastened. The toaster is placed inside the box, the box closed, and the current turned on; when the toaster is well heated, the vacuum-cleaner motor is started. The air entering through the vacuum cleaner is carried through the heated chamber and is delivered through the outlet tube on the opposite side.—H. A. Strickler, Buffalo, N. Y.

Our Bureau of Information will answer all inquiries on radio-instrument construction and operation.

Improved Breakfast-Nook Table

A serious objection to built-in dining or breakfast alcoves is that it is generally necessary for the diners to slide or

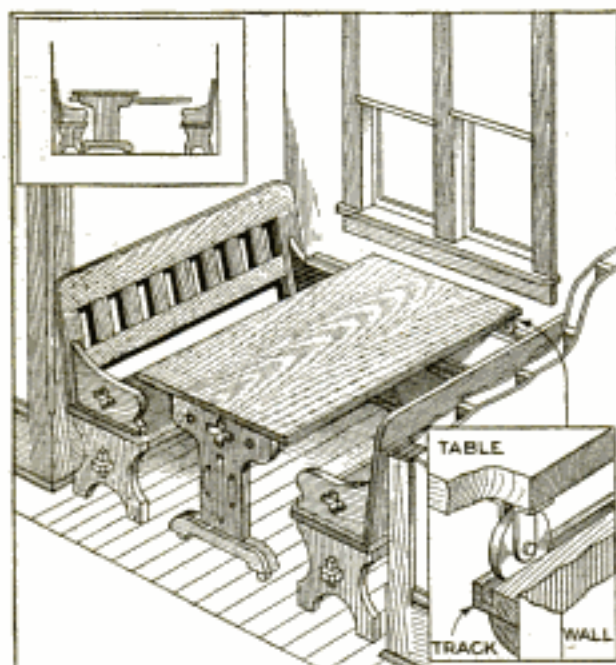

Supporting One End of the Breakfast-Nook Table on Wheels, That Travel in a Track Fastened to the Wall, Makes It Easy for the Users to Seat Themselves

squeeze into the limited space between the table and the benches. This objection, in one instance, was successfully overcome in the manner shown in the drawing. The end of the table next the wall was supported on small wheels, running on a grooved track attached to the wall. Set up in this manner, the table is pushed to one side until the occupants of one of the seats are in place, when the table is pulled back so that others can be seated on the opposite bench. A table made in this manner will require only one pedestal, which, of course, is fitted with casters.—J. H. Kay, Cleveland, Ohio.

Dark Box for Photographers

The amateur photographer frequently finds it necessary to leave the dark room during the process of developing a film or plate, and is then compelled to improvise some sort of light-proof covering for his trays to prevent spoiling of the work. After frequent experiences of this kind, one amateur made a simple cover box, which also serves as a receptacle for storing his apparatus when not in use. A heavy cardboard box, large enough to cover the three trays, was used, a 2-in. strip of red cloth being glued around the edge to form a curtain, and a strap handle attached to the top for convenient lifting.

When it is necessary to open the door of the dark room, the box is placed over the trays, any irregularities on the top of the table or edge of the box being taken care of by the red-cloth curtain, which filters any chance rays of light.

Replacing Worn Spring Bushings

It is sometimes difficult for the amateur mechanic to change the bushings in automobile springs, owing to the fact that the bushing are thin on one side, if not completely worn through. It is also found that the new bushings contract when forced in, making it necessary to ream them out before the shackle bolt will fit.

An easy way to replace the worn bushing with a new one is to remove the old shackle bolt, slip the new bushing over it, and then drive the bolt back into its proper place in the spring eye. This forces the old bushing out and at the same time prevents the new bushing from contracting or from having its end battered. This will probably spoil the old bolt, but that is generally of little consequence. Even when a new bolt must be used, the time and labor saved would be worth the cost. A heavy hammer, or block of wood, should be held against the opposite side of the spring while driving in the bushing. If a heavy arbor press is available, this, of course, should be used to press the bushing into place.—Philip Jonker, Peekskill, N. Y.

Novel Attachment for Fishhook

When fishing with flies or grasshoppers for bait, I tried out the idea of fastening the insect to the shank of the hook with a strip of adhesive plaster. This plan worked well, but, owing to the moisture, the tape soon loosened, and the improvement shown in the drawing was then made. A small strip of thin sheet metal was soldered to the shank of the hook in



such a manner that, by bending the ends around the body of the insect, the latter was held in a lifelike position, floating on the surface of the water, with the barb of the hook underneath.—G. E. Hendrickson, Argyle, Wis.

Spigot for the Oilcan

Many automobile owners buy their oil in 5-gal. cans, and to pour the contents is inconvenient and generally wasteful, due to the weight of the can when full and to the fact that the oil comes out in spurts. A spigot soldered to the top of the can will provide a convenient and wasteless method of pouring. As the screw caps on these cans are very nearly uniform in size, the spigot can be soldered to one of the caps.—R. H. Kasper, Philadelphia, Pa.

Drilling Large Holes in Glass

To drill comparatively large holes in glass, without the danger of breaking it, the arrangement illustrated may be used, and will produce a clean, smooth hole.

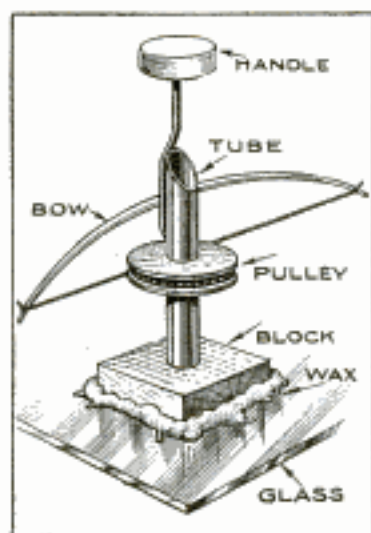

A piece of thin brass or copper tubing, the outside diameter of which is the same as that of the hole to be drilled, is fitted with a wire handle and a small wooden pulley. A wood block with a hole in the center to fit the tubing used, is provided, and is fastened to the glass by running melted beeswax around the edges. The tube is placed in the hole in the block, partly filled with a mixture of emery and water, and rotated by means of a bow, in the manner of a fiddle-bow drill, the string passing around the pulley. This method is particularly suitable for drilling holes in curved glass, as the underside of the block can be shaped to the curvature of the surface, so that the drill will not slip.

Language Study on the Phonograph

The student of foreign languages by the phonograph method usually makes a nuisance of himself to other members of the family when the instrument grinds out the grammatical construction, and other information concerning the language.

The drawing shows how one student

kept the lessons all to himself by closing the front of the phonograph cabinet and carrying the sound to his ears by means of part of a stethoscope and a rubber tube. The board is edged with felt and

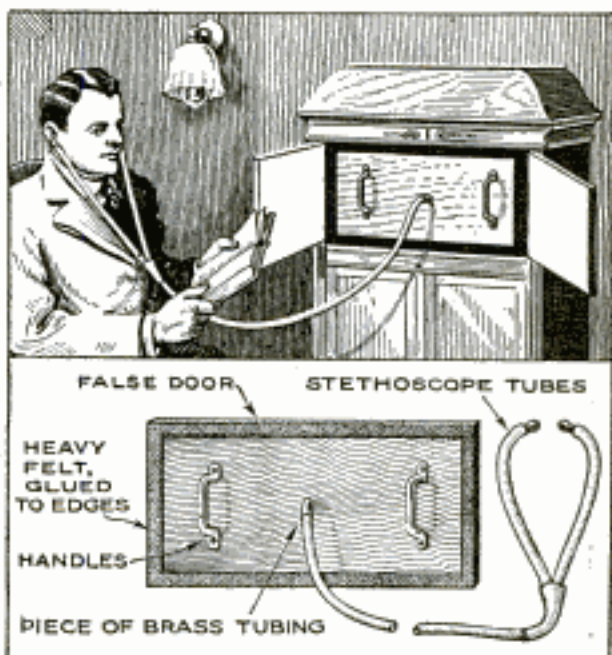

Studying Foreign Languages by the Phonograph Method, a Student Uses the Device Illustrated to Prevent Disturbing the Other Members of the Household

fits tightly into the opening when the sound-chamber doors are opened. A piece of brass tubing, screwed into the center of the board, is used as a connection for the stethoscope ear tubes. The board is fitted with handles, so that it is easily put into place or removed.

Screwdriver Has Extra Leverage

A screwdriver, provided with an extra handle to be used as a lever when an obstinate screw is encountered, may be made of $\frac{5}{16}$ -in. rod. The two handles are formed alike, and the screwdriver bit is forged on the end of one. Both are then flattened slightly at the center, the end of the extra handle cut off, and the handles drilled and connected by a small screw or rivet. Normally, the two handles are parallel, but for driving screws into hardwood, or starting a tight screw, the short handle is brought down as shown and used as a lever.

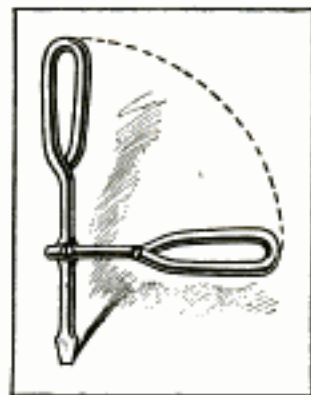

A Simple Boat Hoist

A very efficient and inexpensive apparatus for moving motorboats and similar craft out of the water for winter storage or repairs is illustrated in the photograph. Four 4 by 4-in. uprights, securely braced by 2 by 4-in. material, are erected at a point where the depth of water

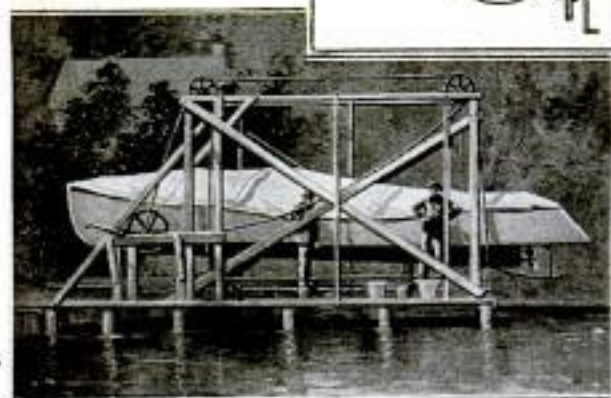
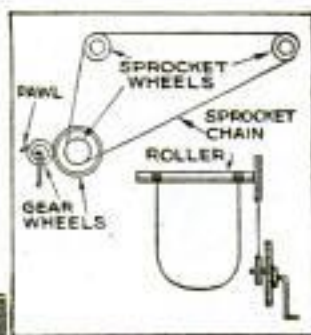

Motorboats and Similar Craft are Easily Lifted from the Water for Storage or Repairs by Means of a Simple and Inexpensive Hoisting Device

is sufficient to float the boat to be lifted. The uprights support 4 by 4-in. crosspieces. The distance between the uprights, as well as their height, will, of course, depend entirely upon the beam of the craft and the elevation to which it is to be hoisted.

The lifting mechanism is quite simple, and consists of three sprocket wheels of the same diameter, operated by an endless chain, to which power is applied by means of a crank, driving a gear and pinion. The gear and one of the sprockets are mounted together on the same shaft, while a pawl, or "click," is provided to engage with the teeth of the pinion to hold the boat at any desired height. Extending from one side to the other of the framework are two rollers, about 3 in. in diameter, with a sprocket wheel rigidly secured to each. Bearings for the rollers are fastened to horizontal crosspieces. Chain slings, with ropes attached to the ends, are passed around the boat hull at stem and stern, the hull being protected from injury by covering the chains with old rubber hose.

By reference to the diagram it will be apparent that this arrangement provides a very powerful hoisting apparatus, requiring but a small amount of power.—C. L. Meller, Fargo, N. D.

Writing on Glass

Names and designs can be etched on glass without the wax ground or hydrofluoric acid generally required, by a simple method, which makes it possible to write directly on the glass with a rubber point or even a quill pen. Two solutions are mixed in separate bottles, and equal parts of each are mixed as required. The first consists of 35 gr. of sodium fluoride and 7 gr. potassium sulphate in 1 oz. of distilled water; the second solution is made by mixing 15 gr. of zinc chloride, 65 drops of hydrochloric acid, and 1 oz. of distilled water. Only enough should be mixed for immediate use, and the glass must be perfectly clean and dry.

A Watch-Crystal Mirror

There is a little unused space on most watch crystals that can be utilized to make a small mirror. Cut a piece of pure tinfoil, not too thin, to the size and shape desired, and clean the surface of the foil and the glass with ammonia. Amalgamate the clean surface of the foil by rubbing a drop of mercury over it with the finger. This done, take the foil in a pair of tweezers, and dip it into some clean



mercury so that some of the latter will adhere to the surface. The piece is then placed on the glass with the amalgamated side next to the crystal. Care must be taken to eliminate all air bubbles between the tinfoil and glass, and this is best done by putting the piece of foil to one side of its final location, and sliding it into place with the finger. The amalgamated tinfoil must be kept under pressure against the glass for about 18 hours; this is best done by clamping foil and crystal between felt pads. Care must be used to prevent any of the mercury from coming into contact with the watch-case or movement. Most watch crystals being curved, such a mirror will be convex and will reflect a reduced image of practically the whole head, making it useful for combing the hair or adjusting a tie.—Walter E. Burton, Kenmore, Ohio.



HOW TO BUILD MODEL AIRPLANES

By DONALD W. CLARK

THE model airplanes illustrated, while they do not exemplify the very best performance or design, nevertheless have proved to be very satisfactory in flight, and have structural features that make them easy to build. Because of this simplicity of design, they will appeal to the person who likes to build, whether he has had experience in this line or not, and there is little doubt of his ability to complete the style of his choice, provided he has the necessary patience and consideration for detail.

Since the "racer," Fig. 1, the "fly-about," Fig. 2, and the "rise-off-ground,"

and the middle of the spars, wrapping two or three thicknesses of paper around them; this is to prevent splitting. From a piece of soft wire, $\frac{1}{16}$ in. in diameter, cut a piece 1 in. longer than the distance between the centers of the spars, and bend right angles $\frac{1}{2}$ in. from each end. Flatten the ends of the wires on an anvil or vise, lay the spars flat on a smooth surface, and insert the short ends of the wires into the holes in the ends of the strips, forcing them in as far as they will go, as indicated in Fig. 5. When these wires are bent to control the direction of flight, they will stay so, because they are

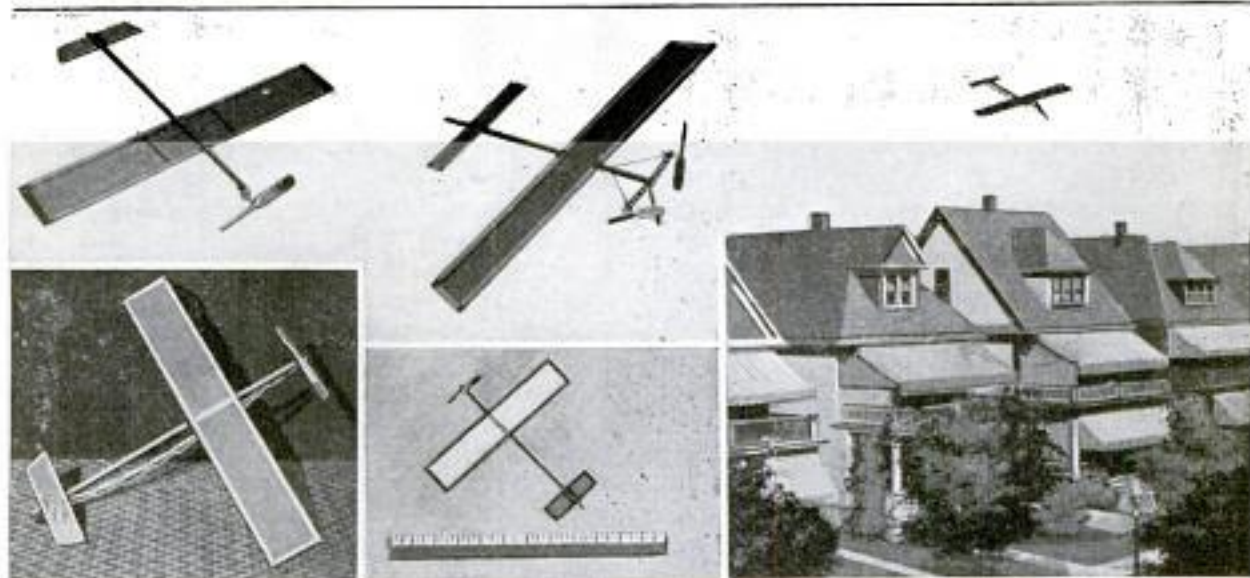

Above, Left: The "Fly-About" Model Shown with Two Extra Wing Ribs; Center: The "Twin-Pusher" Type with a Cruising Radius of from 600 to 800 Feet. Below, Left: This View of the Fly-About Model Shows How the Motor is Assembled; Center: A Tiny Model Compared with a 12-Inch Rule: It is Driven by a Two-Inch Propeller. Right: One of the Model Planes in Flight

Fig. 9, types are nearly alike, they will be described first. The wings of all three are built up in the same manner, using materials of the same kind, but differing in their dimensions. To build the wings for either model, two strips of white pine, basswood, or spruce are selected, a trifle over the required length, planed down to measure exactly $\frac{1}{8}$ by $\frac{1}{4}$ in., and then cut to length. Mark the middle of the strips, and drill a $\frac{1}{16}$ -in. hole through each. In the center of each end of the strips drill a $\frac{1}{16}$ -in. hole $\frac{1}{2}$ in. deep. Next, cut several strips of tough paper 1 in. wide, coat them with glue, and bind each end

soft and because the flattened ends prevent them from moving up and down. This method bends the rear spar a little, but it has proved satisfactory on many models. After the wing frame has been assembled, lay it on a piece of tough paper, mark the outline, and then cut it out, leaving a $\frac{1}{2}$ -in. margin on all sides. Now coat the underside of the frame with glue, place it on the paper, having the margin even all around, and work out the wrinkles, being careful not to bow in the spars. Cut the ends of the paper to fit between the spars, coat them with glue, fold over the wires, and stick to the

top side of the paper. After the glue has dried thoroughly, lay the wing on a smooth board and trim off the surplus paper. Punch a hole through the paper binding over the holes in the spars, and give the whole a coat of waterproof varnish to make an exceedingly tough and durable unit.

For the motor bar, cut a piece of pine or spruce, $\frac{1}{4}$ by $\frac{3}{8}$ by $24\frac{1}{2}$ in. Lay it flat, drill a $\frac{1}{16}$ -in. hole about $\frac{3}{4}$ in. from one end, and another $\frac{1}{2}$ in. from the first. Bend a piece of soft wire as in Fig. 3, slip it through the holes, and bend the ends as shown. The propeller bearing on the racer is made from a piece of sheet metal, drilled for the $\frac{1}{16}$ -in. diameter shaft, and fastened to the bar as shown in Fig. 6, although it can be bound to the shaft with glued paper; the latter will, perhaps, be the better way for the beginner. Figure 7 shows how to make the propeller. The shaft should be made of wire, bent as shown in Fig. 1, and slipped through the hole drilled in the center of the propeller; by indenting the hub a little with the short end of the shaft, the exact position for the extra hole can be found. When this is drilled, slip the shaft through the hub again, pressing the short end into the extra hole; this prevents any chance of the propeller turning on its shaft. Another way is to flatten the end of the shaft and force the widened part into the wood, parallel with the grain.

The elevator, Fig. 4, is made of pine or basswood, bound in the middle with glued paper, as described for the wing spars and indicated by the shaded section in Fig. 1. Plane down the wood to $\frac{1}{16}$ in. in thickness, and cut a piece of the proper size; for the racer, it should measure $2\frac{1}{2}$ by 8 in., for the fly-about $2\frac{1}{2}$ by $8\frac{1}{2}$ in., and for the rise-off-ground model 3 by 9 in. Bind the edges with a strip of paper and varnish. The elevator of the racer is not movable, but is attached with two round-head screws to the motor bar. This makes it impossible to alter the angle of the elevator on this model without removing it from the bar. Two or three small washers underneath the forward edge serve to place it at the correct angle. On the fly-about and rise-off-ground models, however, the elevator is adjustable, and is fastened with but one screw near the rear edge, which serves as a pivot, and one rubber band; the latter holds the elevator down against a flat-headed screw located under the front edge, and also keeps it straight. To increase or decrease the angle of the eleva-

tor, merely turn it to one side, so that the hole shown in the drawing will come over the screw head. Then, with a small screwdriver, turn the screw in or out as needed, and allow the elevator to return to its normal position. The rubber band also prevents breaking of the elevator by absorbing some of the landing shock.

The rise-off-ground model, Fig. 9, is just like the fly-about, except that it has a little more surface than the latter, and the wing is set at an angle large enough to give it a good lift. This is done with small washers, or coiled wire of sufficient thickness to raise the front wing spar about $\frac{1}{8}$ in. The drawing shows how the landing gear, which consists of three wheels mounted on hard wire, is attached. Make the wheels of cigar-box wood, drill the centers, and use the same size of wire for the axles as for the wire supports, the ends of which should be looped around the axles. The small front wheel must be a little lower than the others, so that the forward end of the motor bar will be higher than the rear when the model is resting on the ground. The diameter of the front wheel is $1\frac{1}{2}$ in., and the larger ones are 2 in. in diameter.

The "twin pusher," Fig. 10, is more elaborate than the other three, but is not beyond the amateur's ability. Its elevator does not swing, but it is made in exactly the same manner as the other models. This is also true of the wing, except that in this case the spars are $\frac{3}{8}$ in. square in the middle, tapered down to $\frac{1}{8}$ by $\frac{3}{8}$ in. at their tips. Two extra wire ribs are placed 6 in. from the center, between the spars. The holes are drilled and the ribs inserted before the paper wing covering is applied. The motor bar is of pine or spruce, $\frac{1}{2}$ by 1 by 43 in., shaped as shown in the drawing. Make the front hook from a 4-in. length of wire, insert it in a small hole drilled near the front of the bar, and bend the loops. The crossbar that takes the bearings should be of ash or other hardwood, and be braced with $\frac{1}{16}$ -in. hard wire. The bearings are strips of sheet metal, bent to U-shape and riveted to the crossbar, and hard wire is used for the landing skids. The front edge of the wing should be raised about $\frac{1}{16}$ in. The elevator is adjustable, and is attached to the motor bar by two screws; the front one runs through a small coil spring between the spar and motor bar, and furnishes a means of changing the angle of the elevator.

The power on all these models is furnished by rubber bands, about $\frac{3}{64}$ in.

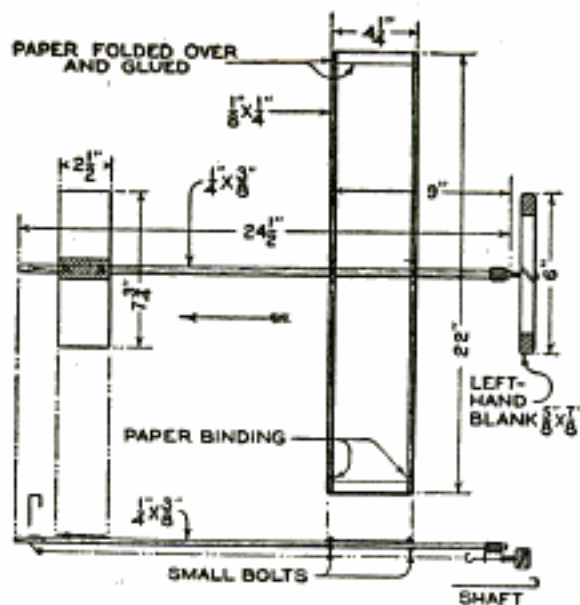

Fig. 1 RACER TYPE

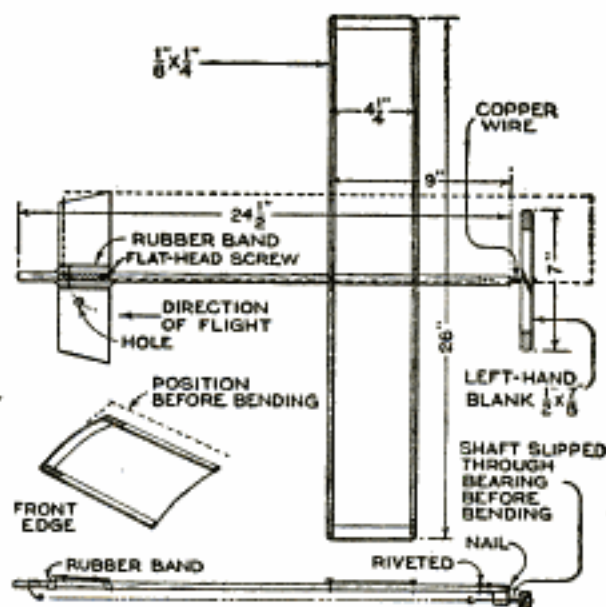

Fig. 2 FLY-ABOUT TYPE

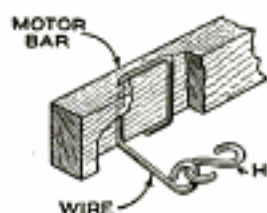

Fig. 3

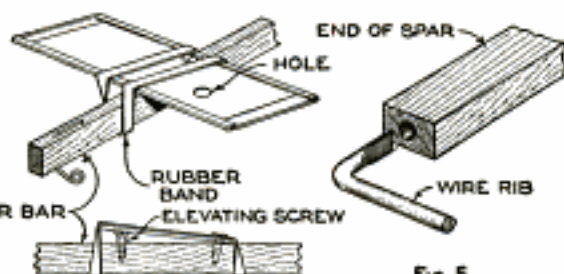

Fig. 4



Fig. 5



Fig. 6

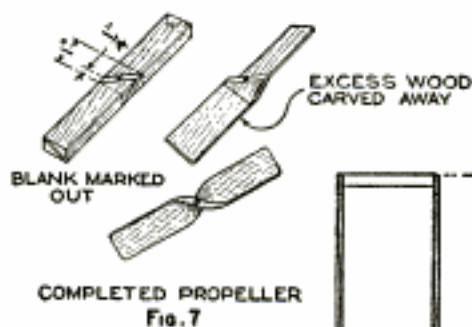
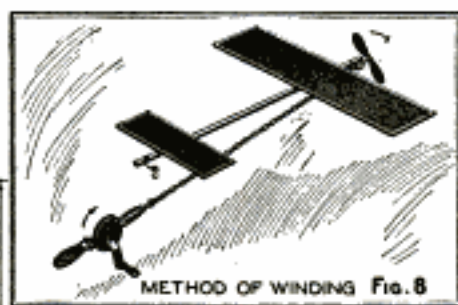

Fig. 7



METHOD OF WINDING Fig. 8

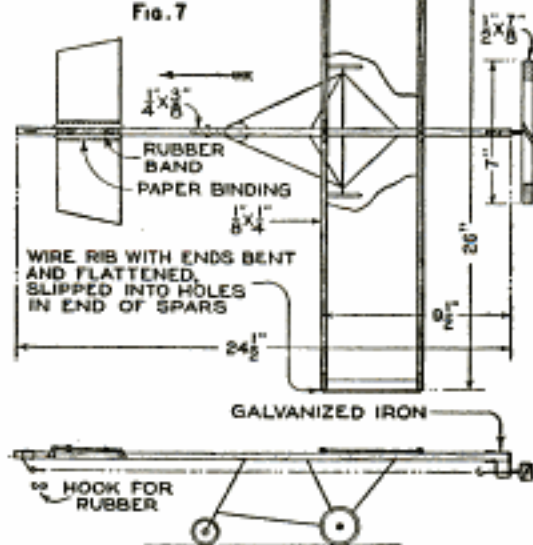

Fig. 9 R.O.G. TYPE

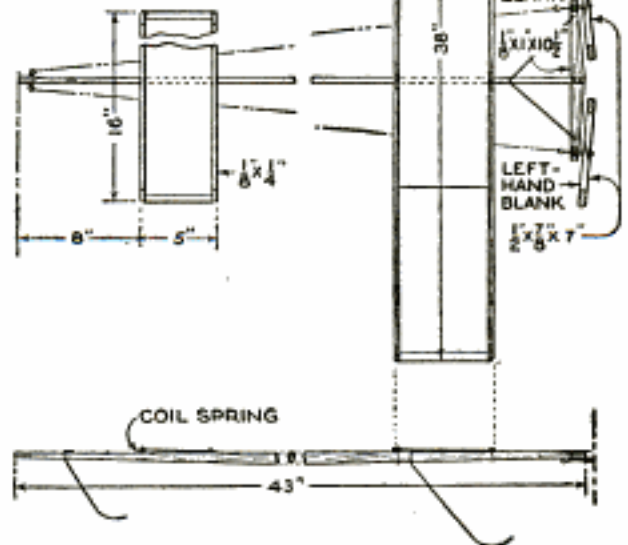

Fig. 10 TWIN-PUSHER TYPE

The Four Styles of Model Airplanes Illustrated have Proved Satisfactory in Flight, and Possess Features That Make Them Easy to Build. The Line of Flight and Altitude of the Models are Regulated by Adjusting the Wings and Elevators. The Driving Power is Furnished by Rubber Bands

thick, $\frac{3}{16}$ in. wide, and 4 in. long, linked together chain fashion, so that three of the bands will only make a length of 6 in. instead of 12 in. This method allows broken bands to be replaced with new ones quickly and easily.

A wire hook, inserted in the chuck of a hand drill, as shown in Fig. 8, will serve as a winder. After linking the bands together on the model, release the front end of the "motor," and hook it to the drill. Stretch the rubber to about twice its length and turn until about half wound. Then keep turning, but gradually release the tension so that the rubber will be straight when fully wound, and hook on again. The number of turns needed will be found through experience; the twin model will stand more than 1,000 turns to each propeller, which means that with a

gear ratio of 4 to 1 on the drill, the handle will have to be turned 250 times. The two propellers on this model must revolve in opposite directions.

To launch, hold the motor bar with the right hand, just ahead of the wing, and the propeller with the left. Then, with a quick, upward push, send the airplane into the air. If it has a tendency to climb too steeply, the elevator should be lowered a little, and if it loses altitude, the elevator should be raised enough to correct this fault. With both wing tips flat, the planes will have a tendency to turn to the right. Curving the right-wing tip down a little will give a straightaway flight; a left turn can be made by curving the right tip down still more. Several trial flights will probably be necessary before the proper adjustment is obtained.

Simple Hanger for Cut Films

An ordinary coil spring, such as used for holding window curtains, can be made into a holder for developed exposures

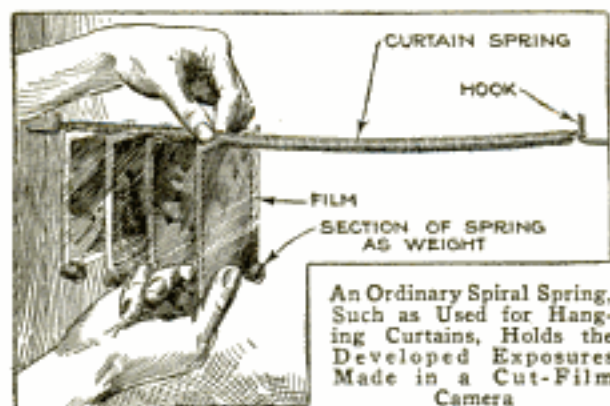

from a film pack. The spring is suspended between two hooks, as shown. The films are inserted between the coils, the compression of the spring preventing them from slipping out. To prevent the cut films from curling, $\frac{1}{2}$ -in. sections of a larger and heavier spring may be slipped over the bottom to serve as weights.—W. W. Baumeister, Cambridge, Mass.

Registers Used as Ventilators

Adjustable steel hot-air registers can be used as a means of ventilating the gables of houses having poor ventilation under the roof. They are very easily put up and are neat in appearance. An opening is cut in the gable end of the house and the register plates fitted and screwed to the siding.—Louis M. Steffen, Dayton, Ohio.

Testing for Leaky Tire Valves

Automobile tires, suspected of having a slow leak at the valve, can be tested without removing the tire from the rim. A convenient method for detecting such leaks consists in filling a small bottle with water and immersing the valve stem in it. The wheel having the suspected valve is turned so that the valve is at the top, and the valve stem is inserted into the neck of the bottle. Leaks will manifest themselves by a series of bubbles.

Neat Tips on Wires

In order to have the wiring look neat on a radio set, or other instrument being made, all wires with visible connection to binding posts should be wound with small bare wire to prevent the insulation from raveling out. Fig. 1 shows the insulation removed from the wire, the winding of the tip started with a piece of bare wire of small diameter, and the neat finished effect. Fig. 2 illustrates the method of making a tip for connecting to another style of binding post. The latter is a connection that is especially useful when the wire is to be frequently connected to or disconnected from a binding post.

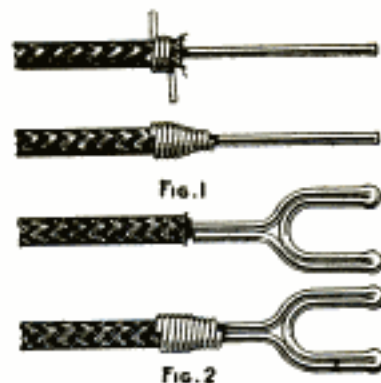

Stencil-Color Pails for Painters

When using different colors of paint in ceiling work, such as in stenciling and painting designs, I have found it quite a help to use several cans containing the separate colors and fasten them onto a cord or belt. Holes or slots are cut near the top of quart cans through which the cord or belt is inserted. About an inch of color is placed in the cans. In use, the belt or cord to which the cans are attached is worn around the painter's waist. This arrangement does away with the constant bending and stooping to the floor or scaffold.—C. O. Soots, North Salem, Ind.

Lawn Edger Made from Shovel

One way to make a lawn trimmer or edger is to use the remains of an old shovel or spade in the manner suggested

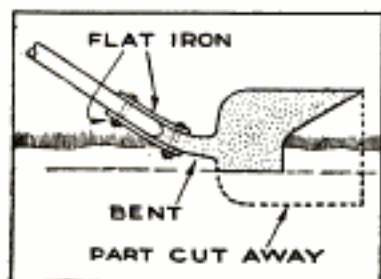

by the drawing. From the front corner of the shovel blade draw a straight line diagonally toward the shank. When about two-thirds of the

distance from the edge to the shank, turn the line downward, and, when an inch or two below the shank, turn again at right angles, as shown. Then cut along this line with a cold chisel and smooth the rough edge on a grinding wheel, sharpening it at the same time; a file will answer the same purpose. Finally, heat the shank a cherry red, bend upward, and insert a long handle, reinforcing it with two pieces of flat iron on the top and bottom. The edger is pushed along in the position shown.

Lining a Hanging Basket

If even a little of the moss lining of a hanging basket falls away, a hole will soon form that will permit the earth to wash out when the plants are watered. This trouble should be prevented when the basket is made up. After the moss lining has been put in place, a circular piece of burlap, or similar material, is laid inside against the moss, before the basket is filled with earth. The burlap lining holds the earth, even should the moss become loose or punctured.

Novel Radio-Rheostat Mounting

When making a radio set that was intended to be as compact as possible, it was discovered that it was out of the question to mount the panel-type rheostat in the usual manner. The difficulty was overcome by using a rheostat in which the resistance wire is molded into the knob and mounting it horizontally instead of vertically. A slot was cut in the panel, through which the rheostat knob projected about $\frac{1}{8}$ in. Thus the knob could easily be revolved with the thumb or forefinger to any desired adjustment.—Leon D. Quick, Milesburg, Pa.

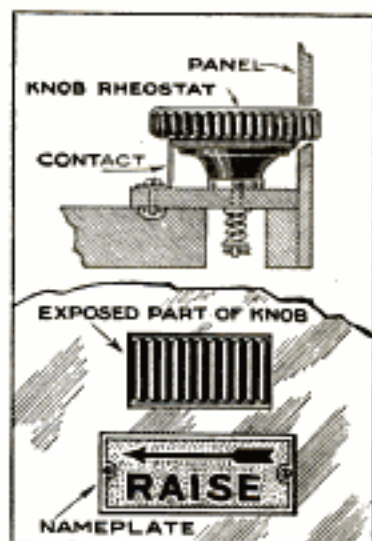

Safety Vent for the Teakettle

When the teakettle is filled with water above the inner opening of the spout, the cover will vibrate when the water begins to boil, making considerable noise, besides which one may easily scald his hands by the escaping steam. This undesirable feature can be overcome by cutting a slot, about $\frac{3}{8}$ in. wide, in the flange of the cover. The steam pressure will raise the cover slightly, and allow the vapor to escape through the vent in a horizontal stream. By turning the cover so that the vent is opposite the handle, all danger of being scalded when picking up the teakettle will be eliminated.

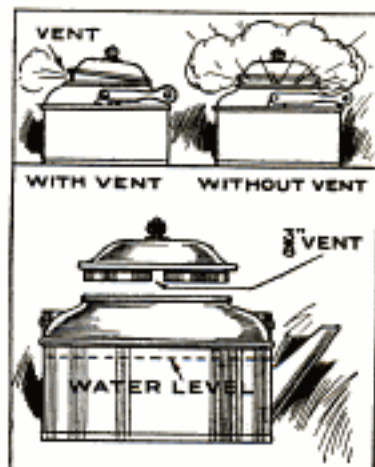

Old newspapers soaked in water, twisted tightly, and dried, make good kindling.

Trouble Lamp Installed under Dash

Many automobiles have no provision for plugging in a trouble lamp or spotlight except by removing the dashlight

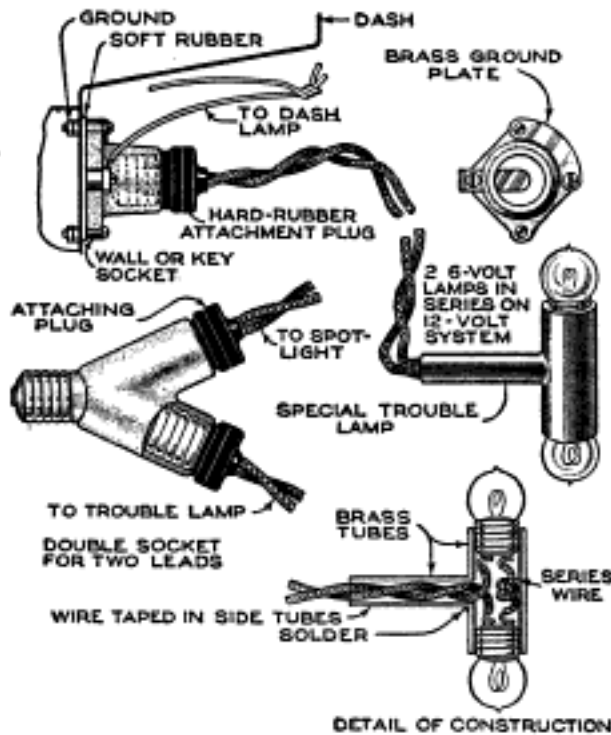

Arranging an Ordinary 110-Volt Lamp Socket on the Automobile Dash So That It Will Not Be Necessary to Interfere with the Dashlight When a Spotlight or Trouble Lamp is Used

bulb and attaching the cord there. The owner himself can easily overcome this lack by installing a standard-size 110-volt porcelain socket, of either the plain or key type, under the dash, where it will be out of sight and protected from accidental injury, yet accessible. The large socket is preferable, as it is more substantial and permits the use of standard attachment plugs or two-way sockets. Only two small holes are necessary through the dash for No. 8-32 machine screws and nuts, with a locknut on each, for bolting the socket to the sheet metal. If the one-wire system is used, one side of the circuit being formed by the metal parts of the car, a curved brass plate is run from one socket terminal to one of the bolts for the ground terminal. The other terminal is preferably soldered to the lead running from the dash lamp, unless some other connection is more convenient. A sheet of soft rubber or packing should be placed between the socket and dash.

A porcelain attachment plug and cap can be used, though the hard-rubber variety is a little smaller and less breakable; ordinary lamp cord may be used for the lead. The drawing shows the construc-

tion of a homemade trouble lamp, the object of which was to use some old 6-volt bulbs on a 12-volt system; 3½-volt flashlight bulbs could be used in the same manner on a 6-volt battery. A large and small brass tube are soldered together at right angles, the run of the "T" thus formed being lined with several layers of shellacked or insulating paper, to leave an opening just large enough for the lamp bases to slip into. The lamp cord is threaded through the small tube and brought out at each end of the larger, and each wire is soldered to one terminal of the lamp bases. The other two terminals are connected by a short piece of insulated wire, thus connecting both lamps in series. By drawing back the lamp cord, both bulbs are drawn into the tube, and tape is wrapped around the lamp cord and tube to hold all in place.

By using a two-way socket, screwed into the main socket, a spotlight or other accessory can be plugged in at the same time as the trouble lamp.

Useful Tool for Home Mechanics

Combining a square, plumb, and rule, the tool illustrated is well worth the slight time and trouble required in making it. Wood is used for the T-shaped piece, the long edge of which is graduated in inches and fractions, while the angles formed at the corners are used as squares. The plumb consists of a weighted pendulum, made from a piece of clock spring. Brads, or pins, are inserted at the proper points on the three ends of the device to indicate the true plumb line, when using the tool to test the level of a surface.

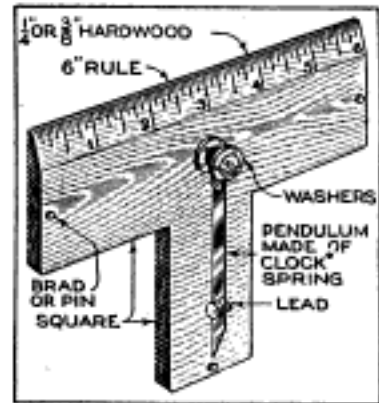

Novel Use for the Phonograph

A phonograph may be used to advantage for winding thread, yarn, or cord on a spool quickly and without trouble. A small piece of paper is placed over the turntable spindle, and a spool slipped down over it. The paper prevents the spool from slipping on the spindle. Upon starting the motor the spool will revolve

with the turntable so that it is only necessary to guide the material being wound onto it. On most makes of phonographs the turntable can be lifted off, should it be found that it interferes with the winding, but in so doing the motor runs free because the brake that controls the starting and stopping of the machine operates on the edge of the turntable.—Robt. U. Matthews, Mist, Ore.

Clothes Cleaned by Vacuum Cleaner

By using the vacuum-cleaner attachment intended for cleaning the upholstery of furniture, clothing can be cleaned with a minimum of trouble. The garments are laid out flat on a table and gone over several times; the results are much more satisfactory than brushing.—Alvin S. Hinnershitz, Reading, Pa.

Cutter for Strawberry Runners

Strawberry plants send out runners, that, unless kept cut off, permit the plants

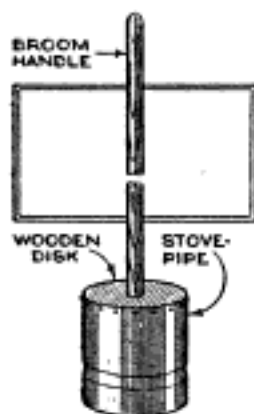

to spread to such an extent that they cannot easily be cultivated. This and other reasons make it necessary to keep the runners cut short, and the drawing shows a tool that eliminates this back-breaking labor of the strawberry grower. As shown in the sketch, a thick wooden disk is attached to the end of a wooden handle.

A piece of stovepipe is nailed to the disk and forms the cutter, the edge of which may be filed to make it sharper. In use, the cutter is merely placed over the plant and pressure applied to the handle, severing any runners longer than the radius of the hollow cylindrical cutter.—Luther Holton, Rushville, N. Y.

Attaching Generator to Boat Engine

A storage battery is a most desirable addition to any boat, because of the advantage in using electric running lights, providing current for a powerful searchlight, and for the signal horn. However, the battery alone is more or less of a nuisance, as it must be frequently removed and recharged, if there is no generator. To avoid this, a charging generator, such as can be picked up at any

automobile-wrecking establishment, can be readily attached to almost any make of marine motor. In the case illustrated,

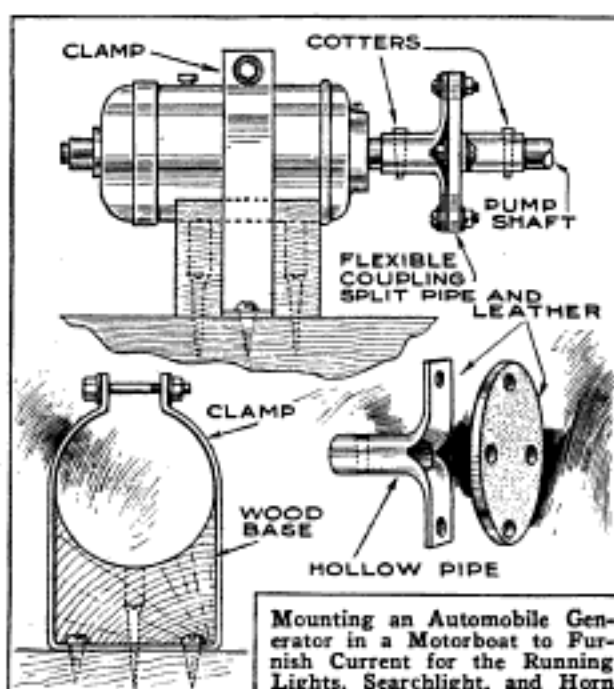

the generator was cylindrical in form, with the cut-out at one end. The pump shaft having been decided upon to drive the generator, the flexible coupling shown in the drawing was made. Pieces of steel tubing were split for a part of their length, and the split ends opened out and flattened. The flattened ends were bolted, at right angles to each other, to a leather disk, and the tubular ends were attached to the generator and pump shafts by cotter pins. The generator itself was held to a wooden block or saddle by means of a simple clamp.

Flashlight Bracket for the Bed

To make the electric flashlight available at any time during the night, a simple bracket can be made and fastened to the bedstead. A piece of No. 16 gauge sheet steel or brass is used. Two strips about $\frac{3}{4}$ in. wide, are needed, and these are bent to fit around the bedpost and flashlight, as shown. After forming the strips, holes are drilled to take two small bolts for clamping it to the bed.

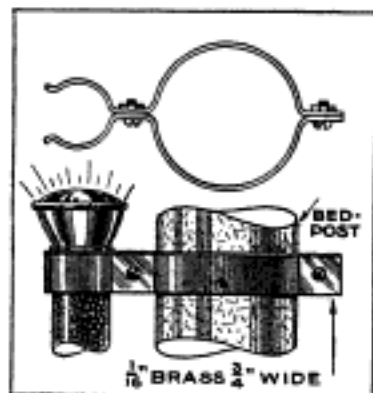

A Cheap Indirect Lighting Fixture



chains are attached by means of small clamps.—Glen McWilliams, Detroit, Mich.

Protecting Grass Seed on Terraces

A newly seeded terrace can be protected effectively against washing if strips of burlap are laid over it, as indicated in the



Covering a Newly Seeded Terrace with Strips of Burlap to Prevent Washing Away of Soil and Seed

illustration. Not only does the burlap prevent the seed from being washed away when the lawn is watered, but it helps to retain the moisture, and the seed will germinate much more rapidly. The burlap is held against the ground with large spikes or wooden pegs. The seed underneath should be watched and the burlap removed whenever the grass requires it.

Timing Snapshot Exposures

Many amateur photographers, although equipped with good cameras, fitted with fast shutters and lenses, do not succeed in making the best use of them, owing to their confusion of ideas regarding the proper time to give for the exposure. This, of course, as is well known, varies with the season as well as the time of day, and if the subject is investigated, leads to an intricate study of such technicalities as focal distances, speed of plates or films, diaphragm opening, and long formulas, all of which, on account of their complexity, are given scant attention by the average amateur, who is out for pictures instead of a course in mathematics. However, this does not minimize the value of various exposure tables and devices, for, although requiring a little time to get the proper exposure, they are worth while in preventing underexposed negatives. The professional, from long familiarity and a better appreciation of the value of light, and its action on the sensitized plate or film, rarely makes an underexposed negative, because he is taught from the first to make his exposures sufficiently long to get detail in the shadows, the lack of which, to him, is sufficient excuse for terming the negative underexposed.

For the benefit of the amateur, who generally has not the patience to calculate the exposure otherwise, a simple rule has been evolved that fits the case with sufficient accuracy to help him get better exposures, which means better pictures.

Notice the length of your shadow as indicated by some object on the ground to which the shadow just reaches, then walk toward it, counting the number of natural steps that are required to reach the object. Divide this number by 100 and the time of exposure in seconds will be obtained. This should be done only when the lens opening f-11 is used, as usually it is. Applying the rule and taking two steps, the time required for the exposure will be $\frac{1}{50}$ second, $\frac{1}{20}$ second if five steps are taken, $\frac{1}{10}$ second if 10 steps are taken, and so on.

These exposures can be varied somewhat, but should be considered as a close approximation. It is understood, of course, that this rule is only applicable to outdoor photography when the sun is shining.—A. Swanson, Los Angeles, Calif.

☛ The firepot of an old cannon-type stove can be used to make an attractive lawn vase.



A TWO-STEP AUDIO-FREQUENCY AMPLIFIER

By F. L. BRITTIN

THIS two-step amplifier is designed to fit the short-wave receiver described in the June issue. With it, and a loud talker, speeches and music can be heard all over a large room.

The complete instrument is shown in Fig. 1; the detector and amplifier are connected by means of jumpers carried in binding posts on the panels, just as the detector and tuner units are connected.

It will be necessary to drill seven more holes in the detector panel for the binding posts, to fit a two-circuit jack instead of the single-circuit one, and to make some changes in the wiring of the detector. No change is made in the wiring of the tuner, except that the jumper at the posts 3 is taken off, leaving these open. It is not necessary to remove the binding posts.

Those who have not already built the receiver may make the panel in one piece, laying it out by combining the dimensions given in both articles; in this case, a shelf should be fastened to the panel, above the variometers and variocoupler, to carry the tubes and transformers, and the jumpers dispensed with, the wiring being run straight through from point to point.

Two new binding posts are placed on the detector panel above the aerial binding posts A; the upper one is for the positive lead of the A-battery, and the lower for the negative. The positive binding post is connected to post 1 on the bottom of the detector panel, and to the positive filament connection on the detector-tube socket; from this latter lead a tap is taken, running to the upper one

of the four new posts on the left-hand side of the detector panel. The A-battery negative post is connected to the switch lever of the detector-tube rheostat, and to the lowest jumper post at the edge of the panel. Posts 2, 4, and 5 are connected as before, but 3 is left open. The .001-mf. variable condenser is also connected as before. It may be well to remark at this point, that, though Fig. 2 shows many

of the wires running parallel with each other for a considerable distance, this is done only for the sake of neatness, and to aid the reader in tracing the circuits, and that the wires must not be run in this manner when wiring the instrument. All wiring should be as short as possible, never running two wires parallel

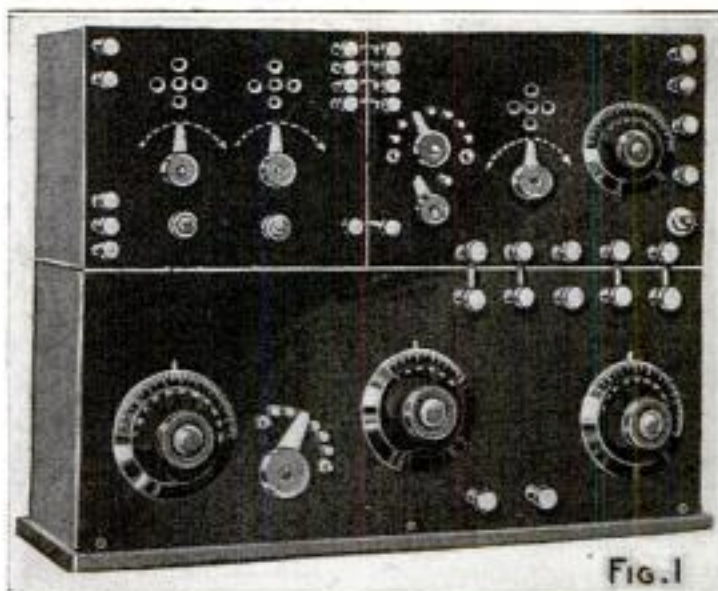

The Complete Receiver and Two-Step Amplifier: Note the Jumpers Connecting the Detector and Amplifier Units

where it can be avoided; this cuts down self-induction and reduces the tendency of the tubes to "howl." This rule applies to the wiring of any radio instrument.

The detector B-battery switch is connected to the 22½-volt tapped unit as shown, the wire from the lever running to post 3 on the edge of the amplifier panel, and a lead from this post to the positive connection of the second-step tube filament. The two 22½-volt amplifier B-batteries need not be tapped units, as no variation in voltage is needed for the amplifier tubes. Note carefully the battery connections; all three are connected in series, the positive lead of the amplifier battery going to post 1 on the amplifier panel, and the positive lead of the detector unit to post 2. The negative lead of the detector unit goes, as before, to the end point of the switch

on the detector panel, and the negative lead of the amplifier battery to the positive post or lead of the detector battery.

The necessary parts for the amplifier, in addition to the panel and cabinet, are two V. T. sockets, two rheostats, two two-circuit jacks, two audio-frequency transformers, ratio 1 to 3, and two U.V.-201 tubes.

If a loud talker is not used, the one-way jack taken from the detector panel may be used on the second step of amplification, to save buying three two-circuit jacks. In this case the wiring shown for the loud talker, and the two binding

filament. If connected near the other end, the resistance will be four ohms, not two. For some tubes, the best point of operation may not be at the two-ohm point, but at some lower resistance than this. The wire should therefore be shifted along toward the resistance-winding post until, with the ear phones on, and the set in operation, the best operating point for each tube is found, testing each step separately. The wire must then be soldered to the resistance winding. The transformer is connected in this manner to hold the grid of the tubes negative, adding much to the quietness of operation of

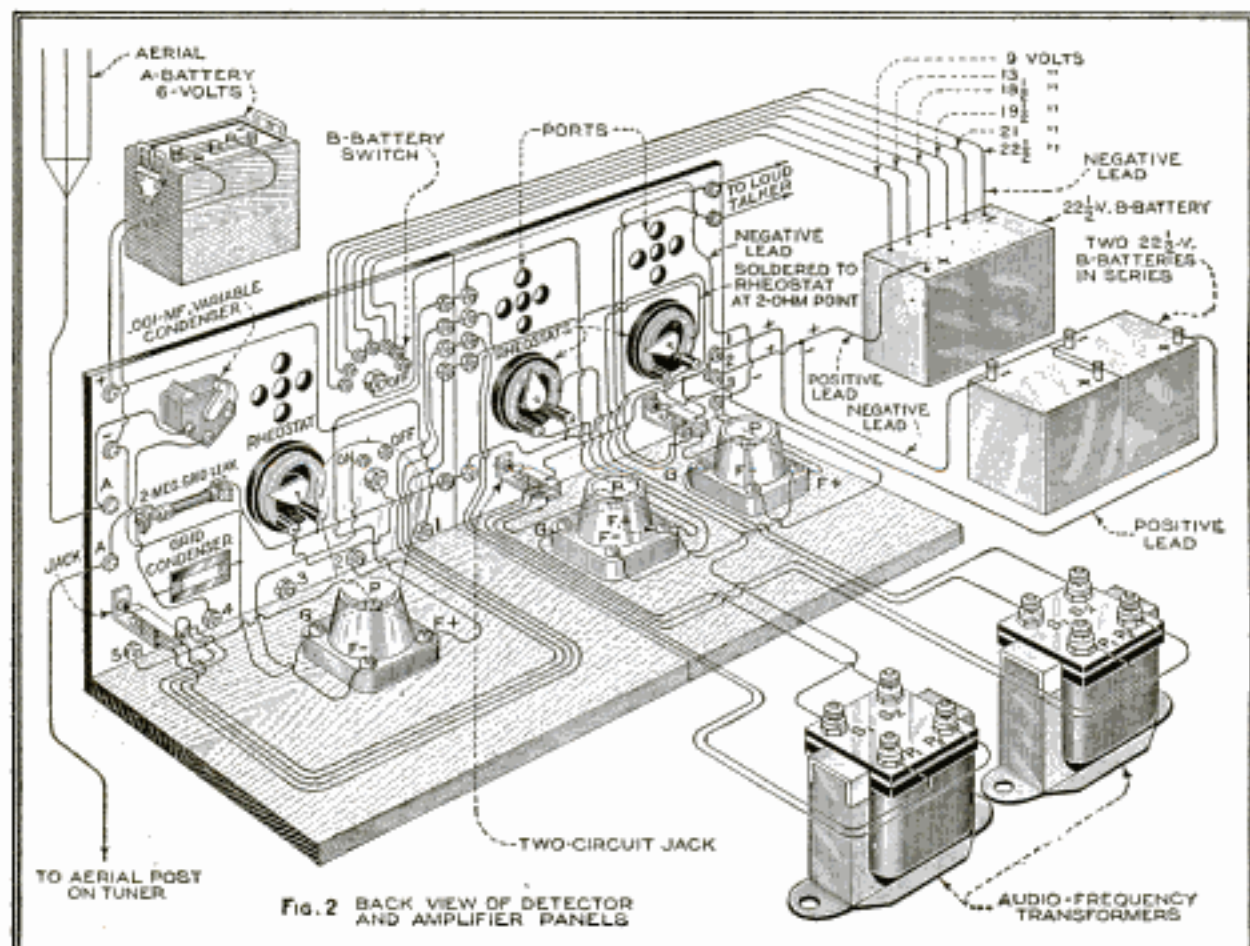

Fig. 2 BACK VIEW OF DETECTOR AND AMPLIFIER PANELS

Back View of Detector and Amplifier Panels: The Audio-Frequency Transformers are Shown Drawn Back to Allow the Wiring to be Seen Clearly. They should be Screwed to the Base behind the Tube Sockets

posts, may be omitted. The rheostats are mounted directly above the jacks, and below the posts; they are of the six-ohm type, made for panel mounting, similar to the one on the detector panel. Note that the secondary post S_1 , on each transformer, is connected to its rheostat by a wire, fastened at a point about one-third of the way around the rheostat winding; in other words, at the two-ohm point. Take care that this connection is attached at the end of the winding nearest the post from which the lead is taken to the

the set. This, of course, is only in the amplifier circuit. Be careful when buying tubes for the amplifier to get "hard" tubes (U.V.-201 tubes are just right), as detector tubes cannot be used for amplifying.

All wiring for the amplifier unit is No. 18 tinned-copper wire, covered with spaghetti tubing, although, as for the detector and tuner, any good insulated wire of this size will do.

This unit can be used in connection with any short-wave regenerative re-

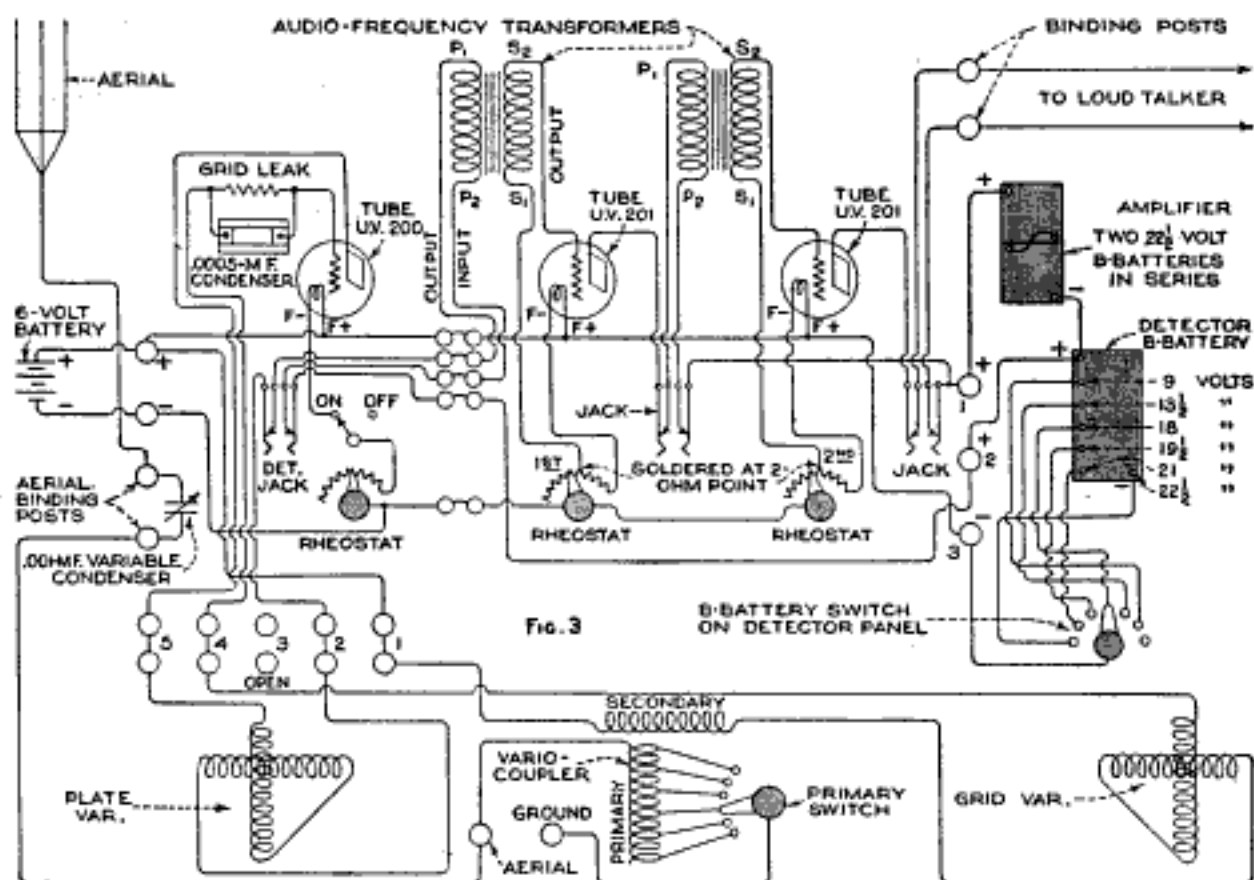

Fig. 3

Complete Wiring Diagram for the Detector, Tuner, and Amplifier: Note Carefully the Wiring of the Detector, Comparing It with the Diagram in the June Article. A Two-Circuit Jack is Fitted on the Detector Panel Instead of the Single-Circuit One. The Latter may be Used on the Second Step, If No Loud Talker is Attached

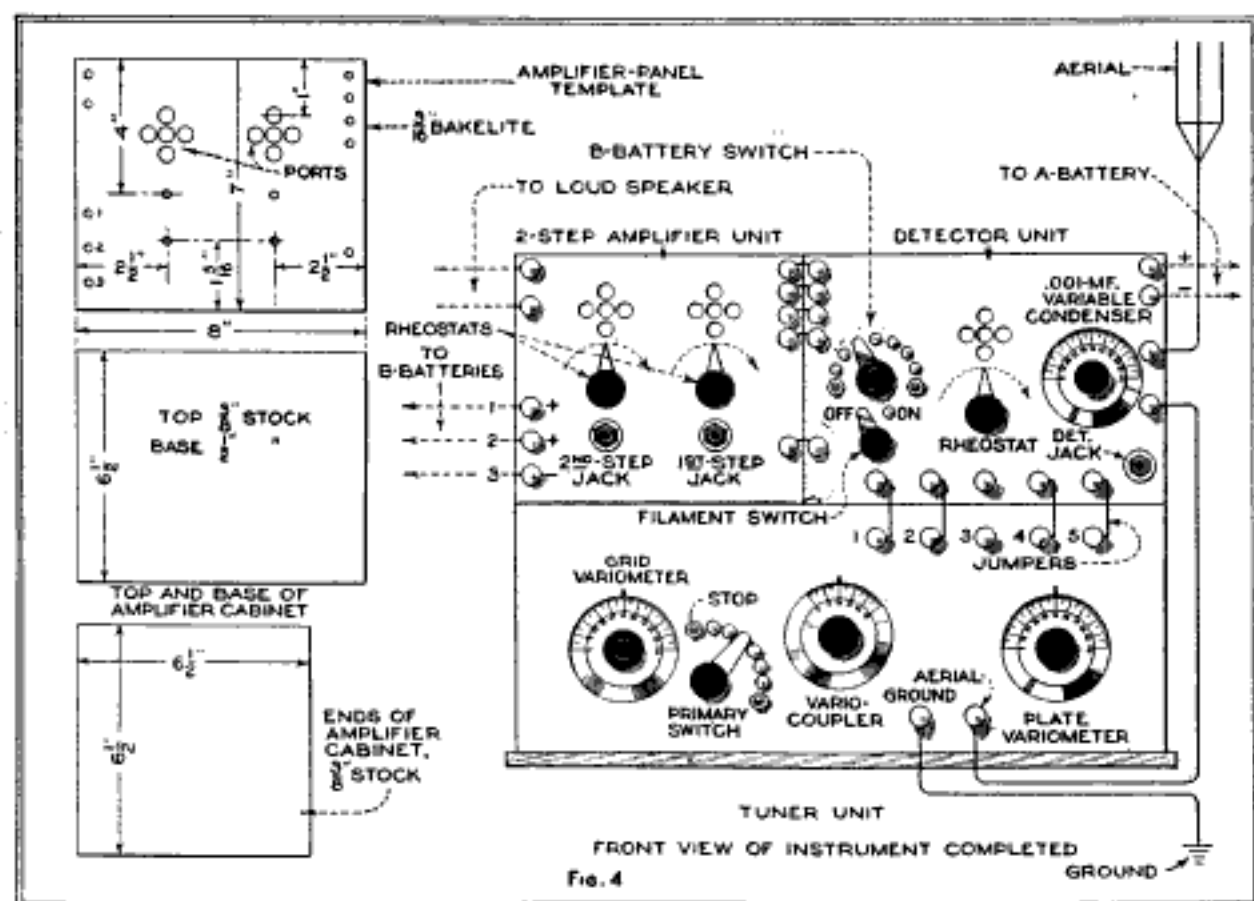

Fig. 4

Front Elevation of Complete Instrument, Top, Base, and Ends of Cabinet, and Panel Template: The Latter should be Laid Out on Cardboard, and Used to Mark Off the Bakelite Panel. Seven New Binding Posts are Fitted on the Detector Panel; Five of These Carry Jumpers, the Other Two being Used for the A-Battery Connections. No Change is Made on the Tuner Panel

ceiver, and will give excellent results. The author receives concerts and news service from local stations on an instrument of this type, loud enough to be

heard all over a large room, using a standard loud talker. The stations at Schenectady, N. Y.; Pittsburgh, Pa., and Detroit, Mich., are heard in Chicago clearly.

MATERIAL LIST

2 pieces of wood, $\frac{3}{4}$ by $6\frac{1}{2}$ by $6\frac{1}{2}$ in.
 1 piece of wood, $\frac{3}{4}$ by $6\frac{1}{2}$ by 8 in.
 1 piece of wood, $\frac{1}{2}$ by $6\frac{1}{2}$ by 8 in.
 1 piece of wood, $\frac{3}{4}$ by 7 by 8 in.
 1 piece of bakelite, $\frac{3}{16}$ by 7 by 8 in.
 2 six-ohm battery rheostats.
 3 two-circuit jacks (two if no loud talker is used).
 2 V.T. sockets.

2 audio-frequency transformers, ratio 1 to 3.
 2 U.V.-201 amplifier tubes.
 2 22 $\frac{1}{2}$ -volt B-batteries, or one 45-volt unit.
 17 binding posts (preferably with black-rubber knobs).
 Round-head wood screws, 1 in. long.
 Flat-head wood screws, $1\frac{1}{4}$ in. long.
 No. 18 tinned-copper wire for circuit.
 Spaghetti tubing.

A Portable Bathhouse

There are countless spots along ocean, lake, and river that would afford wonderful bathing if a bathhouse were available;

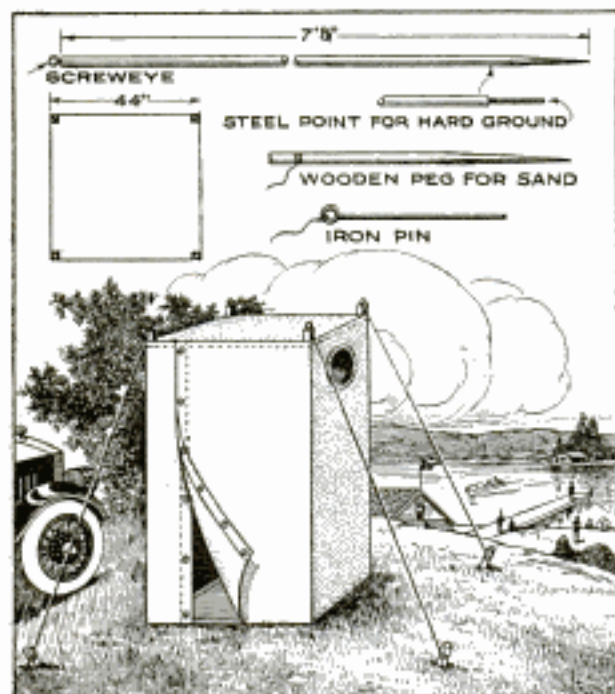

A Portable Bathhouse That can be Rolled Up into a Compact Bundle, Lashed to the Running Board of a Car, and Set Up in a Few Minutes Where There Are No Dressing Facilities

in its absence, the bathers must resort to dressing behind shrubbery, in the auto, or in other ways not to be recommended in thickly settled localities.

The folding bathhouse illustrated provides a means of overcoming this difficulty. Four poles, about $1\frac{1}{2}$ in. square and 7 ft. 8 in. long, are required; one end of each is squared, and the opposite end is sharpened. For use on sandy beaches it will be merely necessary to push the sharpened ends into the sand, but if it is expected that the shelter will be pitched on grassy land, or along a rocky shore,

it is better to drive a steel point into the end of each pole, which is done by drilling a hole in the end and driving in a piece of iron rod about a foot long, in which case the poles can be shortened by the length of the rod projecting. A large screweye is screwed into the squared upper ends of the four poles; these must hold solidly enough to stand a considerable pull. Twelve yards of 48-in. canvas, duck, or similar material, are required to cover the sides. Cut four strips 7 ft. long and two panels 48 in. square. Tack the four long strips to the four poles. By lapping 2 in. of each edge of the strips to the poles, the final result will be an inclosure 44 in. square by 7 ft. high, measuring from about 2 in. below the upper ends of the poles, which part is left projecting. Then fit the two square pieces in the top and bottom of the inclosure, turning the edges and sewing to the bottom edges of the side strips, to form the roof and floor.

Choose one side as the front, and split it down for its entire length, about a foot away from one of the corner poles. Then sew a heavy strip of canvas to the widest portion and hem the opposite edge.

Sew the edges together at the top, and fasten auto-curtain fasteners to the edges of the flaps so that they may be securely fastened together. A piece of celluloid sewed into the canvas in the manner of an auto side-curtain window will give light for the interior.

Tie a stout cord or light wire to each of the screweyes and fasten the opposite end to an iron or wooden peg. A cord or wire can be stretched between the poles on the inside of the shelter, on which the clothing can be hung. The whole can be rolled up into a compact bundle which is easily lashed across the fenders or to the running board of an automobile.

☛ A currycomb makes a good fish scaler.

Extracting Broken Cartridges

The sportsman, when using reloaded shells in his gun, is frequently troubled by a head breaking off and leaving the cardboard cartridge tube sticking in the chamber. If the tube sticks too tightly to be removed by ordinary methods, as it usually does, it can be removed by screwing a tap into the cardboard cylinder from the chamber end. This makes it possible, by inserting a rod in the muzzle, to drive out the cartridge by a light blow or two on the end of the rod.—George Glambeck, Milo, Can.

Concrete Blocks Protect Walks and Lawns

To prevent pedestrians and vehicles from leaving their proper paths and getting onto the lawn, cement blocks cast in nail-keg forms are quite satisfactory.

A mixture of one part cement to five parts sand is poured into the keg forms

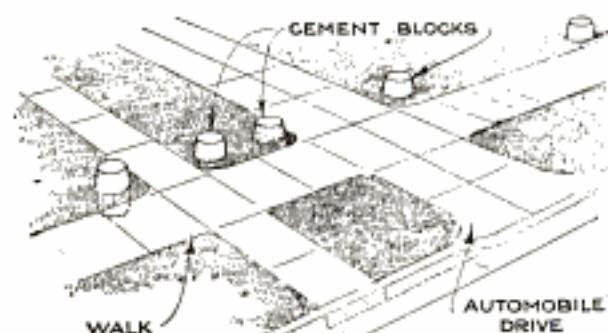

Concrete Blocks, Cast in Molds Made from Empty Nail Kegs, are Half Buried in the Ground to Protect the Lawn from Pedestrians and Vehicles

and allowed to harden, after which the kegs are broken away. The resulting cement blocks are half buried in the ground, wherever their use is necessary or desirable.—M. E. Duggan, Kenosha, Wisconsin.

How to Make a "Water Skate"

A novel little water craft, using a rubber band to furnish power, has a rudder at the stern which is swung from side to side, to produce an effect exactly similar to that obtained when a rowboat is sculled forward with a single oar at the stern.

A short piece of light board is curved at the front end to form the hull of the boat, and a vertical keel is fastened to the underside. The rudder, or, more properly in this case, the propeller, is mounted in a bearing fastened to the rear end of the keel. The upper end of the rudder is provided with a slotted tiller in

which the crankpin on the wooden flywheel engages. The method of supporting the flywheel and the shaft to which it is attached, as well as the manner in

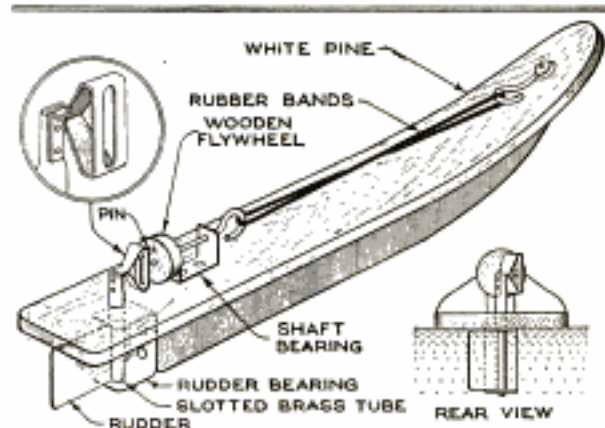

A "Water Skate" Is a Toy Boat Made from a Piece of Light Board and Sculled Forward Exactly as a Rowboat is Propelled from the Stern

which the rubber-band motor is hooked up, are so clearly shown in the drawing that a detailed description is unnecessary. The boat is made ready for operation by turning the flywheel so that the rubber band will be twisted tightly, producing sufficient tension to drive the little craft forward when it is placed in the water.

Repairing Electric-Bulb Filaments

Many burned-out electric-light bulbs that are thrown away can be saved and restored to usefulness by the exercise of a little patience. It is necessary first to examine the bulb, and determine whether

the filament can be mended, by locating the point at which it is broken. If the break occurs very near the leads, for instance, at A, between the points where the wire enters the bulb and where it passes over the first support, repair is impossible. However, if the break occurs elsewhere, between any two of the supports so that part of the filament dangles loosely, as at B and C, careful shaking and turning of the bulb will, in the majority of cases, cause the loose end to come into contact with some near-by section of the filament and complete the circuit. By carefully screwing the bulb into a socket and turning on the current, the filament will be welded into a continuous piece.

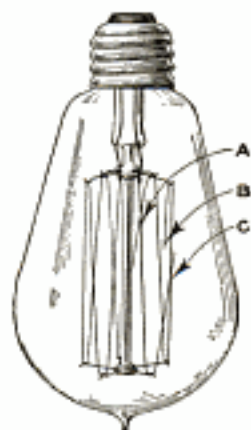

Wind Scoop for Bedroom Window

An adaptation of the porthole wind scoops of vessels plying in tropical waters

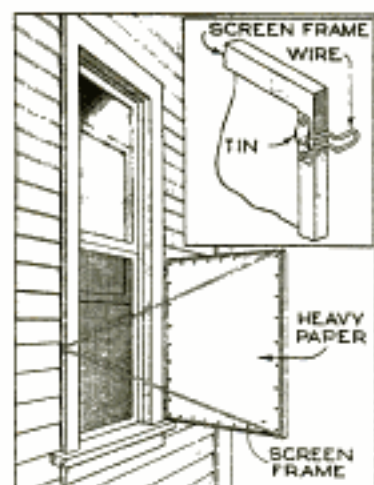

makes it possible to deflect the breeze into the bedroom during hot weather. A wooden frame is covered with stout paper, and fastened to the window frame by wire hooks that fit into the triangular openings between the frame and siding. A wire stay is hinged to the outside corners of the deflector, and it is hooked around the opposite side of the frame, as illustrated in the drawing. It requires only the work of a second to set up or take down the arrangement.

A Novel Hoe Cleaner

One of the petty annoyances of the gardener lies in the difficulty he has in

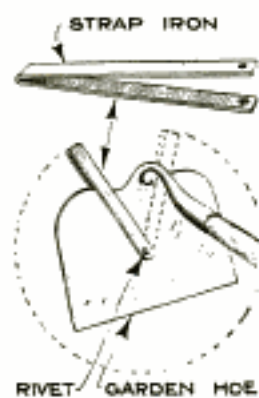

keeping the hoe from accumulating a crust of earth, as with earth clinging to the blade, it is almost impossible to make a deep, clean cut, especially in ground that is moist.

A novel and simple arrangement for keeping the hoe clean takes the form of a scraper that can be attached to any hoe in a few minutes. A hole is drilled through the center of the hoe and a steel corset stay, or similar piece of metal, is heated at the ends and middle to remove the temper. The strip is then bent double and the ends drilled to take a rivet which attaches it to the hoe in the manner shown. The rivet should be hammered down tight enough to prevent the scraper from dropping down of its own weight, where it would be in the way.

With such an attachment it is only necessary to pull the scraper around as indicated by the dotted lines, to clean the hoe quickly and thoroughly.—G. E. Hendrickson, Argyle, Wis.

Binding Hook to Leader for Salt Water

While fishing in salt water, I had continual trouble from the fact that the binding around the hook and gut became corroded, and it would not be long until the hook would part from the leader under the strain of a struggling fish. This trouble was overcome by binding the hook and gut together with fine copper wire, which is immune to the corrosive action of ocean water.—Henry P. Fuller, Portsmouth, Va.

More Room in the China Closet

A woman discovered that, by hanging the goblets and similar stemmed ware from the underside of the shelves, instead of setting them up in the usual manner,

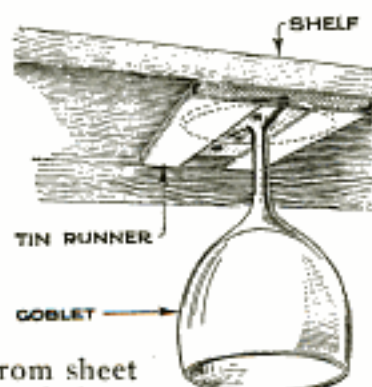

more pieces could be accommodated in the china closet. She had several sets of runners like that shown in the drawing made from sheet metal and fastened them

to the underside of the china-closet shelves. The runners should be just wide enough for the bases of the goblets to slide into easily.

Eye Protection for Motorists

Motorists who are constantly reminded by aching and burning eyes of the glare of the brilliant sunlight when driving by day, or of the flash of oncoming headlights at night, have a simple remedy in

the idea illustrated. Cumbersome and unsightly goggles may be dispensed with by wearing eyeglasses or spectacles having the upper portion of each lens covered with green, blue, or amber-colored celluloid, cut to fit the lens frames. The pieces of celluloid are attached to the lenses at the rim by a light application of glue. This arrangement, while protecting the eyes against glare, allows objects to be viewed in their natural color.—Truman R. Hart, Ashtabula, Ohio.



Motorists who are constantly reminded by aching and burning eyes of the glare of the brilliant sunlight when driving by day, or of the flash of oncoming headlights at night, have a simple remedy in the idea illustrated. Cumbersome and unsightly goggles may be dispensed with by wearing eyeglasses or spectacles having the upper portion of each lens covered with green, blue, or amber-colored celluloid, cut to fit the lens frames. The pieces of celluloid are attached to the lenses at the rim by a light application of glue. This arrangement, while protecting the eyes against glare, allows objects to be viewed in their natural color.—Truman R. Hart, Ashtabula, Ohio.

PRIZE OFFERS AND ANNOUNCEMENTS

9241
WINCHESTER REPEATING ARMS COMPANY ANNOUNCES NOVEL FISHING CONTEST

Open to amateur fishermen throughout the country is a first annual fishing contest announced by the Winchester Repeating Arms Company. The prizes offered consist of seven "Model 94" Winchester high-power hunting rifles. The fish must be caught with either a Winchester rod, line, reel, or bait, but not necessarily with more than one of these as part of the fishing equipment. The fish must be weighed on tested scales, and measured with a tape, the length to be taken from the end of the lower jaw with the mouth closed to the tip of the tail. The weight, length, girth, date, and place, and full description, if possible, of the fishing equipment used in catching the fish, must be given. Contrary to tradition, it is assumed that fishermen are not exaggerators, and no affidavit is required. All that is necessary is to fill out, according to instructions contained thereon, a blank that will be furnished by any local Winchester dealer, who will mail it to the Winchester Repeating Arms Company, New Haven, Conn.

9221
ANNUAL COMMERCIAL AIRPLANE CONTEST CALLED "ITALY'S GREAT TROPHY"

In order to promote the construction of airplanes for commercial use, the Italian ministry of war offers an award, called "Italy's Great Trophy," valued at 30,000 lire (normally \$5,787). There will be two cash prizes awarded annually: first, 150,000 lire (\$28,935); second, 50,000 lire (\$9,645), and the trophy will go to the winner of the first prize. The contest is to be international, open to all air craft with a capacity of at least 550 lb. of commercial load; that is to say, besides the weight of the pilot, which will be figured at 175 lb., and of the fuel, oil, and instruments, which must include a tachometer, a clock, gauges, altimeter, compass, speedometer, and turn indicator. Before the contest any competing plane must demonstrate a minimum speed of 50 miles an hour, under full load.

The contest will take place in Italy over a circular course of 1,250 miles, or by covering that distance in smaller circles of not less than 310 miles. Three landings will be required, and at least one of them must be at night. Applications must be forwarded to the Aero Club of Italy, who will publish, each year before January 1, regulations for the ensuing contest.

9225
GOLD MEDAL WITH CASH TO BE AWARDED FOR EMINENT WORK IN MICROBIOLOGY

From a fund bequeathed for the purpose by the late Prof. E. C. Hansen, of Copenhagen, Denmark, a prize consisting of a gold medal, and cash to the amount of 2,000 crowns (normally about \$350), will be awarded every two or three years for distinguished work in microbiology, published the preceding year in Denmark or elsewhere. This year, it is proposed to award the medal to some worker in general and not medical microbiology. The foundation is in charge of the

chiefs of the Carlsberg Laboratory, at Copenhagen, and the committee of awards will be composed of eminent Danish, French, and American professors.

9050
FUND FOR THE ADVANCEMENT OF SURGERY PROVIDES CASH AWARDS AND MEDALS

The tenth anniversary of the death of Joseph Lister, the great English surgeon who was the originator of antiseptic surgery, is to be celebrated by the establishment of the International Lister Fund for the Advancement of Surgery. Already \$60,000 has been collected, and out of this a sum of \$2,500, with a bronze medal, will be awarded every three years, irrespective of nationality, in recognition of distinguished contributions to the science of surgery. The only condition connected with the award is that the recipient must give an address in London under the auspices of the Royal College of Surgeons.

9228
BOCHER MEMORIAL PRIZE TO BE AWARDED BY AMERICAN MATHEMATICAL SOCIETY

Soon after the death, in 1918, of Prof. Maxime Bocher, of Harvard University, a fund was raised, and turned over to the American Mathematical Society for the foundation of a prize in his memory, to be known as "The Bocher Memorial Prize." It is to be awarded at five-year intervals for a notable research memoir published in the transactions of the society during the preceding five years by a resident of the United States or Canada. The first award of \$100 is to be made for a memoir published during the period 1918-22, and will be conferred at some meeting of the society in 1923. This is believed to be the first prize to be given in this country at regular intervals for research in pure mathematics, and it is considered to be a very fitting memorial to Professor Bocher, who rendered such valuable service to mathematics.

9244
HIGH-SCHOOL PUPILS' CONTEST FOR BEST ESSAYS ON "THE STORY OF MANKIND"

The publishers of Hendrik van Loon's "The Story of Mankind," which is one of the most widely read books of the day, are offering a prize of \$100 in gold, and 40 other prizes, each of a \$5 gold piece, for the best short essays upon any topic suggested by this book. The contest is open to all high-school pupils in the United States, including junior high schools, academies, and all other secondary schools. The essays must be brief—no longer than is necessary to treat the theme selected. These themes may include: a review of the book; its significance in making the study of history more attractive; a comparison with other histories; a similar treatment of some historical episode not covered by van Loon; or a description of interesting ways of using the book in school, at home, or in clubs. The essays should be typewritten, or very neatly handwritten, and must be sent before July 4, 1922, to Educational Department, The Independent, 140 Nassau Street, New York City.

9295
PRIZES FOR NEW OCCUPATIONS FOR SHUT-INS OFFERED BY POPULAR MECHANICS

MANY new occupations for shut-ins and cripples were developed during the war and post-war activities, and, of course, practically every one knows about the old standard ones—such as rug weaving, beadwork, carving, etc. However, the readers of Popular Mechanics Magazine average so high in originality and resourcefulness that, no doubt, they can offer valuable new suggestions that will go far to increase the economic independence of such unfortunate persons. For the three best ideas of this nature, submitted before November 1 of this year, Popular Mechanics offers the following prizes: First, \$100; second, \$50; third, \$25. Any other available ideas will be paid for at the usual rates. Material should be submitted in concise form, with whatever rough drawings or other illustrations may be required. All prize entries should be addressed to Prize Editor, Popular Mechanics Magazine, 6 North Michigan Avenue, Chicago, Illinois.

Miss Peabody

Aerial Age 3/27/22 - Ent. Peter P. Carney

Science 3/31/22

Science 5/6/22

The Independent. Science + The Weekly Review 140 Nassau St. N.Y.C.

Science 5/5/1922

164
9296

SEVERAL EXAMINATIONS FOR POSITIONS
BY U. S. CIVIL SERVICE COMMISSION

The U. S. Civil Service Commission announces the following open competitive examinations:

For copyist topographic draftsmen, at salaries ranging from \$900 to \$1,400 a year. Applications will be received until further notice. For hydrographic and topographic draftsmen, at salaries ranging from \$1,600 to \$2,000 a year. Applications will be received until further notice. For junior physicist, at salaries ranging from \$1,200 to \$1,500 a year. To be held July 5 and Aug. 23, 1922.

For laboratorians (chemical, physical, engineering) at salaries ranging from \$1,200 to \$1,500 a year. To be held June 21-22 and Aug. 9-10, 1922. For laboratory assistants at salaries for junior grade, of \$1,000, and for senior aid, \$900 a year. To be held July 19, 1922. For assistant examiners, Patent Office, at an entrance salary of \$1,500 a year, with provision for promotion to positions paying from \$1,650 to \$3,900 a year. To be held June 21, 22, and 23, 1922. For computers, Coast and Geodetic Survey, for duty in Washington, D. C., at \$1,400 a year, and in Manila, P. I., at \$2,000 a year. To be held, June 21-22, and Aug. 9-10, 1922. In all cases appointees will be allowed the bonus granted by congress of \$20 a month.

All desirous of competing should at once apply for form 1312, stating title of the examination, to the Civil Service Commission, Washington, D. C., or to the Secretary of the U. S. Civil Service Board in the applicant's locality.

For Service to City of Philadelphia: Prize \$10,000; announced September issue, 1921; awarded each year by Edward Bok, former editor of The Ladies' Home Journal.

One Million Francs for Best Motor: Announced January issue, 1922; closes June 1, 1923; address, Aero Club of France, Paris.

Best Slogan Describing Razor: Prize \$500; announced January issue, 1922; closes June 30; address, Durham Duplex Razor Co., 190 Baldwin Ave., Jersey City, N. J.

Best Setting of a Song: Prize \$100; announced April issue, 1922; closes July 1; address, D. A. Clippinger, 617-18 Kimball Building, Chicago, Ill.

Man-Propelled Airplane: Prize 20,000 francs; announced April issue, 1922; closes September 13; address, Maison Peugeot, 80 Rue Danton, Levallois-Perret (Seine), France.

For Poem on "Spirit of Transportation": Prize \$1,000; announced June issue, 1922; closes June 30, 1922; address, Clark Equipment Company, Buchanan, Mich.

For Best System of Management of Household Expenses: Prizes, \$500, and 180 awards of \$25; announced June issue, 1922; closes June 30, 1922; address, The Menter Company, 467 A Seventh Ave., New York City.

For Best Lists of Uses for "Sanlo": Prizes, \$50, \$25, \$10, and three of \$5 each; announced June issue, 1922; closes Aug. 31, 1922; address, Contest Department, The Parker Sanlo Co., Inc., Rochester, N. Y.

Best Lists of Uses of Shoe Polishes: Prizes, \$500, \$300, \$200, 10 of \$25 each, 20 of \$15 each, 50 of \$5 each, 50 of \$2 each, and 100 of \$1 each; announced April, 1922; closes Aug. 31, 1922; address, F. F. Dalley Company of New York, 277 Military Road, Buffalo, N. Y.

CONTESTS PREVIOUSLY ANNOUNCED

Medals, Diplomas, and Money Awards: Announced August issue, 1921; awards offered by the Franklin Institute.

Emb. H. R. Richardson
757 High St. Newark, N. J.
9/22

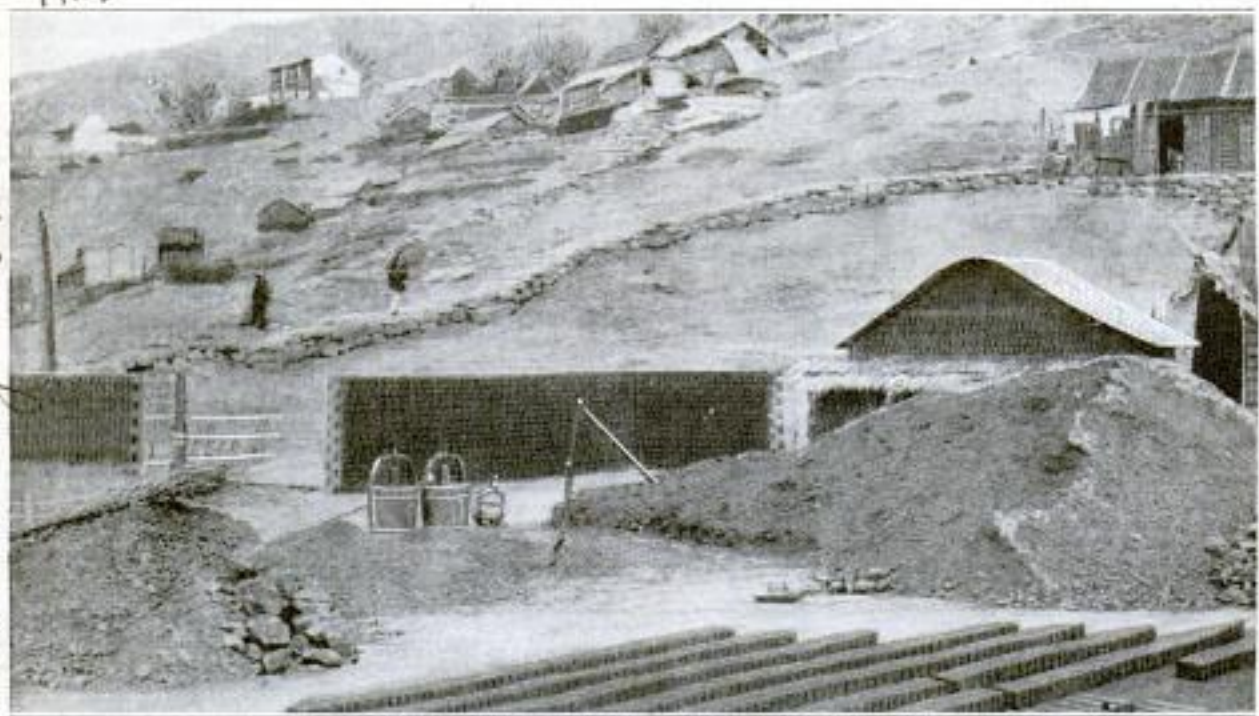

A COAL-BRIQUETTING PLANT IN WESTERN CHINA

MUCH of the coal commonly found in the outcrops on the hillsides in western China is of very friable nature, and due to the crude methods of mining and handling, much coal dust is made. Chinese economy demands that this dust be utilized, so it is made into briquettes. About equal parts of clay and coal dust are mixed with water to form a stiff paste, which is patted with the hands into wooden molds. The briquettes are about the size and shape of small building bricks. Briquettes are shown drying in the foreground, the piles of clay and coal dust farther back, and beyond that a fence made of coal briquettes. All necessary tools and machinery are in view.

IN accordance with the editorial policy of this magazine never to accept compensation in any form for what appears in our reading pages, and also to avoid all appearance of doing so, we are obliged to omit the name of the maker or the seller of any article described. This information, however, is kept on file and will be furnished free, by addressing Bureau of Information, Popular Mechanics Magazine, Chicago. [Editor.]



Only one-fifth of the buildings owned by the Bell System are shown in this picture.

A Telephone City

Above is an imaginary city, made by grouping together *one-fifth* of the buildings owned by the Bell System, and used in telephone service. Picture to yourself a city *five times* as great and you will have an idea of the amount of real estate owned by the Bell System throughout the country.

If all these buildings were grouped together, they would make a business community with 400 more buildings than the total number of office buildings in New York City, as classified by the Department of Taxes and Assessments.

Next to its investment in modern telephone equipment, the largest investment

of the Bell System is in its 1,600 modern buildings, with a value of \$144,000,000. Ranging in size from twenty-seven stories down to one-story, they are used principally as executive offices, central offices, storehouses and garages. The modern construction of most of the buildings is indicated by the fact that the investment in buildings is now over three times what it was ten years ago.

Every building owned by the Bell System must be so constructed and so situated as to serve with efficiency the telephone public in each locality, and to be a sound investment for future requirements.



" BELL SYSTEM "

AMERICAN TELEPHONE AND TELEGRAPH COMPANY
AND ASSOCIATED COMPANIES

One Policy, One System, Universal Service, and all directed toward Better Service

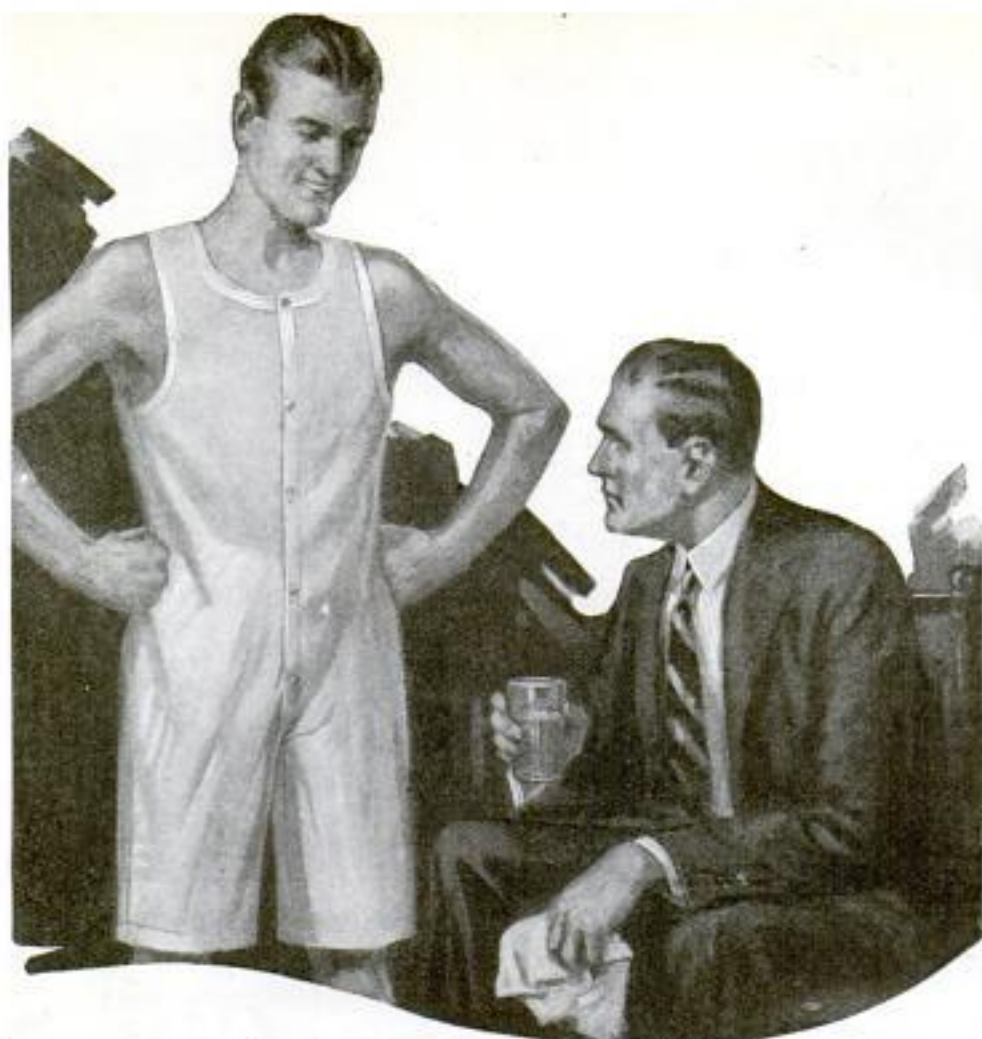

“Wear Topkis and be cool”

I CAN'T help smiling at you fellows who lose all your pep in hot weather. When will you ever learn to dress properly?

“It's all a matter of keeping your skin in condition to meet temperature changes. And the way to do that is to wear Topkis Union Suits.

“Why? First of all, because it lets your skin breathe. Your pores don't get sluggish. They act as nature intended and adjust themselves automatically to any change in the weather.

“Second, Topkis fits—all over. No irritation. No pinch. No pull. Hangs loose and touches your body at few points. There's a protecting cushion of air about your body all the time. No bulky belt at waist. Roomy armholes. Extra

long, extra wide legs. Plenty of stride-room.

“Topkis wears. You can't beat Topkis as a big dollar's worth.”

* * *

Only the best Nainsook and other high-grade fabrics go into Topkis Athletic Underwear. Pre-shrunk—full size guaranteed. Get your size—38 if you wear a 38 coat, and so on.

No reliable dealer will ask more than a dollar for the Topkis Men's Union suit—although many will tell you it's worth more.

Men's Union Suits, \$1.00.

Men's Shirts and Drawers, 75c per garment. 75c for Boys' Union Suits, Girls' Bloomer Union Suits, and Children's Waist Union Suits.

TOPKIS BROTHERS COMPANY, Wilmington, Delaware

General Sales Office: 350 Broadway, New York City

Ask for TOPKIS Underwear.
Look for the Topkis label.

Write today for booklet “Comfort from Neck to Knee.” It's free.

TOPKIS

Athletic Underwear



You can build a better radio receiving set with "YANKEE" Ratchet Screw-drivers

Accurate work is vital for the best wireless results. That's why you need "Yankee" Ratchet Screw-drivers to handle the many small screws.

Just one grip for each screw you drive. None of the wearisome, repeated grip-and-let-go of the ordinary screw-driver. The "Yankee" Ratchet attends to that for you. You can work quicker—easier—better.

Knurled washer on No. 15 lets you start wobbly little screws properly with thumb and forefinger.

Some other "Yankee" Tools

Ratchet Hand Drills	Spiral Screw-drivers
Ratchet Chain Drills	Quick-Return Spiral
Ratchet Bench Drills	Screw-drivers
Automatic Push Drills	Plain Screw-drivers,
Ratchet Tap Wrenches	1½ to 30 inch blades
Bench Vises, Removable Base	



"YANKEE" Tool Book Mailed Free

Illustrates and describes all the ingenious "YANKEE" Tools for saving time and labor. Full of helpful information. Write for your copy today.

*Dealers everywhere sell
"Yankee" Tools*

NORTH BROS. MFG. CO.

Philadelphia

"YANKEE" TOOLS

Make Better Mechanics



No. 10 comes with 2, 3, 4, 5, 6, 8, 10 and 12 inch blades.

No. 11 is same as No. 10 except that Ratchet Shifter moves across instead of parallel with tool.

No. 15 — with knurled washer, comes with 2, 3, 4, 5, 6 and 8 inch blades.

More than just strength is needed—fine skill, care and judgment are necessary in building up your strong, lively Vitalics on the tire-making drum.



"Tougher than Elephant hide" -because of careful workmanship

HAVE you ever noticed the little number near the valve stem on your Vitalic Tires? It's the signature of the man who built it. And if any tire should fail in service because of carelessness on his part, he knows the trouble will be traced right back to him. Do you wonder that he says, "It must be perfect!"

So, after all, it's careful workmanship, as well as

the fine, strong 14½ ounce motorcycle fabric and tough, springy rubber that has made Vitalics the standard by which all tires are judged.

The makers of such splendid bicycles as Black Beauty, Columbia, Dayton, Emblem, Excelsior, Indian, Iver-Johnson, Pierce, and Yale have very good reasons for using Vitalics on their better grade wheels.



This little booklet will tell you the complete story of Vitalic Bicycle Tires. It's yours for the asking.

CONTINENTAL RUBBER WORKS
1932 LIBERTY STREET ERIE, PA.

VITALIC

TRADE MARK REGISTERED

Bicycle Tires



TRADE MARK
"Tougher than
elephant hide"



A Delightful Test

To bring you prettier teeth

This offers you a ten-day test which will be a revelation to you. It will show you the way to whiter, cleaner, safer teeth.

Millions of people of some forty races now employ this method. Leading dentists everywhere advise it. You should learn how much it means to you and yours.

Clouded by a film

Your teeth are clouded more

or less by film. The fresh film is viscous — you can feel it with your tongue. It clings to teeth, enters crevices and stays.

Old methods of brushing leave much of that film intact. The film absorbs stains, so the teeth look discolored. Film is the basis of tartar.

How it ruins teeth

That film holds food substance which ferments and

forms acids. It holds the acids in contact with the teeth to cause decay.

Millions of germs breed in it. They, with tartar, are the chief cause of pyorrhea. So most tooth troubles are now traced to that film, and they are almost universal.

Now we combat it

Dental science, after long research, has found two film combatants. Many careful tests have proved their efficiency. Leading dentists everywhere urge their daily use.

A new-day tooth paste has been created, called Pepsodent. It complies with modern requirements. And these two great film combatants are embodied in it.

Two other effects

Pepsodent brings two other effects which authority now deems essential. It multiplies the starch digestant in the saliva.

It multiplies the alkalinity of the saliva. That is Nature's neutralizer for acids which cause decay.

Send the coupon for a 10-Day Tube and watch these effects for a while. Note how clean the teeth feel after using. Mark the absence of the viscous film. See how teeth whiten as the film-coats disappear.

Then judge the benefits by what you see and feel. You will be amazed.

Pepsodent PAT. OFF.
REG. U.S.

The New-Day Dentifrice

Endorsed by modern authorities and now advised by leading dentists nearly all the world over. All druggists supply the large tubes.

10-Day Tube Free

THE PEPSODENT COMPANY,
Dept. 58, 1184 S. Wabash Ave., Chicago, Ill.
Mail 10-Day Tube of Pepsodent to

.....
.....
.....
Only one tube to a family

Thoroughbreds

Crack machinists, ambitious apprentices — the real thoroughbred mechanics of the metal-working arts — prize and demand the superior precision tool quality found only in

Starrett Tools

— the thoroughbred fine tools.

A typical example is the Starrett Micrometer Case No. 910, designed to meet the demand for a higher finished micrometer case. Nickel plated, round corners, velvet lined, it makes a fit setting for a splendid tool. Made for 1 inch micrometer only.

Send for Catalog No. 22 "A.P."

The L.S. Starrett Company

*The World's Greatest Toolmakers
Manufacturers of Hack Saws Unexcelled*

ATHOL, MASS.

42-283



Starrett Tools

WIN \$10000

OR A
**HUPMOBILE
 TOURING
 CAR**

GEE BUT
 IT'S FUN

I'VE GOT
 NO. 6

NO. 1 IS A
 HARD ONE



WHO ARE THEY?

- ① YOU ALL BANK CLAM RIG
- ② I RACED ALL WE
- ③ DO NOT THRO LADY
- ④ GE HAM IS HOT MAN
- ⑤ MAD MAN GORE TAL
- ⑥ NO GUD BAR IS A FLASK
- ⑦ WET ART IS A TAN
- ⑧ ALL CHEAP IN RICH
- ⑨ LORSA WIN A SONG
- ⑩ RUN EAT TOBSEK

Can You Answer This Movie Puzzle?

On the Movie Screen above are the names of 10 movie stars rearranged. The Operator played a joke on the audience and you'll admit it was a good one.

To Solve the Puzzle rearrange the letters in the sentences on the screen so that they will spell each actor's or actress' name. For example: No. 1 is Clara Kimball Young. If you can name all 10 stars, you can win the Hupmobile or \$1,000.

Probably you know the names of the Most Popular Stars, but just to refresh your memory, we are mentioning below a few of the Most Famous Players:—Norma Talmadge, Otis Skinner, Wallace Reid, Bebe Daniels, Dorothy Dalton, Thomas Meighan, Beverly Bayne, Anita Stewart, Douglas Fairbanks, Blanche Sweet, Charlie Chaplin, Clara Kimball Young, Buster Keaton, Pearl White and Gloria Swanson.

185 "POINTS" WINS FIRST PRIZE

For each name you arrange correctly you will receive 10 "points" toward the Hupmobile Touring Car or the \$1,000 in cash, or you receive 100 "points" if you arrange all 10 names correctly. You can gain 60 more "points" by Qualifying your answer. That is, by proving that you have explained the 10 "Superior Features" of the Wallman Self-Filling Fountain Pen to five people. The final 25 "points" will be awarded by 3 Judges to the person making up the largest and nearest correct list of words from the name of the first Movie Actor listed on the screen above—Clara Kimball Young. It's easy! Can you make out 10-20-30 words like you-young-ball-all, etc. Send in your list of words right away with the names of the 10 Stars. Number each word and in making up your list don't use prefixes and suffixes or obsolete archaic, foreign or compound words if they are so listed in the New Standard Dictionary. Use each letter only as many times as it appears. For example: There are three 'a's. Therefore "a" may be used three times if necessary in forming a word.

The answer gaining 185 "points" (which is the maximum), will win the Hupmobile or the \$1,000. In case of a tie, all tying contestants will receive the same prize. Send in your answer TODAY. As soon as it is received, we will send you a circular telling about the 10 "Superior Features" of the Wallman Self-Filling Fountain Pen, FREE, to assist you in qualifying.

COSTS NOTHING TO TRY

You will not be asked to buy a Wallman Self-Filling Fountain Pen nor to spend a penny in order to win. Just write your answer to the Puzzle on one side of the sheet of paper and PRINT your name and address on the upper right hand corner. Do your best and you can win. Contest closes July 29th. Answer the Puzzle NOW.

WALLMAN PEN CO.

Dept. 61, St. Paul, Minn.

Look! *Only* **\$3.50** *a* **Month**

See It First—No Money Down

Our determination to this year double our sales of the world famous

Santa Fe Special
and
Bunn Special Watches
prompts this matchless offer.

While other watch dealers are raising their prices, asking you for larger monthly payments, and making payment terms harder for you to meet, we are offering you our new model Santa Fe Special, no advance in price, no money down, easier terms and smaller monthly payments. WE realize the war is over and in order to double our business we MUST give you pre war inducements, better prices, easier terms and smaller payments.

Without one penny of advance payment let us place in your hands to see, to examine, to inspect, to admire, to approve, a real masterpiece in watch creation.

A watch which passes the most rigid inspection and measures up to the exacting requirements of the great Santa Fe Railway System, and other great American trunk lines.

Page Twelve of Our Watch Book Is of Special Interest to You!

Ask for our Watch Book free—then select the Watch you would like to see, either the famous Santa Fe Special or the 6 position Bunn Special, and let us explain our easy payment plan and send the watch express prepaid for you to examine. No money down.

SANTA FE WATCH CO.,
76 Thomas Bldg., Topeka, Kans.

Please send prepaid and without obligation your Watch Book free, explaining your "No Money Down" Offer on the Santa Fe Special Watch.

Name

Address

State

Remember —No money down—easy payments buys a master timepiece—a 21 Jewel guaranteed for a lifetime at about half the price you pay for a similar watch of other makes. No money down—a wonderful offer.

SANTA FE WATCH CO.
76 Thomas Bldg. Topeka, Kans.

41 Cash Prizes will be Given Away

First Prize \$500

Big Shipman-Ward 30th Anniversary Contest Open to Every Reader of This Publication. No Purchase Necessary. No Obligation!

Here's an amazing offer! A contest that's different from anything you ever heard of before! It means real money for you. And there's no obligation, purchase, lottery, guessing, fees, or payments of any kind! We are giving \$1,500 away, and anybody in the U.S., except our employes, is eligible!

THE PRIZES

FIRST PRIZE	\$500.00
Second	250.00
Third	100.00
Fourth	50.00
Fifth	50.00
Sixth	50.00
Seventh	25.00
Eighth	25.00
Ninth	25.00
Tenth	25.00
Eleventh	25.00
Twelfth	25.00
Thirteenth	25.00
Fourteenth	25.00
Fifteenth	25.00
Sixteenth	25.00

Seventeenth to forty-first
TWENTY-FIVE \$10.00 PRIZES

We make this big contest offer in celebration of our thirtieth business birthday. Since 1892 this company has been in business in Chicago, and boasts over 337,000 enthusiastic customers. It isn't necessary to own a Shipman-Ward Rebuilt in order to compete in the big profit-sharing contest. Any reader of this paper, excepting our employes, is eligible. Just sign the coupon to the right, and get the full details now.

Our contest plan is so simple that anyone has a good chance of winning. Don't delay, get your chance to win hundreds of dollars in cash absolutely FREE. Just sign the coupon and mail it as soon as possible. That's all—and you're under no obligation. So tear out the coupon now!



This is a photograph of the Shipman-Ward Plant. The big Anniversary contest marks the 30th year of this company in Chicago. In this plant are manufactured the famous Shipman-Ward Rebuilt Underwoods.

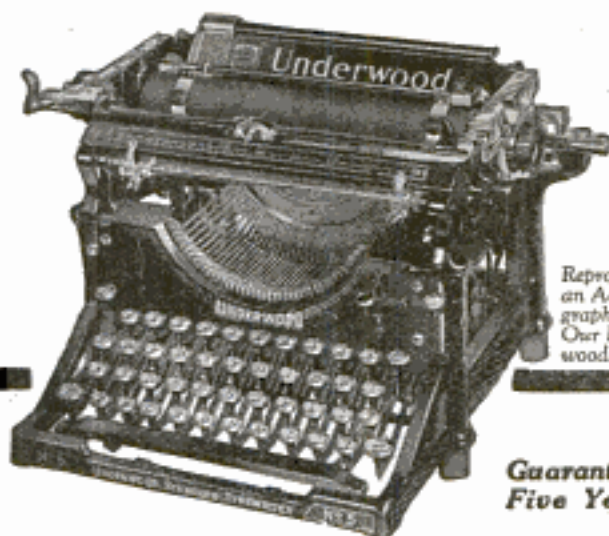

Reproduced from an Actual Photograph of One of Our Rebuilt Underwoods.

**Guaranteed
Five Years**

\$3 Puts It In Your Home

Yes, that's just what we mean. This genuine Shipman-Ward Rebuilt Underwood sent to you for ten days' free trial. Put it in your home by paying \$3 down—we'll refund that \$3 and pay transportation charges both ways if you don't want to keep the Underwood. See for yourself—compare our Underwood with any other typewriter, any make, at any price. If you decide to keep it, you can pay on easy monthly payments—little more than rental.

Less Than Factory Price

Just think of it! Less than the factory price of a new Underwood and yet it's impossible to tell a Shipman-Ward Rebuilt from a brand new machine in appearance, durability or quality of

work. The same three full-size models being made and sold by The Underwood Company today—the same up-to-date features! Two-color ribbon, back-spacer, stencil device, automatic ribbon reverse, tabulator, etc. And the famous Underwood feature—absolutely visible writing—the entire line of typewriting is visible at all times. Standard 4-row single shift keyboard.

Easy Payments

Remember, it doesn't cost you a penny to try the machine. Then, you may pay cash at a substantial discount, or monthly payments so small that you will never miss them. Either way you get the world's standard typewriter at a big cash saving to you. Get all the facts now—mail the coupon today.

Typewriter Emporium SHIPMAN-WARD MFG. CO

"The Rebuilders of the Underwood"

Also Manufacturers of

THE LIGHTNING COIN CHANGER

Est 1892 B212 Shipman Bldg. Ravenswood and Montrose Aves. Chicago

Mail It Now!



Act Today!

SHIPMAN-WARD MFG. CO.
B212 Shipman Bldg., Ravenswood & Montrose
Avenues, Chicago.

(PLEASE MARK WITH A CROSS)

- Please send full particulars about your Thirtieth Anniversary Contest.
- Also send me your beautiful Catalog and tell me how I can get a Shipman-Ward Underwood for \$3 down. This does not obligate me to buy.

Name _____

Street or R.F.D. _____

Post Office _____ State _____



The responsibility of fame

1800 Service Stations sell Westinghouse Batteries and render Westinghouse Attention—a superior service created by Westinghouse for YOUR battery, regardless of make. Get acquainted!

Give your radio set the advantage of "A" or "B"
WESTINGHOUSE
RADIO
BATTERIES

NIGHT—miles from town—a fellow motorist with a "dead" battery—you with brightly glowing lights, snappy ignition and the complacency that comes from the assurance that all's well. In the distance a speeding train, controlled by Westinghouse-built air brakes and automatic signals, to remind you of the responsibility placed upon the name and organization of Westinghouse. That's when you fully appreciate the thorough dependability of your Westinghouse Battery! That's when you can better understand why Westinghouse Batteries must be of one quality—the best Westinghouse can build; and why Westinghouse Batteries can and do carry a guarantee new in features and unexcelled in liberality.

WESTINGHOUSE UNION BATTERY CO., Swissvale, Pa.

WESTINGHOUSE BATTERIES

DIAMONDS
Here at 60%
of Market Price

This blue white perfectly cut diamond, 7-8 - 3-32 ct. at \$32.50 among bargains last list. Many other big values in our lists. Buy HERE. Loan values the price basis, not market values. This 75 year old diamond banking firm has thousands unpaid loans and other bargains we must sell NOW.

Why Pay Full Prices
Any diamond sent for absolutely free examination at our risk. No obligation. No cost to you.

Send for Latest List
Diamond Bargains described in detail. Tells of guaranteed loan values, unlimited exchange privilege, details of free examination. No obligation. Just send name.

JOS. DEROY & SONS
Only Opposite Post Office

1908 DeRoy Building
Pittsburgh, Pa.

This Ring \$52.50
9/8 - 1/16
Carat
Blue
White

Stop Ford Lights Flickering

Union Fuse Block eliminates poor connection of lighting wires and loose screws in terminal block, which cause lights to flicker.

When a wire grounds, a fuse blows instead of wires burning. A new fuse costs but a few cents; new wiring costs real money.

Permits use of standard lamps for both bright or dim lights, instead of high-priced double-filament type. Easy to install.

Sent postpaid for \$1.50 if not at your dealers. Money back if not satisfactory. Write for booklet.

CHICAGO FUSE MFG. CO.
1503 Lavin St., Chicago, Ill.

Eastern Branch: New York

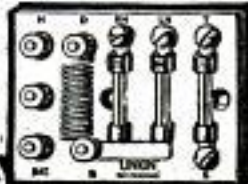



Tirro
The Ideal Mending Tape

FREE
Trial strip of Tirro. Mail coupon below

Golfers

Protect your fingers this new way

Tirro protects the fingers from callouses and blisters. Just the correct width to do the job right. Better, by far, than a glove. Keep a spool always in your golf trousers.

Use Tirro, too, for a grip on a tennis racket; to hold torn cloth together; for repairing quickly the things ordinarily discarded. Sticks to anything—and waterproof. "Wonderful!" you'll say.

Three Sizes: Small, 15c; Medium, 25c; Large, 50c
At Drug Stores

P M 3-24

Tirro

MAIL THIS
For Free Strip

BAUER & BLACK,
2500 Dearborn St., Chicago.

Mail me a strip of Tirro.

Name

Address

City State

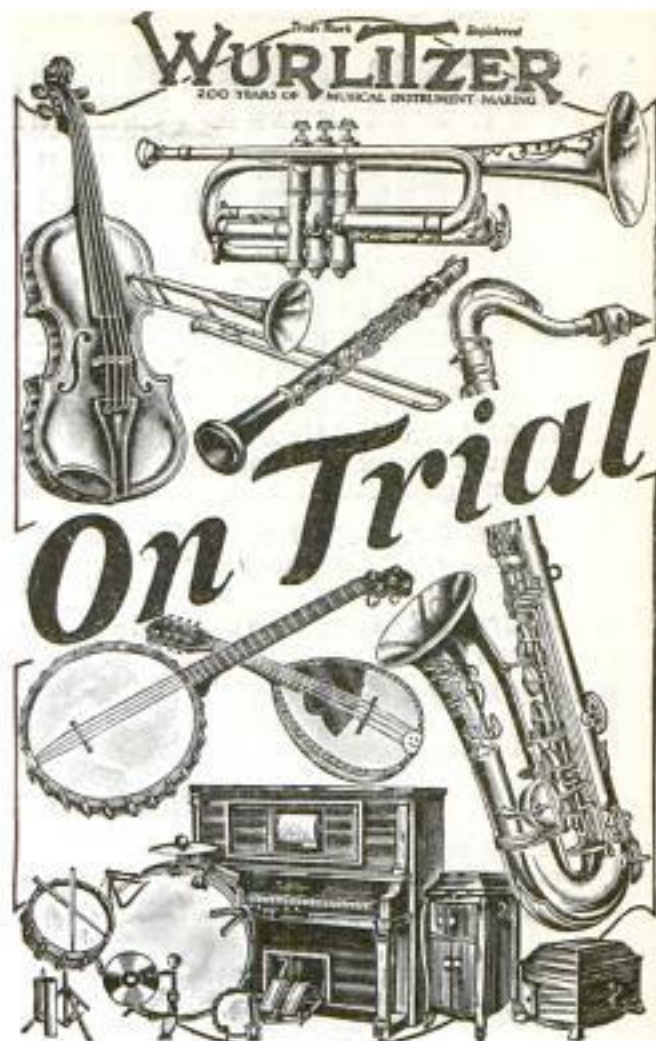

Send for New Book
On Musical Instruments **No Charge**

EVERY known instrument illustrated, many in full colors. All details and complete descriptions. A veritable musical encyclopedia—absolutely free!

You may now have any musical instrument for a week's trial in your home at our risk. No obligation to buy. Return the instrument at our expense at the end of a week if you decide not to keep it. The trial will not cost you a penny.

Monthly Payments

A few cents a day will pay. Special combination offers in complete musical outfits—velvet lined case, all accessories, self-instructor, etc., all at direct factory price—everything you need at practically the cost of the instrument alone.

Wurlitzer instruments are known all over the world for artistic quality. Used by the greatest musicians, bands and orchestras. Wurlitzer has made the finest musical instruments for over 200 years.

Write Today. Wurlitzer has stores in over thirty cities. But no matter where you live, Wurlitzer is no farther than your nearest mail box. Send coupon today.

THE RUDOLPH WURLITZER CO., Dept. B177

117 E. 4th Street, Cincinnati 120 W. 42nd Street, New York
700 W. Jackson Blvd., Chicago 250 Stockton St., San Francisco

Send me your new catalog with illustrations in color and full descriptions of all musical instruments, also details of the Wurlitzer Free Trial Easy Payment Plan. No obligation.

Name

Address

City State

State musical instrument in which you are interested.)
Copyright 1922, The Rudolph Wurlitzer Co.

MOTOR AND GENERATOR BARGAINS For Household and RADIO Use

BARGAIN No. 1—The efficient $\frac{1}{4}$ h.p., 110 volt, 60 cycle, A. C. Motor shown in the cut. Weighs 28 lbs. and easily takes care of $\frac{1}{2}$ h.p. peak loads. Just the motor for washing machines, grinders, large ventilating fans, cream separators, small bench lathes and drill presses.....

\$13.50

BARGAIN No. 2— $\frac{1}{4}$ h.p., 110 volt, 60 cycle, A. C. Synchronous Motor for operating Radio spark gap.....

\$20.00

BARGAIN No. 3— $\frac{1}{4}$ h.p. Motor Generator set; 110 volt, 60 cycle, for charging "A" Batteries.....

\$35.00

BARGAIN No. 4— $\frac{1}{4}$ h.p., 110 or 220 volt, 60 cycle, A. C. Combined Motor-Generator with low voltage for charging "A" Battery, and 500 volts for broadcasting.

\$100.00

BARGAIN No. 5—Big capacity Grinder and Buffer, using the $\frac{1}{4}$ h.p. motor described in Bargain No. 1. Has 6-inch abrasive wheel and 7-inch Standard Cotton Buff. Weight 38 lbs. bare.....

\$25.00

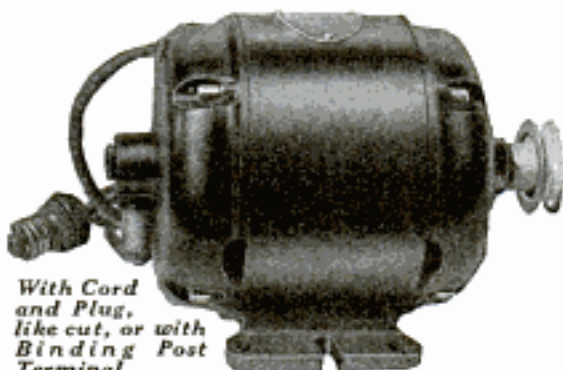

With Cord and Plug, like cut, or with Binding Post Terminal

Immediate Shipment from Stock

Half usual prices. At these low prices, cash must accompany the order. Every outfit is fully guaranteed; money will be refunded on any unsatisfactory apparatus returned to us within 30 days.

NORTHWESTERN ELECTRIC CO., 408 So. Hoyne Ave., CHICAGO

FOR OUTDOORS

Army Shelter Tent.....	\$ 1.45
U.S.A. 16x16 ft. Pyramidal Tent.....	\$16.85
New Khaki Riding Breeches.....	\$ 2.45
New U.S.A. Khaki Shirt.....	\$.99
New Canvas Leggings.....	\$.47
New O. D. Wool Shirt.....	\$ 2.65
New O. D. Wool Coat.....	\$ 1.85
New Army Shoes.....	\$ 4.45
New Leather Puttees.....	\$ 3.45
Army Folding Cot.....	\$ 2.45
New Army Athletic Underwear.....	\$.37
O. D. Wool Blanket.....	\$ 2.25
Western Style Felt Hat.....	\$.99

Add postage to above prices. Money promptly refunded if not satisfied.

ATLANTIC STORES

477 Kaplan Building
ATLANTA, GEORGIA



In Strange Country

You don't need to know the ground if you pack one of the nine styles of Taylor Compasses—reliable guides that take you anywhere.

At your dealer's—ask him for prices.

TAYLOR COMPASSES



Taylor Instrument Companies
ROCHESTER, N.Y.

There's a Taylor Style Compass for Every Purpose

NEW CORD TIRES

\$10.65 TUBE
FREE

30 x 3 1/2

**\$100
REWARD**

To any person
proving our tires not
to be strictly Firsts

GUARANTEED 8,000 MILES

Our Guarantee and challenge assures every customer full protection. You can't afford to overlook these wonderful quality tires at such low prices. Brand new—high grade—cords, guaranteed 8,000 miles and adjusted at list price on that Guarantee.

THESE PRICES INCLUDE NEW PURE GUM TUBE FREE

30 x 3	\$ 8.85	33 x 4	\$17.10	34 x 4 1-2	\$23.95
30 x 3 1-2	10.65	34 x 4	18.60	35 x 4 1-2	24.40
32 x 3 1-2	13.25	33 x 4 1-2	21.48	33 x 5	26.20
31 x 4	14.10	33 x 4 1-2	22.60	35 x 5	28.90
32 x 4	15.95				

RUSH ORDERS! DON'T DELAY No money in advance. Just write today to be sure of getting the sizes and number of tires you want. All tires shipped C.O.D. Pay after you have examined.

WILSON TIRE CO., Dept. 297 325 E. 33d St., CHICAGO

WITTE

LOG SAW

\$75.00

New Price for
Short Time Only

F. O. B. Pittsburgh \$80

F. O. B.
K. C.



**Our
Biggest
and Best Log Saw**

DIRECT
To YOU

Look! See What You Get—Big Surplus Power 4-cycle engine—weight over axle (not on handles)—two-wheel truck—easy to move. Direct geared (no chains or belt). Lever controlled clutch—Arm swing motion. We have only one Log Saw—our biggest and best (at advertised price). Why pay \$50 more for any saw. Order direct from this ad. Lifetime guarantee—Cash or terms—Immediate Shipment. Tree Saw at small extra cost. Catalog Free.

WITTE ENGINE WORKS

1748 Oakland Avenue,
1748 Empire Building,

KANSAS CITY, MO.
PITTSBURGH, PA.

A PERFECT POLISH WITH CLEAN HANDS



**KAXO
SHOE BRUSH**

POLISH, DAUBER and BRUSH combined in one convenient article. Polish is in a tube enclosed in metal case on top of brush, and when tube is used up, new ones may be obtained at leading stores everywhere, 25 cents. Buy of your dealer or order direct, stating whether black, tan, mahogany or white is desired. Fine opportunity for agents. Postpaid anywhere \$1.25. Address Sales Dept. The Kaxo Co., Cambridge, 39, Mass.

HAWAIIAN IM. DIAMONDS



No. 8019
Special price \$2.98

The Greatest Discovery the World Has Ever Known
Just to advertise these 10-ton diamonds we will send you one of these 14K gold rings, postage paid. When it arrives pay postman \$2.38 C.O.D. charges to cover rest etc. Only 10,000 rings given away. Money refunded if you can tell it from a genuine diamond. Send size of finger.

KRAUTH & REED

Dept. C
Masonic Temple Chicago



No. 8011
Special price \$2.98

Only
**\$15
Down**

Play Well in
4 Weeks



—Eight Months to Pay

Latest C Melody Saxophone Outfit complete, only \$100—lowest price ever quoted. Sent on 4 days' trial. If satisfied, pay only \$10 a month for 8 months. No interest to pay—no extra. Outfit includes finest nickel trimmed and gold lined case. Instruction Book, Album of Popular Saxophone Solos, Music Lane, Carrying Strap, Mouthpiece and three fine Reeds.

"Masterbilt" Saxophones

Highest quality, built in perfect tune, assembled and tested by experts. Has all latest key improvements, light, quick action and beautiful finish. Order direct from this advertisement or write for Free Catalog Folder today.

The Saxophone Shop, 427 S. Wabash Ave., Chicago
Largest Exclusive Dealers in Saxophone Supplies in the World



Note the renewable cutting blades. There's the reason why Neverslips will outwear and outcut any plier made.

Here's a Pair of Pliers You Can't Wear Out

Just pick up a pair of Neverslip Pliers—heft them—now look at the blades. Here's a pair of pliers you can't wear out.

The secret of Neverslip's long life is just this: When other pliers are made, their cutting edges are made at the same time, from the same piece of steel. That's why they cannot have high carbon crucible steel blades like Neverslip. Moreover, as the Neverslip cutting blades are made separately, it means they are renewable. Whenever they become accidentally nicked or broken they can be quickly and easily replaced just the same as a safety razor.

Neverslips are guaranteed to outwear and outcut any plier made. Most hardware dealers sell them, or write for leaflet.

THE NEVERSLIP WORKS
NEW BRUNSWICK NEW JERSEY

NEVERSLIP

side cutting pliers

Neverslip Pliers are furnished in 6-7 and 8 inch sizes.

DIAMONDS WATCHES

CASH OR CREDIT

Genuine Diamonds GUARANTEED
Prices Greatly Reduced

We invite comparisons. You will be convinced that you can do better with **LOFTIS**. Our **IMMENSE BUYING POWER** for our Chain of Stores and our large Mail Order House enables us to make lower prices than small concerns.

Send for Free Catalog
 Everything explained. Over 2,000 illustrations of Diamond-set Jewelry, Pearls, Watches, etc. Any article sent prepaid for Free Examination. Satisfaction guaranteed or money refunded.

BARGAINS Selected from "A1 Best Sellers." Diamonds are dazzling, blue white, perfect cut. Mountings are all Solid Gold. Mounted at prices given, and up to any price you wish.

Order by Number.

DIAMOND RINGS: 1-White Gold, \$100. 2-Yellow Gold, \$80. 3-White Gold, or Green Gold with White Gold prongs, \$75. 4-Green Gold, Diamond set in White Gold, \$120. 5-White Gold, \$75. 6-WEDDING RING: Platinum, \$250 Green or Yellow Gold, \$10. 7-WATCH: 17-J. gold filled, guaranteed 25 years. \$25. 8-Wrist Watch: White Gold, 16-J. \$32.50.

Credit Terms: One-fifth down, balance divided into equal payments within eight months. Send for Catalog.

LOFTIS The Old Reliable Credit Jewelers
 DEPT. 8-254
 105 N. State Street, Chicago, Ill.
 BROS. & CO. EST'D 1858
 Stores in Leading Cities

Easy to Play Easy to Pay

BUESCHER

True-Tone SAXOPHONE

Saxophone Book Free
 Tell when to use Saxophone slugs, in sestettes or in regular band; how to play from cello parts in orchestra and many other things you would like to know.

Easiest of all wind instruments to play and one of the most beautiful. You can learn the scale in an hour's practice and play popular music in a few weeks. You can take your place in a band within 90 days, if you so desire. Unrivalled for home entertainment, church, lodge or school.

In big demand for orchestra dance music. The portrait above is of Donald Clark, Soloist with the famous Paul Whiteman's Orchestra.

Free Trial You may order any Buescher Instrument without paying one cent in advance, and try it six days in your own home, without obligation. If perfectly satisfied, pay for it on easy payments to suit your convenience. Mention the instrument interested in and a complete catalog will be mailed free.

Buescher Band Instrument Co.
 Makers of Everything in Band and Orchestra Instruments
 2534 Buescher Block, Elkhart, Indiana

Be the First in Your Club

School, City or Town, to wear this pure, all wool sweater, double collar and cuffs. Your choice in colors. This jersey was selected by 10,000 of my customers for last season. Your chum will recommend it. Send for my big illustrated catalogue. Write me and learn my offer for your club's order. Popular Prices. Best Grade Sporting Goods—Baseball, Basketball, Tennis, Golf, Football, etc.

WRITE ME NOW
 Jack Shannon Co., Dept. 46, 111 So. Dearborn St., Chicago

Do Your PRINTING

Cards, circulars, labels, tags, book, menus, paper, Press, \$12. Larger \$35. Job Press \$150 up. Save money. Print for others, **BIG PROFITS**. All easy, rules sent. Write factory **TODAY** for press catalog, TYPE, cards, paper. **THE PRESS CO. D-37, MERIDEN, CONN.**

SEND NO MONEY

Try this Portable Typewriter 10 Days **FREE**

Now you can buy famous; 9-pound National Typewriter direct from the factory, after 10 days' trial—absolutely free. You be the judge. Then we give you

10 MONTHS TO PAY

Same machine as used by thousands of doctors, lawyers, bankers, salesmen, students, writers and business men in 31 countries. Every feature of best, standard size machines. 28 keys.

84 characters. Brand new—neat, compact carrying case free with every machine. Send today for our 10 Days' Free Trial offer and 10 Months' Easy Payment Plan.

NATIONAL TYPEWRITER CO.
 Dept. 7G. Fond du Lac, Wis.

Are You All Primed?

We can supply you with Masonic books of reference, study, history, etc. Also fine aprons, regalia, novelties, jewelry and supplies.

Send for Free Catalogue X
REDDING & CO.
 Publishers and Manufacturers
 Dept. D 200 Fifth Avenue, New York

The "BEST" LIGHT

Positively the cheapest and strongest light on earth. Used in every country on the globe. Makes and burns its own gas. Casts no shadows. Clean and odorless. Absolutely safe. Over 200 styles. 100 to 2000 Candle Power. Fully Guaranteed. Write for catalog. **AGENTS WANTED EVERYWHERE.**

THE BEST LIGHT CO., 324 E. 5th St., CANTON, O.

FOR CAMP & SUMMER WEAR

Best quality, lowest prices. Our money back guarantee covers all purchases.

Army Shelter Tents	\$3.00
Khaki Riding Breeches	3.00
Khaki Trousers	2.50
Flannel Shirts	3.00
Khaki Shirts	1.50
Camp Cooking Grates	.30
Folding Mess Pans	.25
Athletic Shirts	.75
Army Folding Cots	4.00
Army O. D. Wool Blankets	2.75

Army tents of all sizes and 5000 other articles for camps or outings.

RUSSELL'S, Inc., 245 W. 42nd St., New York
 Formerly Army & Navy Store Co.

Catalog 112 Free on Request

One of the Boss's Habits

He acquired it when he was an apprentice—he used good tools then because the older men told him to. Later he learned from his own experience that good tools helped him. He knows the value of good tools.

He uses—

BROWN & SHARPE TOOLS

He will tell you that they helped him advance

Their high accuracy, clean cut graduations, correct design and construction, first class material, and skilled workmanship show in the better results in the work of the man who is using them.

Catalog No. 28, showing over 2000 of these tools, on request

BROWN & SHARPE MFG. CO.

ESTABLISHED IN 1833

PROVIDENCE, R. I., U. S. A.



RAISE BELGIAN HARES

New Zealand Reds - Flemish Giants - American Blues.
BIG PROFITS, WE PAY \$1.50 TO \$8 EACH.
Also Caries, Mink, Skunk, Fox, Muskrat, Etc.
Easily raised anywhere. **FREE!**
page Catalog and Contract.
Illustrated book "COMMON SENSE RABBIT
RAISING," quarterly journal, and copy of
America's leading small stock magazine, all for 10 cents. Address
Outdoor Enterprise Co., 1005 O. E. BLDG., KANSAS CITY, MO.



NOW TIME TO START BIG DEMAND. HIGH PRICES BEING PAID

An uncrowded occupation. Exceptional opportunities for live men and women. Raised at home. Only small space needed. Small expenditure will start you in a practical money-making enterprise. Big profits. Booklet telling all free. Write
Nat'l Spawn Co., Dept. 12, Brighton, Mass.

Hand
Forged
Razor Steel
Blades, No. 57



Direct at Factory Prices

This \$2 KNIFE \$1.18 Postpaid
Hand Forged Razor Steel Blades
Handy shaped B I a d e makes this
knife best for mechanics, sportsmen
and farmers; light but strong; re-
sharpened easily. Stag handle. Ger-
man silver finish; blades file tested,
hand forged from razor steel and
warranted.

Sample \$1.18 3 for \$3.00 Postpaid.

Send for our 100-page List and
"HOW TO USE A RAZOR" **FREE**

MAHER & GROSH CO., 106 A St., Toledo, Ohio

\$1 A Month

Buy this world-famous Elgin Watch—the watch you can rely upon every second of the day. It is a new, thin, open-face dust-proof model, 12 size movement. Handsome gold-filled case, guaranteed for 20 years.



Only \$13.98—no advance over the standard Cash price—our amazingly low credit terms only \$2.98 upon receipt and \$1 a month for 11 months. Buy it now!

De Luxe Catalog Free

Contains the most wonderful assortment of Watches, Diamonds and other jewelry. Send for your copy today. Address Dept. 532-M.

Capital, \$1,000,000

"The House of Quality"

L. W. SWEET, INC

1650-1660 Broadway New York



THE COOKER WITH A THOUSAND USES



Made of extra heavy PURE COPPER. Note the extreme width of pot, which gives an extra large fire space. These pots are packed in PLAIN wooden boxes and shipped same day your order is received. **IN ORDERING SEND ONLY \$1.00, BALANCE C. O. D. FREE catalog containing valuable information upon request.**

DEVOL & CO.

26 Barker Block
Omaha, Nebr.

Get JENKINS' Big FREE Catalog sent on request

on complete line of high grade nationally known band and orchestra instruments before buying. Big FREE catalog sent on request. Easy payment plan—PLAY WHILE YOU PAY. FREE lesson certificate with each instrument.

Musicians Earn Big Pay. Learn to play from Jenkins' Band and Orchestra Books. First violin or cornet parts FREE. Our 44 years in business is your guarantee of reliable service. Post card brings BIG FREE CATALOG.

J. W. JENKINS SONS' MUSIC CO.
310 Jenkins Bldg. Kansas City, Mo.



WINDOW SIGNS

AGENTS

\$60—\$200 a week. Free Samples GOLD SIGN LETTERS for store fronts and office windows. Anyone can put them on. No experience necessary. Big demand. LIBERAL OFFER TO GENERAL AGENTS.

METALLIC LETTER CO., 433B, N. Clark St., CHICAGO

AGENTS FORD AUTO GIVEN

We want a reliable man or woman to represent us in your territory taking orders for Zanol Pure Food Products, Toilet Preparations, Soaps, Laundry and Cleaning Specialties and Household Supplies. Nationally advertised from coast to coast. Not sold in stores. Fast repeaters. Big income every day. Exclusive sale. No capital needed.



AUTO FREE

\$6 to \$9 a Day

If you can't devote all of your time, work during your spare time and make from \$2 to \$6 every day you work. Big opportunity. No limit to your earning power. **Ford auto absolutely given** to workers. As the result of our fair and square dealing we are today the largest concern of its kind in the world. Every article guaranteed. Write for outfit.

American Products Co., 6678 American Bldg., Cincinnati, O.

Agents: Get Busy

taking orders for Can't Clog

COAL OIL BURNER



Burns like gas. By regulating valve you get as little heat as you want, or heat oven to baking point in ten minutes. Most perfect burner ever invented. Low-priced.

Summer Seller

Burns coal-oil. Cheapest fuel known. Not sold in stores. No experience or capital needed. You take the orders. We ship by Parcel Post and do all collecting. Commission paid same day you take order. Write for Agency.

PARKER MFG. CO., 678 Coal St., Dayton, O.

"BOW LEGS and KNOCK-KNEES" UNSIGHTLY

SEND FOR BOOKLET SHOWING PHOTOS OF MEN WITH AND WITHOUT THE PERFECT LEG FORMS

PERFECT SALES CO.
140 N. Mayfield Ave., Dept. S, Chicago, Ill.

Rabbit Book FREE

Illustrated. Facts about the easy, profitable home industry—growing domestic hares for meat, fur, fancy. Little space—cheap equipment. Big demand. We buy all you raise at \$7 to \$18 per pair. Turn your spare time into cash. Book free—write now.

STANDARD FOOD & FUR ASS'N
407B Broadway New York City

SAVE HALF - INSTALL YOUR OWN PLUMBING AND HEATING BY OUR NEW EASY METHOD

Send for Our Big Handy-Man Plumbing and Heating Encyclopedia

It shows and explains our NEW EASY METHOD—how to save skilled labor, unnecessary material and heavy work. Any handy man can do the installing with our simplified systems and working plans. OUR NEW EASY METHOD saves much cutting, threading, time and material. Even if you are a plumber the big saving by using our products and NEW EASY METHOD will surprise you.

Big Book Saves Labor and Material

Every builder, mechanic, farmer, etc., needs this BIG INSTRUCTIVE PLUMBING AND HEATING ENCYCLOPEDIA. Besides being our wholesale catalog, it contains hundreds of floor plans, elevations, diagrams and installing sketches from the simplest to the most difficult systems, showing our EASY METHOD of installing your own plumbing or heating, gives hundreds of mechanical rules, kinks, receipts, short cuts, etc., how to lay out plumbing and heating, estimate costs, repair leaks, etc. It shows and describes over 10,000 FACTORY FITTED plumbing and heating fixtures and supplies with wholesale prices; helps you to select the best plumbing outfit, or heating plant, to meet your needs. Any handy man can do the installing with the aid of OUR HANDY-MAN PLUMBING AND HEATING ENCYCLOPEDIA.



Our Factory Fitted Plumbing and Heating

BATHROOM OUTFITS, TOILETS, LAVATORIES, BATH TUBS, SINKS, LAUNDRY TUBS, WATER SUPPLY SYSTEMS, WATER HEATERS, PUMPS, PIPELESS AND WARM AIR FURNACES, HOT WATER AND STEAM PLANTS, PIPE, FITTINGS, VALVES, etc. All outfits factory fitted for the handy man, with beauty, durability and EASE OF INSTALLATION built through and through.

SEND 25c FOR YOUR COPY TODAY

COUPON

HARDIN-LAVIN CO. 50 YEARS AT 4547-57 COTTAGE GROVE AVE., CHICAGO

Enclosed find 25c. Please send me your HANDY-MAN PLUMBING AND HEATING ENCYCLOPEDIA with wholesale discounts, and mail me your monthly bulletin, "Service." 25c to be refunded to me with my first order.

Name _____

Street and No. _____

City _____

State _____



TYPEWRITERS

We Save You 50%

FREE TRIAL—EASY TERMS

Your choice of ALL STANDARD MAKES, UNDERWOOD, ROYAL, SHERIDAN, G. SMITH, Self-starting REMINGTON, etc. Rebuilt by the Famous "Young Process." Guaranteed good as new. Lowest cash prices. Time payments or rentals with special purchase privilege. Largest stock in U. S. Write for special prices and terms. YOUNG TYPEWRITER CO., Dept. 357 CHICAGO



Beautiful HOUSES \$900 and BUNGALOWS

CAN BE BUILT FOR AND UP This and many others in my new book, Building Plans for Modern Homes, will save you hundreds of dollars. One of the most complete and comprehensive books of plans ever published by any architect. New edition just off the press. Nearly 500 floor plans and photographs of bungalows, Colonial houses, etc., costing from \$250 up; gives sizes and cost to build. Sent postpaid for \$2.00



FREDERICK H. GOWING ARCHITECT

101 Tremont St., BOSTON MASS.

Automatic Rapid Electric Cooker

EASIEST method known to prepare family meals. Saves 50% to 75% fuel cost—saves time, labor. Insures better prepared, more tasty food. Gives every facility of electric range plus every advantage of fireless cooker at less cost than a good oil stove.

New Invention

Revolutionizes Cooking—Bakes, roasts, boils, steers, fries, broils, toasts. Needs no watching. Shuts itself off. Attaches to any electric socket. No special wiring. No radiators to heat, no thermometer to watch or break. Write for 30-day FREE trial offer. Direct factory prices.

WM. CAMPBELL CO., Dept. 64
DETROIT, MICH. WINDSOR, ONT.



AGENTS: \$50 a Week

taking orders for guaranteed hosiery for men and women. All styles, colors, and finest line of silk hose.



Guaranteed One Year Must Wear 12 Months or replaced free

Often take orders for dozen pairs in one family. Big profits and pleasant work. Repeat orders make you steady income.

Everybody Needs Hosiery

Whether you devote spare time or full time, it will pay any man or woman to handle this guaranteed line. No experience necessary. Get started at once. Best season of the year. Write for agency, territory and samples.

THOMAS MFG. CO., H-2648, Dayton, Ohio

Don't spend a Penny



Sensational Cut Price, \$6.85

Was \$15—now less than half price! High grade, small size, ladies' watch and bracelet. Stem wind and set, beautiful polished case, stylish golden dial, guaranteed 7-jewel movement, accurate time keeper, carefully inspected and adjusted. Elegant jewel case Free.

7 Jewel Gold Filled

FREE! Extra Silk Ribbon Bracelet!

Two watches for half the price of one, because while this sale lasts we give you \$18.85 extra gold mounted silk ribbon bracelet. You also get guaranteed gold filled link bracelet, as shown.

SEND NO MONEY! Pay Postman \$1.85 on delivery, we pay postage! Motor back instantly if you're not satisfied after inspection. We take all the risk, so WRITE TODAY!

Post. 113

STAR WATCH CO. 80 E. South Water St. Chicago





Enders
SAFETY RAZOR

Ask him
Why
Shaving with
an Enders
is—

**“Just like
wiping
your face
with a
towel”**

ENDERS
sells for \$1,
with six
blades, at
all up-to-
date dealers
everywhere.
Extra blades,
package of 5
—35c.

Blades — hand-stropped and hand-tested

ENDERS SALES COMPANY
105-111 West 40th Street
NEW YORK



Please Mention Popular Mechanics

Different from all others—the NEW BENJAMIN



AIR RIFLE

Made on a different principle from all other Air-Rifles. The Benjamin is really a strong air-pump used to compress the air in the air chamber to any degree of power desired. From one to six strokes of the pump give all the force necessary. Each additional stroke gives increased power. The Benjamin works on the same principle as all air-drills and air-hammers—with this difference:

You control the shooting force as you desire. Look at this block of hardwood. It shows how Benjamin power is regulated as you wish.

You can't have accidents with a Benjamin. It's safe, always, because you control the power. The Benjamin never loses shooting force, and has no springs to get out of order or shake your aim. Write us for an interesting folder about this wonderful air-gun.

For sale by all dealers.
Price \$5.00.

BENJAMIN
AIR-RIFLE & MFG. CO.
615 N. Broadway, St. Louis, Mo.

Ask your
dealer for
demon-
stration.



Pacific-Coast
Representatives:
Stuart & Otto
229 Wilcox
Bldg., Los
Angeles,
Cal.



“Lighting Fixtures”

READY TO HANG

(Direct from Manufacturers)

Completely wired, including glassware. New designs. Send for catalogue No 24. Send for DEALERS' proposition.

ERIE FIXTURE SUPPLY CO.
STA. A. ERIE, PA.



SELF-FILLING

INK PENCIL

“INDEPENDENT”

Meets all requirements. Self-filling, non-leakable, safety cap. Attached clip. Smooth writing gold style point.

Guaranteed Improved Fountain Pen. Eliminates fatigue. Promotes efficiency. Writes uniform. A business necessity.

\$2 By Mail

Your Name in Gold—35 Cents Extra

AGENTS WANTED

J. C. ULLRICH & CO., 161 Washington St., New York

FREE



TRIAL

Cut out this ad and mail it to us with your name and address (no money), and we will send you our **FAMOUS KARNAK RAZOR** by return mail, postpaid. You may use the razor for 30 days **FREE**; then if you like it, pay us \$1.85. If you don't like it, return it.

—SEND NO MONEY—

MORE COMPANY Dept. 355 ST. LOUIS, MO.

5 Master Keys

Only keys of their kind in existence—(patented). Open and test thousands of different locks. Tell you instantly if your door or padlocks are burglar proof. Serve in emergencies, too. Thousands of sets in daily use among detectives, policemen, contractors, locksmiths, firemen, mechanics, travellers, home and hotel owners, etc. Give feeling of security and protection worth many times their cost. Nevel key chain **FREE** with each set. Send only \$1 today.

MASTER KEY CO., 132 MANHATTAN BLK., MILWAUKEE, WIS.



A Partner for Your Every Outing

YOU outdoor folks, who spend your week-ends or entire summers at lake or stream, in camp or cottage—for you what vacation pal can compare with an Evinrude?

Distant fishing grounds, favorite picnic spots, neighboring resorts and beaches—all are quickly and easily reached when you have one of these husky little motors to relieve you of oar-work. And every member of your family can use the Evinrude—it's so simple to operate.

You now have the choice of two Evinrude models—the Standard, for more rugged service, and the Lightweight, an easily portable 50 pound motor, preferred by many sportsmen.

See these Evinrudes at your hardware or sporting goods dealer's. Or write for free catalog describing the Built-in-Flywheel Magneto, Tilt-up Attachment and other Evinrude features.

EVINRUDE MOTOR CO.

696 Evinrude Bldg.

Milwaukee, Wis.



Evinrude Outings No. 4. Off for a day at the island.

DISTRIBUTORS: 68 Corliss St., New York, N. Y.
280 Conventwalk Avenue, Boston, Mass.
119 Broadway, Oakland, Cal.
211 Morrison St., Portland, Ore.

EVINRUDE Standard and Lightweight
DETACHABLE MOTORS FOR WATERCRAFT

MAKE YOUR FORD INTO THIS SPORT CAR \$ ONLY 6.40
Other types down to \$1.50. Famous size 64. **Hot-Rod** life-size patterns and simple instructions show how to convert your Ford into this fast, sexy Sport Car. No hundreds have done this with a few dollars worth of material from the hardware store. No need to lay out the car. The "P.A.L." with optional disc wheel pattern. Pressed Metal Streamline Rear only \$6.40 delivered. Built low, ride wonderfully easy. Order NOW while we can make good delivery. Send for coin for illustrated prospectus of Sport Boats. "Jiffy" Tops and "Geez" Windshields. **Kuempel Co., 94 Kuempel Bldg., Guttenberg, Iowa**

Keen, Classy Up-to-the-Minute

\$45 Buys This Motor Cycle
It's a Harley-Davidson, 16 HP., twin, chain drive, magasto and clutch. It has power and can get up and go on the open road at a speed which thrills. This is only one of hundreds of bargains in used motor cycles which you can get. Send for Free Catalog. It tells of big bargains and tremendous values in used motor cycles. Repairs quickly done. Motor cycles exchanged. Send us your machine to be overhauled.

Oliver Cycle and Motor Co., 1045 N. Grand Ave., St. Louis, Mo.

Makes Good beyond Your Hopes
because it is built on sound engineering principles all through.

Play Safe in Buying a Row-Boat Motor
you can't afford to take any chances. No matter what style of motor you require, there is a

Wisconsin Detachable Row Boat Motor

that will suit you. For six years this standard little motor has been making GOOD under all conditions—in the hands of thousands of users. And no wonder, when you examine its mechanical construction. It has a number of exclusive features that you should know about. Write for catalog TO-DAY.

WISCONSIN MACHINERY & MFG. CO.
19 Minor Street, Milwaukee, Wis.



Jimmy's Diary Tuesday, June 27
"Won a bike race today. Ted Barnes and he could beat me. Raced to Nichol's Farm on the highway—two and a half miles.
"Pretty close, I'll say. Old Ted might have won only he got a punk-ture in sight of the finish and the flat tire slowed him up.
"I didn't have to worry. Had good old Neverleak Tire Fluid in my tires. It stops most any leak." **JIMMY.**
The reliable Neverleak, 25c a tube, at all dealers. Stops leaks instantly, and makes tires wear longer.

FREE—Send for handy Neverleak Pencil Clip. In attractive colors, holds pencil firmly in place.

BUFFALO SPECIALTY CO.
103 Ellicott St. Buffalo, N. Y.



NEVERLEAK TIRE FLUID
"HEALS PUNCTURES ON THE RUN."

Please Mention Popular Mechanics

Restful, Healthful Travel

Those who have traveled on D. & C. Navigation Company Steamers, for business or pleasure, have long come to associate every delight and comfort of outdoor travel with this line. Daily trips are made between Detroit and Buffalo; Detroit and Cleveland, on Eastern Time. Train connections at Buffalo for Eastern and at Detroit for Western Points.

Detroit and Buffalo	Detroit and Cleveland
Lv. Detroit 5:30 p. m.	Lv. each city 11 p. m.
Lv. Buffalo 6:00 p. m.	Daylight trips during July and August
FARE, \$6.00 one way, \$11.50 round trip.	Lv. each city 8:30 a. m.
	FARE, \$3.45 one way, \$6.50 round trip.

Berths, \$1.80 up; staterooms, \$4.20 up; parlor, \$7.20 up.

Rail tickets are accepted. Automobiles transported (15% to 25% reduction this year). Gas must be removed. Wireless equipment.

For reservations and further information address, E. G. Stoddard, Gen. Pass. and Ticket Agt., Detroit, Mich.

Detroit & Cleveland Navigation Company

A. A. Schantz J. T. McMillan
Pres. & Gen. Mgr. Vice-Pres.



SEND 5 CENTS

and get our 48 p. catalogue of **IDEAL Model Aeroplanes, Parts and Supplies**. Tells how to build Aeroplanes that fly like real ones. **IDEAL AEROPANE & SUPPLY CO.** 159 Wooster St., cor. W. Houston New York City

TAKE ADVANTAGE OF THIS SPECIAL OFFER



and **SAVE** from \$10.00 to \$500.00 on your BOAT. **SAVE** two-thirds by building your own BOAT with our **KNOCKED DOWN FRAMES and PATTERNS**.

During July we will allow a special Discount of 10% from our very low prices. **ORDER TO-DAY—DON'T DELAY.** Labor and labor will never be as cheap again. Whether it be **SKIFF or SCHOONER, K. D. Frames or COMPLETED Boats**, we can furnish them at lowest prices.

—Suggest up-to-the-minute design—Ask about our New Catalogs.

WRITE our Service Dept. 4, enclosing 25c for **BOAT BUILDERS' Big Manual and Catalog**, full of valuable information.

BROOKS MANUFACTURING COMPANY

Oldest and most reliable **BOAT BUILDING** Specialists. Saginaw, Michigan.

DIAMONDS

1/2 CARAT \$99⁰⁰

Former all-cash price \$165.00. New low prices: 40% discount. 1/4 carat, \$49.00; 1/2 carat, \$147.00; one carat, \$195.00. If satisfied, pay 20% down; balance in 10 monthly payments.

10 MONTHS TO PAY

Genuine sparkling blue-white diamonds now sold direct to you by **DIAMOND IMPORTERS**. ERS on credit, 18 Kt. solid white gold ring included free. We guarantee to satisfy you or to return your money. **30 days free trial!** Order direct from advt. or write for 128-page bargain catalog, sent free.

B. GUTTER & SONS 172 MASSAUI STREET
81 000 000 and 42 years' experience back our guarantee. DR. 369, NEW YORK

"Fishing Tackle that's Fit for Fishing"

KEEPS THEM ALIVE



Banta Minnow Pail

Note the air pump at the side. The Banta is aerated simply by pressing this button occasionally. No changing of water—no trouble—no loss of minnows through stale water. The Banta is self-cooling. Pail is covered with cloth. A wick inside pail is connected with cloth cover and keeps it damp. Evaporation of water from the cloth cools water in pail—it's the principle of the desert water jar. Capacity, 10 quarts. Retail at \$3.50.

Ask your dealer for the famous **Abbey & Imbrie** tackle. Catalog of 16,400 items on receipt of 10 cents.

ESTABLISHED 1820



ABBAY & IMBRIE

Division of Baker, Murray & Imbrie

This Is Our 102nd Year

97 Chambers St. New York

MOTORCYCLE BARGAINS

Save 25% to 65%

on Slightly used and Rebuilt Motorcycles, Side Cars, Johnson Motor Wheels, Evans Power Cycles, Bicycles. Send for Free Bargain Bulletin and Money Saving Message, listing hundreds of Bargains in used, rebuilt and new machines, supplies, accessories, etc.

AMERICAN MOTOR CYCLE CO. Dept. 714 2047 W. Chicago Avenue, CHICAGO



ENINGER WILL SAVE

BIG MONEY SAVINGS FOR YOU

Used and rebuilt motorcycles, single and twins, \$20 to \$100. Used bicycles, \$5.00; tandems, \$10. All machines guaranteed in good working order. New bicycles and motorcycles at Factory prices. You save dealers' profits. Motorcycle and automobile tires too, \$3.00. Complete sets of parts and supplies. **Daninger Cycle Co., Rochester, N.Y.**

YOU 25 TO 50 DOLLARS

Cheapest Way to Go

to work or school and recreation is on a Ranger bicycle. You can have your choice of 44 Styles, colors and sizes. **30 DAYS' FREE TRIAL.** Express prepaid. **Factory-to-Rider** Prices save you \$10 to \$25.

12 Months to Pay if desired. Saved time and cents. Parents often advance first payment. Best quality, at factory prices, express prepaid. Tires, lamps, wheels and equipment, low prices. Send **No Money, do business direct with makers.**

Mead Cycle Company Dept. F 118 Chicago

Write today for free Ranger Catalog, factory prices and marvelous easy payment terms



MOTORCYCLES

RELIABLE STANDARD MAKES that you can **DEPEND** on. Enjoy the glorious experience of going wherever you like—whenever you like. The price is within your means—35% to 50% less than others. These machines are slightly used, thoroughly overhauled or rebuilt. Send for catalogue.



MYEROW BROS. 258 Columbus Ave., Boston, Mass.

DELTA ELECTRIC BICYCLE LAMP

AFTER DARK—

Going and coming from work—Delta Electric Bicycle Lamp lights the road ahead—spotting every danger—

Delta stands the "gaff," nothing to wear out, break, work loose; can't be bumped out of commission.

A brilliant, never failing light that is time-tried.

Ask your dealer, or model 27 (illustrated) fits any bicycle, cost postpaid for \$2.25 complete, (less battery).

DELTA ELECTRIC COMPANY
100 Delta Block Marion, Ind.
Standard Makers of Electric Lamps, Automobile Spotlights,
Bicycle Lamps, Flashlights and all kinds of Dry Batteries.
New York Winnipeg San Francisco

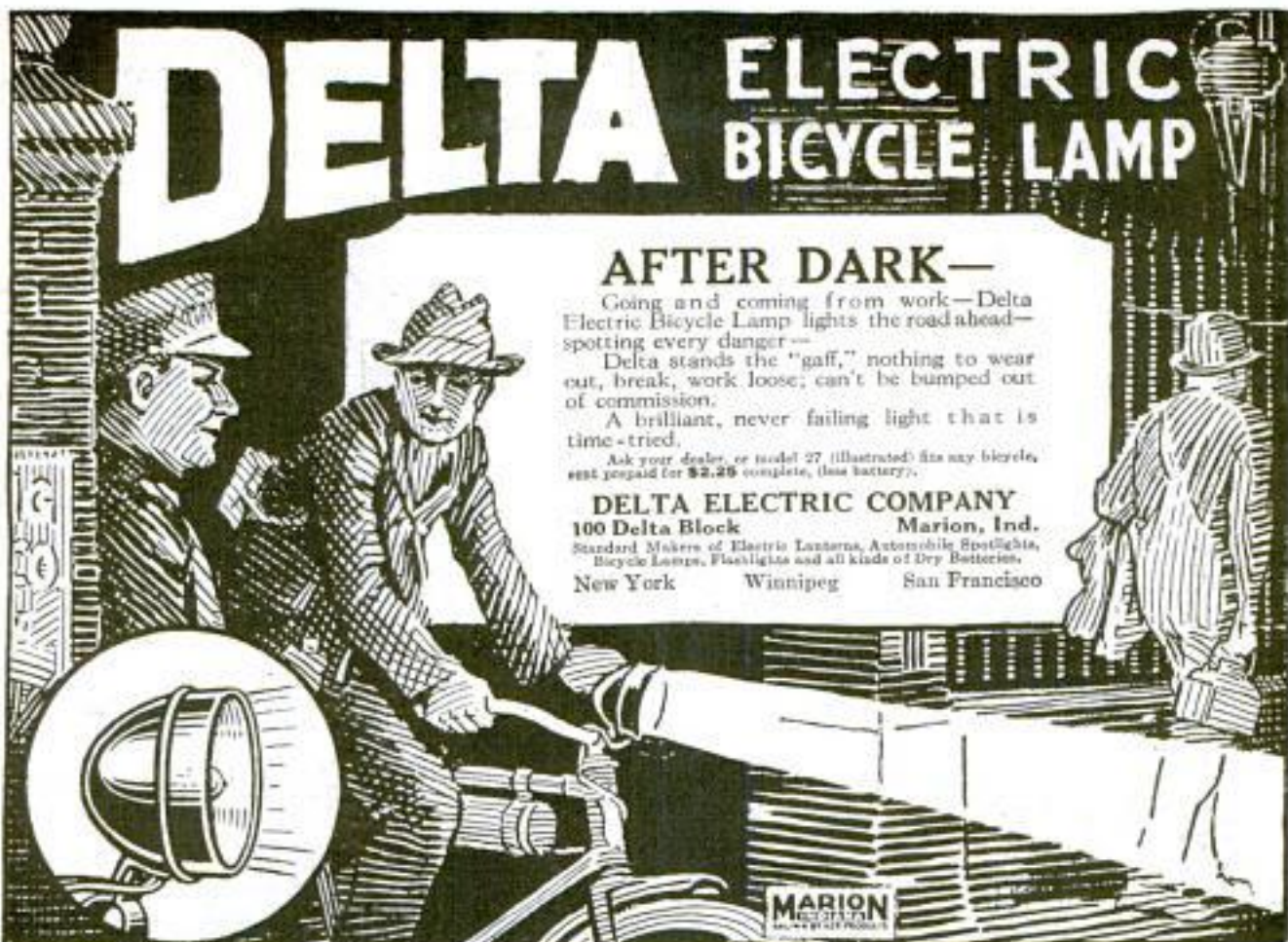

CUSTOM TAILOR MADE

To fit your individual car

Made in our custom shops after your order is received. We ship ordinarily in 2 or 3 days. Perfect fit guaranteed when correct name, year and model of car is given. You can easily apply it yourself. We furnish instructions and all necessary tacks, wets and fasteners. Our catalog No. 10, with samples, is free for the asking.

\$4.40 and up Parcels Post Paid
LIBERTY TOP & TIRE CO., Dept. E-7, Cincinnati, O.

\$10.00 A DAY PAID



Weekly to one man in each county taking orders for **COFFIELD TIRE PROTECTORS**. They prevent punctures, blowouts, stone bruises and fabric breaks. Double tire mileage. Pay for themselves on first tire; used over and over again. Pure live rubber; no metal, no fabric, no friction. Easily applied; no cement or tools required. Nothing like it. Absolute three-year guarantee. Users are boosters. Unlimited demand. Every truck or auto owner a live prospect. No capital required. Checks mailed weekly. Write to

COFFIELD TIRE PROTECTOR CO. 309 Court St., Dayton, Ohio

SQUAB BOOK FREE



Squabs are selling at the highest prices ever known. Breed them and make money. Write at once for free book, prices, etc. Plymouth Rock Squab Co., 634 Howard St., Melrose Highlands, Mass.

HOME LOVERS' BARGAIN BOOK FREE

Showing Over 10,000 Furniture Bargains
All selections loaned free for a month. Take a year to pay if satisfied, paying little by little almost as you please.
SPIEGEL, MAY, STERN CO., 1108 W. 35th St., Chicago



If You Can Tell it from a GENUINE DIAMOND Send it back

To prove our blue-white **MEXICAN DIAMOND** cannot be told from a **GENUINE DIAMOND** and has same **DAZZLING RAINBOW FIRE**, we will send selected 1 carat gem in ladies Solitaire Ring, (Cat. price \$5.25) for Mail Price to introduce, \$2.63, or in Gentle Heavy Tooth Felcher Ring (Cat. Price \$6.50) for \$3.25. Our finest 17K Gold Filled mountings. **GUARANTEED 20 YEARS. SEND NO MONEY.** Just mail postcard or this ad, State Size. We will mail at once. When ring arrives deposit \$2.63 for Ladies ring or \$3.25 for Gents with postman. If not pleased return in 2 days for money back less handling charges. Write for Free catalog. Agents Wanted.
MEXICAN DIAMOND IMPORTING CO., Dept. ET, Las Cruces, N. Mex.
(Exclusive controllers Mexican Diamonds)



Over \$200 Profit Weekly Above Expenses

All over the U. S. and Canada, we are establishing vulcanizing service stations. We instruct you and furnish the most modern methods and equipment—

THE ANDERSON Known the World Over

We have 34 schools in U. S. and 4 in Canada. One is near you. School pays you \$5 per day while learning to operate the station which you start in your town or elsewhere on small capital. Write for full particulars **TODAY.**

THE ANDERSON STEAM VULCANIZER CO.
Manufacturers of Modern Tire Repair Equipment
103 Williams Bldg. Indianapolis, U. S. A.

GET FACTORY PRICES ON GALVANIZED ROOFING

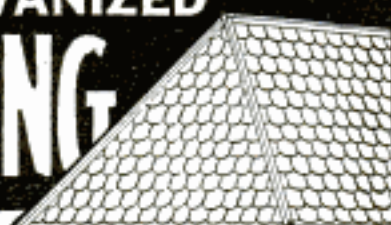

EDWARDS "REO" Metal Shingles

Absolutely rust-proof—edges as well as sides. Not the space of a pin point exposed to weather. Also fire and lightning proof. Reduces insurance. Outlast buildings. Need no repairs—and all roofing expense. Easy to lay—any man can do the work—hammer and nails only tools needed. Lay over old shingles if desired. Patent Interlocking Device makes water tight seams—all nail heads covered—no rust or leaks possible.

Exclusive "Tightcote" Process
Put all Edwards Galvanized Roofing in a class by itself. Bend, twist, strike it with a hammer as much as you like—you can't loosen or scale off the galvanizing—due to our "TIGHTCOTE" process which practically makes zinc covering a part of the metal sheet. No other galvanized roofing can withstand this test.

FREE Roofing Book Don't buy roofing until you get our big free book, describing Edwards famous "Tightcote"



THE EDWARDS MFG. CO.
700-710 Pike St. CINCINNATI, O.



Corrugated

Patent Side Lock
No nail heads in sight or exposed to the weather

Brick Siding

Roofings, Sidings, and Ceilings, and our lowest factory prices. We sell you direct and save you in-between-dealers' profits. Write for Roofing Book No. 250.

Low-Priced Garages

Lowest prices on Ready-Made Fire-Proof Steel Garages. Set up any place. Send postal for Garage Book showing styles.



**FREE
Samples &
Roofing Book**

Pullman Sleeper



can be made out of your Sedan or Touring Car. Folds into very small package. Will last for years. Save hotel bills. Live out doors for better health and a good time. \$14.50. Send no money. Pay your postman.

VANDERPOOL CO. Dept. 6. Springfield, Ohio

DRIVE 100 TACKS AND SAVE \$25.00

Ford Roadster Top Recovering \$5.20, Touring \$6.95 and \$9.95.

Chevrolet, Dodge or Maxwell Roadster \$10.45, Touring \$13.95. All other

5 passenger cars \$16.50, with glass glass lights.

Also made of California Top Goods, all colors \$16

up. Ford regular size suits \$13.25 up. For

other cars \$11.50 up. Ford Seat Covers, Roadster \$2.15, Touring \$6.35, or tailored.

Roadster \$4.20, Touring \$9.50. Other cars \$4 to \$32, Ford Cushions \$3.75. All goods

same as car mfrs. use, high quality and \$5 guaranteed. Easy to apply. Printed instructions

given free to apply. Send for samples. Prices above delivered at your door.

AUTO EQUIPMENT CO., 32 Canal Street, Cincinnati, Ohio



\$5.20 up
Delivered

10c. CHARGES RADIO & AUTO BATTERIES

FROM A LAMP SOCKET At HOME OR BUSINESS With An F-F

BATTERY BOOSTER, which is a FULL WAVE

Magnetic Rectifier for 105-225 volt 60 cycle A. C. Leans Battery

Just as it is in Your Car. Snap Charger Clips on Battery

Terminals. Turn Switch. A Battery Will be Charged in the

Moment. A METER Eliminates ALL GUESSES WORK.

A Complete Portable Automatic Charging Unit, with

Infinite Carbon Rectifying Brushes, which Charge

Uninterruptedly. No Skill Required. A Fully Charged

Battery Starts Car & Tweak Quick, thus lower expensive

Replacement Storage Batteries must be bought, when

travelling. Fully charged. It Costs Less to Buy a Booster

than to be without one. Do Not Think Your Battery is dead

and work out simply because it will not start your car.

Buy a Booster. Fill it with Life and Hear Engine Spin.

BOOSTERS Have, Last Lifetime. PRE-WAR PRICES:

Bottom's eye 6 charges "A" 6 volt Battery, 6 amps \$15

Top 11 charges 2 to 100 Volt Radio "B" Batteries \$15

Radio Type "A" charges Both "A" & "B" Batteries \$20

Batteries Type 12 charges 12 volt Battery 5 amps \$15

Type 109 charges 6 volt Battery at 12 amperes \$24

Type 1020 Combination Type Charges Both

6 & 12 volt Batteries at 12 & 7 amperes.....\$36

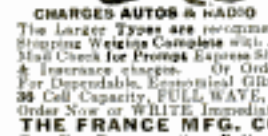

CHARGES AUTOS & RADIOS

The Larger Types are recommended for heavy Batteries, or when time is limited. Strong Warning Complete with AMMETER & BATTERY CLIPS. 12 to 15 Postpaid. Check for Proper Express Shipment. Or if for Parcel Post Shipment add Postage & Insurance charges. Or Order us to forward the TYPE YOU desire C. O. D. For Dependable, Economical GROUP CHARGING, WRITE for FREE Descriptive 36 Cell Capacity, FULL WAVE, Automatic ROTARY RECTIFIER Bulletin 28-A. Order Now or WRITE Immediately for FREE Descriptive BOOSTER Bulletin 24. THE FRANCE MFG. CO., CLEVELAND, OHIO, U. S. A. Canadian Representative: Battery Service & Sales Co., Hamilton, Ontario, Canada

TWO-YEAR GUARANTEED BATTERIES SAVE 50%



© 1921

SPECIMEN PRICES
Ford-Dart-Chev. \$18.80
Overland-Buick 21.85
Maxwell-Dodge 25.60
Save 50% saving on all ours

Famous "Royal" Batteries—highest quality made—now selling direct from factory to car owner. You save half. We give written 2-year guarantee—longest on any battery. Big responsible organization backs guarantee. Batteries for any car, tractor or gas engine.

Save time. Order from this ad. Battery fully charged, shipped immediately—by express C. O. D. You run no risk. Our location same for eight years. Reference: Nat'l Bank of the Republic, Dean or President.

Free Booklet If you want descriptive matter first, send for free booklet. Gives full details of this superior battery. Get this booklet before you buy any battery. Write today! Give year and model of your car.

K - E BATTERY CO., Dept. 109
646 N. Michigan Blvd., Chicago

Largest Exclusive Mail Order Battery House in America
Members of Chicago Association of Commerce

MOTOR REPAIR BOOK FREE

SMOOTH-ON
REPAIR
BOOK



Why spend dollars, when you can make perfect Automobile and Household repairs quickly and easily with SMOOTH-ON IRON CEMENT No. 1 at a few cents' expense? Write for this book and learn how—it's Free.

Smooth-On No. 1 is sold in 4 oz., 1 lb., and 5 lb. tins by Hardware and Auto Supply Stores.

SMOOTH-ON MFG. CO.

Dept. 37G Jersey City, N. J.

SMOOTH-ON IRON CEMENT No. 1 For Motor and Household Repairs

Tire User



Car owner agent wanted in every community to use, introduce and take orders during spare or full time for Harrison Hand Made Tires at our low prices, fully GUARANTEED 10,000 MILES (Not second) finest materials used. Shipped on approval. Capital or experience unnecessary. Sample sections free. Write for local agency order and get our low factory prices to user agents.

HARRISON TIRE & RUBBER CO.
230 Indiana St., Hammond, Ind.

SEND for the INTERNATIONAL CATALOG

Factory to Consumer direct—

PAY ONLY ONE PROFIT



Our net price list of auto bodies and body supplies at Wholesale Prices. Save big money by buying Direct from Factory

For Ford and Chevrolet—prices from \$27.85 up

International Body Works 514 W. Ohio Street, Chicago, Ill. Dept. 7

THE BOOK YOU HAVE BEEN WAITING FOR

Gilbert Radio Telephone and Broadcasting - 35c postpaid

The A. C. Gilbert Company, 312 Blatchley Ave., New Haven, Conn.

Auto Supplies
Knowing HOW to buy is merely knowing WHERE
This is Chicago's Great Wholesale House.
AUTO SUPPLIES AND MOTOR PARTS
WHOLESALE ONLY
Dealers send today for this big money-saving book
ACTELL AUTO ACCESSORIES COMPANY
1570 A South Michigan Avenue
CHICAGO

DEAF?

This Smile Says:
"I Hear Clearly"



If you are hard of hearing you have embarrassing moments—so do your friends. Is it not worth while to see if all this embarrassment can be avoided?

500,000 persons are now hearing clearly by aid of the Acousticon.

A New York Physician says: "It is of great value to me. I should have been obliged to give up the practice of medicine long ago if I had not obtained this best of all devices for the aid of hearing."

We offer you the
1922 ACOUSTICON
For 10 Days' FREE TRIAL
No Deposit—No Expense

Just write, saying "I am hard of hearing and will try the Acousticon." Give it a fair trial amid familiar surroundings—thus you can best tell what it will do for you.

Remember, however, that the Acousticon has patented features which cannot be duplicated. So no matter what your past experience has been, send for your free trial today.

DICTOGRAPH PRODUCTS CORP.
 1307 Candler Building 220 W. 42nd St., N. Y. City

AGENTS—A. I. D. FOR YOU



With the new A. I. D. Package Sealer. Sell every store—everywhere—new—efficient—saves time and money—all will buy. Send \$5.00 for sample and agency offer.

A. I. D. Inc., 1352 Beacon St., Boston, 47, Mass.



Big Money

Made by agents selling our wonderful Facial Soap, Perfumes, Toilet Articles, Spices, Extracts, etc. Free cake of soap and agents' terms mailed to any address.

LACASSIAN CO., Dept. 455 ST. LOUIS, MO.

WIRELESS OPERATORS

—Amateur and Professional—need

SOLDERALL—25c per tube
Pat. Oct. 3, 1911
and TORCH, \$1.50



A Paste That Turns Into Metal When Heated
 A match will do it, but best results can be obtained by using our new improved torch. Requires no acid or soldering iron. Joins or repairs wires, metal or metalware. Sold by Hardware and Electrical Stores, or sent by us postpaid.

SOLDERALL CO., Dept. P
 129 Sussex Avenue NEWARK, N. J.
Dealers Send for Quantity Prices
 Beware of Imitations with Similar Names



"Red Devil" Pliers made in 100 styles—one for every need. Known and used the world over. Style 1024—6½ inch shown here, \$1.00.

Men Who Know Tools Choose

Red Devil

REG. U. S. PAT. OFF.

Hack Saws



THE favorite of mechanics, machinists, electricians and other experts who know from over a quarter century's practical experience what's best for them.

"Red Devil" Hack Saw Frames are tools well worth having. They do better work, in less time and with less effort. *They give greater value for the money.*

Frames are of adjustable type to take blades from 8 to 12 inch lengths. They are durably made of excellent quality steel, nickel plated and finely finished.

"Red Devil" Tungsten steel Hack Saw Blades are good—they work best in "Red Devil" Hack Saw Frames. Try a sample dozen. Ask your dealer.

"Red Devil" Hack Saw Frame No. 1043, shown here, at reliable hardware stores, or us 60c. "Red Devil" Hack Saw Blades No. 1239, 10 inch, 75c per dozen.

Mechanics' tool booklet free

"RED DEVIL" TOOLS—AMERICAN MADE

SMITH & HEMENWAY CO., Inc.

Manufacturers of "Red Devil" Tools
 260 Broadway, New York, N. Y.

"Red Devil" Glass Cutters—the glaziers' standard tools of the world. "It's all in the wheel."
 Made in 40 styles. No. 024 shown here, 20c.



Please Mention Popular Mechanics

Copyrighted material

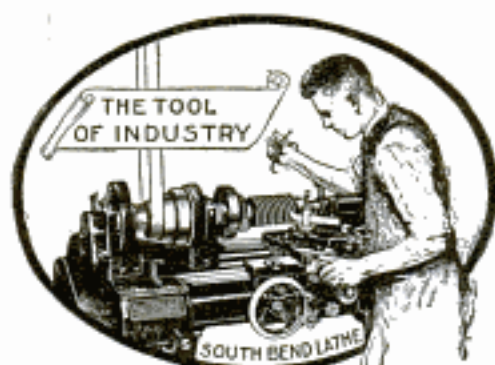

REDUCED PRICES

JUNE 1, 1922

SOUTH BEND LATHES

	Standard Change Gear	Quick Change Gear		Standard Change Gear	Quick Change Gear
9'x3' Lathe	\$150.00	\$189.00	16'x 8' Lathe	\$385.00	\$436.00
11'x4' Lathe	194.00	233.00	18'x10' Lathe	591.00	649.00
13'x5' Lathe	259.00	301.00	21'x12' Lathe	831.00	905.00
15'x6' Lathe	320.00	367.00	24'x14' Lathe	1129.00	1218.00

64-page Catalog No. 76 for 1922 sent free to any address

ESTABLISHED 1906

SOUTH BEND LATHE WORKS

625 E. Madison St.

SOUTH BEND, IND.

How to Run a Lathe:—New 80-page book, Revised Edition No. 24, for 10 cents postpaid, silver or stamps.

Wouldn't this Parks Shaper be just the machine for your shop?

Does everything the most expensive and heaviest shaper can do. Operates on only $\frac{1}{2}$ H. P. Electric-welded, angle-steel frame—weighs only 120 lbs., needs no special foundation. Big, roomy table, adjustable to regulate depth of cut. Instantaneous reverse is the double friction disc type, with knee-lever control. Just the thing for the small shop. PARKS Quick Reverse Spindle Shaper.....\$80.00



Send for complete catalog of Parks Woodworkers

THE PARKS BALL BEARING MACHINE CO.

1500-1540 Knowlton Street

CINCINNATI, OHIO

Canadian Factory, 200 Notre Dame East, Montreal

53

PARKS

WOODWORKING MACHINES

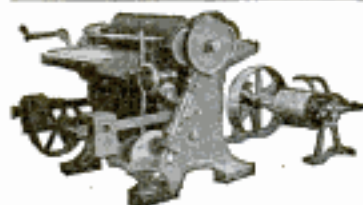

It is the well known quality of CRESCENT machines that justifies you in selecting one of them each time you have need for wood working machinery. The CRESCENT line is better than ever and will always give you satisfaction in every particular. Ask today for catalog of hand saws, saw tables, jointers, shapers, planers, borers, gliders and resters, spiral saws, disk grinder, cut off table, hollow chisel mortiser, variety wood worker. Universal wood workers.

THE CRESCENT MACHINE CO., 83 Columbia Street, Leetonia, Ohio

NEW MOTORS

FOR ALL PURPOSES
STANDARD MANUFACTURERS
PROMPT DELIVERY

ALL SIZES UP TO 5 H.P.

We Specialize In Small Motors & Generators

ALL PHASES AND FREQUENCIES IN STOCK AT ALL TIMES

Largest exclusive Mail Order Small Motor dealers in the world.

CHAS. H. JOHNSTON, Box 115, West End, Pittsburgh, Pa.

WIRELESS, TELEPHONE GENERATORS
500 VOLT - 100 WATT - 3400 R. P. M.
FOR MOUNTING MOTOR GENERATOR SETS.

\$28⁵⁰
EACH

WRITE FOR
CATALOG



PROTECT TOOLS AND SAVE MONEY

ASK YOUR DEALER
TO SHOW YOU

UNION
TOOL CHESTS

for machinists, tool makers, carpenters, plumbers, steam fitters, auto mechanics and general use—the Guaranteed Tool Chest.

Write us for free descriptive booklet that illustrates more than fifty different styles and sizes, including zinc covered models.

UNION TOOL CHEST CO., 22 Mill St., Rochester, N.Y.

GOODELL-PRATT

1500 GOOD TOOLS

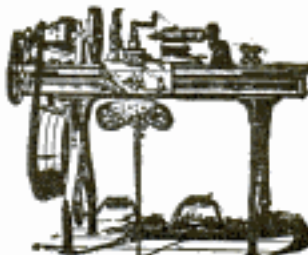

LATHES

9 to 18-inch Swing

List price \$165 and up according to size. When ready to buy send for Lathe Catalog and prices.

W. F. & John Barnes Co.

100 Ruby Street, ROCKFORD, ILL.

One Man Can Move 300 to 800 Bushels of Grain An Hour With the LIBERTY GRAIN BLOWER

Elevate, clean and grade your grain in one operation. A powerful fan does all the work. Only one moving part. No buckets, chains or gears to get out of order. No inside scooping necessary. One man can move it. Assembled or taken down in five minutes. Costs only half as much as old style elevators. Pays for itself in a few days.

FREE! Send name today for FREE Booklet describing the Liberty Grain Blower and special 1922 price offer.

Midwest Steel Products Co., 448 American Bank Bldg., Kansas City, Mo.





THE great emergency tool. Pliers with parallel jaws that meet like a vise, with the cutting blades on the outside and the open throat that swallows wire of any length. The hardware dealer will show you the difference between old-style pliers and Bernard's.

MADE IN SEVEN SIZES

Send for illustrated Plier Booklet M



**BERNARD
PLIERS**

Wm. SCHOLLHORN CO.
NEW HAVEN, CONN.



PARALLEL JAWS

OUTSIDE CUTTER

THE HANDIEST TOOL in the WORLD



OLSON
MAGAZINE
SCREW DRIVER

Large enough to hang a door, small enough to fix a bell. Three blades, oneawl, guaranteed. Fits any common screw and makes holes. Ask your hardware store or send \$1.25, prepaid.

Olson Manufacturing Company
52 Commercial St., Worcester, Mass.

Dealers and Agents: Request Attractive Proposition

Adjusts Instantly to Any Length

Just slide it out. Gives exact inside or outside diameter. No folding. Accurate, strong, brass trimmed. Any length 2 to 8 feet. If not at dealer's, sent postpaid.

Master Rule Mfg. Co., Inc. **"Interlox"**
841-43 East 136th Street
NEW YORK CITY **MASTER SLIDE RULE**

LAKWOOD FAN BELT FASTENERS



MAKE or repair your own flat belts for Autos, Trucks, Tractors, Electric Washers and small Shop Machinery with Lakewood Quick attachable Fasteners. Two sizes— $\frac{1}{2}$ in. and 1 in.; used alone and in combinations handle eight widths flat belting. Simply square up ends, rivet half of fastener to each end, slot together and go. Belt can be removed from pulleys instantly, but can't open in driving. Complete Fastener with rivets, 15c per set; 2 for 25c; 6 for 60c; or 12 sets in neat slide box for \$1.00. Specify size wanted. Sent postpaid same day order received. Fine proposition

Also for V-Type Belts for Garage, Repairmen, and Dealers.
LAKWOOD FABRIC BELTING & MFG. CO.
1518 W. 117th St., Lakewood, Ohio



ON EVERY SIDE you will find

WHITING-ADAMS
TRADE **VULCAN** MARK
RUBBER CEMENTED

BRUSHES

Bristles fastened with Vulcanized Hard Rubber, and held in a vise-like grip. Shedding of bristles and failure of brushes impossible.

The most extensive and best line of Brushes in the world

Send for illustrated literature

John L. Whiting-J. J. Adams Co.
690 to 710 Harrison Ave., Boston, U. S. A.

Brush Manufacturers for Over 113 Years

Whiting-Adams Brushes Awarded Gold Medal, the highest award at Panama-Pacific Exposition, 1915

**ONE-HAND-Y
ELECTRIC DRILL**



Weight
3 lbs.

Capacity
 $\frac{1}{4}$ in.

Westinghouse
Universal Motor
Guaranteed

Knight Engineering & Sales Co.

30 West Walton Place,
Chicago, Ill.

210 W. Seventh Street,
Los Angeles, Calif.

WITTE

2 H-P.
Pulls
 $2\frac{3}{4}$

\$39⁹⁵
F. O. B.
K. C.

From
Pittsburgh
\$44.95

All other
sizes
Lower

Write
for big
FREE Catalog

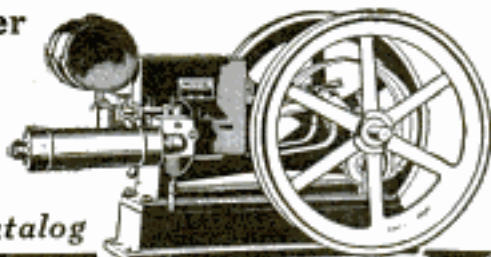

Direct From Factory

WITTE factory price direct saves you money. New quotations are from \$20 to \$400 less than they were last year. All sizes and styles cut in proportion, including Log Saws—Tree Saws—Portable Cutoff Saws and Stationary Buzz Saws.

Lifetime Guarantee Specify what you want and we will send catalog and lowest price—CASH or EASY TERMS, as you wish.

WITTE ENGINE WORKS

1744 Oakland Avenue, Kansas City, Mo.
1744 Empire Building, Pittsburgh, Pa.

NEW SINGLE PHASE A. C. MOTORS

$\frac{1}{4}$ H. P.—110
volt, 60 cycle,
1725 speed, com-
plete with cord,
plug and groov-
ed pulley, \$13.00



$\frac{1}{4}$ H.P. \$47.00
 $\frac{1}{2}$ H.P. 58.00
1 H.P. 62.00
 $1\frac{1}{2}$ H.P. 76.00
2 H.P. 89.00
3 H.P. 108.00
Include pulley
and base.

ONE YEAR GUARANTEE

$\frac{1}{2}$ H.P. and larger, 110/220 volt Rep. Ind. Type
Satisfaction guaranteed or money refunded
Illustrated Catalog of Motors and Supplies FREE
HYRE ELECTRIC CO., 615-H So. Dearborn St., Chicago

DIAMONDS

FOR A FEW CENTS
A DAY

Don't send a single penny. Ten days Free Trial. When the ring comes examine it—if you are not convinced it is the Greatest Bargain in America, send it back at our expense. Only if pleased, send \$1.50 weekly—at the rate of a few cents a day. This Bargain Cluster Ring with 7 Blue-White Perfect Cut Diamonds can be yours. No red tape, No risk.

\$1.50 a Week
SEND NO MONEY
Looks like
\$350 Solitaire
NO. 177B
only **\$59.50**

Million Dollar Bargain Book FREE

Send today. It pictures thousands of bargains. Address Dept. 177B.

J.M. LYON & CO.
2-4 Maiden Lane N.Y.

It Will Pay You to Own A MONARCH JUNIOR Lathe

"The Biggest Little Lathe Built"

There are hundreds of things made of metal or wood, for the shop, automobile and home, that you can make with a MONARCH JUNIOR lathe.

This sturdy dependable small engine lathe, guaranteed to do work with 1/1000 of an inch accuracy, was especially designed for inventors, experimenters and small shop owners who need a lathe of their own.

The Greatest Achievement in Lathe Building
MONARCH JUNIOR \$225 With Bench
9 in. Engine Lathe Legs

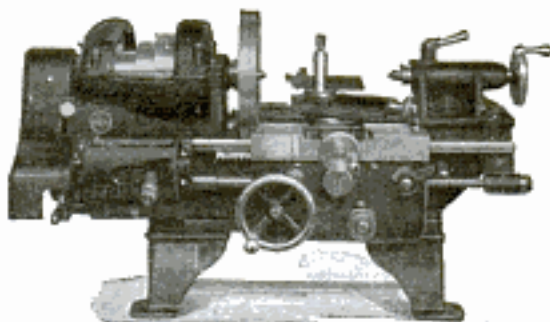

It is easy to learn to operate the MONARCH JUNIOR and even beginners can't jam it. It is equipped in every detail same as the big MONARCH and is guaranteed to do all small work that any other lathe will do.

You can find room for a MONARCH JUNIOR practically anywhere in a small shop or work-room in your home. Write today for catalog and full information about this remarkable—low priced engine lathe.

THE MONARCH MACHINE TOOL CO.
400 Oak Street - - - Sidney, O.

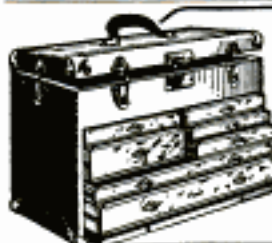

TOOL CHESTS

for Machinists & Toolmakers
Every tool arranged in order. No up-to-date mechanic should be without one. A Gerstner Case costs no more than some tools, and will last a lifetime. Catalog free.

Gerstner & Sons

717 Columbia Street DAYTON, OHIO

"GET BUSY"

MAKE SCREENS WITH
DIAMOND PRESSED STEEL CORNERS

No mortises, mitres, screws or tacks required. Unbreakable screens, hinges attached, made in a few minutes. Big profits making screens to order.

Sample set by mail, 50c postpaid.
DIAMOND HARDWARE MFG. CO.
224 FOURTH AVE., PITTSBURGH, PA.



The Midget "FIVE-IN-ONE" Slide Rule is a combination Mannheim, Log-Log, Add and Subtract, Polyphase and Binary Slide Rule. It will instantly add, subtract, multiply and divide any combination involving whole numbers, fractions, decimals and mixed numbers. Gives every possible root and power of every quantity. The graduations are printed on metal, coated with white celluloid and are grooved and waterproof. While it is the most versatile calculator ever invented, its operation is simple and easily understood. Diameter 4 inches. Price with 16-page Instruction Book, \$1.50. Leatherette carrying case 50c extra. Catalog free. Your money back if you are not satisfied.
GILSON SLIDE RULE CO., Niles, Mich.

MYERS WONDERFUL SEWING AWL

Tools in Handle



A complete repair shop in itself. Sews anything heavy or light, leather, shoes, harness, buggy tops, canvas, bolts, etc. \$1.00 Postpaid.
C. A. MYERS COMPANY, 6330 Woodlawn Ave., Chicago, Ill.

PATENTS TRADE-MARKS AND COPYRIGHTS

OUR OFFER—Free Opinion as to Patentable Nature

Before disclosing an invention, the inventor should write for our blank form "Record of Invention." This should be signed and witnessed and if returned to us together with model or sketch and description of the invention, we will give our opinion as to its patentable nature.

Our Three Books Mailed FREE to Inventors

OUR ILLUSTRATED GUIDE BOOK

HOW TO OBTAIN A PATENT

Contains full instructions regarding Patents, Trade-Marks, Foreign Patents, Our Methods, Terms, and 100 Mechanical Movements illustrated and described; Articles on Patent Practice and Procedure, and Law Points for inventors.

OUR TRADE MARK BOOK

Shows the value and necessity of trade-mark protection and gives information regarding unfair competition.

OUR FOREIGN PATENT BOOK

We have direct agencies in all the principal foreign countries and secure foreign patents in the shortest possible time and at the lowest cost. Write for our illustrated Guide Book on Foreign Patents, sent free to any address.

LIST OF PATENT BUYERS SENT FREE

Containing unsolicited letters from manufacturers and others who are constantly writing us regarding the purchase or leasing of meritorious patents. We endeavor to assist our clients in the commercial development of their inventions.

Specialization—Our Staff

The field of invention is so vast that it is impossible for any one man to become an expert in all the different classes of invention. For this reason Victor J. Evans & Co. employ a number of patent lawyers and mechanical experts who have been selected for their special knowledge and ability in certain lines of invention. Each case is placed in charge of experts in the classes to which the invention relates.

THE VALUE OF YOUR PATENT

will depend much upon the skill and care with which your case is prepared and prosecuted in the United States Patent Office. That every case intrusted to us receives our best efforts, and that our work is done consistently, skillfully, and thoroughly is evidenced by the many unsolicited letters of commendation that we receive constantly from our clients. We will furnish upon request lists of clients from any State in the Union for whom we have secured patents.

Our New York, Philadelphia, Pittsburgh, Chicago and San Francisco Offices

Owing to the growth of our business we have established for the benefit of our clients Branch Offices in New York City, Philadelphia, Pa., Pittsburgh, Pa., Chicago, Ill., and San Francisco, Cal. These branch offices being located in these large commercial cities together with our Main Office located near the U. S. Patent Office, in Washington, enables us to more promptly handle the business of our clients, particularly as the branch offices are in constant touch with the Main Office and fully equipped to handle patent business in all its branches.

Highest References—Prompt Attention—Reasonable Terms

—FREE COUPON—

VICTOR J. EVANS & CO., Patent Attorneys

NEW YORK OFFICES
1007 Woolworth Building

CHICAGO OFFICES
1114 Tacoma Building

PHILADELPHIA OFFICES
714-715 Liberty Bldg.

PITTSBURGH OFFICES
514 Empire Building

SAN FRANCISCO OFFICES
Hobart Building

MAIN OFFICES: 765 9TH STREET, N.W., WASHINGTON, D. C.

Gentlemen: Please send me FREE OF CHARGE your books as described above.

Name Address



PATENTS

IF YOU HAVE AN INvention which you wish to patent you can write fully and freely to Munn & Co., for advice in regard to the best way of obtaining protection. Please send sketches or a model of your invention and a description of the device, explaining its operation.

All communications are strictly confidential. Our vast practice, extending over a period of seventy-seven years, enables us in many cases to advise in regard to patentability without any expense to the client. Our Hand-Book on Patents is sent free on request. This explains our methods, terms, etc., in regard to Patents, Trade Marks, Foreign Patents, etc.

If you are a reader of the
**SCIENTIFIC
AMERICAN**

you are probably aware of the fact that it has a special appeal to the inventor. Each issue contains a description of a large number of recently patented inventions. Pending patent legislation as well as the most recent rulings of the Patent Office and the courts are considered in its columns.

MUNN & CO.

SOLICITORS OF PATENTS

672 Woolworth Bldg., NEW YORK
Scientific American Bldg., WASHINGTON, D. C.
801 A Tower Bldg., - CHICAGO, ILL.
611 Hanna Bldg., - CLEVELAND, OHIO
582 Market St. SAN FRANCISCO, CALIF.

Please Mention Popular Mechanics

RADIO

and other Electrical Inventions patented

MASON, FENWICK & LAWRENCE

Patent Lawyers

Washington, D. C.

Established 1861

We have with us four late members of the examining corps of the United States Patent Office.

Other offices: New York, Chicago, Denver, Seattle

Trade marks registered in United States and foreign countries

PATENTS

C. L. PARKER

Formerly Member Examining Corps, U. S. Patent Office

PATENT LAWYER

MCGILL BLDG.

WASHINGTON, D. C.

Patents, Trade Marks, Copyrights, Patent Litigation

Handbook for Inventors, "Protecting, Exploiting and Selling Inventions," sent free upon request.

PATENTS

TRADE-MARKS

COPYRIGHTS

Send for our free book of patent information.

Beale & Park 802 F St., Washington, D. C.
16 S. Broad St., Philadelphia, Pa.



PATENTS

Send us sketch or model for patentability opinion and exact cost of patent. Our book "How to Obtain a Patent," sent free on request. It tells how to apply for Patents, Trade Marks, Foreign Patents, Copyrights, etc.; gives information on Patent Procedure; tells what every inventor should know. Thousands of inventors, who are our clients, are our references.

Chandlee & Chandlee, 25 Years Experience.
422 7th St. Washington, D. C.

INVENTORS

who derive largest profits know and heed certain simple but vital facts before applying for

PATENTS

Our book Patent-Sense, for Inventors and Manufacturers, gives those facts; free. Write Lacey & Lacey, 616 F St., Washington, D. C.

ESTABLISHED 1869

PATENTS Secured

Prompt service. Avoid dangerous delays. Send for our "Record of Invention" form and Free Book telling How to Obtain a Patent. Send sketch or model for examination. Preliminary advice without charge. Highest references. Write TO-DAY. J. L. Jackson & Co., 327 Ouray Bldg., Washington, D. C.



GEARS ALL KINDS SMALL

The most accurate made and prices reasonable. We carry a complete line of gears in stock for immediate shipment. Can also quote on special gears of all kinds. Send us your inquiries. WRITE FOR CATALOGUE.

CHICAGO STOCK GEAR WORKS
105-109 S. Jefferson St., CHICAGO

PATENTS

Booklet Free

Highest References

Promptness Assured

Best Results

Send drawing or model for preliminary examination

ALL BUSINESS GIVEN PROMPT AND PROPER ATTENTION

WATSON E. COLEMAN, Patent Lawyer, 624 F St., Washington, D. C.

Can You

think of a simple, practical idea that will fill one of the many requests we have on file for new inventions? It may mean a fortune for you. Thousands of things are needed right now. Your brains can help. Send today for our great new book—

"Inventions and Trade-Marks, Their Protection and Exploitation"

and learn more about making money from ideas than you ever knew before. It tells many things that are wanted, too.

**A postal will do—
It is free**

We Help Our Clients

without charge, to get the dollars out of their ideas—having facilities none others possess. Advice free. Don't delay—get the book at once.

American Industries, Inc.
200 Patent Dept.
WASHINGTON, D. C.

Patents Advertised For Sale Free

in Invention and Manufacturing Supplement

Published for the man with an idea. Send for free sample copy. One year's subscription, 50c.

PATENTS

To the Man with an Idea

I offer a comprehensive, experienced, efficient service for his prompt, legal protection and the development of his proposition.

Send sketch, or model and description, for advice as to cost, search through prior United States patents, etc. Preliminary advice gladly furnished without charge.

My experience and familiarity with various arts frequently enable me to accurately advise clients as to probable patentability before they go to any expense.

Booklet of valuable information and form for properly disclosing your idea free on request. Write today.

Richard B. Owen, Patent Lawyer
9-303 Owen Building, Washington, D.C.
2276-E Woolworth Bldg., New York City

PATENTS

If You Have an Invention and Desire to Learn How to Secure a Patent

Send for our Guide Book, **HOW TO GET A PATENT**, sent Free on request. Tells our terms, methods, etc. Send model or sketch and description of your invention and we will give our opinion as to its patentable nature.

RANDOLPH & CO.
600 F St., N.W., Washington, D. C.

NAME.....

STREET.....

CITY.....STATE.....

PATENTS PROMPTLY PROCURED TRADEMARKS REGISTERED

Send disclosure of invention, design, or trademark for actual search of U. S. Patents and novelty report. Validity and infringement investigations. Patent and trademark suits prosecuted and defended anywhere in the United States. Discriminating clients appreciate my efficient service. No literature will be sent you as this is a professional service, *individual* and *Personal*. Specific information and advice given regarding each individual case. Specialize in prosecution of pending cases that have been previously rejected by the Patent Office. Specialize also in unfair competition litigation before the Federal Trade Commission.

George P. Kimmel, Master of Patent Law
53-J Loan & Trust Bldg., Washington, D. C.



WRITE TODAY FOR FREE BOOK ABOUT PATENTS and "RECORD OF INVENTION" for establishing evidence of conception. The book tells how to proceed, the usual cost of obtaining a patent, and contains good sound practical advice every inventor should know. "RECORD OF INVENTION" should be filled out, signed and witnessed before you disclose invention to anyone. Send rough sketch or model and description for free report upon patentable nature and cost to Patent, etc. **Prompt, personal service.** Reasonable fees. Partial payment plan. Preliminary advice without charge.

J. REANEY KELLY
PATENT LAWYER

612-COLUMBIAN BLDG. WASHINGTON, D.C.

TOBACCO USER

Can you quit tobacco? If not, do you know why? Do you know its effect on mental and physical efficiency? These and other questions answered in booklet written by one who has treated thousands for the tobacco habit. Free for the asking. Write

DR. T. H. TRINWITH, Black Bldg., LOS ANGELES, CALIF.

U.S. PATENTS



DON'T LOSE YOUR RIGHTS TO PATENT PROTECTION

Before disclosing your invention to anyone send for blank form "EVIDENCE OF CONCEPTION" to be signed and witnessed. A sample form together with printed instructions will show you just how to work up your evidence and establish the same before filing application for patent. As registered patent attorneys we represent hundreds of inventors all over the United States and Canada in the advancement of inventions. Our schedule of fees will be found reasonable. The form "Evidence of Conception," sample, instructions relating to obtaining of patents and schedule of fees sent upon request. Ask for them—a post card will do.

PATENTS AND TRADE MARKS

LANCASTER & ALLWINE

204 Ouray Bldg. Washington, D. C.
Originators of forms "Evidence of Conception."

INVENTORS AIDED. Ideas developed. Experimental Machinery Built. Individual Service.

RICHARDSON & ROGERS, 7 ALBEE, WASHINGTON

Practice in all Courts.

TRADE-MARKS. We seek the valid PATENTS



Send 10 cts. for Radio Equip. Catalog
Send 10 cts. for Materials of all Kinds
Catalog—Send 15 cts. for Gear and
Exp. Parts Catalog

COLBURN GEAR AND MFG. CO.
5 Woodworth St. Dor. Boston, Mass.



Oh Boy! There are 4 handy tools besides a keen, strong blade in every Keen Kutter Scout Knife. Ask your dealer about the tag plan.



Simmons Hardware Company
KEEN KUTTER



If you have an idea to patent write for free "PATENT ADVICE" and for form "INVENTOR'S RECORD" which contains full instructions for proceeding - Personal Service -

Wm H. MULLIGAN, PATENT LAWYER.
202 Woodward Bldg. Washington, D. C.

PATENTS

Inventors should write for our "Evidence of Disclosure" form. It's Free. Avoid Dangerous Delays. Send sketch or model of your invention for examination and advice. Ask for Free Book "How to Obtain a Patent." Highest references. Write to-day.

Merton-Roberts & Co., 184 Mather Bldg., Washington, D. C.

Light Fibre Legs and Arms

636
Dean Bldg.
RAY TRAUTMAN Minneapolis, Minn.

THE AJAX EYELET FASTENER
BINDS AND INSERTS AJAX EYELETS IN PAPER, CARDBOARD, LEATHER OR CLOTH

It Saves Time by Punching the Hole, Feeding the Eyelet and Clinching It in One Operation.

Drop the eyelets into the magazine and go right ahead. Order from your stationer or direct.



PRICE WITH 1500 AJAX EYELETS, **\$10.00** DELIVERED IN U. S. A.

Write for our catalogue of office tools
MACHINE APPLIANCE CORPORATION

351-353 Jay St.

Spec. Dept.

Brooklyn, N. Y.

NEW CARBURETOR DEVICE USES WATER VAPOR AS FUEL IN FORDS

A remarkable invention known as the Water Vapor and Steam Humidifier, which causes to be separated and used the Hydrogen and Oxygen gases from the waste water vapor from the Ford radiator, and gives startling results, has been patented by Walter Critchlow, of Suite 180, 716 Madison St., Chicago. The invention does away with carbon in the engine and its attendant troubles, prevents fouling of plugs, and approximately doubles the mileage from gasoline. With gasoline constantly growing scarcer and higher in price, this invention becomes of great importance in helping to solve the auto fuel problem. Mr. Critchlow proudly shows many splendid reports of tests made, from which the following were selected as typical: Mr. D. Muskopf, of Ohio, says: "I drove Ford sedan with Humidifier from Somerville, O., to San Bernardino, Cal., loaded, over all kinds of terrible driving, 2,840 miles, averaged 26 miles per gal., and never touched a plug." Dr. Pulfer, Illinois, wrote: "Was getting 17 miles per gal. before, with Humidifier under careful test we got 44 miles with 1914 Ford." Ambrose Dolney, Michigan, reports: "Before getting Humidifier I went to Bay City and back, 32 miles on 2 1/4 gals.; now, thanks to you, I do it on 1 gal." C. E. Porter, St. Louis, says: "To my startling amazement I covered 32 miles on 3 qts. gas, almost unbelievable, but true." Mr. Bawa, Idaho, says: "Humidifier keeps my Ford from boiling on hottest days at 6,300 feet elevation." Mr. Patterson, California, wrote: "Made over 100 miles, from Oakland to home, strong head wind, heavily loaded, some low gear work, on 3 gals. gas, with Humidifier." E. E. Jepner, Nebraska, says: "Can make sand hills on high with Humidifier I never could pull before." Mr. Fleming, Indiana, writes: "I now get twice as many miles per gal. with Humidifier, and more power and pep." A. L. Crisman, Pennsylvania, wrote: "I now get 15 more miles per gal. over same road, and have more power and speed." Wm. J. Klein, Michigan, says: "I have tried every kind of Ford accessory and junked them all, but Humidifier is the missing link for the Ford, and it stays on mine." These are a few of the many reports Mr. Critchlow has already received. He is so proud of his invention that he offers to send it to any Ford owner on 30 days free trial, with a positive guarantee that it will save at least \$100.00 per year in up-keep expense, and agreeing to forfeit \$100.00 reward if he cannot prove every claim under official test before impartial judges. If you would like to try one on your Ford, without any risk or obligation on your part, simply send Mr. Critchlow your name and address with the model of your Ford and the carburetor used on it, and he will send you one with the understanding that if you do not want to keep it at the end of 30 days, you will be out nothing. Any one can attach it in just a little while from the directions accompanying it, without boring or cutting anything. Mr. Critchlow also wants one representative in each locality to represent him and take care of the enormous business that is sure to be created wherever the Humidifier is demonstrated. If you own a Ford take advantage of his liberal introductory offer and write him at once.



PLUMBING & HEATING

Buy Direct—Save 50%

\$66.95 Complete Bathroom Outfit \$66.95

Send NOW for our FREE Catalog "A" of Wholesale prices

Satisfaction Guaranteed

LAMPLOUGH BEAUMONT COMPANY
33 So. Portland Ave. Brooklyn, N. Y.



EQUIP YOUR TIRE REPAIR SHOP WITH AN OUTFIT

that is the very latest invention—Adjustable Cavity Tire Mould. Wedge-shaped cavities instead of straight side cavities. Can use sand bags equally as well as air bags for pressure medium. Will cure more tires per day than two molds of other makes with same number of cavities. Will cure Two 3 1/2", or Three 4" or

Two 4 1/2" Tires at one time and without a reducing shell. No. 3 Mould is Bloc type and comprises complete shop equipment. No. 10 is shipped set up ready to operate—takes up but little room and includes tools and moulds to operate a complete high-class repair shop. A small amount of cash will place this equipment in your shop. Easy payment plan if desired. High-grade equipment—popular price. Write for descriptive booklet and price lists.

F. M. DUNCAN COMPANY
Dept. P 341-49 East Ohio St., Chicago, U. S. A.

BIG PROFITS FOR STATE DISTRIBUTORS & LOCAL DISTRIBUTORS

NATIONAL BANK

by *Johann Krittikon*

SECURITY CHECK PROTECTOR FOUNTAIN PEN

FREE

THE SECURITY CHECK PROTECTOR FOUNTAIN PEN represents the last word in fountain pens; combined with a marvelous patented device that positively protects checks against being "raised." Last year \$20,000,000 was lost thru "raised" checks. It is impossible to "raise" a check where a SECURITY CHECK PROTECTOR FOUNTAIN PEN is used. It gives protection equal to the highest priced office check protector.

Added to the Check Protector Device SECURITY CHECK PROTECTOR FOUNTAIN PEN includes other exclusive patented features of superiority that place it in a class by itself. The price is 30% less than others. A necessity to anyone who writes.

WANTED STATE ORGANIZERS—Are you a salesman—better than the average—and have you had experience in organizing sales forces; or believe you have the ability, energy and force to create and maintain and finance a state organization, then write us your reasons for believing you are one of the men we want. Our proposition will pay \$15,000 to \$25,000 annually to a good man who can handle a state. We are rapidly completing our Sales Organization by States. Your State may not yet be closed. If you want to join a progressive responsible organization and are big enough to handle a State, write today.

Send us your name and address: SECURITY CHECK PROTECTOR FOUNTAIN PEN, will be mailed free. A post card will bring it. Do it now.

KRITIKSON BROS., INC., 116-112 W. Illinois Street, CHICAGO, ILL.

2 TIRES FOR \$11.95

FREE TUBE WITH EACH TIRE

SENSATIONAL CUT IN STANDARD TIRE PRICES!

Two used tires for less than the usual cost of one, and a free inner tube with each tire! No double treads or secret tires. Our big volume means best tire values. Act now and cut your tire cost in two. Thousands of steady customers are getting full mileage out of these tires and you, too, can get them. You can see the mileage in our tires. Order and save it—but order now! This is a special lot selected for record-breaking sale. Supply limited and going double quick.

8,000 MILES

NOTE THE BARGAIN PRICES ON TWO TIRES OF SAME SIZE

Size	1 Tire	2 Tires	Size	1 Tire	2 Tires
30 x 3	\$ 7.25	\$11.55	32 x 4 1/2	\$13.45	\$21.45
30 x 3 1/2	8.25	13.95	33 x 4 1/2	13.95	22.45
32 x 3 1/2	9.45	15.45	34 x 4 1/2	14.45	23.45
33 x 4	10.65	16.90	35 x 4 1/2	14.95	24.90
32 x 4	11.85	18.75	36 x 4 1/2	15.45	25.45
33 x 4	12.45	20.90	33 x 5	15.65	25.95
34 x 4	13.25	21.95	35 x 5	15.90	26.45
36 x 4	14.95	25.95	37 x 5	16.45	26.95

SEND NO MONEY! Shipment C.O.D. express or parcel post. Examine tires on arrival and if not fully satisfied return same at our expense and your money will be promptly refunded. State whether straight side or clincher.

DON'T DELAY! ORDER NOW!

ALSBY TIRE & RUBBER COMPANY
8721 Roosevelt Road Dept. 1648 Chicago, Illinois

FOR RADIO OR AUTOMOBILE

Globe Batteries

SAVE YOU 50%

Buy your Radio and Automobile Batteries direct from factory. Highest quality made—lowest prices.

WRITTEN TWO-YEAR GUARANTEE

SPECIAL "RUBTEX" BATTERY CASE

For Radio and Automobile use we have designed the Rubtex Battery Case that is indestructible and acid proof. Price for this case \$2.50 added to the prices quoted here.

GLOBE BATTERY CO., 1219 S. Wabash Ave., Dept. P., Chicago, Ill.

Comparison of the prices below, with any others quoted, will convince you that Globe Battery is the best buy on the market. Battery shipped immediately. Express C.O.D. Begin now to get 100% battery service at half cost. Mail your order today.

AUTOMOBILE BATTERIES

Fit 90% of cars. Give make of your car.

6 Volt, 11 Plate	Price \$12.50
6 Volt, 13 Plate	Price 14.50
12 Volt, 7 Plate	Price 18.00

RADIO BATTERIES

Volts	Amps	Price	Volts	Amps	Price
6	40	\$ 8.50	6	60	\$12.50
6	60	10.00	6	100	14.50

FORD and CHEVROLET SPEED BODIES

Dealers:
Write for Accessory Catalogue

MAKE DRIVING A PLEASURE



Equip your old Ford or Chevrolet Chassis with one of our new distinctive modern bodies. Up-to-date Roadster, Touring and Speedster designs. Ford bodies as low as \$29.50 and up. Territory open for live wire dealers and agents. Make real profits.

Buy Direct from Factory
FEDERAL MOTOR SUPPLY CO., Inc.
1424 S. Blue Island Ave. Chicago
CANADIAN DISTRIBUTORS
Federal Auto Body Co., Toronto, Ont.; Campbellton, N. B.

FORDS RUN 34 MILES on Gallon of Gasoline



Wonderful new carburetor. Guaranteed to reduce gasoline bills from one-half to one-third and increase power of motors from 30 to 50%. Start easy in coldest weather.

Sent on 30 DAYS' TRIAL

Fits any car. Attach yourself. Fords make as high as 34 miles to gallon. Other cars show proportionate saving. Send make of car and take advantage of our special 30-day trial offer. Agents Wanted.

AIR FRICTION CARBURETOR CO.
3380 Madison Street Dayton, Ohio

Save 15% to 40% Gasoline

Install Kreitner's Automatic Air Valve on your Ford and get more miles per gallon and more power at all speeds. Installed by anyone in less than five minutes. No holes to drill. No parts to remove. 30-day trial. Money back guarantee. Post-paid \$4.50 anywhere in the United States.

Exclusive territory for live agents
KREITNER MANUFACTURING CO.
1017 Title Guaranty Bldg. St. Louis, Mo.

\$1,487.35 RETURNS IN 60 DAYS

Make \$25 daily from Box Ball Alleys. Clean business. Small expense. Quick returns. Installed in spare space anywhere. Full particulars by return mail showing amazing profit possibilities. Write now.

AMERICAN BOX BALL COMPANY
102 Van Buren Street Indianapolis, Indiana

Ford Given

Join our great Auto Club and win Grand Prizes including Ford Sedans! Can you make out two words spelled by figures in picture? The alphabet is numbered—A is 1, B is 2, etc. What are the two words? Other valuable prizes and hundreds of dollars in cash given. Everybody wins! So easy you will be surprised. We've already given away many Autos. Why not you? Send answer today.



A LUXURIOUS SEDAN
The Wonderful ALL-YEAR CAR—Electric STARTER and LIGHTS—Drive Your Own Car

Ford Wilson, Mgr., 141 W. Ohio St., Dept. 2441, Chicago, Ill.

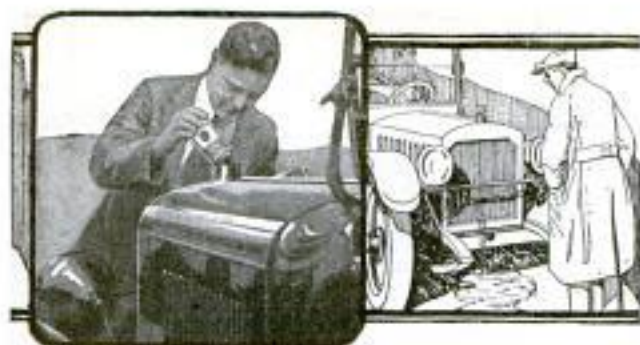

Miracle Number Two

Fast running on ratty roads loosened radiator. Bad leak developed, requiring frequent refilling. Owner saved expensive repair bill by simply pouring into radiator contents of 75c can of

RADIATOR NEVERLEAK

Repair has been made permanent. No bother, no delay, no big expense.

Radiator Neverleak sold on strict money-back guarantee. Cannot harm radiator. Carry a can for emergency. If your dealer can't supply, send 75c for full size can.



Buffalo Specialty Co.

Buffalo, N. Y.

12 Months to Pay

You can easily earn or save money for the small payments. Parents often advance first payment to help buy a **RANGER** bicycle. Choice of 44 styles, colors and sizes. **FACTORY-TO-RIDER** prices. **DELIVERED FREE** express prepaid on approval for **30 DAYS' TRIAL**, actual free riding test.

Tires—best quality, at factory prices, express prepaid. Lamps, wheels, and equipment, low prices. **Send No Money.**

Mead Cycle Company
Dept. F18 Chicago

Write today for free Ranger Catalog, factory prices and marvelous easy payment terms



SAVE MONEY ON GUARANTEED MOTORS



Buy Direct from Headquarters

Save from 25% to 40% on standard makes of new and rebuilt motors. Get the proper size and type of motor to suit your exact needs—and get it fully guaranteed by a motor merchandising house backed with 20 years of dependable service direct to users. Write today for catalog No. 70. It quotes prices on motors of every size and type.

Electrical Equipment Bought, Repaired or Exchanged.

THE FURST-FRIEDMAN COMPANY

CLEVELAND

"Reliability Built In."

OHIO

Tire Agents Wanted

\$4000 A Year



Make Big Money

without risking one cent. I'll start you as I have started so many others in a business of your own. All or part time. The **MELLINGER PLAN** is revolutionizing the tire business. No capital or experience needed.

I Guarantee Your Profits

Let me prove that you can earn from \$100 to \$400 a month and more. Hundreds, discontented with mere jobs, got this **MELLINGER PLAN** and today are making big money.

GUARANTEED BY BOND 10,000 MILES



Mellinger Hand Made, over-size Cords and Extra Ply Tires—the finest, most serviceable tires made. **I GUARANTEE MILEAGE**—some do not. Whether you want **CASH** or guaranteed mileage for yourself at **LOWER WHOLESALE PRICES**, write me today. Get my inside figures and discounts. My new low prices amaze everyone. **Better tires for less money** makes business roll in. One Billion Dollars will be spent for Tires in the next few months. Tires are shipped prepaid on approval.

FREE

Master Salesman Kit showing actual sections of tires, fabric, rubber, cord, tubes, etc., in substantial portfolio. Shows secrets of tire construction. Sent free if you're in dead earnest. Tweedie of Mainz sells \$1,436.00 in few short weeks; A. M. Amigo, Santurce, P. R., sold \$4,024.00 in 7 months; Hincheliff, Pa., sells \$1,500 first month. Others do as well.

If You Own a Car, Write Me Quick!

Don't buy anybody's tires until you see these amazing values. I appoint only one agent in each locality. I will make you a surprising offer that will give you a set of tires **FREE**. Be first in your locality to get my confidential offer. **Mail Coupon right now.**

GET MY FREE BOOK The most fascinating book you ever read. Wonderfully illustrated. Reveals in detail the remarkable **Mellinger Plan** that has proven the golden key to thousands, tells all about tires, facts of construction, how tires are sold, explains manufacturers', jobbers', retailers' profits. **Don't Wait—mail coupon today!**—Get this big Free book—you never read anything like it. It's Free to you—simply send coupon today.

MELLINGER TIRE & RUBBER CO.

1061 Oak St.
Kansas City,
Mo.

B. L. Mellinger, Pres., 1061 Oak St., Kansas City, Mo.

Without obligation, send me your Free Book, details of the Mellinger Plan, and Wholesale Prices and how, without investing any money, I can become your authorized agent.

Name.....

Address.....



Dependable Champions

For Every Engine Everywhere

Last You Longer

Champion construction is simple and effective, and the ribbed core is truly unbreakable and practically foul-proof

Ask your dealer to sell you a full set

CHAMPION SPARK PLUG CO.



Champion Regular now 75c
Champion X . . . now 60c

TOLEDO, OHIO

Only \$45.00 For This Job Complete

Save exorbitant freight rates and one-half original cost by buying Ford Speedster Bodies knocked-down. Simple, complete instructions furnished, all parts cut to exact fit. Any one can assemble this job. Complete with hood, radiator shell, instrument board, upholstery, metal parts, wood parts, bolts screws, etc. Flat radiator shell furnished made up. Designed low with lack of wind resistance. Price set at \$90, further particulars on request.



Not Paper Patterns
All Parts Complete

The Central Auto Supply Co. Eng. Dep. 120, Louisville, Ky.

RADIO For Everybody

Make Radio a profession instead of a plaything. You can earn big money as a Radio-trician. Learn by mail, in spare time, how to design, construct, install, repair, maintain, operate, sell and demonstrate complete radio outfits. Write for free 32-page catalog describing our course entitled, "How to Learn Radio at Home."

National Radio Institute, Dept. 1164, Washington, D. C.

SAY!

Thousands have; why don't you improve your financial condition? Operate a **Kingery Popcorn Popper**, Peanut Roaster or Popcorn Fritter Outfit. 70 cents profit on every dollar. Many styles and sizes. Popping 40 quarts to 12 bushels per hour. Roasting 12 quarts to 5 bushels. Prices \$40 to \$550. Liberal terms. Catalog free.

KINGERY MFG. CO., Est. 1881
Dept. 242 CINCINNATI, OHIO



\$2,500 Monthly for Miller with WILLEY UNIVERSAL VULCANIZER



Walter J. Miller invested \$175 in 1919, came to our plant for instructions for three weeks. Since that time he has bought his own home. He is now doing \$2,500 worth of business per month, employing 2 men and making big money.

Sold on Installments

Tire repair business is all cash. Only small investment necessary. There never has been such an opportunity to enter this big money field.

Thousands and thousands of used cars are being bought and used. Most of them have worn tire equipment. They must go to the vulcanizing shop for repairs. GET IT NOW. We give you practical training in our plant and shop or by mail FREE. The machine is self contained, burns coal, wood, kerosene or gas. Economical to operate. Set up in a few minutes. FULLY guaranteed.

WILLEY UNIVERSAL VULCANIZER CO.
27 Willey Building Battle Creek, Mich.

Men With Autos Wanted



to introduce and take orders for our **NEW PROCESS STORAGE BATTERY**. Plates cannot sulphate or buckle. No expert attention required.

One-half cup water every 3 months. Made for autos, radios, lighting outfits and all other battery purposes.

Guaranteed 2 Years

The biggest money maker and greatest business builder ever known. Write today for our exclusive proposition and low wholesale prices.

HARSHA BATTERY CO.
21 East Van Buren St.

Dept. 10.
CHICAGO



2
SILK
FINISH
PONGEE
SHIRTS
FOR
\$2.85

Five dollar value at today's reduced price. Two elegant, snappy, especially finely woven, Silk Finished, pongee shirts. Only \$2.85 for both. Smart attached collar. Six button coat front. Soft single cuff with button. Plain pocket. Handily sewn, extra fine stitches. Guaranteed by 30 years of shirt making for leading stores of the country. Reference, First National Bank, Philadelphia. Send order today. Pay C. O. D., or if you want shirts quickly, send Post Office order. We pay postage. **YOUR MONEY BACK IF YOU DON'T LIKE THEM.** We won't even ask why. Light tan or all white. Give collar size, 14 to 17 inches. You can have same shirt with laundered neckband without pocket, and double soft cuffs. **SEND FOR BIG LOT OF FREE SAMPLES,** newest stylish colors, patterns, and materials in gentlemen's shirts. Also pajamas and night shirts.

TUTELMAN SHIRT CO.
231 North 12th Street, Philadelphia, Pa.

21 Jewel Burlington



Adjusted to the Second 21 Ruby and Sapphire Jewels
Adjusted to Temperature 25 Year Gold Strata Case
Adjusted to Isochronism Your Choice of Dials
Adjusted to Positions (Including Montgomery H. H. Dial)
New Ideas in Thin Cases

Only \$1.00 Down

Only One Dollar Down will buy this masterpiece of watch manufacture. The balance you are allowed to pay in small, easy, monthly payments. The Burlington—a 21-Jewel Watch—is sold to you at a price much lower than that of other high-grade watches. Besides, you have the selection of the finest thin model designs and latest styles in watch cases. Don't delay! Write for the FREE Watch Book and our SPECIAL OFFER today.

Write *While This Special Offer Lasts*

Get the Burlington Watch Book by sending this coupon. Find out about this great special offer which is being made for only a limited time. You will know a great deal more about watch buying when you read this book. You will be able to "steer clear" of the over-priced watches which are no better. Remember, the Burlington is sent to you for only One Dollar down, balance in small monthly payments. Send the coupon for watch book and our special offer TODAY! Do not delay one minute!

Burlington Watch Company

Dept. B135, 19th St. & Marshall Blvd., Chicago
Canadian Address: 62 Albert St., Winnipeg, Manitoba

Please send me (without obligations and prepaid) your free book on watches with full explanation of your \$1.00 down offer on the Burlington Watch.

Name _____

Address _____

Summer Sale **OTTAWA LOG SAWS**
NOW, get a Log Saw at a big saving. Saws more wood—easier to cut. 10-Year Guarantee. Shipped from nearest to you of nine branch houses. Get FREE BOOK and Special Cut Prices. Write today.
\$64.50
AND UP
l. s. b. Ottawa
OTTAWA MFG. CO., 1741H Wood St., Ottawa, Kas.



Try This Typewriter 5 Days FREE
\$3.00 Down — Balance \$5.00 Monthly
Any standard make. Perfectly rebuilt. Guaranteed satisfaction or your money back. Save \$25 to \$60. Pay while you earn. Try 5 days at our expense. Send postcard for special bargain prices. Save fully 1/4 to 1/3. Do it NOW!
WYNN TYPEWRITER EXCHANGE, 12 Bellvue Bldg., Kansas City, Mo.



MADE TO YOUR ORDER \$
Pants 1.95
NO EXTRA CHARGES *Postage Prepaid*



Send no Money We make this special offer for 30 days, to prove the wonderful value, style and fit of Progress tailoring. We will tailor to your special order, a pair of these stylish \$6.00 pants, send them to you postage prepaid and guarantee two years' solid wear or money back for only \$1.95.

AGENTS WANTED — Earn \$30 to \$50 extra every week, taking orders from your friends and neighbors for our high-class tailoring. No experience necessary.

Big Sample Outfit FREE
Drop us a line today and we will send you absolutely free our big assortment of woolen samples, style book and special wholesale prices, on our made-to-measure suits—\$12.49 up and made-to-measure pants—\$1.50 up. Full details of this offer sent FREE.

The Progress Tailoring Co., Dept. G-145, Chicago, Ill.



Hay Fever — Rose Fever Asthma and Catarrh

—be free from them this year and save the cost of a trip to another climate. Breathe purifying ozone and the balm of pine needles at home with the new

RenuLife Ozone Generator

Ozone destroys the germs in the air passages and soothes and heals the inflamed tissues. This scientifically approved treatment gives immediate comfort and continued treatment should result in permanent relief. *Send coupon for full information, today.*

RenuLife Electric Company,
1107 Newberry Bldg., Detroit, Mich.
(In Canada: Pitt St. E., Windsor, Ont.)

Gentlemen: Please send me full information on your new Ozone Generator and tell me how I can escape Hay Fever and similar ailments through its use.

Name.....

Address.....

\$2 Puts this
ELGIN WATCH
In Your Hands

No Red Tape, No Waiting

Simply send \$2.00 and receive watch. Full seven Jeweled Elgin in stylish Octagon Case. Thin model, guaranteed 20 years.

30 DAYS FREE TRIAL
Send only \$2.00 and watch comes charges paid. Carry for 30 days and if not satisfactory your deposit is returned. Pay balance \$2 a month for 10 months. Price only \$22.00. *Send for FREE ROYAL BARGAIN CULLETIN, addressing Dept. 481.*

ROYAL & WATCH CO.
35 Maiden Lane, New York



All You Need to solder Aluminum

A Clean Soldering Iron and a Bar of
EVERSTICK
Aluminum Solder

No Flux Necessary

Price \$2.50 a Pound—Delivered. Trial Bar 50 Cents, Postpaid

Order TODAY From

GREAT WESTERN SMELTING & REFINING CO.
3100 N. Broadway St. Louis, U. S. A.



They Cost Less
because they give longer service
Every pair of

Nu-Way

Price
75c

OR
EXCELLO
RUBBERLESS
SUSPENDERS

Is guaranteed for a full year's wear. Men like their easy stretch and comfy feel. Ask Your Dealer. If he can't supply you, send direct, giving dealer's name.
Nu-Way Srech Suspender Co., Mfrs.
Adrian, Mich.



AGENTS Wanted for open territory; Exclusive agency. Highest quality of Approved Lightning Rod. More than 1,000,000 buildings now protected. Fire Insurance Cos. give reductions in rates.

Your Chance to **MAKE** a real Success

Sell a necessary protective device for every exposed farm structure. Most profitable and easiest to sell. We help you to sell. Goods are perpetually guaranteed. "KRETZER" Brand **MONEY**

Rods are well worth the **MONEY**
Write today—before territory is gone and ask for our Booklet "Lightning & Lightning Rods."
ST. LOUIS LIGHTNING ROD CO.
2140 DeKalb St. St. Louis, Mo.

Electric Motors below

Big manufacturer of electrical equipment canceled his order after we had them all made. Strictly high grade, entirely new motors. Chance of lifetime to get motor to run sewing, washing, ironing machine; carpenter bench lathe, drill press, etc. Write for circular
REYNOLDS
ELECTRIC COMPANY
2610 West Congress St., Chicago

Washing Machine Size Guaranteed to Satisfy



ADD TO YOUR INCOME

\$5 TO \$10 A DAY MADE EASY

The New Improved Am. Jr. No. 2 is A Wonder

Sharpens and stropps ordinary razors. Sharpens razor blades, scissors, etc.

Complete outfit for only \$35
AM. SHARPENING MACHINE CO.
Dept. 7, 184 Washington St., Chicago

GET A RAZO!

This unique Razor-blade pocket knife is the handiest, safest general utility knife. Uses an old Gillette blade. Artists, writers, draftsmen, tailors, dressmakers, office men, women, school children all need RAZO. Send 25c for yours today. Great money maker for agents.

RAZO NOVELTY CO.
21 E. Van Buren St. Chicago



MOVIES EVERYBODY!

Write for free catalogue of Machines and Film.

Machines \$6.00 to \$25.00. Film 1/2c per foot

PARAMOUNT MFG. CO., Dept. M, Box 1271, Boston, Mass.



Moore Push-Pins
Glass Heads—Steel Points

Moore Push-less Hangers
To hang up things

Ask your dealer to show them

Sold Everywhere **10¢** per packet

Moore Push-Pin Co.

Wayne Junction Philadelphia



Big ENGINE Sale

Prices Smashed Again!

Famous OTTAWA Engines back to 1914 priced New Improved Models. Better built for long, hard service. Direct-From-Factory Sales Plan saves you \$15 to \$150. Big surplus over rated H-P. Built in largest, most modern engine factory. Prices way down on all sizes.

2	H-P	\$38.50
2 1/4	H-P	45.57
3 1/4	H-P	54.50
4	H-P	75.95
5	H-P	97.50
7	H-P	115.15

OTTAWA 90 Days Trial
1922 MODEL ENGINES
stationary, portable or saw size; gasoline or kerosene. Easy to start—may to operate. Guaranteed for 10 years. Cash, or Easy Payments.
Write Today for book "How to Know Better Engines." Send at once while Sale is on.
Ottawa Mfg. Co. 523-F King St. Ottawa, Kans.



Brand-New: From Factory to You.

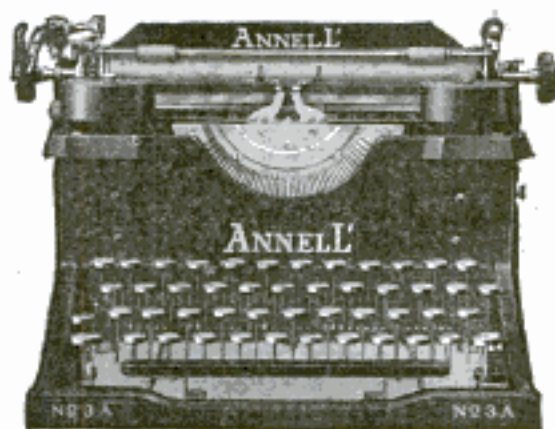

BIG SAVING

This beautiful machine is the only brand-new (unused), standard, full-size typewriter with a 4-row, 42-key, 84-character Universal keyboard that you can buy for less than \$100. It comes direct from factory to you at practically the wholesale price of other high-grade typewriters—a remarkable saving.

Free Trial

Use Annell' on your work at our expense, put it to the test for ten days; then if it doesn't satisfy you in every way, return it to us and we will refund even the express charges. You take no risk. Could anything be fairer?

Easy Terms

While you are using the machine, small monthly payments scattered over a period of more than a year make it easy and convenient to own this full-size, brand-new (unused), 4-row, standard-keyboard typewriter.

Mechanical Marvel

Strength and simplicity are the outstanding qualities of this machine. It embodies the ideas and experience of mechanical geniuses who have been making typewriters for generations. Every essential operating convenience is possessed by Annell', including the 4-row, 42-key, 84-character Universal standard keyboard. It will last a business lifetime and is fully covered by an ironclad guarantee.

Send Coupon Today

For Complete Information

about the greatest of all typewriter offers.

Don't miss it. Act now.

ANNELL' TYPEWRITER CO.

666 No. 230 East Ohio Street, Chicago

NOT AN ORDER - MAIL TODAY

ANNELL' TYPEWRITER CO.

666 No. 230 East Ohio Street, Chicago.

Send me complete information about your wonderful typewriter offer; this places me under no obligation.

.....
.....

Please Mention Popular Mechanics

Copyrighted material

Build Your Own PHONOGRAPH

IT'S EASY WITH OUR HELP

A few hours' interesting work saves over half and gives you a machine to suit your ideas. We furnish motors, tone arms, case material, blue prints and full instructions. Plays any record. Make fine profit building phonographs for your friends.

Write today for our **FREE** Blue print offer.

AGENTS wanted for Choraleon Phonographs.

CHORALEON PHONOGRAPH CO.
722 1st St., Elkhart, Ind.



SAVE
OVER
HALF

We Pay \$6 a Day



taking orders for Insyde Tyres—inner armor for automobile tires. Positively prevents punctures and blowouts. Guaranteed to give double tire mileage. **Work Spare Time or Full Time.**

Every auto owner buys on account of low price. Enormous demand. Write quick for territory and special terms to County Representatives.

AMERICAN ACCESSORIES CO., 8 1476, CINCINNATI, O.

Buchstein's Fibre Limb

is soothing to your stump—strong, cool, neat, light. Easy payments. Braces for all deformities.

D. BUCHSTEIN CO.
113 6th St. S., MINNEAPOLIS, MINN.



Send for Catalog Today

Opportunity for men who can sell

We want men of ambition, preferably with sales experience, who want to increase their present earnings. Field new and unlimited. Every home a prospect for two or more. The Fugo Automatic at \$5 has no equal. America's most prominent fire chiefs recommend it as the simplest, most efficient and dependable fire extinguisher for use in homes. Permanent, year-round work. Exclusive territory still available. Write today.

THE OHIO INSTRUMENT & MFG. CO.
9421 St. Catherine St. Cleveland, O.



FUGO AUTOMATIC
FIRE EXTINGUISHER

RADIO Equipment BY MAIL

Radio appliances of known high quality
at standard prices by mail prepaid

CONDENSERS

23 Plate - \$3.75
43 Plate - 4.50

BRACH Light- ning Arresters

Type 200 - \$2.50
Type 223 - 3.00

CRYSTAL DE- TECTORS, \$2

STROMBERG PHONES

2000 Ohms - \$7.50

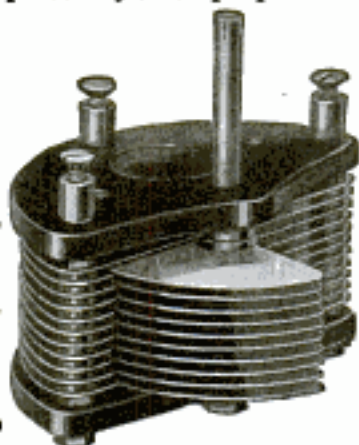

Mounted and Tested Galena Crystals, 18c each
Galena, 25c pound

Remit With Order. Orders Sent the
Same Day Received, Parcel Post Prepaid

L. & G. Radio Sales

314 Kinney Building Newark, N. J.
Exclusively Mail Orders

A, B, C of Radio Illustrated and Explained



RADIO SIMPLIFIED

What It Is. How to Build
and Operate the Apparatus
By KENDALL and KOEHLER
Licensed Operator and Radio Instructor

RADIO MADE PLAIN

Describes in simple non-technical
language the principles and NEW DEVELOP-
MENTS of Radio; the latest and
most efficient HOOK-UPS; VACUUM
TUBES; LOOSE COUPLERS; VARIO-
COUPLERS; VARIOMETERS; and
everything necessary for those who aim
to GET THE BEST RESULTS in build-
ing or operating a Radio outfit.

Illustrated with Diagrams & Photos.

Cloth. 250 pages. Table of Contents on request.

JOHN C. WINSTON CO., H-21 Winston Bldg., Philadelphia

POSTPAID \$1

\$4.00



3000
Ohms

IMMEDIATE DELIVERIES—POSTPAID

Audibility Unsurpassed—Money Back if Dissatisfied
Antenna Wire—7 Strand Tinned 150 Ft.—\$1.60

TOWER MANUFACTURING COMPANY
2 STATION ST., BROOKLINE, MASS.

Every Good Musician Praises the KING

FOR more than a quarter century
King Brass Instruments have been
built to the specifications of world-
famous musicians. Every King Instru-
ment has the latest improvements — is
built by an expert — and is thoroughly
tested in our sound-laboratory before
being shipped. That's why Every Good
Musician Praises the King.

Perfect Instruments Easiest to Play

Whether you are just learning to play
or are a finished musician you will find
these wonderful King Saxophones, Trom-
bones, Trumpets, and Horns easier to
play than any other make. The wonder-
ful tone-quality of the King is admired
by everyone.

It's easy to own a King Instrument.
They are sent on trial, and sold on easy
payments. By buying from the factory
you save all the middleman's profits.

Get Price List of Used Instruments

We now have on hand a large stock of
used instruments of other makes, re-
built and refinished to look like new.
They are sold for cash at very low prices.
Ask for our list of used instruments,
also for our catalog of new factory
guaranteed Kings — Mailed no charge.

The H. N. White Company
5238 Superior Avenue :: Cleveland, Ohio



"KING" BAND INSTRUMENTS

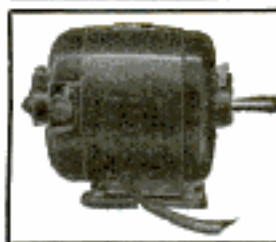

1/4 H. P. Ball Bearing Motor

with cord and plug and grooved
or flat face pulley. (New.)

110 Volt 60 cycle A. C. - - \$15.50

32 or 110 Volt D. C. - - 16.90

By parcel post to your door C. O. D.

Motors guaranteed 1 year.

CONVENIENCE MFG. CO.

5901 Maurice Ave. Cleveland, Ohio

5-Room Home \$398



Price in-
cludes lumber, millwork, paints, hardware, roof-
ing, etc. Materials cut to fit. Our
system makes it easy for anyone
to erect this attractive bungalow.
Seven different floor plans to choose
from. Send for circular No. 2122

THE ALADDIN COMPANY,

BAY CITY, MICHIGAN

MAKE MORE MONEY TORIT ACETYLENE TORCH

NO. 13
For soldering, heating, melting, tempering, auto radiator repair-
ing, battery repair work, and for all kinds of small jobs requiring
a hot flame instantly.

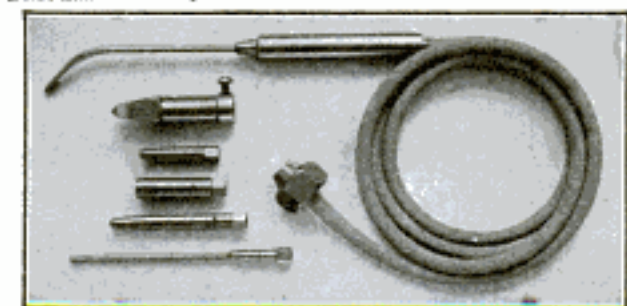

USES ACETYLENE GAS ONLY

Torch with 4 tips for different kinds of work, soldering copper, 5 ft.

tubing and connection for auto-acetylene tank. \$7.50

Order from your jobber. If he cannot supply you send your order to us.

St. Paul Welding & Mfg. Co., 177 W. 3rd St., St. Paul, Minn.

RADIO

Equipment

Big
FREE
Catalogue



THIS FREE catalogue tells you the kind of a Wireless Telephone to own, so that you receive in your own home all the latest news, music, church services, lectures—everything broadcasted throughout the United States.

Every home will soon have a wireless telephone outfit. We now offer complete outfits from \$15 up.

Everyone interested in radio should see our low prices on parts and accessories. Write for this book. Learn about the miracle invention of the age. Easy to install, as simple to operate as a regular telephone.

One copy of this booklet is yours, FREE. Write for your copy.

Address Dept. R-6

Montgomery Ward & Co.

Kansas City

Chicago

St. Paul



RADIO
HEAD SETS, JACKS, PLUGS,
MICROPHONES

Manufacturers

American Electric
COMPANY

State and 64th Sts., Chicago, Ill.

RADIO For Everybody

Make Radio a profession instead of a plaything. You can earn big money as a Radio-trician. Learn by mail, in spare time, how to design, construct, install, repair, maintain, operate, sell and demonstrate complete radio outfits. Write for free 32-page catalog describing our course entitled, "How to Learn Radio at Home."

National Radio Institute, Dept. 1164, Washington, D. C.

WANTED TAILORING SALES AGENTS

Make big money from very start—\$75.00 to \$100.00 weekly. Largest made-to-measure tailoring house, furnishing an equipment of five hundred notions, wants you to take orders. Satisfaction guaranteed. Biggest territories in money to be had. If you want to establish yourself permanently in business and make big money, write for full particulars, giving your experience as salesman or tailor's sales agent.

P. M. HORN, Sales Manager, Lock Box 483, Chicago

Send for
Free Catalog
of Money Saving
Bargains

Bargains in firearms, shot guns fishing tackle and other sporting items await those who send for this big, beautifully illustrated free catalog. Enjoy exceptionally low prices. Write now for your free copy.

Paramount Trading Company
Dept. 2086
34 West 24th St., New York

Bargains
in
Sporting
Goods



Squelching Old Man Lightning!

LIGHTNING strikes—for a mile, high induced charges are created in conducting mediums like the antenna of your radio set. If allowed to go through the delicate instrument they will ruin it.

Squelch the old man. Place a Radisco Lightning Arrester on your antenna. Induced charges will go peacefully to earth. The Radisco is weatherproof. It does not affect incoming radio signals. \$3 at your dealer's, or send to the RADIO DISTRIBUTING CO., NEWARK, N. J.

Ask also for catalogue of Radio Supplies.

RADISCO LIGHTNING ARRESTER

LATEST IN RADIO

Sweeney's Line of Radio Supplies

Personal service, information and instruction for all radio users together with immediate supply of the most complete and very latest equipment. Keep in touch with newest scientific development by getting our catalog. Among new items: See the Variometer for \$5.50 and Variocoupler \$5.00; designed by electrical engineers and finished by instrument maker. Sweeney Battery, 80 Ampere hour, made of hard rubber, (can't leak) \$22.00. Variable condensers \$3.75. Phone condensers 35 cents; Grid condensers and leaks 50 cents.

SWEENEY RECEIVING SET—5 tube receiver (two stages of radio frequency amplification) detector and two stages of audio frequency amplification. Wave length 175 to 1000 meters. This is a wonderful set; price \$150. SEND 15c for illustrated instruction book, hook-up diagrams and complete catalog. Lowest prices and latest radio developments.

Write Dept. B

Sweeney
RADIO & ELECTRICAL CO.
UNION STATION PLAZA, MANSFIELD, OHIO

Please Mention Popular Mechanics

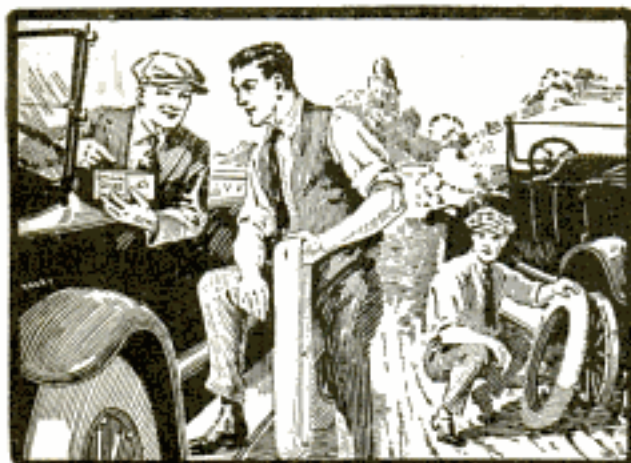

A Friend in Need!

Last tube punctured—patches won't stick—you're ready to start home on the rim. Then along comes a helpful friend and shows you how to vulcanize that puncture for good in five minutes. He'll tell you that he wouldn't take ten dollars for the feeling of security his Shaler Vulcanizer gives him and advise you to get one at the next garage or accessory store you pass. You'll do it, and next time the emergency comes you'll thank your lucky star that you were prepared.

Costs Only \$1.50

Slightly higher west of Denver and in Canada

Vulcanizes boots, rubbers, gloves, coats, etc. No gasoline. Each Patch-&-Heat Unit contains its own fuel. A match is all you need.

C. A. SHALER CO.

2006 Fourth St., Waupun, Wis., U. S. A.



YOU CAN MAKE \$18 DAILY PROFIT

With Our Great Introductory Offer
Giving These \$1.25 Dress-Making Shears **FREE**



\$18.00 a Day PROFIT on only TWENTY Sales



Lucky 11 Toilet Set—Retail Value \$3.35!

MY! HOW THEY SELL!

You get the attention with the free Shears. Walter Harris sold 800 boxes in six weeks. Profit over \$100 a week. You can do this too.

Act Now! Sell like hot cakes year round. A baby could sell Lucky 11. Don't wait a minute. Save time. Send \$1.75 for complete outfit including display case. At least write for circulars explaining our unique plans, including 30 other packages. **ACT NOW!**

E. M. DAVIS CO., Dept. 2357, CHICAGO, ILL.

MOTORCYCLES

ONE YEAR TO PAY



Know the joy of owning—for business or pleasure—a HARLEY-DAVIDSON, EXCELSIOR, HENDERSON, INDIAN, CLEVELAND, or any other standard make; thoroughly rebuilt in our own factory.

Write for Free Bargain Bulletin and Easy Payment Plan.

HAVERFORD CYCLE COMPANY
America's Largest Cycle House
Established 26 years
503 Market St., Phila., Pa., Dept. P. M.

Bam-Bee-No

Real Baseball
Played on any table anywhere. Ask your dealer, or write
The Bambeeno Sales Co., Dept. 672
Toledo, Ohio

SAMSON No. 1 HAND PUNCH

Handles interchangeable. Punches and Dies as illustrated

Maximum punching capacity $\frac{1}{8}$ " thru 20 gauge untempered metal. Will also Perforate Paper, Cardboard, Leather, etc., up to $\frac{1}{4}$ " thickness. A Powerful Punch of general utility, made of Drop Forge Steel. Throat $1\frac{1}{8}$ " deep.



PRICE,
with complete
set of Punches
and Dies. Post
paid in U. S. A.
\$5.00

THE MACHINE APPLIANCE CORPORATION
351 Jay Street,
BROOKLYN, N. Y.

only **\$1**
 Puts this
 Genuine
Diamond
 CLUSTER RING
 ON YOUR FINGER



looks like **1 1/2** carat stone

There is no mystery about this phenomenal offer and we are positive you will be entirely satisfied with this wonderful gem. It's true, a \$1.00 bill will put this beautiful ring on your finger. It has seven perfect cut genuine diamonds.

Looks like 1 1/2 carat

Compare this gem with a 1-2 carat diamond and you will see that it resembles a \$700 solitaire. The perfectly cut, sparkling, brilliant stones are set in solid platinum not just Platinum Top which gives it added beauty. Send us a dollar bill with your name and address and we will ship this wonderful bargain to you by prepaid mail.

Wear it 30 DAYS FREE

If not satisfied after 30 days, return and we will refund your money. Never in history has such a phenomenal offer been made, on convenient terms of \$1. per week or \$4. per month until \$24.00 is paid, 12% in buy (interest for less than \$25. You will agree we offer a real bargain. This is one of many bargains illustrated in our Free catalogue. Rush your order today to Dept. A.C.50.

Guarantee
 You must be absolutely satisfied or money back.

James Bergman
 37 Maiden Lane N.Y.

Be A Floor Surfacing Contractor

New unworked field. Contractors prefer to patch floor surfaces to American Universal Contractors. Machine does work of 6 men. Works quickly, easily. We set you up in business of your own. Furnish office forms, advertising, etc.

Make \$5,000 to \$15,000 or More—Yearly

Prepare for big building booms. Make new floors perfect, old floors like new. Every floor a prospect. Big money in old floors. No towns too small. Beginners often pay for machines first month with profit boards. Get full information.

THE AMERICAN FLOOR SURFACING MACHINE CO.
 523 So. St. Clair St. Toledo, O., U. S. A.

TYPEWRITERS



\$50 buys a brand new Corona, the Personal Writing Machine. Fold it up, take it with you, typewrite anywhere! Write for free booklet No. 8.

Corona Typewriter Co., Inc.
 GROTON, N. Y.

ANY BOY CAN BUILD THIS 20" CAT BOAT



with our complete Construction Set.

"Everything but the paint"

\$5.00

We have other boats, engines, boilers, etc.

Catalog Free

The H. E. Boucher Mfg. Co.
 154 Lafayette St., New York



The Famous
YORK
Saxophone

The Easiest Instrument to Play
 Sent to You ON

FREE TRIAL

Yes, you can have the World famous York Saxophone shipped to you on 10 days' Free Trial. Play it at home for ten full days. Convince yourself of its superb quality and richness of tone.

And then, if our instrument does not completely sell itself to you simply ship it back to us, and it won't cost you a penny.

Take Your Choice

You can get any one of these fine hand instruments made by the House of York on 10 days' Free Trial. Send the coupon below for beautifully illustrated literature and take your pick of the following:

- Saxophones
- Clarinets
- Cornets
- Drums
- Trombones
- Baritones

Easy Payments

You can pay while learning to play. Make a small payment down and the balance in monthly remittances. We send you everything you need—carrying case and all necessary attachments.

Send Coupon Today

Fill out the Coupon now with your name and address and simply mention the instrument you are interested in and we will send illustrated literature and full details of our Trial Offer and Easy Payment Plan. This literature also tells you how to practice and how to learn to play. **Send Coupon today.**

J. W. YORK & SONS
 Dept. 221B
 Grand Rapids, Mich.

Mail This Coupon Today



J. W. YORK & SONS,
 Dept. 221B, Grand Rapids, Mich.

Gentlemen:—

Kindly mail, without cost to me, your beautifully illustrated literature and details of your Free Trial and Easy Payment Offer.

NAME.....

ADDRESS.....

INSTRUMENT.....
 (Mention above the instrument most interested in)



Does Your Ford Engine Suffer from Oil Forgetfulness?

Isn't it a fact that you only put fresh oil in your crank case every now and then when you happen to think about it or just before you are about to start on a long motoring trip? *There is nothing to remind you that you need oil.* The inconvenient, inefficient drain cock test only tells you when your crank case is full—and burned-out bearings, scored cylinders, cracked piston rings and broken connecting rods tell you when it's empty.

Don't let your motor suffer from oil forgetfulness. *A Rajo Oil Gauge* won't let you forget. It is always on the job and registers the exact amount of oil in the crank case at all times. *Just lift the hood and read the red-tipped wire.* Easily installed. Nothing to get out of order. Simple and positive in operation.

Order your gauge *today*—it may save you a repair bill to-morrow. Price \$3.00. Send money order and name of your dealer to address below.

RAJO MOTOR COMPANY

1377 Racine St. RACINE, WIS.

Manufacturers of the famous **RAJO VALVE-IN-HEAD FOR FORDS** (racing and standard types), **RAJO WATER PUMP FOR FORDS**, **FUNNEL-FIL OIL CAP**, **VALVE INSPECTION DOORS**, and **quick removable MAGNETO PLUG CONTAINER**

RAJO
Absolute Protection
for *Fords* 300
Also Adapted to the
NASH & BUICK

FULL
3/4 FULL
1/2 FULL
DANGER



THE BUSINESS FOR YOU!

Make and sell Crispettes, delicious confection. Everybody loves them. Can't get enough. Come again and again for more. Easy to make. I furnish everything. Raw materials plentiful and cheap. Profits enormous.



Quick success possible anywhere—cities, small towns, villages. Amazing market—crowded streets; sarging throngs at fairs, carnivals, parks, etc.; wholesale to grocers, bakeries, druggists, and so on. Possibilities unlimited! Need no experience. Little capital starts you on road to phenomenal earnings.

WRITE—GET MY HELP—BEGIN NOW!

Others are making money—lots of it. Letters just received during this year tell of wonderful successes. You can succeed, too. Start is all you need. I'll gladly help you. Furnish everything—complete outfit, materials, secret formula, full directions, wrappers, etc. Send post card for illustrated book of facts. Tells how to start. Explains most successful methods. Gives all information needed. It's free. Write now!

LONG EAKINS COMPANY

728 High Street

Springfield, Ohio

THIS WONDERFUL INVENTION



converts any ordinary cook stove into a gas stove. OXO-GAS is made from kerosene and air. Cheaper, cleaner and more efficient than coal. Responsible distributors wanted.

GLORIA LIGHT COMPANY
114 N. May St. Chicago, Ill.

LOOK 50¢ LOOK

Wonderful instrument. Greatest thing yet. Nice separate articles in one. Everybody delighted with it. Odd, curious and interesting. Lots of pleasure as well as very useful. It is a double Microscope for examining the wonders of nature. It is also an Opera Glass, a Stereoscope, a Burning Lens, a Reading Glass, a Telescope, a Compass, a Pocket Mirror, and a Laryngoscope—for examining eye, ear, nose and throat. It is worth all the cost to locate even one painful cinder in the eye. Folds flat and fits the pocket. Something great—you need one. Don't miss it. Sent by mail, with 200 page Novelty Catalog, ONLY 50¢ or 3 for \$1.25

JOHNSON SMITH & CO., Dept. 655 3224 N. Halsted St., CHICAGO

Harley-Davidson

World's Champion Motorcycle

PRICES REDUCED ONE HALF Rebuilt and Guaranteed

1915, three speed twin electric \$125; 1916, \$135; 1917, \$150; 1918, \$165; 1919, \$180; 1920, \$200. Shipped on approval. Catalog A free, describing Harley-Davidson, Excelsiors, Indians, Smith Motors at \$40 and upwards. Liberty Bonds taken at full face value. Letters of recommendation from hundreds of satisfied customers. Ref. J. Blake and Harley-Davidson Motor Co. Rapid service on 1922 to 1923 Harley-Davidson parts. 100 page PARTS catalog B. 25 cents. Stamp or coin.

WISCONSIN CYCLE SALES COMPANY
726 NATIONAL AVENUE MILWAUKEE, WIS.

Dealers in the North-west



ATKINS

SILVER
STEEL

SAWS

For Every
Use—

there's an Atkins Saw. The name "Atkins" on the blade is a guarantee it will cut faster and easier—save you

time, labor and money for metal or wood cutting.

Get This FREE Book "SAW SENSE"

We'll mail you this useful book without charge—besides describing Atkins Saws for every cutting use, it is full of helpful facts on caring for saws and interesting facts on construction work. Just send your name and address and the use you make of a saw to—

E. C. ATKINS & CO., Inc.
Makers of "Silver Steel" Saws and Tools
Dept. P. Indianapolis, Ind.

This is the Life

You can get anywhere on the strongly made, easy riding and most comfortable wheel built

BLACK BEAUTY \$1 A Week

and a small deposit brings this superior wheel to you at new low factory prices. Delivered free. Five year guarantee. Six month accident insurance.

Catalog Free

Illustrating 40 styles Tires and Accessories
HAVERFORD CYCLE CO., Dept. 377 Philadelphia, U.S.A.

BURN YOUR NAME ON TOOLS

WITH
ARKOGRAF

Protect your tools from theft. Write any name, engrave any design on metal with electricity as easily as writing on paper with pen or pencil. Complete outfit \$2.50, prepaid anywhere. Interesting descriptive circular free. Write today. Agents wanted. Arkograf Pen Company 895 Capitol Ave. Portland, Oregon



FOR PROTECTION AND GAME

SPRINGFIELD CARBINE 45 Calibre

\$3.50



Made by U. S. Gov't
Breech Loading

First Class Condition. 41 inches long, weight 7 lbs., \$3.50. Then for \$3 more, you may have a smooth bore barrel to shoot shot. This makes a wonderful combination. The smooth barrel can be interchanged by anyone in 5 minutes. Millions of Bird or Ball Shot cartridges, 3 cents each. Send for Catalog.

W. STOKES KIRK, 1627 N. 10th STREET
Dept. P. M., Philadelphia, Pa.

Please Mention Popular Mechanics

\$3,000 to \$5,000 YEAR!

The Business For YOU!



This is new. Nothing like it. Simply great. Go into **battery building** business. Easy. No mystery about it. Demand enormous. Possibilities astounding.

RIDE TO SUCCESS ON RADIO WAVE

Every receiving outfit uses storage battery. Over six hundred thousand in use today. Increasing at rate of hundred thousand monthly. All must be recharged often. Repairs will be amazing. This field alone offers tremendous opportunities

EVERY AUTO MUST HAVE BATTERY

Almost ten million cars swarming country. All—even Fords—have batteries. Car owners seeking money-saving bargains. You can quickly learn to build guaranteed batteries. Can knock competition sky high and still make big money. This is your chance. Opportunity has knocked. Throw open the door. Drop everything and get busy. Nothing to stop you.

LITTLE MONEY STARTS YOU

We furnish everything needed. Fit you out complete with boxes, plates, terminals, tools, distillers, materials, supplies and directions. Our instruction course plain and simple. You can learn almost over night. No business on earth offers greater chances for success. No business on earth can be started with so little money. Don't wait a minute. Get in on ground floor. It's the coming industry. Demand for storage batteries never better. Market increasing by leaps and bounds.

WRITE QUICK FOR DETAILS

It's a proposition you can handle. Nothing hard about it. Pleasant, fascinating work. We help you to the limit. We have been in business over twelve years. Have put thousands of men into business. We'll do the same for you. Write or wire today.

Haywood Hypower Battery Co.

1366 CAPITOL AVE.

INDIANAPOLIS, IND.

YEARS AGO

DID MOTHER AND DAD
EVER APPEAR COSTUMED LIKE THIS?



*Dayton Bicycles have been leaders since
your Dad was a boy*

The above illustration is reproduced from a Dayton Bicycle catalog of 26 years ago.

Styles of dress have changed from year to year but Dayton Bicycle quality has been the same for more than a quarter century.

Today the Dayton is supreme in all those qualities that mean speed, endurance, easy running—and dependability.

Our new booklet, "How to Choose a Bicycle," will be worth while getting. Send for yours now. It will help in arriving at a wise decision regarding the exact bicycle best suited to your needs.

No matter what bike you now own—or what kind you want—get a copy of "How to Choose a Bicycle" at once. With it we will send (also free and postage paid) a copy of our new art catalog. Use the coupon at once.

Cycle Division

The Davis Sewing Machine Co., Dayton, O.

FILL IN—CUT OUT—MAIL TODAY

The Davis Sewing Machine Co., Dayton, O.

Please send me, without obligation, your booklet No. 28, "How to Choose a Bicycle" and the 1922 Dayton Catalog.

Name.....
St. and No.....
City and State.....
Age.....

Please Mention Popular Mechanics

Imperial Sanitary Floor

Put on like Plaster
Wears like Iron



A composition material easily applied in plastic form over practically any kind of floor. Laid about 1/4 inch thick. Imperial floor does not crack, peel or come loose from foundation. A continuous, fine grained, smooth, non-sliping surface. No crevices to gather grease, dirt, dust, disease germs or moisture.

Ideal Floor for Kitchen, Pantry, Bath Room, Laundry, Porch, Garage, Restaurant, Theatre, Hotel, Factory, Office Building, Railroad Station, Hospital—wherever a beautiful, substantial floor is desired. Several practical colors. Full information and sample FREE of your first and second choice of colors.

Imperial Floor Co., 69-71 East Ave., Rochester, N. Y.

A Success for 15 Years

AUTO DRIVERS



Can make big money in spare time or devote entire time to introducing and taking orders for our

IMPROVED CORD TIRES

Highest quality. Sensational prices. Big profits. Permanent business.

Write today for catalog and agent's special offer.

LANGAN & PHILLIPS
Dept. 104 CHICAGO

New Gum Vending Machine Makes You \$10 to \$20 a Day

Pays Rent for Store Owner

Install one in your store or any public place and get this easy profit. Requires no attention. Always works. Machine's profits pay the rent. Write us about rebuilt penny and nickel machines. Finished like new. In excellent running order. Pay their cost in 10 days.

Write or wire today for full particulars. \$25 down payment. Balance C. O. D. Mints \$30 per case—2,000 5 cent packages. Single boxes, 100 5 cent packages, \$2.50.

SILVER KING NOVELTY CO.
400 Williams Bldg. Indianapolis, Ind.



\$104 PROFIT IN 3 1/2 HOURS



G. A. Barton, Indiana, made that amount—making and selling Candy Floss. Others send in amazing reports: Small, Chicago, says— "Did \$125 business on Sunday." Wendel, Kansas, writes, "Averaged \$128 a day for 3 weeks." Gardner reports "2,437 sacks of candy sold from 11 a.m. to 10:15 p.m. Big Money in Candy Floss! Rees says: "Gained up \$225 in 4 nights in Greenville, Ohio." Candy Floss is a delicious, novelty confection—fluffy, soft as cotton, white as snow, or any color or flavor. Can be made anywhere—in store window, in parks, on street corners, at picnics, summer resorts, base ball games, or wherever crowds gather. Machine easy to operate. Raw materials plentiful and cheap. Send name and address for free illustrated book of facts. Drop postal. Act now! Address

**FREE
MY BOOK
CANDY SUCCESS**

A. T. DIETZ

44 Sayso Bldg.

Toledo, Ohio

RADIO HEAD PHONES

World's Largest Distributors of
**Radio Head
Pieces**



We represent 30 manufacturers, showing 75 types and designs, priced from \$5.00 to \$15.00. Following is a partial list of manufacturers:

Manhattan	Corey
Frost-Fones	Everett
Connecticut	Leich
Dictagraph	Elwood
Holtzer-Cabot	
Thompson-Levering	
American Electric	
Western Electric	

Phones on hand for immediate shipment. Ask us for the phone you want. Special—100-ohm single receivers made by old reliable telephone maker. List..... **\$2.50**

B. E. Polczynski & Co.

247 Capital Bldg., 1550 Broadway
DETROIT, MICHIGAN



The end of a perfect howl—

THE squawls of a two year old are as music to the ear beside the howling demonstration put up by a fractious radio set. And how a set can howl unless one offers the soothing influence of the proper amplifying transformer.

Most any transformer can amplify sound, but it will also amplify the stray fields which produce howling and distortion. It takes the Acme Amplifying Transformer with its specially constructed iron core and coil to put an end to the howls and yowls. Only when you add the Acme do you get the realistic tone and volume so markedly absent in the ordinary radio receiving set.

The Acme Radio Frequency Transformer greatly increases the range of any receiving set, either vacuum tube or crystal detector type. The Acme Audio Frequency Transformer produces not only volume, but reality of tone. It is indispensable to the satisfactory operation of loud speaking devices. The combination of one or more stages of Acme Radio and Audio Frequency Transformers assures the maximum of range, of volume and of reality in tone.

The Acme Apparatus Company, pioneer radio engineers and manufacturers, have perfected not only Radio and Audio Frequency Transformers as well as other receiver units and sets, but are recognized as the foremost manufacturers of Transmitting Apparatus for amateur purposes. Sold only at the best radio stores. The Acme Apparatus Company, Cambridge, Mass., U. S. A. New York Sales Office, 1270 Broadway.



S-C Loud Speaker Horn

Delivered at any door in U. S. for 75c

Largest Value on the Market
22 1/2" High; 8 3/4" Bell

Made of soft brass of remarkable tonal quality, on correct, tested acoustic principles. Takes any radio receiver in universal receptacle. Handsome gold bronze finish, lacquered. Counterweight prevents tipping.

In the same high quality with low prices: Variometers, Varicouplers, Variable Condensers, Amplifying Transformers and other Radio parts. Pink-a-Tone Sets, \$25. Ask for Bulletin R.

S-C Products Company

1264 Nicholas Bldg.

Toledo, Ohio

\$3.00

Always Accurate — Carter Oil Gauge for Fords and Chevrolet (490 and F.A.). Attaches to Instrument board. Connecting tube with elbow screws to lower petcock. No moving parts. Can't get out of order. Satisfaction guaranteed or money refunded. Carter Motor Accessories, Inc., 390 Pearl St., Buffalo, N. Y.

RADIO CATALOG

Our New Perpetual Loose Leaf Catalog and Reference Book is ready for distribution. Send 25c and your name will be put on our list. You will receive the catalog now and all new sheets and diagrams as they are issued.

ASK FOR REEL EASY PRODUCTS

I. R. NELSON COMPANY
BOND STREET NEWARK, N. J.
RADIOPHONE STATION W-A-A-M

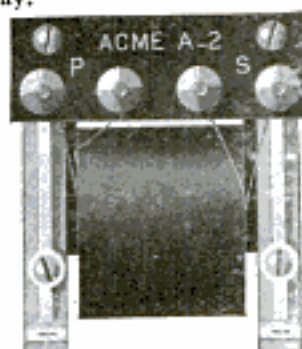

Type A-2 Acme Amplifying Transformer
Price \$5 (East of Rocky Mts.)

ACME

for amplification



Pay Nothing

An amazing new offer—wear this GENUINE DIAMOND for a week at our expense—absolutely no risk to you—deposit nothing—READ EVERY WORD OF THIS OFFER:

**Send No Money
Pay No C.O.D.**

Mail the Free Trial Coupon Below

Just send the coupon below—do not enclose a penny—and we will send you on approval at our expense your choice of these diamond rings. The ring illustrated above is the most beautiful hand engraved solid gold ladies' ring you ever saw, set with a fine, large, genuine blue-white diamond. Pay nothing when it arrives. Merely accept the ring and wear it for a week, at our expense. After a week decide, if you return the ring, that ends the matter. You have risked nothing. But if you keep the ring, send us only \$3.75 a month until you have paid the amazingly low price of \$38.75 for this regular \$50 value. The ring is an elaborate pierced model in solid 14K green gold with hand engraved white gold top. A striking new model. The diamond is a beauty—extra brilliant, blue white, perfectly cut—a remarkably big value.



Men's extra massive 14K solid gold fluted ring with 18K hand cut white gold top set with extra fine perfectly cut blue-white genuine diamond. Extra Big Value. Now \$38.75—\$3.75 a month. Send no money. Pay no C.O.D. A week's trial absolutely FREE. Mail coupon now.

Just mail the Free Trial coupon below. Be sure to enclose finger size. SEND NO MONEY—pay nothing on arrival.

Harold Lachman Co., Dept. B 177 204 S. Peoria St., Chicago

Send me absolutely free and prepaid, for a week's trial, the genuine diamond ring checked below. I am to pay nothing when it arrives. After one week I will either return the ring by registered mail and that ends the matter, or I will send you \$3.75 each month until \$38.75 has been paid. Title remains with you until fully paid. I ENCLOSE MY FINGER SIZE.

Ladies' Ring No. A4350

Men's Ring No. A4450

Name

Address

Copyright 1922, Harold Lachman Co.

New!

The Gilbert Boy Engineering Book for 1923

Boys, just look at these features: Famous Engineers and Their Achievements, Mysterious Card Tricks, World Famous Champions, in the Field of Sports; "How to Broad Jump," by Edward Farrell, trainer of the World's record holder; Chemistry Experiments, Vacuum Tubes and Circuits, complete catalog of Gilbert Toys—all in one wonderful book. A book every boy should have. Don't wait another minute. Send us 10c today.

The A. C. Gilbert Co.
403 Blatchley Ave.
NEW HAVEN, CONN.

10¢

Copper Steam Boiler

Latest improved Solid Copper High Pressure Steam Cooker—Complete and Perfect in every detail. Cannot explode. Absolutely steam tight. Note the safety features, steam gauge, safety valve and special 1/2 inch steam outlet valve. Made of absolutely purest heavy copper throughout. No solder inside. Can screw in large enough for hand—easily cleaned. Has a thousand uses. You pay no more for this heavy solid copper pressure boiler than for those made of cheap metals.

World's Lowest Prices

2 gal.	\$ 7.50	10 gal.	\$17.50
4 gal.	10.00	15 gal.	20.00
6 gal.	12.50	20 gal.	25.00
8 gal.	15.00	30 gal.	35.00
50 gal.	\$50.00		

STEAM GAGE
SAFETY VALVE
STEAM OUTLET
STARTING SCREEN

Send Only \$1

Order any size boiler at the price shown. Just tell us the size you want. Enclose \$1. The Boiler will be shipped at once without red tape or delay. Pay the balance when Boiler is delivered. Also made in wash-boiler shapes—12, 15, 20, 25, 35 gallon sizes. Price \$1 per gallon.

General Products Co.
Dept. 43 B
1827 W. Lake St., Chicago



BALBA SALES MACHINES MAKE \$200 TO \$1000 MONTHLY

This new plan of selling high quality perfume has taken the country by storm. Men everywhere are jumping at the opportunity to get into this big money-making field. See page 171 of March Popular Mechanics.

Over 300 Cities Already Taken

Over 300 cities and towns have already been contracted for—better get busy before yours is taken by someone else. Remember the first who qualify get the exclusive sales rights. We do the local newspaper and national advertising. Get full particulars NOW.

BALBA CORPORATION OF AMERICA, Inc.
Dept. 44, Adams and Jackson Sts.
Toledo, Ohio, U. S. A.



VAN DANDY TOURIST CAMP COOKER

You will make your outing this summer the best ever if you take a Van Dandy Cooker with you. Get a quick hot lunch with it in a jiffy. Made for Tourists, Fishermen, Hunters, Picnic. Order one today. Price without pans, \$13.50. Also makers of auto beds, tents and folding cots.

VANDERPOOL CO., Dept. 7-P, Springfield, Ohio

RADIO TEXT BOOK

10c

Complete 50c instruction book for 10c on how to make and operate crystal and vacuum tube Radio receiving sets. Wonderful information, makes you understand radio. With every order we send FREE our complete Catalog of Radio parts and equipment. Buy direct from factory and save money. Both text book and catalog mailed postpaid on receipt of 10c.



Dept. P, Clearson Radio, 1817 First National Bank Bldg., Detroit, Mich.

MODEL MAKING

New 400-page book covering workshop practice, design and construction of models. The work described is real model engineering and not the construction of mere toys. 303 Illustrations. Cloth. Price, \$3.00 Postpaid. POPULAR MECHANICS BOOK DEPT., 6 N. Michigan Ave., CHICAGO

Junior Bench Saw

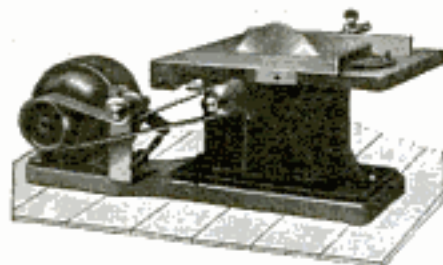

A precision bench machine of highest quality at a low price

Sawing, ripping and grooving become a pleasure when done on this wonderfully useful machine. Handles saws, sand discs and emery wheels. Cuts one and one-half inch stock. All metal construction. Especially adapted to grooving. Equipment includes six inch saw, rip guide, mitre guide and pulley. Machine fully guaranteed. Send for circular.

Price
\$28.75

W. & J. Boice, 114 23rd Street, Toledo, Ohio



MAKE A MOTOR CYCLE

OUT OF YOUR BICYCLE with a STEFFEY MOTOR ATTACHMENT. RELIABLE — ECONOMICAL — EFFICIENT. Easy to attach. Fits any wheel. Send stamp for circular.

STEFFEY MFG. CO., Dept. P, 5925 Brown St., Phila., Pa.

Banish YOUR Ailments



Get rid of your ailments and physical defects. Banish the weaknesses that make your life a wretched failure. What good is life anyway, when one day of misery just follows another with no relief in sight, and big bills to pay for dope and drugs that can never help you and may seriously harm you.

No matter what your condition is or what caused it you can aid Nature in overcoming your nagging complaints and fit yourself for the joys of life with **STRONGFORTISM**, the Modern Science of Health Promotion.

A lifetime's experience and research is contained in my free book, "Promotion and Conservation of Health, Strength and Mental Energy." It will tell you the truth about your physical condition and show you how you can make yourself over into a vigorous specimen of vital, magnetic manhood. Mark the subjects on the free consultation coupon on which you want special confidential information (write additional subjects on extra line) and send to me with a 10c piece (one dime) to help pay postage, etc. Send for my free book **Right Now—TODAY.**

Strongfort
The Perfect Man

LIONEL STRONGFORT

Physical and Health Specialist.

Dept. 907 Founded 1895 Newark, New Jersey

FREE CONSULTATION COUPON

Mr. Lionel Strongfort, Dept. 907, Newark, N. J.—Please send me your book, "PROMOTION AND CONSERVATION OF HEALTH, STRENGTH AND MENTAL ENERGY," for postage on which I enclose a 10c piece (one dime). I have marked (X) before the subject in which I am interested. Also on those I may write on extra line below:

- | | | |
|-------------------------|-------------------------|-------------------------|
| .. Colds | .. Diabetes | .. Rheumatism |
| .. Catarrh | .. Pimples | .. Falling Hair |
| .. Asthma | .. Blackheads | .. Neurasthenia |
| .. Hay Fever | .. Insomnia | .. Weak Eyes |
| .. Obesity | .. Short Wind | .. Gastritis |
| .. Headache | .. Flat Feet | .. Heart Weakness |
| .. Thinness | .. Stomach Disorders | .. Poor Circulation |
| .. Rupture | .. Constipation | .. Skin Disorders |
| .. Lumbago | .. Biliousness | .. Despondency |
| .. Neuritis | .. Torpid Liver | .. Round Shoulders |
| .. Neuralgia | .. Indigestion | .. Lung Troubles |
| .. Debility | .. Nervousness | .. Stoop Shoulders |
| .. Flat Chest | .. Weaknesses (Specify) | .. Muscular Development |
| .. Deformity (Describe) | .. Poor Memory | .. Great Strength |
| .. Increased Height | | |

Mention other ailments here

Name

Age Occupation

Street

City State



TYPEWRITER SENSATION!

Free Trial—Use as You Pay

The World Renowned Late Model No. 10 Royal, than which there is none better, can now be had at only \$5.00 a month until the low total price of \$69.85 is paid, and the machine is yours.

This is absolutely the most generous typewriter offer ever made. Do not rent a machine when you can pay \$5.00 a month and own one. Think of it—Buying a \$102.50 Machine for \$69.85. Cash price \$62.85, just a little more than half its original price.

ROYAL Model No. 10

Perfect machines, Standard size, Keyboard of Standard Universal arrangement, 42 Keys, writing 84 characters—universally used in teaching the touch system. The entire line of writing completely visible at all times. It has all the standard features common to the leading typewriters, such as the tabulator, the 2-color ribbon, with automatic reverse, the back spacer, etc. Exclusive Royal features are: the double shift release, accelerating type bar action, roller trip escapement, reversing paper table, card writing device, line lock and glass panel sides to keep out dust and dirt. Comes to you with everything complete; tools, cover, operating book and instructions—nothing extra to buy. You cannot imagine the perfection of this beautiful reconstructed typewriter until you have seen it. We have sold thousands of these perfect late style machines at this bargain price and every one of these thousands of satisfied customers had this beautiful, strictly up-to-date machine on five days' free trial before deciding to buy it. We will send it to you F. O. B. Chicago for five days' free trial. It will sell itself, but if you are not satisfied that this is the greatest typewriter you ever saw, you can return it at our expense. You won't want to return it after you try it, for you cannot equal this wonderful value anywhere.

SEND NO MONEY Put In Your Order Now

\$4.85
AFTER
TRIAL

When the typewriter arrives deposit with the express agent \$4.85 and take the machine for five days' trial. If you are convinced that it is the best typewriter you ever saw keep it and send us \$5.00 a month until our bargain price of \$69.85 is paid. If you don't want it, return it to the express agent, receive your \$4.85 and return the machine. We will pay the return express charges. This machine is guaranteed just as if you paid \$102.50 for it. It is standard. Over half a million people own and use these typewriters and think them the best ever manufactured. The supply at this price is limited, the price will probably be raised when next advertisement appears, so don't delay. Fill in the coupon to-day—the typewriter will be shipped promptly. There is no red tape. We employ no solicitors—no collectors—no chattel mortgage. It is simply understood that we retain title to the machine until full \$69.85 is paid. You cannot lose. It is the greatest typewriter opportunity you will ever have. Do not send us one cent. Get the coupon in the mails to-day—sure.

SMITH TYPEWRITER SALES CO., 216, 218 N. Wells St., Chicago, Ill.

SMITH TYPEWRITER SALES CO., 216, 218 N. Wells St., Chicago, Ill.

Ship me the Royal Model No. 10, F. O. B. Chicago, as described in this advertisement. I will pay you \$5.00 monthly as rent until the \$65.00 balance of the Special \$69.85 sale price is paid. The title to remain in you until fully paid for. It is understood that I have five days in which to examine and try the typewriter. If I choose not to keep it I will carefully repack it and return it to the express agent. It is understood that you give the standard guarantee.

Name

Street Address

City State

Occupation or Business

CHARGE 2 BATTERIES

IN YOUR HOME
AT THE SAME TIME FOR

Keep Your Batteries Charged

The HULBERT Battery Charger will charge two batteries at the same time, in any of the following combinations (an Automobile and Radio "B" batteries—or, Radio "A" and Radio "B" batteries), at a cost of about 5 cents. And merely by connecting the HULBERT Battery Charger extension cord to any 110 Volt Alternating Current electric lamp socket in your office, home, garage, basement, etc.

Your automobile battery can remain right in the car—just connect the HULBERT Battery Charger to a lamp socket in the garage and the Battery Charger extension to the battery, turn on the "juice" before retiring at night—your battery is fully charged when you get up the morning. It's just as simple as that.

By a New Electrical Principle

The HULBERT Battery Charger represents a new departure in the construction of transforming and rectifying devices which are combined in a single unit. It involves an entirely new electrical principle. Practically no adjustment is required. The charger is self-polarizing; so battery can be connected either way; except when two batteries are being charged at the same time. The charging rate adjusts itself automatically to the type and condition of the battery charged; charging from twelve to five amperes on the six volt batteries and one-half to one-ampere on the ten to twenty-five volt battery. No adjustment is required ordinarily; but if it is, one screw does the whole thing.



The Advantages of the HULBERT Battery Charger

1. Simplicity of Construction.
2. Only one moving part.
3. All parts visible.
4. No permanent magnets.
5. Self-polarizing.
6. No wiring.
7. Two batteries charged at the same time.
8. Heavy construction, ensuring dependable operation.



10 Days' FREE Trial

Order a HULBERT Battery Charger TODAY. Enclose your check, postoffice money order or draft for \$20.00 with your order and it will be promptly shipped, furnished with 10 foot lamp cord and standard lead-plated battery clips attached; a 5 foot lamp cord with nickel plated battery clips attached for "B" battery; and a 5 foot lamp cord with attachment plug.

All instruments and adjustable parts mounted on beautifully finished fibre panel board to match your radio set. Try it 10 days. Give it the hardest test you can. Convince yourself that it is everything claimed for it. If you are not entirely satisfied, send it back and your money will be promptly returned to you. **YOU CAN'T GO WRONG.** This guarantee is positively unconditional. Don't be without one. **ORDER YOURS TODAY.**

FREE A clear descriptive folder, that tells the whole story; with a sketch drawing of this new electrical principle and how it operates. Printed so you can understand it. A postcard with your name and address will bring it to you **FREE.** Send for one TODAY.

DEALERS Write on your business letter-head for our attractive **DEALERS OFFER.** This is a quick, profitable seller.

The Hulbert Electric Mfg. Co.
7010 N. Ashland Ave., Chicago



BIG MONEY MAKERS for AGENTS



SHOCK-PROOF LAMP, the new unbreakable mill type lamp, is fast replacing the old style. Stronger and gives many times the downward light. As its name implies, it is a **SHOCK PROOF** sturdy jar and shatter proof as prevalent in GARAGES, FACTORIES, MILLS, SHIPYARDS, STEAMSHIPS, MINES—yes, even in the HOMES. Lasts longer and is sold for less money. Big money-saver.



FREE Send for our AGENTS PLAN and Booklets, fully explain how easy it is to sell **SHOCK PROOF** lamps. Every GARAGE, FACTORY, MILL, RAILROAD YARD, STORE and HOME is looking for just this chance to get a better lamp for less money and in a **BIG MONEY MAKER**. AGENTS everywhere are "cash-in". This is YOUR opportunity. Don't let it get by. Grab it.

SEND FOR OUR AGENTS PLAN TODAY

EXCLUSIVE TERRITORY given to agents who qualify. Now is the time to get your share of **BIG MONEY** and **EXCLUSIVE TERRITORY**. GET THE AGENTS PLAN TODAY. IT COSTS YOU NOTHING.

MIDWEST LAMP CO., 143 W. Austin Ave., CHICAGO

Where soft solder won't do, use Briggs' Silver Solder

1 oz. Tape—5 ft. long, 3/4 in. wide, 3/1000 in. thick, in non-waste, metal box. **\$1.25**

J. BRIGGS & SONS CO., Mfrs.
67 Clifford St. Providence, R. I.

For FORD CARS Any Year, Any Model Genuine HEINZE-SPRINGFIELD \$49.75 Starting and Lighting System

Limited supply—latest improved type! Price includes Ammeter, Dash and Tail lights, Switch Lock and new high-grade battery of standard make. Quick, sure start—bright, steady lights. Easily attached to any Ford. Order direct from this ad or write for literature.

The Service Products Co., Dept. 9, - Springfield, Ohio

SOMETHING NEW, CATALOG No. 22

New goods, new prices, smallholders, engines, steam and gasoline, 1-8 H. P. up, pumps, castings, blow pipes, gears, valves, electrical goods, model makers' supplies materials, 1-4 H. P. Motor engine, 2 1/2 inch sq. model locomotive, etc. **Catalog post-paid 20 cents stamps (2 stamps preferred).** Refunded first order. **Modern Engine and Supply Co.**
53 W. Jackson Blvd. CHICAGO



Attach Your Own Top

Perfect fit guaranteed. Best materials and lowest prices. As low as **\$4.50**

Full line of fabric accessories in Catalog No. 3

Special Offer for Dealers

A. E. SCHNEIDER MFG. CO.

4265 Hudson Blvd.

West Hoboken, N. J.

And Save Money



MAKE BIG PROFITS CHARGING BATTERIES—\$20 Brings You an HB Charger

Start NOW to make big profits with an HB Battery Charger. Big demand for reliable charging service. Some one will get these profits, why not YOU? No experience needed, anyone can install and operate.

Only \$20 Brings You an HB Charger

Balance easy monthly terms. Sizes for 6, 10, 16 or 32 batteries. Let us recommend outfit for you. Write today. Ask for information about HB Automatic Air Compressors, Tire Buffers, Motor Grinders, Motors, Lighting and Charging Sets, Stock-keeping Cabinets—all big money-makers for you. Sold on easy payments. **HOBERT BROS. CO., Box 474, ... Ohio.**





Deformities of the Back

Greatly benefited or entirely
cured by the Philo Burt
Method.

The 45,000 cases...

BOYS



POPULAR MECHANICS ADVERTISING SECTION



A vacation

Deformities of the Back



Greatly benefited or entirely cured by the Philo Burt Method.

The 45,000 cases successfully treated in our experience of over 20 years is absolute proof of this statement.

No matter how serious your deformity, no matter what treatments you have tried, think of the thousands of sufferers this method has made well and happy. We will prove the value of the Philo Burt Method in your own case.

The Philo Burt Appliance on 30 Days' Trial

Since you run no risk there is no reason why you should not accept our offer at once.

The photographs here show how light, cool, elastic and easily adjustable the Philo Burt Appliance is—how different from the old torturing plaster, leather or steel jackets. To weakened or deformed spines it brings almost immediate relief even in the most serious cases. You owe it to yourself to investigate it thoroughly. The price is within reach of all.

Send for our Free Book today and describe the nature and condition of your trouble as fully as possible so we can give you definite information.

PHILO BURT CO.

53-18 Odd Fellows Bldg., Jamaica, N. Y.



BOYS



Learn Drafting

DRRAFTING offers exceptional opportunities to boys and young men because drafting itself not only commands good pay, but it is the first step towards success in Mechanical or Structural Engineering or Architecture. And drafting is just the kind of work a boy likes to do. There is an easy, delightful way by which you can learn right at home in spare time. For 30 years the International Correspondence Schools have been giving boys just the training they need for success in Drafting and more than 300 other subjects.

Let the I. C. S. help you. Choose the work you like best in the coupon, then mark and mail it. This doesn't obligate you in the least, but it will bring you the information that will start you on a successful career. This is your chance. Mark and mail this coupon now.

----- TEAR OUT HERE -----

International Correspondence Schools

Box 5654-C, Scranton, Penna.

Without cost or obligation, please send me complete information about the subject which I have checked below:

- | | |
|---------------------------------------|---|
| <input type="checkbox"/> DRAFTING | <input type="checkbox"/> BUSINESS |
| <input type="checkbox"/> CARTOONING | <input type="checkbox"/> CIVIL SERVICE |
| <input type="checkbox"/> AUTOMOBILES | <input type="checkbox"/> PHARMACY |
| <input type="checkbox"/> CHEMISTRY | <input type="checkbox"/> ARCHITECT |
| <input type="checkbox"/> ADVERTISING | <input type="checkbox"/> BOOKKEEPER |
| <input type="checkbox"/> SALESMANSHIP | <input type="checkbox"/> GOOD ENGLISH |
| <input type="checkbox"/> ELECTRICITY | <input type="checkbox"/> WIRELESS |
| <input type="checkbox"/> ACCOUNTING | <input type="checkbox"/> CIVIL ENGINEER |
| <input type="checkbox"/> SURVEYING | <input type="checkbox"/> AIRPLANE ENGINES |

Name.....

Address.....

Occupation.....

Persons residing in Canada should send this coupon to the International Correspondence Schools Canadian, Limited, Montreal, Canada

Please Mention Popular Mechanics

CAMERAS

Over a Hundred Styles and Sizes
Send for new illustrated catalog showing latest reduced prices. It's Free.

10 days' trial given

SENECA CAMERA MFG. COMPANY
300 Central Avenue Rochester, N. Y.



RADIO For Everybody

Make Radio a profession instead of a plaything. You can earn big money as a Radio-trician. Learn by mail, in spare time, how to design, construct, install, repair, maintain, operate, sell and demonstrate complete radio outfits. Write for free 32-page catalog describing our course entitled, "How to Learn Radio at Home."

National Radio Institute, Dept. 1164, Washington, D. C.

AUTO OWNERS WANTED



To introduce the best automobile tires in the world. Made under our new and exclusive **Internal Hydraulic Expansion Process** that eliminates **Blow-out—Stone-Bruise—Rim-Cut** and enables us to sell our tires under a

10,000 Mile Guarantee

We want an agent in every community to use and introduce these wonderful tires at our astonishingly low prices to all motor car owners. Write for booklet describing this new process and explaining our amazing introductory offer to owner agents.

Hydro-United Tire Co.

Dept. 100—Chicago San Francisco Pittsburg, Pa.

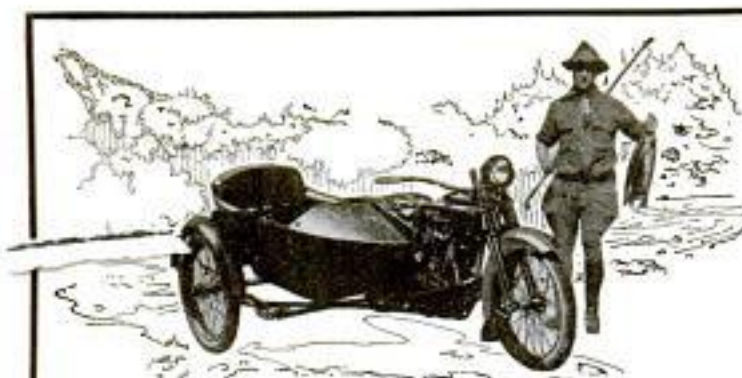

A vacation you'll never forget

SPEED to your vacation land on a real sportsman's steed—the Harley-Davidson. Start your sport the minute you leave home. Take the short cut and let the automobile tourists have their dusty, crowded main roads.

Save money, too. With a Harley-Davidson, a dollar pays for fifty miles (gas, oil, tires and all). Why man, you owe yourself a real vacation this summer. Talk it over with your pal—then see the local Harley-Davidson dealer for free demonstration, reduced prices and easy payment plan. Or write us for free illustrated literature.

HARLEY-DAVIDSON MOTOR CO.
Milwaukee, Wisconsin

Attractive dealer proposition for unassigned territories. Address Desk A-2



Harley-Davidson

World's Champion Motorcycle

Step on'er, Mr. Ford owner

Stoner Foothrottle
IT IS DIFFERENT



Smooth, Quick Acceleration and perfect control on roughest roads. A beautiful device—mechanically perfect

When you step on a **STONER FOOTHROTTLER**, the smooth response lends an ease and confidence to your driving that make it a real pleasure. Can be installed by anyone in a "jiffy" without drilling or boring, as the pedal slips thru the finger hole in the lower toe-board. Fits all models.

FREE—Beautifully illustrated folder. Send for one TODAY. If your dealer can't supply you, mail \$2.50 today and your **FOOTHROTTLER** will be mailed promptly. **Satisfaction absolutely guaranteed or money refunded.**

DEALER—Send for our proposition.

STONER EQUIPMENT CO. 326 W. MADISON STREET CHICAGO, ILL.

A REAL BOAT FOR REAL FISHERMEN

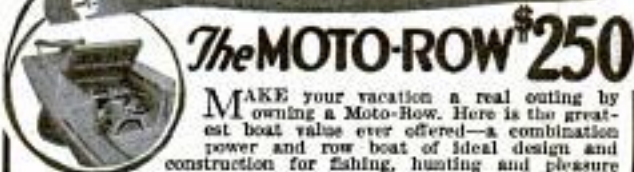

The MOTO-ROW \$250

MAKE your vacation a real outing by owning a Moto-Row. Here is the greatest boat value ever offered—a combination power and row boat of ideal design and construction for fishing, hunting and pleasure purposes at less cost than an outboard makeshift. Built of selected airplane spruce, copper riveted, and equipped with a dependable 2-H.P. motor protected from weather and theft beneath the stern deck, the Moto-Row offers you something distinctly new and practical. Dimensions 16 by 4 ft., speed 7 M.P.H., capacity six persons. Supplied with reinforced skeg which permits backing without injury to propeller. Built water equipment \$25 extra. Built by Sidney McLaugh, Marine City, Michigan. Write for illustrated catalog.

BELLE ISLE BOAT & ENGINE COMPANY

DEPT. I

Builders of Belle Isle Boats

DETROIT, MICHIGAN



\$140 Weldit Outfit For \$75

In price alone, you cannot find in the open market a welding outfit that resembles a value equal to this "Weldit" under \$140 to \$165. In design, proven efficiency and every detail of actual quality it is not surpassed—we might say **not even approximated at any price.**

Preferred by such representative users as Dodge Bros., Ford Motor Co., Owens Bottle Mch. Co., Studebaker Corp., Timken-Detroit, American Shipbuilding Co., Thompson-Starrett, General Motors Corp., it has stood the severest test of years and is acknowledged to be the **highest development of acetylene welding equipment.** All of our apparatus is inspected and approved by the National Board of Underwriters.

The price of only \$75 is **direct to you from our factory,** backed by our reputation and **absolute guarantee.** No salesmen, commissions or dealers' profits, we prefer to do business direct with our customers at our own factory prices. Once you see this equipment you will instantly recognize the great saving and superiority of service this offer represents. **It is a value you cannot afford to pass, if you need or use acetylene welding.**

We suggest that you write today for complete information. Address:

WELDIT ACETYLENE CO., 146 West Larned St., Detroit, Mich.

Factory Prices on Everything for the Welder

FORTUNES FOR SALESMEN!

AMAZING INVENTION A WHIRLWIND SUMMER SELLER

Bentley
F. W. Bentley of Phila. says: "Ye gods—some seller! I made \$215 IN ONE DAY."

Carnegiey
J. Carnegiey of So. Dak. says: "I made big money before but did not expect so much. Am making \$1,000 A MONTH."

Berger
R. Berger of Ontario sends regular weekly order paying him \$258 EVERY WEEK.

"Have averaged \$660 profit a month for last six months."
A. M. Russell, Conn.

Salesmen In Every Territory Reporting Biggest Summer Sales They Ever Made. Good Territories Still Open. Read This Amazing Offer.

HERE'S an amazing new invention that is banishing forever the mess, dirt and drudgery of coal and wood fires,—and saving housewives from roasting kitchens in Summer. Set it in any fire-box of any coal range. Presto! In one minute you have an actual gas stove. Just turn a valve and instantly get just as much or as little heat as is needed—only when it is needed. Kitchens cool and breezy all Summer. Makes an instant hit with housewives. Sales almost automatic. That's why the Oliver Improved Oil-Gas burner is making fortunes for agents.

NO EXPERIENCE NEEDED TO MAKE BIG MONEY!

You don't need to be a high powered salesman to make money on a proposition like this. Housewives all over the country are clamoring for this amazing new invention. The Oliver's amazing features sell it for you.

Besides its other points the Oliver burns 95% air and 5% oil, the cheapest fuel there is. It is not a mere kerosene wick burner. A new invention turns the oil and air into gas. It is the gas that burns—at the turn of a valve. Now you know why W. H. Dow of Michigan made \$85.00 in one day; why L. Zuecher of Ohio made \$21.50 in 3 hours; why A. M. Russell of Connecticut has averaged \$660.00 for the last 6 months; why one order sent by P. M. Ford of Iowa gave him a profit of \$646.25.

QUICK SALES—BIG PROFITS

Every agent we appoint makes big money. You, too, can use this secret of making big money easily. We have a number of definite territories which we are ready to dispose of to those who act quickly.

COUPON BRINGS FULL OFFER

Mail this coupon now for our offer. We are not

making any extravagant claims about this. We don't have to. We want to give you the facts. Writing will not obligate you in any way. But by acting quickly you will receive our offer in time to get an exclusive territory franchise with private selling rights.

But hurry. Send the coupon at once if you want to get in on this big money, whirlwind Summer seller.

OLIVER OIL-GAS BURNER & MACHINE CO.
2014-S Pine St., St. Louis, Mo.

Oliver Oil-Gas Burner & Machine Co.,
2014-S Pine St., St. Louis, Mo.

Please send me full facts about how I can make big money representing you in my territory. Also your plan, if I wish to make big money in my spare time.

Name.....

Address.....

City.....



Agents \$75.00 Weekly

Amazing new seller. **JIFFY-JEANS** (not an overall) protects clothes while working around auto, shop, or home. On and off in 5 seconds. Cannot streak dirt or mud from shoes to clothes when putting on. Kept firmly in place by flexible steel bands. Will not wrinkle clothes. Made of high-grade Ducking. One size fits everyone. Easily laundered.

150% PROFIT

Sells like hot cakes. Just show and sale is made. Nothing else like it. Low price. Make \$75.00 weekly easily. Write today for liberal Agency Proposition.

JIFFY-JEANS, 5650 W. Lake St., Chicago, Ill.

Ten Tools 1000 Uses

Just what you want to construct radio set. Finest of steel in each of 10 tools in beautifully finished cocobola handle. This is a genuine

Handikit \$1.00

Send us your name and address only. Pay on arrival. Money back if wanted.

HANDIKIT CO., M ST., CLINTON, CONN.

We Have an Attractive Proposition for Agents



15 DAY FREE TRIAL

EASY MONTHLY PAYMENTS

SEND NO MONEY

JUST WRITE AND SAY YOU WANT TO TRY A

Faultless Coaster Brake Bicycle or Motobike

When your bicycle arrives, try it **FREE** for 15 DAYS. If then you are fully satisfied with it, send us only \$3.00, then \$5.00 a month for seven months. If it does not suit you, ship it back at our expense and we will refund even the freight you paid on arrival.

Tested Frame of Seamless Steel Tubing. One piece Crank Hanger. Duro Forged Crown Forks. New Departure Coaster Brake. Roller Chain. Every device for Speed, Comfort, Perfect Control and Durability, including Channel Bar Stand.

SIZES and STYLES, for BOYS, MEN, GIRLS and WOMEN

NATIONAL FARM EQUIPMENT CO., INC.
DEPT. 410 98 CHAMBERS ST., NEW YORK

A Vacation Every Week End



That is what you will
enjoy with an

Indian Motorcycle

What you save on carfare riding to work, will pay for your pleasure trips, for the INDIAN MOTORCYCLE'S Powerplus Motor gives you power with economy.

60 to 70 miles to the gallon. No hill too steep, no road too narrow.

Ask any INDIAN dealer for a demonstration. Write Department 37 for literature

Numerous improvements. Two brand new models—New, low prices,

Hendee Manufacturing Co.

*Largest Motorcycle Manufacturer
in the World*

Springfield

Mass.

Please Mention Popular Mechanics

CORD TIRES

First quality new Charles Cords, give unusual service under trying conditions. At the introductory prices quoted below, they afford a considerable saving.

With each tire you buy, we include a brand new tube

PRICE LIST

30x3	\$ 8.75	34x4	\$18.60
30x3½	10.65	32x4½	21.10
32x3½	13.50	33x4½	22.15
31x4	14.75	34x4½	23.20
32x4	16.10	35x4½	24.05
33x4	17.00	35x5	26.50



We guarantee all Charles Cords to be free from defects in materials and workmanship. They are built for 8,000 miles service and that mileage is the basis of adjustment.

We Will Send You a Tire

or a set of tires. Send us your dealer's name, the size tire you use and tell us how many you want. Send no money. The tires will be shipped to you by express C.O.D. with a section left unwrapped for examination. This offer means a large saving on your tire bill. Take advantage of it at once.

CHARLES TIRE CORP., Dept. 756
2824 Wabash Avenue, Chicago, Ill.

8000 Mile Guarantee

KEROSENE

Make Money Men and Women Wanted to Sell

BIG

PERFECTO

Kerosene Iron



No experience necessary. Big profits selling this wonderful self-heating satisfaction guaranteed iron. Easy to operate and demonstrate. Sells itself. Use Kerosene (Coal Oil) or Gasoline with same satisfactory results. Absolutely safe, no smoke or odor. Get facts in detail and let us sell you how to obtain Free Sample and start you in a big profit business. Sample case FREE to Agents.

Perfecto Sad Iron Factory,

Dept. 37,

126 So. Clinton St., Chicago, Ill.



Agents

LARGE MANUFACTURER OF SHIRTS wants Agents to sell complete line of shirts direct to wearer. Exclusive patterns. Big values. No capital or experience required. Write for free samples.

MADISON SHIRT MILLS

507 Broadway

New York, N. Y.

DON'T PASS THIS UP BE YOUR OWN BOSS

A ROUTE OF THESE SCALES
WILL MAKE YOU BIG MONEY

If this were only a coin controlled automatic Weighing Machine, each scale would be worth \$5 to \$20 per month to you in pennies.

BUT with the new Colonial Advertising Scale you can also sell advertising space to 6 merchants at \$2 per space per month, or \$24 per year.

Each space is 9 x 3 and is placed on a drum at top of scale which revolves each time any one uses this scale—Independent of the weighing mechanism. A different advertisement is shown with each revolution.

Sell the 6 spaces and your income from one machine is \$144 per year, and the pennies taken in by the weighing mechanism are extra—\$5 to \$20 per month.

You can easily install a route of 20 or 25 scales in your city. Figure out your income.

Your investment is small. Territory is going fast. Suitable for either whole or part time work. Write or wire for full particulars.

The Colonial Metal Products Co., Inc.

152 Edison St., Syracuse, N. Y.
In Canada, 173 Ontario St. W., Montreal



AUTO SUPPLIES and BEAUTIFUL BODIES at WHOLESALE PRICES

Big Free Catalog

Know the latest prices before you buy. Send for our illustrated price list. Every page is filled with bargains. We buy for cash—and sell for cash.

Save Money on Special Bodies

We carry a complete line of "Fidelity" Bodies for Ford and Chevrolet "490"; at Bargain Prices; \$29.85 and up.

AUTO SUPPLIES FOR ALL CARS



Send for Catalog P. It shows over 3000 bargains in repair parts, tops, radiators and general accessories for Fords and other cars, all guaranteed standard quality.

Fidelity Bodies
\$29.85 and up
for Fords
and Chevrolet "490"

NEMCO BARGAIN SUPPLY HOUSE
1017 W. Jackson Blvd. Chicago, Ill.

COOL BREEZES

New hand operated miniature fan. A cool companion in warm weather.

AERO FAN Price, \$1.50

Just the thing for home or traveling, at the theatre, ball room, cafe, etc. Neat and compact—always ready for use. Carried in the vest pocket or ladies hand bag.

Sold by best dealers everywhere or sent by mail to any address in the United States or Canada for \$1.50.

AERO FAN CO. Dept. 100
501 No. La Salle St. CHICAGO

BINOCULARS

Special value in highest grade genuine imported FRENCH CONDE prismatic binoculars, in fine calf skin case with straps. 8 power; 32 mm. 23 oz. **\$45.80**



Sent on Approval brand new; not war stocks. Over 1000 pr. sold last year. Drop us postcard for illustrated circular.

BARLER & CO.
644-D N. Michigan Ave.
CHICAGO

ENDS YOUR MOTOR TROUBLES



Improved Kirk Transformers can now be bought at half the usual prices. A four cylinder set which used to sell for \$2.00 can now be purchased for \$1.00.

Improved Kirk Transformers are guaranteed to give your motor more power, reduce carbon deposits and decrease gasoline consumption.

No Fouled Plugs

Transformers give us a hotter, more efficient spark, which burns off the oil and gas in your cylinder. Since all is burned none is left to form carbon.

Kirk Transformers overcome the troubles due to oil pumping and are sold on an absolute money back guarantee. For pleasure cars—motorcycles—tractors and gas engines.

Send No Money

Just fill out the coupon below and the transformers will be shipped to you at once. Try them ten days and if you are not satisfied your money will be instantly refunded.

Kirk Accessories Corp.
58 W. Washington St., Chicago

KIRK ACCESSORIES CORP.
Dept. C—58 W. Washington St., Chicago

Send me a set of Improved Kirk Transformers by parcel post. My car is a.....cylinder

(make of car)

I will pay the postman \$1.00 for a 4 cylinder set or \$1.50 for a 6 cylinder set.

Name.....

Address.....

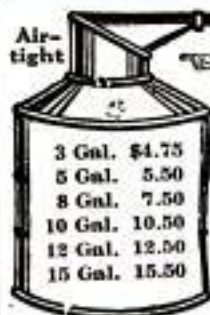

COPPER CANS

Air-tight "E" Screw Top.

FOR GASOLINE AND HOME USE

Postage & Insurance 50c extra. Chicago & West 75c Extra.

Prices on large and special made cans by request.

These cans furn. with 1/2 or 3/4 in. unions.

Deposit Required on All C. O. D. Orders.

Catalogue free on request

NATIONAL CAN CO.

Dept. 43, 1826 Ridge Avenue

PHILADELPHIA, PA.

Eventually on All Fords



Patent Pending

The F-B-Oil-Saver Does All These Things or Money Back

Prevents oil-pumping. Saves 25% to 50% of lubricating oil.

Reduces carbon.

Ends spark plug fouling.

Keeps oil dirt-free.

Reduces wear—improves lubrication.

Saves gasoline.

Stops all oil-leakage.

Sells for **\$1.50**

Dealers and Agents Make \$10—\$30 a Day!

Dealers and agents make wonderful profits selling the F-B-Oil-Saver.

It saves more money for Ford owners than any device ever brought out. Note at left what it does.

A Sure Sale Nearly Every Time

Agents close from 50% to 75% of all prospects talked to. Just put it on a Ford. Show the owner what it does. Only an

instant to demonstrate. No tools, no installation costs.

Hundreds of agents make from \$10 to \$30 a day. No mechanical ability needed. The F-B-Oil-Saver sells itself. Satisfaction or money back guarantee, on every sale. We back you on that. Dealers make big money, too. All Ford owners want this device. Write for our proposition. State whether dealer or agents rights wanted.

Don't wait. Good territory is going fast. Write at once.

PENINSULAR CORPORATION, DETROIT, MICH.
1148 Penobscot Building, Dept. E

The Versatile HAMMOND Folding Portable Typewriter

MULTIPLEX HAMMOND'S
Instantly changeable type
Many styles, many languages
Just Turn the knob to change

Hammond Typewriter Corp., 569A East 69th Street
New York City, N. Y., U. S. A.

RADIO V. T. DETECTOR SET \$24.50 COMPLETE



Shipped Knockdown, including Vacuum Tube, "B" Batteries, Double Headphones. Receiving Range 75 to 100 Miles.

**SATISFACTION GUARANTEED
OR MONEY BACK**

**CORONA ELECTRIC CORP. 265 CANAL ST.
NEW YORK**

Save 75% on Your Tire Bill

Our special buying advantages and tremendous business throughout the U. S. make this remarkable used tire offer possible; every tire rigidly inspected and sold on a fair, square basis of satisfaction; when we say save 75% on your tire bill we mean it.

Thousands of Satisfied Customers

Everyone completely satisfied, including countless Chicago motorists who deal with us personally. They demand the mileage of first class tires and get it at about one-fourth usual cost and so can you.

Card Tires

32x3 1/2	\$8.00
32x4	9.00
33x4	9.50
34x4	10.00
34x4 1/2	12.00
35x4 1/2	12.50
37x5	14.00

Size	Tires	Tubes	Size	Tires	Tubes
30x3	\$4.00	\$1.50	32x4 1/2	\$9.00	\$2.50
30x3 1/2	5.00	1.75	32x4 1/2	9.00	2.50
30x3 3/4	6.50	1.75	34x4 1/2	9.75	2.85
31x4	7.00	1.90	35x4 1/2	10.00	2.75
32x4	7.80	2.00	36x4 1/2	10.00	2.75
33x4	8.00	2.15	36x4	11.00	3.00
34x4	8.50	2.25	37x5	11.00	3.00

HOW TO ORDER: Send \$1.00 deposit for each tire ordered, balance C. O. D. subject to your examination. State whether S. S. or Checker is desired. **Order now; we will allow 15% off our price list** whether full amount is sent or not. 5% discount for full amount with order.
**ROYAL TIRE & SUPPLY CO. 1245 S. Michigan Avenue
Dept. P. CHICAGO, ILL.**

RADIO MESSAGE FORD SPORT BODIES



16 Valve Heads
Speed Differential Gears
Underlung Fixtures
4-Speed Transmission
Crankshaft Counterbalance

"YOU CAN BUILD THIS CAR"

and enjoy the pleasure and thrill of motoring. "Ford-Speed" bodies will fit any Ford chassis and convert it into a beautiful car that will give you speed, safety and economy. Increase work, play, vacation, hunting and fishing trips in "God's Free Country—OHIOHOOR." Two and four Passenger Bodies complete Speed & Power Specialties. Good Dealers Proposition. Write for catalog.

Specials for this month:	Price
Underlung Fixtures	\$15.00 \$9.95
3:1 Chrome Nipple Gears	12.50 7.95
2 1/2:1 Chrome Nipple Gears	15.00 9.95
Speed & Power Crankshaft	15.00 9.95
Steel Wheel Discs (8) Flat	22.00 9.95

Satisfaction or Money Back Guarantee! Terms 50% with order, balance upon delivery
L. Y. FORD SPEED & POWER EQUIPMENT MANUFACTURERS
250 West 24th St., New York
Cable Address "Fordspeed"

TURBULATOR

SETS IN INTAKE
PORTS OF MANIFOLD

INSTALLED
IN
TEN MINUTES

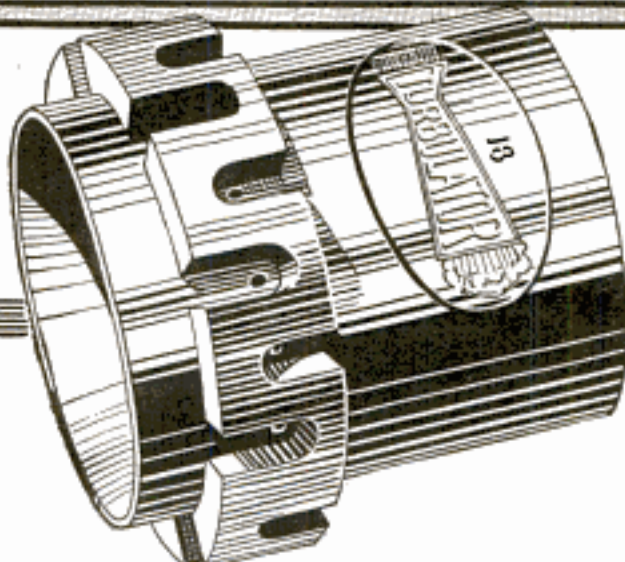

NO HOLES TO DRILL
NO SPECIAL TOOLS

JUST A
MONKEY WRENCH

REDUCES
CARBON

INCREASES
EFFICIENCY

WHAT CAUSES CARBON?

The heavy gas units which pass into the cylinders lodge on the spark plugs and piston heads. Each time the intake valves open these heavy units rush in to take their place among the already collected trouble-making units. By a constant repetition of this operation, enough of these heavy units are collected, forming heavy, hard carbon, causing the improper seating of the valves and fouling spark plugs which, in turn, causes the engine to sputter and miss and lose compression. By installing a set of Turbulators these troubles are eliminated.

HOW THE TURBULATORS WORK

After the gasoline mixture leaves Carburetor, the heavier units of gas drop out of the main air stream. The forward end of the Turbulator breaks up these heavy units by forcing them through small jets—then into the mixture passing through the throat of the Turbulator.

Such gas as is re-condensed after passing through and beyond the Turbulator is drawn back through the rear jets by suction. These heavy units are repeatedly re-introduced into the mixture, passing through the venturi throat at high velocity. This repeated action breaks up these heavy units, resulting in increased power speed—pep, efficiency and economy.

WRITE FOR PRICES ON CARS NOT LISTED

Ford Turbulators	\$ 5.00
Buick Four Turbulators.....	6.50
Buick Six Turbulators.....	9.00
Overland Four Turbulators.....	7.50
Maxwell Turbulators.....	6.50
Dodge Turbulators.....	10.00

EXCLUSIVE DISTRIBUTORS WANTED

We offer an unlimited possibility for real live wire distributors. There are millions of cars and trucks now in daily use and each and every one of them need Turbulators.

We still have some desirable territory available. High grade distributors are requested to write immediately for our exclusive territory proposition. If you really want something worth while and to establish yourself in a permanent organization where you can make real money, write or wire at once.

TURBULATOR CORPORATION, Dept. L
2635 S. Michigan Ave. Chicago, Ill.

15 DAYS' TRIAL AT OUR RISK

Do not wait until tomorrow or next week to order a set of Turbulators. The average car driver wastes enough gasoline in a month to more than pay for a set of Turbulators. Remember, you not only make a big saving on gas but you eliminate a lot of grief, delays and repair bills. No attention required after they are installed, nothing to worry about or get out of order. They outlast the car.

Fill in the coupon, pin a check or Money Order to it. If that is too much trouble, we'll send them C. O. D.

If you are not tickled sick with their performance we will refund your money just as cheerfully as we take it.

CAR OWNER'S COUPON

TURBULATOR CORPORATION, Dept. L
2635 S. Michigan Ave., Chicago, Ill.

Enclosed find \$..... for a set of Turbulators for my

..... car. Model Year
It is understood that I can try them for fifteen days and if not satisfactory you will refund my money upon return of Turbulators to you.

Name.....

Street and Number.....

City.....

State.....



For Summer Time and All the Time

THERE is a certain steady-going faithfulness about Ingersoll Watches that makes them preferred for truthful time-telling. A sturdiness and reliability that is all-American in spirit.

More than that, a new Ingersoll is a matter of relatively small expense, in the event of a possible breakage or loss.

Your dealer can show you a complete line. The models with Radiolite faces are mighty useful in the dark.

Ingersoll Watch Co., Inc.
New York Chicago San Francisco



Ingersoll
Yankee \$1.50

Ingersoll



Learn Drafting

Individual study at home may be successfully engaged in with the aid of our new enlarged book

A Practical Course in Mechanical Drawing
Cloth. 160 Pages. 157 Drawings. Price, 50c Postpaid.
POPULAR MECHANICS BOOK DEPT., 75 East Madison St., CHICAGO

Louder, Clearer RADIO

Bring in the distant stations and increase the range of your messages with

Shinn AMPLITONE Radio Antenna



Braided flat of pure copper wires. Length, 75 feet.

A new discovery in antenna that brings in distant stations with a clearer, louder tone, and reduces scraping and rasping. Greatly increases your enjoyment of the concerts, news, etc., sent from the big broadcasting stations.

It makes the little set work well and the big set work better.

In actual tests the Shinn Amplitone Antenna has brought in distant stations that were never heard before it was installed. Also makes it possible to erect a Radio set with much less trouble, whether inside or outside a structure.

The Shinn Amplitone Radio Antenna is shipped complete, postpaid, for only \$4.00. Orders filled immediately.

Shinn Lightning Arrestor prevents fire hazard. Every Radio outfit should be equipped with one. Price \$2.00

W. C. Shinn Mfg. Co.
1303 Lytton Bldg., Chicago

25c Brings Big 3 ft. Telescope

(In 5 Sections)
See people and objects miles away
just like they were close, see Moon
and Stars as you never did before.

Brass bound, useful and entertaining. "Could tell color of aeroplane 4 miles away" - Mrs. Yarraguth. "Watch my boy arrive at school 2 miles away" - Mrs. Herr. "Read numbers on freight cars mile away, see mountains on moon" - A. C. Palmer, Thousand Oaks, Cal.

SPECIAL OFFER - send only 25c with order. On arrival deposit \$1.00 with postman. Or if you prefer, send \$1.25 with order in full payment. Sent postpaid. Satisfaction guaranteed or money returned.

FERRY & CO. 6832 East End Ave. Dept. 1771 Chicago

Our BUREAU OF INFORMATION will answer all questions regarding articles appearing in this magazine. Address Bureau of Information, Popular Mechanics Magazine, Chicago.



PREMIER "STICKALITE" MAGNETIC TROUBLE LAMP
STICKS ANYWHERE - WITHOUT ATTACHMENT

Electro magnet in base grips against metal surface. Leaves both hands free for work. Operates from car battery. Lasts a lifetime. Long flexible cord gives light wherever wanted. Used as trouble, reading or spot light. 100 other uses. Price \$2.50 from our agents, or by mail, postpaid. Fully guaranteed.

**SALESMEN-AGENTS
Hustlers Making \$200 Weekly**

Greatest selling proposition ever. Full time or evening work only. Sells 8 out of 10 demonstrations. Demonstrated in 30 seconds. Possibilities unlimited. One man sold 14 his first hour, another 56 in 1 1/2 hours. A school boy sold 35 his first afternoon. Exclusive territories. Send for details or save time by sending \$1 for sample and working outfit. Satisfaction guaranteed or money refunded.

Premier Electric Co.
3818 Ravenswood Ave.
CHICAGO, ILL.

**BIG SEASON NOW ON.
ACT QUICK.**

Your Home Is Within Your Reach When You Buy From Us

NOW is the time to build your Harris Home!

And here is a mighty organization of thirty great departments ready to serve you. Managed by expert material buyers, designers and practical builders. We have vast stocks bought at huge quantity price savings which are now at your command. Our sole aim and purpose is

To help you get a home that will prove entirely satisfactory at a price that will mean a substantial saving in actual dollars of your money.

The combined efforts of these great departments in experimenting and testing materials and methods of construction have produced for you a **GUARANTEED** home, expert machine cut, bundled and marked—the last word in building economy.

Not One Penny in Advance

So sure are we of the super-excellence of our material and our **GUARANTEED** Ready-Cut System that we will ship you any **HARRIS HOME** without the payment of one cent down. Our Plan Book explains our liberal terms fully.

FREE Plan Book

The latest edition is waiting for you, contains our **FREE PLAN OFFER** and photographic reproductions, with floor plans and specifications of 100 beautiful homes. Mail coupon today.

Building Material of All Kinds

For over a quarter of a century, thrifty wise buyers have realized that here is the "open door" to real economy, whether it be a brand new home or material for improvements or repairs. Our big stocks of brand new building material, all purchased in tremendous quantities at savings that are passed along to you are ready for quick and complete shipments.

"PRESTO-UP" Patented Bolt-together Buildings!

The wonder buildings of the age. Guaranteed buildings, for quick industrial housing, Individual Homes, etc., extra strong, practical and suitable for all year 'round habitation in any climate. 50 different plans. They come to you in easily handled sections—painted and stained, ready to bolt together and move in.

Plumbing and Heating!

Hot water and heating systems, warm air heating plants, pipeless furnaces and plumbing material of every kind—the product of America's leading makers. Our mammoth plumbing stock offers unlimited possibilities for you to save money. Our heating plants are guaranteed to heat your home in any weather with big fuel economy. Mail the coupon for our Plumbing and Heating Book and get the benefit of our Expert Engineering Service.

Department NM-7

HARRIS BROTHERS CO.

1349-1525 W. 35th St., CHICAGO

**FREE BOOK
of Plans**

HARRIS BROTHERS CO.

Dept. NM-7, Chicago

These books are **FREE** and sent post paid. Mark an "X" in the squares to indicate which ones you wish.

- Harris Home Book of Plans Book of "Presto-up" Houses and Garages
 Building Material Catalog Plumbing and Heating Book

Name.....

Address.....

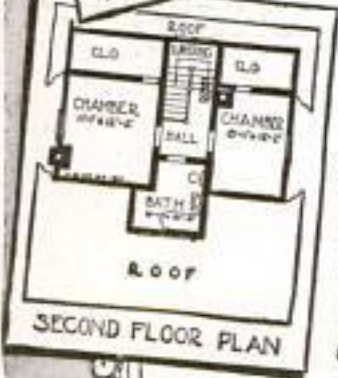



SAVED FROM THE JUNK PILE

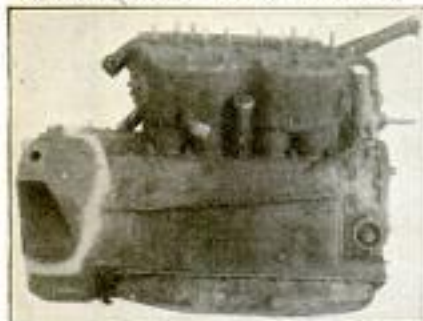

REPAIRED FOR \$18.00

This job, after being thrown in the junkpile, was repaired at a cost of \$18.00, saving the car owner \$50 for a new crank case. The repair was made without PRE-HEATING and without DISMANTLING by the WELDENE PROCESS.

No Pre-Heating! No Dismantling!

WITH
THE WELDENE PROCESS

Weldene Alloys are being used by Machine Shops, Welders, Automobile Repair Shops, Motor Plants, Packing Plants, large Manufacturing Industries and the U. S. Government, with splendid success. Weldene Alloys, when properly applied, make permanent repairs. The time saved on such repairs constitutes an enormous saving to the manufacturer. In the automobile industry, this saving is passed on to the car-owner, cutting his repair bill down one-half. At the same time the repair man is making 100% more profit than by any other method, besides increasing his business. Car-owners will take their machines to the repair man who saves them money.

REMEMBER! NO PRE-HEATING! THEREFORE NO DISMANTLING

Weldene Hard repairs Cast Iron, Steel, Malleable Iron, Brass, Copper and all other common metals. Cracked Motor Blocks can be successfully repaired with Weldene Hard, also Scored Cylinders, Penders, etc.

BETTER THAN EVER—WITH WELDENE

Weldene Aluminum can be used to build out parts where the pieces have been lost. In such instances the part repaired is stronger than the original casting, and will withstand heavy hammer blows. Tests show that the original casting will break before the repair weakens. ALUMINUM, LYNITE, and WHITE METAL can be successfully repaired with WELDENE ALUMINUM.

BOTH ALLOYS ARE NON-CORROSIVE.

MECHANICS! FREE

Send for our WELDENE CIRCULAR which gives you full details on the uses of WELDENE, and shows you how to increase your profits 100%.

ALSO WRITE FOR OUR "SERVICE SHOP PROPOSITION."

THE WELDENE CO.

DEPT. B 5 W. MADISON ST.
CHICAGO, ILL.



SCORED CYLINDER OUTFITS

Weldene Scored Cylinder Outfits will pay for themselves on ONE Scored Cylinder job. Special tools make this work a simple matter.

Weldene Hard repairs Scored Cylinders without reboring. It will not crack nor loosen.

FREE SEND FOR OUR SPECIAL CIRCULAR ON SCORED CYLINDER OUTFITS!

CAR OWNERS—ATTENTION!!!

Specify WELDENE on your car and save both time and money. Beware of imitations. If your repair man does not use WELDENE, refer him to this ad or write us and we will put you in touch with the nearest WELDENE SERVICE SHOP.

QUICK ACTION by Distributor—Sales Manager

will give him exclusive territory sales contract to represent the largest and best known fuel saver company in America. Cities and towns everywhere available. A number of openings for an exceptionally big and profitable business.

Thousands have recommended marvelous success of the Crown as a great fuel saver and heat maker. One easy \$35.00 sale per day means \$500.00 per month net profit. Build a big business all your own. Hire other men to work for you. We instruct you fully to be an expert combustion engineer. We make your success sure if you work.

You can, with the CROWN FUEL SAVER, turn wasteful furnaces into red "hot blasts"—save 20% sure, usually more.

Territory going fast. Write for "A Revelation in Heating" and "How to Build a Business of Your Own."

CFSCO, 15 N. 10th St., Richmond, Indiana



Complete with Ropes and Stakes \$6.50

SAVE \$6.50 to \$15

We guarantee you saving on full weight, fine quality auto tents. You can have a wonderful, healthy, care-free, economical trip with our Moto-Tent. Pays for itself in 2 nights. Up in 5 minutes—no poles needed. Buy Direct—our guarantee protects you. 5x7 ft. \$6.50, 12 ft. 7x7 ft. \$7.50, 15 ft. 7x15 ft. \$9.00, 20 ft. Don't buy till you get our circular.

AMERICAN CAMP EQUIP. CO., Dept. E
700 So. Crawford Ave. Chicago, Ill.

Michigan Marine Motor \$115 Repairs at any Ford Garage



MORE power, greater dependability, less weight, longer life, easier repairs, and lower cost—six salient points which make the Michigan Marine Motor the logical power equipment for your boat. Purchase and repair service available at any Ford garage in the world. Here is a feature of outstanding importance—a feature that you cannot afford to overlook.

Michigan Marine Motor develops 4 h.p., weighs only 125 lbs., is of 4 cycle type, and is fully guaranteed for one year. It is especially designed for use in launches, tenders, fishing boats, and all similar craft requiring a full-powered motor of unending dependability.

Motor equipped with Bosch Magneto and impulse coupling. \$20 extra. Built by Michigan Marine Motor Co. Write for special dealer offer.

BELLE ISLE BOAT & ENGINE CO.
Belle Isle Boat & Engine Co.
Dept. 1, Detroit, Michigan



\$20 Brings You an HB Charger

Pay balance on long, easy terms, more than paid out of your big monthly battery charging profits. No repairs, no renewals, no experience needed.

\$150 to \$300 a MONTH CLEAR PROFIT

Get your HB Charger NOW. Busiest season just starting. Sizes for 6, 10, 16 or 32 batteries. Let us recommend size to make you most money. Write today. Get information also on HB Automatic air compressors, motors, tire buffers, etc., all big money-makers for your shop. Sold on easy payments.

HOBART BROS. CO., Box M77, Troy, Ohio.



NERACAR

"MOTORING ON TWO WHEELS"

makes Motoring the CHEAPEST transportation—and SPORTIER

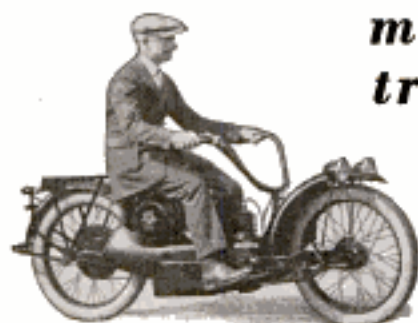

85 to 100
Miles per
Gallon

300
Miles for
a Dollar

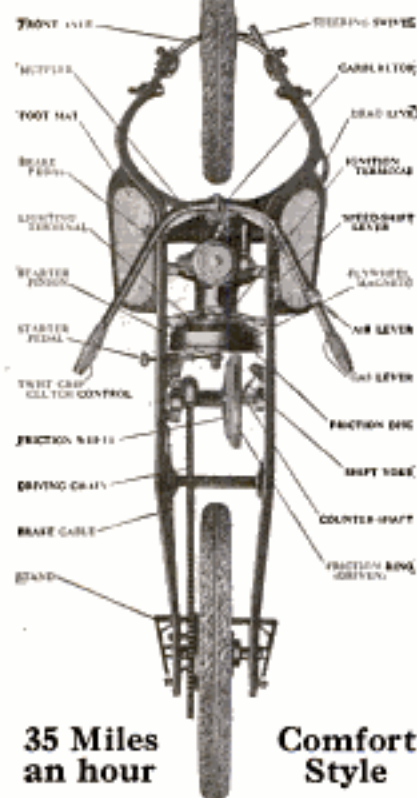

35 Miles
an hour

Comfort
Style

FULLY EQUIPPED
NO EXTRAS!

\$225

AT SYRACUSE, N. Y.

Including 2 Electric Head
Lights, Tail Light, Luggage
Rack and Tools

NEW—different. A two-wheeler on automobile lines—for women as well as men, for girls and boys.

Light—approximately 175 lbs., and this weight is centered lower than the hubs, giving a wonderful balance and stability.

Simple, easy to control. Anybody can learn the NERACAR in five minutes.

Clean—can be ridden in any clothes. Mud guard and deck 18 inches wide. The hood encases the machinery and oily parts.

Step in from the side—no bar to straddle—nothing to interfere with a woman's skirt.

Low riding position, with feet on the ground at start and stop—easy control for the rider.

Low slung pressed steel frame of channel section, with motor and drive down between the side rails.

Only six running parts from motor piston to rear wheel—the simplest drive in the automotive world.

The motor is two-cycle—doubles the power strokes, and is therefore smaller and lighter. No valves, cams, rods, rockers or springs.

High tension magneto. Its rotor is part of the flywheel—hence no drive needed.

No transmission gears or clutch—just a 5-speed friction drive engaged or disengaged by a quarter turn of the left grip. A lever slides the driven friction wheel along the counter shaft, giving 5 drive ratios.

This drive is protected from dust, is capable of pulling many times its normal load and is proven by hundreds of thousands of miles of severe road testing.

A bear cat on any hill.

A car of smart style, a car of fascinating action. Everybody who tries it says there's nothing like it on wheels—it's more like an airplane.

Ride the NERACAR—pay for it with saved car-fare. Sleep later! Lose your grouch on your way to work—get home earlier—join the modern out-doors club and benefit from regular everyday recreation. Get the inspiration of flying on wheels. Have rosy cheeks—abounding health.

Write for descriptive circular.

NER-A-CAR CORPORATION

190 South Geddes Street
SYRACUSE, N. Y.

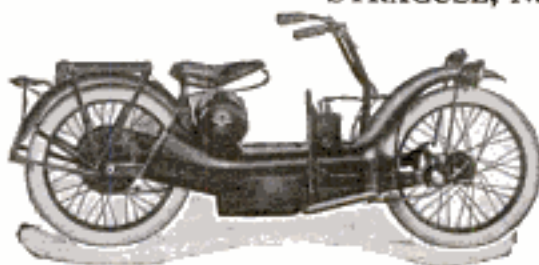

Men and Women
Boys and Girls
Ride in any clothes
—Keep clean

Dealers write for
our plan

Make Your Radio Set Pleasing to the Eye

... as well as the ear

OUR FREE BOOK TELLS YOU HOW

Of course you want the cabinet of your radio outfit to match or harmonize with your other furniture. You can easily and quickly accomplish this with Johnson's Artistic Wood Finishes. There is no economy in using cheap finishing materials, for the cost of the material is small when compared with the cost of application, and what little you save on the gallon price you more than spend for extra labor.



JOHNSON'S WOOD DYE

FREE



S. C. JOHNSON & SON
Dept. PA 7, Racine, Wis.

Please send me, free and postpaid, your book on Wood Finishing.

Name.....

Address.....

Dealer's Name.....

JOHNSON'S Wood Dye is very easy to apply—it goes on easily and quickly, without a lap or a streak. It penetrates deeply, bringing out the beauty of the grain without raising it—dries in 4 hours and does not rub off or smudge.

Johnson's Wood Dye is made in fourteen beautiful shades, all of which may be easily lightened or darkened—full directions on every label.

Insist upon Johnson's Wood Dye—there's no substitute.

FREE-OUR BOOK ON WOOD FINISHING

This Book tells how to finish wood in artistic stained and enameled effects. Gives practical suggestions on making your home artistic, cheery and inviting. Tells just what materials to use and how to apply them. Includes color card—gives covering capacities, etc. Use coupon at left.

S. C. JOHNSON & SON, Dept. PA 7, Racine, Wis.
"The Wood Finishing Authorities"
(Canadian Factory—Brantford)

Was
\$100

Now
\$55

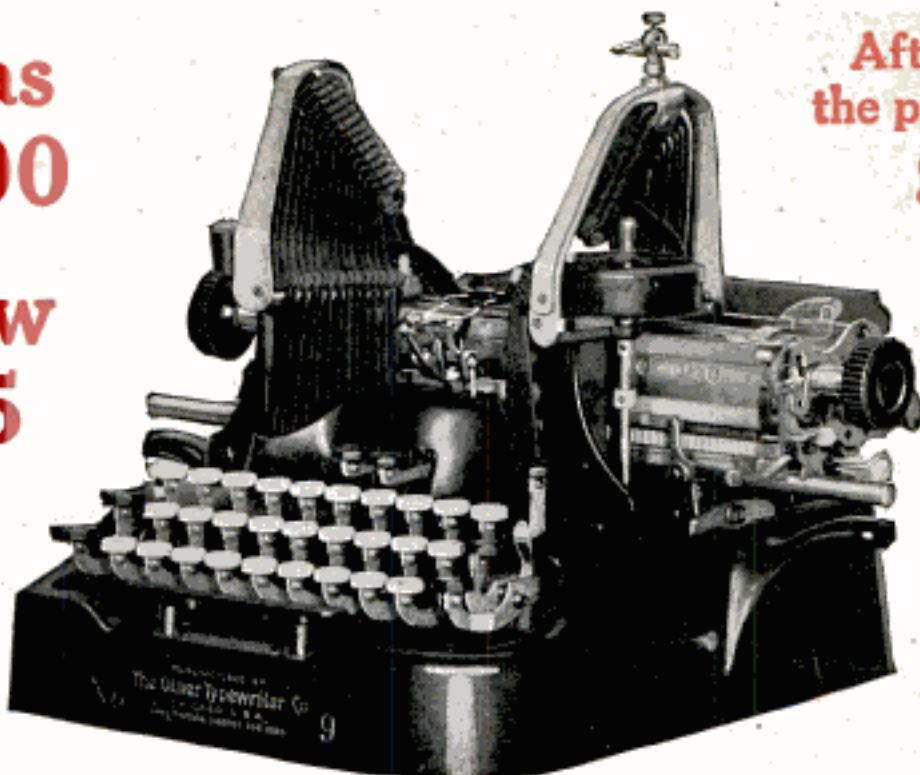

After July 1st
the price will be
\$65

The present price of \$55 has proved too low, so in order to maintain Oliver quality the price will be \$65 after July 1st. This advance notice gives you the opportunity to save \$45 if you act quickly.

ONLY \$4 A MONTH AFTER FREE TRIAL

Merely mail the coupon *now*—send not a cent in advance. Act quickly—the present price lasts but a short time. The Oliver comes to you at our risk for five days free trial in your own home. Decide for yourself whether you want to buy or not. If you don't want to keep the Oliver, simply send it back at our expense. If you do agree that it is the finest typewriter, regardless of price, and want to keep it, take over a year to pay at the easy rate of only \$4 a month.

Last Chance to Save \$45

During the war we learned many lessons. We found that it was unnecessary to have such a vast number of traveling salesmen and so many expensive branch houses. We were able to discontinue many other superfluous sales methods. As a result,

\$55 now buys the identical Oliver formerly priced at \$100.

Our Latest and Best Model

This is the finest and costliest Oliver we have ever built. It has all the latest improvements. It has a standard keyboard so that anyone may turn to it with ease. Try this Oliver five days free and prove its merit to yourself.

Among the 950,000 Oliver purchasers are such distinguished concerns as:

Columbia Graphophone Co., Pennsylvania Railroad, National City Bank of N. Y., Boston Elevated Railway, Hart, Schaffner & Marx, U. S. Steel Corporation, New York Edison Co., American Bridge Co., Diamond Match Co., and others of great rank.

After July 1st, the price of the Oliver will be \$65. As the present price of \$55 has been widely advertised, we want to be perfectly fair and announce the price change in advance. If you act quickly, you can obtain the \$100 Oliver for \$55. Note that the coupon must be mailed before midnight, June 30th.

Send No Money

No money is required with the coupon. This is a real free trial offer. All at our expense and risk. If you don't want to keep the typewriter just send it back, express collect. We even refund the outgoing transportation charges, so you can't lose a penny.

Mail the Coupon

Note the two-way coupon. It brings you an Oliver for free trial or our catalog and copy of our booklet "The High Cost of Typewriters—The Reason and the Remedy."

Canadian Price, \$79

The OLIVER
Typewriter Company

109A Oliver Typewriter Bldg., Chicago, Ill.

THE OLIVER TYPEWRITER COMPANY, 109A Oliver Typewriter Building, Chicago, Ill.

Ship me a new Oliver No. 9 Typewriter for five days' free inspection. If I keep it I will pay \$55 as follows: \$5 at the end of trial period and then at the rate of \$4 per month. The title to remain in you until fully paid for. If I make cash settlement at end of trial period I am to deduct ten per cent and remit to you \$49.50. If I decide not to keep it, I will ship it back at your expense at the end of five days.

My shipping point is

Do not send a machine until I order it. Mail me your book—"The High Cost of Typewriters—The Reason and the Remedy," your de luxe catalog and further information.

Name

Street Address

City

State

Occupation or Business

This coupon not valid unless mailed and postmarked before midnight, June 30, 1932.



I Have 5000 Jobs Open For Sweeney Men

I will give you a contract for employment as soon as you have qualified as a Sweeney Graduate. This position requires not only automotive training but radio training as well. To equip you for this work, I will give you a free course in radio. To fill this job, you must take the eight weeks regular course in this Million Dollar Trade School. Naturally, I will employ Sweeney trained men only.

But I will again help you by paying your railroad fare, no matter where you live, to Kansas City.

5000 qualified men in automobile and radio work are wanted now. I will pay Sweeney men to act as my salesmen and representatives to sell radio sets, storage batteries, etc., in 5000 places where I am opening sales branches.

If you are mechanically inclined and want an assured position, write me today for sample contract. I will make this offer only to those who are sufficiently in earnest and sufficiently energetic to

write me at once. Simply mail coupon or send postcard or letter for full details of my guaranteed position and what this job will actually pay. Do not apply unless you are willing to take the eight weeks' training in the Sweeney School.

(For Big Offer and Catalog Mail This Coupon)

EMORY J. SWEENEY, President
Dept. 1014 Sweeney Bldg.
Kansas City, Mo.

Send me your offer of a guaranteed position, your big free catalog, and full details of the Sweeney eight weeks' course leading to an immediate money-making opportunity.

Name

Address

LEARN A TRADE -
Sweeney
SCHOOL OF AUTO-TRACTOR-AVIATION
1014 SWEENEY BLDG. KANSAS CITY, MO