

April

25 Cents

POPULAR MECHANICS MAGAZINE

WRITTEN SO YOU CAN UNDERSTAND IT

REGISTERED TRADE MARK, GREAT BRITAIN, No. 410425

REG. U. S. PAT. OFF.



SEE PAGE 507

Copyrighted material

Offers No Premiums. Does Not Join in Circular Offers and Employs No Subscribers

A Raise of \$150 a Month

How 8 Weeks' Scientific Practice With Tools Lifted Me From a Laborer's \$12.50 a Week To a Foremanship at \$2,400.00 a Year

**A TRUE STORY—By Louis Beimer
MARLIN, TEXAS**

At the age of 20 years I was drawing \$12.50 a week—laborer's pay.

At the age of 24 I am a foreman and my salary is \$2,400.00 a year.

But it didn't take me four years to make the jump. I qualified for the advancement *by only eight weeks' scientific practice with tools*. Then, in two quick steps, I reached my present position.

Those eight weeks were spent in one of Henry J. Rahe's big auto and tractor schools. I earned \$50 a month before I went there. On my return home, I went to work for \$150 a month and in a very short time was made foreman at \$200 a month—a total salary increase of \$150 a month, due entirely to Rahe training.

If you want to get ahead QUICKLY, take the quick, easy, thorough course at a Rahe School.—Louis Beimer.



Louis Beimer

who says Rahe training put him on "Easy Street" in two months.

Wayne Russell, 20 years old, of Waldo, Ark., says Rahe training multiplied his pay by TEN. "I earned \$1.50 a day before," he writes. "My salary is now \$1.50 an hour."

W. W. Peace, another Rahe graduate, writes of getting \$250 a month and expenses operating a tractor in the oil fields.

Emanuel Rushfeldt, Vulcan, Alberta, says, "Earning \$10 a day. Formerly earned \$50 a month; 20 years old."

Thousands of Rahe-trained experts make success reports like these.

I'll Pay Your Railroad Fare

To CHICAGO, CINCINNATI or KANSAS CITY

I'm going to start hundreds of men to QUICK success in the next few weeks, just as I started Beimer. Be one of them and travel FREE to my nearest school. I'll pay your railroad fare to my school nearest your home, no matter what part of the country you live in.

Training Fee Reduced Again!

With large schools in three cities, I can now sell a Complete Life Scholarship at the lowest price ever quoted. Your total expense will be less than a good Rahe-trained mechanic earns in three weeks.

Be a Specialist! Get out of the grind—out of the army of unskilled job hunters! My easy, practical course in motor-maintenance engineering will make you an expert—a specialist—in just a few weeks!

A Job Is Waiting For You!

This is a BIG year in the motor business. Thousands of Rahe-trained specialists are needed. It's YOUR big opportunity. Let me prove it! Write me today.—

Be Sure to Address My Nearest School

Dept. 2891 **Rahe** Auto & Tractor Schools

CHICAGO
Michigan and Ontario

CINCINNATI
Ninth and Walnut

KANSAS CITY
Twenty-Second and Oak

Thousands of Men Needed; \$3,000 to \$10,000 a Year!

More than 40,000 men have taken the "Rahe Way" to success. Thousands more are needed now. I never knew a better time to start. Calls for Rahe-trained men come from all parts of the country.

Quick, Easy Training

No "book-learning" required—just easy, scientific practice with tools on engines, cars, tractors. Master instructors tell you the "hows" and "whys." I furnish everything. And in just a few weeks you'll be ready for BIG MONEY.

FREE My big illustrated book, details of free fare and low tuition and proof of what Rahe training will do for YOU. Write for them now—a card will do.

Henry J. Rahe

Victrola instruments are made for use with Victor records

Not Victor records alone, nor yet the Victrola alone, but both together bring about the perfect musical result. This is fully evident when you play Victor records on Victrola instruments. In no other way can you get such lifelike reproductions, nor reproductions which meet the approval of the artists themselves.

Victrolas \$25 to \$1500. New Victor Records demonstrated at all dealers in Victor products on the 1st of each month.



Victrola No. 330, \$350
Victrola No. 330, electric, \$415



"HIS MASTER'S VOICE"

Victrola

REG. U. S. PAT. OFF.

Important: Look for these trade-marks. Under the lid. On the label.

Victor Talking Machine Company
Camden, New Jersey

This One



7XYW-KFA-1073

material

"The money you *don't* have to put into repairs is **ALL PROFIT**—

—**USE CYPRESS.**"



"THE WOOD ETERNAL"

"AN ARTISTIC PERGOLA EXTENDS THE 'HOMEY' FEELING TO 'ALL OUT-DOORS.'"

PERGOLA DAYS ALMOST HERE

and **CYPRESS** is the pre-eminent pergola wood because "**CYPRESS lasts forever**"—**DEFIES ROT-INFLUENCES** which destroy other woods—does not warp, shrink or swell like most woods—takes paint and stain perfectly.

A well-planned Pergola is the finishing touch to the architectural and landscape perfection of elaborate grounds—it is "the one thing needful" to confirm the artistic character of a typical modest homestead—and it may be fully relied upon to redeem and beautify even the smallest yard, or one that is lacking in natural advantages.

VOL. 30
OF THE
CYPRESS
POCKET
LIBRARY,
FREE ON
REQUEST

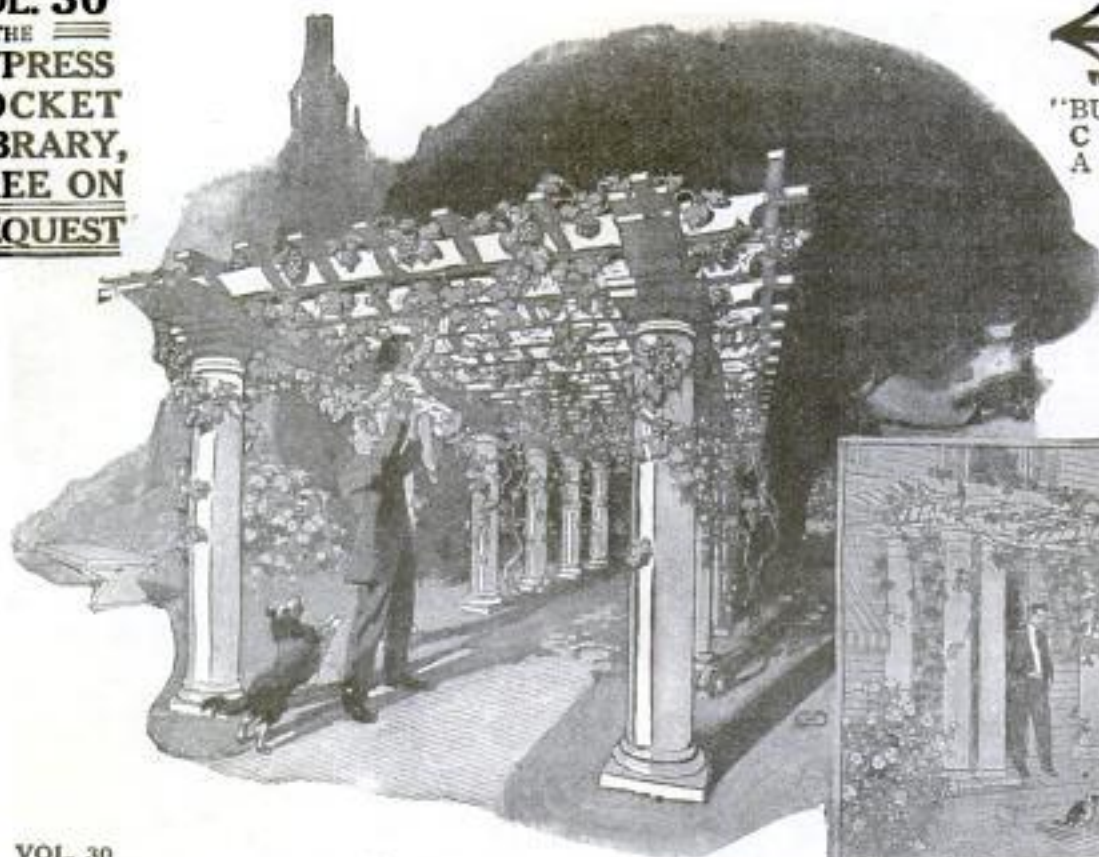

"**BUY BY THE**
CYPRESS
ARROW."

INSIST ON
THIS TRADE-
MARK ON
EVERY BOARD
OR BUNDLE.
IT MEANS
"TIDEWATER"
CYPRESS
THE TRUE
"WOOD
ETERNAL."

VOL. 30

contains ORIGINAL SKETCHES, DETAILED WORKING DRAWINGS (on sheet 24 x 36 inches) and FULL SPECIFICATIONS for erecting a VARIETY of PERGOLAS, GARDEN ENTRANCES, SEATS, etc., of many different artistic styles, and costing from a few dollars up to several hundreds. Not "stock patterns"—each was **SPECIALLY DESIGNED** for us. **WRITE TODAY for Vol. 30.**

When planning a Pergola, Mansion, Bungalow, pasture-fence or sleeping porch, remember—"With **CYPRESS** you **BUILD BUT ONCE.**" Be sure to specify "**ALL-HEART**" GRADE for non-rot purposes.

Let our "**ALL-ROUND HELPS DEPARTMENT**" help YOU. Our entire resources are at your service with Reliable Counsel. (For example, for uses especially inviting decay insist on "**ALL-HEART**" grade.)

SOUTHERN CYPRESS MANUFACTURERS' ASSOCIATION

1219 Poydras Bldg., New Orleans, La., and 1219 Graham Bldg., Jacksonville, Fla.

INSIST ON "**TRADE-MARKED**" CYPRESS AT YOUR LUMBER DEALER'S. IF HE HASN'T IT, LET US KNOW.

Popular Mechanics Magazine

6 N. Michigan Avenue, Chicago, U. S. A.

H. H. WINDSOR, Editor

London: Hachette & Cie,
16-17, King William Street, Charing Cross, W. C. 2

Paris: Hachette & Cie,
111 Rue Reaumur

Melbourne, Australia,
The Australasian News Co.

ISSUED MONTHLY

SUBSCRIPTION:

SINGLE COPY, 25 CENTS

In United States, and its possessions, Cuba, Mexico, and Canada, per year, postpaid . . . \$3.00

To all other countries in the Postal Union 3.50

All subscriptions are discontinued at expiration. Please examine the date printed on your wrapper.

Entered as Second Class Matter Sept. 15, 1901, at the Post Office at Chicago, Illinois, under Act of March 3rd, 1879.

Entered as Second Class Matter at the Post Office Department, Canada.

Published monthly by POPULAR MECHANICS CO.

Copyright, 1922, by H. H. Windsor.

Copyright in Australia.

Vol. 37

Contents for April, 1922

No. 4

Airplane Arresting Tackle for Use on Shipboard.....	508	Danger Signal, Bull's Eye, for Day or Night Use.....	584
Airplane Engine Silencer of Swiss Design.....	490	Dictaphone, One, Ten Pupils Take Dictation from....	506
Airplane, Motorless German, Shows Great Stability...	505	Dike, Long, Protects Channel from Drifting Sand....	558
Alloys, High Melting Point, Less Subject to Corrosion	496	Dirigible "Roma" Meets with Disaster.....	518
Art Treasures, Italian, Motion Pictures to Show.....	583	Doll that Cries Audibly and Sheds Actual Tears.....	546
Automobile Accident, Driver Has Narrow Escape in...	547	Drill, Motor Driven, Also Grinds and Buffs.....	588
Automobile Device Informs Driver Which Car Has		Earthquakes, Accurate Forecasting of, Now Scientific	
Right of Way.....	577	Possibility, by H. H. Dunn.....	501
Automobile Engines, Kerosene Mixing Chamber for...	507	Elm, Historic Old, Saved by Concrete Filling.....	593
Automobile Starting Made Easy in Cold Weather.....	534	Engine, Air Cooled Auto, Has Many Novel Features...	559
Automobile Strikes Gas, Explosion and Fire Result		Engine, Light High Power, of British Design.....	541
When.....	505	Engineering Problem, Noteworthy, in Rio De Janeiro	516
Automobile, Three Wheeled, for Delivery Purposes...	496	Explorer, Great, Terminates 20 Years of Adventure...	507
Automobiles, Police, Identified by Special Marks.....	536	Explosions, Mine, Caused by Telephone.....	570
Automobiles, Safety Light Signal Code for.....	593	Export Trade, Plan to Aid, Abandoned by Sponsors..	578
Backrest, Comfortable, for Outing Purposes.....	565	Feathers, Six Carloads of, Weigh 500,000 Pounds....	568
Ball Bearings, Hundreds of, Used to Construct Auto	533	Floor and Stair Tile, Antislip, Prevents Accidents...	568
Balloon Flight, Manila Bay, Teaches Valuable Lessons	590	Food Dehydration at Home with Simple Apparatus....	503
Baseball Game Called on Account of Tide in Alaska...	583	Food Preserving, Sanitary Vacuum Cabinet for.....	549
Battleship Decorated by Crew in Honor of Commander	548	Forest Rangers Adopt Gasoline Speeder.....	566
Beehives, Scale Registers Weight of.....	542	Freight, Poison Gas Chambers Disinfect, by S. R.	
Belts, Long Carbon Steel, of Extreme Flexibility....	580	Winters.....	595
Blocks, Concrete Building, Interlocking.....	604	Freight, Tallying Machine Used in Handling.....	496
Boat, Hand Propelled, for Bathers.....	594	Fruit Drying, Dehydrators, Investigate.....	492
Boiler, Electric Steam, Economically Operated.....	593	Garage Equipment Replaces Repair Pit.....	529
Bridge, Delaware River, New, by Robert F. Salade...	555	Gas Samples, Automatic, for Mine Explosions.....	530
Bridge, Detroit Windsor.....	523	Gasoline Tanks, Self Acting Filling Cap for.....	600
Bridge, Pontoon, Hulls of Wooden Ships for.....	565	Gasoline, Waste Product May Raise Efficiency of....	503
Brushes Safe and Clean, Packing Box Keeps.....	549	Gun, French, without Recoil Has Increased Power...	524
Bumper, Automatic, Collisions Prevented by.....	532	Hair, When Justice Hangs by A, by John Anson Ford	571
Burner, Adjustable Height, Reduces Gas Consumption	498	Hay, Newly Mown, Dried by Electricity.....	584
Buying at Home Encouraged by Simple Object Lesson	540	Header Thresher, Combined Economical.....	597
Buzzer, Electrical, Prospects Heralded by.....	550	Hoist, Road Tractor as, to Raise Sand from Beach...	551
Cable, Telephone, Containing 2,424 Wires.....	498	Horn Detects Nature's Faint Sounds.....	578
Caliper, Thickness, of New Design.....	566	Household Devices.....	602
Calite Has Unusual Properties.....	554	Houses, Telephone Poles Used in Building.....	542
Camera, Focusing Attachment for.....	522	Hydroelectric Development in Arkansas, by Tom	
Campers, Rigid Collapsible Frame for.....	604	Shivas.....	574
Carbon Monoxide Poisoning First Aid Treatment.....	552	Ice Boats Rival Speed of Hydrogliders.....	490
Catch, Screen Door, Can be Securely Locked.....	509	Ice Cream Temperature, New Apparatus for Taking...	566
Cattle Barn, Huge Exhibition Building Used for.....	579	Icicles, Artificial, Adorn California Log House.....	545
Charcoal as Fuel for Gas Producer on Truck.....	576	Incubator, Small Electric, Regulated by Thermostat..	578
Check, Largest Real, Cashied by Los Angeles Bank...	596	Invalid, Carrier Removes, from Bed Painlessly....	498
Chair for Workers, Adjustable.....	522	Kahr Corn Harvester Heads Two Rows Simulta-	
Children's Pages.....	608	neously.....	490
Chimneys, Compressed Air Now Used to Clean.....	536	Lamps, Incandescent, for Heating.....	610
Cinders, Induced Draft Fan Aids Eliminating.....	591	Lawn Mower, Noiseless Chain Driven.....	521
City Beautiful, Plan for.....	601	Lawn Mowers, Sharpening Device for.....	580
City Plan, Ideal, British, being Tried.....	542	Lignite Can be Converted into High Grade Fuel....	568
City, Walled Chinese, Modernizing A, by Francis		Lock, Door, Burglar Proof.....	606
Dickie.....	509	Locomotive, Coal Burning, 20 Inches Long.....	536
Civic Features.....	518	Logging in South India with Lots of Men and Animals	
Cleaning Machine for Small Parts.....	584	but Little Machinery.....	527
Coal, Alaskan, Assumes Commercial Importance, by		Lunch Booths, Portable, on Ice Skating Rink.....	499
Lawrence Wm. Pedrose.....	562	Mail in Cities, Valuable, Armored Trucks to Carry...	514
Coke, Sulphur Removed from, with Hydrogen Gas..	583	Mail Lock Box, Combination, Has Many Good Fea-	
Colony, Remote Workers', Has Modern Conveniences	593	tures.....	600
Comment and Review, by H. H. Windsor.....	518	Mask, Basket Ball, Protects Eyes.....	597
Concrete Canal Lining, Sliding Steel Form for.....	538	Medal, Bronze, Commemorates Trip of Japanese Prince	596
Concrete Wharf Walls Cost Little More Than Timber...	588	Memorandum Pad, Telephone, Needs No Pencil.....	605
Cooker, Electric Pressure, Replaces Stove.....	606	Meter Counts Telephone Calls in Home.....	595
Copy Holding Board of Simple Construction.....	600	Milk Can Opener, Prepared, Also Closes It.....	600
Creeper, Portable, for Auto Mechanics.....	520	Mop Truck, Two Tank, Used to Clean Floors.....	567
Crime Detection, Radiophones to Aid.....	489	Motion Picture Patrons, Flashlight for Seating.....	559
Criminal, Shackle Boot Prevents Escape of.....	525	Motion Pictures in Farmer's Home Act as Tractor	
Culverts, All Size, Collapsible All Steel Form for...	551	Salesman.....	493

[Continued on Page 4]

Copyrighted material

[Contents—Continued]

Motorboat, Small, Simple Reversing Device for.....	579
Nuts, Pinon, Machine for Shelling.....	606
Oil Production Increased by Compressed Air.....	607
Oil Resources of Alaska being Investigated.....	582
Oil Shale, Distillation of, at Low Temperature.....	496
Oil Well, Diamond Core Drill for Drilling.....	521
Package Campaign, Perfect, Results Announced.....	604
Package Machine Ties and Seals at Once, by Robert H. Moulton.....	532
Paper, Sensitized, Aids Amateur Photography.....	553
Paper, Tensile Strength of, Increased by Rubber Latex.....	409
Park System, Wonderful, Westchester County Plans.....	596
Phonograph Records Are Made, How, by Alexander H. Kolbe.....	561
Phonograph Records Teach Radiotelegraph Code.....	590
Phonograph Tone Amplifier Has Auxiliary Sound Box.....	553
Photograph Printer Has Several New Features.....	548
Photograph Printing, Automatic Light Control for.....	554
Piano, Electric Lights on, Show Tonal Production.....	500
Pier, Amusement, Wrecked by Runaway Barge.....	555
Piles, Round Concrete, with Great Taper.....	600
Piling Driven Upward by Inverted Steam Hammer.....	560
Planes, Carpenters, Extension Attachment Made for.....	561
Plow or Planer, Portable Machine May be, by Henry S. White.....	530
Police, Tear Gas as Emergency Measure for.....	615
Power Plant, Farm Tractors Drive, Made Powerless by Drought.....	584
Power Plant, Vermont, First Step in Development of.....	536
Prize Offers.....	651
Pullman Cars, First Aid Packets Carried Visibly in.....	506
Radiator Warmer, Electric, Prevents Water Freezing.....	578
Radiotelephone Service Station Planned, Commercial.....	580
Radium Clinic, First City, for Rich and Poor, by Douglas C. Miner.....	592
Railroad Inspection Car of Light Construction.....	544
Rake, Self-Cleaning Lawn, to Aid Gardener.....	616
Range, Gas, Has Novel Burner and Cast Iron Range Top.....	588
Razors Quickly Sterilized with Electric Appliance.....	564
Relativity, Theory of, to be Further Tested.....	588
Reservoir Wall Blows Out, Tearing Huge Gap.....	590
Rice Straw, Louisiana, Used for Making Paper.....	544
Rifle Shot, Crack, Man Lacking Hand and Arm is.....	528
Ring, Divorce, for Grass Widows.....	607
Road Maintenance Plan, New, Suggested in Manitoba.....	552
Road Map, Moving, Operated by Speedometer Mech- anism.....	593
Road, Sandy Shore, Made of Sectional Planking.....	589
Roofs, Pure Lead, Not Durable.....	558
Ruins, Ancient Armageddon, Soon to be Explored.....	565
Ruins, Ancient, Excavation of, by R. P. Crawford.....	587
Sand Cutting Machine, Hand Propelled Light.....	584
Saw, Circular, on Tractor for Clearing Land.....	576
Saw Teeth, Metal Cutting, Special Wheel Cleans.....	554
Scientific Research, Field Museum Expeditions of.....	596
Seaplanes, Navy Bureau Asks Bids on Spotting.....	507
Semaphore on Transformer Signals Overload.....	608
Sex Detector Lacks Merit, Government Tests Show.....	554
Shed, Tool, Carried Across River by Aerial Cableway.....	493
Sheep, Grain Elevator Screenings for Fattening.....	586
Shell Bursts Photographed with Long Range Camera.....	591
Shingles, Interlock Copper, Form Durable Roof.....	528
Ship, Agrounded, Breeches Buoy Rescue Work from.....	543
Ship "Leviathan" Reconditioned as Finest Hotel Afloat.....	534
Shock Absorber, New, for Motor Cars.....	610
Signboard, Revolving, Propelled by Wind.....	577
Silicon Alloy, Iron, Melted by Chemical Heat.....	560
Silk Unreeling Machine Invented by Italian.....	520
Skaters, Safety Ladder Apparatus to Rescue.....	508
Skins, Fish and Snake, Used in Place of Shoe Leather.....	567
Smoke Consumer, Locomotive, Canadian.....	605
Snow Shovel, Mechanical, for Highways.....	585
Snowplow, Rotary Road, Driven by Tractor.....	500
Soil Pressure Measured Accurately by Machine.....	577
Sprinkler and Street Sweeper, Three Wheeled.....	550
Studio, Large Glass, Delicate Operation of Moving.....	561
Suction Ejector, Combined, for Pumping Out Cellars.....	521
Sugar Cane, Machine Harvests, by Robert Grimshaw.....	494
Swing as Exerciser Has Support for Feet.....	549
Tank Cars, Pressure Inside, Greater When Standing.....	500
Tape Measuring Attachment Makes Measuring Easy.....	606
Telephone Holder, Safety, Fits Top of Any Coin Box.....	492
Telephone that Tells No Tales, by G. H. Dacy.....	524
Theater Constructed in Three Sections.....	565
Theater One Moment, a Catacomb the Next.....	587
Theaters, Seven Washington, Closed by Investigation.....	548
Throttle Lever, Locomotive, with New Safety Catch.....	590
Tide, Extreme Rise and Fall of, a Natural Drydock.....	529
Torch, Natural Gas, Economical.....	601
Tow Rope, Steel Knot, for Cars and Trucks.....	610
Transformer, Million Volt, for Laboratory.....	497
Transmission Line, Long, Nearing Completion.....	567
Trap, Humane Steel, Holds Animal in Net.....	583
Treatment, Heat, Compact Electric Apparatus for.....	520
Tree Felling Machine Has Motor Driven Saw.....	508
Tree, Tropical, Bears Fruit in Northern Back Yard.....	544
Trees, Rain Proof Joint for, that Grow Through Roof Tunnel Bore Enlarged without Stopping Traffic.....	546
Type Engravers' Fountain Pens, Electrically Heated.....	506
Valve Attachment, Radiator, for Steam Heated Rooms.....	525
Violin Family, Six New Instruments Added to.....	492
Watch, Largest, Exhibited at Washington.....	545
Water Power Development in Netherlands Indies.....	546
Water Towers, Saracen, in Palermo.....	570
Weather Observer Employed by London Power Com- pany.....	549
Weather Stripping, Flexible, of Wrapped Cotton Wick- ing.....	605
Wheelbarrow, Convertible, Has Various Utilities.....	525
Whittling, Skillful, Various Articles Made by.....	547
Window Sash, New, Aids Cleaning Both Sides from Inside.....	610
Wireless Telegraph, English Possessions Linked with.....	582
Wireless Time Signals Received at Elgin.....	550
Woodyard, Great, Aids Jobless Men.....	569
Wool Made Moth Proof by German Preparation.....	614
Wrench, Combination, Fits Eight Sizes of Nuts.....	607
Wrench, Double Grip Socket, for Auto Use.....	596
Wrench Usable as Clamp or Vise.....	596

SHOP NOTES

Aluminum, Action of Metallic Salts on.....	612
Belts Cleaned of Oil.....	626
Blowpipe, Gas, Homemade.....	614
Blueprints for Notebooks.....	631
Boilers, Action of Grease in.....	615
Brake Bands, Fixture for Relining.....	619
Brass Parts, Cleaning.....	630
Broach, Keyway Re-Dressing.....	624
Clamping Kink, A.....	613
Concrete Aggregate, Blower Reduces Cost of.....	623
Compasses, Beam, Substitute for.....	630
Cotter Pins, Locking.....	617
Cylinder Reaming Machines, Homemade.....	620
Drawers, Easily Made.....	631
Drill Chuck, Ball Grip.....	618
Dust Guards on Eccentric Straps.....	615
Eccentrics, Worn, Repairing.....	630
Etching, Resist for, Improved.....	632
Fork, Old, Places Small Screws.....	623
Fountain, Drinking, Attached to Fire Hydrant.....	632
Furniture Panels, Sunken Joints in.....	618
Gas Engine Hoppers, Attachments for.....	631
Gauge for Dividing Circles.....	627
Gauge for Grinding Milling Cutters.....	619
Gauge for Laying Out Square Holes.....	612
Gauge, Taper Turning.....	627
Hacksaw, Slotting, Special.....	615
Hammer, Patternmaker's.....	625
Hammer, Power, for Farm Shops.....	611
Ice Machine Condenser, Efficiency Increased.....	632
Knife Switches Mounted in Safe Position.....	610
Ladder for Work on Shafting.....	612
Lathe Attachments, Overhead Drive for.....	628
Lubricant for Drilling, Soap as.....	618
Metals, Cold Tinning of.....	614
Micrometer Lock for Repetition Work.....	619
Nuts, White Lead Locks.....	627
Porcelain, Drilling Holes in.....	613
Price Marks on Stock Drawers, Safeguarding.....	614
Printing, Multicolored.....	623
Pulley, Small, Keying to Motor.....	616
Reamer, Improvised Valve Seat.....	613
Reamer Protector.....	629
Reamers, Taper, Stop for.....	618
Round Stock Holding in Vise.....	618
Saw, Milling, Preventing Breakage of.....	626
Sawhorse for Uneven Floors.....	625
Scale Holder, Simple.....	624
Sewer Cap Castings, Making.....	619
Shoenails Endanger Electrical Workers.....	622
Soldering Copper, Universal.....	617
Springs, Heavy, Straightening.....	625
Stand for Painting Auto Hoods.....	616
Strap, Machine, Adjustable.....	630
Stuffing Box, Worn, Repairing.....	627
Thumbtacks, Countersunk.....	629

DRAKE'S PRACTICAL MECHANICAL BOOKS

THEY WILL RAISE YOUR PAY—

ORDER ON 5-DAY TRIAL

The books listed below will perfect you in your chosen trade — pave the way to the big positions. Written in non-technical language—easy to read and understand. *Every book covers its subject completely. An entire course of instruction condensed into one volume.* Your choice sent postpaid — you benefit 5 days — money refunded in full if not entirely satisfactory. Order direct from this page.



Automobile Books

- Automobile Ignition, by ManlyLeatherette \$2.00
 Automobile Starting and Lighting, by Manly.....Leatherette \$2.00
 Brookes' Automobile Handbook.....Leatherette \$2.00
 Ford Motor Car, Truck and Tractor, by Manly.....Cloth \$1.50
 Starting and Lighting Troubles, Remedies and Repairs, by Manly.....Leatherette \$3.00
 Automobile Battery, Care and Repair, by Manly.....Leatherette \$2.00
 Automobile Catechism and Repair Manual.....Leatherette \$1.50
 Tires and Vulcanizing, by Tufford.....Cloth \$2.00
 Gas and Oil Engine Handbook.....Cloth \$1.50
 Automobile Upkeep and Care, by Manly.....Cloth \$1.50
 Motorcycle Handbook, by Manly.....Cloth \$1.50

Shop Practice Books

- Sheet Metal Workers' Manual.....Leatherette \$2.00
 Oxy-Acetylene Welding and Cutting.....Leatherette \$1.75
 Sound Welds.....Cloth \$2.00
 Slide Rule and Logarithmic Tables.....Leatherette \$2.00

ORDER DIRECT FROM THIS PAGE—ON OUR MONEY-BACK PLAN

The books listed above are only a few of the many in our catalogue, which you will receive promptly after filling out and mailing us the attached coupon. For quick action order direct from this page—cross name of each book wanted and send in with price quoted. We prepay postage and send the books on our money-back plan.

FREDERICK J. DRAKE & CO.

PUBLISHERS

1008 Michigan Ave., Chicago

Drake Books Are For Sale at All Book Stores

- Handbook for Millwrights.....Cloth \$2.00
 Modern Blacksmithing.....Cloth \$1.25
 Machine Shop Practice.....Cloth \$2.00
 Mechanical Drawing and Machine Design.....Cloth \$2.00
 Pattern Making.....Cloth \$1.50

Carpentry Books

- Cloth Binding
 Modern Carpentry, 2 vols.....\$3.00
 The Steel Square, 2 vols.....\$3.00
 Wooden Boat and Shipbuilding.....\$1.50
 Modern Estimator.....\$1.50
 Timber Framing.....\$2.00
 Builder's Architectural Drawing.....\$2.00
 Concretes.....\$1.50
 Practical Bungalows.....\$1.00
 Low Cost Homes.....\$1.00
 Roof Framing.....\$1.50
 Stair Building and Hand Railing.....\$1.50

Electrical Books

- Practical Applied Electricity.....\$2.00
 Alternating Current.....\$1.50
 Electric Motor Control Systems.....\$1.50
 Wiring Diagrams and Descriptions.....\$1.50
 Electrical Tables and Data.....\$1.50
 Armature and Magnet Winding.....\$1.50
 Modern Electrical Construction.....\$1.50
 Modern Electric Illumination.....\$1.50
 Electricians' Operating and Testing.....\$1.50
 Motion Picture Operation.....\$1.50
 Drake's Electrical Dictionary.....\$1.50
 Electric Motors, D. & A.....\$1.50
 Electrical Measurements and Meter Testing.....\$1.50
 Drake's Telephone Handbook.....\$1.50
 Modern American Telephony.....\$2.00
 Easy Electrical Experiments.....Cloth \$1.25
 Wireless Telegraph and Telephone Handbook.....Cloth \$1.25
 Telegraphy Self-Taught.....Cloth \$1.25

Steam Engineering

- Swingle's Handbook for Steam Engineers and Electricians.....Leatherette \$4.00
 Examination Questions and Answers for Marine and Stationary Engineers.....Leatherette \$2.00

- Steam Boilers.....Leatherette \$2.00
 Swingle's Catechism of Steam, Gas and Electrical Engineering.....Leatherette \$1.50

Painting Books

- Scene Painting and Bulletin Art.....Cloth \$4.00
 A Show at Sho' Cards.....Cloth \$4.00
 Sign Painting.....Cloth \$4.00
 Strong's Book of Designs.....Leatherette \$4.00
 Strong's Art of Show Card Writing.....Cloth \$4.00
 Signet's Alphabets.....Cloth \$1.50
 Modern Painter's Cyclopaedia.....Cloth \$2.00
 Automobile Painting.....Cloth \$1.50
 Estimates, Costs and Profits, Painting and Decorating.....Cloth \$1.50
 New Hardwood Finishing.....Cloth \$1.50
 The Amateur Artist.....Cloth \$1.50
 New Stencils.....Cloth \$1.25

Farm Books

- Farm Mechanics.....Cloth \$1.25
 Farm Buildings.....Cloth \$1.25
 Farm Engines.....Cloth \$1.25
 Traction Farming.....Cloth \$1.50

Business and Reference Books

- Better Business Letters.....Leatherette \$1.50
 Better Business English.....Leatherette \$1.50
 Better Advertising.....Leatherette \$1.50
 Finger Prints Simplified.....Cloth \$2.00
 Practical Bricklaying.....Cloth \$1.25
 Practical Instruction for Detectives.....Cloth \$1.00
 Practical Plumbing.....Cloth \$1.50
 Hot Water Heating.....Cloth \$1.50
 Elementary Chemistry.....Cloth \$1.50
 Courses in Civil Service.....Cloth \$1.50
 Cyclopaedia of Recipes.....Cloth \$1.50
 American Star Speaker.....Cloth \$1.50

Modern Languages

- By Prof. P. S. Allen, U. of Chicago
 French without a Teacher.....Cloth \$1.25
 Spanish without a Teacher.....Cloth \$1.25
 German without a Teacher.....Cloth \$1.25
 Everyday French.....\$1.25
 Everyday Spanish.....\$1.25

FREDERICK J. DRAKE & CO.
 1008 Michigan Avenue
 Chicago, Ill.

GENTLEMEN:—Please send me free, postage paid, your illustrated catalogue which lists and describes over 100 Practical Mechanical Books for Home Study.

My name is

and my address

Mail Coupon For Free Catalogue
 Your Guide to Home Study

NEW KIND OF HEAT!



Try It in Your Stove
30 Days Free

The OLIVER Oil-Gas Burner

Does away with coal and wood—cheaper. Three times the heat in winter—yet no roasting kitchen in summer. Makes any cook-stove, range or heater an oil-gas stove

Don't fuss over a hot, mussy stove! This new invention—the Oliver Improved Oil-Gas Burner—saves money, time, labor, health. No fires to make. No ashes, dirt, smoke, odor, chopping, shoveling, carrying dirty coal or wood. Makes your stove heat or bake better, cleaner, quicker. Doesn't change your stove, simply fits in firebox. Makes its own gas from coal-oil (kerosene) at small cost. Gives even heat instantly, much or little, by simply turning valve. BURNS 95% AIR—5% OIL.



FREE Attractive Book telling all about the "New Kind of Heat," sent you free, postpaid. Also amazingly low introductory-price offer, including 30-Day Trial, if you act quickly. Write today.

OLIVER Oil-Gas Burner & Machine Co.

2014-D Pine Street St. Louis
Oldest, Largest Mfrs. Oil-Gas Burners in World.

AGENTS Oliver Agents earn as high as \$500 a month—\$25 a day spare time is easy. Exclusive territory—real co-operation. Write for full money-making details. Sells like wild-fire all season.

WEALTH, HONOR, RICHES

Do not depend upon opportunity or intellectual brilliancy of any kind, because it is well known that uneducated people often acquire great wealth, while cultured and talented people remain in poverty.

Again, they do not depend upon capital, because many men with capital lose what they have, while others with no capital acquire phenomenal wealth.

Whatever finds a place in human experience is the result of the operation of natural laws, and the determining factors are therefore within your own control.

This may seem "too good to be true," but if you will consider that by the touch of a button or the turn of a lever science has placed almost infinite resources at the disposal of man, it becomes evident that there may be still other laws not generally known which contain even greater possibilities.

We have published a Remarkable little book, giving the conclusions of science concerning these laws, which we will send upon request. If you want to underwrite success on a magnificent scale, send for it.

MASTER-KEY INSTITUTE

210 Howard Bldg.,

St. Louis, Mo.

[Contents—Continued from Page 4]

Tires, Stiff, Removing.....	629
Tool Handle or Pin Vise, Simple.....	626
Valve, Ball Check, Made from Screw.....	617
Water Jacket, Engine, Repairing.....	624
Wood, Laminated, Stresses in.....	626

AMATEUR MECHANICS

Airplane Model, Propeller Bearing for.....	646
Army Pup Tent, Improving and Waterproofing....	644
Automobile Clutch, "Grabbing," New Remedy for..	634
Automobile Ignition System Dry, Newspaper Keeps..	641
Automobiles Pulled Out of Mud or Sand.....	647
Baby Carriage, Extra Seat for.....	643
Birds and Animals, Wild, Photographing.....	633
Blankets, Short, Tucking in.....	635
Bucket, Radiator Filling, Improved.....	637
Camera Shutters Should Not be Oiled.....	650
Chair, Rocking, Felt Tires for.....	642
Chess Trick.....	648
Chicken Feed Box.....	644
Coaster Brake Easily Renewed.....	650
Corks, Obstinate, Removing.....	634
Corrosion of Battery Terminals, Preventing.....	648
Coupler, Loose, Increasing Efficiency of.....	637
Curtains, Aid for Hanging.....	642
Die, Grommet, Simple.....	638
Dust Shields for Plow Wheels.....	635
Electrical Resistance Coil, Simple.....	635
Engine, Oscillating, Twin Cylinder.....	639
Farm Implements, Draft Necessary for.....	643
Faucet Moved by Freezing Pipe.....	636
Fireplace, Furnace Cement Repairs.....	645
Game, Indoor Baseball.....	642
Gate Arbor Made from Wagon Wheel.....	645
Gate Stop, Simple.....	647
Harness, Combination Single and Double.....	641
Hose Stored in Basement Window.....	634
Incubator, Gas Burner for.....	636
Inner Tubes, Old, Uses for.....	635
Lettuce Planted Near Currants, Insects Infest.....	645
Lock, Portable, Handy.....	635
Mail Box, Concrete Base for.....	647
Mat, Rubber, from Inner Tubes.....	642
Parachute Drop for Kite.....	636
Plants, Early, Protecting.....	637
Posts, Buried, Preventing Decay of.....	637
Poultry, Net for Catching.....	635
Rectifier Plates, Electrolytic, Formed.....	646
Roofing, Paper, Fastening under Eaves.....	643
Screwdrivers, Small, from Buttonhooks.....	644
Shotgun Made Comfortable.....	642
Showers, Artificial, for Fishing.....	645
Sweeping Compound Distributor.....	650
Table Leaves, Extra, Storing.....	645
Tape, Adhesive, New Use for.....	642
Tire Chains, Compartment for.....	650
Tires, Rubber, for Wooden Wheels.....	643
Toy Boat, Spring Driven.....	646
Trees, Fruit and Shade, Combined.....	646
Valve, Float, for Engine Hopper.....	638
Watch Fobs, Making.....	645
Water, Getting, from Low Well.....	644

WIRELESS

Be a wireless expert—Study at home in spare time. Get a good job at a good salary. Wonderful opportunity to get in on the ground floor of a fast-growing profession. Easy, fascinating, profitable. Write today for full particulars. **International Correspondence Schools, Box 5626-C, Scranton, Penna.**

COMMERCIAL ENGRAVING and PRINTING

Contains hundreds of ideas and suggestions of service to the advertising man, printer, salesman, student, photographer, artist, engraver, electrotypist, bookbinder, paper jobber, etc., and will be invaluable as a permanent work of reference. 850 Pages. Over 1500 illus. Cloth. Price \$15.00, postpaid. Popular Mechanics Book Dept., 6 N. Michigan Ave., Chicago.

Let These Guides

Solve Your Problems

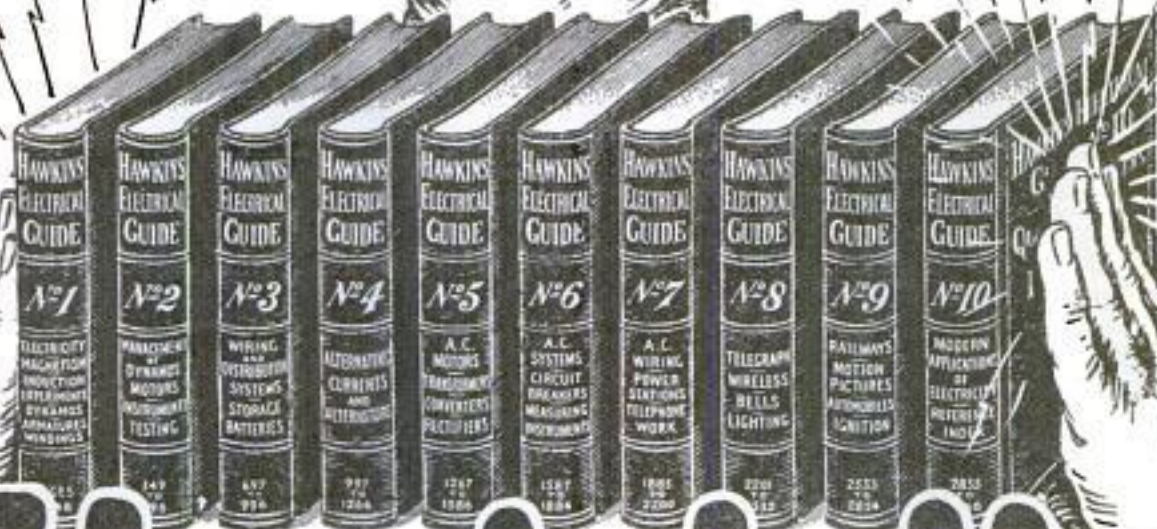

Electricity at your finger ends

HAWKINS ELECTRICAL GUIDES IN TEN VOLUMES

3500 PAGES

4700 PICTURES

\$1 A VOLUME

\$1 A MONTH

Send No Money--Send Only This Coupon

Know the facts in Electricity. They mean more money and better position for you. Hawkins Guides tell you all you need to know about Electricity. Every important electrical subject covered so you can understand it. Easy to study and apply. A complete practical working course, in 10 volumes. Books are pocket size; flexible covers. Order a set today to look over.

LEARN ALL ABOUT

Magnetism—Induction—Experiments—Dynamos—Electric Machinery—Motors—Armatures—Armature Windings—Installing of Dynamos—Electrical Instrument Testing—Practical Management of Dynamos and Motors—Distribution Systems—Wiring—Wiring Diagrams—Sign Flashers—Storage Batteries—Principles of Alternating Currents and Alternators—Alternating Current Motors—Transformers—Converters—Rectifiers—Alternating Current Systems—Circuit Breakers—Measuring Instruments—Switchboards—Wiring—Power Stations—Installing—Telephone—Telegraph—Wireless—Bells—Lighting—Railways. Also many Modern Practical Applications of Electricity and Ready Reference Index of the ten numbers.

SHIPPED FREE

Not a cent to pay until you see the books. No obligation to buy unless you are satisfied. Send Coupon now—today—and get this great help library and see if it is not worth \$100 to you—you pay \$1.00 a month for ten months or return it.

THEO. AUDEL & CO.,
72 Fifth Ave., New York City

Please submit me for free examination, HAWKINS ELECTRICAL GUIDE, (Price \$1 a number). Ship at once prepaid, the 10 numbers. If satisfactory, I agree to send you \$1 within seven days and to further mail you \$1 each month until paid.

Name.....

Occupation.....

Employed by.....

Home Address.....

Reference.....

PSM APR. 23

NOTE:—This announcement answers two questions that big employers repeatedly ask, viz: (1) What makes LaSalle men so practical? (2) Why don't more men train with LaSalle for the high pay positions in business?

The LaSalle Problem Method

—and how it successfully condenses a lifetime of experience into a few months of study

A question has blocked action on the part of many thoughtful men who were and are sincere in their desire to qualify in high salary fields. They have asked themselves whether training gained at home by correspondence might not prove to be mere "book-learning"—impractical—unmarketable.

We have no fault to find with this question—it is a natural one. The burden of our criticism rests on the man who permits the question to be its own answer, and to block and stop him in his upward climb without seeking further enlightenment.

For when more than three hundred thousand men have trained with LaSalle and found bigger, better things thru this training there must be sound reasons for their success.

There are reasons. They lie in the LaSalle Problem Method of imparting—not "book-learning"—but real, practical, usable business experience.

A knowledge of principles is one thing. The ability to apply and use principles—actually do the work at hand, is another—and the gap between the two is bridged by one factor and one only—Experience.

That's why business men place such a premium on experience—it safeguards them against costly experiments.

Suppose you decided to take up as your life work—accountancy, say.

Now stretch your imagination a trifle.

Suppose that thru the offices of an influential friend, arrangements were made for you to step in and immediately occupy the position you intended training to fill—right in the organization of a big corporation—with a complete department under your orders.

Say that by your side were placed, as your instructors and guides, several high grade accountants—men of national reputation—their sole duty being to train and equip you.

With these men instructing you in proper principles—then, you yourself exercising your own judgment in handling transactions and solving problems as they arose in your daily work—do you get the idea? You would be acquiring experience right along with the bed-rock fundamentals of the profession.

Sitting in the chair of authority—dealing with actual business—learning by applying what you learned—with experts correcting your errors, commending good work, guiding you aright through the ramifications, routine and emergency situations of the entire accounting field and making you make good every step of the way—mind—not in a class-room, but right in a business office where you would be actually doing the work you were training for—

wouldn't you, at the end of a year or so in this situation be much farther ahead than men who had spent years seeking the same knowledge in the old, hard, "find-out-for-yourself" way?

You can answer these questions—your good sense tells you that the situation described would make you a practical man—sure, certain and confident—able and capable of holding down any situation the accounting field offered.

And that is why the LaSalle Problem Method makes practical men. Simply because the procedure outlined above is followed—exactly.

True, you do your work at home. True, the experts who help you are located here in Chicago.

Nevertheless, under the LaSalle Problem Method you are actually occupying the position you are training to fill, whether it be in the accountancy field, or traffic or business management, or law, or correspondence—irrespective of what you are studying you are acquiring principles and applying them in actual business under the watchful eyes and helpful guidance of men big in your chosen field.

And when you have completed your LaSalle work, you can truthfully say that you are not only a thoroly trained man, but an experienced man—you know the bed-rock principles and you have used them all—they are familiar tools in your hands.

A LaSalle man can walk in anywhere with confidence. He does not feel the uncertainty and fear that arise when one faces the new and unknown. Under the Problem Method he has explored his chosen field on his own feet—the questions, the problems, the difficulties—he has met, faced and conquered them all.

His experience makes him know that altho he may be assuming a new position at higher pay, the duties of that position are an old, familiar story.

Experience is cash capital in business.

There are only two ways to get it.

One is the old, slow, uncertain way. The man who chooses to learn a branch of business by picking it up bit by bit as he goes along, finds the years slip by faster than he thought and sometimes his progress not as sure as he had anticipated. For all the "bits of knowledge" he sought may not have come his way.

The other road is short, sure and certain. It lies thru the Problem Method, distinctive with LaSalle Extension University. This way condenses into months experience which it takes most men a lifetime to gain.



The LaSalle Problem Method gives you self-confidence—practical, usable knowledge—because it makes you an experienced man.

J. J. Henoplen
President LaSalle Extension University,
of Chicago, Illinois

LaSalle Extension University

The Largest Business Training Institution in the World

If you are in earnest when you say to yourself that you must do something to permanently increase your earning capacity—then—check the coupon below in the square opposite that training which appeals most to you. It is a step you will never regret. And it is a step that is one hundred times as hard to make tomorrow as it is to take today. Where's that pen—never mind—a pencil will do just as well.

INQUIRY COUPON

LA SALLE EXTENSION UNIVERSITY

Dept. 464 R

CHICAGO, ILLINOIS

Please send me catalog and full information regarding the course and service below. Also a copy of your booklet, "Ten Years' Promotion in One," all without obligation to me.

- Business Management:** Training for Official, Managerial, Sales and Executive positions.
- Salesmanship—Principles and Practice:** Training for Sales and Advertising Executives, Solicitors, Sales Promotion Managers, Salesmen, Manufacturers' Agents and all those engaged in retail, wholesale or specialty selling.
- Higher Accountancy:** Training for positions as Auditor, Comptroller, Certified Public Accountant, Cost Accountant, etc.
- Traffic Management—Foreign and Domestic:** Training for positions as Railroad and Industrial Traffic Manager, etc.
- Law:** Training for Bar; LL. B. Degree.

- Railway Accounting and Station Management:** Training for Railway Auditors, Comptrollers, Accountants, Clerks, Station Agents, Members of Railway and Public Utilities Commissions, etc.
- Industrial Management Efficiency:** For Executives, Managers, Office and Shop Employees and those desiring practical training in industrial management principles and practice.
- Modern Business Correspondence and Practice:** Training for Sales and Collection Correspondents; Sales Promotion Managers; Credit and Office Managers; Correspondence Supervisors, Secretaries, etc.
- Banking and Finance.**

- Modern Foremanship and Production Methods:** Training in the direction and handling of industrial forces—for Executives, Managers, Superintendents, Contractors, Foremen, Sub-Foremen, etc.
- Personnel and Employment Management:** Training for Employers, Employment Managers, Executives, Industrial Engineers.
- C. P. A. Coaching for Advanced Accountants.**
- Commercial Law.**
- Expert Bookkeeping.**
- Business English.**
- Commercial Spanish.**
- Effective Speaking.**

Name..... Present Position..... Address.....

I Teach Piano a Funny Way

So People Told Me When I First Started in 1891. But now, after over twenty-five years of steady growth, I have far more students than were ever before taught by one man. I am able to make them successful players of the piano or organ *in quarter the usual time at quarter the usual cost.*

To persons who have not previously heard of my method, this may seem a pretty bold statement.

But I will gladly convince you of its accuracy by referring you to any number of my graduates in any part of the world. There isn't a State in the Union that doesn't contain many players of the piano or organ who obtained their training from me *by mail.*

Investigate by writing for my 64-page free booklet, "How to Learn Piano or Organ."

My way of teaching piano or organ is *entirely different* from all others. Out of every four hours of study, one hour is spent *entirely away from the keyboard*, learning something about Harmony and The Laws of Music. This is an awful shock to most teachers of the "old school" who still think that learning piano is solely a problem of "finger gymnastics." When you do go to the keyboard, you accomplish *twice as much* because you *understand what you are doing.* Within four lessons I enable you to play an interesting piece not only in the original key, but in all other keys as well.

I make use of every possible scientific help—many of which are *entirely unknown* to the average teacher. My patented invention, the COLOROTONE, sweeps away playing difficulties that have troubled students for generations. By its use, Transposition—usually a "nightmare" to students—becomes easy and fascinating. With my fifth lesson I introduce another important and exclusive invention, QUINN-DEX. Quinn-Dex is a simple, hand-operated moving-picture device, which enables you to see, right before your eyes, every movement of my hands at the keyboard. **You actually see the fingers move.** Instead of having to reproduce your teacher's finger movements from MEMORY—which cannot always be accurate—you have



DR. QUINN AT HIS PIANO

From the Famous Sketch by Schneider, Exhibited at the St. Louis Exposition

the correct models before you during every minute of practice. The COLOROTONE and QUINN-DEX save you months and years of wasted effort. They can be obtained **only from me**, and there is nothing else, anywhere, even remotely like them.

Men and women who have failed by other methods have quickly and easily attained success when studying with me. In all **essential** ways you are in closer touch with me than if you were studying by the oral method—yet my lessons cost you only 43 cents each—and they include all the many recent developments in scientific teaching. For the student of moderate means, this method of studying is **far superior** to all others; and even for the wealthiest student, there is nothing **better** at any price.

You may be certain that your progress is at all times in accord with the best musical thought of the present day, and this makes all the difference in the world.

My course is endorsed by distinguished musicians who would not recommend any course that did not maintain the highest musical standards. It is for beginners or experienced players, old or young. You advance as rapidly or as slowly as you wish. All necessary music is supplied without extra charge. A diploma is granted. Write today, without cost or obligation, for 64-page free booklet, "How to Learn Piano or Organ."

FREE BOOK

How To
Learn
Piano

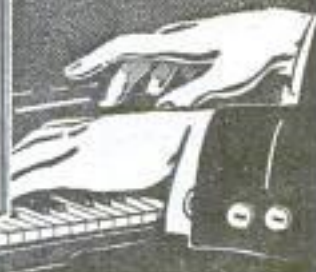

FREE BOOK COUPON

QUINN CONSERVATORY, Studio PM 44,
598 Columbia Road, Boston, 25, Mass.

Please send me, without cost or obligation, your free booklet, "How to Learn Piano or Organ," and full particulars of your Course and special reduced Tuition Offer.

Name.....

Address.....

Marcus Lucius Quinn Conservatory of Music

Studio PM 44

598 COLUMBIA ROAD, BOSTON, 25, MASS.

I Guarantee To Train You

**Until You Are Placed
in a Position Paying**

**\$250 to \$300 Per
Month**

— Chief Draftsman Dobe



Write and I'll tell you how I make you a first-class, big-money-earning draftsman in a very few months! I do this by a method no other man nor institution can imitate. I give you personal training at home by mail. And I mean just what I say—I train you until you are actually placed in a position paying from \$250.00 to \$300.00 per month. Six thousand draftsmen are wanted every month. Hurry up and register so you can start earning.

**I Give YOU
FREE**

**This \$25⁰⁰ Outfit
of Drafting Tools**

High-grade plated instruments. Every one you need. Packed in a handsome plush lined case. Just the kind I use myself. Write to me. I'm giving it entirely and absolutely free.



Chief Draftsman Dobe

Dept. 1354, 4001 Broadway, Chicago, Ill.

Without any obligation whatsoever, please mail your book, "Successful Draftsmanship," and full particulars of your liberal "Personal Instruction" offer to a few students.

Name.....

Address.....

Send This Free Coupon To Me!

It costs you nothing but a stamp to send the coupon for my free book, "Successful Draftsmanship" that tells you all. It tells you how my students get the good positions and how I can afford to train you until you get YOUR position. Remember, 6,000 men wanted every month. So hurry. Register early because I can take only a few students. Send coupon NOW!

Chief Draftsman Dobe

Dept. 1354

4001 Broadway, Chicago

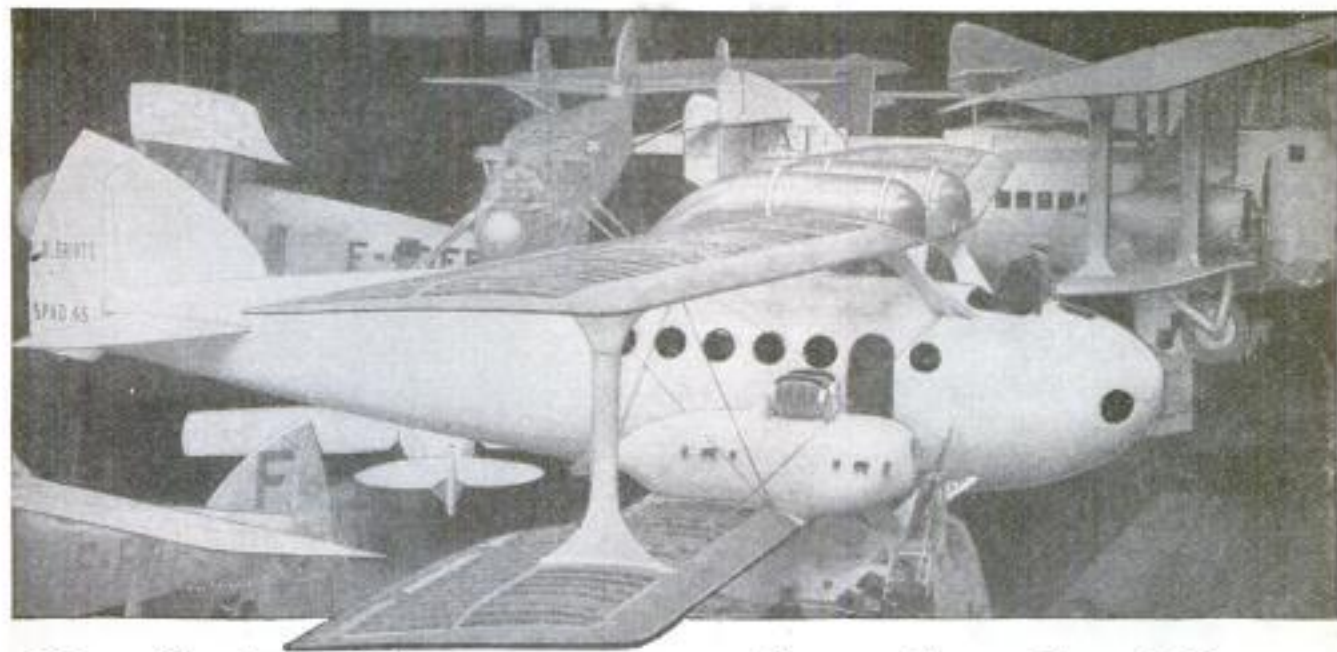

Quick Success in Aviation Fascinating—Daring—Big Paying

To young men of daring, no other field of work offers such a fascination, such high pay, nor such opportunities for quick success as the field of Aviation. As yet, aviation is practically in its infancy. NOW is the time to get in.

Amazing Opportunities in Airplane Industries

In the automobile industry and in the moving picture business hundreds of men got rich by getting in at the start. They made their success before others woke up. Today, these lines offer no greater opportunities than a hundred and one others. BUT AVIATION IS NEW. Get in while the opportunity and pay are big. All over the country there is a clamor for trained men. It is not a question of pay but of getting capable men.

Here Are Real Positions, \$50 to \$150 Per Week

Aeronautical Instructor, Aeronautical Engineer, Aeronautical Contractor, Airplane Repairman, Airplane Mechanic, Airplane Inspector, Airplane Salesman, Airplane Assembler, Airplane Builder.

A Sure and Easy Way to Learn Aviation—at Home



A New Job—The Aerial Postman

The study of aviation is almost as fascinating as the actual work. Every lesson is full of interest. That is why it is easy to learn aviation. You do not have to make yourself study—it is like reading an in-

teresting book that tells you things you have always wanted to know. Only one hour each evening will give you the basic training in a surprisingly short time. You need only a common school education.

One of my students, James Powers, Pa., says, "I am indeed surprised that such a valuable Course can be had from such practical men for so little cost."



A New Seven-Passenger Airplane

Personal Instruction by Experienced Men

Men who have had actual experience give you personal attention. They select the lessons, lectures, blueprints and bulletins. They tell you things that are essential in everyday practice. Each lesson is easy to read and understand.

BIG BOOK FREE of Opportunities

Send coupon below for New Book, just out, "Opportunities in the Airplane Industry." It is interesting and instructive. It will show you many things you never knew before about aviation. Due to shortage of paper we could get only a limited supply of these books—send the coupon before they are all gone.

AMERICAN SCHOOL OF AVIATION 3601 Michigan Ave., Dept. 1194, Chicago, Ill.

AMERICAN SCHOOL OF AVIATION
3601 Michigan Ave., Dept. 1194, Chicago, Ill.

Without any obligation, send me your Free Book, "Opportunities in the Airplane Industry," also information about your Course in Practical Aeronautics.

Name.....

Street.....

City..... State.....

**Play
Without
Notes**

**Be a Master of
JAZZ and RAGTIME**



Anyone who can remember a tune can easily and quickly learn to play Jazz, Ragtime and Popular Songs by ear, at a very small cost. New Niagara Method makes piano playing wonderfully simple.

NO matter how little you know about music—even though you "have never touched a piano"—if you can just remember a tune, you can learn to **PLAY BY EAR**. I have perfected an entirely new system. It is so simple, so easy, and shows you so many little tricks of playing that it just comes natural to pick out on the piano any piece that is running through your mind. Even those who could not learn by the old-fashioned method grasp the NIAGARA idea readily, and follow through the entire course of twenty lessons quickly.

Play By Ear in 90 Days

No need to devote years to study, in order to learn piano nowadays. Neither is special talent necessary. Every lesson is so easy, so interesting and fascinating that you "can't keep your hands off the piano." Just devote a part of your spare time to it for ninety days and you will be playing and entertaining your friends almost before you realize how this wonderful new accomplishment has been acquired. No tiresome scales, no arpeggios to learn—no do-re-mi, no tiresome practice and meaningless exercises. You learn a bass accompaniment that applies to ANY SONG you play by ear. Once learned you have it for all time and become master of the piano. Experienced and talented musicians are amazed at the rapid progress of Niagara School students and say they cannot understand why this method was not thought of years ago. Yet it has never been used before and is not used by any other teacher or school today.

Be the Popular One in Your Crowd

One who can sit down any time without notes or music, reel off the latest jazz and ragtime song hits that entertain folks—always being the popular one in the crowd, the center of attraction, the life of the party, sought and invited everywhere.

As easily as hundreds of others have learned, so you, too, can learn and profit by it—not only through the pleasure it provides, but also by playing at dances, movies and other entertainments.

Decide to begin now. Just spend a little part of your time with my easy, fascinating lessons, and see how quickly you "catch on" and learn to play. You will be amazed, whether you are a beginner or an advanced student.

Write for my book, "The Niagara Method," describing this wonderful new method of playing by ear. It is sent to you FREE.

RONALD G. WRIGHT, Director,

Niagara School of Music, Dept. 447

Niagara Falls, N. Y.

Clip This Coupon Now

NIAGARA SCHOOL OF MUSIC, Dept. 447 Niagara Falls, N. Y.

Please send me your Free Booklet describing "The Niagara Method." Name.....
Street..... City.....
Age..... Ever taken piano lessons?..... For how long a time?.....



The Letter That Saved Bob Johnson's Job

—and paved the way for a better one!

BOB answered the summons to the Chief's office with just a little fear and trembling, for a lot of men were being dropped—a lot more were having their pay reduced.

But as Bob came in, his employer did a surprising thing. He got up quickly from his desk and grasped Bob warmly by the hand.

"I have just received a letter from the International Correspondence Schools telling me that 'Robert Johnson of your office has enrolled for a course of home study and has received a mark of 94 for his first lesson.'

"I want to congratulate you, young man, on your industry and good judgment. I am glad to see that you are training yourself not only for your present job but for the job ahead.

"We're cutting the pay-roll. Until I received this letter, I had you in mind as one of the men to be dropped. But not now. Keep on studying—keep your eyes open—and pretty soon there'll be a still better job for you around here. We're always looking for trained men."

WON'T you let the I. C. S. help you, too? Won't you trade a few hours of your spare time for a good job, a good salary and the comforts that go with it?

It takes but a moment to mark the career of your choice, sign your name, clip out and mail the coupon printed on the right. Yet that simple act has started more than two million men and women toward success.

In city, town and country all over the world, men are living contented lives in happy, prosperous homes—because they clipped this coupon.

In every line of business and industry; in shops, stores, offices, factories, in mines and on railroads, men are holding important positions and receiving splendid salaries—because they clipped this coupon.

Clerks have become sales, advertising and business managers; mechanics have become foremen, superintendents and engineers; carpenters have

become architects and contractors; men and boys have risen from nothing to places of responsibility—because they clipped this coupon.

You have seen it in almost every magazine you have looked at for years. And while you have been passing it by more than ten thousand men and women each month have been making it the first stepping stone to real success in life.

Will you still turn away from Opportunity? Can you still go on, putting in your days at the same grind, getting the same pay envelope with the same insufficient sum, when such a little thing can be the means of changing your whole life?

You *can* have the position you want in the work you like best, a salary that will give you and your family the home, the comforts, the little luxuries you would like them to have. No matter what your age, your education, or your means—you can do it.

All we ask is the chance to prove it. Just mark and mail the coupon, and, without obligation or a penny of cost, let us tell you what the I. C. S. can do for you. It's a little thing that takes but a moment, but it's the most important thing you can do today. Do it now!

----- TEAR OUT HERE -----

INTERNATIONAL CORRESPONDENCE SCHOOLS
BOX 5619-C SCRANTON, PA.

Without cost or obligation please explain how I can qualify for the position, or in the subject before which I have marked an X:

- | | |
|---|---|
| <input type="checkbox"/> ELEC. ENGINEER | <input type="checkbox"/> BUSINESS MANAGEM'T |
| <input type="checkbox"/> Electric Lighting & Railways | <input type="checkbox"/> SALESMANSHIP |
| <input type="checkbox"/> Electric Wiring | <input type="checkbox"/> ADVERTISING |
| <input type="checkbox"/> Telegraph Engineer | <input type="checkbox"/> Show Card & Sign Ptg. |
| <input type="checkbox"/> Telephone Work | <input type="checkbox"/> Railroad Positions |
| <input type="checkbox"/> MECHANICAL ENGINEER | <input type="checkbox"/> ILLUSTRATING |
| <input type="checkbox"/> Mechanical Draftsman | <input type="checkbox"/> Cartooning |
| <input type="checkbox"/> Machine Shop Practice | <input type="checkbox"/> Private Secretary |
| <input type="checkbox"/> Toolmaker | <input type="checkbox"/> Business Correspondent |
| <input type="checkbox"/> Gas Engine Operating | <input type="checkbox"/> BOOKKEEPER |
| <input type="checkbox"/> CIVIL ENGINEER | <input type="checkbox"/> Stenographer & Typist |
| <input type="checkbox"/> Surveying and Mapping | <input type="checkbox"/> Certified Public Accountant |
| <input type="checkbox"/> MINE FOREMAN or ENG'R | <input type="checkbox"/> TRAFFIC MANAGER |
| <input type="checkbox"/> STATIONARY ENGINEER | <input type="checkbox"/> Railway Accountant |
| <input type="checkbox"/> Marine Engineer | <input type="checkbox"/> Commercial Law |
| <input type="checkbox"/> ARCHITECT | <input type="checkbox"/> GOOD ENGLISH |
| <input type="checkbox"/> Contractor and Builder | <input type="checkbox"/> Common School Subjects |
| <input type="checkbox"/> Architectural Draftsman | <input type="checkbox"/> CIVIL SERVICE |
| <input type="checkbox"/> Concrete Builder | <input type="checkbox"/> Railway Mail Clerk |
| <input type="checkbox"/> Structural Engineer | <input type="checkbox"/> AUTOMOBILES |
| <input type="checkbox"/> PLUMBING & HEATING | <input type="checkbox"/> Mathematics |
| <input type="checkbox"/> Sheet Metal Worker | <input type="checkbox"/> Navigation |
| <input type="checkbox"/> Textile Overseer or Supt. | <input type="checkbox"/> AGRICULTURE <input type="checkbox"/> Spanish |
| <input type="checkbox"/> CHEMIST | <input type="checkbox"/> Poultry Raising <input type="checkbox"/> Banking |
| <input type="checkbox"/> Pharmacy | <input type="checkbox"/> Airplane Engines |

Name.....

Street..... 1-10-22

City..... State.....

Occupation.....

Persons residing in Canada should send this coupon to the International Correspondence Schools Canadian, Limited, Montreal, Canada.

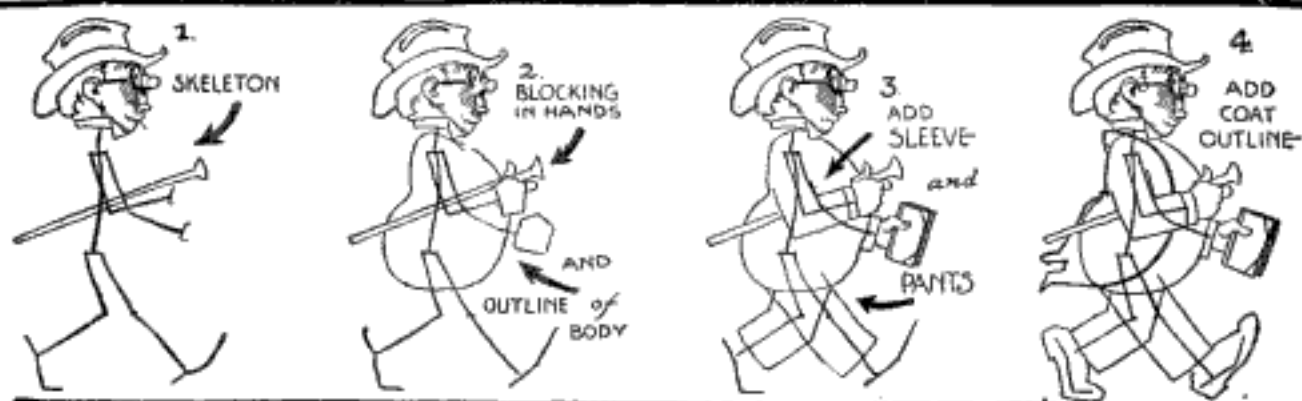

Learn Cartooning Now

THE DEMAND FOR NEW CARTOONISTS has never before been so great. Newspapers want new artists, **trained to do snappy, original work.** That is why they are employing Landon-trained cartoonists.

RESULTS PROVE MERIT. Cartoons by Landon students are appearing daily in hundreds of leading newspapers. If you like to draw, make up your mind **now** to develop your ability and quickly raise your income.

HUNDREDS OF OTHERS have made this decision and through the Landon Course have won life-long success. To-day they are the most successful and best paid of the new generation of newspaper cartoonists.

It's Easy to Learn With Landon Picture Charts

THE SKETCHES ON THIS PAGE show the practical, easy-to-understand method of teaching originated and used exclusively by the Landon School.

EACH LESSON CONTAINS several big Picture Charts, covered with series after series of sketches—clearly explaining how to draw original heads, hands, figures, animals and every subject the cartoonist must understand.

COMPLETE INSTRUCTION ON ORIGINATING cartoon ideas form another exclusive feature of this home-study course. Personal, thorough criticisms guide you at every point.

MAKE PROFITABLE USE OF YOUR SPARE TIME. Write to-day for sample Picture Chart, long list of successful students and information showing possibilities for you. **Please state your age.**

THE LANDON SCHOOL

238 National Bldg.

Cleveland, Ohio

Partial list of newspapers using Cartoons by Landon students

"NEW YORK World"
 "CHICAGO Tribune"
 "PHILADELPHIA Ledger"
 "BOSTON Herald"
 "DETROIT Times"
 "CLEVELAND Plain Dealer"
 "CINCINNATI Post"
 "ST. LOUIS Times"
 "INDIANAPOLIS News"
 "ROCHESTER Dem. and Chronicle"
 "ST. PAUL News"
 "SEATTLE Times"
 "LOS ANGELES Express"
 "SIOUX CITY Tribune"
 "NEW ORLEANS Item"
 "ATLANTA Journal"



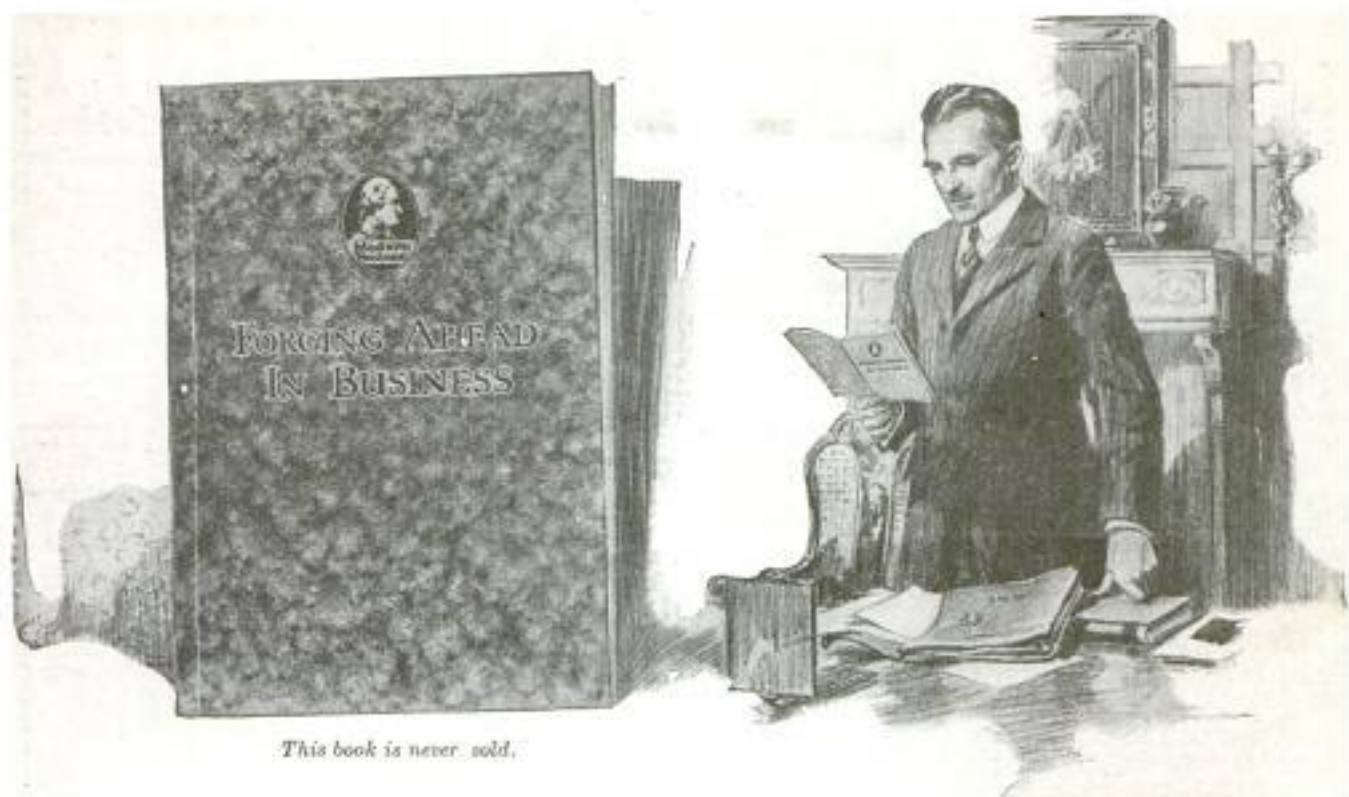

This book is never sold.

This book may not be intended for you

*But more than 155,000 men found
in it what they had been seeking*

HERE is a slim little volume of only 120 pages. It is not the work of a famous writer. It is not illustrated by a celebrated artist. It is not even bound in leather; its covers are of paper.

Yet few books published in the English language have had a wider reading. And those who have turned its pages would not part with what it has disclosed to them for many, many times its simple value.

In itself it is only a key—but it is the key that has unlocked the door of the future for many thousands of business men. Alone it cannot add one penny to your income nor advance your business progress a single step. But it is a guide-post that points the way for you to follow—if you will as others have.

That depends upon you. All the help that others can give you will be of little use unless you are strong enough to make a first effort and earnest enough to sustain that effort.

This page is a test of your

initiative. It will partly determine whether this book is intended for you.

If the very title of the book—"Forging Ahead in Business"—stirs no response, then turn the page and think no more about it.

But if the phrase "Forging Ahead in Business" does awaken a response, then think of this: plenty of men have the power to start a thing, but few possess the courage and the stamina to carry thru their undertakings.

So the question for you to answer is: "If I send for this book, if I find out more about the Alexander Hamilton Institute Course and Service, if I am convinced in my own mind that it offers what I have lacked—then is my resolution strong enough to help me to do what other men are doing?"

Doing what they did means a little money. It means more than a little time. You must ask yourself whether you will sacrifice both. If the answer is a positive "No," then it must be said that this

book is not for you. No system yet devised can impart information by the miracle of telepathy.

But if you are frankly seeking to make yourself a better, more successful man tomorrow than you were yesterday, then start this coupon on its way at once.

Ask yourself this: "Why should any one pay me more next year than this year? Just for living? Just for avoiding costly blunders? Now that I am devoting most of my waking hours to business, what am I doing to become more expert at business?" The answers to those questions will tell you whether to turn the page or mail the coupon.

Alexander Hamilton Institute

452 Astor Place, New York City

Send me "Forging Ahead in Business" which I may keep without obligation.



Name.....
Print here

Business
Address.....

Business
Position.....

Canadian Address, C. P. R. Building, Toronto; Australian Address, 42 Hunter St., Sydney



RADIO

The Greatest Fun a Boy Can Have!

Boys are finding radio the most wonderful fun in the world, with a great practical and educational value.

Its possibilities are so immense that **THE AMERICAN BOY** has planned, beginning with the April number, a series of big, instructive articles by Armstrong Perry—a radio expert, who is in close co-operation with the biggest radio men in America.

Mr. Perry's articles will give you radio from A to Z—the best way to learn radio, how long it will take, what kind of equipment you should have. He will tell you of all the marvelous things you can do with radio, how you can become a practical radio operator and make money out of it.

Start with April and Mr. Perry's first article. Don't miss it!

THE AMERICAN BOY is full of meat every month on mechanics and all sorts of interesting things a boy can do with his hands and simple tools. You'll like it at once and soon find you need it to keep abreast of the times.

A year's subscription to **THE AMERICAN BOY** now costs only \$2.00. Single copies are 20 cents at news-stands. Subscribe for a year or leave a standing order with your news-dealer.



The American Boy

The Happiest, Brightest, Best Magazine for Boys in All the World

THE SPRAGUE PUBLISHING CO.
No. 373 American Bldg., Detroit, Mich.

Herewith find \$2.00. Please send **THE AMERICAN BOY** for one year, beginning with the current issue, to

Name.....

Address.....

Please Mention Popular Mechanics

ELECTRICITY

Learn by the Keysheet Method

Mastering electricity is no longer a problem. The keysheet system has been perfected at a cost of \$10,000. Your problems worked out in advance.

**Be an Electrical Expert —
Earn \$50 to \$100 per week.**

Most complete, accurate, up to date electrical training course ever conceived. Students taught as in practice.

Valuable free booklet. Send for it today.

WORLD TECHNICAL INSTITUTE

Dept. EF, Fuller Building JERSEY CITY, N. J.



The Practical Gasoline Engine

Revised by Berton Elliot

The constant increase of the use of gas and gasoline engines in this country for power purposes makes this authoritative work most timely.

75¢

It is a simple and correct guide to the essentials of engine construction, erection and operation under all conditions. What to do and how to do it is told in everyday language. "The Practical Gasoline Engine" should be in the hands of every prospective gas or gasoline engine owner as well as those now operating an engine. 127 pages, two illustrations. Size 4 1/4 x 6 1/2 inches. Cloth bound. Postpaid.....75c

SHREWSBURY PUBLISHING CO.
5525 West Lake St., Chicago, Ill.

TRAFFIC

Men Needed Everywhere

Big salaries. "Bankers" hours. Dignified position. Your own boss. Work easily learned in a few weeks at home. Course guaranteed. Satisfaction assured. Graduates coached free for two years after in position. You can't fail. Practical experience in actual traffic office offered graduates. Student R. W. Fish appointed General Traffic Manager after six months' study. His salary to start \$2,000.00. Complete training inexpensive. Make up your mind NOW to get started. Easy terms. Write today and save \$34.00. Act at once.

Interstate Traffic School

24 Traffic Building Fort Wayne, Ind.

12 Months to Pay

You can easily earn or save money for the small payments. Parents often advance first payment to help buy a **RANGER** bicycle. Choice of 44 styles, colors and sizes. **FACTORY-TO-RIDER** prices. **DELIVERED FREE** express prepaid on approval for **30 DAYS' TRIAL**, actual free riding test.

Tires best quality, at factory prices, express prepaid. Lamps, wheels, and equipment, low prices. **Send No Money.**

Mead Cycle Company
Dept. C108 Chicago

Write today for free Ranger Catalog. Factory prices and marvelous easy payment terms.



Be an Artist

Comics, Cartoons, Commercial, Newspaper and Magazine Illustrating, Pastel, Crayon Portraits and Fashions. Many money-making careers. Our simple method quickly develops your talent in spare time. By Mail or Local Classes. Write for terms and list of successful students. **ASSOCIATED ART STUDIOS**
87-B Madison Building NEW YORK



BE A MOVIE CAMERA MAN

Enter the third biggest industry. See the world. Do big things. Make big money. 30 years' experience in General and Motion Picture photography enables us to train you quickly for big results. In our modern studios we are daily making pictures in which you can take an active part. Day and night sessions. You can start now. Get our interesting book. Don't delay.

NATIONAL SCHOOL OF PHOTOGRAPHY, 1269 Broadway, NEW YORK CITY

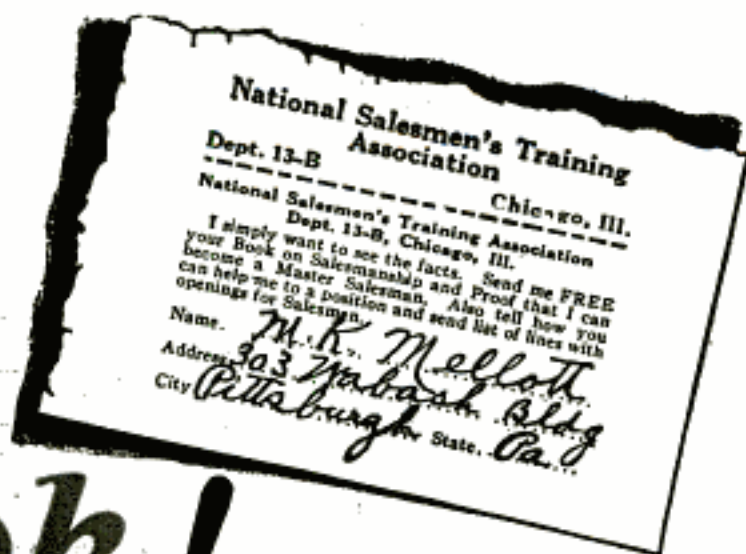

Look!

This is the Coupon that Put Me in the \$10,000 a Year Class

THAT little slip of paper wouldn't cash in for a penny at a bank teller's window. But \$10,000 wouldn't begin to express what it has been worth to me.

Most of us do look upon \$10,000 as a pretty good yearly salary. To me it looked almost impossibly big. Why I was just a young farmer boy! Yet somehow or other the figure "\$10,000-a-year," always stuck in my mind. I used to add it up time and again. I used to figure all I could do with an amount like that coming in each year. I could have a beautifully furnished home in the city, a car—well just about everything I wanted.

And then it happened! Today—not so long afterward—I find myself in the \$10,000 a year class. I am a little amazed myself when I think that just a couple of short years ago I was pushing a plow. And I had never realized that \$10,000 a year was waiting for me in a field in which I had no previous experience whatever!

Why People Laughed

The first time I mentioned the word "Salesman" at home I was greeted with a laugh from everyone in the family. "The idea of a farmer boy making good as a salesman!" they said. But I knew there was a way to do it. I knew that men had stepped down from bookkeepers' stools into high-salaried jobs as salesmen. I knew that clerks who had never sold a dime's worth of goods in their lives had made big money selling. I knew that firemen, city policemen, railway mail clerks, and others who once were farmer boys like myself had become successful salesmen at large salaries. And what is more, I knew HOW they had done it!

The whole thing happened in a rather commonplace way. I had just finished a hard day out in the fields and was sitting in the kitchen resting and waiting for supper. I picked up a magazine and there I read how a great organization of expert salesmen and sales managers had banded together to fit men to succeed in this great field. I read of the wonderful success of their methods. I read how a man from Portland, Oregon, named F. Wynn had stepped from a small-pay job to a salesman's with earnings which amounted to as high as \$550.00 a week. I read of a fireman who never before had earned more than \$60.00 a month. This organization made a salesman out of him and his earnings ran up to the \$300.00 a week figure. His name was George W. Kearns and he came from Oklahoma City. I read about a farmer like myself, Charles Berry of Winterset, Iowa, who earned \$1,000 the very first month he became a salesman. I read about W. Hartle of Chicago who had spent ten years in the railway mail service at a salary ranging from \$900 to \$1200 a year. As a salesman his earnings were \$1,000 in thirty days! These men had never sold goods—had never known they could sell. But that hadn't mattered a bit. They learned of this great organization formed for the express purpose of fitting men for the great opportunities in



M. K. Mellott

seven months when I began to make the money I had once dreamed of earning.

When an organization has done that much for you wouldn't you want to help them too. And that is why I am telling my story here. Because I have no doubt that there are hundreds of others who realize that selling is the real big-money field. But they have never realized that they could easily get their share of this big money regardless of whether they had ever sold a dime's worth of goods before in their lives."

M. K. Mellott.

Send for This Free Book

The same opportunity that has brought Mr. Mellott and hundreds of others their good fortune is open to you. Whether or not you have ever thought of becoming a Salesman, you should examine the facts about the tremendous possibilities for big earnings in this fascinating field. This will not cost you a penny and places you under no obligation. It simply means that you will receive, entirely free, a remarkable book, "The Knight of the Grip," full facts about how the Free Employment Service of the N. S. T. A. will assist you in securing a Sales position as soon as you are qualified and ready, and the personal stories of men in every part of the country who today are enjoying splendid success and earning five, ten and fifteen times as much money as ever before.

Make a start now! Mail at once the coupon that can put you into the \$10,000 a year class too. National Salesmen's Training Association, Dept. 12-D, Chicago, Ill.

National Salesmen's Training Association,
Dept. 12-D, Chicago, Ill.

I simply want to see the facts. Send me, free, your Book on salesmanship and proof that I can become a master salesman. Also send list of lines with openings for salesmen.

Name.....
Address.....
City.....State.....
Age.....Occupation.....

I'LL SHOW YOU HOW TO GET A JOB YOU CAN'T LOSE!

Every newspaper in the country is full of stories about men being thrown out of work. We are facing a period of depression which many say will lead to "soup kitchens and bread lines." Already in New York State tens of thousands of people are idle. "At the present rate," says the Daily News Record, "there will soon be two workers for each job." In Philadelphia in one line of business alone 40,000 employees were dropped. In New England mills and factories have closed or are running on part time. In the South, with cotton selling at low prices, wages are being cut and factories are closing in every section. In Detroit it is reported that the automobile plants laid off 100,000, in Akron the tire companies are running only part of their capacity. In every city in the country, from Coast to Coast, people are working part-time, or looking for work or accepting radical reductions in wages.

How Soon Will You Be Out of Work?

Are you going to wait until YOU are out of work before insuring yourself against loss of income—or are you going to get a job NOW that you cannot lose? That kind of a job is—working for Uncle Sam in any of the numerous branches of the Civil Service. According to Federal Law you cannot be fired or laid off for any religious, personal or political reason. Hard times do not affect the government employe. There are no strikes or lockouts. Your pay comes regularly all year round. You can COUNT exactly on what you will get. Increases are rapid in position and salary.

Let Me Train You for a Job With Uncle Sam

Uncle Sam is careful about his employes. You must pass a Civil Service Examination before you are accepted. There are certain things you MUST know. It is my business to PREPARE you for the examination so you can pass successfully. For eight years I was a Civil Service Secretary-Examiner, so I am perhaps the best-qualified man in the country to coach you. I guarantee to coach you until you succeed in GETTING A POSITION.

\$1600 to \$2300 a Year

NO STRIKES--NO LAYOFFS--NO LOCKOUTS

Figure your earnings for the past year and if you are an average man you didn't get as much as the average government employe! That is due to strikes, lockouts, slack work, layoffs—none of which can happen to Civil Service employes. They get \$1600 to \$2300 a year to start and they get it. Other positions in the government service pay as high as \$3000 to \$10,000 a year! Hours are easy—eight or less a day. Vacation every year with full pay, work at home or travel, or work in Washington or at Panama Canal.

Get My Free Book

Patterson Civil Service School,

Arthur R. Patterson,
Principal

84 Wiser Bldg., Rochester, N. Y.

Please send me your free book about Government positions.

Name

Address

City.....State.....

If you are an American citizen 18 years old or more you are eligible to a Government Civil Service Position, and if you have a common ordinary 4th grade education as a foundation I want you to have a copy of my splendid fully illustrated book telling how I can help you to secure a position with the U. S. Government, in the Railway Mail Post Office, Rural Carrier, Departmental, Internal Revenue, Immigration, Custom House or Postmaster Services. Send in the coupon today or just a postal card.

Arthur R. Patterson,
Principal, Patterson
Civil Service School
Dept. 84, Wiser
Building,
ROCHESTER, N. Y.



**MORE THAN \$100
a Day!**

CLARE BRIGGS, the man who draws "When a Feller Needs a Friend," receives more than \$100 a day. There are many other cartoonists making incomes that would look good to a bank president.

If you have ideas and like to draw, you may have in you the making of a great cartoonist.

Federal training gives you the opportunity to develop your ability under the guidance of 60 of America's leading artists and illustrators. What this school will do for you by mail in your spare time is told in the 32 page book, "A Road to Bigger Things." It contains studio pictures of Briggs, McCutcheon, Sid Smith, Fontaine Fox, and many other stars on the Federal staff. Write for your FREE COPY to-day. Just tear out this advertisement. Write your name, address and age in the margin and mail it now.

Federal Schools, Inc.

403 Federal Schools Bldg.

Minneapolis, Minn.

STAMMER

If you stammer attend no stammering school till you get my large FREE book entitled "STAMMERING, Its Origin and the Advanced Natural Method of Cure," bound in cloth and stamped in pure gold. Ask for special attention and a FREE copy of "The Natural Speech Magazine." Largest, best equipped and most successful school in the world for the cure of stammering, stuttering, etc. No sing-song or time beat. Write today. The North-Western School, 2317 Grand Ave., Milwaukee, Wis.



Wonderful, new device, guides your hand; corrects your writing in few days. Big improvement in three hours. No failures. Complete outline FREE. Write C. J. Gament, D-34, St. Louis, Mo.

WHY not spend Spring, Summer and Fall gathering butterflies, insects? I buy hundreds of kinds for collections. Some worth \$1 to \$7 each. Simple outdoor work with my instructions, pictures, price list. Get posted now. Send 25c (NOT STAMPS) for my Illustrated Prospectus. Mr. Sinclair, Dealer in Insects, Dept. 6, Ocean Park, Calif.



Genuine
\$29.00
Imported

Will Be
Given
To You
FREE

Help me introduce this beautiful Violin in your district. Be first to show how easy it is to play with help of three new inventions and my scientific instructions. You can play it in one week.

10,000 Students Found Violin Playing Easy to Learn

You can learn as easily as others. Surprise your friends. My three new inventions make it very easy. Have been teaching 48 years. Write your name and address on bottom of page and send for free violin offer and three new violin inventions.

PROF. A. HINCHCLIFFE, 233 Broadway
Woolworth Bldg. Dept. 50-4 NEW YORK

Down and Out! Now I Own This Service Station and Earn \$7,000 a Year



The true story of how J. Strauss jumped from a \$30.00 job of drudgery to the ownership of this big Electrical Service Station with an income of \$7,000 a year. By a wonderful new method, any man with a common school education can quickly and easily learn to make \$75 to \$150 a week.

Three years ago I wouldn't have believed it myself. Even now I sometimes rub my eyes and wonder if it is all a dream. But I know it is all true for here around me are the brick walls of an automotive service station that I have just built. In my pocket is a check book which, at a line from me, can bring to my hand as much money as I need any time I need it. Outside of the office my men work busily upon the hundreds of automobiles that drive in here each week. And to think of three years ago I was only a handy man in a little garage.



J. Strauss (Center)

I START "ON SCRATCH"

When I started in this business I didn't know any more about an automobile than the average layman. And I had no education other than that received at the common school.

Every night when I washed the grease from my hands, removed my overalls and went home I was confronted with the same old question: How was my meagre salary to support my growing family, educate my children? I was being paid for what I did rather than for what I knew.

Finally I began to reason. -What business could I enter that didn't require experience or much training?

I would become an automobile mechanic, I thought, but the idea was soon discarded because almost any man could in a few weeks pick up enough mechanical knowledge about an automobile to make simple repairs. Then I remembered that every day from five to ten automobiles came into the garage which needed some electrical repair that no man in our shop could make. And there was not a service station in the community where any electrical repairs any more difficult than changing light bulbs or installing a spot light could be made.

THE REAL SECRET OF IT ALL

That was it! Here was the field which embraced 75 per cent of all automobile repairs and there was not one garage out of fifteen equipped to make anything but mechanical repairs simply because the men who understood the complex units in the electrical equipment of an automobile were few and far between. Here was a field comparatively untouched, a field which was crying out for men who could take the big salaries and seize the big opportunities that are offered to the Automotive Electrical Expert.

From a man on the other side of the town, who could find any repair, I got the story of the Ambu Engineering Institute. When he finished telling me about their wonderful new method of instruction which makes the fundamentals of electricity so easy to learn, I was so enthused that I decided to go to Chicago and become an electrical expert.

You already know what happened. I came back here, started a little service station in a back alley barn, started right off earning from \$60 to \$75 a week. When people discovered there was a man there who could make the electrical repairs their cars needed my reputation spread like wild fire, and now within three years I have bought this big service station from my profits, and have all the money I need to enjoy all the pleasures of life, have plenty of money in the bank and draw all the electrical repair trade within a radius of two hundred miles.

READ THESE SUCCESS STORIES

Doubled His Salary in 3 Weeks

"Before I 'learned how' at Ambu, my salary was \$30.00 a week. Within three weeks after my return I was raised twice, the last salary being \$60.00 a week. As for my success as an Automotive Electrician, I have to give the Ambu Engineering Institute a 100 per cent credit."

Wm. Bass.

Increased His Earnings 70 Per Cent

"I am now earning at least 70 per cent more than ever before, and I never could have done this if it had not been for the course at Ambu."

S. E. Kilgore.

Earns \$75.00 a Week

"I am certainly glad I took the Ambu Course. Every week since leaving school my earnings have been from \$75.00 to \$100 a week—almost double my previous salary."

H. Blotcher.

What Mr. Strauss has done is not at all unusual. Hundreds of Ambu students are doing equally well. You can increase your salary from 50 per cent to 200 per cent. You can start now—in this new field—while it is still practically bare of competition. You can, before summer time, be equipped to command your share of the thousands of dollars to be paid for electrical repairs. There is big money waiting for you.

Do not get into this big money field at once and get your share of the immense sum that will be paid this summer for electrical repairs.

FREE BOOK TELLS HOW

Here in Chicago we have a resident class which is limited to 25 men each two weeks. We give you a thorough grounding in each department of automotive electricity. You learn not only how, but why. You are taught, not the electrical system of a single car but instead you learn the principles which are the same on every car. The inner workings of batteries, generators, starters and ignition and lighting systems become as simple and clear to your mind as the wiring of a bell. You learn the quickest and simplest way of making every repair. And you get big money because you are paid for what you know. Or, if you cannot come to Chicago, our teachers have prepared a complete course which you can take in your own home by mail. It is just as thorough and definite as the resident course.

ACT NOW

This is probably the most important minute in your life. The decision you make now determines your future. If you are contented to go on drawing a small salary for uncontented, unpleasant drudgery, just turn the page. But if you have your face set toward big accomplishments, if you want to have the respect the standing of an electrical expert gives you and the big income that your skill and knowledge will command, indicate on this coupon the course in which you are interested. Let us send you, without cost or obligation, the book which tells how you can quickly get into this big money field. Have your Ambu certificate this spring. Take the big step now, and mail this coupon today.

Ambu Engineering Institute,
Dept. 14, 2632 Prairie Ave., Chicago.

Please send me free booklet and complete information on Automotive Electricity. Tell me of the rich rewards which await me in this uncrowded field. I am interested in your (residence) (home study) course.

Name

Address

City



"I Got the Job!"

"I'm to be Manager of my Department starting Monday. The boss said he had been watching all the men. When he found I had been studying at home with the International Correspondence Schools he knew I had the right stuff in me. Now we can move over to that house on Oakland Avenue and you can have a maid and take things easy. I tell you, Nell, taking that course with the I. C. S. was the best thing I ever did."

Spare-time study with the I. C. S. is winning promotions for thousands of men and bringing happiness to thousands of homes all over the world. In offices, shops, stores, mines, mills and on railroads, I. C. S. trained men are stepping up to big jobs, over the heads of older men, past those whose only qualification is long service.

There is a Job Ahead of YOU

Some man is going to be picked for it. The boss can't take chances. He is going to choose a trained man with sound, practical knowledge of the work.

Get busy right now and put yourself in line for that promotion. You can do it in spare time in your own home through the I. C. S., just as more than two million men have done in the last 30 years, just as more than 130,000 men are doing today.

The first step these men took was to mark and mail this coupon. Make your start the same way—and make it now.

----- TEAR OUT HERE -----

INTERNATIONAL CORRESPONDENCE SCHOOLS
BOX 5623-C SCRANTON, PA.

Without cost or obligation please explain how I can qualify for the position, or in the subject before which I have marked an X:

- | | |
|---|---|
| <input type="checkbox"/> ELEC. ENGINEER | <input type="checkbox"/> BUSINESS MANAGEMENT |
| <input type="checkbox"/> Electric Lighting & Railways | <input type="checkbox"/> SALESMANSHIP |
| <input type="checkbox"/> Electric Wiring | <input type="checkbox"/> ADVERTISING |
| <input type="checkbox"/> Telegraph Engineer | <input type="checkbox"/> Show Card & Sign Ptg. |
| <input type="checkbox"/> Telephone Work | <input type="checkbox"/> Railroad Positions |
| <input type="checkbox"/> MECHANICAL ENGINEER | <input type="checkbox"/> ILLUSTRATING |
| <input type="checkbox"/> Mechanical Draftsman | <input type="checkbox"/> Cartooning |
| <input type="checkbox"/> Machine Shop Practice | <input type="checkbox"/> Private Secretary |
| <input type="checkbox"/> Toolmaker | <input type="checkbox"/> Business Correspondent |
| <input type="checkbox"/> Gas Engine Operating | <input type="checkbox"/> BOOKKEEPER |
| <input type="checkbox"/> CIVIL ENGINEER | <input type="checkbox"/> Stenographer & Typist |
| <input type="checkbox"/> Surveying and Mapping | <input type="checkbox"/> Certified Public Accountant |
| <input type="checkbox"/> MINE FOREMAN or ENGR | <input type="checkbox"/> TRAFFIC MANAGER |
| <input type="checkbox"/> STATIONARY ENGINEER | <input type="checkbox"/> Railway Accountant |
| <input type="checkbox"/> Marine Engineer | <input type="checkbox"/> Commercial Law |
| <input type="checkbox"/> ARCHITECT | <input type="checkbox"/> GOOD ENGLISH |
| <input type="checkbox"/> Contractor and Builder | <input type="checkbox"/> Common School Subjects |
| <input type="checkbox"/> Architectural Draftsman | <input type="checkbox"/> CIVIL SERVICE |
| <input type="checkbox"/> Concrete Builder | <input type="checkbox"/> Railway Mail Clerk |
| <input type="checkbox"/> Structural Engineer | <input type="checkbox"/> AUTOMOBILES |
| <input type="checkbox"/> PLUMBING & HEATING | <input type="checkbox"/> Mathematics |
| <input type="checkbox"/> Sheet Metal Worker | <input type="checkbox"/> Navigation |
| <input type="checkbox"/> Textile Overseer or Supt. | <input type="checkbox"/> AGRICULTURE <input type="checkbox"/> Spanish |
| <input type="checkbox"/> CHEMIST | <input type="checkbox"/> Poultry Raising <input type="checkbox"/> Banking |
| <input type="checkbox"/> Pharmacy | <input type="checkbox"/> Airplane Engines |

Name.....
Street.....
and No.....

City..... State.....

Occupation.....

Persons residing in Canada should send this coupon to the International Correspondence Schools Canadian, Limited, Montreal, Canada.

Please Mention Popular Mechanics

Free Course in Draftsmanship

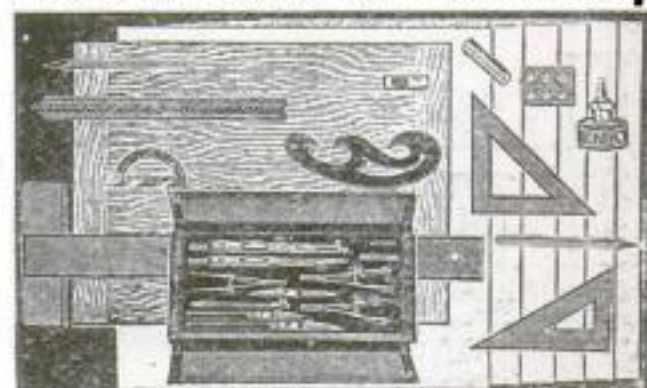

QUICK SUCCESS and MORE MONEY
Salaries up to \$100 per week. Here is your only OPPORTUNITY to get this wonderful, high-priced, Complete Drawing Outfit, including a FREE—PRACTICAL COURSE IN MECHANICAL DRAWING—AT OUR SPECIAL OFFER.

SEND NO MONEY

We ship FREE to any address in U.S., and you pay only \$11.98 on arrival—NO EXTRAS—Write to-day for this remarkable offer, with which you can build your Success in DRAFTSMANSHIP. You can put yourself in a class of Trained Men whose services are always in DEMAND.

EASY TO LEARN at HOME in YOUR SPARE TIME
And in your one chance to earn the biggest money of your life, and will be one of the most profitable investments you have ever made. **OUTFIT** consists of—(set) large size Professionals' Draftsman's drawing instruments, of Fine Nickel-silver, and set into a handsome Velvet Lined pocketbook folding case, size 4 by 8 1/2 inches closed—also, One Drawing Board, 20 by 24 1/2 inches—One 24-inch T Square—One 12-inch standard scale 1/16—One Protractor—Supply of drawing paper—Two Triangles—One French Curve—Pencil—Eraser—One bottle waterproof drawing ink—Thumb Tacks—and one enlarged Edition FREE—A PRACTICAL COURSE IN MECHANICAL DRAWING. You cannot make a mistake by taking up drawing, so—Guarantee Your Future and Act Now.

OFFER IS LIMITED—FURTHER PARTICULARS FREE
NATIONAL INSTRUMENT COMPANY
4704 North Hamilton Ave., Dept. M. Chicago, Ill.

Learn Autos and Tractors



Wonderful opportunities constantly offered trained men; we train you thoroughly to start your own business or make good money as motor expert, driver, shop foreman, etc.

7,000 Graduates making good. Catalog Free

Cleveland Automobile School, 1814 E. 24th St., Cleveland, O.

Delivered to You Free

for 30 days trial on approval. You can have your choice of **44 Styles**, colors and sizes of the famous **RANGER Bicycles**. Express prepaid. Factory-to-Rider Prices save you \$10 to \$25 on your bicycle.

12 Months to Pay if desired. Many boys and girls

parents often advance first payment. Best quality, at factory prices, express prepaid.

Tires Lamps, wheels and equipment, low prices. Send **No Money**, do business direct with makers.

Mead Cycle Company
Dept. C103 Chicago



STAMMERERS

For 55 years we have successfully corrected stammering by our simple and natural course of individual lessons. Attend no session until you have read our free booklet.

SAMUEL A. ROBBINS, Director,
Boston Stammerers' Institute
246 Huntington Ave. Boston 17, Mass.

Learn Watchwork, Jewelrywork and Engraving.

A fine trade commanding a good salary, and your services are always in demand. Address **HOROLOGICAL**, Dept. F, Bradley Institute, Peoria, Ill., for our latest catalog.

SELL US YOUR SPARE TIME

after enrolling for our course in Show Card Writing. We will train you to write show cards for us. No canvassing or soliciting; we supply you with work; distance no object; will pay you good money for work done.
Wilson Methods, Ltd., Dept. M, 64 E. Richmond, Toronto, Canada



Learn In the Great Shops of COYNE

Electricity Will Pay You Up to \$400 a Month and More

**YOU CAN DO
THE SAME**

**Read
These
Letters**



"Now the same man is my helper; my pay is bigger than his. He had been in the shop 2 years, but I'm a 'Coyne Man.'"—M. B. K.



"Eight years ago my time card read 'Laborer—\$1.50 a day.' Today my business turnover runs into thousands of dollars."—J. C. M.



"I'm taking care of generators and switchboards at Edison's, earning \$240 a month, thanks to Coyne."—D. O.

EARN WHILE YOU LEARN

You don't need to wait until you have saved up all the money you need to get this Electrical education. Our Welfare Department will help you get a part-time job at which you can earn money to help pay your way.

Auto Electricity Included

If you enroll within a limited time you get the full course in Automobile, Truck and Tractor Electricity without paying a cent above the cost of the Practical Electrical Engineering Course. THIS COURSE CAN BE TAKEN SEPARATELY IF DESIRED; if so desired state so when writing us. This is the finest course in America. The equipment is complete in every detail, and you get your instruction under experts in this branch of electricity. You learn wiring, ignition, lighting and starting systems of all cars, trucks and tractors; you learn how to make and repair batteries; you qualify as an expert auto electrician.

We Train You in Business

We want every one of our graduates to succeed in a big way. If you enroll within a limited

time, we give you, free, a full course in Business Management. You take this course at the same time you take the others. You learn how to manage a business and make money out of it, regardless of whether you work for others or go into business for yourself.

Own Your Own Business

This training, with that in Practical Electrical Engineering, and in Automobile Electricity opens the way to get into a big paying business of your own—as Electrical Contractors, Auto-Electricians, in Garages and Service Stations, as Armature Winders, Electrical Supply Dealers and as Battery Experts—anywhere.

Get Started Now!

Learn Electricity. Make big money. Be somebody. Make good and get real pleasure and satisfaction out of life.

Own your own car and home and be independent. You can do it. It's easy if you get the right start. Filling out the coupon tonight starts you right. If you never do anything you'll never get anywhere. Will you? Write for full particulars. You will want to reserve the right to get the free courses.

**GET YOUR LETTER
OFF TONIGHT!**

BENNETT W. COOKE,
President

**Coyne Trade and
Engineering Schools**
Dept. 14, 39-51 E. Illinois
St., Chicago, Illinois

Gentlemen: Send me your big free catalog with full particulars concerning your Electrical course and how I may secure your course of Auto Truck and Tractor Electricity and the course in Business Management, free. This places no under no obligation whatsoever.

B. W. COOKE

PRESIDENT

COYNE
TRADE AND ENGINEERING SCHOOL

Dept. 14, 39-51 E. Illinois Street, Chicago, Ill.

**SEND
COUPON
TODAY**

Name.....

Address.....



\$100.00 a Week

He Doubled His Pay

and now enjoys the comforts and pleasures of a real income

Why not double your pay? Thousands of our students have done it and thousands more will do it. You can be one of them. Do not think for a moment that it is luck or pull which brings success and real money—far from it. It is preparing for the big opportunity and knowing what to do when the right time comes that does it. The men who have made success for themselves were ready when their main chance came. Your main chance, too, will come. Are you ready for it?

Remember the Empty Lot?

The older fellows were playing ball and you were watching, wondering if you would ever get a chance to play. You knew if you only got a chance you would show them. Sure enough, one day they boomed, "Come on, kid, grab a bat!" Your chance at the pill had come. That is the way with life. Your chance at the pill will come, but, if you want to stay on the team, you will have to deliver the goods—and that you can do only if you are prepared. The big money and the permanent job go to the man "who knows."

You Can be the Man "Who Knows"

We will show you how. Without less to you of a single working hour, we can show you a sure way to success and big pay. A large number of men in each of the positions listed are enjoying their salaries because of our help. We want to help you. Make a check on the coupon against the job you want and we will help you get it. Write or print your name on the coupon and send it in today.

AMERICAN SCHOOL

Dept. G-474, Drexel Ave. and 58th St., Chicago

AMERICAN SCHOOL

Dept. G-474, Drexel Ave. and 58th St., Chicago

Send me full information on how the PROMOTION PLAN will help me win promotion in the job checked.

- | | |
|------------------------------|----------------------------|
|Architect |Lawyer |
|Building Contractor |Machine Shop Practice |
|Automobile Engineer |Photoplay Writer |
|Automobile Repairman |Mechanical Engineer |
|Civil Engineer |Shop Superintendent |
|Structural Engineer |Employment Manager |
|Business Manager |Steam Engineer |
|Cert. Public Accountant |Foremanship |
|Accountant and Auditor |Sanitary Engineer |
|Bookkeeper |Surveyor (& Mapping) |
|Draftsman and Designer |Telephone Engineer |
|Electrical Engineer |Telegraph Engineer |
|Electric Light & Power |High School Graduate |
|General Education |Fire Insurance Expert |

Name

Address

Please Mention Popular Mechanics

Stop Forgetting

Make Your Mind a File—Not a Pile

Let me show you how to make your mind as forget-proof as a card index file. When you wish to recall a name, place or date, must you grope in vain in a pile of miscellaneous knowledge? Summoned to give facts and figures does your mind become a blank? Be master of your mind's infinite resources—instead of a victim of its disordered details.

KNOWLEDGE IS POWER

and Memory Is the Basis of All Knowledge

I HAVE HELPED THOUSANDS

The Dickson Method of Memory and Mental Training, perfected by 20 years experience, is recognized as the most thorough, efficient of its kind. Highly endorsed—easy to master. Give me 10 minutes a day and I will train your memory so you can classify ideas, names, faces, etc., and recall them instantly. Develop self-control, concentration; overcome bashfulness.

Perfect Your Memory and Command What Salary You Will

Send name and address and I will send you free, my interesting booklet, "How to Remember," and unique, copy-righted Memory Test; also tell you how to secure free of charge my \$3.00 book, "How to Speak in Public."

Prof. Henry Dickson, Principal
DICKSON MEMORY SCHOOL
Dept. 705, 1041 Chicago Ave.
Evanston, Ill.



Stop Forgetting

The Key to Success

Complete Instruction in Auto Radiator Repairing

The Manual of Automotive Radiator Repair is a complete, practical course in book form. Thoroughly teaches construction, cleaning, soldering with iron and torch, rebuilding and rearing; many other subjects. 185 pages; 120 illustrations; strong, flexible binding.

Only
250
CENTS

LEARN RADIATOR REPAIRING; one of BIGGEST and BEST fields open. Start business of your own. Manual teaches everything needed. Easy to study and apply. Order TODAY. Consultation service and advice while learning given FREE by author. Write
CURFMAN & NULL CO., Maryville, Mo.

MINSTRELS Musical Comedies and Revues with Complete Instructions for Staging. You can put on your own show with our books. Opening Choruses and Finales, Skits and Afterpieces, Monologues, Songs, Vaudeville Acts. How to Stage a Minstrel Show, Wigs, Make-up. Big Catalogue free.
T. S. DENISON & CO., 623 So. Wabash, Dept. 19 CHICAGO

What 15c Will Bring You From the Nation's Capital

Only 15 cents gives you the **Pathfinder 13 weeks on trial**. The Pathfinder is a cheerful illustrated weekly, published at the nation's center for people everywhere; an independent home paper that tells the story of the world's news in an interesting, understandable way. This splendid national weekly costs but \$1 a year. The Pathfinder is the *Ford* of the publishing world. Splendid serial and short stories and miscellany. Question Box answers your questions and is a mine of information. Send 15 cents and we will send the Pathfinder on probation 13 weeks. The 15 cents does not repay us, but we are glad to invest in new friends.

THE PATHFINDER, 724 Langdon Sta., WASHINGTON, D. C.

LAW In Your Spare Time At Home for BUSINESS or PROFESSION
Degree of LL.B., Conferred. Only Institution which gives same Course by Correspondence through Lecture System as was given for years at resident classes of this college. We coach you free to pass the Bar Examination. Complete 1921, 15-volume library. Easy terms. Organized 1910. Low enrollment fee. Write for free book.
Hamilton College of Law, 431 S. Dearborn St., Dept. 64, Chicago



The Magic Power of A Few Little Lines



Have you ever noticed a cartoonist draw? A short line here. Another there. A small curve. A splash of shading—and you have a wonderful picture! It was all so easy—because he knew how—he knew which lines to use and just where to put them. Through this New Easy Way to Draw you too can learn the Magic Power of a Few Little Lines and how to make big money in drawing them!

New Easy Way to DRAW

How Easy!



Note how these few little lines are transformed into a picture.

One of the most fascinating, best paid businesses—yours, after a few minutes' training a day.



Delightful pastime! Endless fun! Acquire the knack in your spare time.

Invaluable asset in your present business. A few lines can drive home your intangible ideas. New way makes it easy to learn drawing.



THIS wonderful new method makes it possible for anyone to learn Illustrating, Cartooning, or Commercial Art. Hundreds of our students are now making splendid incomes. And most of them never touched a drawing pencil before they studied with us.

The simplicity of this method will astound you. You will be amazed at your own rapid progress. You learn by mail—yet you receive personal instruction from one of America's foremost Commercial Artists, of 30 years' successful experience, Frank Godwin and Wynn Holcomb (Wynn), the famous artists, are but two of his many successful students. Get into this fascinating game, NOW. You can easily qualify and make big money. A few minutes' study each day is all that is needed.

Newspapers, advertising agencies, magazines, business concerns—all are looking for men and women to handle their art work. Cartoonists and designers are at a premium.

Dozens of our students started work at a high salary. Many earn more than the cost of the course while they are learning! YOU—with a little spare time study in your own home—can easily and quickly get one of these big-paying artists' jobs.

This amazing method has exploded the old idea that talent is an absolute necessity in art—that "it's all a 'gift.'" Just as you have learned to write, this new method teaches you to draw. We start you with straight lines, then curves. Then you learn how to put them together. Now you begin making pictures. Shading, action, perspective, and all the rest follow in their right order, until you are making pictures that bring you from \$50 to \$500 or more! Many artists get as high as \$1,000 for a single drawing!

Big money is gladly paid—and big money is waiting for anyone with foresight enough to prepare for this pleasant profession. Through our new easy method of teaching, YOU can earn big money as an artist, regardless of your present ability. Mail coupon today for interesting booklet telling all about it.

Coupon Brings Fascinating Booklet

An interesting and handsomely illustrated booklet, "How to Become an Artist," has been prepared and will be sent to you without cost. It tells how you can easily become an artist in a few minutes' daily spare time and at the cost of a few cents a day. Explains about this amazing method in detail. Tells of our students—and their wonderful progress—and how we can qualify you for a high-salaried artist's position. Booklet gives full particulars about our "Free Artist's Outfit" Offer. This booklet will be sent free, and without obligation. Read all about this amazing New Easy Way to Draw and how you can quickly learn, at home in spare time. Fill out the booklet-coupon now. Mail it TODAY.



Mail coupon today for this fascinating booklet, and learn how you can become an Artist in a few minutes a day of your spare time. Cut out coupon and mail NOW.

The Washington School of Art, Inc.

1804 Marden Building, Washington, D. C.

Please send me, without cost or obligation on my part, your free book, "How to Become an Artist," and full details about your special Short-Time Offer.

Name.....
(State whether Mr., Mrs. or Miss.)

Address.....

Washington School of Art, Inc.
1804 Marden Bldg., Washington, D. C.



BECOME AN EXPERT ACCOUNTANT

The Profession That Pays Big Incomes

Never before have there been so many splendid opportunities for trained accountants—men whose training combines a knowledge of Auditing, Cost Accounting, Business Law, Organization, Management and Finance. Few professions offer better opportunities to young men of ambition and intelligence. The tremendous business growth of this country has created a rich field for the expert. There are only about 3,000 Certified Public Accountants to do the work of the half million concerns needing proficient accounting service. The expert accountant is also needed today in every big executive organization.

Knowledge of Bookkeeping Unnecessary to Begin

If you are ambitious, you can train for one of these big positions. The LaSalle Problem Method will train you by mail under the direct supervision of William B. Castenholz, A. M., C. P. A., former Comptroller and Instructor, University of Illinois, assisted by a large staff of Certified Public Accountants, including members of the American Institute of Accountants. You will be given whatever training, instruction or review on the subject of bookkeeping you may personally need—and without any expense to you. Our big free book on the accountancy profession fully explains how we train you from the ground up, according to your individual needs, from the simplest bookkeeping principles to the most advanced accounting problems. All text material supplied in the course has been especially prepared in clear, easy-to-understand language so that you can readily master the principles by home study.

Small Cost—Easy Terms

Mail the coupon now and get our free book which fully describes our expert training course and tells all about our Money-Back Guarantee, C. P. A. examinations, state regulations, salaries and incomes, and how you can qualify for a high-grade accounting position without interference with your present position. Send in the coupon and find out how we have helped more than 300,000 ambitious men, and learn what we can do for you.

LaSALLE EXTENSION UNIVERSITY
The Largest Business Training Institution in the World
Dept. 464HR Chicago, Illinois

Please send me catalog and full information regarding the course and service I have marked with an X below. Also a copy of your book, "Ten Years' Promotion in One," all without obligation to me.

Higher Accountancy: Training for positions as Auditor, Comptroller, Certified Public Accountant, Cost Accountant, etc.

Other LaSalle Training Courses
LaSalle is the largest business training institution in the world. It offers training for every important business need. If more interested in any of these courses, check here:

- | | |
|--|--|
| <input type="checkbox"/> Business Management | <input type="checkbox"/> Banking and Finance |
| <input type="checkbox"/> Salesmanship | <input type="checkbox"/> Modern Foremanship and Production Methods |
| <input type="checkbox"/> Traffic Management | <input type="checkbox"/> Personnel and Employment Management |
| <input type="checkbox"/> Railway Accounting and Station Management | <input type="checkbox"/> Expert Bookkeeping |
| <input type="checkbox"/> Law: Degree of LL. B. | <input type="checkbox"/> Business English |
| <input type="checkbox"/> Commercial Law | <input type="checkbox"/> Commercial Spanish |
| <input type="checkbox"/> Industrial Management Efficiency | <input type="checkbox"/> Effective Speaking |
| <input type="checkbox"/> Modern Business Correspondence and Practice | <input type="checkbox"/> C. P. A. Coaching |

Name.....
Present Position.....
Address.....

Please Mention Popular Mechanics

WE TEACH COMMERCIAL ART

Properly Trained Artists Earn \$100 a week and up. Meyer Both College—a Department of the Meyer Both Company—offers you a different and practical training. If you like to draw, develop your talent. Study this practical course—taught by the largest and most widely known Commercial Art Organization in the field with 20 years' success—which each year produces and sells to advertisers in the United States and Canada over ten thousand commercial drawings. Who else could give you so wide an experience? Commercial Art is a business necessity—the demand for commercial artists is greater every year. It's a highly paid, intensely interesting profession, equally open to both men and women. Home study instruction.

Get facts before you enroll in any school. Get our special booklet, "Your Opportunity"—for half the cost of mailing—4c in stamps.

MEYER BOTH COLLEGE
of COMMERCIAL ART
Michigan Ave. at 28th St.
Dept. 15 CHICAGO, ILL.

MUSIC LESSONS FREE

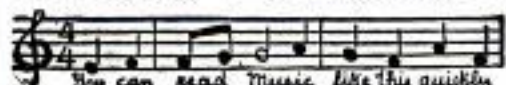

You can read music like this quickly

IN YOUR OWN HOME

Piano, Organ, Violin, Mandolin, Guitar, Banjo, etc. Beginners or advanced players. One lesson weekly. Illustrations make everything plain. Only expense about 2c per day to cover cost of postage and music used. Write for FREE booklet which explains everything in full.

AMERICAN SCHOOL OF MUSIC, 51 Lakeside Building, CHICAGO

-\$5,000 SALARIES-

are often paid to traffic managers. Numberless traffic positions pay \$2,500 to \$5,000 per year. Millions are wasted annually because of ignorance of cheaper ways to ship. You can be a traffic expert—stop losses—make big money for yourself. Thousands of men now needed.

Learn at Home—Book Free New home study Actual Practice Method will quickly make you a Certified Traffic Manager. You can very soon qualify for a splendid traffic position. Write quick for big new illustrated book describing this wonderful training in detail. Write today. Address: Dept. 104, 4043 Drexel Blvd. American Commerce Association CHICAGO, ILL.

LEARN WATCH REPAIRING

Be a watchmaker—you can learn this profitable trade by correspondence in a few weeks in your own home by the DeSelms Chart System. After you complete the course you will know a watch from A to Z. You will know just what the matter is and how to repair one. When you graduate you will be a practical watchmaker and repairer and competent to fill any position. Postage for our graduates.

Ask for our Free Book. It explains our system and terms

THE DeSELMS WATCH SCHOOL
23 Perry Street ATTICA, INDIANA



FREE LESSONS EXPERT AUTO and MOTOR WORK



Men—Boys, 15 or over, can easily learn Expert Motor and Auto operation and construction during spare moments

IN 10 WEEKS
Auto and Motor Experts frequently earn \$40 to \$90 a week

MAIL AT ONCE TO
Franklin Institute
Dept. B 433, Rochester, N. Y.

Send Coupon Immediately
Kindly send me absolutely free, sample lessons in MOTOR AND AUTO OPERATION AND CONSTRUCTION.

Name.....
Address.....

How I Increased My Arm $6\frac{1}{2}$ Inches

When a youngster, I was a thin, frail boy who showed little promise of being anything but a weakling. I always envied my robust companions and wished that I could be like them, but I had been told the old story that strong men are born, not made. What a terrible falsehood this is. And to think of the thousands of people who have been robbed of their ambition by these false teachings. When I entered High School I was fortunate enough to meet an instructor who was willing to work with me and who started me on my road to success. By faithfully following his teachings and by hard work, I gradually developed myself to have an average sized body so that I at least need not be ashamed. My arm measured 10 inches in circumference and my whole body had developed into fair proportions.

The Secret Discovered

I was so pleased with these results that I decided to make this my life study, so I bought all the books I could obtain on "human anatomy" and tested out various forms of exercise to see what their effects would be on my body. I finally discovered the real secret of progressive exercise and I want to say right here that a man discovering a gold mine was never more happy than I. I knew at once my fondest hopes would be realized. I could feel real vim and vigor thrilling my veins and I was soon able to accomplish feats of strength which hitherto I had thought impossible.

Friends who met me on the street began to look at me in astonishment. The boys started to call me the strong man and you can imagine how delighted this made me.

The Result

As I mentioned before, my biceps had measured but 10 inches before I made this discovery. Today they are exactly $16\frac{3}{4}$ inches. This is not only far beyond that of the average strong man of today, but is conclusive proof to me that my secret method far surpasses that of any other system.

Numerous demands were soon made of me to appear in public displaying my wonderful development and also to perform the numerous strength tests which I was able to accomplish. After traveling throughout the country having my name as the headliner in the various theatrical houses, I decided to become a public benefactor and impart this knowledge to others. Today my pupils run into the thousands and I receive letters daily from other men who have sprung into prominence like myself by following my guidance and instructions.

What This Means to You

You too can have this powerful physique and abounding health if you wish it. I don't care how weak you are, I will broaden your shoulders, deepen your chest and give you the same powerful arms and legs which I have developed for myself and thousands of others.

Don't Delay

If you only knew what perfect health meant, you would not hesitate one minute. And the joys of a strong muscular body can never be described. Don't waste your time with foolish methods that cost both time and money. What you want is guaranteed results and you want them in the shortest possible time. Don't take my word for it, make me prove it.

Send for my new book

"MUSCULAR DEVELOPMENT" IT IS FREE!

It tells the secret, and is handsomely illustrated with 26 full-page photographs of myself and some of the world's best athletes whom I have trained, also full particulars of my splendid offer to you. The valuable book and splendid offer will be sent you on receipt of only 10 cents, to cover wrapping and mailing. Sit right down now and fill in the coupon. The sooner you get started on the road to health and strength, the easier it will be to reach perfect manhood. Don't drag along one day longer—mail the coupon today.

EARLE E. LIEDERMAN
Dept. 2004, 305 Broadway, New York



EARLE E. LIEDERMAN
The Acme of Physical
Perfection

EARLE E. LIEDERMAN,

Dept. 2004, 305 Broadway, N. Y. City

Dear Sir:—I enclose herewith 10 cents, for which you are to send me, without any obligation on my part whatever, a copy of your latest book, "Muscular Development." (Please write or print plainly.)

Name.....

Address.....

City..... State.....



**MEN WANTED!
POSITION
GUARANTEED!**

**BE A RAILWAY
TRAFFIC INSPECTOR**

**Earn Up to \$250 per Mo.
Expenses Paid**

THERE are hundreds of openings for trained Railway Traffic Inspectors. Any average man can qualify. Steady, pleasant, outdoor work; travel or remain near home. Something new every day.

Splendid Opportunities

Start at \$110 per month, expenses paid, after 3 mos. spare-time study at home. Advancement rapid with experience. Earn up to \$250.00 and \$300.00 per month. Many splendid opportunities thru contact with big railway officials.

Read What Mr. W. J. Sugg Says:

"Since completing the course, I have been employed by one company in the most pleasant work that has ever been my good fortune to be engaged in. I received a raise in my salary soon after beginning with this company. Without your wonderful course, this could never have been possible. I feel I can't say too much for the Standard Business Training Institute and its good promoters."

YOU TAKE NO RISK

If position is not obtained for you, enrollment fee is refunded without question. You have nothing to lose!

Send coupon for full details and booklet No. D-583

**STANDARD BUSINESS TRAINING INST.
BUFFALO, N. Y.**

**Standard Business Training Inst.
Buffalo, N. Y.**

Send me, entirely free, Booklet No. D-583 giving full particulars about course in Railway Traffic Inspection.

Name.....

Street.....

City.....

BE AN ARTIST

We can teach you **DRAWING** in your own home during your spare time.

Our 18 years of successful teaching prove our ability. 10 Courses in Commercial and Illustrative Drawing. Teachers Normal and Applied Art. Endorsed by high art authorities. Students trained by members of our Faculty are filling high-salaried positions. Artist's Outfit FREE to Enrolled Students. Write today for Art Year Book.

OUR HANDSOME ART YEAR BOOK FREE TO YOU!

SCHOOL OF APPLIED ART
APPLIED ART BLDG. No. 2 BATTLE CREEK MICH.

Learn Photography

Good-paying positions in the best studios of the country await men and women who prepare themselves now. For 28 years we have successfully taught **Photography, Photo-Engraving and Three-Color Work**. Our graduates earn \$25 to \$100 a week. We assist them to secure these positions. Now is the time to fit yourself for an advanced position at better pay. Terms easy; living inexpensive. Largest and best school of its kind. Write for catalog today.

ILLINOIS COLLEGE OF PHOTOGRAPHY
Box P. 999 Wabash Ave. Effingham, Illinois

STAMMER NO MORE

Kill the fear of stammering. Re-education the key. The widely famed Hatfield Method fully outlined in an accurate, dependable, worth-while book—"HOW TO STOP STAMMERING." It has inspired thousands. Free copy today.

THE HATFIELD INSTITUTE, 109 N. Dearborn, Chicago, Ill.

BE AN EXPERT Penman

FREE Particulars, "How To Become An Expert Penman," and Your Name in Fine Penmanship on two Cards, Different Colors, Embellished, Attractive Designs. ALL FREE. Write Today
T. M. TEVIE, Box 25-N, Chillicothe, Mo.

OH BOYS-GIRLS GREAT SPORT

THROW YOUR VOICE

Into a Barrel, under the Table, Back of a Door, into a TRUNK, DESK, in SCHOOL, Any Old Place. Great FUN fooling the TEACHER, friends, EVERYBODY with Our **CLAXOPHONE**

Which Sets on your Tongue Unseen, it NEVER FAILS Anybody Int. Birds, etc. The CLAXOPHONE, with Full Instructions, a Set of SECRET-WRITING TRICK (best in use), a MAGICAL Trick, (a Great Money maker), ALSO, This Marvelous Novelty—

NEW SCIENTIFIC WONDER
"X-RAY CURIO"
3 FOR 25c. BIG FUN

With it you Apparently See thru Clothes, See the bones in your Fingers, Lead in Peas, etc. No end of fun. WE SEND ALL ABOVE Novelties by prepaid Mail for 10c 3 for 25c. A nice Souvenir Free with each 25c order.

CLAXO TRICK CO., Dept. X-P, NEW HAVEN, CONN.
WE GIVE the BEST and MOST for the MONEY.

Repair Any Auto or Auto Truck

Examine These NEW AUTO BOOKS FREE

Be an expert auto repair man. You can have the skill that makes every complicated trouble as easy to fix as taking out a spark plug. Learn every detail of all makes of cars and trucks. Know exactly how to find what's wrong and how to make all repairs quickly. These great new Auto Books show you how.

Make Money Repairing Autos

Over 8 million cars are in operation and thousands of men are needed to keep them in good going condition. There are more jobs open than there are good men to fill them. Never before have expert auto repair men been in such great demand and made so much money. Now is your great money-earning opportunity in the auto repair business. Every mechanic, every chauffeur, every car owner needs this great New Library of Automobile Engineering.

Tells About
Explosion Motors, Welding, Motor Construction and Repair, Carburetors and Settings, Valves, Cooling, Lubrication, Fly-Wheels, Clutch, Transmission, Final Drive, Steering, Frames, Tires, Vulcanizing, Ignition, Starting and Lighting Systems, Shop Kinks, Public Garage Design, Equipment and Operation, Electrics, Storage Batteries—Care and Repair, Steam Cars, Motorcycles, Commercial Trucks, Glossary. More than 100 blue prints of Wiring Diagrams.

75c a Week If You Decide to Buy

Let us send you the complete six-volume set of Automobile Engineering for one week's examination. Read the simple directions for repairing every automobile trouble. Six thick volumes, 5½x8½ inches, flexibly bound and stamped in gold, 2,650 pages, 2,100 illustrations, wiring diagrams, etc. Everything in plain, every-day language, simple to understand. If you decide to keep them, send only \$2.80 in seven days, and \$3 a month thereafter until the special introductory price of \$24.80 has been paid. The regular price is \$45.00, so you save \$20.20 by acting at once.

Send No Money

Don't send a penny! Your name and address in the coupon brings the six books to you at once for seven days' trial. With each set we give you absolutely free a \$12 Consulting Membership, entitling you to ask our staff of automobile experts as many questions as you wish, a whole year free.

Mail Coupon NOW

American Technical Society
Dept. A-194 Chicago, U. S. A.



Starting and Lighting



Welding

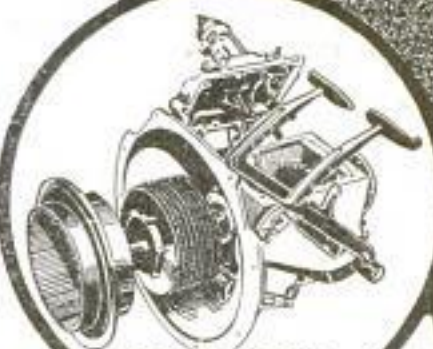

Transmission

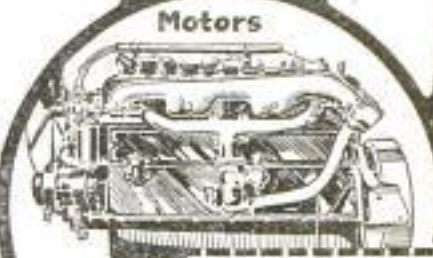

Motors

AMERICAN TECHNICAL SOCIETY

Dept. A-194, CHICAGO, U. S. A.

Please send me the six-volume set of Automobile Engineering for seven days' examination, shipping charges collect. If I decide to buy, I will send \$2.80 within seven days and balance at \$3.00 a month until \$24.80 has been paid. Then you will send me a receipt showing that the set of books and the Consulting Membership are mine and fully paid for. If I think I can get along without the books, I will return them, after 7 days, at your expense.

Name.....

Address.....

Reference.....



Do You Like to Draw?

Here Is a Simple, Easy Way
to Draw a Comic Face

TRY IT

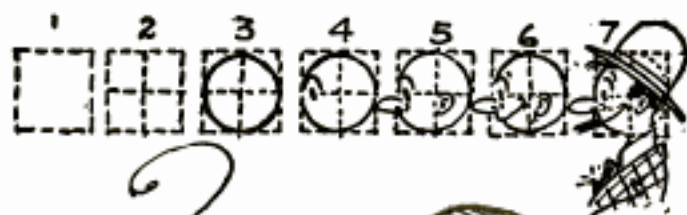

Make a square with pencil, then add to it with pencil as shown in the small squares above. Erase all pencil guide lines after the drawing is completed.

We will not give you any "grand prize," if you draw this picture. Nor will we claim to make you "rich in a week." But if you are anxious to develop your talent with a **successful cartoonist**, so you can **make money**, send a copy of this picture with six cents in stamps for portfolio of cartoons and sample lesson plate, and let us explain more in detail. Some of the **most successful cartoonists** are former students of this school. It is not hard to learn to draw **originals** when you are shown how in a **practical way**.



THE W. L. EVANS SCHOOL OF CARTOONING
"The School That Has the Reputation"
821 Leader Bldg. CLEVELAND, OHIO

Music Lessons

UNDER MASTER TEACHERS

At Home

A Complete Conservatory Course By Mail

Wonderful home study music lessons under great American and European teachers. Endorsed by Paderewski. Master teachers guide and coach you. Lessons a marvel of simplicity and completeness.

Any Instrument Write telling us course you are interested in—Piano, Harmony, Voice, Public School Music, Violin, Cornet, Mandolin, Guitar, Banjo or Reed Organ—and we will send our **FREE CATALOG** with details of course you want. Send **NOW**.

University Extension Conservatory, 545 Siegel-Myers Bldg., Chicago, Ill.

Free to Writers!



A WONDERFUL BOOK—read about it! Tells how easily Stories and Plays are conceived, written, perfected, sold. How many who don't **DREAM** they can write, suddenly find it out. How the Scenario Kings and the Story Queens live and work. How bright men and women, without any special experience, learn to their own amazement that their simplest Ideas may furnish brilliant plots for Plays and Stories. How one's own Imagination may provide an endless gold-mine of Ideas that bring Happy Success and Handsome Cash Royalties. How new writers get their names into print. How to tell if you ARE a writer. How to develop your "story fancy," weave clever word-pictures and unique, thrilling, realistic plots. How your friends may be your worst judges. How to avoid discouragement and the pitfalls of Failure. **How to win!** This surprising book is **absolutely free**. No charge. No obligation. Your copy is waiting for you. Write for it now. Just address **AUTHORS' PRESS, Dept. 216, AUBURN, NEW YORK**

HIGHER EDUCATION

HOME STUDY

Courses in English, Spanish, Mathematics, Chemistry, Drawing, Education, Business and in 35 other subjects are given by correspondence. Begin anytime.

The University of Chicago

30th Year

Division 4, Chicago, Ill.

LEARN MOTOR MECHANICS

Our Big Shop Standard methods prepare you for the best paying jobs—make you a real mechanic. Test and Trouble work alone is worth tuition. Completely equipped shops. Get full information.

Write for **Big Free Book**

IOWA STATE AUTO & TRACTOR SCHOOL
"The Quality School" 739 Nebraska St., Sioux City, Iowa

"STAMMERING

Its Cause and Cure"

You can be quickly cured if you stammer. Send 10 cents, coin or stamps, for 288 page cloth bound book on Stammering and Stuttering. It tells how I cured myself after Stammering and Stuttering for 29 years. **BENJAMIN N. BOGUE**
739 Bogue Building, 1147 N. Ill. St. Indianapolis

LEARN WATCH REPAIRING



You can learn by our modern and original system of instruction every part of the Watch Repairing Trade at home as good or better than at a shop. You can earn money while learning and secure a well paying position or start in business after completing our course of instruction. Good watch repairers are always in demand and earn from \$30 to \$70 per week. For particulars apply to the **WISCONSIN SCHOOL OF WATCH REPAIRING**
166 Mason St., MILWAUKEE, WIS.

ENGINEERS JUST OUT A \$10,000 MASTER SET ON LATEST ENGINEERING



AUDEL'S ENGINEERS & MECHANICS GUIDES \$12^{COMPLETE}

\$1 4750 PAGES—8754 ILLUSTRATIONS—POCKET SIZE—FLEXIBLE

Every Engineer, Mechanic and Electrical Worker will welcome this "New Eight Master Set." It will prove to be a sure source of advancement and higher pay. Contains complete, up-to-date information that is thoroughly and easily explained on every branch of Modern Engineering and Electrical Practice. These new Engineers' and Mechanics' Guides answer your problems. They will help you with your daily work.

THESE BOOKS TELL YOU ALL ABOUT—

- ALL Steam, UNIFLOW and POPPET VALVE ENGINES, LOCOMOBILES, Locomotive and Marine Engines; Turbines, Rotary Engines—The Indicator—Lubrication—PRACTICAL MANAGEMENT. GAS, GAS ENGINES—Aeroplanes and Aviation—Rules and Formulae. Steam Boilers: Heat-Combustion; Fuel and Flue Gas Analysis—CO₂ Recorders—Boiler Construction. Mechanical Stokers—Oil Burners—Setting—Chimneys—Mechanical Draught—BOILER DESIGN. Pipes, Fittings, Heating and Ventilation—Refrigeration—Cooling Towers—Condensers—Distilling Apparatus—Elevators—Cranes—Ropes and Cables—Splicing—Practical Electrical Engineering, covering entire field of Modern Electricity

SHIPPED TO YOU FREE

Not a cent to pay until you see the books. No obligation to pay unless you are satisfied. Send coupon now—today—and get this new Master Set for Engineers and Mechanics and see if it is not worth \$100 to you. Pay only \$1 a month.

SEND NO MONEY—SEND ONLY THIS COUPON

THEO. AUDEL & CO., 72 Fifth Ave., New York City

Please submit me for Free Examination. I agree to send you \$1 with-
in seven days, and to further mail you \$1 each month until \$12 is paid.

Name.....
Occupation.....
Employed by.....
Home Address.....
Reference.....
P. M.
Apr. 22

BOYS



Learn Drafting

DRAFTING offers exceptional opportunities to boys and young men because drafting itself not only commands good pay, but it is the first step towards success in Mechanical or Structural Engineering or Architecture. And drafting is just the kind of work a boy likes to do. There is an easy, delightful way by which you can learn right at home in spare time. For 30 years the International Correspondence Schools have been giving boys just the training they need for success in Drafting and more than 300 other subjects.

Let the I. C. S. help you. Choose the work you like best in the coupon, then mark and mail it. This doesn't obligate you in the least, but it will bring you the information that will start you on a successful career. This is your chance. Mark and mail this coupon now.

----- TEAR OUT HERE -----

International Correspondence Schools
Box 5621-C, Scranton, Penna.

Without cost or obligation, please send me complete information about the subject which I have checked below:

- | | |
|---------------------------------------|---|
| <input type="checkbox"/> DRAFTING | <input type="checkbox"/> BUSINESS |
| <input type="checkbox"/> CARTOONING | <input type="checkbox"/> CIVIL SERVICE |
| <input type="checkbox"/> AUTOMOBILES | <input type="checkbox"/> PHARMACY |
| <input type="checkbox"/> CHEMISTRY | <input type="checkbox"/> ARCHITECT |
| <input type="checkbox"/> ADVERTISING | <input type="checkbox"/> BOOKKEEPER |
| <input type="checkbox"/> SALESMANSHIP | <input type="checkbox"/> GOOD ENGLISH |
| <input type="checkbox"/> ELECTRICITY | <input type="checkbox"/> WIRELESS |
| <input type="checkbox"/> ACCOUNTING | <input type="checkbox"/> CIVIL ENGINEER |
| <input type="checkbox"/> SURVEYING | <input type="checkbox"/> AIRPLANE ENGINES |

Name.....

Address.....

Occupation.....

Persons residing in Canada should send this coupon to the International Correspondence Schools Canadian, Limited, Montreal, Canada

Please Mention Popular Mechanics

SPANISH LEARNED EASILY AND QUICKLY!

Also FRENCH and ITALIAN

Another language will enable you to make more money—whether you are an employer or employee, professional man or woman, boy or girl. **A Few Spare Minutes Can Increase Your Income** Learning a new language by the Rosenthal Language Phone Method, is as easy as learning a new tune. Study when you are in the mood—in the comfort of your own home—on your own phonograph. Soon, you can talk, read and write Spanish, French or Italian.

ROSENTHAL LANGUAGE PHONE METHOD

makes rapid progress possible

Any number of people can learn at the same time—the whole family or groups of friends.

FREE 64-Page Book. It shows how easy, interesting, and profitable it is to learn a foreign language; and explains Dr. Rosenthal's world-famous method of quick study. Also details of **FREE Trial offer.** Send a postal—*to-day.*

FUNK & WAGNALLS COMPANY
549 Hess Building, 354 Fourth Ave., N. Y.



ELECTRICAL ENGINEERING men with training are in demand. For more than a quarter of a century this school has been training men of ambition and limited time, for the electrical industries. Condensed course in Electrical Engineering enables graduates to secure good positions and promotions. Theoretical and practical Electricity, Mathematics, Steam and Gas Engines, Mechanical Drawing. Students construct dynamo, install wiring and test electrical machinery. Course with diploma, complete.



Thoroughly equipped fireproof dormitories, dining hall, laboratories, shops. Over 3000 men trained. Write for catalog. 30th year begins Sept. 27, 1923.

BLISS ELECTRICAL SCHOOL

404 TAKOMA AVENUE, WASHINGTON, D. C.



HOW TO BECOME A PROFESSIONAL PHOTOGRAPHER

Earning \$35 to \$125 a Week

An interesting illustrated booklet (free) on choosing a vocation, the exceptional opportunities Photography offers you and how to avail yourself of these advantages.

Motion Picture—Commercial—Portraiture

Three to six months' course. Practical instruction. Modern equipment. Day or evening classes. Easy terms. Call or write for Catalog No. 49.

N. Y. INSTITUTE OF PHOTOGRAPHY
141 W. 36th St., N. Y. or 505 State St., Brooklyn



SHORTHAND IN ONE MONTH

Boyd—the Wonderful, New, Easy System. Writers hold World's record. 100 to 150 words a minute in 30 days guaranteed. New Principles—dictation first week. Best for Court Reporting and Secretaries. Also Typewriting, Bookkeeping and Commercial Law. Send today for Catalog and Money-Back Guarantee. CHICAGO HOME STUDY SCHOOLS, 862 Resper Block, Chicago, Ill.

LEARN WATCHMAKING AND ENGRAVING

Earn while learning. Most practical watch school. Individual instructions. Graduates in great demand. Book free. Chicago School of Watchmaking, Dept. 20, State-Lake Bldg., Chicago

Our Scientific Method will stop that
STAMMER!
Send for free 200 page book. It tells how to permanently stop stammering or stuttering in a few weeks' time. A natural guaranteed method.
The Lewis School for Stammerers
32 Lewis Bldg., 71-77 Adelaide St., Detroit, Mich.

FREE "Linene" COLLAR
For trial, a sample of our New Style Collar, if you send 2 cents for postage and state size wanted.
Reversible Collar Co., Dept. G., Boston, Mass.

BIGGER AND BETTER THAN EVER!



My policy for GREER COLLEGE OF AUTOMOTIVE ENGINEERING has always been to give our students the very best instruction and training possible. We aim to turn out *real* automobile men—**Certified Automotive Engineers.**

And now, in order to give our Students still greater advantages, we have moved into our new building, all of which is used by Greer College for automotive educational training. In these seven big floors we have much more room, better equipment, better light—finer in every way. Here students study and work on the actual parts of all kinds of cars, under the direction of competent instructors.

BE A "C.A.E." (*Certified Automotive Engineer*)

The prestige enjoyed by Greer graduates is your cue. *A Greer Diploma means something.* Graduate from *Greer College of Automotive Engineering* and be recognized as "*The Man Who Knows.*" Greer students who complete the course and earn their diplomas become *Certified Automotive Engineers.*

REAL INSTRUCTION

It is not enough to merely go to some automobile school for a few weeks. You want to go to the College that makes Master Mechanics, real Certified Automotive Engineers. That means, Greer College of Automotive Engineering. Here we always aim to give such instruction and training that Greer graduates will continue to be recognized as the best. Here we prepare you for success. Write for *free* catalog today.

VALUABLE BOOK FREE A new up-to-date edition of my book, "*How to Succeed,*" has just been published. Full of useful and practical information. Worth \$1.00 per copy—yet sent free to anyone interested. Write today.

Orwin Greer

GREER COLLEGE
of Automotive Engineering
2024 So. Wabash Ave., Dept. 14, Chicago,

**GREER COLLEGE
OF AUTOMOTIVE
ENGINEERING**

2024 Wabash Avenue,
Dept. 14, Chicago, Ill.

Please send me free your big book as advertised in the April Popular Mechanics. Am interested in subjects before which I mark X.

Automobiles Vulcanizing
 Tractors Electric Starters
 Batteries Welding

Name.....

Present Occupation.....

Street or R. F. D.....

City..... State.....

Get Your Name on This Electrical Pay Roll

Weekly Pay Roll	
W. E. Pence	Automotive Elect. Expert \$185 a week
C. E. Lockhart	Contracting Dept. \$120 a week
A. F. Klemz	Supt. Elect. Construction \$150 a week
Harry E. Wolf	Chief Electrician \$100 a week

"I have letters from these men and hundreds of others telling how I helped them out of small-pay jobs into these big-pay positions."

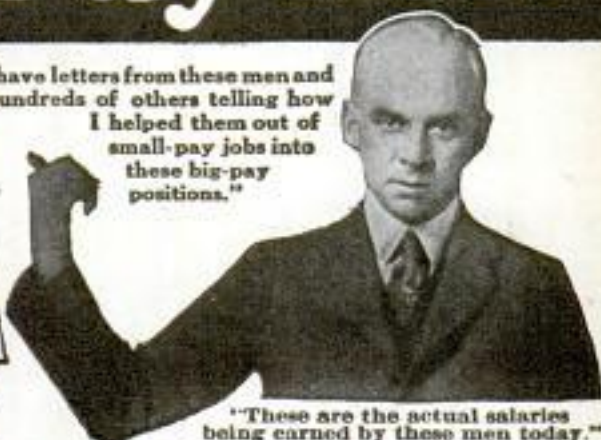

"These are the actual salaries being earned by these men today."

Electrical Experts Earn \$3,500 to \$10,000 a Year

Get out of the small-pay, hard-work class. Earn \$12 to \$30 a day as an Electrical Expert. You can do it. Trained Electrical Men are needed everywhere at the highest salaries. The opportunities for advancement are the greatest ever known. Even the ordinary electrician is highly paid, but you can be an Expert—the man who bosses the big jobs.

Let Me Help You to a Big-Pay Job

I am Chief Engineer of the Chicago Engineering Works and I know exactly what you need to insure your success. I guarantee to give you that knowledge. In a few short months I can fit you to hold down one of the finest paying jobs in the world.

Earn Extra Money While You Learn

Learn right in your own home without losing an hour's time from the work you do now. In fact early in my course I show you how to make extra money doing spare time electrical work. Many of my students earn as high as \$35 a week in addition to their regular pay.

Age or Education Makes No Difference

You don't have to be a college man—not even a high school graduate. If you can read and write English I can make a big success of you. My Electrical Course is the most simple, thorough and successful course in existence. It has revolutionized training by correspondence. It has dozens of successful features never before attempted.

Mail Coupon for My Book "Vital Facts"

Let me send you my big free book of "Vital Facts"—let me tell you more about how you can jump from a "bossed" to a "bossing" job—a regular man's size job that pays \$70 to \$200 a week. Fill out and mail the coupon NOW before you turn this page.

L. L. COOKE, Chief Engineer,
CHICAGO ENGINEERING WORKS
Dept. 14, 2150 Lawrence Ave., Chicago

FREE Electrical Outfit

You need tools, material and instruments to do the practical work I teach—these I give to you absolutely free—there is nothing for you to buy. You are also privileged to use my Electrical Laboratories without cost, as well as my students employment department which helps you land a good job.

Money-Back Guarantee

You take no risk when you enroll for my Course. Under bond, I guarantee to return every penny paid me if you are not entirely satisfied with my instruction. A Million Dollar Institution stands back of me in this guarantee.

L. L. COOKE, Chief Engineer
Chicago Engineering Works
Dept. 14, 2150 Lawrence Avenue,
Chicago, Ill.

Dear Sir: Send at once Sample Lessons, your Big Book "Vital Facts," and full particulars of your Free Outfit and Home Study Course—all fully prepaid without obligation on my part.

Name.....

Address.....



The "Cooke" Trained Man is the "Big Pay" Man

CLASSIFIED ADVERTISEMENTS

WORLD'S BEST WANT AD MEDIUM

Advertisements in this section, 25 cents per word, each insertion, minimum 10 words, payable in advance. To be inserted under proper classification in May issue, copy should be in our office March 25th.

AUTOMOBILE SUPPLIES

AUTO Parts for any car. We save you 10 to 90% and ship same day order is received. Have gears, shafts, bearings, springs, pistons, pins and rings, bushings, cylinder-head gaskets, top slip roofs, clutch leathers, radiators, coils, magnetos, Atwater-Kent, Connecticut, Delco, Remy Ignition systems and parts. Radiators for Ford \$14.00, Chevrolet \$22.00, Chevrolet crankshaft \$13.00. Top roof recoverings Ford touring \$6.50, Ford roadster \$5.20. Send forty cents in stamps for one can quick tube repair outfit. Rex All Season Sedan-type tops seven-passenger Nash \$15.00. When you want auto parts write us, giving make model, and parts wanted. We have it, will get it, or it is not made. We guarantee to please you or will refund your money. Auto Tire & Parts Co., 501 Broadway, Cape Girardeau, Mo.

BATTERY Stations build your own equipment from "Proser" plans. Test bench, \$1.50; magnetizer, 50c; plate press, 50c; high rate discharger, 50c; rheostat, 50c; steamet, 50c; complete set \$3.00. P. R. Electric Starter Co., Dept. M, 7335 Vincennes Ave., Chicago, Ill.

AUTO Parts—Save 25-90%. New gears, axles, bearings, springs, radiators, magnetos—4,000 models. Bankrupt supplies, recapping outfits. Brightman Auto Exchange, 321 Windsor Ave., Hartford, Conn. Largest in the East.

USED Parts in good working condition. Axles, gears, bearings, generators, starters, magnetos; armatures rewound; Continental Six engines, \$75.00; Oakland Six engines, \$75.00. Sisson Mechanical & Electrical Laboratory, Marshall, Ill.

"READ" Ball-Bearing Clutch Screw doesn't drag. It rolls. Makes Hand Brake Operate Easily, 20c (coin). Address "Read," 78 Kingston Ave., Brooklyn, N. Y.

REBUILD Your old tires at home. New method. No stitching, vulcanizing or special tools required. Complete instructions, 25c (coin). H. C. Rowell, Hudson, N. H.

AIR Compressors—Genuine Brunner Compressors, new, on very attractive terms; send post card. Brunner Mfg. Co., Dept. A, Utica, N. Y.

GARAGEMEN, repairmen, mechanics and dealers will be greatly interested in each issue of American Garage & Auto Dealer, for it features a wide range of important subjects, including vulcanizing, welding, accounting, shop hints, business management, advertising, selling, etc. Here is what a North Dakota garageman writes: "I got one idea from you that will just double my sales in 1922." A Southern dealer says: "Every issue is worth the subscription price—we can't get along without your wonderful magazine." 12 months for \$1.00 anywhere in U. S. (\$1.50 Canada or foreign.) Satisfaction guaranteed or money returned. Mail dollar bill, check or money order. American Garage & Auto Dealer, 1004 Lake View Bldg., Chicago, Ill.

COMPTON Spring Oilers automatically lubricate springs, clean rust, stop squeaking, make smooth riding. Quickly attached. Send \$4.00 complete set eight. Special Ford set \$2.00. Compton's Oiler Company, 29 Broadway, New York, N. Y.

BATTERY Stations—Save your broken Battery Jars. Our Hard Rubber Cement makes them good as new; Dollar Bottle; money with order. Address, Cement Works, Peace River, Alberta.

FAN Belts for Fords guaranteed one year, water and oil proof—25c. State Model of car. Address Leather Products Co., Philadelphia, Philadelphia, Pa.

AUTOMATIC Auto Jack, tire-saving device whereby a car can be driven on by its own power; fully tested. Particulars. Hy Schrieber, Nashville, Ill.

PROTECT Your rights. Write for Record of Invention which contains form to establish evidence of conception of your invention. Prompt personal service. Preliminary advice without charge. J. Reaney Kelly, 612 G. Columbian Bldg., Washington, D. C.

SOMETHING new. Gas Economizer tried on Dodge; greatest ever invented. Write. K. H. Schrieber, Nashville, Ill.

AUTOMOBILE parts, guaranteed new, for all cars. Save money; get parts direct at wholesale. We ship immediately from stock transmission and differential gears, Hyatt, Timkin, annular ball and connecting rod bearings, pinion and axle shafts, cylinder-head gaskets, fly wheel gear rings, pistons, pins, rings, bushings, and clutch facings for any car. Get our low prices today. State make of car, model, and parts wanted. We refund your money, including transportation charges, if you are not satisfied. Mechanics Gear Works, Dept. 2, 1446 Catalpa Ave., Chicago, Ill.

AGENTS wanted for Cities and Counties for newly patented automobile accessory. Install it on every Ford and the money is yours. No talking or argument. Ackswell Mfg. & Sales Co., Inc., Northport, N. Y.

ANY Ford chassis plus a Patton body will give you a handsome reliable car. Bodies \$59 and up. Write for free illustrated folder. E. J. Patton Co., 784 Garfield Ave., Aurora, Ill.

Investment \$30⁰⁰

Returns 80,000⁰⁰

AN advertiser invested \$30 in classified advertising in *Popular Mechanics Magazine* and the business resulting to date amounts to \$80,000, with several large deals still pending.

More information will be sent on request.

Popular Mechanics Magazine
6 No. Michigan Ave. Chicago

AUTO-LAVATORY Keeps Motorists-Passengers Clean. Perfected. Invisible. Automatic. Easily Installed. Most Needed Refinement. \$9.75, guaranteed. OK Carbon Gun Kills Carbon Scientifically—\$2. Cannon Manufacturing Co., Alliance, Ohio.

STORAGE Batteries direct from factory. \$15.00 to \$27.00. Write today, giving make and model of car. Absolute guarantee. Akeley-Steel Co., Aurora, Ill.

CYLINDERS re-ground, new pistons and rings fitted. Restores lost power. Write for prices, giving make and model. The Evaris Machine Co., Hartford, Conn.

AUTOMATIC Compressors, Grinders, Battery Chargers, Motors. Unusually easy terms. Write us your needs. Hobart's, Troy, Ohio.

STORAGE Battery Charging Earns Unusual Profits, using HB Chargers. \$20 starts. Balance payments. Hobartsons, Troy, Ohio.

AUTO Parts—Slightly used parts from cars we wreck. Duplicates for almost any make car at 50% to 75% off list. New Cars—We are distributors for all standard makes of differential and transmission gears—for any make and model of car. Satisfaction guaranteed or money refunded. Send in your old parts and we will duplicate them. Address Auto Parts Supply Co., "Everything for the Automobile," 1522 Grand Ave., Kansas City, Mo.

AUTO Top Roof Recoverings, easy to put on. You drive 100 yards and save \$15 to \$40. Ford Roadster \$5.20. Touring \$6.95. Other cars \$14 and \$16, with plate glass curtain lights. Side curtains that open with doors \$10.00 and up; others \$6.50 up. Delivered at your door. Seat covers \$3.10 up. Write for catalog, samples free. Equipment Co., 30 Canal, Cincinnati, Ohio.

STORAGE Battery Plates, Separators, Rubber Jars, "Best Make" Gillette Process, Gillette Battery Corp., 2218 Wabash Ave., Chicago.

FREE Inner Tubes, Veteran's War Patent, Photographer, National Home, Ohio.

AIR Compressor with Tank and Hose, \$49. Motor for same \$22.50. Equipment Co., 21 Canal, Cincinnati, Ohio.

AUTOMOBILE Owners, Garagemen, Mechanics, Repairmen, send for free copy of our current issue. It contains helpful, instructive information on overhauling, ignition troubles, wiring, carburetors, storage batteries, etc. Over 120 pages, illustrated. Send for free copy today. Automobile Digest, 506 Butler Bldg., Cincinnati.

AUTO Motors Supplies: Buick—Michigan—Stoddard-Dayton—E. M. F.—Cadillac—Overland—Continental and Buda Motors. All types, \$50.00 each and up. New Dixie Magnetos \$20.00. Spitzdorf High Tension Magnetos \$10.00. Kellogg Pumps \$3.50. Auto-Lite generators, new, \$10.00. Air Gauges 65c. Remy Ignition Coils, new, \$3.00. Electric and gas headlamps, coils, distributor heads, air compressors, etc. Write for catalog. Motor Sales Dept. 15, West End, Pittsburgh, Pa.

VULCANIZING and Repairing is a paying business. Forty million tires need repairing every day. Make big profits in tire repair. Easy to learn. Instructions free. No hard times. Always busy. Get into this money-making business quick! Plants \$200 up. Write for free catalog. Equipment Co., 1 Canal, Cincinnati, Ohio.

AUTO Owner Tire Agent wanted each locality to use and take orders for hand-made Mellinger extra ply and cord tires; guaranteed by bond for 8,000 and 10,000 miles (no seconds); shipped prepaid on approval; get your tires free; no capital or experience required; make \$100 to \$300 weekly. Write for wholesale prices and sample section, Mellinger Tire Co., 929-K Oak, Kansas City, Mo.

AUTOMOBILES

DYKE'S Automobile Encyclopedia contains the greatest array of automobile facts ever published in one volume. Several separate books containing the same information would cost in the neighborhood of \$21.00. New, enlarged edition, 968 pp., 3262 illus., cloth, \$6.46; American Morocco, \$7.96 postpaid. Popular Mechanics Book Dept., 6 N. Michigan Ave., Chicago.

AUTOMOBILE Repairshop Shortcuts—Over 1500 time and labor saving kinks from more than 1000 of the best Repairshops in the U. S. 256 pp., 1500 figs. Price \$3.50 postpaid. Popular Mechanics Book Dept., 6 N. Michigan Ave., Chicago.

AUTOMOBILE Repairman's Helper. An excellent new book that gives every operation required to adjust or repair the troubles likely to be found in all standard cars. Part 1—Repairshop Practice, Part 2—Passenger Cars, Part 3—Trucks, 535 pp., 417 figs. Flexible. Price \$3 postpaid. Popular Mechanics Book Dept., 6 N. Michigan Ave., Chicago.

A BETTER Job now. If you have no trade you can get a good one in a few weeks. Learn the auto business. Repairmen always needed, get good pay; 10,449,785 autos, trucks, tractors need expert service. You can get in this business in a few weeks. Our free 188-page illustrated catalog gives full particulars. Send name today. See our advertisement on pages 53-75-157-185. Michigan State Auto School, 25 Auto Bldg., Detroit, Mich.

AUTOMOBILE Electrical Systems are fully treated in the new edition of the book entitled "Automobile Starting, Lighting and Ignition Systems." Over 250 complete wiring diagrams. 800 pp. 492 lbs. \$3 postpaid. Popular Mechanics Book Dept., 6 N. Michigan Ave., Chicago.

PATENTS—Write for our free Illustrated Guide Book and Evidence of Conception Blank. Send model or sketch and description of your invention and we will give our opinion of its patentable nature. Highest references. Prompt service. Reasonable terms. Victor J. Evans & Co., 185 Ninth, Washington, D. C.

AUTO OWNERS Wanted to use and introduce our new 5,000 and 10,000 Mile Guaranteed Cord and Fabric Tires. Make big money, part or full time. Free Tires for your car. Write quick for special agent's offer and low wholesale prices. It will pay you to answer this little ad, now. Reliance Tire & Rubber Co., 35th St. and Michigan Ave., Dept. 90, Chicago, Ill.

AUTOMOBILE OWNERS, Garagemen, Mechanics, Repairmen, send for free copy of our current issue. It contains helpful, instructive information on overhauling, ignition troubles, wiring, carburetors, storage batteries, etc. Over 120 pages, illustrated. Send for free copy today. Automobile Digest, 505 Butler Bldg., Cincinnati.

FOR FORD OWNERS

FORD Touring car tops stretch, become loose and rapidly ruin themselves because the hold-down straps cause too much strain on the covering materials. The Pontiac Windshield Top Supports clamp your top in place same as any other car. Prevents cracked windshields. Affords ideal mounting for mirror or spotlight. Makes your car look neat and trim, and affords clear vision. Made entirely of drop forgings. Beautiful baked enamel and nickel finish. For tourings only, 1917 to date. By mail for \$1.75. Satisfaction guaranteed or money refunded. American Forging & Socket Co., Pontiac, Mich.

FORD Car Repair Book sent free. This complete, well illustrated, valuable book explains in a simple way the Causes and Cures of Over-heating; Repairing Ford Timer; Curling Piston Ring Troubles; Carburetor Adjustments and Repairs; Connecting Rods; Transmission Troubles; Care and Repair of Rear Axle; Stopping Axle Grease Leaks; also covers practically every other phase of Ford Car Repairing. Send 25c coin for three months' trial subscription and get the valuable repair book free. Ford Owner and Dealer Magazine, 516 Montgomery Bldg., Milwaukee, Wis.

FORD Magnets Recharged in car without removing any part. Fully charged magnet removes cause of most ignition troubles, gives more power and light, saves gas. Anybody can do it. Complete instructions and wiring diagrams 50c. The Auto Electrician, Box 261 Middletown, N. Y.

CYCLE "Modified Vapor" System saves gas, increases power and makes Ford run hundred per cent smoother. Revolutionary principle of heat control. Ford owners-agents wanted. Cycle Manifold Co., South High St., Akron, Ohio.

WANTED, representatives for water circulating pumps; prevent Fords freezing or over-heating under any conditions. 50,000 satisfied users. Retail \$10.50. Demonstration pump factory price. Satisfaction guaranteed or money refunded. Polar Bear Pump Co., Los Angeles, Cal.

COMPTON Spring Oilers automatically lubricate springs, clean rust, stop squeaking, make smooth riding. Send \$2.00 complete set. Quickly attached. Compton Oiler Company, 29 Broadway, New York, N. Y.

SIMPLEX Starter \$29.00. Easily sold. American-Simplex Co., Anderson, Ind.

FORD Repairing—New valuable book explains use of all up-to-date tools and shop equipment, describes methods of performing work on all different mechanical parts of car. 250 pp., fully illus. Leatherette. Price \$2.50 postpaid. Popular Mechanics Book Dept., 6 N. Michigan Ave., Chicago.

AN old worn out Ford runs like a 12 Cylinder when fitted with Peck's Transformers and Testers. Regular price \$2 for 4. Special price to Popular Mechanics readers 50 cents for 4. Valve Timing Chart sent free with each set. Peck, 2134 N. Carlisle St., Philadelphia.

SPEEDSTER Fans: Don't fail to see "Red-I-Kut" ad, page 137.

FORD spiral ring gears and pinions just out, ratio 33-9, guaranteed nickel steel; no change necessary to install. Special price \$12.00. Order your set today. Mechanics Gear Works, 1446 Catalpa Ave., Chicago, Ill.

LACEY Patent Sense. See page 154.

\$25.00 DAILY to Ford Owners. Exclusive contract, complete line, fastest selling accessories made. Let us prove it. Send \$2.00 for all products. Reserve your territory today. Muter Company, Englewood, Ill.

MOTORCYCLES, BICYCLES & SUPPLIES

WAGNER-DOLPH Co., Inc. are noted for square dealing, 25% to 50% Reductions for Winter Clean-up Sale, 100 to choose from, 1917 Excelsior, three speed, \$70; 1915 Indian \$50; 1920 Harley \$145. Send for list C. 129 Main St., W. Rochester, N. Y.

BALTIMORE Police Indians, '20 model Elec. Equipped, \$160.00; '21 Model, Elec. Equipped, \$210.00; 23" Tris-Frame Bicycles, \$23.00. Howard A. French, Baltimore, Md.

SEND for big list of slightly used motorcycles on our easy payment plan. Howard Cycle Co., 152 N. Broad St., Trenton, N. J.

BARGAINS in used Harley-Davidson motorcycles. Liberal discount to rider agents. Lister Motorcycle Company, Cleveland, Ohio.

HARLEY-DAVIDSON, electric, 3 speed, fully equipped, \$135.00; also other makes. Write for our bargain list and our easy payment plan. Lavin Motor Supply Co., 1952 N. Napa St., Philadelphia, Pa.

REBUILT Motorcycles. Prices slashed to bedrock. All makes. All models. Guaranteed and shipped on approval. Send stamp Big Free Bulletin M. Floyd Clymer, "Largest Motorcycle Dealer in Western America," Denver, Colo.

BRIGGS-STRAITON Motors, brand-new \$70.00. One used two weeks \$50.00. Smith-Flyer (less motor) \$25.00. Beams, 816 Coleman, Johnstown, Pa.

WHY buy a used motorcycle? A new Cleveland costs only \$185. See page 134.

MOTORCYCLES, improved light-weight design; 100 lbs. parts; weighs only 145 pounds. 80 miles per gallon of fuel. Ample power. Openings for hustling agents in some localities. Write Schickel Motor Co., 4906 Garden St., Stamford, Conn.

GUARANTEED Rebuilt Motorcycles of all makes and models. See page 134.

LARGEST stock of new and used motorcycle parts and accessories in the world at your disposal via Uncle Sam's mail. Write for quotations. Motorcycle Parts Mfg. Co., 2030-38 Wabash Ave., Chicago, Ill.

USED parts for all motorcycles cheap. State wants. Schuck Cycle Co., 1922 Westlake, Seattle, Wash.

USED and new parts, Indian, Excelsior, Harley, Reading, Thor, Henderson, Yale. Get our price lists. Kingshighway Cycle Co., 1166 North Kingshighway, St. Louis, Mo.

DON'T buy a Bicycle Motor Attachment until you get our catalogue and prices. Shaw Mfg. Co., Dept. 27, Galesburg, Kan.

NEW motorcycles have been reduced 10%. Our prices have been reduced 35%. Send for big bargain list of rebuilt motorcycles. Western Supplies Co., 359 Hayutin Bldg., Denver, Colo.

USED motorcycles, new and used parts; write us. Mahowald Cycle Co., Mankato, Minn.

BOYS, build your own cycle car! Send 25c for building plans and list of parts. We can supply motor with clutch and all parts at low prices. Shaw Mfg. Co., Car Dept., Galesburg, Kan.

MOTORCYCLE Cylinders reground, fitted with new piston rings, \$8.00. Guaranteed. Muncie Piston Co., Muncie, Ind.

AVIATION

LEARN to fly! Lieut. Harold Peterson (ransomed aviator), formerly U. S. army instructor, now head of own school, equipped with safe airplanes, teaches you; moderate cost; wonderful opportunities. Enroll now for spring course. Booklet free. 805 Plymouth Building, Minneapolis, Minn.

LEARN to fly for \$100. Best offer yet. Limited. Write Frank J. Oneal, Francisco, Ind.

"FLYING Instruction," Standard equipment. Expert instructors. Lowest charges. You'll be surprised. Our course covers theory, practice and license tests, same as schools charging three times as much. Now receiving spring enrollments. Inquiries welcomed. When could you come? Aviation Engineering Co., Lawrence, Kansas.

PROPELLERS for Aeroplane propulsion. Motorcycle sizes \$10 and \$12. High-grade 8-ft. propellers for Fords \$15. Crawford Motor and Aeroplane Mfrg., 142 S. Rampart St., New Orleans, La.

SPORTFORD Tractor Biplane. Uses Ford or 30 horse power aeromotor. Cheaply and easily built. Drawings, instructions and parts price list. \$2. Motors, \$100. Propellers, \$15. Aviation Engineering Co., Lawrence, Kansas.

MOTORCYCLE Engine Mosoplane. Excellent for learning flying. Simple, cheap construction. Drawings and instructions. \$1. Aviation Directory, Lawrence, Kansas.

VERY Small Gasoline Engines for Models, Small Spark Coils, Small Spark Plugs. Weiss Mfg. Co., 323 Washington St., Brooklyn, N. Y.

AVIATION Motorcycle Magazines. List free! Toemp Magazine Agency, Middletown, N. Y.

FOR Sale. A slightly used two cyl. 10 h. p. Aviation Motor. T. B. 473, Harlan, Ia.

FOR April we offer the greatest bargains in the history of aviation. Dopa \$1.65; turnbuckles, all sizes 25c, aero cloth 39c yd.; shock absorber 5c ft.; Curtis or Gnome motors, \$290; new propellers \$18.00; clevis pins 2c; wheel covers \$1.25; steel tubing 5c ft. Other wonderful bargains. Get free sale sheet. Send for our large aeronautical supply catalog containing late ideas. 15c. Heath Airplane Co., Chicago, Ill.

HEATH propellers represent the most efficient method of aerial drive. Each propeller individually designed for the particular work to be done, as laid out by America's oldest aeronautical Engineers. Propeller catalog 4c. Heath Airplane Co., Chicago, Ill.

A WONDERFUL opportunity to learn to fly by our new method, includes three hours' instruction in the air and one month intensive shop course, complete at \$100.00. Only a limited number accepted. Heath Airplane Co., Chicago, Ill.

PROPELLERS \$5. Set airplane wings \$50. Fuselages \$100 and \$150. Supplies Bulletin 4c. Ostergaard Aircraft Works, 4269 North Narragansett, Chicago.

INVENTORS desiring patents should write for our free illustrated Guide Book and Evidence of Conception Blank. Send model or sketch for our opinion of its patentable nature. Highest references. Prompt service. Reasonable terms. Victor J. Evans & Co., 187 Ninth, Washington, D. C.

THE American School of Aviation announces a new correspondence course in Mechanics of Aviation. A thorough training in Practical Aeronautics. American School of Aviation, Dept. 1861, 3601 Michigan Ave., Chicago, Ill.

BIGGEST, best catalogue Model Aeroplanes, Paris and Supplies; 5c postpaid. Ideal Aeroplane Co., 87½ West Houston, New York.

WELDING

LEARN the welding business and always have a good job. We teach welding, cutting, brazing and soldering in our job welding shop. Write for price and terms. Sidney Welding Works, Sidney, Ohio.

WELDING Encyclopedis—A complete instruction book on all welding processes; oxy-acetylene, electric arc, electric resistance and thermit. Welding of all weldable metals fully discussed. 326 pp. 375 lbs. The accumulated experience of the welding brains of America is yours for \$5. Money back if not satisfied. Popular Mechanics Book Dept., 6 N. Michigan Ave., Chicago.

MOTOR Grinder and Tire Buffer, Automatic Compressors, Battery Chargers, Motors. Unusually Easy Payments. Write us. Hubertis, Troy, Ohio.

BOOKS AND PERIODICALS

AMBITION Writers send today for Free copy America's leading magazine for writers of photoplays, stories, poems, songs. Instructive, helpful. Writer's Digest, 683 Butler Building, Cincinnati, Ohio.

FREE Book—"Elijah Coming Before Christ." Address, Megiddo Publishers, Rochester, N. Y.

LIGHTNING Cartoonist's Book, Secrets, Tricks, \$1.00, Christmas, 2925 Euclid, Kansas City, Mo.

LEARN Shoe Repairing at home. Good money in it. Our book of instruction teaches you every detail. Only \$1 prepaid. American Bench Shoe Makers, Dept. 1, Aurora, Ill.

HYPNOTISM—Dr. Bral's Wonderfully successful method \$1.10. Mesmer's \$5.00 Secret \$1.10. "Auto-Magnetism" banishes disease. Generates magnetic energy. Price \$1.10. All three and \$2.00 coupon for \$3. Self-Culture Society, PM516—Salem, Glendale, Calif.

GARAGEMEN, Repairmen, Students: For Homestudy, get the book used by the Auto Schools, Cleveland, Ralfe Greer. "Information" by Phillips, \$2.50. Auto Electric Systems Pub. Co., Box 11, Muncie, Ind. Agents, write.

PLANS for Poultry Houses. All styles. 150 illustrations; secret of getting winter eggs, and copy of "The Full Egg Basket." Send 25 cents. Inland Poultry Journal, Dept. 74, Indianapolis, Ind.

ONLY Original "Master Key." 25 full instructional course \$5.00. Mahatma Vandeville Blindfolded "Mind Reading" course \$1.00. Rare, Magical, Psychological. Catalogues 2c. Sovereign Company, 140 Syracuse, Buffalo.

1,000,000 **INDUSTRIAL** Facts, Calculations, Receipts, Processes, and Trade Secrets for every business are contained in the 1016 page Book "Moore's Universal Assistant and Complete Mechanic." 500 Engravings. Cloth. Price \$2 postpaid. Popular Mechanics Book Dept., 6 N. Michigan Ave., Chicago.

HYPNOTISM controls others—overcomes disease. Wonderful exhibitions possible. Twenty easy lessons \$1.10. "Love's Mysteries Explained" 30c. Science Institute, 1014PM Belmont, Chicago.

SCIENTIFIC American's Cyclopaedia—14,000 excellent formulas \$6. prepaid. E. P. Geuze, 34 Dell Ave., Worcester, Mass.

ATTENTION—For photographs of soldiers killed, wounded and died in world war, \$1.00 per state. S. Michelson, 601 F St. N. W., Washington, D. C.

YOU need "Moore's Universal Assistant." All main facts in 200 trades and occupations, 1016 pages. Cloth, \$2.00 postpaid. Wells & Edwards, 852 George St., Chicago.

6TH and 7th Book Moses: 50c. Black Art: 25c. Mind Reading: 25c. Mock Trials: 25c. Catalogs. Smith's Novelties, 4735 South Elizabeth St., Chicago.

"HOW to Paint Signs." New instruction book, clothbound, containing over 100 illustrations, alphabets and designs; also covers show card writing, Commercial Art and all trade secrets. Prepaid anywhere \$1.50. Satisfaction guaranteed. Address New Era Studio, 2021 Franklin Ave., St. Louis, Mo.

THE Ouija.—Interesting, instructive booklet giving right and wrong way of using Ouija board; Amazing personal experiences. Price 25c including Bulletin on Occult Science. Occult Science Study Club, Kansas City, Mo.

ELECTRICITY Taught by experts; earn while you learn at home; electrical book and proof lessons free; your success guaranteed and position secured. Chicago Engineering Works, Dept. A-14, 2144 Lawrence Ave., Chicago.

THIRTY-FIVE Cent Electrical and Mechanical Books. Fully illustrated. Other popular subjects. Send for list. Spun & Chamberlain, 120 P. M. Liberty St., New York.

BOOKS, All Kinds, Lists. Higene's, 24241 Post Street, San Francisco, Calif.

TOY maker book, 64 pages, illustrated. Postpaid 10c. Western Puzzle Works, St. Paul, Minn.

BRINGING Up Father—Books 1 and 2. Everybody knows the funny cartoons by Geo. McManus. They may be had in book form. One volume for 35 cents or both for 60 cents postpaid. Cartoons Magazine Book Dept., 6 N. Michigan Ave., Chicago.

LATEST Magic — Professor Hoffman, world-famed authority. New stunts, card tricks, sleight of hand. Handsomely bound. Illustrated, \$2.15 postpaid. Spun & Chamberlain, 120 P. M. Liberty Street, New York.

PRACTICAL Books—Mechanical, Electrical, Engineering, many other subjects. Catalogue free. Colonial Book Co., 500 Fifth Ave., Suite 196, New York.

INDUSTRIAL Alcohol, Wright's book everybody wants. Full directions for making with drawings of necessary apparatus. \$2.50 postpaid. Spun & Chamberlain, 120 P. M. Liberty Street, New York, N. Y.

BOOKS, Books, Books. No matter what you want in the realistic book line, I can fill your order. If you cannot find the books you want, send for my list today. Levi Bryant, 4808 Champlain Ave., Chicago, Ill.

INSTRUCTION Book (for shop use) on vulcanizing auto tire, boots and shoes. \$1.00. Equipment Co., 3 Canal, Cincinnati, O.

PICTURES, POSTCARDS AND NOVELTIES

LONESOME! Then join popular Sunset Card Exchange Club and cheer up. Receive thousands view post-cards by exchanging with our hundreds enthusiastic members everywhere. Fascinating pastime. 6 months' trial membership 25c; membership list 10c. Oliver Gandy, General Manager, Crisfield, Md.

TRUE-BLUEERS everywhere. Exchange postals. Organized 1908. Membership: Year, \$1; half, 50c; quarter, 25c. Hundreds listings, 10 cents. Ed. Ericson, 422 Elroy, Wis.

TEN magnificent mountain views, 20 cents. Return for mailing. Surprise friends. Great fun. Write, Hadler, 4085 So. Broadway, Denver, Colo.

JOIN Live Postcard club; Sample paper, list, catalog, 10c. Harvey Teeple, Decatur, Ind.

GAMES AND ENTERTAINMENTS

VENTRILOQUISM taught almost anyone at home. Small cost. Send 2c stamp today for particulars and proof. George W. Smith, Room M285, 125 N. Jefferson Ave., Peoria, Illinois.

TRICKS, Puzzles, Magic Goods. Catalogue free. Address T. Youngblood, 16 Grove, Charlotte, N. C.

NEW Illustrated Catalog of Magical Apparatus—Mindreading, Crystal Gazing, Sensational Escapes, Novelties, Jokes, Card Tricks, Books. We supply amateurs and professionals. Catalog free. Heaney Magic Company, Berlin, Wis.

CHEMICAL Magic—Harmless, easy to prepare, yet mysterious. Send 50c for formula. Linaco, Box 131, Magnolia, Md.

BE a magical entertainer. Particulars and marvelous magical secret 10c. Address, Stanton Rippey, Box 205, Palo Alto, Calif.

SNEEZE Powder. Greatest fun maker on earth. Bottle 10c. C. Feiner, 2401 Jefferson St., Louisville, Ky.

FUN! Fun!! Real joker's sporting goods—pocket novelties. Everybody wants them. Send 2c for illustrated catalogue today. Address Grandfield, 1238 Theriot Ave., Bronx, New York.

TRICKS, Puzzles, jokes, magical apparatus, plays, stage supplies, mind-reading acts, and sensational escapes. 160-page illustrated professional catalogue, 10c. Oaks Magical Co., Dept. 548, Oshkosh, Wis.

250 **MAGIC** Tricks 25c. Big Catalog 2c. Harvey Teeple, Decatur, Ind.

TRICKS, Puzzles, jokes, magical apparatus, plays, stage supplies, mind-reading acts, and sensational escapes. 160-page illustrated professional catalogue, 10c. Oaks Magical Co., Dept. 548, Oshkosh, Wis.

250 **MAGIC** Tricks, with cards, coins, handkerchief, etc., (simplified and illustrated so that a child can perform them). To introduce illustrated catalogue of tricks and entertaining books, 10c (coin). Allen's Enterprises, 1227 Milwaukee Ave., Chicago, Ill.

PLAYS, musical comedies, revues, minstrel choruses, blackface skits, vaudeville acts, monologues, dialogues, recitations, entertainments, musical readings, stage handbooks, make-up goods. Big catalog free. T. S. Denison & Co., 623 So. Wabash, Dept. 11, Chicago.

200 **KINDS** Iron, wood and wire puzzles. Leader and illustrated list 10c. Western Puzzle Works, St. Paul, Minn.

MAGIC—Tricks, Books and Supplies. For Amateurs as well as the great professionals. Anyone can learn through our instructions. Feature Acts in Mind Reading, Spiritualism, Rope Ties, etc. Large illustrated Professional Catalog, 10c. Chicago Magic Co., Dept. B, 140 S. Dearborn St., Chicago, Ill.

FREE! "10 select pocket tricks" and illustrated catalog magic tricks, jokes, puzzles and imported novelties at reduced prices. Send today! Lyle Douglas, Starline A, Dallas, Texas.

STAMP COLLECTING

START a Stamp Collection—65 different stamps from 65 different foreign countries, including Africa, Asia, Australia, Europe, West Indies, etc. Our pamphlet which tells "How to make a collection properly," and price list of albums, packets and sets, all for only 16 cents. Queen City Stamp Co., Room 36, 604 Race St., Cincinnati, O.

LIBERAL Offer: 500 mixed U. S., 1,000 hinges, 100 diff. foreign, Bargain Stamp paper 6 months for 25c. Weatherby, Medina, Ohio.

500 **MIXED** Stamps, 200 var., 25c; 100 rar. Precincts, 20c; 100 Mixed, 10c. Charles Peugh, Elma, Wash.

I BUY Cancelled Stamps and Coins. Price list coin book 10c. Astamp Scott, Cohoes, N. Y.

BEST one-cent approvals in America. F. P. Hand, 1117 So. 60th St., Philadelphia, Pa.

1,000 **VARIETIES** collection \$1.95, postage extra. Free Bargain Lists, Broadway Stamp Co., 115 Nassau, New York City.

WAR Stamps and Neurope—500 different for \$2.00. Unusual bargain. Maxwell Krause, Lebanon, Pa.

U. S. POSTAGE fifty-dollar, two-dollar dime with 50% approvals. Goodman, Wilson Bldg., Los Angeles, Cal.

150 **DIFFERENT** United States \$1.00, others cheap. Grutzmacher, Mukwonago, Wis.

RARITIES Free! to buyers 50% approvals. Rosoco, 317 Worcester Bldg., Portland, Ore.

STAMPS, 1500 different, \$5.45; 1,000, \$2.50; 500, 85c; 200, 15c. Michaels, 5602 Prairie, Chicago.

COLE'S Approvals will satisfy. Write for selection. W. Jay Cole, 3019 Wallace St., Chicago.

UNUSED French Colonials, 48 different, 20c. Nickles, 122 Florida Ave., Washington, D. C.

3 **NYASSA** Giraffe stamps free to approval applicants. Wilmar Edgar, Cherokee, Iowa.

200 **STAMPS** and subscription Stamp Magazine 15c. Harvey Teeple, Decatur, Ind.

HONEST Value approval sheets. Fred Brabant, Spring Valley, N. Y.

STAMPS. 57 all different, from Finland, Poland, Bavaria, Cuba, Czech-Slovakia, etc., hinges, perf. gauge, mm. scale, ruler, price lists to approval applicants who send 10c. 200 diff. 25c; 500 diff. \$1.50; 1,000 all different, from all over the world, a real collection, only \$2.75. Send today. Leader Stamp Co., Dept. P, St. Louis, Mo.

WANTED—We pay high prices for old used postage stamps, also stamp collections. World Stamp Co., Box 2094, Louisville, Ky.

NEWFOUNDLAND packets. Catalogue 50c, 10c; estimating \$1.00, 25c; all different. Postage extra. Will exchange. A. J. Wagborne, Melrose, Mass.

LIECHTENSTEIN, 27 varieties 22c. Fine approval selections of stamps at one cent each. Address G. Gaudenberger, East Chatham, N. Y.

START Stamp Collecting: 500 fine stamps, all different, for \$1.12. World Stamp Co., Box 2094, Louisville, Ky.

COSTA RICA, Nos. 64-65-67—Catalogue \$2.00, only 20 cts. Lists Free. Belmont Stamp Co., Ocean Grove, N. J.

ZAMBESIA, Fiume, Ukraina, Madagascar Stamps, Menagerie Packet, 250 Hinges—10c. Liberty, 3974 Arsenal, St. Louis, Mo.

100 DIFFERENT from 30 different countries, 5c. Lufbery, Yalesville, Conn.

49c FOR 30 Polish Stamps catalogue \$3.70. Guaranteed genuine, used. Alex P. Braun, 2195 Sturtevant, Detroit, Mich.

BELGIUM Olympic Set, also 100 different stamps for 20c. Jacob Fischer, 1539 North Lawler, Chicago.

UNITED STATES: Fine selections for collectors beyond beginners' class. Fred Rotenberg, 3755 Wilton Ave., Chicago.

FREE—Eight Egypt to approval applicants enclosing postage, Emery, 567 Oakwood Ave. Toronto.

FIVE CENTS: Japan, two large battle-ship stamps. Address, Hubert Codwise, Melrose Highlands, Mass.

SWEDISH Stamps free. Approvals 3c postage. F. Seebeck, 1957 Toronto St., Regina, Canada.

NYASSA, 13 varieties 12c. Co-Operative Stamp Co., 710 Pelham, St. Paul, Minn.

100 FOREIGN Stamps sent free. Cornish Company, Schenectady, N. Y.

STAMPS—50 different Jamaica, Venezuela, etc., only 10c; 100 all different, 13c; 1,000 all different, \$4; 100 different U. S., 25c; 1,000 hinges, 10c; 50 per cent approvals with every order. List free. I buy stamps. L. B. Dover, Dept. A, Longmont, Colo.

STAMPS, 50 Varieties, Africa, Brazil, Peru, Cuba, Mexico, etc., 10c. 50 different U. S., 25c; 1,000 mixed, 40c; 1,000 hinges, 10c. List free. C. Stegman, 5948 Cote Brillante, St. Louis, Mo.

STOP! Here's Bargains—1,000 different, \$2.75; 1,000 hinges, 3c; approvals, 1c, or 6 for 5c; can't be beat! A trial's worth while! Baumann, 1033 Levick, Philadelphia, Pa.

1,000 DIFFERENT, \$2.50; 500, \$1.00; 300, 45c; 200, 20c. Fred Onken, 630 79th St., Brooklyn, N. Y.

STAMPS Free—War Stamps, Surcharged, Unused, Pictorials, British, French Colonials 2c postage. Midland Stamp Co., Toronto, Canada.

158 GENUINE Foreign Stamps—Mexico War Issues, Venezuela, Salvador and India Service, Guatemala, China, etc., only 10c. Finest approval sheets, 50 to 60%. Agents Wanted. Big 72-p. Lists Free. We Buy Stamps. Estab. 29 yrs. Hussman Stamp Co., Dept. 54, St. Louis, Mo.

FREE! To applicants for our net approvals, 3 stamps cataloging over \$1.00. Reference necessary. The Stamp Shoppe, 1413 G Street, N. W., Washington, D. C.

FREE, 100 different stamps to applicants for approvals sending 2c. 100 varieties War Stamps 22c. Richard P. Lamprecht, Valparaiso, Ind.

100 DIFFERENT Stamps 10 cents. Perforation Gauge Free. I. Sonnee, 675 Ivy Street, St. Paul, Minn.

25 U. S. FREE with approvals. Send 3 cents. St. Elmo Stamp Co., 4501 N. Ashland Ave., Chicago.

LIKE Triangular Stamps? To introduce our Sudden Service Approvals we'll send triangular Fiume, set China ships, large \$1.00 United States revenue, also packet 50 foreign, millimetre scale, perforation gauge, ruler and bargain lists for only 9c! Fennell Stamp Company, Dept. P, Fullerton Bldg., St. Louis, Mo.

FREE, packet of desirable stamps, exceptional quality, to approval applicants sending satisfactory references. H. Argenbright, Box 352, Staunton, Va.

FREE! Sectional Loose Leaf Postage Stamp Album at the rate of 8 pages each month given with subscription to our monthly Journal. Send two-cent stamp for prospectus. United Stamp Co., 140 S. Dearborn St., Chicago, Ill.

BIG Variety Packet Foreign Stamps free for 2c postage. Gray Stamp Co., Station E., Toronto, Canada.

UNIVERSAL Packet, 100 varieties, all over the world, 10 cents. Covert Stamp, 39 State, Rochester, N. Y.

STAMPS sent on approval at 70% discount. Reference required. Emory Renoll, Hanover, Pa.

STAMPS Free—Ask for money-saving approvals. John P. Borresen, Cedar Falls, Ia.

24 VARIETIES Cuban stamps, 10 cents. List of 6,000 low-priced stamps free. Address Chambers Stamp Co., 111P, Nassau St., New York City, N. Y.

105 CHINA, etc., stamp dictionary, list, 2c. Album (500 illustrations), 3c. Bullard, Sta. A. Boston.

55 ALL Different Stamps, including China, Japan, French Colonies, etc., given to applicants for our high-grade approval selections. Send references and 2c stamp to the Edgewood Stamp Co., Dept. H, Milford, Conn.

20 UNUSED stamps free. All different. Postage, 2c. Flisk Stamps, Toledo, Ohio.

PACKET of 23 stamps, no two countries alike. Packet hinges. Set of \$1 and \$2 U.S. Rev., all for 5c. Mention paper. Miami Stamp Co., Toledo, Ohio.

STAMPS, 20 unused, all different, free. Postage 2c. Mention paper. Quaker Stamp Co., Toledo, O.

FREE 10 different Scandinavian, millimetre scale, gauge, book, lists, etc., to all sending 10c for 57 different Stam, Caylon, Guatemala, etc. 200 different, 25c; 300 different, 40c; 100 different U. S., 25c. Hawk-eye Stamp Co., Cedar Rapids, 39, Ia.

RARE COINS

FIRST Coin with "In God We Trust" was the 2c piece, first coined in 1864. As a special offer, I'll send you a genuine 2c piece, and 50 page illustrated Coin Catalog for Ten Cents. Send for this now and you'll send for more. B. Max Mehl, Numismatist, Mehl Bldg., Dept. P, Fort Worth, Texas. Largest rare coin establishment in the United States.

\$2,500.00 FOR one dollar. Mr. Manning, of Albany, N. Y., received this amount from us for one silver dollar. You may not have this dollar but we buy all other rare coins and pay high cash premiums. Send 6c. Get large coin circulars. It will pay you to be posted. Send now. Numismatic Bank, Dept. H, Fort Worth, Texas.

GET This: Book of Valuable Coins and Their Value, for 15c; Arthur H. Hacker, 1650 N. Fairfield Avenue, Chicago, Ill.

SURPRISE Lot: One of each gold, silver and nickel coins, 50c; \$1,000 Confederate bond 1862, 35c; Bill book, script and price lists, 10c. Bonsall, Richmond, Ind.

150 OLD Coins, all different, \$5.00. 40 Old coins, all different, \$1.00. 10 different Confederate bills, \$1.00. Claude Denney, Denison, Texas.

1832 BANK Note, 10c; California gold half dollar and new list, 50c. Holco, Annawan, Ill.

1838 DIME, 25c; 1817 cent, 20c; Jackson cent, 10c. A. Wylie, Wheaton, Ill.

CONFEDERATE \$10 bill, 10c. Durso, 25 Mulberry, N. Y. City.

CALIFORNIA Gold, Quarter size and Colombia nickel coin only 30c. Italy 20 cents and catalog 10c. Homer Shultz, King City, Mo.

OLD coins, large Spring selling catalogue of coins for sale, free. Catalogue quoting prices paid for coins, ten cents. William Hesselein, 1013 Tremont St., Boston, Mass.

CALIFORNIA gold, Quarter size 27c; 3/4 size, 53c. 3c Piece and catalog, 10c. Norman Shultz, Box 146, Colorado Springs, Colo.

FOR BOYS

BOYS: An electric motor, guaranteed to run. 25c coin, postpaid. Write today. G. Sabin, Box 921, Portland, Ore.

BOYS!—Build Things. Our three books, The Boy Mechanic, 1, 2, and 3 tell you in a way you can understand how to make such things as Boy's Motor Car, Houseboat, Model Monoplane, Water Toboggan and Slide, Aerial Cableway, Ski Sled, sailing Canoe, Searchlight, Electric Locomotive, etc. Each book is complete in itself and has 480 pages and upwards of 800 articles and illustrations. Description of each book sent on request. Price \$2.50 per vol. postpaid. Popular Mechanics Book Dept., 6 N. Michigan Ave., Chicago.

BOYS, Get flying model aeroplane free. Write to Aero Shop, 3060 Huribut Ave., Detroit, Mich.

BOYS!—You who like gripping, thrilling stories of achievement will want to read "Victories of the Engineer," a book that tells in a way you can understand it how the great feats in railroad engineering, building great bridges, ships, dams, canals, harbors, tunnels, mining, etc., have been accomplished. By A. Williams. 487 pp. 259 ill. Price \$2.00 postpaid. Popular Mechanics Book Dept., 6 N. Michigan Ave., Chicago.

PLAY mouth-organ. It's easy. Complete instructor, 25c. G. Elsea, Bowling Green, Ohio.

BOYS, make money selling Marvel Picture Reproducers at your school. Transfers black and colored pictures from newspapers, books, comics, etc. Send 50c for 3 sample sets, complete with Reproducing Compound, Handy Rubbing Tool, Paper and Directions. Nova Co., 326 River St., Chicago.

ELECTRICITY Taught by experts; earn while you learn at home; electrical book and proof lessons free; your success guaranteed and position secured. Chicago Engineering Works, Dept. A-14, 2144 Lawrence Ave., Chicago.

FREE—Self-filling fountain pen. For particulars address: Bonhardt, 1533 Amst. Ave., New York, N. Y.

CAMERAS AND PHOTO SUPPLIES

JUST Published—Our new complete 128-page catalog and bargain book of new and used cameras and supplies. Our goods are guaranteed finest quality obtainable. We have thousands of satisfied customers. Write at once for this bargain bulletin, just hot from the press. Address Central Camera Co., 124 S. Wabash Ave., Dept. E56, Chicago, Ill.

RWK Photo-Printers give continuous economy and results; made in three sizes, 6 1/2x8 1/2, 8x10, and 11x14. Sold to satisfy you. R. W. Kittredge Co., 324 W. Superior St., Chicago, Ill. Write for particulars.

RASS Camera's Bargains are known the world over. Write your needs. Largest stock of Graflex, Kodaks and Mottion Picture Cameras in the world. RASS Camera Company, Mail Order Division, Chicago, Ill.

YOU Can Earn \$50.00 to \$200.00 Weekly—Learn Photography at home. Steady work—Big pay—Travel. Great demand for photographers. Particulars free. Address, Photographic Institute, Dept. M, Wedgeway Building, Schenectady, N. Y.

I COLOR Photos; sample photo with price list 25c. A. H. Bergeron, 268 Alfred St., Biddeford, Me.

KODAK Enlargement from your negative, artistically colored, \$1.00. Order now! Fairhead, 116 West 104th Street, New York.

OLD Tintypes, Daguerreotypes or Faded Pictures of loved ones can be restored so as to produce beautiful enlargements and perfect likenesses under our new process. Individual pictures may also be produced out of groups. Satisfactory results guaranteed. Prompt work. Roanoke Photo Finishing Co., Roanoke, Va.

SEND negative with 10c for 5x7 enlargement; prints 2c, any size. Blad, Warcham, Mass.

8x10 KODAK enlargement, beautifully colored, \$1.00. Kodak, 387 Bellevue Place, Milwaukee, Wis.

CAMERAS, lenses, binoculars, bought, sold, exchanged; priced especially low; we take shutguns, revolvers, musical instruments in trade. National Camera Exchange, 20 Washington Ave., Minneapolis, Minn.

KODAK films developed and finished with attractive margin design 25c. Something new. New England Photo Service, Box 1202, Boston, Mass.

KODAK Finishing. Not the cheap way, but the most reliable. Our Quality Work insures best prints from every negative. Get particulars and List of Prizes. Or send Trial Order. Moon Photo Service, 21A, LaCrosse, Wis.

HAVE You a Camera? Write for Free sample of our big magazine, showing how to make better pictures and earn money. American Photographs, 790 Camera House, Boston, 17, Mass.

MOTION PICTURES

FILMS for Toy and Professional Machines. All famous movie stars. \$3.00 per reel and up. Machine bargains also. Write for big list free. Monarch Theatre Supply Co., Dept. P. M., 724 S. Wabash Ave., Chicago, Ill.

BIG Clearance sale of films. Westerns, comedies, and features \$3.00 per reel and up. Write for list. Also machines and supplies of all kinds. Monarch Theatre Supply Co., 228 Union Ave., Memphis, Tenn.

FILMS, Comedies, etc., \$2.50 and up; New, Used Projectors \$5 to \$250; Theatre Supplies. Address, Movie Sales, High Ridge, Mo.

BOYS—Standard Motion Picture Film, one hundred feet—one dollar, postpaid. Address, Grover Ranck, Majestic Theatre, Grand Rapids, Mich.

BARGAINS in Movie Projectors for homes, schools, churches, roadshows. Films cheap. Address, Werner Brothers, High Ridge, Mo.

MOTION Picture Operation, Stage Electric and Illusions. The only practical handbook and guide published for motion picture operators, theatre electricians and managers. Pocket size, cloth, 393 pp., fully illus. Price \$1.50 postpaid. Popular Mechanics Book Dept., 6 N. Michigan Ave., Chicago.

EARN Money writing photoplays. Plan free. Los Angeles Photoplay Co., Los Angeles, Calif.

MOVIE Cameras, \$20. Drawing, illustrating, Stereopticon, \$15. Hetz, 302 E. 33d, New York.

MOVIE Arc Generator. Eliminates current bills. Superior projection light. Easy terms. Your engine operates. Hobasco, Troy, Ohio.

FILMS For Sale—\$2.50 per Reel up. Address Queen Feature Service, Birmingham, Ala.

MOVIE films—Comedies, cowboys, 200 feet \$1.00. Coleman, Mather Building, Washington, D. C.

MOTION Picture cameras of all kinds at money-saving prices. Write Bass your needs at once. Bass Motion Camera Company, 109 No. Dearborn St., Chicago, Ill.

MAKE money writing photoplays; details free to beginners. No correspondence course. Producers League, 230 Wainwright, St. Louis.

FILMS for Toy Projectors \$1.00 for 100 feet, postpaid, 2,600 reels \$3 to \$10. \$250 new motor-driven suit-case projector \$125. New church and school projector with stereopticon attachment, \$250. Stereopticon \$35. \$350 used church projector \$175. Movie Cameras reduced. Ray, 326 Fifth Ave., New York.

FREE to Writers—A wonderful little book of money-making hints, suggestions, ideas; the A B C of successful story and play writing. Absolutely Free. Just address Authors Press, Dept. 12, Auburn, New York.

SCENERY TO RENT

SETTINGS for Opera, Plays, Minstrels, Plush Dress. Catalog, Amelia Grain, Philadelphia.

EDUCATIONAL AND INSTRUCTION

STUDY Bacteriology—become a laboratory expert. Course interesting, can be mastered in few months at home or in school. Good paying positions open. Degree granted our graduates. School 15 years old. Send for Announcement. American College of Bacteriology, 2923 S. Michigan Ave., Chicago, Ill.

PATENT Drafting. Complete instruction book teaching this artistic, high salaried business for 50 cts. Patent Drafting Syndicate, Box 855, Schenectady, N. Y.

ARCHITECTURAL Draftsmen in demand. Big salary. Easy work. Write for my instruction methods. Designer Evers, Englewood, Denver, Colo.

SUCCEED: Home Shorthand, \$2.50. Send money order. We are responsible. Byrne Publishing Company, Tyler, Texas.

WANTED: Information exchanged about commercial uses for air compressors. Address Engineering Dept., Brunner Mfg. Co., Utica, N. Y.

WORLD-ROMIC System, masterkey to all languages. Six textbooks, \$1.75. French chart, 37c. Spanish chart, 37c. Speech-organs chart, 37c. Sound-tables, 66 languages, 30c each language: Bohemian, Dutch, American English, British English, Finnish, French, German, Greek, Hungarian, Italian, Japanese, Latin, Norwegian, Portuguese, Sanskrit, Scotch, Spanish, Welsh. Languages Publishing Company, 8 West 40th Street, New York.

I CAN teach you a new decorative art, "Engraving" on glass. First prize South Florida Exposition 1922. Pretty demonstrative sample 50c. Address, Frank J. Martinez, 1406 Spring Street, Tampa, Fla.

AMBITIOUS writers—send today for free copy America's leading magazine for writers of photoplays, stories, poems, songs; instructive, helpful. Writers Digest, 708 Butler Bldg., Cincinnati.

PLAY mouth-organ. It's easy. Complete instructor, 25c. Instructors for violin, piano, tenor banjo, ocarina, ukulele, accordion, or drums, 25c. G. Ebesa, Bowling Green, Ohio.

MECHANICAL Drawing taught by mail. Home Study. Instruments and Equipment furnished free. \$15.00. Al. Holtum, Eng. Freeport, Ill.

THE most profitable Art as well as the easiest to learn. Sign Painting and Show card Writing. Complete course \$2.50. Hall's Sign Shop, Franklin Square, Worcester, Mass., Dept. A.

ROFF'S Calculator and Short-Cut Arithmetic shows the answer as quickly as a watch shows the time to all problems likely to occur in office, store, shop, bank, farm or factory. Price, pocket size, paper 35 cents, cloth, 50 cents, leatherette \$1. Desk size, cloth \$1.50 postpaid. Popular Mechanics Book Dept., 6 N. Michigan Ave., Chicago.

VOCABULARY quickly enlarged. Original complete method \$1.00. Refunded if desired. Fred'k. M. Etheridge, Boston 25, Mass.

BEST Stenography or Bookkeeping, 25c. Marr, Teacher, B685, Nashville, Tenn.

BOOKKEEPING in a week. Dukes, Fox Street Station, New York.

HAVE a business of your own; the most fascinating, best paying business-profession in the World, a foot correctionist; easy terms for training you at home in a few weeks, a new protected system that has enabled men and women to rise in one step to greater earnings than they ever thought possible; no capital required or goods to buy, no agency or soliciting. Address, Stephenson Laboratory, 1 Back Bay, Boston, Mass.

ARTIFICIAL Marble, sanitary flooring instructions, ornamental casting, concrete plaster, papier-mache decorations, garden furniture, statuary, Rubber-moulds, Electrometallurgy, particulars and 200 illustrations free. Chris Mahler, Box 122, Huntington, N. Y.

DOUBLE Entry Bookkeeping mastered in 60 hours with 8 keys; guaranteed; Diploma. International Bookkeeping Institute, Dept. 3, Springfield, Mo.

INVENTORS—Write for our illustrated guide book and Evidence of Conception Blank. Send model or sketch and description for free opinion of its patentable nature. Highest references. Prompt attention. Reasonable terms. Victor J. Evans & Co., 167 Ninth, Washington, D. C.

MATHEMATICS taught by mail. Spare time home study courses in Arithmetic, Geometry, Algebra and Trigonometry. J. A. Harding, 76 Brighton Ave., Highland Park, Mich.

WRITE articles, stories, news, in spare time for newspapers and magazines. Big pay. Copyright book free. Press Syndicate, 552, St. Louis, Mo.

LINCOLN-JEFFERSON University. Home study in Academy College, Theological, Law, Music, Pharmacy, Business and Graduate Schools, leading to degrees. Box 239, 64 W. Randolph St., Chicago.

TELEGRAPHY

TELEGRAPHY—Morse and Wireless—taught at home in half usual time and at trifling cost. Omnigraph Automatic Transmitter will send, on Sounder or Buzzer, unlimited messages, any speed, just as expert operator would. Adopted by U. S. Govt. and used by leading Universities, Colleges, Technical and Telegraph Schools throughout U. S. Catalog free. Omnigraph Mfg. Co., 18 Hudson St., New York.

TELEGRAPHY (both Morse and Wireless) and Railway Accounting taught quickly. Big salaries. Great opportunities. Oldest and largest school; established 46 years. All expenses low—can earn large part. Catalog free. Dodge's Institute, H St., Valparaiso, Ind.

WIRELESS

WIRELESS Apparatus. Build your own receiver, V-T Detector, 2 step amplifier, etc. Free plans, "hook-ups," etc. Associate Supply Company, Dept. A. P. 2, Cincinnati, Ohio.

WIRELESS Telephone; Complete receiving outfit. Full instructions. Best and cheapest on market. Write Frank Taylor Mfg. Co., Norwood, Ohio.

WIRELESS Receiving Sets, complete with aerial sent prepaid \$15. Receives Telephone 50 miles, Telegraph 300. Order yours today. Can furnish larger sets and parts. Electric Supply & Pkg. Co., Robinson, Ill.

WIRELESS Books; 53 books by 35 writers. List free. Electric Supply & Pkg. Co., Robinson, Ill.

TRADE SCHOOLS

A BETTER Job now. If you have no trade you can get a good one in a few weeks. Learn the auto business. Repairmen always needed, get good pay; 10,449,785 autos, trucks, tractors need expert service. You can get in this business in a few weeks. Our free 188-page illustrated catalog gives full particulars. Send name today. See our advertisement on pages 53-75-157-185. Michigan State Auto School, 23 Auto Bldg., Detroit, Mich.

STUDY Drafting and make Big Money—taught by mail. Beeman's School, 94 Brighton, Detroit, Mich.

BUSINESS OPPORTUNITIES

THERE is a big opportunity for men who know farming.—know the value of proper cultivation, and the need of saving fertilizer.—to sell the Sprywhol Tractor. This little compact power hoe cultivates better than hand or wheel hoes. Takes the place of five men and operates on one gallon of gasoline a day. Build up your own business. Get in touch with us. H. C. Dodge, Inc., 37 Alger St., Boston, Mass.

MEN Wanted to earn \$3,000 to \$10,000 a year. Prepare quickly and easily through our amazing system for profitable and permanent business reclaiming waste paper for largest manufacturers in country. Boys do the work—you simply direct. Practically no investment necessary—a few dollars will start you. Simply send name for big free opportunity book—a post card will do. Write The Traub System, 383 Traub Bldg., Kansas City, Mo.

MAIL Order Business is your opportunity. Brenner's Famous Handbooks teach how to start small, grow big. Sell merchandise, service, ideas; enormous profits. Spare time to begin. Get complete set, 11 books, \$3.00, and be posted. Brenner, 335 Walnut, Philadelphia. Descriptive Catalog and big batch interesting mail order information. 25c. None free.

MAKE Money with your camera—\$100 to \$300 monthly. Lancaster instruction teaches you thoroughly. Shows how to sell your photos in the best markets. Free information. Send stamp. Lancaster System, 490B Wright-Candler Building, Los Angeles, Calif.

LEARN a trade. Painting signs, name plates, gold letter making. Our patterns do the work. Outfit absolutely free. Address Thomas Clark, 595 Line Ave., Ellwood City, Pa.

PLEASANT work at home for large firms. \$50 weekly spare time, hundreds full time. Book giving particulars to those in earnest \$1. Pitts, Longdale, Okla.

WANTED, local representative; successful plan appeals to all theater managers. Nets you \$35 weekly. Theatre Bulletin Co., 622 Washington Building, Los Angeles, Calif.

GOOD money easily earned at home, spare time silvering mirrors; no capital. Free instructive book tells how. Patterson & Co., Brookville, Ky.

BECOME Business Broker.—Earn big commissions. Details free. Erdman System, Address, Box 647, St. Louis, Mo.

A BIG Business Opportunity. The Sherwood Automatic Clutch Control gives correct clutch engagement without thought or effort of driver. No matter who drives or how they drive, the Sherwood Control prevents stripped gears, jerky starting, or damaged mechanism. Easily attached any Automobile. Greatest improvement since the self-starter. Retail \$12.50. Splendid proposition for State, County Rights, Dealers and Agents. Sold on satisfaction or money-back trial basis. Sherwood Mfg. Co., 200 West Pico, Los Angeles, Calif.

PATENTS Procured. Trade Marks Registered. A comprehensive, experienced, prompt service for the protection and development of your ideas. Preliminary advice gladly furnished without charge. Booklet of information and form for disclosing idea free on request. Richard B. Owen, 39 Owen Building, Washington, D. C., or 2276 R. Woolworth Bldg., New York.

PACIFIC Coast is prosperous. Send \$10 for 24-word advertisement to appear in 15 big dailies on Pacific Coast and secure agents and salesmen to sell your goods. Buchanan Advertising Agency, 247 I. W. Hellman Bldg., Los Angeles, Cal.

PLUMBERS thinking of going into business for themselves soon, write to the Niebuhr Plumbing Business School, Desk P, La Crosse, Wis., for booklet "Making Plumbing Profits," and interesting information regarding financing, accounting, estimating, business practice, etc.

OPEN Hat and Clothes Cleaning parlor at Home. Big profits, particulars free. Byron, Box 27, Station 1, New York, N. Y.

PATENTS—Trademarks. Before disclosing an invention, the inventor should write for my blank form "Evidence of Conception." This should be signed, witnessed and returned to me with sketch or model upon receipt of which I will promptly render opinion as to patentable nature and send booklet on Patents. Highest references. Prompt attention. Reasonable terms. Clarence B. O'Brien, Registered Patent Lawyer, Woodward Building, Washington, D. C.

WAGE Earners: Make big money without capital during spare time. I made \$550.00 monthly, you can do likewise. My money making plans for \$2.00. A. B. Stephens, Box 362, Redondo, Calif.

EASY spare time home work. 400% profit. Send 25c coin for plan. Address, Spencer Agency, 434 Willoughby Ave., Brooklyn, N. Y.

SPECIALTY—Proprietary Manufacturing—Small capital; repeat orders; unlimited field; large profits. Information free. The Thaxly Co., Dept. 29, Washington, D. C.

I MADE \$100,000 as real estate specialist. Free information tells how. American Business Builder, 1129-A Broadway, New York.

LEARN Plating—Automobile Painting, Refinishing, Big Demand—Plans Free—Norman Borick, 427 Carroll St., Akron, Ohio.

MAKE Big Money Opening Safes and Setting Combinations. Wayne Strong, Box 1430, Los Angeles, Cal.

ADVERTISE. Country town newspapers. List for stamp. Pennell, Covington, Ky.

MONEY in mail-order business. Names of 20 supply houses 10c. Pennell, Covington, Ky.

PROTECT Your rights. Write for Record of Invention which contains form to establish evidence of conception of your invention. Prompt personal service. Preliminary advice without charge. J. Beancy Kelly, 612 G. Columbian Bldg., Washington, D. C.

A BETTER Job now. If you have no trade you can get a good one in a few weeks. Learn the auto business. Repairmen, always needed, get good pay; 10,449,785 autos, trucks, tractors need expert service. You can get in this business in a few weeks. Our free 188-page illustrated catalog gives full particulars. Send name today. See our advertisement on pages 53-75-157-185. Michigan State Auto School, 28 Auto Bldg., Detroit, Mich.

ATTENTION! Go into business for yourself. Establish and operate New System real estate; business brokerage, and Insurance Agency in your community. Office at home; earn \$5,000 year. Representatives wanted everywhere; send stamp for booklet. Hayes Realty Association, Cincinnati, Ohio.

REAL Estate men make \$5,000 to \$10,000 yearly. Send \$1 for latest book giving all details and showing you how. Money refunded if not what we claim. Alliance Realty Bureau, Milwaukee, Wis.

ELECTRICITY Taught by experts; earn while you learn at home; electrical book and proof lessons free; your success guaranteed and position secured. Chicago Engineering Works, Dept. A-14, 2144 Lawrence Ave., Chicago.

BE your own Boss—operate Automobile Refinishing, Retrimming, or Cleaning Business; we teach you how. No experience required, unlimited money-making opportunities everywhere. No Fake. Automobile Finishing Co., Sheboygan, Wis.

FORTUNES made preparing box lunches at home, selling local factories, garages, offices, tourists. Success assured, using my system. Particulars free. G. Rood, Sacramento, Calif.

10,000 MONEYMAKING plans, anyone of which may increase your earnings \$5-\$25 daily. Details 25c. Business Builders, Box 730M, Minneapolis, Minn.

IF you have about \$1,000 and capable of organizing sales force, to sell article needed by every merchant, wholesaler and retailer, which should net you \$10,000 profits first year, write Sales Director, 826 Reaper Block, Chicago.

FOR Sale—Established, profitable garage at Daytona Beach, Florida, with established repair business and large line of accessories. Location in heart of city. Building is two-story fireproof construction, 48x168 ft., with large contracts. We show you how. C. Ross to large and convenient living rooms. Daytona Beach has a summer resort patronage from all parts of the state, making the summer business as good or even better than the winter trade. The business also enjoys a large share of the local patronage in a city which has doubled in population in past 3 years and is growing faster all the time. Address F. J. Jones, Box 108, Daytona, Fla.

START a lucrative business of your own. We teach you how to establish and operate a successful collection business, and refer items to you. Capital unnecessary. Practically no competition. Walter Sanford, Nashville, reports \$92,021.94 gross commissions last year. Joseph Cullen, Washington, sends sworn statement showing gross earnings \$8,029.07 for one month. Orrin Overholser, Dayton, says, "I averaged nearly \$400.00 net commissions monthly last year. Such earnings bought my home and farm." Start now in spare time. You can succeed like 4,700 others. Write today for New Plan. American Collection Service, 802 Cass Building, Detroit, Mich.

\$100,000 CORPORATION wants capable man; open office; manage sales for High Class New Device. Every Home a Prospect. Big money-making possibilities for the right man. Opening in every city. Cost \$2.00, retails \$5.00. \$500 to \$2,000 necessary to finance exclusive agency. Scott Corporation, 82 W. Washington, Desk G, Chicago.

EXCEPTIONAL Opportunity for Sales Manager capable of handling state distribution. Marvelous new Adding Machine. Retail \$15. Work equals \$350 machine. Tremendous possibilities. Unlimited profits. Write quick for details. Lightning Calculator Co., Dept. B, Grand Rapids, Mich.

RESPONSIBLE Corporation wants general sales managers to open branch office, manage salesmen. \$500 to \$5,000 necessary; expenses allowed to Baltimore if you qualify. Address Manager, 603 N. Eutaw St., Baltimore, Md.

CLEAN Wallpaper and Window Shades this winter and spring. Big demand. Take large contracts. We show you how. C. Swanson & Sons, Mankato, Minn.

HONEST Mail Order Business in infancy. Alive with unlimited possibilities. 500 high-class, workable plans in detail, \$3.00. Many absolutely new. Others proven very successful. Sworn certified guarantee. If you don't enter business we don't want your money. Send 25c for booklet, "Future Fortunes by Mail." Just published. Universal Advertising Service, Box 321, Oklahoma, Okla.

LEARN Fur dyeing. Formulas guaranteed. Address Rubens, 316 Pulaski St., Brooklyn, N. Y.

THIS May Be Your Opportunity. A large, modern Middle Western manufacturing institution will consider proposals from inventors and small manufacturers, with a view of manufacturing on royalty basis or of buying outright. Small brass products preferred, but any high-grade proposition will be considered. Address P. O. Box 426 Kokomo, Ind.

WE Start You in Business, furnishing everything; men and women, \$30.00 to \$50.00 weekly operating our "New System Specialty Candy Factories" anywhere. Opportunity lifetime; booklet free. W. Hillyer Hagsdale, Drawer 4, East Orange, N. J.

"SCHEMER Magazine." Alliance Ohio, prints big profit schemes; one subscriber making \$25,000 from three; another \$10,000 from one. Try your luck. Year, only \$1.00; three months, 25c.

START a Paying Business of Your Own. Be a business man. Any location. 8,000 new Tire Vulcanizing and Repair Stations needed. Business always good. Are you ambitious? \$200 will start you. Write at once. Wonderful opportunity. Equipment Co., 11 Canal, Cincinnati, Ohio.

INDEPENDENCE and prosperity await you in the furniture cleaning business. Course \$1.00. Circular free. Send today. Address E. M. Ellis, 110 Riverside Ave., Newark, N. J.

GET into the specialty manufacturing business. Amazing profits. We will send you free book explaining our system. Write immediately. A wonderful opportunity awaits you. National Scientific Laboratories, 624 Main, Richmond, Va.

MARBLE mixing instructions, covering wood or cement flooring 1/2 inch thick, fireproof, waterproof, low cost, sanitary, all colors. Particulars, 200 illustrations free. Chris Mahler, Box 122, Huntington, N. Y.

LET Me Show you how to make real money. Absolutely new proposition and new products. Materials cost \$2.00, sell for \$16.00. One man sold a thousand dollars' worth in a week. Exclusive manufacturing and sales rights to one man in each territory. Write today for booklet 5. Crouch, Chemist, 309 Broadway, New York.

SILVERING Mirrors! My exclusive French Tartaric method opens enormously profitable business. Booklet free. H. Barstow, 514 25d Street, Oakland, Calif.

\$3,000 TO \$6,000 Yearly. Want it? Others are making it. Send check or money order today for our invaluable books "How to Sell Real Estate," \$3.00—and "How to Conduct Real Estate and Insurance Business," \$1.50. Absolute satisfaction guaranteed. Free catalog. Realty Book Co., Dept. 52, Cleveland, O.

CHEMICAL Expert will furnish Formulas and Trade Secrets. All lines. Lists Free. W. L. Cummings, Ph.D., 228 Gordon Ave., Syracuse, N. Y.

ENTER a new business. Earn \$3,000 to \$6,000 yearly in professional fees making and fitting a foot specialty, openings everywhere, with all the trade you can attend to; easily learned by anyone at home in a few weeks, at small expense; no further capital required, no goods to buy, job hunting, soliciting or agency. Address Stephenson Laboratory, 11 Back Bay, Boston, Mass.

GET in business yourself; \$4.00 buys marvelous Keystone Economizer. Easily attached to any make car and saves 25% to 50% present fuel consumption. Satisfaction guaranteed or money refunded. Agents make big money. Address Keystone Economizer Company, 323 Stock Exchange Bldg., Los Angeles, Calif.

I MADE \$39 a week home. French bread-making. 15 years' experience; free booklet tells. Ashbrook, 67, Marengo, O.

BE Independent. We teach by mail how to manufacture unexcelled Toilet Preparations. Earn while you learn. Results guaranteed. Particulars Free. School of Cosmetics, Box K, Omaha, Nebr.

FREE—Formula Catalog. S. & H. Laboratories, Boylston Building, Chicago.

LEARN the collection business. Good income, quick results. Interesting booklet. "Skillful Collecting," free. National Collectors Assn., Long St., Newark, O.

CHEMISTRY

I SOLVE your chemical or electrical problem for Five Dollars. Write me. W. Stedman Richards, Consulting Chemist, 220 Washington St., Boston, Mass.

EXPERT Chemical Analysis. Formulas furnished. Reasonable. S. W. Bower, Ph. C., 24 Norway Park, Buffalo, N. Y.

CHEMICAL Analysis. Chemical and Industrial formulas. Burson Chemical Laboratory, 227 West 4th, Ottumwa, Iowa.

FORMULAS AND TRADE SECRETS

500 FORMULAS, 20c. Luminous paint—Resilvering Mirrors—Renewing dry batteries—Mechanics' Soap—Gas Tonic—Carbon remover. Puncture Plugger, 20c each. Entire collection, 50c. Ideal Book Shop, 5501FC, North Robey, Chicago.

VIOLIN E Strings, 6 and Formula for making, \$1.00. Address, Northrup Co., Manufacturers, Norwood, R. I.

ABSOLUTELY any formula \$1.00. Satisfaction guaranteed. Robert Tyler, 256 Park St., Newton, Mass.

HARD, dry paint brushes cleaned in fifteen minutes for two cents without injury to bristles. Along with formulas for Fireproof Paint and Fireproof Preservative to fill paper, cloth, plaster, wood or cement for painting, varnishing, waxing, calomining, paper hanging. All for a dollar. Address E. P. Miller, 3276 Olive Avenue, Fresno, Calif.

3,000 FORMULAS and Trade Secrets; 400 pages, \$1.00. Universal Book Shop, 1049-C N. Whipple, Chicago.

FORMULAS, 20c—Luminous Paint, Paint-Varnish Remover, Gasoline Tonic, Hand Cleaning Paste, Auto-Furniture Veneer, Battery Renewer, Auto Top Dressing, Polishing Cloth, Cementless Patches, Puncture Plugger, Auto Body Cleaner, Auto Sec-Clear. Entire Collection \$1.00. Myers, Box 280, Reading, Pa.

REMARKABLE Discovery—Positively removes tattoos, coal marks, moles; safe, sure, simple process. Original since 1918. Formula \$1.00. Harding Co., 142 Dearborn St., Philadelphia.

FORMULAS of the better sort. Write for our free catalog. National Scientific Laboratories, 624 Main, Richmond, Va.

FORMULAS—All kinds—Catalogue free. Restoval Laboratories, 4049-C N. Whipple, Chicago.

SPANISH Inventor has finally obtained U. S. Patent for new process for plating glass (crystal) without use of heating. Rochelle salt, Ether, Formol or Sezoette salt. Cost of plating crystal per square foot, 2c. No machinery, no capital necessary. A man can silver 500 square feet daily. Anyone can make and silver mirrors. Experience unnecessary. Can make \$10 a day at home. Get raw materials in any drug store. Guaranteed 10 years. Copy of formula with instructions for use and permission, 20 pesetas (\$3.00). Express or International money order. Antonio Formoso, Santa Catalina, 12 La Coruna, Spain.

10,000 SELECTED scientific, chemical technological and practical recipes and processes including hundreds of so called trade secrets for every business alphabetically arranged in one large volume of 800 pages. Price \$4 postpaid. Popular Mechanics Book Dept., 6 N. Michigan Ave., Chicago.

FORMULAS—Catalogue free "Clover." 5501-CC, North Robey, Chicago.

500 RARE Formulas for 25c (coin). We can furnish any formula wanted for 50c. Allen's Enterprises, 1227 Milwaukee Ave., Chicago, Ill.

MAKE and Sell your own products. Formula Catalogue free. C. A. Lutz, Apartment 484, York, Pa.

1,000,000 FORMULAS, Trade Secrets, for Every Business, \$2.25. Ideal Book Shop, 5501MC, North Robey, Chicago.

3,000 FORMULAS—400 pages, \$1.00. Catalogue free. Englewood Book Shop, 7021A So. Winchester, Chicago.

FREE—Formula Catalog. S. & H. Laboratories, Boylston Building, Chicago.

AGENTS WANTED

WHIRLWIND money-maker for agents—sample free. Sell powdered Hanslick, an absolutely new, non-competitive, and unbeatable hand cleanser. Removes grease, grime, ink, paint, etc., without slightest injury to skin. Its use spreads like wildfire. Cheaper than all others. Sells in cans (or bulk with dispensers) to garages, auto clubs, mechanics, factory and office folks, to housewives, hardware stores and to auto supply houses. Huge quantities used weekly by mercantile houses. (Names on request.) Big repeat business assured. Exclusive agencies, crews working for you, fast sales, splendid profits and a permanent business for hustlers. Live ones can clean up \$500 a month. Send 2c stamp for postage on Free sample. Complete sales plan goes with it. Write quick to Solar Products Company, 124 W. Lake St., Chicago, Ill.

AGENTS Wanted—Something New—Fire Fighter sells easily. Makes a spectacular demonstration—car owners, homes, factories, stores practically buy on sight. Our men make \$10 to \$50 a day—exclusive territory. If you wish to establish a business of your own with unlimited possibilities for making big money, write us today. Fry-Fyter Co., 103 Fry-Fyter Bldg., Dayton, Ohio.

350% PROFIT! Quick, Easy Seller. Klean-Rite. New Washing Compound. Washes clothes without rubbing. Women wild over it. Write quick for Free package and Special Offer. Bestever Products Co., 1941-K4, Irving Park, Chicago.

WHY is Zeeta a sure repeater? See our ad in this section. The Zeeta Company, Inc., Gotham National Bank Bldg., 1819 Broadway, New York City, N. Y.

WANTED Agents to sell Yale Oiling System for Fords. Perfect Band Oiler—eliminates chatter and grabbing. Price \$1.00. Force Feed Oiler for engine delivers 10 gallons per hour regardless of road condition or grade, \$3.00. Yale Low Oil Indicator for all cars. Shows oil level at glance. Gives warning "Low Oil" by flashing lamp in dash instrument. Only \$8.00. Owners install without special tools or skill. No drilling. Not an experiment. Thousands operating perfectly. Sells on sight. Agents' discount liberal. Many carry small stock, selling direct at big profit. Write for territory. Yale Corporation, Sales Division, 604 I. W. Hellman Bldg., Los Angeles, Calif.

EARN big money. Greatest opportunity offered you and your friends to become well heeled. One chance in lifetime to ease life burden. Repeats come thick and fast. Every girl, every woman, a prospect. They come to you after first sale. Don't miss this wonderful chance to start splendid, permanent business of your own. One dollar starts you. Don't wait. Write today. Tomorrow may be too late. The Winner Company, Fairfield, Conn.

MANUFACTURER offers unusual opportunity to experienced crew managers or agents in your home territory. This is an opportunity of a life time for right parties. Product is best seller ever offered and repeat business is simply phenomenal. Tremendous demand already existing with absolutely no competition. If you're making less than \$300.00 monthly—write. All replies considered confidential. State experience and qualifications fully. C. L. Beardley, Rock Island, Ill.

AGENTS—16,000 Miles without a puncture with Insyle Tyres. Wonderful invention. Just slip inside casing before replacing tube. No tools needed. Will not heat or pinch. Positively prevent punctures and blowouts. Guaranteed double tire mileage. Old worn-out casings give 3 to 5 thousand miles more service. Biggest thing on the market. Low priced, \$8 to \$20 a day. Write for territory. American Accessories Co., B-978, Cincinnati, Ohio.

AGENTS—We want good honest men or women to represent us in your territory, taking orders for Liberty Guaranteed Raincoats, Brand new. Latest styles. Made in our own factory. No capital needed. We pay \$6 a day taking orders. Pay you every day. Big opportunity for some one who will act quickly. Liberty Coat Co., 2280 Liberty Bldg., Dayton, Ohio.

AGENTS—Earn \$50 to \$100 a week selling Marquette Tire Tool. Simple demonstration sells it. Removes tires in a jiffy. Every owner wants it. Thousands in use. Exclusive territory going fast. Agent's sample \$1.00, retails at \$2.50. Write for full particulars or send \$1.00 for sample and particulars. Marquette Mfg. Co., Dept. A, 218 S. Wabasha Ave., St. Paul, Minn.

AGENTS—Sell Articles which repeat and on which you can build up a permanent business. You can do it with "Zanol" Products, a high class line of Soaps, Perfumes, Flavors, Coffee, Tea, Baking Powder and other Pure Food Products and Household Necessities. Write today for New Money-Making Plan. American Products Co., 5724 American Bldg., Cincinnati, Ohio.

NO Dull Times selling food—people must eat. Federal distributors make big money; \$3,000 yearly and up; no capital or experience needed; guaranteed sales; unsold goods may be returned; your name on packages, build your own business. Free Samples to customers. Repeat orders sure. Exclusive territory. Ask now! Federal Pure Food Co., Dept. 10, Chicago.

ZETA spells repeat orders. See our ad in this section. The Zeta Company, Inc., Gotham National Bank Bldg., 1819 Broadway, New York City, N. Y.

\$6.00 TO \$12.00 a day. Experience unnecessary with our original plans. Household necessity used in every home. 25c to \$1.50 sale eight out of ten calls. Not sold in stores. Territory going quick. Big concern. Write quick for free sample and plan. The Jiffy Soap Products Co., Dept. 1, Dayton, O.

MAIL Order Business is your opportunity. Brenner's Famous Handbooks teach how to start small, grow big. Sell merchandise, service, ideas; enormous profits. Spare time to begin. Get complete set, 10 books, \$2, and be posted. Brenner, 335A Walnut, Philadelphia. Descriptive Catalogue and big batch interesting mail order information, 25c. None free.

\$61.50 WEEKLY. Introducing and selling a new gas light burner for kerosene lamps. Beautiful light. No chimney. No mantle. Samples free. Experience not necessary. Write today. Luther Mfg. Co., Dept. 442, Cincinnati, Ohio.

EASTER will soon be here. Sell our Excel Luminous Crucifix which "Shines in the Dark" at this appropriate time and make some big money. Churches, hospitals and individuals are only waiting for a demonstration before buying. Write today. W. G. Hauman Co., Dept. B, 57 E. 18th St., Chicago.

START in a permanent business of your own selling guaranteed Hosiery and Underwear direct from mills. No capital or experience is needed; many representatives make \$3,000 to \$5,000 per year. Become our district manager—get others working for you. Write for details to Malloch Knitting Mills, 524 Grant St., Grand Rapids, Mich.

DISTRIBUTORS, District Salesmen, Managers, Agents. Do you know that we make the best Waterproof Aprons and Sanitary Specialties on the market? Sell for less, and your profits are largest. Write now and convince yourself. B. & G. Rubber Mfg. Co., 618 Penn Ave., Dept. 138, Pittsburgh, Pa.

"WASHRITE," Reg. U. S. Pat. Off. "The Washing Tablet Supreme." Highest quality, sure repeater. Profits from 150 to 200%. Prosperity package, containing one dozen each, 15c and 25c sizes, postpaid for \$2.50. For further particulars, address The Washrite Mfg. Co., 1569 Breda Street, Dept. P.M., St. Paul, Minn.

\$15 DAILY and more for Men and Women Agents, selling now guaranteed household necessity. Women go wild about it. No experience. Permanent business. New agent sold 100 in two days (profit \$75.00). Write for proof. W. J. Lynch, Box 718, Springfield, Ill.

AGENTS—Big Money—Fast Sales—Every automobile owner wants initials on the doors of his car. Applied while waiting, \$1.35 profit on every \$1.50 job. Write for proposition and samples. Transfer Monogram Co., Dept. 151, 191 Market St., Newark, N. J.

HIGH Grade Printing for Half Price. Send stamps for samples our high grade work and standardized price list that shows you in actual figures the money we can save for you. Geo. S. McGinley, 51-A, 1129 West Moyamensing Ave., Philadelphia.

"PEP and Co." 50c postal order brings Agent's Sample and wonderful offer on newly invented self-selling vest-pocket magnetic extractor for removing foreign bodies from the eyes. Everybody buys. Gem Cinder Extractor Co. (a), 9924 Malta St., Chicago.

100% PROFIT to Agents. Every house a prospect. Over 4000 sold past 30 days in one small city in Illinois. An article of merit—a big seller. Crimp-Grip Clothesline Adjuster. Keeps the line tight—no knots to tie—fastens and releases quickly. It keeps the clothes off the ground—it saves time. Write for particulars or send 50c and we will mail you postage paid one pair in carton with screws and one set mounted on wood with line for agent's sample. Agents are making from \$8.00 to \$20.00 per day. Reference Second National Bank, Belvidere, Illinois. Address, Crimp-Grip Co., Dept. J, Belvidere, Illinois.

AGENTS make \$5.00 per day in spare time introducing Greatest Tire Valve on the market. Stops and prevents leaks. Fits all tires. Rush for particulars. Sample 50c. Stopik Tire Mfg. Co., Buffalo, N. Y.

AGENTS: Men and women, in spare or full time, make big money selling household necessity. Every home a prospect. Quick sales, big profit. Territory open. Write for particulars. Judd & Leland Manufacturing Company, Box 21, Clifton Springs, N. Y.

AGENTS, \$6 a day taking orders for Blue Ribbon Cutlery Set, Stainless steel. Guaranteed. Aluminum handle. We deliver and collect. Pay you daily. Write quick for sample outfit. Parker Mfg. Co., 178 Awd St., Dayton, Ohio.

CHEAPER Fuel—Easier to Handle. Evenheat Kerosene Burner. Fits any stove or furnace. Newest improved invention. Guaranteed not to clog. Every home buys on sight. Big money for hustlers. Staley & Sheehan, 212 Congress Park, Ill.

AGENTS—100 to 300 Per Cent Profit. Sell Mystery Liniment Powder or manufacture and sell the Liniment. 25c package postpaid makes pint Beautiful White Cream Liniment. Every house a prospect. Excelsior Supply, Enid, Okla.

BIG Profits to Agents to sell with our Crimp Grip Clothesline Adjuster. Send us \$1.10 and we will send you postage paid for your inspection a sample set of four Spark Plugs for Ford cars. It is a staple article. They retail everywhere at \$2.40 per set. No better Plug on the market. Crimp Grip Co., Dept. J, Belvidere, Illinois.

AGENTS—\$6 to \$12 a day. Take orders for Aluminum handle Cutlery Set. Brand new. We deliver and collect. Pay you daily. Sample to workers. The Jennings Mfg. Co., Dept. 1748, Dayton, Ohio.

AGENTS—Sell Patented Cigar Lighters and Cigar-Case Moisteners. Big Profits. Start making money at once. Write for circulars, cuts and sales plan. Drake Mfg. Co., Dept. M., Milwaukee, Wis.

DEMONSTRATORS wanted in every town. Men or women. No canvassing. Demonstrators are making \$10 to \$50 per day. Sample \$2. Radium Mfg. Co., 2713 Delaware St. S. E., Minneapolis, Minn.

MEN! Make \$8 to \$10 a day. High grade. Sold man to man. Neat sample case, 100% profit. Only one representative each town. Act promptly. Sales Manager, 709 Spitzer, Toledo, O.

\$12 DAILY Right in Your Own City, Agents, General Agents, Lightning sellers. New Folding Shipping Bag. Waterproof Rubber Aprons, Combing Jackets, Others. Spangler Mfg. Co., 160 N. Wells, Chicago.

MEN or Women—Enormous Profits selling Duo Guaranteed Products. Easy Sales at every house. All or spare time. Big repeaters. Write Quick, Duo Co., Dept. Y-1, Attica, N. Y.

MEN'S Shirts. Easy to sell. Big demand everywhere. Make \$15.00 daily. Undersell stores. Complete line. Free Samples to workers. Chicago Shirt Co., 268 So. LaSalle, Factory 189, Chicago.

AGENTS—The greatest 50c proposition on earth. 7 million now in use. Sells itself. Send 25c for sample, particulars. No free samples. Ideal Specialty Co., Los Angeles, Calif.

\$40.00 WEEKLY (whole or part time) selling guaranteed Hose, Waterproof Aprons, Shampoo Capes, Toilet and Sanitary necessities. Credit given. Jas. C. Bailey Co., Dept. M7, Chicago.

SELL Padding Powders—Delicious dessert. Fast sellers; quick repeaters; big profit. Send for terms and sample. C. H. Stuart Co., 75 Broadway, Newark, New York.

GUARANTEED Hosiery, lowest prices, manufacturer's complete line direct to wearer. Samples without charge. We deliver. Part time acceptable. Joseph Bros., 343 Broadway, New York, N. Y.

SUBSCRIPTION agents in Ohio and Western Pennsylvania for high-grade financial and industrial magazine. Write for proposition. Finance & Industry, Caxton Bldg., Cleveland, O.

GENERAL agents wanted to distribute the latest attractive novelties; excellent sellers; big profits; write quick. The R-D-K-Novelties Co., Inc., 1429 Lexington Ave., New York.

"THE Capital Magazine"—Greatest agents' magazine published; 24 pages money making opportunities. Copy, 10c; three months, 25c. Capital Supply Co., 412 Clark, Cincinnati, Ohio.

AGENTS Wanted—Fibre Brooms outlast 4 ordinary brooms. Guaranteed by old reliable company. Large profits. Fibre Broom Co., 327 E. Grand Ave., Chicago.

MAKE it yourself. Costs \$5.00, sells \$100. Secret, including source of supply, \$1.00. Address Cassia, 215 East 122nd Street, New York City, N. Y.

TIRE Salesmen: Sell guaranteed 10,000-mile Cord tires; Ford size, \$9.95; other sizes 35% discount. Write, Hill, The Arcade, Cleveland, O.

EVERYBODY uses Extracts. Sell Duo Double Strength Extracts. Complete line necessities. Big repeaters. Write today. Duo Co., Dept. E-1, Attica, N. Y.

BIG profits on fiber brooms; a household necessity in demand. Particulars, E. C. Small, 6844 Yale Ave., Chicago, Ill.

AGENTS Take Notice, Ex-Service Men—any person out of employment. Men or women can make big money. Every home a prospect. Write for particulars. Crimp Grip Co., Dept. J, Belvidere, Illinois.

WANTED—Responsible man to take Exclusive State Agency and Distributor for Ford Timers. Olof A. Eckro, Kindred, No. Dak.

POLISHING Cloth—great seller—big profit. Get our proposition. Newton & Co., 19 Main St., Newark, N. Y.

AGENTS—Sell Electric Body Batteries for Nervous Diseases and Rheumatism. Nealeigh & Co., Indianapolis, Ind.

ARTIFICIAL flowers for stores and homes. Quick sales. Large profits. Address McCallum Company, Pittsburgh, Pa.

\$5,000.00 18 yours in 1922. Exclusive contracts, complete line, fastest selling auto accessories made. All you need is Pop. We show you how. Secure your territory today. Leslie Muter Company, 32 West 69th Street, Chicago, Illinois.

MAKE \$50.00 to \$100.00 and more per week, selling our wonderful all wool one price line. Suits sell for \$29.50. None better. Retail stores ask at least \$50.00 for the same quality. Also strong line of feather-weight fabrics to sell at \$16.75 per suit. You collect your profits at once. We ship C. O. D. to customer for balance. We furnish beautiful 6x9 swatch outfit and powerful co-operation. Hustlers write at once, to Salesmanager J. B. Simpson, Inc., Dept. A-58, 881 West Adams Street, Chicago, Ill.

HOW to Sell—and What. Every issue a text book on salesmanship. Tells you how, when and what to sell. Shows up the illegal license game. Puts you in touch with most profitable fast selling lines and reliable manufacturers. Sells for 20c an issue. Worth \$20 to anyone trying for a larger income. Three months' trial subscription 25c (stamps accepted). Address How to Sell—and What, 22 West Monroe St., Dept. AG, Chicago.

AGENTS: Make \$75.00 a week selling our strictly All-Wool made-to-measure suits at \$28.50. You collect profits in advance and keep them. We supply finest selling outfit in America. Many exclusive money-making features. Tailoring, raincoat and side-line men, part or full time, get in touch with us immediately. Address Dept. 754, Goodwear, Inc., 843 W. Adams St., Chicago.

PATENTS—Trademarks. Before disclosing an invention, the inventor should write for my blank form "Evidence of Conception." This should be signed, witnessed and returned to me with sketch or model upon receipt of which I will promptly render opinion as to patentable nature and send booklet on Patents. Highest references. Prompt attention. Reasonable terms. Clarence B. O'Brien, Registered Patent Lawyer, Woodward Building, Washington, D. C.

FREE Sample "Rain Shield Wiper." Retail \$1.00—Costs You 25 Cents (300% Profit). Every Autoist Buys Quickly. No Cloth. No Paste. No Mechanical Attachment. (1) Rub keeps Windshields clear 48 Hours against Rain, Snow Storms. Invention Just Out. Prevents Accidents. (Williams makes \$12 Hour.) Experience Unnecessary. Wonderful Pocket Sideliner. Write Quick for Your Free Sample. Nu-Life (B) Corporation, Hartford, Conn.

TWO Real Money Makers: Self-threading needles. Needle books cost 5c, sell at 15c. Send for samples, S. Lee, 145 E. 23d St., New York, N. Y.

BIGG&ST, fastest sellers. Every woman buys Hawkins' High Grade Toilet and Household Necessities on sight. 100% profit. Colonial Chemical Co., 631 Penn Ave., Pittsburgh, Pa.

WHAT is Zeeta? See our ad in this section. The Zeeta Company, Inc., Gotham National Bank Bldg., 1819 Broadway, New York City, N. Y.

EARN \$25.00-\$50.00 weekly selling guaranteed hosiery for men, women, children. We deliver and collect. Consumers Hosiery House, 724-A City Hall Station, New York.

\$1.00 SALE means 75 cents profit for you. Wonderful New Automobile Invention. Each Quick Demonstration means Sure Sale. Experience not necessary. Riley made \$198 three days. Stomach made \$10 first hour. Prevents Accidents. Gives Better Service. Carried in Pocket. Mail 25 Cents for \$1.00 sample. (Money Back Instantly.) Write Quick for Sample and Exclusive Territory. (Invention, Box 494), Hartford, Conn.

AGENTS—Here's big money and independence. \$5 starts your own business. Be independent—our line assures your future prosperity. Jaco Comb Straps are not a novelty but a necessity—a quick seller and big repeater. What others have done you can do. Act now—write for proposition and exclusive territory. 25c brings sample. The Jay Company, Desk 6, Washington, N. J.

CLEAN up a fortune. New perfected Oriental Pearls undrilled for mounting in pins, rings and ear-rings. First shipment to reach U. S. Perfect reproductions real Pearls. Best agency proposition in 20 years. Send 30c for sample; sell it for \$2.00. Money back guarantee. McCallister Co., Importers, 579 Phelan Bldg., San Francisco, Calif.

AGENTS—Sell Real Solid, 99% pure and seamless Aluminum Ware. Put up in sets or single pieces. Big money for the hustler. Aluminum ware is a repeater and builds you a business. We have several other money-making lines for agents. Write for circulars. H. C. Aluminum Co., Fredericksburg, O.

AGENTS—Full or part time. The most compact, comfortable and portable chair in the market. Used for seashore, mountain resorts, camps, clubs, everywhere. The ideal tourist chair. Sells on sight. Big profits. No competition. Address, Klosepak Manufacturing Co., 107 Erie Street, Camden, N. J.

WANTED At Once—100 live men to fill open territories in our expanding organization. An opportunity to make real money while learning and establishing a permanent and profitable business of your own. J. M. Pitkin & Co., 377 Commercial Bldg., Newark, N. Y.

EVERY Ford owner an easy customer. Closes pedal and brake openings—makes car cleaner and warmer. Exclusive territory. Sell dealers and owners. \$3.50 brings sample and all selling help. Auto Accessory Sales Co., 208 Empire Bldg., Detroit, Mich.

AGENTS—Big profits; easy sales, handling celebrated line matchless self-lighting devices. Practical and useful in every home, store, office, factory. Write for particulars. Urwin Specialty Company, 32 Union Square, New York, N. Y. Samples (2 leaders) 25c.

100% PROFIT selling our felt rugs to homes, hotels, offices, etc. Everybody buys. We are manufacturers, not jobbers. Prices defy competition. \$75 week easy. Newark Felt Rug Company, 56-C Bergen Street, Newark, N. J.

AGENTS (colored preferred) in every state to sell Yarborough Products. Fast sellers, big repeaters, offer good profits. Organize a sales force, make big money. Write today to Yarborough Mfg. Co., Winston-Salem, N. C.

AGENTS Coining Money selling Universal Gas Saver for every gas stove. Wonderful device. Cuts gas bills in half. Big profits. Write quick. B. C. Moore, Gas Saver Co., Topeka, Kansas.

MIDGET Collapsible Garment Hangers sell fast. Penknife size in beautiful leather case. 100% profit. Sample 35c. Money back if not satisfied. Kalina Company, 384-B Alabama Avenue, Brooklyn, N. Y.

SOMETHING Big. Dime puts you on our mailing list one year. You receive latest money making propositions, opportunities from manufacturers and supply houses everywhere. Kentucky Agency, Covington, Ky.

EXCLUSIVE State Distributor experienced in handling Agents and Salesmen calling on Automobile owners. New, quick selling auto accessory, no installing, over 100% profit. Must be able to finance yourself for initial order amounting to \$108. Write for details and State Contract. Box 2071, Denver, Colo.

AGENTS. Ginger up your sales with our line of snappy household articles. All new ones. Big profits. 3 samples and particulars 25c. Circle Sales Co., Moline, Ill.

MEN: Milford Knife Sharpeners always sell. Unusually good article, big profits. Send 25c for sample, full particulars, State territory desired. Milford Sales Co., 17-Cherry, Milford, Conn.

SALESMEN, sell men's made-to-order clothing, attractive materials, lowest prices, good profits, samples ready, give experience. Emerson Tailoring Co., 433 Arch St., Philadelphia.

COMBINATION floor and wall broom going like wildfire. Commission over 50%. Outwears four corn brooms. Convenient shipping points. Address Harnack Co., Keene Building, Fort Worth, Tex.

AGENTS everywhere—sell Mascot keyless lock. Fits any door—Jimmy proof—Carry in vest pocket. Send 50c sample, literature. Milbruck Products Corp., 311a 5th Ave., New York.

AGENTS—Sell the "Endicott" Back-O-Neck Collar Button. Lightning Change—Bumpless—Everlasting. 27 for \$1. Sample 10c. B. B. Co., 27 Grant Ave., Endicott, N. Y.

AGENTS fast office sellers, 144 leads for Eversharp pencils; cost 30c, sell 60c; stamps accepted. Singleton, Postoffice Box 363, City Hall Station, New York City.

EARN \$10 daily silvering mirrors, plating and refinishing metals, autos, chandeliers, bedsteads. Outfits furnished. E. Decle Laboratories, 286 Fifth Ave., New York, N. Y.

VERDINA soaps, perfumes, coconut oil shampoo, etc., sell fastest, pay best. Get our Special offer. Verdina, 416 E. 18th St., New York, N. Y.

QUICK Profits, Soliciting, Opening Agencies for Resharpener Blades, or Selling Finest Improved \$1.50 Razor. Standard Safety Razor Corp., Pittsburgh, Pa.

MEN, Women. Place demonstrating sample tires for mileage tests. Advertising good tres. Good pay. All or part time. Cubberley, Belleville, N. J.

SELL patented necktie holder. 25 cents; five for one dollar. Gross: six dollars. Standard Metal Stamping Works, 224 Centre, New York.

MANUFACTURE Extracts, and other necessities. 200% profit; we tell you how. Write White Manufacturing Drug Co., Box 322, Cincinnati, O.

NEW Garter. Patented pen, No knots, pads, etc. \$1.00 doz.; \$8.50 gross. Art Needle Co., 513 N. Dearborn, Chicago, Ill.

AGENTS: \$12 daily selling Chemical Gas Lighters. No friction. Nothing like it. Sample 15c. Ideal Specialty Co., 1820 Martha St., Omaha, Neb.

AGENTS, Canvasers, Real 50c Necessity. 600% Profit, Cafes, Stores, Homes Buy Quick. Sample, Particulars 25c. Mfg., 4035 Minnehaha, Minneapolis, Minn.

OPEN Rummage Sale Store; we'll start you. Make \$50.00 daily. Wholesale rummage sale supplies. Crosby Co., 609 West Division, Chicago.

SWIFT, easy, sure selling necessities; exceptionally profitable exclusive business. Samples free. Peninsular Specialty Co., 15303 E. Jefferson, Detroit.

SHEEP wool polishers, dusters, cleaners for home. Commercial, auto use. Address Bennington Duster Co., East Boston, Mass.

MAKE \$10 daily selling imported "Aluminum Pencil Sharpeners." Sample 25c. Roman Arndt, 3151 Meldrum, Detroit, Mich.

AGENTS, Self-threading needles. Fastest household seller. Sells 15c. Costs 4c. Address Maher Co., Dover, N. J.

25c SAMPLE free everywhere. Empey, 23 Caldwell Ct., Charlestown, Mass.

ENORMOUS profits applying Transfer Auto Monograms; Window Letters. Address National, Station D., Brooklyn, N. Y.

AGENTS—Men or Women—Build a substantial business of your own. Fastest selling antiseptic toilet powder ever placed upon the market. Zeeta—one of the newest and most important discoveries of medical science. Used, endorsed and prescribed by physicians. Zeeta does not stop perspiration. Zeeta is guaranteed to decrease the excessive amount; eliminate all offensive odors; relieve chafing and quickly heal burns, cuts, scalds and skin irritations. Absolutely relieves tired, burning, perspiring feet without clogging the pores and causing rashes, water blisters and cracks between the toes. Now used by thousands of satisfied men and women who would not be without it. Two sizes. Handsome, big package at attractive price. Quick sales; sure repeater; tremendous profits. Sure-fire territories open if you write quick. Address Department 11. The Zeeta Company, Inc., Gotham National Bank Building, 1819 Broadway, New York City, N. Y.

EASY demonstration gets the dollar. Every man a prospect. Sample pair and literature 35c. Money-back guarantee. Expanding Cuff Links, 335 Macomb, Detroit.

A BUSINESS of your own—Make sparkling glass name plates, numbers, checkerboards, medallions, signs; big illustrated book free. E. Palmer, 511 Wooster, Ohio.

AGENTS sell new "Duplex" can opener. Cuts side or top. High-tempered blade. Sample 25c. Paragon Manufacturing Co., Box 591, New Haven, Conn.

A MAIL-ORDER business of your own, selling movie patrons all year anywhere; free circulars. Wendo, 31 Times Plaza, Brooklyn, N. Y.

MAKE big money, whole or spare time, selling high grade Pure Aluminum Combination Cooking Utensils with new features that every Housewife wants and can afford. Our unique plans make you welcome and get the business. Exclusive territory—no sales limit. Here's chance to connect with a live one. Unlimited stock—prompt shipments. Apply today—Now. Perfection Aluminum Mfg. Co., Lemont, Ill.

SELL "Stikit" Cleanest, handiest mud-casting device. Thousands in use. Beautifully finished, nickel plated desk holder, compact, neat size. Needed in every office, home, store. Handsome profit on first sale; continual profits from refill sales. Sells easily for \$1.50. Details free; or send \$1.50 for 2 pocket samples. Hoffman-Corr Mfg. Co., 318 Lafayette St., New York. References: Any Bank, Duns or Bradstreets.

AGENTS to demonstrate and sell to car owners. Nationally advertised Auto Polish that restores the factory lustre, and leaves a glass hard, dust-proof surface. Thousands of instances prove quick sales result from demonstrations; and steady growth of profits from repeat business. For free testing sample and details address C. S. Manfg. Co., 502 N. Whittier, St. Louis, Mo.

AGENTS: \$5 to \$15 daily easy. Your pay in advance introducing new-style guaranteed hosiery. Must wear or replaced free. No capital or experience required. Just show samples. Write orders. We deliver and collect. Elegant Outfit furnished, all colors and grades including silk. Dept. 401, Mac-O-Chee Mills Co., Cincinnati, Ohio.

AGENTS make \$50 weekly selling Clip-Grip Screw Drivers. See our ad on page 169. Send 70c for sample set of 4 sizes. The Nova Co., 326 River St., Chicago.

\$75 A WEEK: Legitimate business agency for the fastest selling Ford necessity on the market—The Spad Magneto Timer. Price \$2.50. Quick sales. Big profits. Nationally advertised in Motor Age, Ford Owner and Dealer, American Automobile Digest. Write Dept. A, Spad Manufacturing Co., Inc., 44 W. 38th St., New York City.

MANUFACTURER of The "Ever-ready" Combination Rag and The "Everdry" Sanitary Napkin Supporter for women, articles welcomed by every woman, offers exceptional opportunity to agents, men and women, and especially those capable of employing salesladies on a house-to-house proposition. American Rubber Products Company, 608 Fifth Ave., Pittsburgh, Pa.

SELL Ladies' Art Embroidery Needle. Sample 50 cents. Eugene Marguls, 5200 North Keystone, Indianapolis, Ind.

AGENTS—Don't overlook our proposition on page 158. C. B. Haven Co.

SOFT Drinks In Powder; ten kinds. Just add cold water and sugar; no trouble. Fine for the home, parties, dances, etc. Many make \$10 to \$50 day. Ten-glass package, best drink you ever tasted, and particulars 10c postpaid. Morrissey Company, 4403-11 Madison St., Chicago.

STATE Distributors, County and Town Agents wanted for "Bay State" Wrench Sets. See our display adv. on page 136, illustrating set and outlining sales-opportunity. Read immediately—must favor first inquiries—territories being allotted. The Allen Mfg. Company, Hartford, Conn.

AGENTS—Big money taking orders Suits, Pants, Blankets, Raincoats, direct wooden mill to wearer. Big values. Donahue made \$108.00 first week. Pinocci makes \$200 weekly. Complete outfit free. Taylor, Wells & Co., 4274 N. Paulina, Chicago.

PORTRAIT Agents—Earn big money selling our Photo Medallions. Everybody buys. You charge \$3.00; make \$2.40 each sale. \$10 daily easy. Big variety designs. 4-day service. Perry Photo Novelty Corporation, Section 16, 360 Buxary, New York.

1922's FASTEST selling auto accessory. Rear signal light tells what automobilist is going to do. Stop, or turn right or left. Nothing like it. \$20.00 daily average profit. Reliance Products Co., 511 No. La Salle, Chicago.

AGENTS—Don't overlook our proposition on page 154. C. B. Haven Co.

\$10-\$15 DAY putting Monograms on automobiles. You cannot imagine anything easier unless you were born with an income from some rich father's accumulation; free samples. Worcester Monogram Co., Worcester, Mass.

RAYLITE Diamonds, Marvelous Gem Discoverer. Fool's Experts. True diamond color—Beautiful. Guaranteed Rings, Jewelry-Specialties, Stretching Kuff Buttons at Factory Prices. Exclusive proposition for Right man. Master Jewelers, Sheboygan, Wis.

AGENTS, Wonderful seller, Big Profits; quickly sold; every home a prospect. Tool steel knife sharpener. Send Twenty Cents for sample and prices. Strand, 1432 Bryn Mawr, Chicago, Ill.

IMMENSE profits selling rear-end automobile safety stop-lights. Prevents accidents. Costs \$1.35, retails \$5.00. Sample sent C. O. D. with full particulars. National Stoplite Co., 178 W. Randolph, Chicago.

AGENTS Wanted—We give exclusive protected sales right on our new guaranteed safety razor blade sharpener. Write for particulars and prices. Strand, 614 Randolph St., Chicago, Ill.

AGENTS: Make big money selling machine and garage shoes. No competition. Fast seller. Write for full particulars. Stant Tool Co., Room 1110, 115 Broadway, New York, N. Y.

SELL Real Amber Cigarette Holders direct to men and women. Beautiful samples; big demand; big profits. Wm. Brand, 27 East 22nd St., New York City.

AGENTS to sell known brand food flavors in collapsible tubes and cordial extracts. 300% profit. Servis Chemical Co., 217 Bowerman St., Brooklyn, N. Y.

MEN to sell Men's silk neckwear direct to consumer. Wholesale prices to you. Meltsner Neckwear Co., 24 East 21st Street, New York, N. Y.

GET Posted for Spring. Good prices paid for butterflies, insects. See Sinclair's Display Advertisement, page 18.

AGENTS—Don't overlook our proposition on page 156. C. B. Haven Co.

AGENTS—Immense profits, placing gold and silver sign letters; experience unnecessary; samples free. Aesthetic Sign Letter Co., 401 Ward, Wallingford, Conn.

AGENTS See our display advertisement on page 128 in this magazine, then write us immediately. Wide awake agents need no other line. Address, Sales Dept., The Kaxo Company, Cambridge, 89, Mass.

\$50 To \$75 Weekly. Every Housewife Needs Positive Repeater. Sample 10c. Utility Co., 201 Joas Building, Chippewa Falls, Wis.

AGENTS: Manufacturer's Year Book tells where to buy, "saves money," just \$1. Address Nelson, Publisher, 2123 Madison Avenue, New York, N. Y.

SALESPeople. \$1.00 starts you in business. Costs 15c. Sells for \$1.50. 75c package sent for 4c. Address Texply Co., Somerville, N. J.

AGENTS, Men or Women, full or spare time, earn \$25.00 to \$100.00 a week and be your own boss representing the Ho-Ro-Co Mfg. Co., manufacturers of the wonderful Ho-Ro-Co Tonic, the great blood purifier and system builder; some profit-maker. Ho-Ro-Co Medicated Skin and Scalp Soap for the baby, toilet, bath, skin and scalp; a repeater. Over 100 other fast-selling specialties, toilet preparations, perfumes, flavoring extracts, spices, medicinal preparations and household specialties. Every item a fast seller and a big profit-maker. Don't fail to ask for our free sample case offer. We furnish advertising matter and samples free of charge. Ho-Ro-Co representatives are successful. Write today, Ho-Ro-Co Mfg. Co., 154 Locust St., St. Louis, Mo.

AGENTS: Large profits selling National Automobile Cool Ventilators and other accessories to dealers, garages or to auto owners direct. Quick sellers, easy to install in any car. Write for our proposition and descriptive matter, don't wait. National Aluminum Co., 1907 Frederick St., Racine, Wis.

BIG Profits Selling New \$3.50 Automatic Adding Machine. Absolutely accurate. Fully guaranteed. Quick sales. Ten daily easy. No competition. Pocket size. Business people everywhere positive customers. Thousands being sold. Tremendous demand. Here's high-grade money-maker. Bassett Co., 1458-B, Hollywood Ave., Chicago.

AGENTS: 1922's Greatest Sensation. 11-piece toilet article set selling like blazes at \$1.75 with \$1.00 dressmaker's shears free to each customer. Line up with Davis for 1922. E. M. Davis Co., Dept. 506, Chicago.

PLYMOUTH Bags. We are selling this popular bag in green, black, blue and brown leatherette, cretonne lined, \$6-\$6.50-\$7.20 and \$10 per dozen. Sample 65c prepaid. Write for free samples of material. E. Condon, Mfg., 12 Pearl St., Boston, Mass.

TRIAL Order, two each Household Aprons, Kiddie Aprons, Bibs and Baby Pants, \$2.25 postage prepaid. Sell for double. Splendid line rubberized specialties. Get details. Agents coinng money. C. B. Bredler Company, 148 West 23d Street, New York.

LIVE Agents make \$10 Day selling Eureka Strainer and Splash Preventor for every water faucet. Takes on sight. Widely advertised and known. Get details today. A. B. Seed Filter Company, 73 Franklin, New York.

CHAFFIN Polishing cloth cleans without scratching. 25c seller. 150% profit. \$10 daily easy. Every housewife buys one to three. Free sample demonstrator. Chaffin Products Co., 5511 Euclid Ave., Cleveland, Ohio.

MAKE 600% Profit, Free Samples, Lowest priced Gold window letters for stores, offices. Anybody can do it. Large demand. Exclusive territory. Big future. Sideline, Acme Letter Co., 2800-D, Congress, Chicago.

POLMET Polishing Cloth works like magic. Cleans all metals. Gets the attention and money. Fast seller at 25 cents. Sample Free. A. A. Gale Company, 15 Edinboro Street, Boston.

WORLD'S Fastest Agents' Seller, 400% Profit. Needed in every home, office and store. Establish permanent profitable business. Free Sample. Premier Mfg. Co., Detroit, Mich.

AGENTS Sell Neverfall Iron Rust and Stain Remover. Huge profits. Big line. Sample. Write today. Sanford Real Co., Inc., Newark, N. Y., Dept. 6

AGENTS—Advertising Pencils, ready sellers, excellent sideline. Write for proposition. North American Pencil Works, 310 So. Canal St., Chicago.

SELL Advertising Pencils. Big Commissions. Quick Sellers. Write for Proposition. Keystone Pencil Works, Altoona, Pa.

AGENTS—\$40-\$200 a week. Free Samples. Gold Sign letters anyone can put on store windows. Liberal offer to general agents. Metallic Letter Co., 431-C N. Clark St., Chicago.

THE Adapto Tractor Attachment makes any Ford car a practical and guaranteed farm tractor. Agents make \$31.00 profit on each sale. Write for free circular and sales plan. Geneva Tractor Company, Dept. N, Geneva, Ohio.

AT Last—World's Greatest Adding Machine. Almost human. Retails \$15; work equals \$300 machine. \$500 monthly easily made, demonstrating to stores, offices, garages, factories. Simple, easy; adds, subtracts, multiplies, divides, automatically. Speedy, accurate, durable, handsome. Five year guarantee. Tremendous demand; amazing profits. Liberal trial offer. Protected territory. Write quick. Lightning Calculator Corp., Dept. F. Smith Bldg., Grand Rapids, Mich.

DOES \$120 weekly interest you? Putnam made this selling Mystic, the amazing vest-pocket windshield cleaner; for autoists, motormen, engineers; works like magic; one rub keeps glass clear 24 hours; cleans entire shield; sheds water like a duck's back; not a cloth or glove but chemical felt, the new discovery; enameled steel mountings; very snappy; fits pocket; guaranteed year; sells \$1. Smoot sold 2,000 in 4 days; big profits; exclusive territory amazing details free. Security Mfg. Co., Dept. 545, Toledo, Ohio.

COAST to Coast campaign needs 5,000 agents. Sample and terms dime. Dept. 37, Blossom Hair Net Co., 252 Wallabout St., Brooklyn, N. Y.

GALLAGHER made \$336.00 in one week selling guaranteed Collection Systems, used by all business men. Savers Mfg., 2815 Sheffield Ave., Chicago, Ill.

BIG profits. Sell Plate Glass Wind Deflectors, Rear, View Mirrors, Aluminum Foot Scrapers and 20 nationally advertised accessories. Car owners, Dealers, Garages buy one to gross. Write quick for illustrated catalog and agency prices. Rapid Sales Corporation, 11-D Grand Rapids, Michigan.

EVERY Raincoat Agent should get our proposition at once. If you have never sold raincoats now is the time to start. Any man able to talk is able to sell raincoats. Write for our "profit sharing, collective buying, superior quality" offer. Associated Raincoats Agents, Inc., 4448 North Wells, Chicago.

AGENTS—Big Profits, Gold Sign letters easily applied, samples free. Liberal offer to General Agents. Dept. C, Interstate Sign, 2629 No. Halsted St., Chicago.

SELL Grito Laundry Tablets, Whirlwind Seller. Big Repeater. Sales guaranteed. Washes dirtiest clothes absolutely without rubbing. Agents coinng money. Send for free sample and particulars today. Grito Soap & Mfg. Co., Dept. 2X, Rochester, N. Y.

EARN Big Money Fast applying Lithogram Initials to automobile doors. Every owner buys. \$1.35 Profit on each sale. Full particulars mailed. Address, Lithogram Company, 17-8 East Orange, N. J.

BIG Pay. Man or woman of character to distribute religious literature. Chance to make \$600.00 or more. Full or spare time. No capital or experience necessary. Universal Bible House, Dept. H, Philadelphia.

\$1,080 MADE by Wingo in six weeks selling Never Fail Razor Sharpener. Purdy made \$40.50 first day. Other inexperienced men cleaning up big money. Applewhite, La., six orders in thirty minutes. Hurry—investigate—exclusive territory. Write today. Never Fail Co., 126 Allen Bldg., Toledo, O.

AGENTS wanted to handle good automobile accessory line. Fine commissions. J. D. Ignition Construction Co., 6724 Lowe Ave., Chicago, Ill.

AGENTS—Big profits selling "Wunrub Polish" for Furniture, Woodwork, Autos, Etc. Cleans and Polishes. Fritch's Laboratories, 6431 Magnolia, Chicago.

WONDERFUL article for direct selling. Address, Sanitary Mfg. Supply, Dept. 5, Akron, Ohio.

YOU can make \$12,000 a year selling well-known, standard, advertised make of hand-drawn chemical fire engines, motor fire apparatus, extinguishers, hose, and complete line of fire-fighting sundries. We have several openings in good territories. Other men are making \$1,000 a month in territories not so good as we now offer. Address Ajax Fire Engine Works, Bush Terminal Bldg., 10, Brooklyn, N. Y.

\$1,000 PER man per county. Get yours. Inexperienced men pulling down star salesmen's profits. Write for proof: How farmers, ministers, clerks—men in all walks of life—made big money in whole or spare time. You can do it. Amazing proposition—wanted everywhere. Exclusive territory—no sales limit. A hot or cold running water bath equipment for any home at only \$7.50. Self-heating. No plumbing nor water works required. Investigate. Terms. Send no money. Write letter or postal today. Allen Mfg. Co., 654 Allen Bldg., Toledo, Ohio.

PORTRAIT Agents—A new portrait, something entirely different. Write for particulars, also catalogue and price list. Fidelity Portrait Company, Dept. 160, 3047 Harrison St., Chicago, Ill.

WHY work for others? Make and sell your own goods. We show you how. Enormous profits. Write quick for free book explaining everything. National Scientific Laboratories, 624 Main, Richmond, Va.

AGENTS, we have the finest needle case. You can clear \$50.00 to \$200.00 weekly. Send 10c for sample, sells 25c. Empire Specialty Co., 1549 N. Wells, Dept. 301, Chicago, Ill.

SELPOLITE—Agents, Streetmen—Selfolite lights any fire while user sleeps, or any time. Performs surprising stunts. Newly patented. Sample 25c, postpaid; money back. Particulars. Kaytwo Mfg. Co., C195 Station A, Boston, Mass.

AGENTS: Big Profits. Genuine Gold Leaf Window Letters anyone can put up. Scripts and 57 varieties. Chicago Agency Co., 842 Altgeld St., Chicago.

AGENTS wanted to sell "Havana Treat" 5c cigars to smokers and stores. Havana Treat Cigar Co., Utica, N. Y.

REPRESENTATIVES: "Success" user in every home. Quick Sales. Big Profits. Address Sales Department, Elms Commercial College, Newark, N. Y.

GUARANTEED Brushes: 113 different kinds—household—commercial—auto. Tremendous sellers, everyone a prospect. Permanent business—Steady income. Write or wire Desk 6. Universal Brush Company, 181 Quincy Street, Chicago.

AGENTS! A sale in every home for our beautiful dress goods, silks and general yard goods. Quick sales! Big profits! Large book of 1000 handsome fabric samples. Write today. National Importing & Mfg. Co., Dept. 6X, 573 Broadway, New York, N. Y.

PORTRAIT Agents—\$50,000 is what "Picture Man Friedman" made canvassing. Free circular "Profits in Portraits" tells how. 24-hour service prints, finished portraits, frames. Samples free. "Picture Man Friedman," Dept. 8, 127 N. Dearborn St., Chicago.

AGENTS Make \$10 a day selling Presur-own Trousers presser and creaser. Connolly, 55 Vesey St., New York.

AGENTS — Wanted — Men or women. Mother Goose Wringer Mop is a whirlwind seller. New—Patented—Perfect. Demonstration means sale. Retail \$1.50. More than 100% profit. Sample mailed \$1.00. The Alline Company, 6523 Euclid Avenue, Cleveland, Ohio.

MY "Sureshot" Selling Method Free to Agents. K. Home, 1957 Warren, Chicago.

BUILD Permanent Business following our Sure Success Plan introducing Guaranteed Hosiery and Underwear from factory to family. Attractive outfit assures quick sales. Large profits. Investigate for yourself. Address C & D Company, 41-B, Grand Rapids, Mich.

MEN and women make \$100 upwards weekly selling greatest labor and money saving household necessity. Big repeater. Good crew managers' proposition. Free sample and particulars. Holly Co., A-1, Hastings, Neb.

AGENTS Wanted, to sell an improved tool that often pays for itself first time used. Address today. J. 1040 Georgia St., Los Angeles, Calif.

GOOD income, spare time, refinishing chandeliers, brass beds, automobiles, etc., by new method; producing amazing results; every household possible customer; experience unnecessary; simple plan of manufacturing at home starts you in big money-making business. Write for free samples, showing finishes, etc. Gunmetal Finish Co., Ave. H, Decatur, Ill.

COPPER Pots, all sizes; also anything in copper goods desired. Write today for free catalog. Boyer & Co., 609 Reserve Bank Bldg., Omaha, Neb.

GOLD Leaf Sign Letters; make and sell; profits exceed 1,000%; immense demand; particulars free. Johnston Co., Quincy, Ill.

AGENTS—Tense Remedies 200%. Address Int'l. Remedy Co., 1331 Franklin, St. Louis, Mo.

AGENTS—New Invention. Harper's Ten-Use Brush Set and Fibre Broom. It sweeps, washes and dries upstairs windows, scrubs and mops floors and does five other things. Big profits; easy seller. Free trial offer. Harper Brush Works, Dept. X, Fairfield, Iowa.

EASY, pleasant work for Mechanics. Shop Men, Clerks, during spare hours; will add many dollars to their salaries. Also want persons who can give full time. Big wages assured. Novelty Cutlery Co., 67 Bar St., Canton, O.

IF you need good live agents—fellows who can get the business—ask me how others are doing it. I'll gladly render the necessary assistance. J. Roy McClellan, Mgr. Classified Advertising, Popular Mechanics Magazine, Chicago.

BE Successful Agent—Free sample outfit worth \$2.25. "Quality" beauty preparations. Make big money. Extensive line. Established 50 years. Lynas Co., 216, Logansport, Ind.

AGENTS make 140% profit. Iridium (luminous) crucifix shines in the dark. Sells for \$2.00. Costs 84c. Complete line religious articles, crucifixes, bulbs, switch plates, house numbers and match boxes. Novel Ornamental Useful! Every home a prospect. Big sales. Get free demonstrating outfit. The Pioneer Corporation, 1259 W. 63d St., Chicago, Ill.

FASTEST Selling Sanitary Brush Line in America. Huge profit-making opportunity for live workers, with advancement. Other specialties. Get complete details. Act quick. Best season at hand. A. A. Silver-Chamberlain Co., Clayton, N. J.

ANY man handy with paint brush can start new mechanical business on nearly nothing; needed everywhere; nearly all profit; experience not required. John Braceband, 1457 So. Ninth, Philadelphia, Pa.

AGENTS—Clever Invention! Inkspoon makes every pen a fountain pen. Fast office seller; big profit, demand increasing everywhere. Exclusive territory offered. Sample free. H. Marul Company, Tribune Bldg., New York, N. Y.

WRITE for particulars; best article ever offered men; costs 5c, sells quick for dollar; \$15 daily; sworn statement. Beach, 22 Express Bldg., San Diego, Cal.

FREE—Formula Catalog. S. & H. Laboratories, Boylston Building, Chicago.

SELL Necessities. Everybody needs and buys the "Business Guide." Bryant cleared \$500.00 in July. Send for sample. It's free. Nichols Co., Box 4-B, Naperville, Ill.

AGENTS make 500% profit handling Auto Monograms, New Pictures, Window Letters, Transfer Flags, Novelty Signs. Catalog Free. Write Hinson Co., Star City, Ind.

AGENTS—Steady Income. Large manufacturer of Handkerchiefs and Dress Goods, etc., wishes representative in each locality. Factory to consumer. Big profits, honest goods. Whole or spare time. Credit given. Send for particulars. Freeport Mfg. Co., 59 Main St., Brooklyn, N. Y.

AMERICO Booster auxiliary water carburetor makes autos burn water. Eliminates carbon. Low cost; liberal profits; details free. Americo Co., Dept. 178, Cincinnati, Ohio.

WORLD'S Fastest Selling Auto Accessory! County Distributors wanted; write today. G. L. W. Spring Oiler Co., San Diego, Calif.

PORTRAIT Agents, who want good work and prompt service and who desire to purchase their frames at factory prices, should write us at once for catalog and price list. W. G. Hannan Co., Dept. A-5, 57 E. 18th St., Chicago, Ill.

AGENTS—New patented curtain rod, necessity in every home; big profit; 4 to 10 sales at every house. Write for free sample. Home Curtain Rod Co., Providence, R. I.

LARGE shirt manufacturer wants Agents to sell complete line of shirts direct to wearer. Exclusive patterns. Big values. Free samples. Madison Mills, 503 Broadway, New York.

CALIFORNIA Rosebuds selling like hot cakes. Agents coinng money; new stuff. Big profits. Catalog free. Mission Bend Co., PM-2819, West Pico, Los Angeles.

AGENTS: Big Money Monogramming By Transfer Method. Catalogue Showing Over 50 Styles and Particulars Free. Motorists' Accessories Co., Mansfield, Ohio.

AGENTS make one dollar per hour selling "De Luxe Art Panels." Newest thing in art. Men with automobile make forty dollars per day. Tremendous demand. Write for samples and expense money. Consolidated Portrait Co., 225 North Green St., Chicago.

\$200 WEEKLY. Free samples. Sell gold sign letters to stores, offices. No experience. Big future guaranteed. Can travel. Exclusive territory. Become our general agent. Acme Letter Co., 2806D Congress, Chicago.

MAKE \$25 to \$50 Week representing Clows' Famous Philadelphia Hosiery, direct from mill—for men, women, children. Every pair guaranteed. Prices that win. Free book "How to Start" tells the story. George Clows Company, Desk 31, Philadelphia, Pa.

YOU can letter Automobiles, Doors, Trunks etc., without any previous experience by Transfer Process. Make \$27.50 on \$2.50 outfit. Auto Monogram Supply Co., 16 Green St., Newark, N. J.

BEST Proposition on Earth. Kitchen Specialty Every Woman Wants. Nothing like it in existence. 200% profit. Best Novelty Mfg. Co., Dept. C, 160 N. Wells, Chicago.

WE Start You Without a Dollar. Soaps, Extracts, Perfumes, Toilet Goods. Experience unnecessary. Carnation Co., 201 Olive, St. Louis.

AGENTS and portrait men. Crew managers. We give you more for your money. Better and quicker service. Lowest prices on frames and glass. Rejects credited. Catalog free. The Pioneer Corporation, 1259-A West 63rd St., Chicago.

AGENTS: Big profits. Best and cheapest window letters made. Easily applied. Dime brings five samples. Particulars free. Stalbrite Co., 1115 Second Ave., New York.

PORTRAIT Agents: Our goods will make you big profits. Delivery guaranteed. Rejects credited. Prompt shipments. Send for latest catalog and prices. Adam J. Kroll & Co., 602 Blue Island Ave., Chicago, Ill.

MAKE \$2 an Hour. Article that removes iron rust, grass, medicine, fruit, mildew stains. Cleans Panama and Straw Hats. Bleaches clothes. Sells Every home. Write for free demonstrating outfit and start taking orders at once. Christy, 81A Union, Newark, N. Y.

AGENTS: Big Returns, fast office sellers; particulars and samples free. One Dip Pen Co., 2 Daily Record, Baltimore, Md.

AGENTS make a dollar an hour. Sell Mendets, a patent patch for instantly mending leaks in all utensils. Sample package free. Collette Mfg. Co., Dept. 404-B, Amsterdam, N. Y.

SIGN letters for windows at honest prices. Genuine gold leaf. \$50 week easily made. Chicago Sign System F, 150 W. Austin Ave., Chicago.

WANTED—Tailoring Sales Agent—Make big money from very start—\$60.00 to \$75.00 weekly. Largest made-to-measure tailoring house, furnishing an equipment of five hundred woollens, wants you to take orders. Satisfaction guaranteed. Biggest merchants in many towns have started with our line. If you want to establish yourself permanently in business and make big money write for full particulars, giving your experience as salesman or tailor's sales agent. H. F. Foster, Sales Manager, Lock Box 483, Chicago.

MOST Wonderful Seller. 98c profit every dollar. No stock to carry. License unnecessary. Sample free. Mission Bend Co., 1617 Iruia, Los Angeles, Calif.

AGENTS—Best seller; Jem Rubber Repair for tires and tubes; supercedes vulcanization at saving of over 80%; put it on cold, vulcanizes itself in two minutes, and is guaranteed to last the life of the tire or tube. Sells to every auto owner and accessory dealer. For particulars how to make big money and free sample, address Amazon Rubber Co., Amazon Bldg., Philadelphia, Pa., Dept. 505.

AGENTS—If you are making less than \$300 a month our proposition on Sentinel Burglar Alarm for windows and doors will interest you. Many agents earn \$20 daily. Brand new inventions. No wires, batteries or nails. Instantly attached to any door or window. Handsomely nickel plated. Sell on sight. No competition. Provides cheap burglar insurance. Big money makers. Write today for extremely liberal terms to agents. Sentinel Alarm Co., 140 S. Dearborn St., Chicago, Ill.

AGENTS—Stamping names on Pocket Key Protectors; sample Check with your name and address, 25c. Stamping Outfits, Emblem Checks, Check Fobs, Name Plates. Hart Mfg. Co., Desk 2, 303 Degraw St., Brooklyn, N. Y.

YOU can be your own boss with our Key Check outfit. Good for \$5 a day stamping names on pocket key checks, fobs, etc. Sample check with your name and address, 20 cents. Pease Die Works, Dept. 31, Winchester, N. H.

PATENTS—Write for our free illustrated guide book and Evidence of Conception Blank. Send sketch or model for our opinion of its patentable nature free. Highest references. Prompt attention. Reasonable terms. Victor J. Evans & Co., 163 Ninth, Washington, D. C.

BIG money and Fast Sales. Every owner buys Gold Initials for his auto. You charge \$1.50; make \$1.35. Ten orders a day easy. Write for particulars and free samples. American Monogram Co., Dept. 40, East Orange, N. J.

DICHINOLINDIMETHYLSULPHATE. It's a Chemical. Millers The Chemist supplies Latest Manufacturers' Formulas for Food, Beverage, Household, Automobile, Summer Specialties in all lines. Grape-ola New Beverage with the Kick. Stamp brings Lists. Valuable Information to start a business paying Fifty to Five Hundred Dollars weekly with small investment. Miller, Chemist, Tampa, Florida.

PANTEST Selling Auto Specialty on market; 500,000 will be sold next six months. Splendid proposition; write quick; \$5.00 brings samples and full details. Write O. B. Herth Mfg. Co., Inc., Hartford, Conn.

HIGH-GRADE SALESMEN WANTED

BEST Seller: Jem Rubber Repair for tires and tubes; supercedes vulcanization at saving of over 80%; put it on cold, vulcanizes itself in two minutes, guaranteed to last life of the tire or tube; sells to every auto owner and accessory dealer. Get particulars how to make big money and free sample, Amazon Rubber Co., Philadelphia, Pa., Dept. 510.

SALESMEN—Greatest selling proposition of the age. Two sales daily pays you \$1,400.00 monthly. Deal sells for \$100.00 to merchant; easy terms. Clears merchant \$400.00 to \$600.00 yearly. You can clean up on this. Write quick. Hot P-Nut Mach. Co., 350 E. Long St., Dept. 200, Columbus, Ohio.

SALESMEN—To sell the Victor, first high-class adding and listing machine at low price. Reduction to \$100 makes it greatest seller in the business. Sold on small monthly payments if desired. Commission basis. Address, F. B. Willis, 3047 Carroll Ave., Chicago.

ONLY one policy a day means \$130 per month profit; same on renewals. Policy pays \$5,000 death; \$25 weekly benefit for injury or sickness. Premium \$10 yearly. Full or spare time. Easy seller. Write quick for territory. Underwriters, Dept. K28, Newark, N. J.

SELF-ADJUSTING Robert Wrench, most wonderful wrench on market. Grasps pipes, nuts, bolts. Sells for \$1.85. You make 98c on each. Sample 95c. Write Robert Wrench Co., 71-C Murray St., New York.

SALESMAN Wanted. An honest, industrious man to sell very low-priced farm-lighting plants and electrical appliances to farmers. R. M. Owen & Company, Inc., 1825 S. Michigan Ave., Chicago.

DISTRICT Sales Managers and Salesmen. Get our proposition selling men's high-grade shoes direct from manufacturer. No collections or deliveries. Commissions daily. Dept. 16, Quick Shoe Co., Braintree, Mass.

MEN'S Shirts Easy to sell. Big demand everywhere. Make \$15.00 daily. Undersell stores. Complete line. Free samples to workers. Chicago Shirt Co., 208 So. LaSalle, Factory 131, Chicago.

SELL Holmes Tires and Tubes. No capital required, \$100 weekly income. Price sells them, quality gets re-orders. Holmes Rubber Co., 1500 W. 15th, Dept. F, Chicago.

SOMETHING New, a necessity. All business and professional men need it. Sells \$7.50, costs you \$2.50. Big repeater. Sample free. Merchants Assn., Minneapolis, Minn.

WANTED: Men to act as jobbers in each locality for automobile equipment; must have auto or \$100. Paul U. Towles, Ashton Bldg., Grand Rapids, Mich.

SALESMEN and agents for world's best auto accessories. American Rubber Products Co., Atlanta, Ga.

FOR 1922 we will increase our sales force. Some valuable territory open. If you are a real salesman and want to build a permanent business, aided by our co-operation and national advertising with success assured from the start, write today. Goods sell to hardware, drug and general stores. Splendid commissions with liberal weekly advance to producers. Continental Company (Established 1900), 1922 Euclid Avenue, Dept. 200, Cleveland, O.

INTERVIEW business men, demonstrating "office device of a hundred uses." Earn \$7.44 on retail sale and as high as \$15.14 on advertising contract. Write today for free sample, enclosing business card. Side line or full time. K. K. Co., Fourth Floor, 132 S. 15th, Philadelphia.

DISTRIBUTORS or Salesmen can make quick commission profits selling live necessary auto accessory to trade or users. Retail \$1.75. Exclusive territory available or can be sold some sections as convenient immediate delivery sideline. Approved Appliances Corp., Box 14, Ann Arbor, Mich.

SPLENDID opportunity sell fan belts garage and accessories trade, full time or side line; exclusive territory open. Send 25c for sample Ford belt and full information. Address Leather Products Co., Frankford, Philadelphia, Pa.

SALESMEN—Professional and business men readily buy Zim's \$7.50 Peerless Collection System. Collects slow and bad accounts. Has special, exclusive collecting features. Creditors' Association, 312 McKnight Bldg., Minneapolis, Minn.

OIL Gauge for Fords. Remarkable new invention. Sell on sight. Big profits easy. Exclusive distributors wanted. Address Sales Mgr., 22 Pa. C. Omaha, Neb.

SALESMEN—Live; sell dealers and jobbers household article of national reputation; 25 per cent commission; tremendous appeal. Write quick. Pyramid Oil Company, Minneapolis, Minn.

SEE our ad. under Agents Wanted. "Best sales proposition in 20 years." McCallister Co., 370 Thelan Bldg., San Francisco, Calif.

GIANT-GRIP Tube Patch "Never lets go." Salesmen and County Distributors wanted. P. Lee Rubber Company, Waukesha, Wis.

SALESMEN: Make \$10 to \$50 daily selling our Penny Hot-P-Nut Machines; commission paid daily. New salesman writes—Sold ten to first party called on—his commission \$100. Positive knockout—write quick. Hot P-Nut Machine Co., P.M.350 East Long Street, Columbus, Ohio.

AUTOMOBILE Accessory Company want local representative to introduce and take orders for newly patented device thoroughly tested, and proved superior to any similar tool now in use. Product absolutely guaranteed. A big field and splendid opportunity for hustlers. Liberal commission. Address for description, terms and details, Beacon Bronze Co., Division 17, Beacon, N. Y.

\$13.95 GOODYEAR All-Weather Coat Free. Goodyear Mfg. Co., 1524-R, Goodyear Bldg., Kansas City, Mo., is making an offer to send a handsome, Rainproof, All-Weather coat to one person in each locality who will show and recommend it to friends. If you want one, write today.

SPECIALTY Salesmen here's your chance. Want it? Nifty, clever little Cataract Washer cleanses autos quickly. Attaches to Garden Hose. All Brass—can't rust. Won't mar finest varnish. Every car owner a customer. Two Styles No. 1—\$2.50, No. 2—\$1.75. Handsome Profits. Dept. P., Cataract Auto Washer Co., Topeka, Kansas.

ASKO—Salesmen to sell Auto Acc. as side line; can carry sample in vest pocket; sells on sight. Big comm. Write for sample. Allen Specialty Co., 2721 West Lake St., Chicago.

UNUSUAL big-money opportunity for regular or side-line salesmen calling on retail trade. Business stimulator. Every retailer a prospect. Liberal commissions. P. O. Box 1163, Milwaukee, Wis.

"OUTOSITE," aluminum hip suspenders, 50c. Shirt down, pants up. Enormous seller. Woods, 501 North Seventh, St. Louis.

SELL Advertising Pencils. Big Commissions. Quick Sellers. Write for Proposition. Keystone Pencil Works, Altoona, Pa.

SPECIALTY Salesmen calling on Garages and Accessory Dealers, to handle side line. "Oil King" Piston and Compression Rings. Dygert & Stewers, Chamber of Commerce Building, Los Angeles, California.

GREAT demand everywhere for high grade solid leather specialties. Can you sell the best quality at the lowest price? Write David H. Zell, 532-534 Broadway, New York, N. Y.

SALESMEN—Fastest \$5.00 seller to homes and biggest money-maker ever invented. Saves 3/4 gas, makes cooking better and easier. Stanley Manufacturing Company, 417 So. Campbell, Chicago.

\$5,000 EVERY year. \$2,000 easy in spare time. We share profits with you besides. Sell "Weather Monarch" Raincoats—Ask about "Dual Coat" No. 999. Get your sample raincoat free. Associated Raincoat Agents, Inc., 4446 N. Wells, Chicago.

SALESMEN—Sell State Pocket Maps, showing auto roads, to advertisers and dealers. Easy to sell. Get our splendid offer. Standard Map Company, 127 W. Ohio St., Chicago.

SALESMEN can make \$5.00 a day selling our Calendars, Fans, Pencils, Signs, Advertising Novelties, Yard Sticks, Whistles, etc. Liberal terms. Sells entire year. Fine side lines. Local and traveling agencies. Model Calendar Company, Dept. 226, South Bend, Ind.

\$300 PER month and bonus guaranteed salesmen successfully demonstrating wonderful new adding machine. Retail \$15.00. Work equals \$350 machine. Genuine opportunity. Full time or side-line. Lightning Calculator Co., Dept. G, Grand Rapids, Mich.

AGENTS—\$60-\$200 a week. Free samples. Gold sign letters anyone can put on store windows. Liberal offer to general agents. Metallic Letter Co., 431-E N. Clark St., Chicago.

57 MILES per gallon made with new patented gasoline Vaporizer. Write for particulars. Vaporizer Co., Pukwana, S. Dak.

EVERYBODY Eats Every Day. You can handle Sugar, Flour, Canned Goods, Dried Fruit, Coffee, and entire line of groceries, as well as Paints, Roofing, Aluminum Ware and Automobile Oils, with no rent to pay; no money invested; take large orders from samples. Goods are guaranteed and proven quality. Selling experience not necessary. Steady, profitable work for "workers." Address Hitchcock-Hill Co., Dept. 209, Chicago, Ill. Reference: Any Bank or Express Co.

\$20.00 A DAY easily made introducing Rite-Way Auto-Life—The newly perfected paste auto polish; demonstrates in two minutes. Makes old cars look new. Retail for \$1. Every car owner buys. Send \$1 for 2 full size Cans, instructions, territory reservation and Free sample-case offer. Sheldon Booth & Co., 922 East 41st St., Chicago.

\$200 TO \$400 Weekly. Free Samples. Lowest priced Gold Sign Letters for Stores, Offices. No experience necessary. Large demand. Appoint subagents. Excellent sideline. Acme Letter Co., 2800H Congress, Chicago.

LIVE Wire Distributors and Dealers everywhere make money selling Seal-Fast inner-tube repair kits because of the unequalled efficiency and our aggressive and helpful sales promotion and advertising co-operation. Write Sales Manager for particulars, Robert M. Bowes Co., Indianapolis, Ind.

WANTED—Salesmen—soaps, greases, oils; old manufacturer, Baum's Castorino Co., Rome, N. Y.

HELP WANTED

DISTRICT Managers—Big Profits. Men capable of organizing and managing crews of lady solicitors can easily clear \$100 to \$200 per week with the B. & G. Protector, the original and best protector on the market. Every woman needs and buys it. Two grades. B. & G. Rubber Co., 618 Penn Avenue, Dept. 133, Pittsburgh, Pa.

ELECTRICITY Taught by Experts; earn while you learn at home; electrical book and proof lessons free; your success guaranteed; position secured. Write, Chief Engineer, 2146 Lawrence Ave., Dept. 1294, Chicago.

START a pressing, cleaning and dyeing shop; splendid field, excellent profits. We tell you how. Write for booklet, Ben-Yonde System, Dept. C, Charlotte, N. C.

FIREMEN, Brakemen, Baggage-men, Electric Motormen, Conductors, Sleeping Car and Train Porters (colored). Railroads everywhere \$140-\$200. 810 Railway Bureau, East St. Louis, Ill.

YOUNG Men, over 21, fair education, for service and repair work on adding machines. Address, Dalton Adding Machine Co., Cincinnati.

I MADE \$100,000 as real estate specialist. Free information tells how. American Business Builders, Dept. 567, 1133 Broadway, New York.

BOYS—Men. Become automobile experts. \$45 week. Learn while earning. Franklin Institute, Dept. B-461, Rochester, N. Y.

FINGER Print Lesson based on Henry System included with Detective Course. Particulars free. Write, American System, 1968 Broadway, New York.

JANITORS: You can make big extra money in your building. Write, J. Brace-land, 1457 So. Ninth, Philadelphia, Pa.

START Silvering Mirrors, Auto Head-lights, Tableware, etc. Plans free. Clarence Sprinkle, Dept. 28, Marion, Ind.

STEADY work. No strikes. No layoffs. Commence \$134 month. Raise each year until you get \$192 month. Men—boys, over 17. Become U. S. Government Railway Mail Clerks. Pleasant work. Traveling constantly. Vacation with pay. Common education sufficient. Influence unnecessary. List positions free. Write today sure. Franklin Institute, Dept. C-3, Rochester, N. Y.

MEN and Women wanted to learn the New Honest Method of earning large commissions in spare time without leaving home. No canvassing. Dignified permanent position. Write Will L. Rufe, W. 510 4th Ave., Spokane, Wash.

MAIL Order Articles Wanted. moderate price, good profits, easily mailed. Will stock at once, and use liberal quantities, if salable. No schemes. Full details please to W. care Brenner Advertising Agency, 333 Walnut, Philadelphia.

WANTED—Men, women, to learn Show Card Writing at home. Earn big pay. We teach you. Complete Outfit and All Necessary Materials Free. National School of Lettering, 47 Charlotte St., Detroit, Mich.

SELL us your spare time; desire representatives many small towns and cities. Positively no sales work. Positions pay salary \$15.00 to \$50.00 per week. American Methods, 4347 Ellis Avenue, Chicago.

LOCOMOTIVE Firemen, beginners \$150, later \$250 monthly, for railroads nearest their homes, everywhere in United States and Canada. Address Railway Association, Desk M-1, Brooklyn, N. Y.

U. S. GOVERNMENT Railway Mail Clerks get \$92-\$192 month. Men—boys over 17. Steady work. List positions free. Write immediately. Franklin Institute, Dept. C-21, Rochester, N. Y.

ELECTRICAL Manufacturer offers you a permanent opportunity. We want ambitious men looking for independent future. Write today for particulars to the Allmar Manufacturing Company, Marion, Indiana.

MEN—Make money in spare time mailing letters; experience unnecessary. Send stamped addressed envelope for terms. E. Normande, 147 W. 23d St., New York, N. Y.

EARN \$10 daily silvering mirrors, plating and refinishing metalware, autos, chandeliers, ledsteads. Outfits furnished. E. Decie Laboratories, 286 Fifth Avenue, New York, N. Y.

YOU are wanted. Get Government Jobs. \$92-\$192 month. Men—Women. List free. Write immediately. Franklin Institute, Dept. C-21, Rochester, N. Y.

ALL men—women over 17, willing to accept Government Positions \$135 (Traveling or Stationary), write Mr. Orment, 101 St. Louis, Mo.

MEN, over 17, Become Railway Mail Clerks. \$133-\$192 month. List positions free. Franklin Institute, Dept. C-21, Rochester, N. Y.

BOYS—Men. Become Automobile experts. \$45 week. Learn while earning. Write Franklin Institute, Dept. C-401, Rochester, N. Y.

SILVERING mirrors, French plate taught. Easy to learn, immense profits. Plans free. Wear Mirror Works, Excelsior Springs, Mo.

I MADE \$100,000 as real estate specialist. Free information tells how. American Business Builder, 1129-B Broadway, New York.

\$133 MONTH commence. Become Railway Mail Clerks. List positions free. Franklin Institute, Dept. C-21, Rochester, N. Y.

A BETTER Job now. If you have no trade you can get a good one in a few weeks. Learn the auto business. Repairmen always needed, get good pay; 10,419,785 autos, trucks, tractors need expert service. You can get in this business in a few weeks. Our free 138-page illustrated catalog gives full particulars. Send name today. See our advertisement on pages 53-75-157-185. Michigan State Auto School, 23 Auto Bldg., Detroit, Mich.

WANTED—Men and women to sell our choice line of calling and business cards, social stationery. Pleasant work, liberal returns. Forman Printery, Box 75X, Plantsville, Conn.

START a pressing, cleaning and dyeing shop, splendid field, excellent profits. We tell you how. Write for booklet, Ben-Yonde System, Dept. C, Charlotte, N. C.

GET Posted for Spring. Good prices paid for butterflies, insects. See Sinclair's Display Advertisement, page 18.

GOVERNMENT needs Railway Mail Clerks. \$133 to \$192 month. Write for free specimen questions. Columbus Institute, E-2, Columbus, Ohio.

DISTRICT Manager: 150,000 sales of a household appliance in New England have paid District Managers upwards of \$3,000 yearly. We are ready to expand. Office work entire or side line. The Reeves Co., 64 Broad Street, Milford, Conn.

STORIES, poems, plays, etc., are wanted for publication. Good ideas bring big money. Submit manuscripts or write Literary Bureau, 522, Hannibal, Mo.

BE a Finger Print Expert. Particulars free. National System, 150 E. 19th, New York.

UNITED States Government Wants Men. Excellent positions at attractive salaries. Railway Mail Clerk Examination soon. Let our expert (former United States Civil Service Examiner) prepare you for this and other fine positions. Write today for free catalog P.M. Patterson Civil Service School, Rochester, N. Y.

BE a Railway Traffic Inspector! \$110 to \$250 monthly; expenses paid after 3 months' spare-time study. Splendid opportunities. Position guaranteed or money refunded. Write for free booklet CM-46. Stand. Business Training Inst., Buffalo, N. Y.

GOVERNMENT Wants Railway Mail, Postoffice Clerks. Other positions. Salary \$135 month. Experience unnecessary. Write for information concerning positions and instruction. Columbia School of Civil Service, 411 Pope Bldg., Washington, D. C.

START a Paying Business of Your Own. Be a business man. Any location. 8,000 new Tire Vulcanizing and Repair Stations needed. Business always good. Are you ambitious? \$100 will start you. Write at once. Wonderful opportunity. Equipment Co., 175 Canal, Cincinnati, Ohio.

WRITE Articles, stories, news, in spare time for newspapers and magazines. Big pay. Copyright book free. Press Syndicate, 553, St. Louis, Mo.

GOVERNMENT needs Railway Mail Clerks, \$133 to \$192 month. Write for free specimen questions. E-2 Columbus Institute, Columbus, Ohio.

SIGN Letter Agents and Painters; 500% Profit Gold and Silver Sign Letters for Stores and Office Windows. Anyone can put on. Big demand. Free samples. Metallic Letter Co., 431D N. Clark St., Chicago.

CALIFORNIA Rosebuds selling like hot cakes. Agents coinng money. Absolutely new. Big profits. Catalog free. Mission Road Co., SP2519 West Pico, Los Angeles.

SALESMEN—Become Independent. Own your business; experience unnecessary; selling our \$7,500 Accidental Death, \$50 Accident, \$25 Sick Weekly Benefits; \$12.50 yearly; other amounts proportionate. Guaranteed steady income from renewals. \$250,000 deposited Insurance Department, Registration Dept. A, Newark, N. J.

MAKE money writing Photo-plays; details free to beginners. No correspondence course. Producers' League, 230 Wainwright, St. Louis.

INVENTORS desiring to secure patents should write for our book, "How to Get Your Patent," tells our terms and methods. Send sketch for our opinion of its patentable nature. Randolph & Co., Patent Attorneys, 620 F, Washington, D. C.

OUR genuine gold window sign letters are an excellent money-making proposition for handy men. Slann Sign System, St. Antoine St., Detroit, Mich.

WANTED: Railway Mail Clerks—\$1,600 to \$2,300. Exams everywhere. Write today for full information. Patterson, Civil Service Expert, Box 4025, Rochester N. Y.

MANUFACTURER'S AGENTS

SALES organization operating Brooklyn, Long Island, desires several additional responsible lines. Knowlan Company, 23 Flatbush, Brooklyn, N. Y.

FOR ADVERTISERS

21 WORDS \$0 good Louisiana and Texas weeklies, all for \$2.00. Address Elpod Agency, 1513 Polyania, Suite 18, New Orleans, La.

YOUR 25-word advertisement in 75 magazines \$1.00. Riley, Publisher, 1333 S. 55th Court, Cicero, Ill.

ADVERTISE in 24 Big Sunday Newspapers 25 words \$15.00. Catalog listing 1,000 leading Dailies, Weeklies, Magazines, 4c stamps. Union Advertising, Baltimore Bldg., Chicago.

ADVERTISE—Your 25-word ad. in 100 magazines for \$1.00. Sample Copy 10c. Harley Snell, 1621 State Ave., Cincinnati, Ohio.

ADVERTISE. Country town newspapers. List for stamp. Pennell, Covington, Ky.

SPECIAL!!! Inch display advertisement 161 Magazines Thrice \$15. Year \$50. Wood's Popular Services, Atlantic City.

INFORMATION

MUSCLE Shoals: 50 cents brings complete, valuable information on Muscle Shoals, planned as world's greatest enterprise and to give real opportunity to tens of thousands. Latell McClung, Florence, Ala.

RELIABLE information furnished on any subject or money refunded, 75c. Co-operative Service, Times Plaza, Box A61, Brooklyn, N. Y.

PUZZLE Contestants: Win the larger prizes. Lists of B, C, D, P, and S words all possible objects; single list \$1.00, all for \$3.00. P. L. Service, 18 Boston Ave., Youngstown, Ohio.

LETTER SPECIALISTS

ATTENTION—Gripping, desire-creating sales letters. So strenuous they have to bring business. Ewald, 200 East 87th, New York.

BIGGEST Pullers on Earth—Jacobus Letters, \$3.50. Jacobus Advertising Service, Irvington, N. J.

BUSINESS SERVICE

SOUTH Carolina, Rock Hill, Collections, Legal Business. J. H. Foster.

YOUR Business represented here for \$5.00 monthly. Letters forwarded 5c each. Kennedy's, 1965 Broadway, New York.

INCORPORATE. Our lawyers do the work, saving you time, annoyance and money in incorporating under the most liberal laws of Arizona. Laws and forms free. Southwestern Securities & Investment Co., Box D488, Phoenix, Ariz.

MAILING LISTS

LIVE lists. Prosperous Northwest. Fifty cents hundred. Address, Box 22, Vancouver, Wash.

500 NAMES Real Mail Order buyers \$2.00. Other lists on application. Address Box 423, Scranton, Pa.

NAMES of farmers and agents our specialty. Pennell, Covington, Ky.

TYPEWRITERS AND SUPPLIES

UNDERWOOD Typewriters at far less than manufacturer's price; rebuilt, all worn parts replaced, guaranteed good as new. Cash, installment payments. Write for Catalogue 1514. Typewriter Emporium, estab. 1892, Montrose and Ravenswood Ave., Chicago, Ill.

ALL Makes \$100 used typewriters, \$6 up. Free trial. Write for Bargain List 287. Manco, 320 Goethe Street, Chicago.

TYPEWRITERS: All makes \$15.00 up; guaranteed five years; one month free trial; get our list before purchasing. Peckskill Typewriter Exchange, Peckskill, N. Y.

NEW Simplex Typewriters \$6.50; Rebuilt Remingtons \$12.50; 1,000 Imprint Commission Circulars 25c. Demco, Miantonomi Court, Providence, R. I.

TYPEWRITERS, \$20.00 up. All makes. Easy payments. Free trial. Payne Company, Rosedale, Kans.

REBUILT Typewriters, All Makes, \$10.00 up. We sell for cash at prices 20 to 30 per cent lower than installment houses. Every machine fully guaranteed. Send for free descriptive circular. The M. & M. Typewriter Co., 42 N. Wells St., Chicago.

DUPLICATORS AND DEVICES

"MODERN" Duplicators. Business Getters. \$2.25 up. 50 copies from pen, pencil, typewriter. No glue or gelatine. 40,000 in use. Free trial. Need one? Booklet Free. J. E. Durkin-Reeves Co., Pittsburgh, Pa.

"QUICK Process Duplicators." Makes 100 copies in 10 minutes. Remarkable time savers. Thousands in use. Circular Free. Hever Duplicator Co., 160-PM, N. Wells St., Chicago.

ADDING MACHINES

NEW \$3.50 Automatic Adding Machine. Adds, Subtracts, Multiplies. Absolutely accurate. Capacity \$999,999.99. Fully guaranteed. 75,000 pleased users. Makes adding easy, positive, quick. Eliminates Mistakes. Saves Time. Postpaid, \$3.50. Bassett Co., 1458-A, Hollywood Ave., Chicago.

FREE Trial. Marvelous new Adding Machine. Adds, Subtracts, Multiplies, Divides, automatically. Work equals \$350.00 machine. Price only \$15.00. Speedy, durable, handsome. Five-year guarantee. Used by largest corporations. Write today for catalogue and free trial offer. Lightning Calculator Co., Dept. E, Grand Rapids, Mich.

PRINTING, ENGRAVING AND MULTIGRAPHING

1,000 20-LB. Hammermill bond letterheads \$3.75; 5,000 \$15.00. Distinctive display, highest quality workmanship, and prompt service guaranteed. Waverly Pub. Co., Box 2035, Waverly, Iowa.

5,000 HEAVYWEIGHT Hammermill letterheads, \$13.50. Cheaper grade paper, \$10.00. Hoessler, Roseville, N. J.

HIGH-GRADE Printing for Half Price. Send stamps for samples our high-grade work and standardized price list that shows you in actual figures the money we can save you. Geo. S. McGinley, 51-A, 1129 West Moyamensing Ave., Philadelphia, Pa.

STATIONERY! Name and address printed on 100 Bond Letterheads and 100 Bond Envelopes, same quality, only \$1.50 postpaid. Satisfaction guaranteed. Stationery Printing Company, 507 South Main Street, South Bend, Ind.

OUR price is higher because our work is better. 500 each, Bond Letterheads \$3.75, Envelopes \$2.75, Cards \$2.50. Vandenberger Printery, 4150 Hamilton, Cincinnati, Ohio.

30" PAPER Cutter, perfect condition, \$175. Other printing machinery bought and for sale. F. M. Ruddle & Co., West Newton, Mass.

PRINTING Material, Type, Rule, Borders, Etc. No junk. Catalog Free. Lawrence, 1426 South St. Francis, Wichita, Kan.

200 QUALITY Business Cards artistically printed \$1.50. Automatic Printery, 309 W. 29th St., Norfolk, Va.

WE print anything. Circulars, stationery. Catalogs. Samples. Commercial Press, Batavia, Ohio.

100 BOND Letterheads, 100 Envelopes \$1.35. Others reasonable. Economic Press, Leonia, N. J.

PRINTED Stationery—Envelopes, letterheads, cards, 100 each \$2.00 postpaid. Samples free. Lenox Press, 876 Park Ave., New York, N. Y.

5,000 CIRCULARS, 300 words, \$7.50, 10,000, \$12.50. Bargain List. Samples Free. Good's Printery, Harrisonburg, Va.

WE specialize in Ad-Pencils. Sample, with your name on in gold 10c. S. Mustal & Co., 422 Walnut St., Yonkers, N. Y.

300 HAMMERMILL Bond Letterheads, Envelopes, Billheads, or Business Cards, \$1.00 postpaid. Race Printing Company, Hudson, N. Y.

REDUCED prices for better printing, 1,000 Bond letter-heads, \$5.00; 1,000 good envelopes, \$4.25; 1,000 four-page folders, 3½x6½ inches, \$12.00. Catalogues, circulars, booklets our specialty. All printing at reduced prices. Samples free. Fantasy, 525 S. Dearborn St., Chicago.

QUANTITY Users save 30%. Wolf Roll Labels, Sta. E, Philadelphia.

PRE-USED Printing Presses, Type and supplies. List for stamp. Popular Bargains, Richland, Pa.

EMBROSSED business, personal stationery. Samples, stamp. Daniels Co., Pittston, Pa.

1,000 LETTERHEADS or Envelopes, \$3.00, sent prepaid. Samples Free. Monitor Press, Morrisville, Pa.

1600 FULL-SIZE Hammermill Bond Letterheads \$3.65. Postpaid. Other stationery in proportion. Business building Multigraph letters cheap. Samples free. Charles B. Hatfield, Box 353, Oswego, N. Y.

250 LETTERHEADS, 250 White Envelopes, printed and mailed, \$3.00. Samples printing free. Write Sun, Mohawk, N. Y.

2,000 LETTERHEADS or Envelopes \$7.50 prepaid 3rd class. Samples Free. Quality Printery, Marietta, Ohio.

PRINTING Outfits—Presses, type supplies, type uncetries. Send stamp for catalogue. Model Press, York, Penna.

FOR MEN

WHY Many Men are Old at Forty. Men—If depressed, if backache, sciatica or tender feet annoy you—if nerves are gone—if your sleep is disturbed, send for our free book on gland faults. It concerns a simple, drugless treatment that cannot interfere with your work or doctor's care. If you are suffering you will bless this book. Write now before you forget. The Electro Thermal Company, 2127 Main St., Scrubenville, Ohio.

I WANT to send Free to every chronic pipe smoker in the country a good, big, generous sample package of my pure, sun-cured, nature-flavored Old Green River Pipe Tobacco. No money to pay. If you are a tobacco crank, all the better. Try the pure stuff. No syrup, flavoring or dope. After you try it free, I'll show you how to cut your smoke bill one-half and get more pipe joy. Just send name and address, and say whether you want mild, medium or strong. Pete Moberly, Box 820, Owensboro, Ky.

RAZORS AND BLADES SHARPENED

BLADES Resharpended. Single edge 2c, double 3c. Guaranteed. Ideal Sharpening Works, Kankakee, Ill.

BLADES re-sharpended. One edge 2c, double 3c each. New York Edge Co., Glen Cove, N. Y.

BLADES Resharpended 3c. any make. Guaranteed Service. Standard Safety Razor Corporation, Pittsburgh, Pa.

GUNS, SPORTING GOODS, ETC.

AUTOMATIC Pistols; Mauser, Orgies. 25-cal., \$11.50; 32-cal., \$12.50; Remance, 7-shot 25-cal., \$9.75. Sent C. O. D. Unwin Trading, 305 Broadway, New York.

BOATS AND LAUNCHES

"HOW to make your boat leakproof." Send for booklet. L. W. Ferdinand & Co., 152 Kneeland St., Boston, Mass.

DARROW Steel Boats. Eighteen designs—eighty sizes. Everything in the flat bottom line from the smallest one man skiff to the Family Motorboat. Rowboats, Outboard Motorboats, Duckboats, Canoes and our World Famous Sectional Boats. Also a Build Your Own Boat Plan. Catalogue free. Darrow Boat Company, Albion, Mich.

16' ROWBOAT—Easily made. Construction blueprint 30c. List free. Wee-Sho-U Co., West Market, Detroit, Mich.

12' ROWBOAT construction plans and instructions, 30c. Address Racorn Boat Works, 4519 Frankford Ave., Philadelphia, Pa.

OPTICAL GOODS

ULTRALENS microscope, magnifies 25,000 times, 75c. Patents pending. Get circular P-5 of other models. Specialty Mfg. Co., Milton, Pa.

DIAMONDS, WATCHES AND JEWELRY

TURKISH Lucky Stones are beautiful. Send \$3.50 and change your luck. Red stamp brings large list cut and uncut stones. Satisfaction guaranteed. Old-Young King Brady Gem Co., 150 W. 90th St., Los Angeles, Calif.

ANTIQUES AND RELICS

GENUINE Indian Baskets and Wampum. Wholesale catalog. Gilham, Kelseyville, Cal.

INDIAN Relics—24-page Clearing List free. Grutzmacher, Mukwonago, Wis.

FOR Dens: Relics from Europe's Battlefields, Guns, helmets, medals, insignias, etc. Catalogue and War Photos 10c. Lieut. Welsh, 50 Fl. Greene, Brooklyn, N. Y.

PHONOGRAPHS AND RECORDS

IF you want a real phonograph, get Sonora double spring motor, \$15.00; Sonora reproducer, \$5.00; tonearm for Sonora reproducer, \$5.00. Phonographs with Sonora motors, Sonora reproducers, 5 1/4 inches high, 24" deep, 22" wide, mahogany piano finish, electric light works on battery, latest improvements, price \$100.00. Address, Frank, 1658 Washington Ave., Bronx, New York.

BUILD your phonograph. Quality Phonoparts. Highest quality spring and electric Motors, Tone Arms, Reproducers, Amplifiers, Case Material and Accessories. Free Blue Prints and Building Instructions. Big saving. Wonderful results. New catalog mailed for ten cents. Hoosier Manufacturing & Supply Co., Phonograph Supply Department, 813 Baldwin Block, Indianapolis, Ind.

BUILD a genuine Choralion phonograph and save over half. Big profit building and selling. We furnish motors, tone-arms, full instructions and all necessary parts. Send for catalog and free blueprint offer. Choralion Phonograph Co., 422 11th St., Elkhart, Ind.

DON'T Destroy Worm Phonograph Records. Revive Tone, Reduce Scratching. Formula 50c coin. Address Record Chemical Co., West Mansfield, Ohio.

SUPERIOR Quality Motors, tone outfits, amplifiers, hardware and cabinets make the finest phonographs. Superior Phonoparts Co., Erie, Pa.

BUILD Best Phonographs. Write for parts catalog and free blueprint offer. American Phonograph Co., 3515 North Crawford, Chicago.

MUSIC AND MUSICAL INSTRUMENTS

YOUR Song printed—words and music 50 copies \$5.00. Sample for 4 cents, stamps. Ayeon Quartet, Box 507, Wilmington, N. C.

SONG Writers—Have you poems or melodies? I have wonderful proposition to offer you. Ray Hibbler, D110, 4040 Dickens Ave., Chicago.

SEND four-cent stamp for "Secrets of Song Writing." Casper Nathan, 928 Garrick Theatre Building, Chicago.

"MUSIC Composed" to words. Bauer Bros. (formerly of Sousa's Band), Oshkosh, Wis.

DIXON'S Instantaneous Hits. "All Babies Look Alike to Me" and "Thy Goal" on his wonderful double album music sheet. Two 30c songs, 25c, 30 days. Sovereign Company, 160 Sycamore, Buffalo.

VIOLINS—Deep, Mellow, Soulful—on credit. Easy terms for wonderful instrument. Get details today. Gustav F. Hemming, Box 2943, Denver, Colo.

JUST a card brings my helpful and interesting literature to any song writer. Reliable, established. Jeffries, Michigan, Arctic, Atlantic City, N. J.

RAG-JAZZ Piano or Saxophone in 30 lessons. "Christensen" Schools in most cities. See your phone book or write about Mail Course. Teachers wanted. Axel Christensen, 488, 20 E. Jackson Blvd., Chicago.

JOIN our Sheet Music Club and receive latest popular music of all publishers. \$1.00 year plan. Write for details. Sheet Music Club, Suite 703, 1545 Broadway, New York, N. Y.

CORNETISTS—Trombonists—Saxophonists—Clarinetists. Send for "Free Pointers." Name instrument. Virtuoso School, Buffalo, New York.

WRITE Songs. Big money and reputation. Write for information. J. Gordon Pub. Co., 261 N. Hoyne Ave., Chicago.

PATENT ATTORNEYS

PATENTS—"How to Obtain a Patent" is the name of a book which every inventor should have. It will be sent free upon request, and will tell you what you want to know about patents. It contains the whole story. It describes the different parts of the application and explains in simple language the prosecution before the Patent Office. It tells about joint applications, reissues, agreements, assignments, licenses, interferences, infringements, process patents, design patents, trade-marks, and prints and labels. If you are interested in patents either as an inventor, manufacturer or owner of a patent you will enjoy reading this book which was written by a lawyer who has had twenty-five years' experience in patent matters. If you have an invention and will send us a sketch, model or photograph of it we will promptly make a search of the Patent Office records and advise you whether or not, in our opinion, your invention is patentable, our charge for the service being \$5.00. We feel that our experience of twenty-five years has fitted us to render prompt and efficient service which will merit your confidence. Write today. Talbert & Talbert, 463 Talbert Building, Washington, D. C.

PATENTS—Trademarks. Before disclosing an invention, the inventor should write for my blank form "Evidence of Conception." This should be signed, witnessed and returned to me with sketch or model upon receipt of which I will promptly render opinion as to patentable nature and send booklet on Patents. Highest references. Prompt attention. Reasonable terms. Clarence B. O'Brien, Registered Patent Lawyer, Woodward Building, Washington, D. C.

PATENTS—Trademarks. Thirty-five years' experience. Send model or sketch for opinion as to patentability. Free "Inventors Guide." Highest references and personal attention assure best results. Franklin H. Hough, 522 Washington Loan & Trust Bldg., Washington, D. C.

PROTECT your rights. Write for "Record of Invention" which contains form to establish evidence of conception of your invention. Prompt personal service. Preliminary advice without charge. J. Kearney Kelly, 612-G, Columbian Bldg., Washington, D. C.

PATENTS Procured. Trade Marks Registered. A comprehensive, experienced, prompt service for the protection and development of your ideas. Preliminary advice gladly furnished without charge. Booklet of information and form for disclosing idea free on request. Richard B. Owen, 30 Owen Building, Washington, D. C., or 2276 R. Woolworth Bldg., New York.

PATENTS—Prompt, personal efficient service by an attorney-at-law, skilled in all branches of Patent Practice. Over 12 years' actual experience; full information upon request. B. P. Fishburne, 331 McGill Bldg., Washington, D. C.

PATENTS, Trade Marks, Designs and Copyrights. Registered firm of attorneys-at-law. Careful, prompt personal service assured. Moderate fees. Full information free upon request. Gross & Collings, 606 Ouray Building, Washington, D. C.

PATENT applications filed on partial payment plan. Trade-marks, copyrights, etc. Milo B. Stevens & Co., 635 F St., Washington; 352 Monadnock Bldg., Chicago, Estab. 1864.

PATENTS and Trade-marks obtained. Prompt service. Write for our new book on patents. Established in 1889. D. Swift & Co., 369 7th St., Washington, D. C.

TREATISE on patents mailed free. Benjamin Roman, patent lawyer, 290 Broadway, New York, N. Y.

MONROE MILLER, Ouray Building, Washington, D. C., patent attorney, mechanical and electrical expert. Best quality of work and results. Moderate charges.

FREE Advice on patenting new inventions. Total cost divided, six payments. Sterling Buck, Near Patent Office, Washington, D. C.

PATENTS promptly procured. Personal, careful and efficient service. Highest references. Moderate fees. Send sketch or model for actual search and advice. George P. Kimmel, Master of Patent Law, 540 Loan and Trust Bldg., Washington, D. C.

INVENTORS—Send for form "Evidence of Conception" to be signed and witnessed. Form, fee schedule, information free. Lancaster & Allwine, 221 Ouray Building, Washington, D. C.

PATENTS. Booklet free. Highest references. Best results. Promptness assured. Send model or drawing for preliminary examination. Watson E. Coleman, Patent Lawyer, 624 F Street, Washington, D. C.

ROBB, Robb & Hill offer a strictly professional service to manufacturers and inventors in patenting inventions and registering trade-marks, a service which is the result of 20 years' experience. Write for free booklet and names of prominent manufacturers and inventors represented by us. Send sketch for preliminary advice, 811 McLachlen Bldg., Washington, D. C.; 1348 Hanna Bldg., Cleveland, Ohio.

PATENTS—Trademarks—Write for our free illustrated guide book and Evidence of Conception Blank. Send model or sketch and description and we will give our opinion of its patentable nature free. Highest references. Prompt attention. Reasonable terms. Victor J. Evans & Co., 166 Ninth, Washington, D. C.

EDWARD C. SASNETT, patent attorney, former Principal Examiner U. S. Patent Office; former examiner in electrical, optical and mechanical divisions U. S. Patent Office. High-grade personal service. McGill Bldg., Washington, D. C.

INVENTORS! Send sketch or model of your invention for opinion concerning patentable nature and exact cost of applying for patent. Book, "How to Obtain a Patent," sent free. Gives information on patent procedure and tells what every inventor should know. Established twenty-eight years. Chandless & Chandless, 426 Seventh St., Washington, D. C.

PATENTS—Herbert Jenner, patent attorney and mechanical expert, 422 F St., Washington, D. C. I report if a patent can be had and its exact cost. Send for circular.

PATENTS—Trademark, copyright; folder free; results procured. Write Metzger, Washington D. C.

PATENT your invention. But note: a patent is no better than its claims. Be sure your patent is as good as your invention. Patent claims skillfully drafted by Lamb & Co., Patent Attorneys, 1419 G Street, Washington, D. C.

FOR INVENTORS

PATENTS. If you have an invention which you wish to patent you can write fully and freely to Munn & Co. for advice in regard to the best way of obtaining protection. Please send sketches or a model of your invention and a description of the device, explaining its operation. All communications are strictly confidential. Our vast practice, extending over a period of seventy years, enables us in many cases to advise in regard to patentability without expense to the client. Our Hand-Book on Patents is sent free on request. This explains our methods, terms, etc., in regard to Patents, Trade Marks, Foreign Patents, etc. "Scientific American" contains Patent Office Notes, Decisions of interest to inventors, and particulars of recently patented inventions. Munn & Co., Solicitors of Patents, 623 Woolworth Bldg., New York; Scientific American Bldg., Washington, D. C.; 801 A Tower Bldg., Chicago, Ill.; Hobart Bldg., 582 Market St., San Francisco, Calif.

PATENTS Secured. Prompt service. Avoid dangerous delays. Send for our "Record of Invention" form and free book telling How to Obtain a Patent. Send sketch or model for examination. Preliminary advice without charge. Highest references. Write today. J. L. Jackson & Co., 242 Ouray Bldg., Washington, D. C.

PATENTS—"How to Obtain a Patent" is the name of a book which every inventor should have. It will be sent free upon request, and will tell you what you want to know about patents. It contains the whole story. It describes the different parts of the application and explains in simple language the prosecution before the Patent Office. It tells about joint applications, interferences, infringements, process patents, design patents, trade-marks, and prints and labels. If you are interested in patents either as an inventor, manufacturer or owner of a patent you will enjoy reading this book which was written by a lawyer who has had twenty-five years' experience in patent matters. If you have an invention and will send us a sketch, model, or photograph of it we will promptly make a search of the Patent Office records and advise you whether or not, in our opinion, your invention is patentable, our charge for the service being \$5.00. We feel that our experience of twenty-five years has fitted us to render prompt and efficient service which will merit your confidence. Write today. Talbert & Talbert, 464 Talbert Building, Washington, D. C.

INVENTORS and Manufacturers. For developing your invention, designing and constructing Automatic Machinery, Labor-saving Devices for all purposes, Coin-Controlled Beverage and Food-Dispensing Machines, Consult John Frick, Mechanical Engineer, 699 Stroh Bldg., 28 Adams Ave. W., Detroit, Mich.

INVENTORS. Send sketch or model of invention for advice. Write for Evidence of Disclosure form and Book on Patents, Free. Prompt Service. Merton-Roberts & Company, 181 Mather Building, Washington, D. C.

WHY pay from \$7.50 to \$16.00 a sheet for Official Patent Office Drawings when you can get the same for \$5.00. Boardman, 932 D St., N. W., Washington, D. C.

WOODEN Products Mfg. wants patents or ideas for "Built-In Features" in homes. Royalty or Purchase. Pratt & Warner, Los Angeles.

MODELS—Developing your idea, mfg. same is my specialty. Why experiment? Write me and get facts. Henry Backer & Co., 804 Evans, Cincinnati, O.

MR. INVENTOR: We can develop that idea and build that working Model for you. Consult us—with our staff of expert engineers, and thoroughly equipped experimental machine shops, can develop any invention into a commercial proposition, whether mechanical, electrical or automotive—simply and perfect it, and Make It Work. Designing, building and testing gasoline motors a specialty. Experts on automatic labor saving machinery. Mechanical drawings made from sketches or specifications. All business confidential—absolute secrecy guaranteed. Elk Mfg. Co., Inc., 1326A Broadway, New York.

PATENTS—Trademarks. Before disclosing an invention, the inventor should write for my blank form "Evidence of Conception." This should be signed, witnessed and returned to me with sketch or model upon receipt of which I will promptly render opinion as to patentable nature and send booklet on Patents. Highest references. Prompt attention. Reasonable terms. Clarence B. O'Brien, Registered Patent Lawyer, Woodward Building, Washington, D. C.

PATENTS Procured—Trade Marks Registered—A comprehensive, experienced, prompt service for the protection and development of your ideas. Preliminary advice gladly furnished without charge. Booklet of information and form for disclosing idea free on request. Richard B. Owen, 30 Owen Building, Washington, D. C., or 2276-R Woolworth Bldg., New York.

PROTECT Your rights. Write for Record of Invention which contains form to establish evidence of conception of your invention. Prompt personal service. Preliminary advice without charge. J. Benny Kelly, 612 G. Columbian Bldg., Washington, D. C.

INVENTORS. Well executed drawings and properly prepared specifications are the basic features of protective Patents. I offer twenty years' experience in illustrating inventions. Send Sketch for examination and free advice. W. H. Rockwell, Oriental Building, Washington, D. C.

900 MECHANICAL Movements and 50 Perpetual Motions illustrated and explained in my book. Inventor's Universal Educator, 5th Edition—Tells how to procure and sell patents. Government and other costs. Covers the matter from A to Z—160 pages—Elegantly bound. Contains noted decisions of U. S. Supreme and State Courts on Patent cases. Mechanical Movements greatly assist inventors—suggest new ideas that might prove of great aid in perfecting inventions. Tells how to select an Attorney. Has valuable information regarding Patent Sharks, Selling Agents and promoters. Price, \$2. Postage free everywhere. Fred G. Dieterich, 621 Ouray Bldg., Washington, D. C.

ENGINEERS and Inventors: Expert and Confidential Service in Machine design, patent office sheets, advertising cuts, labels, trade-marks. Free circular. Bank references. The Engineering Service Co., Canton, Ohio.

I SELL Patents. Established 1900. Address, Charles A. Scott, 773PM Garson Avenue, Rochester, N. Y.

FREE: Preliminary examination of Patent office records to determine patentability of your invention, for a limited time only. Send sketch or model at once and secure the benefit of this generous offer. Address Harry E. Coleman, Oriental Building, Washington, D. C.

PATENTS. Write for free illustrated guide book. Send model or sketch and description for free opinion of its patentable nature. Highest references. Prompt attention. Reasonable terms. Victor J. Evans & Co., 157 Ninth, Washington, D. C.

HAVE You an Invention? If so, write for our free book, "How to Get Your Patent," tells our terms and methods. Send model or sketch for our opinion of its patentable nature. Randolph & Co., Dept. 144, Washington, D. C.

"INVENTOR'S Guide," free on request; it gives very valuable information and advice. Write Frank Ledermann, 21 Park Row, New York, N. Y.

INVENTORS: The first step toward a patent is a proper search of the pertinent United States records. Send sketch. Horace L. Woodward, Attorney, 700 9th St., Washington. Highest references, reasonable charges.

INSTRUCTIONS how to sell your invention without patenting for 25c. Emil Dahlene, Manson, Iowa.

GET your own patent. Complete instructions \$1. Cuttington, Campbell, Calif.

PATENTS FOR SALE

PATENTED Carburetor, Soatless type—outright or royalty. Gas saver; starts easy in cold weather. Will start easy and run good from start after having been packed in ice for five hours. For particulars write to Orville Z. Frazier, 1317 N. Main St., Elkhart, Ind., or Henry N. Hill, Room 3, Myers Bldg., South Bend, Ind.

PATENTS Secured. Prompt service. Avoid dangerous delays. Send for our "Record of Invention" form and Free Book telling How to Obtain a Patent. Send sketch or model for examination. Preliminary advice without charge. Highest References. Write today. J. L. Jackson & Co., 244 Ouray Bldg., Washington, D. C.

PATENT for marcelling the hair, electrically or gas heated. Something every woman will want to buy. Manufacturing costs very reasonable. Wm. Loeffler, 484 Mass. Ave., N. W., Washington, D. C.

"FLY Trap" now completed; a sure catcher, highly simplified, constructed, durable in use, and cheap to manufacture. Royalty considered; prints, etc., on request. Address, Fred Day, Alcester, S. Dak.

LADY inventor, sell cash or royalty, metal household novelty; simple, cheap—Nothing like it; eager buyers waiting. Louise T. Keene, Corning, N. Y.

FOR Sale—Patent No. 1326906 of a collapsible Bath Cabin making small, light and portable package. For particulars, terms, E. Steinhilber, R. 4, New Brunswick, N. J.

PATENT for Sale—Foldable screened rocking chair, adapted for porches, country places, hospitals, seashore. Address, Strausky, 200 Greenway, Darby, Pa.

PATENT 1,302,105 on Tube Brushes, for sale. J. Bergesen, Sr., 261 E. 31st, Brooklyn, New York.

LOCK Nut, Particulars. John Schofield, Beacon Apt. 23, Washington, D. C.

PATENTS 1,382,458 and 1,392,629 for sale. Nothing but cash offer will receive consideration. W. O. Batts, Wilmat, Kan.

OUTRIGHT or royalty. Three Wheeled One Foot Roller Skate for sidewalks. Elmer Lee, 1016 Bank St., Waterbury, Conn.

PATENT for sale or royalty; shoe nail No. 465,217. Best offer takes it. John Jasus, P. O. 114, Catlin, Ill.

PATENT on "Diving Apparatus," Submerges approximately one mile. Address, Joe Freeze, 2917 N. 16th, Kansas City, Kan.

INVENTORS. Send sketch or model of invention for advice. Write for Evidence of Disclosure form and Book on Patents, Free. Prompt Service. Merton-Roberts & Company, 181 Mather Building, Washington, D. C.

FOR Sale—Patent Never-Kom-Loose garment fastener. Isaac Heatwole, Dalton, O.

CONDENSERS—12,698-1; templates—12,674-1. Talbert & Talbert, Talbert Bldg., Washington, D. C.

FOR Sale—Patent burglar catcher known as the Watch Dog. Davis Phonograph Shop, LaPorte, Ind.

EXCEPTIONAL opportunity; self-blowing alcohol torch; best offer takes Canadian patent; U. S. patent successfully on the market. Watch for the "Duplex" torch; investigate. Address, Folgman, 31 Third Street, Brooklyn, N. Y.

PATENT for Sale—Combination Step and Wall Ladder, hinge construction; may be cast or forged; practical, safe and attractive. Reges, 803, 110 West 40th Street, New York, N. Y.

BASIC Patent on best Tree Felling and Log Sawing Machine, easily manufactured, price low account illness. Holmes, 55 Hicks St., Brooklyn, N. Y.

MANUFACTURERS, Attention! Inventions for sale. Telescope rib pocket umbrella. Pearl holding pocket. Sash and Door Lock, 118 Fulton St., New York City.

OUTRIGHT or Royalty. Patent on Hygienic Paper Toilet Seat Cover; very cheap to manufacture. Justin Bloch, 110 West 40th Street, New York.

HARDWOOD darning, needle and thimble cage; novel invention; good seller; patent applied for; best offer considered. Address Hanov, Newark, N. J.

PATENT for sale. New game trap; very reasonable. Address, J. Arnoth, 925 C St., S. W., Washington, D. C.

PATENT 1,399,827. Wonderful door hanger. Simple. Mfg. cheaply; outright. Address Edward Larson, Grand Forks, N. Dak.

FOR Sale—Reasonable, with or without royalty. Nonloseable Cuffbutton Patent. H. Bantz, Thomastown, Ala.

FOR Sale—Patent Mold for building Hollow-Wall Concrete Houses. Fast seller. Big profits. This is a basis for a national sales and manufacturing enterprise. Address, Thompson, 238 Superior St., Fond du Lac, Wis.

SALE or Royalty—Patent No. 1,386,296. Burglar Trap for stairways; it locks when catches and gives signal to Police Station. Address Jeremiah Hicks, 237 W. Poplar St., Philadelphia, Pa.

FOR Sale or Royalty—Floor oiling device of simple construction; does an hour's work in five minutes; saves labor, also oil. Address, Wenger, 432 Broadway, Bayonne, N. J.

PATENT for Sale: Locking and guiding bolt for combined swinging and sliding doors. Several special features. Will pay you to investigate. Genuine bargain. Edward T. Murphy, 14 W. 103d St., New York City.

HAVE you a Patent to Sell? Sell direct to manufacturers. B. M. Bosman, 94 Brighton, Detroit, Mich.

PATENT Fireproof, Weatherproof Wood Shingle. Will sell outright. Particulars free. Write Cecil Davis, Atlanta, Ind.

PATENTED cattle dehornor for sale, or royalty or partnership. Address Van Amber, 7036 Yale Ave., Chicago.

OUTRIGHT—Royalty: Hydraulic Engines for raising water to farm houses, G. N. Wertz, Abingdon, Va.

INVENTORS: The first step toward a patent is a proper search of the pertinent United States records. Send sketch. Horace L. Woodward, Attorney, 709 9th St., Washington. Highest references; reasonable charges.

HAVE you a Patent to sell? Would you like to know what a small classified ad in this column could do for you? Ask me to send you proof of how other inventors sold their patents. J. Roy McClellan, Manager Classified Advertising, Popular Mechanics Magazine, Chicago, Ill.

MODELS AND MODEL SUPPLIES

IF you have pattern work of any description, either wood or metal, get my terms before ordering. No job is too large or too small. Prompt attention is given to all orders. Geo. J. Lauser Pattern Works, 1887-89-11 John St., Cincinnati, Ohio.

MODELS: We have fully equipped model shop and carry complete line of model supplies. Modern Machine & Pattern Co., Terre Haute, Ind.

COMPLETE set Scale Blue Prints for 3" by 9" Horizontal Boiler fitted with water tubes and firebox, also High Speed Engine. Shows how to make boiler fittings without castings. This set comprises six sheets 18" by 15". Price \$1.50. Stamps not accepted. Marshall, 1229 Alberta Ave., Dayton, Ohio.

WORKING Models Designed and Built. Inventions Developed. Dies, Tools, Metal Stamping, Manufacturing. Wisconsin Experimental & Model Works, Madison, Wis.

WE make working models for inventors and do experimental work and carry a complete stock of brass gears and model supplies. Send for catalogue. The Pierce Model Works, Tinley Park, Ill.

INVENTORS—Write for our free illustrated guide book and Evidence of Conception Blank. Highest references. Prompt attention. Reasonable Terms. Victor J. Evans & Co., 165 Ninth, Washington, D. C.

PUNCH Press work, tool and die making, model and special machine work wanted. Completely equipped with new machinery of the latest type. Prompt delivery, reasonable prices guaranteed. Quality Hardware & Machine Co., 6154-56 N. Clark St., Chicago.

FOR MANUFACTURERS

POWER Users—Have you considered the economy and advisability of changing from steam to gas producer operation? Our authentic book "Power Gas and the Gas Producer" written by a recognized authority on this subject will enable you to judge intelligently. Price \$1 postpaid. Popular Mechanics Book Dept., 6 N. Michigan Ave., Chicago.

CALIFORNIA, the bright spot of business. Let us represent and sell for you here. Correspondence invited. Mormark Company, Garland Building, Los Angeles.

WANTED—Metal Stamping and Model work taken on contract basis. We are ideally located and equipped to develop patents. Meyers Company, Box 263, Bedford, Ind.

MANUFACTURING

EXPERIMENTAL Work, stampings and special machines for any purpose designed and built at reasonable prices. Address Brownstein Manufacturing Co., Engineers and Manufacturers, Ellwood City, Pa.

WE will manufacture for you; submit your article; get our quotations. H. C. Zennert Co., Metal Specialties, 1752 North Park Ave., Chicago, Ill.

PATTERNS, wood and metal. Models, tools and dies. Brass and Aluminum castings. General machine work. Modern Machine & Pattern Co., Terre Haute, Ind.

PATENTED Articles, Models, Brass Work, Machine Construction; Dies Made. Baum's Metal Specialties, Kansas City, Mo.

LET us be your factory! Write today. Logan Machine Company, 222 South Clinton Street, Chicago, Illinois.

MACHINE Work of any kind—Special Devices—Experimental Work—Jigs and Fixtures. Up-to-date Shop. The Advance Tool Co., Canal and Jackson Sts., Cincinnati, Ohio.

A. A. TIMMERMAN, tools, dies. Stamping Manufacturing, 410 Kimball, Danville, Ill.

WANT quantities small patented articles manufactured. Jesse Lynda, Wilburton, Okla.

STANDARD Metal Stamping Works. Tools, Dies, Patents. 224 Centre, New York.

WE have a light modern well equipped machine shop to make your models and to manufacture your article. So, if it is to be made of metal, let us make it for you. Victor Engineering Co., 2524 W. Chicago Ave., Chicago.

WE make high-grade dies, tools, jigs and gauges. Stamping and press work of all kinds. Special machinery. Model and experimental work. Patents perfected. Strand, 644 Randolph St., Chicago, Ill.

METAL Specialties. If of metal, we can make it for you. Complete equipment. Western Die & Stamping Works, 721 Fulton St., Chicago, Ill.

IF you want dies and metal stampings, write us. Lyons Machine Works, Lyons, Ia.

WELL equipped machine shop, pattern shop and foundry is prepared to manufacture any automobile or garage tools or accessories, portions of which are castings, on royalty or other basis. Send us your prints and specifications for estimate. Patented articles preferred. Connersville Foundry Corporation, Connersville, Ind.

SPECIAL Devices and Machinery developed and built at reasonable rates. Jigs and fixtures designed and built for interchangeable and economical manufacturing. Punches and dies made for all kinds of metal stamping. Machine work to order. Simplex Tool Company, Woonsocket, R. I.

METAL Stamping, Dies, Tools, Special Machinery and Machine Parts Remodeled, Designed and Built. Efficiency Increased. Cylinder Grinding. Wisconsin Experimental & Model Works, Madison, Wis.

WIRE Goods, all kinds made to order. Cooley Mfg. Co., 524-530 N. Western Ave., Chicago.

MACHINERY, TOOLS AND SUPPLIES

WANTED—Machines to Build. Machine Work, Day or Contract. Iron, Brass, Aluminum Castings. No order too small. Address, Briggs-Shaffner Company, Winston-Salem, N. C.

WANTED: Information about new air compressors. Write for free manual. Engineers Dept., Brunner Mfg. Co., Utica, N. Y.

PULLEYS, Grooved and Motor, Reducing Gears, Light Transmission Machinery. Send for catalog. Winfield H. Smith, Buffalo, N. Y.

BENCH Lathes, Johnston. "Monitor Nine" Hi-Duty Screen-Cutting Engine Lathes, actual swing 9 1/2"; center distance 18"; hole thru spindle 3/4". Stamp for Catalog. The Johnston Manufacturing Co., Arlington, N. J.

EIGHT-HORSE Pons gas engine \$95. Four-horse gas engine \$40. 20" Back-gear drill press \$90. Excellent condition. Walter Rabbi, Dover, Ohio.

FOR Sale—Anderson Steam Vulcanizer and Western Retreader. Porterfield Tire Works, S. Manchester, Conn.

CONCRETE Building Block Machines and Molds. Catalogue free. Concrete Machine Co., 112 S. Second St., St. Louis, Mo.

OTHERS have successfully sold their machinery through our columns—so can you. Ask me for proof. J. Roy McClellan, Manager, Classified Advertising, Popular Mechanics Magazine, Chicago.

ENGINES, MOTORS AND DYNAMOS

ALTERNATING and direct current motor bargains. New and rebuilt. All guaranteed for one year. Special prices. Get our price list before buying. Motors exchanged and repaired. Hyre Electric Co., 633-RM South Dearborn St., Chicago.

AUTOMOBILE Owners, Garagemen, Mechanics, Repairmen, send for free copy of our current issue. It contains helpful, instructive information on overhauling, ignition troubles, wiring, carburetors, storage batteries, etc. Over 120 pages, illustrated. Send for free copy today. Automobile Digest, 507 Butler Bldg., Cincinnati.

SPECIAL Garage Motors: Manufactured by the General Electric Co. 1 H. P., \$78.50; 2 H. P., \$110.00; 3 H. P., \$128.50; 5 H. P., \$166.50. All sizes, both single and Poly-phase Motors, for immediate delivery. Special charging generators, all voltages. Write for catalog. Motor Sales Dept. 15, West End, Pittsburgh, Pa.

ELECTRIC Motors, 500 Heavy Duty 1/2 H. P. motor. General Electric and other standard makes, 110 Volt, 60 Cycle, Single Phase. New, original packages, guaranteed perfect. \$18.00 to \$22.00. Pennsylvania Motor Exchange, Lancaster, Pa.

BALL-BEARING motors, automatic compressors, grinders, battery chargers, lighting generators. Unusually easy terms. Write us. Hobart, Troy, Ohio.

ELECTRICAL

WASHING Machines, Electric-Universal, Portable and Butterfly, \$39.00 and \$65.00; Electric Irons, 5 and 8 lb., \$2.50 and \$3.15; Electric Motors, \$10.00 and up; Dry Cells and Flashlight Batteries, 30c and 10c; Nitrogen, Tungsten Lamps, etc., at extremely low prices. Agents with capital wanted. All material standard, new, guaranteed. Send for complete lists. We buy your surplus stock. J. Strauss & Blum, 254 W. 41st St., New York.

TATTOOING Outfits, Hand and Electric, \$1 up. Address Roberts Co., 635 West Ave., Buffalo, N. Y.

FOR Sale—600 feet insulated weather-proof solid copper wire; size of copper 3/8-inch diameter. Miller Bros., Downs, Kansas.

1/2 H. P. ELECTRIC Motors, 110 volts, 60 cycle, single split phase, 1725 R. P. M. at a bargain. Write us your requirements in Electric Motors, Unit Electric Sales Co., 20 East Jackson Blvd., Chicago, Ill.

ELECTRICITY taught by experts; earn while you learn at home; electrical book and proof lessons free; your success guaranteed and position secured. Chicago Engineering Works, Dept. A-11, 2144 Lawrence Ave., Chicago.

ELECTRIC Fixtures: Buy direct and install them yourself. Send for descriptive Fixture circular and wholesale prices of motors and all electrical supplies. Electric Supply & Plumbing Co., Robinson, Ill.

ELECTRIC motors and supplies, including sockets, wire conduit, cleats, loom, tassettes, switches. New revised wholesale prices. Illustrated Catalog free. Hyre Electric Co., 633-GH, South Dearborn St., Chicago.

AIR Compressor with Tank and Hose, \$49. Motor for same, \$22.50. Equipment Co., 169 Canal, Cincinnati, Ohio.

FOR MECHANICS

INVENTORS. Send sketch or model of invention for advice. Write for Evidence of Disclosure form and Book on Patents, Free, Prompt Service, Merton-Roberts & Company, 183 Maiber Building, Washington, D. C.

PATENTS—Write for our free illustrated guide book and Evidence of Conception Blank. Send model for sketch and description of the invention for our opinion of its patentable nature free. Highest references. Prompt attention. Reasonable terms. Victor J. Evans & Co., 184 Ninth, Washington, D. C.

FOR THE SHOP

SHOP Notes for 1922—Bench Lathe, Electric Soldering Outfit, Jib Crane, Pump Troubles, Road Roller, Bench Grinder, Bench Miller, are among the 655 articles in this new volume. 224 pp. 50 cents postpaid. Popular Mechanics Book Dept., 6 N. Michigan Ave., Chicago.

MINING

COMPLETE drawings with specifications for making Ore and Metals Locator sensitive to a depth of 25 ft. on ferrous and non-ferrous metals. Price of drawings \$2.00, which will be allowed if instrument is ordered from us. Ore Instruments Co., 3225 Sheffield Ave., Chicago, Ill.

BLACKSMITHS

BLACKSMITHS. Listen: Any Handy man can make more money doing hard jobs easy. Forging and welding solid, with Toy's Modern Methods of Blacksmithing. Hardening and tempering to a standard with colored tempering charts. All for one dollar. Samples Free. W. M. Toy, Sidney, O.

FOR SALE—MISCELLANEOUS

ADDRESSOGRAPHs. Letter Folders, Multi-graphs, Envelope Sealers, Duplicators, less than half price. Guaranteed. Pruitt Co., 112-B N. La Salle, Chicago.

FOR Sale—New riding device, jazz swing, 100 reels, films, machine outfit, troupe of trained dogs, and Doves doll rack air rifle shooting gallery, street piano and organ, bottling and ice cream machinery. F. P. Light Plant, Ball Games, Carnival goods, Harry Smith, Gratz, Pa.

\$17.50 GENUINE Carl Zeiss Field, Marine and Aviation Glasses, eight power, adjustable focus and eye pieces, cost \$38.00, with carrying case. Sent C. O. D. subject to examination. Money refunded. We have other Glasses, Binoculars and merchandise. Weil's Curiosity Shop, 29 S. 2nd St., Philadelphia, Pa.

FOR Sale—Screen Door Catch, Simple, inexpensive; patent No. 1,335,100. Investigate. M. P. Embach, Holdenville, Okla.

ANTIQUITY fashion Furniture, Carpets, etc., for sale. Particulars on request. J. C. Larocheville Langevin, Quebec, Canada.

LUMINOUS Paint. Bottle 20c. Laboratories H, Box 316, Portland, Ore.

VIOLIN, very fine tone, 21 jewel watches, taken in trade on cameras; will trade these articles for shotguns, revolvers, or lenses, what have you? National Camera Exchange, 20 Washington Ave., Minneapolis, Minn.

AUTO Tire Vulcanizing Molds, Air Compressors, Motors, Battery Charging Outfits, Reduced Prices. Write for catalog. Equipment Co., 147 Canal, Cincinnati, Ohio.

FEATHER Flowers. Fine seller Florists, Poultry Shows, Fairs, etc. Unexcelled for home, office, store. Samples one dollar. Address De Witt Sisters, Battle Creek, Mich.

REAL ESTATE AND FARM LANDS

FREE Government Lands—Our official 112 page book, "Vacant Government Lands," lists and describes every acre in every county in U. S.; tells location, place to apply, how secured Free: 1922 diagrams and tables, new laws, lists, etc.; price 50 cents postpaid. Webb Publishing Co., Dept. 71, St. Paul, Minn.

FREE Book of Florida Facts. Own your own orange grove in beautiful Fruitland Park. A few cents a day you now waste will buy it for you. A few dollars a month may provide you with a life income. Schnitzler sold his twenty acre grove here for \$40,000—two thousand an acre. He saw the same opportunity that's offered you and planted a grove. Result—he reaped a small fortune. You have the same chance but you must act now. Write today for Free Book of Actual Photographs, Florida Facts and the interesting story of a Fruitland Park Farm. Learn of crops that help you buy it. Address today, Lake County Land Owners' Association, 93 Sunset Way, Fruitland Park, Florida.

LAND Opportunity! 20, 40, 80 acre tracts near bustling city in Michigan. Fine for poultry, truck, fruit and general farming, only \$15 to \$35 per acre. Very easy terms. Write today for Free booklet giving full information, Swigart Land Company, P-1259, First National Bank Building, Chicago.

STROUT'S New Catalog! Farms!! 1200 Bargains! Just Out!! \$10 to \$150 acre; throughout 30 states. Full equipments. Easy terms. Copy Free. Strout Farm Agency, 1509 Naussau St., New York City, N. Y.

MINNESOTA good wild land, part timber, splendid location, \$13.50 per acre. Address P. Fonoos, New Richmond, Wis.

\$5.00 DOWN, \$5.00 monthly; 20 acres unimproved fruit, poultry, stock, woodland; Ozarks; \$100. Fishing, hunting, trapping. Address, Alfred Zimmerman, 1809 N. Fifth, Kansas City, Kan.

AM forced to sell 5 Sections, Volusia County, Florida. On Hard Road. Sacrifice \$10.00 an acre. Sell Section lots same price. Terms. Address, W. A. Kieffer, 1026 Scarritt Bldg., Kansas City, Mo.

ATTENTION!! "Let's get acquainted." Cash for your property, farm, hotel, retail store or factory. Confidential service. Hayes Business Agency, Cincinnati, Ohio.

WANT to hear from party having farm for sale. Give particulars and lowest price. John J. Black, 11th St., Chippewa Falls, Wis.

SELL your property quickly for cash, no matter where located. Don't pay big commissions. Particulars free. Real Estate Salesmen Co., Desk B, Lincoln, Neb.

WANTED—MISCELLANEOUS

MAIL old gold, unused postage, war and thrift stamps, Liberty Bonds, silver, platinum, diamonds, jewelry, watches, false teeth, magneto points, etc., new or broken. Cash immediately. Held ten days, returned if unsatisfactory. Ohio Smelting Co., 205 Lennox Bldg., Cleveland, Ohio.

WILL buy light machine shop. Jesse Lynds, Wilburton, Okla.

CASH by return Mail for Old Gold, Silver, Platinum, Diamonds, Gold Crowns, Bridges, Magneto Points, Liberty Bonds. Your goods returned if offer refused. Yonover Bros., 1631 Roosevelt Rd., Chicago.

CASH Paid. Mail us your discarded jewelry, gold crowns and bridges, watches, diamonds, silver, platinum, War Savings Stamps and old false teeth. Highest prices paid. Money sent by return mail. Packages held 4 to 12 days and returned at our expense if our offer is refused. United States Smelting Works (The Old Reliable), Dept. 71, Chicago, Ill.

HIGHEST cash prices for old gold, silver, platinum, diamonds, watches and jewelry. Held ten days; returned if offer unsatisfactory. Carson & Banks, Manufacturing Jewelers, 445 Barker Block, Omaha, Neb.

MACHINE guns, shells, guns, any war relic. Kestler, 50 Ft. Greene, Brooklyn, N. Y.

FOR THE HOME

MAKE Inexpensive Iceless Refrigerator. Blueprint 35c. William Quemore, Camden, N. J.

FOOD PRODUCTS

PINON Nuts—Will deliver ten pounds by insured mail for two dollars. Address Hayes Trading Post, Hayes, New Mexico.

GIGANTIC Climbing New Guinea Bean. The new Edible Vegetable Wonder. Grows 3 to 5 feet long, weighs 10 to 15 lbs. Delicious eating; flavor like sponge mushrooms. Guaranteed as advertised. 6 seeds 25c; 15 for 50c; 45 for \$1.00. No stamps. Address, Musketopunk Co., Dept. A, Pekin, Ill.

TOBACCO

PURE red leaf tobacco, quality guaranteed. Best chewing, 3 lbs., \$1.00; 10 lbs., \$3.10. Mild smoking, 4 lbs., \$1.00; 10 lbs., \$2.10, postpaid. O. D. Collier, Agent, Martin, Tenn. Collier is absolutely honest and reliable. Martin Bank, Raymer, Cashier.

TOBACCO, Natural Leaf, for mild smoking; 10 lbs. \$1.50; 20 lbs. \$2.75; will furnish free receipt for preparing. Leaf Tobacco Exchange, Mayfield, Ky., Star Route.

DOGS, BIRDS, POULTRY AND PETS

ALL White Scotch Collies from registered. Healers. White Collie Kennels, Burlington, Kans.

CANARIES, fully guaranteed singers, \$7.50 up. Breed them now and make money in your spare time. Cages and breeder supplies, lowest prices. We ship anywhere. Replied stamp required. 32 years' experience. 566-568 Kensington Ave., Buffalo, N. Y., Canary Breeding Plant.

DOG Owners' Text Book Free. An expert guide for dog owners on proper training, feeding and care of dogs. Sent free with three months subscription to Sportsman's Digest. Send 25 cents (coin or stamps) today. Sportsman's Digest, 367 Butler Bldg., Cincinnati, O.

SILVERBLACK Foxes \$300.00. Booklet free. Time payments. Arthur Schumacher, Lockland, O.

LIFE Preserver—a dependable remedy for white diarrhoea, roup and cholera among poultry. 16 oz. bottle, \$1.00 postpaid. Agents and Dealers wanted. Walter Achard, 4503 Lincoln Ave., Chicago, Ill.

REGISTERED Collies, Intelligent, Beautiful, High-class breed matrons, best breeding in America. Eagle Collie Kennels, Eagle Lake, Texas.

FOR Sale. Fox hounds. J. R. Thomas, Booneville, Miss.

BABY Chicks, 18c up; Bred-To-Lay. Prepaid guaranteed delivery. Send for circulars. Roy Clark, Dept. P, East Hartford, Conn.

POLICE or Shepherd Dogs and Puppies, pedigreed champion stock, \$50.00 and up. Wolfburg Police Kennels, Aqueduct, L. I.

BREED Squabs. Book free. E. Rice, Melrose Highlands, 77, Massachusetts.

GREAT Dane Pups—For Dames that have size and intelligence write Collins Kennels, Box 169, Reedsburg, Wis.

CLIP THAT COUPON



CHICAGO TECHNICAL COLLEGE, 430 Chicago "Tech" Bldg., Chicago, Illinois.

Without obligation on my part, please send free and paid, instructions on how I can become an expert in subject marked below.

- | | |
|---|--|
| <input type="checkbox"/> Architectural Drafting | <input type="checkbox"/> Auto. Engineering |
| <input type="checkbox"/> Machine Drafting | <input type="checkbox"/> Aero. Engineering |
| <input type="checkbox"/> Electrical Drafting | <input type="checkbox"/> Gas Engines |
| <input type="checkbox"/> Structural Drafting | <input type="checkbox"/> Plan Reading—Buildings |
| <input type="checkbox"/> Sheet Metal Drafting | <input type="checkbox"/> Estimating—Buildings |
| <input type="checkbox"/> Topographic Drafting | <input type="checkbox"/> Plan Reading—Machinery |
| <input type="checkbox"/> Surveying | <input type="checkbox"/> Plumbing—Estimating |
| <input type="checkbox"/> Designing | <input type="checkbox"/> Heating and Ventilating |
| <input type="checkbox"/> Contracting—Buildings | <input type="checkbox"/> Steam Engineering |

Name.....

Address.....

Post Office..... State.....

College or Home Study. State which.....

Free Lesson when inquiry is for Draftsmanship or Plan Reading.

Learn Draftsmanship At Home



The employer today knows the value of technical knowledge. He surrounds himself with experts—not merely good mechanics but technically trained practical men. He is ready and willing to pay their price, for he wants expert advice and service. Get the facts about the Chicago "Tech" Course in Draftsmanship (or any of the other big paying professions listed on the coupon). You can master all these courses quickly by spare time study at home. Draftsmen earn bigger salaries than ever before, because trained men are scarce. Hundreds of big paying jobs waiting and not enough experts to go around.

Constant Demand for Trained Draftsmen

Proficient men are needed badly in the drafting departments of big manufacturers, architects, railroads, electrical plants, etc. Many experts with large concerns earn \$60 to \$150 weekly.

This is your big chance. See how well

Experts Teach You Their Practical Methods

The Chicago "Tech" method trains you under experts who equip you for important positions in the shortest practicable time. You learn exactly the methods which they use in their own practical work. They give you the training that ranks you with draftsmen of long experience—that is required of men who aim to

hold executive positions. Why be content just to take orders when you have it in you to Give orders, once your training gives you the confidence to assume charge of the men who do the actual work? The practical knowledge you get from Chicago "Tech" experts fits you to step right out and earn a big salary.



Send For **FREE** Test Lesson

Shows you how well qualified you are for draftsmanship. Other schools ask you to enroll and send money first. We send the free lesson first. Read it—practice the exercises—no obligation. Decide for yourself whether you want to take the course or not.

Choice of 18 Courses that Will Increase Your Salary

No better way to spend your leisure hours than in fitting yourself for the big jobs above you. If you want to master quickly any other technical study, make your choice from the wide range of big paying professions listed on the coupon. If you cannot come to the college, you will get the same thorough individual instruction from the same experts by mail. It does not matter where you live. Your

lessons are directed and every exercise corrected by experts who make every point clear. You progress as quickly as you show that you have mastered their subjects. With the practical knowledge you have gained from a Chicago "Tech" course, you will be the kind of man wanted for important work because you will not only know how to do things but why they should be done.

Act Today — Clip That Coupon

Decide right now—get the facts. Find out how hundreds of ambitious men have prepared themselves for high positions merely by using their spare time for

study. This information costs you nothing. Just put X in the square on coupon opposite the course you want to know about. Then clip, sign and mail the coupon today.

Chicago Technical College

430 Chicago "Tech"
Building,
Chicago, Illinois

**CLIP THE
COUPON NOW**

Continued from Page 50

BELGIAN HARES, GUINEA PIGS, ETC.

BELGIAN Hares. A very interesting and instructive book on raising Belgian Hares and other rabbits. It tells how to select the stock, how to make the hutches and pens, how, when and what to feed them, how to prepare for the young, weaning, marketing, killing, their ailments and everything the beginner should know. Price 25c; worth double. Rabbit Culture, Fredericksburg, O.

RAISE guinea pigs. Pay better than poultry or rabbits; easy to raise; little space required. We guarantee market. Particulars and booklet how to raise free. Caries Distributing Co., 3102 Grand Ave., Kansas City, Mo.

PERSONAL

DOES your husband snore? The Morpho Silencer prevents mouth breathing, grinding the teeth in sleep, and in 90% prevents snoring; you do not inhale the impurities in the atmosphere; can be used in mouth closure in dusty occupations. Physicians recommend its use. Price \$1.00. Morpho Silencer Co., 4296 Cleveland Ave., St. Louis, Mo.

SWEATY Feet stop smelling, and feel comfortable, by using Footoline. At drug-gists or direct, 25 cents. Emil Breithaupt, 3155 Melburn, Detroit, Mich. Agents wanted.

YOUR Horoscope—Life revelation showing your character, talents, suitable occupation. Scientific and accurate. Send birth date, 10c. The Astrolite Company, Sharpsburg, Pa.

YOUR Horoscope covering full year for 35c. Includes an extensive reading, valuable daily guide, large pictorial chart and special forecasts for each month. Scientific, complete. Try it! Money back if dissatisfied. Give birthdate. Address, H. Daniels, Flatbush Sta., Box 32, Brooklyn, N. Y.

COMPLETE life reading 35c. Give birthdate, Jay Wambaugh, Goshen, Ind.

SUCCESS or Failure! Which is your destiny? Scientific information. "Success" pointers and Personality sketch for 10c and birthdate. Thomson-Heywood, Dept. 983, Chronicle Bldg., San Francisco, Calif.

ST-STU-T-T-TERING and stammering cured at home. Instructive booklet free. Walter McDonnell, 46 Potomac Bank Bldg., Washington, D. C.

FREE—Stop using tobacco. We will give free information how to conquer habit easily and permanently. Results guaranteed. Anti-Tobacco League, Box K, Omaha, Nebr.

FULL Horoscope readings—three questions answered. Birthdate, 50c. Crystal Balls sold. Gaining books \$1. Delmore, 664 N. 12th, Philadelphia.

TOBACCO or Snuff Habit cured or no pay, \$1.00 if cured. Remedy sent on trial. Soperba Co., TP., Baltimore, Md.

TOBACCO Kills Manly Vigor—Quit easily. Cigarettes, chewing, smoking, snuff, conquered or no charge. Small sum if satisfactory. Stops craving; harmless. Full treatment on trial, Perkins Co., 34A, Hastings, Nebr.

Do the Dead Live? Fake mediums exposed 25c postpaid. Bert Walton, 314 Washington Bldg., Seattle, Wash.

SURVEYING INSTRUMENTS

NEW and used surveying instruments direct from factory. Satisfaction guaranteed or money refunded. Winstler, 619 Broadway, St. Louis.

MISCELLANEOUS

MOLES, Warts, False Growth removed without knife, blood or pain. "While you wait." 1922 Discovery. Prof. Gregor Katsanik, Duluth, Minn.

SPENCER Microscope, like new, \$37.50; .32 cal. Colt or Savage automatic, like new, \$16; .45 Colt automatic as new, \$20. National Camera Exch., 20 Wash. Ave., Minneapolis, Minn.

GET Posted for Spring. Good prices paid for butterflies, insects. See Sinclair's Display Advertisement, page 18.

I MADE \$100,000 as real estate specialist. Free information tells how. American Business Builder, 1129-C Broadway, New York.

\$10.00 DAILY. Lettering windows and signs. Complete working demonstrations 50c. Particulars free. Freeburn, Hicksville, Ohio.

ART Metal Workers—You will find our book "Metal Work and Etching" a complete manual on making book ends, desk sets, pad corners, paper knives, letter openers, stationery racks, rocking blotters, desk calendars, arts and crafts jewelry, etc., 50 pp. illus. Price 50 cents postpaid. Popular Mechanics Book Dept., 6 N. Michigan Ave., Chicago.

GRANDFATHER clock works, \$5.00. Build your own case, instructions free; make good profits selling your friends. Clock works with chimes for old or new cases. Write for full particulars. Clock Co., Nicetown, Philadelphia, Pa.

CUTS anybody can make. Simple, cheap process. \$1. Specimens, particulars. 2c stamp. M. Day, Windfall, Ind.

SAVE incorporating expenses and excess profit taxes and avoid personal liability by organizing your company on the Common Law Plan under a Declaration of Trust. Anyone, anywhere, can fill in Demaree Standard Forms, issue shares and begin doing business same day. Pamphlet B-53 free. C. S. Demaree, Legal Blank Printer, 613 Walnut, Kansas City, Mo.

ARTIFICIAL Eyes, \$3. Booklet free. Denver Optic, 539 Barclay, Denver, Colo.

FREE BOOK on SIGNAL ENGINEERING

SIGNAL ENGINEERING

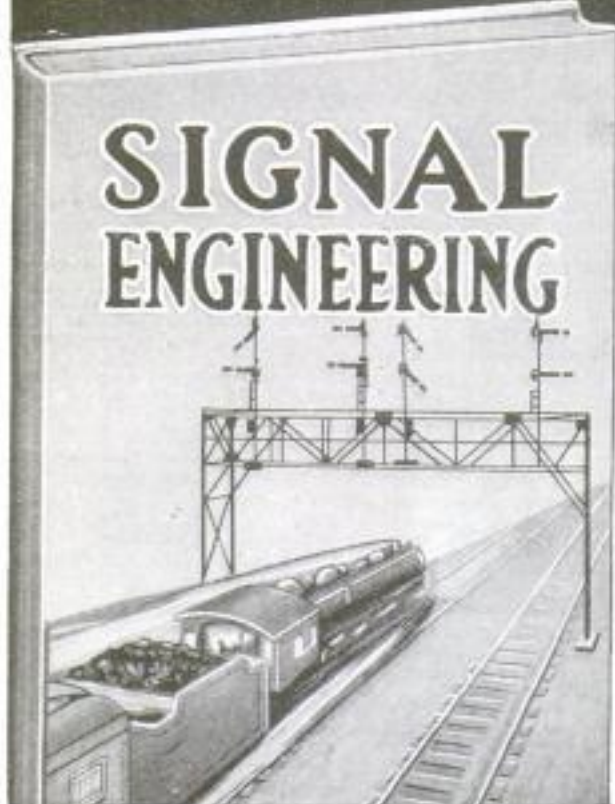

THERE are thousands of miles of railroad that must be equipped with block signal systems. To superintend these installations men are necessary. *Golden opportunities are offered.* Every ambitious man should write for the Free Book on Signal Engineering.

Men Are Needed to Accept High Salaried Positions

Less than one-fourth of the passenger lines in this country are equipped with automatic block signal systems. The day is fast coming when the law will compel railroads to install them. Remarkable opportunities are offered to ambitious men in the profession of Signal Engineering. High salaries are paid. \$250.00 a month is an ordinary salary for a Signal Engineer.

Send the Coupon

Now and get the free book about Signal Engineering. Too, we will tell you how you can get the training that you need in order to become a Signal Engineer. You will be under no obligation by writing for this free book. Do it **Now**.

Department of Signaling
Dept. 1354
1924 Sunnyside Ave., Chicago

DEPARTMENT OF SIGNALING
Dept. 1354, 1924 Sunnyside Avenue
CHICAGO

Gentlemen:—Please send me absolutely free and prepaid your big new book on Signal Engineering. Also full particulars about your great special free outfit offer. It is distinctly understood that I assume no obligations of any kind.

Name.....
Address.....
Age.....Occupation.....

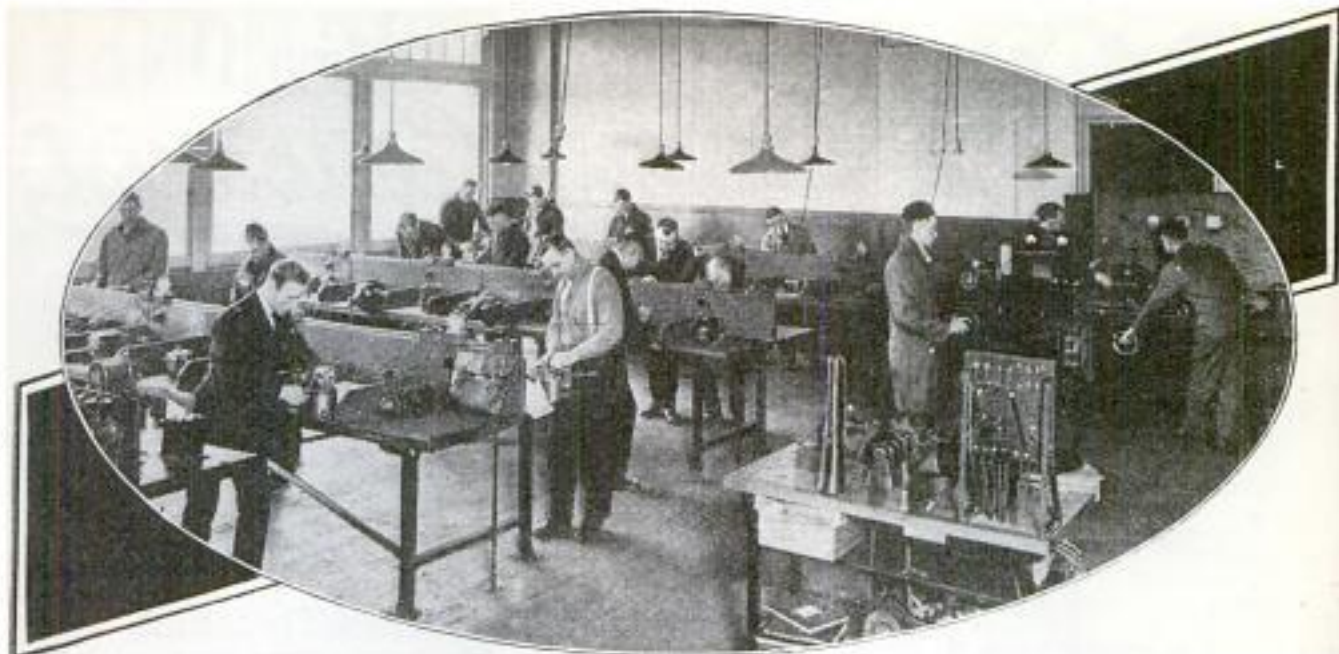

Mechanics!—Learn Automotive Electricity

Earn More Money and Advancement

Free Book Shows How Mechanics Can Double and Triple Their Salaries
by Discovery of Vital Secret to Success in the Auto Business

How Frank E. Howard, of Lackawanna, New York, jumped ahead of men having twelve years more experience than he—how F. W. Johnson, an auto-mechanic, trebled his salary in less than one year, and how hundreds of other similar successes were made is the message carried to you in big illustrated book sent FREE, if you send the coupon below.



You Can Learn in a Few Weeks

This course includes scientific teaching and experiments of everything electrical about the automobile. The student has actual practice in testing, wiring and adjusting every part of starting, lighting and ignition systems; also overhauling all systems; tearing down and assembling; operating them on live motors; trouble shooting on live cars; building and repairing of storage batteries; armature winding, farm lighting systems. This course is advanced work, and will enable experienced mechanics to do better work and earn better salaries—to reach the top. Your enrollment entitles you to Life Scholarship in Factory-Endorsed School, with the privilege of our service FREE at any time.

Write for this Book of Wonderful Opportunities

We want to acquaint ambitious men everywhere with this wonderful opportunity. This book tells in detail about M. S. A. S.—training, methods and equipment. It includes letters from graduates, telling what this training has enabled them to do, and letters from leaders in the auto and tractor industry, endorsing our methods. There is no obligation in sending for this catalog. It's FREE. Send your name and address today. Use coupon below or postcard. But write NOW.

The Step Ahead Be an Expert Auto Electrician

Hundreds of good mechanics are kept in the small-pay jobs simply because their knowledge is limited to the mechanical end of the business. They may be first-class motor repairmen, but there is a vital difference between holding the big salary job and getting the ordinary mechanic's pay. Here is the secret! Nine out of ten auto mechanics are weak on automotive electricity, while 75% of car troubles come from this source. An amazingly few men are auto electrical experts. The field is wide open—thousands upon thousands of men are needed. It's the logical step ahead for mechanics. Everywhere, experts are wanted who can tell definitely what is wrong with the electrical systems of cars, trucks, and tractors, and can make the repairs properly and quickly. The Michigan State Automobile School now offers a special **Advanced Electrical Course.**

MICHIGAN STATE AUTOMOBILE SCHOOL

A. G. ZELLER, President

3704 Auto Bldg., 3729 Woodward Ave., Detroit, Mich.

The Factory Endorsed School

SEE OUR PAGE ADVERTISEMENT ON PAGES 75, 157, 185.

Mail Coupon To Day

MICHIGAN STATE AUTOMOBILE SCHOOL
3704 Auto Bldg. 3729 Woodward Ave.
Detroit, Michigan

Please send me your big illustrated catalog and special information on the **Advanced Electrical Course.**

Name.....

Street or R. F. D.....

City..... State.....

BOYS



Learn

ELECTRICITY

There is a wonderful opportunity right now for boys who like electricity. Boys who are ambitious and will train themselves in spare time can step into positions just as soon as they are ready. Good salaries are offered to start with splendid chances for rapid promotion.

For 30 years the International Correspondence Schools have been training boys for success in electricity and over three hundred other subjects. They will help you prepare right at home for a position in the line of electrical work you like best—or in any other work that appeals to you. Thousands of boys, through I. C. S. training, have stepped into fine jobs, but never were opportunities so great as now.

Let the I. C. S. help you. Choose the work you like best in the coupon below, then mark and mail it today. This doesn't obligate you in the least, and it will bring you information that may start you on a successful career. This is your chance. Don't let it slip by. Mark and mail this coupon now.

TEAR OUT HERE

INTERNATIONAL CORRESPONDENCE SCHOOLS
BOX 5622-C SCRANTON, PA.

Without cost or obligation please explain how I can qualify for the position, or in the subject before which I have marked an X:

- | | |
|--|--|
| <input type="checkbox"/> ELEC. ENGINEER | <input type="checkbox"/> BUSINESS MANAGEM'T |
| <input type="checkbox"/> Electric Lighting & Railways | <input type="checkbox"/> SALESMANSHIP |
| <input type="checkbox"/> Electric Wiring | <input type="checkbox"/> ADVERTISING |
| <input type="checkbox"/> Telegraph Engineer | <input type="checkbox"/> Show Card & Sign Ptg. |
| <input type="checkbox"/> Telephone Work | <input type="checkbox"/> Railroad Positions |
| <input type="checkbox"/> MECHANICAL ENGINEER | <input type="checkbox"/> ILLUSTRATING |
| <input type="checkbox"/> Mechanical Draftsman | <input type="checkbox"/> Cartooning |
| <input type="checkbox"/> Machine Shop Practice | <input type="checkbox"/> Private Secretary |
| <input type="checkbox"/> Toolmaker | <input type="checkbox"/> Business Correspondent |
| <input type="checkbox"/> Gas Engine Operating | <input type="checkbox"/> BOOKKEEPER |
| <input type="checkbox"/> CIVIL ENGINEER | <input type="checkbox"/> Stenographer & Typist |
| <input type="checkbox"/> Surveying and Mapping | <input type="checkbox"/> Certified Public Accountant |
| <input type="checkbox"/> MINE FOREMAN or ENGR | <input type="checkbox"/> TRAFFIC MANAGER |
| <input type="checkbox"/> STATIONARY ENGINEER | <input type="checkbox"/> Railway Accountant |
| <input type="checkbox"/> Marine Engineer | <input type="checkbox"/> Commercial Law |
| <input type="checkbox"/> ARCHITECT | <input type="checkbox"/> GOOD ENGLISH |
| <input type="checkbox"/> Contractor and Builder | <input type="checkbox"/> Common School Subjects |
| <input type="checkbox"/> Architectural Draftsman | <input type="checkbox"/> CIVIL SERVICE |
| <input type="checkbox"/> Concrete Builder | <input type="checkbox"/> Railway Mail Clerk |
| <input type="checkbox"/> Structural Engineer | <input type="checkbox"/> AUTOMOBILES |
| <input type="checkbox"/> PLUMBING & HEATING | <input type="checkbox"/> Mathematics |
| <input type="checkbox"/> Sheet Metal Worker | <input type="checkbox"/> Navigation |
| <input type="checkbox"/> Textile Overseer or Supt. | <input type="checkbox"/> AGRICULTURE <input type="checkbox"/> Spanish |
| <input type="checkbox"/> CHEMIST | <input type="checkbox"/> Poultry Raising <input type="checkbox"/> Banking |
| <input type="checkbox"/> Pharmacy | <input type="checkbox"/> Airplane Engines |

Name.....
Street and No.....

1-10-22

City.....State.....

Occupation.....

Persons residing in Canada should send this coupon to the International Correspondence Schools Canadian, Limited, Montreal, Canada.

Earn BIG MONEY as a Cartoonist

\$3000 to OVER \$100,000
A YEAR

now earned by successful cartoonists. Never before has the demand for cartoonists been so urgent or their earnings so great. Newspapers, Magazines, Advertising Agencies, Movie Industries—thousands of high-salaried opportunities are right now open to the new cartoonist in this fascinating field.



Learn At Home This Easy Way

YOU can now easily learn in your spare time at home to draw the comic strips, political cartoons, caricatures and animateds, which are in such big demand. No matter what your experience or education has been, this original method quickly teaches you to draw splendid salable cartoons.

Send for This **WONDERFUL**
FREE BOOKLET

Learn more about the amazing opportunities for you in this fast-growing uncrowded field. An intensely interesting booklet has just been prepared which is crammed full of valuable information about Cartooning—stories of the famous cartoonists, history of cartooning, details about every branch, a thorough explanation of the method which enables you to enter this field and thousands of other equally important facts. Sent without obligation upon request. **Write TODAY.**

WASHINGTON SCHOOL OF CARTOONING
Room 1028 Marden Building Washington, D. C.

Taxidermy Book FREE. **Stuff Beautiful Birds.** Learn by mail to stuff and mount

all kinds of birds, animals, fish and game heads, make rugs, tax skins. Mount your own specimens and make money preserving for others. Men, women and boys learn easily and quickly. Success guaranteed or no tuition. Write today for our wonderful FREE book "How to Learn to Mount Birds and Animals. N.W. School of Taxidermy, 1774 Elwood Bldg., Omaha, Neb.

Write Today.

HIS MARK!

Police departments, factories, banks, and industries everywhere are adopting the finger print method of identification.

BE A FINGER PRINT EXPERT

You can train yourself at home in spare time. Write for FREE reports telling of the uses of finger prints and how you can learn this profitable profession. Positions guaranteed.

U. S. SCHOOL OF FINGER PRINTS
ROOM 934, 7003 N. CLARK ST. CHICAGO, ILL.

Learn to be a Magician

"The Great Hermann" is a familiar figure to thousands of theater-goers. Baffling performances have delighted audiences from coast to coast. He now tells you how to do dozens of his tricks with cards, coins and handkerchiefs; 158 pages. Paper covers; 4¼ by 7¼ inches. Postpaid.....40c

SHREWSBURY PUBLISHING CO.
5525 West Lake Street Chicago, Ill.



ELECTRICAL Training Book FREE

Send me your name and address and I will send you my big new Electrical Training Book Free. It will show you how to qualify for high paying jobs in Electricity. Thousands now open. Prepare at home—quickly—during spare time under an Electrical Engineer. Take advantage of this unusual offer—only temporary.
A. W. WICKS, President WICKS ELECTRICAL INSTITUTE
Dept. 1194 3601 Michigan Ave. CHICAGO



Joseph S. Linnehan
Night Manager, Hotel Monterey
"Rose from clerk to Night Manager in a few short months."



Roy B. Eddleman
Room Clerk, Hotel Martinique
"Making Good Progress in Hotel Work."



F. L. Starrett
Manager Men's Hotel
"Heads Large Y. M. C. A. Hotel."



Fred Springing
Steward, Hotel Starline
"A Successful Young Man in His Chosen Profession."

HOTELS NEED HUNDREDS OF TRAINED MEN—NOW!

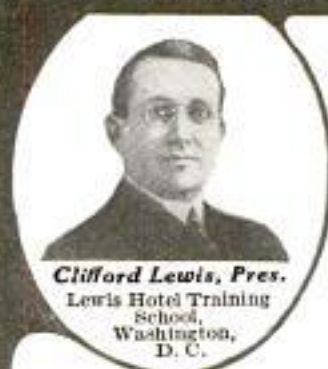

Clifford Lewis, Pres.
Lewis Hotel Training School, Washington, D. C.

PREFERS LEWIS STUDENTS

"I want another one of your students for a managership. At present I have two of your students, who are doing splendid work—one is managing my hotel at Storm Lake and one is manager of my Eatherville place."

Edward A. Boss, Prop.
Oelwein, Iowa.

DEMANDS PROPER TRAINING

"Please send me immediately one of your students to fill the position of assistant manager and chief clerk."

I would rather have a little less experience and plenty of courtesy and proper training than a self-sufficient, experienced one."

F. W. Bergman, Mgr.
The Lee House,
Washington.

Hundreds of Modern Hotels Now Building in the United States

Will You Accept One of These Big-Paying Positions in America's Fourth Largest Industry?

This fascinating business has expanded to America's **FOURTH LARGEST INDUSTRY**. Hundreds of big paying hotel positions now open, waiting for trained men. You can easily get one of these fine positions! No previous experience necessary!

MAKE \$2,500 TO \$10,000 A YEAR

The Lewis Hotel Training School is the only school of its kind in the world. It has qualified hundreds of men and women for \$2,500 to \$10,000 a year hotel jobs. Get into this delightful profession and earn from \$45 to \$125 a week—**living expenses are usually included**. You need no previous experience—you learn in your spare time at home. Many students have obtained hotel jobs paying them as high as \$2,500 a year, even before they had finished the course! You can do as well!

BIG PAY—FINE LIVING—FASCINATING WORK

All this may be yours if you fit yourself for the thousands of opportunities in AMERICA'S **FOURTH LARGEST INDUSTRY**. Hotel work offers many big advantages to trained executives. The work is easy, dignified and fascinating! The hours are excellent—you will find plenty of time for recreation. Just think of the pleasures that are yours as a member of the staff of a mountain or seaside resort! Bathing, fishing, sailing, long walks in the invigorating mountain or sea air—in fact, it is just like spending a delightful vacation—only you get well paid for it. The luxurious city hotel

offers equally attractive advantages—big salaries, free meals and apartment, fine environment, quick advancement and constant contact with people of influence and wealth.

I GUARANTEE TO TRAIN YOU

20 Weeks' training with the Lewis Course will qualify you for one of these attractive positions. **I GUARANTEE to teach you all that the leading hotel experts know about the business—men making \$5,000 to \$50,000 a year!** I give YOU the valuable knowledge that it has taken some of the most successful hotel men years to obtain—all your training under the personal direction of **CLIFFORD LEWIS**, a hotel expert of national reputation. Our students employed, our methods endorsed by the great hotels in the country who eagerly seek our graduates.

A few spare time hours a week given to the simple, clear lessons of the Course open the way to a good position, a fine living and a handsome salary. The training will in no way interfere with your present activities.

SEND FOR FREE BOOK

Mail the coupon NOW for our vitally interesting book, "YOUR BIG OPPORTUNITY." It tells about the wonderful opportunities now open to YOU in this fascinating profession. Shows exactly how you can quickly become a high-salaried hotel executive. Also tells of our students and their wonderful success with Lewis training. Life membership in our Employment Bureau FREE to all graduates. Illustrated book entirely free! Send for it today! Simply fill in the coupon below.

LEWIS HOTEL TRAINING SCHOOL

Founded 1916

Clifford Lewis, Pres.

Room 327

WASHINGTON, D. C.

OPPORTUNITY COUPON

LEWIS HOTEL TRAINING SCHOOL,
Room 327, Washington, D. C.

Please send me the free illustrated book entitled "Your Big Opportunities"; also details of FREE membership in your Employment Bureau.

NAME.....
(Please Print Name)

STREET.....

CITY..... STATE.....

LEARN RADIO FREE

Free concerts, news, auto topics broadcast

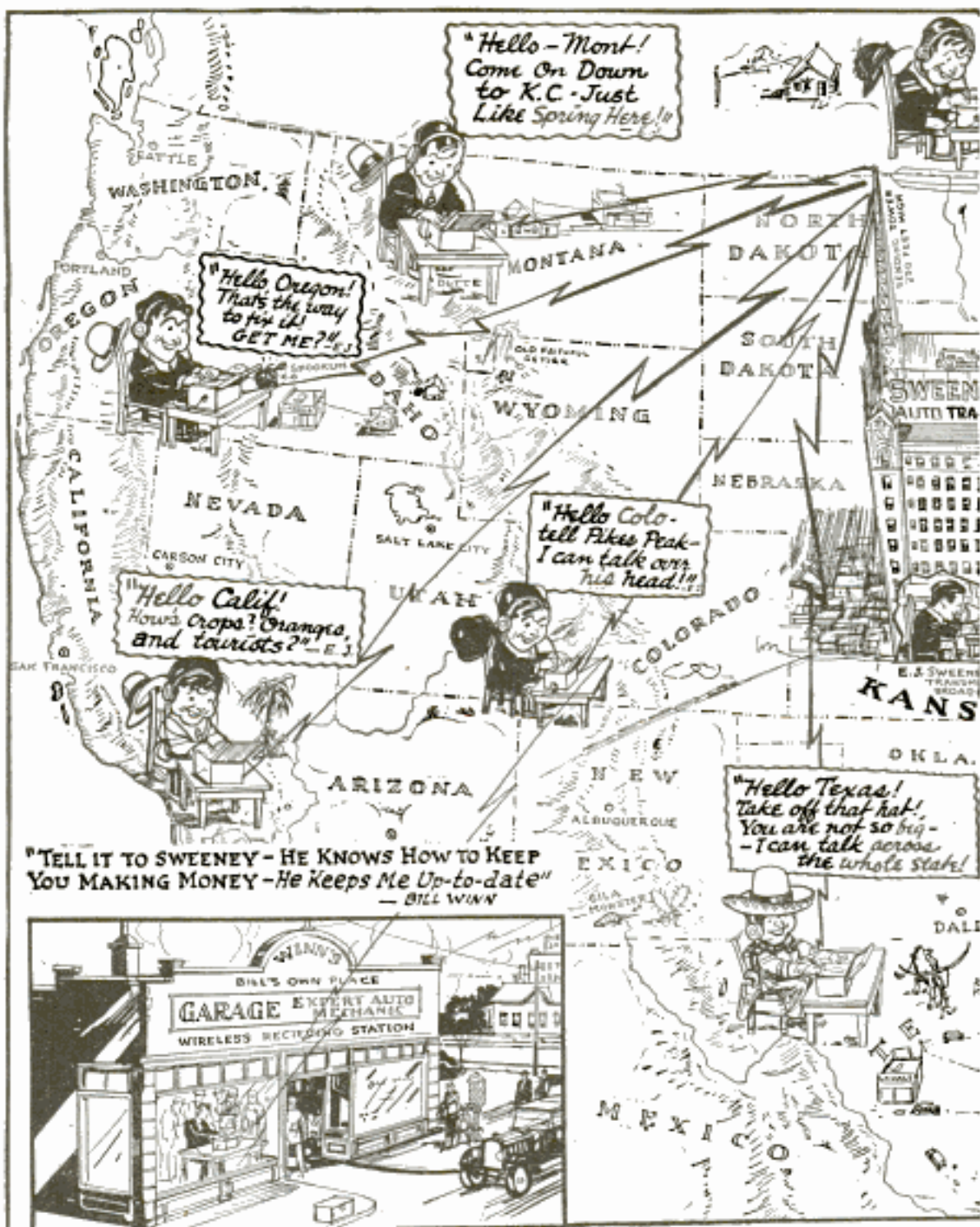

Come to the Sweeney Auto School and learn Radio work without a cent's extra charge. Receive messages—learn to build and install Radio sets—get agencies and sell sets—receive messages from all over the world—all this is now part of the regular eight weeks' course without advance in tuition.

The World is Radio Mad "Voices in the air" are the most amazing development of the century. Who is the right man to sell and install these simple receiving sets? The garage man or auto mechanic. These sets are cheap and easily made. Learn how to make them.

The Sweeney School is always the leader. That is why I am offering this great new development free.

SEE SWEENEY DOUBLE-PAGE SPREAD ON PAGES 78 AND 79

LEARN A TRADE
Sweeney
 SCHOOL OF AUTO-TRACTOR-AVTATION
 1008 SWEENEY BLDG. KANSAS CITY, MO.

AT SWEENEY SCHOOL

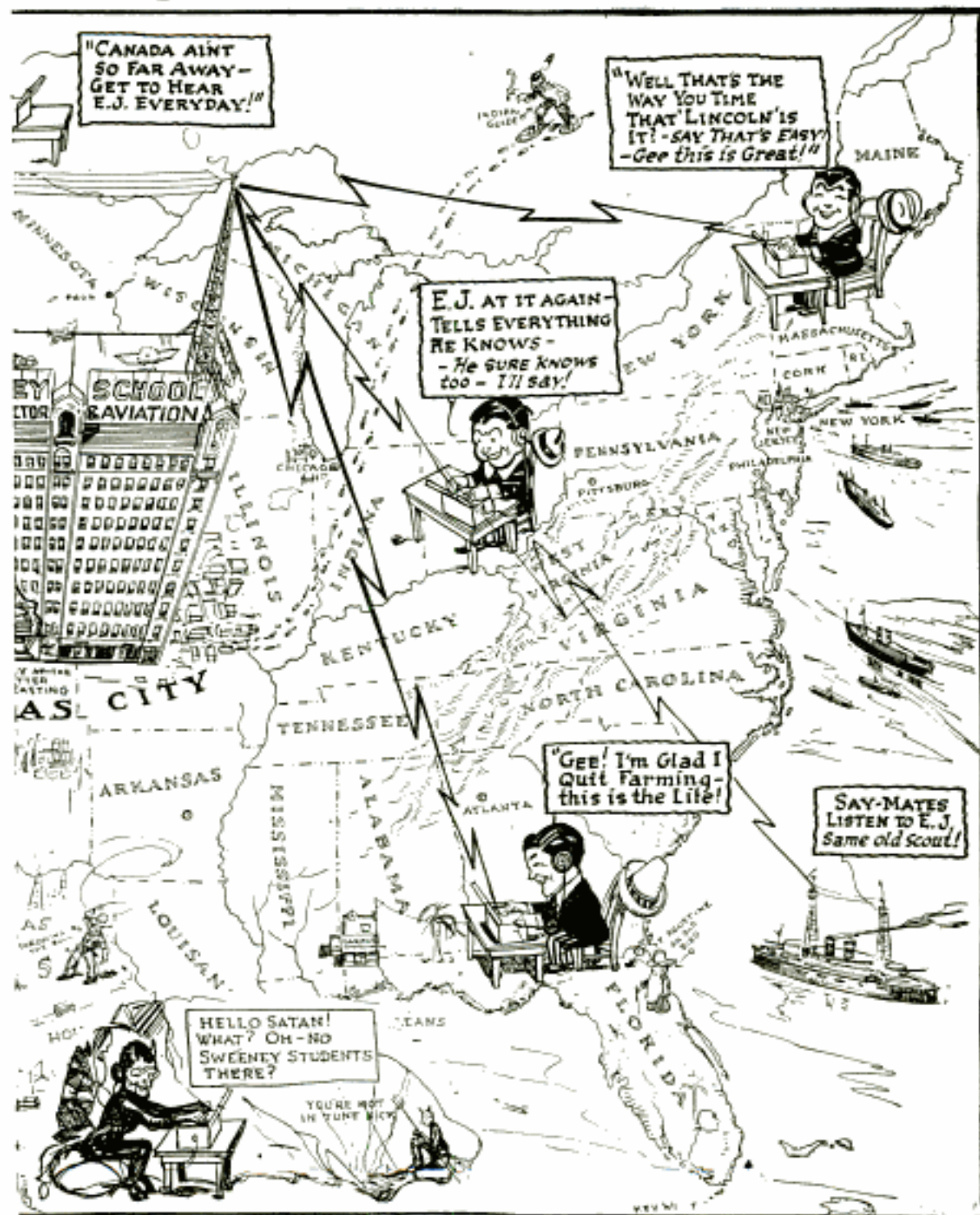

Talks to you anywhere in the United States

I am not offering a course to make commercial operators but with one of the greatest sending stations right here in the Sweeney building, with free instruction and practical experience in receiving messages and assembling sets, with famous experts in charge, a thousand new opportunities are open to you.

Sit here in the receiving room and hear New York and San Francisco talk, hear concerts, news, the mysterious voices in the air. Learn to make a set of your own.

FREE The first step is to send right now for my big 72-page catalog. Tells how men just like you prepared themselves for and got big paying mechanical jobs. Takes you thru the Million Dollar Trade School. Hundreds of photographs. Facts about your opportunity in the automotive business. Sweeney News tells all about the new Radio work and the free course. Simply send name today.

E. J. SWEENEY, President.

SEE SWEENEY DOUBLE-PAGE SPREAD ON PAGES 78 AND 79

Mail This Coupon

EMORY J. SWEENEY, President
1008 Sweeney Bldg., Kansas City, Mo.

Please send me free without any obligation on my part, your 72-page catalog and your Sweeney School News. Tell me of the opportunities in the Auto and Tractor Business.

Name

P. O.State



FREE

PROFESSIONAL TONE MUSICAL INSTRUMENTS

and lessons sent on **free** trial. Violin, Tenor Banjo, Hawaiian Guitar, Ukulele, Mandolin, Cornet, Banjo-Mandolin, Banjo-Ukulele, Guitar, Banjo-Guitar, or Banjo. Wonderful new copyrighted system of teaching note music by mail. Four lessons will teach you several pieces. Over 100,000 successful players. Do not miss this free trial offer. Write for booklet. No obligations.

SLINGERLAND SCHOOL OF MUSIC, INC., 1815 ORCHARD ST., DEPT. 104, CHICAGO, ILL.

READ THIS! ACT QUICK! MAKE MONEY MAKE SHOW CARDS & SIGNS



EARN \$10.00 to \$25.00 DAILY—salary, or have own shop and independence. Easy to learn by our new complete course with individual correspondence instruction. Course includes hand lettered show cards, and large assortment MILLERINE COLORS and BRUSHES FREE. Graduates established in paying sign shop, or good paying "Jobs" await them. **WRITE TODAY** for illustrated matter.

price and terms

Empire Pm Art Institute, Inc. 2050 Amsterdam Ave. New York City.

SURVEYING

Are you fond of outdoor work? Would you like to become a Civil Engineer? Then take up Surveying. It not only pays big salaries itself, but it is the stepping stone to something even better. You can learn at home. Write for particulars. International Correspondence Schools, Box 5630-C, Scranton, Pa.



HOME LOVERS' BARGAIN BOOK FREE

Showing Over 10,000 Furniture Bargains. All selections loaned free for a month. Take a year to pay it satisfied, paying little by little almost as you please. SPIEGEL, MAY, STERN CO., 1108 W. 35th St., Chicago



THROW YOUR VOICE

Under the table, down in the cellar, into a trunk or any old place. With our **VENTRILO** which fits into the mouth you can have lots of fun fooling your friends. Also full instructions in the art of Ventriloquism, and big book of jokes. Sent by mail for 10 cts. Stamps or coin.



AERIAL AIRSHIP

UP IT GOES!

Climbs in the air by its own power. The propeller spinning automatically at a lively rate. Floats around a

room or outdoors. Lots of fun. By mail 10c.



Invisible Ink



Letters written with this ink look like blank paper. Can be brought out plainly by heating over lamp or stove. Bottle in wooden box. 10 cents.

SKULL RING



The eyes in this ring are either Emeralds or Rubies and would scare the timid. Either Roman Gold or Oxidized Silver. 25c by mail.

WONDERFUL WIRELESS TELEGRAPH



Two instruments and 2 Codes in a box. Can Telegraph from room to room or house. Full instructions. By mail 12 cents.

All the Above by Mail for 50c.

STAMPS OR COIN

UNIVERSAL NOVELTY CO.

DEPARTMENT 206 STAMFORD, CONN.

**BE A
Railway Mail Clerk
\$1600 to \$2300
A YEAR**

Men—Boys—Over 17—should write at once

Rapid advancement. "No lay-offs." THE POSITION IS YOURS FOR LIFE. Common-sense education sufficient. Political influence NOT REQUIRED.

Write immediately for schedule showing the places and dates of ALL coming Government examinations. Do it to-day.

FRANKLIN INSTITUTE, Dept. B177, Rochester, N. Y.



Hundreds of Railway Mail Clerks Appointed Yearly

FRANKLIN INSTITUTE (The Pathway to Plenty) Dept. B177, Rochester, N. Y.

This coupon, filled out as directed, entitles the reader to free specimen questions; a free copy of our book, "Government Positions and How to Get Them"; a list of Government positions now obtainable, and to consideration for Free Coaching for the examination fees checked.

COUPON

.. Railway Mail Clerk (\$1600 to \$2300) .. Postoffice Carrier (\$1400 to \$1800)
.. Bookkeeper (\$1340 to \$1800) .. Rural Mail Carrier (\$1800 to \$2600)
.. Postoffice Clerk (\$1400 to \$1800) .. Customs Positions (\$1100 to \$2000)

Name..... Address.....
Use this before you lose it. Write plainly!

From Poverty To Riches



Walter Michael Barry

I STARTED WITH \$60 and built up a \$100,000.00 Business

When I resigned my U. S. Army commission on July 19, 1919, I discovered that I was dead broke. Uncle Sam handed me a bonus of \$60. I am now the head of a \$100,000.00 corporation and another \$25,000.00 corporation. I am going to make more money than ever and you can help me while learning the secret of my success.

I DON'T CARE WHO OR WHAT YOU ARE—you may be established in a business or profession; at school or college; at skilled or unskilled work—I can help MEN AND WOMEN to success, whether they retain their present vocations or apply themselves exclusively to the NEW OCCUPATIONS I can indicate to them.

Do you want to make big money in whole or spare time?

I can help you. No! I have not discovered a mysterious, unknown power; it is all so simple that any MAN, WOMAN, BOY OR GIRL who can read plain English will understand and appreciate it instantly. It does not require weeks of study.

Let me tell you, without obligation, the amazing story of my success and show you how my plan will benefit you.

WALTER MISHAEL BARRY

ECONOMY EDUCATOR CORP., (Dept. 6)
1664 BROADWAY, NEW YORK, N. Y.



SEND NO MONEY MAIL THIS COUPON or a Written Copy of Same

ECONOMY EDUCATOR CORP. (Dept. 6)
1664 Broadway, New York, N. Y.

Kindly send me Mr. Barry's story. Enclose copyrighted Economy Plan introducing 30 methods of making and saving money, personal efficiency secrets for business and social success, etc.

When the above is delivered to me I will hand the postman 65 cents to pay for preparing, postage, or save 15 cents P. O. fees by remitting 50 cents with this coupon, without further obligation. (No personal checks.) If your terms which accompany it are satisfactory, I will comply with same. I am to be the sole judge of this.

Name.....

Address.....

Whatever Your Question;—be it the pronunciation of Bolsheviki, the spelling of a puzzling word, the location of Murman Coast—the meaning of blighty, ace, tank, ukulele, etc., this Supreme Authority—

WEBSTER'S NEW INTERNATIONAL DICTIONARY

contains an accurate, final answer. 400,000 Words, 2700 Pages, 6000 Illustrations. Regular and India-Paper Editions. G. & C. MERRIAM CO., Springfield, Mass.

Write for specimen pages, prices, etc. and FREE Pocket Maps per Popular Mechanics



DRAW A BIG SALARY

as Mechanical or Architectural Draftsman

Why plod along at distasteful, hard and low-waged work, when we can qualify you in spare time at home to earn big pay in this easy, fascinating profession. Drafting is the language of construction—the open door to progress and success in

Address, Dept. 353

INDUSTRIAL CORRESPONDENCE

engineering and architecture. Latest, greatest, easiest course. Famous Foster System originated by our President, the founder of mail instruction, who has made thousands of draftsmen, engineers and architects out of clerks, mechanics and salesmen. Drawing Booklet and sample plates free.

UNIVERSITY, Inc.

1504 Locust Street, Philadelphia, Pa.

POWERFUL AIR RIFLE

Length 32 inches. Working parts of the best grades of steel. The stock is finely polished walnut. Shoots small game. Powerful, accurate, durable. You can have this air rifle for distributing only 2 of our fast selling art pictures at 25 cents on our special offer. Everybody will take one.

IT COSTS YOU NOTHING to try, as we take back those you can't dispose of.

Send no money. C. M. THOMAS, 337 W. MADISON ST. 3-D-93 CHICAGO.



GIVEN

Arthur Murray Invents New Easy Way to Learn to Dance—at Home—Quickly

Arthur Murray, America's greatest teacher of social dancing, has invented a remarkable new method which enables anyone to learn any of the newest ballroom steps at home in one short evening—at less cost and better than from a personal teacher. So simple, a child can learn quickly. No music or partner needed. 60,000 have learned to dance by mail. Your own success is guaranteed.



Arthur Murray
Instructor to the
Vanderbilts

Why Good Dancers are Popular

Everyone wants to meet and dance with an accomplished dancer. No longer need you be a wallflower. You can quickly and easily learn to be a really good dancer by the Arthur Murray method. Surprise your friends—learn to be a confident dancer soon.

For a short time only, Arthur Murray will send, in plain cover, a FREE dancing lesson including Secret of Leading, and How to Gain Confidence—to prove how readily you can learn. For mailing, send 10c today.

ARTHUR MURRAY SCHOOL OF DANCING STUDIO 172 290 Broadway, New York



Walter Camp's New Way to Keep Fit

Walter Camp, Yale's celebrated football coach, has been teaching men and women everywhere how to keep fit—"on edge"—full of bounding health and youthful vitality—and how to enjoy doing it. Walter Camp says that a civilized, indoor man is a "captive animal," just as much as a tiger in a cage. But the tiger instinctively knows how to take the kind of exercise he needs to keep fit—he stretches, turns and twists his "trunk muscles"—the very same muscles that tend to become weak and flabby in indoor men and women. With Mr. Camp's permission the "Daily Dozen" exercises have now been set to spirited music on phonograph records. They supply exactly the right movements to put these vitally important "trunk muscles" into the pink of condition, and keep them there. These twelve remarkable exercises, done to music, with a voice on the record calling out the commands, are all you need to keep your whole body in splendid condition—and they take only 10 minutes a day. You will also receive a set of handsome charts, with actual photographs showing exactly the move to make at each command. It is simple as A-B-C.

RECORD FREE

See for yourself what Walter Camp's "Daily Dozen" combined with the Health Builder System will do for you—without a dollar of expense. We will send you, *entirely free*, a sample phonograph record carrying two of the special movements, with a voice giving the directions and commands, and specially selected music to exercise to. Also a *free chart* showing positions, with complete directions. Get this free record, put it on a phonograph, and try it. There is no obligation—the record is yours to keep. Just enclose a quarter (or 25 cents in stamps) with the coupon to cover postage, packing, etc. Send coupon—today—now—to Health Builders, Dept. 294, Oyster Bay, New York.

FREE SAMPLE RECORD AND CHART



directions for doing the exercises. I enclose a quarter (or 25 cents in stamps) for postage, packing, etc. This does not obligate me in any way whatever and the sample record and chart are mine to keep.

Name.....
(Please Write Plainly)

Address.....

HEALTH BUILDERS

Dept. 294, Oyster Bay, N. Y.

Please send me your free sample "Health Builder" record giving two of Walter Camp's famous "Daily Dozen" exercises, also a free chart containing actual photographs and simple directions



NAVIGATION TAUGHT BY MAIL

Hundreds of Ship Officers needed in Merchant Marine and Navy. Salaries up to \$412 monthly and living expenses. You can qualify through Captain Warren Sheppard's Home Study Course on Navigation. Chance of a lifetime to see the world as a ship's officer at a big salary. Write for free Book, "Your Future is on the Seven Seas."

World Technical Institute, Dept. 100A, Fuller Building, Jersey City, N. J.

PRACTICAL ELECTRICAL EDUCATION—

In 6 MONTHS. We teach by scientific and original methods the theory and practice of **Electric Light Wiring, Testing, Meter Work, A. C. and D. C. Armature Winding, Transformer, Motor, Generator Repair and Maintenance.** No matter what your education, we guarantee to train you until competent and assist you to secure **profitable employment.** Hundreds of successful graduates and satisfied employers. Write for new ill. Book. Absolutely **FREE** to the earnest knowledge seeker.

SCHOOL OF PRACTICAL ELECTRICITY
P. M. 4, 415 Marshall Street Milwaukee, Wis.

SCENARIO WRITERS

BIG MONEY can be made through the method outlined in our "Key to Successful Scenario Writing." Send \$2 today.

AM. INST. OF CINEMATOGRAPHY, INC.
STEINWAY HALL BLDG. CHICAGO



You can Ukulele!

You can easily play quaint, dreamy Hawaiian music or latest songs on the Ukulele. Prof. Harry J. Clarke's latest method enables you how to play the Ukulele in a few weeks. We give you a genuine Ukulele absolutely **FREE** with complete home course of *Lessons*. Write at once for **FREE** narrative of Hawaiian music and offer. No obligation! Send now!

The Hawaiian Institute of Music, 308 W. 34th Street, Dept. 2A, New York City

FREE MOTOR with simplified course in electricity.
S & H Electrical Works
Dept. D 1, 308 So. Green St., Chicago

Learn Drafting

Individual study at home may be successfully engaged in with the aid of our new enlarged book
A Practical Course in Mechanical Drawing

Cloth. 160 Pages. 157 Drawings. Price, 50c Postpaid.
POPULAR MECHANICS BOOK DEPT., 78 East Madison St., CHICAGO

DYKE'S AUTOMOBILE ENCYCLOPEDIA

Will Teach You How to Become:

- (1) An Automobile Repairman.
- (2) Engine Expert.
- (3) Electric Trouble Shooter.
- (4) Ignition Expert.
- (5) Tire Repair Expert.
- (6) Storage Battery Expert.
- (7) Carburetor Expert.
- (8) Tractor Expert.
- (9) Truck Expert.
- (10) Operator and Radiator Repairman.

968 Pages, 6 1/2 x 9 1/4 in.
3,362 Illus.

Price Prepaid. Cloth, \$8.40
American Morocco, \$7.96

POPULAR MECHANICS BOOK DEPT.
8, N. Michigan Ave., Chicago



Piano
Organ
Violin
Cornet
Guitar
Banjo
Mandolin
Harp
Drums and
Traps
Hawaiian
Steel Guitar
Voice and Speech
Culture



'Cello
Trombone
Flute
Clarinet
Piccolo
Ukulele
Sight
Singing
Harmony
and
Composition
Tenor Banjo
Automatic Finger
Control

Learn Music at Home

Music no longer difficult! New plan makes it easy to learn by home study. Positively easier than with private teacher. Faster progress. You will be able to play your favorite instrument in a few short months. Read the letters in our free book. More than 250,000 men, women and children have learned by our method. You, too, can learn. Write for particulars.

Amazing Offer We want to have one pupil in each locality at once to help advertise our home study method. For a short time, therefore, we offer our marvelous lessons at practically no cost, amounting merely to about the cost of sheet music, postage, etc. Beginners or advanced pupils.

Mail the Coupon NOW

Mail coupon or postal for free book, telling how we teach by mail. Act quick, while offer of free lessons is open. Write today—NOW. Instruments Supplied when needed, cash or credit. Please write name and address plainly.

U. S. School of Music
74 Brunswick Bldg. New York City

U. S. School of Music

74 Brunswick Building New York

Please send me your free book, "Music Lessons in Your Own Home," and particulars of your Special Offer. I am interested in the following course.

(Name of Instrument or Course)

Name..... Please Write Plainly

Address.....

City..... State.....

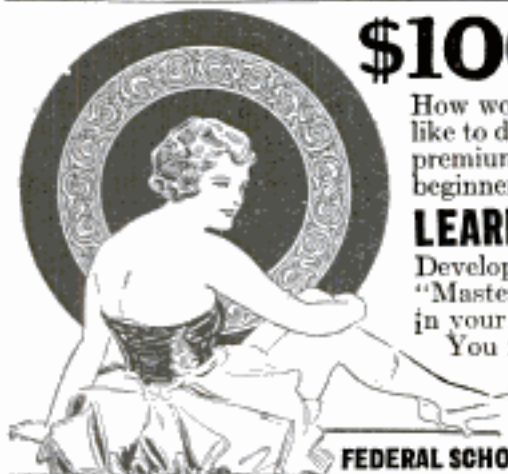

\$100 a WEEK for DRAWING

How would you like to make \$100 a week as a commercial artist? If you like to draw, you are indeed fortunate—well-trained artists are always at a premium. They readily earn \$75, \$100, \$150 a week, and even more, and beginners with practical ability soon command \$50 a week.

LEARN QUICKLY AT HOME IN YOUR SPARE TIME

Develop your talent—put your natural ability to its best use. The Federal "Master" Course, endorsed by high authorities, teaches you by mail in your spare time. No experience needed, each step is clearly explained.

You receive individual personal criticisms on all your lessons.

Send for "Your Future," a splendid book showing work of Federal Students, telling all about this remarkable course, and pointing out opportunities that will surprise you. If you are in earnest and 16 years old or more, write today for this free book, kindly stating your age.

FEDERAL SCHOOL OF COMMERCIAL DESIGNING, 675 Federal Schools Bldg., Minneapolis, Minn.

\$95 to \$135 a Month

Men—boys—over 17—should write at once
Rapid advancement. "No Lay-offs." THE POSITION IS YOURS FOR LIFE.

Common-sense education sufficient. Political influence NOT REQUIRED.

Write immediately for schedule showing the places and dates of ALL COMING Government examinations. Don't delay.

FRANKLIN INSTITUTE, Dept. B178, Rochester, N. Y.

WANTED!



MAIL CLERKS

Franklin Institute, (The Pathway to Plenty), Dept. B178, Rochester, N.Y.

This coupon, filled out as directed, entitles the sender to free specimen questions, a free copy of our book, "Government Positions and How to Get Them," a list of Government positions now open, and to consideration for Free Coaching for the examination here checked.

COUPON

.. Railway Mail Clerk [\$1600-\$2300] .. Postoffice Carrier [\$1400-\$1800]
.. Bookkeeper [\$1340-\$1800] .. Rural Mail Carrier [\$1800-\$2600]
.. Postoffice Clerk [\$1400-\$1800] .. Customs Positions [\$1100-\$2000]

Name

Address

Use this before you lose it. Write plainly.

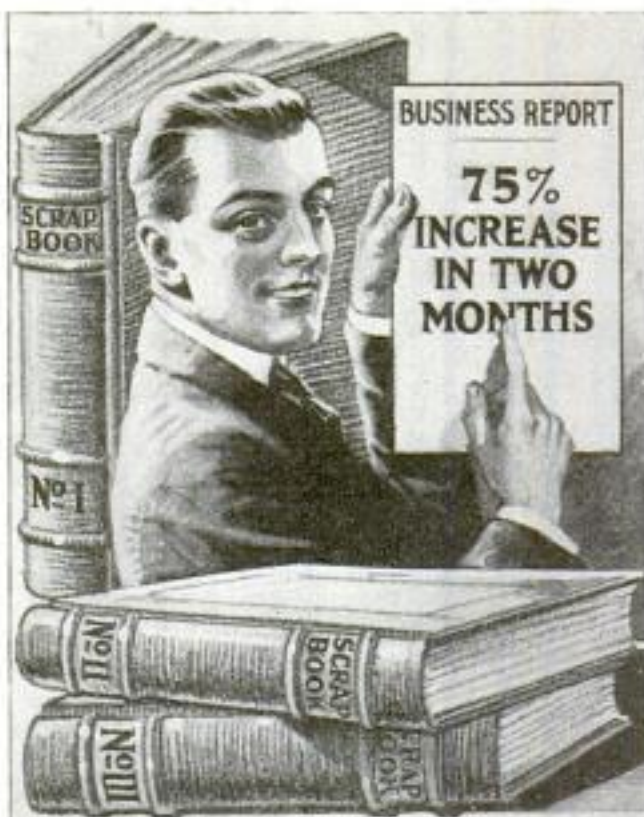

A New Jersey student writes: "I have purchased a business and by the use of methods explained in my course have increased the business 75 per cent in two months." This is just one extract from

Three Big Scrap-Books

filled with appreciative, interesting letters from young men throughout the United States—all received recently. They show a national recognition of the unique features of the United Y. M. C. A. Courses and correspondence-teaching methods.

"You bring out a man's resourcefulness."—California student. "I like your personal service."—Missouri student. "You take an interest in each student individually."—Connecticut student. "You remind me of a great brother—always ready to lend a helping hand."—Another Connecticut student. "Too much cannot be said for Y. M. C. A. instruction service."—Illinois student. "What I have learned from the poultry course pays in dollars and cents."—Iowa student. "Course insures thorough training. Am able to use the instruction in my regular work."—Ohio student. "Don't know how I can ever pay the good old Y and its corps of officials and teachers."—Vermont student. "You seem to read every single word of my answers and even catch my pen-errors."—Massachusetts student. "Course did me more good than the course I took in college."—N. Carolina student. "If a man intends to do anything at all, your system will bring it out."—Texas student. "My course has not only brought more interesting work but multiplied my earning power by three."—Nebraska student.

Let us give you the "Six Reasons" why these ambitious young men and thousands of others have selected the United Y. M. C. A. Schools to guide them in their preparations for greater personal development, more responsibility, more congenial work or better-paying work. Our friendly counsel is free.

UNITED Y. M. C. A. SCHOOLS
Dept. 2-A, 375 Lexington Avenue,
New York City

I am interested in United Y. M. C. A. Schools' service. Please give me free counsel as to the position or home-study course I have marked.

- | | | |
|------------------------|-----------------------|------------------------|
| —Accountant | —Dairy Farming | —Poultry Husbandry |
| —Advertising Man | —Druggist | —Radio Operator |
| —Agricultural Courses | —Electrician | —Radio Engineer |
| —Architect | —Electrical Engineer | —Railroad Engineering |
| —Auto Mechanic | —English Courses | —Salesman |
| —Banking | —Factory Management | —Secretarial |
| —Better Letters | —Farm Management | —Short-hand and |
| —Bookkeeper | —Farm Motor Mechanics | —Typewriting |
| —Building Construction | —Foreign Languages | —Steam Engineer |
| —Business English | —Foremanship | —Structural Drafting |
| —Business Law | —Highway Engineering | —Surveyor |
| —Business Organization | —Locomotive Operator | —Tool Designing |
| —Civil Engineer | —Machine-Rip Practice | —Traffic Management |
| —Civil Service | —Mechanical Engineer | —Use of the Slide Rule |
| —Complete Engineer | —Printer | |

Are you an essential man?.....

Name and Occupation.....
Please Write Plainly
Complete Address.....

Please Mention Popular Mechanics

IN THE ELECTRICAL INDUSTRY

THE MAN WHO KNOWS IS THE MAN WITH THE JOB

Think this over then

Write to The Burgess Company, 744 E. 42nd St., Chicago, Ill., for their Training Book, P-4, which gives full particulars of the best Home Study Course in Electricity and how men can obtain and hold good positions. If you MUST know more about ELECTRICITY, write

TODAY

BURGESS ELECTRICAL SCHOOL
744 E. 42nd Street Dept. P-4 Chicago, Ill.
Canadian Branch:
201 Crawford St., Toronto, Can.



"BECOME A LIGHTNING TRICK CARTOONIST"

MAKE MONEY CHALK TALKING. SEND \$1.00 FOR SHARPEL DODD'S TRICK DRAWINGS WITH INSTRUCTIONS BY A PROFESSIONAL CARTOONIST. SATISFACTORY GUARANTEED. CIRCULAR FREE. BALDA ART SERVICE, 21, OSHKOSH, WIS.

TRI STATE COLLEGE OF ENGINEERING

Makes you a Civil, Mechanical, Electrical or Chemical Engineer in two years, 48 weeks each. No entrance examinations. High School Diploma not required. Compact courses made up of essentials only. Expenses low. For catalog address

100 "M" STREET, ANGOLA, IND.



Wrestling Book FREE

Be an expert wrestler. Learn at home by mail. Wonderful lessons prepared by world's champions Farmer Burns and Frank Gutch. Free Book tells you how. Secret holds, blocks and tricks revealed. Don't delay. Be strong, healthy. Handle big men with ease. Write for free book. State your age. Farmer Burns, 1774 Range Building, Omaha, Neb.

Gibson Instruments

Mandolin, Mandola, Mando-Cello, Guitar, Tenor-Banjo, Mandolin-Banjo, Cello-Banjo, Guitar-Banjo, Harp-Guitar, Mando-Bass —



Easy to Play
Easy to Pay

Select your Gibson now. You can soon be playing the music of the day. Your friends will be surprised and delightfully entertained. Let us help you organize a Gibson Orchestra in your community. You can increase your popularity, income and pleasure by playing for Concerts, Entertainments, Church Affairs, etc. A small down payment and then \$4 a month will soon pay for a Gibson and will furnish you with wholesale, year-round entertainment. If you have an old instrument, we will make liberal allowance on a Gibson. Write for Free Book, Catalog, Free Trial Offer, information about Wm. P. Rose, Jr. Book and instrument you prefer.

GIBSON MANDOLIN-GUITAR COMPANY
1164 Parsons Street Kalamazoo, Mich., U. S. A.

The Wireless Pioneers of Today Are the Leaders of Tomorrow

THE amazing expansion of Wireless astonishes the World—Wonderful opportunities are opening up every day on land and sea. Here is your chance to get in on the "ground floor" of a profitable profession, in your spare time, and enjoy the interesting study of this new means of communication.

Up to \$10,000 a Year Is Earned by Many Men

The fascinating profession of Wireless is calling on you to share in its gigantic future—the field is wide—hundreds of big pay positions are waiting—waiting for more men—more men like you!

Start now—be a pioneer in Wireless—tomorrow you will have a job that will allow you to save more money than you can earn ordinarily in a single year! Every vessel on the sea must have from one to five operators. Openings are constantly available to operators, salesmen, mechanics, executives, engineers, in the land station areas—in a few years you can work yourself up to the \$10,000 a year class, where every man hopes to land but few ever get there!

Get Your Instruction From the Largest School

The National Radio Institute was the first school of its kind to teach Wireless by mail. Today it is the largest in America. Situated in Washington, the heart of our country's Radio activity, we keep constantly in touch with the newest developments in the science of Wireless. The Institute is close by the Bureau of Standards where the latest wireless inventions are tested and perfected, it is near the Department of Commerce where Government examinations are made up and held. Two of the largest Radio stations in the world, Annapolis and Arlington, are only a few miles away!

The National Radio Institute is officially recognized by the Department of Commerce, and at Government examinations its diploma is credited with ten points in the student's favor—The U. S. Shipping Board heads its list of recommended Schools with the National Radio Institute. Every employer of Radio operators knows the class of students we turn out, and looks to us as the best source for competent operators to fill the places they have open.

Already more than 8,000 students have taken up their life's work through the instruction received from us, our graduates are holding important positions all over the world.

You, too, can fit yourself to fill one of these fine jobs by allowing us to train you in your spare time at home!

A Complete Course in Wireless

No matter what field of wireless you are interested in, the National Radio Course is for you. If you have just purchased a wireless receiving set and want to learn more about it—if you have an amateur license and want to get a First Class Commercial License so you can hold the Big Jobs—if you are tired of listening to music only and want to "Listen in" on code messages—if you are a beginner and want to know wireless from the ground up—you need the **National Radio Course**, because this is the one course that teaches **EVERYTHING**.

We keep our instruction right up-to-date, and include the latest developments in wireless knowledge. You not only learn how to send and receive code messages as fast as any expert, but you also learn how to build wireless apparatus, how to install it, maintain it, operate it; how to keep it in repair. The one course teaches the two big branches of Radio—Wireless Telegraphy, the wireless of dots and dashes, and Wireless Telephony, the wireless of the voice. You learn the use of the Radio Compass, the latest and most important invention in this wonderful field. You learn the duties of an operator, an executive, a mechanic, a salesman of Radio equipment—in fact everything you want to know about wireless can be found in this one, all-comprehensive Course.

Mail Coupon for Free Book

It makes no difference how little you know about wireless, or whether you are a man or a woman, you can train yourself for a splendid position. If you have had a common school education or better, you can easily learn wireless in your spare time at home through our wonderful Automatic Self-Instruction Method.

It costs nothing to get our interesting illustrated booklet, "Wireless, the Opportunity of Today," Send for this booklet and full facts about the National Radio Institute and its complete course today. Fill out and mail the coupon at once. But please do not waste your time

if you are not genuinely interested. Our book is not for triflers, but for serious minded men and young men.

NATIONAL RADIO INSTITUTE

Radio Headquarters

Dept. 1047 1345 Pennsylvania Ave., N. W. Washington, D. C.

NATIONAL RADIO INSTITUTE,
RADIO HEADQUARTERS
Dept. 1047, 1345 Pennsylvania Ave., N. W.,
Washington, D. C.

Send me your FREE book, "Wireless, the Opportunity of Today," which explains your Home Study Course in Wireless Telegraphy and Wireless Telephony. I am truly interested!

Name.....

Address.....

City..... State.....

We Want to Hear from Men Who Mean Business!

The chief purpose of the National Radio Institute is to prepare men to take up Radio Work in a Commercial Way and to help those already interested as Amateurs to realize their ambition to become expert on the subject—

The opportunity for competent Radio Operators with practical training is unlimited—

But there is no room in the Wireless Field for men who do not want to succeed—

A Wireless Operator holds an important position—he is no mere employee—but an expert whom trained by us, who is responsible for every message he receives and every message he sends—thousands look to him for the knowledge his training conveys to them—so it takes a man who wants to be somebody—a man with sufficient intelligence to realize that he is head and shoulders above the ordinary professions that crowd on every side!

Plenty of people write us about instruction who think that with a week's study they can become proficient—

We do not want anyone to get that idea—It takes four to six months to master the subject—

No mere curiosity seeker or interested person who just thinks he wants to be a Radio Operator should apply for information—If you mean business—if you want to get out of the rye!

If you are tired of doing things that thousands of other men can do as well as you, for less money—

If you are dissatisfied with labor conditions, strikes, lockouts, shut-downs, unemployment—here's your chance to enter a field where such things are practically unknown! But bear in mind—**WE WANT MEN WHO ARE FIRED WITH AMBITION AND WANT TO PUSH AHEAD OF THE COMMON CROWD!**

These are the kind of students that command good salaries and quick promotion—**WHAT KIND OF A MAN ARE YOU?** (Signed) E. R. Hoop.

Director.



Study Law

Win for Yourself a Real Career!

Would you be independent, command a substantial income and an opportunity for public service that will make you an influential figure in your own community?

The one profession above all others that brings to those who make good not merely wealth but also prominence and public leadership, is—LAW. Successful law-trained men—both in business and in active practice—are today earning from \$10,000 to \$50,000 a year. For the *ablest* minds in this great profession, there is practically no income-limit.

Train at Home by the Problem Method

Start today toward this wonderful goal. Right in your own home, under the LaSalle Problem Method, you can study the same cases you would read at the resident universities, master the fundamental principles set forth by some of the most eminent authorities in the profession.

LaSalle text-books, "lesson talks," lectures, quizzes and examinations have been prepared by leading members of the American bar—prominent practitioners, judges, law professors in the great universities. You graduate with the degree of LL. B.—prepared for independent practice or for a responsible position with one of the big corporations.

Send today for definite information regarding the unusual opportunities in law, together with letters showing just how scores of LaSalle-trained men are cashing in on home-study training. With this data we will send you particulars of our *convenient-payment plan*; also your free copy of "Ten Years' Promotion in One." Mail the coupon.

LaSalle Extension University

The Largest Business Training Institution in the World
Dept. 464-LR Chicago, Illinois

Please send me catalog and full information regarding the course and service I have marked with an X below. Also a copy of your book, "Ten Years' Promotion in One."

LAW, Degree of LL. B.

LaSalle is the largest business training institution in the world. It offers training for every important business need. If more interested in any of these courses, check here:

- | | |
|--|--|
| <input type="checkbox"/> Business Management | <input type="checkbox"/> Banking and Finance |
| <input type="checkbox"/> Salesmanship | <input type="checkbox"/> Modern Foremanship and Production Methods |
| <input type="checkbox"/> Higher Accountancy | <input type="checkbox"/> Personnel and Employment Management |
| <input type="checkbox"/> Traffic Management | <input type="checkbox"/> Expert Bookkeeping |
| <input type="checkbox"/> Railway Accounting and Station Management | <input type="checkbox"/> Business English |
| <input type="checkbox"/> Commercial Law | <input type="checkbox"/> Commercial Spanish |
| <input type="checkbox"/> Industrial Management Efficiency | <input type="checkbox"/> Effective Speaking |
| <input type="checkbox"/> Modern Business Correspondence and Practice | <input type="checkbox"/> C. P. A. Coaching |

Name.....

Present Position.....

Address.....

Please Mention Popular Mechanics

LEARN BY DOING

Every phase of all branches of

ELECTRICITY

Taught by Actual Practice

In America's foremost and oldest institution for trade training.

No Books Used
Individual Instruction
Start Any Day

A SPECIAL and SEPARATE Course in Ignition, Auto Lighting and STARTER Systems. Write for FREE 64-page catalog.

THE
NEW YORK ELECTRICAL SCHOOL
44 West 17th Street NEW YORK CITY

LEARN The BUSINESS of Advertising



QUICKLY BY MAIL

We guarantee to teach you. It's *easy* to learn—and easy to get into! Make the start *this week*. This free book tells how.

\$75 to \$100 a Week

—frequently paid beginners. There is *no limit* to opportunities which men and women trained in advertising meet on every hand.

FREE This interesting book on advertising is sent free. Tells just the things you want to know about getting into this fascinating field. Full of *facts*.

PAGE-DAVIS SCHOOL, Dept. A16, Page Bldg., Chicago

MECHANICAL DRAWING

Practicing Engineer, Experienced Draftsman and Teacher Will Train You for High Class Position.

High salaries paid Mechanical Draftsmen. Learn by doing practical work at home under personal instruction of expert. Thoro, up-to-date courses by mail. PREPARE NOW FOR BIGGER INCOME. Complete draftsman's outfit included with course.

UNIVERSAL CORRESPONDENCE SCHOOLS
519 New York Life Bldg., Minneapolis, Minn.

Send me without obligation free book on draftsmanship and information concerning course marked below.

- | | |
|---|--|
| <input type="checkbox"/> Mechanical Drawing | <input type="checkbox"/> Architectural Drafting |
| <input type="checkbox"/> Machine Drafting | <input type="checkbox"/> Blueprint Reading and Cost |
| <input type="checkbox"/> Structural Drafting | <input type="checkbox"/> Estimating for Builders and Tradesmen |
| <input type="checkbox"/> Topographical Drafting | <input type="checkbox"/> Shop Mathematics |
| <input type="checkbox"/> Reinforced Concrete Drafting | |

Name.....

Address.....

YOU CAN MAKE \$35 to \$100 a WEEK as a "TROUBLE WIZARD"



**We teach YOU
how - in from
6 to 8 weeks in
Washington, the
Nation's Capital**

equipment to give you an opportunity to work on the ignition, carburetor, transmission and timing systems of all the popular makes of cars. You know them—you learn them all not merely by reading or hearing the teacher talk but by repairing them yourself under his personal direction. This one big feature of the American Motor Schools training will quickly help you to a better job in the Auto business than you can get thru any other training.

You Need Not Pay a Cent

until you, yourself, have come down here to Washington and have

YOUR ambition is to become a "trouble wizard" in this great auto repair game—well able to hold down a job or work for yourself anywhere in the country, at \$35 to \$100 a week. All you need is 6 to 8 weeks' TRAINING down here in Washington under the wing of Ed Cooley, our Chief Instructor. Think of it! Only 6 to 8 weeks and you begin drawing big money and building up a "rep" as the "trouble wizard" of your town and paving the way for a future business of your own. But don't choke your ambition by waiting around for something to turn up.

Come Down to Washington— The Nation's Capital

See our new \$250,000 School Building. Make a thorough investigation of our equipment and methods. Watch our students at work.

The big difference between the American Motor Schools and the usual "theory" school might be summed up like this:

The courses you get at the American Motor Schools are not a lot of "talk" about carburetors, magnetos, gears and so forth. No siree. You get into your overalls, down on your hands and knees and take "knocks" and "groans" and other troubles right out of real engines. You don't spend your time on one old "trial horse" motor but on dozens of different standard motors—just as they do in a repair garage.

The American Motor Schools has the complete

conducted a thorough investigation of our method. You can even write your Senator or Congressman about us if you want to.

We have room for a thousand new students. We want these students to talk about us and recommend our School. As a result—we are still offering, but not for long, a rebate of \$50, enough to pay your fare to Washington and leave plenty over to help defray your expense. If you come down NOW, you can save \$50. Write tonight for our Registration Blank.

You know mighty well what the opportunities are in the Auto repair game. Trained mechanics are wanted bad in every town from coast to coast. And you know that this School gives you a thorough practical training in 6 to 8 weeks. The only thing left for you to do now is to CLIP THIS COUPON and send it in. We'll send you complete information by return mail.

AMERICAN MOTOR SCHOOLS, Inc.
Dept. 233 Washington, D. C.

American Motor Schools, Inc.
Dept. 233, 1612-22 U St., N. W.
Washington, D. C.

Without cost or obligation, please send catalogue of information on your Automobile Mechanics Course.

Name.....

Address.....

City.....

State..... Age





\$500 REWARD for TWO HOURS WORK

It was in answer to a request from the Chief of Police that Warren Biglow, the Finger Print Expert, arrived at the scene of the daring robbery of the T—O— Company offices. The job was undoubtedly the work of skilled cracksmen and robbers of uncommon nerve. \$6,500 in currency—the company payroll—was gone. Not a single apparent clue had been found by the police. Almost immediately after his arrival Biglow turned his attention to a heavy table which had been tipped up on its side. Examination of the glossy mahogany showed an excellent set of finger prints. The thief might just as well have left his calling card. To make a long story short, his prints were photographed and taken to Central Office, where they were matched with those of "Big Joe" Moran, a safe blower well known to the police. Moran was subsequently caught and convicted on Biglow's testimony and finger-print proof. Most of the money was recovered. In the meantime the T—O— Company had offered a \$500 reward, which was given to Biglow—his pay for two hour's work.

Be a Finger Print Expert — Learn at Home in Spare Time

Could you imagine more fascinating work than this? Often life and death depend upon the decisions of finger-print evidence—and big rewards go to the EXPERT. Thousands of trained men are now needed in this great field. The fingerprint work of governments, corporations, police departments, detective agencies and individuals has created a new profession. Many experts regularly earn from \$3000 to \$10,000 a year in this fascinating game. And now you can easily learn the secrets of this new science in your spare time—at home. Any man with common school education and average ability can become a Finger Print Expert in a surprisingly short time.

FREE Finger-Print Outfit and Large Illustrated Book!

For a limited time we are making a special offer of a complete Professional Finger Print outfit, absolutely free and also a Free Course in Secret Service Intelligence. Mastery of these two kindred professions will open a brilliant career for you. Write quickly for fully illustrated free book on Finger Prints which explains this wonderful training in detail. Don't wait until this offer has expired—mail the coupon now. You may never see this announcement again! Address

University of Applied Science

Dept. 1354, 1920 Sunnyside Ave., Chicago

University of Applied Science, Dept. 1354, 1920 Sunnyside Ave., Chicago

Gentlemen: Without any obligation whatever send me your new, fully illustrated, FREE book on Finger Prints and your offer of a free course in Secret Service Intelligence.

Name.....Age.....

Address.....

Town.....State.....

Please Mention Popular Mechanics

MECHANICS!



This Book has Raised Many a man's SALARY

MACHINISTS, tool makers, pattern makers, engineers, firemen, railroad men—ALL mechanics, office men and salesmen handling mechanical matters need the I. C. S. Mechanics' Handbook. A few of the subjects treated are:

Weights and Measures; easily understood Mathematics. Formulas. Mensuration. Belt-ing; Hydro-mechanics. Strength of Materials. Boiler Design; Care and Inspection of Boilers; Horsepower of Boilers; Chimneys Exhaust Heating; Machine Design; Horsepower of Engines, Benders and Pumps. The Slide Valve; Belt Pulleys; Rope Belting; Cylinders and Steam Chests. Electricity. Currents; Wiring; Dynamos and Motors; Batteries; Cable Testing. Compass Surveying; Curves; Leveling; Calculation of Earthwork, Trackwork, etc.

Just mail this advertisement with a dollar bill and your name and address and this 330-page Mechanics' Handbook will come to you by return mail. You run no risk! Money back if desired!

INTERNATIONAL CORRESPONDENCE SCHOOLS
Box 5618-C, Scranton, Penna.

Only \$1

330 pages
174 illustrations

WRITE NOW FOR Dyke's FREE Booklet

AN NEW IDEA OF TEACHING BY MAIL tells how you can learn at home—spare time—and Become an Auto Expert on repairing and electrical systems.

DYKE'S SCHOOL OF MOTORING, Box 300 Granite Bldg., St. Louis, Mo.
A department of the Firm: A. L. Dyke, Publisher. Originals lend only system of instruction. Endorsed by leading motor authorities of the world.

DEAFNESS IS MISERY

I know because I was Deaf and had Head Noises for over 30 years. My invisible Antiseptic Ear Drums restored my hearing and stopped Head Noises, and will do it for you. They are Tiny Megaphones. Cannot be seen when worn. Effective when Deafness is caused by Catarrh or by Perforated, Partially or Wholly Destroyed Natural Drums. Easy to put in, easy to take out. Are "Unseen comforts." Inexpensive. Write for Booklet and my sworn statement of how I recovered my hearing.

A. O. LEONARD, Suite 226, 70 5th Avenue, New York City

NO MORE BALD HEADS



WHEN our VACUUM CAP is used a few minutes daily. We accept no pay until you have tried the Cap 60 days and are satisfied. The Vacuum Cap is an appliance that draws the blood to the Hair Roots and starts a new healthy crop of hair. It stops Dandruff, stops the hair from falling out.

Bought by Doctors and men who know that it is the only reasonable HAIR GROWER known to science. No Drugs Used. Write for application blank, testimonials, and booklet on "HAIR," sent sealed in plain envelope. FREE.

THE MODERN VACUUM CAP CO.

W 559 BARCLAY, DENVER, COLO.



“He Gets \$100 a Week”

“Two years ago Evans was out in the shop earning \$18 a week. Now he is my Chief Draftsman.

“One day he came to me and asked for a job in the Drafting Room. When I asked him how he could fit in, he explained that he had taken a Home Study Course in Drafting through the COLUMBIA SCHOOL OF DRAFTING, and after showing me some of his work, I put him on.

“I soon realized that he was the best Draftsman I had and on the first of the year I promoted him to Chief Draftsman at \$100 a week.”

One evening two years ago when Evans was working for \$18 a week he read an ad which told him to get out of the “rut” and earn BIG MONEY. He filled out a coupon like the one below and became a COLUMBIA Student. His progress is similar to that of thousands of COLUMBIA graduates.

Evans was not an unusual chap. He had just a common school education and no particular mechanical ability. Yet, though he had no previous training or experience in Drafting, he easily mastered the COLUMBIA course. As a matter of fact, Evans is only one of thousands who have been helped to BIG PAY positions through COLUMBIA training. To-day they are expert professional Draftsmen.

The rapid advancement made by this man can be explained by the fact that he got the RIGHT training. Nor did he have to leave home to get it. Through the Home Study Course of the COLUMBIA SCHOOL OF DRAFTING he secured practical training by mail in his spare time. To-day he can tackle any Drafting problem because he **knows**.

Remember, Evans had only a limited education and average ability but he succeeded because he grasped his opportunity—the same opportunity you have to win success. You need not be satisfied with a small pay job if you want to earn BIG MONEY.

Will you decide now to win success through COLUMBIA training just as Evans and thousands like him have done? If so, mail this coupon to-day.

COLUMBIA SCHOOL OF DRAFTING

Roy C. Claffin, President

Dept. 1711, 14th & T Sts. Washington, D. C.

Roy C. Claffin, President,
COLUMBIA SCHOOL OF DRAFTING,
Dept. 1711, Washington, D. C.

I want to make more money. Please send me your booklet “Your Future in Drafting”, telling me how COLUMBIA training can help me do this.

Name.....Age.....

City.....State.....

Learn to Write

GOOD hand-writing has been truly called the "Bread and butter of a business education." It should be the determination of every body to learn to write at least a good business hand. Good writing is the very foundation of business success.

Easy to Learn By my system you can become a good penman at home, in your own room during spare time. Don't be content with the notion that good penmen "are born" such. Because one's ancestors may have been noted for poor penmanship, is no excuse for him to remain an illegible scribbler. My system is original, unique, and highly successful—the result of 25 years' experience.

Your Spare Time Just your spare moments—that's all I ask. If you follow my instructions you will soon be able to write a beautiful hand that will be a source of pride to yourself and envy to your friends. Notice the improvement shown in Mr. Campbell's writing below.

Leland M. Campbell

"I am astonished at the improvement I've made by means of The Tamblin System in so short time."

LELAND M. CAMPBELL,
Campbelltown, Ohio.

Leland M. Campbell

Mr. Campbell wrote his upper signature July 20, and the lower one November 10—a little less than 4 months apart. Hundreds and hundreds of others in all parts of the world are doing as well with my system.

I have had unbounded success in making poor writers good ones and good writers better penmen than they thought possible.

32
PAGES
HIGHLY
ILLUSTRATED



FREE
BOOK
WRITE
FOR IT
TODAY

Penmanship is particularly adapted to correspondence instruction, and I absolutely guarantee satisfactory improvement. Distance no barrier. Ladies taught just as successfully as men.



F. W. Tamblin

Don't wait, don't delay, begin now to prepare for that position where good penmanship will be required. Send today for my Free Book, "How to Become a Good Penman," which contains copies and beautiful specimens and tell how others have become good penmen by means of the Tamblin System. Your name will be beautifully written on a card with white ink if you enclose stamp.

F. W. TAMBLIN,
418 Ridge Building,
Kansas City, Mo., U.S.A.

FREE BOOK COUPON

F. W. TAMBLIN, 418 Ridge Bldg., Kansas City Mo., U.S.A.

I am interested in improving my penmanship. Please send me free your Book "How to Become a Good Penman."

Name

Address

Sign and mail this today, before you forget it.

Please Mention Popular Mechanics

Practical Electricity with Questions and Answers

By
Cleveland Armature Works and
John C. Lincoln

A standard book on the most interesting subject in the industrial world.

Contains numerous questions and answers, a dictionary of 1500 electrical terms, 25 valuable tables; also many original ideas. 1480 pages—illustrated and cloth bound. Postpaid \$2.00

SHREWSBURY PUBLISHING CO.
5525 West Lake Street
Chicago, Illinois



Introductory
Price

\$2.00

For students, electricians, engineers, and all those who wish to gain accurate information concerning the designing, operation, and care of dynamos and motors, as well as wiring, batteries, lighting systems and other information. The entire electrical field is well covered in easy to understand language.

10c CHARGES STORAGE BATTERY

FROM A LAMP SOCKET

At HOME or BUSINESS With An F-F BATTERY BOOSTER, which is a FULL WAVE Magnetic Rectifier for 105-125 volt 60 cycle A.C. Leads Battery just as it is in your Car. Snap Clips on Battery Terminals, Turn Switch, Lock Garage, knowing Battery will be Charged in the Morning. A METER shows the Charge Work. A Complete Compact Dependable Self-Contained Portable Automatic Charging Unit. No skill Required. A Fully Charged Battery starts Cars & Trucks quick in the coldest winter weather & thus saves Expensive Replacement Storage Batteries must be bought, when kept Fully Charged; so it Actually Costs Less to Buy a Booster than to be without one. Don't think your Battery is dead and wear out simply because it will not start your car. Buy a Booster. It is well made and bears engine spin. BY BUYING A BOOSTER YOU SAVE MONEY. These Types Look A Little Like PRE-WAR PRICER:

Remain Type 6 charges 6 volt Battery at 6 amperes \$11
Remain Type 12 charges 12 volt Battery 5 amperes \$13
Type 166 charges 6 volt Battery at 12 amperes \$24
Type 1612 charges 12 volt Battery at 7 amperes \$24
Type 1626 Combination Type Charges Both 6 & 12 volt Batteries at 12 & 7 amperes.....\$36

CHARGING SERVICE

The Larger Types are recommended for heavy batteries, or where time is limited. Shipping Weights Complete with ASYMMETER & BATTERY CLIP, 13 to 15 Pounds. Mail Check for Prompt Express Shipment. Or if for Parcel Post Shipment add Postage & Insurance charges. Or Order or to forward the Terms and Conditions. C. O. D. Order New or Write Immediately for FREE Descriptive BULLETIN BULLETIN 24. For GROUP CHARGING write for Free BATTERY RECTIFIER BULLETIN 24-A. Real Economy in First Cost & in Service. It charges up to 25 Cells. Automatically. THE FRANCE MFG. CO., CLEVELAND, OHIO, U. S. A. Canadian Representatives: Battery Service & Tube Co., Hamilton, Ontario, Canada.

BRUSHES and SUPPLIES
FOR SIGN and SHOW CARD WRITERS

Largest sign shops and studios use BLUE HANDLE BRAND brushes and supplies. The PIONEER Line Established 1899.

Recognized Quality—Tremendous purchasing power, and long years of practical experience, permit us to offer the highest quality supplies at the lowest prices. Theos. Cusack Co., of Indianapolis, writes: "We offer you the highest recommendation for your goods."

Write for our new 1922 catalogue. It's FREE.

DETROIT SCHOOL OF LETTERING, 1184 D. S. of L. Bldg.
SUPPLY DEPT., Detroit, Mich., U. S. A.



Mystic Skeleton

A jointed figure of a skeleton 14 in. in height, with dance to music and perform various gyrations and movements while the operator may be some distance from it.

Serpent's Eggs

Box contains 12 eggs. When lit with a match, each one gradually hatches itself into a snake several feet long, which curls and twists about in a most life-like manner. Price per box, 10c ppd.

JOHNSON SMITH & CO., Dept. L785, 3224 North Halsted Street, CHICAGO



Good Luck Ring

Quality and Novel Design

A VERY striking and uncommon ring. Silver finish, skull and crossbone design, with two brilliant, flashing gems sparkling out of the eyes. Sold by many to bring Good Luck to the wearer, hence its name, Good Luck Ring. Very unique ring that you will take a pride in wearing. ONLY 25 CENTS.

5 Master Keys

Only keys of their kind in existence—(patented). Open and test thousands of different locks. Tell you instantly if your door or padlocks are burglar proof. Serve in emergencies, too. Thousands of sets in daily use among detectives, policemen, contractors, locksmiths, firemen, mechanics, travellers, home and hotel owners, etc. Give feeling of security and protection worth many times their cost. Novel key chain FREE with each set. Send only \$1 today. MASTER KEY CO., 85 MANHATTAN BLK., MILWAUKEE, WIS.





Now as Never Before You Need THE ENCYCLOPÆDIA BRITANNICA

What has been the lasting heritage of the war? In brief, a nation of keener thinking, knowledge-demanding people. The war has had a profound effect on the 100,000,000 inhabitants of this country. It has carried their interests from the town or city in which they live across the water into foreign countries, to every part of the world. They have become no longer content to know only their neighbor across the street, but they want to learn of their neighbors in all nations of the earth. The war created in the people a thirst for knowledge, world wide in compass. The war instilled in the people the habit of thinking broadly in world wide terms, of wanting information on subjects they never dreamed of before, of thinking more deeply on the problems of the day. Over the three years since the war, during the political, social, economic adjustment in this country, this habit of the people has grown stronger and stronger until there has never been manifest such eagerness for knowledge as there is today.

Where can people find the means to satisfy this demand for knowledge? The greatest reservoir of knowledge in existence, authoritative and comprehensive, is the Encyclopaedia Britannica, the most widely known, the most esteemed—the resource of thousands of men and women, seekers of knowledge in every generation for a century and a half. It is the book of the hour.

How shall America readjust her industrial conditions? Is the present League of Nations likely to succeed? Is the fall of the Bolshevik regime in Russia imminent? Will Germany fulfill its treaty obligations?

By means of the exhaustive articles in the Encyclopaedia Britannica on economics, industries, politics, government, labor and capital you will be able to obtain a clear insight into the problems of today. The Britannica will enlighten you on such timely topics as prohibition, suffrage, tariffs, currency, waterways, transportation and government ownership.

A Treasure Chest of Knowledge.

The Britannica is a complete library of knowledge on every subject. It discusses in a way that you can understand every branch of science, industry, literature, art, religion, inventions and engineering; history and race development; war and peace; architecture, astronomy, chemistry, sociology, education, steam, electricity, geology and geography, biography, law and physics. You and your family will find in the Britannica a liberal education. In answer to the hundred questions which every day come to your mind and to your wife's and children's minds, it will give you more precise information than you can get from any other source.

29 Volumes

30,000 Pages

44,000,000 Words

500,000 References

Complete Latest Edition

You Pay in Small Monthly Payments

If you are ready to subscribe now, write an order on a piece of paper and mail with a dollar bill and we will give your order prompt attention.

The Britannica in Women's Affairs.

The Encyclopaedia Britannica gives to the woman fundamental information on politics, on economics, child welfare, domestic science, on foods and their relative values, on hygiene, sanitation, home decorations, furniture, rugs and furnishings. As an educational influence the Encyclopaedia Britannica is supreme. As an aid to children in school it is indispensable to supplement, interpret and broaden their knowledge on the subjects which they are studying.

Printed on the Famous India Paper.

These sets are printed on the genuine India paper—the beautiful, light, strong, thin but opaque sheet which has proved an ideal medium on which to print the Encyclopaedia Britannica, because it makes this great work more compact, much more convenient to handle and more inviting to read.

Mail Coupon Today.

Mail to Sears, Roebuck and Co. today the attached coupon with your name and address and we will send you, without charge, postpaid, our 128-page illustrated booklet, which will give you full information about the Britannica and what it will mean to you and yours to have such a great work in your home; also, how we are able to sell it to you at so low a price on such liberal terms of payment.

Sears, Roebuck and Co.

Gentlemen:—Please send me, postpaid, your illustrated book 18AA giving full information about the Encyclopaedia Britannica. Also tell me what I will have to pay for a set of the Handy Volume issue of the Britannica printed on genuine India paper.

Name

Postoffice

R. F. D. Box

No. No. State

Street

and No.

SEARS, ROEBUCK AND CO., CHICAGO

Little Mistakes In English Make Others Judge You Unfairly

You are sized up every day by what you say and write. The words you use, how you use them; your spelling, grammar, punctuation—these tell the measure of your ability, your experience, your breeding, more clearly than anything else. Your English says to all the world, "This is what I am!"



SHERWIN CODY

How Poor English Hurts You

English is the advertisement of your ability. Your language determines your position in the social and business scale. Charming personality, fine clothes, wonderful appearance, count for little if handicapped by imperfect or "sloppy" English.

People will think you are lacking in education and culture if you spell incorrectly such common words as "business," "abbreviate," etc.; if you say "between you and I" instead of "between you and me;" if you use "who" for "whom" and "shall" for "will." What can you expect people to think if you don't know when to use one or two "c's" or "m's" or "r's" or when to use "el" or "le," or if you say "hosPitable" when you should say "HONspitable?" Fairly or unfairly, everybody everywhere judges you the same way. Poor English is an unnecessary handicap.

15 Minutes a Day Perfects Your English

If your English does not make people think the best of you then it must be improved. Extensive tests show that most men and women are but 61% efficient in the essential points of English.

But now there is a way to improve your English. Sherwin Cody, perhaps the best-known teacher of practical English, has perfected and patented a remarkable device which quickly gives you a commanding mastery of English. He has thrown aside all the "junk" which makes the old methods so inefficient. The drudgery of rules and tiresome drills is discarded. Each evening you are assigned an easy 15-minute lesson. No time is wasted on what you already know. You are quickly shown your mistakes in spelling, punctuation, grammar, and pronunciation, and you concentrate on the points that need attention. By actual use correct English soon becomes a habit.

Astonishing Book on English Sent Free

Make your English proclaim you in the most favorable light—make it a help instead of a hindrance. Poor English keeps you down, it makes people judge you unfairly. Good English is invariably the surest sign of education and culture. You can quickly acquire a masterly command of English through Mr. Cody's remarkable new invention.

Write for our new free book, "How to Speak and Write Masterly English." It describes Mr. Cody's invention thoroughly and explains just what it will do for you. Merely mail the coupon, a letter, or postal card. Your greatest possibilities in business and social life will be reached only when you know and use correct English. Write today.

SHERWIN CODY SCHOOL OF ENGLISH

54 Searle Building Rochester, N. Y.

SHERWIN CODY SCHOOL OF ENGLISH,
54 Searle Building, Rochester, N. Y.

Please send me at once your Free Book, "How to Speak and Write Masterly English."

Name.....

Address.....

City.....State.....

To Succeed Like ROOSEVELT



You must, like him, learn to use ALL of your mind. Most of you use only about 20% of your mental power—you do not know how to put the balance to use.

Learn the true secret of full mental training through a new method of instruction—

The Mystic Road to SUCCESS

A practical adaptation of certain secrets of Oriental Psychology for the modern American mind. Send for the first two lessons. THEY ARE FREE. Practice them and you will want to "carry on" to full success.

INSTITUTE OF BUSINESS SUCCESS

307-A, E. Garfield Blvd.

Chicago

Learn Advertising

Earn
\$40 to \$150
Weekly

You learn easily and quickly by mail in spare time at home. We assist you to earn \$20 to \$40 weekly while learning. Highest paid profession, tremendous demand, positions waiting. Write for handsome book of particulars. Applied Arts Institute, Dept. 116, Witherspoon Building, Philadelphia, Pa.

MECHANICAL

A wonderful field for men who have a liking for things mechanical. Study at home in spare time with the largest correspondence school in the world. Thousands of students have good jobs at big salaries. Write today for full particulars. International Correspondence Schools, Box 629-C, Scranton, Pa.

"The College in the Home"

ENGINEERING

LEARN WATCHMAKING

and become independent. Good-paying positions secured.

Easy to learn. Send for FREE CATALOG.

ST. LOUIS WATCHMAKING SCHOOL, Dept. 5, ST. LOUIS, MO

LEARN SIGN LETTERING IN 20 HOURS

Using our New Method Patented Mechanical Device—no stencils. Have a business of your own earning from \$2,000 to \$6,000 a year lettering store windows, show cards, barns, roofs, walls, fences, and signs of all kinds. Students can have established business doing finest of work in thirty days. We guide you step by step. Absolute satisfaction guaranteed.

Write today. Details free

AMERICAN SCHOOL OF LETTERING
Dept. P Omaha, Nebraska

BIG PROFITS FROM POULTRY

We Teach You How; Easily Learned at Home;

our guaranteed methods make success certain; write for free booklets "How to Raise Poultry for Profit" and "Absolute Evidence." Free.

The National Poultry Institute, Inc., Desk 313, Marden Bldg., Washington, D.C.

The Dying Pig



The most laughable novelty yet produced. Made of rubber, and you have only to blow it up and it is a d

the pig on his feet, when he begins to equal as he slowly collapses and finally lies down and dies in the most natural manner. You can blow him up as often as desired, and each time he will go through the same performance to the great amusement and delight of your friends.

Price 15 cents; 3 for 40 cents; see dates \$1.35, mailed postpaid.

Johnson Smith & Co., 3224 N. Halsted Street, Dept. 735, Chicago

Popular Watch Charms



Very pretty little curiosities and decidedly novel. Fitted with Magnifying Lenses that enlarge the pictures to a very surprising degree; in fact, it seems almost incredible that a clear picture could be possible in such a small compass, and how sharp and distinct they show up when you look through. Come in assorted sizes—Antiques, views of Passaic Canal, Lord's Prayer in type, etc.

Price 15c; 3 for 40c; \$1.35 doz.

You Can Play the Hawaiian Guitar Just Like the Hawaiians!

Because Our Native Hawaiian Instructors Will Help You

OUR STUDENTS SAY

241 E. Stargrant St.,
Gto. Phila., November 9, 1921.
First Hawaiian Conservatory of Music.

Dear Sir:—
I received my guitar and first lesson and am very much pleased with it, and its fine appearance and tone. I have learned how to tune it and am getting along fine with the lessons, and can hardly wait for my next lesson. Your method is very simple; it is great for all beginners. I must say it is better than personal teaching. Thanking you very much for the enrollment blank, I gave your enrollment blank to my friend and he said he will send it and the money order for ten dollars for your violin course.

Yours truly,
Milton H. Johnson.

October 1st, 1921.
Koster School,
214 So. Franklin St.,
Chicago, Ill.

First Hawaiian Conservatory of Music.

I shall certainly be very glad to recommend your course whenever the chance is mine to do so. Mr. W. H. Johnston has not phoned me yet, and if he does not phone in a day or so, will write him. Am sending a letter to Mrs. Helen Sivik today which I think may help to secure her enrollment, and I shall be glad at any time to write a personal letter to anyone whom you may suggest.

Your former student,
W. L. Walker.

Vinton, Iowa, 10-7.

Dear Sir:—
Received picks and first lesson September 22nd. Sure was surprised how much I learned first lesson. Wishing you the best of success with your course, I am
Respectfully yours,
Van Wreck,
Mgt. Western Union, Vinton, Ia.

Our improved method of teaching is so **simple, plain and easy** that you begin on a piece with your first lesson. **In half an hour you can play it.** Thousands of successful students prove this to be true.

ONLY 4 MOTIONS We have reduced the necessary motions you learn to only four, and you acquire these in a very few minutes. Then it is only a matter of a little practice to acquire the weird, fascinating, tremolos, staccatos, slurs and other effects that make this instrument so delightful. **The Hawaiian Guitar plays any kind of music**, both the melody and the accompaniment.

FREE Just think of it. 52 lessons on this wonderful guitar. You get a beautiful large sized **Genuine Hawaiian Guitar absolutely free as soon as you enroll for the lessons.** All the necessary picks, the steel playing bar and 52 pieces of music are included **without cost to you.**

Special Arrangements for Lessons if You Have Your Own Guitar

Play Any Music

In half an hour after you get the free Hawaiian Guitar and the first lesson, you can play Hawaiian Melodies.

In a very short time after a little practice you can play any kind music as well as Hawaiian, both the melody and accompaniment.

[TEAR OUT COUPON]



Tear Off and Mail Today

First Hawaiian Conservatory of Music, Inc.
233 Broadway (Woolworth Bldg.), New York City

Please send me full information about your 52 easy lessons and FREE GUITAR OFFER.

NAME.....
ADDRESS.....
TOWN..... STATE.....
Print name and address clearly. P.M.4

How I Earn \$15 to \$25 a Week at Home in my Spare Time

By Wm. S. Coulthard



I needed money. I had a lot of time on my hands in the evenings, Saturday afternoons, etc.—for I had no hobby—and besides my expenses had been mounting fast—so you will see the receptive mood I was in when I saw your little ad, "MAKE MONEY AT HOME."

I sent for your free booklet.
I read it.

Your plan looked good to me—your guarantee so liberal—and on investigation I found you were reliable, so I accepted your offer. If others could make money by your plan, I could.

That was less than a year ago.
Now I am earning \$15.00 to \$25.00 a week, each week, writing show cards in my spare time. In addition to this, I still hold my regular job, and my salary has been increased there, too. I believe my spare time work has made me better satisfied with life, and so I'm doing my regular work better.

I have been offered positions writing show cards, but I am not interested, as my present position is perfectly satisfactory, but I certainly am glad I enrolled in your school—my spare time money is exceedingly attractive. Besides, I find show card writing an interesting occupation that fills in those evening hours that used to drag so. In fact, it is really a hobby now with me—and a profitable one, as you can well imagine. Only last week I received a check from your school for \$70.00 for work done over the last three weeks. Of course, you'd have paid me regularly each week if I'd bothered about it, but I was too busy to tell you the amount of work I'd finished.

There are times, however, that I feel show card writing by your simple method is almost too good a thing—that's when I have so many orders ahead that I cannot see my way clear to finish them—and have to turn down work.

Your system of supplying work to your students has certainly helped me, but sometimes you send too much—I'm only working at it in my spare time, you know. Please note this, and don't try to overload me too much.

By the way, I think you'll be interested to know that previous to enrolling in your school I had never tried my hand at any work of this nature.

I'm glad to thank you for what you've done for me—and you can certainly use my name and tell prospective students, for I feel I'll be doing anyone a real good turn if I can help them get started in this profitable work.

Yours sincerely,
WM. S. COULTHARD.

NOTE:—The above is the story of Mr. Coulthard. It tells of facts, for Show Card Writing offers a marvellous opportunity to both men and women, either for spare time or full time work. What Mr. Coulthard has done and is doing, you can do. Colbran, Dusenberry, Wendt, Blade, Poulson, Charles, Wright, Babineau and many other men have proved it. Mrs. Latherdale, Mrs. Lush, Mrs. Le Moine and dozens of housewives have added to the family income in this way. Girls like Misses MacDonald, Clegg, Bordreau and Hoyle are but a few of those who have bettered their positions in this pleasant way. All these owe their success to the American Show Card School method of training—the old established school which has trained hundreds to make money in SHOW CARDS. The American Show Card School will gladly send you full particulars if you but send your name and address to them.

American Show Card School
203 Ryrie Bldg.
Toronto, Can.

Send me your Free Booklet on Show Card Writing, and show me how I can make money at home—without canvassing or soliciting. It is understood that this places no order or obligation of any kind.

Use this Coupon. Name.....
(Print your name plainly)
Address.....
(In full)
State.....

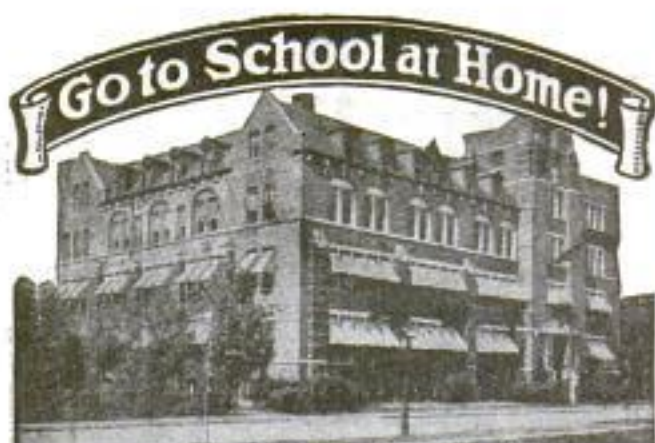

High School Course in Two Years!

You Want to Earn Big Money!

And you will not be satisfied unless you earn steady promotion. But are you prepared for the job ahead of you? Do you measure up to the standard that insures success? For a more responsible position a fairly good education is necessary. To write a sensible business letter, to prepare estimates, to figure cost and to compute interest, you must have a certain amount of preparation. All this you must be able to do before you will earn promotion.

Many business houses hire no men whose general knowledge is not equal to a high school course. Why? Because big business refuses to burden itself with men who are barred from promotion by the lack of elementary education.

Can You Qualify for a Better Position?

We have a plan whereby you can. We can give you a complete but simplified high school course in two years, giving you all the essentials that form the foundation of practical business. It will prepare you to hold your own where competition is keen and exacting. Do not doubt your ability, but make up your mind to it and you will soon have the requirements that will bring you success and big money. YOU CAN DO IT.

Let us show you how to get on the road to success. It will not cost you a single working hour. We are so sure of being able to help you that we will cheerfully return to you, at the end of ten lessons, every cent you sent us if you are not absolutely satisfied. What fairer offer can we make you? Write today. It costs you nothing but a stamp.

AMERICAN SCHOOL

Dept. H-474, Drexel Ave. and 58th St., Chicago

AMERICAN SCHOOL

AMERICAN SCHOOL

Dept. H-474 Drexel Ave. and 58th St., Chicago

Explain how I can qualify for position checked:

...Architect \$5,000 to \$15,000	...Lawyer \$5,000 to \$15,000
...Building Contractor \$5,000 to \$10,000	...Mechanical Engineer \$4,000 to \$10,000
...Automobile Engineer \$4,000 to \$10,000	...Shop Superintendent \$3,000 to \$7,000
...Automobile Repairman \$2,500 to \$4,000	...Employment Manager \$4,000 to \$10,000
...Civil Engineer \$5,000 to \$15,000	...Steam Engineer \$2,000 to \$4,000
...Structural Engineer \$4,000 to \$10,000	...Foreman's Course \$2,000 to \$4,000
...Business Manager \$5,000 to \$15,000	...Sanitary Engineer \$2,000 to \$5,000
...Certified Public Accountant \$7,000 to \$15,000	...Telephone Engineer \$2,500 to \$5,000
...Accountant and Auditor \$2,500 to \$7,000	...Telegraph Engineer \$2,500 to \$5,000
...Draftsman and Designer \$2,500 to \$4,000	...High School Graduate in two years
...Electrical Engineer \$4,000 to \$10,000	...Fire Insurance Expert \$3,000 to \$10,000
...General Education in one year.	

Name..... Address.....

Earn \$35-\$125 a Wk



Your Opportunity in MECHANICAL DENTISTRY

Ambitious men of all ages can rise above small salaried positions into this profession of unlimited possibilities.

Taught by actual practice—day or evening. Three months' course. Modern laboratories. No previous knowledge or experience required. No charge for tools or equipment. The men we train are in demand. Established 30 years. Catalog free.

Address your inquiry to Dept. 2

BODEE SCHOOLS OF MECHANICAL DENTISTRY

NEW YORK
136 W. 52 St.

PHILADELPHIA
15 1/2 and Walnut Sts.

BROOKLYN
15 Flatbush Ave.

HOW TO PAINT SIGNS AND SHO' CARDS

Our book gives a complete course of instructions, enabling any one to learn to paint good signs. WHY NOT MAKE YOUR OWN either for your business or for others?

CONTENTS: Alphabets, Composition, Color Combinations, How to Mix Paints, Show Cards, Window Signs, Banners, Board and Wall Signs, Ready Made Letters, Gilding, Commercial Art and Tricks of the Trade—Contains 100 alphabets and designs. Cloth bound, size 7 x 5 inches, price \$1.00 postpaid.

J. S. Ogilvie Pub. Co., 577 Rose St., New York

Clear-Tone FOR PIMPLES

Your skin can be quickly cleared of Pimples, Blackheads, Acne Eruptions on the face or body, Enlarged Pores, Oily or Shiny Skin. \$1,000.00 Cold Cash says I can clear your skin of the above blemishes. WRITE TODAY for my FREE Booklet—"A Clear-Tone Skin"—telling how I cured myself after being afflicted for fifteen years.

FREE

E.S. GIVENS, 129 Chemical Bldg., Kansas City, Mo.

Regain Your Vigor and Vitality



Are you dragging yourself about from day to day—always tired and dependent, groping your way thru life, handicapped with Catarrh, Constipation, Indigestion, Dyspepsia, Nervousness, Poor Memory—crippled with Rupture, Rheumatism, Weak Heart, Weak Lungs? Have you given up hope that you will amount to anything in life? It looks mighty gloomy for you and those dependent on you—but cheer up, I'll show you how to win back your health and strength—your vigor and vitality. I want to help you—I can help you.

STRONGFORTISM—The Modern Science of Health Promotion will banish your ailments—conquer your weaknesses and build up your vigor and vitality. I guarantee it.

Mention the ailments on which you want special confidential information and send with 10c to help pay postage, etc., on my book, "Promotion and Conservation of Health, Strength, and Mental Energy." It contains a message that is worth a fortune to you. Send for my free book Right Now—TODAY.

LIONEL STRONGFORT

Physical and Health Specialist

Dept. 779

Newark, New Jersey

Draftsman's Complete Outfit

FREE



Everything Used by Expert Draftsmen Given You Absolutely FREE

Outfit includes "professional" complete set of fine drawing instruments with double set of compasses and dividers all in velvet lined case. Drawing board, T square, two triangles, protractor, universal curve, triangular, standard scale, water-proof ink, pens, pencils and all accessories—furnished you free in this expert's complete outfit.

Draftsmen Make \$225.00 to \$500.00 a Month

There is a tremendous demand for trained draftsmen. Now is the time to start. Draftsmen get good pay from the start and can work up to \$500 a month *and more*. Draftsmen are needed everywhere. Once you are trained you can choose your own business and work in any part of the country you please. Coyne training makes everything easy for you. Coyne student, L. T. Duhendorf, writes:

"Immediately after completing Coyne course I went to work for Armour & Co. Work was easy for me. Five months later I accepted a position in New York at a large increase in salary."

3 Months' Course at School

You can qualify as an expert draftsman by 3 months' intensive training at the school in Chicago. Living cheap. Possibilities of earning way wide study. (If you are lay to rise to school instead of the "learn it today" course, check coupon and send it for complete information.)



B. W. Cooke

President

COYNE

HOME STUDY DEPT.

TRADE & ENGINEERING SCHOOLS

Recognized Producer of Successful Men

39-51 E. Illinois St., Dept. 1774, Chicago, Ill.

Easy to Learn at Home from Great School Known all over the World

The Coyne Home Study course guarantees to train you. Remember, the Coyne Trade and Engineering Schools are recognized by educators all over the world. Students come from all over the *world* to get Coyne training. Why? Because of the Coyne school's long established, tremendous reputation for successful teaching by its great staff of experts. Coyne is not a "one man" school, but a great educational institution, 22 years old, an acknowledged leader and originator. Coyne originated the "Learn by Doing" method now endorsed by educators everywhere. Coyne has graduated thousands of successful, prosperous men all over the world. You can't make a mistake if you write for the Coyne free book. Coyne students say every minute of the course was enjoyable. Some students took *good positions three months before their course was finished.*

Send for FREE Book

Mail this coupon for our interesting book, "Drafting, the Foundation of Industry," sent you free. It explains all about the Coyne home study method and shows you how to become a draftsman in the quickest and easiest way. You want to know all about this great institution. Don't put it off. Send for this book now. It's absolutely free, no obligation. It contains the most valuable information you will ever get in your life. Send the coupon now.

Check Coupon Below and Mail Now!

Coyne Trade and Engineering Schools,
Department 1774, 39-51 E. Illinois St., Chicago, Ill.

Dear Sirs:—Please send me, absolutely free, without obligation, your book, "Drafting, the Foundation of Industry," also full information about the Course in Drafting. (Check which course you prefer.)

Home Study Course School Course

Name

Address

City State

Dr. T. O'Connor Sloane Will Teach You CHEMISTRY Right In Your Own Home



DR. T. O'CONNOR
SLOANE

A. B. A. M., LL. D., Ph. D.,
Educational Director
Chemical Institute of
New York, formerly
Treasurer American
Chemical Society and
a Practical Commercial
chemist as well as a noted
instructor. Dr. Sloane
personally examines and
corrects the examination
papers of every student.

Good chemists command high salaries. Industrial firms of all kinds pay tempting salaries to get the right man. Salaries of \$10,000 a year are not unusual for those who have proven their abilities. The work of the chemist is extremely interesting. If you are fond of experimenting, take up chemistry. If you want to earn more money, the way is open through our Course in Chemistry.

You Can Learn at Home

Dr. Sloane will teach you Chemistry at home in a practical, intensely interesting way. Our Course is remarkably simple. No special education required—if you can read and write plain English, you can thoroughly understand and master every lesson.

Easy Monthly Payments

The price of our course is very low and the tuition includes everything, even the chemistry outfit—there are no extras to buy with our course. You can pay in small monthly amounts as you go along. Our plan places a chemical education within the reach of everyone.

Experimental Equipment Given Free to Every Student

One special feature of our course is that we give to every student, absolutely free, the chemical equipment he will need for his studies, including forty-two pieces of laboratory apparatus and supplies and eighteen different chemicals and reagents. The fitted, heavy wooden box serves not only as a carrying case, but as a laboratory accessory as well.

SPECIAL THIRTY-DAY OFFER

In addition we are making a special offer for a short time only. You owe it to yourself to find out about it. Mail the Coupon today for free book, "Opportunities for Chemists" and full details of our special offer. Act immediately before this offer is withdrawn.

CUT HERE

CHEMICAL INSTITUTE OF NEW YORK, Inc.
(Home Ext. Division 4) 140-P, Liberty St., N. Y. City

Without obligation or cost, send me your free book "Opportunities for Chemists" and full particulars about the Experimental Equipment given free to every student, and tell me about your plan of payment and special 30-day offer.

Name.....

Address.....

City..... State.....

PALATIAL FLORIDA HOME

THE finest estate in that part of Florida, situated amid five acres of orange, grape fruit, sweet bay, palmetto and a large variety of semi-tropical trees and foliage. A water front of 400 feet, with entrance from a Boulevard, in a community of 30,000, affording every modern convenience. House recently completed and never occupied. Has every modern improvement, large sun parlors, sleeping porches and eight bath rooms. Inexhaustible supply of absolutely soft water; steam heat, high, light basement under entire house. This is one of the best built houses in the entire state of Florida. Surf bathing all winter within 5 minutes walk.

For full details, photographs and price, address

E. H. PECK

S. OSGOOD PELL & COMPANY
17 West 44th Street New York City

ELECTRICAL Training Book FREE

Send me your name and address and I will send you my big new Electrical Training Book Free. It will show you how to qualify for high paying jobs in Electricity. Thousands now open. Prepare at home—quickly—during spare time under an Electrical Engineer. Take advantage of this unusual offer—only today.
A. W. WICKS, President WICKS ELECTRICAL INSTITUTE
Dept. 3124 3601 Michigan Ave. CHICAGO

"THERE'S MONEY IN IT"

AT HOME LEARN TELEGRAPHY AT HOME

MORSE AND WIRELESS

TEACH YOURSELF in half usual time, at trifling cost, with the wonderful Automatic Transmitter **THE OMNIGRAPH**. Sends unlimited Morse or Continental messages, at any speed, just as an expert operator would. Adopted by U. S. Government, and leading Universities, Colleges and Telegraph Schools. 3 styles. Catalog free.
OMNIGRAPH MFG. CO. 16-22 Hudson St., NEW YORK

WANTED—RAILWAY MAIL CLERKS

\$135 to \$190 a Month for Life
Every second week off with full pay—no "lay offs" because of strikes, poor business, etc.—sure pay—rapid advancement to higher positions. City and country residents stand same chance. Common sense education sufficient—no political influence. Examinations likely in every city very shortly.

CANDIDATES PREPARED FREE
Write for free schedule of Spring examination places. Every day's delay means so much less coaching—so write at once.
FRANKLIN INSTITUTE, Dept. B179, Rochester, N. Y.

Mail This Coupon
Write Plainly
Use It Before You Lose It

COUPON
FRANKLIN INSTITUTE, Dept. B179, Rochester, N. Y.
Kindly send me, without any obligation whatever on my part and entirely free of charge, (1) a full description of the position checked below; (2) Sample examination questions; (3) Free copy of copyrighted book "Government Positions and How to Get Them"; (4) A list of U. S. Government Jobs now open; (5) Schedule showing dates and places of all coming examinations.

.. Railway Mail Clerk (\$1600 to \$2300) .. Customs Positions (\$1100 to \$2000)
.. Postoffice Clerk (\$1400 to \$1800) .. Internal Revenue (\$1100 to \$2000)
.. Postoffice Carrier (\$1400 to \$1800) .. Rural Mail Carrier (\$1800 to \$2600)

Name.....
Address.....

A Better Job Now!

Why take small pay from uncertain jobs? Why be buffeted around from this to that, and not know whether you are going to have a job tomorrow or not? You can change all that. Learn a trade. Know autos—how to repair them and take advantage of the countless opportunities to make big money. Pave the way for a business of your own—a business that can make you independent for life. You can do it with a few weeks' training at the Michigan State Auto School—the great auto-trade school in the heart of the industry.

Be a Trained Man—Successful!

Fellows just like you step out and make great successes. Trained men wanted all the time—everywhere! More than 10,500,000 autos, trucks and tractors in use. All need service and repairing. 50 million tires, millions of batteries to be kept in commission. More men needed for good jobs. More garages—more electric service stations—more tire-repair shops—welding shops—battery stations needed. This means amazing opportunities for the men who start now. Fit yourself to win a good job, or to start a business of your own. Very small capital is needed. You are right on the threshold of big money if you decide now to make this your business.

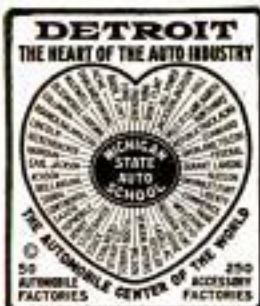

Come to the Auto Center

Learn Autos in a Few Weeks by Factory-Endorsed Methods

Come to Detroit. Here is where autos are made. Come to the Michigan State Auto School where you get first-hand experience and knowledge. Great auto factories endorse and recommend M. S. A. S. training. *The Cadillac Motor Co.* says: "We believe you have the best and most complete school of its kind." *The Hudson Motor Co.* says: "The best equipped and most efficient school in America." You can learn the business thoroughly on latest equipment. You visit the great Detroit auto-plants. Get first-hand knowledge and a quality-training that means certain success, if you do your part.

Get All Facts—Mail Coupon Today!

Decide now to grasp this opportunity. If you like autos—and are mechanically inclined—there are big-money jobs—a business of opportunities waiting for you. Classes always open. Your enrollment includes Life-Membership with privilege to come back at any time to brush up on the latest equipment, and get new money-making ideas. Investigate! Let us show you what we can do for you. Mail the coupon for big illustrated catalog.

Colored Students Not Solicited

MICHIGAN STATE AUTOMOBILE SCHOOL

A. G. ZELLER, President

304 Auto Bldg. 3729 Woodward Ave.
DETROIT, MICHIGAN

FREE CATALOG
MICHIGAN STATE
AUTO SCHOOL

Mail Coupon To Day

MICHIGAN STATE AUTO SCHOOL
304 Auto Bldg., Detroit, Mich.

Gentlemen:— Send FREE and without obligation, your illustrated catalog, and Auto School News, giving complete information and showing the opportunities and advantages of a Factory Endorsed Detroit-Training to make the most money.

Name

Street or R. F. D.

City State

The Factory Endorsed School

SEE OUR PAGE ADVERTISEMENT ON PAGES 53, 157, 185

Copyrighted material



Don't tell me you never had a chance!

"Four years ago you and I worked at the same bench. I realized that to get ahead I needed special training, and decided to let the International Correspondence Schools help me. I wanted you to do the same, but you said, 'Aw, forget it!' You had the same chance I had, but you turned it down. No, Jim, you can't expect more money until you've trained yourself to handle bigger work."

There are lots of "Jims" in the world—in stores, factories, offices, everywhere. Are you one of them? Wake up! Every time you see an I. C. S. coupon your chance is staring you in the face. Don't turn it down.

Right now over one hundred thousand men are preparing themselves for bigger jobs and better pay through I. C. S. courses.

You can join them and get in line for promotion. Mark and mail this coupon, and find out how.

----- TEAR OUT HERE -----

INTERNATIONAL CORRESPONDENCE SCHOOLS
BOX 5624-C SCRANTON, PA.

Without cost or obligation please explain how I can qualify for the position, or in the subject before which I have marked an X:

- | | |
|---|---|
| <input type="checkbox"/> ELEC. ENGINEER | <input type="checkbox"/> BUSINESS MANAGEMENT |
| <input type="checkbox"/> Electric Lighting & Railways | <input type="checkbox"/> SALESMANSHIP |
| <input type="checkbox"/> Electric Wiring | <input type="checkbox"/> ADVERTISING |
| <input type="checkbox"/> Telegraph Engineer | <input type="checkbox"/> Show Card & Sign Ptg. |
| <input type="checkbox"/> Telephone Work | <input type="checkbox"/> Railroad Positions |
| <input type="checkbox"/> MECHANICAL ENGINEER | <input type="checkbox"/> ILLUSTRATING |
| <input type="checkbox"/> Mechanical Draftsman | <input type="checkbox"/> Cartooning |
| <input type="checkbox"/> Machine Shop Practice | <input type="checkbox"/> Private Secretary |
| <input type="checkbox"/> Toolmaker | <input type="checkbox"/> Business Correspondent |
| <input type="checkbox"/> Gas Engine Operating | <input type="checkbox"/> BOOKKEEPER |
| <input type="checkbox"/> CIVIL ENGINEER | <input type="checkbox"/> Stenographer & Typist |
| <input type="checkbox"/> Surveying and Mapping | <input type="checkbox"/> Certified Public Accountant |
| <input type="checkbox"/> MINE FOREMAN or ENG'R | <input type="checkbox"/> TRAFFIC MANAGER |
| <input type="checkbox"/> STATIONARY ENGINEER | <input type="checkbox"/> Railway Accountant |
| <input type="checkbox"/> Marine Engineer | <input type="checkbox"/> Commercial Law |
| <input type="checkbox"/> ARCHITECT | <input type="checkbox"/> GOOD ENGLISH |
| <input type="checkbox"/> Contractor and Builder | <input type="checkbox"/> Common School Subjects |
| <input type="checkbox"/> Architectural Draftsman | <input type="checkbox"/> CIVIL SERVICE |
| <input type="checkbox"/> Concrete Builder | <input type="checkbox"/> Railway Mail Clerk |
| <input type="checkbox"/> Structural Engineer | <input type="checkbox"/> AUTOMOBILES |
| <input type="checkbox"/> PLUMBING & HEATING | <input type="checkbox"/> Mathematics |
| <input type="checkbox"/> Sheet Metal Worker | <input type="checkbox"/> Navigation |
| <input type="checkbox"/> Textile Overseer or Supt. | <input type="checkbox"/> AGRICULTURE <input type="checkbox"/> Spanish |
| <input type="checkbox"/> CHEMIST | <input type="checkbox"/> Poultry Raising <input type="checkbox"/> Banking |
| <input type="checkbox"/> Pharmacy | <input type="checkbox"/> Airplane Engines |

Name.....

Street and No.

City..... State.....

Occupation.....

Persons residing in Canada should send this coupon to the International Correspondence Schools Canadian, Limited, Montreal, Canada.

Please Mention Popular Mechanics

Learn to Fly

Aviation is making such strides that it needs more men right now.

You Can Learn to Fly

I can teach you how to become a successful pilot in a short time. My course is so arranged that you get only the things you need to make you a good aviator.

The Diggins Extension Course

is up-to-date, teaches you what you must know to become an expert flyer. This course is written by competent instructors right on my flying field. It is kept right up to the minute—all new developments in aviation are included. That is why it is recognized as the most complete and practical course offered today. My course saves you time and money because it prepares you at home so that you are ready to begin flying the day you arrive at the flying school.

Superior Points of the Diggins School

1. The Diggins school is the oldest, largest and most complete commercial aviation school in America.
2. The Diggins school is located in Chicago, the center of Aviation.
3. Living quarters and free employment service are maintained for students.
4. Diggins guarantees to make you a pilot.
5. Diggins' pilots get top notch salaries.
6. References, any aero club in America.

Write Today Write today for the new Diggins beautifully illustrated catalog.

THE RALPH C. DIGGINS SCHOOL OF AERONAUTICS

Dept. 3 140 N. Dearborn St. Chicago, Ill.

STOP USING A TRUSS

Do Away With Steel And Rubber Bands

FREE TRIAL



Inner surface is made adhesive to secure the PLAPAO-PAD firmly to the body, keeping the PLAPAO continually applied and the pad from slipping. No straps, buckles or springs attached. Soft as velvet—easy to apply.

It's the Non-Slipping, yet Non-Rigid Pad and What is Within it That Counts

FREE to 5,000 Truss Sufferers

To the extent of 5,000 sufferers who may apply I will send, ABSOLUTELY FREE, a sufficient quantity of the PLAPAO to positively convince them that this is the only logical, common-sense way of treating rupture. Plapao is a highly astringent medication placed within the Plapao-Pad and being absorbed through the skin, creates a wonderful feeling of relief and at the same time tends to strengthen the weakened muscles and thus permanently close the rupture opening. The process of recovery is natural, so you'll have no use for a truss—you can throw it away forever! Old and young have testified under oath that the Plapao-Pads cured their rupture—many of them long-standing, aggravated cases—without delay from work. Patent allowed in U. S. and foreign countries. Awarded Gold Medal at Borne and Grand Prix at Paris.

Send No Money—for a sufficient quantity of the Plapao is sent without charge to enable you to give it a thorough test; you pay nothing for this trial now or ever. Write for it and full information today. Address: Plapao Laboratories, Block 1427 St. Louis, Mo.

New \$25.00 Drawing Outfit FREE

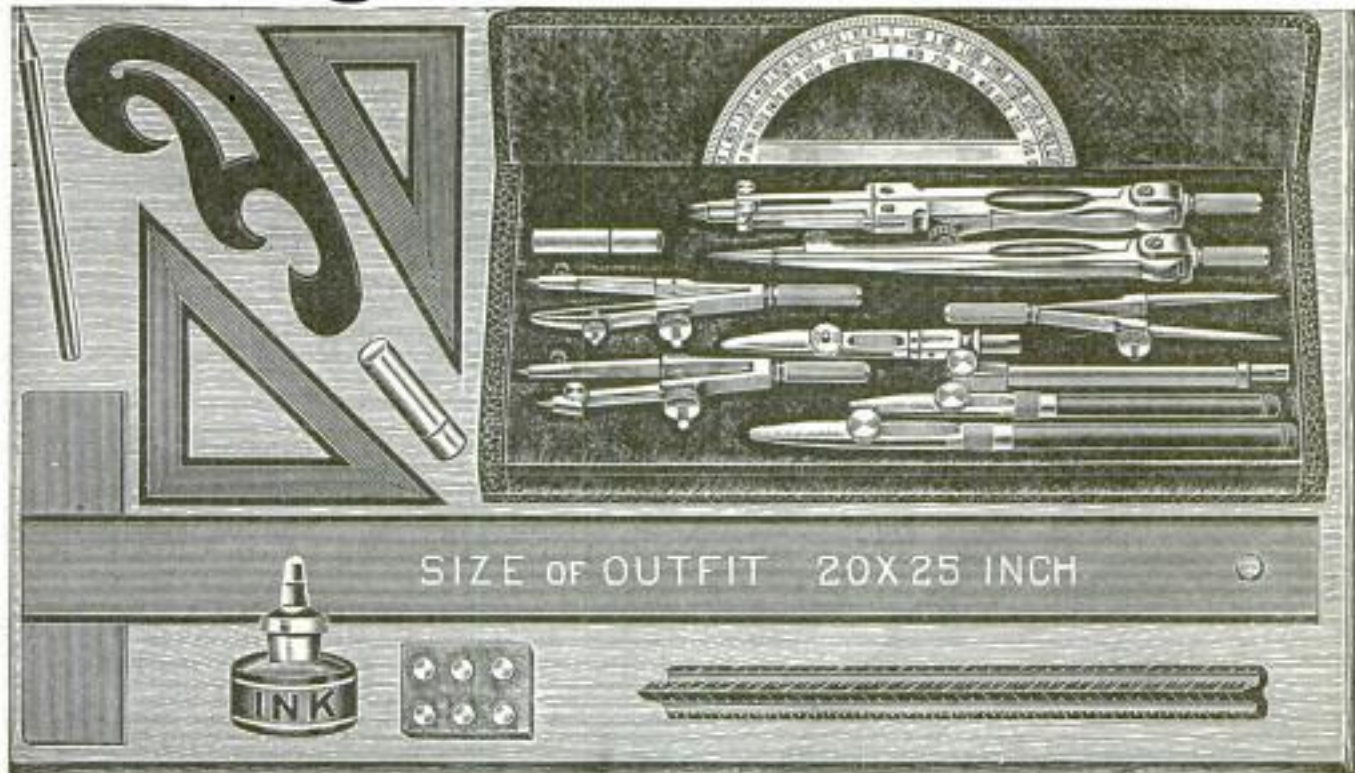

You Can Have It!

I want to have an opportunity of sending you this complete drawing outfit absolutely free. I will send you my book, "Successful Draftsmanship", at once and this will tell you all about my great offer. This drafting outfit, which I am offering to send you absolutely free, contains every instrument you need—all packed in a beautiful and enduring plush lined case. This

is positively a \$25.00 outfit, containing in addition to the fine plated instruments, a 20x25-inch drawing board, a 24-inch T square, rule, drawing paper, two triangles, French curve, pencils, erasers, thumb tacks, etc. Write to me so that I may have an opportunity of sending this splendid new outfit to you as soon as possible.



I Guarantee To Train You
Until You Are Placed in a Position Paying
\$250⁰⁰ to \$300⁰⁰ Per Month

This is a binding, steel-ribbed guarantee which makes your future certain before you start. You should not waver nor hesitate. You should

Send This Coupon!

Get my book, "Successful Draftsmanship." That tells you everything—what opportunities there are in Drafting, especially NOW—how much money there is to be made—how, when you are skilled in Drafting, as I make you by my personal man-to-man method, you will not be in want of money or a position. Send the coupon for the free book TODAY!

Chief Draftsman Dobe, Dept. 9354 4001 Broadway, Chicago

Chief Draftsman Dobe

Dept. 9354 4001 Broadway, Chicago

Without any obligation whatsoever, please mail your book, "Successful Draftsmanship," and full particulars of your liberal "Personal Instruction" offer to few students.

Name.....

Address.....

Sweeney Says

Young man—you want A BETTER JOB—more money—opportunity—success. If you are mechanically inclined write me today—don't bother about a letter—just a postcard will do—or clip and mail the coupon.



E. J. SWEENEY

As the Soldier Looks to West Point, so the Mechanic Looks to Sweeney's

I Will Make You An Amazing Offer

If you are interested in mechanical work, if you are interested in automobiles and WILL WORK, this Million Dollar Trade School offers you an opportunity that may never come to you again. Will you PUT EIGHT WEEKS' TIME in this great trade school IF YOU ARE CONVINCED IT MEANS A REAL JOB AND A LIFETIME SUCCESS?

Because of the demand for Sweeney trained men I am making now MY BIGGEST AND MOST SURPRISING OFFER—no matter where you live—no matter if you have had no previous experience—no matter how old you are.

But I will make this offer ONLY to those who are sufficiently IN EARNEST and SUFFICIENTLY ENERGETIC to write me AT ONCE.

CAN YOU MAKE A BATTERY? Sweeney trained men are battery experts—special work on starting and ignition. Battery service BIG BUSINESS NOW. Learn to make a \$25 Ford battery for \$7.00.

CAN YOU WELD a broken crank case? It's easy by the Sweeney method. Weld holds stronger than original steel or aluminum. Expert welders wanted everywhere. Learn to solder a crank case without taking it down.

TIRES. Can you make a real 4,000 mile tire from 90 cents' worth of old casing and rubber? Sweeney men are TIRE BUILDING EXPERTS. Make and repair them right in our shops.

THE SWEENEY SYSTEM, famous the world over, can be had only in the Sweeney School. It trains men to be mechanics by practical work. You learn by doing—no books—you do the actual work. The course takes only 8 weeks. No place in the world can you get so much real instruction—so much actual value, for so little money. If you are in earnest, there is a real job looking for you. Write me today—don't put it off—I've got some information that will open your eyes—but you must take the first step—Write for my Big Free Book.

Chauffeurs	\$90 to 150.
Truck driver	\$125.
Tire Vulcanizer	\$100 to 200.
Welders	\$140 to 200.
Battery Man	\$150 to 200.
Auto Mechanic	\$6. to 10. a day
Auto Electrician	\$225.
Tractor Engineer	\$10 a day
Garage Manager	\$150 to 400
Demonstrator and Salesman	\$150 to 500.

PICK THE JOB YOU LIKE



LEARN A TRADE
Sweeney
 SCHOOL OF AUTO-TRACTOR-AVIATION
 1004 SWEENEY BLDG. KANSAS CITY, MO.

SEE SWEENEY DOUBLE PAGE SPREAD ON PAGES 56 AND 57

Copyrighted material

"Learn a Trade"

Can You Fill This \$150 Job?

Even before finishing his course, at Sweeney's, Runsey is grabbed by the American Radiator Co., at \$150 a month for his special skill in soldering. Soldering and welding are just one part of the **Sweeney System of Practical Experience**. Another man has left us to work for 85 cents an hour as a welder. Hadn't finished either, but these big concerns couldn't wait. Practical Experience quickly qualifies men! And employers want Sweeney men—NOW.

Sweeney trained men are in demand everywhere at good wages, **\$50 a week and more**, from garages, tire shops, welding concerns, auto repair shops, etc. **HERE'S THE PROOF:** South Dakota wires: "Will pay most any price for a good man. Send him right away." Neck City, Mo., says: "Put us in touch with a first-class repair man. Excellent opening." Indiana says: "Want one more Sweeney man for my new garage. Steady work at good prices." Kansas appeals: "Send me man who understands Ford Car from A to Z. Will pay top wages." Mississippi telegraphs: "Want a post graduate mechanic. Will pay all he is worth. Wire at my expense." Florida calls: "Want head mechanic. Will pay \$50 a week. Let me hear by return mail." **Thousands of Sweeney graduates now owning their own business** in various parts of the country **naturally favor** Sweeney trained men. Sweeney loyalty is wonderful. Our daily mail is conclusive proof that the trained man with the SWEENEY diploma can secure jobs like these at **\$50 a week and more**.

Free I will gladly send my 72-page illustrated catalog FREE. Also a free copy of Sweeney School News, a most interesting monthly school paper, published here. You will enjoy them. Read the worth-while stories of men like yourself who came to Sweeney's and found success. Read how Frank Powell and Harry Wilson built up a \$20,000 business in about two years after graduating. Read how Elbert A. Pence built up a \$25,000 yearly garage business at Clearmont, Mo. These stories and many more are told by the Sweeney students. Also I want you to learn how my students enjoy themselves after work in the swimming pool, the club and reading rooms, etc. Send today for this free catalog. Get my big, new, special offer. See page after page of mechanical pictures. Read what students say. Note the latest ideas in auto work. Hundreds of illustrations. Learn about the jobs open—the actual present opportunities in the business for Sweeney men. **DO IT NOW.**

Yours very truly,
EMORY J. SWEENEY,
President.

This FREE Book
Tells You
Every-
thing



EMORY J. SWEENEY, President
1004 Sweeney Bldg., Kansas City, Mo.

Send me, free, your 72-page catalog and Sweeney School News and tell me of the opportunities in the auto and tractor business.

Name

P. O.

State

Three Points:

1. Learn the Auto Business
2. Learn it at Sweeney's
3. Get the Catalog TODAY

NO COLORED STUDENTS ACCEPTED

SEE SWEENEY DOUBLE PAGE SPREAD ON PAGES 56 AND 57

THE SCIENTIFICALLY BUILT WATCH



MECHANICAL

PERFECTION



The Pinions

THE machine is man's utmost ability and skill multiplied thousands of times.

The world's inventors and engineers are always striking for mechanical perfection.

For sixty-seven years Waltham has been inventing and perfecting machines for watch-building—machines to create perfection of accuracy and unlimited durability in every part of a Waltham watch.

And Waltham machinery is so far in advance of other watch machine development that it provides many reasons why Waltham watches invariably excel all other watches in mechanical perfection and accuracy.

The machine illustrated above cuts the pinions, or gears, which distribute power to the escapement. Years have been spent by Waltham inventors in perfecting this one unit.

No other watch has the smooth running gears and scientifically built power transmission that you find in a Waltham watch.

When you buy a Waltham watch, the wonderful machines back of the watch itself are represented in what you pay for it.

This mechanical perfection provides also the lowest up-keep cost of any watch made today. And there are many other unanswerable reasons why the Waltham watch is unsurpassed in life-long value. Therefore, your watch selection should be a Waltham.

Write for a valuable booklet that is a liberal "watch" education. Sent free upon request. The Waltham Watch Company, Waltham, Mass.

Makers of the famous Waltham air-friction quality Speedometers and Automobile Time-pieces used on the world's leading cars



Ribbon loops patented

Waltham Cushion 10 Ligne
Ribbon Wrist Watch
\$95.00 and up

WALTHAM

THE WORLD'S WATCH OVER TIME

Where you see this sign they sell Waltham Watches

GIFTS THAT LAST

Popular Mechanics Magazine

REGISTERED IN U. S. PATENT OFFICE

WRITTEN SO YOU CAN UNDERSTAND IT

Vol. 37

APRIL, 1922

No. 4

8410 *Apparatus - Police* Radiophones to Aid Crime Detection

THE simplification of wireless communication, made possible by the "resonance wave coil," invented by Col. Joseph O. Mauborgne, and Capt. Guy Hill, that was fully described and illustrated in the issue of March, 1921, of this magazine, has already led to several interesting new applications of the radiophone. One of the most recent is an attempt to adapt it to their service by the Police Department of Chicago. It will be remembered that the principal point about this new radio antenna was that it entirely eliminates the use of any receiving apparatus other than a detector and a pair of phones. It can be made small enough to be carried in the pocket. The work of the Chicago Police Department is still in the experimental stage, but it had gone so far as to fully equip an auto mobile for both trans-

mitting and receiving wireless messages. It is fitted with this new resonance wave coil, and may eventually prove to be of inestimable value in the detection of crime by maintaining constant communication with police officers wherever situated. In its fullest development this would include small pocket sets that could be carried by the officers, and make communication possible under all conditions. These last, however, are the most experimental part of the enterprise. When they are developed they will take the form of small receiving sets that can be carried in the pocket, and in connection with which will be a small buzzer, worn on the sleeve of the officer's uniform, that would operate by an impulse from any of the department's sending stations.

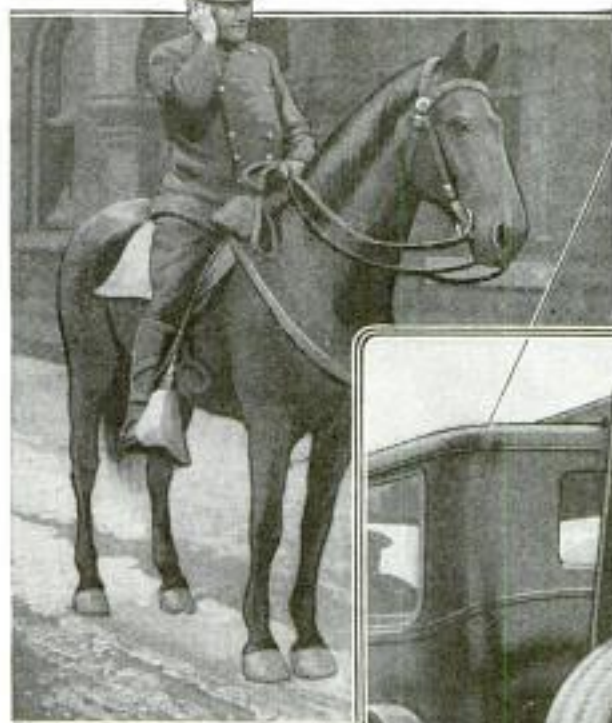

Above: Mounted Police Officer Who Carries, in Addition to Warning Buzzer on Sleeve, a Small Receiving Set Which He is Holding to His Ear



Above: Police Officer with Wireless Receiving Apparatus Pinned on His Sleeve. An Impulse from the Transmitting Station Makes It Buzz Audibly, and Notifies the Officer That He should Hasten to the Nearest Station

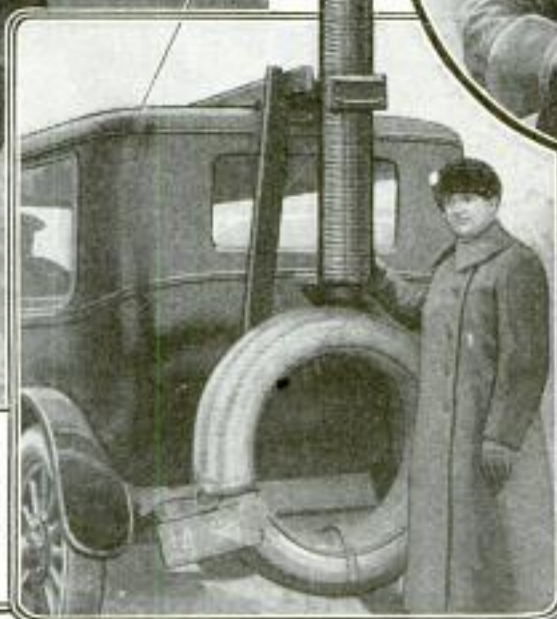

Left: Automobile Equipped by Chicago Police Department with New Resonance-Wave-Coil Antenna, Enabling the Car to be Used for Both Receiving and Transmitting Wireless Messages

Inventor **Claude Woodall**, **Supply Okla.**
 490 POPULAR MECHANICS
 Inventor **M. Berger**
 22 ^{Uranibae} **Uranistrasse**
 Zurich, Switzerland.

8225

KAFIR-CORN HARVESTER HEADS TWO ROWS SIMULTANEOUSLY

Cutting the heads from two rows of Kafir corn in one operation is possible with a header produced by an Oklahoma

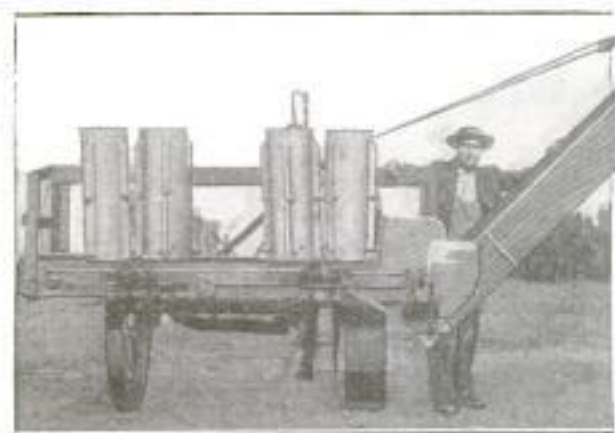

Kafir-Corn Header, Showing the Four Revolving Cylinders with Projecting Vanes, and the Loading Conveyor

farmer. The cutting mechanism consists of two keen-edged disks placed horizontally with the edges overlapping, which can be raised or lowered according to the height of the corn. On the top of each disk is a cylinder, about 3 ft. in height, from which project vanes forming a "V" with the body of the cylinders, so that when the pair of cylinders revolves inward, like the disks, the corn is fed to the sharp cutters, after which the grain is thrown upon a conveyor that loads it into a wagon. There are two of these cutting units on the machine, one of which is movable laterally so that adjustment can be made for different spacings between the rows.

8203

ICE BOATS THAT RIVAL SPEED OF HYDROGLIDERS

Ice boats that skim over the ice much as hydrogliders skim over the water, and that resemble these gliders in many other respects, are now becoming quite common wherever ice boating is a favorite sport. These ice boats follow, more or less closely, the lines of the airplane, and in all cases are driven by an air propeller, and usually a motor of the airplane type. Two notable examples attracted much attention this winter at Grosse Point, a fashionable suburb of Detroit, Mich. One of these ice boats was constructed largely from the parts of a standard small light automobile, with the same motor, which was belt-connected to the propeller at the bow of the boat. The other machine had the motor and propeller mounted at the

A silencer for airplane engines has recently been brought out by a Swiss engineer. It consists of a steel cylinder of streamline form with interior baffles which divide it longitudinally into three compartments. Exhaust gases enter at the rear, expand through the three compartments, and pass out through holes in the front. Over the front is a shield with spiral vanes which is rotated by the blast from the propeller.

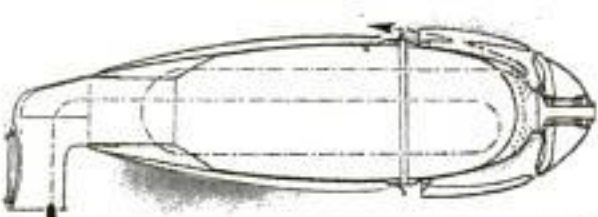

Above: Cross Section of the Silencer, Showing the Path of the Expanding Exhaust Gases. Below: When Running, the Blast from the Propeller Causes the Front Shell of the Silencer to Revolve Rapidly

"Silencer Ad. Ober"

stern, on a frame 3 ft. 6 in. high. A much larger and more pretentious type of these machines is one that, during this winter, has been skimming over the ice daily at Crystal Lake, Ill. It has accommodation for 10 passengers, besides the driver, who sits in front, and the helmsman, who sits in the rear. The hull of the boat is like a huge fuselage, and at its prow is an air propeller, driven by a 90-hp. airplane motor. Like its insigne—an angry cat, graphically shown thereon—it has an elevated tail that, together with adjoining horizontal planes, is the means of steering and steadying it in airplane fashion. It may be run on pneumatic-tired wheels, or on bobsleigh runners. It is the first boat of this type operated commercially.

8303 cont. C. E. Stevens

3312 Maconck Ave. Swiss City Iowa

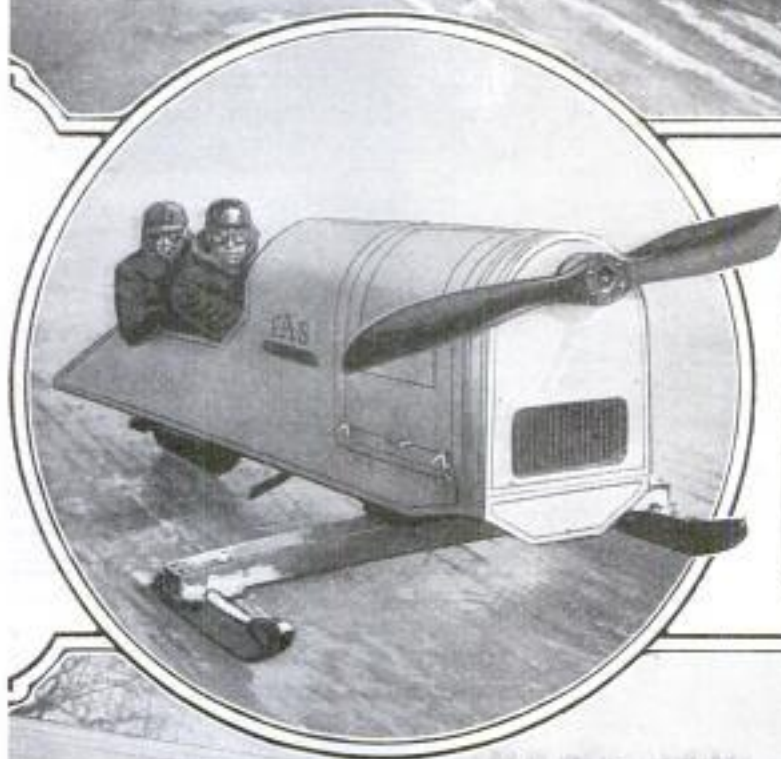
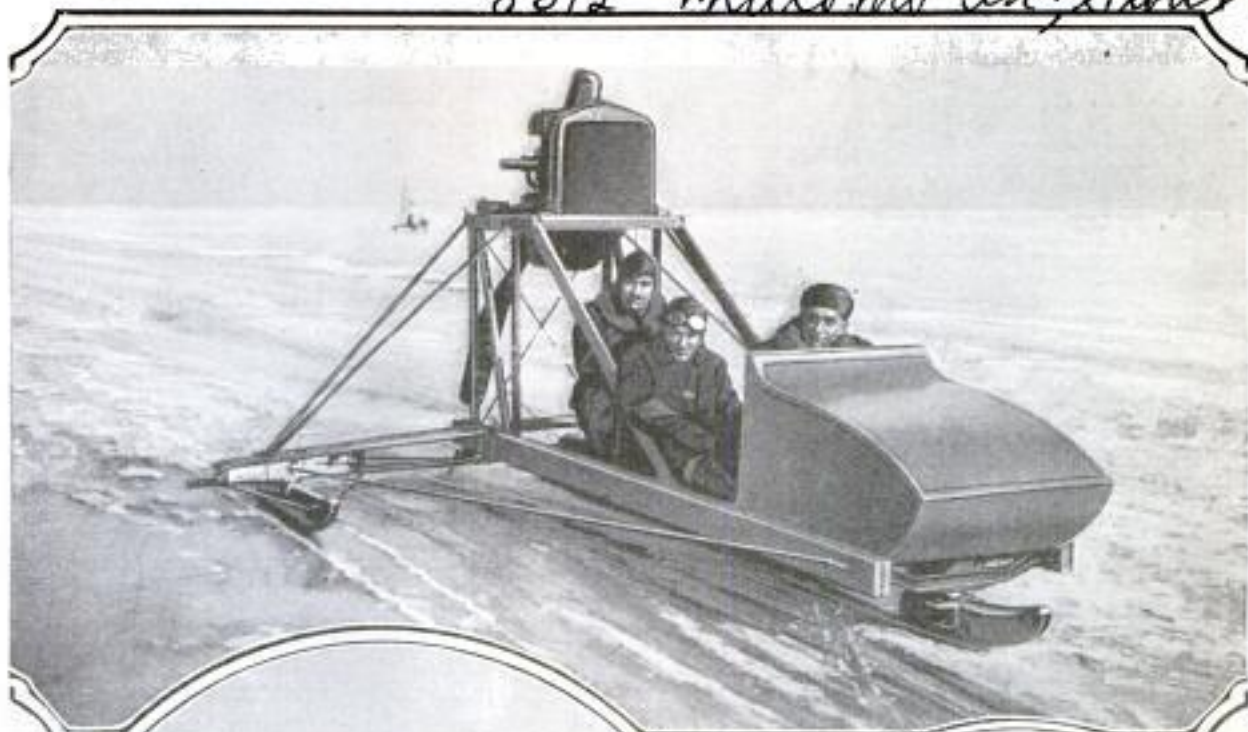

Above and at Left Are Two Ice Boats Driven by Air Propellers. That Took Part This Winter in the Ice-Boat Races, Held Annually at Grosse Point, a Fashionable Suburb of Detroit. This Year the Ice Was Exceptionally Good, and Some of the Boats Attained a Speed of 60 Miles an Hour. The Machine at the Left was Built Almost Entirely of Parts from a Small, Light Automobile, with Its Propeller Belt-Driven by the Auto Motor. The Ice Boat Above Is More Freakish, with Motor and Propeller Mounted Astern as Seen.

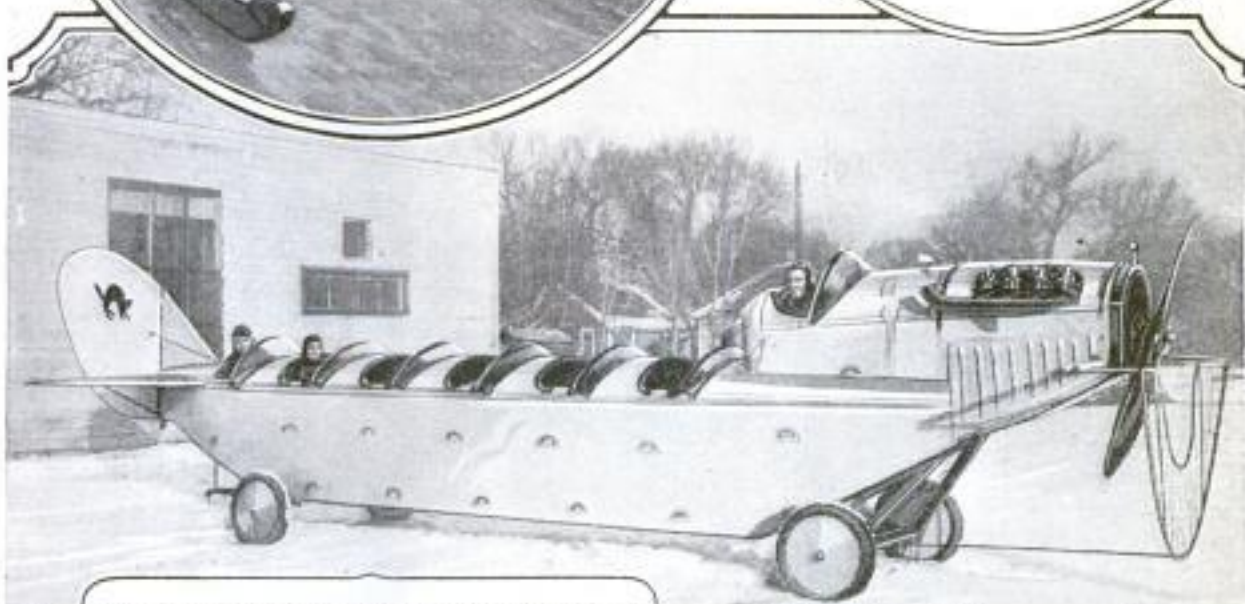

Ice Boat That Carries 10 Passengers Sight-Seeing at Crystal Lake, Illinois: Air-Propelled, as Seen, It Runs Either on Wheels or Runners

Telepho Wash Co.,
 492 *219 S Dearborn*
POPULAR MECHANICS
Chicago

**8109 SAFETY TELEPHONE HOLDER
 FITS TOP OF COIN BOX**

It is not always convenient to provide a table or stand for the regular desk telephone, but this is no longer necessary, as a holder has lately been devised which fits over the coin box and holds the telephone securely when not in use. The device consists of a metal shelf provided with two spring clips which fit



the base of the instrument, the shelf being extended to fit the coin box and provide means of fastening the holder to the wall.

**INVESTIGATE DEHYDRATORS
 13 FOR FRUIT DRYING**

Recent extensive investigations of many different types of dehydrators have shown that a completely equipped and satisfactory dehydrator can be built for not over \$500 per green-ton capacity per 24 hours. This includes cost of trays, cars, and all necessary equipment. It was found that the air-blast tunnel type of

dehydrator is the most economical to operate in regard to both fixed charges and operating costs. The cost of dehydration varies from \$6.68 to \$22.89 per green ton, depending on the cost of fuel and labor, type of plant used, and kind of fruit dried.

**SIX NEW INSTRUMENTS ADDED
 8351 TO THE VIOLIN FAMILY**

It has been said by musicians that the violin family is composed of two pygmies—the violin and the viola—and two giants—the violoncello and the double bass. It is reasonable to suppose that the great gap between these two extremes could be advantageously diminished. It is not surprising then that two well-known French musicians, father and son, have, after years of study and experimentation, created a number of intermediary instruments. They have entirely changed the nature of the violin family. They have retained the four older members, and they have added six new ones, that now make it a family of ten. At the bottom of the scale remains the double bass. Between that and the old violoncello comes a new instrument, called the sub-bass. Bridging the gap between the violoncello and the viola are three new instruments, successively called barytone, tenor, and contralto, which are played like the violoncello. Between the viola and the violin comes a new instrument called mezzo-soprano, and the violin gets a smaller brother, called super-soprano. They afford added resource in composition.

*University of California Press
 Nov. 1921
 Bulletin 338*

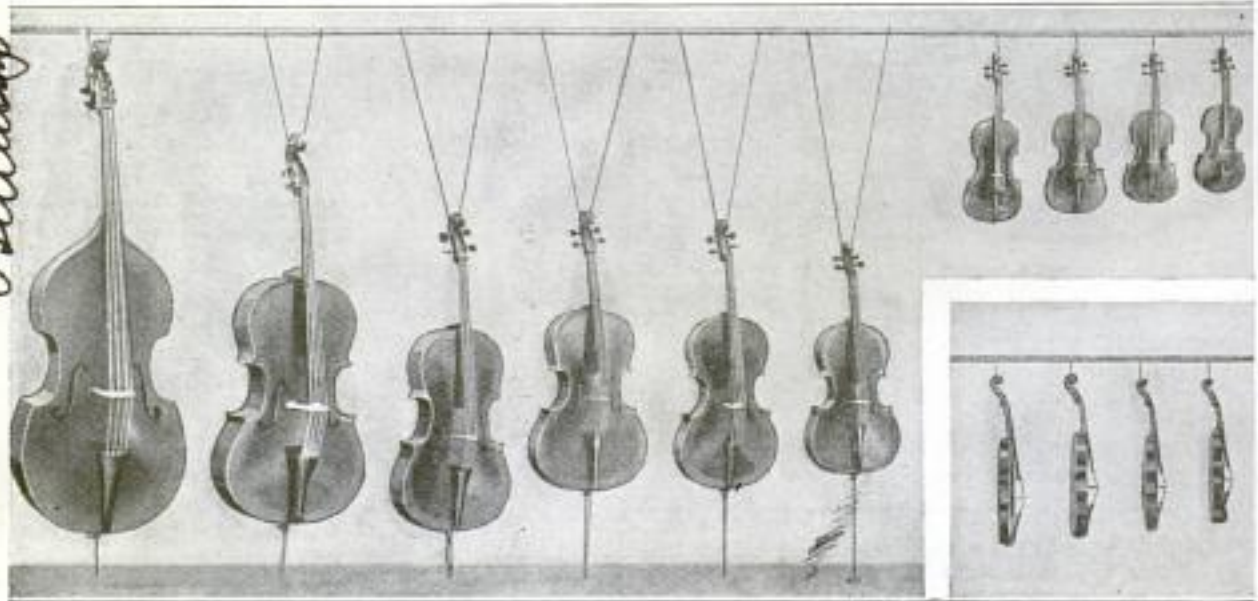

The Violin Family as Now Constituted Is as Follows, Reading from Left to Right: Double-Bass (Old), Sub-Bass (New), Violoncello (Old), Barytone, Tenor, and Contralto (All Three New). Above and Below, Two Views of Viola (Old), Mezzo-Soprano (New), Violin (Old), and Super-Soprano (New)

L'illustration 1/14/22

8275
Cml. George H. Paul

8440

900 Ellsworth Bldg

POPULAR MECHANICS

493

Chicago
**AERIAL CABLEWAY CARRIES
TOOL SHED ACROSS RIVER**

**MOVIES IN HOME OF FARMER
ACT AS TRACTOR SALESMEN**

Aerial transportation has proved a great aid during construction work on the Marseilles locks of the Illinois Waterway, where many engineering difficulties have been encountered. A cableway has been built, which has a span of 1,400 ft. and a carrying capacity of 10 tons, and with which a tool-storage house, 16 by 40

Tractors are now being sold by using a motion-picture outfit as a salesman, ac-

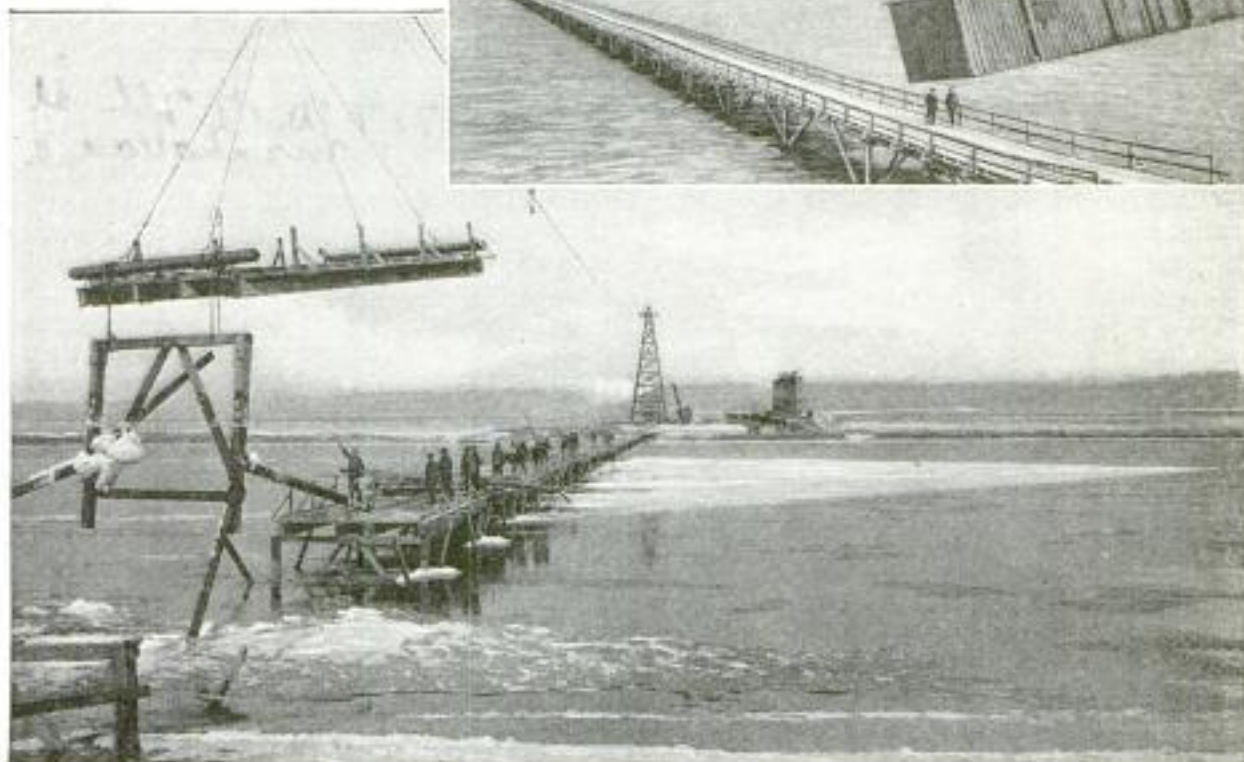

At the Top is Seen the Tool-Storage House being Carried across the River by Means of the Cableway, While at the Bottom the Cableway is Shown Transporting the Temporary Bridge from the River to the Shore

ft. in size and weighing more than six tons, was safely transported across the river. A bridge had been placed across the stream to afford a means of delivering the concrete to the locks under construction, but with the coming of cold weather ice jams formed that compelled the engineers to remove the bridge to save it from being swept downstream. Accordingly the cableway was again pressed into service, and the heavy structure, one section at a time, was easily lifted and carried to the shore to remain until spring, when similar methods would be used in its replacement.

Extensive experiments are to be made with the natural tar sands of Alberta, Can., to determine their suitability as a road-base material.

According to the idea utilized by a Bloomington, Ind., manufacturing company. A house-to-house selling campaign is in progress, whereby the farmer can see the merits of the implement he is asked to buy, displayed under actual working conditions upon a portable screen, or sheet, which is erected in his home. In addition to showing pictures of its product, this concern conducts a four-course school, for which no tuition is charged, and where the buyers can learn how properly to operate, take down for repairs, and rebuild the machine, thus assuring the farmer a future saving of time and money. Since inaugurating this method of selling, the firm in question claims the greatest number of tractor sales in that state, which fact seems to prove the efficiency of the method.

Bloomington
Ill.
Braham Motor Sales Co.

8277

Luce Cane Harvester Co
1540 Broadway
New York City

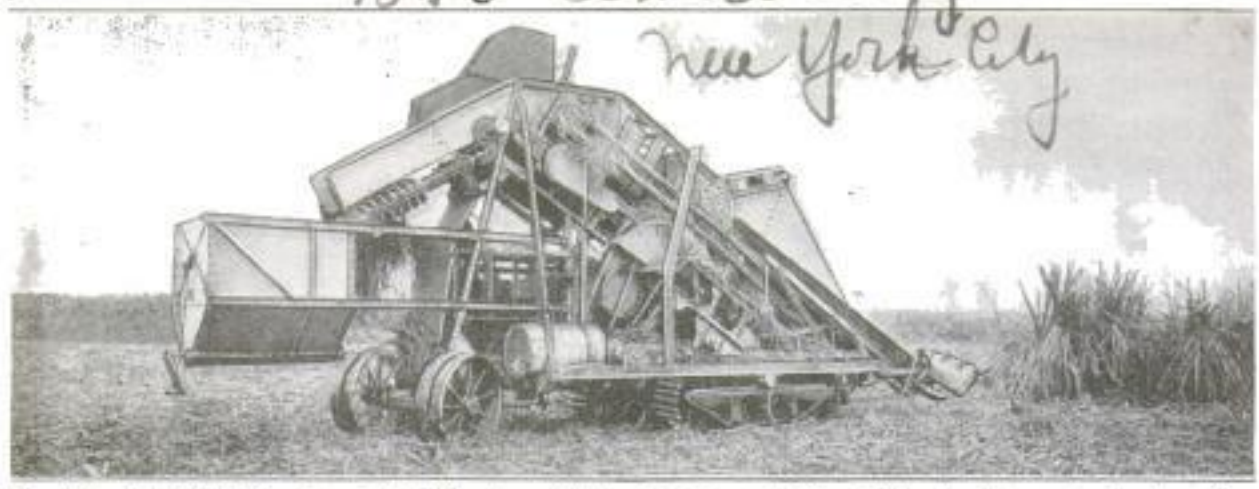

The "Trash," Which Consists of the Brushes and Tops Cut from the Cane Stalks, is Thrown to the Ground at the Sides and Back of the Machine, While the Clean Cane, Ready for the Crushing Rolls, Goes to the Hopper

MACHINE HARVESTS SUGAR CANE

BY ROBERT GRIMSHAW, 717 W. 17th St. Manhattan, N. Y.

EVER since cane has been the principal source of sirup and sugar the same crude methods of harvesting have been employed. A laborer, using a large knife, hacks off the cane stalk near the ground, removes the top and leaves, and loads the cane into cars or carts. Even under favorable conditions an expert can harvest only about four tons of standing stalk per day, and as the harvesting must be done in only a few months, a veritable army of laborers is required to handle the crop. Because an indolent type of labor is employed, it is almost impossible to induce them to work full time steadily.

Under such conditions, it is only natural that attempts should be made to develop a machine for harvesting the cane, and many have been made, but only recently has a machine been devised and used in Cuba, which promises to fulfill requirements. The problem of machine harvesting has not been an easy one to solve, for the cane stalks vary from 3/4 in. to 1 1/2 in. thick at the butt and are from 8 ft. to 14 ft. high. As the lower part of the stalk has the greater contents and a higher percentage of juice, it is necessary

that the stalks should be cut off at, or even below, the ground. In topping, only the tassel and the top joint should be removed and discarded.

The present machine is of the tractor type; is driven by an 80-hp. gasoline engine and has three speeds ahead and reverse. While harvesting, it can move at 60 ft. or 120 ft. per minute, while on the



The Harvester, in Passing, Cuts the Cane Stalks at, or below, the Ground Line and Delivers the Cane, Free of Trash, to the Hopper at the Rear or to a Trailer

road it has a speed of 4 1/2 miles per hour. In harvesting, the machine is driven forward into the standing cane, which is cut off at, or even a trifle below, the ground level, by two horizontal, overlapping, inwardly rotating disks. Conveyor chains then take the stalks one by one upward and backward through the machine.

During their passage the stalks are stripped of brushes and topped and are then dumped into a hopper behind the machine or into a trailer. The trash removed from the stalks is kept separate so that no trash is mixed with the cane that is to go to the crushing rolls. The machine itself is 31 ft. long, has a 20-ft. wheelbase with tractor treads 6 ft. long, but can turn in a circle of 30-ft. radius. The operator stands on a platform at one side of the

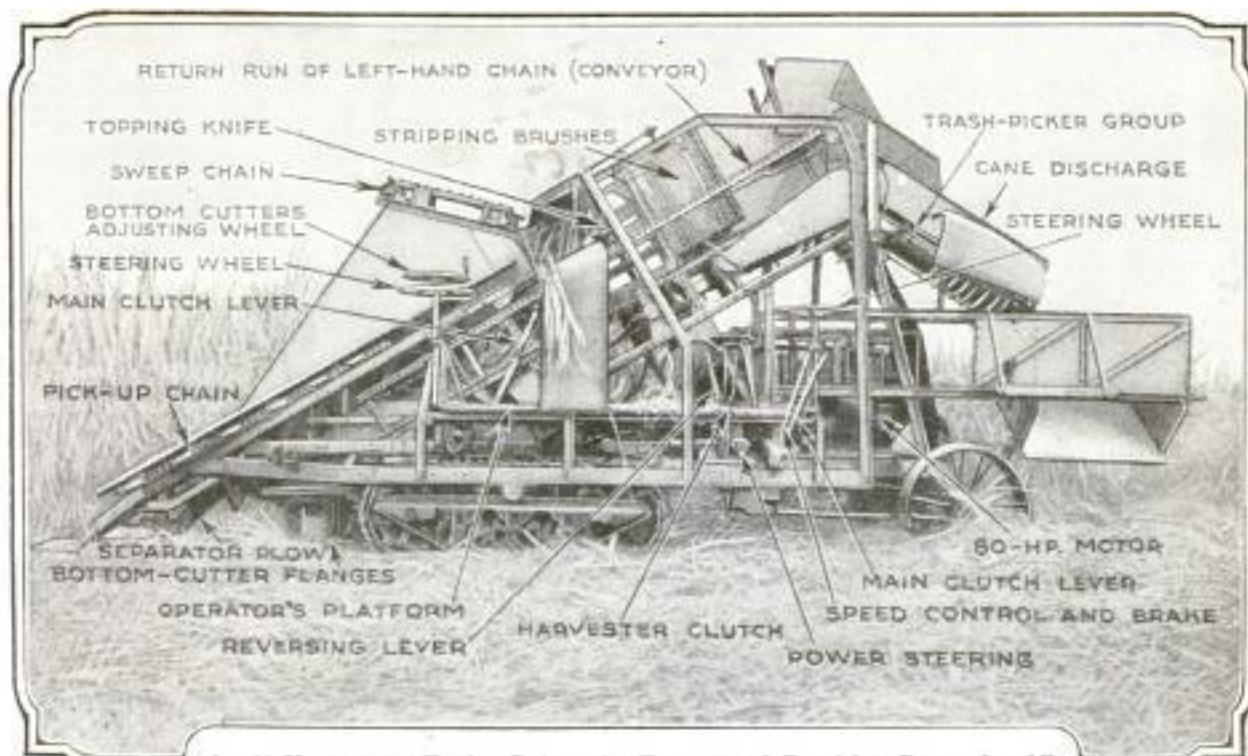

An 80-Horsepower Engine Drives the Tractor and Furnishes Power for All of the Harvesting Operations. The Operating Crew Rides on a Platform on the Side of the Machine and Directs Its Movements by Means of Conveniently Placed Levers and Wheels. The Machine, Which Has an Over-All Length of 31 Feet and a Wheelbase of 20 Feet, with Tractor Treads Six Feet Long, can Turn in a Circle of Only 30-Feet Radius.

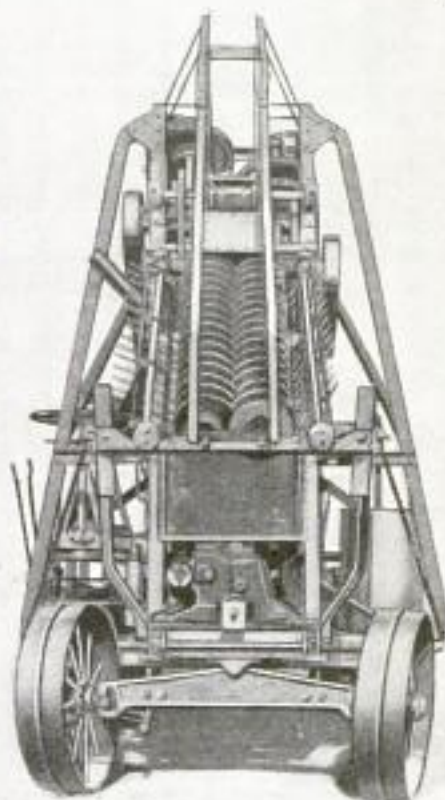
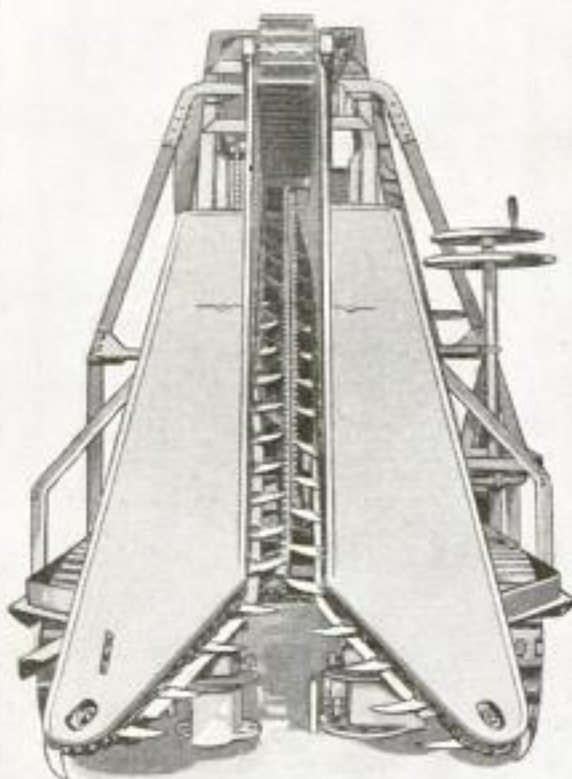

Left: Front View of the Harvester as It would Appear When Advancing into the Standing Cane. Two Overlapping Rotating Disks Cut Off the Stalks, Which are Then Carried Upward and Backward through the Machine, Where the Brush and Tops are Cut Off and Removed. Right: Rear View of the Machine with Hopper Removed. The Trash is Thrown to the Sides of the Machine, While the Cane is Delivered at the Rear to a Hopper or Trailer.

8386

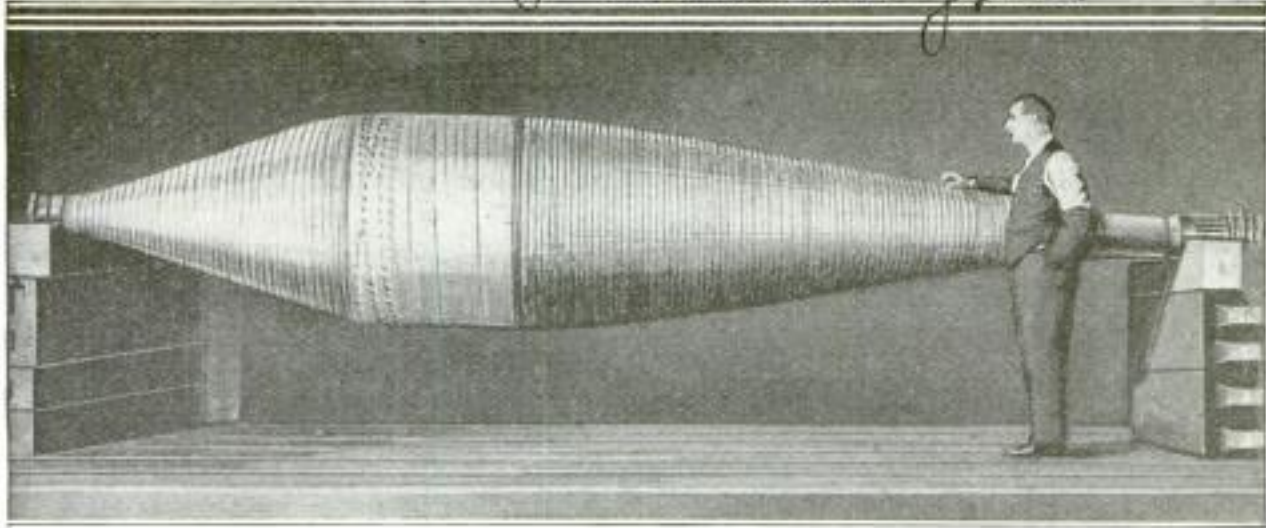
Westinghouse Electric & Mfg. Co.
East Pittsburgh, Pa.

This Terminal Bushing Weighs 9,000 Pounds, Is 19 Feet in Length, 41½ Inches in Diameter, Making It One of the Largest Ever Built, and is Used to Bring the Line Lead Out of the Transformer Tank

MILLION-VOLT TRANSFORMER FOR LABORATORY

One million volts is the capacity of a mammoth transformer, which has recently been installed in the Westinghouse experimental laboratory at Trafford City, Pa. The huge product possesses unusual winding features, that make it exceptionally well fitted for very high voltage testing, and is of the core form of construction, common to this type of transformer. The windings contain nearly 70 miles of wire, are divided into many cylindrical coils, each consisting of a layer of copper turns wound upon an insulating tube, and as the coils increase in diameter they decrease in length. There are two sets of windings, one on each leg of the core, and these are cross-connected so as to produce a progressively increasing voltage "above ground," from the inner, or smallest-diameter coils, to those of the outer, or largest diameter.

The terminal bushing, through which the line lead is brought out of the transformer tank, measures 19 ft. in length, 41½ in. in diameter, weighs 9,000 lb., and is the largest ever built by the makers. Various tests

have been made in the past at approximately 1,000,000 volts, but these tests were accomplished by connecting two



Million-Volt Transformer in Course of Construction, Showing the Completed Windings on the Two Legs of the Core and Illustrating How the Coils Increase in Diameter as They Decrease in Length

transformers in series, "grounding" the connection between them, and then using the voltage across the line terminals. With the completion of the new transformer, experiments more reliable in

character can be made by delivering the full 1,000,000 volts "above ground," and it is believed that this latest development will prove of great value to electrical progress.

8349

**ADJUSTABLE-HEIGHT BURNER
REDUCES GAS CONSUMPTION**

Recent tests by the Bureau of Standards show that the distance between the

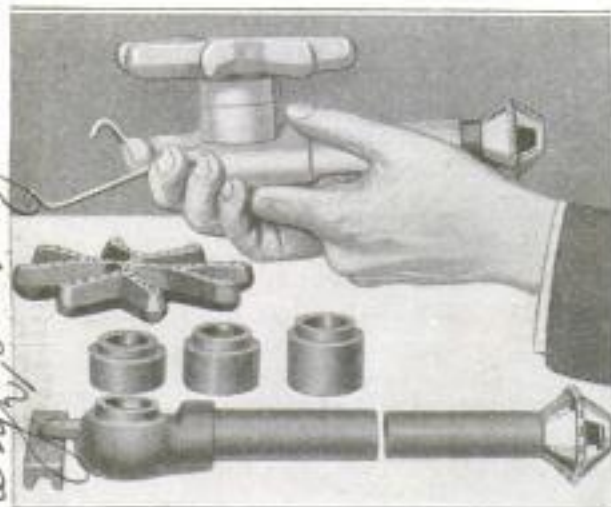

To Insure the Lowest Gas Consumption in Cooking, the Height of This Burner may be Changed by Inserting One or More of the Extra Bushings Provided

gas burner and the cooking utensil has an important bearing on the amount of gas consumed in cooking, and an adjustable-height burner has been developed to take advantage of this fact. Where natural gas under high pressure is used, the regular burner is set very low. As the pressure of the gas gradually decreases, the height of the burner may be changed

by inserting one or more of the bushings provided, thereby keeping the flame at the proper distance to give the greatest efficiency.

8277

**CARRIER REMOVES INVALID
FROM BED PAINLESSLY**

Sometimes, to the patient, the most painful part of a surgical operation is the removal from the bed to the operating table. When this is the case, the most painful part of this proceeding is while being manually lifted, generally by two attendants, from the bed to the stretcher. A recently patented invalid carrier transfers the patient from the bed to the carrier quite painlessly, and without any perceptible lift, then rolls smoothly to the operating table, to which, just as painlessly, the patient is again transferred, without any perceptible drop. The recumbent invalid is thus raised and lowered by means of a flexible sheet, formed of stout canvas with thin-steel transverse stiffening bars, which from a rolled-up position at the invalid's feet is unrolled by turning a handwheel until it gradually moves under the whole length of the patient's body, in which position it forms a comfortable stretcher, with the bed pillow still under the patient's head. The stretcher frame is slung by chains from a supporting portable frame.

Cont. John H. Schales 813 Union Bank Bldg.
 Mr. General Esas Light Co., 214 Wood St. Pittsburgh, Pa.

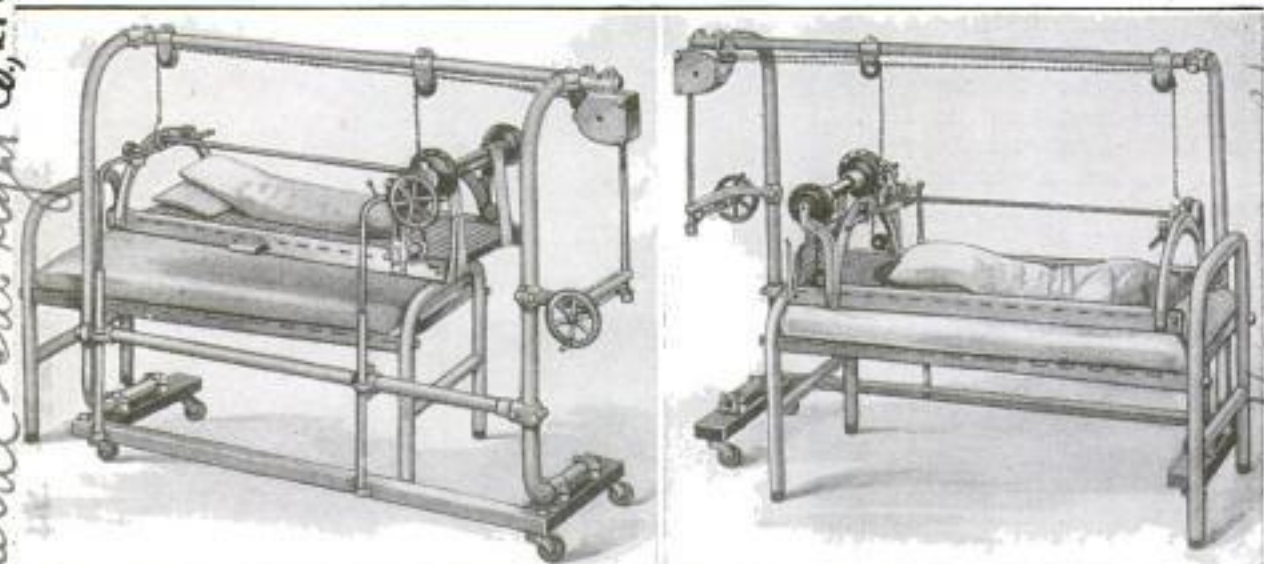

Invalid Carrier That Lifts Patient from Bed Painlessly. Left: Dummy, Representing Patient, is Shown Transferred from Bed to the Carrier. Right: Dummy being Transferred by Unrolling of Flexible Canvas Sheet

Cont. Jno. W. Severn, Chicago
 3103 Armitage Av.

Herman Dignets
 d no.

8364

John L. Slougheny
643 Arvidale,
POPULAR MECHANICS

Toledo, Ohio 1919

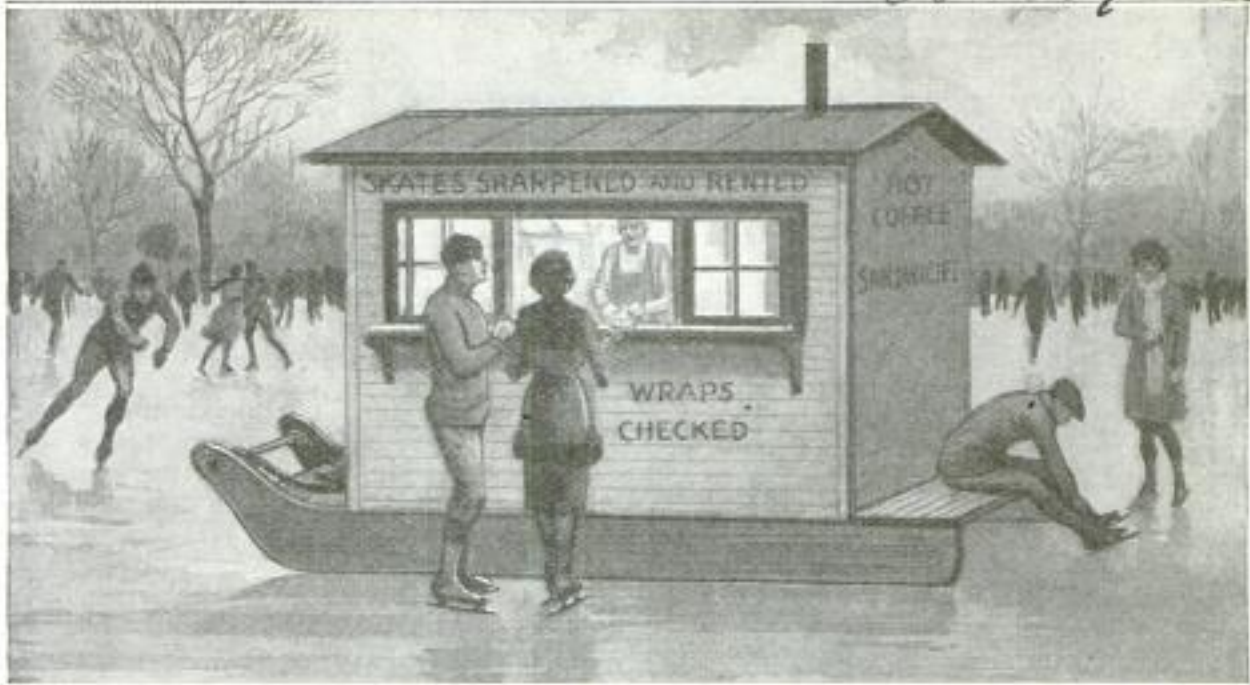

Portable Lunch Booth Mounted on a Large Sled So That It can be Pushed from Place to Place on the Ice-Skating Rink, and from Which Coffee and Sandwiches are Sold, and Other Services Rendered to the Devotees of This Exhilarating Sport

8364

**PORTABLE LUNCH BOOTHS
ON ICE-SKATING RINK --**

Thousands of persons enjoy the ice skating on the Maumee River at Toledo, Ohio, and a new industry has sprung up there—that of selling hot coffee and sandwiches on the ice. Booths, mounted on large sleds, contain facilities for this service, and also serve as checkrooms, or for the renting and sharpening of skates. It is said that this plan of catering to the skaters has been profitable for the originators of the venture, and is welcomed by the throngs of pleasure seekers.

8434

**TENSILE STRENGTH OF PAPER
INCREASED BY RUBBER LATEX**

It is claimed for a new process in the manufacture of paper that it will not only reduce the cost and simplify the methods of manufacture, but will also greatly improve the quality of the product. The keynote of the process is the addition of small quantities of rubber latex to the fibers used in paper making. Experiments showed that fiber made into paper containing .1 per cent rubber could be folded and refolded without breaking, 5,000 to 6,000 times, while paper made in the usual manner had a folding number of only 30. Tests of the tensile strength of this product containing one per cent rubber seem to indicate that it may find uses in the manufacture of rubber tires for automobiles or trucks.

**INSTALL TELEPHONE CABLE
CONTAINING 2,424 WIRES**

834

Underground telephone cables are laid in all the larger cities of this country, although few persons realize their presence. The largest of these cables ever installed, in Portland, Ore., is now being pulled into the conduits, or ducts, of the Pacific Telephone and Telegraph Company, and contains 2,424 wires, or 1,212 pairs. The numerous conductors are

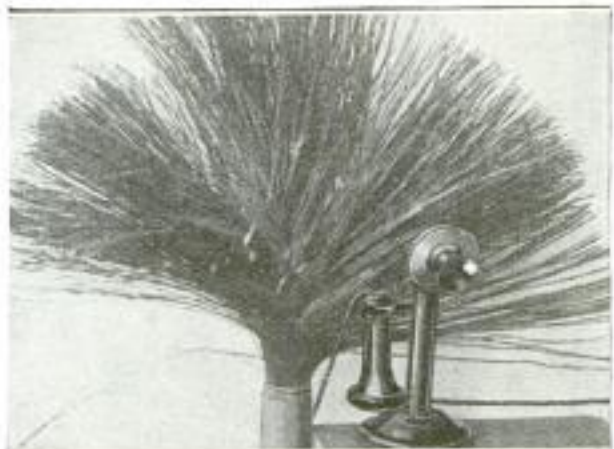

Telephone Cable with Lead Covering, or Sheath, Removed, Showing the Mass of Wires inside, as Compared with Size of Ordinary Phone

compactly compressed inside a lead sheath, 2½ in. in diameter, and present a strange appearance when the outer covering is removed for splicing, testing, or any other purpose necessary to the maintenance of the intricate telephone system.

Report from Council of Singapore
 Ward Beach Road Straits Settlements

Ammerce 2/19/22
 d. no. H. research 1 Kaye

Out. H. E. Sigurd
 911 Cluncky Ave.
 Portland Ore.

Copyrighted material

Clms. W. D. J. Atlas Sherman
 500 *Clay & Co.* *San Francisco Calif*
 POPULAR MECHANICS

ELECTRIC LIGHTS ON PIANO
SHOW TONAL PRODUCTION

8312

For the demonstration of the tonal production of player pianos a column of 15 electric lights is connected to the bel-

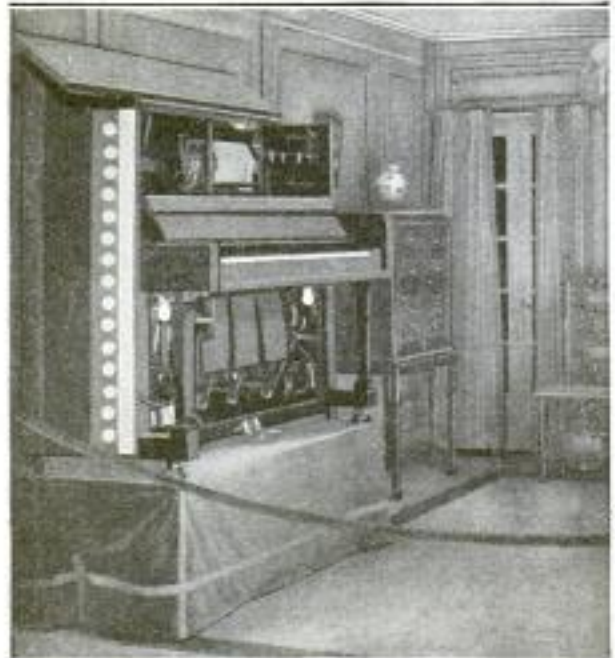

Player Piano Connected to a Column of 15 Electric Lights Which can be Made to Show the Gradual Increase in Tonal Production from the Most Delicate Touch Obtainable by the Artist to Fortissimo

lows, and thence indirectly to the tracker bar of the piano in such a manner that, as the music roll passes over the series of 15 holes in the tracker bar, corresponding holes in the roll turn on one or more of the lights, and also increase the tonal

production, until at fortissimo all the lights are ignited. Thus the music roll can be perforated so as to give any tonal expression desired, with modulations of 15 degrees between pianissimo and fortissimo. Electric contacts on the bellows operate the lights.

8422

PRESSURE INSIDE TANK CARS
GREATER WHEN STANDING

Recent investigations have shown the rather surprising fact that the pressure developed in tank cars loaded with natural-gas gasoline is considerably less while in transit than while the cars are standing still. This is no doubt due to the fact that, while moving, the gasoline is constantly agitated, preventing the surface of the gasoline from reaching as high a temperature as when standing.

Reason of higher temp. of standing

ROTARY SNOWPLOW FOR ROADS
IS DRIVEN BY TRACTOR

8376

Taking account of the increase in automobile travel, it is not surprising that the tractor should be linked with the rotary snowplow in an attempt to keep roads open during the winter. One such unit has already been designed and tested with considerable success. A 60-hp. tractor furnishes the power. Plans are being made to use a fleet of these machines to keep the auto roads in the Yosemite open during the winter months and thus make possible touring through the park at all seasons of the year.



Above: The Rotary Snowplow is Combined into One Unit with the Tractor and is Driven by the Tractor Engine. As It is Forced Ahead, the Wings and Scoop Bank the Snow Up in Front of the Fan. Left: The Fan Cuts into the Snow and Throws It Clear of the Road by Means of the Deflector Mounted above the Fan

ACCURATE FORECASTING OF EARTHQUAKES NOW SCIENTIFIC POSSIBILITY

By H. H. DUNN,

*2616 Parker St
Berkeley Calif*



Dr. Andrew C. Lawson, Professor of Geology at the University of California. Who has Made Possible the Forecasting of Earthquakes

PREDICTION of earthquakes, with the same accuracy with which conditions of the weather are now foretold, has become possible, according to a discovery just made by Dr. Andrew C. Lawson, professor of geology at the University of California. However, the theory will necessarily have to be checked against the actual occurrences over a period of years before the scientists would dare to make public their forecasts in advance of the disturbances.

The discovery of the method of forecasting the time and place of earthquakes follows, and is based upon, another recent discovery, also made by Professor Lawson, that movements of the earth's surface, technically known as "the creep of the earth's crust," are antecedent to, as well as consequences of, earthquakes. That is to say, the crust of the globe, to a depth varying from a few feet to scores of miles, is constantly on the move, in a generally northward direction, though during and following earthquakes, such movement may be in two or more directions.

This latter discovery is of far greater interest to scientists than the forecasting of the earthquakes, or the discovery of the method of forecasting. Thus, Doctor Lawson, by his two discoveries, has added tremendously, not only to the available knowledge of the globe on which we live and its movements within itself, but to the safety of millions of persons who live in zones in which earthquakes have occurred and may occur again.

The creep of the earth's crust, to explain it briefly and in nontechnical language, is due indirectly to the fact that the poles of the earth do not run true. The North Pole describes a circle of about 60-ft. diameter every time the earth revolves on its axis. It is as if the earth were a globe revolving on a shaft which oscillated around its center. While this deviation of a 60-ft. circle is so small, in view of the size of the earth, as to be almost infinitesimal, it is sufficient to set the soil and the rocks, even the mountains and the valleys, in a slow but steady motion, usually to the northward.

Like a liquid tide setting ever in one direction, this current of earth creates a tremendous strain in its own mass. The pull is so great that a distinctly measurable tension ensues in all the layer of earth crust which is creeping. When this

tension reaches a certain point, something has to give way. The result is a tearing open of the earth's crust, and a backward or a sideways motion—which Doctor Lawson calls "the elastic rebound"—and the visible, tangible phenomenon known as an earthquake occurs. As soon as Doctor Lawson had definitely established the creep of the earth's surface, and its rebound under the strain of its own tremendous weight, he said:

"If we find the rate of creep and the length of time necessary to produce the limit of tension in the earth's crust, we shall know when and where there is to be the next earthquake, merely by watching closely the increase in tension."

It is necessary, however, that constant, consistent, accurate observations of the rate of the creep of the earth's crust be made at frequent intervals. With the known factors of the time and rate of creep necessary to create the limit of tension in the earth's crust, the observer knows all the time whether or not there is to be an earthquake in his section of the world, and, by the rate of creep, the time the elastic rebound will take place, within a few hours. "This gives to the forecasting of earthquakes," says the University of California, in its bulletin announcing Doctor Lawson's double discovery, "the same precision as that with which weather forecasts are made."

With the object of establishing the exact rate of creep of the earth's crust along the Pacific slope, and of fixing the limit of tension which that crust will endure, the University of California has appropriated \$4,000 for the purchase of a photographic latitude telescope, to be installed and used in the observatory on Mt. Hamilton, California, permanently. Arrangements also have been made for Doctor Lawson, W. W. Campbell, director of the Lick Observatory on Mt. Hamilton, and R. H. Tucker, astronomer, to make continuous studies of this earth movement, all along the Pacific slope, tabulating the results, and thereby establishing records and tables from which all necessary data regarding the creep, tension, and rebound may be obtained at a moment's glance.

During past seismic disturbances entire mountains have been moved as much as 5 or 6 ft.; other areas have been moved even farther; buildings, fences, monuments, trees, and similar ordinarily fixed objects, having been carried 10 or 12 ft., without being damaged, by a movement of the entire crust of the earth for a considerable distance around the object moved. The segment of the earth's crust which moved prior to the Pacific coast earthquake of April, 1906, is estimated to have been approximately 15,000 square miles in area, and about 65 miles in depth—that is to say, 975,000 cubic miles of earth shifted distances varying from 1 ft. to 10 or 12 ft., depending on its distance from the main center of disturbance, the so-called "San Andreas fault," running, roughly, southeast to northwest, and disappearing in the Pacific Ocean.

With these conditions, it is obvious that the only manner in which the position of any point on the earth's surface can be fixed, is by accurate astronomical observations at regular intervals. Even by this method, a certain amount of error creeps in, but much of

this error will be eliminated by the use of the Ross photographic latitude telescope, which surpasses the international latitude instrument (visual) in accuracy. It records on the photographic plate, automatically, and so removes the human element in recording its own observations.

Some of the figures obtained by Doctor Lawson in his investigations of the creep of the earth's crust are of surprising interest, as denoting the movements which supposedly immovable mountains and hills have made prior to, during, and after earthquakes. From 1854 to 1906, for example, Mt. Tamalpais, a peak rather more than 2,000 ft. in height, on the Marin Peninsula, north of the Golden Gate entrance to San Francisco Bay, moved, by strain creep, 9.97 ft. in a north-northwesterly direction. In 1906 it moved, by elastic rebound, 6.46 ft. in a

south-southeasterly direction, but not along the line of the previous movement.

Some of the interesting movements of fixed points in this same section, as discovered by Doctor Lawson, are shown in the accompanying table, which covers two periods, from 1868 to 1874, over the earthquake of 1868, and from 1892 to 1906, over the earthquake of 1906. The directions given are east and west of the San Andreas fault.

Place.	Movement (in Feet) 1868-1874	Movement (in Feet) 1892-1906	Miles and Direction from Fault
Mt. Tamalpais.....	5.4	1.9	4—E
Farallon Lighthouse	4.6	5.8	23—W
Pt. Reyes Hill.....	5.0	12.2	1.7—W
Ross Mountain.....	5.6	1.8	4.3—E
Bodega Head.....	5.3	11.8	1.4—W
Tomaes Point.....	5.2	11.8	1.2—W
Mershon	5.2	6.4	.7—E
Hammond	5.1	7.5	.7—E
Chaparral	6.0	4.4	1.1—E
Loma Prieta.....	9.9	3.2	3.0—E



Prior to the Earthquake of 1906 This Building Stood at the Point Marked by the Black Stake. During the Quake the Building and Part of the Back Fence were Moved a Distance of 12 Feet to Their Present Location

Interesting comparisons between the movement due to strain creep and the backward, or sideways-backward, movement due to rebound, of several points, are made by Doctor Lawson. For instance, Chaparral moved 8.56 ft., almost due north, by strain creep, from 1856 to 1906, and in a few

seconds in 1906 moved backward, by elastic rebound, in a southeasterly direction, 6.76 ft.; almost as much as it had moved in the previous 50 years. Farallon Lighthouse, located on an island off the Golden Gate, moved 6.76 ft., in a northwesterly direction, by strain creep, in the 46 years between 1860 and 1906, and in the short duration of the earthquake of 1906, moved by rebound 4.23 ft., almost due west. Other places and groups of places moved similarly, but in varying directions. Yet, out of all these movements, closely recorded, studied, compared, and tabulated, order can be worked, and the rate of creep, as well as of rebound, ascertained. Differences of soil characteristics, and of subsoil structure, have to be taken into consideration, since some forms of soil and rock will endure more strain than others before reaching the breaking point.



"Giant's Stairway," Formed during the Earthquake of 1906: When the Tension in the Earth's Crust, Due to the "Creep," Became Greater Than the Resistive Strength of the Formation, "Elastic Rebound" Occurred and Portions of the Crust Moved with Respect to Each Other

One interesting feature of these studies is that no general change of elevation of any of the points has been found "of sufficient magnitude to be detected with certainty." The announcement of this remarkable discovery by the University of California, through the office of President David P. Barrows, says, in part:

"It is well known that, on the occasion of the April, 1906, earthquake, there was a relative displacement of the earth's surface stratum on the two sides of the San Andreas fault line. This amounted, in the Bolinas region, to as much as 24 ft., and at many points, to about 17 ft. That this relative displacement included areas lying several miles away from the fault line was shown conclusively for several critical observing stations by the work of the United States Coast and Geodetic Survey conducted shortly after the date of the earthquake. Intercomparisons of the results for the positions of these observing stations made at different epochs left no doubt that earth movements on a general scale were intimately connected with the earthquake phenomena of 1868 and 1906. In fact, researches of this nature, made by A. C. Lawson, professor of ge-

ology at the University of California, have shown that these earth movements are antecedents, as well as consequences, of earthquakes connected with the San Andreas fault.

"There is reason to believe that suitable instruments located comparatively near the fault line would be capable of detecting the creeping of the earth's surface stratum from year to year, and that such knowledge would be of high value in the prediction of future earthquakes.

"Professor Lawson recently has called attention to the fact that the studies of the latitude-variation problem by the astronomer royal for England, Sir Frank Dyson, reveal, in addition to the short-period variations at the Ukiah, California, station, a secular trend such that the average annual latitude of that station has been slowly and persistently increasing (i. e., moving northward) during two full decades. Assuming that Dyson's investigation is free from error, which we have no reason to doubt, we can scarcely question the correctness of Lawson's conclusion."

The practical study of the possible movements of the crust of the earth, due

to strain creep, is now going on by means of monuments established at Olema, Marin County, and Crystal Springs Lake, San Mateo County, California. These points are about 40 miles apart on the rift. Each monument consists of four concrete piers, two on each side of the fault trace of the 1906 seismic disturbance. These piers are sunk about 6 ft. and founded on the rock "backbone" of the country. The piers rise 2 or 3 ft. above the surface, those at Olema being 13 in. square, and those at Crystal Springs 18 in. square. A bronze plate is set firmly

on the top of each pier, with appliances for holding the 10-in. altazimuth instruments always in identically the same position with respect to the pier itself.

The record of observations will be tabulated and from this data deductions will be drawn which in turn will be checked against the actual disturbances. This procedure will be carried forward until such time as there is no reasonable chance of error, when it will be possible to forecast the location and probable intensity of coming earthquake shocks, in time, at least, to prevent serious loss of life.

8331
FOOD DEHYDRATION AT HOME WITH SIMPLE APPARATUS

Preservation of foods in the home by dehydration has been made possible by



The Dehydrator Used on Top of Ordinary Gas Stove: This Type Has Six Shelves, Accommodating 12 Trays of Different Foods to be Preserved

the production of an ovenlike arrangement manufactured by a New York com-

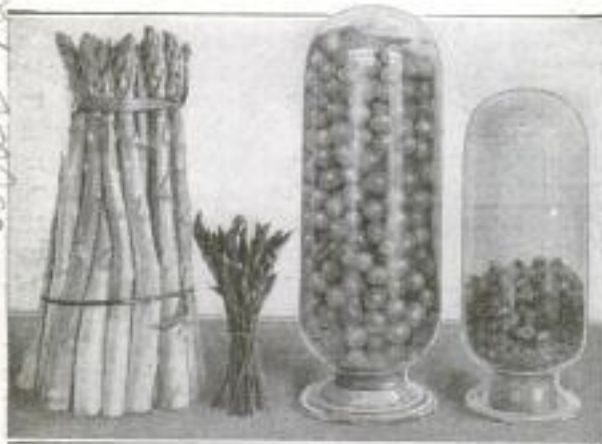

Here are Shown the Relative Sizes of Foods before and after the Dehydration Process: At the Left Is Asparagus, and at the Right Peas

pany. In operating, a number of trays containing the food to be dehydrated, are placed in the apparatus, while underneath these is a pan, or humidifier, having a certain amount of water in it, and which has been previously heated to the proper temperature. From the humidifier, the moist heat rises, passes through and over the different trays, and then out through vents at the top. After a period of from six to eight hours, depending on the kind of food used, the contents of the trays are dehydrated, and can be kept in containers for an indefinite length of time without spoiling. The containers used need not be sealed, as the food in its new state does not lose any nourishing values even though exposed to the atmosphere.

8433
WASTE PRODUCT MAY RAISE EFFICIENCY OF GASOLINE

Recent preliminary experiments indicate that small quantities of tellurium compounds added to gasoline will make possible the use of higher compression in gasoline engines than is allowable at present. Higher compression results in greater fuel efficiency and higher power. Up to date, tellurium has been considered one of the useless metals, but if future experiments bear out the first results, a market may be created for large quantities of a material which is now a waste product. The use of higher compression in automobile engines will necessitate alterations in design, but the increased efficiency will justify the changes.

M. G. Lewis 2/15 P. 12
 While Bureau of Mines statistics show that coal-mine fatalities for the year 1921 were lower than for any year since 1903, the most remarkable fact is that there were but five accidents in which five or more men were killed.

Domestic Dehydrator Co., 489 N. 4th Ave., Letter Box 12/21/23 New York City

8454 Cmt. Maurice E. Pelgrims,
35 Place de la Beare

POPULAR MECHANICS

505

Antwerp, Belgium

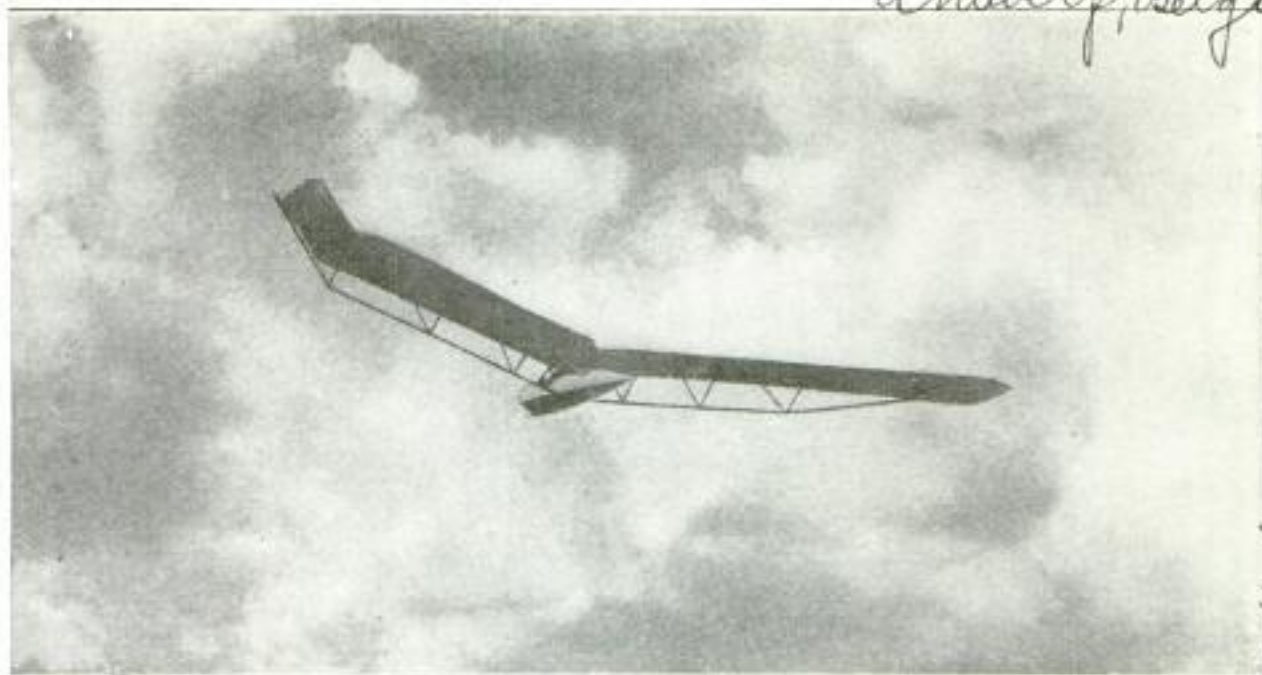

This Glider is in Full Flight with the Pilot Sitting Comfortably in the Tiny Basket Supported below the Wings. The More Inherent Stability the Glider Has, the Less Expert Skill is Required by the Pilot

8454
**MOTORLESS GERMAN AIRPLANE
SHOWS GREAT STABILITY**

As much of the success of the experiments in gliding flights being made in Germany depends on the skill of the pilot, great attention has been given to the question of inherent stability of the gliders themselves. One of the recent, most successful gliders has shown a marked degree of inherent stability, due primarily to the peculiar form and arrangement of the wings. In this machine the pilot rides in a small boat-shaped basket placed beneath the plane. The form of the wings is such that the large flexible tips are easily controlled through cords and pulleys, controlled by levers conveniently placed in the basket.

**EXPLOSION AND FIRE RESULT
WHEN AUTO STRIKES GAS,**

8514
Plunging into a hole where natural gas had accumulated, near Desdimonia, Tex., an automobile caused an explosion which ignited the car and the surrounding woods. Five persons, comprising an entire family, were in the machine, of whom three were fatally injured by the flames, while the two survivors—both children—received terrible burns.

Chicago Tribune 2/21/22
Poplar Mechanics Magazine does not publish the name of maker or seller of any device described in its pages, but this information is kept on file and will be furnished free by addressing our Bureau of Information.



This Glider is of Extremely Light Construction and, Due to the Peculiar Form of the Wings, is Said to Possess a Remarkable Degree of Inherent Stability, in Spite of the Fact That No Tail Surface is Used

Wetmore
Irwell Schaff

Photograms, 129 E. 27th St.

Johnson & Johnson
New Brunswick, N.J.

506

POPULAR MECHANICS

New York City

TEN PUPILS TAKE DICTATION FROM ONE DICTAPHONE

FIRST-AID PACKETS CARRIED VISIBLY IN PULLMAN CARS

Connecting 10 hearing tubes to one dictaphone, so that the same number of pupils can take dictation simultaneously,

For several years first-aid packages have been carried on Pullman cars, but hitherto always in lockers, where,

although secure, they were out of sight. As a consequence, often when they were most needed, the locker was found to be empty. In order to make such a condition impossible in the future, these first-aid packets are now being placed in a steel box, finished to match the car, that accommodates two packets, and that is attached to the wall in the passageway of the car, high enough to be out of the way of passers-by, but within easy reach. In the lid of the box are two small windows that show plainly at all times whether the packets are where they should be.



Typewriting Class Taking Dictation Simultaneously from One Dictaphone by Means of a Long Tube or Pipe Attachment Which can be Seen on the Center of the Table between the Rows of Typewriters

is the method employed by a typewriting school in New York City. The single dictaphone is placed near a table, around which are grouped the students, and the machine has a pipe, or metal tube, extending from it for the connection of the earpieces.

The lid is kept locked, but, as plainly announced thereon, the key is always in the possession of the Pullman conductor, so that it is never more than a matter of a minute or two to get it, and unlock the box. Each packet contains three pieces



Steel Box Mounted on Wall of Pullman Car Holds Two First-Aid Packages, Each Containing Sterile Gauze and Bandages, Shown Wrapped at Right, and Unwrapped at Left

of sterile gauze, 3 by 12 in. in size, and one sterile bandage.

A SAFETY-LADDER APPARATUS TO RESCUE SKATERS

Instead of rushing wildly around for ropes and planks when a skater breaks through the ice, it will only be necessary now to skate up with the new life-saving ladder recently developed by the park commissioners of Brooklyn. The device is extremely simple, consisting of only two runners which support a ladder about 3

ELECTRICALLY HEATED TYPE ENGRAVES FOUNTAIN PENS

Engraving names upon fountain pens, vulcanized-rubber pencils, celluloid, or

composition tooth-brush handles, cigar and cigarette holders, pipe stems, umbrella handles, etc., can be easily and rapidly executed with the use of a new machine, in which is incorporated a set of

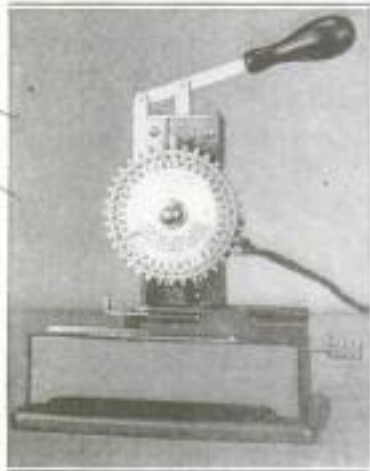

electrically heated type. The apparatus operates from any light socket, weighs 7 lb., and is said to be strictly fool-proof.

829

Price - \$100.00
modern inventors corp.
1123 Broadway, New York

modern inventors corp.
1123 Broadway, New York

8488

International Newsreel Corp
326 W. Madison
POPULAR MECHANICS 507
Chicago



COPYRIGHT, INTERNATIONAL NEWSREEL CORP.

The Short Section of the Ladder is Depressed Until It can be Grasped by the Person Who has Broken through the Ice. The Rescuer Then Bears Down on His End of the Long Ladder and Drags the Victim Back to Safety

ft. above the ice. The ladder is pivoted in the center and has a short section of ladder hinged at one end. The apparatus is placed near the edge of the break; the short section of ladder is lowered to the person in the water; the other end of the long ladder is then pressed down, and the victim is pulled out of the water and away from the edge of the break. By keeping the pressure away from the edge of the break in this way, the danger of the rescuer joining the victim in the water is reduced to a minimum.

BIDS ON SPOTTING SEAPLANES ASKED BY NAVY BUREAU

Airplane manufacturers have been asked recently for bids on a few small new-type seaplanes, designed by the Naval Bureau of Aeronautics, to be used for spotting the fire of the guns of the fleet. They will probably be small fast planes carrying a pilot and one or two observers. Makers have been asked to bid on three machines, although the exact number to be ordered has not been stated.

Ariston 2/20/22

GREAT EXPLORER TERMINATES 20 YEARS OF ADVENTURE

ON board the steamship "Quest," on January 5, Sir Ernest Shackleton, the famous antarctic explorer, became the victim of his irrepressible fever of adventure. He died of angina pectoris, heart failure, induced and aggravated by his restless activity, while the "Quest" was off Grytviken station, on the little island of South Georgia, close to the antarctic region, whither Sir Ernest was bound, to continue the research work that has occupied so much of his time during the last 20 years. This work had included an approach to within 111 miles of the South Pole, in 1909, which was then the nearest point reached by any explorer. It was only on account of the danger of starvation that he was prevented from going farther. Before that he had been, as early as 1900-03, with the expedition under Commander R. F. Scott, and later he led other expeditions in 1911-12, and in 1914. Accompanied by Captain Hussey, of the "Quest," the body of this intrepid explorer was brought to Montevideo on board a Norwegian whaler, and will be taken by another steamer back to South Georgia, where it will be buried. Meanwhile the voyage of the "Quest" will be continued under charge of Commander Frank Wild.

New York Times 2/8

508

Thos. W. Benson
3722 N. St.

**NEW TREE-FELLING MACHINE
HAS MOTOR-DRIVEN SAW**

A motor-driven saw for felling trees, invented by a New York man, has been

**SEMAPHORE ON TRANSFORMER
SIGNALS ANY OVERLOAD**

An instrument, in the shape of a semaphore, is so constructed that when attached to an electric pole transformer for power distribution, it will signal a visible warning when the transformer is overloaded. When mounted in a transformer, the semaphore is completely exposed, and has a small window at the top which appears normally black, because of a shutter behind it, but which, when the transformer is overheated, becomes white by the automatic removal of the shutter, indicating that a burn-out is imminent. The instrument operates through the action of the oil that is



Tree-Felling Machine in Operation, Showing the Driving Motor and Also the Method of Chaining the Apparatus to the Base of the Tree to Provide the Pressure Necessary to Feed the Saw into the Trunk

Wide World Photos

given a successful trial at Central Park, in that city. Propelled back and forth by a horizontal wheel geared to a small gasoline engine, an ordinary saw can cut through a 15-in. tree in two minutes, thus greatly reducing the time required to do the same work by human hands.

**AIRPLANE ARRESTING TACKLE
FOR USE ON SHIPBOARD**

With a view of making it possible for an airplane to make a safe landing on the deck of a ship, an arresting gear has been devised and tested at Hampton Roads, which, if proved successful, will be adopted by airplane carriers. It consists of two sets of wires at right angles to each other, supported about 9 in. above a platform which represents the deck of a ship. The longitudinal wires act as guides and prevent the airplane from slipping sideways. Sandbags are attached to the cross wires which are picked up by hooks on the axle and tail skid of the airplane when landing. These act as a drag and bring the airplane to rest gradually. The platform is so constructed that it can be rotated to bring the longitudinal wires in the direction of the wind.

At the Brazilian centennial exposition in September of this year, the United States will have an exhibit showing the work done by the various bureaus in promoting the mining industry.

used as the cooling medium for the transformer. The bottom of the stem to which the semaphore is connected extends down into this cooling oil, and has a bimetallic element that is sensitive

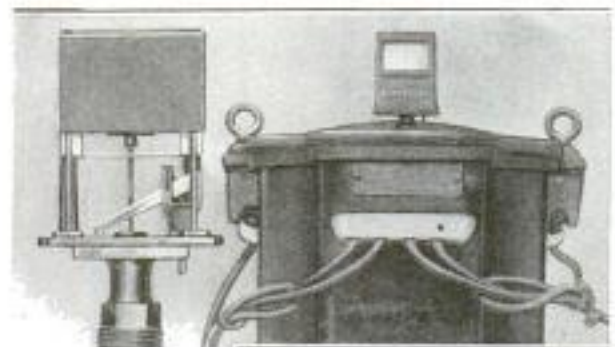

Device for Signaling Any Overload in Transformer, with Semaphore Visible above It: As Shown, the Shutter has Fallen, Leaving Window Transparent. Left: The Device Shown Enlarged, with Shutter Raised

to temperature changes, and that automatically releases the black sliding shutter in the semaphore, causing it to fall from behind the window when the temperature reaches the danger point. Connected with the semaphore is a button for resetting the shutter. The semaphore is not affected by changes in temperature outside the transformer case.

8405

8362

8470

Aviation 2/13/22

8484 Capt. Francis Dickie
Hercot Bay, B.C. Canada.



After the Great Wall was Torn Down, the Modern Boulevard was Constructed in Its Stead. The Boulevards Are from 80 to 125 Feet Wide, and Where Necessary, Shacks along the Sides were Torn Down to Provide Space

MODERNIZING A WALLED CHINESE CITY

BY FRANCIS DICKIE

THROUGH the resource and perseverance of a white man, Canton, China, one of the most ancient, and walled, and most backward cities of that backward empire, has now a modern street-transportation system of motor busses, modeled after the European type. The bringing about of this is one of the big romances of white-man endeavor in the Chinese republic.

In 1916, Tom MacInnes, a Canadian lawyer and promoter

Tom MacInnes, the Promoter, Whose Vision and Energy Made the Undertaking Possible



Statues in the Temple of "The Five Hundred Genii," of Prominent Chinese of Ancient Times: Among Them, Shown at the Right, is Found an Effigy of Marco Polo, One of the Earliest European Explorers of China

8484



A Bridge over One of the Numerous Canals, Some of Which were Dug as Much as 3,000 Years Ago: In Many Cases the Material Excavated in Making the Canals was Used in Constructing the Great Wall

from Vancouver, went to China. Previous to this he had much experience with Chinese, having in his capacity of a lawyer drawn up the Anti-Opium Act for Canada in 1909, and the Chinese Immigration Act in 1910. Besides his knowledge of law and of the Chinese people, he had a keen mind for promoting big projects. Arrived in China, MacInnes went to Canton on business, and while there traveled much about the city. In one of the temples, called "The Five Hundred Genii"—where men who had done something of importance in past times in China were represented in effigies, and worshiped now as gods—he came upon a strange

anomaly, a statue of Marco Polo, the most famous of the early explorers who went to China in the 14th century. In the intervening years he had become so famous among the Chinese as to be made a saint, probably the only instance on record of a European being exalted in such manner by a yellow people. In his wanderings around the city, near the portion where foreigners lived, MacInnes saw how a few Chinamen had tried to be up to date, putting up such advertisements as this in English: "Dentistry Practised with Great Peace;" "Coffins, Domestic, and in Latest Foreign Fashion;" "First Class Gambling House," and many similar signs showing



In Some Cases Existing Streets were Widened to Form Part of the Boulevard System Which will Serve Not Only the Older City but Also the New City Which has Sprung Up Outside the Original Wall

2484



Mun Tak Maloo, Looking South, as It Appeared in 1920, Before the Boulevard Work had Progressed Very Far: One-Half of the Roadway had been Opened for Traffic While Work Went Forward on the Other Half

how quaintly the Chinese interpret the white man's ideas of advertising. But aside from these things, the promoter found Canton a primitive place. It contained about 2,000,000 inhabitants. Along one side of the city flows the Pearl River. Around the other three sides of the old city ran an immense fortified wall, in some places 45 ft. through at the base and from 20 to 25 ft. high. But for many years the population had outgrown these old fortified boundaries, and a new city had sprung up outside the wall. Countless narrow passages, from 7 to 15 ft. wide, composed the streets. But they were a vast tangled maze, a veritable modern labyrinth. Through a portion of the city ran canals, mostly made by the excavations to build the wall, some of them dug 3,000 years ago. On these canals sampan boats were huddled together, upon which lived a varying population numbering from 10,000

to 25,000. No other city on the face of the earth contained so many people in so cramped a space; and to serve all this great population there was no street transportation. There was not even a street worthy of the name. Here in a narrow alley was the street of public executions, where criminals had their heads taken off by the sword. Afterward, relatives of the dead were permitted, on the payment of a small sum to the executioners, to take the head and body away, and sew the head back on again. This was necessary, as according to their belief the person in after life would have to go on without a head if left after the execution. Here, too, were the terrible cages in which men were slowly strangled to death by kicking the brick supports from underneath their feet after they had been locked in the cage which supported only their necks. Through the intervention of white men

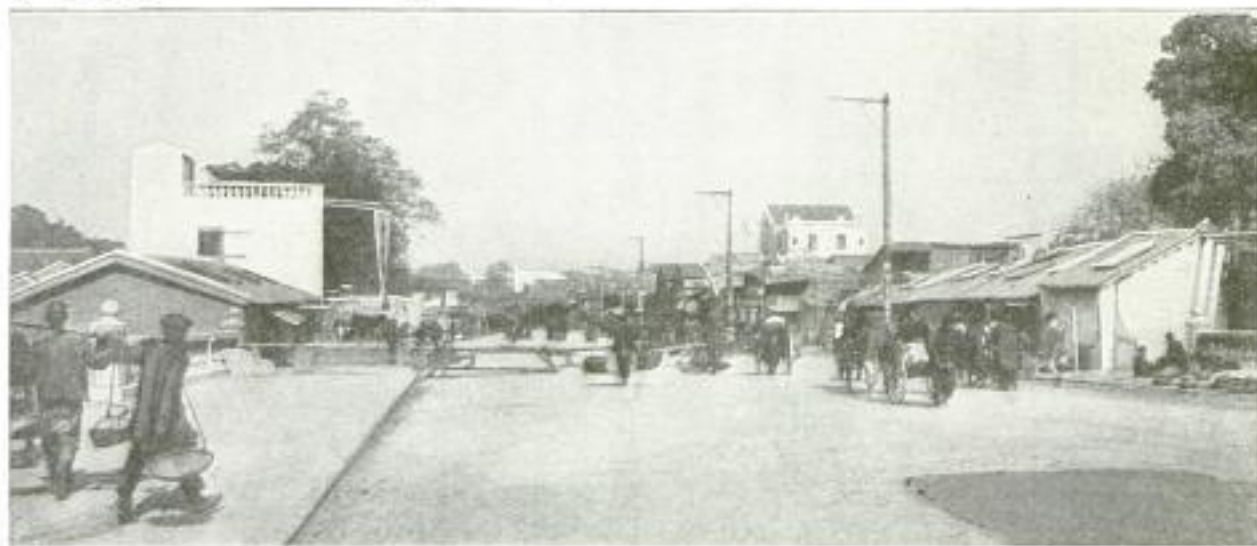

Mun Tak Maloo, Looking North, as It Appeared in 1921, When This Portion of the Boulevard was Practically Completed: Quite an Improvement over the Great Wall Which Formerly Occupied This Space

8484

POPULAR MECHANICS



Wing Hon Maloo Central, as It Was in 1920, Lined with Small Flimsy Shacks and Buildings, Typical of the Older Business Places of Canton Before the Era of Progress Was Fairly Underway

the method of death was changed to shooting; but the promoter, having witnessed the different methods, believes that by the sword the more humane.

His travels about Canton developed in MacInnes' mind an idea. He saw that by tearing down the major portion of the great circular wall, room could be made for a magnificent belt-line boulevard around the old city, which would also serve the new. With this done, and a few thousand of the rickety buildings swept away, cross boulevards could be made at a fairly reasonable cost, and the whole population afforded a splendid transportation system.

He started out enthusiastically to make his plan reality. Despite the discouragement of consuls and Chinese in high office, MacInnes finally got the ear of the governor, Chu-Chin-Lan, and obtained a

grant of \$2,000 for preliminary surveys. The survey and estimate of costs were just finished late in 1917, when the south of China seceded from the north. The following revolution held up further work until 1918. Then, with the estimates all in, the promoter was granted the concession to tear down some six miles of wall, and sweep away some 10,000 dwellings; the only things that were not permitted to be removed were the temples. So the boulevards had to be laid out in accordance.

But though he had the concession, the promoter now had to get capital for the undertaking. His success in getting the Chinese to go ahead thus far encouraged him to believe he could get the capital to operate a tramway from rich Chinamen. So he did not bother with American or European capitalists. After much busi-



Wing Hon Maloo South, in 1921, with Its Up-to-date Structures on Both Sides of the Great New Thoroughfare, Which Is Part of the Boulevard System Connecting All Parts of the City



Kwongtung Tramway Company Offices and Canton Office Building, Erected in 1921, Compare Favorably with Buildings Found in Any City and Are Samples of the Modern Buildings That are being Constructed

ness adventure he got in touch with Eng-Hok-Fong, one of the outstanding figures in Chinese financial history, and a romance in real life of business success. Starting as a poor boy, Eng-Hok-Fong in 1909 controlled a line of steamships operating between China and Mexico and other points in America. At the time MacInnes came to Eng-Hok-Fong the Chinese financier had on hand a lot of cash, having received indemnity from the British government for three of his ships which that government had used for war purposes and which had been sunk by German submarines. Eng-Hok-Fong saw the possibilities of big profit in a street-transportation system in Canton, and went in with MacInnes and a few other Chinese.

Finally, in 1919, the work was begun on the tearing down of the enormous wall, some of which had stood for 3,000 years. Here in the work entered one of the strangest business romances perhaps ever recorded. The wall was known to contain great stores of hidden treasure placed there in the past by brigands and countless private citizens for various reasons, much of which had never been recovered. But until the order came to tear down the wall, no one had dared to search for the treasure. When the contracts were put up for tender, the most amazing thing took

place: many contractors offered to do the work for nothing, provided they might retain all things found in the wall. These offers were accepted. And in the six miles of wall great quantities of silver coin, ancient ornaments, rare jade, and other treasure were found, repaying the contractors handsomely. No estimate could ever be made, but it is thought that over \$1,000,000 in value was recovered.

A system of wide boulevards was built on the site of the ancient wall, and where thousands of rickety houses had formerly stood. The boulevards are from 80 to 125 ft. wide. Down the center of each, for a width of 25 ft., right of way was given the company.

The original plan of MacInnes was to build an electric tramway of the type used in all American cities. But the difficulties in the way of lowering stone bridges



One of the Modern Motor Buses Which will be Used on the New Boulevards: The Forward Portion Is for First-Class Passengers, the Rear for Second-Class

across canals, and other reasons, caused the company to put in operation a modern motor-bus system. This is now known as the Kwongtung Tramway Company, and has received a monopoly to operate for 25 years in any part of Canton and its suburbs, for which right it paid \$1,000,000. In the spring of 1921, Tom Mac-

Innes saw his dream realized by a fleet of European motor busses operating on the streets of Canton. These carry 30 passengers per car, one-third first class and two-thirds second class.

Canton has begun a new era, a cleaner, brighter city, yet still a picturesque and romantic one.

ARMORED TRUCKS TO TRANSPORT MAIL IN CITIES



trucks are to be tested. In one, the body of the truck is completely covered with $\frac{3}{16}$ -in. steel plate, with portholes in the sides and end, through which rifles or pistols may be fired. In the other type the armor is carried only around the driver's compartment, while the balance of the truck is inclosed in a protective screen of heavy wire mesh.

Copyright, Keystone View Co. 91-7th Ave New York.
Above: The Truck Body Protected with Steel Plate with Portholes in Sides and End. Right: Truck, in Which Only the Driver's Compartment is Armored. Steel Cover Plates are Provided for the Windshield

The adoption of armored trucks is the most recent move of the postal authorities in protecting mail against the activities of robbers. One of these trucks, nicknamed "The Battler," has already been added to the New York City fleet of mail-transport trucks, where it will be tried out. Two types of



GERMAN PREPARATION MAKES WOOL MOTH-PROOF

An odorless powder, slightly soluble in water, which it is claimed makes wool moth-proof, has been produced by a German company. Wool is saturated with a solution of 6 grams (about $\frac{1}{8}$ oz.) per liter (about $\frac{1}{4}$ gal.), with the addition of about 3 grams of concentrated sulphuric acid (in the case of half wool, formic acid

is used), and after several hours is well rinsed. The wool itself is not affected, and only a few colors are slightly changed. If no alkalis are used, the treatment will be unaffected by frequent washings and scourings. In one test of two samples of the same wool, one treated and the other not, with 50 moth eggs placed in each, in six months the untreated wool had completely disappeared, whereas the treated wool remained intact.

Commerce Reports 2/20/22

Journal Technical Institute
22 Park Road
N.Y.C. 10011

St. Sedalia, Mo.
 Moniteau St.
 502 N.
 Hinkle,
 Hibble,
 Alliman
 Evans.



Above: The Gas-Bombing Squad of the Philadelphia Police, Receiving Instructions in the Method of Laying a Smoke Screen of Tear Gas about a Building or Locality Where a Criminal is Supposed to be Hiding. Left: The Policeman Is About to Place the Detonating Charge in the Tear-Gas Bomb, After Which It is Thrown as One would Throw a Baseball. Right: The Protective Gas Mask is Carried in a Pouch Strapped over the Shoulder and around the Waist, and So Arranged That the Mask Is Available for Use on a Moment's Notice



COPYRIGHT, KESSING VIEW CO.

POLICE WILL USE TEAR GAS AS EMERGENCY MEASURE

Combating an abnormal crime wave with the use of tear gas, is the action taken by the Philadelphia Police Department, and a gas-warfare school has been established with a class of 100 policemen as students. The course consists of practical experience with masks in entering gas-filled chambers, and the placing of smoke screens about a building or locality, wherein an imaginary bandit or other lawbreaker is assumed to be in hiding. In the event of a riot, or mob disorder of any kind, such a gas squad would be of particular advantage, and it is with this emergency in mind that the present preparations are being made. With the employment of the new weapons, it is expected that lawless acts will be discouraged, and that there will be a decrease in the number of robberies and homicides. Mention of the experimental use of tear gas by the New York Police Department was made in the October, 1921, issue of this magazine, which dealt with its effectiveness in quelling mob disorders.

SELF-CLEANING LAWN RAKE TO HELP THE GARDENER

It seems very appropriate that a self-cleaning rake should be devised now that the gardening season is almost upon us. A cleaning bar fits over the teeth and is held in its raised position by cables fastened to a lever on the rake handle. When

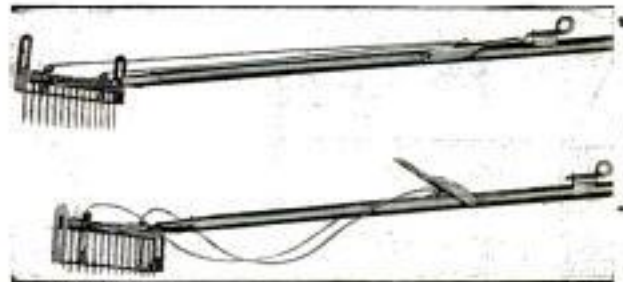

When the Finger Trigger is Released, Springs Back of the Cleaning Bar Force It Down, Removing the Material Accumulated between the Teeth of the Rake

this lever is released, springs back of the bar force it down, cleaning the teeth of the rake.

Our Bureau of Information is for your benefit. Use it as often as you please.

8442

REMOVING A MOUNTAIN IN RIO DE JANEIRO

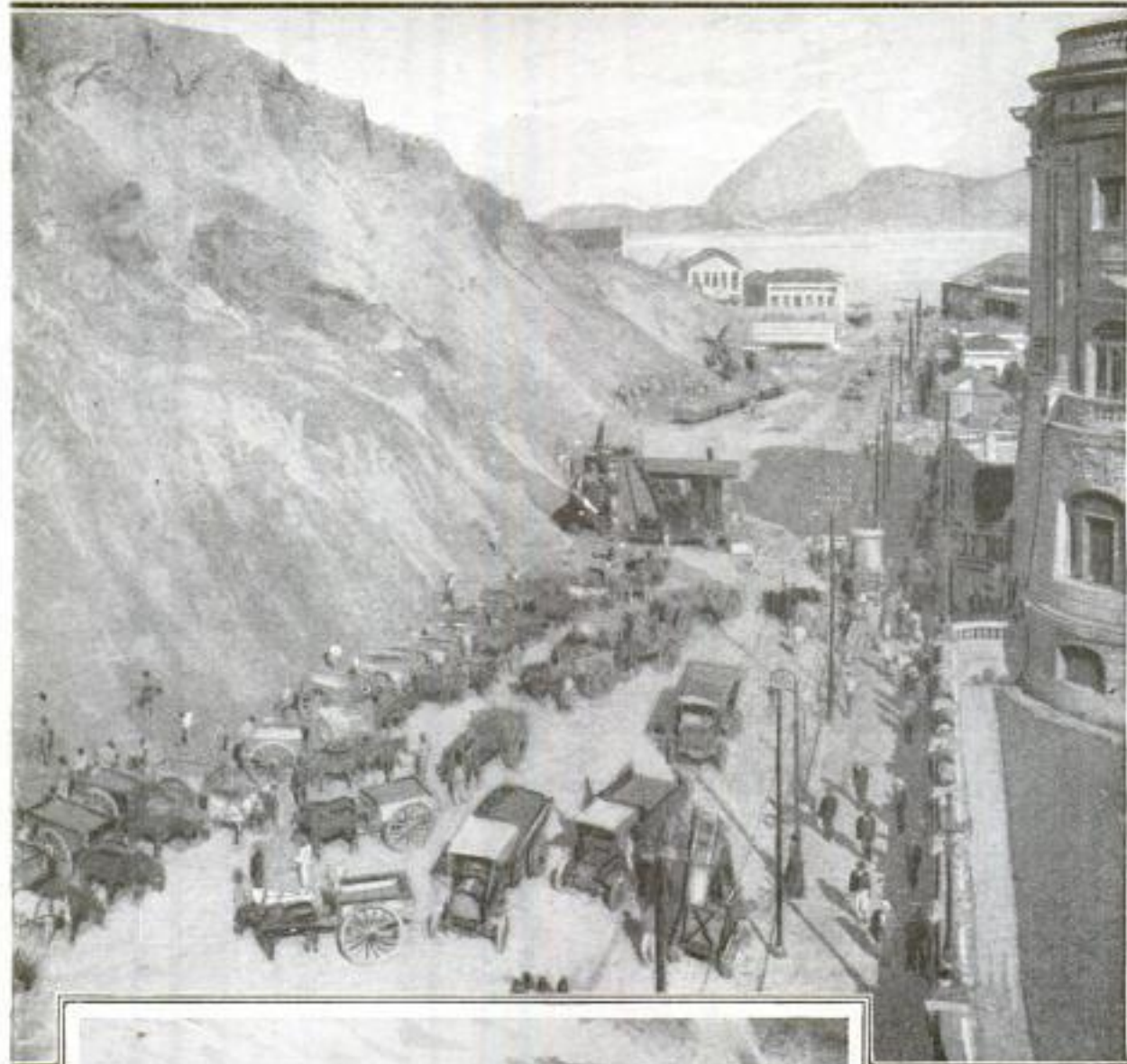

MOVING a mountain is the huge task undertaken by engineers in Rio de Janeiro, where the Morro do Castelo—consisting of an estimated 7,000,000 cu. yd. of earth and rock—is being obliterated, the completion of which is expected to make the southern metropolis much more breezy, cool, and healthful, besides adding some 66 blocks to the heart of the city. Various methods have been tried in the transporting of this mass from its present location and depositing it in the bay, among these being pick and shovel, mule

PHOTOS BY UNDERWOOD & GULLYHOOD

TO AFFORD MORE AIR AND BUILDING SPACE

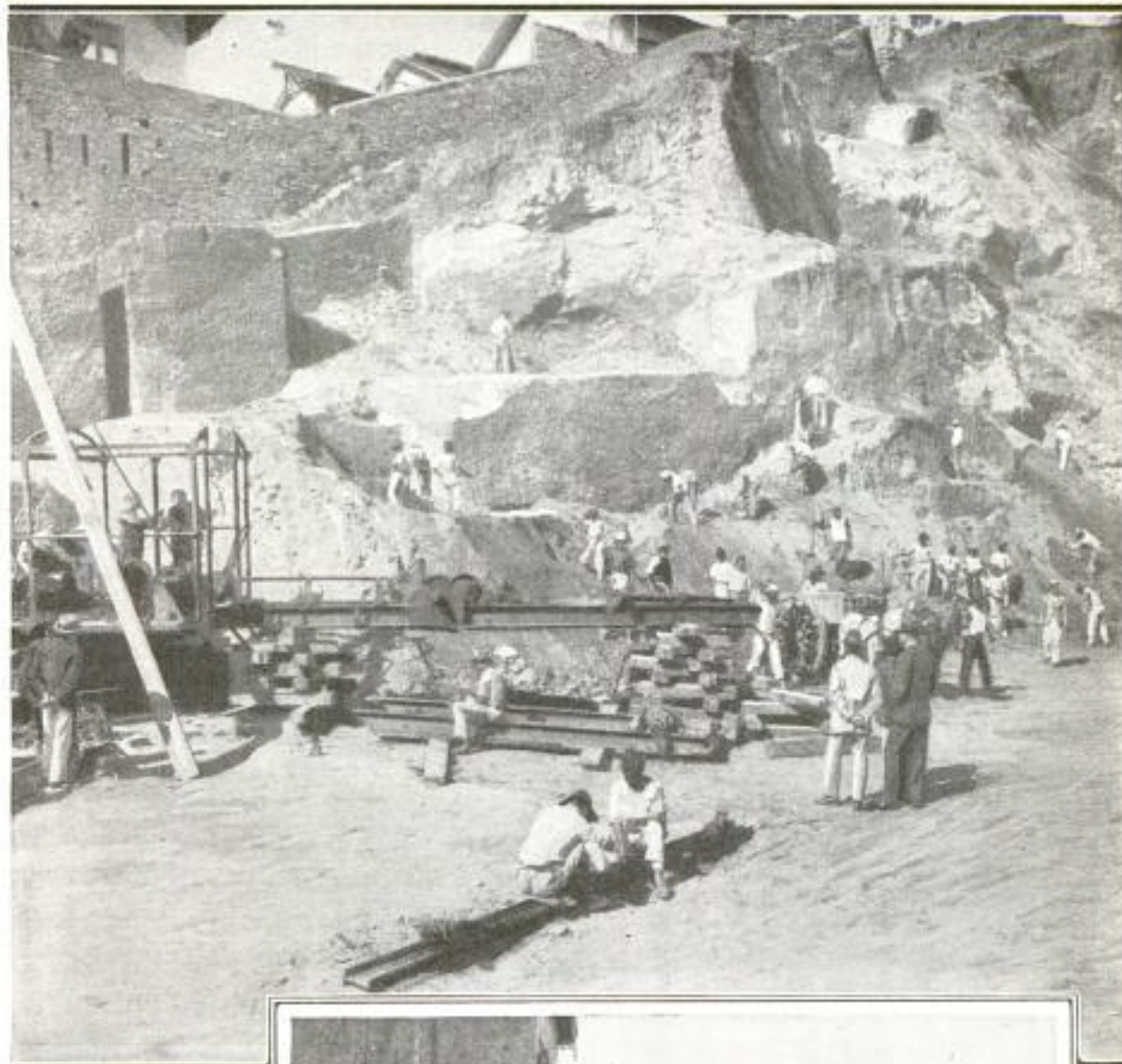

cart, steam shovel, and "dinky or dummy train." At the upper left are seen the mule carts, and pick and shovel workers, with a steam shovel also visible, while below is shown one of the locomotives of a dirt train. The upper right shows more of the pick and shovel force, and also an abandoned steam shovel, while below is seen a street on the mountain top. The presence of an old convent on the summit has given rise to the rumor that gold is hidden near it, and causes added zest among the credulous workmen.



8502 International Newsreel Co.
New York City



aviation *Army Base, Norfolk, Va*

GIANT DIRIGIBLE "ROMA" MEETS WITH DISASTER

STARTING from Langley Field on what was to have been a short trial flight to test the Liberty motors substituted for the original Italian motors, the big dirigible airship "Roma" crashed to the ground and burned on the afternoon of February 21. There were 45 persons on board at the time of the flight and fall, 34 of whom were killed and the others more or less burned or injured. The immediate cause of the disaster seems to have been some trouble with, or breakage of, the rudder planes at the stern of the gas bag, while the airship was at an elevation of about 1,000 ft. It was observed to nose down and fall rapidly in spite of the fact that large quantities of ballast were thrown out.

Just before reaching the earth, the nose of the airship struck and broke the electric wires which furnish current to the Hampton Roads army base. The sparks from this contact ignited the hydrogen gas with which the "Roma" was inflated, causing an explosion and subsequent fire. The "Roma" was the largest of the semirigid-type airships, being 410 ft. long and approximately 85 ft. in diameter at the largest point, and burned fiercely until all inflammable material was consumed, leaving only the twisted metal framework.



COMMENT AND REVIEW

[These pages were printed February 25, 1922]

THE destruction of the "Roma," presumably the largest and one of the most recently built of all the semirigid dirigibles in the world, ought to satisfy those advocates of the dirigible who refuse to be convinced it is not the one great avenue of development in air craft. Whatever their beautiful theories may set up, the plain unvarnished facts are that a dirigible is both difficult and dangerous to have around, to attempt to fly, or try to land. It is so unwieldy when it meets with adverse air currents, it is buffeted about. It must have selected weather to take off, and is altogether a fair-day toy. When one reviews the work of the German dirigibles over London during the war, the results are all out of proportion to the damage one would expect

Dirigible Complete Failure

of them. It is true, at first they destroyed the morale of some old men and a lot of women and children, and they did blow up an occasional building, but with all the Zeppelins floating over a mark which a city of eight millions affords, I repeat the net results were all out of proportion to what can be accomplished today with the same amount of money invested in airplanes.

The dirigible, besides affording a target of great visibility, is a constant menace to itself. There are always the unpreventable leaky gasoline pipes, the red-hot exhaust pipes, a blast of fire and sparks when an engine back-fires, and the ever-present danger from static electricity caused by the friction of the air on the envelope. There are other self-contained fire risks, but those named are quite sufficient, to which must be added that of bent and broken skeleton structure due to sudden strains. To date the dirigibles have undoubtedly killed more of their own crew and people than they have taken lives of an enemy. They never have accomplished any great engineering feat. They are dangerous, unreliable, costly, with a minimum of results, and now that we expect to take a naval holiday we can well afford to cut out dirigibles of the "Roma" type.



THE jingoes in Congress, both in the senate and house, will do well to go a bit slow in indulging petty politics to the extent of slowing down the final work left over from the Peace Conference. The people as a whole are in favor of the ten-year naval holiday and all the accessories which the conference worked out in connection with this great step toward world peace. To put any stone in the path of the successful carrying out of the plan is wicked; to do so for mere personal reasons is outrageous. The voters are very long-suffering, but Congress will do well to reflect occasionally on just how long the voters will consent to suffer.

Jingoes and the Naval Holiday



THE farmer living near Muscle Shoals, who has been given to understand he can throw a sack over the old mule and ride up to Ford's fertilizer factory like he now goes after a grist of meal, is being "bamboozled." The fact is, the immediate product of that plant is only one of several ingredients in a well-balanced fertilizer, of which nitrogen products are only the beginning. Ford's lawyer also failed to comment on the fact that in the various gas and coke industries which are so rapidly increasing, they can and are making for \$15 per ton, as a by-product, what costs \$50 a ton to produce at the Muscle Shoals plant. The claim of Ford's lobbyist at Washington that he can run the railroads of the United States electrically is ridiculous. Every high-school boy knows the limitations in distance to which current can be sent. Not all the railroads within transmission distance of the plant could begin to use the output. Ford is peeved because, having been invited to bid on the property, the Secretary of War invites other bids, but this is obviously his duty. Ford offers to pay down \$5,000,000, if the Government will complete the water-power plant at a cost of \$50,000,000 additional expenditure. Meanwhile army engineers say the plant as it stands, without the expenditure of another dollar, has a wrecking value of \$16,000,000. The present 120,000 horsepower is ample for all fertilizer requirements, but Ford wants the Government to go ahead and install 530,000 horsepower more than the manu-

Fertilizer or "Flivvers"

facture of fertilizer requires. With coal, iron, lime, wood, and other natural resources close at hand, Muscle Shoals with a half million of horsepower free would make a beautiful proposition for a manufactory of automobiles. Against this nothing is to be said, provided Ford pays the Government what the property is worth, but it is dishonest and unpatriotic to attempt to put an automobile enterprise over on the Government and the people under the guise of selling fertilizer to the farmer for next to nothing.

H. H. WINDSOR

Garage Equip

ADJUSTABLE CREEPER IS MADE FOR AUTO MECHANICS' USE **COMPACT ELECTRIC APPARATUS FOR HEAT TREATMENT**

Automobile mechanics will welcome a new adjustable creeper which was de-

In surgical cases, and as a treatment for other ailments, it is often beneficial to



Above is Shown the Adjustable Creeper Tilted Up to Display the Lever and Brake Mechanism

Adjustable Creeper with Headrest Raised, Showing How It Is Possible for the Mechanic to Work in a Comfortable Posture: The Operating Lever is Seen at the Side

signed especially for the use of those who have to crawl under motor cars. The unusual features of the creeper are a headrest which can be raised or lowered by means of a lever, and a brake to prevent the ball-bearing casters from rolling.

MACHINE FOR UNREELING SILK INVENTED BY AN ITALIAN

The delicate task of unreeling silk thread from the cocoons has, up to date, been done by hand and has been one reason for the high cost of silk compared with other kinds of cloth. It is now reported that an Italian inventor has perfected a machine for doing this mechanically. Such a machine, if commercially successful, would have a great influence on the silk industry, making it possible to prepare the raw silk in countries of relatively high-priced labor.

cause heating of the body by electrical means, and an apparatus for this purpose has just been placed on the market by a London concern. The instrument receives an electrical current through the medium of a flush plug which is fitted to the base of an inclosing cabinet, and which is designed for either high or low-voltage alternating current, or for receiving direct current by means of a connection to a portable rotary converter. A foot-switch is provided and connected to another flush plug on the cabinet, and a fuse box is installed for the protection of the apparatus, should any wrong connections accidentally be made. An easily adjusted transformer for the control, and a milliammeter for indicating the amount of current passing through the patient, are placed in the circuit, thus rendering the entire outfit very elastic and extremely

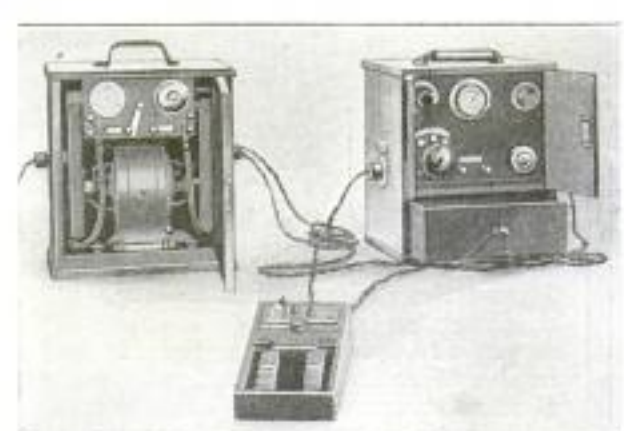

Left: Rotary Converter for Direct Current. Center: Foot Switch. Right: Cabinet Showing Milliammeter, Switch, Fuse Box, and Transformer

easy of operation in giving heat treatments.

*Messrs. Watson & Sons
London, England*

Report from Attache Commercial H.C. MacLeary Italy. 117 Lumber Exchange Bldg. 7775

Commerce Reports 2/6/22

Copyrighted material

CHAIN-DRIVEN LAWN MOWER
8366 PRACTICALLY NOISELESS

Possessing unusually high wheels from which a chain drive is attached to the cutting-knife shaft, a newly designed lawn mower operates at a high speed and without the usual noise. The knives and cutter bars are made of tungsten steel, the

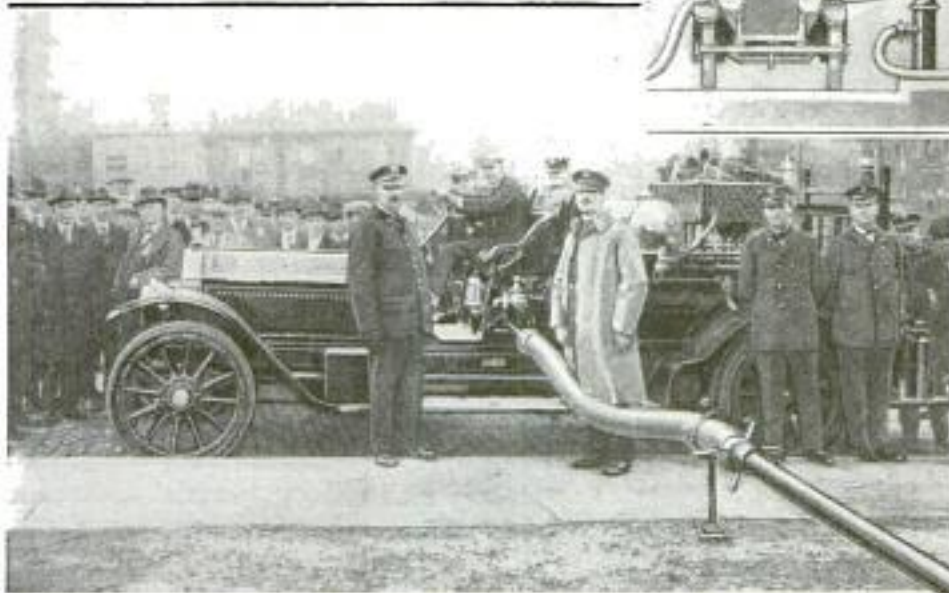

The Suction Hose from the Pumping Engine is Attached to the Upper End of the Ejector, While Water under Hydrant Pressure is Introduced at the Bottom. The Suction Hose of the Ejector is Attached to a "Y" at Its Side, and This Combination Enables Water to be Lifted from a Depth of 50 Feet

gears of machined bronze, and all bearings have full-length rollers similar to those used in automobile wheels. Added features are lightness in weight, which is attained by having all the cast parts made of an aluminum alloy; flexibility of the blade adjustment, which allows them to be set within $\frac{1}{4}$ in. of the ground, and a pivoted handle that permits the ready access of the mower under and around

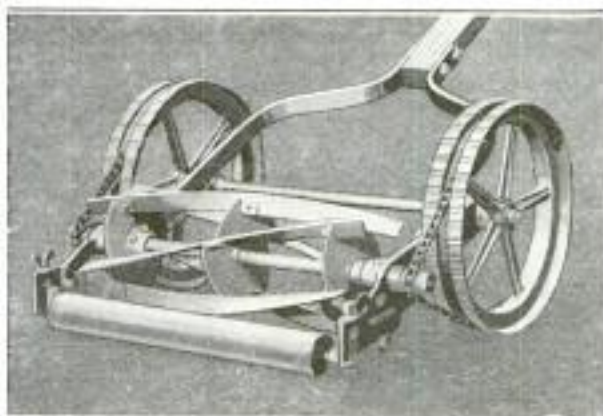

Lawn Mower Which Operates without the Usual Noise, Showing the High Wheels and the Silent Chain Drive to the Cutting-Knife Shaft

bushes, shrubbery, and trees, thus effecting a great saving of time.

⁷⁹²⁶
COMBINED SUCTION EJECTOR
FOR PUMPING OUT CELLARS

The Omaha Fire Department has combined a simple ejector with the suction

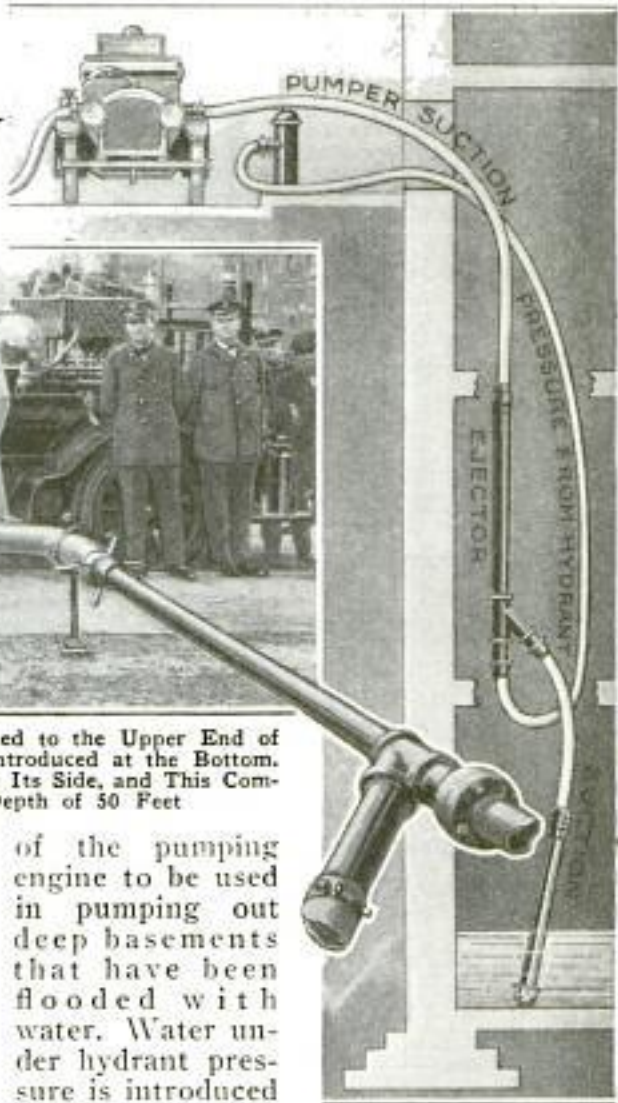

of the pumping engine to be used in pumping out deep basements that have been flooded with water. Water under hydrant pressure is introduced at the bottom of the ejector, while the suction from the pump is attached at the top, the ejector suction being taken out at the side. With this combination it has been found possible to lift water from a depth of 50 feet.

EMPLOY DIAMOND CORE DRILL
FOR DRILLING OIL WELL

⁸⁴⁸⁹
The recent completion of an oil well in Mexico with a diamond core drill proves that this type of drill can be used successfully for this purpose. The great objection to their use is the small bore of the hole, but, particularly for testing purposes, they have the advantage over other forms of drills, that they produce a continuous core of the formations through which they pass. They are also much lighter than other forms of drills.

Bureau of Mines
Illuminated material
Bulletin

*Capt. Frank Omond 2324 Harney av.
Omaha, Neb.*

Engr. H. W. Hollingsworth
 Boston Mass
 522

The Engineer
 2/3/22
 Radio Stations

COLLISIONS ARE PREVENTED BY AUTOMATIC BUMPER

LINKING ENGLISH POSSESSIONS BY WIRELESS TELEGRAPH

8260

Collisions of cars can be prevented by the employment of an automatic bumper,

463

It seems reasonably certain that the plan to link all English possessions with

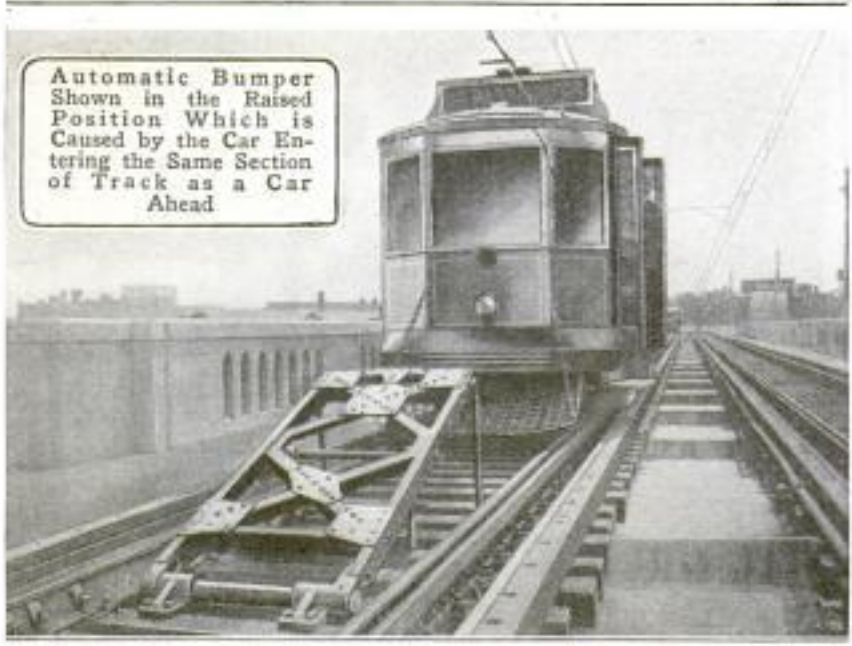

which has been adopted by the Boston, Mass., elevated roads. By means of a control system, a second car within the same block, or section of the right of way, that is occupied by another, automatically causes the bumper to spring up between the tracks. The device has been found effective in preventing accidents.

a chain of wireless stations will be carried through at an early date. In its report the wireless commission has recommended that all except the isolated stations be equipped with the vacuum-tube system, while the stations in East Africa, Singapore, and Hongkong should be equipped for arc transmission; further, that all transmission stations should be capable of working with either of two wave lengths to suit atmospheric conditions, and that the vacuum-tube stations should have a normal sending range of 2,500 miles, and be

capable of transmitting continuously at hand speed, or at 90 words per minute at full power.

CHAIR MADE FOR WORKERS IS EASILY ADJUSTABLE

8174

An adjustable chair is now available, which can be easily and quickly adapted to the needs of any worker, as far as pertains to the



proper height of the seat and backrest. The chair is constructed mostly of metal, so that it is practically indestructible, while at the same time assuring an increased efficiency of the worker, because of the

possibility of always obtaining the correct posture.

SIMPLE FOCUSING ATTACHMENT FOR FOLDING CAMERA

8376

Amateur photographers will welcome a device recently developed by an Austrian

concern which combines the good features of the reflecting-type camera with the portable feature of the ordinary finder. It consists of a finder which is fastened to the camera and is focused as the bellows are moved. By looking in the finder a person can see if the object to be photographed is in proper focus.

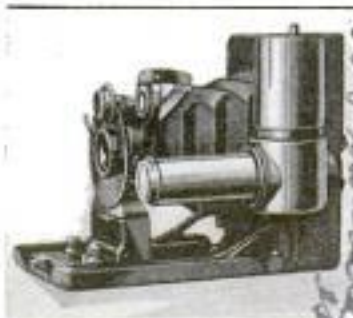

The Popular Mechanics' Bureau of Information offers its free service to all readers of our magazine. Names and addresses of manufacturers and dealers in articles described, and any other details in our possession, will be promptly furnished by addressing the Bureau.

Oliver Co., 117-119 Leonard St. New York City

Engr. Maurice E. Polignin, C. Estroff Polignin

8503 American Transit Co
 837 Elme Boul Bldg
 POPULAR MECHANICS
 Detroit, Mich.

Scientific American 2/22 P. 88
 San Fran, Calif.
 D. H. Meade
 866 S. Third St.



Huge International Suspension Bridge That is to Connect Detroit, Michigan, with Windsor, Ontario: The Main Span Is 1,803 Feet, and the Towers Rise 380 Feet above the Water. Of the Eight Cables Six will Be 21 Inches in Diameter, and the Other Two 18 Inches

HUGE INTERNATIONAL BRIDGE ACROSS THE DETROIT RIVER

The international suspension bridge that is to connect Detroit, Mich., and Windsor, Ont., and that was first proposed about two years ago, as described in our issue of April, 1920, has now reached the point of actual construction. The work is to commence this spring. The plans show that it will have the longest single span in the world, namely 1,803 ft., or 53 ft. longer than the proposed Delaware River bridge that is described in this issue, on page 555 and following pages. At the time this last-named bridge was designed, it was expected to be the longest suspension bridge in the world, but the actual figures of the design for the Detroit-Windsor bridge, now so soon to be under construction, show a comparatively small excess of length in its main span. With a width of 93 ft., the international bridge will be of double-deck construction, accommodating street-car, automobile, and pedestrian traffic on the upper deck, and passenger and freight-train service on the lower deck.

Write our Bureau of Information, if you wish to know who makes or sells any article described in this magazine. Send no postage; the service is free.

MOVING ROAD MAP OPERATED BY SPEEDOMETER

Every turn and crossroad can be seen for two miles in advance of a touring motor car, by the use of a traveling road map, which is fastened just below the steering wheel, and is operated by the speedometer mechanism. The map is 2 in. in width, and "runs" for a distance of 1,000 miles, so that with a sufficient supply of maps, the tourist is enabled to have the entire road, as he proceeds upon his journey across the country, constantly unrolling before his eyes.

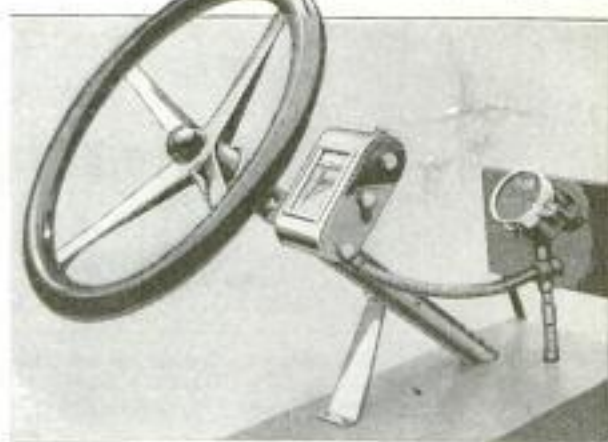

Moving Road Map. Showing the Method of Fastening It Just below the Steering Wheel So That It Is Always in Full View of the Driver

8424
 A TELEPHONE THAT TELLS NO TALES

BY G. H. DACY,

*National Press Club
Washington, D.C.*

CONFIDENTIAL secrets and intimate business matters can be discussed freely over the telephone henceforward—and no one except the persons concerned



Copyright, Underwood & Underwood
 General George O. Squier (at left), Chief Signal Officer of the United States Army, Testing the New "Superphone," of His Invention, That Provides Absolute Secrecy in Transmission of Messages

will be the wiser—by the use of a new device that prevents the telephone from "telling tales." This appliance will be of particular importance as a means of secret communication in warfare, but it will be of equal, if not greater, value to the butcher, the baker, and the candlestickmaker who desire to talk over business affairs with their bankers or brokers without danger of eavesdropping.

This telephone invention—the "superphone" as it is called—is an outgrowth of the "wired wireless," or "line radio," developed and perfected some years ago by Gen. George O. Squier, chief signal officer of the U. S. Army. It consists of a small portable set of instruments which can be readily connected to telephones in residences or



The Superphone Which can be Connected to Telephones in Homes or Offices: By Closing a Switch It is Put into Operation in Place of the Ordinary Phone

office buildings. It only takes a few minutes to hook up one of the devices to the regular telephone. The apparatus is in-

cased in a small wooden box and hooks directly to the bell box of the telephone. Once adjusted and in place, the superphone is ready for constant service. It does not require any readjustment at regular intervals. It occasions no more bother than the ordinary telephone so far as upkeep is concerned. All the user has to do is to close a switch or press a button to connect in the superphone in place of the ordinary phone. A special advantage is that it permits a number of secret telephone conversations to be carried on simultaneously over the same line without interfering with each other.

The mechanism is operated according to the principles of wired wireless, by which high-frequency alternating currents are employed that are modulated at the transmitting end by speaking into an ordinary microphone, and are detected at the other end of the communication system by the ordinary radio instruments which ultimately transmit the sounds to an ordinary telephone receiver. Speech is transmitted by this new invention even more distinctly and clearly than by the ordinary telephone. Long-distance conversations can be carried on where the speakers are several hundred miles apart by the use of a very small amount of electrical energy. For such conversations, .1 watt is usually sufficient, while the power required to light an ordinary electric lamp is about 50 watts.

 8464
 FRENCH GUN WITHOUT RECOIL
 HAS MUCH INCREASED POWER

Much interest has been attracted, in Europe, to a new gun in which, it is said, the recoil is eliminated, and the speed of the projectile practically doubled. When constructed as a French "75," the old muzzle velocity of this gun of about 1,740 ft. per second was increased to 2,789 ft. It is believed that later improvements may increase this velocity still further, and that possibly 3,300 ft. per second will be reached. The French inventor of the gun asserts that, with the recoil done away with, it will be possible to build guns of power equal to existing guns with only a third of their weight.

☐ The installation of a central heating plant is contemplated in Tokyo, Japan. Experiments are at present being conducted, using lignite to generate gas.



Convertible Vehicle That may be Used for Several Different Purposes: Above, It is Shown in Use as a Low Pick-Up Cart for Hauling Heavy Barrels or Other Material. To the Right of That It is Shown in Use as a Painter's and Paperhanger's Cart

8301

RADIATOR-VALVE ATTACHMENT FOR STEAM-HEATED ROOMS

A humidifier for steam-heated rooms carries water in a crescent-shaped can that is hung from the valve of the radiator. A tube is connected to the outlet of the valve, and is bent downward into the inside of the can. Thus the noise of the issuing steam is silenced as it passes to the water in the can, the evaporation of which it increases.

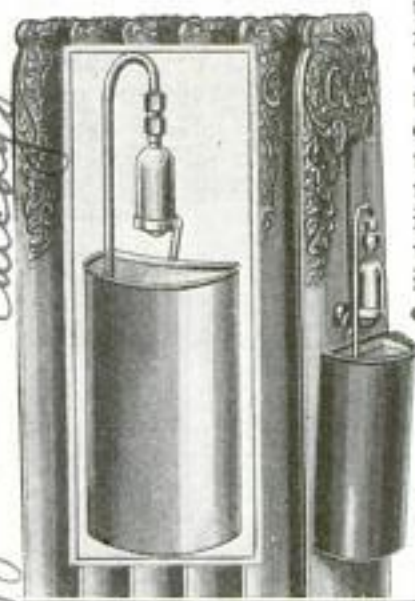

Any water leakage from the valve is caught by the can, and instead of being a disadvantage is an advantage, for it helps to replenish the water supply that is lost by the evaporation. The device is easily connected to any radiator valve. 8140

CONVERTIBLE WHEELBARROW HAS VARIOUS UTILITIES

An elaboration of the common wheelbarrow has furnished a vehicle that may be interchangeably used as a hand truck, as a painter's and paperhanger's cart, or as a garden cultivator. In the conversion of the vehicle no tools are necessary



Left: Front View of the Convertible Vehicle, with Its Body Removed, Used as a Garden Cultivator. It Has Six Teeth

other than a common wrench, the adjustment consisting mainly in the raising or lowering of the body

of the vehicle. To transform it into a cultivator, this body is removed, and in its place are set six adjustable digging tools, 8413

PREVENT ESCAPE OF CRIMINAL BY USING SHACKLE BOOT

When it is necessary to take criminals on long journeys by train, constant vigilance is required to prevent attempts to escape.

Now, however, a shackle has been devised which should discourage this quite effectively. It consists of a 50-lb. steel ring which fits loosely around the ankle, and a separate steel housing that goes under the foot and supports the weight of the ring when the wearer is sitting or standing still.



International Film
 Our Bureau of Information is for your benefit. Use it as often as you please.

Triangle Mfg. Co., 318 W. 43rd St., Chicago

8352
Cmbr. Mel Wharton 590 E. Alder St.
Portland Oregon

LOGGING IN SOUTH INDIA WITH LOTS OF

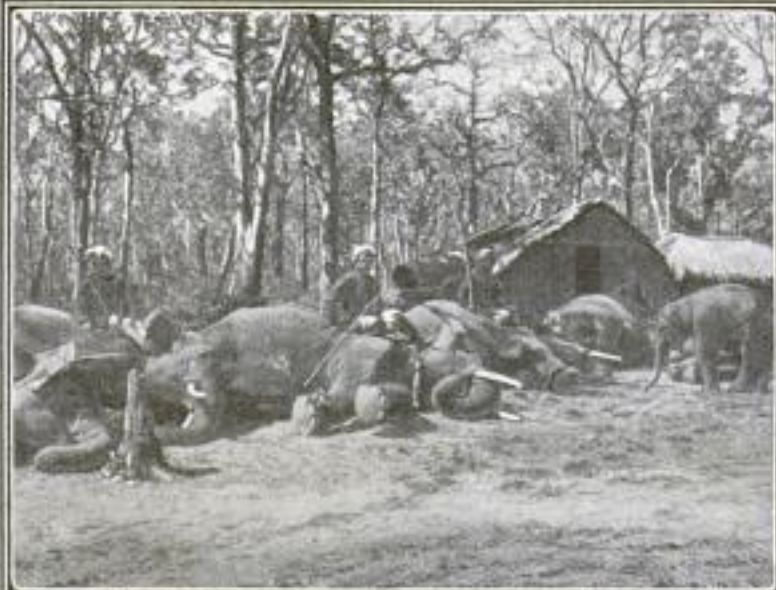

THE ponderous elephant, the patient water ox, and the plodding coolie still furnish almost exclusively the power for carrying out lumbering operations in the presidency of Madras, India. There the chief timbers are teak, sal, messua, hopea, poon, bombax, and poou. The trees are chopped down by coolies with crude axes, who work without any regard to the direction in which the tree may fall, and thus lead to the destruction of much young timber. In the handling of the logs, chopped from the fallen trees, powerful elephants are the leading factor. Above, a number of these elephants are seen undergoing training. When completely trained, they work with almost human intelligence, and with many times human muscular power. To the left is shown an interesting fragment of a south Indian evergreen forest, with a poou tree in the foreground.

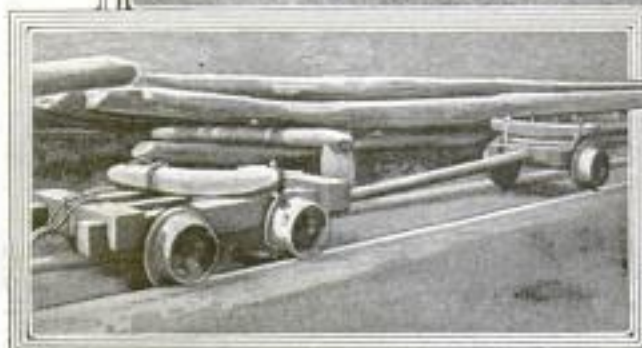

Above: Logging Crew, Composed of Coolies Mounted on Trained Elephants, Lined Up in a South Indian Forest Ready to Start to Work. Left: Trailer or Rough Truck Used for Light Logs and Poles. It is Drawn by Elephants on the Pole Railroad Shown Elsewhere

MEN AND ANIMALS BUT LITTLE MACHINERY



In the lumbering industry of south India, where the work is still done almost exclusively by human and animal power, the logs, chopped from the felled trees, are first hauled by coolies, laboring with sticks and ropes, to a by-path—in most cases near by. From this point the elephants or buffaloes—not to be confused with the American bison—drag the logs to the top of a chute down which they are made to scoot at a speed of from 20 to 30 miles an hour to a log depot below, which they reach undamaged. To the right is seen this chute with the log depot below, and a bullock cart with which they are taken to a railway station. Here they are loaded by a hand crane onto a rough kind of railroad truck that runs on rails made of poles, as seen above, and which carries them to their destination. Elephants are the "locomotives" of this "poloroad."



Above: Dirt Slide down Which Logs are Rolled. At the Bottom of the Slide the Logs are Picked Up and are Carried Farther On in Carts. Right: The Patient Buffalo at Work in a Manner Strongly Reminiscent of the Ox Teams of the Early Days in Our Own Country

Cml. Paul H. Cochran,
40 Journal News
528

8419

**MAN LACKING HAND AND ARM
IS CRACK RIFLE SHOT**

The fact that he has lost his right arm at the shoulder and his left arm between the elbow and wrist, does not prevent



Above: Left, Winemiller in Shooting Position; Right, Target Score of 10 Shots at 50 Yards. Below: Winemiller, the "Armless" Crack Rifle Shot

Wm. A. Winemiller, of Ohio, from being a crack rifle shot. He uses a special .22-caliber rifle having a leather-covered hook beneath the balance point, against which he presses his left forearm. He pulls the trigger with a small wire having a rubber button on the end, which he holds in his mouth. A slight motion of the lower jaw exerts the necessary pressure. He loads, unloads, and cleans the gun without assistance.

8415

**COPPER SHINGLES INTERLOCK
TO FORM DURABLE ROOF**

Being in possession of two well-established facts, it would seem like a very simple thing to combine these facts and arrive at a certain definite conclusion, yet it has remained for one of the large mining companies to do this in a truly constructive way. The two facts are, that the United States is one of the largest producers of copper, and that copper makes one of the best roofing materials. The conclusion: copper shingles.

The pioneers in this new departure were not content simply to cut sheets of copper in the form of shingles; they wished to make a roof covering that

would be a definite advance in building construction. With this in view, they have formed the shingles in such a manner that they are interlocking in all directions, making a water-tight covering on even flat-pitched roofs. A driving rain cannot beat in under or between the shingles, and this is accomplished without having recourse to soldered joints, which have always been a source of annoyance and expense.

The shingles are made in three sizes, 6 by 18, 8 by 18, and 8 by 60 in., and no skilled work is needed in laying them, for the operation is extremely simple. Special flashing and verge strips are furnished as required, as well as copings and eave starters. The copper shingles may be laid over existing wooden shingles if desired. But in all cases, it is desirable first to put on a layer of sheathing paper as an insulating material.

The shingles are supplied in the natural copper finish and in seven shades, ranging from green to rich russet brown. These permanent colors are produced by a patented process which in no way affects the lasting qualities of the copper.

Many instances are known of copper roofs more than 100 years old which are still in a good state of preservation. The copper shingles are, of course, fire-resist-

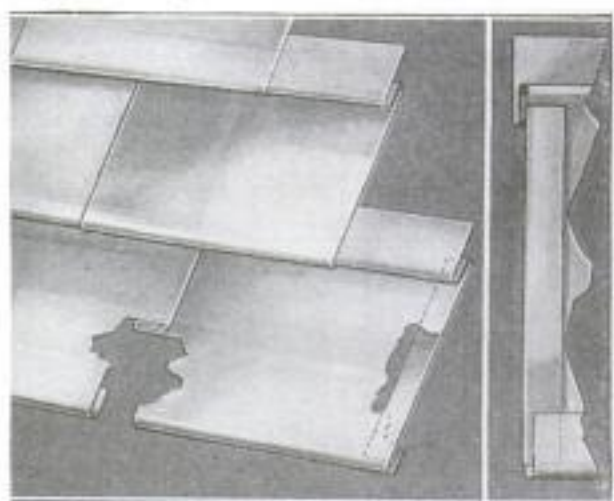

The Copper Shingles are So Formed That Each Shingle Interlocks with Those on Both Sides in the Same Row and in the Rows Above and Below. Two Shingles are Cut Away to Show the Joint Formed

ing, and it is claimed that they can be produced at a price which will compete with other forms of roof coverings.

Popular Mechanics Magazine does not publish the name of maker or seller of any device described in its pages, but this information is kept on file and will be furnished free by addressing our Bureau of Information.

Anacanda metal roofing Co.
25 Broadway New York City

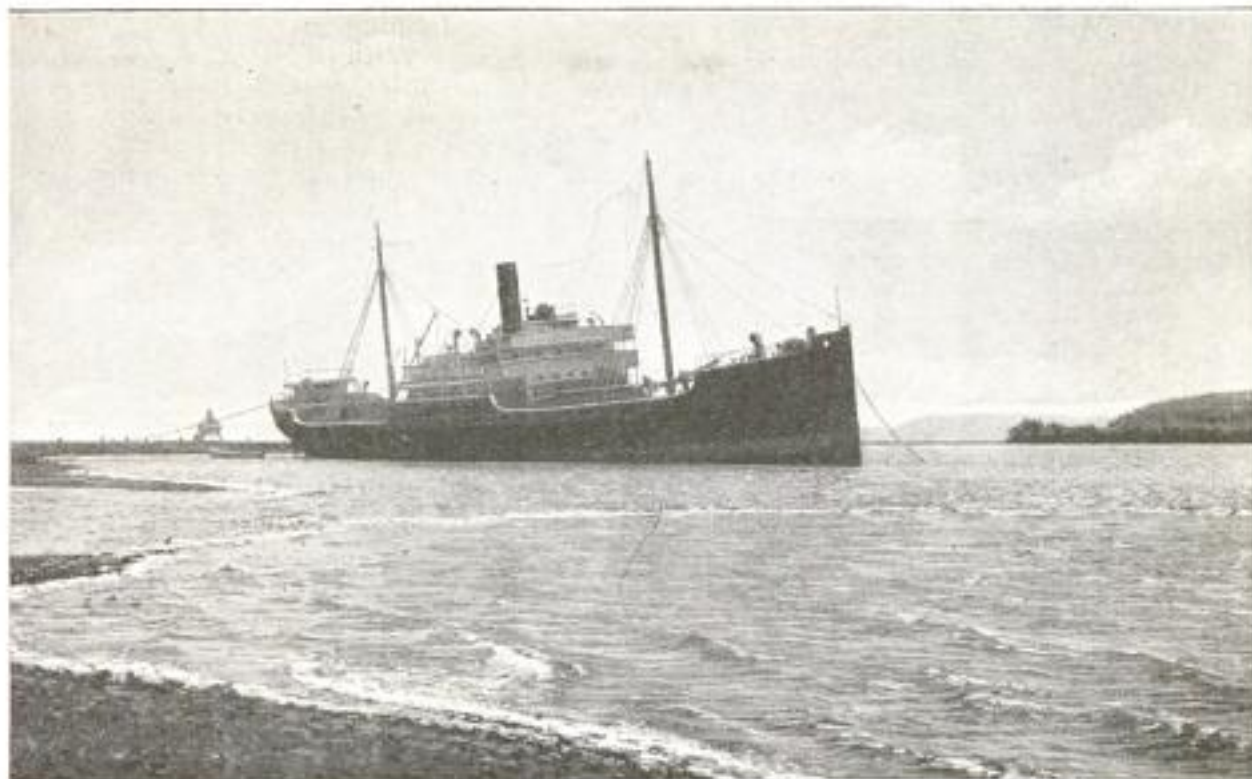

EXTREME RISE AND FALL OF TIDE PERMITS A NATURAL DRYDOCK

MADE possible on account of the phenomenal rise and fall of the tide in the Bay of Fundy, which is sometimes as much as 60 ft., a natural drydock is in use off the Nova Scotian coast, near Parrsboro. Bilge-blocks are arranged in the sand for supporting a ship, which is allowed to settle on them as the tide falls. The hull is then pierced so that when the tide returns the water will enter the ship without raising it. This natural drydock is actually dry for from six to eight hours each tide. The ship shown docked in the picture is one that was built in 1918, under war emergency, by the U. S. Shipping Board, at a cost of \$350,000, and that was sold in December, 1921, for \$6,000. It is to be converted into a barge.

7845

LATEST GARAGE EQUIPMENT REPLACES REPAIR PIT

Repair pits in garages, with all their inconveniences and dangers from collecting gasoline and oil, are objectionable

and may now be replaced by a new piece of garage equipment. It consists of two uprights, on casters, connected at the top by a pipe drum on which a chain is wound by means of a geared windlass. Two metal channels extend from the tops of the uprights to the floor and are braced at the bottom. These can be quickly detached and the whole outfit moved out of the way, against the wall, by one man. When work is to be done under a car, the chain is fastened to the front or rear axle, as required, and the car pulled up the channels to any

desired height, by means of the windlass. This takes only a few minutes and places the car in the most convenient position for doing the repair work, allowing the mechanics to work in a comfortable manner.

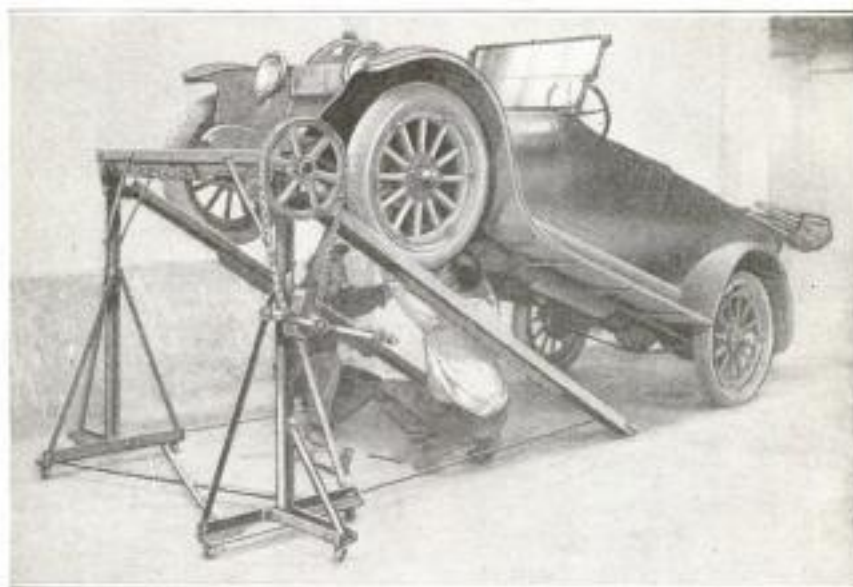

When It Becomes Necessary to Make Adjustments or Repairs on the Under-side of the Car, the Wheels are Run onto the Channels Which are Raised by the Windlass and Chain to Any Desired Position

Manley Mfg. Co., York, Pa. Copyrighted material

AUTOMATIC GAS SAMPLER FOR MINE EXPLOSIONS

8388 In studying mine-gas explosions it is desirable to obtain samples of the gases generated during the explosion, so an automatic sampler has been developed.

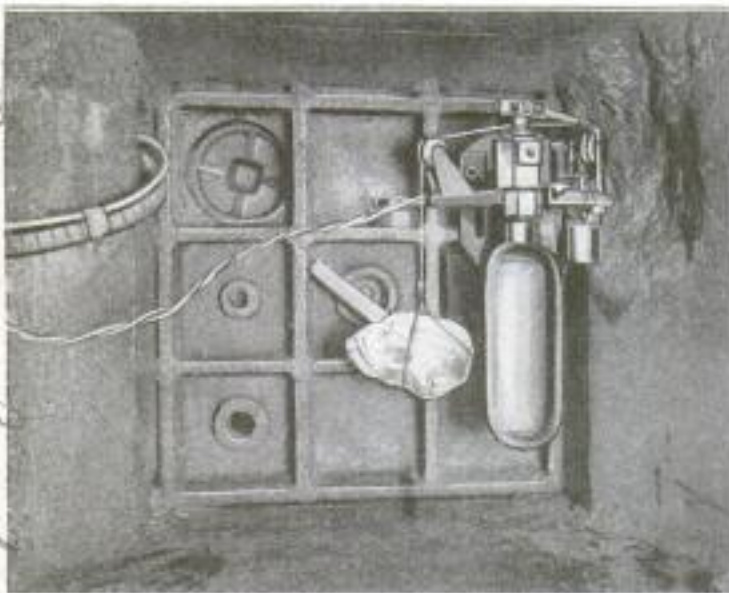

A Sample of Gas is Drawn, by Vacuum, into the Steel Bottle When the Glass Cover is Broken. An Electromagnet Releases the Weight Which Closes the Valve, Sealing the Sample of Gas in the Bottle

A steel bottle is supplied with a valve and a glass cover. The air is exhausted from the bottle, and it is placed where the sample is to be taken. The pressure of the explosion operates an electric contact which drops a hammer, breaking the glass cover of the bottle. The gas rushes in to fill the vacuum. The electric contact also operates an electromagnet, which, by delayed action through a weight, closes the valve of the bottle, sealing the sample of gas.

¶ We want all our readers to write us freely and often whenever they wish additional information on articles published in this magazine. Address Bureau of Information, Popular Mechanics, Chicago.

Humeral

PORTABLE MACHINE MAY BE A PLOW OR A PLANER

BY HENRY S. WHITE

3683
IN principle and in most of their details the same, two machines have been designed, and are now being manufactured, for two quite different purposes. A description of the methods of operation of one will cover the other, and their special functions can be explained separately. Fundamentally the machine consists of a flat triangular frame made of standard steel shapes, of which the outside member is a medium-sized channel. This triangular frame is inclosed at top and bottom with steel plates. Mounted above it is a housing with some resemblance to an automobile hood, that contains a standard gasoline engine with radiator and regular automobile equipment. The motor is connected to a two-speed transmission, through which it drives a large bevel gear at the front point of the triangular frame. On the shaft of this bevel gear, and below it, is a sprocket which, by means of an endless chain, drives a number of other sprockets that are disposed around the three sides of the frame. On each of two of these sides these sprockets drive four vertical shafts mounted below the frame that carry different cutting tools—in one case radial

plows, and in the other milling cutters for surfacing roads or trimming ice.

This triangular frame, with its motor, driving mechanism, and operating tools, is a unit that is mounted on three wheels, one at each side, at or near the rear, and one in front, which may be in the form of twin wheels, for steering. This makes the machine transportable and adjustable with regard to the level at which the tools operate. The nine tools overlap each other in their action, and revolve in different directions. In their work they cover a surface that has a width of 12 ft., and also assist the traction of the machine in the direction of the forward point of the triangle.

In the plowing machine, the tools on the sprocket shafts are like spiraled augers, which do the work of a plow, a cultivator, and a harrow simultaneously. One operation is said to put the soil in better shape for planting than is done in the old way by two, or even three, separate operations. In the other machine the tools are like milling cutters. This is used for surfacing roads, for planing ice for skating or curling, and for other similar purposes.

*Bureau of Mines
U. S. Dept. of Interior
Spiral Machinery Co.
18th + Brady Street
St. Louis, Mo.*

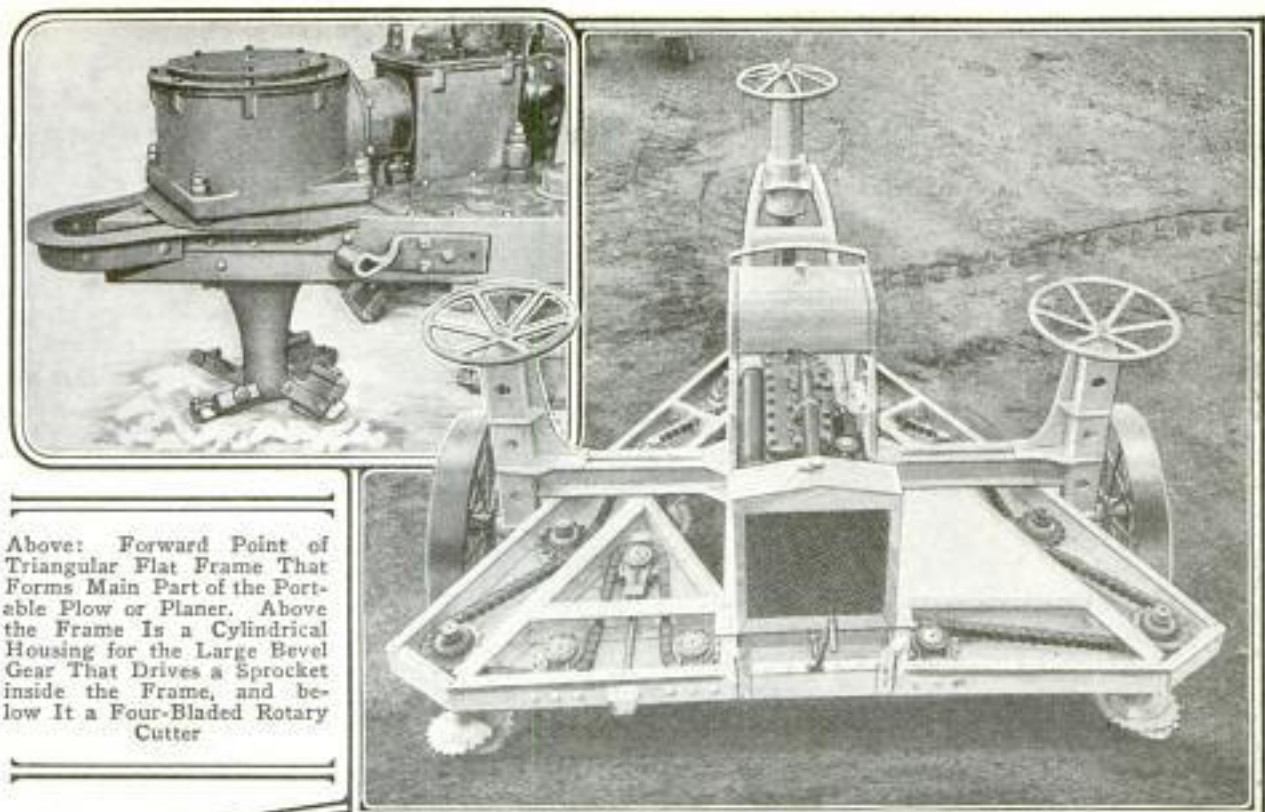

Above: Forward Point of Triangular Flat Frame That Forms Main Part of the Portable Plow or Planer. Above the Frame is a Cylindrical Housing for the Large Bevel Gear That Drives a Sprocket inside the Frame, and below It a Four-Bladed Rotary Cutter

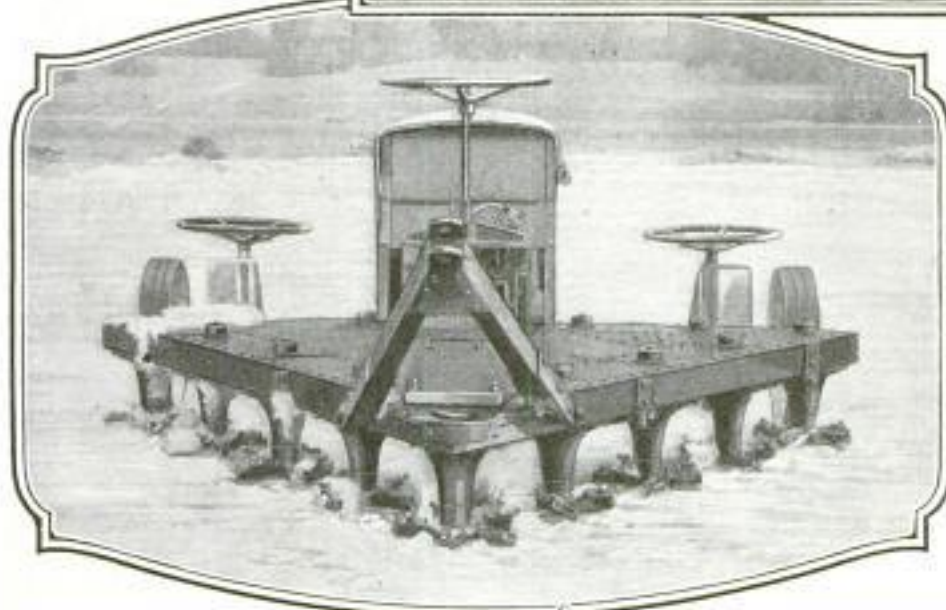

Above: Machine, Fitted with Rotary Spiral Plows, Shown with the Top Plates Removed from the Triangular Frame That Acts as a Kind of Chassis to Which the Three Transporting Wheels of the Machine are Connected in Such a Manner That This Chassis can be Raised or Lowered by the Handwheels Seen Above Them, in Order That the Depth to Which the Spiral Members Work the Soil may be Adjusted. Left: Similar Machine Fitted with Four-Bladed Rotary Cutters to Act as a Planer

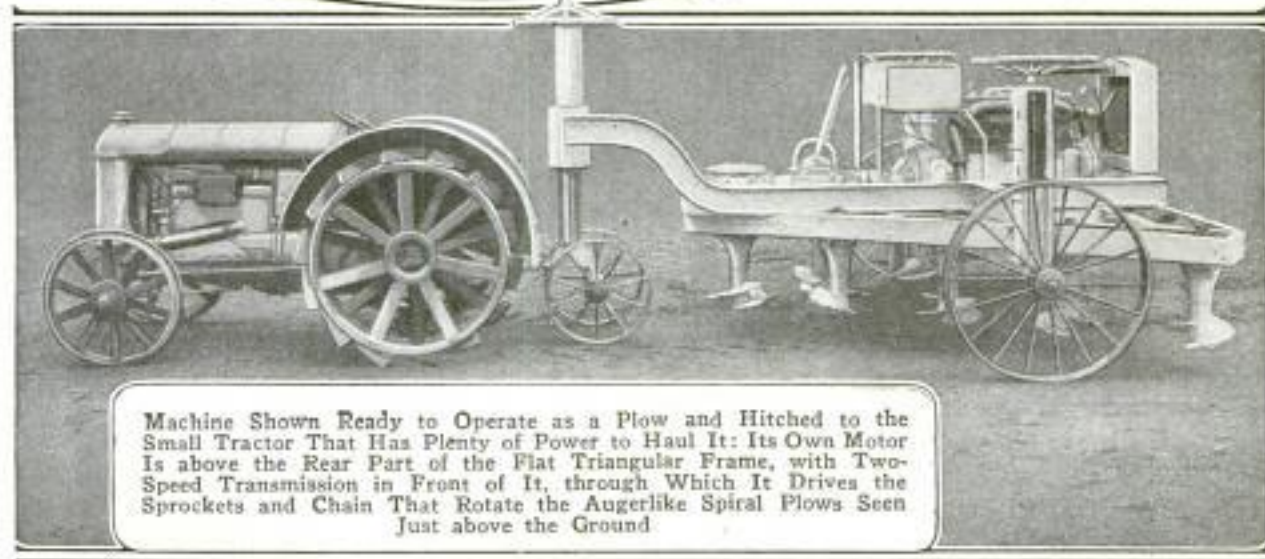

Machine Shown Ready to Operate as a Plow and Hitched to the Small Tractor That Has Plenty of Power to Haul It: Its Own Motor Is above the Rear Part of the Flat Triangular Frame, with Two-Speed Transmission in Front of It, through Which It Drives the Sprockets and Chain That Rotate the Augerlike Spiral Plows Seen Just above the Ground

International Binding
+ Binding Co., 149 W. Ohio, Chicago
MACHINE TIES AND SEALS PACKAGES AT ONE TIME

BY ROBERT H. MOULTON

Room 2, Board of Trade Bldg. Chicago

8475
THERE are any number of industries which have long been confronted with the problem of packages being plundered during transit and shipments arriv-

shipment has been tampered with in transit and furnishing him with a strong claim for damages from the transportation company.



Binding Machine in Action: One End of the Bundle has been Tied and is being Swung Around So That a Wire can be Placed on the Other End

ing at their destination in unusable condition, due to poor packing and rough handling. The use of wooden cases has overcome these troubles to some extent, although not even boxes are always strong enough unless they have been strapped or wired.

While the economy and strength of the metal-reinforced wooden package are generally recognized by shippers, not much use has been made of this style of package because there has been no machine capable of doing the wiring quickly, easily, and cheaply. A Chicago man, however, has recently invented a wire-tying machine which seems to point the way to better and safer bundles for everybody.

The primary purpose of the new device is to wire cases and bundles—anything from a pail to a bundle of boards—but it really does more than that. It actually seals each case or bundle, so that if the wire binding is deliberately removed, it cannot be replaced, thus giving unmistakable evidence to the receiver that his

In the wiring of boxes, this machine possesses numerous advantages over any other method heretofore employed. In the first place, it not only puts around the box a band of steel strong enough to keep the contents intact, even under rough handling that would split the boards or loosen the nails of a box not so reinforced, but permits a lighter and therefore cheaper box to be used. This also means the elimination of considerable dead shipment weight. In addition to tensile strength, which in the case of No. 13 gauge wire is over 600 lb., wire has other advantages: It cuts into the corners of the box, making it impossible to slip the band off, and when applied with the new machine, the combined seal and tie, consisting of three complete turns on each side, or six twists in all, is stronger than the wire itself.

The seal-tie machine is motor-driven, both the tensioning of wire and the subsequent operations of twisting it and cutting it off being performed automatically. A box, for instance, is strapped with what is practically one continuous operation, as against a dozen or more different motions employed by other methods. Moreover, the wire used for binding purposes does not have to be cut up into special lengths or otherwise specially prepared, but is drawn from the coil form, just as it comes from the mill.

A notable feature of the machine is its

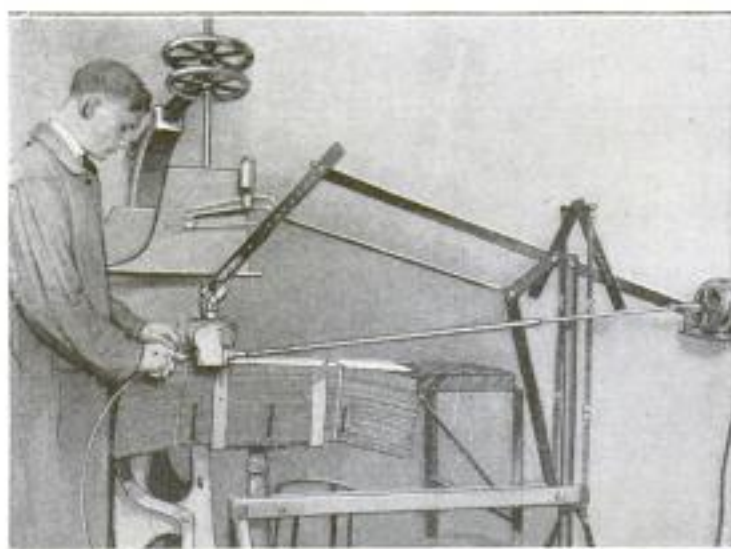

Another View of the Binding Machine, Showing a Bundle of Ordinary Shingles being Tied: At the Extreme Right End of the Apparatus can be Seen the Small Electric Motor That Drives the Machine

simplicity, as anyone can operate it without previous training or long practice.

The operator merely places the wire in position, presses the foot treadle, which puts the package under pressure, and the same operation lowers the tying mechanism onto the package. The wire is then passed around the overhanging end of the article to be tied and laid in the rotating tension drum, which immediately seizes it and draws it to the required tautness. The tension is necessarily adjustable, because a tension that a fragile container could not stand might be very desirable on a large heavy box, carrying heavy, bulky goods.

Once the tension is determined and set by the operator, however, the machine will continue to pull each band to this exact degree of tightness indefinitely, or until another adjustment is made.

When the required tension is reached in binding a

package, the tension drum stops, and the twisting mechanism is automatically engaged, making the tie and cutting off the ends in a fraction of a second. The ends are cut off close and at the same time turned toward the surface of the box. Thus, with the ends down and entirely out of the way, there is no chance for injury to the handlers of the packages, and nothing to interfere with their even piling. Rigid back stops and side stops are provided for forming a corner into which loose pieces of board, shingles, or similar material, may be quickly and evenly stacked. These stops may be moved by loosening two clamping

screws provided with large wingnuts. This can be easily done while the machine is being adjusted for height, for instance, when a change of package occurs. The operation is performed by the manipulation of two handwheels on the overarm.



Complete View of the Binding Machine Together with a Coil of the Iron Wire Used: The Pedal Which Applies the Pressure to the Packages can be Plainly Seen

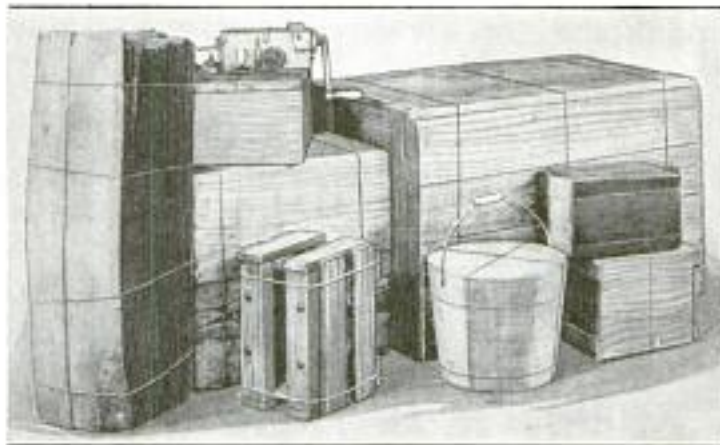

Illustrating the Various Shapes and Sizes of Packages, Boxes, Buckets, and Crates That are Securely Bound with the Binding Machine, Thus Assuring the Safe Delivery of the Goods

HUNDREDS OF BALL BEARINGS USED TO CONSTRUCT AUTO

Ball bearings form the principal and most conspicuous part of a miniature racing automobile, which is the product of a western dealer in motor accessories. Constructed almost entirely of discarded and worn-out bearings, the tiny speedster model is thought to be unique among such creations.

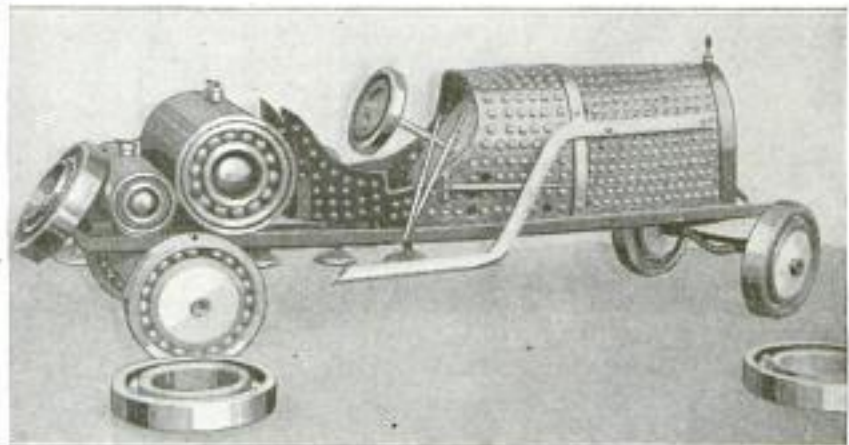

Miniature Racing Auto Which is Composed Mostly of Discarded and Worn-Out Ball Bearings, Taken from Many Different Makes of Machines While They were Undergoing Repairs

Photograms, 129 E. 27th St. new York City

American Foundry
Equipment Co.
366 Madison Ave. New York

POPULAR MECHANICS
LIGHT SAND-CUTTING MACHINE
THAT IS HAND-PROPELLED

To provide the advantages of mechanically tempered sand in small foundries, for which the older sand-cutting machines are too large, a small

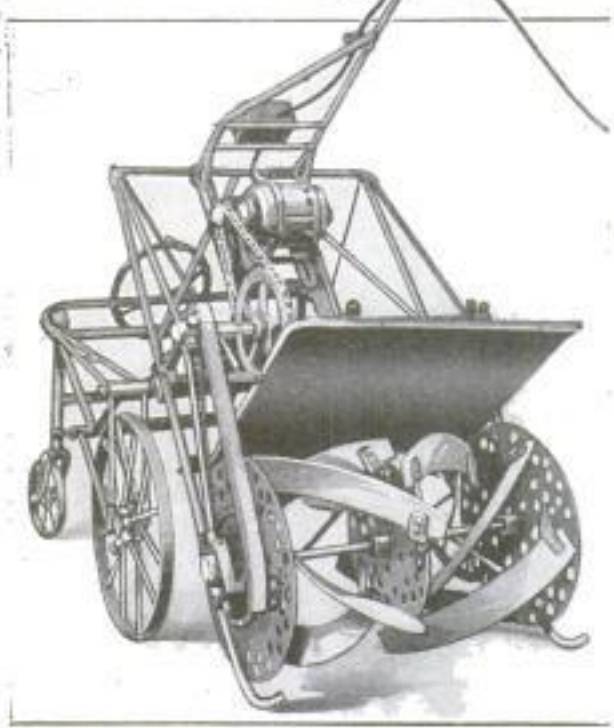

Light Hand-Propelled Sand-Cutting Machine for Use in Small Foundries: On Well-Paved Floors It can be Handled by One Man, but on Uneven Floors Two are Required

light type of the same machine, weighing less than 700 lb., has been placed on the market. The cutting principle remains the same, but power is needed only for rotating the cutting cylinder. The machine is propelled and guided by hand, like a pushcart, by grasping the rear frame member. The cylinder blades when cutting have so much traction in the sand that very little effort is required to propel the machine. Its size makes it convenient for foundries with narrow floors, for its over-all width is only 55 in. Besides cutting and mixing floor heaps, it can be used for mixing batches of core and facing sand. One man can handle it on well-paved floors, but on soft or uneven floors two are required.

TO RECONDITION "LEVIATHAN"
AS FINEST HOTEL AFLOAT

Contracts have been awarded for reconditioning the "Leviathan" as one of the finest passenger ships afloat, and work will start at an early date. All staterooms will be equipped with telephones for local communications on shipboard and for

connection to land telephone lines when the ship is docked. In addition, most of the staterooms will be supplied with radiophones. There will be public rooms, libraries, and a gymnasium for use of the guests. The latest type of standardized American plumbing will be used throughout, the first installation of this kind on shipboard. The power plant of the ship will be converted to use oil as fuel instead of coal, which was formerly used.

MOTOR STARTING MADE EASY
IN COLD WEATHER

Heating of the intake air, or of the carburetor of an automobile engine by means of the exhaust gases, or the water from the radiator, to facilitate starting in cold weather, requires the elapse of a certain amount of time, being therefore less effective than if the heating could be done instantaneously, as it is claimed to be done in a new French device that employs an electric resistance heater made of a patented platinum alloy which, with an ordinary 15-ampere current, heats to 800° C. (1,472° F.) in 15 seconds. It has a flange connection that is bolted between the carburetor connection and the intake manifold. In this flange is an air passage leading into a socket into which the device itself is screwed. This is in the form of a small cylinder in which is housed the resistance wire of special platinum alloy,

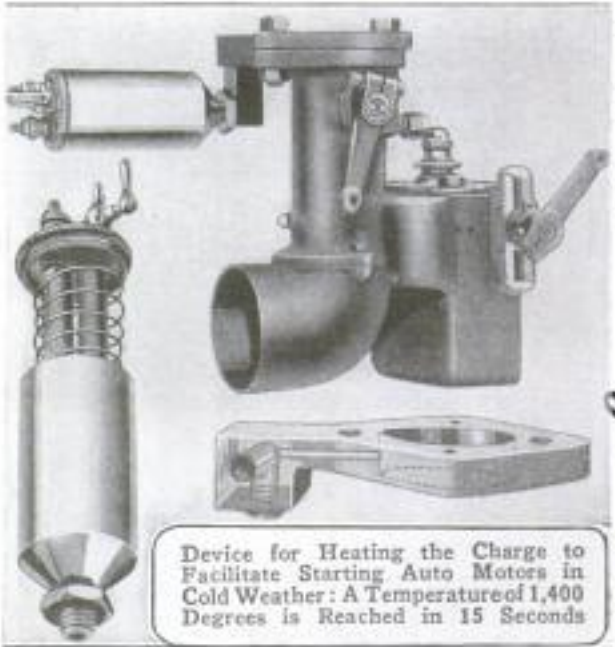

Device for Heating the Charge to Facilitate Starting Auto Motors in Cold Weather: A Temperature of 1,400 Degrees is Reached in 15 Seconds

and which has a small air inlet and a binding post. The current is switched on, and in 15 seconds the motor is ready to be started. It will be of particular advantage on airplane motors.

Com. E. H. Weiss, 80 de Valenciennes, Paris.

8334

8243

8506

Nauticus 2/19/22

Christian Science Monitor 2/16/22

8460 Used by Hydro. ^{Magnum & Supplies} Electric Power
Commission of Ontario,
Niagara Falls, Ont., Canada.

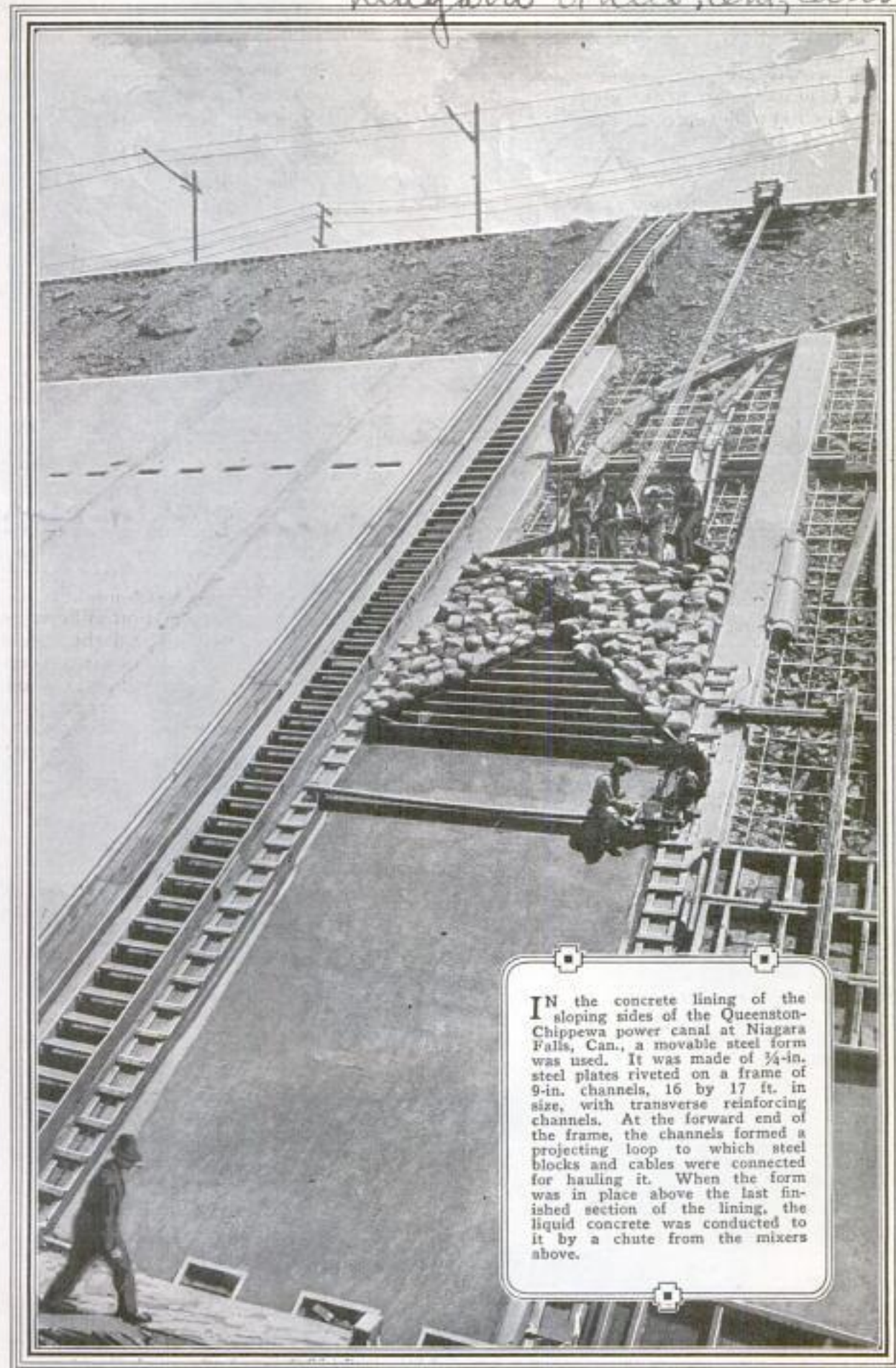

IN the concrete lining of the sloping sides of the Queenston-Chippewa power canal at Niagara Falls, Can., a movable steel form was used. It was made of $\frac{3}{4}$ -in. steel plates riveted on a frame of 9-in. channels, 16 by 17 ft. in size, with transverse reinforcing channels. At the forward end of the frame, the channels formed a projecting loop to which steel blocks and cables were connected for hauling it. When the form was in place above the last finished section of the lining, the liquid concrete was conducted to it by a chute from the mixers above.

cont.
Hogg & Ward,

Chas. George Boshart,
Ardmore, Pa.

536

POPULAR MECHANICS

4 POLICE AUTOS IDENTIFIED BY SPECIAL MARKS

837

To prevent motorcycle officers from needlessly pursuing police automobiles as speeders, identification marks have been



Two Aluminum Disks Placed on the Back of the Ton-
neau Identify This Police Auto by Day, While an
Extra Taillight of Blue Color Serves at Night

placed on the machines so that they may be readily distinguished. Two aluminum disks are attached to the back of the tonneau, and the car carries also a blue tail-light in addition to the usual red one. In this way the speeding car can be readily identified either day or night. Where this system has been adopted, it has been declared a misdemeanor for other motorists to use these marks.

COAL-BURNING LOCOMOTIVE ONLY 20 INCHES LONG

838

A tiny locomotive has been added to the collection of the National Museum at Washington which is a complete working model of a standard-type engine. To build such a small locomotive is quite an accomplishment, for the over-all length



Constructed to Exact Scale, This Model Locomotive
Burns Coal and Operates like the
Standard-Sized Engine

is only 20 in., and the height from the rails to the top of the cab is 7³/₈ in., while the driving wheels are only 3¹/₂ in. in diameter. All the small pipes are hollow and carry steam or air.

FIRST STEP IN DEVELOPMENT OF VERMONT POWER PLANT

846

The first step has been taken toward the ultimate development of 20,000 hp. hydroelectrically at Davis Bridge, Vt., a project that has been long under consideration. There has been awarded a contract for the driving of a tunnel, 25 ft. in diameter and 1,600 ft. long, through the hill country near this point, the purpose of which will be to free the river bed so as to facilitate the construction later of a storage dam capable of backing up the water about 10 miles, which will furnish water power for the two 10,000-hp. units under consideration.

COMPRESSED AIR NOW USED TO CLEAN CHIMNEYS

8328

Cleaning the soot from chimneys with the aid of compressed air, is the method used by a Wisconsin inventor, the idea of which is said to have been provided by the bursting of an automobile tire. The apparatus consists of an air pump, and an air chamber having a circular vent, against which is clamped a soft rubber disk. The air chamber is placed

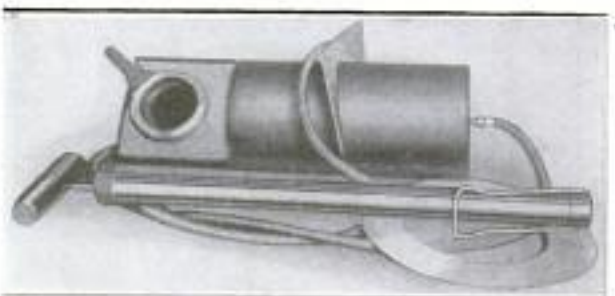

Compressed-Air Chimney Cleaner, Showing the Air Pump, Hose, and Air Chamber with Circular Vent on Which is Placed the Rubber Disk

in the chimney at the bottom, and the operation of the pump expands the rubber disk until, at a pressure of about 50 lb., it finally bursts, which either blows the soot out of the flue or causes it to drop to the clean-out, whence it is easily removed.

The Canadian air board has made a complete photographic survey of the proposed Great Lakes-St. Lawrence River deep waterway, with special reference to suggested sites for dams and locks.

Chas. John Koudelka, Antigo, Wis.

new England Power Co. Davis Bridge, Vt.

Nov. 20, 1920

material

4825 C

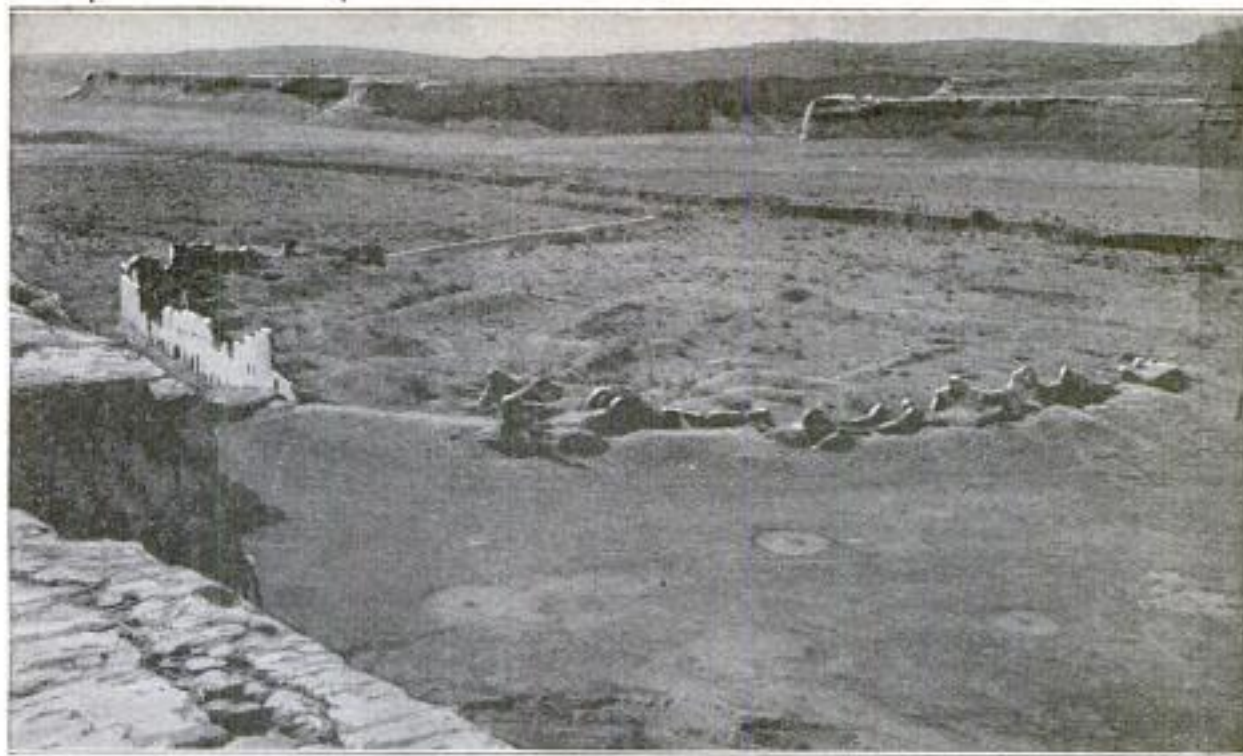

Pueblo Bonito, upon Which the National Geographic Society Began Work Last Summer: Years Ago Some Work was Done in Restoring This Ruin, Before Anything Very Definite was Known Regarding the Prehistoric Pueblos

PEEPING THROUGH THE CURTAIN OF THE AGES

Pueblo BY R. P. CRAWFORD, 153 W. 93rd St. New York City

MYSTERY, romance, and glamour have surrounded the Pueblo Indians of the Southwest ever since white men set foot in America. Explorers have long speculated as to the meaning of the great ruins of over 600 abandoned villages stretching at intervals from southern Colorado and Utah into Mexico. Tourists have made long journeys, often across unsettled country, to view these ruins and to wonder at the genius of their one-time inhabitants. Every schoolboy has read and dreamed of the Spanish conquerors and has lived over again their exploits.

Prehistoric! That word calls to mind the days before Greece and Rome ever came into existence. But right here in America are prehistoric ruins, for history in the Southwest did not begin to be recorded until the coming of the Spaniards early in the sixteenth century.

However, the great curtain of the ages had fallen before even the Spaniards set foot on American soil. Most of the great villages were no more. Dirt swept in by the wind had all but obscured many of them. One could only imagine what races of people lived here in centuries gone by. One could only speculate as to the cliff dwellers and other mysterious tribes. But out of the 600 Indian villages that rose and fell within the ages past, only some 30 are inhabited today.

Within the last few years, however, the scientists have come, steadily but surely pushing back that curtain. We can now take a peep and for the first time acquire some coherent idea as to when and how these prehistoric races existed. We can now know with some degree of definiteness how these early apartment-house dwellers lived—these aborigines who showed such wisdom in performing huge tasks with the most scanty tools. The American Museum of Natural History has been making a study of these prehistoric races in northwestern New Mexico. It chose for its special field of activity Aztec—not to be confused with Mexico. Aztec, in northwestern New Mexico, is a little village, and the great ruins on which the museum has been working are only a short distance away. Last summer the National Geographic Society started an expedition at Pueblo Bonito, perhaps some 60 miles from Aztec, where some work had been done years ago, before there was any accurate information at hand. Nor does one forget what Dr. J. Walter Fewkes has been doing in the Mesa Verde ruins in southwestern Colorado. Perhaps even more interesting and wonderful than the excavations and historical facts deduced, are the methods by which these things were accomplished.

"The point of greatest interest to most people is that these ruins were not inhabited by some mysterious people entirely strange to the Pueblos of the present day," N. C. Nelson, of the American Museum, explained to me. "The cliff dwellers were not, as has often been supposed, some wonderful tribe of individuals, the like of which is to be found nowhere today. The Pueblos, who built the 600 or so prehistoric towns, were the ancestors of the modern Pueblos, who are now to be found in some 30 villages in the Southwest. They were closely related to modern Pueblos, even though many of them did live 1,000 to perhaps 1,500 or 2,000 years ago."

To go back 1,000 years in the history, or rather prehistory, of our country is quite an achievement in itself. While Europe was groping through the Dark Ages, there was something of a civilization in our own great Southwest. How science is able to "get at" things of this sort is often more interesting than the facts themselves.

A favorite method is to locate the refuse heap at one of these abandoned villages. The Pueblos were just like many of our modern people today. They threw all the rubbish into the back yard. One

generation after another piled its refuse in the same place. Since these villages were in reality usually a single great apartment house, the accumulation of rubbish grew rapidly. The scientist comes along and reads history in this rubbish heap.

He simply digs right down to the very bottom of it. Then he can pick out the pottery fragments which have been dumped in the pile by the successive tenants of these ancient apartments. Naturally the kind of pottery found at the very bottom of the pile indicates the civilization of the earliest dwellers. Of course these villages from time to time were entirely abandoned and new tribes came in.

Quite often the succession of pottery fragments would be interrupted. But by studying many different ruins and by comparing the remnants of the pottery

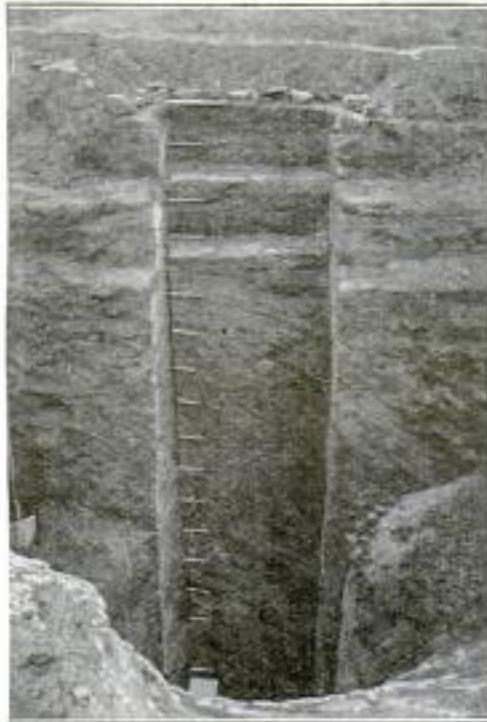

Section through Refuse Heap: By Comparing the Pottery Fragments in Different Parts of the Pile with Those from Other Ruins, a Good Idea of the Age of the Particular Village is Gained

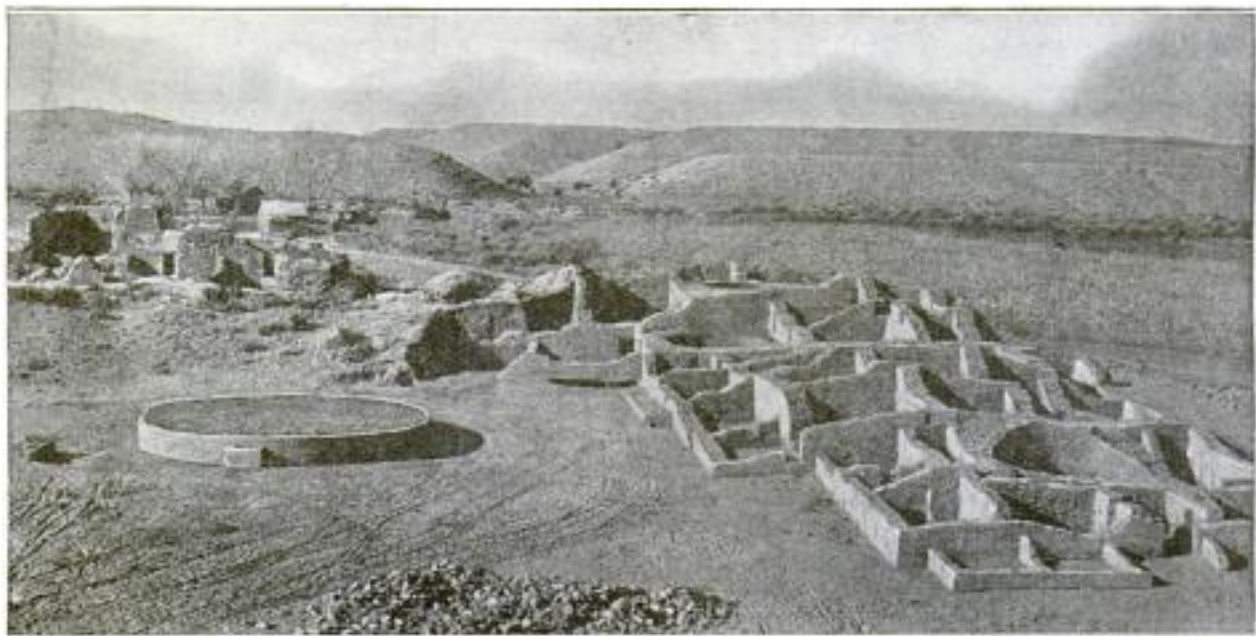

Excavated Section of the Aztec Ruin: The Circular Mound on the Left Is the Roof of an Underground "Kiva," or Ceremonial Chamber, in Which were Found a Rude Stone Altar, and a Sacred Serpent, Carved in Wood, on the Ceiling



An Unusual Photograph Showing the Actual Exploration and Unearthing of the Aztec Ruins in Northwestern New Mexico: A Small Railway has been Built to Haul Away the Débris

in different places, one gets a fairly good idea of the development of this civilization. Naturally the pottery fragments on the top indicate the type of civilization at the time the village was abandoned.

The very first residents of which there is any record, according to Dr. Clark Wissler, of the American Museum of Natural History, were basket makers.

They had no knowledge of pottery making. Then came a period of crude pottery, known as the pre-Pueblo period. Next came the early period of black and white pottery, and about this time small houses began to be erected from which such ruins as Aztec ultimately developed.

The following period in the history of this country was also featured by black and white pottery. Toward the close of this period Aztec and Pueblo Bonito were built, along with the cliff houses in Mesa Verde Park.

The next was a period of two-color glazed ware. Pueblo culture at this time was beginning around what is now Santa Fe and was becoming extinct at Aztec.

The latest prehistoric period extended up to about 1540, and was featured by the development of three-color glazed and painted pottery. At this time many Pueblo villages around Santa Fe came into existence. The historic period, featured by two-colored glazed ware, begins with 1540. Doctor Wissler has estimated that it was 1,000 to 2,000 years ago that Aztec, now being explored by the museum, came into existence.

The greatest development at Mesa Verde, consisting of cliff houses, is estimated by Doctor Fewkes to have occurred in the neighborhood of 600 years ago.

Perhaps of still more interest

is the method by which minor differences in time are estimated. For instance, it is now generally agreed that Pueblo Bonito was built from 30 to 50 years earlier than Aztec, and such a fine distinction is quite an achievement. Probably most of the credit for such fine distinctions as this goes to Prof. A. E. Douglass, of the University of Arizona, who originated a system of measuring the

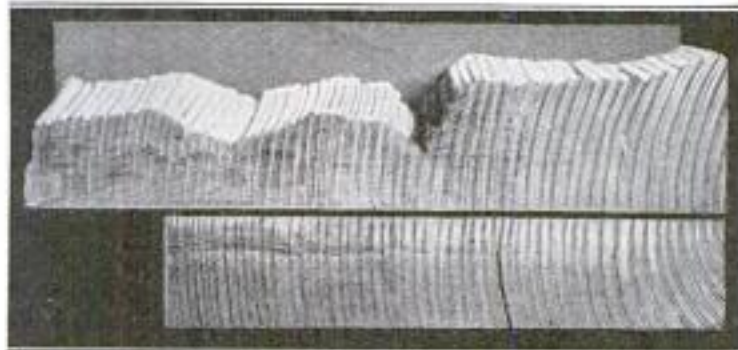

How the Relative Age of Ruins is Determined: The Piece of Wood Above Is from the Aztec Ruin, While the Piece Below Is from the Bonito Ruin, Some 60 Miles Away. The Climatic Changes of the Years are All Recorded in the Trees Which Formed the Beams of the Ruins. It Is Possible to Find Where These Growth and Climatic Rings Match in Samples of Wood from Different Ruins, and in That Way Determine How Much Later a Certain Ruin was Built

age of ruins by means of the wooden beams used in their construction. There is little doubt that in Aztec and Bonito these beams were made from trees living simultaneously for more than a hundred years. By counting and studying the growth rings in the beams from Aztec and Bonito, it is possible to estimate with some degree of accuracy the difference in the age of the two ruins, for it has been found that the climatic conditions are recorded in these growth rings, so that some year from which to begin counting may be found in the beams of the two ruins. To such seemingly insignificant details the scientist often owes the solution of a puzzling problem.

When the explorers began work on the Aztec ruin it was only a patch of jungle rising above the surrounding country. Weeds and dirt had long obscured the ancient village. But as soon as this had been uncovered only partially, the customs and habits of the aborigines began

were being manufactured. The only stonecutter's tools were halves of pebbles. In some of the rooms were found the remains of turkey, deer, rabbit, beans, and corncocks, showing the variety of the food that the natives had.



Modern-Day Pueblo Village of Taos, New Mexico: There Are Only About 30 of These Villages in the Southwest Today. These Pueblos Are Descendants of the Prehistoric Races

time, as demand for more rooms arose. Some sections were three stories high. The only difference between the Pueblos and the cliff dwellers was that the latter built on the sides of cliffs for better protection.

The Aztec ruin is in the shape of a letter "E," 280 by 360 ft. in size. Part of it was constructed of cobblestones and adobe, part of iron concretions, and part of sandstone. The sandstone blocks were cut out and laid with remarkable skill.

Some distance from the ruin were found the quarries from which the stone was obtained. The stone had to be transported from two to five miles by human means, no beasts of burden being used by the Pueblos. The stones were hewn and fitted into the building by dressing them with sharp pebbles. It has been estimated that 200 pine trees, 30 ft. in length, and 600 cedar logs, 10 ft. long, were also used in the construction of the building. These logs had to be trimmed down and smoothed off with stone tools.



Cliff Dwellings at Mesa Verde Park in Colorado: Civilization Here Reached Its Height About the Year 1300. The Cliff Dwellers Were Not a Strange Race of People, but the Far-Off Ancestors of the Modern Pueblo Indians

to be apparent. One of the excavated rooms was a factory, where *metates*, or slabs on which cornmeal was ground,

ing and one of the most beautiful rooms in the entire structure was brought to light only a little over a year ago. The

interior was plastered and painted in a brilliant white, with dull-red side borders covered with triangular designs. There was a rude stone altar, and a sacred serpent was carved in wood over the ceiling. Strands of beautifully made rope hung from the ceiling. This was a *kiva*, or ceremonial room. In another room, the body of some individual who had met with a serious accident was discovered. The arm had been broken and six splints of wood had been used to hold it in place. The splints were some 7 in. in length and were flat on the inner surface and curved on the outer. However, the body showed more serious injuries which the native surgeons had been unable to cope with. It was the custom among the Pueblos to use one of the rooms in the house as a burial chamber. The bodies were first wrapped in cotton cloth, next in a mantle of feather cloth, and lastly in a mat of plaited rushes. The bodies were piled in, one on top of the other, with only a layer of sandy earth between. When the room was filled, it was sealed up. In one of the burial chambers great quantities of relics were uncovered. More than 40 pottery vessels were lying near the bodies, together with arrow points, and some 50,000 beads. The smallest beads were disks of black stone about $\frac{3}{16}$ in. in diameter. Three thousand of them made a string some 6 ft. long. Over 30,000 beads of slightly larger size were sifted from the earth and restrung into a strand, 57 ft.

8393

long. All of these beads had to be shaped and bored with stone tools.

The residents of Aztec were skilled basket makers. They also made coiled pottery, consisting of long strips of clay wound round and round until the desired jar was completed. A wooden cradle board was unearthed, with a curious headpiece, which is believed to account for the flattened skulls of some of the bodies found. Cotton cloth, with printed designs, was woven by the Pueblos. Sandals made from yucca leaves, yucca fiber, and cotton were discovered, as well as the pattern boards over which the sandals were made. Needles for sewing were made of sharp-pointed yucca. That the Pueblos were expert stonecutters is shown not alone in the construction of their dwellings, but in their cutting of ornaments. The dwellers at Aztec, unlike those at Mesa Verde, were in close touch with other tribes in the Southwest. Turquoise was secured from the valley of the Rio Grande, copper bells and macaw feathers from Mexico, and sea shells from the Gulf of California and from the Pacific Ocean.

The life of an explorer is not an easy one. There is an immense amount of manual labor connected with the excavation of ruins such as Aztec. The rattlesnakes come trooping out of their holes and add to his troubles. Then there are the centipedes, which seem to come from everywhere.

LIGHT HIGH-POWER ENGINE OF BRITISH DESIGN

A new airplane engine of English design is claimed to be the lightest yet produced for the power generated. The engine complete, except electric starter and exhaust pipe, weighs only 698 lb. and develops 450 hp. at 1,850 r.p.m. There are nine cylinders supplied through three carburetors. Each carburetor feeds to one of three central chambers in which spiral vanes distribute the gas to the cylinders. The cylinders are of steel. The crankpin bearing is relieved of some of its pressure by a clever system of balance weights.

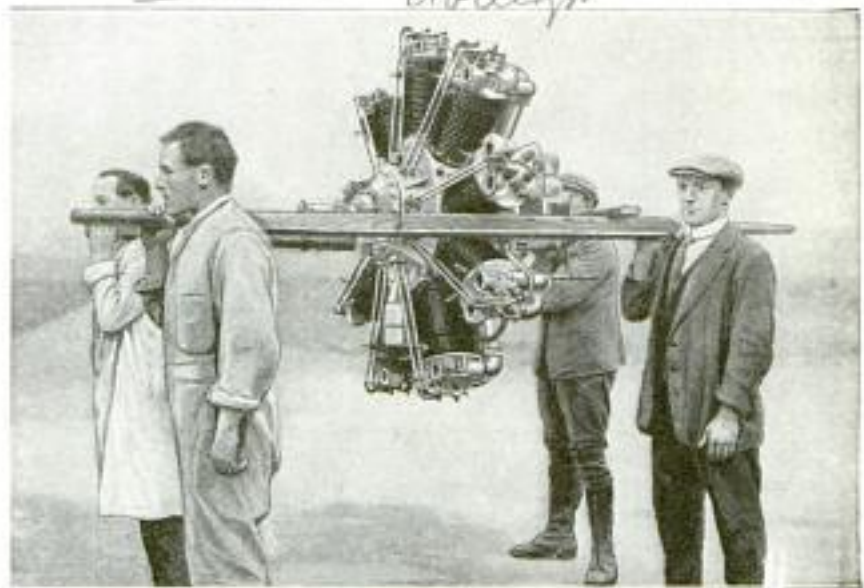

This Nine-Cylinder Aero Engine of British Design Develops 450 Horsepower and Weighs Only 698 Pounds, or About One and One-Half Pounds per Horsepower. Each Cylinder is Fitted with Two Separate Inlet and Exhaust Valves.

*The Aeroplane Bristol Co., Ltd.
Hilton House, Bristol, Eng.*

Cml. C. A. Briggs
 542 1521 *Clall. St. N. W.*
 Washington, D.C.

POPULAR MECHANICS

SCALE REGISTERS WEIGHT OF BEEHIVES

A special form of weighing device has recently been developed for a southern

by a steel tape attached to the scale mechanism below. An interesting feature is the use of short strips of steel tapes in compression in place of knife-edges for the small lever system. The recording lever system is placed in neutral balance so that it does not react upon the indication.

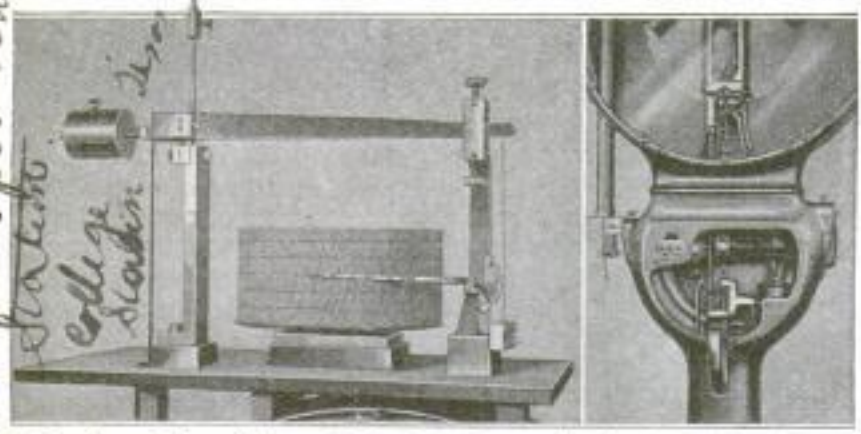

Left: Paper-Covered Drum Driven by Clockwork; the Recording Pen can be Seen on the Center Line. Right: Interior View of the Scale Mechanism

In using the scale, the beehive is first placed upon the platform and the weight read directly on the dial. The recording device is then connected with the pen, starting on the base line in the middle of the chart, so that either an increase or decrease in weight can be recorded. The clock is set running, and the weight is registered as a line, giving in one revolution of the drum a continuous record for a week. The range in weight variation provided for is 25 lb. By means of this arrangement exact particulars relating to bee culture can be obtained.

university, for recording the variation in the weight of beehives. A clockwork drives a paper-covered drum mounted on the top of a modern automatic dial scale. A pen which registers on the drum is connected through a small lever system

cabins, and the porch supports also consist of poles. The upper part, or second story, is of shingle construction, upon which is placed an ordinary roof.

TELEPHONE POLES USED IN BUILDING HOUSES

Economical and unusual means were employed in the building of several homes in Kansas City, Kan., not long ago, when poles, formerly used for telephone and lighting purposes, were utilized. The base, or first story of the house, is constructed after the fashion of the old log

BRITISH "IDEAL-CITY PLAN" NOW BEING TRIED

As a practical development in the "ideal-city plan" the city of Welwyn, Eng., has taken a long step ahead. Around the city proper there is a belt of agricultural land amounting to 1,600 acres which will be cultivated by a self-governing guild of workers. This guild, which is actually at work, will supply produce needed by the citizens on a basis of service rather than of private profit. Large-scale methods of cultivation will be used, needed capital for equipment being furnished by the sale of shares and loan stock. Interest on the shares will be limited to four per cent, and guild members may own only one share each.



Economical House in Which Discarded Telephone and Lighting Poles Form the First Story and the Porch Supports: Seventy-Five Poles were Used in the Construction of This Dwelling

6416
 8176
 8398
 6/19
 6/19
 6/19

Christian Science Monitor 2/6/22
 Copyrighted material

8411 International Water Service
226 William St.

RESCUED FROM THE "GRAVEYARD OF CAPE COD"

Life-Saving

New York City

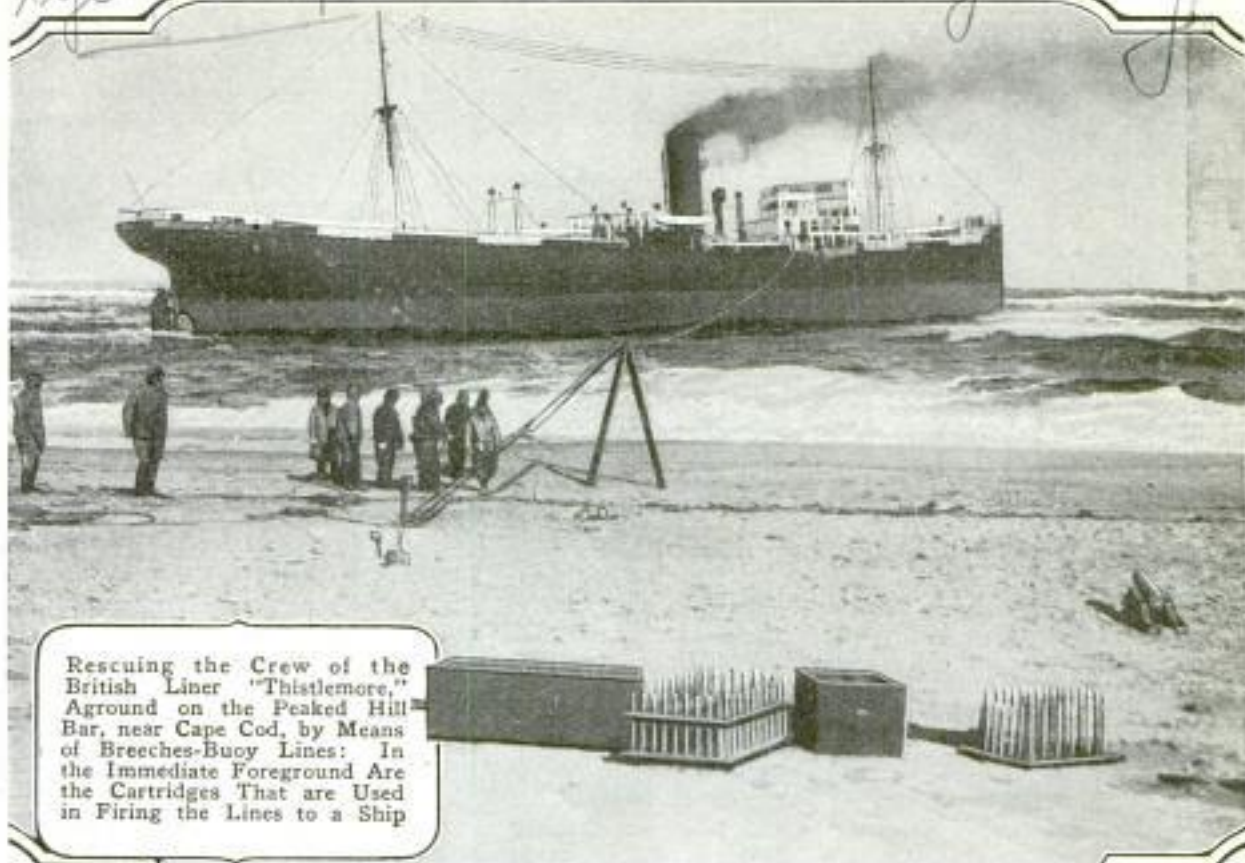

Rescuing the Crew of the British Liner "Thistlemore," Aground on the Peaked Hill Bar, near Cape Cod, by Means of Breeches-Buoy Lines: In the Immediate Foreground Are the Cartridges That are Used in Firing the Lines to a Ship



The "Thistlemore," Aground near Cape Cod, on a Bar Known as the "Graveyard of Cape Cod": The Ship was Driven Close Inshore by Heavy Seas, Which Later Moderated, and When 18 of the Crew had been Rescued, as It was Getting Dark, the Remainder Decided to Stay on Board Overnight

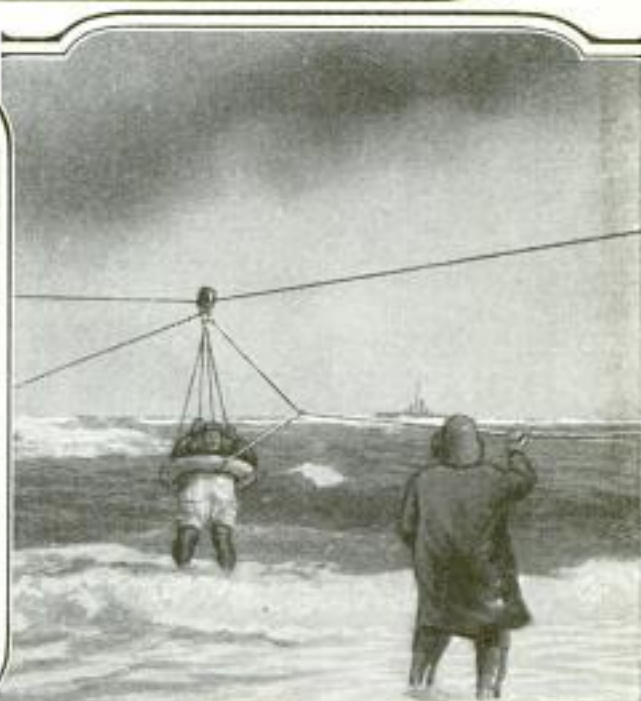

Breeches Buoy in the Act of Rescuing a Member of the Crew: The Breeches Buoy is being Hauled along the Line That was Fired from the Shore to the Ship, to Which It will be Hauled Back After the Sailor is Rescued. At the Time the Photo was Taken Ten had been Rescued in This Manner

Cleveland Motorcycle Mfg. Co. POPULAR MECHANICS
 544 Cleveland Ohio. 402 Parkside Ave. Brooklyn, N.Y.
 RAILROAD INSPECTION CAR TROPICAL TREE BEARS FRUIT
 OF LIGHT CONSTRUCTION IN NORTHERN BACK YARD

8293

Railway inspection and repair men have been aided by the production of a light-weight car, which can easily be handled by one man in placing it on or

Outside of botanical gardens, a bearing fig tree is a rarity north of the Mason and Dixon line. The severe winters of the northern states are fatal to the semi-tropical fig, but a resident of Brooklyn, N. Y., has had one of these trees growing beside his garage for the past seven years. For four years it has furnished him with an average annual yield of 20 lb. of excellent fruit. This remarkable fig tree is about 12 ft. high, and the limbs must be supported by several props when it is loaded with fruit. But during the winter months the tree must be treated like a sick kitten. When ready for the icy blasts, it looks something like a queer chimney built up from the ground. Early in the fall the limbs are bound with burlap and straw, after which an air-tight covering of roofing paper is securely wired on, and the top closed with a section of metal piping. Thus the tree hibernates until all chance of a freeze-up is past and it can start on its annual job of raising 20 lb. of figs. Necessarily, it is an Adriatic fig tree, as no other kind

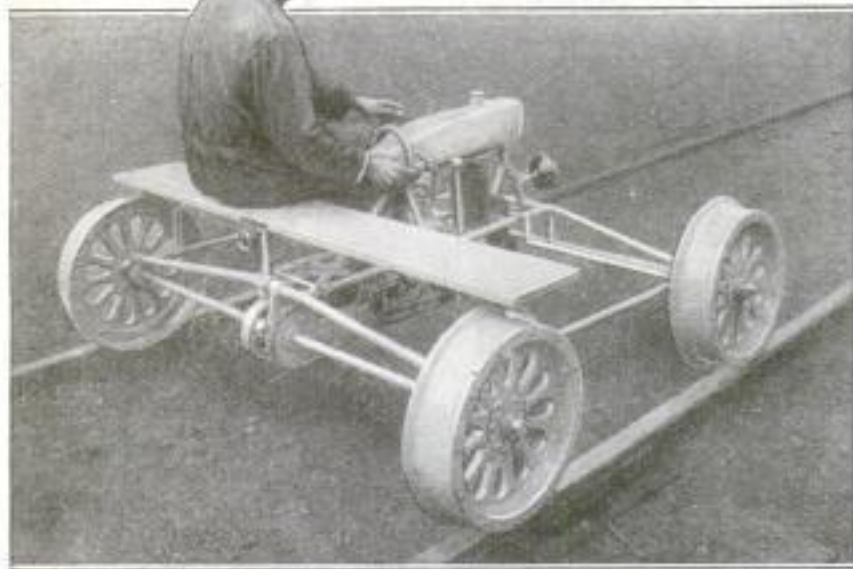

Railroad Inspection Car, Showing the Small Motorcycle Engine and the Framework of Light Construction: The Smooth Board Seat Is a Safety Feature, as the Driver can Quickly "Unload" in the Event of a Collision

which has a speed range of from 5 to 20 miles per hour. The driving power consists of an engine identically the same as a motorcycle engine, except that the gear shift is operated by a lever instead of by the usual pedal arrangement common to those machines. Both rear wheels are driven by the centrally located engine, and all four wheels are of the same size.

LOUISIANA RICE STRAW USED FOR MAKING PAPER

Rice straw, which has hitherto been a waste product on the rice farms of Louisiana, is now being used in the manufacture of paper. A plant has been established at New Iberia, La., that is making corrugated paperboard from rice straw. Tests made before the establishment of the plant showed that the straw produced 65 per cent of its weight in pulp. The new paper mill is situated in the heart of the rice-producing section of Louisiana. It is a source of new profit to the local farmers, for the straw that was once no better than a nuisance now sells for \$6.25 a ton. Recent tests have shown that the straw will produce good paper as well as the corrugated board. There is enough rice straw available to supply several paper mills with raw material.

8473

Chas. Goldk Paper Mill Co., New Iberia, La.

tight covering of roofing paper is securely wired on, and the top closed with a section of metal piping. Thus the tree hibernates until all chance of a freeze-up is past and it can start on its annual job of raising 20 lb. of figs. Necessarily, it is an Adriatic fig tree, as no other kind



Above: Fig Tree during the Summer Months, Showing the Supports for the Fruit-Laden Branches. Right: Winter Covering of Tree

bears edible fruit unless fertilized by the otherwise worthless caprifig and the tiny wasp that carries the fertilizing pollen.

Our Bureau of Information will answer all questions regarding articles appearing in this magazine.

8353

Carl Frank B. Howe
 412 Mason Opera House Bldg
 POPULAR MECHANICS
 Los Angeles, Calif

545

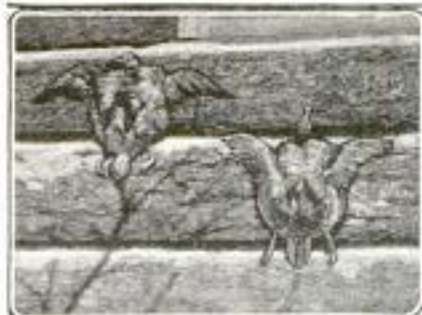

Above: Outside Walls of the Log Cabin, Showing the White Plaster Which is Placed between the Logs to Give the Impression of Drifted Snow, and the Imitation Birds Fastened to the Logs



Front View of the Log Cabin, Which is Built in the Midst of Totally Different California Bungalows, and Which Possesses Counterfeit Wintry Decorations: At the Left are Seen Some of the Imitation Icicles Which are Made of Wood and Painted White. The Roof of White Sand is Also Shown, the Whole Giving the Appearance of Winter



ARTIFICIAL ICICLES ADORN CALIFORNIA LOG HOUSE

An eastern actor whose motion-picture work requires him to live in California resolved that his forced domain should not be entirely without the pleasures of the eastern winter. Consequently he has just completed a modern log cabin in the heart of the residential section of Los Angeles, on which he has placed artificial icicles, snow, and other reminders of that beloved season.

The icicles are made of wood, painted white. The snow on the roof is of a special white sand, while white plaster between the cracks looks like snow and at the same time serves the very practical purpose of preventing drafts.

This log cabin, with its atmosphere of blizzards, set in the midst of light California bungalows, gives the passer-by a sudden shock of surprise.

LARGEST WATCH EVER BUILT EXHIBITED AT WASHINGTON

Many times the size of an ordinary 23-jewel watch, being $9\frac{1}{2}$ in. in diameter and $1\frac{1}{2}$ in. thick, a watch that is believed to be the largest one ever built has been placed on exhibition at the National Museum, Washington, D. C. Although it has a mainspring 9 ft. long, a heavy weight

concealed in the rear of the mahogany cabinet wherein it is displayed is required to operate it, somewhat on the same principle as the old "grandfather" clocks. To insure it against corrosion, the wheels are all of solid gold, excepting the wind-



COPYRIGHT, HARRIS & ERING
 Comparative Demonstration of the Largest Watch in the World, Shown with Its Works Exposed beside an Ordinary 23-Jewel Watch, of Which It is an Exaggerated Reproduction

ing wheel, which is of steel. The 23 jewels are rubies. Its cost was approximately 5,000 dollars.

Carl Frank B. Howe
 702

Wenters National
 Electric Bank, Washington, D.C.

Hammilton Watch Co., Lancaster, Pa.

784

Cml. Arthur A. Davidson
1933 S 35th Ave
Omaha
8436
Nebr.

POPULAR MECHANICS

RAIN-PROOF JOINT FOR TREES THAT GROW THROUGH ROOF

BUYING AT HOME ENCOURAGED BY SIMPLE OBJECT LESSON

One of the summer residents of Shin Lake, Me., wished to build a cottage

Circulating a silver dollar, inclosed in a leather case, is the means employed by a newspaper in Council Bluffs, Ia., to impress upon the local citizens the importance of patronizing the home-town merchants. Every time this dollar is spent, a record is made of the transaction and the purchased articles enumerated, all of which is published each week in the news columns. The intention is to have the people use the coin the same as other money, such as paying bills, for wages, or depositing it in a bank, but the main requirement is—"keep the dollar at home." Surprising facts have been learned concerning the number of

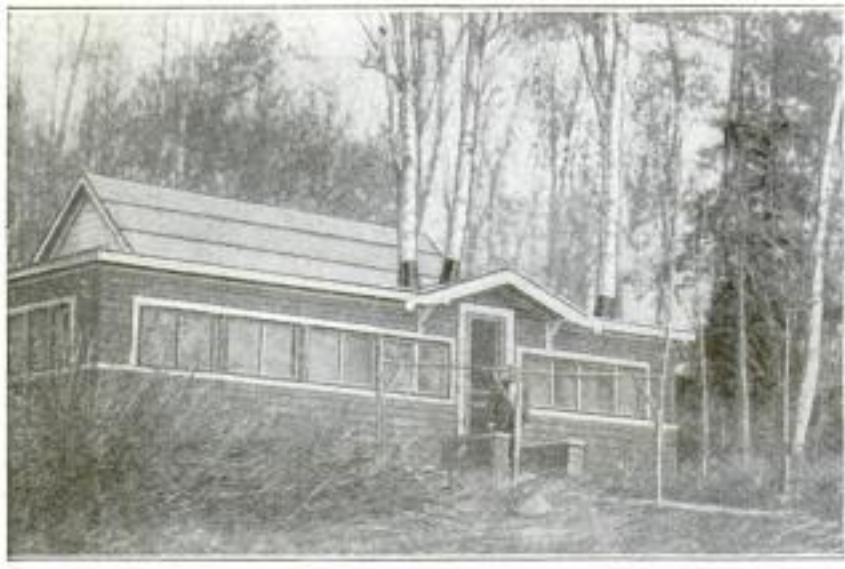

Three White-Birch Trees Grow through the Center of the Living Room of This Cottage. An Ingenious Method was Used to Prevent Rain from Coming through the Openings in the Roof and at the Same Time Allow the Trees to Sway with the Wind, to Keep them from Breaking

around three white-birch trees, inclosing the trunks in the living room as a decoration. The necessity of allowing the trees to sway with the wind and at the same time making the roof tight, presented a problem which he solved in an ingenious way. He tacked the edge of a piece of waterproof fabric around each of the holes in the roof and the other edge to the trunk of the tree, thus forming a loose apron. He then cemented the edges with a waterproofing composition. The trees have plenty of play to resist the most severe wind, and the roof is absolutely tight against rain.

uses to which a dollar will be put in the course of a week.

DOLL THAT CRIES AUDIBLY AND SHEDS ACTUAL TEARS

Dolls have been made to squeak, dolls have been made to make a noise like laughter, and now there is a doll that cries. It sheds actual tears, or at any rate something that is just as wet as tears. The tear drops issue from a rubber bulb behind the eyes, inside of the doll's head.



Doll That Cries When Pressed Gently on the Back: Streams of Tear Drops Issue from the Small Rubber Bulb Behind

A little pressure on a tube that leads from this bulb to the back of the doll is all that is necessary to cause the doll to weep.

Classic Illustrated
Daily Journal

Cml. Frank Anderson, Chicago
Shin Lake, Maine

Far Eastern Review 845
12/19/21

Stapleton, N.Y.
Doyler
Inventory George J.

DRIVER HAS NARROW ESCAPE IN AUTO ACCIDENT

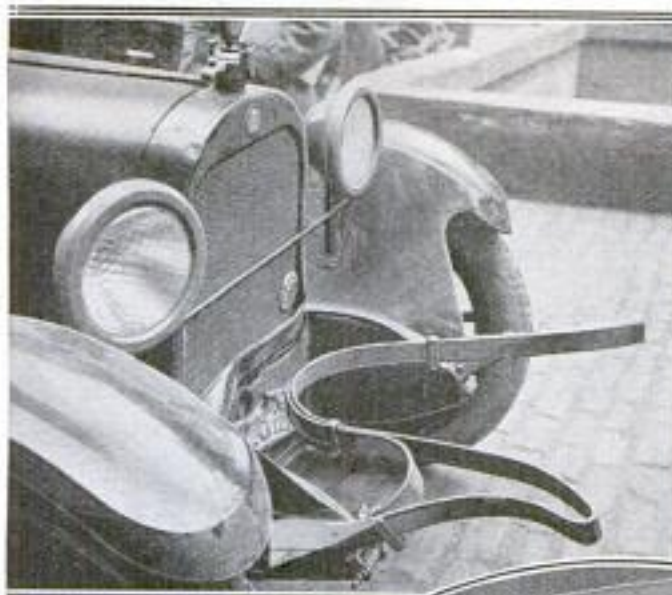

Front of the Motor Car Which Struck the Lamp-Post and Threw It into the Air, Showing the Twisted and Bent Spring-Steel Bumper

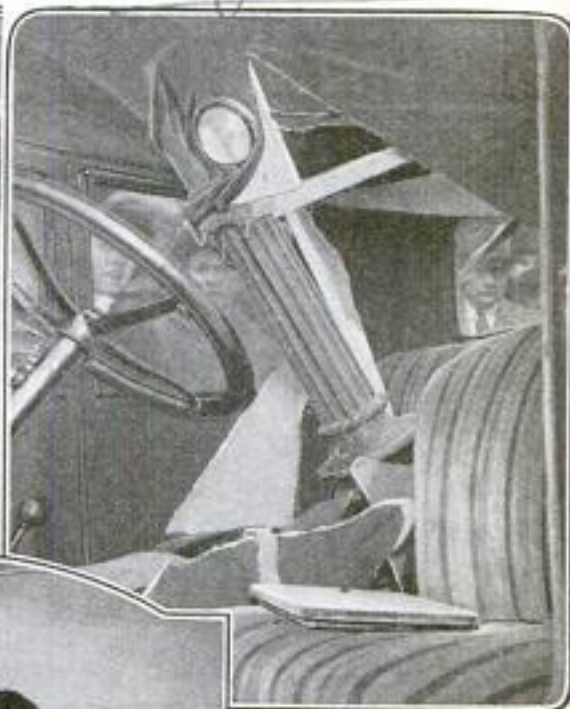

Lamp-Post Resting in the Front Seat of the Machine After It had Fallen through the Top of the Car, and Narrowly Missed Injuring the Driver

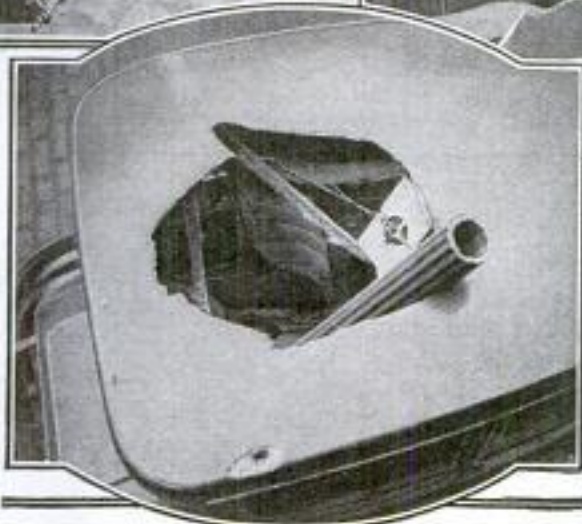

Top of the Automobile, Showing the Hole Made by the Wrecked Lamp-Post, Part of Which can be Seen Sticking Out of the Rent

A recent automobile accident presented some unusual features. The car, going at a high rate of speed, became unmanageable and crashed into a safety island on which was a cast-iron light post. The spring bumper struck the post, breaking it off in such a way that it was thrown into the air and came down through the top of

the car. Fortunately the driver was the only one in the car, as the post in coming down struck the right-hand front seat and remained in an upright position. It is considered remarkable that the driver of the machine escaped without injury.

8205

VARIOUS ARTICLES MADE BY SKILLFUL WHITTLING

Surprisingly skillful whittling, done mostly with Oregon sugar pine, is the result of long and patient practice by a Missouri man who is quite willing to follow out the maxim of his state and show them to anybody. Out of these wonderful whittlings he has fashioned lengthy small-linked ornamental chains, designed to be hung over doorways, small pliers of all shapes, scissors, canes, and other articles. On the tools are hinges and swivels that operate as if they were made of steel. The work is all done with a small keen pocketknife.



Articles Made by Whittling Wood, Mostly Oregon Sugar Pine: All are Carved with Great Skill, Particularly the Canes

Cont. George B. Schwartz
 803 W. Lincoln Blvd. Chicago, Illinois

Chas. W. M. Slye
 c/o Arthur Hallam
 548 POPULAR MECHANICS
 8068 214 Cedar Ave.

PHOTOGRAPH PRINTER HAS SEVERAL NEW FEATURES

A new photograph-printing machine includes several features not found in other machines. The ground-glass dif-

fusion screen may be raised or lowered one inch by means of a small wheel at the left edge of the table. Two extra diffusion screens may be slid into place by handles at the right side of the table. By means of a double hinge, the lower part of the pressure back comes down flat on the print and is held by springs to prevent the paper from sliding. With the pressure back clamped, the entire printing bed may be raised and a spotlight applied to dark spots, where local printing is needed. A pilot light is cut in between the terminals of the printing lights, and when the switch is open, it draws enough current to light and to keep the printing lamp filaments warm without lighting them. This prolongs the life of the lamps.



Photograph-Printing Machine, Showing the Two Hinged Sections of the Pressure Back: The Printing Bed is Clamped Down and below It can be Seen the Spotlight, While the Filing Cabinet is Shown at the Right End of the Apparatus. The Insert Shows the Ground-Glass Screen Exposed

P166

Hallam

SEVEN WASHINGTON THEATERS CLOSED BY INVESTIGATION

Because of the recent collapse of the Knickerbocker theater, recorded on page 587 in this issue, an investigation of other playhouses in the city has been made which resulted in the closing of seven of them as unsafe. This seems to indicate a rather general condition of either faulty design or construction. It is a fact worthy of note, that the District of Columbia has no licensing law for engineers and architects who design and supervise the construction of buildings, while such legislation has already been passed in seventeen states and is pending in four.

Write our Bureau of Information, if you wish to know who makes or sells any article described in this magazine. Send no postage; the service is entirely free.

CREW DECORATE BATTLESHIP IN HONOR OF COMMANDER

Marriage is not usually associated with grim-appearing warships, but the British battle cruiser "Queen Elizabeth," flagship of the Atlantic fleet, recently bore evidence of such an event. The crew of this vessel gaily decorated the mainmast and wireless with beribboned floral wreaths in honor of the ship's commander, who had been married a short time before.

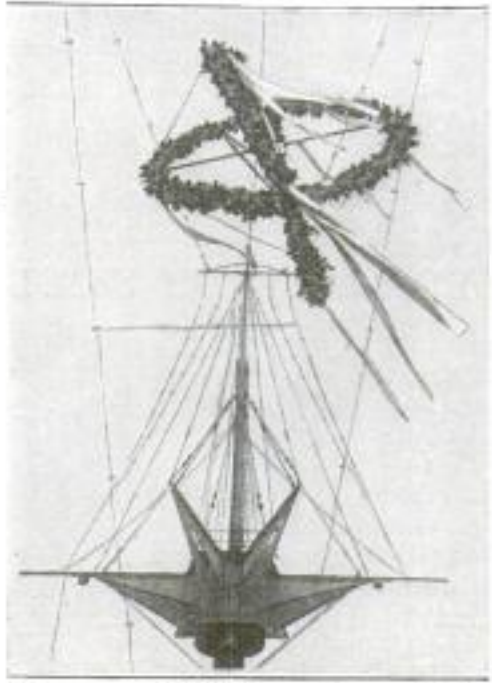

Mainmast and Wireless Antenna of the Flagship of the British Atlantic Fleet with Decorations of Floral Wreaths and Ribbons in Honor of the Commander's Wedding

Kadel + Herbert
 In Tokyo, Japan, 350 applicants for telephone service were required to wait nearly 15 years before the Central Telephone Bureau granted the privilege. Five of the would-be subscribers could not be located at the addresses they gave in 1907, but these persons have been granted about a year of grace in which to appear and claim their right to a telephone.

Engineering News Bulletin 1/20/22 469
 Chicago Tribune 2/19/22

WEATHER OBSERVER EMPLOYED BY LONDON POWER COMPANY

Stationed high above the city's dust and smoke, in a small glass observatory, a "weather watcher," employed by a London power company, remains on duty from 8:00 a. m. till 6:00 p. m. Signs of approaching fogs, storms, or any impending changes in climatic conditions, are communicated to the different power plants so that necessary precautions may be taken to meet the emergency.

PACKING BOX KEEPS BRUSHES SAFE AND CLEAN

For keeping paint and varnish brushes safe, handy, and always in condition for instant use, a telescoping air-tight box is constructed so as to hold a number of similar containers, each with a clamp from which hang one or two brushes.

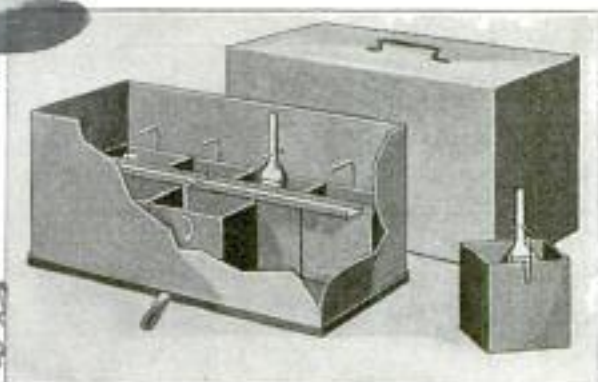

Air-Tight Box for Holding a Number of Similar Containers in Which Brushes are Hung: Each Container is Filled with the Liquid with Which the Brush is Used

Each container is filled with the varnish, paint, or other liquid for which the brush is used. Thus the brushes are always ready for use, and do not have to be cleaned. The containers may be removed from the box and the contents used, or replenished as desired. The boxes are made in two sizes, one for holding up to 14 brushes.

SANITARY VACUUM CABINET FOR PRESERVING FOOD

Vacuum insulation has been provided in a sanitary food cabinet designed for the use of ice-cream manufacturers and dealers, and for preservation at home of ice cream and foods which must be kept in a chilled or frozen condition. The cabinet is constructed entirely of white cedar, known as a resistant of brine, and is so built that there is an air space of one inch between the outer and inner walls on

all sides. The food container is made of heavy wire mesh, around which the ice is packed, and at the top of the container is

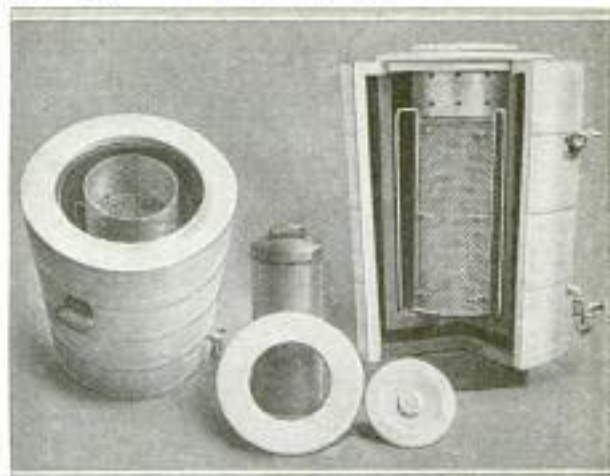

Left: Vacuum Cabinet with Top and Food Container Removed. Right: Wire Mesh, Ice Chamber, and Air Space between Walls are Shown

a galvanized-iron removable sleeve, to keep any insanitary substances in the ice compartment from falling into the food chamber when the cabinet is open for serving purposes.

SWING USED AS EXERCISER HAS SUPPORT FOR FEET

Children may receive exercise as well as pleasure when using a new swing which causes considerable play of the leg and back muscles, because of a solid support for the feet. Added features are a pair of sliding aluminum grips, which assure a firm hold, and a backrest, the whole arrangement serving to eliminate much of the danger usually attendant upon this favorite recreation of the youngsters.



This Swing is Made in Such a Way That the Feet Rest upon a Solid Support, Allowing the Legs to be Used in Pumping. Sliding Aluminum Grips are Provided, Assuring the Child of a Firm Handhold

Dr. J. H. Ward, 418 Indiana Ave. Dordche, Wis

Mr. George Mambow, 1615 Central Av. Minneapolis, Minn

Dr. W. J. A. Verrill, Verrill Mfg. Co., Hancock, Mich

Cnd. Charles A. Loddard Popular
559 5626 *Chromyton Place* Astronomy
 POPULAR MECHANICS, *Los Angeles, Calif* Radio 2/1922
 "PROSPECTS" ARE HERALDED BY ELECTRICAL BUZZER
 WIRELESS TIME SIGNALS RECEIVED AT ELGIN

8257 Curiosity caused many persons to accept the invitation to "step on it," which

8456 Late last year an observatory maintained by a watch factory at Elgin, Ill., obtained its first record of the French scientific radio time signals from the La Fayette Station, at Bordeaux. The recording apparatus is entirely automatic, the signals, coming a distance of 4,400 miles, directly controlling the movement of the chronographic pen. The receiving antenna is only 180 ft. long and 30 ft. high, and consists of a single wire.



Passer-By Accepting the Invitation of the Arrow-Shaped Sign, and Thus Electrically Announcing His Presence to the Salesman Inside

a dealer in electric sewing machines placed on the treadle of his sidewalk display. As the treadle was arranged so that pressure on it would operate a buzzer inside the store, the curious passer-by would soon find a salesman at his side, ready to explain the merits of the product.

8245 **THREE-WHEELED SPRINKLER AND STREET SWEEPER** *Cleaning*

A European manufacturer has produced a three-wheeled motor car which is said to yield good results in the sprinkling and sweeping of streets. Because of its peculiar construction, the machine is more easily and quickly maneuvered than other cars, and consequently much time is saved in making the numerous twists and turns required by a vehicle doing this kind of work. The speed of the three-wheeled sweeper is sufficient to clean about 210,000 sq. ft., or a 50-ft. street for a distance of nearly four-fifths of a mile, in the space of an hour. A rotary brush is applied to, and lifted from, the surface being swept, by a simple lever attachment, and the chassis is strong enough to support a water tank of moderate capacity.

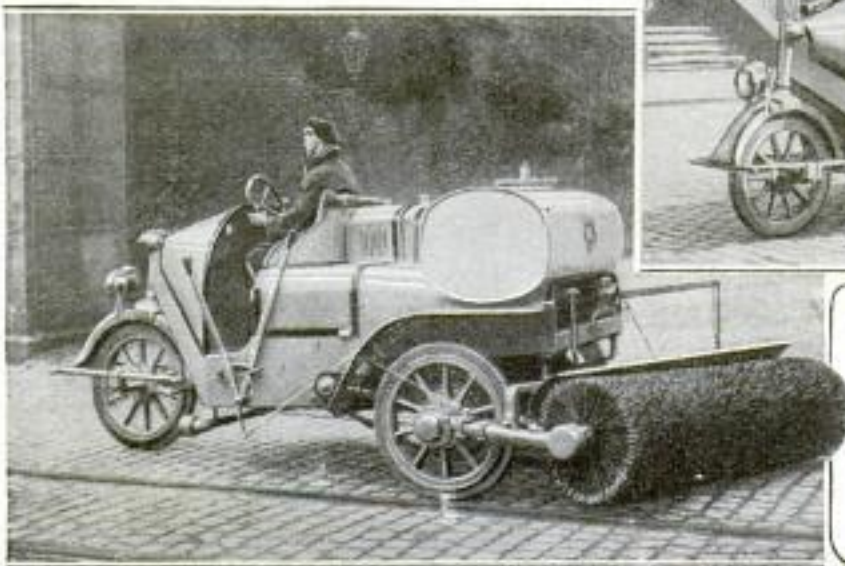

Above: Three-Wheeled Motor Car of European Design Which is being Used with Success as a Street Sweeper. Left: Same Type of Machine with a Water Tank Mounted on the Rear. The Lever Attachment for Applying the Rotary Brush to, and Lifting It from, the Pavement can be Seen on the Side of the Car at the Left of the Driver

Cnd. E. H. Weiss, 80 Boul. Jurdan
Paris, 14, France Copyrighted material



Above: Improved Hoisting Arrangement in Action, Showing One of the Loaded Buckets Midway of the Long Stretch of Trolley Line Used to Transport Sand from the Beach to the Bluff. Left: The Tractor was Used as a Hoisting Engine; Its Front Wheels were Blocked, the Rear Wheels Jacked Up off the Ground, and a Winding Drum Fitted to One of the Latter

8365 Universal Wheel
ROAD TRACTOR ACTS AS HOIST TO RAISE SAND FROM BEACH

When the city of Racine, Wis., wished to take a quantity of sand from a point on the beach which was inaccessible for teams or trucks, it made good use of its road tractor in an ingenious way. From the bluff back of the beach, a trolley line was stretched to a concrete pier at the point from which the sand was to be taken. The tractor was placed at the upper end of the trolley, the front wheels were blocked, the rear wheels jacked up, and a wooden winding drum fastened to one of the rear wheels. A rope was then passed through pulleys to the traveler on the trolley. The traveler was filled with sand at the pier, and was pulled to the top of the bluff by the tractor. The equipment, though crude, proved efficient.

8110

COLLAPSIBLE ALL-STEEL FORM FOR CULVERTS OF ALL SIZES

A collapsible form, made entirely of plates and structural steel shapes, for building arch and flat-top concrete culverts and bridges of any size, should certainly be a great saver of lumber, labor, and time. It is segmental in construction, all segments being alike except at the top corners, and each of a length of 6 in., so that both span and height can be varied by any multiple of a foot or half a foot.

The top segments are made of plates 4 ft. long, flanged at each side to provide means for joining the sections, and supported on 2 by 4-in. timbers cut to suit the span. The corner plates bend over to the sides, and connect to similar segmental plates which are supported by 4-in. lengths of I-beams, one

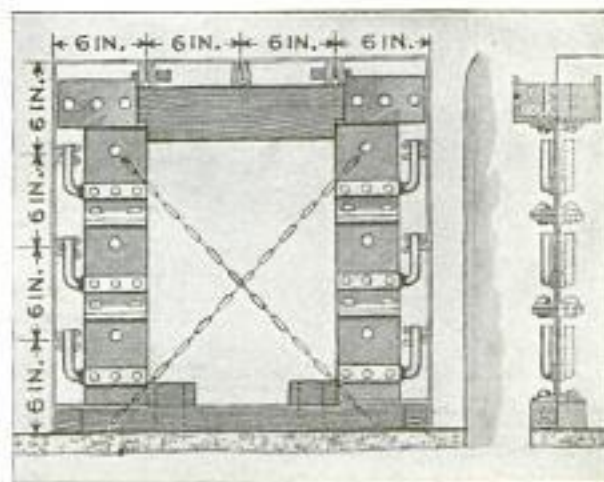

Collapsible Form, Made Entirely of Steel, in Four-Foot Lengths for Building Arch and Flat-Top Concrete Culverts and Bridges: Sizes Are Variable in Multiples of Six Inches

for each segment, and placed one on top of the other for the required height, at the junction of each of the 4-ft. lengths.

Investigations have just been completed of different types of low-pressure gas burners for use in oil-field boilers. Tests will be made to find the pressure and load at which each burner would be most efficient.

Highway Culvert Form Co.
5460 Ferdinand St., Chicago

Capt. E. W. Kraft
50 42-11 St. Aie. N.W.
552

Bureau of Mines
Dept. of the Interior

POPULAR MECHANICS

Seattle Wash.

GAME CALLED ON ACCOUNT OF TIDE—IN ALASKA

CARBON-MONOXIDE POISONING FIRST-AID TREATMENT

4259

8420

The baseball fans in Ketchikan, the metropolis of southeastern Alaska, have to time their ball games to correspond with the tidal movement of the ocean.

Because of the large number of cases of carbon-monoxide poisoning, the Bureau of Mines has developed and tested a method of treatment which has proved successful in practice and can be given by first-aid men.

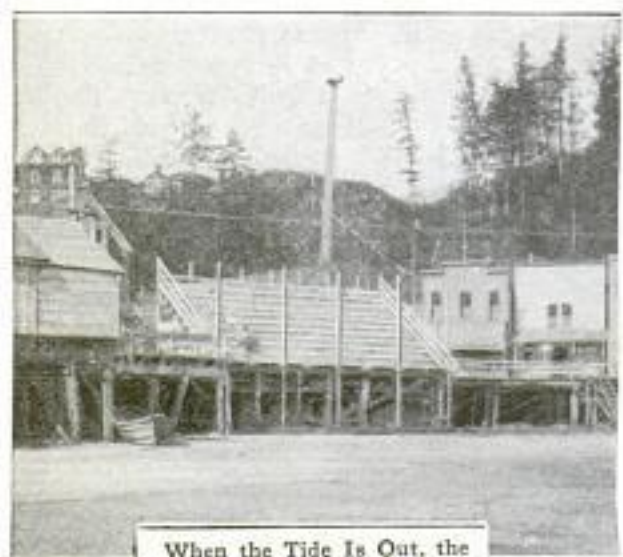

When the Tide Is Out, the Baseball Diamond is Laid Out on the Tide Flat, and the Game Goes On until the Tide Comes In

Carbon monoxide is a colorless, odorless, tasteless gas formed by incomplete combustion, and may exist in buildings having a leaky furnace or chimney, or where a gas stove is used without proper flue connections. It is always present in the exhaust gases of gasoline automobile and launch engines.

Some of the symptoms of poisoning are yawning, tiredness, and a feeling that the skin is stretched tightly across the forehead; dizziness and nausea may result, and if the exposure to the gas is sufficient, the person may become unconscious.

The treatment for poisoning is as follows: Remove the person from the atmosphere containing carbon monoxide; administer oxygen as quickly as possible, and in as pure a form as is obtainable, preferably from a cylinder of oxygen through an inhalator mask; if breathing is feeble, start artificial respiration by the prone pressure method; keep the victim flat, quiet, and warm; assure plenty of rest. Exercise or exertion on the part of the victim must be avoided, for this would tend to increase the heart action, and would delay the recovery, or might even lead to fatal results. Stimulants also should be avoided.



The Tide Flat Is the Only Ground Available for a Baseball Diamond at Ketchikan, Alaska, but When the Tide Comes In, the Game is Called

The town is the center of the Alaska salmon-fishing industry, and is built at the foot of a mountain which rises abruptly from the sea. Since the blown-in-the-bottle baseball fans must have their game, they have reclaimed the only available flat surface from Clarence Straits on a part-time contract. A commodious grand stand has been built inshore, but the diamond is not permanently laid out, being of necessity relaid before each game is begun. Similarly the tide tables must be consulted before the season's game schedule can be arranged, for when the tide is in, the "ball park" becomes part of the Pacific Ocean, and the game must be called.

NEW ROAD-MAINTENANCE PLAN SUGGESTED IN MANITOBA

That the control of road maintenance be taken out of the hands of the various municipalities and given to a specially appointed highway board, is the proposal of the Manitoba motor league, of Canada. This body also suggests that the board pay 75 per cent of the construction cost of a contemplated 2,400-mile highway system, the remaining 25 per cent to be borne by the communities that are directly affected.

Christian Science Monitor
2/10/22



Box for Making Reprints: The Original is Placed at the Left; in the Center Are Two Electric Bulbs and Lens, While Reprint Is at Right

Amateur Photographer Removing a Roll Spool of the New Sensitized Paper, Which is Made in All Sizes Common to the Ordinary Celluloid Film Rolls, Preparatory to the Developing and Finishing of the Inexpensive Pictures

Above: Developing and Finishing the Pictures in Only 10 Minutes. Left: Specially Designed Box for Making Reprints of the Sensitized Paper, Which have been Found to Be as Clear, Sharp, and Detailed as the Original

8255 SENSITIZED PAPER AIDS AMATEUR PHOTOGRAPHY

Amateur photographers have been aided by the introduction of sensitized paper in both roll-spool and cut-sheet form of all the important sizes, which will fit any camera without using special attachments. This paper is used in the same manner as are the celluloid film or dry plates, and the picture is printed directly on the paper when the shutter is operated. After the exposures are made, the rolls or sheets can be developed in approximately 10 minutes, and dried in a very short time also, as the solutions and water used do not penetrate deeply into the paper. Some of the advantages claimed for this innovation are extreme speed in getting finished photographs, better average pictures, extensive gradation of tones, and low cost, of which the latter, of course, is the most satisfactory feature for the amateur.

8204 Attachment

PHONOGRAPH TONE AMPLIFIER HAS AUXILIARY SOUND BOX

Sound amplifiers for phonographs have been made in many varied forms since the days of the first trumpet-shaped horn. All have the same object—to amplify the

musical tones without including other sounds from the needle and moving parts, or from vibrations of the amplifier itself. In a recent invention, the amplifier, inside the phonograph case and below the record, has an auxiliary sound box or air chamber around the flared horn. This sound box is so arranged with respect to

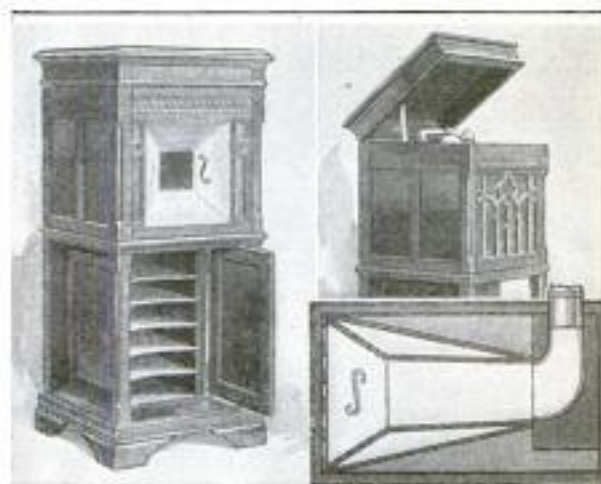

Phonograph Sound Amplifier, with Auxiliary Sound Box, or Air Chamber, around the Flared Horn, So Arranged as to Harmonize the Various Sound Waves

the horn that it facilitates proper harmonizing of the various sound waves, and assures a sweet and mellow tone. Communication between them is by S-shaped openings.

Inventor H. Stolty, of Ora
 Brinneman, Holland, Mich

Dr. W. Oscar B. Shupine Comb. & H. Cone
7460 Sheridan Road 84th St.

554
829
Chicago
**AUTOMATIC LIGHT CONTROL
FOR PHOTOGRAPH PRINTING**

A new light-control device for either continuous or step photographic printing machines provides sufficient light changes

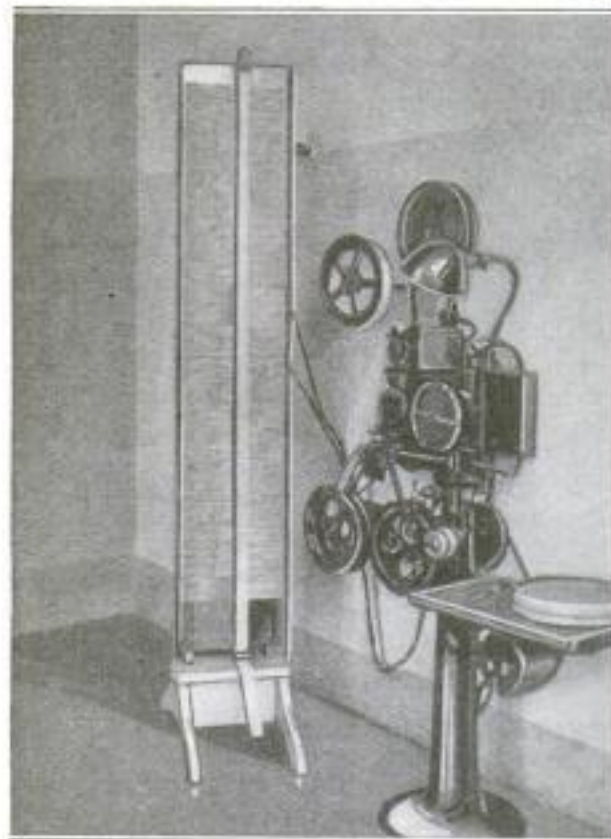

Control Board with Resistance Units in Place on Which the Contact Point is Moved Automatically. The Paper Strip in the Center Identifies the Scene

for negatives up to 1,000 ft. long. Twenty-two different densities of light are possible, the intensity of the light being changed by means of a rheostat. This feature practically doubles the printing speed and reduces the amount of patching. The light changes, while rapid, are shaded from each one to the next, and are automatically controlled by notches cut in the margin of the film. A strip of paper in the center of the board gives the title abbreviation, footage, and serial number of each scene.

8369
**TESTS BY GOVERNMENT SHOW
SEX DETECTOR LACKS MERIT**

Recent tests by the Department of Agriculture have proved that devices designed for the purpose of testing the sex germs in eggs are without merit. One device consisted of a small nickel cylinder, filled with two chemicals, which was supposed to gyrate in different ways when brought into the presence of eggs con-

U. S. Dept. of Agriculture
Washington, D. C.

POPULAR MECHANICS

Marching N. Y.

taining germs of different sex. Another device for the same purpose consisted of a wooden sphere on a cord. Both devices were tested by a number of persons, and no two obtained the same results with the same eggs.

8390
**"CALITE," A NEW METAL ALLOY,
HAS UNUSUAL PROPERTIES**

There is a peculiar fascination about the subject of metal alloys and it is also a field of research which has scarcely been touched. A new alloy, called "calite" and composed principally of aluminum, nickel, and iron, has shown remarkable properties particularly at high temperatures. The claim is made that it will stand, without oxidation, temperatures up to 2,372° F., and that it is specially resistive to atmospheric corrosion.

8322
**SPECIAL WHEEL CLEANS TEETH
OF METAL-CUTTING SAW**

One difficulty encountered in the use of metal-cutting saws has been the accumulation of metal chips between the teeth with consequent added strain on the teeth and greater risk of breakage. To overcome this difficulty, a simple device has been placed on the market. It consists of a bracket carrying a small sprocket with teeth so shaped that they fit the spaces between the saw teeth, and

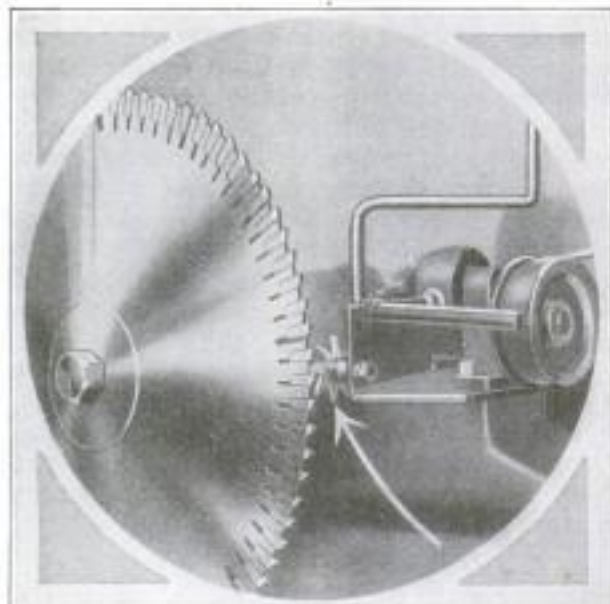

As the Metal-Cutting Saw Revolves, the Teeth of the Small Sprocket Slide In between the Teeth and Clear Away the Metal Chips

as the saw revolves, these sprocket teeth clear the metal chips away and leave the saw free to do its best cutting.

Henry. Shupine & Sons
Philadelphia, Pa.

AMUSEMENT PIER WRECKED BY "RUNAWAY" BARGE

Breaking loose from its moorings, more than two miles off Ocean Park, Calif., a heavy fishing barge, 120 ft. in length, was carried toward the shore by the breakers. Launches were sent out in an effort to tow the craft away and avert the impending disaster, but the high seas were too much for the small boats,

and the "runaway" dashed against the side of an amusement pier. Striking



Above is Shown One of the Concession Buildings Which was Thrown from Its Foundations When the Barge, Seen at the Left, Wrecked the Amusement Pier

about 600 ft. from the beach, the terrific pounding, which could be heard for a long distance, soon damaged the piling to the extent of \$100,000 and precipitated several of the concessions from their foundations.

THE NEW DELAWARE RIVER BRIDGE

P327

BY ROBERT F. SALADE,

4741 W. 15th St.
 Philadelphia
 Pa.

THE new Delaware River bridge, which is to be built by the states of Pennsylvania and New Jersey, and the city of Philadelphia, is estimated to cost about \$28,871,000. This bridge will cross the Delaware River starting from Franklin Square, Philadelphia, to Pearl and Second streets, Camden, N. J. It will be the longest suspension bridge in the world.

The main structure is to be of the two-cable suspension type, crossing the river with a single span 1,750 ft. long, from center to center of the main piers. The clearance above mean high water will be 135 ft. over a width of 800 ft. in the center of the span.

The bridge and approaches are to be built to provide a single deck carrying an unobstructed roadway for six lines of vehicles, lines for surface cars, and two lines for rapid transit, besides which there will be two 10-ft. sidewalks above the roadway. The width of the main roadway, from curb to curb, will be 57 ft. The total width of the bridge will be 125½ feet.

The diameter of each of the two great cables will be 30 in. Each cable will be composed of 16,500 wires, made up into 61 strands, bound together and wrapped with serving wire. The single wires, which are to be of fine quality high-carbon steel, galvanized, will be .192 in. in diameter. At intervals of 20½ ft. measured horizontally, a circumferential steel saddle will be fastened to the cable, over which four galvanized wire ropes, 2⅝ in. diameter each, will be hung to carry the suspended structure.

The cables are to rest on cast-steel saddles on the towers and at the anchorages. Back of the anchorage saddles, the cables are to be fastened to anchor chains imbedded in the mass of the anchorage masonry. Each anchorage will require 90,700 cu. yd. of masonry, and in each will be four passenger elevators, connecting the sidewalks and the surface-car stations with the ground level.

The two towers will be of steel, and will rise to a height of 380 ft. above water level. The legs of the towers will have a

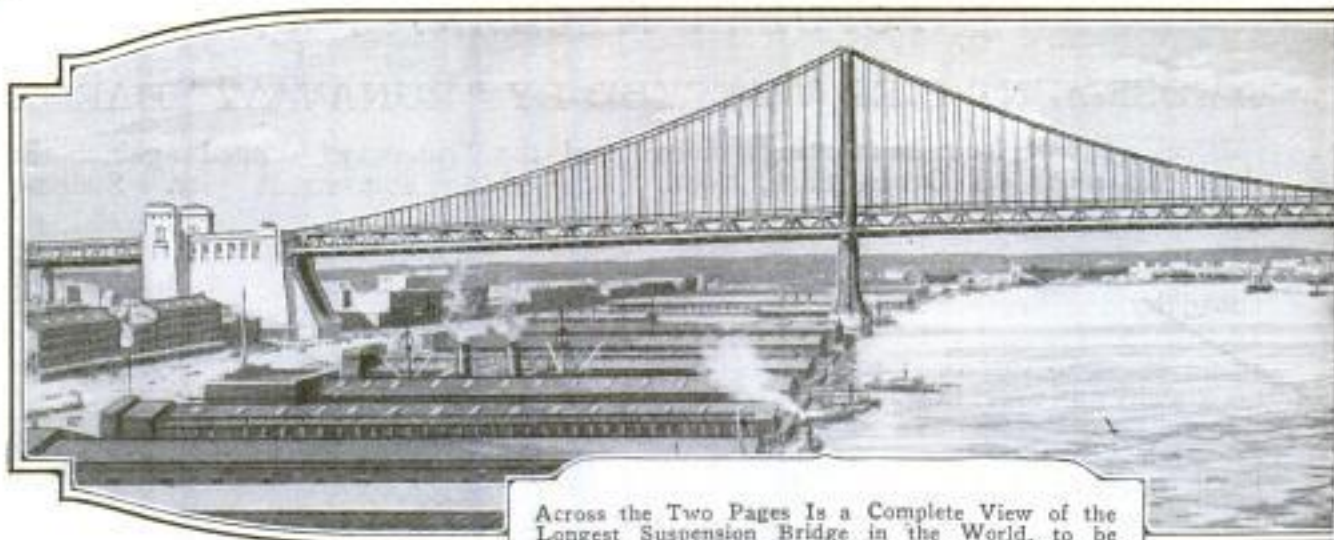

Across the Two Pages Is a Complete View of the Longest Suspension Bridge in the World, to be Built across the Delaware River, from Philadelphia, Pennsylvania, on the Left, to Camden, New Jersey, on the Right. The Main Span will Be 1,750 Feet. The Clearance, over a Width of 800 Feet at the Center, will Be 135 Feet above Mean High Water

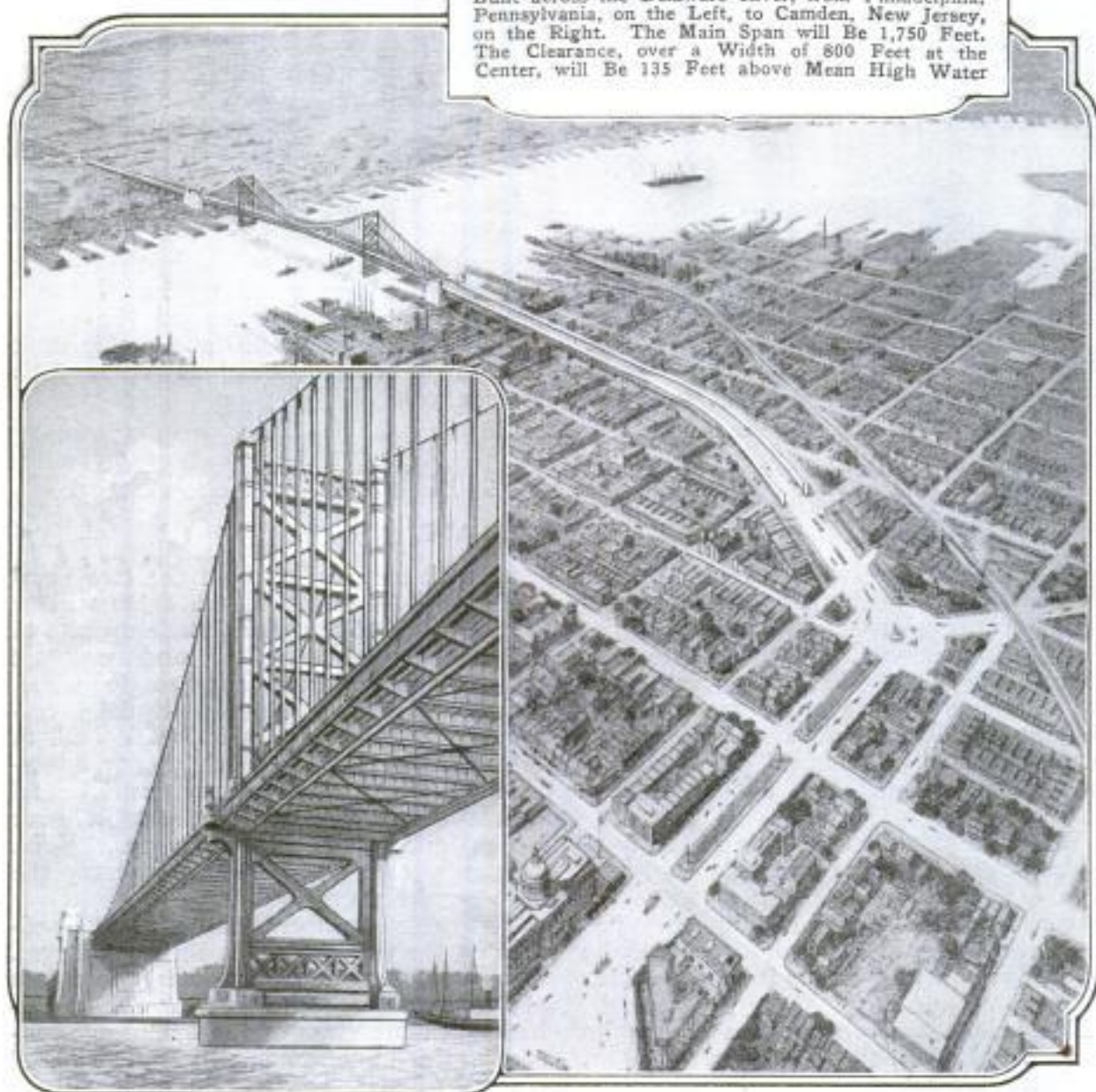

Bird's-Eye View, from Above Camden, Showing the Proposed Avenue from the Courthouse to the Plaza, and Onward to the Bridge Itself, Shown Spanning the River: In the Inset Is a View, beneath the Bridge, of One of the Steel Piers and Towers. Each Tower Is 380 Feet above Water Level. In Line with the Cables, These Towers Are 12 Feet Wide at the Top, and Taper Out to a Width of 40 Feet at the Base

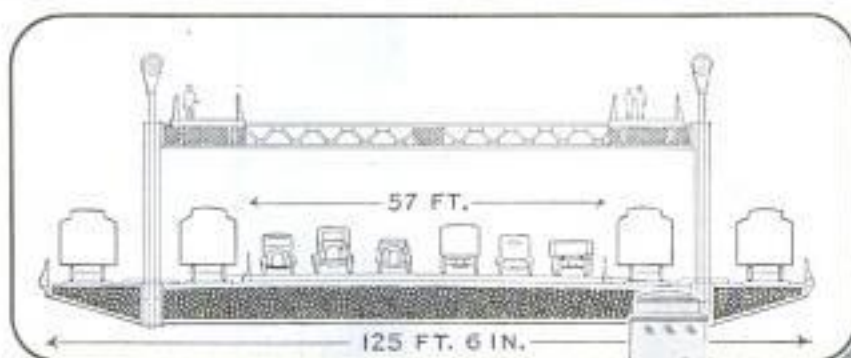

Left: Cross Section of Bridge, Showing Diagrammatically How the Roadway, 57 Feet Wide, Accommodates Six Lines of Vehicles. Outside of These Are Two Tracks for Surface Cars and Two for Rapid Transit. Above Are the Sidewalks, Each 10 Feet Wide

At the Right Is a Transverse View, and Below a Longitudinal View, of One of the Huge Abutments for the Longest Suspension Bridge in the World, Showing the Anchorage for the Two Great Cables, Each to Be 30 Inches in Diameter. In This Structure Are Four Passenger Elevators Connecting the Sidewalks and the Surface Cars with the Ground Level. The Entrance can be Seen in the Longitudinal View. There Are Over 90,000 Cubic Yards of Masonry in the Building

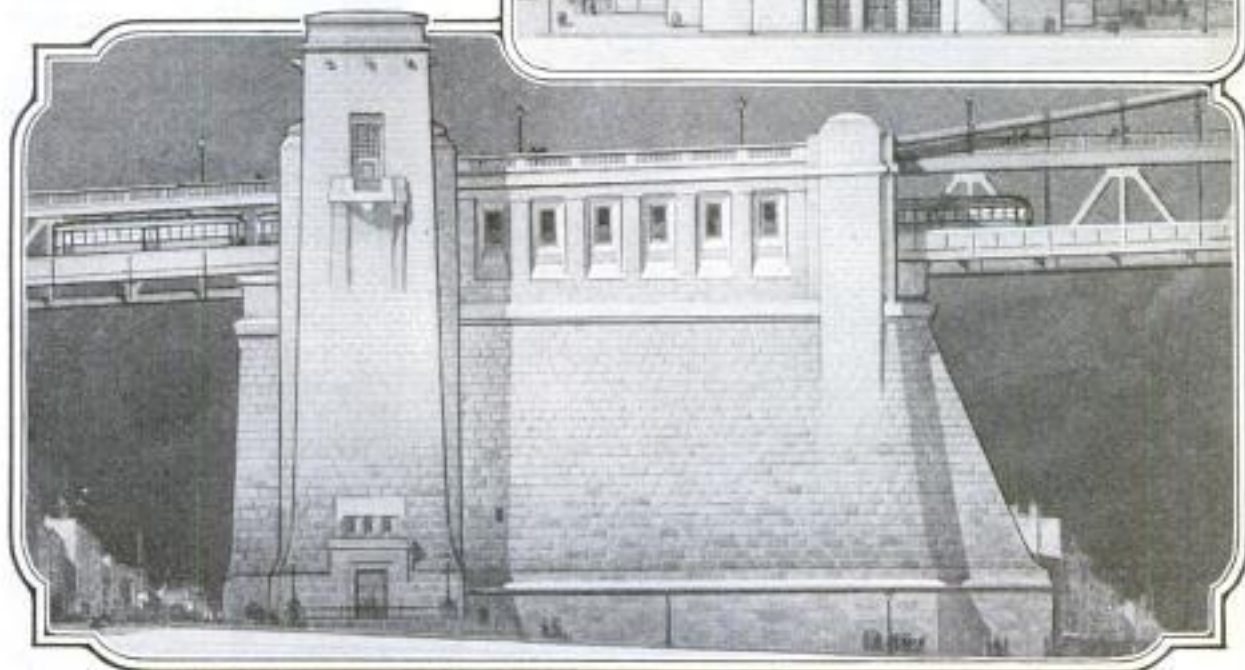
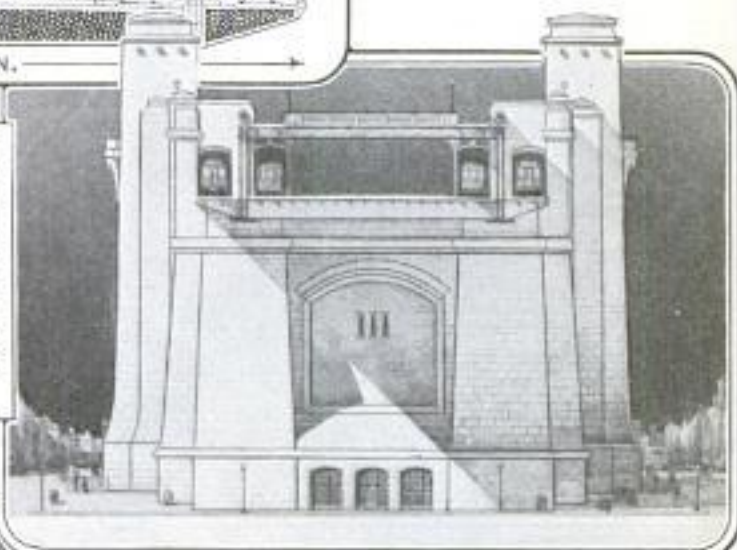

width, parallel with the cables, of 12 ft. at the top, widening to 40 ft. at the base. Transversely, the width is 7 ft. above the floor level. About 33,000 tons of metal will be required to build the bridge. It is proposed to construct a beautiful plaza

on both the Philadelphia and Camden sides. It is expected to have the bridge completed by July 4, 1926, in time for the 150th anniversary of the Declaration of Independence, when a great international exposition will be held in Philadelphia.

LONG DIKE PROTECTS CHANNEL FROM DRIFTING SAND

A dike, 1,200 ft. long, has been built at the confluence of the Willamette and Columbia rivers to prevent the sand carried by the Columbia from drifting in and filling the channel of the Willamette. The dike protects the channel from sand just as a snowshed protects a railroad track from drifting snow. The heavy sand which has been causing trouble rolls along the bottom of the Columbia, and much of it has been lodging at the mouth

of the Willamette, filling the channel and seriously interfering with shipping.

For many years the city of Portland, situated only a few miles up the Willamette, has kept the channel open by dredging. The new dike is expected to make this unnecessary at this point and thus greatly reduce expenses. The dike will perform a further function by keeping the silt brought down by the Willamette moving, until it is well out in the

Columbia, where it will either continue to drift or will settle down and be dredged out. The channel of the Columbia is so much wider than the shipway of the Willamette that a temporary obstruction in some part of it is not a serious obstacle to shipping.

Just above the dike stands a picturesque lighthouse that marks the mouth of the Willamette. The lighthouse is supported on high piling, not only that it may be seen at a great distance, but to protect it from the freshets in the two rivers.

PURE-LEAD ROOFS NOT DURABLE

Commercially pure sheet lead used as covering on steep roofs has been found to be too soft, the metal having a tendency to drag downward under its own weight, enlarging the nail holes. Tests by the Bureau of Standards resulted in a recommendation to use so-called "hard lead," which contains about six per cent antimony and is much harder than the commercially pure lead.



The Dike Built at the Confluence of the Willamette and Columbia Rivers to Prevent Shoaling of the Ship Channel



This Lighthouse on Stilts Guides Ships That Enter the Willamette River from the Columbia

out. H. E. Thomas, 911
 Larchley Ave. Portland
 Oregon

8113 Cmt. Milton B. Palmer
 305 Lincoln Bldg.
 POPULAR MECHANICS
 Detroit, Mich. 559

Mfr. Detroit Air-Cooled Car Co. Detroit, Mich.
 3745-Case Ave.

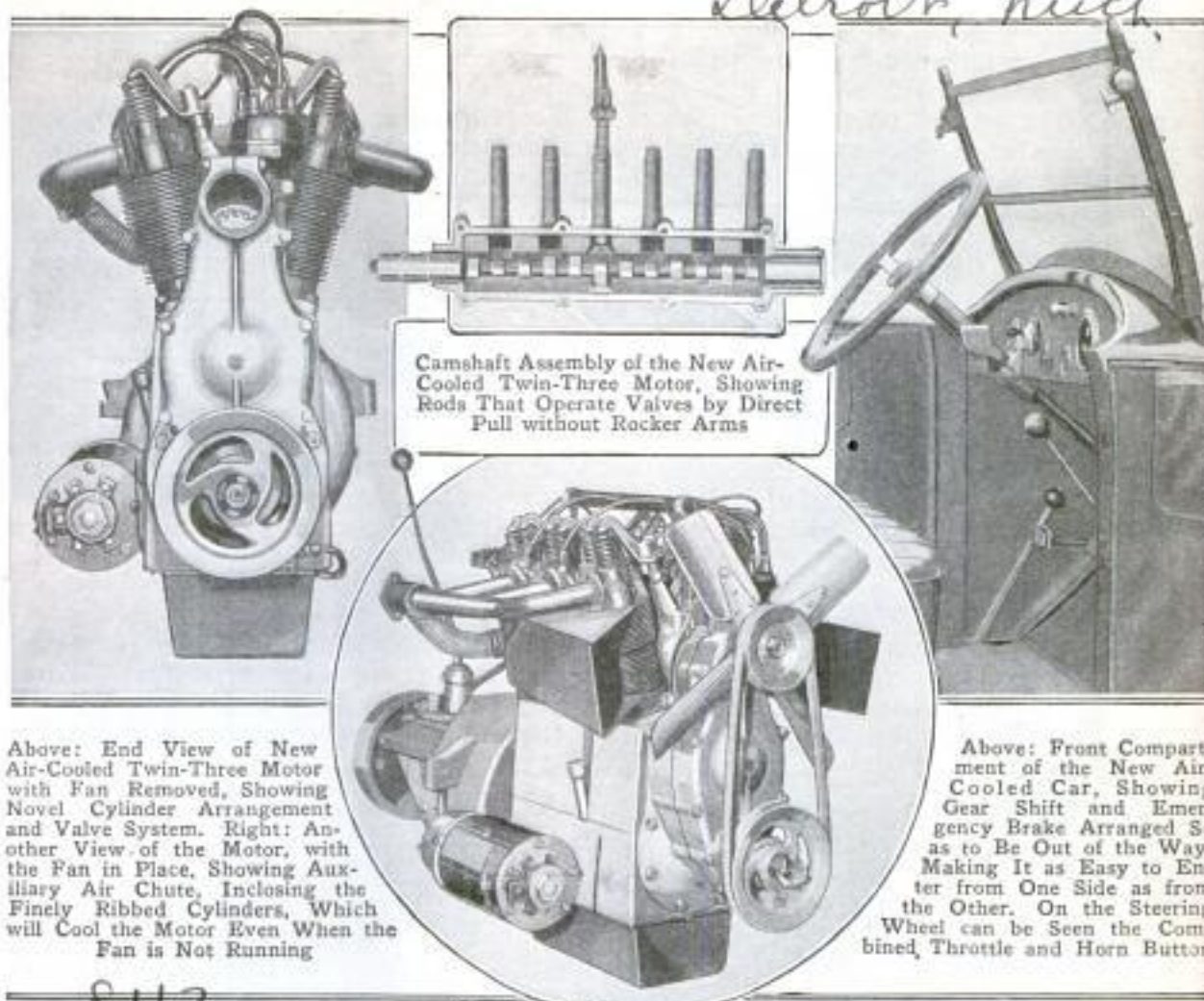

Camshaft Assembly of the New Air-Cooled Twin-Three Motor, Showing Rods That Operate Valves by Direct Pull without Rocker Arms

Above: End View of New Air-Cooled Twin-Three Motor with Fan Removed, Showing Novel Cylinder Arrangement and Valve System. Right: Another View of the Motor, with the Fan in Place, Showing Auxiliary Air Chute, Inclosing the Finely Ribbed Cylinders, Which will Cool the Motor Even When the Fan is Not Running

Above: Front Compartment of the New Air-Cooled Car, Showing Gear Shift and Emergency Brake Arranged So as to Be Out of the Way, Making It as Easy to Enter from One Side as from the Other. On the Steering Wheel can be Seen the Combined Throttle and Horn Button

8113 *accus*
NEW AIR-COOLED AUTO ENGINE HAS MANY NOVEL FEATURES

Although the car with the water-cooled motor is still very much the more popular, there have always been enthusiastic advocates for air cooling. Shown for the first time at the Detroit Auto Show, a new air-cooled car, with quite a novel motor, will certainly attract a great deal of attention from water-cooling as well as from air-cooling advocates. Its engine is in the form of a twin-three, with a novel overhead-valve system operated by direct pull from a single camshaft, instead of by the usual tappets, push rods, and rocker arms. In this manner the motor has been greatly simplified, facilitating the air cooling, and allowing complete exposure of a large number of cooling fins on the cylinders to a constant current of air from a powerful fan, as well as from auxiliary air chutes. It is claimed that, running at a fair speed, the engine will not overheat even with the fan at rest. There are other features in connection with this car. The gear-shift and emergency-brake levers are arranged

so that they are out of the way of the driver, and it is as easy to get into the car from one door as from the other. The throttle and the horn button are combined, a disk being rotated to open or close the throttle, while the same disk, when pressed down, sounds the horn.

8287
FLASHLIGHTS FOR SEATING MOVIE-THEATER PATRONS

Seating the patrons of moving-picture theaters, which is always difficult on account of the darkness, will be simplified by furnishing the usher with a new flashlight signaling device, invented by a resident of New Orleans. About the size and shape of a hand camera, the device is slung by a strap from the usher's neck, handy to him and visible to the seat seeker. It has



Inventor, Wilfred L. Esmerio, New Orleans, La.

Amation 1/23/22
Disinfectant
1024

on its outside face two rows of five flashlights, the upper one white and the lower one red. Each of the lights is operated by a button on top of the box, which makes or breaks an electric contact, and throws the lights on or off. Standing in the aisle the usher thus signals, by flashing a corresponding number of white lights, the number of seats side by side, and with the red lights the number of single seats that are vacant.

8343
MANILA BAY BALLOON FLIGHT
TEACHES VALUABLE LESSONS

Floating over and in Manila Bay was an experience of three army airmen recently which provided not only thrills but also much valuable information. An old kite balloon which had been condemned as unserviceable for observation purposes was used for the flight, which started from Corregidor Island with Manila as the objective. When about five miles from Corregidor, the wind died out, and adverse conditions were encountered which necessitated a forced landing in the bay. When this became apparent the airmen cut away the lining from the inside of the basket so that it would not be forced up in landing and spill them into the water. The landing was made without accident and the gas bag remained floating in the air above the basket, showing that there is no danger of the balloon falling upon the basket when landing in water, and that the bag should not be ripped as long as there is any gas in it.

8251
INVERTED STEAM HAMMER
DRIVES PILING UPWARD

A decidedly novel use of a steam hammer is to make it pull out of the ground steel sheet piling that it had previously



Steam Hammer, Slung from Derrick in Upside-Down Position, Drives Frozen-In Piling Upward by Means of Cable Slung over Hammer and Connected to Piling

driven into it. This was done recently with some piling that had become so tightly frozen in that it could not be pulled out by the derrick alone. The steam hammer was hung upside down from the derrick, and around the hammer four strands of 3/4-in. cable were slung so that they carried below the hammer a clevis that was bolted through the eye of the piling. A few strokes of the hammer upward were enough to loosen the piling so that the derrick could easily extract it.

84
IRON-SILICON ALLOY MELTED
BY CHEMICAL HEAT

The fact that when certain chemicals are brought together they combine and give off heat has long been known, but is now employed in a commercial way in Germany. Powdered silicon is mixed in proper proportions with one of the lower oxides of iron, and the mixture is heated to a temperature where the chemical action will start. Once started, the silicon takes the oxygen from the iron, liberating enough heat to melt the mixture. The alloy formed is rich in silicon and is specially adapted for making containers that must resist the action of acids.



Iron-Silicon-Alloy Casting, Produced by New Combination-Process, Weighs Almost 7,700 Pounds

Conc. of Conc
8 Ash to 2 bushing
2-4.

4426 Townsend Ave
Detroit Mich
Cmd. W. K. Crosson

8238

*Soldwyn Studios, Culver City
Calif*

POPULAR MECHANICS

861

*Cont. Hagg + Ford, 416 Union League
Los Angeles, Calif.*



The Motion-Picture Studio at the Left being Moved across the Open Space to be Joined to the Studio at the Right: The Journey Took Four Days and was Accomplished without Accident

8239

MOVING LARGE GLASS STUDIO EXTENSION ATTACHMENT MADE
IS DELICATE OPERATION 8241 FOR CARPENTERS' PLANES

We have become accustomed to the feats performed in moving houses and buildings, but the moving of a motion-picture studio presented problems which were rather out of the ordinary. The structure is 100 ft. long by 75 ft. wide, and, with the exception of the floor, is composed entirely of steel and glass. There are no partitions in the building to give added strength. The most precise methods were used in jacking up the building and alining the supporting timbers. The same care was used in placing the timbers for the rollers during the moving. Once on the rollers, the building was cautiously moved to its new location and placed on the foundations ready to receive it. The entire operation was carried out successfully and should rank as one of the most delicate house-moving jobs ever accomplished. The combined stage is 100 by 150 ft., making it one of the largest weatherproof studios and providing space for the largest indoor sets, thus making it possible to continue scene taking right through the rainy season.

Jobbing carpenters will appreciate the introduction of an extension attachment for use with a smoothing plane, whereby it can be utilized as a jackplane or jointer. The arrangement consists of a large base, into which the small plane can be placed, and where it is rigidly held by means of screws and clips. The considerable space saved in the tool kit, due to the com-

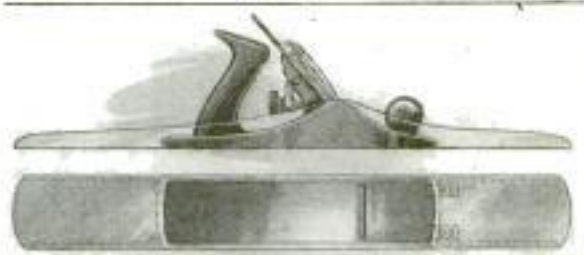

Side and Face Views of the Extension Attachment for Carpenters' Planes Shown by Dotted and Light Lines; Plane is Shown in Heavy Lines

binning of the three tools, and the reduction of weight to be carried, are features that will especially appeal to the mechanic.

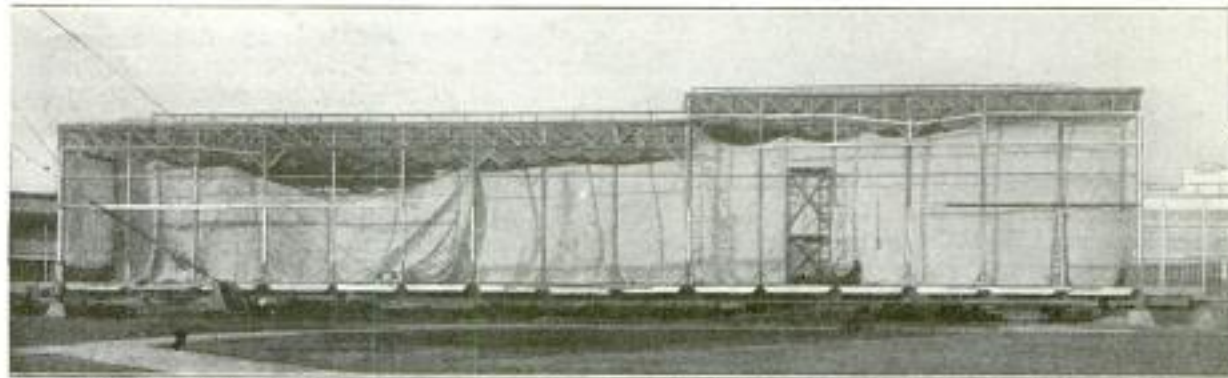

Broadside View, Showing the Fragile Construction of the Building: The Walls and Roof Are of Glass and Steel, and There Are No Partitions to Give Added Strength

*Oldy
Henry C. Copeland,
Waltham
James, 50
Inventor of
over
Seattle, Wash
8467
James Black,
Canada.
106
Winnich
Oldy.
Vancouver, B. C.
Canada.*

2323

ALASKAN COAL ASSUMES COMMERCIAL IMPORTANCE

*By Lawrence William Pedrose
Hanchley Bldg.
Seattle, Wash.*

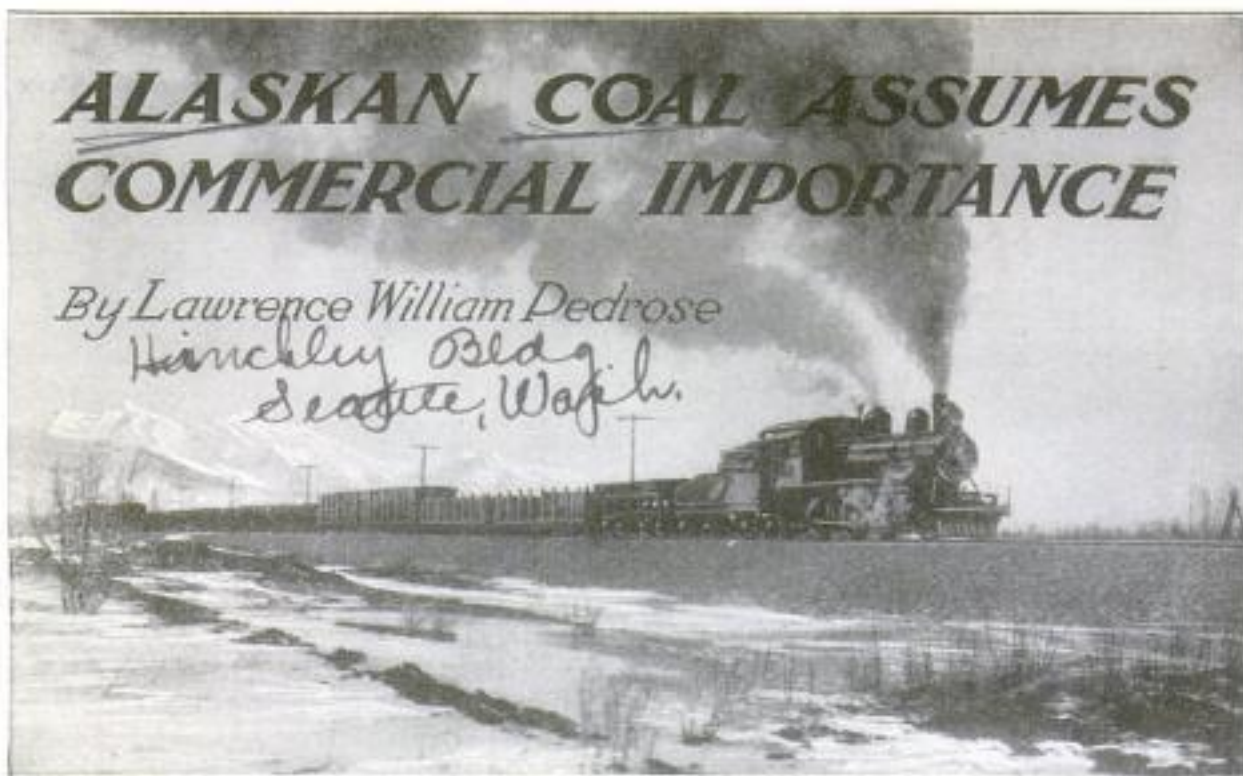

Coal Train on the Government Railway Carrying Empty Cars to the Matanuska Fields: The Road Is Modern in Every Respect, and Is the Connecting Link to the Alaskan Coal Fields

ON February 1, several hundred tons of coal from the Matanuska fields of Alaska, the initial shipment from the northern territory, were brought to Puget Sound, marking the entrance of Alaska into the field of commercial coal production. The coal was high-grade bituminous, a quality approved by the Navy Department for use by the Pacific fleet.

Due to alleged fraudulent locations, the Alaska coal fields were closed to entry in 1906 by presidential order. However, with the start of construction of the Seward to Fairbanks railway, years later, the Alaska engineering commission proved by extending a spur track to the Chickaloon district, where fuel for the railway was obtained, that it was practicable to mine the coal commercially. In March, 1921, previous laws were amended to permit extensive leasing of Alaska coal lands, and active development of the Matanuska and Chickaloon fields was begun. A unit-leasing plan, operated by the government, enables honest development of the fields by American individuals or corporations, but prevents any possibility of the rich coal resources of the territory falling into the hands of speculators.

Through the efforts of the Department of the Interior, 300,000 tons of bituminous navy-specification steaming coal were blocked out for mining in the Matanuska fields in 1921. From the angle of military resources, the coal of Alaska is highly important, as it assures a plentiful supply of high-grade fuel easily accessible for the

American battleships in the Pacific. In January, announcement was made of completion of the rail laying on the Seward to Fairbanks railroad. When three necessary bridges on the railway, the steel for which is on the ground, are completed, this year, a practically unlimited supply of fuel oil is also assured for naval and commercial use.

Geologists declare the northern Alaska oil region comprises thousands of square miles and will undoubtedly become the greatest oil-producing area on the continent as development proceeds. The district is much larger than the combined areas of Texas, Oklahoma, Wyoming, Montana, Arkansas, and Louisiana.

The importance of the Chickaloon and Matanuska coal fields with their millions of tons of accessible coal may be realized from the fact that these fields lie only about 75 miles from tidewater on the government railway. The principal coal deposits are located in the valley of the Matanuska River, a stream 80 miles in length, draining approximately 1,000 square miles of territory, whose source is in the Talakeetna and Chugach mountains and which empties into Cook Inlet.

It has been determined that the Chickaloon and Matanuska formation is of the Upper Eocene period and about 5,000 ft. thick, consisting largely of shale and sandstone. Great physical disturbances have taken place since the extensive coal beds were formed. Except for the rugged ramparts of the Talakeetna Mountains,



Completing the Rail Laying on the Last Section of the Important Seward to Fairbanks Railroad: Freight is Now Taken from Seward to Fairbanks for \$30 a Ton While Formerly It Cost \$350 a Ton



Government Coal Bunkers at the Riley Mine, on Moose Creek in the Matanuska District: The Crude Bunkering System and Tram on Hillside Above Illustrate How Easily Accessible the Coal Is

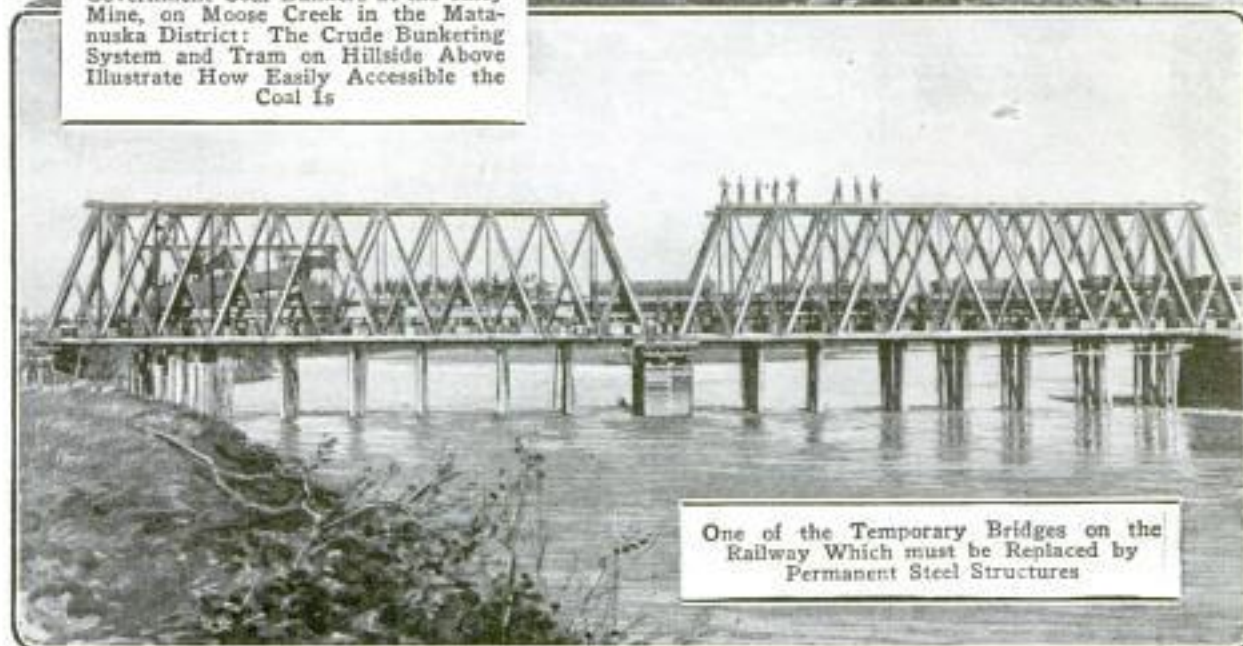

One of the Temporary Bridges on the Railway Which must be Replaced by Permanent Steel Structures

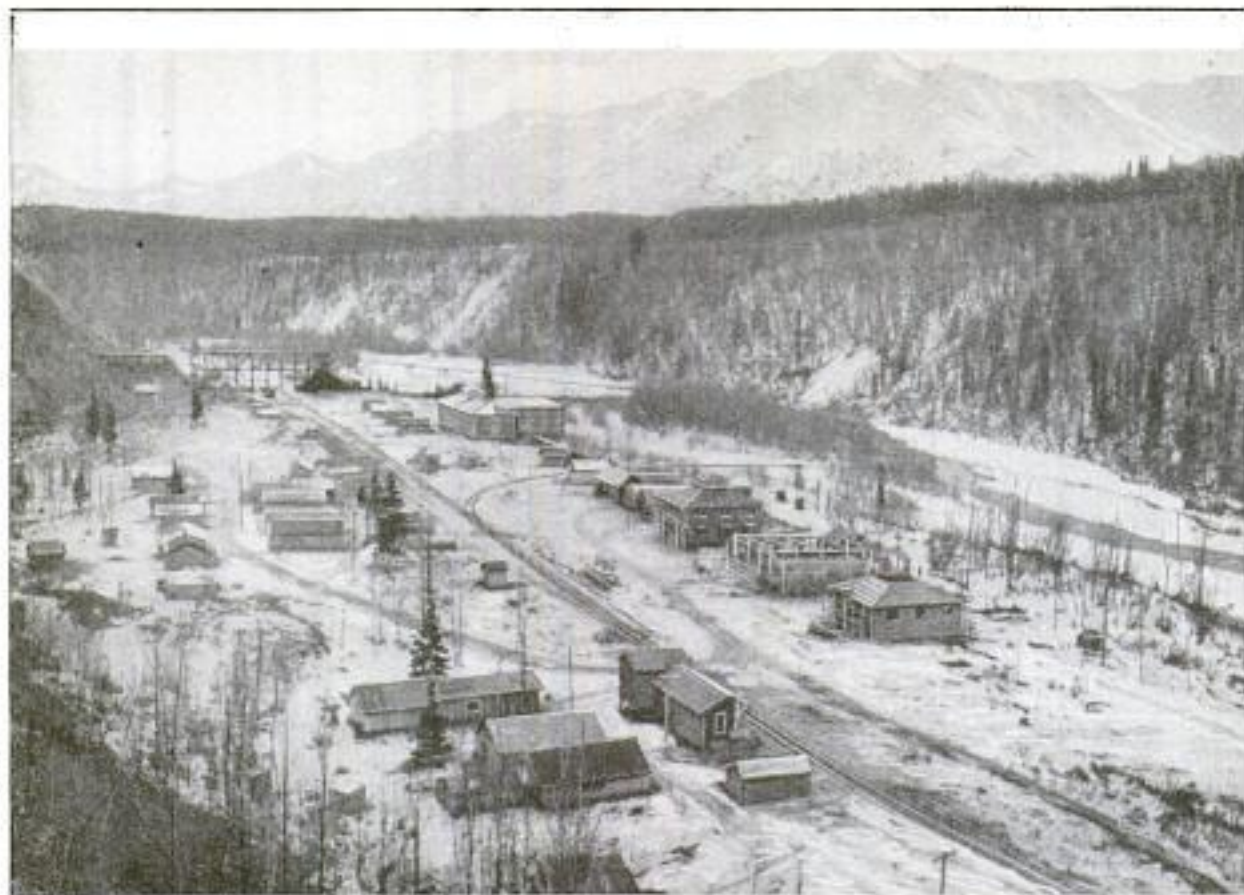

The Town of Chickaloon in the Lower Matanuska Gives Promise of Soon Becoming a Big Industrial City. This Coal-Producing Field Lies Only 75 Miles from Tidewater on the Government Railway from Seward to Fairbanks

which rise to a height of 8,000 ft. on the north of the Matanuska, the surrounding hills are rounded and timbered with dense forests of birch, spruce, and cottonwood, which assures a plentiful supply of timber for mining purposes, which is an important consideration. In the govern-

ment mine alone, the engineers have completed 12 miles of underground workings, such as galleries, airways, crosscuts, etc. It has been determined that high-grade coal can be produced in the Alaska fields at a cost of approximately \$5 a ton, using present-day mining methods.

105
**RAZORS QUICKLY STERILIZED
 WITH ELECTRIC APPLIANCE**

Barbers are continually waging war upon infectious germs, and numerous

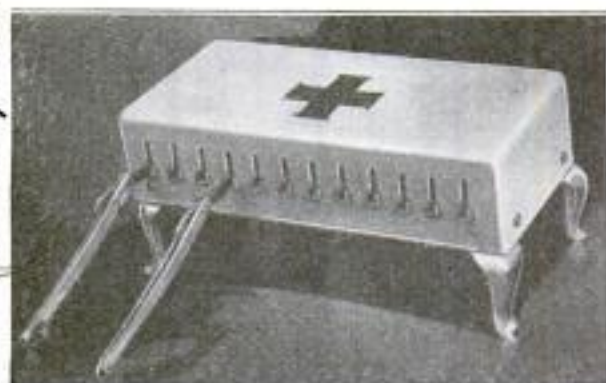

Electric Sterilizing Appliance for Barbers' Razors, Showing How the Blades of These Instruments are Inserted into the Heater

sterilizing arrangements have been invented for their use, the latest of these being an electric heater to keep razors in sanitary condition. The appliance operates on either direct or alternating current of 110 volts, and has slots in it for the accommodation of 12 blades, which it will heat to a temperature of 375° F. The temperature is prevented from rising above this point by a thermostatic cut-out, so that the apparatus cannot be overloaded, nor draw the temper of the instruments.

☐ The Popular Mechanics' Bureau of Information offers its free service to all readers of our magazine. Names and addresses of manufacturers and dealers in articles described, and any other details in our possession will be promptly furnished by addressing the Bureau.

Invention of J. J. Walter, of Mansfield, Ohio.
 Mfr. Walter Elec. & Mfg. Co.

Christian Science
Monitor 2/4/22

Conf. W. K. Crossman
4426 S. Woodward St

8400

POPULAR MECHANICS 8252
Theater Constructed
in Three Sections

ANCIENT ARMAGEDDON RUINS
WILL SOON BE EXPLORED

Unusual construction was manifested
in the erection of a large motion-picture

Archæological treasures are thought to be hidden amidst the ancient ruins of the city of Armageddon, once the scene of so many battles, according to Biblical history, and an exploring expedition to that place is being planned by the University of Chicago. Preliminary surveys will be made of the locality very soon, although the exploring party may not set out this year because the necessary funds are lacking. The value of this city for archæological material was proved by the University of Pennsylvania, whose excavators recently unearthed, but a few miles from Armageddon, a stone pillar carved with hieroglyphics, a photograph of which is at present in the hands of a scientist for deciphering. This discovery, together with other known facts, have convinced the scientific world that the ancient Palestine city will yield older records than any heretofore uncovered.



Front of Motion-Picture Theater Which was Constructed in Three Sections and Which Possesses the Most Modern Arrangements for Ventilation, Heating, and Lighting Purposes

theater in Detroit, Mich., when three portions of land, belonging to as many different persons, were used for this purpose. A 99-year lease was obtained on the land, with the condition that the building be erected in three sections, so that if the theater project should be abandoned before the lease expired, each owner would, with but slight changes to the interior, have a separate structure on his property.

COMFORTABLE BACKREST
FOR OUTING PURPOSES

Tired backs and soiled clothing, the inevitable result of summer outings, may be alleviated by the use of a backrest consisting of a cushion seat, combined with a springy metal frame which supports another cushion for the back. The innovation folds, and weighs but five pounds, thus making it easy to carry.



Cushioned Backrest Which Affords a Comfortable Seat When on an Outing: Insert Shows It Folded

HULLS OF WOODEN SHIPS
FOR PONTOON BRIDGE

According to present plans the city of Seattle, Wash., is to build a pontoon bridge between the mainland and Mercer Island in Lake Washington. The plan contemplates the purchase of 12 wooden ship hulls from the Shipping Board and by placing them stem to stern construct a pontoon bridge 3,000 ft. long. Engineers predict that the hulls will last at least 25 years in fresh water.

South Pasadena
California
Clarks Ave.
W. A. Sallette
1307 7 air

Wp.

Polhemus + Sallette
South Pasadena Calif

Marine Journal
Copyright
2/11/22

7872 **FOREST RANGERS ADOPT
GASOLINE SPEEDER**

8335

**NEW APPARATUS FOR TAKING
ICE-CREAM TEMPERATURE**

The fact that during extremely dry seasons even a small spark from passing locomotives may be the means of starting a dangerous forest fire, has led to the establishment, in some sections, of the "speeder patrol." Members of the Forest Service on a gasoline speeder equipped with fire extinguishers, axes, shovels, etc., patrol the right of way behind the trains and extinguish any small fires that may have been started by falling sparks.

To facilitate the study of problems in ice-cream making, the dairy division of the Department of Agriculture has made a new application of devices for taking and recording temperatures electrically. The apparatus is somewhat similar to the instrument used by the department for recording temperatures inside refrigerator cars, described in the December, 1921, issue of Popular Mechanics. With the new apparatus it is possible to take temperatures continuously in the interior of power ice-cream machines while the mixing is being done, with an accuracy within .01° C. (.18 F.), the readings being taken several hundred feet away. Although the apparatus was designed for use in scientific investigations, it is expected that it may find application in commercial plants.



Members of Forest Service on Gasoline Speeder Equipped with Fire Extinguishers and Tools Patrol Railroad Right of Way and Put Out Fires Caused by Falling Sparks

comotives may be the means of starting a dangerous forest fire, has led to the establishment, in some sections, of the "speeder patrol." Members of the Forest Service on a gasoline speeder equipped with fire extinguishers, axes, shovels, etc., patrol the right of way behind the trains and extinguish any small fires that may have been started by falling sparks.

hundred feet away. Although the apparatus was designed for use in scientific investigations, it is expected that it may find application in commercial plants.

**WRENCH THAT CAN BE USED
AS A CLAMP OR VISE**

8314

The utility of a monkey wrench has been amplified by adding to it an extension of the threaded spindle that operates the lower jaw, allowing this extension to pass through the wrench handle and out at the bottom, where a viselike lever gives means for applying very much more power than by means of the ordinary



Monkey Wrench with a Viselike Lever below the Handle, and a Ratchet and Pawl That Make the Wrench Convertible into a Vise or Clamp

milled nut. In connection with the latter is a spring pawl which, acting with the nut as a ratchet, holds the lower jaw in any position when set. Thus the tool can be used also as a vise.

Write our Bureau of Information, if you wish to know who makes or sells any article described in this magazine. Send no postage; the service is free.

221 **THICKNESS CALIPER
OF NEW DESIGN**

Objects, whose diameters or thicknesses range from .001 to .5 in. may be easily and rapidly measured by the aid of a caliper just introduced. Due to the design of the instrument, it can be used for obtaining measurements in many places where the employment of a large gauge of any kind would be impossible. The scale is made of German silver, one side of which can be read to .001, and the other to 1/64 in. The measuring points are in spherical form, of hardened steel, and are readily replaced in the event of wear.



Thickness Caliper, Showing the Scale at the Left, and the Spherical Measuring Points at the Right

anw. Gene Stuette
7509, N. 30th St. A.C. Copyrighted material
Lincoln Neb

Emb. S. A. Winters, 702 District National Bank Bldg Washington D. C.
Bausch + Lomb Optical Co
Can be stored

9340 Elect

1/28

POPULAR MECHANICS

Made & Sold by:
Edward Serrett & Co.
Ltd. 6-Ft. St. John St.
816 2 London, S.W. England.

LONG TRANSMISSION LINE NEARING COMPLETION

Exceeding 1,200 miles in length, an interconnected electric-power transmission system on the Pacific coast, extending from Yuma, Ariz., to The Dalles, about 70 miles east of Portland, Ore., is nearing completion. The last section of the line, which is now being built between Prospect and Springfield, in the latter state, is 115 miles long and will carry 66,000 volts, to be later increased to 110,000 volts. From its southern end, the system reaches northward in eight divisions, which are controlled by as many different power companies, between the following cities: San Bernardino, Bakersfield, Merced, and Redding, Calif., and Springfield, Salem, and Portland, Oregon.

FISH AND SNAKE SKINS USED IN PLACE OF SHOE LEATHER

Shoes are now being made of fish and snake skins. This substitute for leather is said to cost less, and to be practically



PHOTOS BY RADEL & BERBERT
Above: Fish Skins being Cut Up and Fitted as a Substitute for Shoe Leather. Below: Ladies' Footwear being Made from the Skin of the Indian Python

8254

MOP TRUCK WITH TWO TANKS USED TO CLEAN FLOORS

New mopping outfits, of various sizes, have two tanks, one of which has an improved type of wringer fitted to it, the whole being

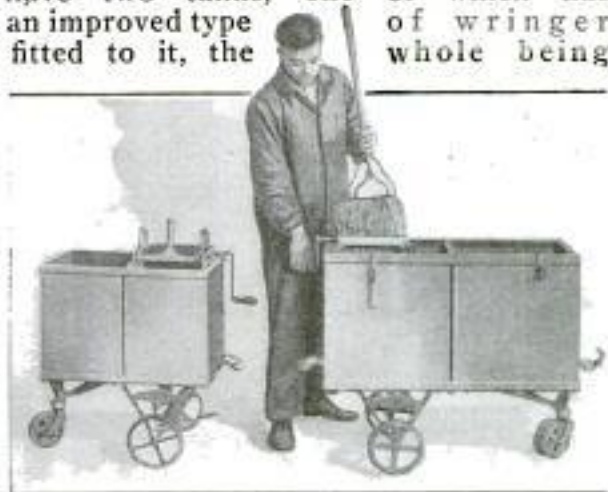

Left: Mop Truck with Two 15-Gallon Tanks and Wringer. Right: Mop Truck Having Two 25-Gallon Tanks and Wringer Attachment

mounted upon a three-wheeled rubber-tired truck. In use one tank is filled with water, which is allowed to run out upon the floor. The mop, when filled with dirty water, is then wrung dry over the second tank, so that there is always both a clean mop and clean water with which to work.

American Scrubbing
Equipment Co., Hannibal, Mo.

everlasting. Of reptiles, the various kinds of python, as well as lizards from Ceylon and Java, furnish skins that are serviceable, and attractive in appearance, with a special charm for the ladies. Almost any kind of fish that is large enough furnishes material that, with the scales removed, makes beautiful patterns of great variety. The skins are cut and fitted in the same manner as leather, and are used for shoes of various shapes for both men and women. In some parts of the country they have attracted favorable attention, and have become quite popular.

Wild elephants have caused considerable difficulty on the island of Sumatra, during oil-development work, as these animals seem to have taken a special dislike to the pipe lines laid above ground through the jungles, and have repeatedly torn them up, so that gangs of men are kept busy repairing the damage.

Made in England -
no records of makes

2158 E 42nd St.
New York

8298

Com. H. E. Thomas 911 Blinchley
 Ave., Portland, Oregon, 569

POPULAR MECHANICS

Oregon



As a Means of Providing Work for Jobless Men, the Wooden Foundations and Flooring of This Dismantled Shipyard are being Torn Up and Converted into Fuel. Left: In Bad Weather the Men Work under Sheds. Sawing Up Giant Logs Which have been Rafted down the River

8298 GREAT WOODYARD GIVES WORK TO JOBLESS MEN

The city of Portland, Ore., has gone far toward solving its problem of unemployment by converting a dismantled shipyard into a great woodyard for cutting fuel. Huge rafts of logs are floated down the river to the yard, where a donkey engine pulls the logs out of the water. The men then saw them into 4-ft. lengths, and afterwards split them into cordwood, which is sold for fuel. The wooden foundations and flooring are also being torn up and cut into firewood. In bad weather, the men work under the sheds that once covered the shipways.

☐ A new Italian airship, the "Napoli," it is reported, will have an electrically operated kitchen capable of providing meals for 100 passengers.

810 SCREEN-DOOR CATCH THAT CAN BE SECURELY LOCKED

A catch for screen doors, made of pressed steel throughout, with antique-

copper or electro-galvanized finish, has, besides the ordinary catch, a means of locking it that keeps the screen fly-tight and secure from any form of intrusion. The

latch is in two parts, one attached to the screen door, and the other to the jamb. On this latter part is a small lever that, by a simple turn, securely locks the door.



Pressed Steel Products Co.
 Plantsville, Conn.

Cmt. Edward Beard
26, Heathfield Road

570 POPULAR MECHANICS
Croydon, Surrey, England

THE SARACEN WATER TOWERS
IN PALERMO

8382
A curious architectural feature of Palermo, Sicily, and one which never fails to arouse the curiosity of visitors, is the tall



Tower in Palermo, Sicily. More Than 1,000 Years Old: The Upper Half Is Hollow and was Originally Used for Water Storage

thin stone towers scattered throughout the city. Many of them drip with water and are covered with lichen, moss, and ferns, and they are certainly not the least picturesque sight of that city, particularly on a hot and dusty day. Very few persons, however, know what these towers are, or why they are, and even Palermians themselves are very vague on the subject. In fact, they are water towers, erected by the Saracens during their domination of Sicily in the ninth century A. D., in order to regulate a somewhat troublesome water supply.

The Saracens ruled the island for over 100 years, and of all the foreign influences that have affected Sicily at various times, theirs has been the most lasting, particularly as regards hydraulic engineering and architecture. For about half

the year the climate of Sicily is very dry, and an extensive system of irrigation is essential in the cultivation of the lemons, oranges, and grapes for which the island is famous. The Saracens were not unaware of the art of cultivating these fruits, and many of their irrigation canals and wells are actually in use today. But it is the water towers that are of most interest in this connection. In order to get a true idea of their use, it must be realized that Palermo lies facing the sea in the embrace of a semicircle of hills, none of which is less than 2,000 ft. high. Since all the water for domestic purposes comes down from these hills, the pressure may well be imagined. To modern hydraulic engineers the problem presents no difficulties, but 1,000 years ago engineering was not so far advanced, and it was left to the Saracens to evolve a system of keeping the water under control. The position was further complicated by the fact that too little water was available for the needs of the population in summer, and too much in winter.

At various centers throughout the city, they built towers about 60 ft. high and 12 ft. square, the upper halves of which are hollow, and in most cases subsidiary reservoirs of greater holding capacity were attached—none of these last is now in existence. During the dry months from May to September, tower and reservoir served to collect the water and to enable it to be distributed at a regular pressure. During the remainder of the year the problem was not merely to keep the cisterns full, but to prevent them from overflowing and flooding the city. Flood-gates were accordingly set up in the hill channels and the water was diverted when necessary. A constant supply of water was thus maintained at a regular pressure throughout the whole year. Some of the towers are still in use for local distribution of water in outlying districts.

8431
**EXPLOSIONS IN MINES
CAUSED BY TELEPHONE**

Recent tests have shown that telephones used in mines are capable of igniting gas and causing explosions. There is no danger from the current used when talking over the telephone, but, under proper conditions, explosions may occur when ringing the magneto. The tests show that while the telephones used in mines may be practically dust and moisture-proof, they are not explosion-proof in a gaseous atmosphere.

Bureau of Mines
Washington, D. C.
Copyrighted material

WHEN JUSTICE HANGS BY A HAIR

BY JOHN ANSON FORD, 516 Union League Bldg
Los Angeles, Calif.

PROBABLY more extensively than in any other police department in America, comprehensive classified knowledge as to hair—human and animal—is being used by the police department of Berkeley, Calif., in solving crime mysteries. With the possible exception of an investigator in continental Europe, no agency has undertaken in so comprehensive a manner to make data regarding hair an adjunct in identifying criminals and others connected with crimes.

What the Berkeley Police Department

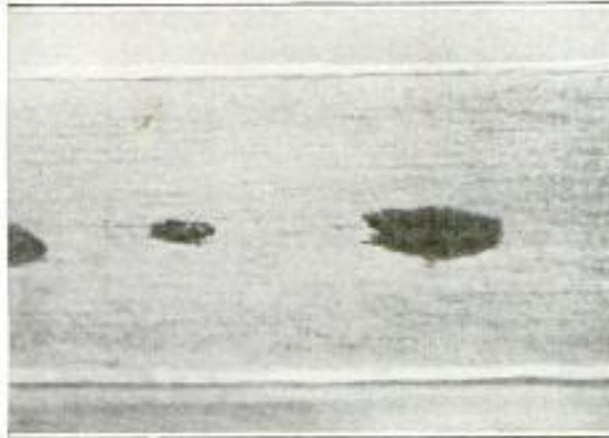

This Is a Hair from the Head of a Boy, Five Years Old, Showing the Pigment Granules, Which Give the Hair Its Color, Just Beginning to Appear

has undertaken is to make microscopic studies of hundreds of different kinds of hair and determine, so far as it is possible, the distinctive characteristics of each. Data already gathered are of immense value in helping determine the age, state of health, race, as well as something of

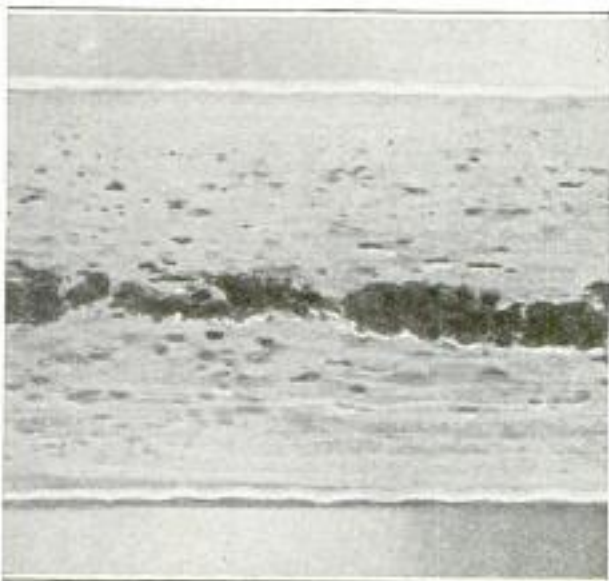

Hair of a Male Person, Aged 40 Years, Showing the Almost Complete Continuity of the Pith, Which Is a Characteristic of the Hair of Adult Persons

the personal habits of the individual. Microscopic study of hair which has been

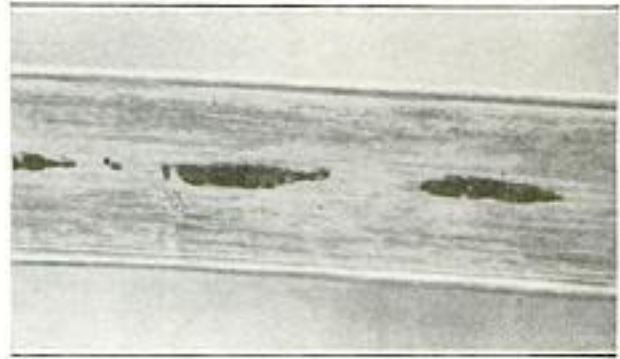

The Microscope Reveals That This Is the Hair of a Child, as Shown by Its Small Diameter and the Lack of Continuity in the Pith, Which Is Normally a Distinguishing Feature in the Hair of Children

uncut for a long period shows the ends slightly frayed, whereas the ends of hair that is frequently barbered are more smooth and less broken.

The photographic files of the Berkeley police include one of the largest collec-

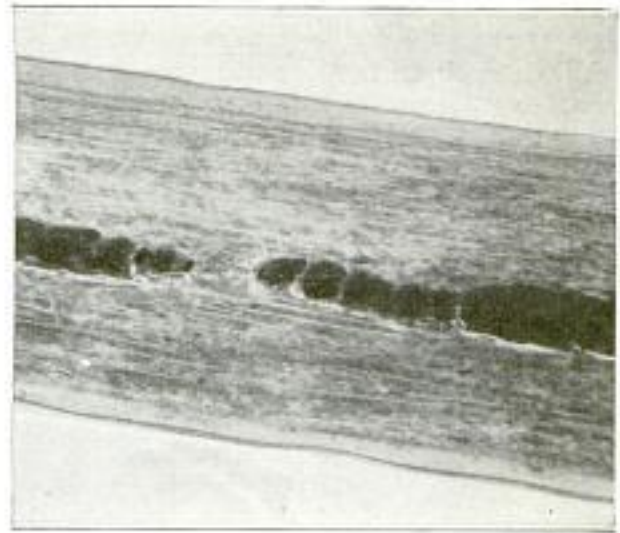

The Almost Unbroken Pith and the Large Diameter of This Hair, from a Woman 26 Years Old, Tend to Show That It Is the Hair of an Adult Person

tions of photomicrographs of animal hairs to be found in this country. Not infrequently these data are of great importance in apprehending murderers where the crime has been committed with a razor or other sharp blade. A hypothetical case will illustrate the point: An old man is found with his skull crushed by some blunt instrument, probably an ax. His hair is suspected. An ax, the property of the heir, is found, and on it is a dried drop of blood to which a gray hair adheres. The suspected person, confronted with this evidence, declares that he recently used the ax in killing a rabbit, and that the blood and hair undoubtedly are

from that animal. Examination by the police at once reveals that the hair and blood are of human origin.

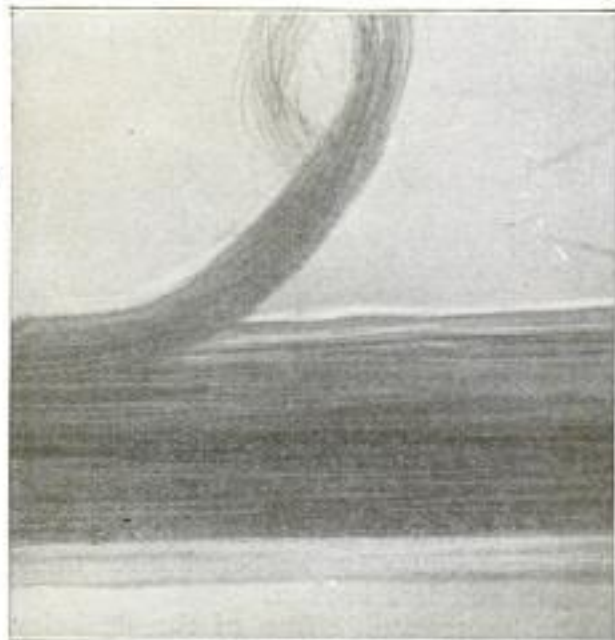

A Case of Literally Splitting Hairs: This Hair has been Split with a Razor. Note the Solid Dark Pith, Indicating Full Maturity of the Subject

While such an instance may seem somewhat overdrawn, the Berkeley police declare that several years of experience in dealing with criminals of many races and

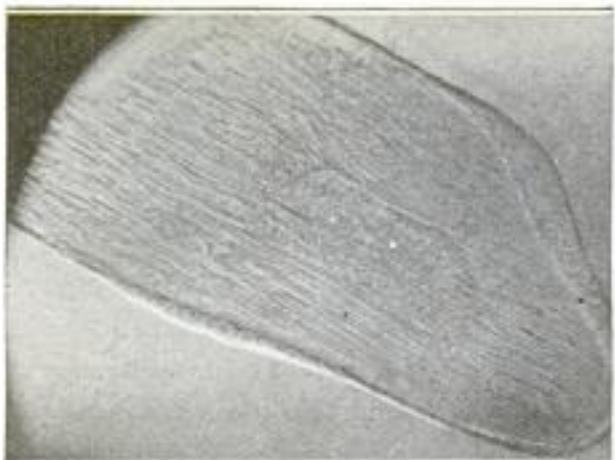

The Extreme Coarseness of This Hair Indicates That It Is from the Beard. The Picture Shows the End Which has been Cut Off on the Bias in Shaving

of various degrees of intelligence, show that such an example is typical of actual crime problems. Their records show cases in which scientific data regarding hair presented as evidence were a determining factor in securing conviction.

Human hair, these files of hundreds of photomicrographs show, is differentiated from other hair by its size, relative width of pith, or medulla, and cortex, or outer layer beneath the scales. The coarseness of a hair may indicate the region of the

body from which it was taken, the coarsest coming from the beard, eyebrows, etc. These measure from $\frac{1}{230}$ to $\frac{1}{160}$ in. in diameter. Hair from the nostrils, backs of hands, scalp and eyelashes, the police find, measures from $\frac{1}{600}$ to $\frac{1}{330}$ in. in diameter. Fine downy hair measures $\frac{1}{3,000}$ to $\frac{1}{1,500}$ in. in diameter. Women and children usually have finer hair than men.

The condition of the pith, as revealed in these microscopic-study records, is often a determining factor in evidence. The pith of human hair does not appear to be continuous or to reach full width until maturity of the individual. Another factor used by these investigators in determining the age of the individual from which hair is taken is the amount of pigment, the color-determining substance.

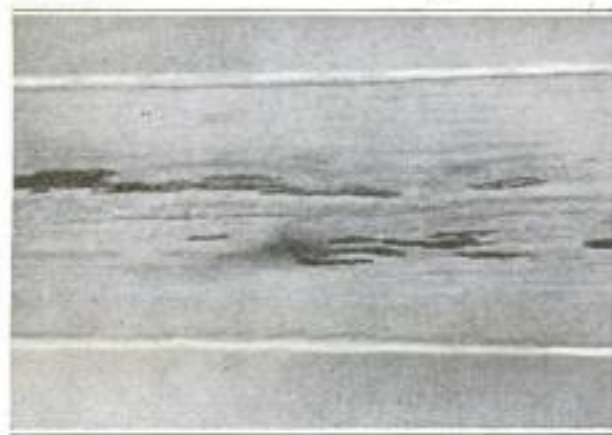

Here the Pith Lacks Continuity, but Its Appearance Is Different and, to the Expert, Indicates Advanced Years

Ordinarily this does not reach its maximum until maturity has been reached. In other words, study of a child's hair under the microscope reveals fewer pigment

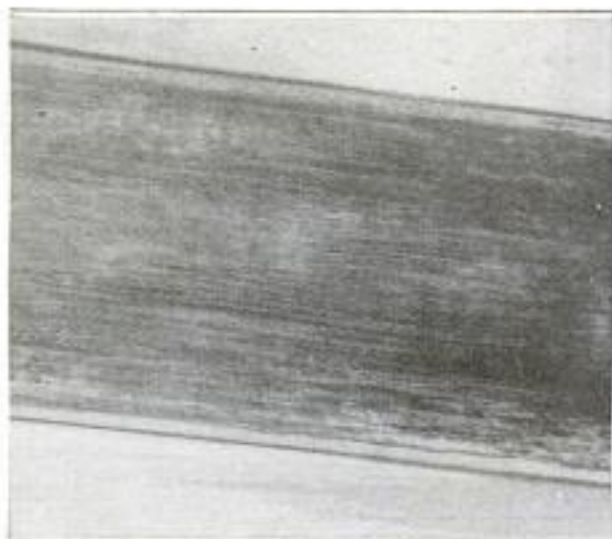

A Hair Whose General Mottled Condition Indicates That the Subject Was Not in Vigorous Health

granules than does hair from an adult. With the approach of advanced years, the pigment begins to disappear, giving the hair its grayish color. Likewise, in old age, the continuity of the pith of the hair is broken. On the outer surface of the hair are often found deposits of fatty matter, which may serve as an index to the robustness of the individual in question.

In the past two years the experts in the Berkeley Police Department have made several hundred photomicrographs of hair, and are now carrying the investigation still farther. One question to which they are giving special attention is what differences are to be found in hair from persons of different races and what distinguishing characteristics obtain for each race. Once such a set of characteristics can be determined, they will be of much value in criminal investigation.

It was in solving the mystery of repeated thefts on Berkeley's water front, a few years ago, that the attention of the police department was first turned to a comprehensive study of hair with the microscope. Careful search by the police assigned to catch the thief in this case revealed some of the loot in a

apparently was from the head and very light, while the other was evidently from the beard, being much coarser. Its color was light sandy.

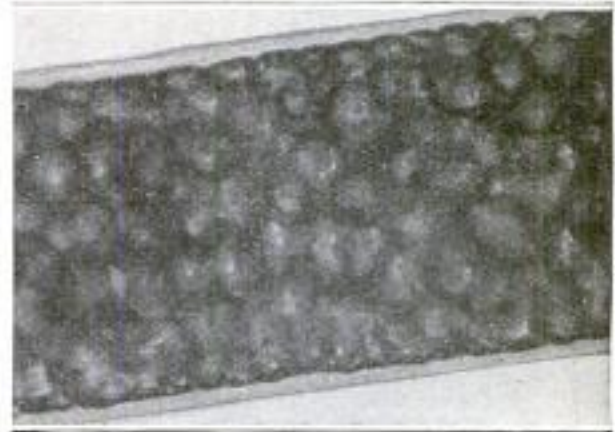

The Hair of a Deer, Identified by the Fact That It is Much Coarser Than Any Other Shown Here

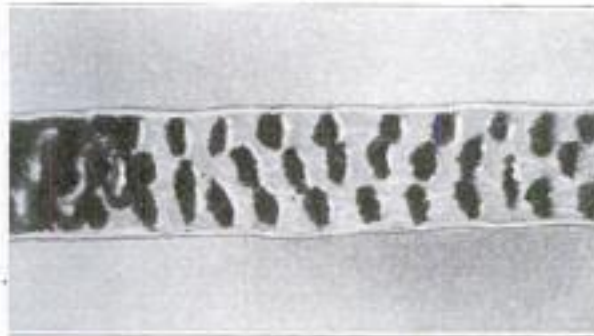

A Hair from the Body of a Mouse, Which is Easily Identified Once the Peculiar Structure is Noted; Each Kind of Hair Has Some Peculiar Characteristic

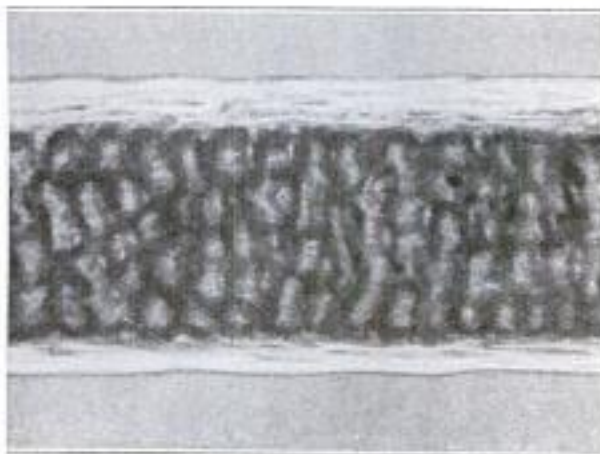

Illustrating the Difference between Human and Animal Hair under the Microscope, Here Is the Hair of a Rat. Note the Difference from the Hair of a Deer

launch anchored in the bay. In the launch was also found a comb and a razor, each bearing a fragment or two of hair. With the aid of the state university, a microscopic study of these tiny bits of evidence was made. It was found that one hair

As the owner of the launch was not known, a watch was set. For days no one approached the launch, until finally the police observed a man on shore who loitered for a time not far from the launch but failed by word or act to reveal any interest in the boat. However, the sus-

picious of the police were aroused because of his very light hair and light sandy beard. On the strength of that suspicion they arrested the man and he later confessed to the thefts. The incident opened the eyes of Chief of Police August Vollmer to the value of microscopic study of hairs, and since then Officer C. D. Lee has been placed in charge of the work and probably has gathered more scientific data on the subject than any other police authority in the country.

PLAN TO AID EXPORT TRADE IS ABANDONED BY SPONSORS

Because of lack of support, the plan of the "world trade cruise" of the steamship "St. Louis" has been abandoned. The cruise was to have started early this year, the object being to stimulate American export trade by exhibiting representative products of the United States. Because the exhibition could not be made to represent the best that could be produced in America, the plan was dropped.

8384
New York Times
Feb 6, 1922 P. 20

7468

mountain dome, Ark

HYDROELECTRIC DEVELOPMENT IN ARKANSAS

BY TOM SHIRAS

mountain dome, Ark

THE lethargy of the Arkansas Ozarks along the White River, near Cotter, in

drill foot by foot through solid rock, testing the foundation on which one of the largest power dams in the United States will rest sometime in the near future.

The White River, and its tributaries, the Buffalo and the Big Northfork, all mountain streams, will soon be acting as a gigantic engine, supplying power to several batteries of dynamos, which will in turn shoot some 350,000 hp., 180,000 miles a second, over high-tension wires to surrounding cities in Arkansas, Missouri, and Tennessee.

The drilling program which is now in progress will complete the preliminary work on the first unit. The foundations of two sites will be investigated—one eight miles above Cotter, the other

at Cotter—and the dam constructed on the best site. Engineering work has been in progress since the fall of 1919. The

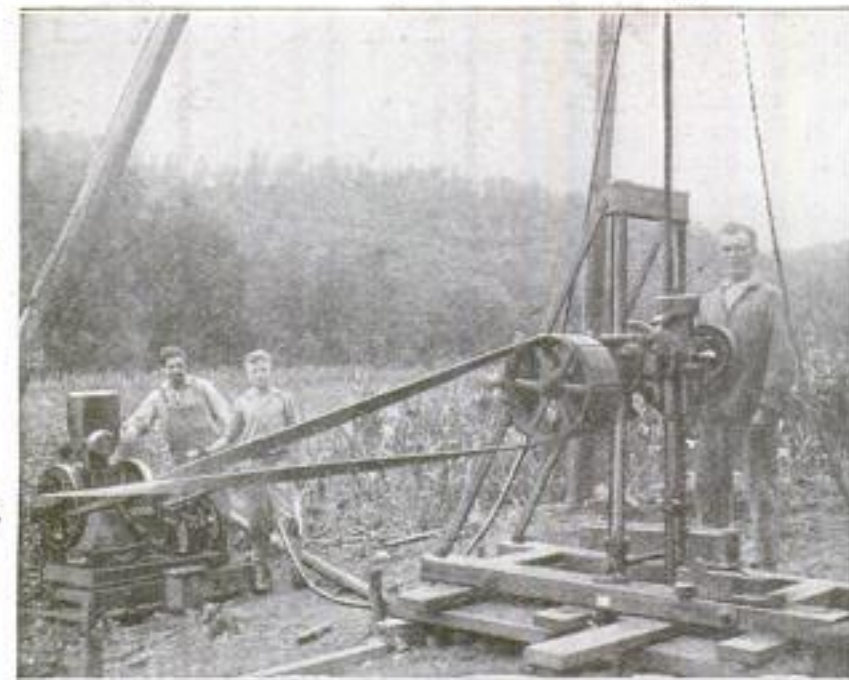

Diamond-Bit Core Drill at Work in the Arkansas Ozarks, near Cotter, Testing the Foundation for One of the Largest Power Dams in the United States, Which is to be Erected There

Baxter and Marion counties, is being disturbed by the regular exhausts of an oil engine, as it drives a diamond-bit core



Left: Small Homemade Turbine in Homemade Mill on Spring Creek, Baxter County, Arkansas. Under a Full Head of Water It Develops 12 Horsepower. Right: Large Overshot Wheel That Develops 20 Horsepower and Operates a Sawmill, a Gristmill, and a Small Flourmill. Plants of This Kind Were the Only Ones in Existence before the Building of the Taney Dam in Missouri

Electric Power Co., Cotter, Ark.

7468

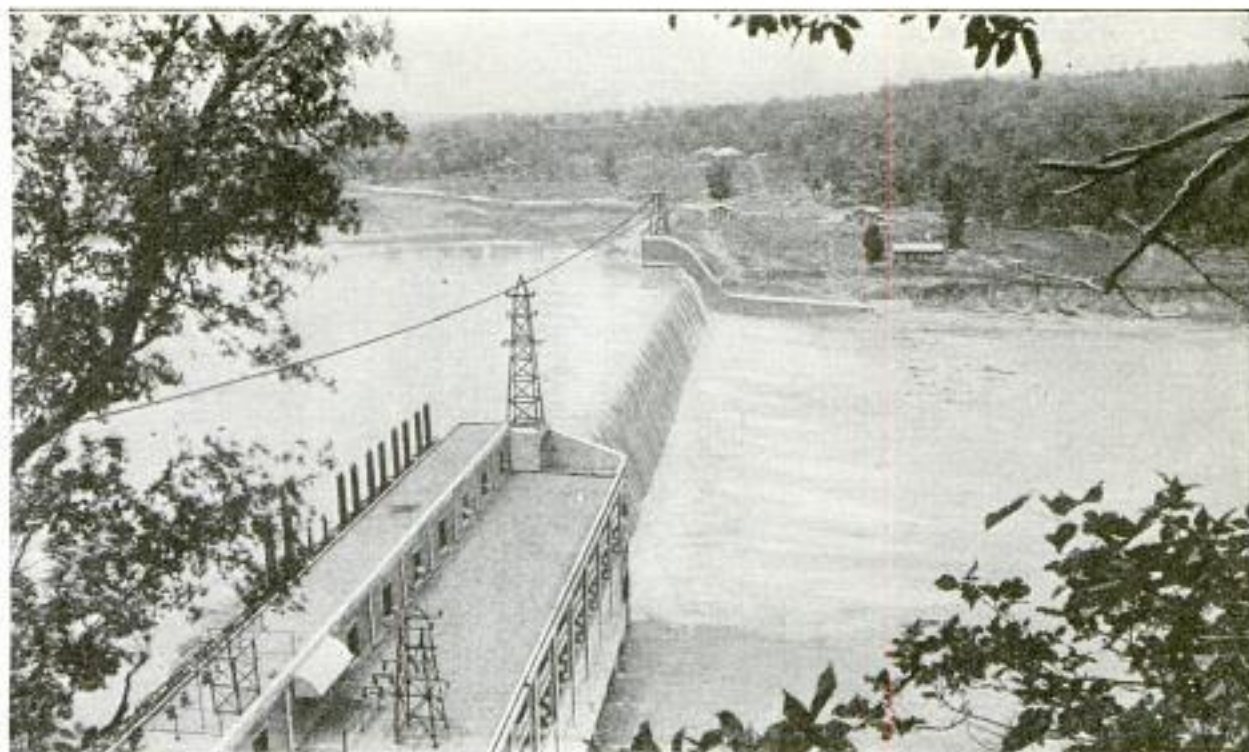

Modern Hydroelectric Plant on the White River, in Taney County, Missouri, Which Develops Approximately 20,000 Horsepower: It was Constructed 10 Years Ago, and Furnishes Electric Power to Points in Southwest Missouri. It Is One of the First Attempts to Utilize the Gigantic Water Power in the Ozarks

consulting engineer states that the project ranks fifth among the major water-power projects of the United States.

The Cotter dam, which will be the first unit in the program to be developed, will be from 230 to 250 ft. high, approximately 2,300 ft. across at the crest, and proportionately thick to withstand the water. This dam will develop about 140,000 hp. A high-head dam on the Northfork and Buffalo rivers, and three low-head dams on the White River, below Cotter, to be constructed after the Cotter dam is completed, will develop approximately 210,000 hp. A dam in the White River, 120 miles north of Cotter, in Taney County, Mo., which develops approximately 20,000 hp., was constructed 10 years ago, and has been a decided success, supplying electric power to points in the southwestern parts of Missouri.

The Cotter dam will be unlike this, and many other structures of its kind, in that it will be a solid-type dam instead of a hollow type, and will have no spillway in the dam proper. The overflow waters will be discharged through a spillway constructed in the rim of the basin, into a creek, which empties into the river below the dam site. The topography of the country at each site under investigation is such that this plan can be carried out. By this plan the foundation of the dam will not be subjected to the terrific force of the water as it makes its fall.

The construction of the dam will create in the White River, above the structure, a clear-water lake, 120 miles long and several miles wide at the widest place.

The survey of the basin shows that some 52,000 acres will be inundated. Approximately 5,000 acres of this will be river-bottom farmland now in cultivation, the balance, rough mountain sides. No towns, railroads, or other high-valued property are in the inundated area.

Besides the power developed, the lake will afford transportation for a large inland territory now dependent on rough mountain roads. By releasing the water during dry periods, it will also have the effect of maintaining a better stage of water below the dam, which will make the river navigable for small boats to Cotter, and by catching the flood waters, will alleviate disastrous floods in the bottoms on the lower reaches of the stream.

Until the Taney County, Mo., dam was constructed, and the several smaller ones on Spring River, in Fulton County, Ark., no effort had been made to develop, on a commercial scale, the gigantic power that was running to waste in the Ozarks.

The natives of the Ozarks, however, have been using the power in small units for a half a century. They developed the power by crude, yet ingenious, overshot and undershot wheels, and small wooden turbines.

Emt. Howard Howler, Rogers Ark.

POPULAR MECHANICS

576
83 24

CIRCULAR SAW ON TRACTOR FOR CLEARING LAND



With the increasing use of the small tractor on the farm, it is a logical step that it should be adapted for clearing land, and this is now done by mounting a circular saw on the front of the tractor. The saw, belt-driven from the engine, is carried on a swinging frame and can be used in a horizontal position for felling trees or, by removing two bolts, can be swung into a vertical position for cutting wood.

When used in the vertical position, there is a large spring which holds the saw in place. The saw and frame may be removed when not needed.

This Circular Saw, Mounted on a Swinging Frame at the Front of a Small Tractor and Driven by the Tractor Engine, can be Used in Clearing Land, or can be Swung into Position for Cutting Wood

8246

GAS PRODUCER FOR TRUCK USES CHARCOAL AS FUEL

In a new French gas producer, installed on a truck, charcoal, coal, coke, or even wood may be used as fuel in a fire box

producer is connected with the motor in such a manner that these gases are sucked into the cylinder when the motor is running. When the motor is at rest there is no gas produced, and as all that is produced when running is drawn directly into the cylinders, there is no danger from escaping gases that might cause asphyxiation, fire, or explosion. Air is used for combustion of the gas in the cylinders, and

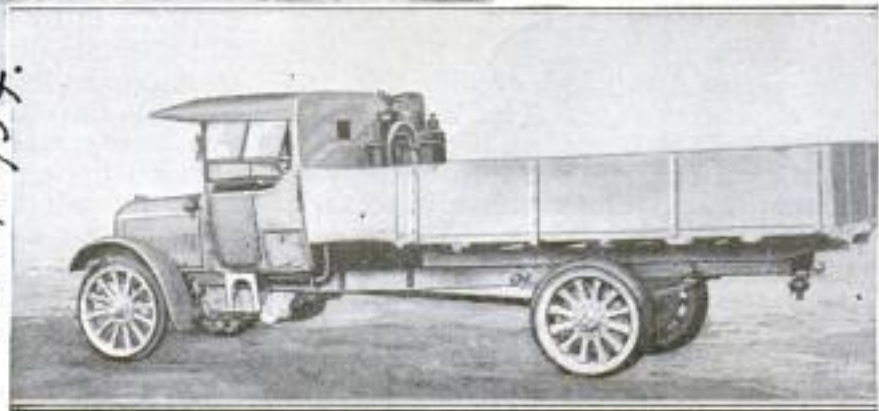

Another Truck Fitted with a Gas Producer, Here Mounted behind the Cab: It Also Uses Charcoal as Fuel, Which Decomposes Water Vapor into Hydrogen and Carbonic Oxide

Gas-Producer Truck, That Uses Charcoal as Fuel, Hauling a Heavy Load of Logs

which is part of a closed container in which, by the action of the burning fuel, water vapor is decomposed into hydrogen and carbonic oxide. The gas

Emt. E. H. Weiss 80, Boul. Jourdan, Paris, 14e France

Belle rue 1742734

Mrs. Doueti des Sasognes Casco
Sasognes 11, Avenue de l'Opera, Paris, France

Copyrighted material

*R. E. Royall, Highway Engineer,
 U. S. Dept. of Agriculture,
 POPULAR MECHANICS
 Washington, D. C.*

*Developed by: A. J. Leboldbeck, Bureau of Public Roads
 S. B. Smith*

this air is heated in a special device by the hot gases from the producer. This raises the temperature of the air used for combustion, and cools the hot producer gases, thus reducing the whole to a uniform temperature. Tests have shown a consumption of charcoal, in a four-ton truck, of about 3½ lb. per mile and about 1 lb. per horsepower-hour.

SOIL PRESSURE MEASURED ACCURATELY BY MACHINE

The earth pressure exerted against retaining walls, earth dams, sand fills, and in road construction is a subject of vital importance, and can now be measured accurately to within one-tenth of a pound by a simple soil-pressure cell. The cell consists of a cast-iron base, protecting ring, and a central unit consisting of two circular iron plates with a thin brass diaphragm bolted between them. When the cell is assembled, this brass diaphragm holds the central unit out of contact with

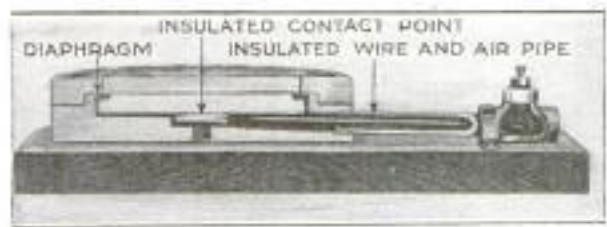

Pressure on the Center Disk Makes an Electrical Contact; Compressed Air is Pumped In to Balance This Force and Measures the Soil Pressure

an insulated steel button carried by the baseplate, and also acts as a flexible seal for an air-tight chamber formed between the baseplate and the central unit. In operation, the cell is first buried where the pressure is to be measured, and the earth filled in. The soil pressure forces the central disk against the steel button, forming an electric circuit and causing a small light to burn; compressed air is forced in under the brass diaphragm until the air pressure just balances the earth pressure, causing the iron disks to move and breaking the electric circuit. This air pressure corresponds to the earth pressure on the cell.

8211 REVOLVING SIGNBOARD PROPELLED BY WIND

Outdoor signboards are usually stationary, but a Waterloo, Ia., company has introduced a revolving type which is propelled by the wind. Four panels, 4 by 6 ft. in size, are mounted on a pyramidal wooden support, the height of the whole

being 15 ft. Owing to the manner of fastening them to the framework, both sides of the panels can be seen from the adja-

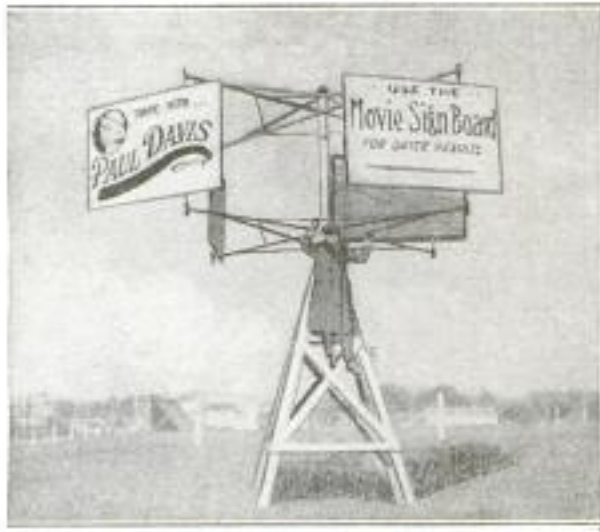

Revolving Signboard Which was Designed for Use in Rural Districts Where the Turning Panels may be Seen by Passing Motorists

cent highway as they are turned by the breezes, so that eight advertisements may be displayed.

8300 AUTO DEVICE INFORMS DRIVER WHICH CAR HAS RIGHT OF WAY

In an effort to reduce the number of automobile accidents many states have passed a law which holds that the car approaching a road intersection from the right has the right of way over a car approaching from the left. A new device has been brought out which fits on the radiator cap or at the front of the car and shows a red disk to the left and a green disk to the right. A light is provided so that the disk is visible day or

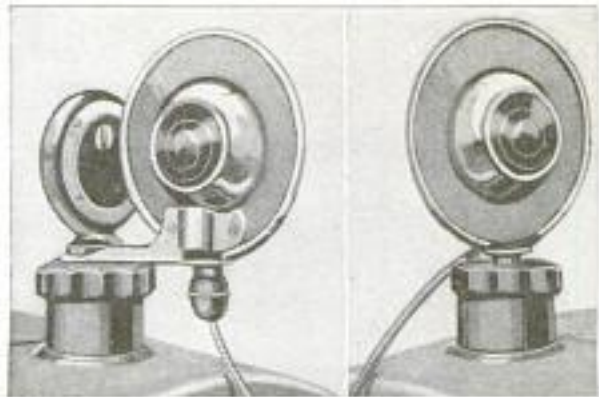

An Illuminated Disk at the Front of the Car Shows Red to the Left and Green to the Right, Thereby Informing the Drivers Which Car Has the Right of Way

night, thereby informing drivers approaching an intersection which car has the right of way.

movie Sign Board Co. Waterloo, Iowa. Boesch Lamp Co. San Francisco Calif.

**ELECTRIC RADIATOR WARMER
PREVENTS WATER FREEZING**

For preventing the water in an automobile radiator from freezing, a small flat electric heater is furnished, with a chain

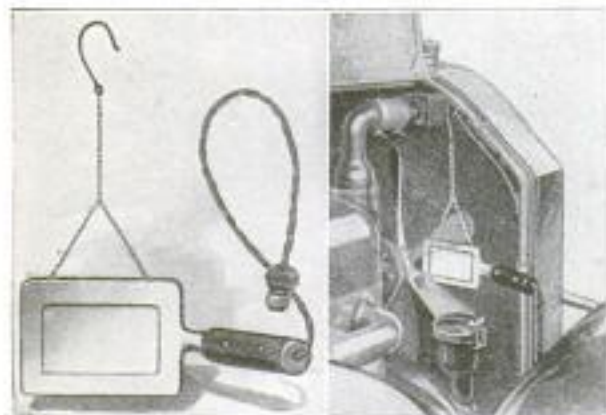

Radiator Warmer, Which is Hung against the Side of an Automobile Radiator, as Shown at the Right

and hook so that it can be suspended against the side of the radiator. It is fitted with a socket for a wire connection, and operates on 110-volt alternating or direct current. It is made in various sizes, with a capacity of 50 watts or more. When the car is at rest, the current can be switched on, and the heat of the plate is sufficient to make the radiator safe from the effects of severe frost.

**HORN DETECTS NATURE'S
FAINT SOUNDS**

Many of the sounds produced by insects and birds are not readily perceptible to the human ear, by reason of their faintness. Thus there are a host of insect notes, of low enough pitch to be heard, if only they were of sufficient strength.



Experimenting with the Instrument Which Enables the Listener to Hear Otherwise Inaudible Sounds Made by Insects: At the Right is a Diagram of Its Construction

The same thing applies, though in a less degree, to the notes of birds. To meet the need of some apparatus whereby these faint sounds may be made audible, an equipment has been designed and is now in use in the field. It consists of a large horn, some 3 ft. in length and 1 1/2 ft. in diameter at its largest end, connected to a pair of receivers by tubes. The receivers are placed to the ears.

By means of this device extremely faint sounds may be detected, and the device is proving of value in the study of the notes of birds and insects. Distant sounds, which reach the unaided ears but faintly, or not at all, can be magnified in intensity. With this device it is possible to hear the ticking of a watch 50 ft. away, and the sound of ordinary conversation, on a quiet day, for over a mile.

A much larger horn is now being designed and built, supported on a framework. With this enlarged apparatus the inventor expects to be able to detect the notes of birds within a radius of five miles.

8363

**SMALL ELECTRIC INCUBATOR
REGULATED BY THERMOSTAT**

Hatching chickens by electrical heat is achieved with a 65-egg incubator which



This Small Electrically Heated Incubator is Automatically Regulated. It is Made of Mahogany-Finished Redwood Trimmed with Brass

should appeal to poultry raisers. The heating element consists of a stitched wire fabric that covers the entire top of the hatching chamber. A simple regulating thermostat maintains an even temperature, after having been adjusted to any desired point by means of a thumbscrew attachment, and a light inside the egg compartment can be switched on when it is necessary to examine the thermometer or the eggs.

Imps. Electric Controlled by Thermostat

Dr. H. A. Haysman, 802 University Ave., N. Y.

*Copyrighted material
Curt Kenneth Magas
318 E. 10th St.
Indianapolis, Ind.*

8329

Emt. Arthur Hallam,
315 Andrus Bldg Minneapolis
POPULAR MECHANICS
579
Minn



Exterior of the Mammoth Building Erected on the Minnesota State Fair Grounds for the Housing of Blooded Cattle While on Exhibition: It Contains the Most Modern Equipment in the Way of Ventilation, Sanitation, and Protection against Fire Hazard



Interior of the Building, Showing the Manner of Placing the Cattle in Rows with Wide Aisles between Them: The Stalls Are of the Latest Type, and if It is Desired to Use the Place for an Industrial Exhibit, the Stalls can be Removed in 24 Hours

**HUGE EXHIBITION BUILDING
USED FOR CATTLE BARN**

Blooded stock always receives the greatest of care, and to provide for the proper attention required by prize cattle on exhibition, a huge building was erected on the Minnesota State Fair grounds. Constructed of steel, concrete, and brick, the fireproof structure covers 246 by 411 ft. in area, cost \$600,000, and, including a basement as well lighted as the main floor, furnishes nearly 250,000 sq. ft. of floor space. Added features of the place are a mezzanine balcony, 35 ft. in width and extending completely around the building; a special ventilating system; modernly equipped stalls for washing cattle; lockers for feed and storage, which reduce the fire hazard and allow the aisles to be kept clear at all times, and convenient accommodations for the herds-men in charge of the valuable animals.

Our Bureau of Information is for your benefit. Use it as often as you please.

**SIMPLE REVERSING DEVICE
FOR SMALL MOTORBOAT**

An extremely simple reversing device for small motorboats has been developed in Canada and has given excellent results. A universal joint in the shaft permits the propeller to be raised by a handle

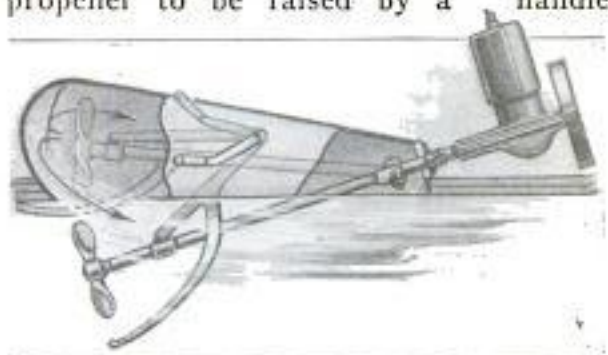

In Its Raised Position, the Propeller, Driving in Forward Direction, Causes the Boat to Move in Opposite Direction

into a chamber where the direction of the moving water is reversed causing the boat to move in the opposite direction.

Chas. Andrew MacLean
349 Adelaide St. W.
Toronto, Canada

d.no. Walter S. Hill, 4135 W. Kennett, Chicago, N.Y. James 2/11/22 P. 14

580

POPULAR MECHANICS

SHARPENING DEVICE FOR LAWN MOWERS

COMMERCIAL RADIOTELEPHONE SERVICE STATION PLANNED

Sharpening a lawn mower by hand is a long and tedious process, and any method of doing this as well, if not better, me-

It has become known that a new development in wireless-telephone broadcasting is to be undertaken by the American Telephone and Telegraph Company. According to the plan, a transmitting station will be installed in their New York building with the antennae carried by steel towers on the roof. The antennae will be more than 400 ft. above the street level. A government permit for the station has already been issued. The use of the station will be leased to individuals or firms who wish to broadcast information, much on the order of the leasing of long-distance lines at present. It is expected that many news-service companies, department stores, and mercantile concerns will wish to use the service as a means of conveying information to their subscribers and customers. Should the New York station prove a success, other stations will be installed at important centers.

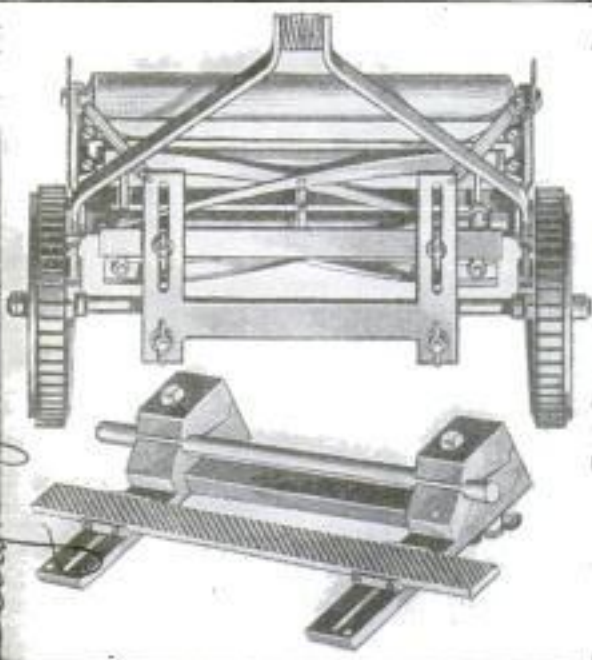

Attachment for Sharpening Lawn Mowers: Below, It is Seen Separated from the Mower, Showing the Flat File against Which the Blades Rotate When the Mower is Pushed Along

mechanically will be welcome to the owners of this widely used implement. A recently patented sharpening device is in the form of a U-shaped attachment that is clamped on the stationary shaft of the mower wheels. This attachment carries adjustably a flat file, against which the mower blades rotate when the mower is pushed over the ground for a distance of 50 to 100 ft., which is sufficient to sharpen them. The file can then be removed, and the lower stationary blade sharpened.

LONG CARBON-STEEL BELTS OF EXTREME FLEXIBILITY

For special service in conveying warm, sticky, sharp, or abrasive material, which rubber and fabric belts do not handle satisfactorily, a steel belt has been perfected that is remarkable for its strength, and for a flexibility that is the result of its extreme thinness. The material used in these belts is a cold-rolled steel with a carbon percentage of .65, that is hardened and tempered by a special process. One of these belts has been made that is 285 ft. long, 16 in. wide, with a thickness of only .035 or a little more than 1/32 in. It weighs 550 pounds.



Above: Flexible Carbon-Steel Belt, Weighing 550 Pounds, That is 285 Feet Long, 16 Inches Wide, and Only .035 or a Little Over 1/32 Inch Thick. Left: Adjustable Scrapers by Means of Which Material Conveyed by Belt can be Discharged at Various Points. Right: Interior View of Iron-Ore Concentrator, Showing One of These Belts in Use. The Belts are Made Either Flat or Trough-Shaped to Suit Varying Service Conditions

Woolworth Bldg. New York City. Sandwich Steel, Inc.

Crk George H Paul, Ellsworth Bldg Chicago Copyrighted material

HOW PHONOGRAPH RECORDS ARE MADE

By ALEXANDER H. KOLBE

908 E. 12th St.
Brooklyn, N.Y.

MANUFACTURERS of phonograph records ordinarily refuse to let out the secret of how these disks are made, because they all design their own machinery, lay out their own electrical apparatus, and often use special machines of their own invention. For this reason the public knows little about the process.

The first step in the manufacture of phonograph records is the making of the original wax disk, which is about $\frac{1}{2}$ in. larger in diameter than the finished record, and about $\frac{3}{4}$ in. thick. These disks are made of a fairly soft wax composition. This original, or master record, is placed on a recording machine, similar to a phonograph, but more delicately made and with the needle action reversed, that is, instead of the needle falling into a groove it is forced into the soft wax by the vibrations of the transmitting diaphragm.

Impressions on the wax master record are very delicate and therefore it can not be used directly in producing other records. Copper matrices are made from the wax disks by much the same process used in electrotyping. Suspended on two

these rods and midway between them, is another rod on which are swivel connections. From these the wax disks are sus-

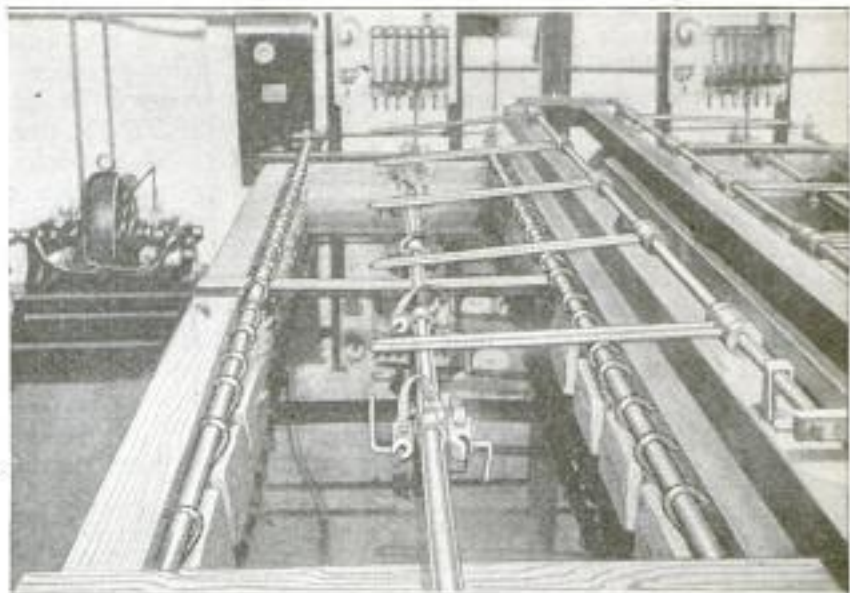

Tank in Which the Master Records are Suspended and Copperplated: The Copper Shells Become the Master Matrices, from Which Mother Matrices and Pressing Matrices are Later Produced

pendent in the solution by means of small rods.

The electric current, circulating through the anodes and the solution, deposits particles of copper on the wax disks, completely covering the face and grooves. After 24 hours the disks, covered with a coating of copper, are removed from the tubs. The copper shell is carefully stripped off, and the rough edges trimmed. These disks become the master matrices.

After coating the back and edges of a master matrix with wax so that copper will not adhere to those parts, it is suspended in the solution exactly as the wax disks were suspended. Again after 24 hours it is removed and stripped of the newly deposited coating. This second copper disk is known as the mother matrix, and by repeating the process with the mother matrix, there is produced what is called the pressing matrix. This last matrix

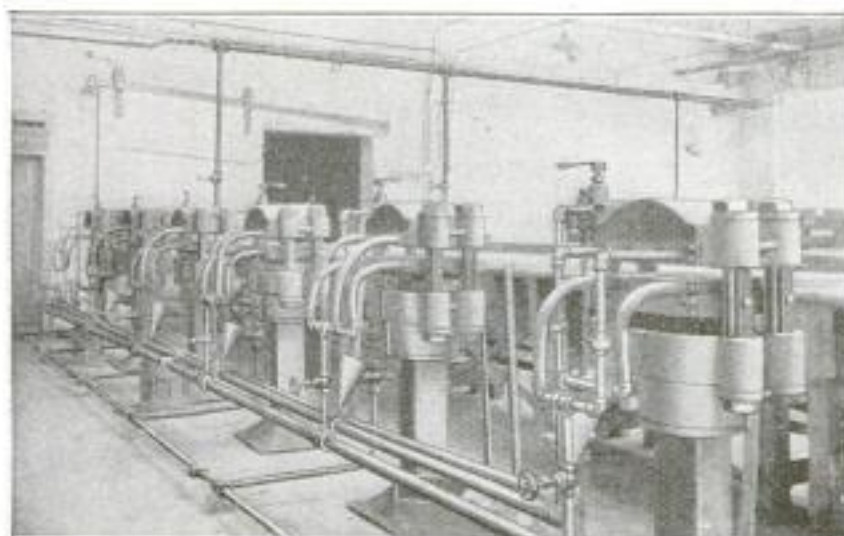

Hydraulic Presses in Which Ordinary Phonograph Records are Formed by Pressure of from 10,000 to 20,000 Pounds between Two Pressing Matrices

brass rods running across lead-lined tubs, are anodes, usually copper plates with wires attached to the rods. Parallel with

is the one used for pressing records for the trade. The master matrix is carefully guarded by the producing concern.

In the press room there is a rolling mill consisting of two or three steam-heated rollers and their driving gear mounted in a frame. On top of this machine is a hopper in which is placed the composition of which the commercial records are made. The material used in the ordinary black record is chiefly shellac with portions of rotten stone and lampblack. It is carefully pulverized, and screened to free it of foreign matter. The composition is heated in the hopper and mixed by the rollers to a consistency a little stiffer than bread dough. Great care is exercised to secure a mixture that will produce a hard, glossy record, impervious to slight changes in temperature. If a too soft mixture is used the records tend to warp.

The mixture is next flattened out into strips by another set of heated rollers. Rectangular strips, about 5 in. wide and $\frac{3}{16}$ in. thick, are cut. These are laid on a heating plate until warm enough to press, a hole is punched in them, and they are placed between two dies or molds. The molds consist of square steel plates, into the faces of which circular depressions have been turned, equal in depth to one-half the thickness of the finished record, plus the thickness of the copper matrix. A separate ring holds the matrix by its outer edge, face up, so that when the ring is screwed down, the matrix becomes a part of the half mold. After the strips of composition have been placed between

them, the halves of the mold are held together by a central pin and two dowels. The complete die is placed in the hydraulic press. As the two half dies are pressed together, the stock is flattened out until it fills the entire opening, with a little overflow forming a slight fin around the outside edge of the record. Each record is subjected to from 10,000 to 20,000-lb. pressure.

The finished record is placed in a trimming lathe and the fin or overflow is trimmed off. It is then tested on an ordinary phonograph and, after being labeled, is ready to be shipped.

7304 OIL RESOURCES OF ALASKA BEING INVESTIGATED

Judging from preliminary investigations carried on last summer, there is a possibility that Alaska may, at some future time, become one of the oil-producing countries of the world. A party of investigators from San Francisco found several oil seepages east of Point Barrow, which is the most northerly point of Alaska. At one place the oil flowed down from a small hill and spread out over the surface of a small lake. While oil seepages may indicate the presence of oil-bearing formations, they do not necessarily promise discovery of oil in commercial quantities. Up to date, nothing has been done by way of commercial development, and even if drilling should dis-

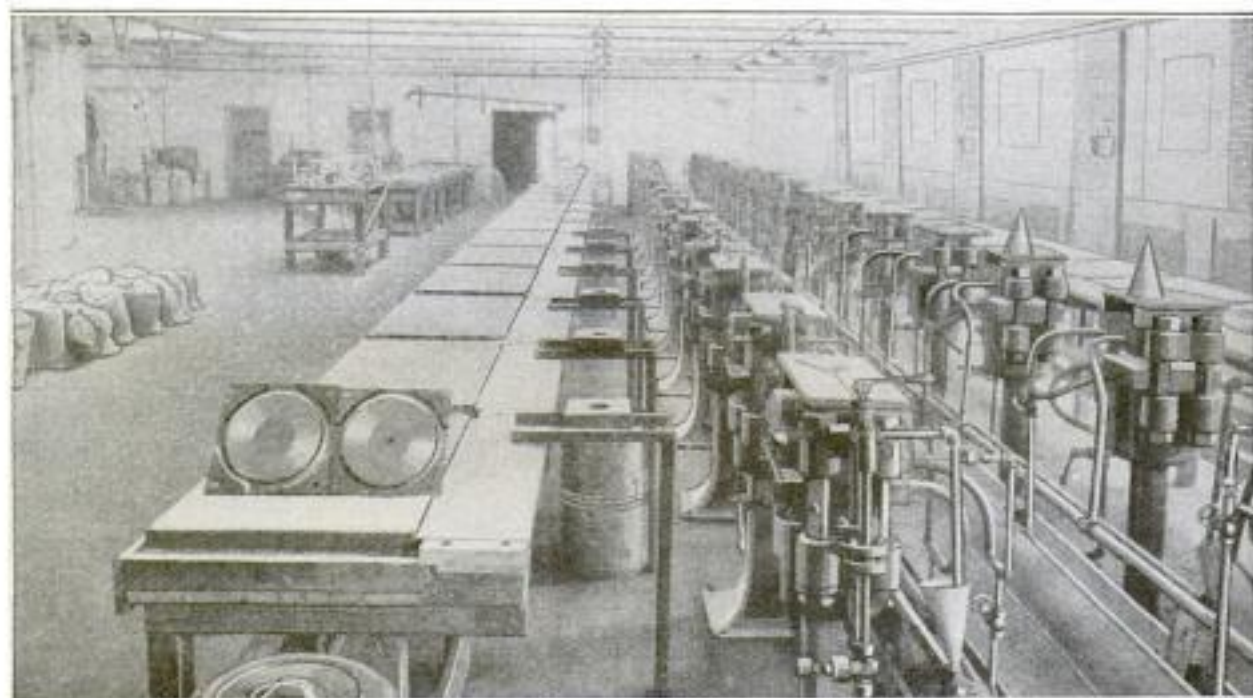

General View of the Room Containing the Hydraulic Presses, and the Tables on Which the Record Material is Heated Until It Becomes Plastic: In the Left Foreground is Shown One of the Dies Used to Make the Impressions on a Double Record

7304

International Patent Service

326 W. Madison

POPULAR MECHANICS

583

Chicago



Above: Oil Seeping Down from a Small Hill Soon Becomes Thick and Heavy. Below: The "Silver Wave" in Which the Party of Investigators Made the Trip from Nome to Point Barrow, Alaska

close oil in quantities, there would still remain problems of transportation that would be difficult to solve in such a way that the Alaska oil might compete with oil from present sources which are close to railroad transportation.

the jaws have been greatly enlarged and provided with a steel net. The trap is set and baited in the usual way. When an animal touches the bait plate, the trap is sprung, and the animal is held securely, but without injury, in the steel net.

8357
REMOVE SULPHUR FROM COKE BY USING HYDROGEN GAS

The Bureau of Mines has recently obtained rather promising results in its experiments in the purification of coke by removing the sulphur. Experiments on a small scale have been conducted by passing hydrogen gas through the coking mass while it is under heat, the sulphur being removed by combining with the hydrogen to form sulphuretted-hydrogen gas. Several important questions remain to be answered before the process can be considered a commercial success.

7954
HUMANE STEEL TRAP HOLDS ANIMAL IN NET

To meet the demand for a trap which would catch and hold small animals securely, yet in a humane manner, a new trap has been developed. The trap is an adaptation of the familiar steel-jaw trap, but

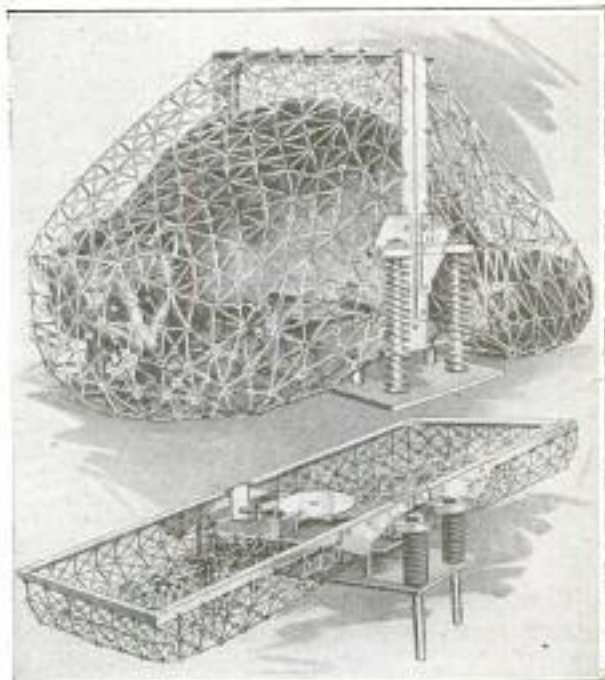

Steel Trap with Jaws Enlarged to Pass Completely over Small Animals, Holds Captured Quarry Securely in Steel Net

E. H. Cone 8 Park St. 7 U. S. Shipping

Inventor Mrs. N. E. Arrone
 25 Steele Block, Winnipeg, Canada

Copyrighted material

BULL'S-EYE DANGER SIGNAL FOR DAY OR NIGHT USE

A day-and-night danger signal, of novel construction, for protection of autoists against street obstructions or pitfalls, has

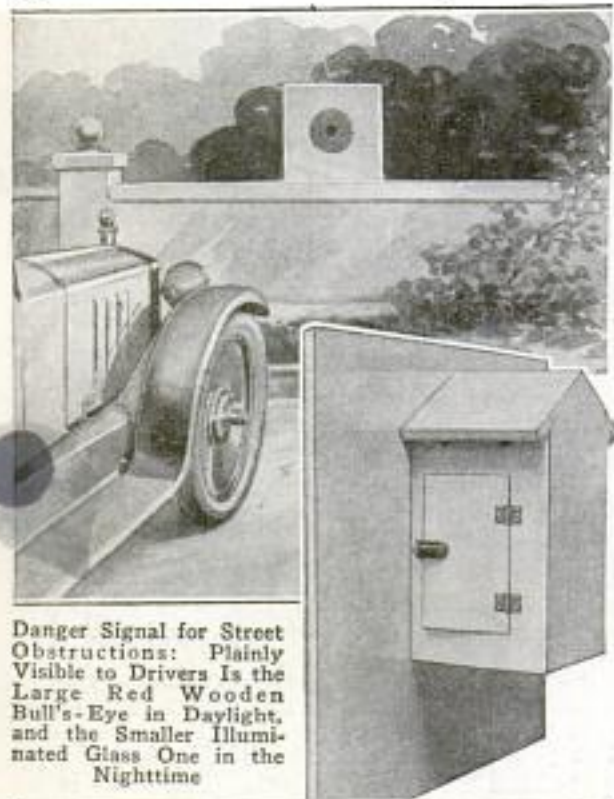

Danger Signal for Street Obstructions: Plainly Visible to Drivers Is the Large Red Wooden Bull's-Eye in Daylight, and the Smaller Illuminated Glass One in the Nighttime

been introduced in Philadelphia, and has met with general approbation. It can be made of either wood or metal, and may be of different sizes. The one in actual use is composed of a $\frac{7}{8}$ -in. white-pine board, 4 ft. square, which on the display side is painted white, with a bright-red bull's-eye at its center, 12 in. in diameter. This is the daylight signal. In its center is a smaller glass bull's-eye, $3\frac{1}{2}$ in. in diameter, also bright red, which is illuminated at night with either an oil or electric lamp. This is contained in a small weatherproof housing on the back of the board, with ventilating holes and a brass-hinged door that is kept locked with a hasp and padlock. The signal is set up on a level with automobile headlights, and immediately attracts the attention of a driver.

FARM TRACTORS DRIVE PLANT MADE POWERLESS BY DROUGHT

That tractors may be used as stationary power plants was again shown in Europe recently. A large automotive-vehicle plant, ordinarily using electric power generated by water power from the Alps, was threatened with an entire absence of

power due to the lack of water at the power plant, caused in turn by the drought. As an emergency measure 150 of the factory's 25-35-hp. tractors were used to furnish power by belting them to the line shaft of the factory, and it is said that they proved entirely satisfactory.

8403

MOTION PICTURES TO SHOW ITALIAN ART TREASURES

Assurance is given that patrons of the moving-picture theaters are to see Italian art treasures which have heretofore been accessible to only a favored few. A Milanese company has been formed, and has already obtained permission to use as background for its performances some of the celebrated palaces of Venice showing art treasures unknown to a majority of even the traveled public.

7816

MACHINE CLEANS SMALL PARTS WITH SAFETY AND DISPATCH

Any small part connected with machine or repair-shop work can be cleaned with convenience and safety in a machine recently placed on the market. On top of a cast-iron pedestal, about waist-high, is a bowl 13 in. in diameter and 12 in. deep, with a fine-mesh brass screen about 5 in. from its bottom. On the bowl is a lid, which, when raised, allows a handle connected with it to operate a plunger pump, on the outside of the bowl and integral with it. Gasoline, or any other cleaning liquid, is poured into the bowl, and the pump forces a stream of this fluid into the center of the bowl. The part being cleaned is held in this stream, which washes off all dirt, and deposits it on the screen.



Black & Shecker
Baltimore, Md.

The Engineer 1/28/22

Cml. Jno. H. McClarren, 1026 Walnut St. Philadelphia

8399

General Use

8250 Milwaukee Snow Conveyor Co
 1348 Forest Home Ave.
 POPULAR MECHANICS Milwaukee, Wis 585

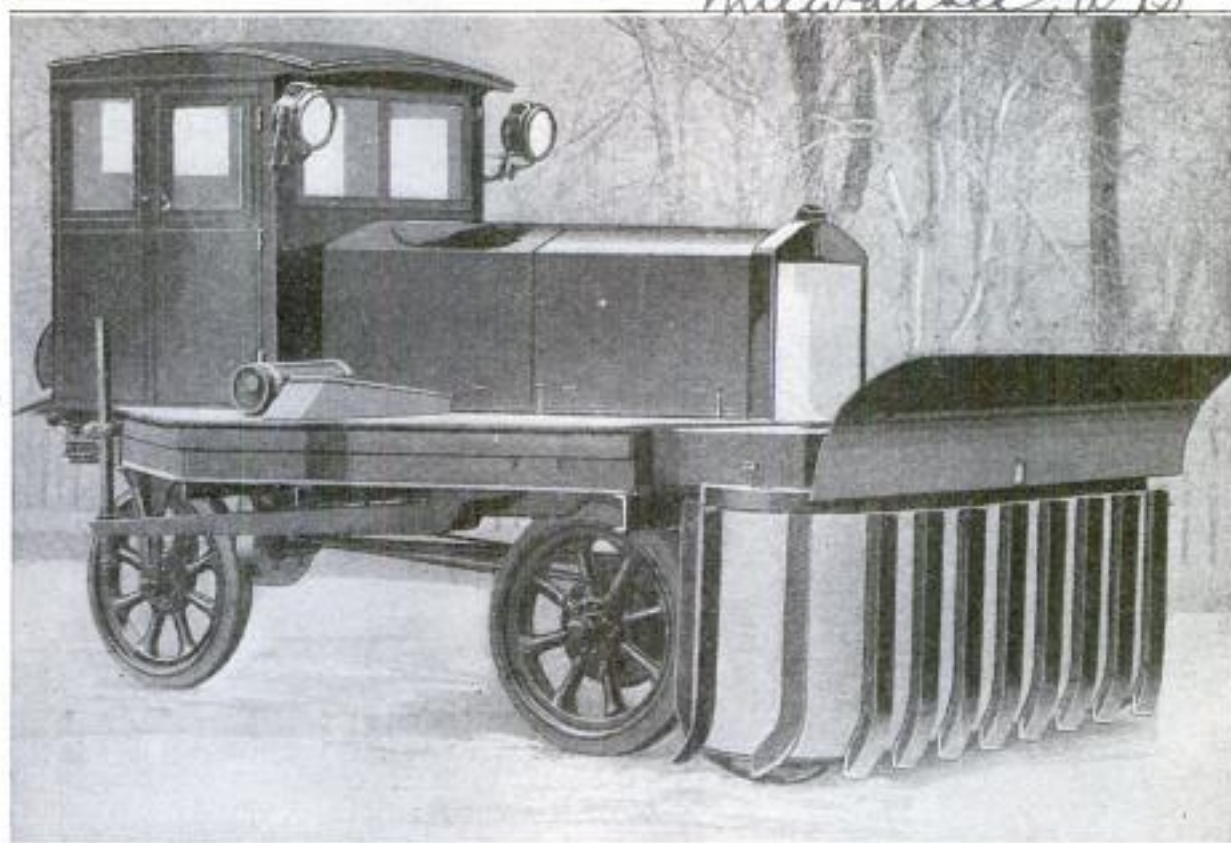

The Mechanical Snow Shoveler is Driven by the Front Wheels and Steered by the Single Rear Wheel. The Vertical Conveyor at the Front Cuts into the Snow and Throws It to the Side of the Road. The Speed of the Conveyor Is Variable, All Operations being Controlled by the Driver

**MECHANICAL SNOW SHOVELER
 KEEPS HIGHWAYS OPEN**

One of the problems faced by highway commissioners in northern countries is that of keeping the roads open for automobile traffic in the winter. For this purpose a mechanical snow shoveler has been developed. A three-wheeled auto truck, driven by the front wheels and steered by the single rear wheel, carries a conveyor across the front. This conveyor operates in a vertical plane and carries angle-iron scoops which cut into the snow and throw it to one side of the road as the truck is driven forward. The speed of the conveyor is controlled by the driver.

**TELEPHONE CALLS COUNTED
 BY METER IN THE HOME**

Counting outgoing telephone calls has heretofore been accomplished by the operating companies, but this practice has been reversed by the use of a meter which is installed in the home and allows the subscriber to do the registering. The meter, which is small and can be attached, or placed adjacent, to the telephone, has an open dial so that the user can see it register. To make a call, the subscriber must first press a button and record the

message, after which the mechanism is locked until the call is completed, when it is returned to normal by the called party hanging up his receiver. In the

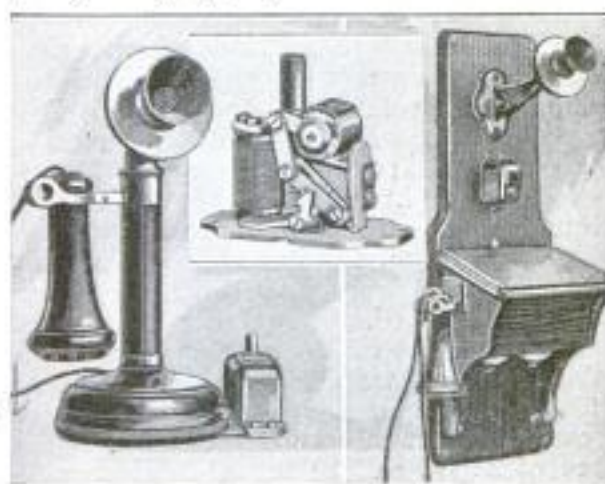

Left: Meter Fitted to Base of Common Desk-Type Phone. Center: Meter with Cover Removed Showing Mechanism. Right: Meter on Wall-Type Phone

event of a wrong number being given, the subscriber can again signal central without operating the meter, by raising and lowering the receiver hook.

(Names and addresses of manufacturers of articles described in this magazine will be furnished free by our Bureau of Information.

*measured service meter Co.
 Uniontown, Pa.*

Encl. Baggs + Hardy
486 Union League Bld.

586

POPULAR MECHANICS

Los Angeles, Calif

8057

TUNNEL BORE ENLARGED WITHOUT STOPPING TRAFFIC

By the use of out-of-the-ordinary methods engineers charged with the difficult task of enlarging the bore of a series of

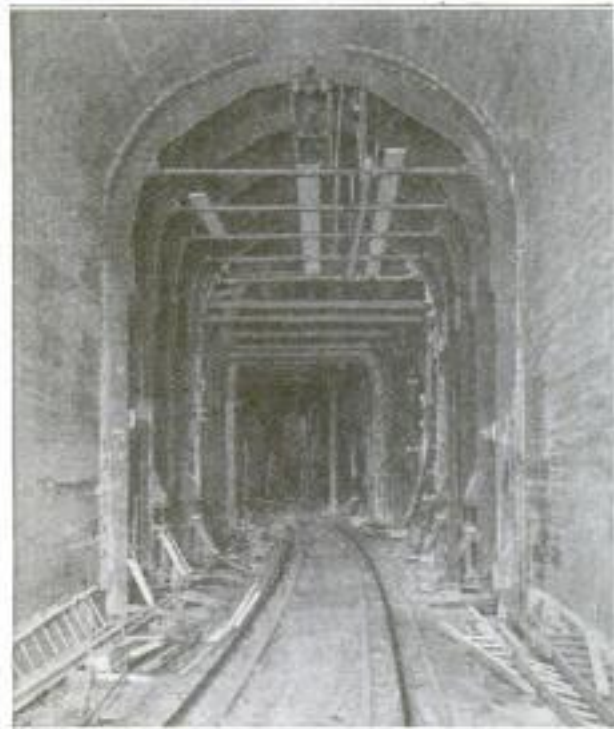

Interior of Tunnel with One of Steel-Ribbed Forms in Place: They Run on Rails near the Sides of the Tunnel, and Have Joints at the Top Allowing for Expansion and Contraction of the Form

much-used railway tunnels were able to carry on their work without interfering with the movement of trains, which in some cases totaled 67 per day. The stretch of railroad where the unusual engineering feat was performed comprises 48 miles of right of way in the Tehachapi Mountains in southern California. Built many years ago, the tunnels in question were of small bore and for the greater part timber-lined.

The problem of the engineers was to enlarge these passageways to a minimum width of 16 ft. on a tangent, and 17 ft. on a curve, and a minimum overhead clearance of 22 ft., and to line the bores with reinforced concrete, all work to be done without any interruption of traffic. This situation was met by the construction of steel forms, 20 ft. in length, which were mounted on tracks of their own, so that they could be moved along as fast as the concrete had set. Instead of delivering the concrete by any of the more usual means, it was decided to deliver the concrete pneumatically, the material being blown through a pipe by machinery located at a convenient point outside the tunnel.

The forms devised for this work, in addition to being mounted on wheels which ran on special rails laid close to the sides of the tunnel, were so constructed that they could be expanded and contracted by means of threaded reinforcing rods located just beneath the arch. A joint at the apex of the arch allowed for the expansion or contraction caused by lengthening or shortening the reinforcing rods. Approximately 6,000 ft. of tunnel were lined in this manner at a cost of \$1,000,000. It was estimated that, expensive as the work was, it was cheaper than if done in the ordinary way, which not only would have seriously delayed traffic but would also have increased the danger of fires and cave-ins.

8404

GRAIN-ELEVATOR SCREENINGS FOR FATTENING SHEEP

An experiment which may prove of great value to stockmen is being tried at Fort William, Ont., where a rancher is wintering a flock of 7,000 sheep. They are being fed on screenings from the grain elevators and are reported as being healthy and thriving. Each sheep consumes three pounds of screenings per day.

W. J. James 2/9/22 P27

BRONZE MEDAL COMMEMORATES TRIP OF JAPANESE PRINCE

8273

During 1921 the Japanese crown prince made a trip abroad, and upon his return to Japan a medal was struck off at the Osaka mint commemorating the event. The face of the medal shows a portrait of the prince, and the inscription reads: "In commemoration of the round trip abroad of His Highness the Prince." The reverse side shows a view of the battleship on which the trip was made and the inscrip-



This Bronze Medal, About Two and One-Half Inches in Diameter, was Struck Off at the Osaka Mint to Commemorate the Trip Abroad Which was Taken by the Japanese Crown Prince Last Year

tion, "March 3rd the 10th year of Taisho." This enumeration corresponds to our year 1921.

Yuzo Araki, Suffield School, Suffield, Conn.

8345 Accident

A THEATER ONE MOMENT, A CATACOMB THE NEXT



View of the Inside of the Knickerbocker Theater, Washington, District of Columbia, Taken Shortly after the Collapse of the Roof That in a Few Moments Changed the Building from a Theater into a Catacomb: Nearly 100 Dead Bodies Lay beneath the Fallen Roof, and Many More Injured. When This Picture was Taken, the Rescue Work, Carried Out by Firemen, Police, and Marines, was Well Advanced



Close-Up of Part of the Collapsed Roof of the Theater, Looking from Above: Amongst the Débris in the Center of the Picture Was the Body of One of the Hundreds of Victims of the Catastrophe. One Hand is Seen Plainly Protruding from the Wreckage

4852
 588
 8256

William M. Crane Co. d.w. Saggart
 16 W. 32 nd St. 4852 Astor,

POPULAR MECHANICS
 New York City. Bellingham Wash.

GAS RANGE HAS NOVEL BURNER AND CAST-IRON RANGE TOP

CONCRETE WHARF WALLS COST LITTLE MORE THAN TIMBER

A gas range of recent design combines the efficiency of the gas stove with some

In wharf walls fireproof construction is as desirable, though not nearly as common,

Ant. John A. Schalek, 813 Union Road
 Ptdg. Pittsburg, Pa.

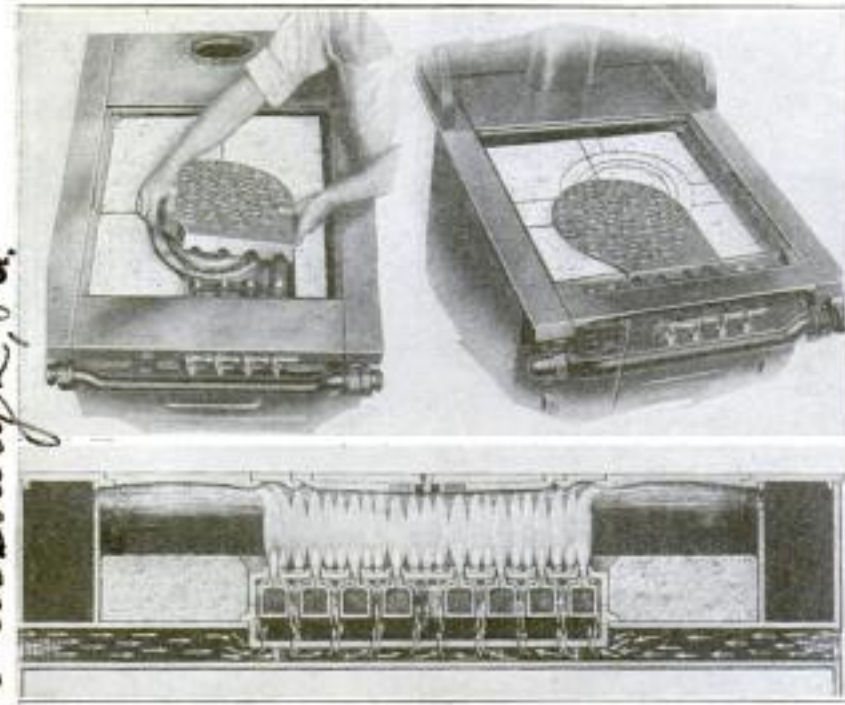

Upper Left: The Burner may be Easily Removed for Cleaning. Upper Right: The Range Top has been Removed, but Its Position is Shown by the Light Lines. Below: Extra Air is Drawn In around the Circular Burners

of the convenient features of the old-fashioned coal range. In preparing a large dinner where many utensils are used, it is often desirable to allow some of the viands to simmer slowly while others cook rapidly. The heating element of the new range consists of four circular burners, placed one inside the other and all separately controlled. There is also a cast-iron range top having circular openings in which utensils may be placed for quick heating, while the entire top of the range is available for cooking at slower rates.

as in any other industrial structure. Existing types of concrete and masonry construction are so costly that they have been largely prohibitive. To remedy this condition, a type of fireproof construction has been developed on the Pacific coast that is said only slightly to exceed the cost of timber structures. The wharf is supported by reinforced concrete columns built inside of temporary steel cylinders, with belled bases, resting a little below the ground, on top of timber piling. These columns support precast concrete bents, at about 18-ft. centers, of a trussed rectangular form, stepped down from about the level of high tide to about the level of

the column tops. The bents in their turn support precast reinforced concrete L-shaped troughs, that carry the selected filling, on top of which is the floor of the wharf. Back of the columns are square concrete piles, at about 6-ft. centers, which support the rear end of the concrete bents. The structure is braced along its whole length by a rubble mound with its summit near the top of the concrete piles.

d.w. Saggart Astor, 595 Hudson St.
 Portland, Oregon.

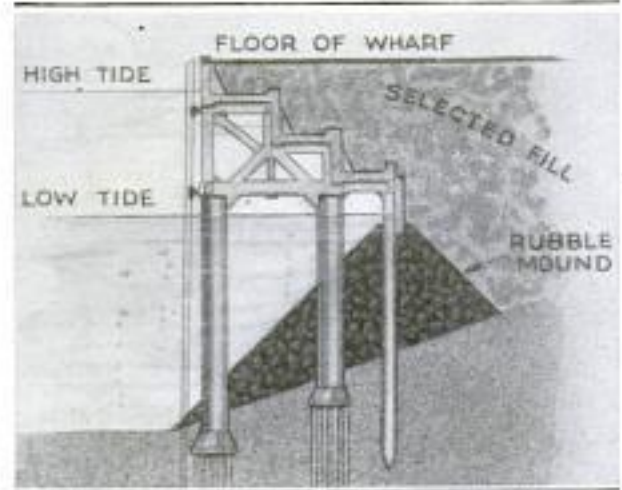

Stepped-Down Type of Concrete Wharf That Is Proof against Fire, Insects, or Brine: The Methods and Materials Used in This Construction are Clearly Shown

8344 **THEORY OF RELATIVITY TO BE FURTHER TESTED**

Professor Einstein's contention that rays of light are bent when passing the sun's gravitational field is to be further tested by observations of the next eclipse of the sun. This work will be done at Christmas Island, near Java, in the Indian Ocean, by the assistant to the British royal astronomer of Greenwich, and also by an American expedition, sent by the University of California, which will have headquarters at Ninety-Mile Beach on the northwest coast of Australia, where the total eclipse will last the longest.

new York World 1/28/22

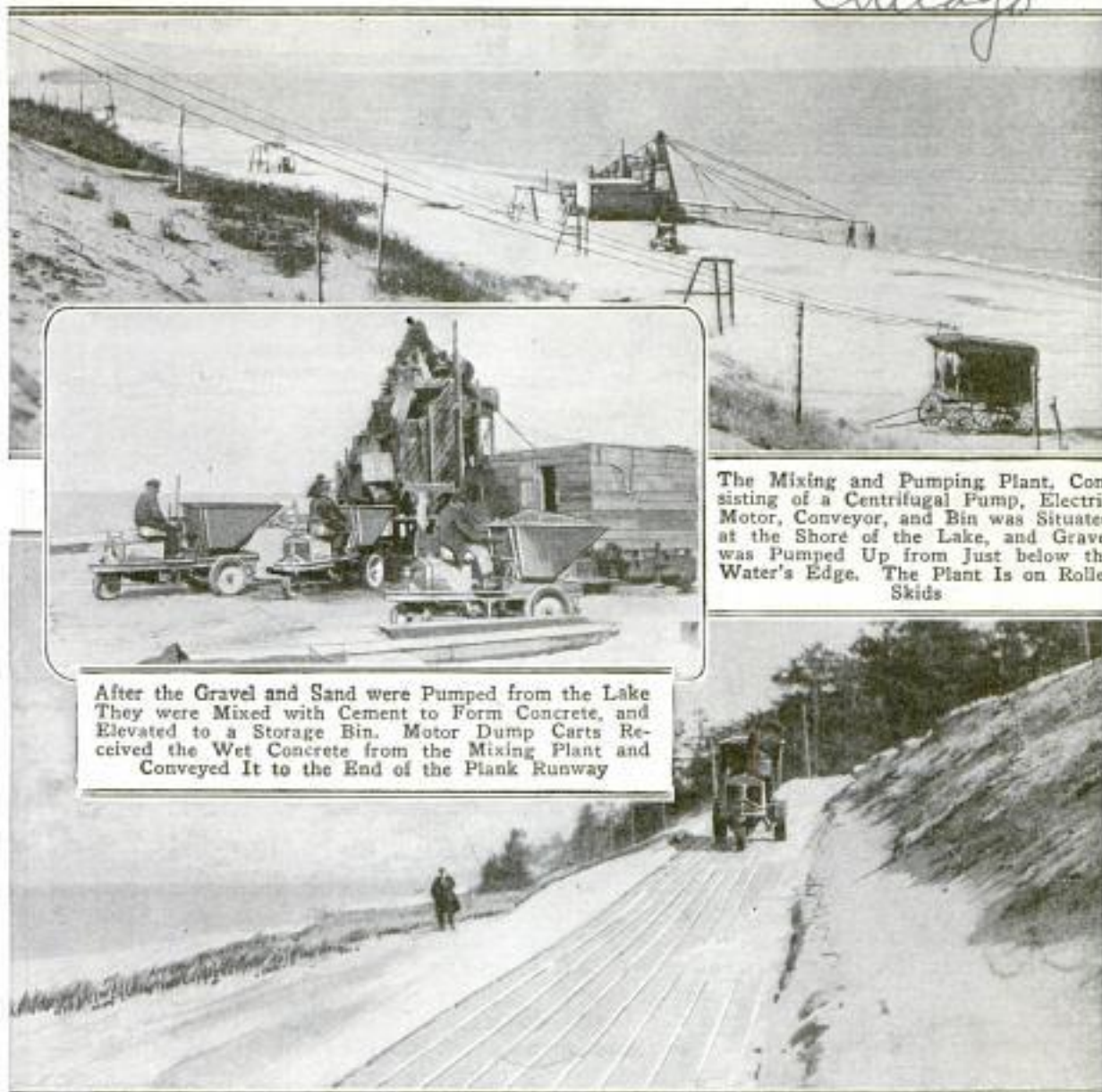

The Mixing and Pumping Plant, Consisting of a Centrifugal Pump, Electric Motor, Conveyor, and Bin was Situated at the Shore of the Lake, and Gravel was Pumped Up from just below the Water's Edge. The Plant is on Roller Skids

After the Gravel and Sand were Pumped from the Lake They were Mixed with Cement to Form Concrete, and Elevated to a Storage Bin. Motor Dump Carts Received the Wet Concrete from the Mixing Plant and Conveyed It to the End of the Plank Runway

The Sectional Planking Made It Possible for the Motor Dump Carts to Haul the Wet Concrete from the Mixing Plant to the Point Where the Road was being Laid. As the Road was Completed, the Duckboards were Removed and Taken Back to the Mixing Plant

ROAD BUILT ON SANDY SHORE USING SECTIONAL PLANKING

By the use of sectional planking it was possible to build a stretch of reinforced-concrete highway along the shore of Lake Michigan, east of Michigan City, on what is known as the Long Beach Road extension. Starting at the central mixing plant, the contractor put down 2,000 ft. of sectional planking, made up in sections, 5 ft. wide and 10 ft. long, 2 by 6-in. boards being used for this purpose. He then had the wet concrete carted from the mixing plant to the end of the walk, and as the road was laid, the duckboard was taken up and conveyed back to the mixing plant. When he had worked back to the mixing plant, he used the same planking,

extending it 2,000 ft. in the opposite direction and working back in the same manner. When this strip was finished, the planking was extended 2,000 ft. from the end of the first completed section, and so on. The completed highway is nearly two miles long. A strip of gravel was fortunately found right along the water's edge. A centrifugal pump operated by a 50-hp. motor, with current taken from a near-by power line, was used to suck up this gravel. The pumping plant was fitted with hoppers and mounted on roller skids so that it could be moved.

According to present plans, construction work will start this year on a 10,000,000-bu. grain elevator at Montreal, Canada.

and William C. Aybell
Trinidad, Colo.

Victor Talking
Machine Co
Camden, N. J.

590

Accessories

POPULAR MECHANICS

Camden, N. J.

8076 **LOCOMOTIVE THROTTLE LEVER
WITH NEW SAFETY CATCH**

It has always been possible with standard locomotive equipment for the catch on the throttle lever to become so worn that the throttle is liable to be thrown open after it has been closed and ap-



parently latched. Locomotives, at a standstill and unmanned, have been known to start running in this manner, with resulting danger to traffic. There is, therefore, a promising field for a safer form of throttle-lever catch, such as one that has a double rack bar with the teeth on the upper bar set at an angle opposite to those on the

lower bar, thus making it equally impossible for the lever to move backward or forward. In the space between the bars is a double dog, pivoted on the lever, with teeth at either end that engage respectively the teeth on the upper and

the lower bars. This dog is controlled by a lift rod, but without this positive control it cannot possibly become disengaged from the bars.

8360 **TEACH RADIOTELEGRAPH CODE
WITH PHONOGRAPH RECORDS**

As a result of the widespread interest in wireless telephony, one manufacturer has brought out a set of six double-faced records for teaching the telegraph code. Many people have purchased small receiving sets for listening to the radiotelephone concerts and news service, and after the telephone broadcasting stopped for the evening have tuned in and heard the familiar "buzz-buzz" of the wireless-telegraph messages being sent. Curious to know the meaning of the sounds, they have cast about for some means of learning the code. This fact led to the development of the code phonograph records.

8304 **RESERVOIR WALL BLOWS OUT
TEARING HUGE GAP**

For some unknown reason the wall of a reservoir in California gave way, sending a flood of water down the valley. The walls of the reservoir are about 16 ft. wide at the top and approximately twice as wide at the bottom, and are formed of earth faced with concrete. The water rushing out tore a huge gap in the wall and cut a considerable gully in the downhill slope, but left the top of the wall in place, forming a bridge over the gap. The location of the reservoir is being withheld until the cause of the break has been investigated.

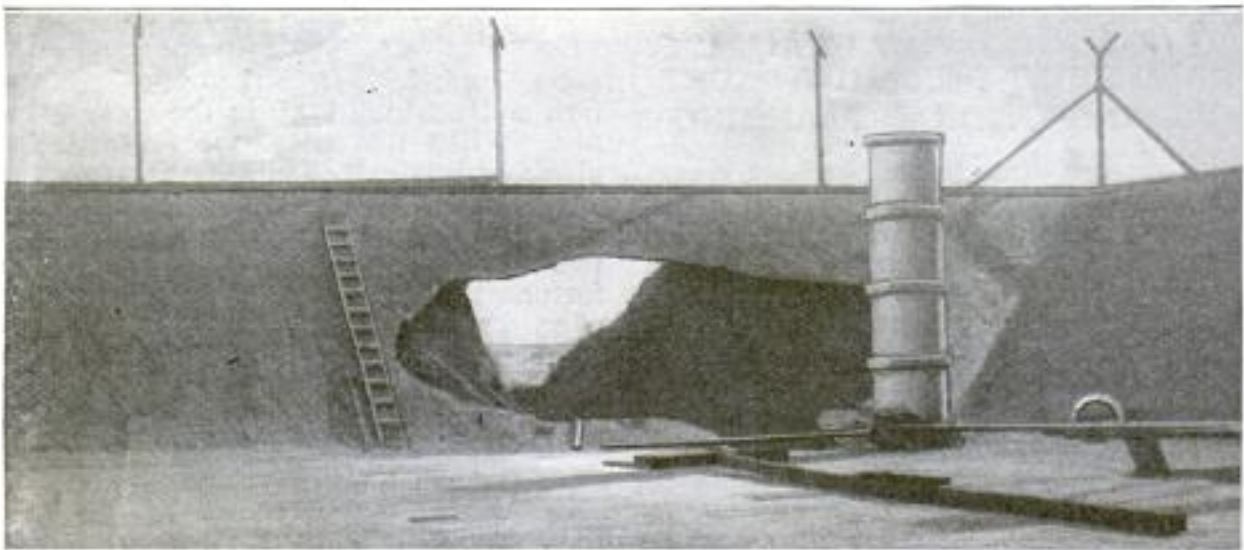

The Wall of This Storage Reservoir Gave Way, Sending a Flood of Water down the Valley. The Concrete Facing near the Top of the Wall Withstood the Rush of Water, Forming a Bridge over the Gap.

The Wall Consists of an Earth Fill Protected by a Concrete Facing

and George H. Paul, 900 Ellsworth Bldg
Chicago

Hyde Park, Mass

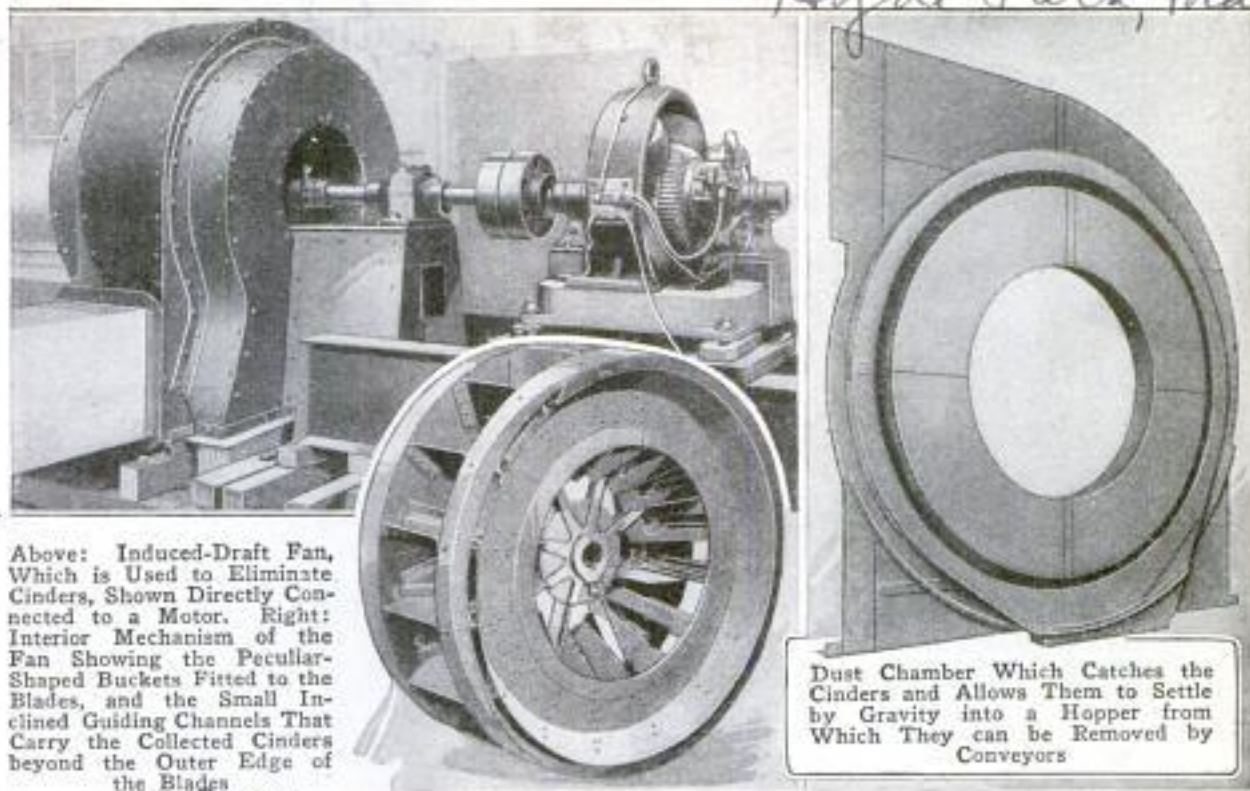

Above: Induced-Draft Fan, Which is Used to Eliminate Cinders, Shown Directly Connected to a Motor. Right: Interior Mechanism of the Fan Showing the Peculiar-Shaped Buckets Fitted to the Blades, and the Small Inclined Guiding Channels That Carry the Collected Cinders beyond the Outer Edge of the Blades

Dust Chamber Which Catches the Cinders and Allows Them to Settle by Gravity into a Hopper from Which They can be Removed by Conveyors

INDUCED-DRAFT FAN AIDS IN ELIMINATING CINDERS

The construction of an induced-draft fan which also serves to separate the cinders from the flue gases, has been accomplished by an eastern manufacturing company, and several of the type developed are now in use in different cities. Buckets of a peculiar design are placed upon the blades of an ordinary fan in such a manner that they catch the cinders in the rush of air from the boilers. By means of small inclined guiding channels, the cinders are then carried beyond the outer edge of the blades, into a stationary cinder chamber, where the contents of the channels are emptied by gravity. At the base of this chamber is a hopper into which the cinders fall, and from which they can be removed periodically, or continuously by means of a screw or other conveyor.

tion, a telescope for sighting, so that the subject can always be seen clearly. This apparatus demonstrated its worth during the recent experiments at Chesapeake Bay when former German warships were bombed, pictures being obtained that would have been impossible to secure with

SHELL BURSTS PHOTOGRAPHED WITH LONG-RANGE CAMERA

Producing motion-pictures of bursting shells has been rendered safe and accurate by the development of a long-distance camera, which has a range of from 300 to 20,000 yd. The camera is fitted with a common-type box for the film reels, which are operated by a small motor, a lens of 27½-in. focal length, and in addi-



COPYRIGHT, UNDERWOOD & UNDERWOOD
Long-Range Camera Set Up for Action on the Deck of a Ship: Insert Shows Photographer Using the Sighting Telescope to Get the Proper Range for the Camera
the ordinary camera, unless the operator had exposed himself to the constant danger of being hit by the flying fragments of the high-explosive bombs.

Pathe Motion Picture
Carl Zeiss Lens

FIRST CITY RADIUM CLINIC FOR RICH AND POOR

By DOUGLAS C. MINER

4244 Chestnut Philadelphia, Pa.

8138

A MUNICIPAL radium clinic, the first in America, was recently opened in Philadelphia. The city purchased two grams of the precious element for \$154,000, a bargain price, for this quan-

precaution has been taken to protect the substance that is about 130,000 times as valuable as gold.

While physicians emphasize the fact that radium emanations cannot cure every case of cancer, yet they believe in its curative properties generally. The radium, about as much as two peas, is dissolved in water and hydrochloric acid, the result being an amber-colored fluid. The gas emanation resulting from its disintegration is pumped through a glass tube from which the air has been withdrawn. A series of bulbs filled with mercury prevents air from getting back in. Tiny quantities of the gas gradually accumulate in the tube after the mercury is withdrawn from the traps. The emanation, purified by the tube being run over a red-hot copper bar, is forced into a glass tube the size of a hair. This is sealed and divided into tiny fractions which are also fused and sealed.

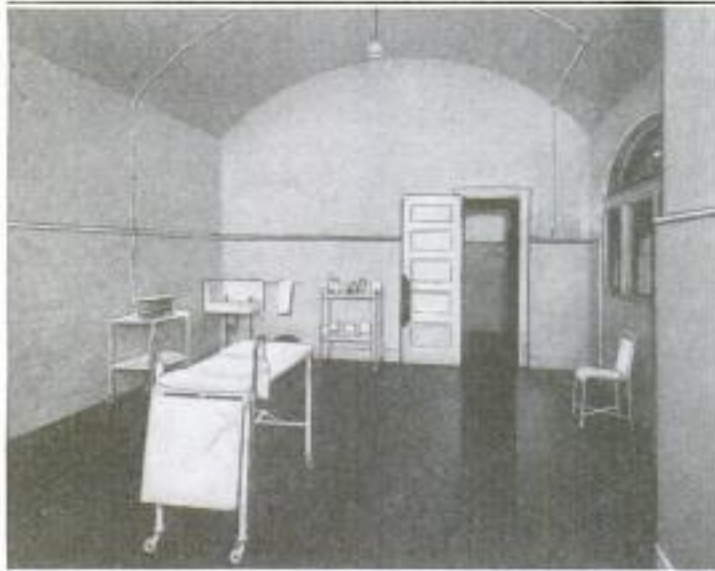

Ward in the Philadelphia General Hospital Reserved and Equipped by the Municipality for the Treatment of Cancer with Radium: Patients Who cannot Afford to Pay are Treated Free of Charge

tity would ordinarily cost \$200,000. The commercial possibilities of this substance when used for treatment of cancer are seen when it is stated that the emanation obtained is usually sold at \$13 per "millecurie," the standard of measurement. The emanation mentioned is a heavy gas, and is the first disintegration product of the original radium, whose power of yielding the emanation is estimated to last for over 1,000 years. While many radiologists use minute particles of the radium itself, properly inclosed, for application to cancerous areas, it is, of course, its emanation that has the curative effect, and in this hospital the emanation is collected and sealed, in millecurie doses, in tiny silver tubes. As a first supply, a quantity of 250 millecuries, salable commercially at \$3,250, was collected.

Treatment will be free in the city hospital, however, to those patients who cannot afford to pay. The radium is contained in a lead-lined, hermetically sealed safe in the laboratory of the hospital. The room is protected with a fine network of burglar-alarm wires, and every

Each section is placed in a silver container and put in a jewel box. The silver tube is applied to the cancer, the emanation burning out the diseased tissues. Great care is taken to protect the workers, the tubes being handled with forceps, and the persons handling the radium re-

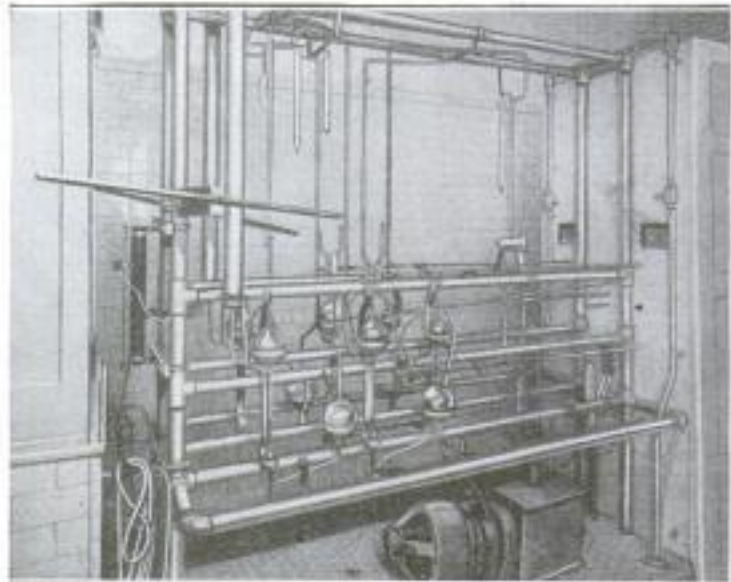

Radium Laboratory in the Hospital: At Center Are the Bulbs, Filled with Mercury, That Draw the Gas from the Radium Stored in the Lead-Lined, Hermetically Sealed Safe at Left

maintaining behind lead-lined cast-iron blocks designed to protect them. The apparatus



Left: Historic Old Elm After the City Forester had Scraped Out the Decayed Matter Which Extended to a Height of 20 Feet. Center: Elm in the Municipal Park, Showing the Opposite Side of the Tree. Right: Elm after being Filled with an Eight-Ton Mixture of Concrete and Scrap Iron

to measure the strength of the emanation is the finest ever devised, and cost \$10,000. Fifteen to twenty persons are examined each day, by a staff of the best physicians in the city.

834
REMOTE WORKERS' COLONY HAS MODERN CONVENIENCES

In building a new water reservoir for the city of Bradford, Eng., in a remote section of the Yorkshire moors, the necessary motive power is derived from a hydroelectric plant whose wheels are turned by water conveyed in a pipeline from an existing reservoir. In addition, this plant will furnish power for the miniature village erected to house the workmen, making possible a motion-picture theater, and assuring the inhabitants of the colony the most modern heating, cooking, and lighting facilities.

830
HISTORIC OLD ELM SAVED BY CONCRETE FILLING

Interesting tales would be related, if an elm tree in Wichita, Kan., could but voice an account of the happenings under its spreading boughs during the period of 140 years it has been in existence. Having given shade to wild buffalo and Indians, two generations before the white man appeared, it has successfully withstood the elements despite great handicaps of recent time, and now graces a municipal park in that city. Thirty years ago, boys built a fire beside the tree, and the flames scarred the trunk, with the re-

sult that decay set in and continued until lately, when the heart was rotted out to a height of 20 ft. Fearing that the historic landmark might be blown down, the city forester scraped out all the decayed wood, painted the walls of the cavity with creosote, and then filled the hole with concrete and scrap iron. Eight tons of this mixture were used, and experts who have examined the tree since the operation, declare that its life has been prolonged for several decades.

8230
SAFETY LIGHT-SIGNAL CODE FOR USE ON AUTOMOBILES

A copyrighted signal code works in connection with a patented equipment that is mounted on the left front fender of an automobile, and is in the shape of a hollow cross with duplicate faces at front and rear. The cross is divided into five compartments with an electric light in each one. These are controlled by a switch



with two levers, which can be manipulated so as to display any single light, or combination of lights. A round light in the center of the cross shows red in rear, and green in front, and is permanent. The four square lights in the arms of the cross are readable at 600 ft. The meaning of the lights is according to a code that has to be known by other drivers.

Biggs Safety Light Co.
 Marshall, Texas.

Electrical World 1/28/22

Safety Utility Economy Co
R. 2074, 89 Beach St

594
8175

POPULAR MECHANICS
Boston Mass.

**ELECTRIC STEAM BOILER
ECONOMICALLY OPERATED**

To satisfy the export trade demands of countries in which the price of kerosene is prohibitive, and in which there is



no gas available, but where the hydroelectric power is cheap, an American concern has produced a small electrically heated steam boiler. The boiler satisfies all the insurance requirements, having a safety-valve, steam gauge, water glass, fusible

plug, petcock for drainage, and a valve connection for outlet, with a plug in the bottom for the return. The heating units are so constructed that, with slight changes in the wiring, either 110 or 220-volt current can be used, and by means of a three-point switch, or rheostat, the power range is regulated from 300 to 1,200 watts. It is claimed that after the maximum pressure of 30 lb. is obtained by using a 1,200-watt current, this pres-

sure can be constantly maintained with the power consumption reduced to 450 watts, thus making the boiler economical to operate.

**NEWLY MOWN HAY DRIED
BY ELECTRICITY**

Swiss farmers have a method of preserving newly mown hay by storing it between two sheets of metal in silos of about 400-cu.-ft. capacity. The sheets are connected in an electrical circuit, so that an alternating current of from 200 to 500 volts passes through and dries the grass between them, and also kills any microbes present. From 130 to 200 kilowatt-hours are sufficient to treat five tons of hay, which is said to contain twice the usual amount of nutriment.

8402

Electrical Review 1/20
**HAND-PROPELLED BOAT
FOR USE OF BATHERS**

Accessories

As a pleasure craft for use of bathers, an eastern man has invented a boat having an open well in the center, in which there is provided a folding seat on which the user rides. The boat is propelled and steered by paddle wheels on the sides, the wheels being turned by hand cranks in the well of the boat. The body is divided into water-tight compartments, which make it nonsinkable. Handles are provided on the sides, so that a person standing in the well can carry the boat easily when desirable.

8220

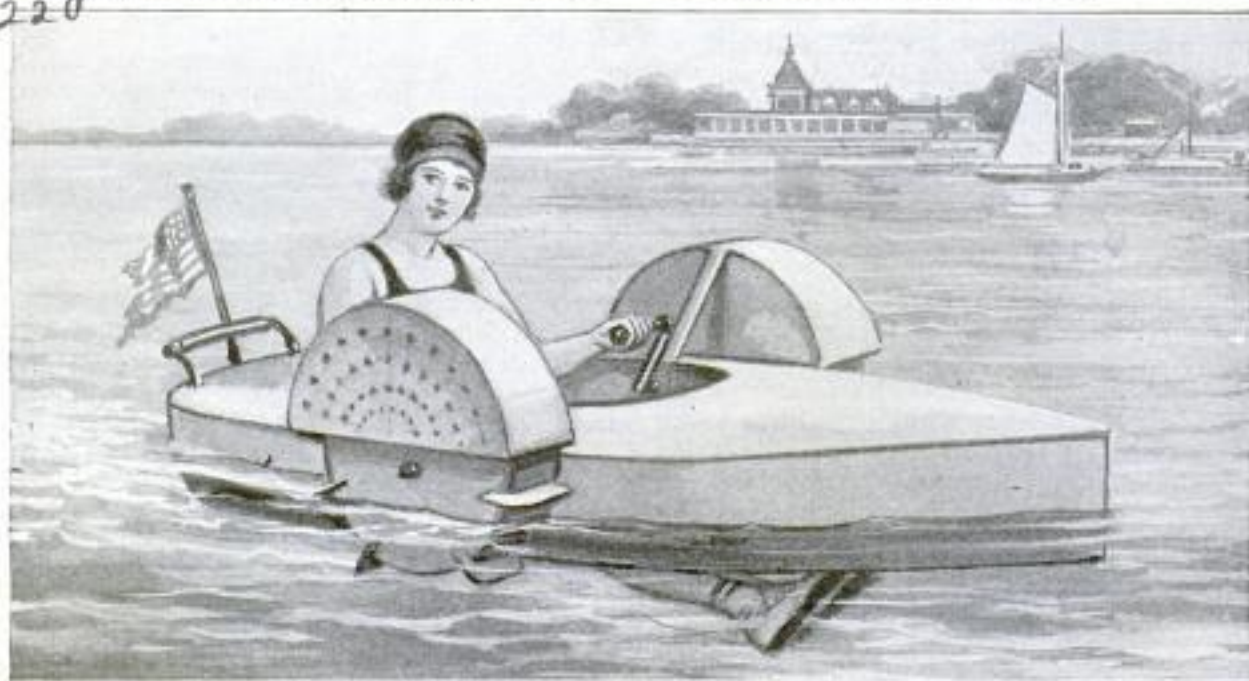

Sitting Comfortably in the Open Well, the Bather Propels the Boat by Turning the Paddle Wheels with a Crank. The Boat is Light Enough to be Carried through Shallow Water, across Sand Bars or on Land, by Means of Handles Provided for the Purpose

*inventor, John Sebots, 553 6th Ave.
Brooklyn, N.Y.*

Copyrighted material

POISON-GAS CHAMBERS DISINFECT FREIGHT

BY S. R. WINTERS

902 District
National Board

HAVING a capacity of disinfecting 250 railway cars a day, four fumigation houses located at several stations on the Texas-Mexico border represent the largest installation of its kind in the world. The buildings, erected at a cost of nearly \$85,000, are large enough to admit entire trainloads of products consigned from Mexico to the United States. Cyanide, a poisonous gas, is used for the fumigation as a safeguard against the importation of the pink bollworm.

The buildings are designed to permit a locomotive to convey its train of cars directly into the gas chambers, the doors then swinging closed. The fumigation quarters are divided into air-tight compartments. One of the largest houses, located at El Paso, has three five-car units, each of which measures 225 ft. in length, 12 ft. in width, and 16½ ft. in height. One of these units is subdivided into two two-car rooms and one one-car room by sliding doors, operating in grooves on all four sides. This arrangement makes possible the disinfection of one, two, three, four, or five cars in that sectional compartment.

The fumigation houses are operated by



Trainload of Cars from Mexico being Pushed into One of the Fumigating Houses on the Texas-Mexico Border for the Purpose of Disinfecting It as a Safeguard against Importation of the Pink Bollworm

the government, and manufacture their own gas. A room for this purpose is maintained in one corner of the building.

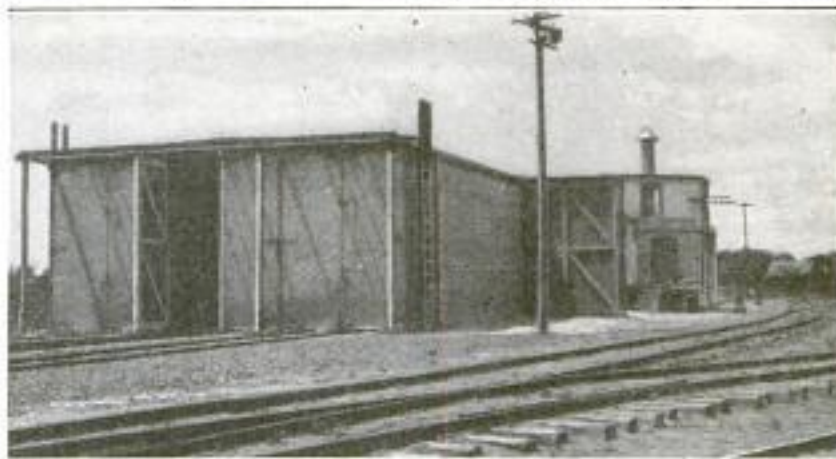

Fumigation House of 15-Car Capacity, at Laredo, Texas: It is Divided into Compartments, by Sliding Doors Operating in Grooves, So That They Are Gas-Tight. This Plant Has Three Gas Generators

The equipment consists of tanks for storing solutions of sodium cyanide and of acid; other tanks that measure the cyanide solution, acid, and water, so that

the correct proportion of each enters the gas generators, from which the gas is distributed by pipes to the various chambers of the plant. In a 15-car fumigation house there are three generators, one for each large compartment. From two of these a main leads to the undivided chambers, where they branch and convey gas to the extreme ends of the rooms. The third generator leads to the subdivided unit, and is provided with an outlet "manifold" that conveys two-fifths of the gas to each of the two-car compartments, and one-fifth to the single-car room.

In addition to these four fumigation stations, with a yearly capacity of 60,000 freight cars, gas supplies and quarters are maintained at Del Rio, for automobiles, wagons, buggies, and other vehicles, employed in the international trade. For this purpose, the Federal government purchased approximately \$100,000 worth of chemicals in 1920 for the manufacture of gas. The fumigation service is partly self-supporting; the railway company paying \$4 for each car treated. This form of protection is an

amplification of the inspection service still maintained to bar from import any suspected cotton seed or other product.

Federal Horticultural Board

Black St. Photo Service n.Y. Times
 520 S Broadway
 596 POPULAR MECHANICS 2/8/22
 Los Angeles, Calif 8385 P.3
 LARGEST REAL CHECK CASHED BY LOS ANGELES BANK
 7989 FIELD MUSEUM EXPEDITIONS OF SCIENTIFIC RESEARCH

When the proprietor of a Los Angeles, Calif., dance hall made a contribution to the local police-relief association, he

Six scientific expeditions will be under way in a short time and will be conducted under the auspices of the Field Museum

of Natural History, of Chicago. Four of these are going to South America, of which two will gather geological specimens in the area from Brazil to Patagonia, and the remaining two, one zoological and the other botanical, will study the animal and plant life of Peru. The Isthmus of Panama and Colombia, South America, are the points to be visited by the fifth expedition, which will undertake archaeological explorations, while the sixth will go to the Malay Peninsula, for ethnology research. All of these bodies will have left this country by June next, and expect to remain in their different



Treasurer of the Police-Relief Association Cashing What is Thought to Be the Largest Check Ever Drawn on Any Bank

presented them with the largest check ever honored by a bank. It was 6 ft. long and 2½ ft. wide. This "stunt" occurred on the occasion of the recent policemen's annual ball. The amount of the check was 25,000 pennies. Because of its size, the clearing house refused to accept it, but the bank on which it was drawn paid over the cash to the treasurer of the association.

fields for periods ranging from two to five years, during which time it is believed that much valuable data and many new specimens will be obtained for the benefit of science.

WESTCHESTER COUNTY PLANS WONDERFUL PARK SYSTEM

As a means of protecting from pollution New York's water supply obtained from the Croton watershed, a bill is to be introduced before the legislature to allow Westchester county to acquire the Mohansic Lake Reservation. If this is done, it is planned to form a system of parks connected by parkways extending from the Hudson River near Croton Point to Long Island Sound. This would form one of the most extensive pleasure grounds in the world and would become one of the most beautiful suburban colonies in America. Bathing beaches, artificial lakes, and zoological gardens are among the features of the prospective park system.

DOUBLE-GRIP SOCKET WRENCH FOR AUTOMOBILE USE

A double-grip socket wrench, specially adapted for tightening and loosening nuts

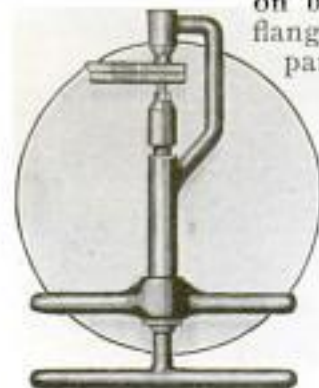

on bolts in an extended flange, common on many parts of an automobile, does the work of two separate wrenches. The upper socket has a U-shaped connection to a sleeve, through which passes the shank of the lower socket, which has a

handle like an ordinary T-wrench. On the sleeve is another handle, and the wrench is operated by grasping the two handles with both hands, drawing the handles together and forcing the sockets over the bolt head and nut.

Inventor, Warren H. Best, Williamsville, N.Y.

P.383
 n.Y. Times 2/6/22 P.15

8141 Comb. Joseph H. Wiley
 2800 1/2 W. Madison Ave
 POPULAR MECHANICS
 Madison, Ill.

597

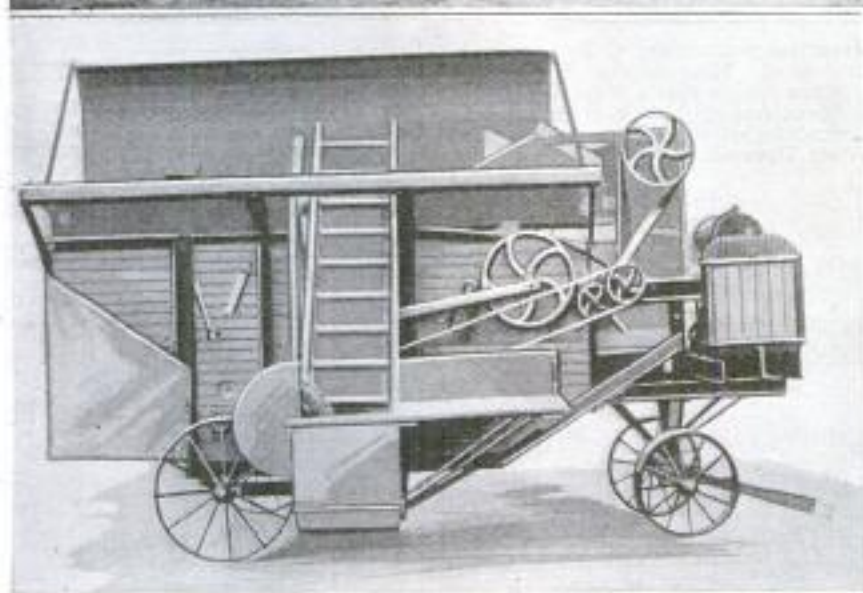
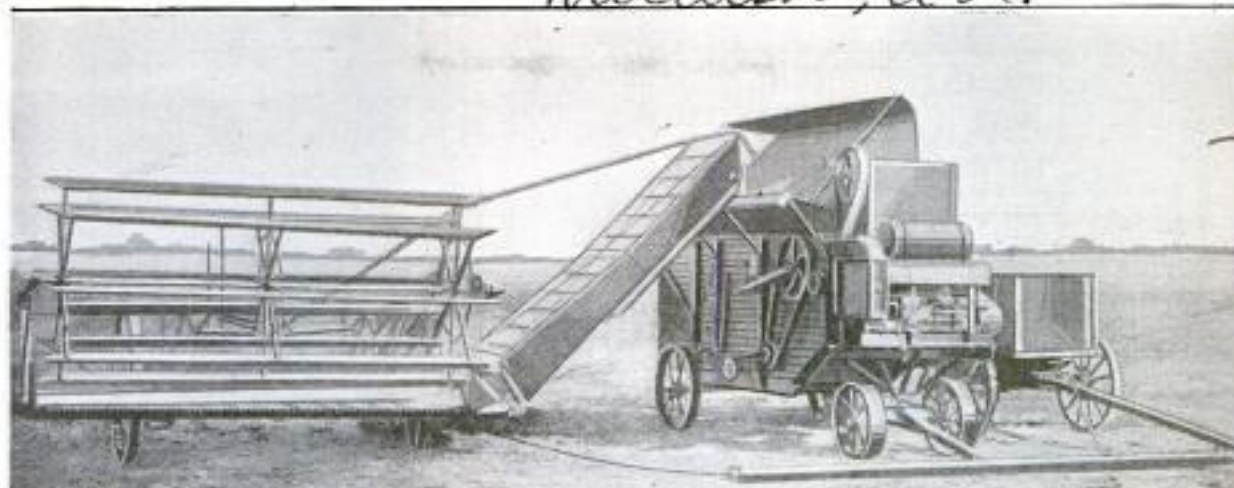

Above: Combined Header-Thresher Ready for Operation in the Wheat Field. Left: Side View of the Implement, Showing the Equipment for Sawing Off the Tops of the Various Sorghum Grains

ent sorghum grains, such as kaffir, maize, feterita, etc., and if desired, by removing only four bolts, the 14-28-hp. motor can be taken from the machine for use as a portable pumping engine, or for other power

8141
COMBINED HEADER-THRESHER IS ECONOMICAL MACHINE

Wheat raisers have been particularly benefited by an addition to the numerous combined header-threshers which are now on the market, and with which the farmer can successfully meet the varying problems presented in the uneven ripening of his crop. These implements are operated as ordinary headers at the beginning of the harvest, stacking the wheat in the usual manner so that it may thoroughly dry before being threshed, but when the main crop attains the correct, evenly ripened condition necessary for harvesting and threshing simultaneously, the old way is discarded and the header-thresher completes both operations at the same time. After the harvest is completed, the farmer can then use the same machine to return to, and thresh, the stacks that were cut at the outset of the work. On the implement just introduced, a saw attachment is provided for the efficient topping and handling of the differ-

purposes, thus adding to the versatility demonstrated with the use of these outfits.

8281
BASKET-BALL MASK PROTECTS EYES

Basket-ball players, who ordinarily wear glasses, need not lay them aside when playing the game, if a lately introduced guard is used. The safeguard is fashioned after the familiar mask worn by baseball catchers, and enables the contestant to engage in the roughest scrimmages without any hindering fear of an accident to his glasses, or injury to his eyes.



A. L. S. Palmer & Bros
 \$2.75 211 S. Dearborn Chicago

The New Co., Brown, & Co. New York City
 Atwell - 155 E. 4th Ave.

8266

CIVIC FEATURES THAT PROMOTE THE COMFORT



Two Typical Signs Used by the Municipal Authorities of Detroit in an Endeavor to Decrease the Cost of the Maintenance of the Public Parks by Attacking the Tax Payer Where He is Most Vulnerable—in His Pocket Book: The Signs Are at Belle Isle Park, Where the Practice of Parking Automobiles on the Lawns beside the Roadways Was Very Destructive



Bronze Tablet Dedicated by the Citizens of Galva, Illinois, to the Memory of Their Fellow Townsman, George Helgesen Fitch, Author of the "Old Siwash" Stories, Who Died Recently at the Untimely Age of 38, Just When Fame Was within His Grasp

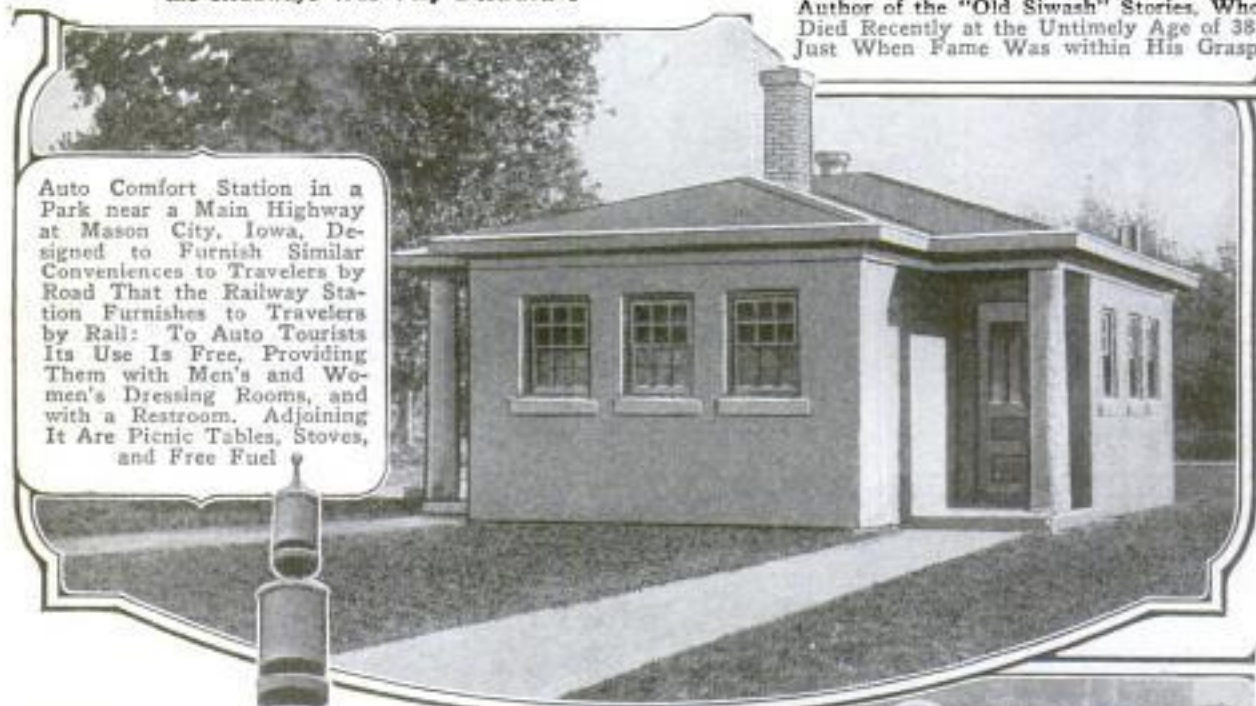

Auto Comfort Station in a Park near a Main Highway at Mason City, Iowa, Designed to Furnish Similar Conveniences to Travelers by Road That the Railway Station Furnishes to Travelers by Rail: To Auto Tourists Its Use Is Free, Providing Them with Men's and Women's Dressing Rooms, and with a Restroom. Adjoining It Are Picnic Tables, Stoves, and Free Fuel



Huge Steam Whistle Erected in Kansas City in the Year 1887: Blown Every Night Since Then at Nine O'clock, It Has Failed Only Twice to Operate Effectively



Safety Island at One of the Busiest Corners in Detroit: This Photo was Taken Early in the Morning before the Traffic Started. The Bumper with the Two Red Signal Globes on Top Is to Defend the Island from Collision with Automobiles. The Island Is 60 Feet Long by Six Wide

AND ENJOYMENT OF VISITORS AND RESIDENTS

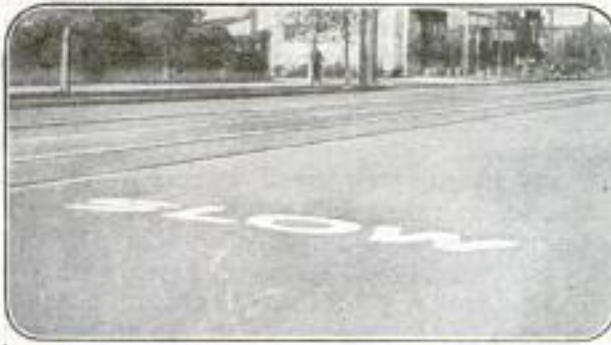

Under Normal Conditions a Defense Often Made by Traffic Violators in Oakland, California, Was That They were Watching the Road So Carefully That They Failed to Notice the Signs on Posts at the Curb. To Make This Pretext Unavailable, Signs have been Painted across the Entire Street Surface, as Shown in the Pictures. This Leaves a Violator Defenseless, for There can Be No Other Reason for Overlooking These Signs Than That He was Driving Too Fast to See Them

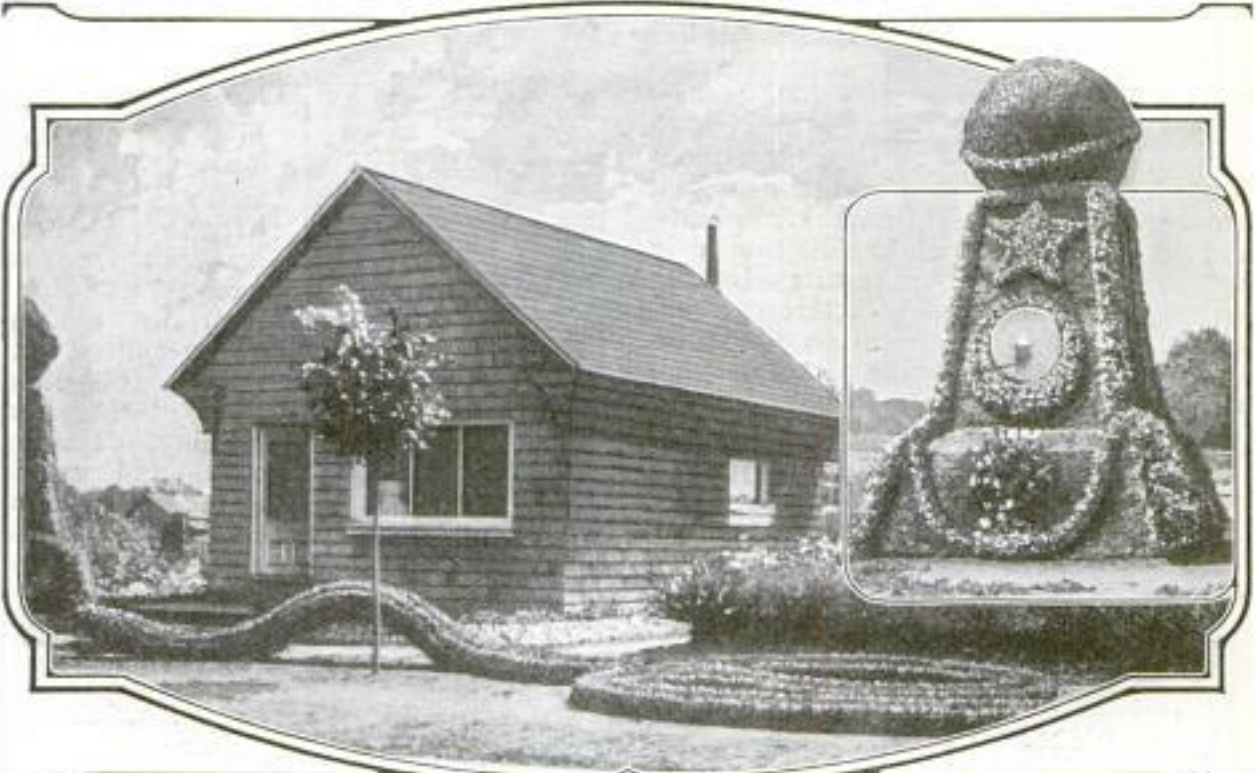

Wonderful Examples of the Art of Reproduction by the Skillful Use of Flowers, Shrubbery, and Garden Products Exclusively: On the Roadside in Front of the Little Lonely Cottage amongst the Hills of British Columbia, near Vancouver, Is This Flowered Reproduction of a Huge Snake, 18 Inches in Diameter and 150 Feet Long, So Lifelike That It Takes More Than a Distant View to Realize That It Is Not Something Living. In the Inset Is a Similarly Constructed Monument in Honor of Canada's Fallen Heroes of the World War

Sign at the State Line between Texas and New Mexico: It Marks the Exact Location of the Line, and Points with Separate Arrows to Each State. It Also Indicates, with Another Arrow, the Direction, at a Distance of 12 Miles, of a Ladies' Restroom

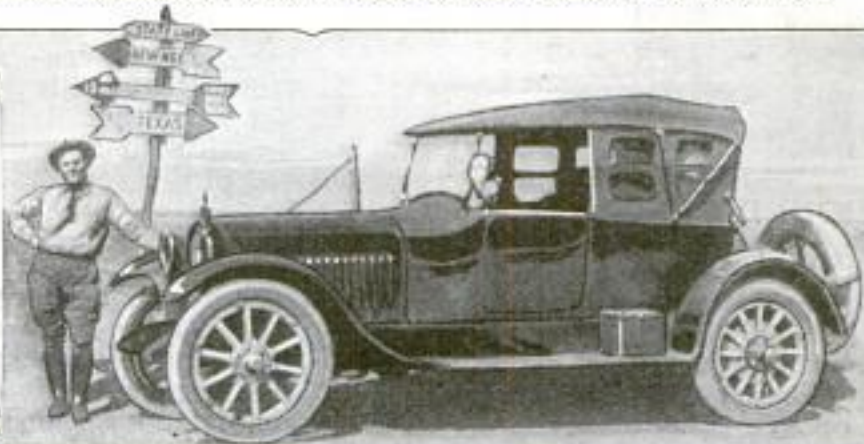

Inventor, Fred B. Ashton
Ashton Equipment Co

Barco Services Co.
Mutual Home Bldg

600
 8143 159 N. State, Chicago
POPULAR MECHANICS Dayton, Ohio

**COMBINATION MAIL LOCK BOX
 HAS MANY GOOD FEATURES**

Strength is the main essential in the manufacture of any kind of lock boxes, with simplicity of operation following a close second. These two qualities have been admirably incorporated in a box designed by a former post-office inspector, which has met with approval wherever it has been demonstrated. The box has a lock of cast bronze, a dial with eight numbered points, and an indicator which can be moved in either direction. The entire locking mechanism is inclosed in a strong cover which is securely fastened to the door, with not a screw or spring accessible that affects the combination.



nary piles the resistance to driving makes great taper prohibitive. The difficulty has been overcome in a new concrete pile, recently demonstrated in England, that is made by first driving reinforced tapered steel shells made in telescoping sections to any number required by the height of the pile. These shells are driven by means of a collapsible steel core, which is withdrawn, leaving a steel-lined hole ready for the pouring of the concrete. Standard piles of this make are of the following diameters at the corresponding heights: 8 in. at the point, 16 in. at 20 ft., 20 in. at 30 ft., and 22.8 in. at 37 feet.

**SELF-ACTING FILLING CAP
 FOR GASOLINE TANKS** *Rec'd*

A self-acting cap for automobile gasoline tanks is so constructed that it need not be taken off when refilling the tank. The nozzle of the gasoline hose is pressed against an automatically closing valve-seated lid, which it holds open during the refilling. It saves time, and unlike detachable caps, cannot be misplaced or lost.



8218
**BOARD FOR HOLDING COPY
 OF SIMPLE CONSTRUCTION**

As a means of facilitating the reading of copy in printing establishments, a Flint, Mich., school-teacher has produced a holding board. The copy paper is held in place on a metal frame by a common-type clip at the top, and kept smooth by a metal slide which can be moved down so that each line can be read without confusion.



PREPARED-MILK CAN OPENER
8286 **WILL ALSO CLOSE IT**

Prepared-milk cans may now be opened, and while the can is in use, may be kept closed, by a new opener in the shape of a flat bar that straddles the can and grasps it, and that has pivoted at its center a second thin flat bar that is flexible. At each end of this second bar is a metal punch that by pressure pierces the can lid, making holes for admitting air and for pouring the milk. While pouring, the punches are withdrawn from the holes, and the bar is revolved sufficiently to clear them. To close the can, this operation is reversed.



Cmd. Chester Shaper, Flint, Mich.

8358
**ROUND CONCRETE PILES
 WITH GREAT TAPER**

It is obvious that round concrete piles with great taper would have such increased frictional resistance, as compared with ordinarily tapered piles, that they could bear an equal load with a considerable reduction in their length. In ordi-

London Times Engineering Dept. 1/21/22
mfr. of H. Kelly
5109 Cmt. St. New Orleans, La.

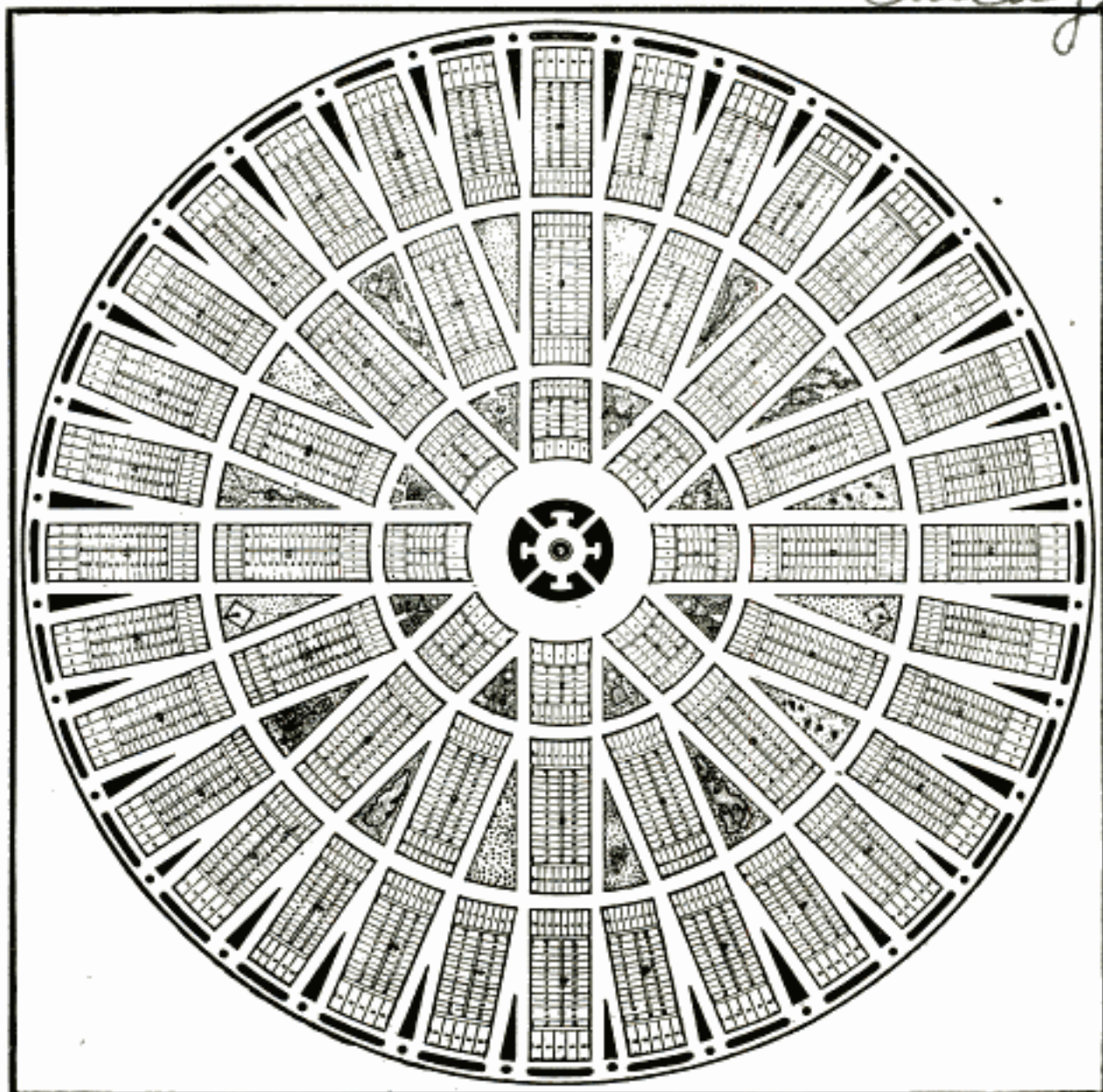

COPYRIGHT, PHILIP FARINA

PLAN FOR CITY BEAUTIFUL WITH PARKS AT EVERY BLOCK

A NOVEL plan for a city beautiful, applicable particularly to inland locations, has the whole city laid out around a center with radial blocks and concentric streets. Between the radial blocks are radial streets with triangular spaces between them at each block, which are used for gardens or small parks. Thus practically every house in the city faces a garden spot, and none is more than a few steps away from one. The plan is the result of the work of a one-time poor immigrant boy, named Philip Farina, of Chicago, who, starting as a section hand on a railroad, became a foreman, and in the process traveled over a great part of the country. He always kept his eyes open, and his mind occupied with means for improving the deplorable conditions he found in the slums of every city he visited. Finally, he conceived the plan for a city where there would be no slums—a city beautiful with parks at every block.

8074

NATURAL-GAS TORCH IS ECONOMICAL

Natural gas and compressed air are used as fuel in a lately developed torch which can be economically operated for radiator repairing, battery-lead burning, and various kinds of light soldering or brazing. Features of its construction are a sharp needle-pointed flame for concentrating the heat at any desired spot, a large bushy flame for accomplishing work

of a heavier nature, and an appliance which prevents the flame from being extinguished by motion of the torch or by increasing the air pressure.



Natural-Gas and Compressed-Air Torch, Designed as Substitute for Other Torches, Where Natural Gas Is Available

Roberts + Heimerger 430 N. High
 St. Columbus, Ohio

8267

SOME NOVEL AND LITTLE-KNOWN ACCESSORIES

Convenient Shopping Bag Which can be Folded to the Size of an Ordinary Handbag When Desired.



Attachment Which Slips over the End of the Ironing Board and Holds the Cord Out of the Way When an Electric Iron is Used

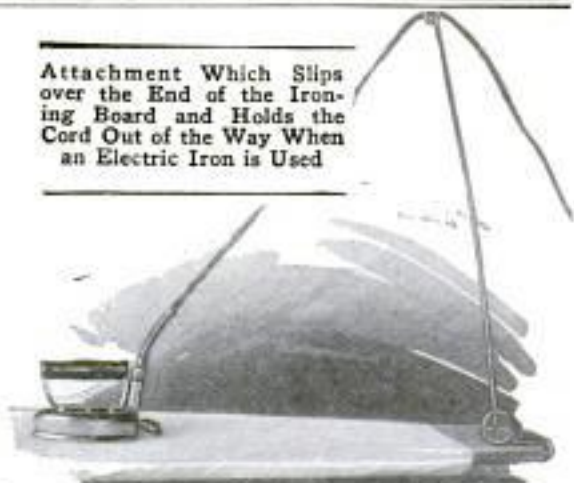

This Dishcloth Holder Permits the Use of Hotter Water for Washing Dishes and Aids in Cleansing Deep and Narrow-Necked Utensils



Small Electric Iron That Is Simple of Operation and a Great Help in Doing Millinery Work: Two Different-Sized Heads are Furnished. The Iron can be Held in the Hand, or Set Upright in a Base Clamped to the Workbench or Table



Electric Waffle Baker Whose Baking Surfaces Are Removable for Scrubbing, and Which is Opened by a Downward Pressure on the Handle

Electric Cookstove with Equipment: The Ovens Are Large Enough to Roast Two Chickens, or to Accommodate Any Meat Roast Up to 10 Pounds

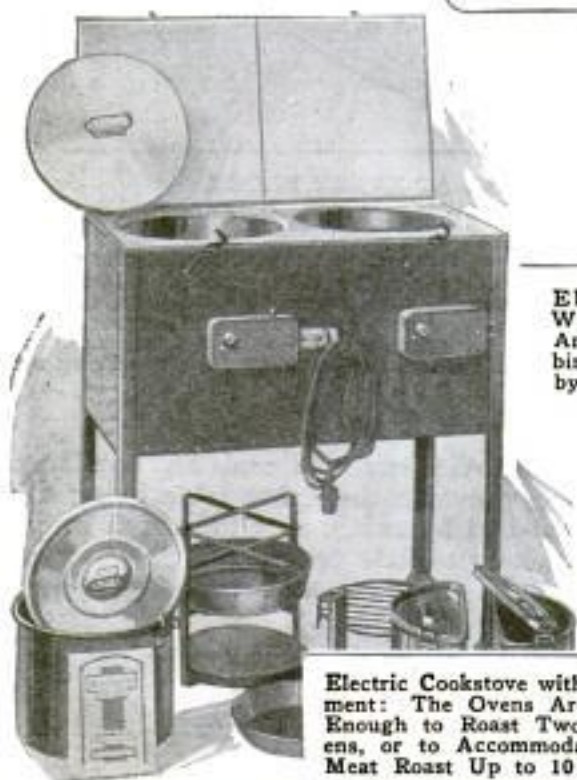

Safety Attachment for Preventing Teapot Lid from Falling Off, and the Spout from Dripping



INTENDED FOR THE HOME AND ITS MEMBERS



Bathing Shoe That Saves Time, Energy, and Patience Because It Needs to be Laced But Once: After the First Time, the Shoe is Taken Off and Put On by Opening and Closing the Back. It is Made in Numerous Colors



Glass Beanpot Which Holds the Heat Longer and Bakes the Beans More Quickly Than Other Types: The Wire Frame is Provided to Prevent the Pot from Breaking When Placed upon a Cold Surface



Tea Caddy Which is Placed over the Teapot, the Metal Slide at the Bottom being Withdrawn Each Time a Spoonful of Tea is Desired, Thus Automatically Measuring It without Using a Spoon



This Knife Sharpener Consists of a Carborundum Wheel Mounted in a Black-Japanned Bracket, Which is Embossed on the Sides to Make It More Rigid, the Whole being Screwed to a Wall or Table. Scissors can Also be Sharpened

An Electric Appliance for Kitchen Work That will Mix Dough, Beat Eggs and Potatoes, Chop Ice, Strain Vegetables for Soup, Grind Coffee, Slice Fruit or Vegetables, and Make Ice Cream with an Attachment That Indicates When Cream Freezes



Deodorizer for Purifying the Atmosphere in Smoking Rooms, Closets, or Any Place Where the Air Becomes Stagnant: It Contains a Specially Prepared Germicidal Compound



Waterproof Protector Which is Designed as an Emergency Covering When Caught in the Rain without Umbrella or Raincoat

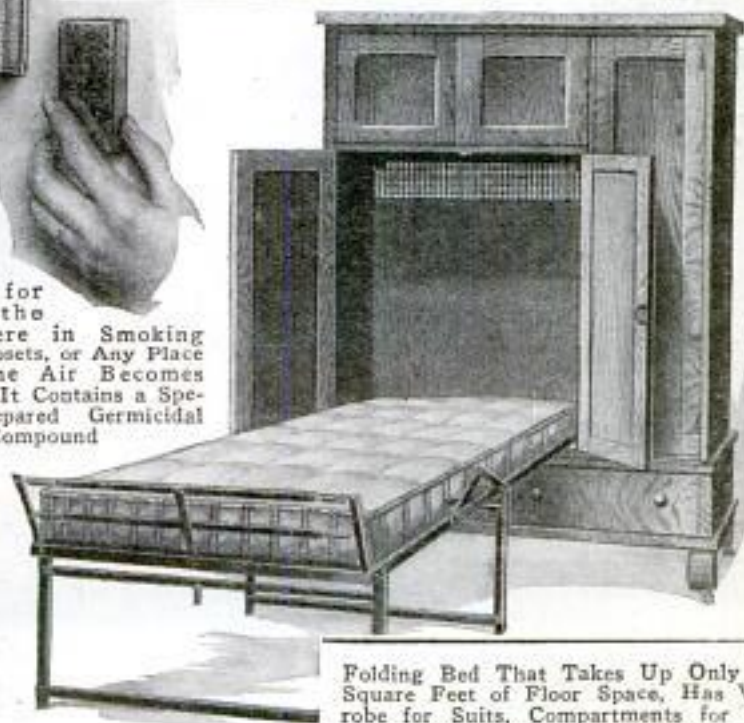

Folding Bed That Takes Up Only Nine Square Feet of Floor Space, Has Wardrobe for Suits, Compartments for Hats, and Contains Two Drawers

S
I
S
S
E
E
E
D
C
I
M
W
N
Te
Ba
N
Be
Wa
3
El
De
Te
Kn
H
Fc

George A. Fairbank
659. 20th St

694
d no.
6365

POPULAR MECHANICS
RIGID COLLAPSIBLE FRAME
FOR USE OF CAMPERS

When camping out it is not always possible to secure the necessary material for making the tent frame, and to fill this

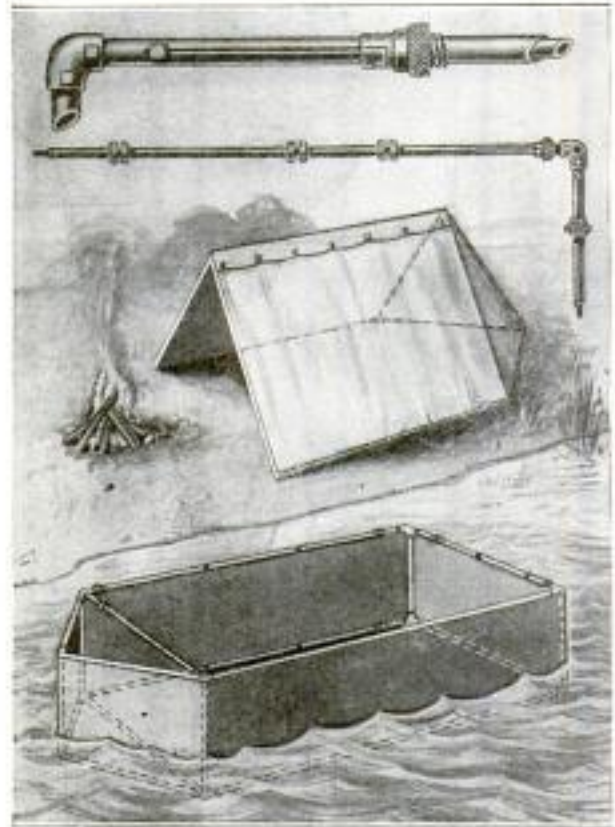

From Members of Telescoping Tubing, Such as Those Shown at the Top, It Is Possible to Form Collapsible Tent Supports, Frameworks for Boats, and Other Articles of Use to Campers

need, a collapsible frame has been patented recently. It consists of tubing of such size that the tubes slide one inside the other, and when knocked down, can be folded into small space. When extended for use, the tubes are locked to form a rigid structure. Similarly the various tubing members can be assembled to form a frame for a canvas boat, for a tub, and for other articles of use to the camper.

"PERFECT PACKAGE CAMPAIGN"
RESULTS ARE ANNOUNCED

A report of the results of the "Perfect Package Month" campaign, announced in the November, 1921, Popular Mechanics, has been published by the committee of the American Railway Association and the American Railway Express Company. During the "Perfect Package Month," as November was designated, the railroads were credited with handling 9,339,745

Perfect Package Campaign Committee
51 Broadway, N.Y.C.

freight shipments, to which 101,760 exceptions were filed by the carriers. During the same period the express company handled 10,899,352 shipments, to which 81,070 exceptions were taken. In other words, all of the carriers handled 20,239,097 shipments, freight and express, on which 182,830 exceptions were entered by carriers, giving 99.10 as the national percentage.

7949

BUILDING BLOCKS SO SHAPED THAT THEY LOCK TOGETHER

A new kind of building block, recently patented, is in the form of a rectangular concrete block, in section very much like an I-beam, but with the web thicker than the flanges. These are laid with the web horizontal, and are so proportioned that two contiguous flanges of one tier exactly fit into the web of a block of another tier. In the center of the inside face of the flange of one block is a groove, and in the face of the block that fits it, a corresponding tongue, so that the blocks are all securely locked together. Between the tiers plaster is applied, and the whole

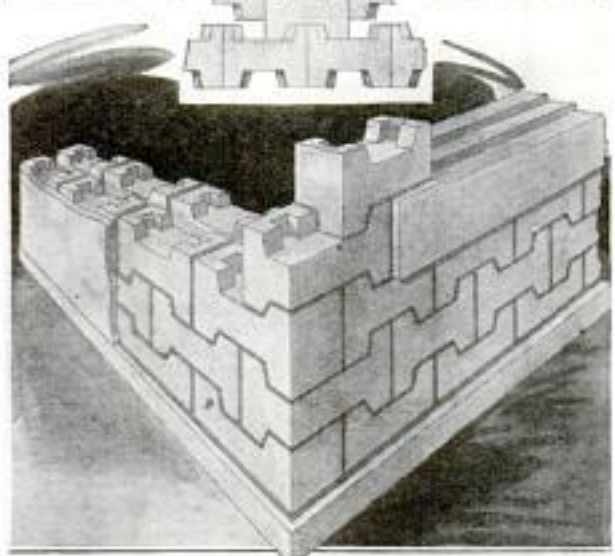
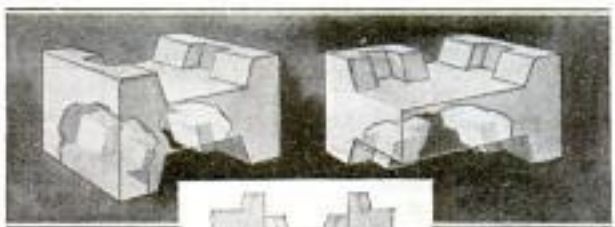

Interlocking Building Blocks: Slipping is Prevented by the Flanges and Webs of the Blocks, Which Interlock in Adjacent Tiers

should make a very solid structure. They may be used for fireproof walls, and can be shaped to form tunnels, or arches, being adapted for surfacing roads, and for storage tanks, silos, and grain bins.

W. L. Pace & Sons Co.
Beaumont, Texas

Edw. George El Brown
Alexandria, Ont.

Canada

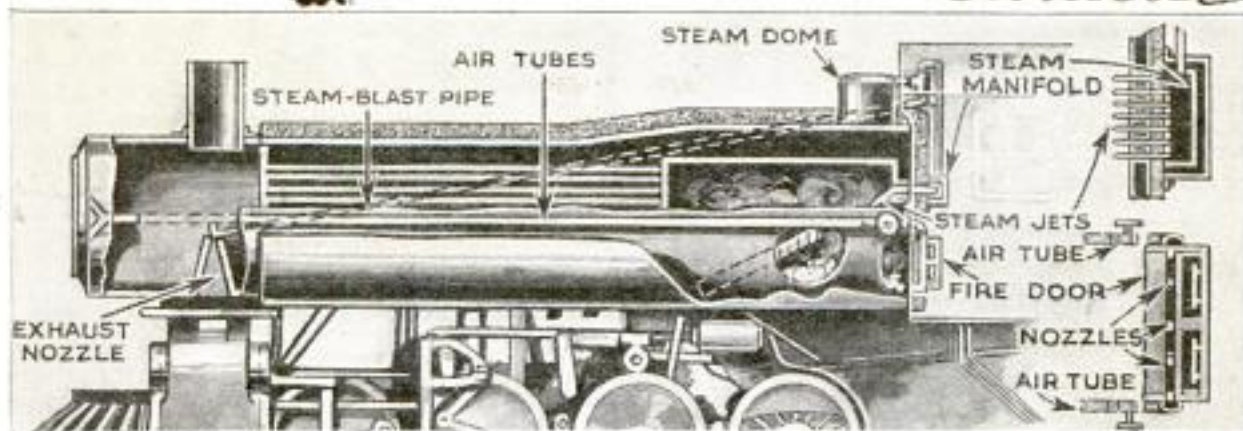

Locomotive Smoke Consumer with Air Tubes and Nozzles around Fire Door, Steam Manifold, and Pipe to Exhaust Nozzle: At the Right Is an Enlarged Horizontal View of the Parts around the Fire Door

8019
**LOCOMOTIVE SMOKE CONSUMER
 OF CANADIAN DESIGN**

A smoke-consuming device, recently patented in Canada for use on locomotives, requires a specially constructed fire door. Around the fire-door opening is a pipe fitted with a number of nozzles pointing into it. Connected to this pipe are tubes that extend longitudinally along the outside of the body of the boiler and inside its insulating cover to the forward end of the smoke box, where the tube ends are formed into a trumpetlike flare. When the locomotive is in motion, air is forced down these tubes, is heated on its way along the boiler body, and is then discharged from the nozzles around the fire-door opening, into the fire box. Above the fire door is a steam manifold into which steam is piped from the locomotive dome, and from which, through jets extending from the manifold through the walls of the fire box, it is directed over the fire. From this manifold a pipe leads to the top of the exhaust nozzle in the smoke box, and furnishes a means of creating an upward blast when the locomotive is stationary. The main purpose of this construction is to carry heated air and dry steam separately into the fire box, which, it is thought, will aid combustion more effectively than if they were mixed before coming into contact with the smoke particles.

8290

**WRITE MESSAGES ON MEMO PAD
 WITHOUT USING PENCIL**

One of the telephone accessories recently developed is a memo pad which is always ready for business. It consists simply of a piece of cardboard on which is mounted another piece of blue cardboard which is coated with wax.

*Importers - Hamburger
 & Co., Inc.
 36 S. State, Chicago.*

placing a piece of transparent paper on this waxed surface messages may be



Wax-Coated Memorandum Pad, on Which Messages can be Written with the Fingernail

written with the fingernail, a coin, or any other hard object at hand.

8112
**FLEXIBLE WEATHER STRIPPING
 OF WRAPPED COTTON WICKING**

A novel form of weather stripping, now being marketed, is composed of a core of cotton wicking that is wrapped with rubber-covered cloth. This cloth has a selvage, where the wrapping meets, which is perforated to receive the tacks that hold it in place. When installed, a thin metal strip similarly perforated is placed over this selvage, making the strip weather-proof and very sturdy, besides being flexible and easily applied. It is made in various sizes.



Weather Strip with Core of Cotton Wicking Wrapped with Rubber-Covered Cloth: It is Fastened with Tacks through the Perforated Selvage Which is Covered with Thin Metal

*Sluagh Plaster Pad Co.
 110 Locust St., St. Louis, Mo.*

*Agent - Mark S. Weil
 208 San Fernando Blvd., Los Angeles.*

**ELECTRIC PRESSURE COOKER
 REPLACES STOVE COOKING**

An electric pressure cooker has now been placed on the market. Like other pressure cookers, it is a metal container



in which food is cooked under steam pressure, but it has an electric element imbedded in the bottom to supply heat. Current can be obtained from an ordinary 110-volt circuit by means of a plug and cord. A three-heat plug is provided. Pressure is brought up to

20 lb. on "high," and cooking continued on "medium" or "low." The operating cost is three cents an hour on high, two cents on medium and one cent on low. The cooker comes in 10 and 12-qt. sizes, with insets to permit the cooking of several articles at one time.

**SIMPLE, STURDY DOOR LOCK
 SPECIALLY BURGLAR-PROOF**

A patented door lock, specially adaptable as a night lock for protection against burglars, is exceptionally strong

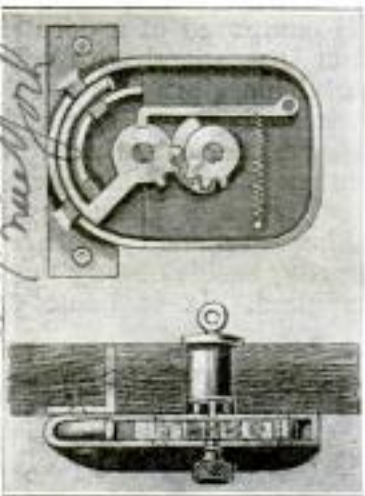

and secure, and at the same time comparatively simple. Inside a cast-metal case attached to the door is a semicircular bolt that engages sockets on the door frame. This bolt is connected by an arm to a hub, mounted on a spindle

at the center of the semicircle and having a notch that engages a horizontal pawl above it when the bolt is in its upward locked position, thus holding it im-

movable. A second hub, also mounted on a spindle, when rotated by a key from the outside of the door, or a knob on the inside, lifts the pawl and revolves the bolt until it is disengaged from the sockets, thus releasing the lock.

**MACHINE FOR SHELLING PIÑON
 NUTS INVENTED BY WOMAN**

Though most delicious, the tiny piñon nut of the Southwest is little known outside of its native region,



because of the difficulty of shelling it. A machine, recently invented by a woman in Albuquerque, N. M., will do this work. The nuts are graded, for size, and placed in an adjustable cracker. This consists of two cones,

one within the other, the adjacent surfaces of which are provided with burrs, similar to a wood rasp. The inner cone revolves at 1,500 r.p.m., and the nuts are cracked between the burrs. They fall into a separating tray, where deflectors separate the kernels and shells. After passing the deflectors, the kernels fall into a container, while the lighter shells are blown out by a fan.

**MEASURING-TAPE ATTACHMENT
 MAKES IT EASY TO HANDLE**

With the aid of a simple pin, specially devised for use under varying conditions

in connection with the buckle at the end of a tape, measurements of any length can be made by one man. The pin can be pressed into wood or plaster, carpet or linoleum, and

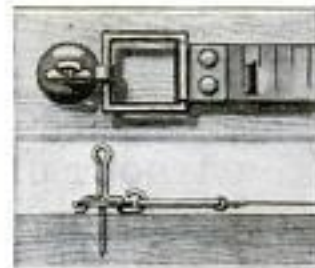

leaves a hole so small that it is not noticeable. For use outside, on open ground, anything in the nature of a wooden peg may be attached.

7843

7847 individual machines for sale

7894

John Holtzman
 Denver, Colorado

Copyrighted material
 J. M. Augustus H. Bell, 858 S. 13th St., Newark, N. J.

OIL PRODUCTION INCREASED BY COMPRESSED AIR

That a percentage of the oil which is left in the ground when an oil well is abandoned can be recovered, has been proved by experiments conducted by the Bureau of Mines. A metal cylinder was filled with sand which was then saturated with oil, whereupon gas under a pressure of 200 lb. per square inch was introduced. When a valve at one end of the cylinder was opened, the gas rushed out carrying with it from 15 to 25 per cent of the oil contained in the sand, proving that gas under pressure is mainly responsible for the oil production from wells. This has been commercially applied in the East by forcing compressed air or gas into a central well, from which it passes through the oil sand to surrounding wells, causing production from wells that had been considered ready for abandonment.

8299

COMBINATION WRENCH FITS EIGHT SIZES OF NUTS

A new wrench has been developed which takes the place of four old-style wrenches, because, instead of having but two jaws at each end of the handle, it

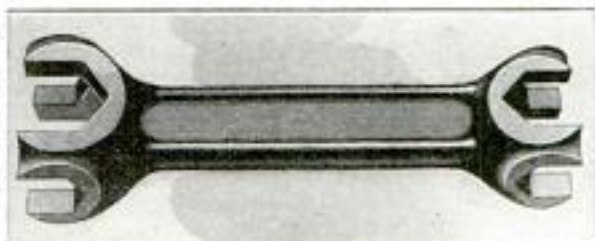

This Wrench Has Four Jaws at Each End of the Handle Instead of Two, the Jaws being Arched in Such a Way That They Brace Each Other

has four jaws arranged in the form of a crown. This construction makes each jaw as strong, if not stronger than, the ordinary wrench jaw.

7951

KEROSENE-MIXING CHAMBER FOR AUTOMOTIVE ENGINES

The regulation gasoline engine, after being "warmed up," will operate very satisfactorily with kerosene as fuel, and with this object in view, a device of compact design has recently been developed. The chamber, with necessary supply valves and air ports, is bolted between the regular carburetor and the intake manifold. In operation, the engine is started and warmed up with gasoline as fuel, then the gasoline throttle is closed and the

kerosene throttle is opened. The kerosene is fed from the supply tank by a wick inclosed in a tube, to a "hot-spot well," where its temperature is raised to a

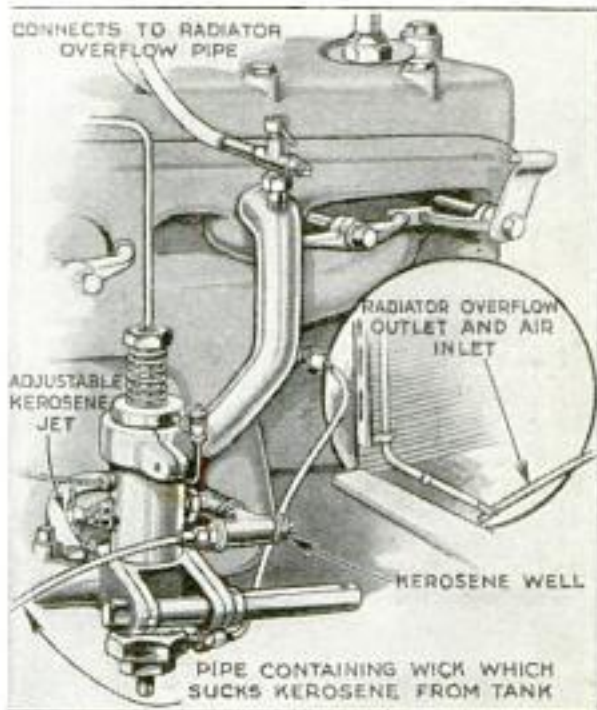

After Engine is Started and "Warmed Up," Kerosene is Used for Fuel Instead of Gasoline. Kerosene is Fed to the Chamber by a Wick and is Vaporized in a "Hot-Spot Well"

point of easy vaporization, the well being heated by a tube from the exhaust manifold. Water vapor is also introduced to prevent excessive carbon deposit. Control is by means of a foot throttle.

8212
DIVORCE RING LATEST FAD FOR GRASS WIDOWS

A novelty ring for grass widows is now on the market. It is worn on the same finger as the wedding ring, the design being a broken Cupid's arrow. For those who have the habit, space is provided for jewels, each jewel to signify one divorce.



International

Those wishing further information on anything described in the editorial pages can obtain it by addressing Bureau of Information, Popular Mechanics Magazine, Chicago.

no record of maker.

Commercial Service Co., Providence, R.I.

*opt
 Me
 hic
 ent
 tr.
 as
 n
 ex
 he
 hi
 nd
 re
 he
 i.*

8265

CHILDREN'S PICTURE-STORY DEPARTMENT

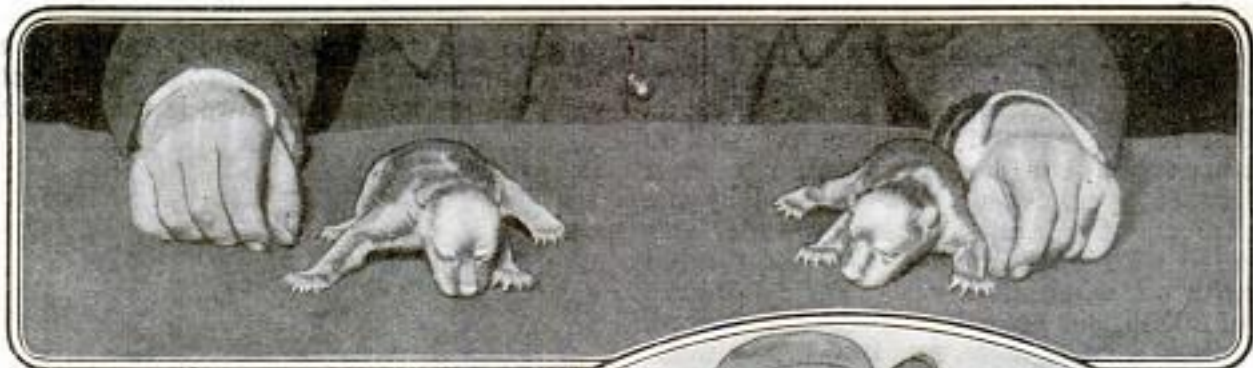

Two Newly Born Bear Cubs That, as They Sprawl upon the Table, with Their Eyes Still Unopened, might Very Well be Mistaken for a Pair of Bull Pups. They were Born in Captivity in Paris, and Are Hybrids, Their Mother Being a Siberian and Their Father an American Bear. It is Said That Their Owner has been Offered 10,000 Francs for One of Them



*Invention
Henry Barall
Philadelphia, Pa.*

Sled That Has a Fifth Runner Which is Held from the Ground by a Spring on the Post: Pressure on the Handle Pushes It to the Ground into Convenient Position for Steering



On June 10, 1921, While Engine Company Number 5, of Hoboken, was Responding to a Fire Call, Little Walter Casler was Run Over by the Engine, and as a Result His Right Leg had to be Amputated. Last Christmas the Firemen Heard That Little Walter had Appealed to Santa Claus for a New Leg. They Subscribed \$300, and Little Walter Now Has a Perfectly Nimble Leg



Popularly Known as the "Tootsie Doll," This Baby Is a Very Naughty Little "Tootsie-Wootsie," for When Pushed along It Kicks Its Feet, Waves Its Arms, and Cries Out Peevishly, Refusing to be Quiet Until the Buggy Stops

*Cambridge
Mechanical Toy Co.
Cambridge, Ma.*

OF MODERN ACTIVITIES AND INTERESTS

mp. J. Blake- Willenden
29 E Madison Chicago

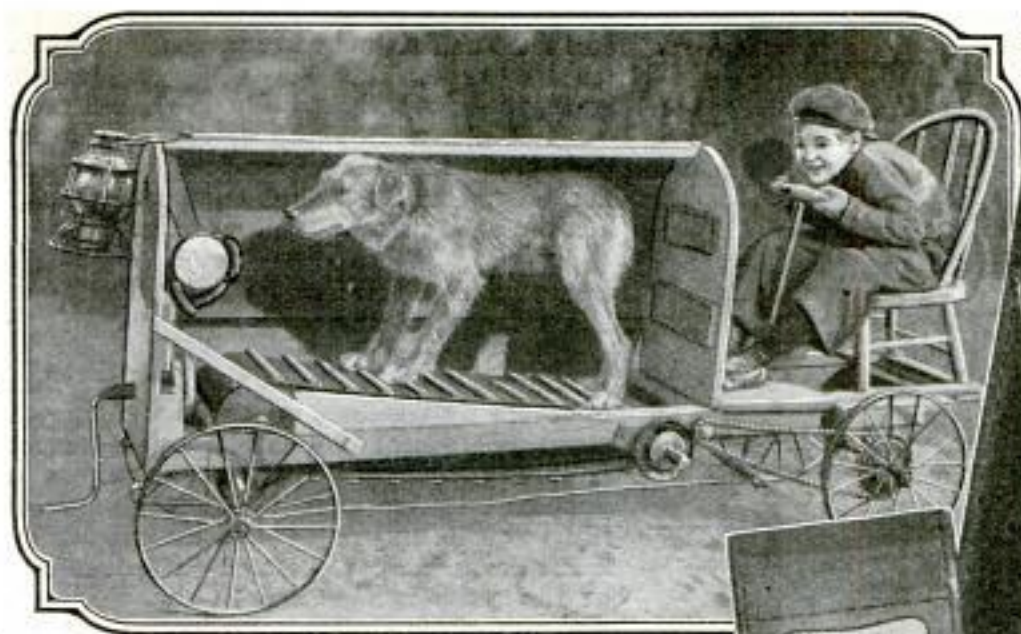

The Latest Thing in Horseless Carriages—a 1922 Model of a "Four-Paw-Power Dogmobile," with No Speed Limit, and No Visits to Filling Stations Required, Being Therefore, Very Economical to Run: The Dog Keeps on Trotting in a Futile Attempt to Reach the "Wieners" in Front of Its Nose, and the Treadmill Does the Rest. It was Built and is Operated by a Young Movie Actor in Los Angeles

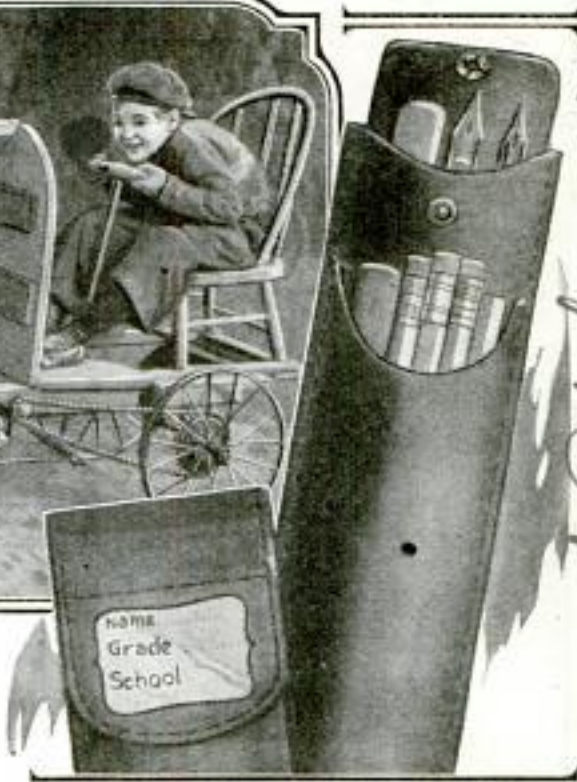

Handy Pen and Pencil Case for School Children of All Ages: Made of Leather, It Contains Erasers, Pencils, Penholders, and Pens. The Flap Has a Little Glazed Window behind Which is a Card for the Student's Name, Grade, and School Number



This Cat Drinks Milk in a Most Unfeline Manner—Not Sometimes but Always. From Its Kittenhood It has Never Lapped, but has Always Used Its Paw Instead of Its Tongue, to Pick Up the Milk, and Throw It into Its Mouth. It Takes a Little More Time, but in the End It is Just as Effective. Pussy Lives on a Farm in Northern Wisconsin, Where the Photo was Taken

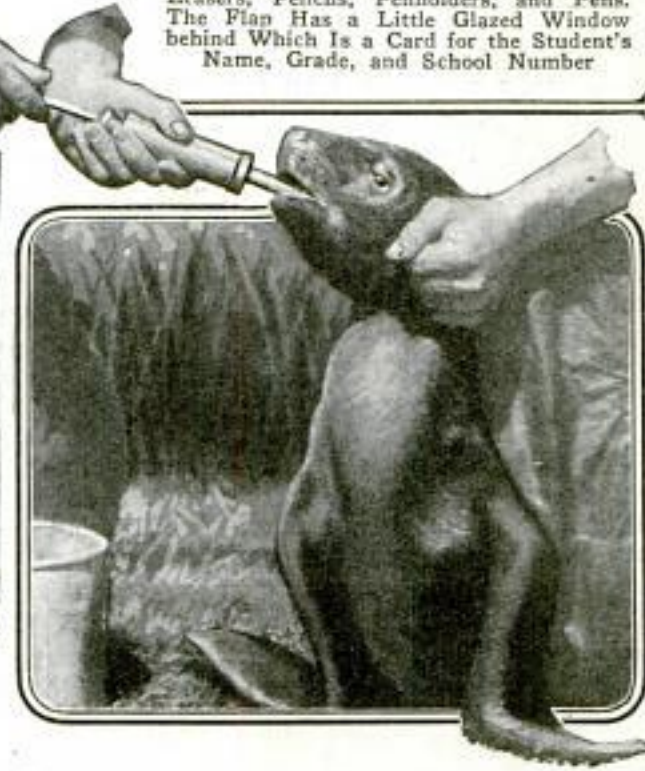

Four Baby Seals were Recently Brought from Alaska to the Woodlawn Park Zoo, in Seattle, Washington. There They Went on a Hunger Strike, and Three of Them Died. To Save the Remaining One, a System of Forcible Feeding was Adopted. With an Oil Gun, Condensed Milk was Forced down Its Throat in the Manner Shown in the Picture

CLEAN BOTH SIDES OF WINDOW FROM INSIDE USING NEW SASH

To make the housewife's duties easier and safer, a new window sash has been designed. The window may slide up and

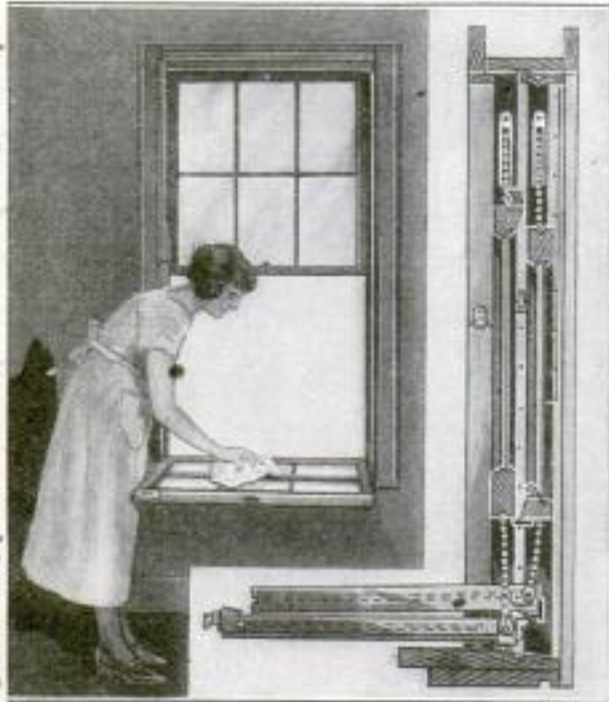

When the Sash is Lowered and the Fasteners on the Side have been Disconnected, the Sash may be Tilted into the Room for Cleaning

down as does the standard window, but in addition, either sash may be tilted toward the room much like a transom, giving ample ventilation but without drafts. By disconnecting the fastener the window may be turned completely into the room for cleaning.

STEEL-KNOT TOW ROPE FOR CARS AND TRUCKS

To take the place of the ordinary slip-knot on the end loop of a tow rope, a steel knot is now on the market that can be attached to the end of any manila rope or



Steel Knot Attached to Ends of Tow Ropes or Steel Cables, Specially for Use on Motor Cars and Trucks: In Emergencies It can be Used as an Antiskid Chain

steel cable, and that is very easy to hitch and unhitch. Attached to the ends of 3/8-in. manila rope, the tow has a tensile strength of 4,000 lb. On a 3/8-in. steel cable it has a breaking strength of over five tons. It is being made specially for use on automobiles and trucks, and may also be used as an antiskid chain.

NEW SHOCK ABSORBER FOR MOTOR CARS

A new form of shock absorber, that operates by winding up and unwinding a strap, does not depend upon a direct snubbing principle, because it offers a proportioned resistance from the beginning to the end of any recoil caused by a shock on the car springs. The free end of the strap is fastened to the car axle, and the other end is a flat coiled spring. When the car spring is compressed by a shock, the strap is wound up to whatever extent the car body and axle have been caused to approach each other. As the car spring recoils, forcing the body and axle apart, the unwinding of the strap is

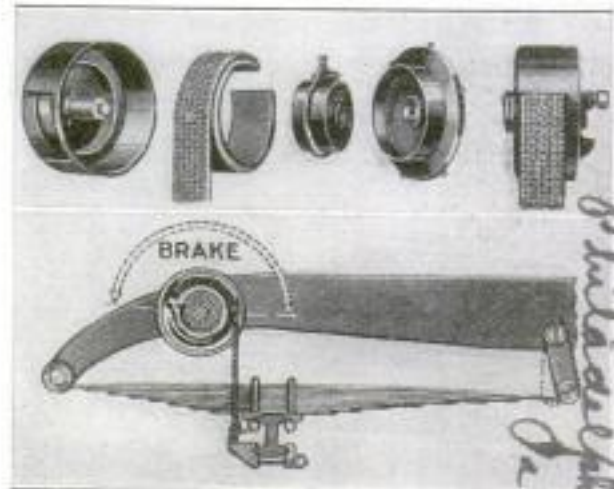

Shock Absorber Shown Installed at Motor-Car Spring: The Arrow Shows Range of Rotation. Its Several Parts, and, at the Right, a Side View of the Absorber are Shown Above

resisted without any jerk by the action of a brake in connection with the coiled spring.

INCANDESCENT LAMPS USED FOR HEATING PURPOSES

Under proper conditions, a very small amount of heat will keep a person comfortable. Recently, a number of girls working at a bench in an unheated room were kept warm by allowing them to rest their feet on a long wooden box lined with slab asbestos and heated by one 8-cp. carbon-filament lamp for each girl.

Standard Comfort Window Co. 426 Broadway New York

918

7625

Auto

John W. Green Ocean Co 24 St + Townsend Philadelphia Pa

Steel Knot Tow Rope Co. 600 1/2 E Main St. Halamagoo, Mich

The Engineer 1/6/22

Copyrighted material



A Power Hammer for Farm Shops

By L. B. ROBBINS

A BLACKSMITH shop is a necessity on the modern farm, and where heavy work must occasionally be handled, a simple power hammer, built of material found around any farm, will prove of great value.

The site selected for the erection of the hammer should be close to the forge; the foundation should be solid, and there should be a good ceiling, or heavy roof beams, against which to butt the hammer guides.

To construct the hammer, first obtain a discarded lightweight-automobile or carriage spring, full-elliptical type, and be

indicated from a piece of heavy steel; a wide dovetail groove is cut in the bottom, to accommodate hammers of various depths, thus altering the distance between hammer face and anvil, and consequently the force of the blow. A dovetailed key

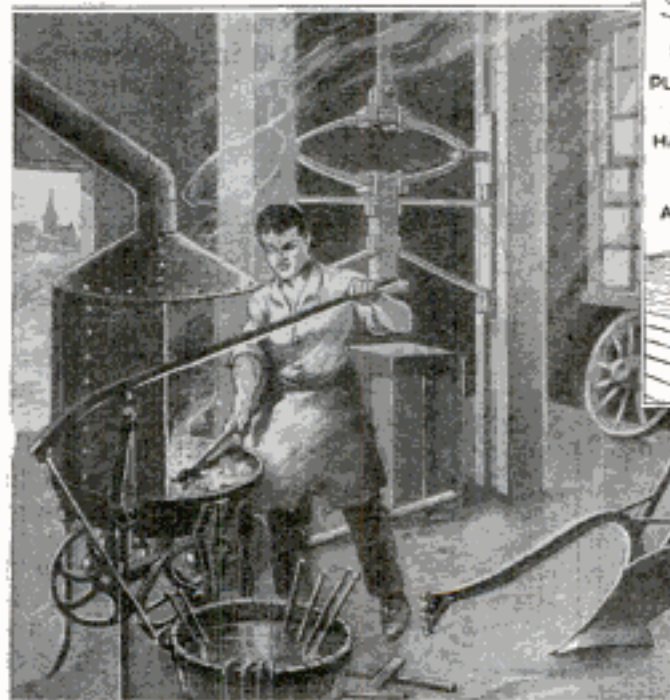

sure that it is quite springy. Two heavy posts, of a size suitable for the hammer to be built, say about 12 by 12 in. in cross section, are then cut to length, and a rectangular groove cut along the center of one face of each. A length of channel iron is fastened in each groove, to serve as guides for the plunger or head of the hammer.

The plunger can be forged to the shape

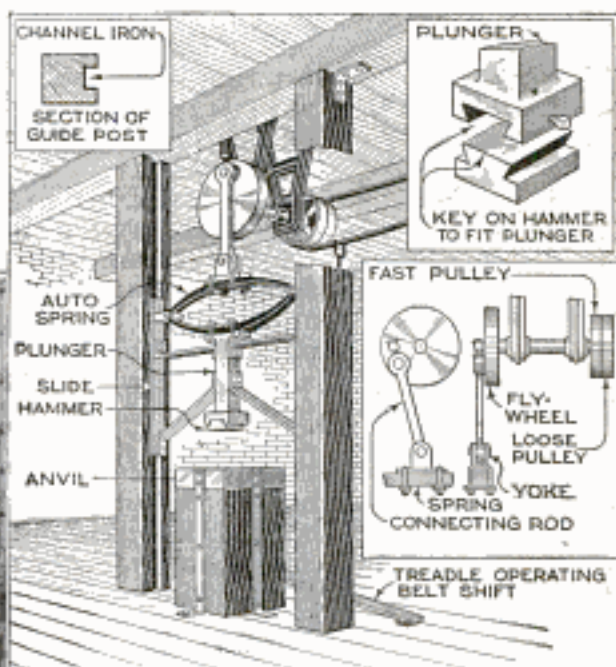

A Power Hammer for the Farm, Built of Materials Picked Up around the Shop, or Easily Obtained from Any Junk Dealer: It will Save Much Time and Hard Labor Where Any Heavy Forging is Done, Especially on an Out-of-the-Way Farm, Where Any Breakdown of the Farm Machinery Means a Long Wait for New Parts

on the top of each hammer fits in the groove in the plunger, and is tightly locked in place with a setscrew.

Horizontal and angular braces, of heavy flat iron, are bolted to the sides of the plunger, and to lengths of rectangular steel, sliding in the guides. These should be so fitted that the plunger will slide easily, and yet have no undue side-play. The ends of the spring are yoked to the sliding pieces in the same manner as they were fitted to the auto or carriage. The upper side of the spring is bolted to a yoke, in which the connecting rod is pivoted. The latter is a forging, and is at-

tached to a disk crank mounted on a shaft on the end of which are fast and loose pulleys. The crankpin should be set 3 in. from the center, giving the hammer a 6-in. stroke. The bottom of the spring is fastened to the top of the plunger by U-bolts.

The belt shifter should be operated by a foot treadle, working through a bell crank, and should be so arranged that the belt is on the fast pulley when the treadle is down, while the bell crank should have a spring attached to it, so that when pressure is taken off the treadle, the belt

will automatically be shifted to the loose pulley. The crankshaft should be driven at a speed sufficient to operate the hammer at about 40 strokes a minute. The anvil consists of a heavy iron block, fastened to a wooden block by flat-iron straps, which hold the whole to the floor.

It is obviously impossible to give any dimensions, or lay down any hard and fast rules for constructing a machine that is to be made of any material at hand. These instructions, however, should enable anyone to build a hammer that will save much heavy hand forging.

Ladder for Work on Shafting

An ordinary ladder is more or less unsuited for such work as oiling lineshaft hangers, repairing belts, and the like. The



ladder shown in the drawing has many advantages for work of this kind, as it is not top-heavy, and can be rested against the shafting when the pulleys are but a few inches apart. The top of the ladder should be as narrow as possible, while the bottom should be at least 3 ft. wide, so that it can be rested on a minimum of space and yet not slip to one side when the workman leans to one side or tugs at a pulley or belt.

A hook at the top to fit over the shaft and spikes at the bottom are suggested as measures for reducing the possibility of accident.

Action of Metallic Salts on Aluminum

Aluminum utensils should not be used as containers for certain solutions of metallic salts, such as copper sulphate and mercuric chloride (bichloride of mercury). The reason for this is, that aluminum is higher in the electrochemical series than mercury or copper and will displace mercury or copper from their salts when the latter are in contact with it. The same thing happens when aluminum is in contact with the salt of any other metal that is below it in the electrochemical series. In the case of a piece of aluminum being placed in a solution of copper sulphate,

aluminum will go into solution and copper will be forced out in the metallic form. When mercuric chloride is in contact with aluminum, the latter goes into solution as aluminum chloride and metallic mercury will be deposited on the aluminum surface. Metallic mercury in contact with aluminum forms an amalgam that is oxidized, with the formation of aluminum oxide. This process goes on until the aluminum is eaten away. Consequently, aluminum utensils should not be used for antiseptic mercurial solutions, or for the mercury intensifier used in photography. Also, medical instruments that are made entirely, or in part, of aluminum should not be sterilized in bichloride solutions.

Gauge for Laying Out Square Holes

To inclose a circle accurately in a square requires considerable time and care, and when a number of squares are

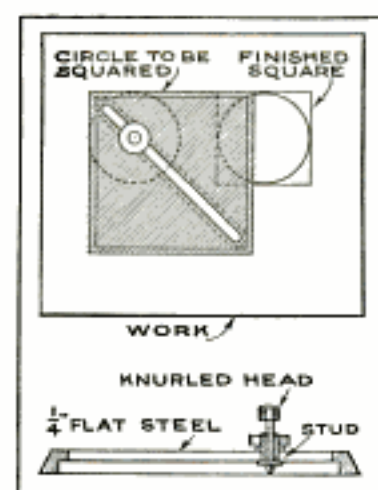

to be laid out, the job becomes very tedious. The tool shown in the drawing, if accurately made, will greatly simplify the squaring of circles of any diameter within its capacity. The body is made from $\frac{1}{4}$ -in. flat steel, ground square and

beveled on the edges. A slot is cut diagonally through the piece and then milled out to a slightly greater width for about two-thirds of the thickness of the stock. A center, made of tool steel,

has a knurled head pinned or riveted to it after final assembly, as indicated by the drawing. To enable this center to slide up and down in the slot, a stud is made with a head of the same diameter as the greatest width of the slot, with a shank which is a sliding fit in the smallest width. A knurled nut, fitting the threaded stud, completes the tool.

To square a circle, push down the center and place it in a punch mark made in the exact center of the circle, the nut on the stud being loose; let the body of the tool rest flat on the work and slide it gently until the two edges coincide exactly with the scribed circumference of the circle; then tighten the nut. After lines have been scribed along the two sides, turn the tool around on its center and repeat the operation to form the other two sides of the square.

An Improvised Valve-Seat Reamer

In a small shop, not provided with too many tools, a machinist was working on the cylinder head of a stationary gasoline engine, on which one of the valve seats was so badly pitted that it would have been impossible to make a good face by the ordinary process of "grinding in."

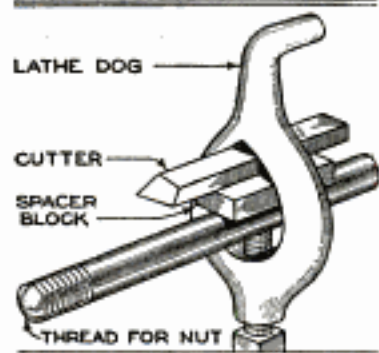

The shop had no reamer that would fit, and it seemed that the whole head would have to be swung in a lathe just to remove less than an ounce of metal. The mechanic, however, found an easier way. A piece of cold-rolled steel, the same size as the valve stem, and about 1 ft. long, was cut and threaded on one end. An ordinary tool bit was then ground with a bevel on one end, to correspond to the angle of the seat. A lathe dog and a spacer block completed the outfit. The tool bit was clamped against the rod with the dog, the spacer block holding the cutting tool just far enough away from the rod to face the seat. The rod was inserted through the guide hole, a nut run on, and screwed up just tight enough so that, when the tool was turned with the dog, the cutter would scrape the seat. As the seat was trued up, the nut was tightened until the seat was free from pits.—James Ellis, Memphis, Tenn.

Drilling Holes in Porcelain

The mechanic who undertakes to drill holes through porcelain bathroom fittings, and other expensive equipment of the same material, is quite likely to break the article unless considerable care is used. Although brittle and hard, glazed porcelain can be drilled easily if properly handled. The main difficulty lies in getting the drill properly sharpened; the proper way is to grind the point of the drill perfectly square and then,

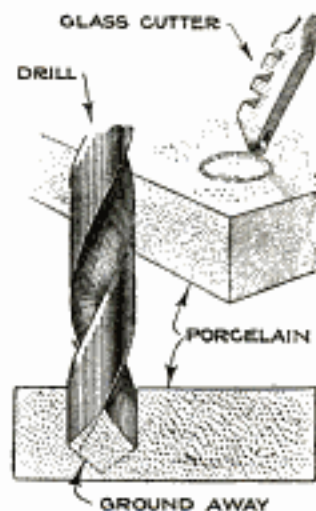

holding it on one edge of the wheel, to grind the cutting edges as shown in the drawing. To start the drill through the vitreous glaze, cut a circle, the same diameter as the hole, at the proper location, with a glass cutter, the cut being carried through the glaze; the drill will then enter easily. As soon as the drill stops cutting take it out and carefully chip off the triangular peak in the center of the hole with a narrow chisel, nailset, or similar tool. This operation is repeated until the hole has been drilled through.—W. Norman Fox, Atlantic City, New Jersey.

A Clamping Kink

It frequently happens, when clamping a piece of work to the bed of a machine, that there are no bolts of sufficient length on hand. The drawing illustrates a method of clamping that will be found useful in such cases. Two short bolts are necessary;

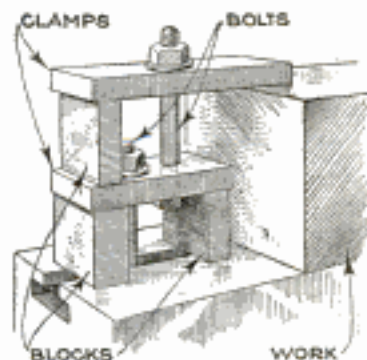

one is set in a T-slot, and used to clamp a plate and blocks to the table. The plate is provided with a second hole, through which the other bolt is passed, clamping the work as shown.—Chas. Homewood, Ontario, Calif.

Homemade Gas Blowpipe

A small blowpipe, suitable for soldering or light brazing, can be made almost entirely of pipe fittings; it is used with illu-

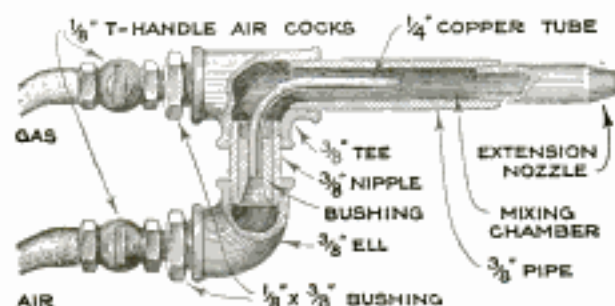

An Air-Gas Blowpipe for Light Brazing and Soldering Jobs That Uses Illuminating Gas, under the Usual City Pressure, and Light Air Pressure from a Blower, Bellows, or Compressor

minating gas at the usual city pressure, and air from a small compressor, blower, or foot-operated bellows. Only a few pounds' air pressure are needed. Most soldering jobs can be better done with this apparatus than with a soldering iron, as the heat is applied directly to the work, and the size of the flame may be regulated by varying the size of the nozzle, as well as from the valves. For very fine work, a small-diameter nozzle, giving a thin, pointed flame, is attached.

The body of the blowpipe is made from $\frac{3}{8}$ -in. pipe and fittings, then reduced down to $\frac{1}{8}$ or $\frac{1}{4}$ in. for the cocks. An interior air nozzle is made by filling a piece of $\frac{1}{4}$ -in. (outside diameter) copper tube with melted lead, giving it a short right-angled bend and then melting out the lead. Then, a fiber, brass, or iron bushing is driven into a $\frac{3}{8}$ -in. pipe nipple and drilled out to a close fit for the copper tube, one arm of which is pushed into it and the whole screwed into a $\frac{3}{8}$ -in. tee. A brass or iron nipple, about 5 in. long, is then screwed into the tee, the outer end tapped to $\frac{1}{4}$ -in. pipe size, and a smaller extension nozzle screwed in. Several different sizes of these tips or nozzles are made up for light or heavy work. An elbow is screwed onto the lower end of the nipple, both tee and ell are reduced to $\frac{1}{8}$ or $\frac{1}{4}$ -in. pipe size, and two ground-in brass T-handle air cocks attached. The blowpipe is connected to the gas and air supply by means of rubber tubes.

Cold Tinning of Metals

Finely divided block tin is mixed with metallic mercury to form an amalgam having the consistency of soft paste, and, of course, the finer the tin is divided, the easier it will be to amalgamate the two

metals. The work to be tinned is cleaned thoroughly so that it will be free from all greasiness. Then the area to be tinned is rubbed with a rag moistened with muriatic acid. Immediately after, a little of the amalgam is applied to the surface and rubbed with the same rag, the amalgam adhering to the surface of the work and thoroughly tinning it. Cast and wrought iron, steel, copper, and other metals, can be tinned by this process. In case it is found difficult, if not impossible, to make soft solder adhere to iron when using sal ammoniac as a flux, no trouble will be experienced in soldering if the surfaces to be joined are first tinned as described and then the same procedure as in soldering tin is followed.

Safeguarding Price Marks on Stock Drawers

The owner of a hardware store was greatly bothered by the price marks, which were written on stickers gummed on the side of the drawers, becoming rubbed and torn off after the drawers had been opened and closed a few times. This meant that the office force had to prepare

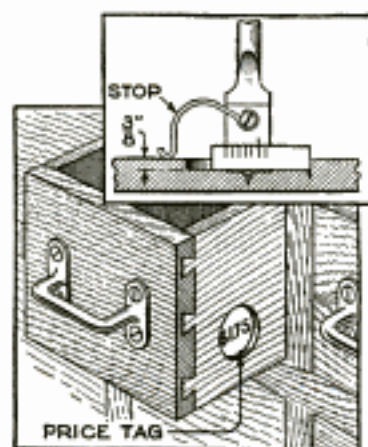

a new set of tags every few weeks, and with nearly 2,000 drawers to be marked, this meant considerable extra work. The problem was solved by the store's carpenter. He removed each drawer and turned it with its right side up. Then with an expansion bit, he drilled a depression in the side of the drawer about $\frac{3}{8}$ in. deep and $1\frac{1}{2}$ in. in diameter. The depth of the depression was made uniform by means of a stop made from steel wire, which was fastened to the setscrew of the bit. Circular gummed price stickers, with the price of the article contained in the drawer written on them, were then pasted against the bottom of the depression, and as prices were changed or the contents of the drawer altered, new stickers were pasted over the old ones. No amount of chafing against the sides of the drawers can damage the price marks thus protected, and the system has proved to be a great labor saver.

Action of Grease in Boilers

The action of grease in a steam boiler is peculiar. Grease does not dissolve or decompose in water, nor does it remain on the surface. Heat in the water and its violent boiling cause the grease to form in sticky drops which adhere to and varnish the metal surfaces of the boiler. The varnish, by preventing the water from coming into contact with the metal, prevents the water from absorbing heat, and this causes a blister or burning of the plates that often results in a serious rupture or violent explosion.

Stand for Painting Auto Hoods

When painting the automobile, best results on the hood are obtained by removing it and

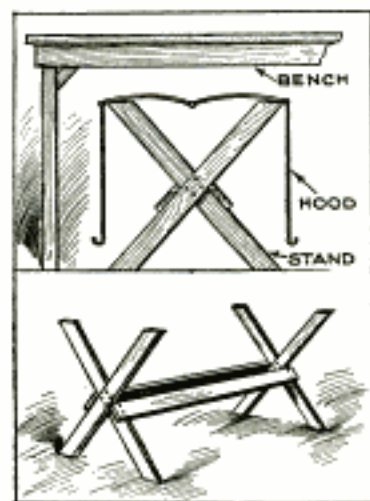

treating it as a separate job, as, aside from the body, it is the most conspicuous part of the car and should be treated accordingly. By building a simple stand of the type shown, the hood is supported in a manner that

makes all parts of it conveniently reached with the brush. While the paint on the hood is still wet, the whole thing can be pushed into a room or inclosure that is free from dust.

A Special Slotting Hacksaw

A common operation in most small shops is the slotting of odd screws, the slitting of bushings, and similar work. The device illustrated will be found a convenient aid whenever a saw slot is desired in the center or along the axis of a piece of circular work. While it may not be necessary, for example, in the case of a screw, that the slot be exactly in the center, it will be agreed that nothing looks worse on a finished article than screws that have their slots cut on one side. Trusting entirely to the eye in such cases, often results in the slot being far enough off center to be unsightly. The tool shown in the drawing is made after

the manner of an ordinary saw frame, but fitted with a V-guide. The frame is bent or forged, as indicated, with one end

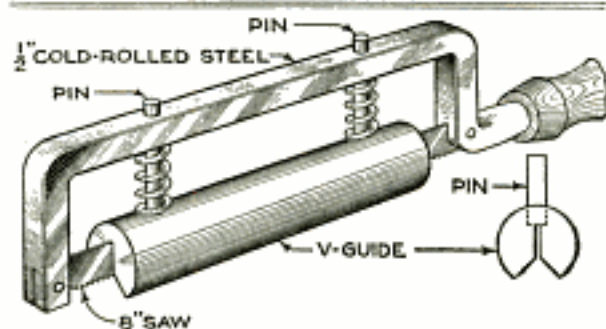

A Special Hacksaw for Slotting Heads of Machine Screws, Slitting Round Stock Parallel to the Axis, and Similar Work

drawn to a tang to fit the handle. The V-guide is a piece of 1-in. cold-rolled steel with a "V" cut in the bottom, the center of the cut being slotted or sawed to accommodate the saw blade. Holes are drilled in the top of the guide, to take two pins that pass through two clear holes drilled in the frame. When the whole is assembled, two light springs are slipped over the pins between the guide and the saw frame; the tool has a 6-in. guide when used with an 8-in. saw.

When slotting work, the guide is placed on it, and the operator saws in the usual manner, the guide moving along with the saw and keeping it centered on, and in close contact with, the work.

Dust Guards on Eccentric Straps

The sliding and revolving parts of machinery used for coal, ashes, and sand, are continually exposed to more or less gritty dust, which quickly destroys the reciprocating and revolving parts and their bearings. The drawing shows an eccentric for an automatic boiler stoker, which has been fitted with a dust guard, to prevent coal dust from shortening the life of the eccentric straps. The dust guard, or cover, is cast on both sides of the upper strap, deflecting the dust that would otherwise fall directly onto the revolving sheave.—M. E. Duggan, Kenosha, Wis.

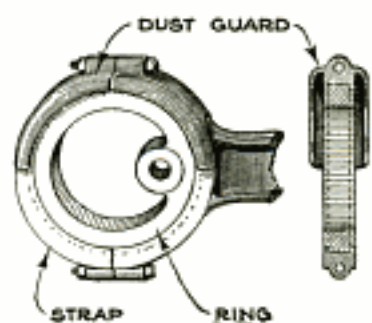

Keying Small Pulley to Motor

After buying a $\frac{1}{4}$ -hp. electric motor to operate a small lathe, it was found that the 2-in. grooved pulley with which the motor was equipped was unsuited to the work. This pulley was secured to the

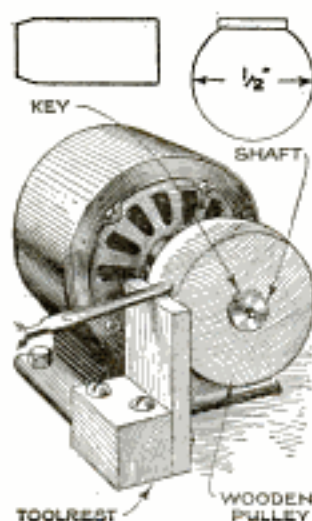

armature shaft with a setscrew. The shaft was filed flat as shown. As a flat-face pulley was necessary and an iron one could not be obtained, a wooden pulley, of $2\frac{1}{2}$ -in. diameter and $1\frac{1}{2}$ -in. face, was cut from a $2\frac{1}{2}$ -in. square of maple plank. A $\frac{1}{2}$ -in. hole was drilled through the center, and a key was cut from thin sheet metal.

One end of the key was slightly tapered for easy insertion, and it was then driven in on the flat side of the shaft. The key was about $\frac{1}{32}$ in. wider than the flat, so that it took good hold in the wooden pulley. The motor was then set up, and a simple toolrest made as shown; then, by connecting the motor to the current and using a wood-turning gouge, the face of the pulley was crowned as well as it could have been done on the lathe.—Edwin J. Bachman, Fullerton, Pa.

Mounting Knife Switches in a Safe Position

By removing the unprotected knife switches from the front of the back of the lathes, a large manufacturing concern has,

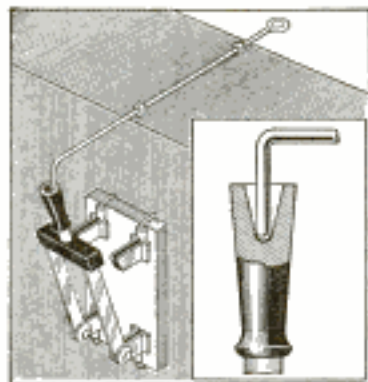

at small expense, done away with a constant source of danger to its workmen. Mounted on the back of the tool-cabinet end of the lathe, as indicated in the drawing, the switch is out of reach of the operator and is operated by means of a rod over the top of the cabinet. This rod is fastened by ordinary staples, or screweyes,

so that it may slide freely. The end of the rod behind the cabinet is bent at right angles and fits loosely into a hole drilled in the end of the switch handle. The end of the rod that projects in front of the cabinet is bent into a ring, or fitted with a convenient knob or handle.—Clementine Paddleford, New York City.

Gauge for Grinding Milling Cutters

To grind the tooth face of formed milling cutters, the work is, as a rule, held on a stud fastened to the grinder table.

In order to keep the form of the cutter true, it is necessary to set the stud central with the face of the grinding wheel. The gauge shown in the drawing forms a handy means of aligning the stud; it is made from flat steel, cut to form a "V,"

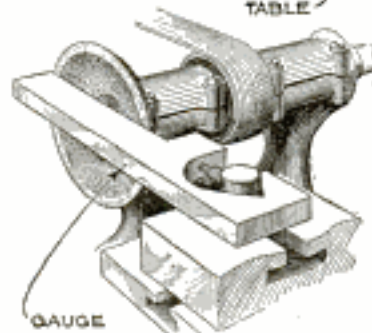
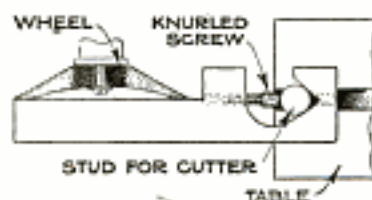

with the flat face that touches the wheel in line with the apex of the angle. The gauge is drilled from the V-end and tapped for a knurled screw which holds the device to the stud. As studs of different diameters are required to accommodate different cutters, the V-construction referred to automatically takes care of this. In use, the gauge is slipped over the stud, and the screw is turned out until it grips the latter lightly. This leaves the operator's hands free to adjust the table, which, of course, is set correctly when the face of the gauge is touching both sides of the grinding wheel. Stock about $\frac{3}{8}$ in. thick will be found best for a gauge of this type.—Harry Moore, Montreal, Can.

Sunken Joints in Furniture Panels

A defect in manufacture known as a sunken joint is sometimes noticeable in thick panels, especially tops of tables, desks, and other pieces of furniture. This defect appears as a long shallow depression in the surface, and may be very conspicuous when viewed at certain angles.

In modern practice, furniture tops are

generally built up of five plies of wood, consisting of a thick core, cross-banding, and faces. The core is usually made of a number of pieces of lumber glued together, and investigation proves that the defect in question occurs over the joints in the core stock.

It has been found that too rapid progress in the preparation of the core is the basic cause of sunken joints. The wood next the joint absorbs moisture from the glue and swells. If insufficient time is allowed between the gluing of the joints and the surfacing of the core, which is the next step in manufacture, more wood will be removed at the joints, because of the greater swelling there than at intermediate points. During subsequent drying and seasoning, greater shrinkage takes place at the joints, causing permanent depressions.

The remedy for sunken joints is an extension of the seasoning period between gluing and planing. The proper length of this period will vary with the thickness and species of wood, and with atmospheric conditions, but it should be long enough to allow the moisture added by the glue to evaporate, or to distribute itself through the wood.—U. S. Forest Products Laboratory, Madison, Wis.

Ball-Check Valve Made from Screw

There are many cases in which a small ball-check valve could be used to advantage in experimental work, or even for constant service. Such an article is carried in stock by but a few dealers, and

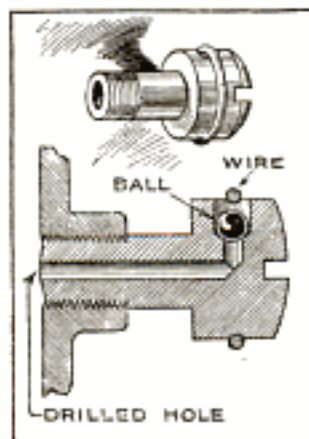

it is consequently more or less difficult to obtain. The drawing shows how an ordinary machine screw can be made into a thoroughly serviceable check valve, with a minimum of trouble, by drilling a small hole along the axis of the screw body, to the center of the head, where it intersects

a similar hole drilled at right angles. The latter hole is counterbored to take a steel ball of the right size, and this is prevented from coming out by means of a wire ring which fits into a groove filed or turned in the circumference of the head.—G. A. Luers, Washington, D. C.

Universal Soldering Copper

The trouble with the ordinary fixed-handle soldering copper is that it is impossible to use it to the best advantage in cramped places and corners, this shortcoming being most apparent in soldering the seams of tanks and similar work.

For this particular class of work, the flat, broad point shown in the drawing will be found the best.

By drilling the rear end as shown, and tapping it to fit a threaded $\frac{3}{8}$ -in. handle, three different positions of the head are obtainable, and by tightening the locknut, the head is held firmly. The sizes given in the drawing are for a general-utility copper, one that will hold its heat for a long time. One such universal tool will take the place of three of the solid type, and will reduce the weight of the journeyman tinsmith's tool kit.

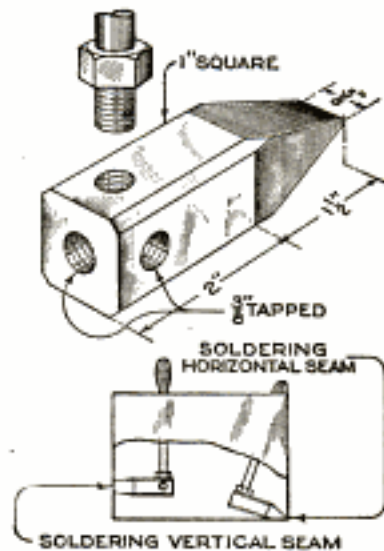

Locking Cotter Pins

Link connections on the carburetor and spark-lever controls of an automobile are usually held in place and prevented from becoming loose by cotter pins. However, as these parts are often disconnected, which requires that the ends of the cotteners be bent back and forth, the result is that the ends break off after using a few

times. The modified cotter pin shown in the drawing avoids the necessity of bending the points for insertion or removal, yet provides a perfect lock. These pins are made by cutting off one end of the cotter and bending the other back, as shown in the drawing. The bent end is sprung out enough to catch against the link, so that the cotter cannot come out.

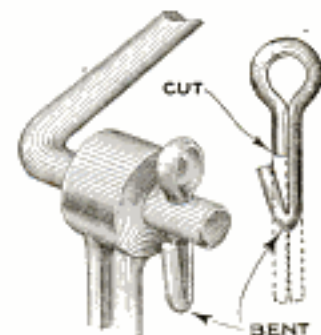

Holding Round Stock in Vise

A handy fixture for the shop holds round stock in the vise at any angle, so that the work cannot slip. The body of the device is made from a 3-in. disk of cold-rolled steel. This disk is drilled and counter-bored in the center for a fillister-head screw, and V-grooves are cut across the face, starting with a deep groove and finishing with a shallow one suitable for holding very small pieces of drill rod and similar work. To complete the attachment, a piece of $\frac{1}{2}$ -in. flat stock is bent to the shape of the vise jaw, and drilled and tapped to take the screw that holds the revolving disk. The opposite jaw of the vise can be covered with an ordinary copper clamp, if it is desired to avoid marring the work.

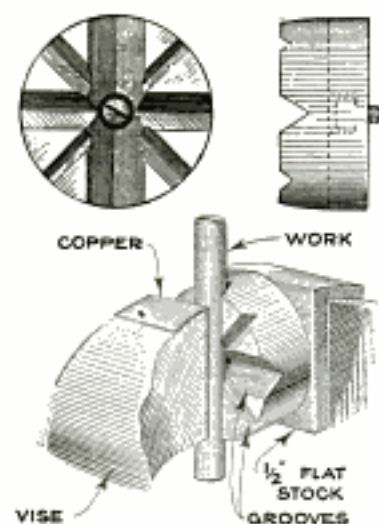

holding very small pieces of drill rod and similar work. To complete the attachment, a piece of $\frac{1}{2}$ -in. flat stock is bent to the shape of the vise jaw, and drilled and tapped to take the screw that holds the revolving disk. The opposite jaw of the vise can be covered with an ordinary copper clamp, if it is desired to avoid marring the work.

Ball-Grip Drill Chuck

A drill chuck for holding small drills up to $\frac{1}{8}$ in. in diameter is a convenient article of shop equipment, but one not always at hand.

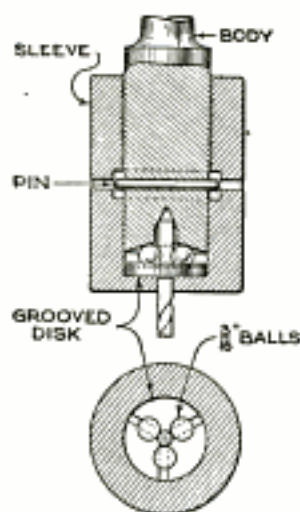

The chuck shown in the drawing can easily be produced in the average small shop, as it has no intricately shaped parts.

The body is made of $\frac{3}{4}$ -in. cold-rolled round stock, is turned on the shank to suit the drill-press spindle, threaded, drilled with a long-pointed $\frac{1}{8}$ -in. drill, and drilled for a stop pin, then beveled

as shown, the completed piece being case-hardened. Three $\frac{3}{16}$ -in. steel balls are required, as well as a disk with three radial grooves, about $\frac{1}{16}$ in. deep, for the balls to rest in, and to keep them equally

spaced. The sleeve is bored out to accommodate the grooved disk, which has the same outside diameter as the body, is tapped to fit the threaded portion of the body, and recessed to clear the stop pin. This pin is necessary to prevent the sleeve from being screwed too far down, and allowing the balls to slip out of their grooves.

Soap as a Lubricant for Drilling

A bar of common laundry soap makes a good lubricant for the drill when cutting holes in fibrous materials, such as red or black fiber, and similar substances. The soap is held against the drill point occasionally, and prevents the chips from packing around the drill, which would cause heating and binding. With soap as a lubricant, the chips feed readily up the flutes of the drill, regardless of the depth of the hole. The same lubricant can be used when tapping.

Stop for Taper Reamers

When using taper reamers with a stop attached to the reamer itself, a solid stop consisting of a metal ring reamed out to the size required is generally used. This makes a good stop, but it has the distinct disadvantage of being useful for but one particular size or depth of cut, and if a cut even $\frac{1}{16}$ -in. deeper is to be taken, it is necessary to use another stop, or ream out the first one. Various depths are required

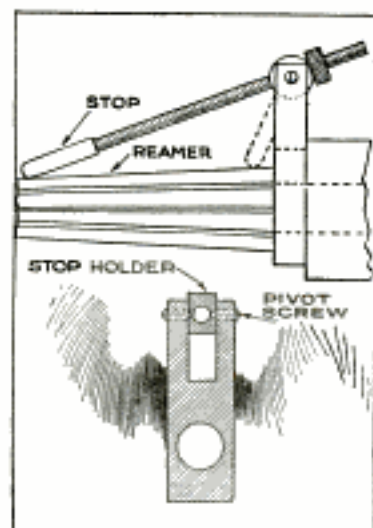

on one reamer, and the adjustable stop illustrated was designed to meet such requirements. The main part of the attachment is made from a block of tool steel, drilled at one end to fit over the shank of the reamer, the opposite end being slotted

to take the stop holder, which is a small steel disk, with small centers on its sides, and a hole drilled and tapped through its center for the threaded stop. The stop holder is held in place by two screws, the pointed ends of which fit into the centers.

The stop proper is made from a piece of $\frac{5}{16}$ -in. drill rod, rounded at one end, threaded to fit the tapped hole in the stop-holder block, and fitted with a knurled locknut.

When in use, the device is slipped over the reamer shank, which is then inserted in its holder, or wrench, the attachment being held tightly between the reamer and face of the holder. To set the reamer for any desired depth of cut, the stop is screwed in or out, and the adjustment held by screwing down the knurled nut. The single round end of the stop makes an ideal stop, as the cuttings do not collect around it as in a solid stop, and when correctly set, the rounded end will lie snugly in one of the reamer flutes.

Making Special Sewer-Cap Castings

A change from the standard in the curbing and paving of a certain street

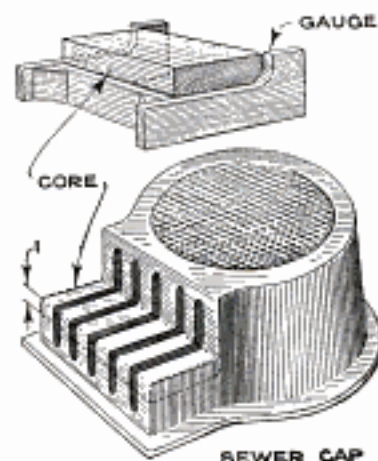

called for an alteration in the standard sewer-cap casting; 10 of the altered caps were needed. The road step was to be 1 in. lower than in the original pattern. There were two patterns made for this job, a wooden master pattern and a cast-iron working pattern. The patternmaker suggested that the wooden pattern be altered to correspond to the change in requirements, but to do so meant quite an expense, and besides, the covers made from the metal pattern would not fit the holes in the castings produced from the altered pattern.

Instead of altering the pattern, the job was taken in hand by the foundry foreman who made the castings with a minimum of trouble. A frame of 1-in. lumber was made to fit the ends and front of the mold 1 in. below the top. This frame formed a guide in cutting 1 in. off the top of the mold along the dotted lines. Then 1-in. slab cores, taken from stock, were cut and filed to the required shape. These cores were placed in the molds in place of the material previously removed.

With a correctly made gauge, and a core box to produce the cores, the making of the castings was very simple.

Fixture for Relining Brake Bands

The fixture shown in the drawing, which is of particular usefulness for relining the brake and transmission bands of automobiles,

consists of a piece of shafting on which brake and transmission drums of the commonest sizes are mounted. Brackets at the ends support the shaft, and make it possible to revolve the drums. In use, the brake band to be relined, together with the strip of new brake lining, is placed over a drum of the proper size, and clamped. The split rivets, after penetrating the brake lining, strike the face of the drums and spread, clinching the lining tightly to the brake band.

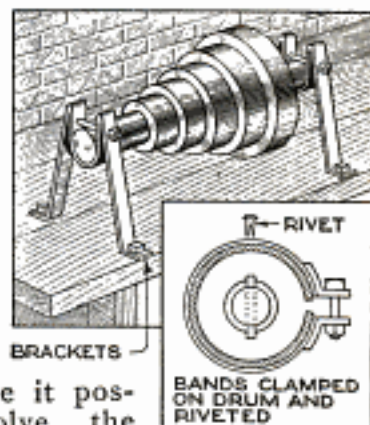

Micrometer Lock for Repetition Work

When gauging repetition work, or finishing work that requires constant testing with a micrometer, it is necessary to have some means of locking the sleeve of the instrument, else the setting must be examined and perhaps adjusted every time it is picked up. Large numbers of micrometers are not provided with locknuts, and the simple device shown in the drawing is designed for use in such cases.

An L-shaped piece of cold-rolled steel stock, $\frac{3}{8}$ by $\frac{1}{2}$ in., is slotted at one end to fit the frame of the micrometer very closely, and bored at the opposite end to make a neat fit for the sleeve. A slot is sawed through the hole, and a hole drilled and tapped to take a $\frac{1}{16}$ -in. knurled-head screw. The lock is placed on the micrometer as shown in the drawing, and tightened in position when the sleeve is adjusted to the proper measurement. On some micrometers the knurl on the sleeve extends down almost to the graduations; in this case, of course, the hole in the clamp is bored to fit the outer diameter of the knurls.

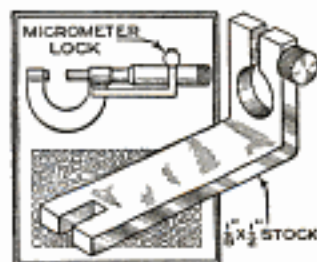

Homemade Cylinder-Reaming Machines

By L. R. PERRY

THE owner of any auto-repair shop can easily and cheaply build a cylinder-reaming machine from parts rescued from the junk pile, or obtained from the automobile "graveyards" of the larger communities. Practically any make of engine cylinder can be reamed with these devices, using stock reamers of the expanding type.

In Fig. 1 is shown one of the simplest

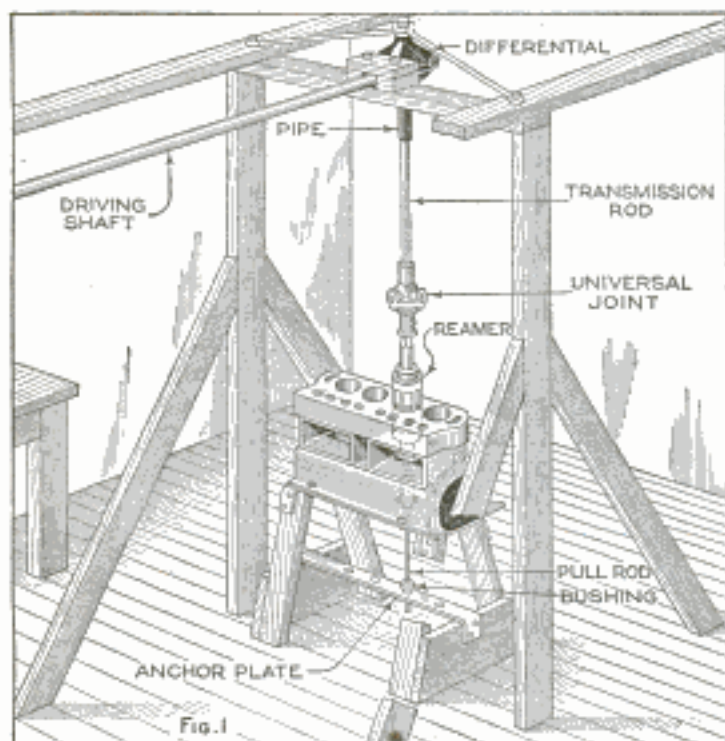

Above: The Simplest Type of Cylinder-Reaming Machine. The Feed is Obtained by the Pull Rod, Working through a Bushing Screwed into the Anchor Plate. Right: Reaming Cylinders in the Drill Press. The Insert Shows How the Reamer is Connected to the Drill-Press Spindle

machines, the important features of which are the universal joint and the pull rod. A wood-and-steel horse is first built, along the lines indicated, to support the cylinder block while being reamed; the block is bolted down to the flat-steel bars forming the top of the horse, or stand. The short bars at the ends may be given a downward curve between the legs of the stand so that the crankshaft can be swung into place, if desired. An anchor plate, of $\frac{5}{8}$ by 2-in. stock, is bolted or screwed to the stand as shown, and drilled with four holes, each accurately centered under one cylinder. These holes are tapped to receive a $\frac{1}{2}$ by $\frac{1}{8}$ -in. pipe bushing, which serves as a feed nut, and causes the threaded pull rod to draw the

reamer into the work. It is important that the thread on the pull rod be quite fine, such as the $\frac{1}{8}$ -in. standard pipe thread. The pull rod itself may be a piece of $\frac{1}{8}$ -in. pipe threaded for the proper distance, but a piece of cold-rolled steel, with a $\frac{1}{8}$ -in. pipe thread cut in the lathe, would be better. Another piece of $\frac{1}{8}$ -in. pipe, 5 in. long, and threaded at both ends, is screwed into the lower end of the reamer. This is connected to the pull rod by means of a sleeve, which is screwed to the reamer pipe; the lower half of the sleeve is reamed out to make a free fit over the end of the pull rod, and the latter is held in place in the sleeve by a heavy cotter pin. The reamers used are tools of standard manufacture, and are obtainable in various sizes. The guides furnished with most cylinder reamers of this type must always be inserted in the top and bottom

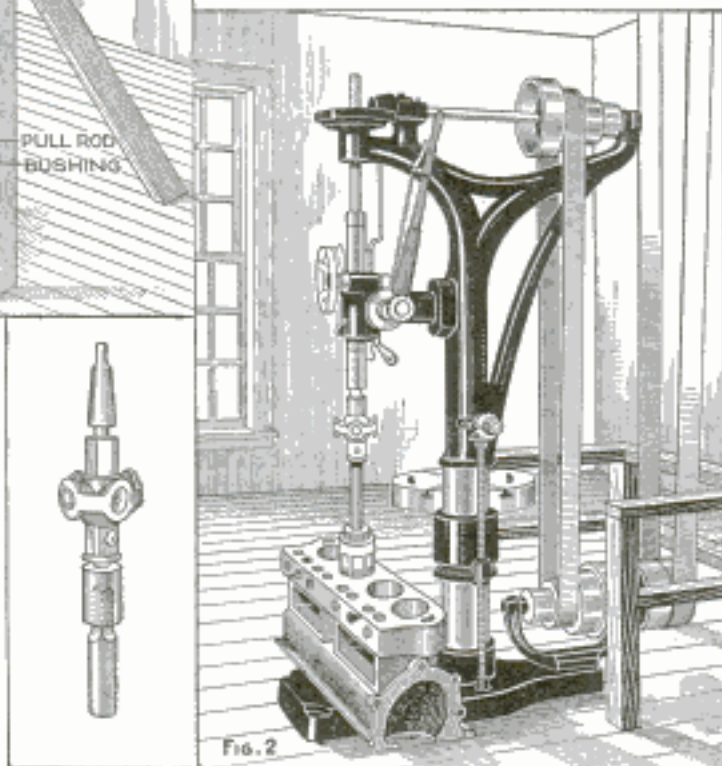

of the cylinder before starting to ream. An interesting feature of this machine is the driving mechanism. The source of power is optional, but the speed should be uniform, and should be such that the reamer will not make more than 15 or 20 revolutions per minute. The builder of the original machine used a 4-hp. gas engine to drive it, clamping a small pulley to the side of the flywheel, and running

a belt from this to a large pulley on a countershaft. Another belt conveyed the power from a small pulley on this shaft

being bolted to the bed of an ordinary drill press. A standard taper shank, fitting the drill-press spindle, is connected

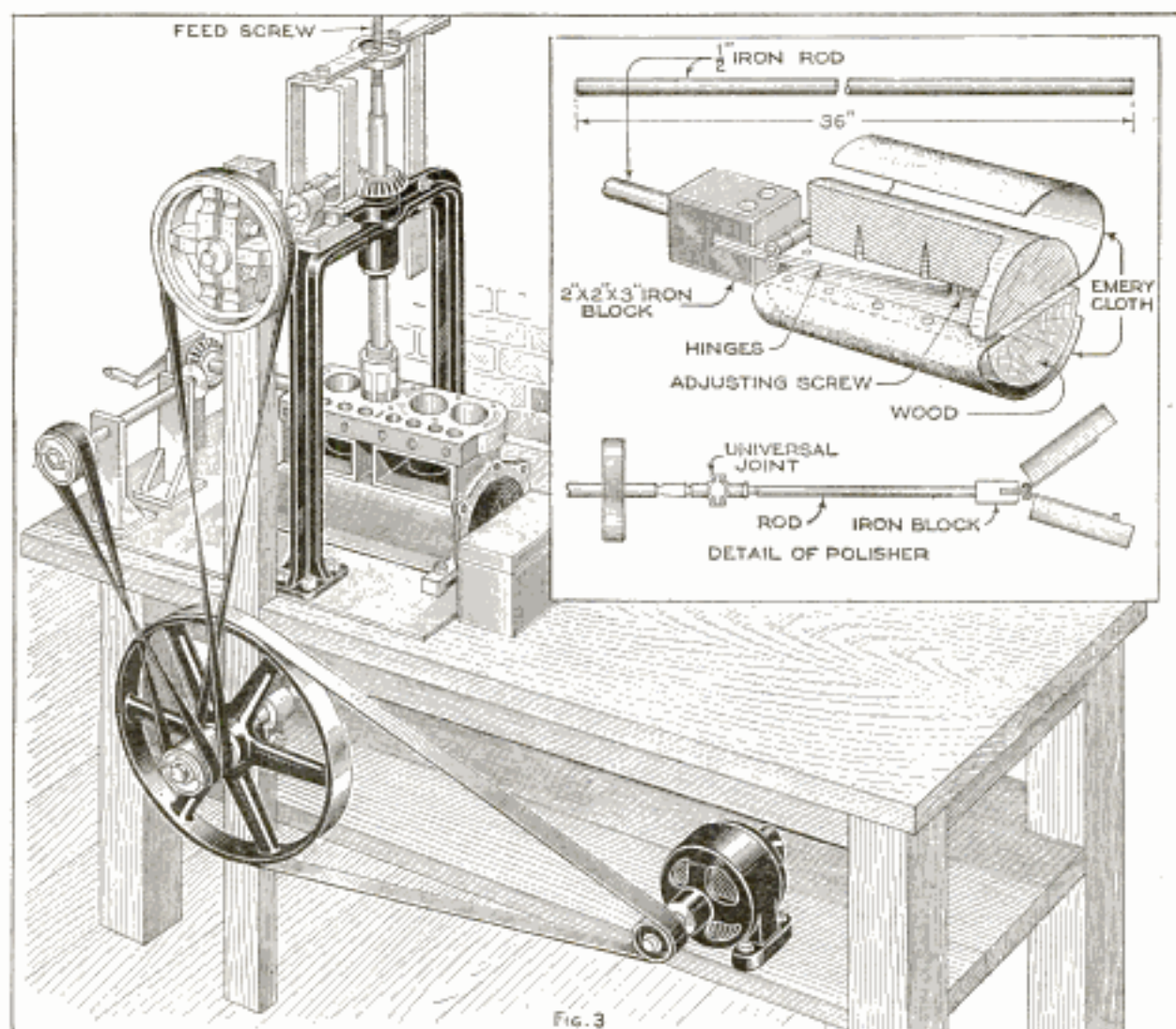

FIG. 3

Assembly View of a More Elaborate Homemade Reamer: No Universal Joint is Used in This, as the Frame is Aligned Accurately with the Block. The Insert Shows a Cylinder Polisher That may be Used in Any Type of Machine: It is Provided with a Universal Joint, to Allow It to Float in the Bore

to a large pulley clamped to a discarded motorcycle wheel, which was fastened to the driveshaft. The drawing shows how the power from the driveshaft is transmitted to the reamer through the differential of a light automobile, with a universal joint between the vertical shaft and reamer, to take up any inequalities of alignment. The differential end of a left-axle shaft is cut off short, and a 12-in. length of 1½-in. pipe is brazed onto it; the lower end of the pipe has one of the square-socket ends of a universal joint brazed into it. This arrangement permits vertical movement of the square transmission rod, and makes it possible to feed the reamer down through the cylinder.

Another method of using the same type of reamer is shown in Fig. 2, the work

to one end of a universal joint in any desirable manner; the square end of the reamer shank can be fitted directly into the universal-joint socket, as shown. It is advisable that some form of universal joint be used when cylinders are reamed out in the drill press, as the spindles of many repair-shop drill presses are badly out of line, and the results depend altogether upon how well the drill spindle lines up with the cylinder bore. Slow speed and hand feed should be used.

A more elaborate machine, built by another auto repairman, is illustrated in Fig. 3. In this machine a casting is used for the frame bedplate and some other parts, but there is no reason why they could not be made from built-up parts. The work is bolted to a heavy cast-iron

bedplate, 2 in. thick, to which also the cast frame, which supports the reamer feed and drive gear, is fastened. No uni-

of the photographs gives a view of the cylinder reamer from a different angle, and also the method of reaming out

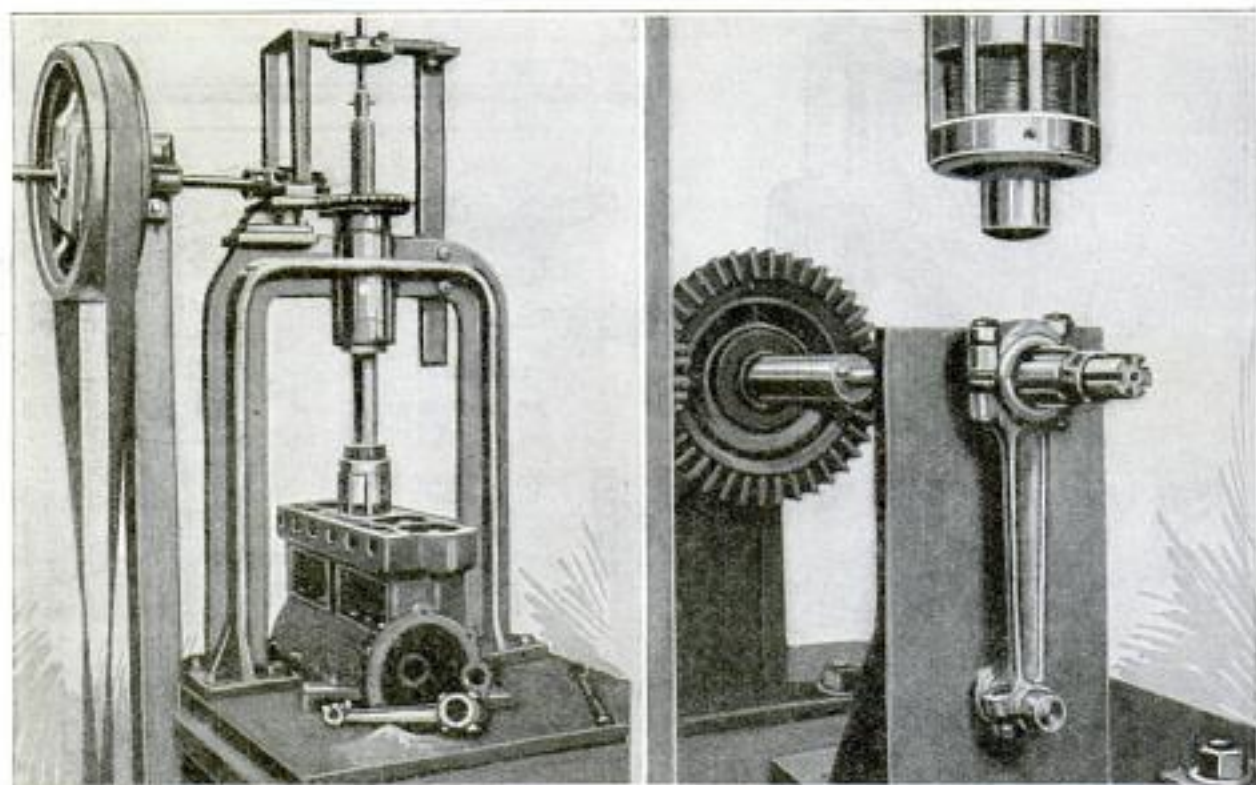

Left: Another View of the Machine Shown in Figure 3. The Connecting-Rod Reaming Fixture is Not Shown in This View, for the Sake of Clearness, but is Shown on the Right, with a Connecting Rod Mounted on the Angle Plate in Process of Reaming

versal joint is needed in this design, as the casting and cylinder may be accurately aligned. The reamer-spindle sleeve is splined so that it can be moved vertically, a key in the bevel gear causing it to revolve. The motor driving the machine is a $1\frac{1}{2}$ -hp. unit, running at 1,800 r.p.m. The motor pulley is $1\frac{3}{8}$ in. diameter by $2\frac{1}{2}$ in. face; this drives a 26-in. pulley, keyed to a countershaft running in boxes under the bench. On the same shaft is a 4-in. pulley, and a belt from this runs to a 16-in. pulley on the bevel-gear shaft; the bevel gears are taken from the differential of a light car. The reamer is fed into the work by a handle, mounted on a threaded extension of the spindle; this is $\frac{3}{4}$ in. in diameter and is cut with a $\frac{1}{16}$ -in. pitch thread. Another feature of this particular device is a connecting-rod reaming fixture, which is partially illustrated in the drawing, and more fully in one of the photos. The connecting rod is merely slipped onto a stationary wrist-pin or stud in the vertical face of the angle plate of the fixture, and the reamer is inserted through the crankpin end. The connecting-rod reamer is fed into the work by a hand feed, identical with the one used with the cylinder reamer. One

the crankpin bearings of connecting rods, with a rod in place on the fixture.

The insert in Fig. 3 illustrates a polisher for finishing the reamed cylinders, and giving them a perfectly smooth surface. The iron rod is threaded at one end and screwed into an iron block, and a pair of hinges are riveted into a slot cut in the opposite face of the block. A wooden cylinder, turned to fit loosely in the cylinder bore, is cut in two, and the separate halves are fastened to the free ends of the hinges. Sheets of very fine-grained emery cloth are attached to the blocks, as shown, so that the whole can be inserted into the cylinder and turned in one direction without doubling up the cloth. The blocks are made adjustable for cylinders of slightly varying diameters by an adjusting screw in the flat face of one of the blocks. While primarily designed for use with the device shown in Fig. 1, the polisher can be adapted for use with the other designs, and can also be used horizontally.

☛ A convenient anvil, horse, or trestle for many uses is made by using a suitable length of old steel rail to form the top crosspiece.

Multicolored Printing

Some very pretty multicolored printing can be done on an ordinary platen job press without any expensive attachments. In the first place, the ink platen must be fixed so that it does not move when the press is in motion; this is accomplished by tying the pawl that revolves the platen at each impression. Then inks of different colors are put on the platen in the form of dots running in a row parallel with the top of the chase. Care must be taken not to put too much ink on the platen at one time, or it will spread too far and spoil the effect. By starting the press and letting the rollers work over the platen, the ink will be distributed over it in parallel columns running at right angles to the top of the chase. As the ink is used up, a little more of the same color must be put on, care being taken to guard against using too much. The printing done by this method will have a rainbow effect that is quite pleasing.—Russel Raymond Voorhees, West Hoboken, N. J.

Old Fork Places Small Screws

Some useful and labor-saving tools can be made from old table forks, the photograph showing such a tool that facilitates

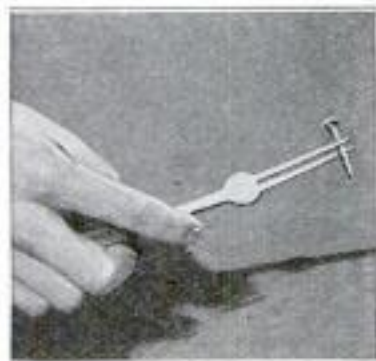

replacing of small screws and bolts in positions that would be practically inaccessible by other means. A fork that has seen better days will make just as good a tool as a new one, when it is flattened out and the outside tines ground off, leaving just two at the center, as in the picture.—John H. Schalek, Pittsburgh, Pa.

Blower Reduces Cost of Concrete Aggregate

A western roadbuilder has devised a simple attachment for a gravel screen that enables him to get a uniformly fine aggregate from near-by gravel banks, thus saving the cost of transporting a higher-grade material from a distance, as was at first thought necessary. The equip-

ment is so simple that the same idea can doubtless be used in many similar situations.

The apparatus consists of an ordinary bucket conveyor that elevates the sand

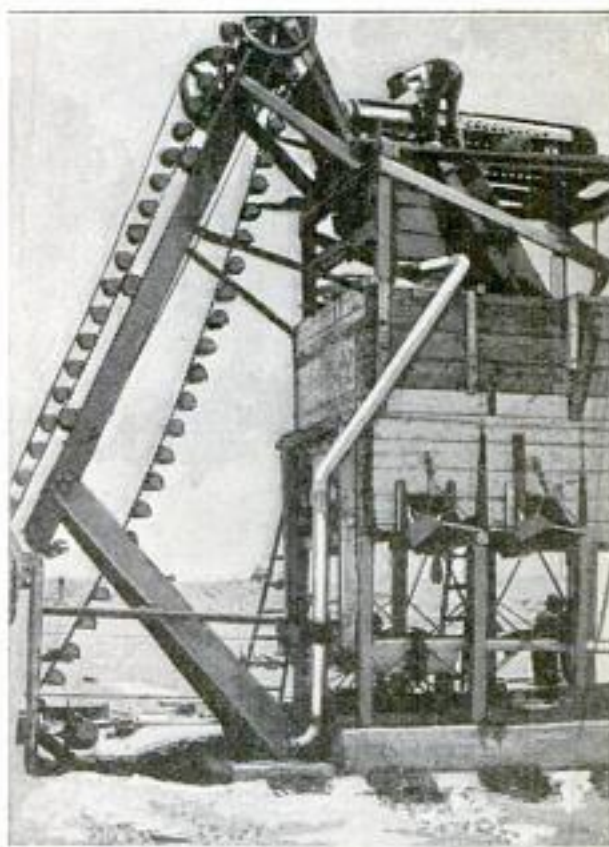

Blowing the Light Material from Sand and Gravel, as It is Screened, by an Air Blast to Make It Conform to Certain Specifications

and gravel to a revolving cylindrical screen, through which the material that will pass through a $\frac{1}{4}$ -in. mesh is discharged into a hopper. This hopper, placed under the screen, collects the screened gravel, and passes it, through a slot, 2 in. wide and 13 in. long, into a bin underneath. As the material pours into the bin in a stream of uniform width and thickness it is met by a blast of air from a centrifugal blower.

The exact amount of fine material that is thus separated from the coarser can be accurately controlled by a pressure regulator. A few tests will demonstrate the proper amount of pressure to use for the air blast.

The blower is installed at the base of the elevator; and is operated by a belt from the gas engine that drives the latter. One point must be borne in mind if satisfactory results are to be obtained: The gravel must be dry. In many cases the cost of drying the gravel can be kept so low that the use of this simple arrangement is highly desirable.

A Simple Scale Holder

When laying out work set up on the surface plate, some kind of scale holder is usually employed to hold the scale in a vertical position, with its end resting on the plate, so that measurements may be transferred from it to the work by means of the surface gauge. While the combination-square head is generally used for this purpose, homemade holders are also popular, but since in most

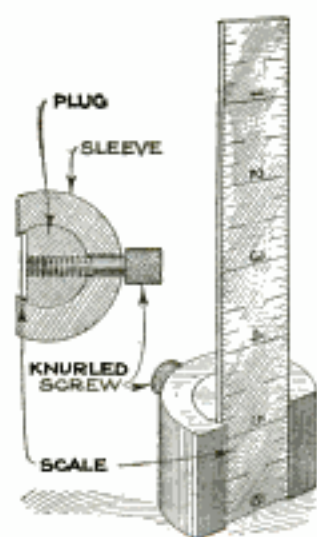

cases the scale is not adjustable, it often happens that the first mark scribed on the work is not an even number of inches above the plate, but is a mixed number, say $5\frac{17}{32}$ in. If other lines are to be scribed above and below this line, and located from it, it is very easy to make a mistake in setting the scriber to a

fixed scale. A better way is to mark the first line with the end of the scale resting on the plate, and then set the scale to some even inch, corresponding to the height of the surface-gauge scriber. Then it is only necessary to take dimensions from this inch mark, thus avoiding confusion.

The scale holder illustrated herewith holds the scale securely at right angles to the plate, allows the scale to be adjusted vertically, and, moreover, is easily made, as no delicate machining, to get a correct line-up when assembled, is required. The holder is made in two pieces, a plug, 1 in. in diameter, and a sleeve or collar that fits neatly around it, the latter having an outside diameter of about 2 in. The plug is then machined flat on one side, until the scale will just slip between it and the sleeve, in the manner shown. The sleeve is also cut away to expose the scale. The two parts are then clamped together, and a hole is drilled and tapped for the knurled tightening screw. A holder made to the dimensions given will be heavy enough to hold a 12 or 24-in. scale solidly. A small brass plug is placed in the tapped hole in front of the tightening screw, so that the scale will not be injured; little pressure is required to hold the scale in any position.

Repairing an Engine Water Jacket

Many gasoline engines, upon the water jacket becoming cracked, have been put out of commission for indefinite periods, until a new casting could be obtained from the factory, or the broken one welded. There is a simple method of making a repair, however, that will put the engine back into commission in a short time.

Take a narrow square-pointed chisel, and cut along the crack to make a narrow channel in the casting. Fill this channel with a little white lead and then lay in a piece of copper wire, a little larger in diameter than the width, and slightly longer than the length of the channel. The wire is forced into the channel by means of hammer and punch, completely filling it and making a smooth job.—Wm. J. Douglas, Missouri Valley, Ia.

Keyway Re-Dressing Broach

When repairing or overhauling old or secondhand machinery one generally finds that the keyways are more or less banged up, and to put them into proper shape for further use they must be straightened up on the sides and fitted with new and wider keys. To dress up a damaged keyway is quite a job, and to do it properly, without taking the work to a machine shop, requires some fine, accurate handwork. To eliminate this handwork, yet obtain a perfect-fitting job, the broach illustrated was designed. The broach proper is made of good tool steel and has teeth cut on one face, as shown, $\frac{1}{4}$ -in. screws holding it tightly against a mild-steel shank. The proper adjustment is obtained by the insertion of paper shims between shank and tool. The broach should be hardened and drawn to a straw color, care being taken when hardening to pack the holes in order to prevent cracking.

In actual use, select the good side of the keyway, place the face of the shank against this side, and set up the broach

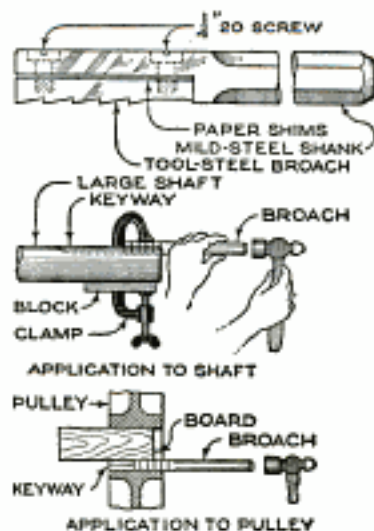

with paper shims until it takes a light cut. Oil the cutting as well as the rear sliding surfaces and drive it through the keyway with a hammer. If the broach has a tendency to rise, hold it down with a C-clamp, which will follow along if not screwed too tightly. Internal keyways are treated in the same manner, using a block to keep the broach down in the keyway. When fitting a key, care should be taken to have it fit well on the sides as this is more important than having it fit at top and bottom. Rather than depend on the taper for holding the key, use a setscrew and get a good side fit.

Straightening Heavy Springs

After the loop has been bent, on heavy spiral springs made by hand, it is generally found that the spring is bent, and to straighten it by hand is often impossible owing to the great strength of the wire. A good way to do this job is to use a cross-peen hammer. The spring is laid on an anvil, or plate, convex side down, and the wedge-shaped hammer is driven between the separate coils, as shown in the drawing. This will open up each coil just a trifle so that the spring can be easily straightened. If a spring has been wound too closely, it can be opened up by peening all around until the desired tension is obtained.

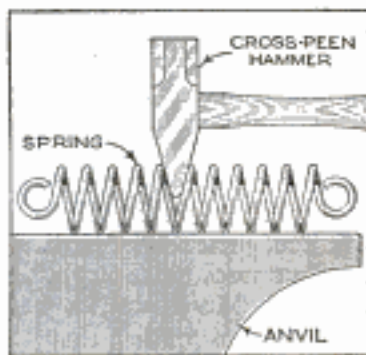

Cleaning Belts of Oil

Leather belts can be cleaned of an accumulation of machine oil and grease by first scraping off all gum and glaze from the belt with a putty knife, or other scraper, the edges of which have been rounded off to prevent cutting or scratching the leather. Then the belt is spread on a flat surface and first one side, then the other, cleaned by the vigorous application of clean, dry sawdust with a clean, stiff broom, or brush, whereupon it is packed in fuller's earth, fine sawdust, or powdered chalk, and allowed to remain for several days in a warm room. Practically all of the oil and grease in the belt will be absorbed by the packing material.

Sawhorse for Uneven Floors

Frequently the woodworker finds it necessary to work in a shop with a rough or uneven floor, where it is almost impossible to locate a sawhorse so that all four feet will bear solidly on the ground. A convenient method of overcoming this difficulty is to use a three-legged horse of the type shown in the drawing. This sawhorse will stand solidly on a very uneven surface, and all rocking and swaying are eliminated. For the craftsman working on small jobs, in which a great part of the sawing is done on one horse, it is well to use a solid top piece, 5 or 6 in. wide, as shown.—Geo. N. Weaver, Indianapolis, Ind.

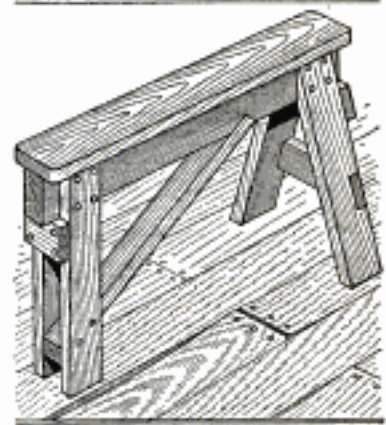

A Patternmaker's Hammer

A patternmaker's hammer is always admired by woodworkers, and justly so, as it is a very sensible and well-balanced tool. The small end is just the thing for setting sprigs and small nails, while the large end is heavy enough to drive them home. The hammers are generally homemade, in two sizes, small and large; the small one, being the most popular, is the one described, and is very easily made from a piece of cold-rolled steel. The piece is centered as in the drawing and turned up in the lathe, throwing the tailstock over to get the correct taper, and polishing all over. The head is then drilled and the slot cut for the handle. After this is done, the hammer is bent, making the drop of the small end about $\frac{3}{8}$ in.

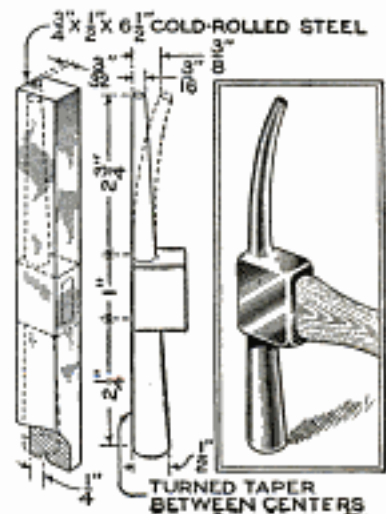

The hammer is finished by heating it to a cherry red and sprinkling powdered cyanide of potassium (poison) over the whole surface. Sprinkle the head and rear tip most, as these must be the hardest, and quench in cold water. The cyanide will melt and run over the whole surface, giving the head a very beautiful mottled finish that also prevents rust.

A Simple Tool Handle or Pin Vise

The drawing shows a simple form of tool handle suitable for holding files, screwdriver blades, drills, and similar tools, or used as a hand vise, for holding small pins, screws, or other parts. It is made in two pieces and consists of a clamping nut and a handle. The

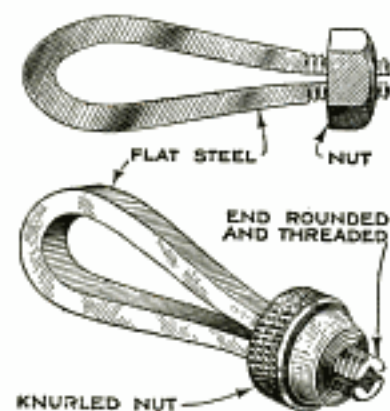

clamping nut is made with a taper thread, and the handle is formed from flat-steel stock, bent as shown and ground down sufficiently to permit threading with a pipe-threading die. Two different styles are shown, one involving the use of a lathe to produce the knurled and turned nut, while the other uses an ordinary hexagonal nut to clamp the jaws.

Stresses in Laminated Wood Construction

The use of heavy and light material of the same species in laminated or glued-up wood construction has less injurious effect than has been generally supposed. Laminated-wood specimens under observation at the Forest Products Laboratory, at Madison, Wis., show little weakening or tendency to warp from this cause. Most warping and checking in laminated construction can be traced to one of two causes. The first is the use of plain-sawed and quarter-sawed lumber in the same construction, and the second is the combination of material of different moisture content.

Plain-sawed lumber of any species shrinks and swells more than quarter-sawed lumber; and when the two kinds are glued together, they pull against each other with every change in moisture con-

tent. If the block containing such a combination is kept for a long time in the same atmospheric conditions, the stresses die out, because the block checks or changes shape more or less to relieve the stretched condition of its fibers. As soon as the atmospheric conditions change, new stresses will be set up.

If boards of different moisture contents are glued together, internal stresses will result from unequal shrinkage of the boards, as their moisture contents equalize through seasoning. In some blocks made at the laboratory, these stresses were great enough to rupture the wood. If the wood is not ruptured, the stresses will in time permanently disappear, but the block will have changed its shape somewhat in getting rid of them.

From these facts it becomes apparent that for laminated-wood articles, where strength and accurate shape are required, it is desirable to use all plain-sawed or all quarter-sawed material, to have all pieces of a uniform moisture content when glued, and to prevent, as far as possible, subsequent moisture changes by means of moisture-resistant coatings. For the manufacture of rougher articles, where slight changes in form are of no consequence, these precautions are of less importance, although, by paying some attention to them, a better product will result.

Preventing Breakage of Milling Saws

When cutting stock clamped to the table of a milling machine, the burr caused by the saw has a tendency, when the cut is completed, to catch and

draw the cut stock under the saw, with the result that the saw is broken. The attachment shown in the drawing consists of a flat-spring finger, inserted into a steel block,

which is bolted to the table of the machine. When the stock has been set, ready for cutting, the spring is adjusted against the work in such a manner that, as soon as the saw completes the cut, the spring will straighten out and push the cut-off piece clear of the saw.

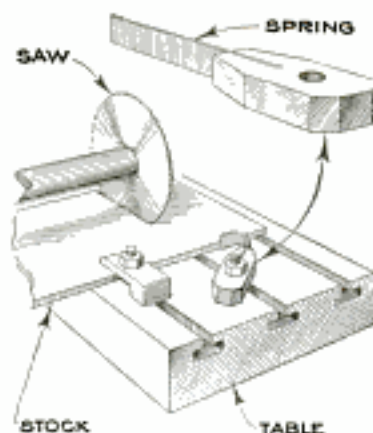

White Lead Locks Nuts

Many machines, notably agricultural implements, are not fitted with cotter pins to prevent bolts and nuts from loosening. Under continued use, the nut loosens and drops off, or rusts solidly in place, making it difficult to remove. A liberal coating of white lead applied to the threads before screwing-on the nuts, prevents each of these conditions. The white lead will harden and lock the nuts, rust is prevented, and the nut can be removed with a wrench. The white lead is also effective as a lock washer when the face of a nut is in contact with wood.

Gauge for Dividing Circles

A novel gauge, designed to divide a circle into equally spaced parts, for drilling or other operations, is shown in the drawing. A disk of $\frac{1}{4}$ -in. iron plate is drilled and reamed at the center for a

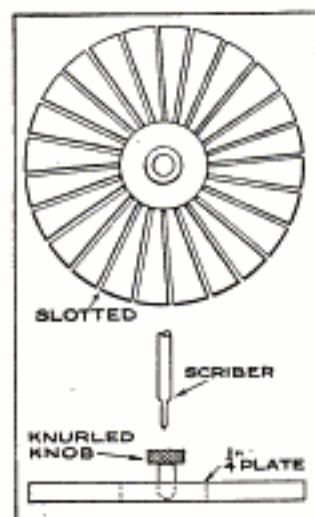

knurled-head centerpiece, the bottom of which is pointed, and cut down on the outside to any diameter desired. Mounted on a short arbor, the plate is next slotted in the milling machine, 24 slots being milled with a $\frac{1}{16}$ -in. saw. A special scriber or scratch awl is required for use with the gauge; the point of this should be filed flat near the end to fit into the slots. With the centerpiece of the gauge in the center of the circle to be divided, press the gauge down firmly and run the scriber through the desired slots. If the circumference is to be divided into, say, eight equal spaces, make a fine chalk line across every third slot to avoid confusion. If the circumference required to be divided is larger than the gauge, proceed as above and then extend the lines with a scale until they intersect the periphery of the circle.

☐ Boiler feed water should always be preheated, not only because it saves expense, but because it causes much of the scale-forming material to be deposited in the heater instead of in the boiler.

Repairing a Worn Stuffing Box

As the end of the threshing season drew near, the valve-rod packing of a 20-hp. steam engine refused to remain in place, regardless of the kind of packing used or the method of using it. The reason for this was found to be that the gland and rod had become worn to such an extent that even a new gland would have afforded but little improvement. The worn condition of rod and gland left an opening between them, as shown at A in the drawing.

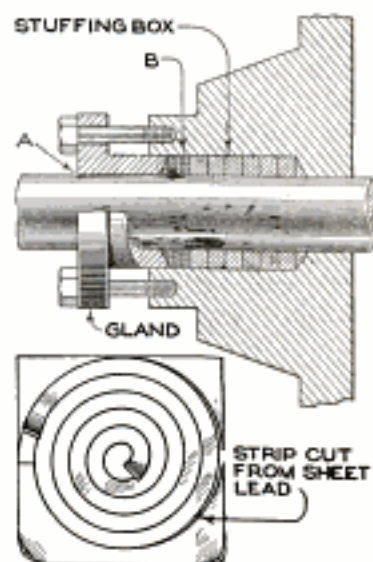

To remedy the trouble without removing the rod, a spiral strip was cut from a piece of $\frac{1}{16}$ -in. sheet lead. This strip was then formed around the rod in a continuous helix inside the gland, as at B, in such a manner that when forced up against the packing a tight solid-lead packing was obtained, which fitted the rod so snugly that the season's work was finished without further trouble.

A Taper-Turning Gauge

To make a good job of taper turning, the work should be completed to a gauge, or template. A taper-turning template that has some novel and unusual features is shown in the drawing.

As will be noted, the device is provided with a movable blade, which makes it possible to use the same gauge for various tapers. This blade is held to the body by a square-headed setscrew and a washer. The body of the gauge is not solid, but is relieved at the center; this makes allowance for any slight inaccuracy in the mandrel or work. The handle makes the gauge very convenient to use.

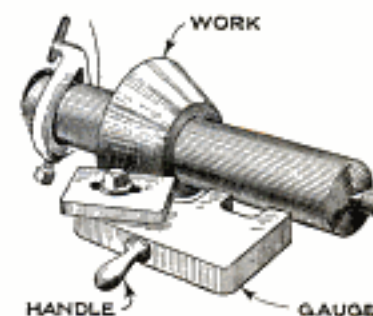

Overhead Drive for Lathe Attachments

By H. H. PARKER

UNLESS a small independent electric motor is available, some sort of overhead belt drive is required for the small lathe equipped with a tool-slide grinding head and milling or drilling attachments. Once such an installation is made, the range of the work that may be done on the lathe is greatly increased, and the time and labor spent in making it will be well repaid. As the overhead belt drive should be available for the whole length of the lathe bed, or the travel of the rest, a long straight drum pulley on the overhead shaft will be needed, but one running on a fixed shaft would be im-

scheme is to mount a pulley on the projecting end of the lathe countershaft extending toward the tailstock end of the machine. Then another shaft is installed in boxes on a line with the countershaft, but independent of it and extending the length of the lathe bed; this shaft does not rotate but only rocks, and has two swinging arms setscrewed, or pinned, to it. These must be well secured to the rocker shaft, and the shaft itself must be large enough in diameter not to twist under the tension of the drive belt when near the end of the drum. The countershaft and rocker shaft need only be in

approximate alinement; not lined up as though they were to be coupled together. Probably iron pipe and fittings will be the most available material for making the arms and other parts, the bearing housings being either tees or crosses filled with babbitt or bronze-bushed. Steel tubing, if obtainable, would be stronger and lighter. Castings, as shown in the drawing, could be used, or the arms might be built up of bar stock, with the bearing hubs bolted or riveted in place. For light work, the arms might even be made of hardwood. One arm is extended back, and an iron counterweight slides along this extension, or, if there is room, two

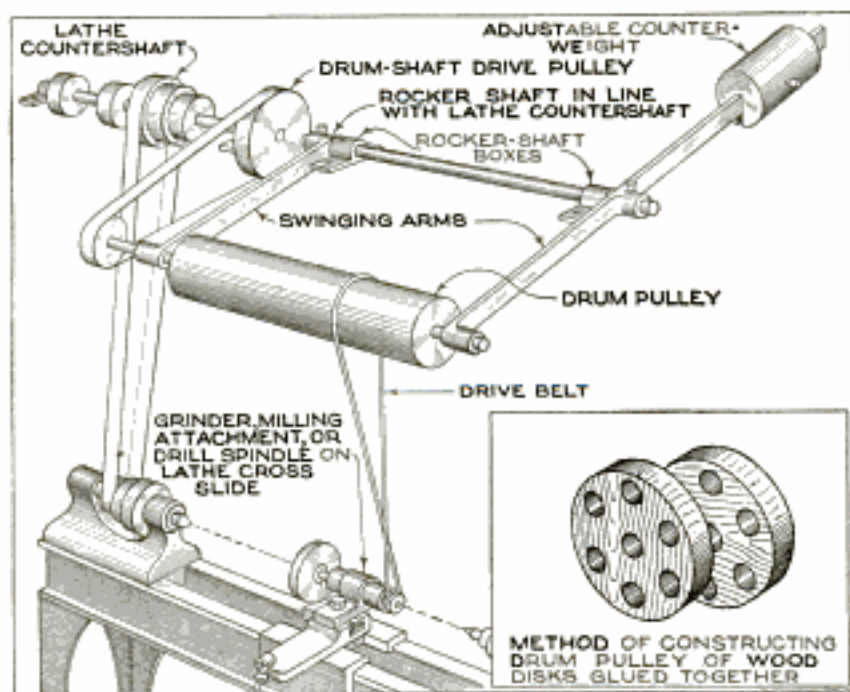

An Overhead Belt Arrangement for the Lathe Which Permits the Operation of Grinding and Milling Attachments throughout the Length of the Machine Bed. The Belt is Kept at a Uniform Tension by a Counterweight

practicable without some form of belt tightener to maintain an even tension on the belt, to allow the use of different lathe attachments, or when one is used that must be moved in and out laterally on the cross slide. The best way is to have the drum-pulley shaft swing up and down, with a constant upward tension on the drive belt furnished by an adjustable counterweight, thus doing away with an extra pulley as a belt tightener, which would require means for shifting it along with the lathe carriage.

The layout shown is merely suggestive, as the actual details of construction will necessarily be regulated by the lathe-countershaft installation, the type of lathe used, and the material and equipment at hand with which to do the work. The

arms and two counterweights would be better, owing to the more equal distribution of strain thus obtained. The distance between the rocker and drum shafts should be as short as practicable.

A pulley is placed on the projecting end of the drum shaft, and is driven by a belt from the pulley on the end of the countershaft. As the drum shaft swings up and down, the belt tension will be constant, since the counter and rocker shafts are in line. If these two pulleys are of the stepped type, the drum can be driven at varying speeds. One way of building up the drum from disks, turned from plank and bored with lightening holes, is shown. These disks are glued and nailed together with the grain of adjacent disks at right angles, assembled

on the shaft, and turned to the finished diameter as a whole, a blank disk being used at each end. Another way is to saw off a length of old spar or house-moving roller, bore a shaft hole for the full length, mount it on the shaft, and turn to size. Or a section of large pipe or well casing could be plugged with hardwood heads, then accurately bored and turned.

In case it is desired to operate the tool-slide attachment without rotating the lathe spindle, the headstock cone on the lathe should be set free, the back gears thrown out, and the cone allowed to run idly without moving the spindle. Either a round belt on a grooved pulley, or a flat one, running on a straight-faced flanged pulley on the driven apparatus, may be run over the drum. If a drive entirely independent of the lathe countershaft is desired, another countershaft in line with the rocker shaft and driven by a belt from the lineshaft, or from a separate motor, can be installed.

Countersunk Thumbtacks

T-squares have a disagreeable habit of catching and holding on the thumbtack heads. Besides being a nuisance, this slows up the worker's production. Students, and in many cases professionals as well, use standard-sized sheets of drawing paper. The drawing shows a method by means of which the heads of the thumbtacks are brought

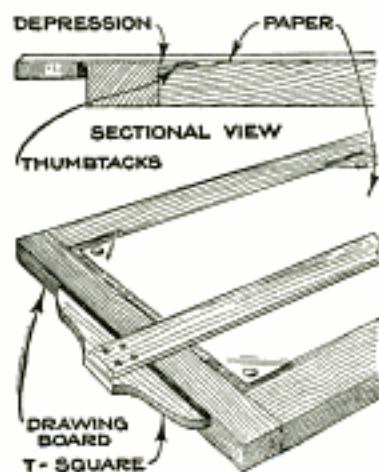

below the surface of the board or at least flush with it. V-shaped notches, about $\frac{1}{8}$ in. deep and placed at the corners of a standard sheet, are cut into one or both ends of the board, as shown.

Removing Stiff Tires

A useful and inexpensive article of equipment for the garage and tire-repair shop, for removing tires that have rusted onto the rims, or that, for other reasons, are found difficult to remove, consists of

nothing more than an ordinary barrel. The barrel should be a tight one, that is, one that has contained vinegar, oil, or other liquids. One of the heads is removed, and a slot is cut out with a saw to accommodate the tire valve, after the hoops have been secured on each side of the slot. In use, the tire, on its rim, is slipped over the barrel, with the valve in the slot. At one point on the bilge the diameter of the barrel will be greater than that of the rim, and the latter will be firmly held at such a height that the work of removing the tire can be done conveniently and with comparative ease. It may be found desirable to ballast the barrel by filling the bottom with several inches of cement, or old iron, to prevent it from being tipped over easily.—C. C. Spreen, Birmingham, Mich.



A Reamer Protector

Reamers that are allowed to lie around the bench or in the tool box together with other tools soon have their cutting teeth nicked and dulled, so that they become practically worthless for fine work, or at least would require re-grinding to make them serviceable. The drawing shows a simple and inexpensive method of protecting each reamer in an individual case, which consists simply of a square block of wood, bored out large enough to accommodate the reamer, and marked with the size of the tool on the outside. A small metal hanger of the type shown is fastened to the top of each case so that it can be hung over a screw in the wall, or on a special rack.—E. N. Davey, Montreal, Canada.

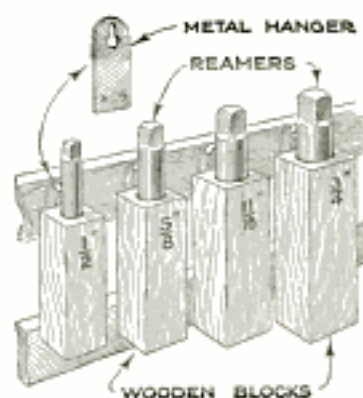

Substitute for Beam Compasses

A handy substitute for the draftsman's beam compasses, on large work, is obtained by equipping the T-square with a

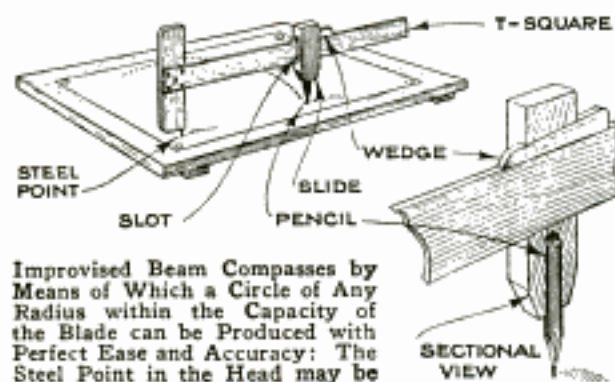

Improved Beam Compasses by Means of Which a Circle of Any Radius within the Capacity of the Blade can be Produced with Perfect Ease and Accuracy: The Steel Point in the Head may be Left Permanently in the T-Square

pencil slide, and inserting a point into the head, in the manner illustrated. The slide that holds the pencil is made by gluing two pieces of hardwood together, half of the slot for the blade being cut in each, thus making it possible to work out the slot in an easy manner. The bottom end of the slide is drilled to fit the regular drawing pencil tightly. A hardwood wedge, pushed into the slot between the T-square blade and the slide, holds the pencil at the proper radius. The steel needle in the head of the T-square need not be removed, as it is never in the way. A circle of any radius up to the capacity of the blade can be produced by these improvised compasses with perfect ease and accuracy.

Repairing Worn Eccentrics

There is a great deal of wear on the circumference of the eccentric sheaves of any engine using the Stephenson valve

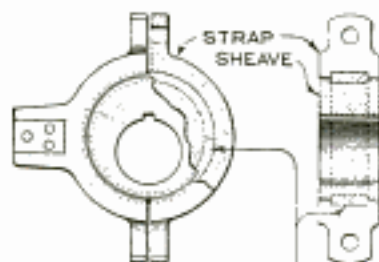

BRASS BUSHING, MILLED IN FOUR PARTS

re-turn their eccentrics and rebabbit the straps. Just as soon as the blocks must

gear, and a large number of eccentrics are scrapped annually on account of this wear. Railway shops are now using a system that will also appeal to the users of traction and similar reversing-gear engines, who find it necessary to

be re-turned, they should be grooved as in the drawing. A brass shoe or bushing, cut into four sectors, is made to fit the sheaves and strap; as the brass will wear faster than the sheaves or straps, they can be run much longer without re-turning, by renewing the brass bushing when necessary. If the eccentric sheave is so made that it cannot be grooved as shown, it may be reduced in size, still keeping the original shape, and the bushing made to fit both it and the strap, as shown in the upper right-hand detail.—A. A. Stafford, Reno, Nev.

An Adjustable Machine Strap

When strapping work down to machine tables, it is very convenient to have a little "adjustability" in the strap. If the work is of slight thickness, the strap alone may be sufficient without packing, but the principal object

of the strap shown in the drawing is to facilitate setting it at the correct height without the usual bother of looking around for washers or pieces of scrap. The ordinary heel-type strap of the drawing has a hole drilled in the back, to which the angular machine-steel piece illustrated is riveted. The distances of the faces of these angles should vary by about $\frac{1}{32}$ in., measured from the center. When in use, packing is put underneath the strap to approximately the right height, the final setting being obtained by turning the hexagon-shaped piece that raises or lowers the strap.



Cleaning Brass Parts

The small brass fittings of an automobile, or other mechanism, such as petcocks, carburetor parts, and the like, can be made to look like new by dipping them into a pickle composed of 75 parts nitric acid, 100 parts sulphuric acid, 2 parts lampblack, and 1 part salt. This solution should be mixed and kept in an earthenware or glass jar, and the parts should be thoroughly rinsed and dried after dipping. When dried, the work should be lacquered or given a thin coating of some light grease.—D. V. Wilson, Houston, Tex.

Blueprints for Notebooks

Drawings, diagrams, or similar information that the reader would like to transfer to a notebook, are often found in technical books or magazines. When such matter is contained in the books of a reference library, from which they cannot be removed, the transfer must be made in the library. To make a sketch and finish it at home is tedious, and some of the finer details are likely to be lost or misdrawn. This is particularly true of dimensions.

To overcome these difficulties, I take some tracing cloth or paper to the library; this is fastened with paper clips to the page on which the drawing appears. Then, with drawing ink, a straight-edge, ruling pen, and bow pen, I trace the drawing in ink, just as one would trace an original drawing. If one takes time, it is not necessary to use the pencil first. Blueprints are made from the tracing and pasted in the notebook, or the tracing itself may be pasted in.—R. E. Deering, Clements, Kan.

Easily Made Drawers

An extra drawer is often needed on the drawing board or table, for small instruments, thumb-tacks, and the like, and such a drawer can be provided in a few minutes' time from an ordinary slide-cover box. The sliding cover of the box is fastened to the underside of the table or board with small screws, and the box is then slid onto it. A screw-eye or small knob can be fastened to one end of the box to serve as a handle.—Chas. I. Reid, Millersburg, Pa.

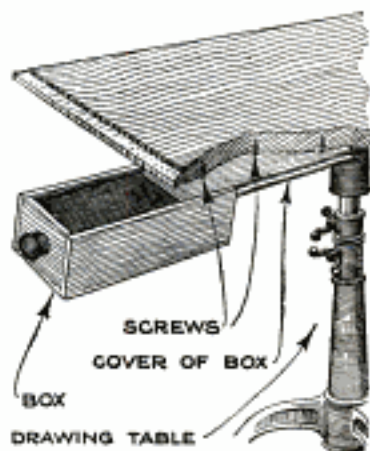

Attachments for Gas-Engine Hoppers

The hopper-type water jacket is a convenient design for portable gasoline engines, and those located where a supply of running water is not available are familiar with its merit. But there is the disadvantage of the water boiling and slopping over the top, very often causing

a short circuit in the ignition system. One way to overcome this objection is to

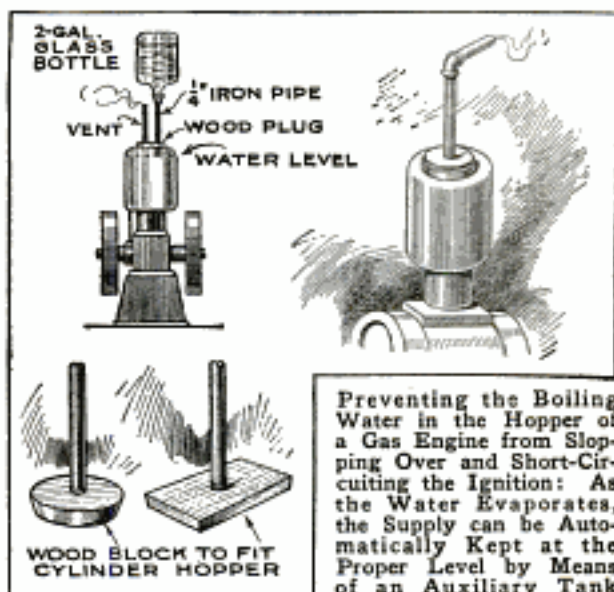

fit a thick wooden plug in the hopper opening. It should be tapered enough to permit its being driven to a fairly tight fit, allowance, of course, being made for the wood swelling when steamed. In the center of the plug a hole is drilled, and a length of pipe screwed in for a vent. This prevents the water from slopping or boiling over, when the engine is being moved from one location to another or when it is in use. An elbow and short length of pipe may be fitted to carry the steam off to one side of the spark plug and wiring.

The water in the hopper needs to be replenished frequently as it is evaporated. One of the drawings shows how an auxiliary water tank may be made from a large glass bottle, or similar container. A metal container would work as well, but by using the bottle the operator can always tell just how much water is left. A plug is fitted into the hopper opening, as mentioned before, although this is not necessary if the pipe is otherwise well supported. The vessel is filled with water, fitted with a stopper into which a pipe fits tightly, then inverted over the hopper. The lower end of the pipe should be at the high-water level of the hopper and be kept in that position. Then, as soon as enough water evaporates to uncover the end of the pipe, more will flow in from the bottle. If the stopper is airtight, the hopper will be automatically kept filled until the bottle is empty.

Be sure there are no sags or pockets in steam mains that would allow water to accumulate and be carried over to the engine in "slugs."

Shoenails a Peril to Electrical Workers

Electrical workers should accept the dictum that all shoes worn by them must have the soles fastened to the uppers by



The X-Ray Photo Shows How Nails in the Shoes Form a Metal Path for an Electrical Current to the Ground

wooden pegs, for the life of a worker may depend upon the absence of metal nails.

The X-ray photograph gives a view of the nails in the shoe of an electrical worker who was killed by a heavy current. Everyone of the dozens of deadly little things is just waiting for the chance of being turned into a live wire, and to carry the current to the ground, as soon as the wearer of such shoes comes into contact with an electrical potential.—Geo. F. Paul, Chicago, Ill.

Drinking Fountain Attached to Fire Hydrant

In many instances the cost of installing drinking fountains and connecting them to underground supply and drain pipes,



is higher than the authorities of a municipality or village care to pay; in such cases, the arrangement shown in the illustration can be used in conjunction with the fire hydrants, without in the least interfering with their regular use. The hand-controlled bubbling drinking cup, a short length of pipe, and a shut-off cock are the only materials to be bought, and the assembly is screwed into a hole drilled in the top of the hydrant in the manner illustrated, the excess water simply running off into the

gutter. The same idea can be applied to fire hydrants of other types, by making the tapped hole on the side and bringing the bubble cup up to a proper height by means of a nipple and elbow.

Improved Resist for Etching

When using beeswax as a resist for etching tools, the beeswax sometimes breaks away from the metal, causing much trouble. When this happens, a neat job is impossible, as the etching solution will leave a ragged edge wherever the wax is raised off the steel. If one-tenth part of powdered resin is thoroughly mixed with the melted beeswax before being applied, this trouble will not occur.—Louis M. Steffen, Dayton, Ohio.

Increasing Ice-Machine Condenser Efficiency

A large ice-cream factory was suddenly and severely handicapped in the rush of its summer production by the inefficiency of the condensing system and the extremely high pressure which it was forced to maintain. The pressure had to be run up to 250 lb. and higher, the normal pressure being 180 lb. This condition, besides creating a dangerous situation, also meant extra cost for power. On investigation, it was found that the trouble lay in the warm city water which was used for cooling the condenser. The condenser was 20 pipes high, and had a water inlet at the bottom and an outlet into a drain at the top. The water entered the inlet at a temperature of about 70°F. and circulated through the pipes, coming out at the top with a temperature of from 150 to 160°. It was suggested that the water-supply system of the condenser be cut in two, cutting the supply piping in the center of the condenser, and fitting it with a new inlet and discharge. When this had been done, the high pressure dropped immediately to 190 lb., and the temperature of the discharge water fell to around 100 to 110°. This change was effected without any increase in the quantity of water used. By creating two circulating systems in this manner, a quicker absorption of heat from the hot ammonia liquid took place.

☐ Powdered resin, mixed with denatured alcohol to form a thick paste, makes a soldering flux that is free from the objections inherent in most fluxes, as it does not corrode the work.



Photographing Wild Birds and Animals

BY NELSON EDWARDS

IT is the ambition of every amateur photographer, and some professionals, to get good close-up pictures of birds and animals. There are a number of more or less satisfactory methods of placing the camera and releasing the shutter, but what is probably the most effective arrangement is operated electrically. The shutter-releasing mechanism is the most important detail, and can be made from

dry cells in series with a suitable push button. In this manner the operator can be concealed several hundred feet away and be assured that, when the button is pressed, the camera shutter will be positively operated.

Practically any camera can be used, although it is preferable to use a long-focus lens, because then the camera will not have to be placed so close to nests

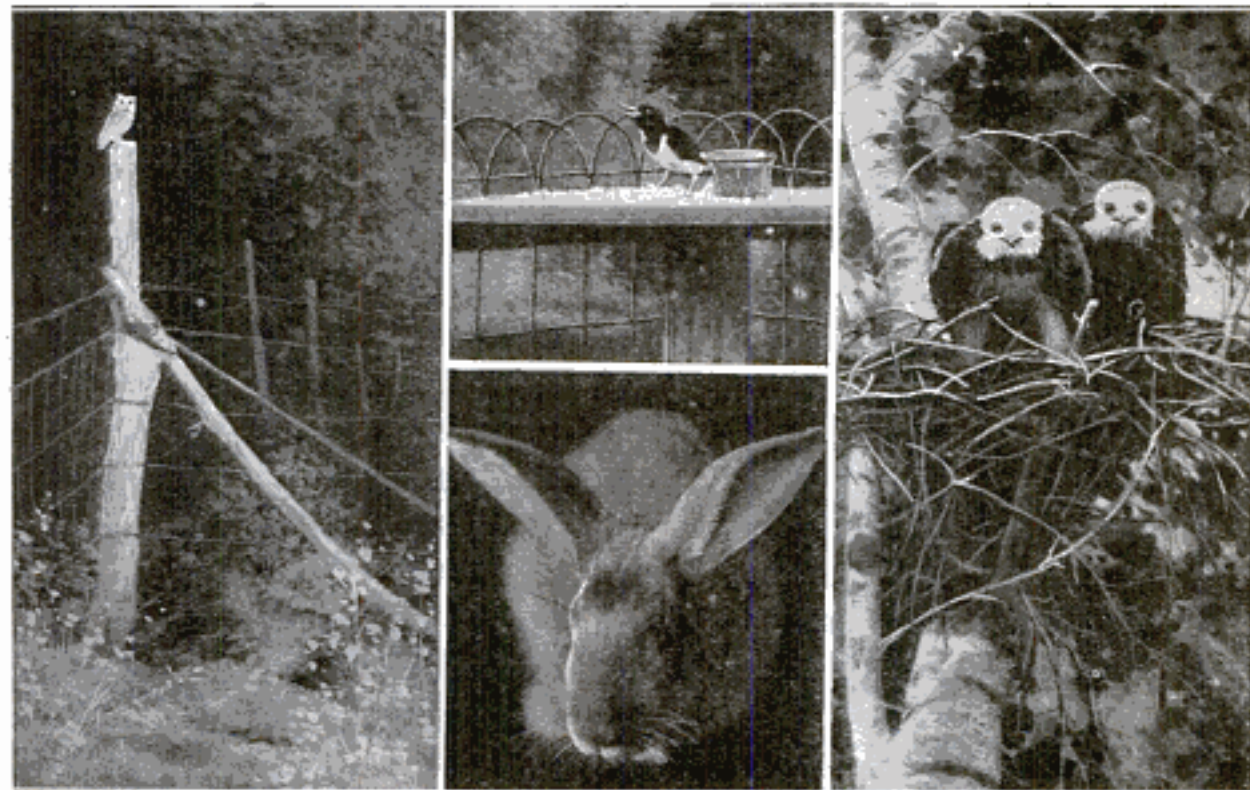

Photographs of Wild Birds and Animals That Show Good Close-Up Views, Are the Ambition of Many Amateur, and Some Professional, Photographers. Left: Flashlight Photograph of a Prairie Owl, the Flash being Set Off Electrically. Upper Center: Red-Headed Woodpecker Getting a Free Lunch from the Feeding Board. Lower Center: Close-Up Portrait of a Rabbit. Right: A Pair of Aggressive Young Hawks in Their Cottonwood

the electromagnet of an old doorbell. The magnet is attached to the camera bed, and the shutter trigger is connected to the armature by means of a link made from part of a bicycle spoke. Any lost motion between the armature and trigger can be taken up by turning the threaded nipple on the end of the spoke. The magnet is connected to one or two

and roosts. The camera should be camouflaged to correspond as closely as possible to the surroundings, and whenever possible, it is best to do this by degrees; then, after a few days, when the suspicions of the animals have been allayed, the camera can be set. The object of this is to avoid the frightened appearance found in many photographs of birds and

animals. As fast a lens as possible is advised, and the lens opening, or stop, and duration of exposure depend entirely upon the light conditions. Under some conditions a hand mirror can be used to reflect light into dark places. At times it is advisable to

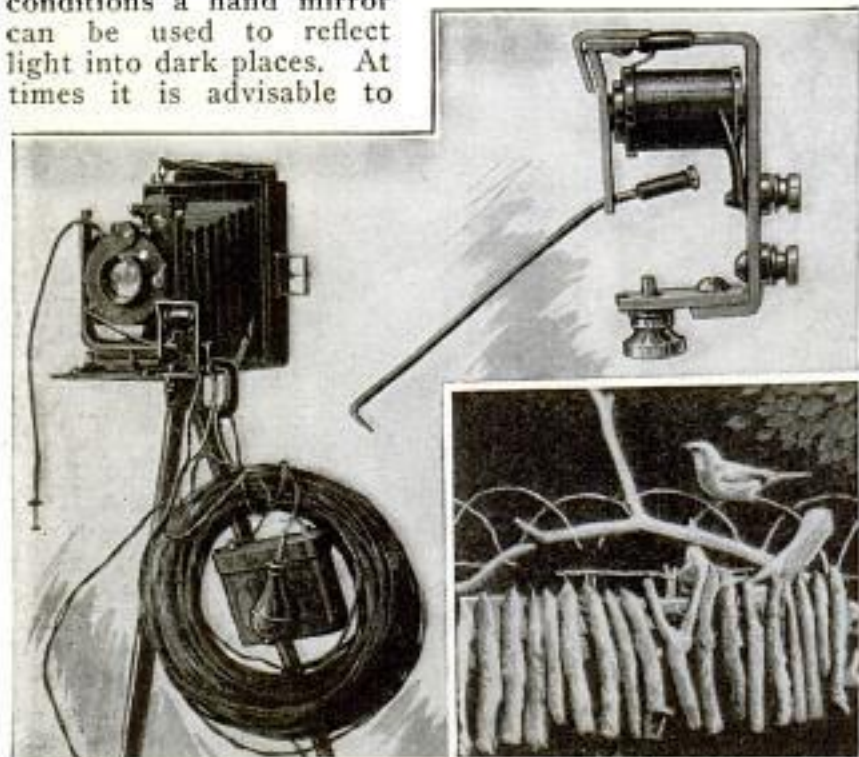

The Electromagnet from an Old Doorbell Clamped to the Camera Bed Makes a Positive-Acting Shutter Release. The Connecting Link between the Shutter Trigger and Armature is Made from a Bicycle Spoke. The Device is Operated by Dry Cells, and Wire can be Strung to the Point Where the Operator is Concealed. Lower Right: Snapshot of an English Sparrow

cut away a few branches to admit light over the spot on which the lens is focused, and this point should be marked so that the sharpest possible image of the subject will be obtained when the shutter is opened. It is hardly advisable to use a shutter speed of less than $\frac{1}{25}$ second, as birds and animals are generally on the move and their movements are quick.

The concealed operator will find a pair of field glasses useful, and if he has the required degree of patience and a genuine love of nature and photography, he will spend many a pleasant hour in making a pictorial record of his wild neighbors.

Removing Obstinate Corks

Large corks in bottles and jugs are not always easy to remove if one is in a hurry. In order to facilitate removal of such corks, cut strips of tape, and, when inserting the corks, place a strip on the cork so that the two ends will project beyond the neck. When the ends of the tape are pulled, the stopper will come out easily.—S. L. Bastin, Bournemouth, Eng.

New Remedy for "Grabbing" Clutch

A "grabbing" clutch is something that most motorists are bothered with at one time or another, especially if the car is equipped with a dry-disk type of clutch.

It is easy to advise the application of castor oil, but it is a harder job to apply a few drops of the thick oil so that it will reach the troublesome portions of the disks, and still not saturate the surface so much as to allow the clutch to slip.

By diluting the oil with four to five times its bulk of alcohol or gasoline, an easily applied mixture is obtained. The gasoline or alcohol serves the additional purpose of carrying the oil into the fibers of the clutch facing and softening the hardened spots, and since the diluting agent rapidly evaporates, the nonvolatile oil remains distributed in small quantities over the whole surface of the

disks. Used in this dilute form it is nearly impossible to apply too much oil to the clutch.—G. W. Greene, Madison, Wisconsin.

Hose Stored in Basement Window

Dragging the garden hose up and down from the basement whenever it is used is a tiresome and bothersome task, but by utilizing one of the cellar windows in the manner shown, the hose is conveniently stored close to the water connection. A box or shelf is built inside the window. The legs of the hose reel are cut off and securely fastened to the shelf, to prevent it from pulling loose when the hose is unreeled.—L. B. Robbins, Harwich, Mass.

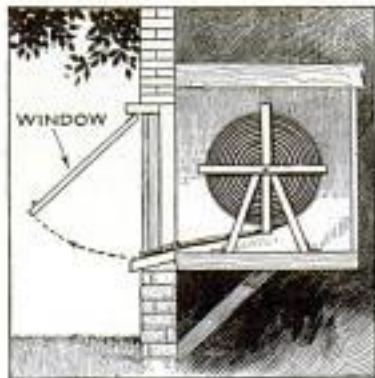

Tucking in Short Blankets

Woolen blankets are usually a little too short to make it possible to tuck them under the foot of the mattress and still cover enough of the bed to protect the occupant. For this reason, when the bed is made up, the blankets are not allowed to extend far enough at the foot for proper tucking in, to the discomfort of the sleeper whose feet are often exposed to the chilling atmosphere of the sleeping room.

To remedy this, sew a strip of strong muslin, about 1 ft. wide, across one end of the blanket; the extra length is tucked under the end of the mattress, leaving the entire woolen blanket on top of the bed.—Herbert A. Strickler, Buffalo, N. Y.

A Simple Electrical-Resistance Coil

A cheap resistance coil for arc lamps can easily be made by any amateur electrician from a length of stovepipe, suitably insulated and wound with resistance wire.

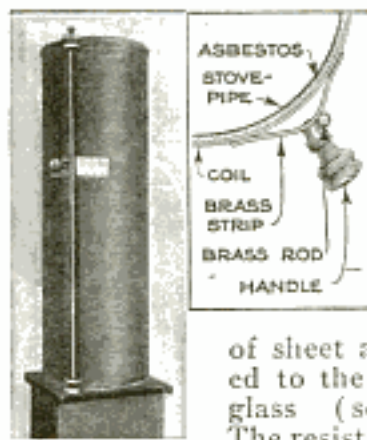

ably insulated and wound with resistance wire.

An 18-in. length of 5½-in. stovepipe is the foundation for the coil, and this is covered with a piece

of sheet asbestos, cemented to the pipe with water glass (sodium silicate). The resistance is composed of about 125 turns of ¼-in.

iron wire, the turns being spaced about ⅝ in. apart. A brass rod, held at its ends in porcelain insulators, is spaced about ⅜ in. away from the winding. The insulators are secured to the opposite ends of the stovepipe by wire loops. The upper end of the rod is connected to one side of the arc-lamp circuit, and the upper end of the resistance winding connected to a binding post. A strip of stiff sheet brass, about ½ by 1 by 3 in., is bent to the form indicated, provided with an insulated knob, and pushed under the brass rod and against the coils. The resistance of the circuit is controlled by moving the brass slide up or down. About 250 ft. of wire will be required for the winding, and, when completed, the resistance can be mounted on a piece of asbestos, fiber, or plaster board.—Frank B. Howe, Los Angeles, Calif.

Landing Net for Catching Poultry

A poultryman who handles hundreds of fowls has found that an ordinary landing net, such as used by fishermen, is one of his most useful pieces of equipment. The net is of large size and is provided with a 4-ft. handle. With such an arrangement it is a comparatively simple matter to capture a fowl with a minimum of confusion to the rest of the flock, and with very little exertion on the part of the poultryman.—Orin Crooker, Wheaton, Ill.



A Handy Portable Lock

Travelers who feel insecure behind the flimsy or disabled locks that may be found in many out-of-the-way hostleries—and some city hotels—can use a detachable lock of the type shown in the drawing, and sleep with the assurance that anyone trying to force the door to which it is attached, will arouse the occupant of the room. An ⅛-in. steel plate is cut to the form and dimensions given, and the two points are bent over and sharpened. Several slots are cut through the plate, and a metal wedge, or key, is provided to fit them. In use, the sharpened points of the lock are forced into the wooden door jamb against the stop strip; then the door is closed, and the wedge pushed home tightly in the proper slot.—Louis Schneider, Clinton, Missouri.

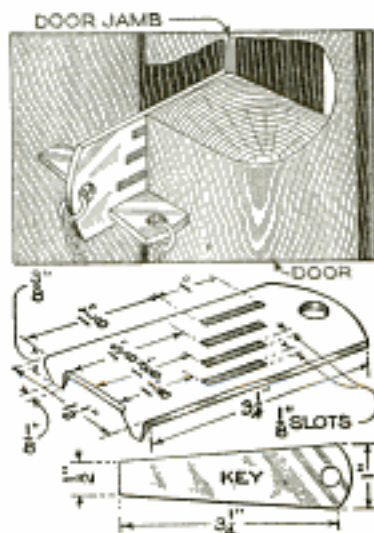

Parachute Drop for a Kite

Every boy likes to drop a parachute from his kite when it is high in the air, but nearly always he has trouble getting

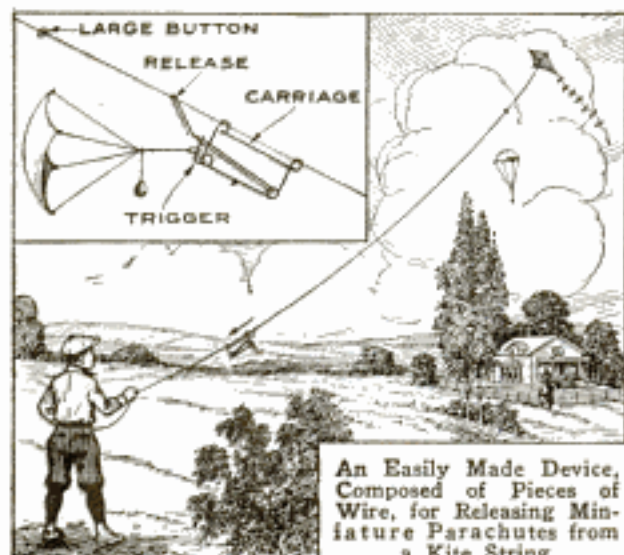

it to drop when he wants it to, or else gets things hopelessly tangled and spoils the fun.

The little device shown in the drawing can be placed on the kite string without breaking the cord. Wire is used for making all the parts, and the completed article should not be more than about 5 in. long. The carriage is first formed, then another small piece for the trigger, and a third for the release.

When formed as shown, the "drop" can be hooked over the string. Tie a short piece of string to the parachute just above the weight, make a loop in the end to slip over the trigger, and drop the release over the trigger, as well. The wind will catch the parachute and pull it toward the kite, right up the string. Then, the minute the release strikes the large button that has already been tied to the kite string, the former will be raised, releasing the trigger and liberating the parachute, while the drop comes sliding down the string ready for another trip.—A. R. Mutton, Waterloo, Ia.

Uses for Old Inner Tubes

When shucking corn in wet weather, the lower limbs are always wet from wading in the grass, and this is a fertile cause of rheumatism and its allied afflictions. In place of rubber boots, that have various disadvantages, sections cut from a 4-in. inner tube, that are pulled over the legs, afford complete protection. Larger or smaller tubes can be used as

demanding by the size of the ankle. The rubber tubes are pulled on over the trousers and are entirely waterproof.

Another application of old tubes by the corn husker makes use of a 6 or 8-in. section, punched with holes and pulled on over the wrists; this provides complete protection against chapped, cracked, and sore wrists.

Saws, when stored and shipped with other tools, are very likely to jar loose from their supports, and to have their teeth practically ruined. To overcome this, a carpenter who travels about considerably, pulls a section of inner tube over each saw before placing it in his tool box.—Rufus E. Deering, Clements, Kansas.

Freezing the Pipe to Move a Faucet

When it became desirable to change a faucet from one position to another in the pipe line, it was necessary to cut a piece out of the line and thread the end. There being no way to shut off the water, the plan of freezing the pipe was tried and found to work perfectly. As the same line of pipe could be reached at a point somewhat nearer the source of supply than the place where the work was to be done, a mixture of salt and ice was packed around the pipe at that point, freezing the water so that the pipe could be cut and threaded.—C. D. Shupp, Nehawka, Neb.

Gas Burner for Incubator

Where a supply of gas is available, it is possible to do away with the messy, odorous, and generally bothersome kerosene lamps that are used to furnish the proper warmth in incubators. An ordinary inverted-mantle Bunsen burner is arranged as shown and connected to the gas supply, the pressure of which is quite closely controlled by regulating the needle valve.—Roy Sterritts, Springfield, Ohio.

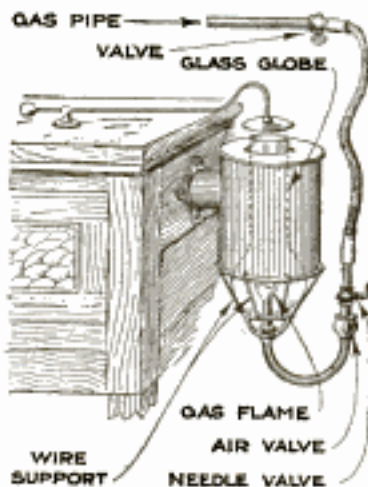

Preventing Decay of Buried Posts

A simple method for preventing the decay of posts supporting rustic structures and, in fact, wherever a post is buried in the ground, consists in inserting the post in a concrete-filled section of drain tile.

The post hole is dug and the tile inserted. Several inches of concrete mixture are poured into the bottom, the post put in position, and the surrounding space between the post and tile filled with cement.

Protecting Early Plants

Paper bags are widely used for protecting plants that have been set out before the danger of frost has entirely

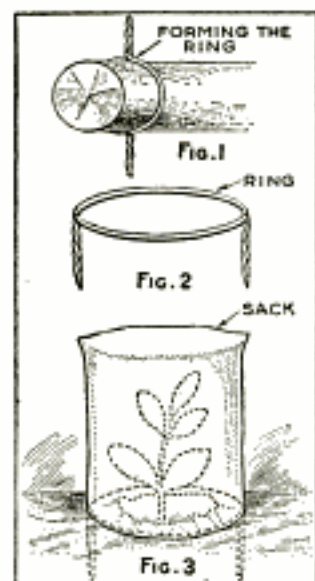

passed, but if the bags are not securely fastened they are easily blown away. A holder, which can be made easily, from odds and ends of wire, will keep the bags securely in place. Two pieces of wire of equal length are formed into a circle around the end of a smoothed-off log, or piece of pipe, as in Fig. 1, the ends being tightly twisted.

After the ring has been removed, the twisted ends are bent at right angles, as indicated by Fig. 2. In use the ring is slipped inside the paper bag and the mouth is crimped over so that the protruding wire ends will pierce the paper, as in Fig. 3. The wires are pushed into the ground until the mouth of the bag rests against the earth.—Dale R. Van Horn, Lincoln, Neb.

An Improved Radiator-Filling Bucket

The average garage or filling station usually has a bucket of the round galvanized-iron type for filling automobile radiators; a spout on any of these buckets is a rarity, and in consequence, water is poured over the car and splashed over the shoes and trousers, making an unsatisfactory and disagreeable job of an ordinarily simple task.

The drawing shows how one enterprising garageman attached a spout to his

filling bucket for the convenience of his patrons. A hole was punched just under the upper rim of the bucket, and a pipe

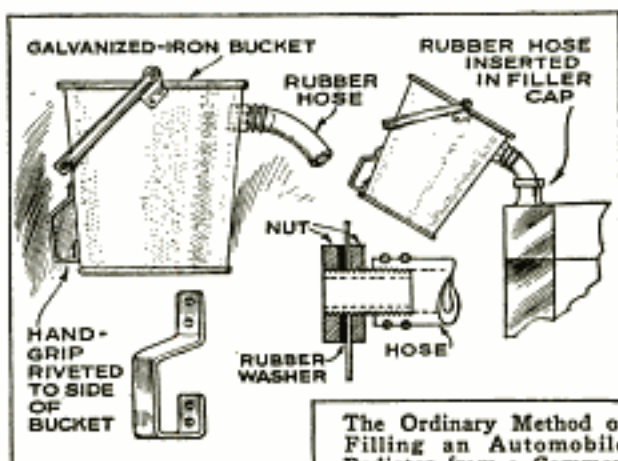

The Ordinary Method of Filling an Automobile Radiator from a Common Bucket Makes a Disagreeable Task Out of a Simple Job. The Addition of a Flexible Spout and a Handle Makes a Great Difference in the Ease and Cleanliness of the Task

nipple fitted in position with locknuts, rubber gaskets being used between the nuts and the bucket. A short length of hose was wired to the pipe to provide a flexible pouring spout.

A handle, for convenience in pouring, was made of flat iron and riveted to the side of the bucket opposite the spout. Any bucket can be altered in this manner for either public or private convenience.—G. A. Luers, Washington, D. C.

Increasing Loose-Coupler Efficiency

The efficiency of the familiar loose coupler, that forms a part of a considerable number of amateur radio stations, can be increased

measurably by a simple dodge. Wind some No. 28 or No. 30 gauge wire into a coil sufficiently large to fit loosely over the secondary of the coupler, as indicated in

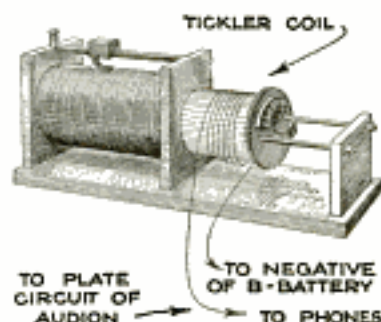

the drawing. No definite number of turns can be given as this is best determined by experiment. Connect the ends of the coil to the plate circuit of the audion, one wire to the negative pole of the B-battery, and the other to the phones. Application of this idea to the loose coupler really turns it into an inductive feed-back regenerative set, giving results that rival those of the more complicated regenerative set.—Wayne W. Leyrer, Atlantic City, N. J.

Float Valve for Engine Hopper

Hopper-cooled internal-combustion engines, such as are commonly used for power purposes on the farm, have an ailment all their own, which is, that if the hopper goes dry, the engine overheats,

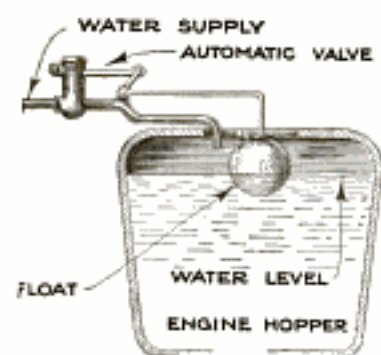

and the cylinder is likely to "seize," unless strict watch is kept on the water supply. The drawing shows how a closet-tank float valve was arranged to keep a sufficient supply of water in the

hopper at all times. A longer float rod was substituted for the original one, so that it could be bent at right angles and yet be at the proper height for shutting off the flow of water. Then the intake side was connected to the water-supply pipe, and the outlet bent down over the edge of the hopper. A valve was placed in the water line back of the float valve, so that the water could be turned off when repairs were necessary. In this manner the hopper can be kept filled to its maximum level, regardless of how long the engine is run without attention.

A Simple Grommet Die

The camper, motorist, or boat owner who makes one of the grommet dies shown in the drawing, will be able to make up his own tents, covers, sleeping bags, sails, and similar canvas gear, putting in

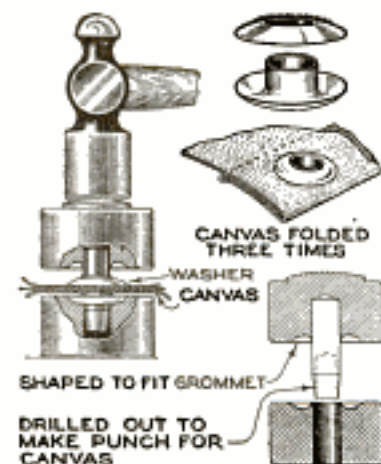

the grommet rings wherever needed. If the edge of the canvas is folded over to make three thicknesses, no sewing will be required.

Two short pieces of cold-rolled steel bar, or shafting, will be needed, and also a third piece to form the punch, which should have the same diameter as the center hole of the grommet, a separate punch

and die being required for each size. The punch is made a driving fit in the center of the upper part of the die, and an easy push fit through the hole in the lower half. If the end of the punch is drilled out and tapered to a sharp edge, it can be used to punch holes in the canvas preparatory to the insertion of the grommets. The inner face of each of the die blocks is next faced off accurately, preferably in a lathe, and then the annular grooves shown are turned to the shape of the grommet ring and washer, with a hand tool.

In use, a grommet is placed upon the face of the lower die, the perforated canvas placed over the upturned sleeve, and the washer put on; the punch is then inserted, pushed down, and then lightly hammered, until the punch block is all the way home. This operation curls the end of the grommet sleeve over the washer and swages the whole tightly together, with the canvas between.

Dust Shields for Plow Wheels

The greatest factor contributing to the wear of farm machinery is the dust and sand that find their way into the wheel bearings, where, mixing with the grease, they form a grinding compound that soon wears out the

axle and its bearing. Some provision is usually made to protect the bearings from the entrance of such grit, but it is usually not very effective, as it does not conform closely to the shape of the wheel hub and the irregular-shaped shank which supports the

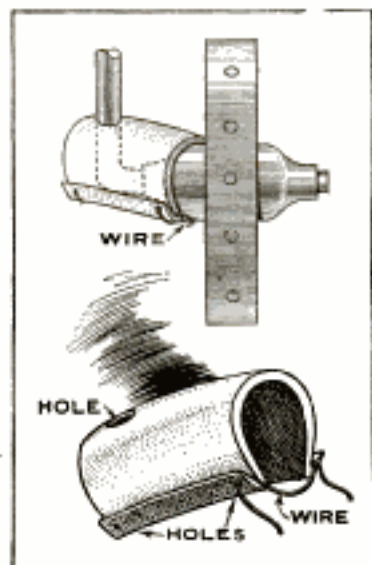

piece to form the punch, which should have the same diameter as the center hole of the grommet, a separate punch and die being required for each size. The punch is made a driving fit in the center of the upper part of the die, and an easy push fit through the hole in the lower half. If the end of the punch is drilled out and tapered to a sharp edge, it can be used to punch holes in the canvas preparatory to the insertion of the grommets. The inner face of each of the die blocks is next faced off accurately, preferably in a lathe, and then the annular grooves shown are turned to the shape of the grommet ring and washer, with a hand tool. In use, a grommet is placed upon the face of the lower die, the perforated canvas placed over the upturned sleeve, and the washer put on; the punch is then inserted, pushed down, and then lightly hammered, until the punch block is all the way home. This operation curls the end of the grommet sleeve over the washer and swages the whole tightly together, with the canvas between.

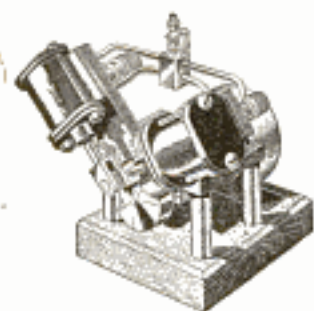

A TWIN-CYLINDER OSCILLATING ENGINE

By J. V. ROMIG

BEFORE describing the construction of a model oscillating engine, a few words on the history of this type of prime mover will add greatly to the interest of the work, and to the possession of any model engine of this type.

The first oscillating engine was built in 1785, by Murdoch, manager of the Boulton and Watt works, the first builders of separate-condensing engines. Richard Trevithick, a pioneer in locomotive building, also is said to have suggested this form of engine in the latter part of the 18th century. The first 60 years of the 19th century saw the engine perfected and widely applied to paddle steamers. The introduction of the compound engine and the screw propeller, however, marked the beginning of the end for the oscillating engine, and it is now practically obsolete. Many very simple and interesting models of this type may be made, however, and for model power boats it is still one of the best types, due to the low headroom necessary for its installation.

The model oscillating engine described herein is a particularly suitable engine with which to start the young model maker on his model engineering career, as no castings are employed in its construction, and the cylinders are so made that the engine may be entirely dismantled at any time, either for repair or for instructional purposes.

With this design, the engine is so well balanced that the flywheel may be dispensed with, if desired; dimensions for a suitable flywheel are given in the drawing, however, as its presence adds greatly to the appearance of the model.

The first part to be made is the frame;

this is made of steel angle bar, which should be $\frac{1}{4}$ to $\frac{1}{2}$ -in. larger on the sides and about $\frac{1}{4}$ in. longer than the finished size shown, say about 2 by 2 by $4\frac{1}{4}$ in., so that, when finished to size, the edges will be square and clean. The faces should be filed square before cutting the frame to shape, and finished after cutting, with a fine file and scraper, until the faces are dead square and flat. The holes for the pivots, steam and exhaust ports, bearings, and columns, if the last are used, can

then be laid out and drilled, and the bearing and column-screw holes tapped. The cylinders are cut from brass tubing of $\frac{3}{4}$ -in. outside and $\frac{5}{8}$ -in. inside diameter, and each cylinder has soldered to it a $\frac{3}{4}$ by $1\frac{1}{2}$ -in. brass plate, scraped to fit perfectly against the vertical face of the frame. Before soldering these plates to the cylinders, they are drilled and countersunk for the $\frac{3}{16}$ -in. pivot screws, which are then sweated into place.

The joints of the plates and cylinders should be well filled in with solder, which is filed with a rat-tail file to form neat fillets, as shown. The cylinder ports may now be laid out and drilled. The upper cylinder heads have a $\frac{1}{2}$ -in. boss turned on one face, to fit the cylinder heads, and the top faces are plain. The lower heads also have this boss, and, in addition, a $\frac{5}{16}$ by $\frac{1}{8}$ -in. boss on the lower side, which forms the packing gland, and a $\frac{3}{16}$ -in. hole for the piston rod. Two stuffing boxes should be made, fitted, and drilled at the same time as the cylinder heads. Perfect alinement of the cylinder-bolt holes may be assured by clamping the heads and stuffing boxes to their respective cylinders and drilling all at once, with the tapping-size drill, the

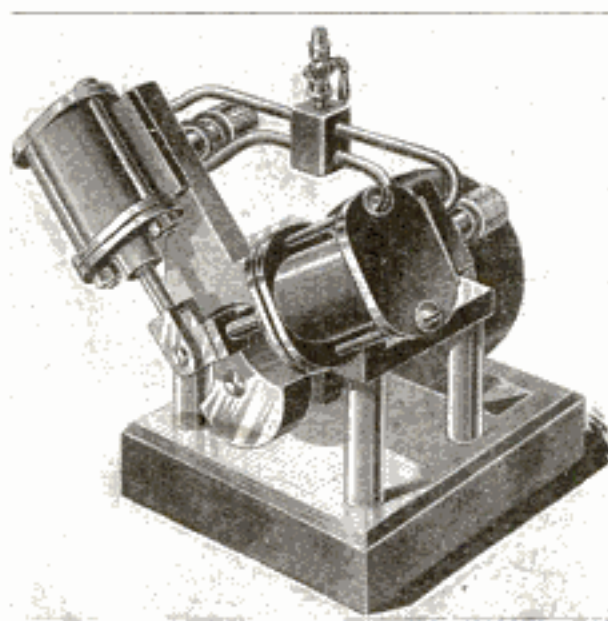

Suggested Assembly of Model If Used for Exhibition Purposes: Properly Built and Finished, This Makes a Most Attractive Engine

holes in the upper heads and stuffing boxes being drilled out afterward with a clearing drill. The lower heads are tapped to fit the bolts. Soft cord, dipped in melted paraffin, makes a good packing for the box.

bar, the ends being riveted into counter-sunk holes, drilled in the pistons while the latter are held in the lathe chuck. The lower ends of the rods are shaped as in the drawing, the area of the ends bearing on the crankpin being equal. The rods should be slipped through the lower heads and stuffing boxes before riveting. The crankshaft is built up, the pin and shaft being preferably of drill rod, and the web is cut to shape from a mild-steel disk. The crankshaft bearings are split, and

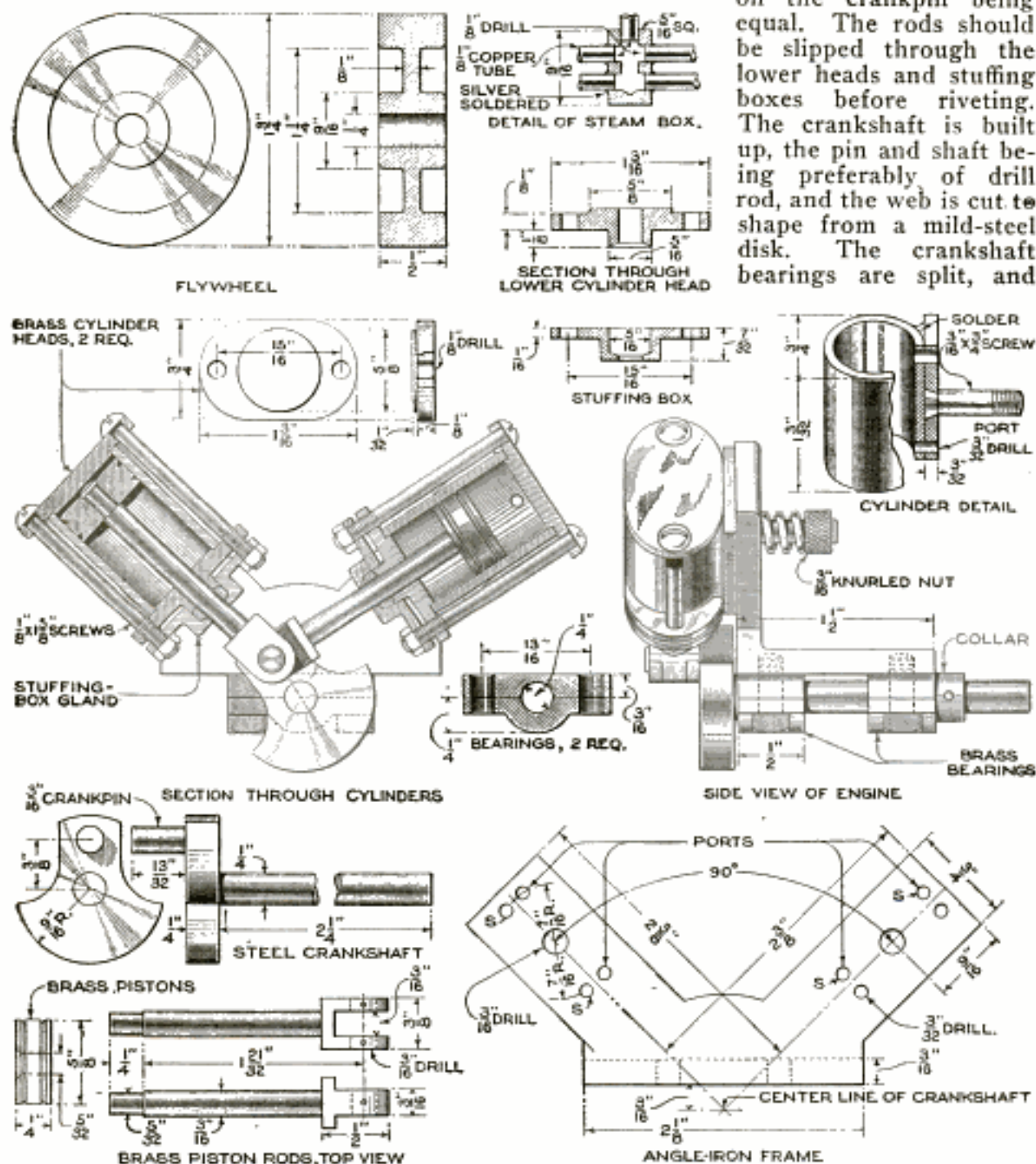

Full Details for Building the Model: Note Particularly the Location of the Steam and Exhaust Ports. Steam Ports are Marked "S" on the Drawing of the Frame. The Exhaust Ports are Not Piped, the Steam Escaping Directly into the Air. For Land Use, the Engine may be Provided with a Flywheel, a Suitable Design for This being Shown at the Top of the Drawing

The pistons are turned from brass-bar stock, and have V-grooves turned in the periphery, as shown; these grooves retain oil and water, and are quite as efficient as piston rings in engines of this size. The piston rods are turned from square brass

these should be cut out, the screw holes drilled, and the bearings clamped together endwise against the bottom face of the frame, before the crankshaft-bearing holes are drilled; every care should be taken that these holes are in alinement, as a little

extra time spent in this will save much work later on. Oil holes should be provided for all bearings. Where a flywheel is not used, a small collar, pinned to the shaft, will keep the latter in its bearings.

All the steam ports are connected to one common supply pipe; a simple way to do this is to make a "steam box," as shown in the detail, of square brass bar. Holes are first drilled in the bar, as shown, of the same diameter as the bore of the tubing used. These are then counter-bored to the outside diameter of the tubing, and the four tubes sweated in place with silver solder. The tubes are connected to the steam ports in the frame in the same way. The exhaust ports are not piped; the steam is allowed to exhaust directly to the atmosphere.

The arrangement of the engine shown in the assembly view is entirely suggestive, but is a very suitable one, if the model is to be used only for exhibition purposes or for driving model machinery. The columns are made of brass rod, drilled along the axis, and screws are run right through them, from the underside of the wooden base to holes drilled and

tapped in the base of the frame. This arrangement is favorable to the use of a flywheel, which may be of either brass or steel, although steel is preferable for appearance's sake. It may be setscrewed or pinned to the shaft, or may even be keyed, if more realism is desired.

One feature of this design, as before mentioned, lies in the ease with which the engine may be taken apart. To remove the cylinders, it is only necessary to unscrew the pivot nuts and slide the piston rods off the crankpin, and the cylinders are dismantled by merely unscrewing four bolts.

Owing to the underhung crankshaft, this engine is very suitable for small model power boats; the frame, when the engine is used for this purpose, is bolted to small sills, and, the flywheel being dispensed with, the engine can be set right down in the bottom of the boat, thus giving a very small angle to the propeller shaft—a very desirable feature. The connection to the propeller shaft should be through a flexible coupling of simple design, which will compensate for any slight error in alinement.

Ignition System Kept Dry by Newspaper

A simple practice that results in keeping the ignition system of an automobile dry during a heavy shower, consists in placing a newspaper over the cowl and engine hood. The rain plasters it in place, and as long as it remains wet, the paper will stick in place. The paper closes the gap at the edge of the cowl and at the hood hinges, causing the rain to run off.

Combination Single and Double Harness

Farmers and teamsters using double harnesses of the type that has a saddle, or backband, can easily adapt them for the use of a single horse, thus saving the cost of a special set of harness. The only extras required for the change are a pair of shaft tugs; two pieces of strap, about 8 in. long; two other pieces, about 24 in. long, and two links. The latter are permanently fastened to the ends of the saddle with the short pieces of strap. The longer straps are riveted to the shaft tugs, being provided with metal hooks to take the wear of the links. Shaft tugs, with the lower strap already attached, can be bought ready-made from any harness dealer. When the harness is to be used single, the shaft tugs are fastened to the

links, as shown in the drawing, with the lower strap fastened to the buckle on

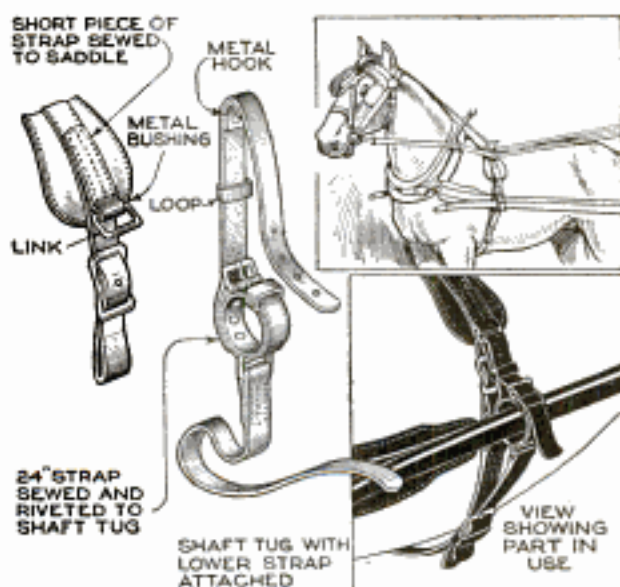

Changing a Double Harness into a Harness for One Horse is Quite Simply Effected by the Addition of a Few Straps and a Pair of Shaft Tugs

the bellyband. Only a few minutes are needed to make the change from a double to single harness without removing it from the animal, and if properly made, such a harness will be as strong and as satisfactory as any single harness.—Chas. Albert, Chicago, Ill.

An Indoor Baseball Game

A light 8 by 16-in. board is elevated at one end by means of a square stick, and drilled with five holes, about 1 in. in diam-

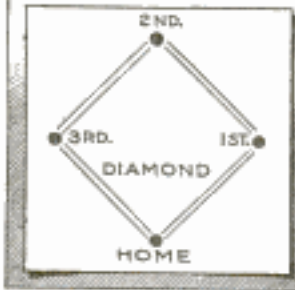
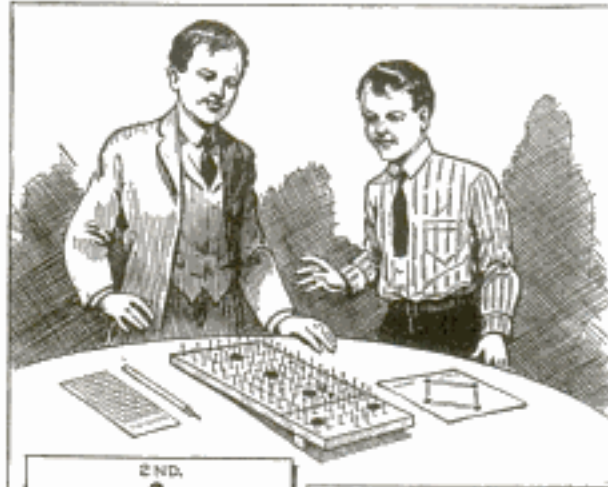

An Indoor Baseball Game That may be Played by Two Players, and is Made Only of Two Pieces of Wood and Some Nails

eter, in the positions shown in the drawing. The two upper holes are called "singles," the hole just below this a "double," the next a "triple," and the last one is a "home run." Around these holes small wire brads are driven into the board, irregularly placed but with sufficient space between them to allow a marble to pass. The outline of a ball diamond is drawn upon a card, and the three bases and homeplate are indicated on it. Each of the two players is provided with nine checkers which correspond to the players on his team.

When the game is on, one of the players places a checker on the homeplate as a batter. Then, the marble is placed between the two nails at the top center of the inclined board and allowed to roll. If it falls into the "single" hole, the "batter" is advanced to first base, and another checker is put up. The game is played just as the regular game, and when three men are out, the second player's team of checkers comes to bat, and the other team takes the field. If the marble lodges in the tacks below the horizontal line on the board, it is a "base on balls" and if the marble stops above the line, it counts a "strike-out." Should the marble roll entirely off the board without entering any of the holes, it counts an "out." Score-cards can be prepared and the game made almost as exciting as a real game.

New Use for Adhesive Tape

Of the hundreds of purposes for which adhesive tape has been used, none is more original than that of a camper who, having been deprived of his hose supporters as a practical joke, used strips of tape in place of his missing property. Several short strips of adhesive tape were cut, a part of each strip being applied to the top of the hose, and the other end stuck to the skin of the leg.

Felt Tires for the Rocking Chair

It is aggravating to the housekeeper when the varnished surface of a floor becomes worn by the rockers of a chair. This annoyance can be prevented, and longer life

given the floor finish by gluing a strip of felt to the underside of each chair

rocker. Liquid glue or linoleum cement can be used for holding the felt strip to the wood. In order to bring the felt into contact with the wood at all points, the method of clamping shown in the drawing should be used, and the board and clamps allowed to remain overnight.—Harry H. Houck, Rochester, N. Y.

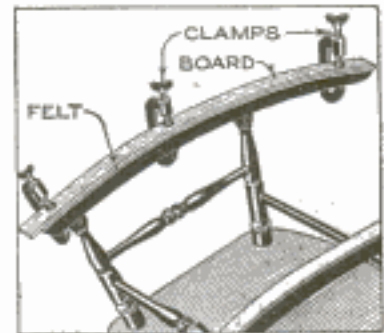

An Aid for Hanging Curtains

The device shown in the drawing is intended to be used for placing curtain poles and rods on their brackets, or for removing them without the necessity of climbing a ladder, table, or other furniture, at the risk of personal injury.

The notched end blocks are about $\frac{1}{2}$ in. thick and 3 in. wide, and are fastened to a piece about 1 ft. long, the being mounted on a handle of ble length—a broom handle will answer the purpose. To put up or remove the curtains it is only necessary to place the rod in the notches and lift or lower as may be necessary.—C. S. Cierpik, Chicago, Ill.



Draft Necessary for Farm Implements

In estimating the power required to operate different farm implements it is necessary to know several things. The depth of operation is of most importance, next the slope of the land, the character of the soil, and the amount of cut made by the implement. A grain drill of the single-disk type, with from 16 to 20 holes, on average level ground usually requires about 30 lb. pull. Shoe and hoe types require more; this is for an average depth of two inches. A tooth harrow will require a draft of about 50 lb. for each foot of width, the harrow having four bars and the teeth spaced 12 in. apart. A disk harrow will require about 100 lb. per foot of width to operate in plowed ground, and about 80 lb. in operating on cornstalk land.

Fastening Roofing Paper under Eaves

When roofing paper is used to cover a building, it is at times something of a problem to figure out a way of fastening it to the eaves, so that the roof will not leak, and so that the wind cannot get underneath it and tear it away. To make a good job of such work, the roofing boards should extend about 2 in. beyond the cornice strip.

Allow the roofing paper to extend about 4 in. beyond the edge of the roof; fold this back underneath and nail it into the corner with a strip of quarter-round molding. The same method can be used to fasten the ends of the roofing underneath the gables.—Geo. G. McVicker, North Bend, Neb.

An Extra Seat for the Baby Carriage

The four-year-old son of the family would often tire of walking on the necessary outings of a younger occupant of the baby carriage, and would have to be carried by the father while he propelled the perambulator. Seeking some method of relieving himself of carrying the child in his arms, he fitted a detachable seat between the handles for the first-born.

Two iron-rod crosspieces were fitted to the frame, by means of eyebolts pass-

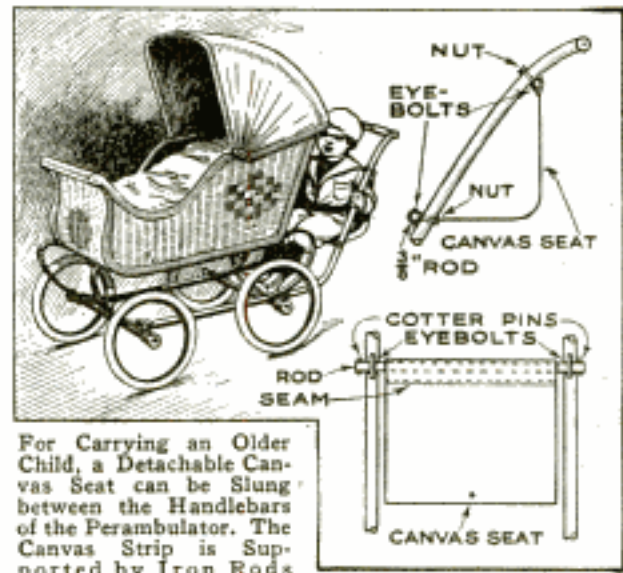

For Carrying an Older Child, a Detachable Canvas Seat can be Slung between the Handlebars of the Perambulator. The Canvas Strip is Supported by Iron Rods

ing through holes drilled in the handles. A strip of canvas, long enough to make a seat, was made with a hem at each end through which the rods were inserted. The ends of the rods were placed in the eyebolts, and were prevented from coming out by cotter pins inserted into holes in the ends of the rods.—Frank Harazim, New York City.

Rubber Tires for Wooden Wheels

The small wooden wheels that are frequently used on various articles of household furniture and toys can be fitted with rubber tires that will make them run more easily and noiselessly. Old automobile inner tubes are used as in the drawing. First, two strips of rubber are tacked around the

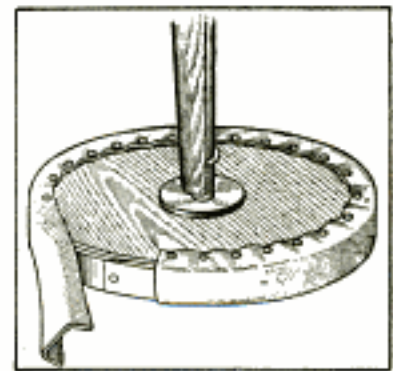

outside of the wheel, after which another and somewhat wider strip is applied, the edges of which are turned over and tacked down. When the outer band has become worn, it can be removed and another applied in its place. In case the tacks on the outside of the wheel are deemed unsightly, they, as well as the edge of the rubber strip, may be concealed underneath a suitable gimp.—S. E. Gibbs, Corydon, Ia.

Getting Water from Low Well

A well contained so little water in dry periods that it was impossible to draw water by means of the pump; as water

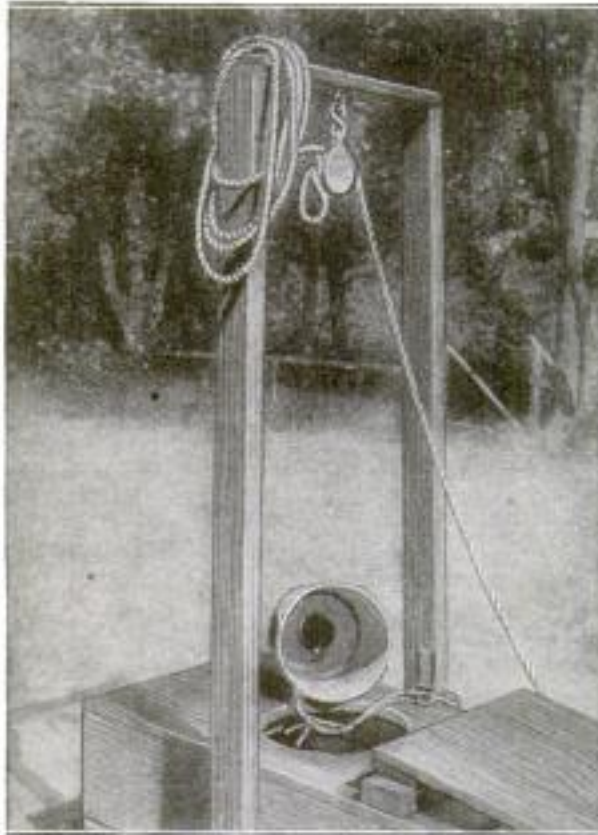

Galvanized-Iron Bucket with a Leather Flap Valve, Used to Draw Water from an Almost Dry Well

was necessary, the pump was pulled up, and the bucket shown in the photograph used. An ordinary galvanized-iron bucket had a 2½-in. hole cut through the bottom at its center. A leather flap valve was riveted to the inside so that, when the bucket was lowered, the water was forced up through the hole, the leather flap preventing it from running out again. A heavy iron ring was riveted around the lower rim of the bucket, to prevent it from floating on the surface and to hasten the filling.—Harry W. Poor, Boston, Massachusetts.

Improving and Waterproofing the Army Pup Tent

Probably no shelter man has ever crept into has been so abused as the army shelter tent, the principal score against it being that it affords but little room, as it has no walls and the pitch comes straight down to the ground. The improvement consists in adding a wall or sides to the tent, and this is all that is needed to make it thoroughly serviceable. This wall need

not be of any great height, a strip of canvas, about 1 ft. wide, sewed around the bottom of the tent, will raise it sufficiently to provide space for two. The weight of a tent thus altered is increased but a few ounces, and, with a twig bed, accommodates two comfortably.

To waterproof the tent, dissolve about 1 lb. of alum in ½ gal. of boiling water. When this has been thoroughly stirred and the alum dissolved, pour it into 2 gal. of cold water. The tent is soaked in this solution for 24 hours, when it is removed and the excess solution wrung from it. The tent is then immersed in a second solution made by dissolving ½ lb. of sugar of lead in 3 qt. of boiling water, which is added to 2 gal. of cold water. In this, the tent is soaked for about eight hours; then removed and hung up to dry without wringing it.—Robert Page Lincoln, Minneapolis, Minn.

Small Screwdrivers from Buttonhooks

An ordinary buttonhook, converted into a small screwdriver by filing off the end to a chisel-shaped point, provides a means for handling the many small screws in the lamp sockets and other lighting apparatus of the average automobile. As it is frequently necessary to handle screws in deep recesses, this light tool will often prove its value.

Chicken-Feed Box

A handy arrangement for keeping the chicken feed in or near the runs where it is to be

used, may be made after the manner of the one shown in the photograph. By using this, it is unnecessary to store the feed in the house or barn and carry it thence to the poultry yard. The feed box is a



wooden box supported on legs, with the rear end somewhat higher than the front. An opening is cut into the lower end of the box and the outflow of feed is regulated by a sliding gate.—E. E. Johnson, Ingleside, Calif.

Furnace Cement Repairs Fireplace

Annoyed for a long time by the bricks becoming loose and falling out of the fire wall of an open fireplace, and being unable to find anyone who could guarantee a permanent repair, the owner decided to cover the wall with furnace cement. This cement, used by furnace men to seal the joints between the sections of cast-iron furnaces, becomes almost iron-hard when subjected to heat. The cement was applied to the brick surface with a putty knife, and no further trouble has been experienced.—Burke Powell, Albia, Ia.

Planting Lettuce near Currants

Currant bushes are notorious as the favorite breeding place of some varieties of aphids, and if lettuce is planted near by, it is almost certain that the latter will also become infested with the insects. Lettuce planted near currant bushes is an open invitation to the pests, which are very hard to wash off the lettuce leaves. There is only one way to get rid of them, and that is to soak the lettuce for an hour in strong salt water, but it is better to use a little forethought and plant the lettuce as far away from the currant bushes as possible.

Storing Extra Table Leaves

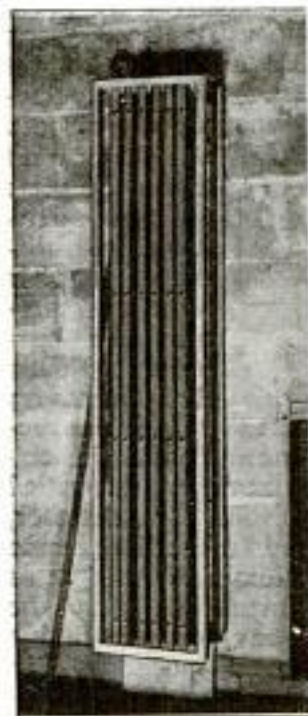

the entire outfit is elevated from the floor, within easy reach, and secured so that there is no possibility of the narrow crate being upset.

The crate of table leaves that is furnished with every extension dining table is generally stored in some closet, or other out-of-the-way place, where it is difficult to get at the boards when company comes.

The photograph reproduced here-with shows how one householder disposed of his table leaves. The crate is nailed to the sill of the house in the basement, near the cellar stairs. Being thus disposed of,

Gate Arbor Made from Wagon Wheel

The felloes from one or more old wagon or buggy wheels can be used to make an artistic curved arbor over a gate,



An Artistic Arbor for a Gate or Garden Seat That can be Easily Built from the Felloes of Old Wagon or Buggy Wheels

garden seat, or other garden furniture in which a curve is desired. In the arbor shown in the photograph, the sectors of the wheel are mounted on posts, and support a flowering vine, greatly improving, at little expense, the appearance of what would otherwise be a very commonplace entrance.—Harry Warneck, New York City.

Artificial Showers for Fishing

Seasoned and practical fishermen have wondered why, after fishing on a bright day without a nibble, the fish should strike ravenously during a light shower. There are two reasons for this. In the first place, the falling drops agitate the surface of the water so that the fish cannot see the fisherman and are not afraid to bite, and secondly, the rain knocks insects upon which the fish feed into the water. Taking advantage of this habit, the fishermen of Catalina Island, off which the famous tuna and yellowtail are caught, install a small power pump in their boats and throw a spray close to the boat where they wish to fish.—Rev. O. P. Avery, Portland, Ore.

A Spring-Driven Toy Boat

A boat that is propelled by springs, and that will furnish much amusement to children, may easily be made from no more

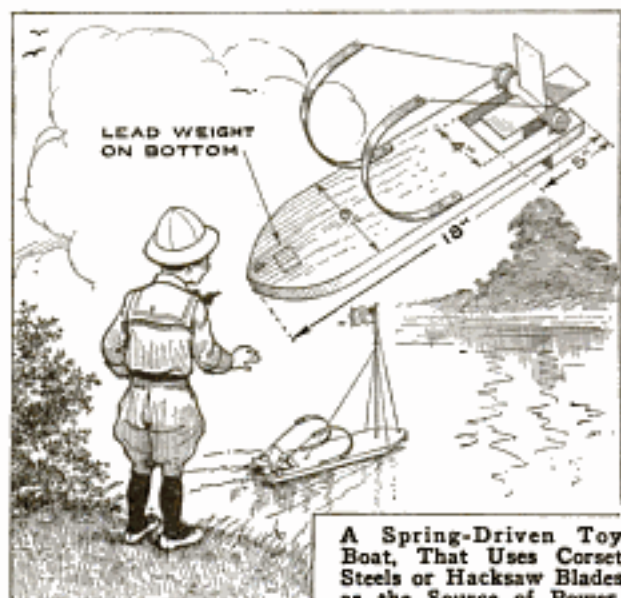

A Spring-Driven Toy Boat, That Uses Corset Steels or Hacksaw Blades as the Source of Power, can be Driven in a Forward or Backward Direction, Depending upon How It is Wound Up

elaborate materials than a piece of board, a pair of corset steels or hacksaw blades, and some pieces of tin.

The board is cut to approximately the outline of a boat, and a piece is cut from the stern to accommodate the paddle wheel, the latter being made by inserting pieces of tin into slots cut into a round wooden axle. Staples are used to secure the ends of the axle to the board. The two springs are mounted opposite each other, as shown, and a piece of stout string is attached to the free ends and to each side of the paddle-wheel axle. When the paddle wheel is wound up, the string will draw the springs up in arcs as illustrated, and as soon as the wheel is released, the tendency of the springs to resume their horizontal position will revolve the paddle wheel and cause the boat to move forward or backward, depending upon which direction the wheel is turned when winding.—Paul E. Rimbe, Roodhouse, Ill.

Propeller Bearing for Model Airplane

In making model airplanes, trouble is often experienced in finding a suitable bearing for the propeller shaft. For this purpose a short piece of glass tubing, of a diameter just large enough to permit free turning of the shaft, may be used. The end next the propeller is heated in a gas or alcohol flame until it is softened, when the sharp edges become rounded off.

Combined Fruit and Shade Trees

There is one kind of shade tree that is also a fruit tree—the apple. The apple is a native American tree, and at one period was much used for the grounds of farm and village homes.

One of the first points is the particular apple variety. As varieties have been evolved and propagated by budding and grafting, trees with different characteristics of trunk and limb growth have come into common use.

Some trees naturally make a low head, while others go high in the air; some mature early and others late; therefore, when one plants an apple tree for shade, the standard type of that tree in maturity should be known. One of the varieties that makes a particularly good shade tree is the so-called Stayman winesap. The winesap is not only a splendid apple, one of the best of winter varieties, but it makes a beautiful tree. The blossoms in spring and the fruit in autumn are additional charms possessed by the apple as a shade tree. The apple is a naturally long-lived tree and does not attain a size that is much out of proportion to its surroundings as do some other trees.—Oscar C. Place, Boulder, Colo.

"Forming" Electrolytic Rectifier Plates

The operation of an electrolytic rectifier depends upon the formation of an insulating film on the aluminum plates when the current flows from the electrolyte to the plate, thus opening the circuit.

A current from the plate to the solution will dissipate this film and permit the current to pass.

It is necessary that the plates be "formed" before the rectifier is permanently connected in the circuit. The electrolytic rectifier, described on page 459 of the March, 1920, number, has the plates connected to the line, hence excessive current will flow until the plates are formed. The formation may be brought about by the heavy current in due course, but the preferred method is to connect the device as shown in the diagram.

The cell is left connected, as shown, until the lamps go out, indicating that the film is formed and the circuit is open. The length of time required for this

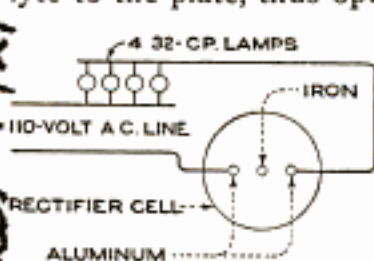

formation varies greatly, depending upon the grade of aluminum used. Some plates will form at practically the first surge of current, others take an hour or more; the formation can be hastened by scratching the surface of the plates with a wire brush.

When in use, the device will pull a little over four amperes, and the more perfect the plate formation, the closer the current will be to this figure. After the plates have been formed, the rectifier is connected in the circuit according to the diagram shown in the previous article.

Owing to the fact that alloys of aluminum are sometimes sold as pure aluminum, a set of plates may not function properly. Should this happen, and the plates not form within an hour, it is advisable to try another electrolyte. A common one consists of a saturated solution of ammonium phosphate, to which is added a few drops of acid to reduce the resistance. The plates should also be formed in this solution. There is no question of the rectifier working properly once the plates are formed.

Pulling Cars Out of Mud or Sand

To pull a car or truck out of sand, or a mudhole, under its own power, is quite simply done by the use of an iron-shod

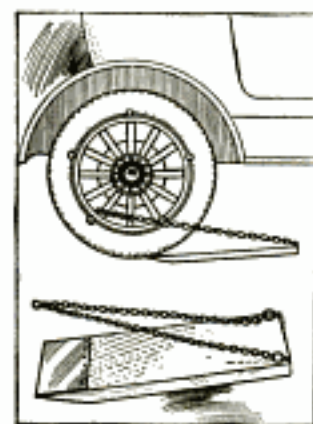

plank with a chain attached to the front corners, as shown in the drawing. In use, the skid is placed on the ground in front of one of the rear wheels and the chain is passed around one of the spokes. As the power is gradually applied, the car is pulled up onto the plank. The only

objection to this method is the possible damage to the spokes from contact with the chain, and this can easily be prevented by covering the chain with a length of heavy hose.—Robt. H. Neill, Ottawa, Ohio.

Concrete Base for Mail Box

A type of concrete base used for the mail boxes along rural routes in one of the western states has a number of features to commend it.

The concrete base is 16 in. square and 6 in. high, with a bevel of 2 in. The

standard is made from 1½-in. pipe, and the box is simply screwed or nailed on a wooden base bolted to the horizontal member of the standard. The whole out-

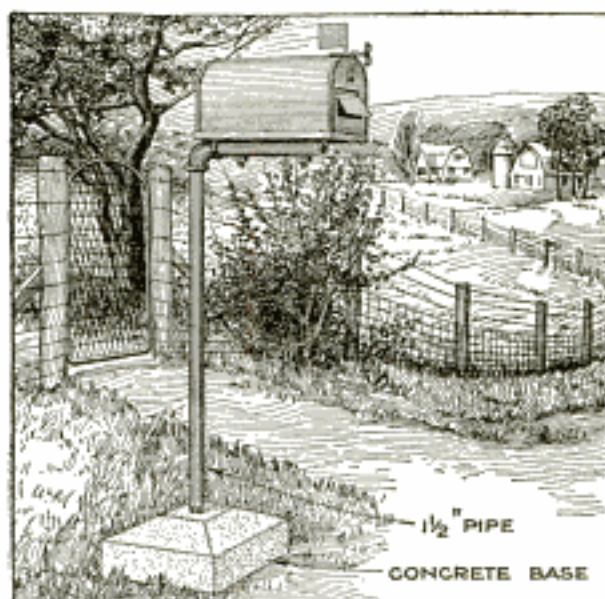

A Type of Standard for Supporting Mail Boxes along Rural-Delivery Routes, That Is Attractive, Practically Indestructible, and Easily Portable

fit costs but a trifle over a dollar to make, and besides being sightly and practically indestructible, it is portable, so that the position of the mail box can be altered as desired.—Stuart C. Mahuran, Mason City, Ia.

A Simple Gate Stop

A simple device for keeping a gate closed consists of an iron-faced wedge, securely attached to the walk back of the gate. The wedge should have a long, gradual slope, be faced with a strip of flat iron, and be just a trifle higher than the distance between the bottom of the gate and walk. Fasten the wedge firmly to the walk so that when the gate is closed it will ride up the inclined face of the wedge

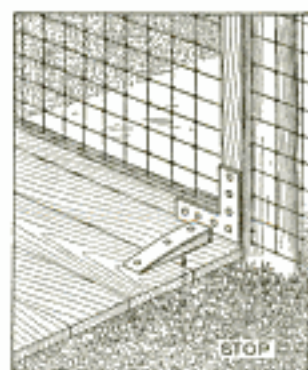

and drop down behind the end, thus holding it shut. See that the stop is not so high that too much effort is required to open the gate. Such a wedge will take the place of a latch, and the gate is opened by lifting it the fraction of an inch necessary to raise it above the end of the stop.—J. Alexander, Lincoln, Neb.

Making Watch Fobs

Brass, copper, german silver, and other metals in sheet form lend themselves admirably to the manufacture of watch fobs,

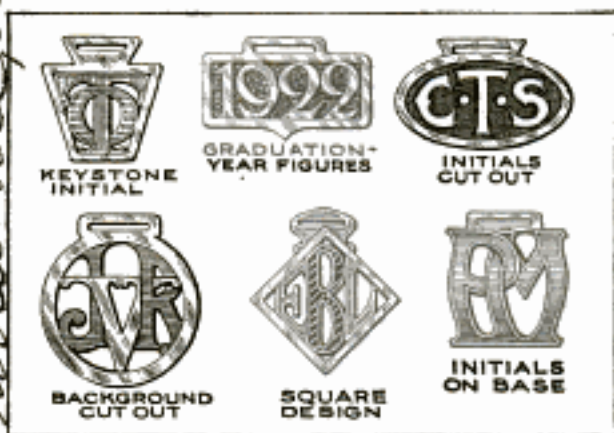

Various Forms of Monograms That can be Cut from Sheet Metal with a Small Coping Saw: Automobile-Radiator Monograms, Belt Buckles, Monograms for Leather Handbags, and Similar Articles can be Made in the Same Manner

which can be finished in an endless variety of pleasing designs.

The design is first drawn on paper; this is then pasted onto a disk or square of the metal to be used, and small holes are drilled at the corners of the design, large enough to permit the insertion of a jeweler's or coping-saw blade. The metal is sawed out between the letters and figures, and the edges and borders are then finished with small files. Tooling the surface of the letters or background adds richness, but considerable skill in the use of a graver is necessary before good work of this kind can be done.

The tools required for work of this kind are a small hand or breast drill, a set of small drills, coping saw and blades, bench vise, files, dividers, and scribes for laying out the work. There is a wide field for such work, and with a fair degree of skill, it is entirely possible to build up a flourishing business in monogrammed watch fobs, belt buckles, radiator monograms for automobiles, monograms for leather handbags, and the like, without the investment of more than a few dollars for tools and materials.

Preventing Corrosion of Battery Terminals

Almost every motorist sooner or later experiences the annoyance caused by his starting motor failing to respond when the starter pedal is depressed. Many of these cases are caused by increased resistance at the battery terminals, as a result of corrosion from exposure to the

air and fumes from the battery. Cleaning the terminals relieves the trouble temporarily, but does not cure. Soldering is not advisable, because it interferes with the removal of the battery, should this be necessary, but the corrosion can be prevented by covering the terminal and lug with paraffin. To do this, a small pasteboard box should be fitted over each terminal in such a manner as to cover completely the edges of the actual points of contact between the lug and terminal. Melted paraffin can then be poured into the box and allowed to harden. The contact surfaces should be thoroughly cleaned with emery cloth before the wax is applied. Should it be necessary to remove the battery for any reason, the wax can easily be removed.—C. M. Crouch, Minneapolis, Minn.

The Knight's Tour

The knight's move in chess can be made the basis of a very effective "memory" feat, suitable for presentation by any ama-

1	2	3	4	5	6	7	8	1	11	5	15	32	22	39	56
9	10	14	12	13	14	15	16	62	45	60	50	33	43	26	9
17	18	19	20	21	22	23	24	3	20	14	6	23	29	12	2
25	26	27	28	29	30	31	32	19	25	35	41	58	52	37	47
33	34	35	36	37	38	39	40	64	54	44	59	49	34	17	27
41	42	43	44	45	46	47	48	10	4	21	6	16	31	46	35
49	50	51	52	53	54	55	56	55	61	51	57	42	36	53	63
57	58	59	60	61	62	63	64	46	40	30	24	7	13	28	18

The Moves of the Knight in Its Tour around the Board are Outlined in the Left-Hand Drawing. This Trick may be Used with Telling Effect as a Master "Memory" Feat

teur magician. This move is a peculiar one, the piece moving two squares straight across the board, then one square at right angles to the first one, or one square straight across the board, then two squares at right angles; the first move may be in any direction, forward, backward, or to the right or left, except diagonal. The tour may begin at any square on the chessboard, the problem being to move the knight in such a manner that it will, in the course of the tour, cover every square on the board, without stopping twice on the same square, returning finally to the square from which it started.

A blackboard is ruled off into 64 squares, corresponding to the chessboard, and the squares are numbered as shown in the left-hand drawing; the board is placed on an easel in full view of the audience. This done, a member of the audience is asked to call out the number of the square he wishes the performer to

start from, which, for example, will be number 37. The person giving the number is furnished with a piece of chalk, and instructed to draw a straight line from square to square as the performer calls out the numbers. By examining the drawing, it will be seen that these straight lines, while not showing the actual right-angled move of the knight, show the starting and stopping points of each move.

The performer steps well away from and to the back of the blackboard, so that it is impossible for him to see it. As the numbers are called out the knight's path is traced until the piece is back at the starting point, in this case number 37 square.

The trick requires an indicator, which is a card, $1\frac{3}{4}$ in. square, divided into 64 squares, and each row numbered from left to right as shown in the right-hand drawing, the numbers representing the consecutive moves of the knight. Beginning with the number called, the consecutive numbers are read from left to right, then the numbers in the next row below, and so on, always reading from left to right, and when the last number, 18, is called, the performer goes to the upper left-hand corner and calls out number 1, continuing until number 37 is again reached.

When the performer steps away from the board, he casually folds his arms, so that the indicator is concealed in his right hand; it is then only necessary to glance down at the indicator and call off the number, beginning at 37, or any other number specified.

In working up the effect, the numbers should not be read off in too much of a hurry; for example, say, "You are on 37—go down—down to 47, now—away down to 64, in the corner,—up to—er—54, now to 44," and so on.

Properly presented, this trick gives the audience the impression that the performer has a master memory.

Making the Shotgun Comfortable

Many hunters and trapshooters would derive more pleasure from their sports if it were not for two drawbacks, which cause inconvenience even to experienced men. These are the recoil of the gun when discharged, and the cold hands the user gets if he is not equipped with gloves. Many cannot shoot with gloves on, and even for those who can, shooting with gloves on is inconvenient because it does not allow the gun to be handled with the proper speed for quick shooting.

By covering the grip and forearm of

the piece with rubber or leather, the cold grip is eliminated, and the ability of the user to handle the gun quickly is not interfered with. By gluing the covering to the wood, the leather or rubber can be

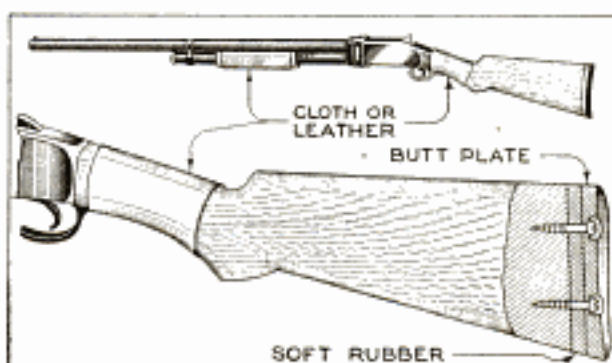

Two Methods of Making Hunting and Trapshooting More Comfortable for the Sportsman: Leather or Rubber-Covered Grips Prevent Cold Hands, and Soft Rubber between the Butt Plate and Stock Takes Up Some of the Recoil

removed at any time without marring the gun. The sharp and heavy "kick" resulting from the discharge of heavily loaded shells can be considerably reduced by removing the hard-rubber butt plate and inserting a piece of soft rubber between it and the stock. The rubber should be trimmed neatly so as not to project beyond the stock, and long screws should be used, to steady the butt plate.

Rubber Mat from Inner Tubes

A novel use for old inner tubes is shown in the drawing of a woven rug, or mat, that may be used as a covering for the floor of the car.

Two sections of inner tube, about $2\frac{1}{2}$ ft. long, are split lengthwise, and the rectangular pieces thus formed are slitted lengthwise, spacing the cuts equally and running them to within an inch or so of the ends. Another section is cut up into strips of the proper width and length and these are

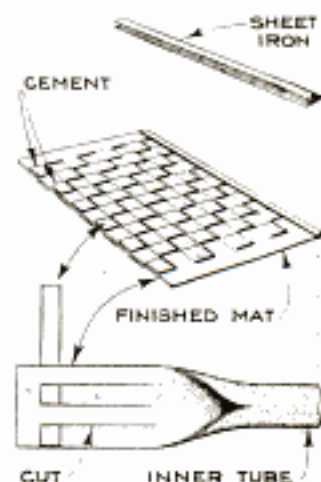

woven through the slits, as indicated in the drawing. When both sections have been woven, the loose ends of the strips are fastened with a little rubber cement. If desired, two strips of sheet iron may be bent and clamped on the edges, to stiffen the mat.

Easily Renewed Coaster Brake

The brake that forms a part of most models of children's toy wagons and coasters of various kinds, is usually un-

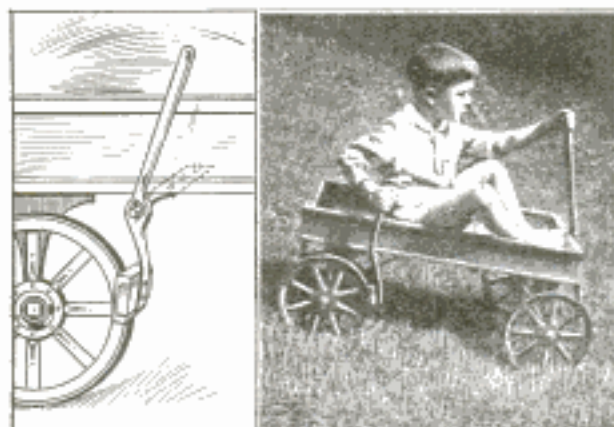

A Hand Brake for Children's Toy Wagons and Coasters, in Which Provision is Made for Renewing the Brake Shoe When It is Worn Out

satisfactory because of its short life. The wooden lever wears down rapidly, and an iron brake wears the tires, and there is usually no way to renew either.

The drawing and photograph illustrate an iron brake handle that has provision made at its lower end for holding a wooden-block brake shoe, so that as soon as there is any amount of wear, a new block can be inserted, and the brake will be as good as new. The brake lever is forged from a piece of round iron, with one end flattened to accommodate the brake-shoe holder, to which it is riveted. The brake lever is fastened to the wagon by means of a stud attached to the underside of the wagon box.—C. R. Gains, Colfax, Ia.

Compartment for Tire Chains

Muddy tire chains are not easily cleaned, and mess things up generally when thrown into the tool box of a car, but this trouble can be completely overcome by providing a special box for them fastened underneath the floor boards, and so mounted that it will clear the

driveshaft and other parts of the car. The bottom of the box should slope down toward the center, in which a hole is drilled to allow the dirt to fall through. Access to the chains is gained by lifting off

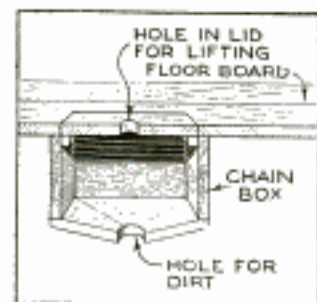

the cover, which is provided with a finger hole. With an arrangement of this character, the muddy chains can be dropped into the box and forgotten until needed again, when they will be found clean and ready for service. As the mud dries, it is shaken off the chains by the vibration of the car, and soon finds its way through the hole in the bottom of the box.

Camera Shutters should Not be Oiled

One of the surest ways of putting a camera shutter out of commission is to oil it. The fact that a watch needs oil does not indicate similar need on the part of the shutter. The construction of the camera shutter differs greatly from that of the watch. It has comparatively few bearings and these operate only when the shutter is opened or closed, and they are designed to work wholly without lubrication; consequently, if oil is introduced into the bearings of a shutter it will seriously interfere with its working. By remembering these facts and never oiling the shutter on a camera, it will, if protected against dust, moisture, and physical injury, render good service for many years.

Sweeping-Compound Distributor

To reduce the amount of sweeping compound required, and to apply it uniformly, the handy device shown in the drawing can be used to advantage. The container for the compound is made from a 2-gal. sirup can, the sides of which have been perforated with $\frac{1}{4}$ -in. holes. The detachable handle is made of

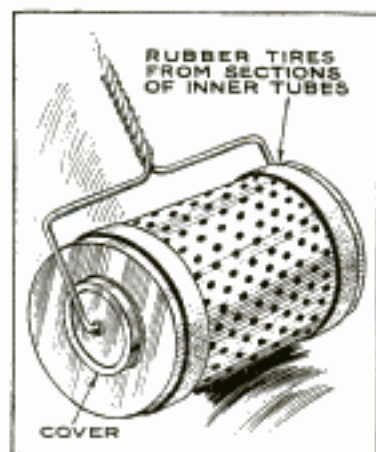

twisted wire, the ends of which fit into holes punched through the centers of the top and bottom of the can. To elevate the can a sufficient distance above the floor to allow the compound to sift through, and to provide silencers, rubber tires, made from cross sections of old inner tubes, are slipped over the ends. The cylinder is filled with compound by removing the handle and cover.

PRIZE OFFERS

8417

Prize Offer 3278

WHETHER YOUR NAME BE LUCKY OR NOT DECIDED BY HOROSCOPE MEANS

A novel means of attracting readers—so novel that it is not only copyrighted, but is also the subject of a patent application—is a prominent feature these days of the Chicago Daily Tribune. Every day a blank is printed in a corner of a page of the paper, that contains spaces to be filled in, as follows: full name, father's name, mother's name, full address, birthday, and the date sent in. From these data the horoscope editor decides whether the applicant is lucky enough to win one of the following prizes: first, \$200; second, \$100; third, \$50, and 40 or 50 of \$5 each. Thus each day some names are lucky, others are luckier, but the luckiest of all will be the name that is finally picked for an additional prize of \$10,000. Nobody will dispute the fact that that person will be unusually lucky. It is not stated when this opportunity to "try your luck" will be terminated.

8283

BEST LISTS OF USES OF SHOE POLISHES WILL BE AWARDED CASH PRIZES

It has been found that the shoe polishes known as 2-in-1 Black, 2-in-1 White, and 2-in-1 Tan Paste, can be used for other purposes besides shining shoes. The manufacturers, therefore, are offering the following cash prizes for the best lists of new uses of these polishes separately or in combination: First, \$500; second, \$300; third, \$200; 10 of \$25 each; 20 of \$15 each; 50 of \$5 each; 50 of \$2 each, and 100 of \$1 each. The rules are: Write on one side of the paper only, and list uses according to colors. Awards will be made on or before Oct. 1, 1922. Address: Prize Editor, F. F. Dalley Company of New York, 277 Military Road, Buffalo, N. Y.

8446

ONE-HUNDRED-DOLLAR PRIZE OFFERED FOR BEST SETTING OF A SONG

Announcement is made of a competition for a prize of \$100 for the best musical setting of Sir Walter Scott's poem, "Hunting Song," by the Swift & Company Male Chorus. The conditions are as follows: The composer must be a resident of the United States. The setting must be for chorus of men's voices with piano accompaniment. The composition must sing well, and should be kept within a reasonable vocal compass. Parts may be doubled at pleasure. Each composition must bear a fictitious name, and must be accompanied by a sealed envelope bearing on the outside the fictitious name and having inside the composer's real name and address. For return of manuscript, loose stamps should be inclosed.

Competitions should be sent to the conductor of the chorus, D. A. Clippinger, 617-18 Kimball Building, Chicago, Ill., and must be in his hands on or before July 1, 1922. The award will be made Aug. 1, 1922. The composition winning the prize will be produced by the chorus, whose property it becomes, during the season of 1922-1923.

PRIZE-POSTER CONTEST FOR SCHOOLS TO TEACH KINDNESS TO ANIMALS

Pupils in the public and private schools of Massachusetts are offered an incentive to join in the eighth national observance of "Be Kind to Animals Week" (April 24-29) and "Humane Sunday" (April 30), through the interest of the Massachusetts Society for the Prevention of Cruelty to Animals, which for the best posters received before April 18 will give nine annual subscriptions to its publication, Our Dumb Animals, and nine cash prizes as follows: For pupils in high schools, training classes, etc., first, \$20; second, \$15, and third, \$10; for pupils in grammar grades above the sixth, and also for pupils in the fifth and sixth grades, first, \$15; second, \$10, and third, \$5. The offer is open to all pupils of public or private schools in Massachusetts. The posters are intended as propaganda in the interests of all dumb animals, domestic or wild. The drawings must be on cardboard or heavy paper of about 14 by 20 in., and should be shipped flat, in time to reach the offices of the Massachusetts S. P. C. A., 180 Longwood Ave., Boston, not later than April 18. The prize-winning posters will be sent to the American Humane Association, Albany, N. Y., to compete in a national prize contest.

man S.P.C.A. 180 Longwood Ave Boston, Mass

SILVER LIFE-SAVING MEDALS AWARDED TO THREE HEROIC NAVY MEN

Three enlisted men in the navy have been awarded silver life-saving medals by the Treasury Department, as follows: Leslie Robert Ebaugh, coxswain, for rescue from drowning of a seaman, and the attempted rescue of another, at Hampton Roads, last May 12; Bernard M. Noonan, seaman, for rescuing from drowning a pharmacist's mate at Bremerton, Wash., last July 5; and Ralph Joseph Martin, chief torpedo man, for rescuing a fireman who was swept overboard from submarine "O-10," April 18, 1921, while en route from Bermuda to New London.

PRIZE OFFERED FOR ANY MAN-PROPELLED AIRPLANE THAT CAN HOP 164 FEET

Some time ago a prize was given to a French former for hopping 10 meters (nearly 33 ft.) on a winged bicycle. Now another prize of 20,000 francs is offered for the first man-propelled airplane which shall hop 50 meters (164 ft.) over a flat surface once in each of two opposite directions. No artificial buoyancy, or independent assistance, may be employed. The dates for making attempts for the prize in 1922 are April 23-30, June 23-30, July 23-30, September 23-30, and possibly a supplementary date. The competition is open to all nationalities except former enemy nations. Entries, accompanied by a fee of 10 francs, returnable under certain conditions, must be made at least 10 days prior to any of the weeks stated above, to Maison Peugeot, 80 Rue Danton, à Levallois-Perret (Seine), in the name of the competitor, and with the name of the maker of the machine.

MAGICIANS' SECRETS TO BE RESPECTED

MMAGICIANS earn their living by mystifying the public. Performances such as "The Vanishing Elephant" and "Passing through a Brick Wall," both of which have been explained in this magazine, are produced not merely at great financial cost for paraphernalia and equipment, but also at the expenditure of much clever brain work and severe physical training. What then—when the magician has perfected his idea and begun to delight large audiences with its presentation—what must be his dismay to have the secrets of his patiently mastered art revealed by the press! To him it is a catastrophe.

Realization of this fact leads to the announcement that henceforth Popular Mechanics Magazine will publish no detailed articles of magicians' performances, but, instead, will cooperate with the American Society of Magicians in protecting the secrets of a form of amusement which has always met with popular favor.—Editor.

Aerial Age 651
2/6/22

Copyrighted material

8292
TWO EXAMINATIONS FOR COMPUTERS
BY U. S. CIVIL SERVICE COMMISSION

The U. S. Civil Service Commission announces an open competitive examination, closing May 2, 1922, for computer (Grades I and II). Vacancies for the Ordnance Department of the War Department, for duty at the various proving grounds within the United States, will be filled from this examination. Entrance salaries for these positions will range as follows: Grade I, from \$1,400 to \$1,800; Grade II, from \$900 to \$1,400 a year. The duties of the appointees will be to make ballistic computations. Competitors will not be required to report for examination at any place, but will be rated upon sworn statements of their education and experience. Applicants must have graduated from a four years' high-school course, or have completed a course of study equivalent to that required for such graduation. For Grade I, they must have had at least four years' experience in engineering, or other pursuits involving the application of higher mathematics, and in Grade II, two years of such experience. The equivalent of this in a college, or university of recognized standing, embracing mathematics up to and including integral calculus, and physics and applied mechanics, will also be accepted as a qualification.

The department also announces an open competitive examination for computer, to be held April 26-27, 1922, to fill vacancies in the Coast and Geodetic Survey, for duty in Washington, D. C., at a salary of \$1,400 a year, and in Manila, P. I., at \$2,000 a year. Appointees whose services are satisfactory will be allowed the bonus granted by congress of \$20 a month. The subjects of examination will be mathematics, astronomy, physics, surveying, practical computations, and one foreign language. Applicants may be examined at any place at which this examination is held, regardless of their place of domicile; but only those who have been domiciled in the state in which they reside for at least one year previous to the examination, and who have the county officer's certificate in the application form executed, may become eligible for permanent appointment to service in Washington.

In the examination for computer in the Ordnance Department, all citizens, men or women, who have not reached their 50th birthday, and for computer in the Geodetic Survey, all male citizens who have not reached their 70th birthday on the day of the examination, are eligible.

All desirous of competing should at once apply for form 1312, stating title of the examination, to the Civil Service Commission, Washington, D. C., or to the Secretary of the U. S. Civil Service Board in the applicant's locality.

8483
"HOOSIER TON LITTER CLUB"
HELPS INDIANA FARMERS

During the past two years the Department of Agricultural Extension of Purdue University, Lafayette, Ind., has made investigations that proved that the number of pigs raised and marketed per litter is the governing factor in determining the cost of producing pigs. Therefore, in cooperation with the Indiana Livestock Breeders' Association, they formed the "Hoosier Ton Litter Club," which offered a gold medal for any litter of pigs that would weigh 2,000 lb. or more when six months old. In connection with this prize offer the club demonstrates methods of breeding, feeding, and management of hogs which will produce ton litters. Executive committees are appointed in each county or township who explain the plans of the club, enroll members, and appoint committees to inspect and weigh litters according to the rules of the club. Besides the gold medals for litters weighing a ton, silver medals were offered for 1,800-lb. litters, and bronze medals for those of 1,600 pounds.

The idea is decidedly novel, and will doubtless stimulate the interest of all Indiana farmers in animal husbandry. The plan might very well be imitated in other states.

8491
CENSUS THAT WILL SHOW EXACT NUMBER
OF SAFETY MEN IN MINING INDUSTRY

It has never been established definitely how many persons in the mining industry are engaged in accident prevention and industrial health work. Now for the first time the National Safety Council, with the cooperation of the Bureau of Mines, is engaged in the compilation of a census of safety men in the mining industry, including also safety men in nonmining industries. It is expected that when this census is completed there will be registered at the headquarters of the National Safety Council in Chicago the name of every man and woman responsible for the safety work of every industrial plant, public utility, municipality, and every organization which devotes any part of its efforts toward the promotion of either industrial or public safety in the United States. The council continually receives requests from all kinds of organizations and associations for help in finding speakers or writers on safety subjects, and the census records will greatly increase the facilities of the council for filling such requests.

8160
SIXTH SWISS SAMPLE FAIR TO BE HELD
AT BASLE, APRIL 22 TO MAY 2, 1922

Five annual Swiss sample fairs have already been held in the great exhibition building at Basle, and from the steadily increasing popularity of these shows, it is expected that still greater interest will be taken in the sixth show, which takes place April 22 to May 2, 1922. The principal object of these annual expositions is to develop already existing commercial relations, and to afford opportunities for forming new connections. The sample fairs are also intended to remove conditions resulting from the war, and to help re-establish international economic relations. The exhibits are confined strictly to Swiss products and manufactured goods. Sales at one of these fairs reached a total of 50,000,000 francs (normally about \$10,000,000). Many foreign buyers, including several from this side of the Atlantic, attended the last fair, and still more are expected this year.

Official Bureau
CONTESTS PREVIOUSLY ANNOUNCED

Medals, Diplomas, and Money Awards: Announced August issue, 1921; awards offered by the Franklin Institute.

For Service to City of Philadelphia: Prize \$10,000; announced September issue, 1921; awarded in spring or summer of 1922 by Edward Bok, former editor of The Ladies Home Journal.

Model in Clay by Students of Chicago Art Institute: Prizes, \$1,000, \$100, and \$50; announced November issue, 1921; closes April 15, 1922; address, Daily News Office, 15 N. Wells St., Chicago, Ill.

One Million Francs for Best Motor: Announced January issue, 1922; closes June 1, 1923; address, Aero Club of France.

Best Slogan Describing Razor: Prize \$500; announced January issue, 1922; closes June 30; address Durham Duplex Razor Co., 190 Baldwin Ave., Jersey City, N. J.

American-History Essays: Prizes, \$3,000 for professors, \$2,000 for specialists, \$1,000 for school-teachers, \$1,000 for students, and \$500 for undergraduates in U. S. colleges; announced March issue, 1922; closes May 31. Address, Knights of Columbus Historical Commission, K. of C. Bldg., 199 Massachusetts Ave., Boston, Mass.

8367
The National Billiard Association of America has been organized for the purpose of encouraging the game of billiards, and at the same time to correct any evils that are connected with the sport. While doing everything possible to upbuild billiards, it is also the intention of the association to close up any billiard rooms that allow objectionable practices.

301 1st Nat Band Bldg
IN accordance with the editorial policy of this magazine never to accept compensation in any form for what appears in our reading pages, and also to avoid all appearance of doing so, we are obliged to omit the name of the maker or the seller of any article described. This information, however, is kept on file and will be furnished free, by addressing Bureau of Information, Popular Mechanics Magazine, Chicago. [Editor.]
New Haven, Conn.



10 Days'
Free
Trial

Small
Monthly
Payments

\$4 down brings this Brand-New Typewriter

Pay the balance in small monthly installments—
We will ship the typewriter to you for ten days' free trial

The Amazing Story

A real need has long existed for a full-size, 4-bank, 42-key, 84-character-keyboard typewriter, with the entire line of writing completely visible, selling for less than \$100.

Annell has been evolved to fill that need; it is the creation of, and is sponsored by, men who know every phase of typewriter manufacturing and typewriter use.

The Annell turns out the most beautiful work that ever came from a writing-machine. The type is clear, clean-cut, hard; the alignment and spacing are utterly perfect. The speed is unlimited, no operator can crowd the Annell. Above all, this Model No. 3A Annell is of extremely simple construction. It is trouble-proof and sturdy; it is free from devices which without adding real writing value complicate the mechanism. It will last a business lifetime.

Every Operating Feature

The Annell has every late style feature and modern operating convenience—each letter completely visible as written (together with all the previous writing), Back Spacer, Tabulator, Two-Color Ribbon, Right and Left Hand Shift Key, Shift Lock, Margin Release, Adjustable Line Spacing, Adjustable Margin Stops, Paper Release, Automatic Line Spacer on Carriage Return, Adjustable Paper Fingers, etc., also the 42-key, 84-character Universal Keyboard. Rubber Cover and all extras shipped with each machine.

The operator of any Universal Keyboard machine can easily change to the Annell because the keyboards have the same relative position of the letters.

The Annell is Standard in size, Standard in appearance, construction and mechanical action—a typewriter that honestly reflects the great lessons learned from years of typewriter experience, with an action so smooth and a touch so responsive as to be a source of constant pleasure to the experienced operator, and making the progress of the novice immeasurably easier.

An Immense Saving

Our wonderful machine and remarkably low price are astounding the typewriter world. Never before in the history of the typewriter business has so much real, honest writing value been offered at so low a price. We are the only company selling a Standard 42-Key, 4-Row, Brand-New Typewriter direct to the user by mail at practically the wholesale price of other high-grade typewriters.

Typewriter users who once paid around \$100 for typewriters are now buying the Annell; they appreciate its sturdy day-after-day dependable performance and ease

of operation. You can pay more for a typewriter, but you cannot get more writing value at any price than in the Annell. *Absolute reliability, the utmost quality, at a lower price.*

No Risk—10-Day Free Trial

The high-grade quality of this beautiful machine is even better than we can tell you, or show in pictures; we will prove this to you by sending the machine to you for ten days' trial. You use the machine on any of your work and satisfy yourself that this typewriter will do your work to your complete satisfaction—satisfy yourself that the Annell is the best typewriter value offered today by anybody, regardless of price. If you are not entirely satisfied after trying it thoroughly, return the machine to us. We will refund the express charges and any money you have paid, and the trial will cost you nothing. You are the only judge. Nothing could be more fair.

Over a Year to Pay

Our remarkably low price, together with our convenient monthly payment plan, makes it possible for you to buy a brand-new typewriter easily and without inconvenience—over a year to pay.

Fully Guaranteed

The Annell is built to watchmaking standards, just so perfectly; from the best of materials money and brains can buy; patterned along proven, standard design; using the best workmanship and the most modern factory equipment obtainable. Yet we absolutely protect you with an iron-clad guarantee against any flaw in the material or workmanship. Annell is built to assure reputation—for leadership.

Send No Money—Just the Coupon

The coupon below brings—free and postpaid—booklet and all the interesting facts of how you can receive the utmost in writing value at an immense saving from the usual typewriter price.

At present we can make prompt delivery but our volume of orders is increasing and will soon tax our factory capacity. Better send the coupon for more complete particulars about our remarkably low price and free trial offer. It does not obligate you—mail coupon today—don't delay.

ANNELL TYPEWRITER COMPANY

1200 First National Bank Bldg. CHICAGO

TEAR OUT AND MAIL

ANNELL TYPEWRITER CO.,	PM.
1st Nat'l Bank Bldg., Chicago.	
Send me further information about the Annell; this places me under no obligation.	
.....	
.....	



One of the 250,000 who provide Bell Service.

At Your Service

Imagine a bird's-eye view of the United States. Imagine it criss-crossed with telephone wires or underground cables connecting every city, town and hamlet. Imagine these wires reaching nearly 14,000,000 destinations—in city homes and offices and in 2,500,000 farmhouses.

Imagine all this and your vision is still short of the truth regarding the Bell System. A telephone at your elbow, a wire circuit to your farthest neighbor. Apparatus which embodies the latest developments of an army of trained scientists. The picture is still incomplete.

In every center of population is a telephone exchange and an organization of skilled workers to give life to the nation-wide facilities of communication. Every circuit must be tested; every inch of wire watched and kept in repair; every switchboard operated day and night.

But that is not all. There is the new construction to meet the increasing needs of the telephone-using public. Every day, from one end of the country to the other, thousands of crews of linemen and cablemen, and installers of every kind of telephone equipment, carry on this work with the continued growth of the nation.



" BELL SYSTEM "

**AMERICAN TELEPHONE AND TELEGRAPH COMPANY
AND ASSOCIATED COMPANIES**

One Policy, One System, Universal Service, and all directed toward Better Service

Add 1,000 Miles To Every Tire

in this amazingly simple way

Proved by 100,000-mile tests. Fully guaranteed. A Real Tire Saver. Yet the cost is but \$1.25 per tire.

P. T. Coffield, a Californian, invented this method of cutting tire mileage costs.

Apply the Coffield Tread yourself, according to simple directions, to any smooth-tread tire in 6 minutes, and get 1000 more miles per tire *guaranteed*. Pay only \$1.25 to \$1.50 per tire according to the size. Apply to old or new smooth-treads or to tires worn down to the fabric.

If the tread, applied properly, doesn't give 1000 more miles or comes off, we *return every penny*

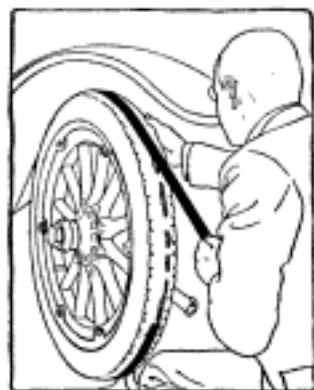

Apply it yourself in 6 minutes and add 1,000 miles per tire.

Coffield Tread

Adds 1,000 Miles to Tires

that you've paid. (Reference: Southern Trust & Commerce Bank, San Diego, California.)

We know what Coffield Treads will do, and so we make this broad gauge guarantee.

100,000-Mile Tests

This amazingly simple method was developed in California—the world's greatest testing ground for tires. Here cars are used every day in the year and are driven long distances at high speed.

Scores of thousand-mile tests on great motor stages over roughest mountain roads have proved that this *wonderstrip* makes good.

Hundreds of private users have secured two, three and four thousand extra miles from old tires by re-applying Coffields in their own garages. In 6 minutes' time per tire they save the cost of expensive retreading or the buying of new tires.

Prove it on *your* tires at our risk—get *your* extra thousand miles.

Then get *another* thousand miles by putting on a second Coffield Tread.

Takes All Road Wear

You'll want to try this method some day if it adds 1000 miles to tires. Try it now and prove

it at our risk. Make old tires go twice as far. The Coffield Tread is the product of motoring experts of fourteen years' experience. And all that experience was gained in this great testing ground that quickly points out tire troubles and their cure.

The Coffield, inexpensive, but efficient, *takes all the road wear from the tire tread*. When the Coffield wears out the *tire tread* is still there. Repeat the Coffield tread every thousand miles and get *all* the life from tires.

Get Them Now

Don't wait. Get your Coffields now. Prove them on at least two tires. We'll send direct by mail, charges prepaid.

If your tires are 3½-inch, send \$2.50 for a two-tire package with special tread-cement and brush. Send \$3.00 if your tires are 4-inch or over. If your fabric is exposed, send 50 cents for one can of Liquid Tread sufficient for two tires.

Money guaranteed returned, remember, if they don't add 1000 miles per tire.

Complete simple directions and legal guarantee mailed with every shipment. At least learn more about it. Mail coupon now. Save thousands of tire miles. Mark coupon as indicated if you want shipment at once or further information.

Coffield Tread,

Dept. M104, Southern Title Bldg., San Diego, California.

My tires are size, State size in inches as marked on tires.

Please send further information about Coffield Treads.
(Place check mark in square above if you wish information—check mark in square below if shipment is desired.)

I enclose \$..... for Coffield Treads (according to size above), and \$..... for cans Liquid Tread.
Coffield Treads are sold only in pairs or fours.

It is understood that I am to get all my money back if the Coffields don't save as guaranteed in legal guarantee I receive with the treads.

Your Name.....

Address.....

Brown-skinned natives tap the rubber trees for the highest grade plantation rubber. Only the best is good enough for your lively, tough Vitalic Bicycle Tires.

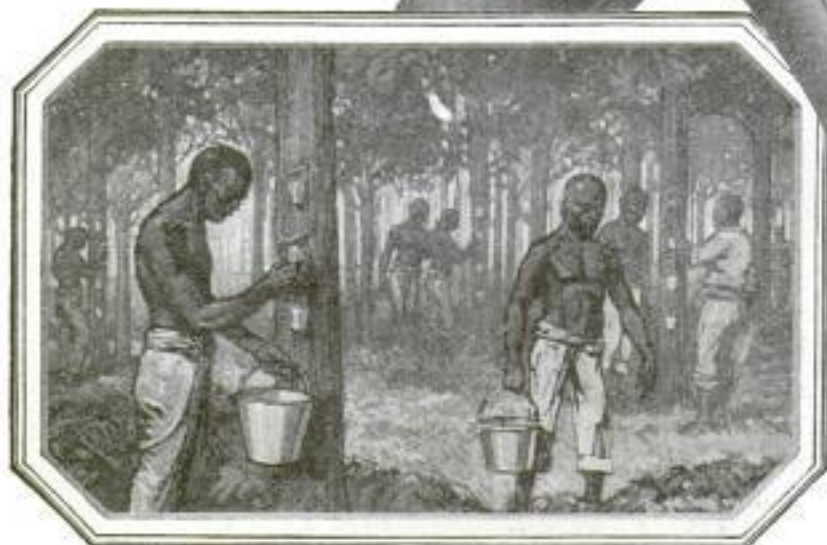

Tougher than Elephant hide - Because Real Rubber

THAT'S the reason Vitalic Bicycle Tires never seem to wear out. Over good roads and bad — they spin merrily on, adding mile after mile of trouble-free service.

The man who rides on sturdy Vitalics knows they will take him there and back, no matter how long and hard the trip may be. What if the roads are wet? He need not worry, for the famous Vitalic V-

shaped tread clings to the road with a non-skid safety grip.

Rarely a puncture; seldom a bad cut and never a loose tread or porous tire!

No wonder the makers of such good bicycles as Black Beauty, Columbia, Dayton, Emblem, Excelsior, Indian, Iver-Johnson, Pierce and Yale use Vitalics on their better grade wheels!



Send for this free book today. It tells you the interesting story of how Vitalic Bicycle Tires are made.

CONTINENTAL RUBBER WORKS
1928 LIBERTY STREET ERIE, PA.

VITALIC

TRADE MARK REGISTERED

Bicycle Tires



TRADE MARK
Tougher than elephant hide



“Biggest dollar’s worth I ever saw”

“I’VE tried pretty near every athletic union suit ever made and almost gave up hope of finding the right one. Then I found Topkis. No more experimenting—it’s Topkis for me from now on.

“First underwear that ever really fit me. Hardly seems to touch my body at all. Walking, sitting, running, I never feel my underwear. Not a hint of pinch or pull at any point.

“My health is better, too. Topkis lets your skin breathe!”

Best nainsook and other high-grade fabrics. Pre-shrunk—full size guaranteed. Be sure you get *your* correct size—38 if you wear a 38 coat, and so on.

No good dealer will ask more than a dollar for the Topkis Men’s Union Suit—although many will tell you it’s *worth* more.

Men’s Union Suits, \$1.00.

Men’s Shirts and Drawers, 75c per garment. 75c for Boys’ Union Suits, Girls’ Bloomer Union Suits, and Children’s Waist Union Suits.

TOPKIS BROTHERS COMPANY, Wilmington, Delaware

General Sales Offices: 350 Broadway, New York City

Illustrated booklet tells about underwear. Write for it.

Ask for TOPKIS Underwear. Look for the Topkis label.

TOPKIS

Athletic Underwear

Look! Only \$3.50 a Month

See It First—No Money Down

Our determination to this year double our sales of the world famous

Santa Fe Special
and
Bunn Special Watches
prompts this matchless offer.

While other watch dealers are raising their prices, asking you for larger monthly payments, and making payment terms harder for you to meet, we are offering you our new model Santa Fe Special, no advance in price, no money down, easier terms and smaller monthly payments. WE realize the war is over and in order to double our business we MUST give you pre war inducements, better prices, easier terms and smaller payments.

Without one penny of advance payment let us place in your hands to see, to examine, to inspect, to admire, to approve, a real masterpiece in watch creation.

A watch which passes the most rigid inspection and measures up to the exacting requirements of the great Santa Fe Railway System, and other great American trunk lines.

Page Twelve of Our Watch Book Is of Special Interest to You!

Ask for our Watch Book free—then select the Watch you would like to see, either the famous Santa Fe Special or the 6 position Bunn Special, and let us explain our easy payment plan and send the watch express prepaid for you to examine. No money down.

Remember —No money down—easy payments buys a master timepiece—a 21 Jewel guaranteed for a lifetime at about half the price you pay for a similar watch of other makes. No money down—a wonderful offer.

SANTA FE WATCH CO.
46 Thomas Bldg. Topeka, Kans.

SANTA FE WATCH CO.,
46 Thomas Bldg., Topeka, Kans.

Please send prepaid and without obligation your Watch Book free, explaining your "No Money Down" Offer on the Santa Fe Special Watch.

Name

Address

State



Your Home Is Within Your Reach When You Buy From Us

NOW is the time to build your Harris Home!

And here is a mighty organization of thirty great departments ready to serve you. Managed by expert material buyers, designers and practical builders. We have vast stocks bought at huge quantity price savings which are now at your command. Our sole aim and purpose is

To help you get a home that will prove entirely satisfactory at a price that will mean a substantial saving in actual dollars of your money.

The combined efforts of these great departments in experimenting and testing materials and methods of construction have produced for you a GUARANTEED home, expert machine cut, bundled and marked—the last word in building economy.

Not One Penny in Advance

So sure are we of the super-excellence of our material and our GUARANTEED Ready-Cut System that we will ship you any HARRIS HOME without the payment of one cent down. Our Plan Book explains our liberal terms fully.

FREE Plan Book

The latest edition is waiting for you, contains our FREE PLAN OFFER and photographic reproductions, with floor plans and specifications of 100 beautiful homes. Mail coupon today.

Building Material of All Kinds

For over a quarter of a century, thrifty wise buyers have realized that here is the "open door" to real economy, whether it be a brand new home or material for improvements or repairs. Our big stocks of brand new building material, all purchased in tremendous quantities at savings that are passed along to you are ready for quick and complete shipments.

"PRESTO-UP" Patented Bolt-together Buildings!

The wonder buildings of the age. Guaranteed buildings, for quick Industrial housing, Individual Homes, etc., extra strong, practical and suitable for all year 'round habitation in any climate, 50 different plans. They come to you in easily handled sections—painted and stained, ready to bolt together and move in.

Plumbing and Heating!

Hot water and heating systems, warm air heating plants, pipeless furnaces and plumbing material of every kind—the product of America's leading makers. Our mammoth plumbing stock offers unlimited possibilities for you to save money. Our heating plants are guaranteed to heat your home in any weather with big fuel economy. Mail the coupon for our Plumbing and Heating Book and get the benefit of our Expert Engineering Service.

Department NM-7

HARRIS BROTHERS CO.
1349-1525 W. 35th St., CHICAGO

HARRIS BROTHERS CO.
Dept. NM-7, Chicago

These books are FREE and sent post paid. Mark an "X" in the squares to indicate which ones you wish.

- | | |
|--|---|
| <input type="checkbox"/> Harris Home Book of Plans | <input type="checkbox"/> Book of "Presto-up" Houses and Garages |
| <input type="checkbox"/> Building Material Catalog | <input type="checkbox"/> Plumbing and Heating Book |

Name.....

Address.....

**FREE BOOK
of Plans**

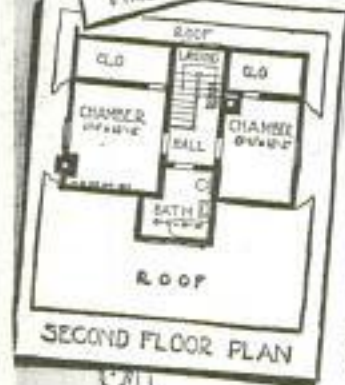



Another New Starrett Tool — T-Handle Tap Wrench No. 93



An exceptionally handy tool. Although especially designed for holding taps to be turned by hand, it will be found exceedingly convenient for holding drills, reamers and many other small tools.

Special clamping construction insures firm holding of tool gripped. A centered body permits this wrench to be used on lathe centers or drilling machine to start the tap straight. Heat-treated jaws and clamping nuts guarantee durability.

You'll find this new No. 93 T-Handle Tap Wrench—like all Starrett Tools—thoroughly practical, dependable and durable. It's a tool you will want to keep handy.

Ask your hardware man to show it to you, with other new Starrett Tools illustrated and described in our special Supplement to Starrett Catalog No. 22 "AP". Write for a copy of this Supplement—and, if you haven't a copy of the Starrett Catalog No. 22 "AP", ask for that too. Both free on request.



THE L. S. STARRETT CO.

The World's Greatest Toolmakers
Manufacturers of Hack Saws Unexcelled
ATHOL, MASS.



42-202

Use Starrett Tools

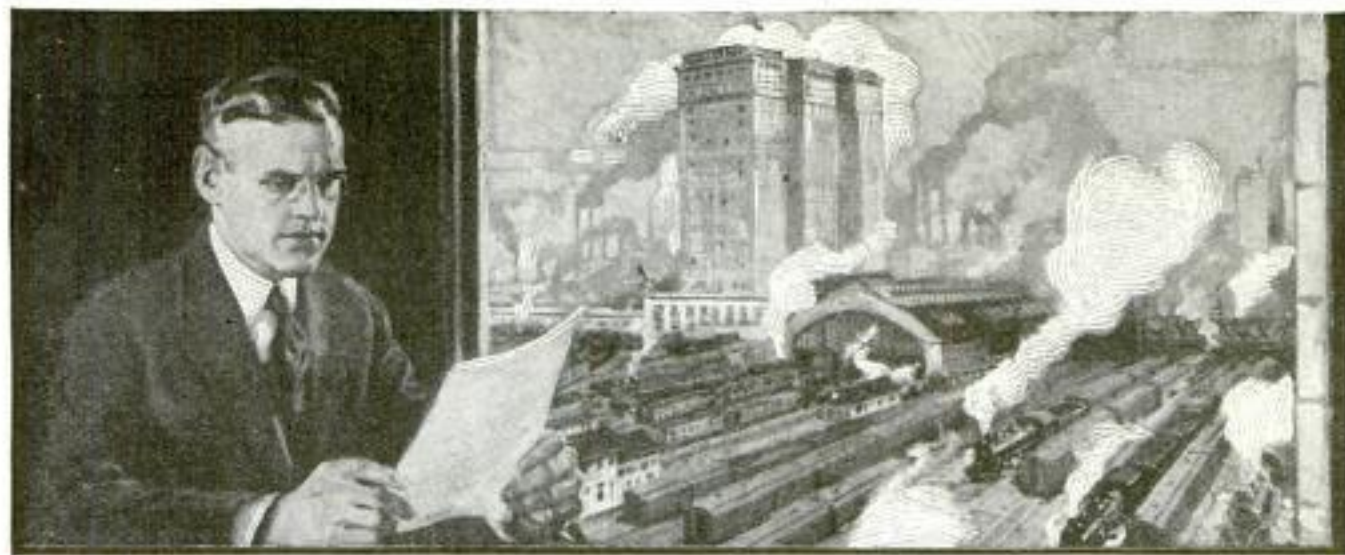

A Real Chance to Command Big Pay!

Competent Traffic Managers Earning \$100 to \$200 a Week

Five hundred thousand business firms in the United States are paying freight charges annually totaling billions of dollars. Fifty thousand concerns pay a freight bill of \$5,000 and over every month.

Once—when business was riding the crest of the wave—these firms could entrust their transportation problems to "second-raters"—shipping clerks who had learned all they knew about traffic at the warehouse.

TODAY—in this era of intense competition upon which Business is entering—

WANTED—as never before in the history of American commerce—*trained traffic managers*. To men who are really competent in this field, business firms are gladly paying from \$50.00 to \$200.00 a week.

The Straight Route to Promotion

Here's the way promotions are won in this field of Traffic Management:

A trained traffic man recently pointed the way for a large concern making woodworking machinery to save \$6,000 a month on freight charges simply by making a few changes in construction to permit its bandsaws to be shipped in box cars instead of on flat cars. Result—a salary of \$6,000 a year.

Another LaSalle man—at that time only a rate clerk for one of the big packing companies—discovered by investigation and study that his firm was paying a rate of \$1.60 a hundredweight on certain shipments, as against a rate of \$1.53 to which it was entitled. He recommended the filing of claims with the Interstate Commerce Commission and recovered for his company \$200,000 in cash—\$80,000 of which was refunded by a single railroad company. He is now Traffic Manager for the largest cement company in the world.

Nothing extraordinary about these men. They are simply cashing in on *scientific knowledge*—instead of *haphazard experience*. Big promotions are the logical result.

Swift Advancement by the Problem Method

Here, then, is a field in which the *demand* for competent men vastly exceeds the *supply*—a field that affords every opportunity to *show results*—a field in which you are offered every opportunity to qualify—swiftly, surely—right in your own home—under the direction of a Traffic Advisory Council of 150 nationally-known traffic men, who will train you in the practical traffic methods utilized by the most efficient organizations in America.

Under the LaSalle Problem Method you will work to all purposes side by side with men who are authorities in their field, handle the very problems met daily by the traffic managers of the railroads and by the big shippers. They will answer every question you ask, make every point clear, direct your training every step of the way. You will cover under their instruction the entire field of traffic, including the

organization and administration of a traffic department, freight classification, rates, claims, law of carriers, procedure before the Interstate Commerce Commission, express service and rates, ocean traffic and trade, even to the point of working with the actual forms, agreements and contracts in daily use.

Make Your Start TODAY!

"Big men," says J. Ogden Armour, "are simply small men who have had a chance to grow." *Give yourself that chance!*

The coupon below will bring you complete information regarding the training you are interested in, together with details of our *convenient-payment plan*. With this information we will send you your free copy of "Ten Years' Promotion in One," a book that has inspired thousands of ambitious men to greater achievement.

Make TODAY your starting point toward big success—by mailing the coupon NOW.

LaSalle Extension University

The Largest Business Training Institution in the World

INQUIRY COUPON

LaSalle Extension University
Dept. 464 TR Chicago, Ill.

Please send me catalog and full information regarding the course and service I have marked with an X below. Also a copy of your book, "Ten Years' Promotion in One," all without obligation to me.

Traffic Management—
 Foreign and Domestic:

Training for positions as Railroad and Industrial Traffic Managers, etc. **Other LaSalle Training Courses**

LaSalle is the largest business training institution in the world. It offers training for every important business need. If more interested in any of these courses, check here:

- | | |
|--|--|
| <input type="checkbox"/> Business Management | <input type="checkbox"/> Banking and Finance |
| <input type="checkbox"/> Salesmanship | <input type="checkbox"/> Modern Foremanship |
| <input type="checkbox"/> Higher Accountancy | <input type="checkbox"/> and Production Methods |
| <input type="checkbox"/> Railway Accounting and Station Management | <input type="checkbox"/> Personnel and Employment Management |
| <input type="checkbox"/> Law—Degree of LL. B. | <input type="checkbox"/> Expert Bookkeeping |
| <input type="checkbox"/> Commercial Law | <input type="checkbox"/> Business English |
| <input type="checkbox"/> Industrial Management Efficiency | <input type="checkbox"/> Commercial Spanish |
| <input type="checkbox"/> Modern Business Correspondence and Practice | <input type="checkbox"/> Effective Speaking |
| | <input type="checkbox"/> C. P. A. Coaching |

Name

Present Position

Address

Champion-X

Price now

¢

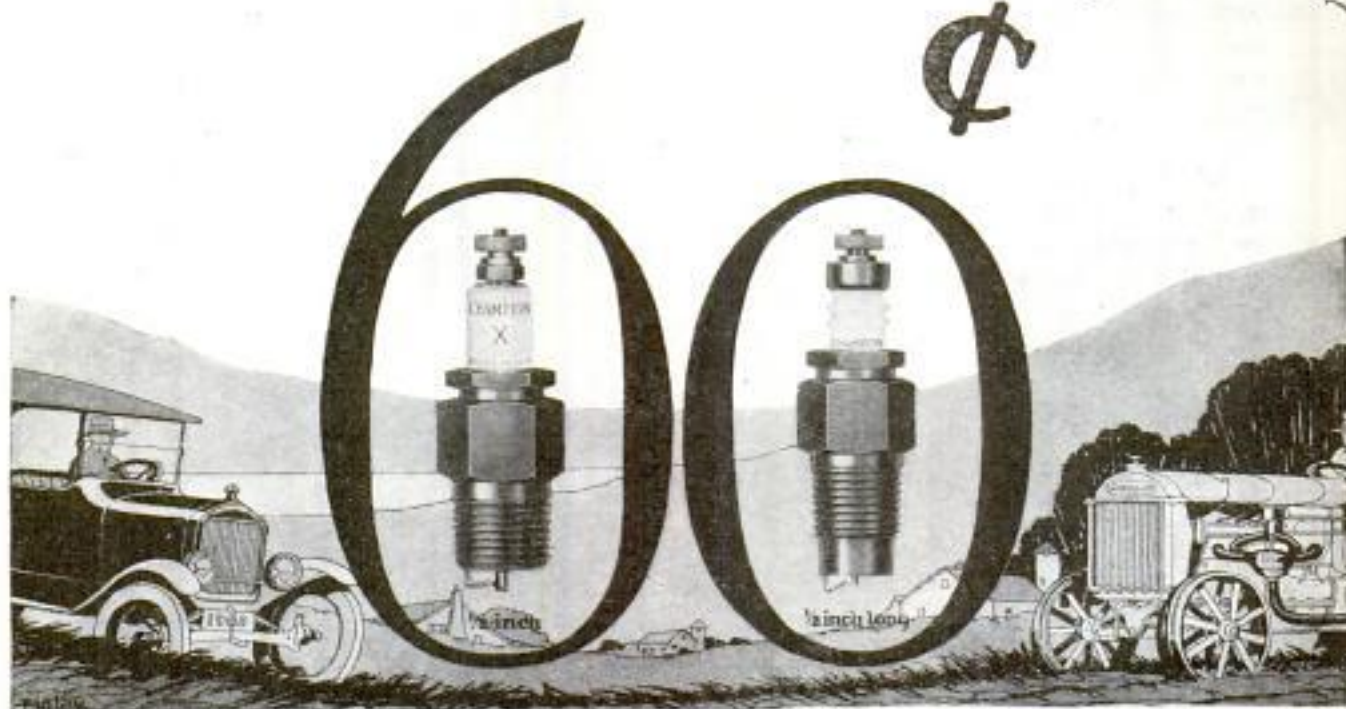

The Good old Genuine Champion-X

*Now sells for***60¢**
Champion-X Cores. .30¢

Ten years satisfactory service in millions of FORD and FORDSON ENGINES. You can rely on CHAMPION-X for dependable Ignition
CHAMPION Regulars now sell for 75¢

CHAMPION-SPARK-PLUG-CO. TOLEDO, OHIO.

GODELL-PRATT

1500 GOOD TOOLS

"Clean as a Whistle!"

Mr. Punch says:

"I'm an automatic drill. I just bore and bite my way right through anything and everything. And I leave a good clean hole, too—a hole as clean as a whistle!"

Of the boring of holes there is no end—everybody sooner or later feels the need of putting a hole into something or other. In the house, in the garage, in the laundry, in the kitchen—there's always

something that requires a good hole for a screw or a hanger, a lock or a bolt.

With Mr. Punch, the Goodell-Pratt Automatic Drill, you just look in the handle and select any one of eight different sizes of drill points. You pick out the right size, fit the point into the "chuck," and Mr. Punch, the Automatic Drill, does the rest—the hole is made in a minute.

Pushes right through plaster without a crack or a chip

Through the hardest wood without a split. Through soft lumber and no mushing, crumbling, or balling up on the point of the drill.

This Goodell-Pratt Drill makes every man a repair man. Any amateur busybody can use it. Butlers, chauffeurs, laundrymen, farmers, newlyweds—everybody with a

head and two good hands can use this drill.

There are more than 1500 Goodell-Pratt Good Tools. Every one of them made to stand up and give long and faithful service. Remember the name when you go into a hardware store—and forget all future tool worries.

Interesting Illustrated FREE BOOK—"The House that Jack Fixed," sent on request. It gives home "putterers" many ideas on how to keep things ship-shape around the house.

GODELL-PRATT COMPANY, Greenfield, Mass.

Toolsmiths

Mr. PUNCH:
Automatic Drill No. 185
with 8 Drill Points.
Size 1'16 in. to 11'64 in.
Price, \$2.60

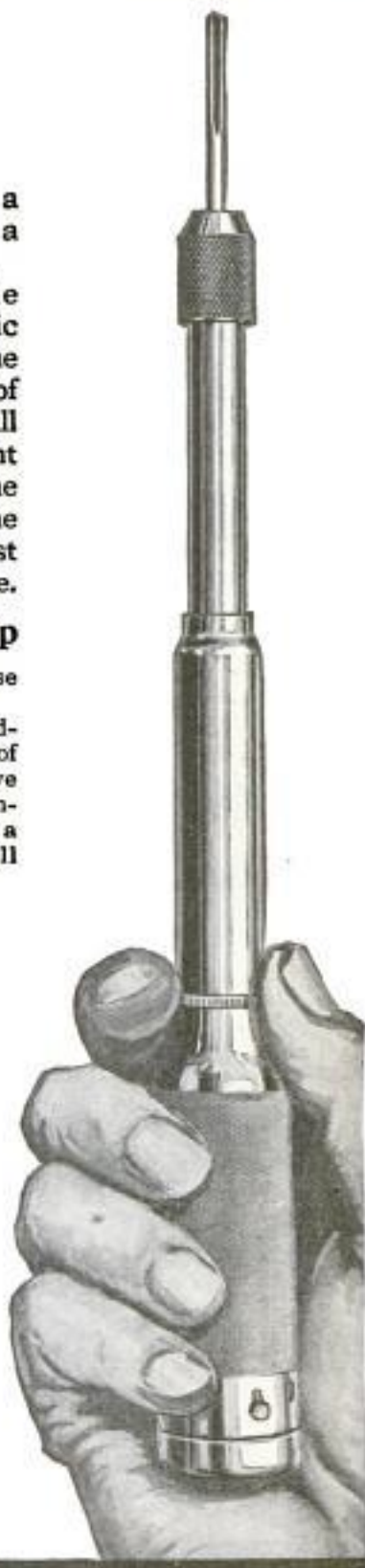

OXO-GAS

*Made from Kerosene (Coal Oil) and Air—
The Cheapest, Cleanest and Most Efficient Fuel
—No Smoke, Ashes, Soot or Dust—Just Heat*



OXO-GAS is the combination of vaporized kerosene with atmospheric air; 96% oxygen, 4% oil vapor. The resultant blue flame of high heating intensity is passed through and applied to perforated lava discs, heating them to a point near incandescence, producing the effect of a bed of coals at its highest efficiency. The addition of this incandescent refraction increases the heat units contained in kerosene oil from 25% to 35%.

The installation of an Oxo-Gas heating appliance for any purpose results in heat production that is far more economical than that of any other fuel known to science. It is easily regulated to just the degree of heat wanted—there is no waste. Anyone without mechanical knowledge can install an Oxo-Gas Heating Appliance in less than half an hour.

An OXO-GAS heat appliance for every purpose

Cook stoves, heating stoves, base burners, hot water heating units, fireplaces, furnaces, urn heaters, camp stoves, garage heaters, etc.



Two Cents Worth of Kerosene Made into OXO-GAS Will Cook a Meal

We want responsible, energetic men as territorial managers and distributors in unoccupied territory. Only those who can finance themselves considered

GLORIA LIGHT COMPANY
113-119 N. MAY ST. CHICAGO, ILLS.

1/2 SAVED
BUY
DIRECT
 GET BIG BOOK



DO YOUR OWN PLUMBING & HEATING AT LOW COST

Send for our big instructive 256-page well-bound **HANDY MAN Book-Catalog**. Every homeowner, contractor, farmer, mechanic, institution, etc., needs it. Shows over 10,000 fixtures and supplies in plumbing and heating at wholesale; how to save skilled labor, hard work and unnecessary material by our new

Cut-To-Fit Method

This wonderful encyclopaedia on plumbing and heating helps you select and install the proper plumbing, water system, hot air, water or steam plant. Besides being our wholesale catalog, it has many practical plans, diagrams, sketches, elevations, handy kinks, etc., showing how to do the work this newer easy way. Any handy man with a few tools can do his own installing with the aid of this



Pipeless Furnace

Big Handy Man Book

We have spared no effort, and have gone to a GREAT EXPENSE to compile this valuable book, and to keep from sending it to uninterested persons, we request 25c, which will be refunded on your first order, or send for our free bulletin.

Write today and save.

HARDIN-LAVIN CO.

50 Years at 4547-4557 Cottage Grove Avenue, CHICAGO

\$500,000 Plants Behind Our Guarantee



Hot Water Boiler

Do Your PRINTING

Cards, circulars, labels, tags, book, menus, paper, Press, \$12. Larger \$35. Job Press \$150 up. Save money. Print for others, BIG PROFITS. All easy, rules sent. Write factory TODAY for press catalog. TYPE, cards, paper. THE PRESS CO. D-37, MERIDEN, CONN.

RADIO DETECTOR

GALENA PATENT NICKEL DETECTOR CUP AND BINDING POST

SLIDING HARD RUBBER KNOB

NICKEL HOLDER AND BINDING POST

SOLID COMPOSITION BASE

This is the smallest and lowest priced detector on the market. It does a variety of things as well and better than many \$5.00 detectors. Has composition base; all metal parts nickel plated; furnished complete with galena crystal. Study illustration and notice new features. Note particularly patent nickel detector cup and binding post. Size 1 1/2 x 1 1/2 x 1 inch. Sent prepaid anywhere. Price complete **50c**

If you build your own radio set you must have the **RARCO** catalog containing 185 illustrations and 50 vacuum tube connection diagrams—the greatest collection published in any catalog. Catalog contains the greatest assortment of parts and raw materials in U.S. Send 15c stamp or coin for this catalog. "Radio Man No. 1"

RADIO SPECIALTY COMPANY, 98E Park Place, N. Y. City

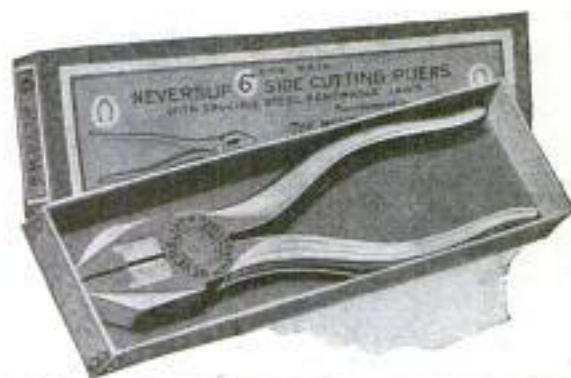

This Plier Will Outcut And Outlast Any Plier Made

Neverslip cutting blades are made from special high carbon crucible steel. Crucible gives a strong, tough edge that resists wear and remains sharp for a long time. But should you accidentally nick the crucible edge, the plier need not be thrown away.

Neverslip Pliers are made with removable cutting blades—you merely remove the blades, insert new ones and you have a brand new plier ready for use at the cost of only one pair of blades.

Neverslips will cut soft wire or insulation clean and even—no rough or ragged edges.

If your dealer hasn't them in stock, send us his name and we'll see that you are supplied.

THE NEVERSLIP WORKS
 NEW BRUNSWICK NEW JERSEY

NEVERSLIP side cutting pliers

Neverslip Pliers are furnished in 6-7 and 8 inch sizes.

DIAMONDS

For a Few Cents a Day



Send No Money

We will send you—upon your simple request—your choice of diamond bargains—the greatest in America! Do not send a penny in advance. When the ring comes, examine it. You are the judge. If it is not, without exception, the greatest value you have ever seen, send it back—at our expense! If you decide to keep it, it is yours—for a few cents a day. You may order direct from this advertisement if you wish. Don't send a cent. You do not risk a penny.

Charge-Account Plan

By our new charge-account plan, you may pay for your choice of hundreds of pieces of exquisite jewelry in sums so small that you would never think of saving them. You are also guaranteed 8% yearly dividends—and a 5% bonus may be earned.

Send for Bargain Book

Send your name and address today for our new 128-page book, showing hundreds of unmatched diamond bargains. Sent absolutely free. It explains the dividend offer and bonus plan.

Write today to Dept. 1774

J. M. LYON & CO.
1 Maiden Lane, New York N.Y.



AGENTS 500% PROFIT

Gold and Silver Sign Letters

For store fronts, office windows and glass signs of all kinds. No experience necessary. Anyone can put them on and make money right from the start.

\$75.00 to \$200 a Week!

You can sell to nearby trade or travel all over the country. There is a big demand for window lettering in every town. Send for free samples and particulars. Liberal Offer to General Agents.

METALLIC LETTER CO.

433B North Clark Street

CHICAGO, ILL.

ASBESTOS

We are miners and shippers of Crude Asbestos in any quantity. We produce all grades at our world-famous BELL ASBESTOS MINES, in Canada. We also card fibres, spin yarns, weave cloths, and make all sorts of Asbestos products.

For anything you want in Asbestos, turn to

KEASBEY & MATTISON COMPANY

Dept. S-3, AMBLER, PENNA., U.S.A.

Owners of the world's largest Asbestos Mines

BINOCULARS

SPECIAL VALUE in high grade, genuine, imported FRENCH PRISM Conde Binoculars. Give remarkably clear and brilliant image. Come in an elegant plush lined, genuine calf skin carrying case with straps.

\$45.80

Including War Tax

8 POWER, 32 mm. 23 OZ.



BRAND NEW—not war stock! Sent C. O. D., express prepaid, subject to examination and 10 day approval. If not satisfactory we refund your money and pay return charges.

Order Now!
Over 1000 pairs sold.
Wonderful value.
Order now or write for descriptive folder.

BARLER & CO.
645 N. Michigan Ave.
CHICAGO

A PERFECT POLISH WITH CLEAN HANDS



POLISH, DAUBER and BRUSH combined in one convenient article. Polish is in a tube enclosed in metal case on top of brush, and when tube is used up, new ones may be obtained at leading stores everywhere. 25 cents. Buy of your dealer or order direct, stating whether black tan, mahogany or white is desired. Fine opportunity for agents.

Postpaid anywhere \$1.25

Address Sales Dept.
The Kaxo Co., Cambridge, 39 Mass.

GILBERT BOY ENGINEERING The greatest boys' book in years, 128 pages of articles on athletic Training, Football Strategy, Flying, etc., by noted authorities. Chapters on many wonderful sciences. Contains complete catalog of Gilbert Toys. Sent at cost, 25c. Also write for free folder on Gilbert Toys.

A. C. GILBERT CO., 477 Blatchley Ave., New Haven, Conn.

Send for a Complete Catalogue of

MASONIC BOOKS

Jewelry and Goods

REDDING & CO.

Publishers and Manufacturers

Dept. P 200 Fifth Avenue, New York



The
Prophy-lactic

Tooth Brush

Earned its reputation by
"mouth to mouth" advertising

W. L. DOUGLAS

FOR MEN AND WOMEN

\$7.00 & \$8.00 SHOES

ALSO MANY STYLES AT \$5.00 & \$6.00

YOU CAN ALWAYS
SAVE MONEY BY WEARING
W. L. DOUGLAS SHOES
SOLD DIRECT FROM FACTORY
TO YOU AT ONE PROFIT

STAMPING THE RETAIL PRICE
AT THE FACTORY



THE STAMPED PRICE
IS YOUR PROTECTION
AGAINST
UNREASONABLE PROFITS



WHEN YOU BUY W. L. DOUGLAS SHOES
CONSIDER THE EXTRA QUALITY
YOU RECEIVE FOR THE PRICE PAID

W. L. Douglas shoes are made of the best and finest selected leathers the market affords. We employ the highest paid, skilled shoemakers, all working with an honest determination to make the best shoes for the price that money can buy.

When you need shoes look for a W. L. Douglas store. We own 108 stores located in the principal cities. You will find in our stores many kinds and styles of high class, fine shoes that we believe are better shoe values for the money than you can buy elsewhere.

Our \$7.00 and \$8.00 shoes are exceptionally good values. There is one point we wish to impress upon you that is worth dollars for you to remember. W. L. Douglas shoes are put into all of our stores at factory cost. We do not make one cent of profit until the shoes are sold to you. When you buy shoes at any one of our stores you pay only one small retail profit.

No matter where you live, shoe dealers can supply you with W. L. Douglas shoes. They cost no more in San Francisco than they do in New York. Insist upon having W. L. Douglas shoes with the name and retail price stamped on the sole. Do not take a substitute and pay one or two extra profits. Order direct from the factory and save money.



BOYS'
SHOES

\$4.00 & \$4.50

W. L. Douglas name and portrait is the best known shoe Trade Mark in the world. It stands for the highest standard of quality at the lowest possible cost.

The intrinsic value of a Trade Mark lies in giving to the consumer the equivalent of the price paid for the goods.

Catalog Free.

W. L. Douglas

President

W. L. Douglas Shoe Co.,
128 Spark St., Brockton, Mass.

"BOW LEGS and KNOCK-KNEES" UNSIGHTLY

SEND FOR BOOKLET SHOWING PHOTOS OF MEN WITH AND WITHOUT THE PERFECT LEG FORMS
PERFECT SALES CO.
140 N. Mayfield Ave., Dept. S, Chicago, Ill.

MAKE MONEY Building Phonographs

We furnish everything—blue print plans—case material, tone arms, motors, full instructions. You can easily make \$100 to \$200 a month in spare time. Even boys of 14 make them. They play any record. Wonderful tone—equal to any you ever heard. Sell to friends and neighbors. Write now for free blue print offer.

Choraleon Phonograph Co.
422-1st Street ELKHART, IND.



It's easy
with our
plans.

Please Mention Popular Mechanics

SEND NO MONEY

Try this Portable
Typewriter 10 Days
FREE



Now you can buy famous, 9-pound National Typewriter direct from the factory, after 10 days' trial—absolutely free. You be the judge. Then we give you

10 MONTHS TO PAY

Some machine as used by thousands of doctors, lawyers, bankers, salesmen, students, writers and business men in 31 countries. Every feature of best, standard size machines. 28 keys.

84 characters. Brand new—not a rebuilt typewriter. Neat, compact carrying case free with every machine. Send today for our 10 Days' Free Trial offer and 10 Months' Easy Payment Plan.

NATIONAL TYPEWRITER CO.
Dept. 7D. Fond du Lac, Wis.



FREE
For 10 Days Wear

Compare with a DIAMOND

Yes, free—not a penny to send. Just take your choice of these exquisite Tifnite gems and we will send it on our liberal 10 days' free trial offer. When you receive the ring, examine it closely. Note its dazzling brilliancy. Compare it with the finest diamonds. If you can tell the difference, send it back.

SOLID GOLD MOUNTINGS

It takes an expert to distinguish between a Tifnite and a genuine diamond. Tifnites stand every diamond test—fire, acid and diamond file. All set in latest solid gold mountings.

No. 1. Solid gold mounting, 8-claw design. Wide flat band. Almost a carat in size, guaranteed genuine Tifnite Gem. Price, \$12.50; only \$3.50 on arrival. Balance \$3 per month.
No. 2. Latest solid gold mounting. Guaranteed genuine Tifnite Gem, almost a carat in size. Price, \$12.50; only \$3.50 on arrival. Balance \$3 per month.
No. 3. Solid gold, six prong tooth Belcher mounting. Guaranteed genuine Tifnite Gem, almost a carat in size. Price, \$12.50; only \$3.50 on arrival. Balance, \$3 per month.

Order Now—Quick! Tifnite Gem prices reduced—same now as before war. Easiest terms. Send strip of paper fitting exactly around second joint of finger for size and mention style wanted. Pay only \$3.50 on arrival. No obligation—wear it 10 days. If you keep it, pay balance at \$3 per month until special price of \$12.50 is paid. If not satisfied, return it and get money back. Don't wait. Send today.

THE TIFNITE COMPANY 511 S. Plymouth Ct. Dept. 2211 Chicago, Ill.

\$6.00 Starts You

Big opportunity to become independent. Develop your own business. Send \$6.00 for TRIAL OUTFIT of 1 gross IN A F O BAGS and Display Cases. Money back if they don't sell. Sample does \$1.00. Dept. 51.

THE JAY COMPANY
WASHINGTON, NEW JERSEY.



BOYER PRESSURE COOKER

The cooking utensil of 100 uses. Saves fuel and cooks food more rapidly.

Ideal for home, hotel or restaurant. Write TODAY for our free illustrated booklet showing our complete line of copper ware. It is sent by first class mail.

Cap's'y. Price
3 gal. \$7.00
5 gal. 9.00
7 gal. 11.00
10 gal. 15.00
20 gal. 22.00
30 gal. 28.00
40 gal. 35.00

Boyer & Co., 1212 Jones St., Omaha, Neb.
DEALERS—Write for dealer prices



Different from all others—the NEW BENJAMIN

AIR RIFLE

Made on a different principle from all other Air-Rifles. The Benjamin is really a strong air-pump used to compress the air in the air chamber to any degree of power desired. From one to six strokes of the pump give all the force necessary. Each additional stroke gives increased power. The Benjamin works on the same principle as all air-drills and air-hammers—with this difference:

You control the shooting force as you desire. Look at this block of hardwood. It shows how Benjamin power is regulated as you wish.

You can't have accidents with a Benjamin. It's safe, always, because you control the power. The Benjamin never loses shooting force, and has no springs to get out of order or shake your aim. Write us for an interesting folder about this wonderful air-gun.

For sale by all dealers.
Price \$5.00.

BENJAMIN
AIR-RIFLE & MFG. CO.
615 N. Broadway, St. Louis, Mo.

Ask your dealer for demonstration.



Pacific-Coast
Representatives:
Stuart & Otto
220 Wilcox
Bldg., Los
Angeles,
Cal.

CAMERAS

Over a Hundred Styles and Sizes
Send for new illustrated catalog showing latest reduced prices. It's Free.

10 days' trial given

SENECA CAMERA MFG. COMPANY
300 Central Avenue Rochester, N. Y.



Moore Push-Pins
Glass Heads—Steel Points

Moore Push-less Hangers
To hang up things

Ask your dealer to show them

Sold Everywhere 10¢ per packet
Moore Push-Pin Co.
Weyne Junction Philadelphia



THE AJAX EYELET FASTENER

Binds Papers Quickly and Permanently

It Saves Time by
Punching the Hole,
Feeding the Eyelet
and Clinching it
in One Operation.

Drop the eyelets into the magazine and go right ahead. Order from your stationer or direct.

Write for our catalogue of office tools

MACHINE APPLIANCE CORPORATION
351-353 Jay Street ★ Brooklyn, N. Y.

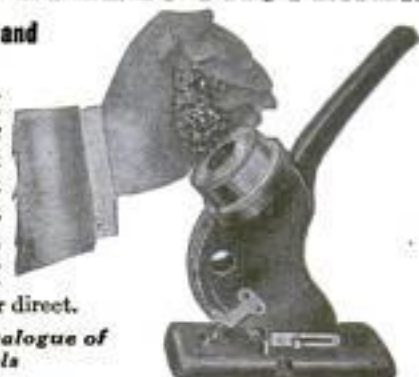



VISION

To Select the Right Tools, is a Help to Success

Brown & Sharpe Machinists' Tools

serve with full satisfaction (long life with accuracy) the technical student, apprentice, inspector, toolmaker, foreman—every user of mechanical tools. With the world-known, fine traditions of over 70 years—being the first

precision tools in America—they show their superiority in the finished work.

Send for Catalog No. 28. Select your tools from this book showing over 2000 of the best tools you can buy.

BROWN & SHARPE MFG. CO.
Providence, R. I., U. S. A.

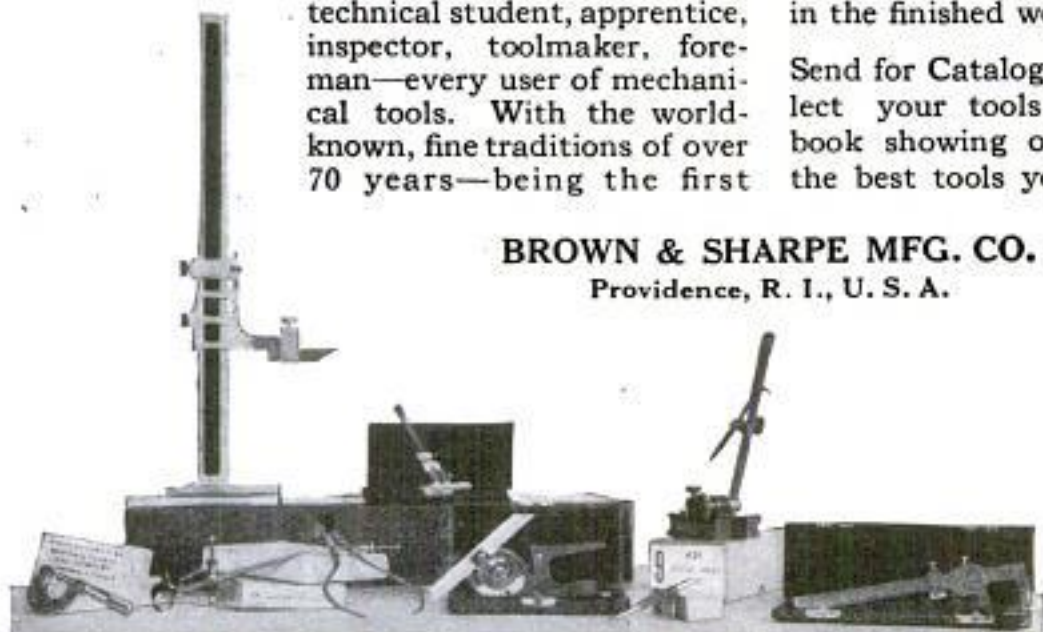

FREE TRIAL



Cut out this ad and mail it to us, with your name and address (no money), and we will send you our **FAMOUS KARNAK RAZOR** by return mail, postpaid. You may use the razor for 30 days **FREE!** then if you like it, pay us \$1.85. If you don't like it, return it. —**SEND NO MONEY**—

MORE COMPANY Dept. 355 ST. LOUIS, MO.

CHEMISTRY



Good salaries await trained men. No work is more interesting—no other profession offers greater opportunity for advancement. You can learn quickly and easily at home—in an hour a day of the spare time that now goes to waste. Write today for full particulars. International Correspondence Schools, Box 5628-C, Scranton, Penna.

Conn Saxophone Book FREE



Send now for your copy.

It describes opportunities with saxophone, how to use it singly and in quartets, sextets, etc. Illustrates exclusive improvements which make Conn *easiest of all to learn*, most beautiful in tone. Pictures scores of stars who use and endorse Conn as the world's finest saxophone. A postcard brings book and details of **Free Trial, Easy Payment** plan on any Conn instrument.

C. G. CONN, Ltd.

431 Conn Bldg., Elkhart, Ind.



Evinrude Outings No. 1
The best bathing
places are always near
at hand when you
have an Evinrude.

The Best of Picnic Pals

Sparkling water, a shady nook on shore, care-free companions—and an Evinrude—to motorize your rowboat! Can you think of a happier setting for a wonderful day in the open?

Across the lake or miles upstream to favorite picnic grounds—distance means nothing when you have one of these husky little motors to do your ear-work. Always on the job—costs but a penny a mile for "gas" and oil.

Both Evinrude models, Standard and Lightweight, are practically the same in design, size, power and speed. Due to the judicious use of aluminum alloys, the Lightweight scales just under 50 pounds, complete—easily carried with you in car, train or trolley.

See these Evinrude motors at your sporting goods or hardware dealer's. Or write for catalog and new prices (recently cut to pre-war level).

EVINRUDE MOTOR CO.

647 Evinrude Bldg., Milwaukee, Wis.

DISTRIBUTORS:

69 Cortland St., New York, N. Y.

440 Market St., San Francisco, Calif.

780 Commonwealth Ave., Boston, Mass.

211 Morrison St., Portland, Ore.

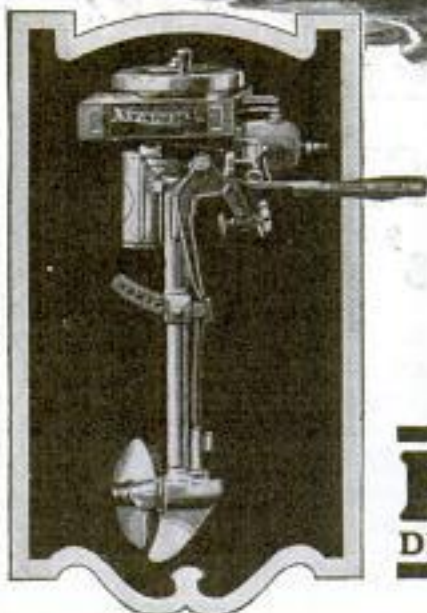

EVINRUDE Standard and Lightweight DETACHABLE MOTORS FOR WATERCRAFT

Standard—the famous 2 H.P. motor used all over the world.
Lightweight—the sport model, lightest practical motor built.



SHOOTING white water, or lazily gliding through shadowy reflections, an "Old Town Canoe" answers every pressure of the paddle. An "Old Town" is speedier, steadier, and gives years more of rugged service.

"Old Towns" are the lightest and strongest canoes made. For they are patterned after the old-time Indian models. And they are built by expert "Old Town" craftsmen. Every "Old Town Canoe" is built on Indian speed-lines. They are the lowest priced canoes made. \$54 up from dealer or factory.

Write for profusely illustrated new catalog. Leading models shown in full color. FREE.

OLD TOWN CANOE CO.
1264 Middle Street, Old Town, Maine, U. S. A.

"Old Town Canoes"

CHOICE CANADA FARM LANDS

You can buy a farm in Western Canada at an average of \$18 an acre, with 20 years to pay. Write for information, M. E. Thornton, Supt. Colonization.

Canadian Pacific Railway, 166 First Street E. - Calgary, Alberta

START NOW—SAVE 2/3 COST



Build Your Own Boat
LOWEST PRICED and BEST BOATS in the World Built by BROOKS SYSTEM
Brooks K. D. Outfits make Boat Building a pleasure. You can easily and quickly assemble your own boat by using our simple method. Let Us furnish you at trifling cost our instructions, Full Sized Patterns, a K. D. Outfit with parts already shaped and fitted, or build you a Completed Boat. Brooks Models are speedy, staunch and seaworthy. Thousands of satisfied patrons. Get our prices before building, they are lower than ever before.

Send 10 cents or BIG catalog, full of information for BOAT buyers.
Brooks, Oldest Established Boat Builders

BROOKS MANUFACTURING COMPANY

Address Cat. Dept.

Saginaw, Mich.



Racine Wis

America's Finest Canoe

Because it's built that way

Write for Complete Catalog

RACINE BOAT COMPANY
Dept. 61 Racine Wisconsin

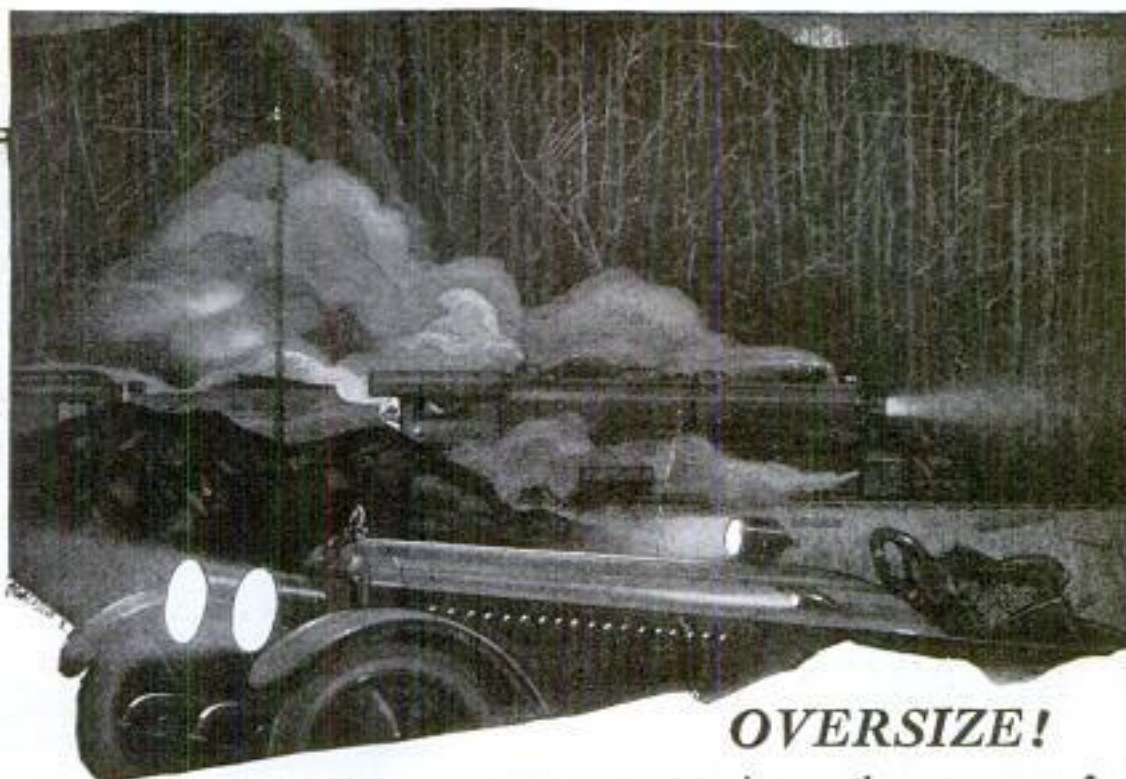

OVERSIZE!

WESTINGHOUSE BATTERIES give you the same sense of added security you have when using oversize tires.

For they, too, are built "oversize"—as much as 25 per cent in common sizes. Their larger plate area means greater capacity, longer life, less strain and drain—more reserve power for emergencies.

To uphold the fame of the name they bear, Westinghouse Batteries have *one quality only*—the best Westinghouse can put into them.



To fulfill the factory-backed Westinghouse Guarantee, or to furnish Westinghouse Attention for the battery *now* in your car, seventeen hundred Westinghouse Service Stations are at your command.

WESTINGHOUSE UNION BATTERY COMPANY, Swissvale, Pa.

WESTINGHOUSE BATTERIES



**Battery Charging Pays
\$1500 to \$3000 a Year!**

Build a Big, Permanent Business with an HB Charger

\$20 CASH—BALANCE EASY TERMS

First small payment brings you an HB Charger. Long easy terms on balance. HB Chargers make big profits for users. Economical, trouble-proof, no repairs or costly renewals. Built in sizes for charging 6, 10, 16 or 32 batteries at once. Choose size you need, then write for information. Ten days' trial on absolute money-back guarantee. No experience needed. Write us TODAY. Ask about HB Air Compressors, Misty Grinders, Ball Bearing Motors, Lighting Generators—all big money-makers in your shop. Sold on easy payments.

HOBART BROS. CO. Box M 4, TROY, OHIO

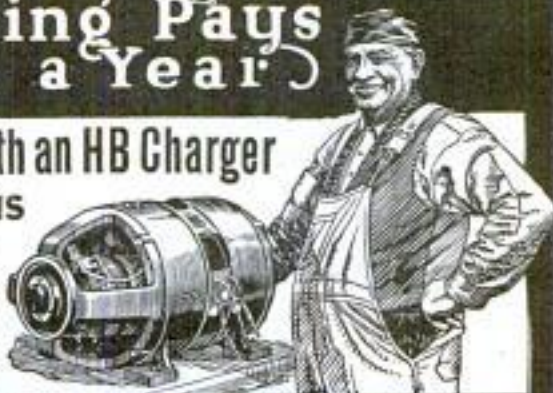

Small Cash Payment—Balance Easy Terms

Be a Leader



Bobby Walthour, Jr.
 Astride his famous Dayton which he pedaled to the American Amateur Championship in the grueling series of races at the Newark, N. J., Velodrome.

THERE is real sport in leadership — and show your blood tingles with the joy of winning a victory.

Bobby Walthour, Jr., America's amateur bicycle Champion, knows the delights of leadership.

A good body, a good mind, the will to win, and a Dayton Bicycle are the factors responsible for his great success.

There are just two kinds of boys—leaders and followers. Leaders of boys grow up to be leaders of men. Be a leader!

Dayton Bicycles

Have Been Leaders Since
 Your Dad was a Boy

This leadership will continue. The Dayton is built from the ground up in our own factory by men who have devoted their lives to making high grade bicycles.

Skillful design, careful workmanship and tested materials make the Dayton an easy running, fast flying mount which will last for years.

Ride the bike that the American Amateur Champion rides. It costs less than an ordinary "assembled" bicycle because it gives more in pleasurable and exhilarating service.

An intensely interesting book—"How to Choose a Bicycle"—will be mailed free and postage paid if you will send your name and address on the attached coupon. We will send you the new Dayton catalog at the same time. Both will be of value and interest to the boy who wants to help himself toward the goal of real leadership.

Get your free copy of "How to Choose a Bicycle" now. It's yours for the asking.

CYCLE DIVISION
 THE DAVIS SEWING
 MACHINE CO.
 DAYTON, OHIO



FILL IN—CUT OUT—MAIL TODAY
 The Davis Sewing Machine Co., Dayton, Ohio
 Please send me without obligation your booklet No. 28,
 "How to Choose a Bicycle," and the 1922 Dayton
 catalog.
 Name.....
 St. & No.....
 City & State.....
 Age.....

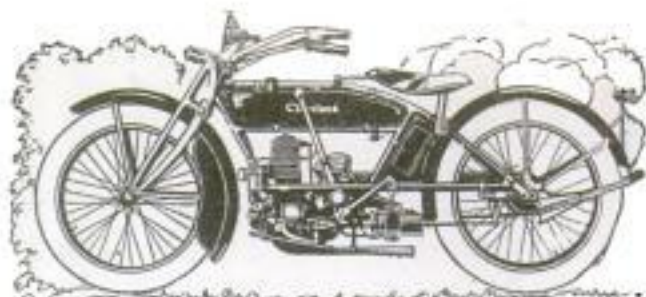

PRICE
\$185

Here is a Motor Vehicle You Can Afford

You have always wanted a motor vehicle of your own, to take you to and from work, and to carry you independently anywhere, any time.

Cleveland, the Motorcycle of Mo-lyb-den-um, will do all of that at a great saving in initial cost, upkeep and storage. It will give you all the pleasure and durability of a heavy-weight motorcycle, costing twice as much, and give you more comfort, safety and economy. 75 miles to the gallon of gas—15,000 miles on tires! Write now for catalog "M".



Can you recommend a "live" man for a Cleveland dealer in your town?

CLEVELAND MOTORCYCLE MFG. CO. **7th**
 CLEVELAND, U.S.A. **YEAR**

Cleveland

MOTORCYCLES

RELIABLE STANDARD MAKES that you can **DEPEND** on.



Enjoy the glorious experience of going wherever you like—whenever you like. The price is within your means—33% to 50% less than others. These machines are slightly used, thoroughly overhauled or rebuilt. Good for catalogues.

MYEROW BROS.
 258 Columbus Ave., Boston, Mass.

Rider Agents Wanted

Select from the 44 Styles, colors and sizes of Ranger Bicycles. Ride and exhibit sample Ranger and make money. Delivered free, express prepaid, on approval. Factory-to-Rider prices save \$10 to \$25.

12 Months to Pay on any Ranger if desired. Boys and girls easily save the small monthly payments. Parents often advance first payment.

Tires best quality, at factory prices, express prepaid. Lamps, wheels and equipment, low prices. Send **No Money**, do business direct with maker.

Mead Cycle Company
 Dept. C108 Chicago

Write today for free Ranger Catalog, factory prices and installment easy payment terms.



Harley-Davidson

World's Champion Motorcycle

PRICES REDUCED ONE HALF
 Rebuilt and Guaranteed

1915, three speed twin electric \$125; 1916, \$135; 1917, \$150; 1918, \$165; 1919, \$180; 1920, \$200. Shipped on approval. Catalog A free, describing Harley-Davidsons, Excelsiors, Indians, Smith Motors at \$40 and upwards. Liberty Bonds taken at full face value. Letters of recommendation from hundreds of satisfied customers. Refs.: Banks and Harley-Davidson Motor Co. Rapid service on 1922 to 1922 Harley-Davidson parts. 100 page PARTS catalog \$1.25 cents. Stamps or coin.

WISCONSIN CYCLE SALES COMPANY
 726 NATIONAL AVENUE MILWAUKEE, WIS.

Oldest and Largest Dealers in the North-west Milwaukee—World's Largest Motorcycle Center!



Roofing Book FREE

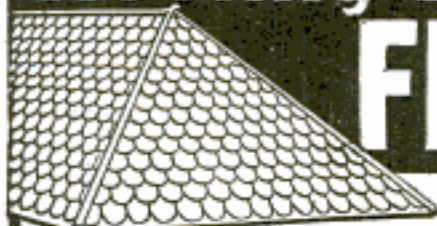

World's Best Roofing at Factory Price

Don't buy Roofing of any kind until you get our big Free Roofing Book, describing full line of Edwards Famous "Tightcote" Galvanized Roofings, Sidings and Ceilings, and our lowest factory prices. Then see for yourself how much we save you by selling direct and saving you all in-between dealers' profits.

EDWARDS "REO" Metal Shingles

Absolutely rust proof. By our patented "Tightcote" process, edges as well as sides of metal sheets are heavily coated with zinc—not a space the size of a pin point exposed to weather. Fire and lightning proof. Outlasts three ordinary roofs. Forever wind and weather proof. Need no repairs—end all roofing expense. Patent INTERLOCKING DEVICE makes water tight seams—all nail heads covered—no chance for rust or leaks.

EDWARDS Galvanizing Test

Edwards "Tightcote" Galvanized Roofing can be bent, twisted or struck by lightning, and the galvanizing will not crack or flake. Bend it or hammer it—you can't loosen or scale the galvanizing. No other galvanized roofing can withstand this test.

Low Priced Garages

Wide variety of styles, all sizes of Portable Fireproof Metal Garages. Lowest prices ever made. Postal brings Big Garage Catalog free.

Write Today for free samples and proof that we can save you a lot of money on any kind of roofing siding or ceiling you may need. Ask for Roofing Book No. 150.

THE EDWARDS MFG. CO.,
400-450 Pike St., Cincinnati, O.

FREE
Samples &
Roofing Book

DRIVE 100 TACKS AND SAVE \$25.00

Easy to put on. We furnish instructions. We tailor top recoverings for all cars, and guarantee them to fit. Ford Roadster, \$5.25, Touring, \$6.95; other cars, \$14.00 to \$18.00, delivered at your door. Side curtains that open with doors \$10, \$16, others \$6.50 and up. Best covers \$5.15 up.

\$520 up
Delivered

Write for Catalog and Samples

AUTO EQUIPMENT CO., 32 Canal Street East, Cincinnati, Ohio

Used Motorcycles
\$40⁰⁰ and up
Bulletin FREE
ALL MAKES
ASH MOTOR CORPORATION ROCHESTER, N.Y.

START IN BUSINESS

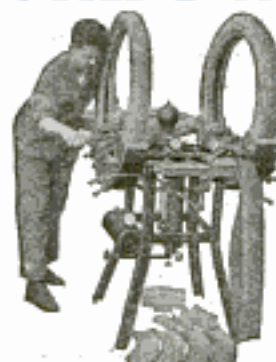

Make Real Money on Small Capital
All over the U. S. and Canada we are establishing Vulcanizing Service Stations. Start one in your town. Make \$10 to \$30 per day on a \$350 investment. We instruct you and furnish the **Most Modern Methods and Equipment**—

THE ANDERSON
Known the World Over
We have 34 Schools in U. S. and 4 in Canada. One is near you. School pays you \$5 per day while learning to operate your station. Write for full particulars—**TODAY.**

THE ANDERSON STEAM VULCANIZER CO.
Manufacturers of Modern Tire Repair Equipment.
103 Williams Bldg., Indianapolis, U. S. A.

TIRE AGENTS WANTED

\$4000 A YEAR

A Quick Way To Make Real Money

Earn and bank big money without risking one cent. I will start you as I have started so many others in a business of your own. Begin all or part time. The **MELLINGER PLAN** is revolutionizing the tire business. Different from anything you ever heard of. No previous experience needed. Tires shipped prepaid on approval. No risk. Sample sections furnished. Just what millions of tire buyers have been looking for.

I Guarantee Your Profits

Let me prove that you can earn from \$100 to \$400 a month and more. I don't ask you to risk one cent. I don't care what you have been doing or whether you live in city or country. Hundreds discontented with mere jobs got this **MELLINGER PLAN** and almost overnight made a financial success that changed their whole life.

Guarantee Bond Up to 10,000 Miles

Behind Mellinger Hand Made, oversize Cord and Extra Ply Tires—the finest, most serviceable tires made. 25 to 35 per cent. actual over-strength guaranteed. 98 tire Manufacturers say:—"We do not guarantee Mileage," Mellinger Does. **One Billion Dollars** will be spent for tires in the next few months. You can dip your hands into this golden flood and take out all the money you need—whether you want CASH or simply want guaranteed mileage for yourself at **LOWER PRICES, write me today.** Buy at wholesale prices. Get the discounts. See how the **MELLINGER PLAN** saves car owners big money. My new low prices amaze everyone. Get my inside figures. **BETTER TIRES FOR LESS MONEY** makes business just roll in for Mellinger Agents.

FREE Master Salesman, Kit showing actual sections of tires, fabrics, rubber, cord tubes, etc., all substantial portfolio containing tire and tube samples, demonstrating all the secrets of tire construction. You have everything you need to start right in taking orders. Sent free if you are in dead earnest. Tweedle of Maine, sells \$1436 in few short weeks. A. M. Amigo, San-turce, Porto Rico, sold \$4024 in seven months. Hincheliff, Pennsylvania, sold \$1500 first month. A Franklin, Pennsylvania, sells \$600 a month.

If You Own A Car

Write me quick. Don't buy anyone's tires until you see these amazing values—See these tires on your own car. **THINK OF IT.** Oversize Cord Tires for less than fabrics used to cost. I appoint only one exclusive agent in each locality. I will ship this magnificent cord tire prepaid. For a little of your time and enthusiasm, will make you a surprising offer, that will give you a set of tires **FREE.**

Be the first from your locality to get my confidential offer. **Mail the coupon today—right now.** Don't turn another page—tear it off—Get this Free Book that has proven the golden key to thousands. It's worth actual cash to you.

MELLINGER TIRE & RUBBER CO.
1842 Oak Street Kansas City, Mo.

FREE BOOK TELLS HOW!

Mr. B. L. Mellinger, Pres.,
Mellinger Tire & Rubber Co.,
1842 Oak St., Kansas City, Mo.

Without obligation, send me details of the Mellinger Plan, Free Book and Wholesale Prices and how, without investing any money, I can become your authorized agent.

Name.....

Address.....



Wanted—State Distributors

County and Town Agents for BAY STATE Wrench Sets. No. 21-1 Set (illustrated) takes place of 138 different socket wrenches!—sells for \$6.50 list. Compact, complete outfit for mechanics, garage and repairmen, service stations and car owners. Demonstration will sell any mechanic with money to buy. Guaranteed against breakage; replacements free; responsible backing. Territory assigned to you restricted to yourself. While still openings for State Distributors and District Agents, write for proposition.

The Allen Mfg. Co., Hartford, Conn.

Ford Owners WANTED!

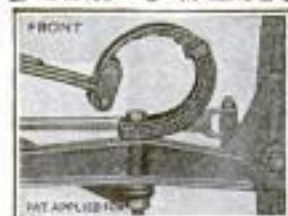

to Show and Sell

GREY GOOSE SHOCK ABSORBERS

Easiest riding absorber of all time. Easily and quickly attached—only 4 bolts to change—requires no special tools. Put a set on your car. Invite other Ford owners to ride with you. Make sales easily at our price of only \$10 for a complete set of 4.

We pay liberal commissions. Many of our men are making \$50 to \$150 a week. Sales experience not necessary. Just use your Ford to drive and demonstrate Grey Goose. They almost sell themselves. Order direct from this advertisement. Money back if not satisfied. Write for Free Folder.

Dept. 195
Indiana Parts Co., Richmond, Indiana

10c CHARGES STORAGE BATTERY

FROM A LAMP SOCKET

At HOME Or BUSINESS With An F-F BATTERY BOOSTER, which is a FULL WAVE

Magnetic Rectifier for 105-125 volt 60 cycle A. C. Leave battery just as it is in your car. Snap Clips on Battery Terminals, Turn Switch, Lock Garage, Keeping Battery will be Charged in The Morning. AMMETER eliminates Guess Work. A Complete Compact Dependable Self-Contained Portable Automatic Charging Unit. No skill Required. A Fully Charged Battery starts Cars & Trucks quick in the coldest winter weather & thus fewer Expensive Replacement Storage Batteries must be bought, when kept Fully Charged! So It Actually Costs Less to Buy a Booster than to be without one. Don't think your Battery is dead and worn out simply because it will not start your car. Buy a Booster. Fill it with Life and bear Engine safe. BY BUYING A BOOSTER YOU SAVE MONEY.

These Types Last a Lifetime. PRE-WAR PRICES:

Bostain Type 6 Charges 6 volt Battery at 6 amperes \$15

Bostain Type 12 Charges 12 volt Battery 6 amperes \$15

Type 144 Charges 6 volt Battery at 12 amperes \$24

Type 1612 Charges 12 volt Battery at 7 amperes \$24

Type 1626 Combination Type Charges Both

6 & 12 volt Batteries at 12 & 7 amperes.....\$30

CHARGING SERVICE

The Larger Types are recommended for heavy batteries, or where time is limited. Shipping Weights Complete with AMMETER & BATTERY CLIPS, 12 to 15 Pounds. Mail Check for Prompt Express Shipment. Or if for Parcel Post Shipment add Postage & Insurance charges. Or Order us forwarded the Type you desire. C. O. D. Order Now or Write Immediately for FREE Description BULLETIN BULLETIN 94-A. For GROUP CHARGING write for Free BATTERY RECTIFIER BULLETIN 94-A. Real Economy in First Cost & in Service. It charges up to 26 Cells. Automatically. THE FRANCE MFG. CO., CLEVELAND, OHIO, U. S. A.
Canadian Representatives: Battery Service & Sales Co., Hamilton, Ontario, Canada.



2 Tires for \$11.25

FREE Tube with Each Tire

Most sensational used tire offer of the year! Two tires for less than the usual cost of one—and a free tube with each tire! This is a special lot—all standard makes—selected for record-breaking sale. No double trends or saved tires. Our big volume means best tire values! Thousands of steady customers everywhere are getting full mileage out of these tires and you, too, can get

Size	1 Tire	2 Tires	Size	1 Tire	2 Tires
30x3	\$ 7.00	\$11.25	32x4 1/2	\$13.50	\$22.90
30x3 1/2	7.95	13.65	33x4 1/2	13.95	23.45
32x3 1/2	9.00	15.45	34x4 1/2	14.45	23.90
31x4	10.00	16.90	35x4 1/2	14.95	24.45
32x4	11.50	19.75	36x4 1/2	15.45	25.45
33x4	12.25	20.90	35x5	15.90	26.15
34x4	13.25	22.45	37x5	16.45	26.55

SEND NO MONEY! Shipments C.O.D. Express or Parcel Post. Examine tires on arrival and if not fully satisfied return same at our expense and your money will be promptly refunded, including shipping charges. State whether Street Side or Clincher. DONT DELAY! ORDER NOW!

ALBANY TIRE & RUBBER COMPANY
2721 Roosevelt Road Dept. 164 D Chicago, Illinois

For FORD CARS Any Year, Any Model Genuine MEINZE-SPRINGFIELD \$49.75 Starting and Lighting System---

Limited supply—latest improved type! Price includes Ammeter, Dash and Tail Lights, Switch Lock and new high-grade battery of standard make. Quick, sure start—bright, steady lights. Easily attached to any Ford. Order direct from this ad or write for literature.

The Service Products Co., Dept. 9, - Springfield, Ohio

25 MILES PER HOUR!



is record of our stock car, using our special 1922 motor. Anybody can assemble this car. Send 30 cents for plans, instructions and price list of parts.

SYEPHER MFG. CO.

146 Sypher Bldg. TOLEDO, OHIO

SEND for the INTERNATIONAL CATALOG

Factory to Consumer direct—

PAY ONLY ONE PROFIT



Our net price list of auto bodies and body supplies at Wholesale Prices.

Save big money by buying Direct from Factory

For Ford and Chevrolet—prices from \$27.85 up
International Body Works 614 W. Ohio Street, Chicago, Ill. Dept. 7

AUTO DRIVERS

Can make big money in spare time or devote entire time to introducing and taking orders for our

IMPROVED CORD TIRES

Highest quality. Sensational prices. Big profits. Permanent business.

Write today for catalog and agent's special offer.

LANGAN & PHILLIPS
Dept. 104 CHICAGO



AGENTS--SALESMEN--SALES MANAGERS

EXCLUSIVE TERRITORY ON NEW INVENTION

Will you listen when opportunity knocks? Fortunes have been made in new automobile inventions. **Grab this one quick.** Your minutes are like dollars—don't waste them now. **Read—investigate—then act.** The Speederator for Ford cars is a new invention that makes any Ford run like a Packard. Stops stalling—bucking and motor racing. Gives a smoothness to Ford driving that is wonderful. And just think—Speederator is put on without boring holes or special tools of any kind. Any Ford driver can put one on complete in twenty minutes. Never wears out—never needs attention—operates automatically. Sells like lightning. Old Ford drivers say best and only necessary Ford part. Get full information.

LISTEN This is not a ready made fortune but it is the opportunity to secure the exclusive sales agency for this new invention. Don't take our word—get the proofs. Just be honest with yourself and investigate. Let the money you make talk for now on. Smashing records of success will show the way; Helton, Utah, sold six hundred in five weeks—profit \$1,800.00. Crist, N. Y., sold 23 first day—said would have sold more if he had had them—now averages more than 400 a month—profit \$1,200.00. McAllister, Ills., say, sold four first afternoon. He is now using 100 a week. These straight-from-the-shoulder-facts point the way. Hoover down in Ohio sold 29 in one day, profit \$87.00. Benke, Mo., averages 200 a month. Campbell, Tenn., 1,000 a month. Crandall, Iowa, put on thirty sub-agents in one week. Dryden, Calif., sold 150 in ten days. Grace, Hawaii Island, 200 in two weeks. Teeters, Mich., first three dozen in ten days. We say you can make

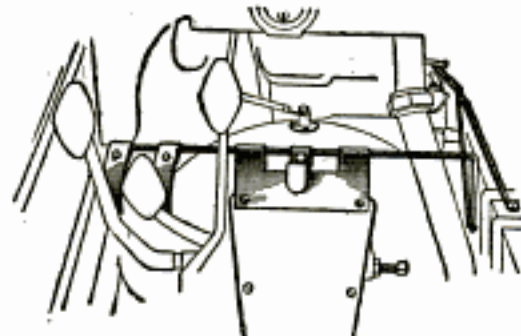

THE GREATEST FORD INVENTION

THE PERRIN METAL PARTS CO.

\$55.00 TO \$300.00 WEEKLY

selling the Speederator. Best article to advertise itself you ever saw. Once on a car the driver will never let you take it off. Sales are made fast and furious. Boyer, Penna., made \$72 first day. Cook, N. Dak., 150 sold first two weeks. Cahon, Ariz., 72 in two weeks—\$216.00 clear. Join the ranks of successful men in this work.

NO EXPERIENCE NECESSARY

Just show us that you mean business and are ready for business and we will show you how. But first, make us prove these facts. We have nothing to apologize for. The Speederator is a grand success—you can make money fast if you have the territory—so get busy now. Write to-day for the necessary information and see for yourself. Don't delay—plenty of good territory left—if you are a hustler you can have money in the bank in a few weeks. Just write—now—to

1127 Wolverine Bldg.

Toledo, Ohio

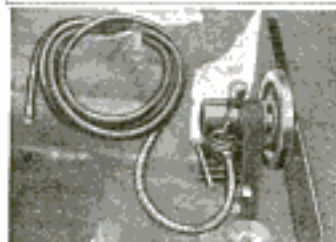

A.I.D. FOR FORDS

The A.I.D. Airnit pumps a Ford tire in less than 5 minutes. Aero Fan keeps motor cooler—any one can attach. A Real Tire Pump—no gears, cams, chains or noise. Agents Wanted. Send for Circular A. I. D. Inc. 1352 Beacon St., Boston 47, Mass.

MAKE YOUR FORD INTO THIS SPORT CAR \$ ONLY 6.40

Other types down to \$1.50. Famous size 16. *Red Hot* life-size patterns and simple instructions show all details. You can easily convert your Ford into the fast, snappy Sport Car as hundreds have done with a few dollars worth of material from the hardware store. No need to lay up the car. The "PAL" with casual disc wheel pattern. Pressed Metal Streamline Rear only \$6.40 delivered. Built low, rides wonderfully easy. Order NOW while we can make good delivery. Send 5c coin for illustrated prospectus a Sport Sedan, "Jiffy" Trend & Gear Windshield. Kuempel Co., 84 Kuempel Bldg., Gattensberg, Iowa



Small Cash Payment—Balance Easy Terms

\$20 Starts Battery Charging Business

Only \$20 cash brings an HB Battery Charger and starts a business that can make \$150 to \$300 clear monthly profit. Long easy terms on balance, easily paid by your profits. No experience needed. Big demand for reliable battery charging. Write us TODAY for complete information. Do it NOW. HOBART BROS. CO., Box M44, Troy, Ohio

Battery Charging Pays \$1500 to \$3000 a Year



Catch Fish, Eels, Rabbits, Skunk, Weasel, Mink, Muskrats etc., in large numbers, with our new, folding, galvanized Steel Wire Traps. They catch them like a fly-trap catches flies. Made in all sizes. Strong and durable. Write for Descriptive Price List, and our Free booklet on best bait known for attracting all kinds of fish.

J. F. GREGORY, Dept. 24, LEBANON, MO.

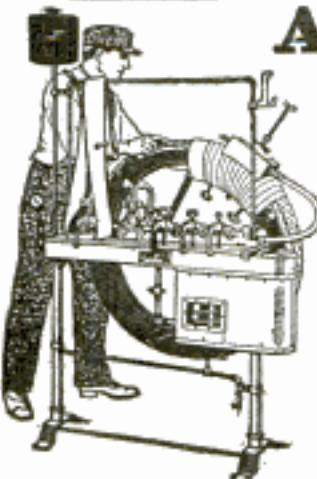

An Easy Way to Make Money

Don't be content to plod along on a small salary. Be independent. Go in the tire repairing business and make \$60 or more a week. One man made \$45 the first day he received his outfit. Others are making \$25 a day and hundreds of wide-awake men are making \$200 to \$500 a month.

No experience needed. We teach you how. Very little capital required. But slight risk, as every car owner in your town is a possible customer. Jobs are plentiful because tires blow out and puncture every day. Business is good the year round.

SHALER Tire Repair Outfit, \$75

Will do as much and as perfect work as the big \$250 to \$500 vulcanizing outfits. A boy can vulcanize perfectly with this simple machine. It's the only vulcanizer that has Automatic Heat Control. It must vulcanize just right. It can't undercure or overcure a tire. Requires no watching or regulating. You can learn to do expert tire vulcanizing in half an hour with the Shaler.

WRITE FOR FREE BOOK "HOW TO OPEN A TIRE REPAIR SHOP" and complete Catalog, which gives full information.

WRITE QUICK BEFORE SOME HUSTLER GETS AHEAD OF YOU.

C. A. SHALER CO., 2003 Fourth Street, WAUPUN, WISCONSIN

Avoid Trouble—Buy a Stromberg Gasoline Filter

It performs an urgent duty—cleans the gas—takes out the dirt—every drop of water. Reduces repair bills—cuts down operating expenses, keeps carburetor from becoming clogged with dirt.

No mechanical knowledge needed—attach it yourself. Needle valve shuts off gas flow when sediment chamber is released for cleaning. Prevents theft—it locks the car.

Every car owner needs one. Pays for itself. State name and model of your car.



STROMBERG MOTOR DEVICES CO.
Manufacturers of the Stromberg Carburetor
64 E. 25th St., Dept. 414
CHICAGO

Reduces Repair Bills

\$3.00

MOTORCYCLE BARGAINS

Save 25% to 65%

on Slightly used and Rebuilt Motorcycles, Side Cars, Johnson Motor Wheels, Evans Power Cycles, Bicycles. Send for Free Bargain Bulletin and Money Saving Message, listing hundreds of Bargains in used, rebuilt and new machines, supplies, accessories, etc.

AMERICAN MOTOR CYCLE CO.
Dept. 414 2047 W. Chicago Avenue, CHICAGO



FORDS RUN 34 MILES on Gallon of Gasoline



Wonderful new carburetor. Guaranteed to reduce gasoline bills from one-half to one-third and increase power of motors from 30 to 50%. Start easy in coldest weather.

Sent on 30 DAYS' TRIAL

Fits any car. Attach yourself. Fords make as high as 34 miles to gallon. Other cars show proportionate saving. Send make of car and take advantage of our special 30-day trial offer. **Agents Wanted.**

AIR FRICTION CARBURETOR CO.

3380 Madison Street

Dayton, Ohio

EARN \$150.00 A WEEK BY YOURSELF

WITH A **Duncan Vulcanizing Plant**

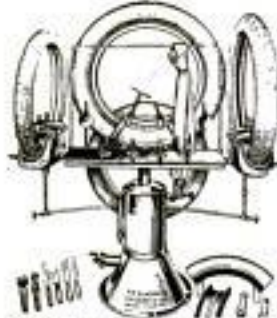

It includes every tool and vulcanizer for a high-grade repair business. Will handle the work of six men.

We start you in business for as low as \$125.00, balance easy monthly payments. We teach you approved factory methods of tire repair at home or in one of our own repair shops, FREE. We also pay you \$5.00 to \$6.00 per day for the last eight to ten days, when you take the course in one of our repair shop schools in connection with the purchase of a No. 10 or No. 3 Equipment.

Can you beat this big chance to own your own business upon so small a capital?

F. M. DUNCAN COMPANY

OFFICES AND FACTORY:

341 East Ohio St., Dept. 5, Chicago, U. S. A.

The Duncan will cure two or three times as many tires a day as any other mould. It is the only mould made that will operate with sand bags equally as well as with air bag.

Auto Owners WANTED!



To introduce the best automobile tires in the world. Made under our new and exclusive Internal Hydraulic Expansion Process that eliminates Blow-Out—Stone-Bruise—Rim-Cut and enables us to sell our tires under a

10,000 MILE GUARANTEE

We want an agent in every community to use and introduce these wonderful tires at our astonishingly

low prices to all motor car owners.

Write for booklet fully describing this new process and explaining our amazing introductory offer to owner agents.

Hydro-United Tire Co.

Dept. 100 Chicago, San Francisco, Pottstown, Pa.

30 Days' Free Trial

Select from 44 Styles, colors and sizes, famous Ranger bicycles. Delivered free on approval, express prepaid, at **Factory Prices**. You can easily save \$10 to \$25 on your bicycle.

12 Months to Pay on any Ranger if desired. Parents often advance first deposit. Boys and girls can easily earn small monthly payments.

Best quality, at factory prices, express prepaid. Tires, lamps, wheels and equipment, low prices. Send No Money, to business direct with makers.

Mead Cycle Company
Dept. City Chicago

Write today for free Ranger Catalog, featuring prices and marvelous easy payment terms.



We Pay \$6 a Day



taking orders for Insyde Tyres—inner armor for automobile tires. Positively prevents punctures and blowouts. Guaranteed to give double tire mileage.

Work Spare Time or Full Time

Every auto owner buys on account of low price. Enormous demand. Write quick for territory and special terms to County Representatives.

AMERICAN ACCESSORIES CO., B 1476, CINCINNATI, O.

A LATHER THAT SOOTHES

Palmolive Shaving Cream gives soft, creamy lather that makes the beard wiggle. The razor moves smoothly, Palmolive is also a lotion. Contains both Palm and Olive oils. Write for free trial tube. Large size tube at drugists 30c.

THE PALMOLIVE COMPANY, Milwaukee, U. S. A.
PALMOLIVE SHAVING CREAM



SEND NO MONEY

If You Can Tell it from a GENUINE DIAMOND Send it back

To prove our blue-white MEXICAN DIAMOND cannot be told from a GENUINE DIAMOND and has same DAZZLING RAINBOW FIRE, we will send a selected 1 carat gem in a fine Solitaire Ring. (Cat. Price \$5.50) for Half Price to introduce, \$2.63, or in Gentle Heavy Tooth Belcher Ring (Cat. Price \$4.00) for \$2.25. Our finest 1/2k Gold Filled mountings. GUARANTEED 20 YEARS, SEND NO MONEY. Just mail postcard or this ad, State Ring. We will mail at once. When ring arrives deposit \$5.00 for Ladies ring or \$3.50 for Gents with postman. If not pleased return in 2 days for money back less handling charges. Write for Free catalog. Agents Wanted. **MEXICAN DIAMOND IMPORTING CO., Dept. ET, Las Cruces, N. Mex.** (Exclusive controllers Mexican Diamonds)

8000 MILES GUARANTEED



**No Rim Cut—
No Stone Bruise
Better Tires For Less Money**
Big Hand Made Oversize Tires. Built to stand cuts and weather. None better. The big tire companies no longer guarantee mileage. Our ALL ROAD TREADS are Guaranteed 8,000 Miles and adjusted on this mileage basis. Positively Brand New and Firsts at lowest prices ever offered. The absolute limit in tire bargain.

Read These Prices

Size	Tires	Tubes
22 x 3	\$ 7.70	\$1.25
22 x 3 1/2	7.90	1.30
22 x 4	8.60	1.50
22 x 4 1/2	11.85	1.75
24 x 4	12.10	1.90
24 x 4 1/2	14.10	2.05
24 x 4	14.95	2.10
24 x 4 1/2	15.45	2.15
24 x 4 1/4	20.25	2.50
25 x 4 1/4	21.50	2.60

Send No Money

Order now. You risk nothing. Just send name and address and size and number of tires and tubes wanted. We ship C. O. D. Pay only on arrival. Tires shipped in original factory wrapper. If after examination you are not perfectly satisfied that they are the finest, most serviceable tires made and the greatest tire bargain you ever saw, return them. We will promptly refund your money, including postage. Take advantage of this liberal offer now while these low prices last.

All orders shipped same day received.
NEW TIRE CO., 3457 Michigan Ave., Dept. 52, Chicago, Ill.

You Can Save \$40.00

By recovering your old auto top frame yourself. We make these covers to fit all makes and models of cars. Any person that can drive a car can put it on. We furnish instructions. Roof and quarters sewed together with rear curtain, fasteners, welts and tacks. All complete. Give us the name, year and model number of your car, and we will send you our catalogue with samples and quote you exact price.
LIBERTY TOP & TIRE CO., Dept. E7, Cincinnati, O.



AMAZING OFFER In Imported SAFETY RAZORS 39c

Can't be told from \$5.00 Gillette. Use Gillette blades. Just so durable, same appearance. Packed in attractive, outpocket case, can be put in vest pocket. A bargain while they last. **AGENTS MAKE BIG MONEY EASY** selling these razors. Send 39c, stamps or M.O., and get your razor today. Satisfaction guaranteed—or money back.
ALFRED DAY COMPANY
Monroe Building Chicago, Illinois

RAISE BELGIAN HARES
New Zealand Reds—Flemish Giants—American Blues. **BIG PROFITS, WE PAY \$1.50 TO \$3 EACH.** Also Carries Mink, Beak, Fox, Mink, etc. Easily raised anywhere. 32-page Catalog and Contract **FREE!** Illustrated book "COMMON SENSE RABBIT RAISING," quarterly journal, and copy of *America's leading small stock magazine*, all for 10 cents. Address **Outdoor Enterprise Co.,** 1005 S. E. 136th., KANSAS CITY, Mo.

HAWAIIAN IM. DIAMONDS

The Greatest Discovery the World Has Ever Known. Just to advertise them to more Im. diamonds we will send you one of these 14k gold rings, postage paid. When it arrives pay postman \$2.98 C.O.D. charges to cover cost, etc. Only 10,000 rings given away. Money refunded if you can sell it for a genuine diamond. Send size of finger.

KRAUTH & REED
Dept. C
Masonic Temple Chicago

No. 8010 Special price **\$2.98** No. 8011 Special price **\$2.98**



TYPEWRITER SENSATION! Free Trial—Use as You Pay

Send us only \$5.00 a month until the low total price of \$64.85 is paid, and the machine is yours.

This is absolutely the most generous typewriter offer ever made. Do not rent a machine when you can pay \$5.00 a month and own one. Think of it—Buying a \$100.00 Machine for \$64.85. Cash price, \$59.85, just a little more than half its original price.

L. C. SMITH Model No. 5

Perfect machines, Standard size, Keyboard of Standard Universal arrangement, 42 Keys, writing 84 characters—universally used in teaching the touch system. The entire line of writing completely visible at all times, has the tabulator, the two color ribbon, with automatic reverse, the back spacer, ball bearing type bars, ball bearing carriage action, ball bearing shift action, in fact every late style feature and modern operating convenience. Comes to you with everything complete; tools, cover, operating book and instructions—nothing extra to buy. **You cannot imagine the perfection of this beautiful reconstructed typewriter until you have seen it. We have sold thousands of these perfect late style machines at this bargain price and every one of these thousands of satisfied customers had this beautiful, strictly up-to-date machine on five days' free trial before deciding to buy it. We will send it to you F. O. B. Chicago for five days' free trial. It will sell itself, but if you are not satisfied that this is the greatest typewriter you ever saw, you can return it at our expense. You won't want to return it after you try it, for you cannot equal this wonderful value anywhere.**

SEND NO MONEY Put In Your Order Now \$4.85 AFTER TRIAL

When the typewriter arrives deposit with the express agent \$4.85 and take the machine for five days' trial. If you are convinced that it is the best typewriter you ever saw keep it and send us \$5.00 a month until our bargain price of \$64.85 is paid. If you don't want it, return it to the express agent, receive your \$4.85 and return the machine. We will pay the return express charges. This machine is guaranteed just as if you paid \$100.00 for it. It is standard. Over half a million people own and use these typewriters and think them the best ever manufactured. **The supply at this price is limited, the price will probably be raised when next advertisement appears, so don't delay. Fill in the coupon to-day—the typewriter will be shipped promptly.** There is no red tape. We employ no solicitors—no collectors—no chattel mortgage. It is simply understood that we retain title to the machine until full \$64.85 is paid. You cannot lose. It is the greatest typewriter opportunity you will ever have. **Do not send us one cent. Get the coupon in the mails to-day—sure.**

SMITH TYPEWRITER SALES CO., 222, 218 N. Wells St., Chicago, Ill.

SMITH TYPEWRITER SALES CO., 222, 218 N. Wells St., Chicago, Ill. Ship me the L. C. Smith Model No. 5, F. O. B. Chicago, as described in this advertisement. I will pay you \$5.00 monthly as rent until the \$60.00 balance of the Special \$64.85 sale price is paid. The title to remain in you until fully paid for. It is understood that I have five days in which to examine and try the typewriter. If I choose not to keep it I will carefully repack it and return it to the express agent. It is understood that you give the standard guarantee.

Name.....
Street Address.....
City..... State.....
Occupation or Business.....

Kingery
MAKING POP CORN POPPERS

New 1922 Prices

MAKE BIG MONEY! OWN YOUR BUSINESS

Kingery Pop Corn Poppers and Peanut Roasters are proving the business salvation of thousands of men. You need but little capital and your dividends are enormous—70c profit on every dollar.

Adaptable for outdoor use, shows, drug stores, fruit stores, general stores, confectioners, news dealers—for any one who wants to make big money with least expense of time, effort or money.

Write for new 1922 catalog showing FULL line for any location or any business. Over a hundred styles. Most reasonable prices and terms.



THE KINGERY MFG. CO.

Established 1876

Dept. 242

Cincinnati, Ohio

GET A RAZO!



This unique Razor-blade pocket knife is the handiest, safest general utility knife. Uses an old Gillette blade. Artists, writers, draftsmen, tailors, dressmakers, office men, women, school children all need RAZO. Send 25c for yours today. Great money maker for agents.

RAZO NOVELTY CO.
23 E. Van Buren St. Chicago

WINDOW SIGN LETTERS

LARGE PROFITS

184

**EDWARD GOLDSMITH
DELICATESSEN
AND
GROCERY**

CIGARS & TOBACCO
GOODS DELIVERED

SAMPLES FREE

AGENTS AND SALESMEN

\$75.00 to \$150.00 a week. Lowest price gold and silver sign letters for stores, offices, automobiles, etc. Large demand everywhere. Anybody can do it. Exclusive territory or travel all over while you earn. Write for free samples and catalog.
ACME LETTER CO., 2800 X Congress St., Chicago

Send No Money

21 Jewel Illinois

The greatest watch value ever offered. Unequaled for beauty, accuracy and reliability. 21 ruby and sapphire jewels—adjusted to positions, temperature and isochronism, 20 year gold-filled case.

**Special: Silver
Damasked Dial
10 Days' Free Trial**

Wear it for 10 Days at our risk. Note its absolute exactness. If at the end of ten days you are not satisfied, just send it back at our expense.

Knife and Chain Free
We are offering for a limited time this handsome gold-filled knife and chain ABSOLUTELY FREE.

ONLY 11c A DAY

Just send your name and address. The watch, chain and knife come to you, prepaid. Give the expressman \$5.50 as a deposit. If after 10 days, you do not wish to keep them, return at our expense; your deposit will be refunded instantly. Trial is absolutely free. If you keep the watch pay \$3.40 a month until full price of \$42.50 is paid. This splendid watch will cost you less than 11c a day. Act at once. De Luxe catalog of Diamonds, Jewelry, etc., sent free. Address Dept. 62-J.

CAPITAL \$1,000,000

"The House of Quality"

L. W. SWEET, INC

1650-1660 Broadway New York



SELF-FILLING INK PENCIL "INDEPENDENT"

Meets all requirements. Self-filling, non-leakable, safety cap. Attached clip. Smooth writing gold Stylus point.

Guaranteed Improved Fountain Pen. Eliminates fatigue. Promotes efficiency. Writes uniformly. A business necessity.

\$2 By Mail

Your Name in Gold—25 Cents Extra

AGENTS WANTED
J. C. ULLRICH & CO., 161 Washington St., New York



**COPPER
OIL CANS
LAST A LIFE TIME
IDEAL FOR GARAGES**
Circular Free

STANDARD METAL WORKS
6 BEACH ST. BOSTON, MASS.

10 Cents a Day Pays



For smaller Symphonolas. Style pictured and others 17c to 25c a day. Tens of thousands giving satisfaction.

SYMPHONOLAS

No expensive attachments needed to play all Records. Tone natural, life like. Well built. Highest quality equipment.

NO MONEY DOWN
Shipped anywhere in U. S. 30 Days FREE Trial before you make first payment. If pleased take up to 2 years time.

RECORDS 70c EACH
Play on all phonographs using steel needles. Latest vocal and instrumental hits. Also Sacred and Operatic. Full size 10 inch. Postpaid. Ask Today for Symphonola Booklet and Record List.

Larkin Co Inc.

Desk SPM-422

Buffalo, N. Y.

DEAF?

This Smile Says:
"I Hear Clearly"

If you are hard of hearing you have embarrassing moments—so do your friends. Is it not worth while to see if all this embarrassment can be avoided?

500,000 persons are now hearing clearly by aid of the Acousticon.

A New York Physician says: "It is of great value to me. I should have been obliged to give up the practice of medicine long ago if I had not obtained this best of all devices for the aid of hearing."

We offer you the

1922 ACOUSTICON

For 10 Days' FREE TRIAL
 No Deposit—No Expense

Just write, saying "I am hard of hearing and will try the Acousticon." Give it a fair trial amid familiar surroundings—thus you can best tell what it will do for you.

Remember, however, that the Acousticon has patented features which cannot be duplicated. So no matter what your past experience has been, send for your free trial today.

DICTOGRAPH PRODUCTS CORP.
 1307 Candler Bldg. 220 W. 42nd St., New York City

MUSIC LESSONS FREE

 **IN YOUR OWN HOME**

You can read Music like this quickly

Piano, Organ, Violin, Mandolin, Guitar, Banjo, etc. Beginners or advanced players. One lesson weekly. Illustrations make everything plain. Only expense about 2c per day to cover cost of postage and music used. Write for FREE booklet which explains everything in full.

AMERICAN SCHOOL OF MUSIC, 50 Lakeside Building, CHICAGO

Army Auction Bargains

 NEW rope lariat with snap \$1.00
 Armyknapsack .75 up | Saddles \$6.50 up
 LUGER pistol \$21.50 | Cal. 30 rifle \$16.50
 Full set Army steel letters and figures \$1.00.
 15 acres army goods. Illustrated catalog for 1922—312 pages—including full and highly interesting information (specially secured) of all World War small arms, mailed 60 cents. Circular 16 pages 10 cents. Established 1865.

FRANCIS BANNERMAN SONS, 501 Broadway, N.Y.

MOVIES—BOYS! GIRLS! GROWN-UPS!

 Write to-day for free Catalogue of our MOVIE MACHINES

REAL MOVIES FOR THE HOME
 Wonderful Models \$6.00 to \$25.00, with film

PARAMOUNT MFG. CO., Dept. M.
 Box 1371 Boston, Mass.

TYPEWRITERS

We Save You 50%

FREE TRIAL—EASY TERMS

Your choice of all STANDARD MAKES: UNDERWOOD, ROYAL, SILENT L. G. SMITH, Self-starting REMINGTON, etc. Rebuilt by the Famous "Young Process". Guaranteed good as new. Lowest cash prices. Time payments or rentals with special purchase privilege. Largest stock in U. S. Write for special prices and terms.

YOUNG TYPEWRITER CO., Dept. 158, CHICAGO

Mechanical Engineering



Learn at Home!

EMPLOYERS everywhere are looking for men with mechanical ability. Splendid salaries and rapid advancement are offered those with special training.

There is an easy, delightful way in which you can learn right at home in spare time. For 30 years the International Correspondence Schools have been giving men and women just the training they need for success in mechanical engineering and more than 300 other subjects. Hundreds of thousands have stepped into good positions through I. C. S. help, but never were opportunities so great as now.

Let the I. C. S. help you. Choose the work you like best in the coupon below, then mark and mail it today. This doesn't obligate you in the least and it will bring you information that will start you on a successful career. This is your chance. Don't let it slip by. The most important thing you have to do is to mark and mail this coupon **NOW**.

----- TEAR OUT HERE -----
INTERNATIONAL CORRESPONDENCE SCHOOLS
 BOX 5620-C SCRANTON, PA.

Without cost or obligation please explain how I can qualify for the position, or in the subject before which I have marked an X:

- | | |
|---|---|
| <input type="checkbox"/> ELEC. ENGINEER | <input type="checkbox"/> BUSINESS MANAGEMENT |
| <input type="checkbox"/> Electric Lighting & Railways | <input type="checkbox"/> SALESMANSHIP |
| <input type="checkbox"/> Electric Wiring | <input type="checkbox"/> ADVERTISING |
| <input type="checkbox"/> Telegraph Engineer | <input type="checkbox"/> Show Card & Sign Ptg. |
| <input type="checkbox"/> Telephone Work | <input type="checkbox"/> Railroad Positions |
| <input type="checkbox"/> MECHANICAL ENGINEER | <input type="checkbox"/> ILLUSTRATING |
| <input type="checkbox"/> Mechanical Draftsman | <input type="checkbox"/> Cartooning |
| <input type="checkbox"/> Machine Shop Practice | <input type="checkbox"/> Private Secretary |
| <input type="checkbox"/> Toolmaker | <input type="checkbox"/> Business Correspondent |
| <input type="checkbox"/> Gas Engine Operating | <input type="checkbox"/> BOOKKEEPER |
| <input type="checkbox"/> CIVIL ENGINEER | <input type="checkbox"/> Stenographer & Typist |
| <input type="checkbox"/> Surveying and Mapping | <input type="checkbox"/> Certified Public Accountant |
| <input type="checkbox"/> MINE FOREMAN or ENG'R | <input type="checkbox"/> TRAFFIC MANAGER |
| <input type="checkbox"/> STATIONARY ENGINEER | <input type="checkbox"/> Railway Accountant |
| <input type="checkbox"/> Marine Engineer | <input type="checkbox"/> Commercial Law |
| <input type="checkbox"/> ARCHITECT | <input type="checkbox"/> GOOD ENGLISH |
| <input type="checkbox"/> Contractor and Builder | <input type="checkbox"/> Common School Subjects |
| <input type="checkbox"/> Architectural Draftsman | <input type="checkbox"/> CIVIL SERVICE |
| <input type="checkbox"/> Concrete Builder | <input type="checkbox"/> Railway Mail Clerk |
| <input type="checkbox"/> Structural Engineer | <input type="checkbox"/> AUTOMOBILES |
| <input type="checkbox"/> PLUMBING & HEATING | <input type="checkbox"/> Mathematics |
| <input type="checkbox"/> Sheet Metal Worker | <input type="checkbox"/> Navigation |
| <input type="checkbox"/> Textile Overseer or Supt. | <input type="checkbox"/> AGRICULTURE <input type="checkbox"/> Spanish |
| <input type="checkbox"/> CHEMIST | <input type="checkbox"/> Poultry Raising <input type="checkbox"/> Banking |
| <input type="checkbox"/> Pharmacy | <input type="checkbox"/> Airplane Engines |

Name.....

Street..... 1-16-22

City..... State.....

Occupation.....

Persons residing in Canada should send this coupon to the International Correspondence Schools Canadian, Limited, Montreal, Canada.

Please Mention Popular Mechanics

Finest Instruments Are Easiest to Play



You cannot learn to play correctly on a cheap, imperfect instrument and expect to achieve success in music. The best teachers will always recommend the finest instruments for their pupils.

King Instruments Now Easy to Own

A quarter century ago the first King Brass Instrument was made to the specifications of a famous artist, and for years thereafter Kings were made and sold only for cash to great musicians. But now, our new easy payment plan makes it possible for anybody to own a King. You can now buy direct from the factory, save middleman's profit, and get a brand new, acoustically perfect, laboratory-tested King Instrument. And, with every new King goes our famous free factory-service and guarantee.

Big Stock of Used Instruments
Thousands of musicians have turned in good instruments as part payment on new and better Kings. These used instruments we sell for cash at very low prices. They are refinished and look like new. Send for our latest complete catalog and list of these bargains before they are gone. Ask for details of easy payment plan on new instruments.

KING

THE H. N. WHITE CO.
5237 Superior Avenue,
Cleveland, Ohio

SQUAB BOOK FREE



Squabs are selling at the highest prices ever known. Breed them and make money. Write at once for free book, prices, etc.
Plymouth Rock Squab Co., 634 Howard St., Melrose Highlands, Mass

"Lighting Fixtures" READY TO HANG

(Direct from Manufacturers)

Completely wired, including glassware. New designs. Send for catalogue No 24. Send for DEALERS' proposition.

ERIE FIXTURE SUPPLY CO.
STA. A. ERIE, PA.



DIAMONDS WATCHES One Year to Pay

Diamond Prices Smashed to Less Than Cash Prices

Amazing money-saving prices on finest quality genuine diamonds, watches and jewelry. DIAMOND RINGS \$14.85 and up. Wrist Watches \$19.95 up. Men's Elgin and Waltham Watches \$28.75 up.

Get DeLuxe Catalog FREE. Explains easiest credit Terms and Money Back Guarantee fully. Examine Diamonds first if you wish. One whole year to pay. Use Your Credit. Get this Beautiful Bargain Catalog. NOW!

Klein & Co., 122 W. Madison St., Dept. B74 Chicago, Ill.
Nearly 1-4 century same location



\$4.50
A Month
payments will buy this magnificent hand engraved "Lady Lorraine" ring. 14K Solid Gold. Large Steel-blue white perfect cut Diamond of Berry brilliancy. Was \$100.00.

Now Only
\$68.00

Use Your Credit
No Delay—No Red Tape

Automatic Rapid Electric Cook Stove

EASIEST method known to prepare family meals. Saves 50% to 75% fuel cost—saves time, labor. Insures better prepared, more tasty food. Gives every facility of electric range plus every advantage of fireless cooker at less cost than a good oil stove.

New Invention

Revolutionizes Cooking—Bakes, roasts, boils, stews, fries, broils, toasts. Needs no watching. Shuts itself off. Attaches to any electric socket. No special wiring. Write for 30-day FREE trial offer. Complete facts and special introductory, direct factory prices.

SEND NAME AND ADDRESS

Wm. Campbell Co., Dept. 64, Detroit, Mich.



NEW Self-heating IRON



AGENTS MAKE \$12 A DAY

New scientific development makes ironing remarkably easy. No wires or attachments—all self contained. Gives clean, quick heat, easily regulated. Costs one cent for 3 hour's use. Saves steps. Cuts ironing time in half.

Sells fast. Mrs. Wagner, Ohio, sold 25 in few hours spare time. Moyer, Pa., made \$164.00 in one week. You can do as well. No experience necessary. Work all or spare time. You simply take orders, we deliver by parcel post and do collecting. Commissions paid same day you take orders. Send for Catalog and FREE OUTFIT OFFER. Write today.

AKRON LAMP CO. 33 Iron St., Akron, O.

"Best" Hand Lantern



A powerful portable lamp, giving a 300 candle power pure white light. Just what the farmer, dairyman, stockman, etc., needs. Safe—Reliable—Economical—Absolutely Rain, Storm and Bug proof. Burns either gasoline or kerosene. Light in weight. Aerials wanted. Big Profits. Write for Catalog.

ADOPTED BY THE U. S. GOVERNMENT

The Best Light Co., 324 E. 5th St., Canton, O.

Beautiful HOUSES \$900 and BUNGALOWS

CAN BE BUILT FOR AND UP
This and many others in my new book, Building Plans for Modern Homes, will save you hundreds of dollars. One of the most complete and comprehensive books of plans ever published by any architect. New edition just off the press. Nearly 500 floor plans and photographs of bungalows, Colonial houses, etc., costing from \$200 up; gives sizes and cost to build.



FREDERICK H. GOWING
ARCHITECT

Sent postpaid for \$2.00

18 Tremont St., BOSTON, MASS.

WHITE FLAME

BURNERS make your old kerosene lamps and lanterns give a brilliant white light better than electricity or gas. Doubles your light. Saves oil. NO MANTLE TO BREAK. Guaranteed Safe and Reliable. Delights every user. Send now for complete sample postpaid 50 cents, stamps or coin. 3 for \$1.25. Money Back if Not Satisfactory.
Live Representatives Wanted. Exclusive Territory.
WHITE FLAME LIGHT CO., 68 Clark Bldg., Grand Rapids, Mich.



MONEY NOW TIME TO START

IN MUSHROOMS
BIG DEMAND. HIGH PRICES BEING PAID
An uncrowded occupation. Exceptional opportunities for live men and women. Raised at home. Only small space needed. Small expenditure will start you in a practical money-making enterprise. Big profits. Booklet telling all free. Write Nat'l Spawn Co., Dept. 12, Waban, Mass

Dollars in Hares

We pay \$7.00 to \$18.50 and up a pair and express charges. Big Profits. We supply guaranteed high grade stock at lowest prices and buy all perfect pairs you raise. Use back yard, barn, cellar, attic. Contract and Illustrated Catalog FREE.

STANDARD FOOD & FUR ASS'N
407 B Broadway NEW YORK





Free Trial

YOU may have any instrument with complete musical outfit, for a week's free trial at home. No obligation to buy. Return it at our expense after trial if you wish. No charge for trial. Outfit includes velvet lined case, self instructor, music and all accessories at factory cost. A tremendous saving.

Convenient Monthly Payments

A few cents a day will pay for instrument and outfit. This offer gives you genuine Wurlitzer instruments, known all over world for artistic quality. Have one now for Free Trial.

Send Coupon for Beautiful New Catalog

Every instrument known illustrated with price, easy terms and free trial blank. Catalog absolutely free. Write today.

The Rudolph Wurlitzer Co., Dept. 1774
 117 East 4th Street, Cincinnati — 700 Jackson Blvd., Chicago
 120 W. 42nd St., New York — 225 Stockton St., San Francisco

Send me your new catalog illustrated in color with full details of Wurlitzer Complete Outfits and free trial and easy payment offer.

Name.....
 Address.....

State instrument you are especially interested in

WURLITZER
 200 YEARS OF MUSICAL INSTRUMENT MAKING
 Cincinnati Chicago
 New York San Francisco
 Copyright 1920, Rudolph Wurlitzer Co.

Build and Fly Model Aeroplanes

Build your own Model Aeroplane; make trial flights and learn the principles of Aerostation. With **IDEAL** Scale Drawings and Building and Flying Instructions you can easily build exact 3-ft. duplicates of Real Planes. Send now for the Plans for the one you want to build.

Curtiss JN4D-2 Training Plane; DeHavilland Battle Plane; NC-4 Naval Seaplane; Curtiss Military Tractor; Blériot, Nieuport or Taube Monoplane; also Coak Peell Racer; 25c each, postpaid.

Catalogue **IDEAL Model Aeroplanes and Supplies**, 5c postpaid

IDEAL AEROPLANE & SUPPLY CO. New York City
 159 Westcott St., cor. W. Houston St.

PLANS AND INSTRUCTIONS 25c

GREAT INTERCHANGEABLE-TYPE TYPEWRITER
Hammond
MULTIPIX A NEW **FOLDING** MODEL Full Capacity

Write for Free Booklet. Hammond Typewriter Co., 508A East 69th St., New York

TIRRO

the ideal mending tape of a thousand uses—sticks to anything and stays stuck. For sale at all druggists. A Bauer & Black product.

GREEN AUTOMATIC MACHINE



ADD TO YOUR INCOME WITH LITTLE EFFORT \$5 to \$10 A DAY MADE EASY WITH

New Improved Green Automatic Machine

Sharpens, Honors and Strips all kinds of safety razor blades, in one operation, from four to six blades per minute. For both Quality and Quantity, this machine is in a class by itself. There is nothing like it on the market. Let us send you our descriptive literature explaining everything, including the "AMERICAN" Key Cutter—cuts square, angular or round slots.

AMERICAN SHARPENING MACHINE CO. (Inc.), Dept. 4, 184 W. Washington St., CHICAGO



Go Into Business for Yourself



Enormous profits can be made by any man, woman or bright boy who will establish one of our "NEW SYSTEM SPECIALTY CANDY FACTORIES" in his or her community. Big openings in cities, towns and villages everywhere. Our original "New System" of candy-making will enable you almost immediately to turn out a large variety of "Specialty Candies"—all big sellers. Wholesale or retail. No previous experience necessary. Only small space required at start. We furnish everything ready for work. Hundreds have become successful. Useful Candy Book FREE

Our Big Candy Book gives all details. It is Free. Write for it at Once.

W. Hillier Ragsdale, Drawer 201 East Orange, N.J.

50¢ FOR

An Unusual Introductory Offer

Save you money Write today for particulars CALIFORNIA LEATHER PRODUCTS CO. 610 Luchenbach Bldg., Los Angeles, Cal.

YOUR OLD BELT



A New \$69⁰⁰

OTTAWA Lower factory costs, and closer buying enables us to build this new improved Log Saw and sell it for a lower price. Ottawa's Newest Log Saw saws 8" logs as easily as 5 ft. logs; lighter in weight; easier to move; new non-skidding base; many other wonderful improvements; has genuine Ottawa quality. Write today for Big Free Book and complete information about this new saw.

FREE BOOK

Send Today—a postal will do, and get the Big new book on wood cutting. Valuable and interesting. Get it Now!

OTTAWA MFG. CO.
1745E Wood St.
Ottawa, Kansas



\$25 Brings HB Tire Buffer balance on easy monthly terms. Quickly buffs tires and rims, grinds castings, sharpens tools. Built extra heavy to avoid vibration. A necessity for garage, machine shop or factory. Heavy duty non-stalling 2 h. p. ball-bearing motor. Ample clearance for large work. A big money-maker for your shop. No repairs. Send \$25 TODAY, or write for information. Sold on money-back guarantee.

HOBART BROS. CO. Box M 44B Troy, Ohio

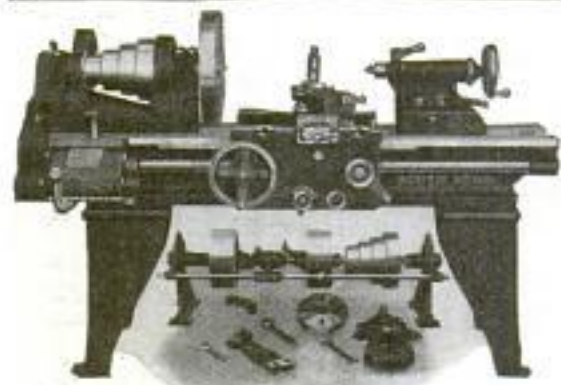

How to Run a Lathe An 80-page book, postpaid to any address for ten cents, silver or stamps accepted.

Single
Phase
60
cycle

$\frac{1}{2}$ hp
A C

\$13⁵⁰

Weight
24 lbs.

BARGAIN!

Send for Circular

explaining how we can sell this efficient motor at about half usual prices. Gives full mechanical details, of all types of both Alternating and Direct Current for various voltages.

When you write, state use to which you wish to put motors; and get the free advice of our Engineering Department.

NORTHWESTERN ELECTRIC COMPANY
408 So. Hoyne Avenue
CHICAGO



LATHES

9 to 18-inch Swing

List price \$165 and up according to size. When ready to buy send for Lathe Catalog and prices.

W. F. & John Barnes Co.
100 Ruby Street, ROCKFORD, ILL.



It is the well known quality of **CRESCENT** machines that justifies you in selecting one of them each time you have need for wood working machinery. The **CRESCENT** line is better than ever and will always give you satisfaction in every particular. Ask today for catalog of hand saws, saw tables, jointers, shapers, planers, borers, splitters and cutters, swing saws, disk grinder, cut off table, hollow chisel mortiser, variety wood worker. Universal wood workers.

THE CRESCENT MACHINE CO., 93 Columbia Street, Leetonia, Ohio

REDUCED PRICES

Back to Normalcy -- 20% Further Reduction

SOUTH BEND LATHES

	Standard Change Gear	Quick Change Gear		Standard Change Gear	Quick Change Gear
9'x3' Lathe	\$176.00	\$216.00	16'x 8' Lathe	\$452.00	\$512.00
11'x4' Lathe	228.00	273.00	18'x10' Lathe	656.00	721.00
13'x5' Lathe	304.00	354.00	21'x12' Lathe	848.00	923.00
15'x6' Lathe	376.00	431.00	24'x14' Lathe	1140.00	1230.00

64-page Catalog No. 73 for 1922 sent free to any address

ESTABLISHED 1906

SOUTH BEND LATHE WORKS,
625 E. Madison St. **SOUTH BEND, IND.**

I Made \$1412.63 on the Side

During the Grass Season with your IDEAL Lawnmower Grinder, writes W. F. Kendt.

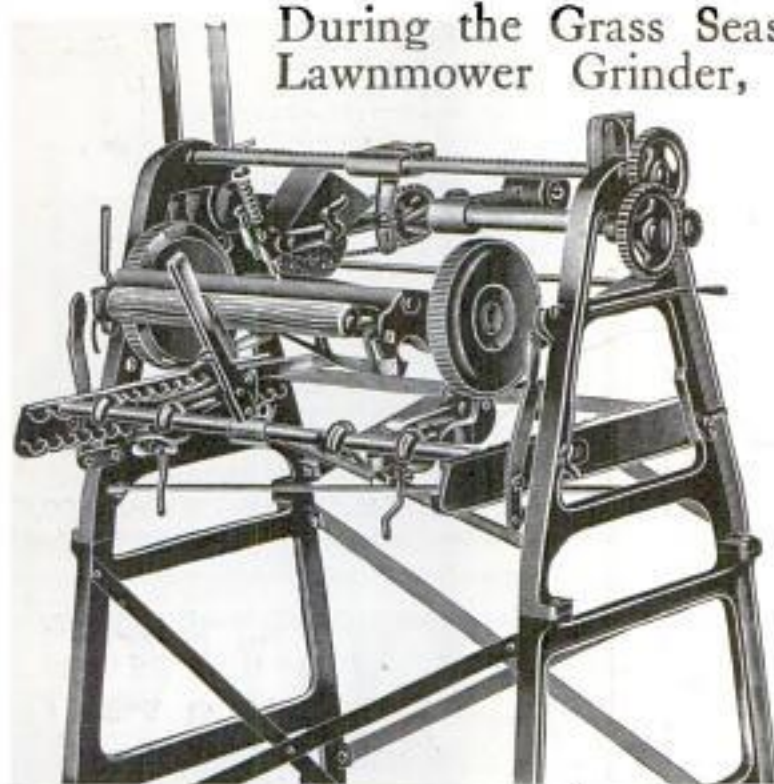

Mr. Kendt lives in Buffalo, and sharpened 790 lawnmowers. Says best investment ever made.

Read What Zeno Says:

Zeno Brandon lives at Middletown, Ohio, and writes:

"I have worked 55 days and made \$820.70. Have made as high as \$38.70 in one day."

WRITE FOR CATALOG

And little booklet, "LET GEORGE SAY IT." It tells the stories of profit as the boys tell it. Mr. Brown bought early, made \$1400 by fall, and built a new shop with the money. Write today.

The Fate-Root-Heath Co.
PLYMOUTH, OHIO

Six Machines in One

Combines bench grinder, polisher, buffer, disc sander, drill and saw for working in wood and soft metals.

A Precision Machine

A high production precision machine especially adapted to the rapid and accurate production of small duplicate parts.

Handles 4" and 5" grinding wheels, 6" saws, 6" and 8" sand discs and 3/8" chuck. Saws 1 1/2" wood. Mountable on separate base with motor. Height 10". Weight 31 lbs. Top 10" x 12" easily removed. All metal construction. Easily driven by 1/2 HP. motor. Especially suited for Private Shops, Laboratories, Manual Training Schools, Shipping Depts., Printers, Builders, Cabinet and Pattern Makers, Furniture Repairmen, etc.

Machine sold with a Money-Back Guarantee.

We also handle bench joiners, bench band saws, 1/4 and 1/2 HP. Ball-Bearing motors, circular saws, disc Sanders, and larger motor driven bench saws.

Write for circular

W. & J. Boice

114 23d St.

Toledo, Ohio



SIZES OF HOLES - PUNCH NO. 1

SAMSON No. 1 HAND PUNCH
Handles interchangeable. Punches and Dies as illustrated

Maximum punching capacity 1/8" thru 20 gauge untempered metal. Will also Perforate Paper, Card-board, Leather, etc. up to 1/4" thickness. A Powerful Punch of general utility, made of Drop Forge Steel. Throat 1 3/8" deep.

PRICE,
Postpaid, with 3 extra Punches and dies, any sizes specified,
\$3.50

THE MACHINE APPLIANCE CORPORATION
351 Jay Street, BROOKLYN, N. Y.

A LOWER PRICE ON A POWER MOWER

\$175 is now the price of our 24-inch machine.

This price—below that of other mowers—is possible because of its patented features, which eliminate dozens of parts and hundreds of pounds of weight—only eleven moving parts—weighs only 160 pounds. Same fine workmanship, durable construction, as our more expensive machines. Cuts five acres a day easily. Used by hundreds of prominent individuals and concerns.

Send us the dimensions of your grass area, and we will give you an estimate of your cutting cost and the savings you could expect, together with an interesting book about the Moto-Mower.

Large Model, 27-inch Moto-Mower—Price Complete \$210.

THE MOTO-MOWER CO.
3250 East Woodbridge St., Detroit, Mich.



Moto-Mower



Get this valuable Book on Better Lawn Care



The Ideal Junior

Every one interested in the care of large, beautiful lawns should have a copy of this book which tells all about Ideal Power Lawn Mowers. It shows many photos of well-known homes, parks, golf clubs, cemeteries, colleges, etc., where the lawns are cared for the "Ideal Way." It tells about the Ideal Junior, a moderate-priced power mower for medium-sized lawns, the 30-inch Ideal Power Lawn Mower for large lawns, and the Ideal Triplex Power Mower for large parks, golf clubs, etc. Write for this book today—learn how to keep your lawn in better condition at less cost.

IDEAL POWER LAWN MOWER CO.

R. E. OLDS, Chairman
418 Kalamazoo St. Lansing, Mich.

World's Largest Builders of Power Lawn Mowers.

Dealers in all principal cities.

IDEAL Power Lawn Mowers

Put this Parks band saw in your shop!

Constructed for real work. A fine, high-grade foot-power machine for the experienced mechanic. Sets firm and solid on any foundation. Runs fast and smoothly with little effort. 18-in. swing, cuts to center of 36-in. circle. Roomy table. Ball-Bearing disk saw guide. Takes material up to 7-in. thick. Band saw wheel covered with endless rubber bands to prevent slipping. Takes saws 12 ft. long. This machine can be furnished with pulley drive at same price. Guaranteed 10 years. 30-days' trial. Price—\$40.00



Send for complete Parks catalog

THE PARKS BALL BEARING MACHINE CO.

1500-1540 Knowlton Street

CINCINNATI, OHIO

Canadian Factory, 200 Notre Dame East, Montreal

49

PARKS

WOODWORKING MACHINES

Pilliod

General Service Case



Heavy copper-plated over zinc. Brass-plated hardware. Handsome, durable, great for machinists, repair men, motormen, autoists, etc. Will last a lifetime.

FREE—Illustrated folder including tool cases for every purpose. THE PILLIOD LUMBER CO. Dept. 1 SWANTON, OHIO

ONE-HAND-Y ELECTRIC DRILL



Weight
3 lbs.

Capacity
 $\frac{1}{4}$ in.

Westinghouse
Universal Motor
Guaranteed

Knight Engineering & Sales Co.

30 West Walton Place,
Chicago, Ill.

210 W. Seventh Street,
Los Angeles, Calif.

MYERS WONDERFUL SEWING AWL

Tools in Handle



A complete repair shop in itself. Sews anything heavy or light, leather, shoes, harness, buggy tops, castron, bolts, etc. \$1.00 Postpaid. C. A. MYERS COMPANY, 6339 Woodlawn Ave., Chicago, Ill.



The Midget "FIVE-IN-ONE" Slide Rule is a combination Mannheim, Log-Log, Add and Subtract, Polyphase and Binary Slide Rule. It will instantly add, subtract, multiply and divide any combination involving whole numbers, fractions, decimals and mixed numbers. Gives every possible root and power of every quantity. The graduations are printed on metal, coated with white celluloid and are grooved and waterproof. While it is the most versatile calculator ever invented, its operation is simple and easily understood. Diameter 4 inches. Price with 16-page instruction book, \$1.50. Leatherette carrying case 50c extra. Catalog free. Your money back if you are not satisfied. GILSON SLIDE RULE CO., Niles, Mich.

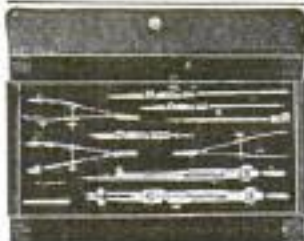

\$20.00 Value Set Mechanical Drawing Instruments

Special Wholesale

Price \$6.75 Postpaid

Pocket case 4x8 1/2 inches—velvet lined—Instruments constructed of solid nickel silver and steel—guaranteed. Order now—supply limited. Free illustrated particulars.

NATIONAL INSTRUMENT CO.
4704 N. Hamilton Avenue, Chicago, Ill.

NEW MOTORSFOR ALL PURPOSES
STANDARD MANUFACTURERS
PROMPT DELIVERY

ALL SIZES UP TO 5 H.P.

We Specialize In Small Motors & Generators

ALL PHASES AND FREQUENCIES IN STOCK AT ALL TIMES
Largest exclusive Mail Order Small Motordealers in the world.

CHAS. H. JOHNSTON, Box 113, West End, Pittsburgh, Pa.

WIRELESS, TELEPHONE GENERATORS
500 VOLT-100 WATT - 3400 R. P. M.
FOR MOUNTING MOTOR GENERATOR SETS.\$28⁵⁰
EACHWRITE FOR
CATALOG**WIRELESS OPERATORS**

—Amateur and Professional—need

SOLDERALL—25c per tube

Pat. Oct. 3, 1911

and TORCH, \$1.50

A Paste That Turns Into Metal When Heated
A match will do it, but best results can be
obtained by using our new improved torch.
Requires no acid or soldering iron. Joins or
repairs wires, metal or metalware. Sold by
Hardware and Electrical Stores, or sent by
us postpaid.**SOLDERALL CO., Dept. P**
129 Sussex Avenue NEWARK, N. J.
Dealers Send for Quantity Prices
Beware of Imitations with Similar Names**Pepsodent**
REG. U.S. PAT. OFF.

The New-Day Dentifrice

Combination Tool Kit5 in 1—Screwdriver, Bit, Awl,
Tweezers and CorkscrewGuaranteed. Pocket size. All steel tools
and handle. Large enough to hang a door.
Handy for electricians, carpenters, farmers
and mechanics. Postpaid \$1.00. Spring
key ring FREE with each order.**AMERICAN TOOL CO.**
3258 N. Cicero Ave., Dept. M4, CHICAGO, ILL.
Dealers and Agents: Write for special proposition**Interlox**
MASTER SLIDE RULEQUICK AND ACCURATE
INSIDE
MEASUREMENTS!Exact Inside Measurements
to Smallest Fraction of InchUSE IT for all measuring—inside or out. The only interlocking, sliding Rule.
Ideal for Carpenters, Mechanics, Engineers, Electricians, etc. If not at dealer's,
send his name and 25c per ft. for rule sent prepaid (any length, from 2 to 8 ft.).
MASTER RULE MFG. CO., INC. (FORMERLY DAHL MFG. CO.)
841-43 E. 136th St., NEW YORK CITY
Dealers and Agents: Write for Liberal Proposition**BURN YOUR NAME ON TOOLS
WITH
ARKOGRAF**Protect your tools from
theft. Write any name, engrave any design
on metal with electricity as easily as writing
on paper with pen or pencil. Complete
outfit \$3.50, prepaid anywhere. Interest-
ing descriptive circular free. Write today.
Agents Wanted. **Arkograf Pen Company**
895 Capitol Ave. Portland, Oregon**ATKINS
METAL-CUTTING
SAWS****Cut Costs With
Atkins Saws**Save time—money—material! On
your next metal cutting job—try
an Atkins Non-Breakable Hack
Saw Blade. Atkins laboratories have
discovered the right process of gas-and-
oil tempering to make these selected
steels cut faster and easier without break-
age. Just tell us your work, send 10c and
we'll send a sample 8 or 10 inch blade.
If it doesn't give you better results—your
money back.**26% Added Service**Atkins "KWIK-KUT" machines use 76%
of the cutting edge of the blade at every
stroke. Other machines use only 50%.
This added value costs no more.**Get These FREE Books**No matter what use you make of a saw—
for wood or metal cutting—there is an
Atkins book telling you how to get better
results. Ask for "Atkins Metal Saws", "Atkins
Hack Saw Chart", "Atkins Metal Cutting Ma-
chines". Put your name and address and the use
you make of a saw below. Mail it—NOW! Save
money, time and material.**E. C. Atkins & Co., Inc.,**
Dept. P., Indianapolis, Ind.

I am interested in saws for.....

.....

Please send booklets to

.....

.....

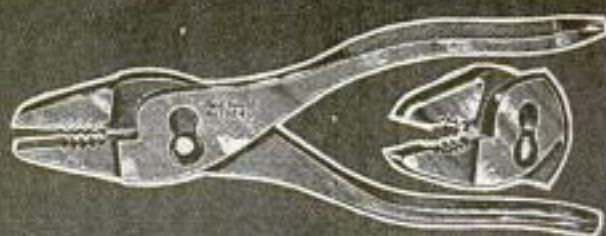

"Red Devil" Pliers made in 100 styles—one for every need. Known and used the world over. Style 1024—6½ inch shown here, \$1.10.

Red Devil

Reg. U. S. Pat. Off.

Tungsten Steel Hack Saw Blades for Hardest Cutting



"RED DEVIL" dependable hack saw blades of tungsten steel have been giving satisfaction for years. They do 30% more work than others, and last longer.

Every blade individually tempered. This means extra money and time—but gives a blade that cuts practically anything without breaking or teeth stripping. Guaranteed absolutely.

Teeth are milled, not punched, with sharp, square points that cut metal easily and rapidly.

Try them to your own satisfaction and you'll always use them. Obtainable from your dealers, or if not in stock send 75c for one dozen "Red Devil" Hack Saw Blades No. 1239—10 inch.

Write for Mechanic's Tool Booklet

SMITH & HEMENWAY CO., Inc.

Manufacturers of "Red Devil" Tools
260 Broadway, New York, N. Y.

"Red Devil" Glass Cutters—the glaziers' standard tools of the world. "It's all in the wheel." Made in 40 styles. No. 024 shown here, 20c.



MONARCH JUNIOR LATHES

"The Biggest Little Lathe Built"

A real engine lathe—small, sturdy, compact, low-cost—guaranteed to do all small work with 1/1000 of inch accuracy. Built with the same care and precision that made MONARCH ENGINE LATHES the world's standard of quality and efficiency.

THE MONARCH JUNIOR is ideal for beginners. Occupies small space in your own home or shop. Easy and economical to operate. Simple and trouble-proof, automatic safety features. Fully equipped.

The Greatest Achievement in Lathe Building History

Monarch Junior 9 in. \$225 With Bench Engine Lathe Legs

Full particulars and a Monarch Junior Catalog will be sent you on request.

THE MONARCH MACHINE TOOL CO.
200 Oak Street Sidney, Ohio

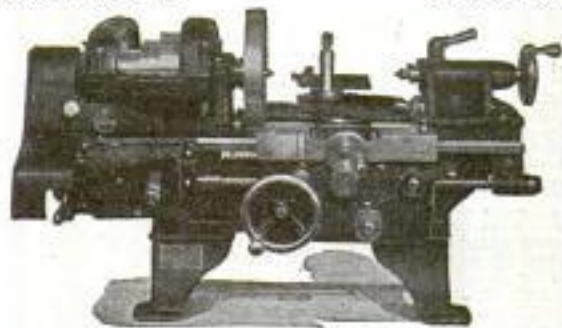

TOOL CHESTS

for Machinists & Toolmakers
Every tool arranged in order. No up-to-date mechanic should be without one. A Gerstner Case costs no more than some tools, and will last a lifetime. Catalog free.

Gerstner & Sons

717 Columbia Street DAYTON, OHIO



\$28 Brings HB Automatic Air Service

Balance small monthly payments, more than carried by increased trade from new customers you get by offering reliable free air service. Maintains constant pressure 125 to 150 lbs. Automatic stop and start. No noisy gears or breaking belts. Ball-bearing motor. Specially designed and built for garage air service. Sold on trial under money-back guarantee. Complete, ready to connect and operate. Send \$28 NOW, or write for information on this business builder.

HOBART BROS. CO. Box M 4A Troy, Ohio

TWO-YEAR GUARANTEED BATTERIES SAVE 50%



Famous "Royal" Batteries—highest quality made—now selling direct from factory to car owner. You save half. We give written 2-year guarantee—longest on any battery. Big responsible organization backs guarantee. Batteries for any car, tractor or gas engine.

Send no money Save time. Order from this ad. Battery, fully charged, shipped immediately—by express C.O.D. You run no risk. Our location same for eight years. Reference: Nat'l Bank of the Republic, Den or Brodstreet.

Free Booklet If you want descriptive matter first, send for free booklet. Gives full details of this unique history. Get the booklet before you buy any battery. Write today! Give your address and model of your car.

K-E BATTERY CO., Dept. 91
14 E. Jackson Blvd., Chicago

© 1931
SPECIMEN PRICES
Ford-Dart-Chev. \$18.80
Overland-Buick 21.85
Maxwell-Dodge 25.60
Save 50% saving on all cars

Largest Exclusive Mail Order Battery House in America
Members of Chicago Association of Commerce



Send today for this free booklet.

Own a Corona!

Increase your income

THIS wonderful little 6½ pound folding typewriter pays for itself in time it saves and work it turns out. Fold it up—take it with you—typewrite anywhere.

CORONA

The Personal Writing Machine

REG. U. S. PAT. OFF.

Corona Typewriter Co., Inc.,
108 Main St.,
Groton, N. Y.



Agents: \$6 a Day

Taking orders for Mend-All, the most practical household device ever invented for mending Pots, Pans—all Metal Ware. Just out. A necessity in every home.



Our Representatives taking thousands of orders every day. Easy to demonstrate. Pocket Sample. No Capital needed. Full time workers cleaning up. Big money for spare time. Write Today for Sample and Money-Making Proposition. Hurry.

American Products Co., 6537 American Bldg., Cincinnati, Ohio

MADE TO YOUR ORDER \$
Pants 1.95
NO EXTRA CHARGES Postage Prepaid



Send no Money We make this special offer for 30 days, to prove the wonderful value, style and fit of **Progress** tailoring. We will tailor to your special order, a pair of these stylish \$6.00 pants, send them to you postage prepaid and guarantee two years' solid wear or money back for only \$1.95.

AGENTS WANTED—Earn \$30 to \$35 extra every week, taking orders from your friends and neighbors for our high-class tailoring. No experience necessary.

Big Sample Outfit FREE Drop us a line today and we will send you absolutely free, our big assortment of woollen samples, style book and special wholesale prices, on our made-to-measure suits—\$12.45 up, and made-to-measure pants—\$1.50 up. Full details of this offer sent FREE.

The Progress Tailoring Co., Dept. D-145

Chicago, Ill.

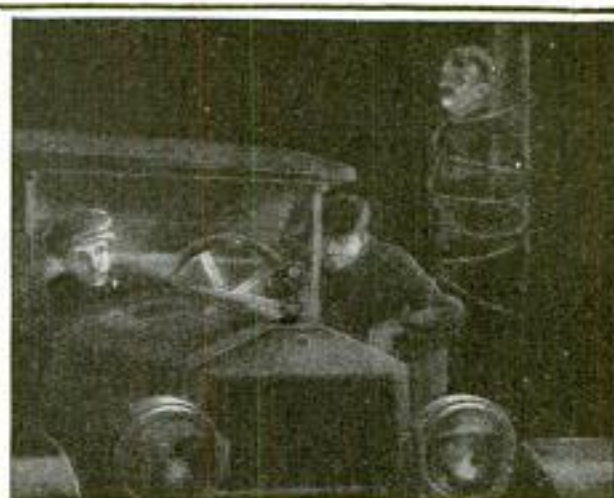

FREE— Actual Reports of Secret Service Operator 38

HERE is something money can't buy. More fascinating than detective stories. Confidential reports of a real operator—No. 38—to his Secret Service Bureau, headed by the most famous detective in America. Absolutely free. No cost. No obligation. Don't fail to send for them. They may point the way to Big Money for you. See how the modern detective works. Read these inside stories of the solution of great mysteries. See what possibilities this most fascinating and eventful of all professions offers to you—and how you may fit yourself for it.

Be a Finger Print Expert

To command the highest fees, the Secret Service man must also be a Finger Print Expert. These reports show why. This profession may be easily learned at home, in your spare time. Wonderful opportunity in this UNCROWDED, PROFITABLE field.

Make \$5,000 to \$10,000 a Year

The unfilled demand for trained Finger Print men is increasing daily. Opportunity is waiting for you. No time to lose. Send today for these reports, also our big Free book on Finger Prints. Gives all particulars and accessories of our graduates! Brilliant future ahead if you act now.

Special Offer Limited Time

Everyone getting these Free Reports will also receive my Special offer of a Professional Finger Print Outfit, absolutely Free. Made for a limited time only. Send coupon today—sure. Reports, Finger Print Book, and special outfit offer, all Free and Prepaid. Don't delay and perhaps forget. Do this right now.



← **Also FREE**
Send the Coupon

UNIVERSITY OF APPLIED SCIENCE

1920 Sunnyside Ave., Dept. 9354 Chicago, Ill.

T. G. COOKE, Pres. University of Applied Science
1920 Sunnyside Ave., Dept. 9354 Chicago, Ill.

Dear Mr. Cooke: Please send me FREE and prepaid, Reports of Operator 38, your new illustrated book on Crime and Crime Detection and your Special Outfit Offer. It is fully understood I assume no obligation.

Name ----- Age -----

Address -----

Town ----- State -----

Please Mention Popular Mechanics

WANTED IDEAS

Inquiries from Manufacturers and Others Who Are Looking
for Good Ideas

PROTECTED BY PATENTS

are constantly being received. Manufacturers are always interested in any new device for which there is a market, which fills a long felt need, which makes production possible at a lower cost, or which will do the work BETTER. Extracts from some of the more recent letters received are printed herewith. There is undoubtedly a great demand today for really worth while inventions.

Your First Step

If you have an idea, send immediately for my blank form "TO RECORD YOUR INVENTION." You should serve your own best interests by filling out and signing this form before you disclose your invention TO ANY ONE. This document will help you determine and establish evidence of invention before filing an application in the U. S. Patent Office. A copy, with full instructions, will be gladly sent free on request.

NEW BOOK "SUCCESSFUL PATENTS" SENT FREE

Every man who has an invention, or ever hopes to have one, should send for a copy of my book "SUCCESSFUL PATENTS." It tells what everyone should know about patents, trade-marks, copyrights, etc. It describes my methods, fees and terms, gives information relative to assignment or sale of rights, and instructions in detail. Mail coupon today for a free copy of this book or a post card request will do.

To the Man with an Idea

I offer a comprehensive, experienced, efficient service for his prompt, legal protection, and will endeavor to aid him in the commercial development of his proposition—my service is distinguished by over 12 years' successful practice, and by thousands of satisfied clients and by reasonable fees.

Send sketch, or model, and description, for advice as to cost, opinion as to its patentable nature, etc. Preliminary advice gladly furnished without charge.

COUPON

RICHARD B. OWEN, Patent Lawyer

Main Office, 9-303 Owen Bldg., Washington, D. C.
Branch Office, 2276-E Woolworth Bldg., New York City.

Please send me, without charge, or other obligation, a copy of your book, "SUCCESSFUL PATENTS," your form "TO RECORD YOUR INVENTION," and information concerning patents, etc.

Name..... Address {

Can You Help?

Here are abstracts from a few recent requests I have received from those who wish to buy, finance or manufacture good inventions. Have you an idea that will fill the bill?

Following is an extract from letter dated July 20, 1921, from a middle western manufacturer whose volume of business last year was approximately \$1,000,000. "If you are in touch with any meritorious proposition seeking manufacturing facilities, in the automotive or some other good field, we shall be glad to have you place us in touch with it. We are willing to consider outright purchase of patents or manufacture upon a royalty basis."

Another request from a large corporation, dated June 27, 1921, follows: "Should you have clients whose inventions are worthy of commercial manufacture and exploitation, we shall be glad to consider the financing of such projects, if they are interesting. In that event, we indicate also that we are identified with two large machinery manufacturing plants located, respectively, in Bridgeport, Ct., and Providence, R. I. These plants, besides having their own foundries, are thoroughly equipped to manufacture anything from a small lathe to a complete automobile. Whether your clients have mechanical inventions or otherwise, we shall be pleased to hear of any proposition requiring financing."

Another letter dated April 28, 1921, from a large corporation whose officers include some of the best known men of the country, says in part: "We are in the market for an invention of merit possessing undoubted economic and commercial value combined with ADEQUATE PATENT PROTECTION."

PATENTS TRADE-MARKS AND COPYRIGHTS

OUR OFFER—Free Opinion as to Patentable Nature

Before disclosing an invention, the inventor should write for our blank form "Evidence of Conception." This should be signed and witnessed and if returned to us together with model or sketch and description of the invention, we will give our opinion as to its patentable nature.

Our Three Books Mailed FREE to Inventors

OUR ILLUSTRATED GUIDE BOOK

HOW TO OBTAIN A PATENT

Contains full instructions regarding Patents, Trade-Marks, Foreign Patents, Our Methods, Terms, and 100 Mechanical Movements illustrated and described; Articles on Patent Practice and Procedure, and Law Points for inventors.

OUR TRADE MARK BOOK

Shows the value and necessity of trade-mark protection and gives information regarding unfair competition.

OUR FOREIGN PATENT BOOK

We have direct agencies in all the principal foreign countries and secure foreign patents in the shortest possible time and at the lowest cost. Write for our illustrated Guide Book on Foreign Patents, sent free to any address.

LIST OF PATENT BUYERS SENT FREE

Containing unsolicited letters from manufacturers and others who are constantly writing us regarding the purchase or leasing of meritorious patents. We endeavor to assist our clients in the commercial development of their inventions.

Specialization—Our Staff

The field of invention is so vast that it is impossible for any one man to become an expert in all the different classes of invention. For this reason Victor J. Evans & Co. employ a number of patent lawyers and mechanical experts who have been selected for their special knowledge and ability in certain lines of invention. Each case is placed in charge of experts in the classes to which the invention relates.

THE VALUE OF YOUR PATENT

will depend much upon the skill and care with which your case is prepared and prosecuted in the United States Patent Office. That every case entrusted to us receives our best efforts, and that our work is done consistently, skillfully, and thoroughly is evidenced by the many unsolicited letters of commendation that we receive constantly from our clients. We will furnish upon request lists of clients from any State in the Union for whom we have secured patents.

Our New York, Philadelphia, Pittsburgh, Chicago and San Francisco Offices

Owing to the growth of our business we have established for the benefit of our clients Branch Offices in New York City, Philadelphia, Pa., Pittsburgh, Pa., Chicago, Ill., and San Francisco, Cal. These branch offices being located in these large commercial cities together with our Main Office located near the U. S. Patent Office, in Washington, enables us to more promptly handle the business of our clients, particularly as the branch offices are in constant touch with the Main Office and fully equipped to handle patent business in all its branches.

Highest References—Prompt Attention—Reasonable Terms

---FREE COUPON---

VICTOR J. EVANS & CO., Patent Attorneys

NEW YORK OFFICES
1007 Woolworth Building

CHICAGO OFFICES
1114 Tacoma Building

PHILADELPHIA OFFICES
135 South Broad Street

PITTSBURGH OFFICES
514 Empire Building

SAN FRANCISCO OFFICES
Hobart Building

MAIN OFFICES: 765 9TH STREET, N.W., WASHINGTON, D. C.

Gentlemen: Please send me FREE OF CHARGE your books as described above.

Name Address



PATENTS

IF YOU HAVE AN INVENTION which you wish to patent you can write fully and freely to Munn & Co., for advice in regard to the best way of obtaining protection. Please send sketches or a model of your invention and a description of the device, explaining its operation.

All communications are strictly confidential. Our vast practice, extending over a period of seventy years, enables us in many cases to advise in regard to patentability without any expense to the client. Our Handbook on Patents is sent free on request. This explains our methods, terms, etc., in regard to **Patents, Trade Marks, Foreign Patents, etc.**

If you are a reader of the
SCIENTIFIC AMERICAN

you are probably aware of the fact that it has a special appeal to the inventor. Each issue contains a description of a large number of recently patented inventions. Pending patent legislation as well as the most recent rulings of the Patent Office and the courts are considered in its columns.

MUNN & CO.

SOLICITORS OF PATENTS

672 Woolworth Bldg., NEW YORK

Scientific American Bldg., WASHINGTON, D. C.

801 A Tower Bldg., CHICAGO, ILL.

582 Market St., SAN FRANCISCO, CALIF.

Please Mention Popular Mechanics

Can You

think of a simple, practical idea that will fill one of the many requests we have on file for new inventions? It may mean a fortune for you. Thousands of things are needed **right now**. Your brains can help. Send today for our great new book—

"Inventions and Trade-Marks, Their Protection and Exploitation" and learn more about making money from ideas than you ever knew before. It tells many things that are wanted, too.

**A postal will do—
It is free**

We Help Our Clients

without charge, to get the dollars out of their ideas—having facilities none others possess. Advice free. Don't delay—get the book at once.

American Industries, Inc.
200 Patent Dept.
WASHINGTON, D. C.

Patents Advertised For Sale Free

in Invention and Manufacturing Supplement

Published for the man with an idea. Send for free sample copy. One year's subscription, 50c.

U.S. PATENTS



SEND FOR THIS FORM

DON'T LOSE YOUR RIGHTS TO PATENT PROTECTION

Before disclosing your invention to anyone send for blank form "EVIDENCE OF CONCEPTION" to be signed and witnessed. A sample form together with printed instructions will show you just how to work up your evidence and establish the same before filing application for patent. As registered patent attorneys we represent hundreds of inventors all over the United States and Canada in the advancement of inventions. Our schedule of fees will be found reasonable. The form "Evidence of Conception," sample, instructions relating to obtaining of patents and schedule of fees sent upon request. Ask for them—a post card will do.

PATENTS AND TRADE MARKS

LANCASTER & ALLWINE

204 Ouray Bldg. Washington, D. C.
Originators of forms "Evidence of Conception."

Inventors

in all cities and many towns in the United States and Canada have secured patents through us. We secure patents in **delayed, neglected, and**

Rejected

cases. Write giving data.

Abraham Lincoln in an Address to Law Students said:

"As a rule, never take your fee in advance, nor any more than a small retainer. When fully paid beforehand, you are more than a common mortal if you can feel the same interest in the case as if something was still in prospect for you, as well as your client; and when you lack interest in the case, the job will very likely lack skill and diligence in the performance."

Engaged in Patent Soliciting exclusively since 1875, we have procured more than 40,000

Patents

Send us a model, drawing or photo with description of invention, remit \$5.00 for search in U. S. Patent Office to find if patentable.

Our booklet on patent protection at home and abroad sent free. Write or come to

C. A. SNOW & CO.

Patent Attorneys Since 1875

710 8th Street, Opp. North Front of U. S. Patent Office
WASHINGTON, D. C.



Secrets of Invention

Which all Inventors Must Learn



Raymond Francis Yates

Invention is the product of imagination. Everyone has imagination, and everyone invents. Even children have enormous imaginative power. The trouble is, most people do not properly DIRECT their imaginations; they do not utilize this NATURAL ABILITY in the most profitable way. Imagination is a giant of energy, the basis of all human progress, of all

civilization—yet not one person in a thousand KNOWS HOW TO harness this giant and put it to work at greatest personal advantage. At last, a PRACTICAL INVENTOR and a PSYCHOLOGIST has enlisted the aid of great inventors everywhere, and has prepared a simple, fascinating Course which teaches the habits of thought and the methods of work used by ALL successful inventors, and discovered by them only after years of painful discouragements and costly experiment. It tells exactly how to develop, patent and market your ideas—what to invent—what NOT to invent. It actually gives you inventive problems and trains your mind to think them out. It SHOWS you what makes for successful invention. It is the ONLY course of its kind, psychologically sound, and helpful to every man and woman who has ever had, or who may ever have an idea worthy of a patent; as well as to inventors who have had patents granted but who could not market their inventions.

Entirely New Course Taught By Mail

Prepared by Raymond Francis Yates, with the help of 15 other inventors, and based on the suggestion of Edison who said: Invention should be taught as a profession. Remarkably easy to understand, but it is not for triflers.

Big Fortunes in Little Inventions

The crown bottle capper, the crimped hair pin, the egg beater, the safety razor, the snap fastener, the flashlight, the thin-lead automatic pencil, the fountain pen—all these simple inventions paid inventors fortunes. ONE IDEA may win you a fortune if it is properly developed, manufactured and marketed.

WRITE FREE BOOK FOR

A wonderful book explaining this wonderful new course in detail has been written and will be sent free to those genuinely interested. This book explains the course in detail, and proves that anyone can become an inventor who trains his mind—it may be the beginning of a fortune for you. If you have ever had an idea for an invention, or if you would like to become a spare-time or professional inventor, and if you would like to know what to invent, send in your name at once on the coupon NOW! Only a limited number of these books are available for free distribution.

BUREAU OF INVENTIVE SCIENCE
Dept. 44, Wisner Bldg.
Rochester, N. Y.

Please send me your free book, "The Science of Invention."

Name

Address

City

State

Bureau of Inventive Science, 44 Wisner Bldg., Rochester, N. Y.



WRITE TODAY FOR FREE BOOK ABOUT PATENTS and "RECORD OF INVENTION" for establishing evidence of conception. The book tells how to proceed, the usual cost of obtaining a patent, and contains good sound practical advice every inventor should know. "RECORD OF INVENTION" should be filled out, signed and witnessed before you disclose invention to anyone. Send rough sketch or model and description for free report upon patentable nature and cost to Patent, etc. Prompt, personal service. Reasonable fees. Partial payment plan. Preliminary advice without charge.

J. REANEY KELLY
PATENT LAWYER

612-COLUMBIAN BLDG. WASHINGTON, D.C.

PATENTS PROMPTLY PROCURED TRADEMARKS REGISTERED

Send disclosure of invention, design, or trademark for actual search of U. S. Patents and novelty report. Validity and infringement investigations. Patent and trademark suits prosecuted and defended anywhere in the United States. Discriminating clients appreciate my efficient service. No literature will be sent you as this is a professional service, *individual and Personal*. Specific information and advice given regarding each individual case. Specialize in prosecution of pending cases that have been previously rejected by the Patent Office. Specialize also in unfair competition litigation before the Federal Trade Commission.

George P. Kimmel, Master of Patent Law
53-G Loan & Trust Bldg., Washington, D. C.



PATENTS

Send us sketch or model for patentability opinion and exact cost of patent. Our book "How to Obtain a Patent," sent free on request. It tells how to apply for Patents, Trade Marks, Foreign Patents, Copyrights, etc.; gives information on Patent Procedure; tells what every inventor should know. Thousands of Inventors, who are our clients, are our references. **Chandlee & Chandlee, 25 Years Experience, 422 7th St. Washington, D. C.**

PATENTS

TRADE-MARKS COPYRIGHTS

Send for our free book of patent information.

Beale & Park 802 F St., Washington, D. C.
16 S. Broad St., Philadelphia, Pa.

PATENTS

C. L. PARKER

Formerly Member Examining
Corps, U. S. Patent Office

PATENT LAWYER

MCGILL BLDG.
WASHINGTON, D. C.

Patents, Trade Marks, Copyrights, Patent Litigation

Handbook for Inventors, "Protecting, Exploiting
and Selling Inventions," sent free upon request.

PATENTS and TRADE-MARKS

As one of the oldest patent firms in America, and representing a clientage extending to all parts of the country, we afford Inventors and Manufacturers, at lowest consistent charges, a service noted for efficiency and results, evidenced by many well known Patents and Trade-Marks of extraordinary value. **Lacey & Lacey, 646 F St., Washington, D.C.**

ESTABLISHED 1869

PATENTS

Inventors should write for our "Evidence of Disclosure" form. It's Free. Avoid Dangerous Delays. Send sketch or model of your invention for examination and advice. Ask for Free Book "How to Obtain a Patent." Highest references. Write to-day.

Merton-Roberts & Co., 184 Mather Bldg., Washington, D.C.

GIVEN AWAY! FOR BOYS AND GIRLS



Get this beautiful Aviators' Wrist Watch. Small size; latest 5th Ave. style; good timekeeper. Given away for selling 48 bottles of our select perfume at 15c each. We send you the perfume free. When sold, return us \$8.00 and the watch is yours. Send your name and address to us at once.

New England Novelty Co. Department 4-DD, Brockton, Mass.



SEND FOR CATALOGUES

Gear and Experimental Parts, 15c
Materials of all kinds 10c
Model Engine Circulars 5c
COLBURN GEAR & MFG. CO. Successors
5 Woodworth St., Boston 22, Mass.

PATENTS

Booklet Free

Highest References

Promptness Assured

Best Results

Send drawing or model for preliminary examination

ALL BUSINESS GIVEN PROMPT AND PROPER ATTENTION

WATSON E. COLEMAN, Patent Lawyer, 624 F St., Washington, D. C.



WIRELESS TELEPHONE

BBROADCASTING stations are now in operation at important centers all over the country. You can easily receive these interesting daily programs with an ABC wireless receiving

UNIT. ABC UNITS come to you ready-to-operate and complete in every detail. They are built on the sectional system, so that you can increase the range of your station at any time.

Ask your radio or electrical dealer about this and other exclusive features of ABC UNITS. If he cannot supply you, send us his name and address and enclose ten cents for your copy of our booklet, "How I Put Up a Complete Radio Station in Two Hours." Request Booklet P4.

Jewett Mfg. Corp.
21 E. 40th St., N. Y. C.

ABC UNITS
Standard Radio
Sectional Receiving



GEARS ALL KINDS SMALL

The most accurate made and prices reasonable. We carry a complete line of gears in stock for immediate shipment. Can also quote on special gears of all kinds. Send us your inquiries.

WRITE FOR CATALOGUE.

CHICAGO STOCK GEAR WORKS
105-109 S. Jefferson St., CHICAGO

PATENTS Secured

Prompt service. Avoid dangerous delays. Send for our "Record of Invention" form and Free Book telling How to Obtain a Patent. Send sketch or model for examination. Preliminary advice without charge. Highest references. Write TODAY. J. L. Jackson & Co., 327 Ourny Bldg., Washington, D. C.

PATENTS If You Have an Invention and Desire to Learn How to Secure a Patent

Send for our Guide Book, **HOW TO GET A PATENT**, sent Free on request. Tells our terms, methods, etc. Send model or sketch and description of your invention and we will give our opinion as to its patentable nature.

RANDOLPH & CO.
600 F St., N.W., Washington, D. C.

Brings This Genuine Diamond RING for 10 Days FREE TRIAL

\$2

Resembles \$350. Solitaire No Red Tape No Delay

14 K

SET IN PLATINUM—MOST SENSATIONAL RING OFFER EVER MADE

Think of it—seven brilliant steel blue genuine diamonds massed by a secret process in a setting of solid platinum set so closely together that only close inspection will distinguish it from a solitaire valued at \$350.00. Shank of ring is 14 kt. solid gold.

TEN DAYS' FREE TRIAL

You take no chance—if it is not satisfactory at the end of ten days, or if you can duplicate this genuine diamond ring in any jewelry store for less than \$85.00, your deposit will be refunded to you.

Send only \$2.00 and the ring goes to you in a handsome gift box, charges paid. A legal guarantee bond as to quality and value accompanies each ring. After ten-day trial pay balance \$4.65 a month for ten months. Price only \$48.50.

Free Royal Bargain Bulletin. Illustrates and describes over 800 special offers in Diamonds, Watches and Jewelry which we are making this month from our \$2,000,000 stock.

Established 1896.

Address Dept. 506.

ROYAL DIAMOND & WATCH CO
35-37-39 Maiden Lane New York

Our BUREAU OF INFORMATION will answer all questions regarding articles appearing in this magazine. Address Bureau of Information, Popular Mechanics Magazine, Chicago.

NAME.....

STREET.....

CITY.....STATE.....



"Let's Keep This Stream Secret, Bob"

"FEAST your eyes on this old grand-daddy, Mae. I'll bet he weighs three pounds. Wow! How he hit that fly!"

"He's a beauty, Bob. But you can't have *all* the credit for catching him. Without our Harley-Davidson, we never could have reached this out-of-the-way stream. Why, an automobile couldn't get within 10 miles of here."

"No argument, girlie. It sure takes a motorcycle to let you in to these happy fishin' grounds. We'll sneak up here again next Saturday and help ourselves. And if we have any trout left, we'll give 'em to some poor neighbor fisherman—one who hasn't a Harley-Davidson."

Attractive dealer proposition for unassigned territories. Address Desk A-2

HARLEY-DAVIDSON MOTOR CO.
Milwaukee, Wis.

You'll say a Harley-Davidson is the best pal you ever had—for work or play. And 50 miles for a dollar—gas, oil, tires and all—is mighty low upkeep, isn't it? Ask your local dealer for free demonstration and reduced prices. Or write us for illustrated literature.

Harley-Davidson

World's Champion Motorcycle

DISTRIBUTORS Wanted

Big Money For FORD OWNERS

Steer your Ford with one hand at thirty miles an hour over rough roads. Shoot through sand, mud, gravel, in and out of ruts and over car tracks. Your front wheels CAN'T turn and ditch you. Your Ford will stick to the middle of the road like a Packard or a Cadillac if it is equipped with

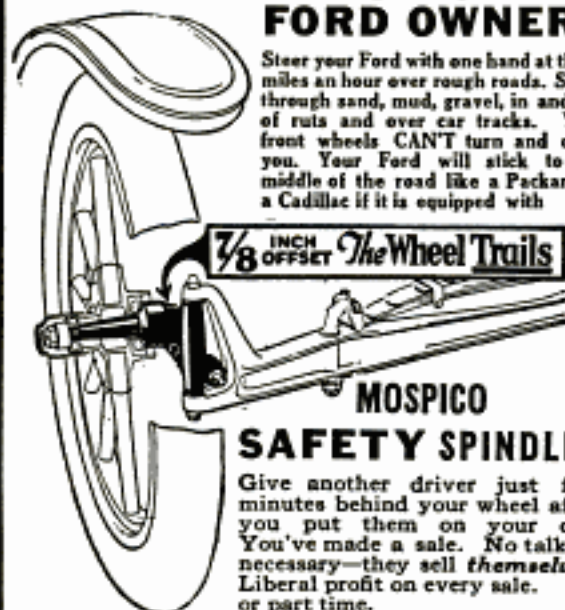

Give another driver just five minutes behind your wheel after you put them on your car. You've made a sale. No talking necessary—they sell *themselves*. Liberal profit on every sale. All or part time.

Get Exclusive Contract For Your County

Hundreds of Ford owners within a few miles of you. Most of them will buy after a five minute trial. Make big money wherever you drive your car with these and other fast selling accessories of our manufacture. WRITE US TODAY.

Motor Spindle Corp. 422 East Jefferson Avenue
DETROIT, Mich.

Please Mention Popular Mechanics

ADVANCE DOOR LOCKING HANDLES for FORD Closed Cars



Installed quickly by anyone. They fit in place of original handles. Ford owners delighted with them. Left handle locks automatically, right handle locks with key. Fully guaranteed. Agents: Beautiful sample pair furnished with full particulars. \$3.50 U. S. \$4.50 Canada. Check, money order or C. O. D.

C. B. HAVEN CO., 544 E. Fort St.
Detroit, Mich., or Windsor, Ont.

Only \$45.00 For This Job Complete

Save exorbitant freight rates and one-half original cost by buying Ford Speedster Bodies knocked-down. Simple, complete instructions furnished, all parts cut to exact fit. Any one can assemble this job. Complete with hood, radiator shell, instrument board, upholstery, metal parts, wood parts, bolts, screws, etc. Flat radiator shell furnished made up. Designed low with lack of wind resistance. Price set up \$90, further particulars on request.



Not Paper Patterns
All Parts Complete

The Central Auto Supply Co., Eng. Dep. 120, Louisville, Ky.

STEADY WORK

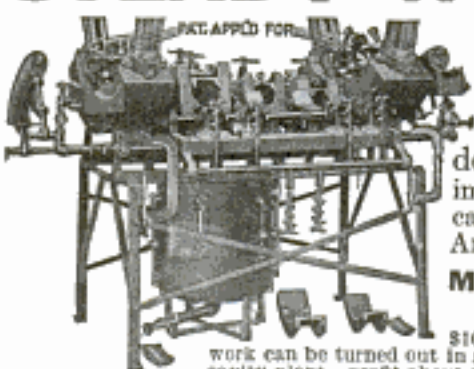

in a fast growing business. With Vanderpool latest improved Vulcanizer made in America you can **MAKE MORE MONEY**

\$100 to \$150 worth of work can be turned out in a day with the five cavity plant—profit about one-half.

VANDERPOOL VULCANIZER CO., Dept. P4, Springfield, Ohio
F. H. Dibb, Agent for the British Isles, 26 Fairfield Rd., Winchester, England.

Copyrighted material

GUARANTEED!

AUTO AND TRACTOR TRAINING

MAKE THIS STEP TO A BETTER JOB

No previous experience necessary if you are mechanically inclined. Make a start—that's the thing. At the Michigan State Automobile School in a few short weeks, under guaranteed quality-training, you can become a first-class, all around, practical auto and tractor mechanic capable of filling any garage job. Or, you can quickly become an Auto Electrician—double your earnings. You can go into business for yourself—start a garage—electric service station—tire-repair shop—battery station or welding shop. It's a great business—a certain money-making future. The demand for men is getting greater and greater. A million more autos, trucks and tractors this year than last—10,500,000 now in use. All need repairing, rebuilding, overhauling. More than 50,000,000 tires to be repaired—put to longer use. Millions of batteries must be replaced. This spells **opportunity**—a wonderful opening for ambitious go-getting men.

A Complete Training—in the Auto Center

Train Head and Hands: Who Knows Better How to Teach Autos Than the Men Who Build Them? Come to Detroit! Choose the school in the heart of the auto industry. Here's where they are made. Isn't it logical that this is the place to learn?

The Courses at the M. S. A. S. (Detroit's Auto School) are outlined, planned and endorsed by the leaders of the Auto Industry. Manufacturers here, and everywhere, supply M. S. A. S. with equipment, latest model cars, latest trucks, engines, transmissions, axles, electric equipment, etc.—everything complete to give thorough training. Everything is right up to date. The very last word in automotive training. The CADILLAC, the PACKARD, the BUICK, HUDSON, HUPMOBILE, STUDEBAKER, DODGE, MAXWELL, CHALMERS—makers of quality cars—recommend and endorse M. S. A. S. quality training.

Start Any Time— Stay as Long as You Like

Classes are always open. Your enrollment entitles you to life-membership, with privilege of our service at any time. Many students come back to brush up on latest automotive ideas and new equipment. It doesn't cost a penny extra. The location of the M. S. A. S., in the heart of this industry, insures most thorough, most practical, systematic training, at a cost so low any man, anywhere, can afford it.

FREE Illustrated Catalog

Decide now you will forever discard the old, plodding, low-pay life and make this step to success. You can do it just as well as thousands of M. S. A. S. graduates. Learn all the facts about this unlimited opportunity. We will send you FREE, without obligation, big illustrated book that tells all about it, and what the M. S. A. S. can do for you. Book is positive proof. Don't fail to get it. Send coupon or postcard today.

Colored Students Not Solicited

MICHIGAN STATE AUTOMOBILE SCHOOL

A. G. ZELLER, President

1504 Auto Bldg., 3729 Woodward Ave., Detroit, Mich.

The Factory Endorsed School

Read What Factories Say:

CADILLAC MOTOR CAR COMPANY
DETROIT BRANCH

CADILLAC BUILDING, CASS AVENUE AT YORK STREET

"We believe you have the best and most complete school of its kind in the country."



BUICK MOTOR COMPANY

"We believe the MICHIGAN STATE AUTO SCHOOL, Detroit, would best meet your requirements, as its course of technical training is most thorough and complete in every detail."

THE STUDEBAKER CORPORATION
OF AMERICA

"We do not know of a better automobile school than the MICHIGAN STATE."

Ask About Plan for Financial Assistance

If you are short of money to pay your tuition, and can give good references, we can make special arrangements to give you a year to pay. If you need this help, tell us when you write.

Mail Coupon To Day

Michigan State Automobile School,
1504 Auto Bldg., Detroit, Mich.

Gentlemen: Send FREE, and without obligation, your catalog and Auto School News, giving complete information and showing the opportunities and advantages of a Factory-Endorsed Detroit-Training.

Name.....

Street or R. F. D. No.....

City..... State.....

SEE OUR PAGE ADVERTISEMENT ON PAGES 53, 75, 185



Get This Wonderful Ring. If You Can Tell It From a Genuine Diamond Send It Back

These amazing, beautiful CORODITE diamonds positively match genuine diamonds in every way—same glitter, flash and dazzling play of living rainbow fire. They, alone, stand the diamond tests, including the terrific acid test. Even lifetime diamond experts need all their experience to see any difference. Prove this yourself.

Wear a Corodite Diamond 10 DAYS FREE

Make this test. You risk nothing. Wear a genuine Corodite and a diamond side by side on the same finger for 10 days. If you or your friends can tell the difference, return the Corodite. You won't be out a single penny. If you decide to keep the ring, the price printed here is all you pay. No installments. Remember, only Corodites have exactly the same cutting as genuine stones.

No. 1—Ladies' Tiffany Style 14K Gold S. Ring \$2.84
No. 2—Gents' Heavy Bolcher 14K Gold S. Ring \$3.48
No. 3—Gents' Massive Hexagon Platinum Finished \$4.27
No. 4—Ladies' Corved Platinum Finish \$3.96

All stones 1 carat size and the mountings are beauties of the very latest design. Gold or the popular white platinum finish. Unqualified 20-year guarantee. Handsome art leather velvet lined case free with each ring.

SEND NO MONEY Keep your money right at home. Just send your name, address and number of ring wanted, and size as shown by strip of paper fitting end to end around finger joint. Your ring will come by return mail. When ring arrives deposit amount shown with postman. If you decide not to keep ring after 10 days' wear, send it back and your money will be immediately returned. Send today.

E. RICHWINE CO.

333 South Dearborn Street, Dept. 105, Chicago, Ill.
We are sole importers of Corodite Gems for the United States

HIGH GRADE WIRELESS

Head Receivers, Microphones, Keys, Jacks, Plugs, Etc.

American Electric

COMPANY

STATE AND 64TH STS. CHICAGO, U. S. A.

FEDERAL BODIES

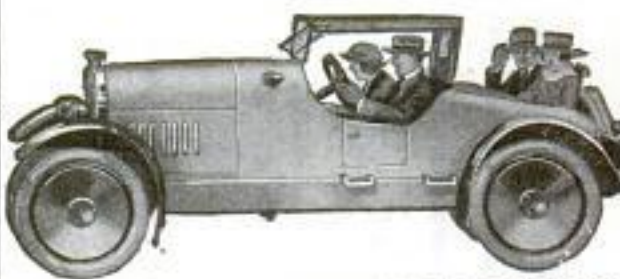

FOR FORD and CHEVROLET CHASSIS

"THE FOURSUM" illustrated above is a cozy, convertible four passenger complete with special long and narrow radiator with a massive hand hammered German silver shell. Makes driving a pleasure. Other roadster, touring and speedster designs. Big cut in prices. Bodies as low as \$29.50. Territory open for live wire dealers and agents. Make real profits. Write for our catalogue.

Buy Direct from Factory

FEDERAL MOTOR SUPPLY CO., Inc.

2626 So. Michigan Blvd. Chicago

CANADIAN DISTRIBUTORS

Federal Auto Body Co., Toronto, Ont.; Campbellton, N. B.



Build Vigorous Health

and sparkling beauty with the penetrating, stimulating violet ray. Pure blood, a clear skin, calm, steady nerves can be yours. No shock or unpleasant sensation—just the healing warmth and stimulation of

RenuLife

Violet Ray

Recommended for quick relief of rheumatism, neuritis, asthma, lumbago, constipation, nervousness, skin affections, etc. Endorsed and used by physicians and sanitariums.

Trial Plan Enables you to use RenuLife in your own home without cost if unsatisfactory.

Send for "Health for All" **Free Book** describes remedial effects of RenuLife treatments, with testimonials from users. Contains pictures and prices of 7 models each fully guaranteed.

Write fully and receive special letter.



RENULIFE ELECTRIC CO., Inc.

1104 Newberry Bldg., Detroit, Michigan
In Canada: Pitt St. E., Windsor, Ontario



FOIL BURGLARS

Make sure your home or buildings aren't next to be robbed. Thousands of dollars lost yearly because most locks are worthless and offer no protection. Test your locks with these wonderful 5 Master Keys. Only set of its kind in the world (patented).



Have proved their power to open thousands of different locks and showed hundreds of people that their homes really weren't protected. Novel key chain FREE. Send Only \$1.00 today. Money back if not satisfied.

MASTER KEY CO.

87 Manhattan Block Milwaukee, Wis.

MYSTIC EGYPTIAN LUCK RING



FROM ancient Egypt, land of mystery and magic, comes the Egyptian Luck Ring, with its ancient characters and sacred scarab, bringing Life, Prosperity and Health to all who wear it. Cleopatra is said to have worn one of these rings to protect her from misfortune. Many people wearing them today, claim that they bring power and success to men—charm and admiration to women.

Whether you believe in its magic properties or not, you will be proud to wear a Mystic Egyptian Luck Ring for its unique design and historical interest. Guaranteed Sterling Silver. Money refunded if not pleased. Enclose strip of paper fitting over knuckle of ring finger. Order Quick—TODAY. Cash, \$1.45. C.O.D., \$1.55.

ORIENTAL IMPORTERS

2814 S. Wabash Ave.

Dept. 144 Chicago, Ill.

A MOTOR FOR YOUR BICYCLE



Attach powerful Belt Drive **ROLLAWAY** to your bicycle. **Forget pedals.** Ride in comfort. **ROLLAWAY** gives **positive, dependable power.** Light weight. Runs 100 to 150 miles on gallon gasoline. **Fits any bicycle.** Economical—costs **less than one-fifth cent per mile** to operate. Shipped complete. Anyone can attach in few minutes. Outfit includes motor, reinforced fork, wheel and guaranteed tire. Hundreds in use. A wonder for **economy and performance.** Price, F.O.B. factory \$35.00. Write for circulars. Add **joy, speed and comfort** to cycling.

Be Our Salesman!

Buy a demonstrator. Sell. Good commission paid. Write today for our proposition. Address

The Rollaway Motor Co.

421 Shepard Street
Toledo, Ohio

Rollaway

TRADE MARK

Going to Build Remodel or Repair?

DON'T think of planning a new home or repairing an old one without copies of our two free books.

Our Building Material Catalog shows latest ideas and most advanced styles for everything in building. We ship everywhere everything in the way of high grade lumber

roofing, doors, windows, porchwork, screens, builder's hardware, paints, wallboard, interior woodwork, plumbing, heating and water supply outfits—all at money saving prices direct to you. Plan Book shows skillfully planned homes of all kinds, bungalows, city houses, suburban residences, country homes, farms. Tells you how to get building plans **FREE**. Write today. No obligation.

Let us develop plans from your rough sketches. Send your material bill for free estimate price.

Catalog of
Books
Price
Receipts

Beautifully
Illustrated
PLAN BOOK

CHICAGO MILLWORK SUPPLY CO., 1111 W. 27th St., Chicago, Ill.
PLEASE SEND ME YOUR FREE BOOKS

Name _____ St. No. _____
Town _____
State _____
Occupation _____



Material Complete for Houses from \$500.00 Up

Books Are Free

ELECTRICITY

Big money in Electricity. Thousands of men just like yourself have become Electrical Experts by spare-time study at home. You can do as well. There is not the slightest doubt about it. Without cost or obligation, write today for full details. International Correspondence Schools, Box 5627-C, Scranton, Pa.

Detroit Incubator \$12⁴⁵

140-Egg Size—Guaranteed—has double walls, copper tank, full-size nursery, automatic regulation thermometer held so that chicks cannot break it when hatching. Detroit Brooders, too. Double walled, hot water heated. Write for special low price on both machines.



Detroit Incubator Company

Dept. 32 Merritt Street, Detroit, Michigan

THE HANDIEST TOOL in the WORLD

THE OLSON MAGAZINE SCREW DRIVER

Large enough to hang a door. Small enough to fix a bell. Used by—Carpenters, Machinists, Farmers and Automobile men. Three blades and oneawl guaranteed. Dealers and agents write for special proposition. Only 5 1/4" long.

Olson Mfg. Co., 52 Commercial St., Worcester, Mass.

\$1.25
Prepaid

Big Engine Sale



Smashed on prices
OTTAWA Engines. Only sold direct from factory. 3 months' trial. Easy Terms. Write for Engine BOOK and Sale Prices Today.

OTTAWA MFG. CO.
531 B King St., Ottawa, Kan.

1 1/2 H-P \$35.50
2 H-P \$38.50
3 1/2 H-P \$54.50
7 H-P \$117.50
10, 12, 16, 22 H-P. at Low Prices

Only \$15 Down

Play Well in 4 Weeks



—Seven Months to Pay

Latest C Melody Saxophone Outfit complete, only \$65—lowest price ever quoted. Sent on 6 days' trial. If satisfied, pay only \$10 a month for 7 months. No interest in pay—no extras. Outfit includes finest nickel trimmed and richly lined Case, Instruction Book, Album of Popular Saxophone Solos, Music Lyre, Carrying Strap, Mouthpiece and three fine Reeds.

"Masterbilt" Saxophones

Highest quality, built to perfect tune, assembled and tested by experts. Has all latest key improvement, light, quick action and beautiful finish. Order direct from this advertisement or write for Free Catalog Folder today.

The Saxophone Shop, 427 S. Wabash Ave., Chicago
Largest Exclusive Dealers in Saxophone Supplies in the World

No Rubber but More Stretch

in

Nu-Way

OR
EXCELLO
RUBBERLESS
SUSPENDERS

—and a Year's
Wear Guaranteed
Ask Your Dealer



Price 75c

If he hasn't them, send direct, giving dealer's name. Accept no substitute. Look for guarantee label and name on buckles.

Nu-Way Stretch Suspender Co., Mrs. Adrian, Mich.

Copyrighted material

CIGARS

**100 SPITZER'S
SPECIAL EXTRA
\$3.75**

BY MAIL
DIRECT TO SMOKER
AT HALF PRICES

We Guarantee Satisfaction or
Money Refunded

You can't judge this cigar by the price because you are used to paying 50 per cent extra for dealers' profit.

These are Sumatra wrapped and Havana filled cigars that you will enjoy to the last puff. And the small cost is only possible because it comes direct from the manufacturer.

100 Special Extras \$3.75
Made of tobacco used in
10c cigars, but not decorated.

100 Perfecto Grande
(2 Boxes) 4.75
The equal 2 for 25c
As Illustrated

50 Perfecto Grande (1 Box) 2.50

Order to-day. Send check or money order or you may pay on arrival. All orders we send post-paid.

H. SPITZER

32 Union Square, NEW YORK CITY

P. S.—To each purchaser of 50 Cigars we will extend the privilege of ordering for \$1.25 additional, one of our "Sample Boxes," containing 1 sample cigar each of our best sellers. "All Bargain Values," priced up to 25c per piece. Include this in your order; it is the biggest sample value ever offered.

ACTUAL SIZE

Light Fibre Legs and Arms

636

Doan Bldg.

RAY TRAUTMAN Minneapolis, Minn.

AGENTS—Earn \$35.00 to \$50.00

a week extra money selling this new and wonderful pencil. Everybody buys. Latest and best automatic pencil.

The Craftsman Pencil

It's different from others. Mechanically perfect. Beautiful in appearance. Sells for only 50c, complete with clip and extra leads.

If you are employed in office or factory you can make a lot of extra money selling craftsman pencils to employes and officials. Our agents are coining money. The beauty and efficiency of the craftsman sells it. Fully guaranteed. Send 50c for sample and our proposition.

Money back if not satisfied

CRAFTSMAN PRODUCTS CORP.

668 Washington Blvd.

Chicago



FOR a slipless grip and a quick, sure cut, the answer is always **BERNARDS**. The pliers with jaws that meet like a vise—on the square—not on an angle. Hardware dealers sell 'em and praise 'em.

MADE IN SEVEN SIZES

Send for illustrated Plier Booklet M



PARALLEL JAWS

BERNARD PLIERS

Wm. SCHOLLHORN CO.
NEW HAVEN, CONN.



OUTSIDE CUTTER

One Hand Will Do CLIP GRIP SCREW DRIVER



Holds screw firmly while inserting or removing. Easy to reach most difficult places. Ideal for auto mechanics, wireless, etc.

Handy for the home. Set of 2 sizes, 50c.

THE NOVA CO., 326 River St., Chicago

A Baseball Jersey



Be the First in Your Club

School, City or Town, to wear this pure, all wool sweater, double collar and cuffs. Your choice in colors. This jersey was selected by 10,000 of my customers for last season. Your chum will recommend it. Send for my big illustrated catalogue. Write me and learn my offer for your club's order. Popular Prices. Best Grade Sporting Goods—Baseball, Basketball, Tennis, Golf, Football, etc.

WRITE ME NOW.

Jack Shannon Co., Dept. 46, 111 So. Dearborn St., Chicago

1000 SHOT ALL STEEL MAGAZINE AIRRIFLE GIVEN **WE GIVE TO BOYS** **HAMILTON 22 CAL. HUNTING RIFLE WITHOUT COST**

Choice of Six Guns (on four easy plans) for selling our Magic Healing Wave-Lens at 25c Box. WE TRUST YOU! Order Seven Boxes Today On Postal Card—we send promptly, Prepaid. Easy to sell—used in every home. Return money as instructed, choosing your Gun according to one of the plans shown in our Big Premium List. Also 200 other Gifts or Big Cash Commission if you prefer. If you are prompt—a special Free Gift.

WAVERLY CO. 235 Tower Bldg., Monongahela, Pa.

350 SHOT REPEATER
SEND ORDER TODAY. FREE!



DIAMONDS, WATCHES ON CREDIT

YOU SHOULD HAVE THE JAMES BERGMAN JEWELRY BOOK IN YOUR HOME. It is full of many bargains. Diamonds, Watches, Jewelry, Toilet Articles, etc. Select any article desired, have it sent to you, all charges prepaid. If satisfactory, send one-fifth of purchase price and keep it, balance in TEN monthly payments. No interest charged. No security required. Write Today for Big Free Catalogue No. 5. It tells **JAMES BERGMAN 37-39 MAIDEN LANE** about Our Low Prices and binding guarantee. **Est. 1896. NEW YORK CITY**

Make Extra Money at Home!



No matter where you are—in town—on the farm. You can turn idle hours after regular day's work into profit. Mend auto tires, tubes, gum boots, rubbers, hot water bottles, etc.

Make \$30.00 to \$50.00 Week Extra Evenings and During Spare Time

Haywood's home outfit does it. It's a wonder. Simple. Practical. Inexpensive. Guaranteed. Can be operated anywhere—basement, garage, barn. Average \$5.00 to \$8.00 evenings easy. Keep present job. Stay at home—whether in town or on farm. Do neighbors' work. There is lots of it.

It's Your Opportunity

Settle that financial question right now. Stop wishing for more money—get it. Haywood offers you quick way. Get full details. Write at once for information. Postal with name and address will do or use this coupon. Mail it tonight.

READ WHAT WILLIS SAYS

"Am doing all business I can handle during spare time. Have machine in shed at home. Picture enclosed. Am going to say goodbye to my job." Works during day. Operates Haywood machine in evening. Fixes punctures. Vulcanizes casings. Mends boots. Repairs all kinds of rubber goods. Does thriving neighborhood business. One tire and pair of boots yield \$5.00 clear profit. Work all done in one evening.

\$98.00 STARTS YOU OUT

Includes everything complete. Machine, tools, materials, clamps and roll directions. Instructions simple. Possibilities unlimited. As business grows Haywood can furnish larger outfits. Men with Haywood's big equipment now making from \$3,000 to \$10,000 year! Same opportunity open to you.

M. HAYWOOD, President

HAYWOOD TIRE & EQUIPMENT CO.

1350 CAPITOL AVENUE

INDIANAPOLIS, IND.

Send for Free Book

Mr. M. Haywood, Pres.,
Haywood Tire & Equipment Co.,
1350 Capitol Ave., Indianapolis, Ind.

Dear Sir:—Please send complete information on how I can make extra money at home.

Name.....

Address.....

**AUTO SUPPLIES
WHOLESALE
3000 BARGAINS**

SEND FOR THIS
CATALOG -

it's FREE!

Everything you need
in Auto Supplies at

Amazingly LOW PRICES.

NEMCO BARGAIN SUPPLY HOUSE

1017 Jackson Boulevard - Chicago, Ill.

LAKWOOD FAN BELT FASTENERS



MAKE or repair your own flat belts for Autos, Trucks, Tractors, Electric Washers and small Shop Machinery with Lakewood Quick attachable Fasteners. Two sizes— $\frac{1}{2}$ in. and 1 in.; used alone and in combinations handle eight widths flat belting. Simply square up ends, rivet half of fastener to each end, slot together and go. Belt can be removed from pulleys instantly, but can't open in driving. Complete Fastener with rivets, 1pc per set; 2 for 2pc; 6 for 6pc; or 12 sets in neat slide box for \$1.00. Specify size wanted. Sent postpaid same day order received. Fine proposition for Garage, Repairmen, and Dealers.

LAKWOOD FABRIC BELTING & MFG. CO.
1518 W. 117th St., Lakewood, Ohio

TIRES BEST VALUES EVER OFFERED

32x4-\$7.50 33x4-\$8.00 34x4-\$8.50
Used tires. Other sizes just as low. Cords and fabrics. Send no money. Return tires if not satisfactory when received. State if you want s.s. or cl. Supply limited at this price. Order quick.
ROYAL TIRE & SUPPLY CO., 1245 S. MICHIGAN AVE., DEPT. P, CHICAGO, ILL.



Globe Batteries

SAVE YOU 50%
of THE USUAL COST
and You Get
an Unconditional

WRITTEN TWO-YEAR GUARANTEE

6 VOLT 11 PLATE
for Overland, Edin, Ford, Scripps-Booth, Grant, Dort, Saxon, Hupmobile, etc. Usual Cost \$32.00. **Our Price \$13.00**

6 VOLT 11 PLATE
for Oakland, Vette, Nash, Studebaker, Maxwell, Cole, Chevrolet, Mitchell, Buick, Reo, Hudson, Paice, etc. Usual Cost \$40.00. **Our Price \$15.00**

12 VOLT 7 PLATE
for Dodge, Regal, Franklin, Briscoe, etc. Usual Price \$52.00. **Our Price \$20.00**

GLOBE STORAGE BATTERIES FOR WIRELESS USE

Volts	Amps.	Price	Volts	Amps.	Price
6	20	\$7.00	6	35	\$13.00
6	40	9.00	6	55	15.00

Shipped fully charged ready for installation

Begin now to get 100% battery service at half cost, by sending us your order today.

GLOBE BATTERY COMPANY

Dept. P, 1219 S. Wabash Ave.

Chicago, Ill.

STASET

Diamond Truer for Abrasive Wheels

\$5.00

Half Actual Size



diamond-point wheel-truers.

Genuine diamond keeps abrasive wheels true. Stone guaranteed to remain sharp and in place till completely used up. Send \$5.00 today for one of these guaranteed

Staset Tool Co., Room 1109, 115 Broadway, New York City



The Clark Glare Shield

Don't let the other fellow's headlights put you in the ditch

The Clark Glare Shield absolutely kills glare. By adjusting it to the proper angle you can drive toward the most glaring headlights or the brightest sun with perfect vision and comfort. Nothing else like it on the market. As necessary as emergency brakes. Easily and quickly adjusted to any car with a pair of pliers.

Special Offer

For 30 days we are offering a \$3.75 Clark Glare Shield and agency rights in unassigned territory—for only \$2.75. Order one today, install it on your car. Use it 10 days. If not satisfactory, your money will be refunded. Make big money by selling the Clark Glare Shield in your community. Order now. Specify make of car. This offer may not be repeated.

CLARK PRODUCTS CO.
SPRINGFIELD 611 Arcue Bldg. OHIO

DIAMONDS WATCHES CASH OR CREDIT



"SYLVIA" Diamond Ring
 Blue white, radiant, perfect cut Diamond, the ring is 18-K Solid White Gold, carved and pierced. Extra special at \$100. Credit terms at \$2.50 A WEEK.

Others at \$75, \$150, \$200 up.

Diamonds We Start!

PRICES ARE DOWN
 Our immense buying power for our Chain of stores in leading cities and our large Mail Order House enabled us to make lower prices than small concerns. We invite comparisons. You will be convinced that you can do better with LOFTIS. Money back if not fully satisfied. LIBERTY BONDS ACCEPTED AT PAR.

Send for Free Catalog
 Everything explained. Over 2,000 Illustrations of Diamond-set Jewelry, Pearls, Watches, Wrist Watches, Mesh Bags, Silverware.

Genuine Diamonds GUARANTEED
 Our Diamonds are distinctive in fiery brilliancy, blue white, perfect cut. Sent prepaid for your Free Examination, on Charge Account.

Wrist Watch \$2.25 A Month

Cushion Shape
 Gold filled, guaranteed 20 years. 15 Jewels, warranted. Ribbon bracelet with gold filled clasp. Special \$21

Octagon, Tonneau, Cushion and other shapes, in White Gold, as low as \$30

LOFTIS THE OLD RELIABLE CREDIT JEWELERS
 BROS & CO. 1123 108 N. State St. CHICAGO, ILL.
 Stores in Leading Cities

Evans \$135



150 Miles to Gallon of Gasoline **LOW FUEL COST DEPENDABLE SPEEDY**

America's Lightest Weight and Lowest Priced Complete Motorcycle

Join the thousands of motorcycle riders who have chosen the Evans because it costs less to operate, is easier to handle and readily understood even by a boy.

The Evans catalogue, fully describing this wonderful machine, sent upon request

Attractive offer to rider agents in territory not controlled by an Evans dealer

Manufactured by

CYCLE MOTOR CORPORATION

Box 1031 - Rochester, N. Y.

BUILD YOUR OWN CAMPING BODY

Complete set of Blue Prints \$1.00 (Pre-paid) with full description. Price

Any handy man or carpenter can build it at very low cost. Enjoy all the comforts of home in a traveling bungalow. It contains two full sized berths, kitchen cabinet, sitting or dressing room.

No. 1 fits cars of 100 inch and No. 2 cars of 124 inch wheel base.

Write Today and Get Ready for Your Vacation.

TOURISTS CAMP BODY CO., 1726 Prairie Ave., CHICAGO, ILL.

MOTORCYCLES

ONE YEAR TO PAY

Know the joy of owning—for business or pleasure—a HARLEY-DAVIDSON, EXCELSIOR, HENDERSON, INDIAN, CLEVELAND, or any other standard make; thoroughly rebuilt in our own factory.

Write for Free Bargain Bulletin and Easy Payment Plan.

HAVERFORD CYCLE COMPANY
 America's Largest Cycle House
 Established 26 years
 503 Market St., Phila., Pa., Dept. P. M.

LOOK 50¢ Look



Wonderful instrument. Greatest thing yet. Nine separate articles in one. Everybody delighted with it. Odd, curious and interesting. Lots of pleasure as well as very useful. It is a double Microscope for examining the wonders of nature. It is also an Opera Glass, a Stereoscope, a Burning Lens, a Reading Glass, a Telescope, a Compass, a Pocket Mirror, and a Laryngoscope—for examining eye, ear, nose and throat. It is worth all the cost to locate even one painful cinder in the eye. Folds flat and fits the pocket. Something great—you need one. Don't miss it. Sent by mail, with 800 page Novelty Catalog, ONLY 50¢ or 3 for \$1.25

JOHNSON SMITH & CO., Dept. 705 3274 N. Halsted St., CHICAGO

CAMCO Turbine Pump for FORD Cars and Trucks



**A Necessity!
Saves Money,
Time and Trouble.**

Keeps Fords from boiling in any weather. Saves Alcohol in winter. Absolutely prevents freezing on the road. Especially desirable for Ford Trucks. The only circulating pump for Fords that automatically delivers varying required circulation according to motor speed.

Drives from regular Ford fan belt. Installed in a few minutes with wrench and screw driver. Any belt trouble will not stop water circulation. Saves its cost in 3 months in lubricating oil, gasoline and alcohol; not to speak of *Repair Bills* and loss of car use.

Money Back Guarantee.

Sent for \$12.50 postpaid. Money back, if not satisfied. Liberal discount to Agents and Dealers. Big profits for live wires, especially Ford owners willing to introduce among friends. Write nearest office for Free Trial OFFER.

THE C-A-M-CORPORATION,
2006 Central St., KANSAS CITY, MO.
488 Arcade Bldg., ST. LOUIS, MO. FREDERICK, MD.

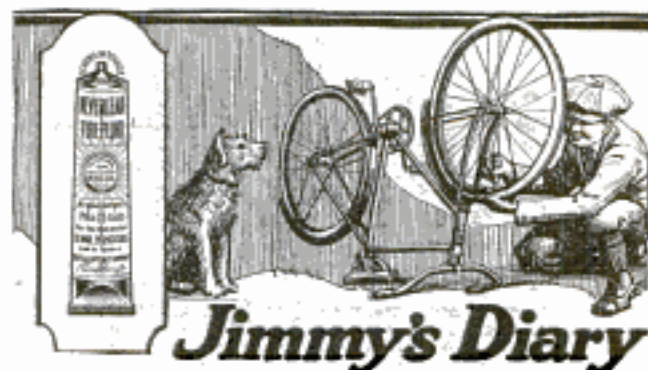

Jimmy's Diary

Monday, March 20

"**W**ARM day. Got the bike out for Spring overhauling. One flat tire. Found little puncture. Fixed that alwrite by getting tube of Neverleak Tire Fluid down to Henry's Bike Shop. Squeezed it into tire and blew her up. Holds air like new. Cost 25c (for the Neverleak)."

Jimmy.

NEVERLEAK

is the old standby. Stops leaks instantly and permanently. 25c a tube at all bicycle and repair shops.

Buffalo Specialty Co.
Buffalo, N. Y.

Look for the green, white and yellow tube. Be sure to get the original GUARANTEED Neverleak Tire Fluid.



NEVERLEAK TIRE FLUID

"HEALS PUNCTURES ON THE RUN!"



"SIMPLE DEVICE MAKES LOCKS BURGLARPROOF"—Says Popular Mechanics.
MASCOT The Portable Keyless Lock Fits ANY door instantly without tools. Force and Jimmyproof. Needs no keys—only lock in the world that cannot be opened from the outside. Can be carried in your vest pocket. No larger than a pea-kalfe. Satisfactorily approved. 30c each; 4 for \$1.00; \$3 a doz. Satisfaction guaranteed.
AGENTS WANTED EVERYWHERE
MILBRUCK PRODUCTS CORP.
311 5th Ave. Dept. M New York

Add \$5.00 a Day to Your Profits With a Torit Acetylene Torch No. 13

For radiator repairing, general soldering, light brazing, heating, battery repairing, etc. Produces instant hot flame, works rapidly. Furnished with 4 different tips and soldering copper, enabling you to do a wider range of work.

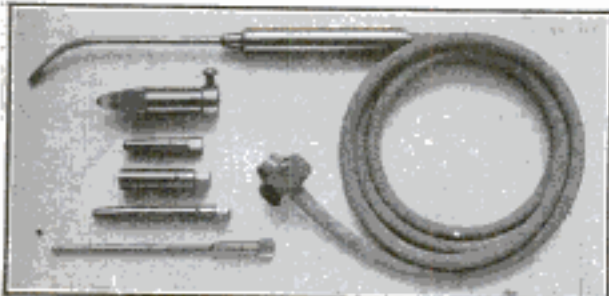

USES ACETYLENE ONLY
A splendid use for discarded auto acetylene tanks. Many owners make the Torit No. 13 pay for itself in a single day. Torch with 4 different tips, soldering copper, 5 ft. tubing and connection for auto acetylene tank \$7.50
ORDER TODAY FROM YOUR JOBBER, OR
ST. PAUL WELDING & MFG. CO.
177 W. Third Street St. Paul, Minn.

Enders

SAFETY RAZOR

has made the world
safe for tender faces



Shaving
with an
Enders is—

*“Just like
wiping
your face
with a towel”*

ENDERS sells for \$1.00, with six blades of the best quality Swedish-base steel. Packed in black Keratol box, velvet lined. Extra blades, package of 5—35 cents. For sale by all up-to-date dealers everywhere. In Canada: Razor, \$1.50; Blades, 50c.

ENDERS SALES COMPANY
105-111 West 40th Street, New York

Please Mention Popular Mechanics

BUY

TODAY

10 MONTHS TO PAY



**SPECIAL
VALUE**

Sweet's Cluster
7 Fine Diamonds set
in Platinum. Looks
like 1½ carat solitaire.

**Only \$3.80
a month**

SPECIAL TERMS—Ten months' credit on any article selected from the SWEET catalogue. **NO MONEY IN ADVANCE.** Shipment made for your examination. First payment to be made only after you have convinced yourself that SWEET values cannot be equalled. If not what you wish return at our expense.

No Red Tape—No Delay

Every transaction **CONFIDENTIAL.** You don't do justice to yourself and your dollars unless you inspect our unusual values in Diamonds, Watches, Jewelry, Silverware, Leather Goods, etc. Send **TODAY** for SWEET De Luxe Catalogue. Write **NOW** to Dept. 532-J.

Capital \$1,000,000

“THE HOUSE OF QUALITY”
L.W. SWEET INC.
1650-1660 BROADWAY, NEW YORK



**SPORTSMAN'S
CATALOGUE**

**Quality Goods
at Lowest Prices**

Write today for your **FREE** copy of this complete Sporting Goods Catalogue. Buy by mail and save money. Every price is cut, every article is absolutely guaranteed. Your money back if you are not satisfied.

It shows fishing rods—split bamboo, as low as \$1.35; reels at all prices; guaranteed 12 ft. best casting lines at 48¢; 12 ft. steel boats \$22.48; wyo tents 7 x 7 ft. \$7.65; tents 8 x 8 ft. \$12.45; also bathing suits, skates, athletic goods, camp clothes—everything for the out-of-doors, of standard quality at a big saving.

Write today for this complete *Sporting and Athletic Catalogue*

Address: Dept. 10 G

Montgomery Ward & Co.
St. Paul Chicago Kansas City



Buchstein's Fibre Limb

is soothing to your stump—strong, cool, neat, light. Easy payments. Braces for all deformities.

D. BUCHSTEIN CO.
115 6th St. S., MINNEAPOLIS, MINN.

KENNEBEC

CANOES

“Safest to Use”

Because the “Tumble Home” makes them so. The dotted line here is the “Tumble Home” of the ordinary canoe—and the heavy line of the Kennebec.

“Tumble Home” is the blige of a canoe. You should get our 1922 illustrated book giving the fullest particulars about this wonderful feature of the Kennebec. Mailed to any address, postpaid. **KENNEBEC BOAT AND CANOE CO., 28 R.R. Square, Waterville, Me.**



MEN WANTED

to call on garages, stores, factories, schools, hotels, homes, auto owners and demonstrate and take orders for new

Super Fyr-Fyter

Approved by Underwriters, makes spectacular demonstration. Sells easily.

Blak made \$59.60 first week. DePries has averaged \$7,000 per year for last 3 years. We can train you, without cost, so you can do as well or better. No experience necessary. Write at once for free details showing how you can earn \$2,000 to \$10,000 a year.

THE FYR-FYTER CO.
53 Fyr-Fyter Bldg. Dayton, Ohio

SOMETHING NEW, CATALOG No. 22

New goods, new prices, small bulbs, etc., engine, steam and gasoline, 1/8 H. P. up, pumps, castings, blue prints, gears, pulleys, electrical goods, model makers' supplies, machinery, 3-4 H. P. Marine engine, 2 1/2 inch sq. model locomotive, etc. Catalog postpaid 20 cents stamps 12 stamps preferred. Refunded first order.

Modern Engine and Supply Co.
53 W. Jackson Blvd. CHICAGO



Of course you need a tool chest but be sure you get a **UNION**

Union Chests are made for every trade. The entire line comprises more than fifty patterns and sizes. Sold on the satisfaction or money back basis. Made as substantially as the tools you use.

Ask your hardware dealer, or write us direct for illustrated literature.

UNION TOOL CHEST CO.
22 Mill St. Rochester, N. Y.



a hundred hurts—occur unexpectedly. For bruised or broken skin nothing is so convenient as antiseptic, germicide and liniment in one container. Makes each more efficient. A few drops suffice. \$1.25 at most druggists or postpaid. Liberal trial bottle, 1cc, postpaid.

W. F. YOUNG, Inc.
147 Temple Street
Springfield, Mass.



Absorbine J^r
THE ANTISEPTIC LINIMENT

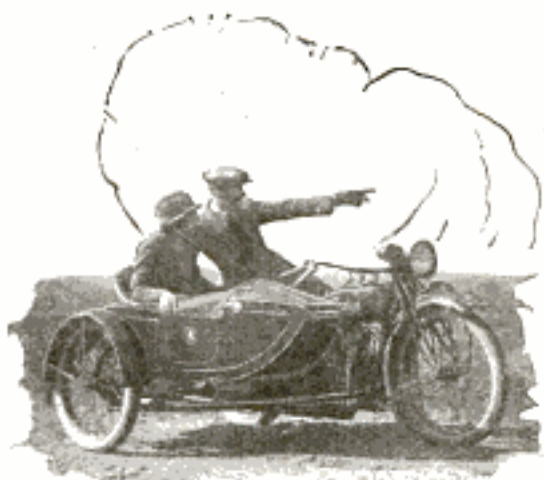

Indian Chief

The Big Brother of the Indian Scout

Strictly a 1922 engineering conception. From hub to hub it embodies the very latest and best in motorcycle design.

It's modern and distinctive; strong and powerful; designed for side-car use and heavy duty service.

A demonstration will prove a revelation.

Ask any Indian dealer, or write department 50 for literature

Hendee Manufacturing Company

*Largest Motorcycle Manufacturer
in the World*

Springfield

Mass.

AN INCOME FOR LIFE

Do you want it? Then send for this free book. It shows you how the man and woman of average means can buy outright, with two years to pay, high-grade listed and dividend paying securities such as U. S. Steel, Westinghouse, Western Union, etc. This interesting book explains in detail how—

1. You can buy five times as much with your available cash.
2. You can take immediate advantage of present low prices of high-grade securities.
3. You get all dividends and market increases from date of purchase.
4. You have two years to pay through this new monthly payment plan.
5. You are absolutely protected against fluctuations and are guaranteed against call for additional funds.

You can start "An Income for Life" by small monthly payments which you will never miss. The business man or woman, farmer, teacher, mechanic, in fact every one who is thinking of his future and will lay aside \$10, \$15, \$25 a month or more can take advantage of the present opportunity to secure high-grade securities at bargain prices and start building "An Income for Life." Don't fail to write for this valuable book today—it's more than worth while. It means "AN INCOME FOR LIFE."

GET THIS BOOK
FREE

Investment Securities Co.
Suite 430 Meffat Bldg., Detroit, Mich.



1/6 H.P. Motor Less than cost to

make \$10



Washing
Machine
size

F. O. B. Chicago

Not a job lot, but strictly new, first class motors bearing our well known name plate and guaranteed for one year. Why the price at less than manufacturing cost?

A Big Manufacturer Cancelled His Contract After These Motors Were All Ready for Assembly

Your chance of a lifetime to buy high grade motor at less than half what you'd ordinarily pay. Get one to run your washing machine, ironer, dish washer, compressor, beach lath, blower, fan, drill press, scroll saw or any small machine around house, shop, garage.

Delivers full 1-6 H. P. with liberal overload capacity. Made for 110 volts, 60 cycle current. (Also for 25, 30, 40, 50 cycle or 220 volts, if desired, at \$1.50 extra.)

Less Than Half Usual Retail Price Satisfaction Guaranteed or Money Back

New motor or free repairs if anything goes wrong within one year. Parts always obtainable. Net weight 20 pounds, shipping weight 26 pounds. Easy means of reversing direction of rotation. 10 ft. cord with 2-piece attachment plug, 65c. Pulleys, 1 1/2 inch or 2 inch. 50c. Don't lose out. Read each or order C. O. D. by express. Get your money back quick if you aren't more than satisfied.

REYNOLDS ELECTRIC CO.

2610 West Congress Street Chicago, Illinois

Try This Typewriter 5 Days FREE



\$4.00 and you keep it

The balance in easy monthly payments. Save fully \$25 to \$50 on any standard make.

Every rebuilt machine guaranteed to be in perfect condition. Try 5 days at our expense. Write for specs (price). A postcard will do. Send NOW.

WYNN TYPEWRITER EXCHANGE, 10 Reliance Bldg., Kansas City, Mo.

Bull Dog Metallic Filler

That new wonderful metal that expands on heating and cooling, for making repairs on all metals except aluminum.

Repairs SCORED CYLINDERS and
CRACKED WATER JACKETS
permanently

For 50c we will send you a trial lot with instructions, sufficient to make several repairs.



WONT LET GO

Metals Repair and Supply Co., Inc.

1525 14th Street, N. W.
Washington, D. C.

DIAMONDS

Here at 60%
of Market Price

This blue white perfectly cut diamond 7/8-3/32 ct. at \$52.50 among bargains in recent list. Many other big values in our lists. Buy HERE! Prices based on loan values, not market values. This 75 year old diamond banking firm has thousands of unpaid loans and other bargains. Must sell NOW.

Why Pay Full Prices
Any diamond sent for absolutely free examination at our risk. No obligation. No cost to you.

Send for Latest List
Describes Diamond Bargains in detail, gives guaranteed loan values. Explains unlimited exchange privilege. Write for list today. Send NOW.

JOS. DeROY & SONS
Only Opposite Post Office

1985 DeRoy Building
Pittsburgh, Pa

This Ring \$52.50
3/8 - 3/32
Carat
Blue
White

The WONDERFUL ERICKSON PATENT LEG

Will not
chafe,
overheat,
nor draw
end of
stump.



ERICKSON ARTIFICIAL LIMB CO., 38 Wash. Av. N., Minneapolis, Minn.

AGENTS: \$66 a WEEK

taking orders
for Can't Clog
COAL OIL
BURNER



Burns just like gas. By regulating valve you get as little heat as you want, or you can heat oven to baking point in ten minutes. Most perfect burner ever invented. Can't clog up.

BIG SUMMER SELLER
Burns coal-oil. One hour for two cents. Cheapest fuel known. Low-priced. Nothing else like it. Not sold in stores.

\$1.50 AN HOUR TO HUSTLERS

No experience or capital needed. You take the orders. We ship by Parcel Post and do all collecting. Commission paid same day you take order. Write Quick for Agency and Sample.

PARKER BURNER CO., 678 Coal Street, Dayton, Ohio

DELTA

ELECTRIC BICYCLE LAMP

REAL SEARCH LIGHT BUILT BICYCLE SIZE

Delta Electric Bicycle Lamp projects an intense, piercing "Searchlight" beam fifteen to twenty feet ahead.

It's an attractive accessory that adds "class" to your bicycle—at night it's a dependable safeguard and spots danger at long range.

No. 80 solves problem of rear red light—complies with all the laws. Mounts left side front wheel under axle nut. No. 27 mounts on handle bar.

Ask your dealer or either model sent prepaid for \$2.25 complete (less Battery).

DELTA ELECTRIC COMPANY
100 DELTA BLOCK, MARION, IND.

Standard Makers of Electric
Lanterns, Automobile Flash-
lights, Bicycle Lamps, Flash-
lights and all kinds of Dry
Batteries.

New York - Winnipeg - San Francisco



Crane's Handisaw

—A practical little bench saw of surprising capacity for all kinds of light sawing. Completely equipped with adjustable rip guide, combination cut-off and mitre guide, 4 in. saw, and 3-8 in. grooved pulley. Top 6 in. by 9 in. Saw projects 11-4 inch. Cuts 1 inch stock easily. Specially designed base catches saw and provides self-emptying dust chute. Adjustment screw elevates top for grooving. Cuts massive groove 1-8 inch wide. All parts neatly finished. Grease cup lubrication. Easily operated with 1-4 H. P. motor. Adapted for small shops or home use. Speedy and accurate—precision-adjusted. Nothing to get out of order. High grade in every respect—Fully guaranteed. Send today. Money back if not satisfied.

Only
\$13.50
Money back guarantee.
Shipping weight 22 lbs.

BOICE BROS., 1504 Boice Bldg., 114 23rd St., Toledo, Ohio



Build This Phonograph Yourself

TREMENDOUS SAVING IN COST
Easy fascinating work with our SIMPLIFIED PLANS. We furnish blue prints, diagrams, motor, cabinet pieces, ready-built horn, etc. You don't need to be a cabinet maker. A few hours assembling and you will have a fine instrument at one-quarter the regular retail price. **AGENTS MAKE MONEY** making and selling these instruments. Write today for full details of our FREE OFFER. Address:—**Modern Phonograph Supply Co., 639 Springer Bldg., 313 S. Clinton St., Chicago, Ill.**

\$50 a Week
EASY

AGENTS

Free Sample Offer



You can start a big paying business at once. Don't wait. Get big money. We tell you how—selling the famous E-Z Self-Heating Sad Iron. No experience necessary. Easy to sell. Possibilities great. Every home a prospect. Satisfaction guaranteed. Absolutely safe. Thousands in use.

Write today for proposition.

Enterprise Tool & Metal Works, Dept. 34, 126 So. Clinton St., Chicago

THE NATIONAL GAME
Bam-Bee-No
Trade-mark Registered

It is the only baseball game ever invented that has received the unqualified endorsement of leading players, sport writers and experts. It presents actual baseball on a miniature ball play by play as you see it on the diamond. All the interest, thrills and intense excitement of a "world's series." Price \$2 prepaid. (Canada and west of Denver \$2.25.) Write today for free descriptive folder and testimonials.
THE BAM-BEE-NO SALES COMPANY, Dept. 642, TOLEDO, OHIO
DEALERS: WRITE FOR OUR PROPOSITION

Car owner selling agents wanted **BIG PROFIT**

To sell a storage battery that only needs $\frac{1}{2}$ cup of water every 3 months. No other attention. Replaces any storage battery. Cannot sulphate or corrode. The most wonderful battery. *2½ years written guarantee.* You sell, we ship direct. Exclusive agencies given. Write for proposition.

Harsha Battery Company
21 E. Van Buren St., CHICAGO Dept. 10

21 Jewel Burlington



Adjusted to the Second
Adjusted to Temperature
Adjusted to Isochronism
Adjusted to Positions
21 Ruby and Sapphire Jewels
25 Year Gold Strata Case
Your Choice of Dials
(Including Montgomery R. R. Dial
New Ideas in Thin Cases

Only \$1.00 Down

Only One Dollar Down, will buy this masterpiece of watch manufacture. The balance you are allowed to pay in small, easy monthly payments. A 21-Jewel Watch—is sold to you at a price much lower than that of other high-grade watches. Besides, you have the selection of the finest thin model designs and latest styles in watch cases. Write for FREE Watch Book and our SPECIAL OFFER today.

Write While This Special Offer Lasts

Get the Burlington Watch Book—write today. Find out about this great special offer which is being made for only a limited time. You will know a great deal more about watch buying when you read this book. You will be able to "steer clear" of the overpriced watches which are no better. Write for Watch Book and our special offer TODAY!

Burlington Watch Co., Dept. 1354 19th St. and
Marshall Blvd., Chicago, Ill.



MAJOR'S CEMENT

Unexcelled for repairing china, glassware, earthenware, furniture, masonry, stoves, books; for tipping billiard cues, etc. Saves money.

The reliable cement, famous since 1878. Major's Rubber and Leather Cements are good.

All three kinds—29¢ per bottle. At dealers or by mail.
MAJOR MANUFACTURING COMPANY, New York

\$47.25 PROFIT in Four Hours

Doughnut business has wonderful possibilities. Enormous demand. Capacity automatic machine is 800 dozen per day. Sell for 30¢ per dozen. Over 150% profit. No experience needed. Flour ready prepared—add water—put dough in hopper—turn crank—out drop delicious golden doughnuts. Jos. Donmoyer, Pa., made \$47.25 profit four hours. Others make big money. Write today for complete details FREE.

BUTLER CO.
5650 W. Lake St. Chicago, Ill.

Easy to Play Easy to Pay

BUESCHER

True-Tone SAXOPHONE

Saxophone Book Free
Tells when to use Saxophones singly, in sextettes or in regular bands; how to play from solo parts in orchestras and many other things you would like to know.

Free Trial You may order any Buescher Instrument without paying one cent in advance, and try it six days in your own home, without obligation. If perfectly satisfied, pay for it on easy payments to suit your convenience. Mention the instrument interested in and a complete catalog will be mailed free.

(34) In big demand for orchestra dance music. The portrait above is of Donald Clark, Soloist with the famous Paul Whiteman's Orchestra.

Buescher Band Instrument Co.

Makers of Everything in Band and Orchestra Instruments
2534 Buescher Block, Elkhart, Indiana

YOU CAN MAKE \$18.00 DAILY

Great Introductory Offer
Giving These \$1.25 FREE

With each sale of our wonderful 11-Piece Toilet Article Assortment for only \$1.75. Total store value \$4.60

VALUE \$1.25
Self-Sharpening SHEARS

MY! HOW THEY SELL

You get the interest with the free Shears. Walter Harris sold 800 boxes in 6 weeks. Profit over \$600.00.

ONLY 20 Boxes a Day Means \$18.00 Daily Profit!

ACT NOW! Sells like hot cakes year 'round. A baby could sell "Lucky 11." Don't delay a minute. Write for circulars explaining our unique plans, including 30 other packages.

Act Now!
E. M. DAVIS CO., DEPT. 3354, CHICAGO, ILL.

MAKE YOUR FORD A SPORTSMAN'S IDEAL CAR

Fordspeed Bodies Four Models



Observe the beauty of this body and the wonderful change in the lines of the Ford. Our CHUMIPOUR with additional disappearing seat for two, outclasses anything ever built in a 4-passenger Sport Model.

NEW 1922 MODELS—Class—Quality—Variety—Reasonably Priced

Dealer—Your opportunity to make money reselling new and used Ford chassis.

This month's Special—Underwing Fixtures—4 1/2 inch
Drove makes safer steering; gives low, racy lines. Price Now
2 1/2 Nickel Bevel Gears..... \$15.00 \$ 9.95
3 1/2 Nickel Bevel Gears..... 12.50 7.95
Speed and Power Camshaft..... 13.95 11.95

E. L. FORD SPEED & POWER EQUIPMENT MANUFACTURERS
250 West 54th St., New York
Cable Address "Fordspeed"



The most portable and adjustable of all typewriter stands

ONLY \$100 DOWN Brings You The World Popular "SATELLITE" Typewriter Stand

That's all—just a single dollar bill and we will send you the famous portable and adjustable, all-metal "Satellite" Typewriter Stand—brand new—direct from the factory. You need not send a penny now. Simply send us your name and address for full details of our amazing Free Trial Easy Payment Offer.

10 DAYS' FREE TRIAL

We will positively ship you the Satellite Typewriter Stand on 10 Days' Free Trial. Convince yourself of its serviceable features, its durability and its appearance. This is the same stand used by Morgan & Co., Standard Oil, Larkin & Co., Pennsylvania Railroad, Remington Typewriter, Dayton Laboratories and thousands of others.

EASY PAYMENTS

If you decide to keep it after 10 days' free trial all you have to do is pay the balance in small monthly installments. If for any reason you do not want it, ship it back to us and we will refund your dollar and all shipping charges. Remember our supply of stands for this offer is limited.

Send today, without delay, for full free particulars of this great offer

Adjustable Table Company
Dept. 2214 GRAND RAPIDS, MICH.

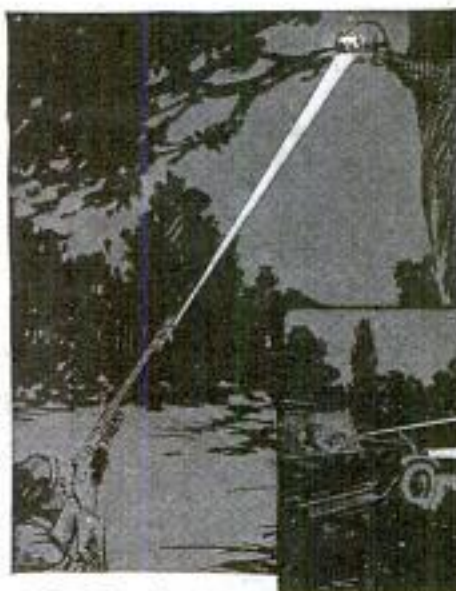

Dealers attention! Get behind Lite-Site. It is nationally advertised. We protect you on mail orders from this publication from your customers—Write for details.

AT LAST!

A perfected night-sight. A 400 foot beam of concentrated light on your gun or rifle barrel

"WHERE the spot-light shows the bullet goes." A great brilliant beam of light coming from your gun and throwing the target aimed at into flood-light prominence. Put the spot-light on the target and pull the trigger—that's all—and you'll score a bull's eye every time.

Lite-Site is not just an ordinary flashlight. It is a new invention—strongly patented. Lite-Site is effective at 400 feet. It makes night shooting an overwhelming success. Quickly attached or detached. 30 seconds and Lite-Site is on or off.

What's more—you can focus it—turn the head and you have either a narrow, piercing beam or a diffused flood light. This means that you can use Lite-Site as a hand searchlight as well.

The Lite-Site battery is unique—it has a longer life than any other battery manufactured. With ordinary use every night it will last for months or burn from 10 to 15 hours steadily and brilliantly.

Lite-Site is completely equipped with extra bulb, battery and attachment to fit any size gun or rifle barrel.

Its price is \$6.00—West of Denver, \$6.50—Canada, \$7.00, plus duty.

Remember, Lite-Site is guaranteed satisfactory or your money returned without question or quibble. Order Lite-Site now—today. If you don't want to keep it return at our expense and we will immediately send back your money.

If your sporting goods dealer cannot supply you, order direct from us, giving us his name.

Surprise **FROG** Jumps a considerable distance and turns a perfect somersault. Has secret spring; can be timed to jump at a certain interval. A good joker and funmaker! Surprise people who see it, but never suspect it is going to jump. Looks like a real live frog. 10c each, or 3 for 25c, sent postpaid. Catalog of Novelties, Jokers, Etc., sent free. Write For It. THE FLASUM CO., DEPT. 45, 3802 ELLIS AVENUE, CHICAGO, ILLINOIS



NEW SINGLE PHASE A. C. MOTORS

$\frac{3}{4}$ H. P.—110 volt, 60 cycle, 1725 speed, complete with cord, plug and grooved pulley. \$13.00



$\frac{3}{4}$ H.P.	\$47.00
1 H.P.	58.00
1 1/2 H.P.	62.00
2 H.P.	76.00
3 H.P.	89.00
3 H.P.	108.00

Include pulley and base.

ONE YEAR GUARANTEE

$\frac{3}{4}$ H.P. and larger, 110/220 volt Rep. Ind. Type
Satisfaction guaranteed or money refunded
Illustrated Catalog of Motors and Supplies FREE

HYRE ELECTRIC CO., 615-H So. Dearborn St., Chicago



10 Days Trial

Send only \$1 and we will mail you a Lachnite on 10 days Free Trial. Compare it with any \$690 diamond for brilliance, hardness, and acid resistance. Guaranteed ever-lasting. Your choice of lady's or man's ring, both solid gold. If you can tell it from a diamond, send it back and we will return your \$1 at once. If you decide to buy, send \$2.50 a month until \$18.75 is paid. No red tape.

Write Today Give finger size, your choice of rings, enclose \$1 deposit, \$10.00 now wear Lachnite.

Harold Lachman Co., 204 S. Peoria St., Dept. 1774, Chicago, Ill.
Copyright 1922 Harold Lachman Co.

Light Sight
Products Corporation
Warren Pa

Dept. E

LIGHT-SIGHT
PRODUCTS
CORP.
Warren, Pa.

Enclosed is (money order, check) for one Lite-Site complete with all attachments. Provided I am not satisfied you agree to return my money upon receipt of article.

Name.....
Address (street)..... (city).....
Dealer's name and address.....



There's real style
in these pretty
Reed and Fiber
Furnishings.

This Cosy Fiber Rocker 20c a Day

Furnished in the popular Frosted-Gray. Other Rockers, Chairs, Settees, Day-Beds in fiber and reed all on little monthly payments. Substantial, beautifully designed Furnishings for the whole home, shown in our big 128 Page helpful, FREE Larkin Book of Better Homes.

- Furnishings
- Symphonic Pianos
- Symphonic Player Pianos
- Symphonolas

(Check offer interested in)

Symphonic Pianos, Symphonic Player Pianos and Symphonolas (the phonograph with natural tone, which plays all Records) sold to tens of thousands of music lovers the past nine years. Get our Book describing these famous musical instruments by checking above.

**NO Money Down—30 Days FREE
Trial—1 to 4 Years TIME**

Check offer now. Cut out this ad. Give your full name and address. Mail TODAY.

Desk FPM-422 *Larkin Co Inc.* Buffalo, N. Y.

\$600 to \$5,000 PROFIT FROM WASTE STORE SPACE



Business men! Send for amazing story of Butter-Kist Peppercorn and Peanut Machine profits. Pays big in drug, department, candy, other stores, theatres, etc. Write

HOLCOMB & HOKE MFG. CO.

946 Van Buren St. Indianapolis, Ind.

Wireless Manufacturers and Amateurs

Send for our free price list on Magnet Wire, Treated Tubes, Tuning Coils, and other Radio Apparatus.

Wholesale or Retail

I. R. NELSON CO.

Bond Street Newark, N. J.

DIAMONDS

10 MONTHS TO PAY ONE CARAT \$195.

SPECIAL LOW PRICES 30 DAYS TRIAL

Genuine blue-white diamonds now sold direct to you by **DIAMOND IMPORTERS** at wholesale prices on **credit at 40% discount**. 14 Kt. solid gold rings included free. Give finger size. **1/4 carat only \$48.75**; **1/2 carat \$97.50**; **3/4 carat \$146.25**. If satisfied pay 1/3 down and balance in 10 monthly payments. We guarantee to please you or return your money. Order direct from ad. or write for 128-page bargain catalog of other jewelry. \$1,000,000 and 42 years' experience are back of our guarantees.

B. GUTTER & SONS 312 NASSAU ST., Div. 305, New York

Get a Copy of this Book

HOW TO TAKE **VIOLET RAY**
TREATMENTS AT HOME

Tells how to treat yourself successfully for ailments caused by disordered nerves, impoverished blood or poor circulation. How to energize every cell and tissue to healthy activity, banish aches and pains eradicate poisons and build a healthy, normal body. A big, valuable book that will help every ailing person—sent without obligation. Merely send stamps with your request.

Ra-Tone Electric Co. 1104 W. Park Place, Detroit, Mich.



CAR OWNERS

Make Bigger Profits By Introducing and Taking Orders For Our Special Oversize

**INTERNATIONAL TIRES
AND PIRON (NO-RIP) TUBES**

Made under new and exclusive processes. Lower prices—astonishing guarantee—larger discount to agents—exclusive territory with sales help. Write for details of our remarkable proposition—a real money-maker.

Dept. 109 **INTERNATIONAL RUBBER CORPORATION**, Grand Rapids, Mich.

Any Boy Can Build This 30 Inch Boat



With Our Construction Set

Also other sailboats, power boats, engines, boilers.

Complete
Partly finished
Rough.

CATALOG FREE

**The H. E. Boucher
Mfg. Co.**

151 Lafayette St. New York

AGENTS \$1.75

YOU CAN
Sell This For



and Give
These Shears **FREE**



8 inch—with spring tension device
MY! HOW THEY SELL!

ONLY 20 Boxes A Day Means \$18.00 Daily Profit

You get the interest with the free Shears. Walter Harris sold 600 boxes in 6 Weeks. Profit over \$100.00 a week. A total retail value of \$4.62. A real bargain at \$1.75. The array of fine toilet goods (that always appeals to lady's heart) will dazzle her eye, and when at the end of your talk you state the low price of \$1.75 for these 11 articles, with the shears FREE, the money is yours, even if she has to borrow, or beg it.

ACT NOW! Sells like hot cakes year 'round. A baby could sell Lucky 11. Don't delay a minute. Save time. Send \$1.75 for complete outfit including display case. At least write for circulars explaining our unique plans, including 30 other packages. **ACT NOW.**
E. M. DAVIS CO., Dept. 2354 CHICAGO, ILL.

\$6 to \$12 A DAY



Taking orders for New Music Chest. Wonderful invention. Does more than Machines costing ten times its price. Easily carried with you anywhere.

NO CAPITAL NEEDED

We deliver and collect. All you do is take orders. Pay you every day. If you can't devote full time you can work 2 hours or 6 hours a day and make from \$4 to \$8 every day you work.

Easy to take orders on account of low prices. Biggest proposition ever offered to our Special Representatives. Write for demonstrating sample.

THOMAS MFG. CO., Chest 645

Dayton, Ohio

BURN Home GAS

In Your Old Wood or

COAL STOVES



Change your coal or wood stove into a gas stove in 3 minutes. A Child can do it. Burn kerosene Vapor Gas—hotter than coal or wood and costs less. Safe and simple.

FREE TRIAL

Just turn a valve and get even heat instantly. No ashes, no dirt, no smoke, no wood to chop or carry. No fires to build and feed. No fuel wasted. Cooks and bakes better. No damage to stoves. Makes its own gas from common coal oil, cheapest, cleanest fuel. Guaranteed five years. Money back if not satisfied after 30 days trial.

Write for FREE folder with proof and SPECIAL OFFER

SIMPLEX UTILITIES MFG. CO.,
410 Simplex Bldg. 2537 S. State St., Chicago



\$20⁰⁰aWeek

This Man

Wouldn't Stay Down

He was putting in long hours at unskilled work. His small pay scarcely lasted from week to week.

He saw other men promoted. Then he learned the reason. They had special training. He made up his mind to get that kind of training.

He sent to Scranton a coupon like the one below. That was his first step upward.

The reward was not long in coming—an increase in salary. Then he was made Foreman. Now he is Superintendent.

It just shows what a man with ambition can do!

What about you? You don't have to stay down. You can climb to the position you want. The way to do that is easy. Without cost—without obligating yourself in any way, mark and mail this coupon.

----- TEAR OUT HERE -----

INTERNATIONAL CORRESPONDENCE SCHOOLS
BOX 5625-C
SCRANTON, PA.

Without cost or obligation please explain how I can qualify for the position, or in the subject before which I have marked an X:

- | | |
|---|---|
| <input type="checkbox"/> ELEC. ENGINEER | <input type="checkbox"/> BUSINESS MANAGEMENT |
| <input type="checkbox"/> Electric Lighting & Railways | <input type="checkbox"/> SALESMANSHIP |
| <input type="checkbox"/> Electric Wiring | <input type="checkbox"/> ADVERTISING |
| <input type="checkbox"/> Telegraph Engineer | <input type="checkbox"/> Show Card & Sign Ptg. |
| <input type="checkbox"/> Telephone Work | <input type="checkbox"/> Railroad Positions |
| <input type="checkbox"/> MECHANICAL ENGINEER | <input type="checkbox"/> ILLUSTRATING |
| <input type="checkbox"/> Mechanical Draftsman | <input type="checkbox"/> Cartooning |
| <input type="checkbox"/> Machine Shop Practice | <input type="checkbox"/> Private Secretary |
| <input type="checkbox"/> Toolmaker | <input type="checkbox"/> Business Correspondent |
| <input type="checkbox"/> Gas Engine Operating | <input type="checkbox"/> BOOKKEEPER |
| <input type="checkbox"/> CIVIL ENGINEER | <input type="checkbox"/> Stenographer & Typist |
| <input type="checkbox"/> Surveying and Mapping | <input type="checkbox"/> Certified Public Accountant |
| <input type="checkbox"/> MINE FOREMAN or ENG'R | <input type="checkbox"/> TRAFFIC MANAGER |
| <input type="checkbox"/> STATIONARY ENGINEER | <input type="checkbox"/> Railway Accountant |
| <input type="checkbox"/> Marine Engineer | <input type="checkbox"/> Commercial Law |
| <input type="checkbox"/> ARCHITECT | <input type="checkbox"/> GOOD ENGLISH |
| <input type="checkbox"/> Contractor and Builder | <input type="checkbox"/> Common School Subjects |
| <input type="checkbox"/> Architectural Draftsman | <input type="checkbox"/> CIVIL SERVICE |
| <input type="checkbox"/> Concrete Builder | <input type="checkbox"/> Railway Mail Clerk |
| <input type="checkbox"/> Structural Engineer | <input type="checkbox"/> AUTOMOBILES |
| <input type="checkbox"/> PLUMBING & HEATING | <input type="checkbox"/> Mathematics |
| <input type="checkbox"/> Sheet Metal Worker | <input type="checkbox"/> Navigation |
| <input type="checkbox"/> Textile Overseer or Supt. | <input type="checkbox"/> AGRICULTURE <input type="checkbox"/> Spanish |
| <input type="checkbox"/> CHEMIST | <input type="checkbox"/> Poultry Raising <input type="checkbox"/> Banking |
| <input type="checkbox"/> Pharmacy | <input type="checkbox"/> Airplane Engines |

Name.....

Street.....

and No.....

City.....

State.....

Occupation.....

Persons residing in Canada should send this coupon to the International Correspondence Schools Canadian, Limited, Montreal, Canada.

Please Mention Popular Mechanics



ONLY \$7.75

Yankee VIOLET RAYS

The wonderful disease destroying action of these marvelous rays has been endorsed by the foremost physicians in the treatment of **Rheumatism, Colds, Gout, Lumbago, Gleet, Catarrh and other diseases.** YANKEE VIOLET RAYS impart a gentle flowing life-giving stream of vital energy and this healthful and stimulating action reverberates throughout the system giving that snap and dash enjoyed by the young.

The rays penetrate to the innermost recesses of the body and are powerful factors in stopping and benefiting tissue that is giving way to the ravages of disease.

This health-giving agent never gets out of order and can be used indefinitely. As first aid to aches and pains, it has no equal. At all the large clinics and hospitals it is used extensively as a curative agent of recognized merit.

A Remarkable Home Outfit at a Remarkable Price

The YANKEE VIOLET RAY OUTFIT is a complete apparatus small and compact. It works on alternating or direct current. Packed in a neat box with cord and plug which fits any lamp socket and includes a book of detailed instruction. The outfit will last a lifetime with ordinary use.

5 DAYS' FREE TRIAL

Send no money—just mail the coupon. \$7.75 does not have to be paid until Home Outfit is delivered. If dissatisfied after 5 days return it and your money will be refunded.

BOOKLET ON REQUEST

-----CLIP AND MAIL COUPON-----

To Yankee Laboratories, Inc.
315 East 43rd St., New York, N. Y.

Gentlemen—Please send me the Yankee Violet Ray Outfit by mail or express collect—\$7.75. I am to use this outfit 5 days and if not satisfied you are to return my money upon receipt of the outfit in good condition.

Name.....
Address.....

1922 Thin Model GUARANTEED WATCH \$1.95

HIGH GRADE
thin 1922 model, beautifully polished SILVEROID Case. Stem set and stem wind, movement carefully tested. Men's and women's sizes. Price slashed to only \$1.95 to advertise our bargains.

SEND NO MONEY! Send name and address quick! (Write plainly). Pay postman only \$1.95 on delivery. If you are not delighted, return watch and we'll instantly refund every cent of your money.

CAMBRIDGE WATCH CO., 114 Cambridge Bldg., CHICAGO



AGENTS \$75.00 WEEKLY

Amazing new seller. **KOVER-KWICK** (not an overall) protects clothes while working around auto, shop, or home. On and off in 5 seconds. Cannot streak dirt or mud from shoes to clothes when putting on. Kept firmly in place by flexible steel bands. Will not wrinkle clothes. Made of high-grade Ducking. One size fits everyone. Easily laundered.

150% PROFIT

Sells like hot cakes. Just show and sale is made. Nothing else like it. Low price. Make \$75.00 weekly easily. Write today for Liberal Agency Proposition.



BEN BUTLER, 5650 W. Lake Street, CHICAGO, ILL.

BALBA SALES MACHINES MAKE \$200 TO \$1000 MONTHLY

This new plan of selling high quality perfume has taken the country by storm. Men everywhere are jumping at the opportunity to get into this big money-making field. See page 171 of March Popular Mechanics.

Over 300 Cities Already Taken

Over 300 cities and towns have already been contracted for—better get busy before yours is taken by someone else. Remember the first who qualify get the exclusive sales rights. We do the local newspaper and national advertising. Get full particulars NOW.

BALBA CORPORATION OF AMERICA, Inc.
Dept. 44, Adams and Jackson Sts.
Toledo, Ohio, U. S. A.

EARN \$75.00 to \$150.00 A WEEK

By Repairing and Rebuilding TIRES with the greatest Money Making VULCANIZER ever placed on the market. Does Better Work at One Third the usual Cost of Repair. You can guarantee Repair Work to outlast the balance of the tire. Complete Illustrated Instructions with each machine. We teach you how and help you to get started in this big profitable business of tire rebuilding. Complete Outfits \$100.00, \$200.00 and \$250.00. Cash or in Payments. Write today for Circular No. 837.

The Adams-Barre Co.
1248 North High St.
Columbus, Ohio



TWO NOVELTIES FOR THE PRICE OF ONE

The **DYING PIG**: Infuse him, and will look like a real Pig; stand him up on his wooden legs, and watch him die—then collapse. Can be inflated as often as desired. The **BARKING DOG**: Made of metal head, and rubber bulb. Press the bulb, and he will bark like a real dog. Will send both novelties, postpaid for 25c, or six Dogs and six Pigs for \$1.00, together with our big novelty Catalogue.

M. K. BRODY, 1118-20 S. Halsted St., Chicago, Ill.



BLANK CARTRIDGE PISTOL

PRICE \$1.00

Well made and effective; modelled on latest type of Revolver; appearance alone is enough to scare a burglar. When loaded it may be as effective as a real revolver without danger to life. Does not shoot real bullets but takes standard .22 Cal. Blank Cartridges, obtainable everywhere. **A Great Protection Against Burglars, Tramps and Dogs.** You can have it lying about without the danger attached to other revolvers. **PRICE \$1.00 Postpaid. Blank Cartridges .22 Cal., shipped express, 50c per 100.**

JOHNSON SMITH & CO., Dept. 785, 3224 N. Halsted St., CHICAGO



You Designed this Motorcycle

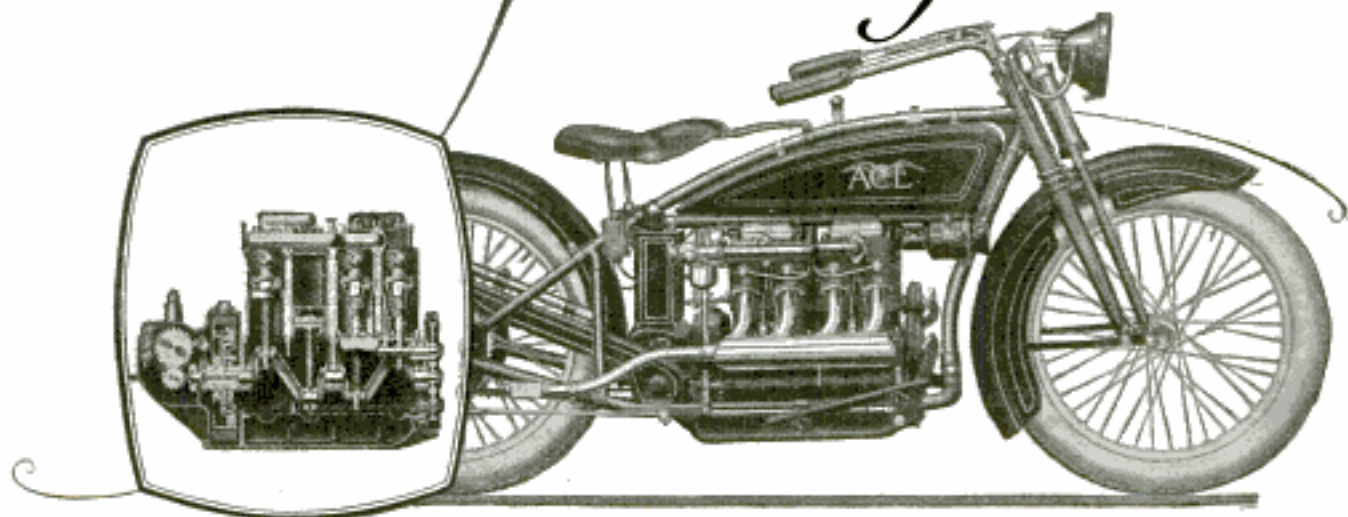

Diagram of the Ace
Four-Cylinder Motor

The features you believe a motorcycle
ought to have you will find in the Ace

INSTANT response like the dashing action of a thoroughbred, daring speed and astounding hill-climbing power, or the comfort of a slow swinging gait that eats up miles with perfect rhythm—such is the performance of the New Ace Four Cylinder Motorcycle.

You'll thrill as it slips away at the slightest twist of the wrist. You'll marvel at its pep on steep grades. You'll find it hard to believe there's a gasoline motor under you—so silent, clean and vibrationless is the Ace Four.

You and thousands of other motorcycle riders helped design this machine. It was built with those features which we learned you wanted and needed, but which were so impossible to find. It was your opinion that helped make possible this new kind of motorcycle transportation.

Don't miss another day of it. Go to the Ace dealer now. Get a demonstration. If you don't know the Ace dealer, write us for illustrated descriptive catalog and his name and address.

ACE



DEALERS

Limited territory is still
open to a few responsible
dealers. Send for com-
plete agency particulars.

ACE MOTOR CORPORATION

Erie Ave. & Speviva St.
Philadelphia, Pa., U. S. A.

\$375.75 One Day!

Ira Shook, of Flint, Did That Amount of Business in 1 Day

—making and selling **Popcorn Crispettes** with this machine. He says in letter dated March 1, 1921: "I started out with nothing, now have \$12,000.00 all made from **Crispettes**." Others have amazing records: Gibbs says: "Sold \$50.00 first night!" Erwin's little boy makes \$35.00 to \$50.00 every Saturday afternoon. Melxner reports \$600.00 business in one day. Kellogg writes: "\$700.00 ahead first two weeks." Master's letter says: "—sold \$40.00 in four hours." During March, 1921, Turner was offered \$700.00 clear profit above cost of his investment to sell. **There is money—lots of money—in Crispettes.**

Times make no difference for most of these records were made in 1921—were made while people are crying hard times and are looking for jobs! Location makes no difference. It's common for **Crispette** machines to make \$10.00 to \$25.00 profit daily in small towns!

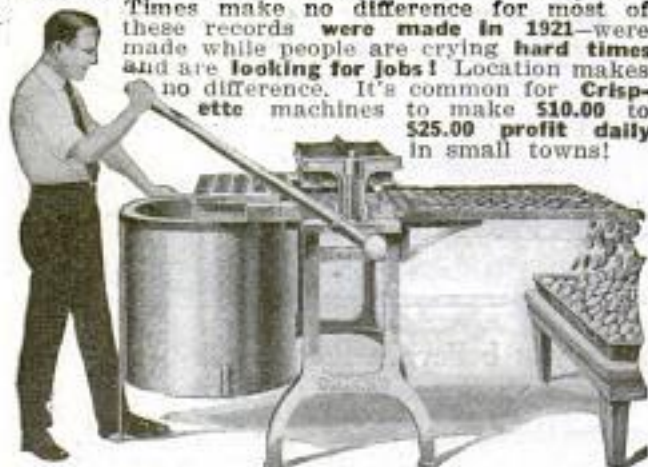

I Start You In Business

Write me—get my help. Begin now. Others are making money selling **Crispettes**. You can, too! You don't need much capital. Experience not necessary. I furnish everything—secret formulas, equipment for shop or store, full directions, raw materials, wrappers, etc. Splendid chances everywhere! Crowded streets, amusement parks, concessions, wholesaling and stores!

\$1,000.00 Monthly Easily Possible

Crispettes are a delicious, delightful confection. People never get enough. Always come for more. Raw materials are plentiful and cheap. You make enormous profits. Trade grows by leaps and bounds. It's an easy, pleasant and fascinating business. Send post card for illustrated book of facts. Contains enthusiastic letters from men and women who have quickly succeeded. Tells how to start. Explains most successful methods. Gives all information needed. It's FREE! Write Now! Address

LONG EAKINS COMPANY

428 High Street

Springfield, Ohio

Fibre-Lite Limbs



Easy Payments—Do Nature's Work.
AGENTS WANTED who use Artificial Leg. GOOD PAY.
FREE Fibre Sample
DESCRIBE STUMP TO **WORMAN CO** 252-P HENNEPIN AVE.
MINNEAPOLIS, MINN.

TOBACCO

OR SNUFF HABIT
CURED OR NO PAY
\$1.00 IF SUCCESSFUL

No matter whether used in pipe, cigarettes, cigars, chewed, or used in the form of snuff, Superba Tobacco Remedy contains nothing injurious, no dope, poisons, or habit forming drugs.
SENT ON TRIAL GUARANTEED.
Costs nothing if results are not satisfactory.
WRITE FOR FULL TREATMENT TODAY.
SUPERBA CO. M-19 Baltimore, Md

GOOD LUCK!



From the deep interior of the Mystic Orient comes this odd token ring of Chinese Princesses. Through countless centuries it has been surrounded with deep superstition, believed to be

almost uncanny in its power to bring to each and every wearer **Good Luck, Health, Happiness, Long Life and Prosperity.** It is true that Oriental superstition cannot, of course, be accepted as fact, but scores of wearers testify that it has brought good luck to them even in this modern age. Actresses, bankers, mechanics, card players, women and men everywhere assure us that a turn in their luck for the better came after they started wearing this ring. The popularity of this ring has been instantaneous and widespread. **The fad of the hour in fashionable New York Society.** Be the first in your neighborhood to wear this curious talisman. **Complete instructions on how to get best results with each ring.** Write name and address plainly. **Made in solid sterling silver.** State whether men's or women's size wanted. Yes, cannot just size to fit finger exactly. **Money refunded if not pleased.**



Price, Postpaid:—
Cash with order, \$1.50
(C. O. D.) \$1.60

The ZANZIBAR CO.
Dept. AB
353 FIFTH AVENUE
NEW YORK CITY

WARNING!

If you are looking for Good Luck. Don't waste money on useless, lower priced imitations. This is the original and genuine Chinese Good Luck Ring, and is stamped inside with the ☸

WRITE TODAY for
Our 168-PAGE
FREE BOOK on

Deafness

and learn how Perfect Hearing is now being restored in every condition of deafness or defective hearing. Our "Little Wireless Phones for the Ears" require no medicine, but effectively replace what is lacking or defective in the natural ear drums. They are simple devices, which the wearer easily fits into the ears, where they are invisible. Soft, safe and comfortable.

WILSON EAR DRUM CO., Incorporated
588 Inter-Southern Bldg. LOUISVILLE, KY.



Big Money

Made by agents selling our wonderful Facial Soap, Perfumes, Toilet Articles, Spices, Extracts, etc. Free cake of soap and agents' terms mailed to any address.

LACASSIAN CO. Dept. 455 ST. LOUIS, MO.

Don't Wear a Truss

Brooks' Appliance, the modern scientific invention, the wonderful new discovery that relieves rupture, will be sent on trial. No obnoxious springs or pads.



MR. G. E. BROOKS

Brooks' Rupture Appliance

Has automatic Air Cushions. Binds and draws the broken parts together as you would a broken limb. No salves. No lies. Durable, cheap. Sent on trial to prove it. Protected by U. S. patents. Catalog and measure blanks mailed free. Send name and address today.
BROOKS APPLIANCE CO., 1286 State St., Marshall, Mich.



Tobacco Is Hurting You

Look at the facts square in the face, Mr. Tobacco User. You may think tobacco is not hurting you.

That is because you haven't as yet, perhaps, felt the effects of the nicotine poison in YOUR system. For you know that nicotine, as absorbed into the system through smoking and chewing tobacco, is a slow working poison. Slow, yes—but sure.

Tobacco is lowering your efficiency. It slows a man down. Makes it harder for you to concentrate your mind on your work. You haven't near the amount of "pep" and energy you would have if you stopped using it. There's many a man twice as old as you in years who's twice as young in energy, simply because he lets tobacco alone.

Some day you will realize to what an alarming extent tobacco has undermined your system.

When your hands begin to tremble—
and your appetite begins to fail—
and your heart seems to "skip a beat" now and then—
and slight exertion makes you short of breath—
then you have a right to suspect that
TOBACCO is getting the upper hand.

Any well-informed doctor will tell you that these are only a few of many symptoms of tobacco poisoning.

And YOU know that the use of tobacco in any form is an expensive, utterly useless habit. You know you ought to quit.

Tobacco Habit Banished Let Us Help You

It doesn't make a particle of difference whether you've been a user of tobacco for a single month or 50 years, or how much you use, or in what form you use it—whether you smoke cigars, cigarettes, pipe, chew plug or fine cut or use snuff—**Tobacco Redeemer** will positively remove all craving for tobacco in any form in a very few days. Not the slightest shock to the nervous system. Your tobacco craving will usually begin to decrease after the very first dose—there's no long waiting for results.

Tobacco Redeemer contains no habit-forming drugs of any kind and is marvelously quick, scientific and thoroughly reliable.

It is in no sense a substitute for tobacco. After finishing the treatment you have absolutely no desire to use tobacco again or to continue the use of the remedy. It helps to quiet the nerves and make you feel better in every way.

Results Guaranteed A single trial will convince you. Our legal-binding, money-back guarantee goes with each full treatment. We will refund every cent you pay for the treatment if after taking it according to the easy-to-follow directions, it should fail to banish the tobacco habit completely.

SEND Coupon for Free Proof Let us send you our free booklet on the deadly effects of tobacco, together with testimonial letters from men all over the country telling how they have been absolutely freed from the tobacco habit by this simple home treatment. You could not ask for stronger proof that **Tobacco Redeemer** will free you from the habit than the evidence we will gladly send on request. Just mail the coupon—or a postal will do.

NEWELL PHARMACAL CO.
Dept. 300 St. Louis, Mo.



Free Book Coupon

NEWELL PHARMACAL CO.
Dept. 300 St. Louis, Mo.

Please send, without obligating me in any way, your free booklet regarding the tobacco habit and proof that **Tobacco Redeemer** will positively free me from the tobacco habit or my money will be refunded.

Name

Street and No.

Town..... State.....

SAVE YOUR BODY

Conserve Your Health and Efficiency First

"I Would Not Part with it for \$10,000"

So writes an enthusiastic, grateful customer. "Worth more than a farm," says another. In like manner testify over 100,000 people who have worn it.

The Natural Body Brace

Overcomes WEAKNESS and ORGANIC AILMENTS of WOMEN AND MEN. Develops erect, graceful figure.

Brings restful relief, comfort, ability to do things, health and strength.

Wear It 30 Days Free at Our Expense

Does away with the strain and pain of standing and walking; replaces and supports misplaced internal organs; reduces enlarged abdomen; straightens and strengthens the back; corrects stooping shoulders; develops lungs, chest and bust; relieves backache, curvatures, nervousness, raptures, constipation, after effects of flu. Comfortable and easy to wear.

Keep Yourself Fit Write today for illustrated booklet, measurement blank, etc., and read our very liberal proposition.

HOWARD C. RASH, Pres. Natural Body Brace Co.
223 Rash Building SALINA, KANSAS



For Boys and Girls Also



has enabled John G. Anderson, Aurora, Ill., to keep on the payroll since his right arm was amputated some years ago. The reproduction (from an actual photograph) shows Mr. Anderson at work on an intricate machine using his Carnes Artificial Arm.

INCONSPICUOUS - SERVICEABLE

The Best Substitute for the Natural Arm.

To see him on the street you would not realize that his right arm was artificial. Wearers of this wonderful arm find that it practically takes the place of the natural arm. With it you can dress yourself, use knife and fork, carry grips, write, pick up large and small objects—in fact, do practically everything that was possible before. Even though the amputation be at the shoulder, the CARNES ARTIFICIAL ARM bends at the elbow and wrist, and the fingers open and close as desired.

WONDERFUL BOOK SENT FREE Every armless man or woman should write today for the wonderful illustrated 100 page book showing with actual photographs what can be done with this invention. Write today to

CARNES ARTIFICIAL LIMB CO.
208 CARNES BUILDING — KANSAS CITY, MO.

Please Mention Popular Mechanics

NO JOKE TO BE DEAF

—Every Deaf Person Knows That I make myself hear, after being deaf for 25 years, with these Artificial Ear Drums. I wear them day and night. They are perfectly comfortable. No one sees them. Write me and I will tell you a true story, how I got deaf and how I make you hear.

Address
GEO. P. WAY, Artificial Ear Drum Co. (Inc.)
80 Adelaide St., Detroit, Mich.



Medicated Ear Drum
Pat. Nov. 3, 1908

How to Get Rid of Moles



A simple, safe home treatment—
15 years' success in my practice.
Moles (Also BIG Growths) Dry Up.

Ask for Free Booklet of Full Particulars

WM. DAVIS, M. D.

124-5 Grove Ave., Woodbridge, N. J.

I Make Strong Men

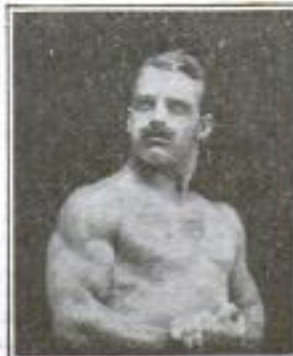

That is my business. I make no other claims. But what I promise, I fulfill. I will increase your arm one full inch in 30 days and your chest in proportion. In three months I will make you a finished strong man. Are you interested? Read my book "Physical Perfection." It tells you how. All I ask is 10 cents to cover postage and wrapping. Don't put it off. Send today.

Arthur L. Hyson
100 Langdon Bldg. New York City

The Road to Health

Vi-Rex Violet Rays

Treat yourself
at home
for—

Asthma
Boils
Blackheads
Catarrh
Colds
Corns
Eczema
Falling Hair
Hay Fever
Headache
Insomnia
Lumbago
Sore Throat
Nervousness
Neuralgia
Paralysis
Pimples
Rheumatism
Skin Diseases

Learn the secret of beauty, health and happiness—

We have just published a remarkable book for **free distribution**. This book explains in detail the manifold uses of Violet Rays in treating almost every known human ailment. It also contains charts and diagrams of the nervous system, and organic locations, and fully describes just how the Violet Ray works its many seeming miracles; written in a simple style—devoid of all technical language.

Vi-Rex Violet Rays carry life and vim to every cell—



The Violet Ray, as used in the treatment of the body, sends a spray of mild, tiny currents through every part and organ; flowing through each infinitesimal cell, massaging it, invigorating it and re-vitalizing it. It leaves no soreness after use, only a delightful sensation of relief. Vi-Rex is **not a vibrator**. It creates cellular massage, the most beneficial electrical treatment known.

Wonderful **FREE**
Book
10-day free trial proves all we claim

Clip this coupon and mail it today! This wonderful free book will be a revelation to you. We will also give you the details of our 10-DAY FREE TRIAL OFFER, which enables you to test the benefits of Vi-Rex Rays free in the privacy of your home.

Vi-Rex Electric Co.
Dept. 24, 326 W. Madison St.
Chicago

For New York City ONLY, Address 47 W. 34th St.

VI-REX ELECTRIC COMPANY

326 W. Madison St., Chicago, Ill. Dept. 24

Please send me without cost or obligation your free book describing your wonderful Violet Ray Machine and particulars of your special 10-day Trial Offer.

Name.....
Address.....
City..... State.....



Now, Dad's Stuck!

Jim came in the other night with the funniest looking game under his arm. "What's that?" asked Dad. "Oh, that's Puzzle Peg," said Jim, "the simple looking little game that all the boys over at the club have worked on every night for a week."

Dad laughed and said, "Give me a try at it. I'll show you young chaps how puzzles are solved." So Jim put the saucy looking little pegs in the holes and Dad started in to show how puzzles are done.

That was three nights ago and Dad's still at it—and Jim chuckles—and Dad's face gets red. Tonight he told Jim he didn't believe it could be done.

But Jim just laughed and said, "Dad, already there have been found thirty different ways of doing it. Don't give up." So Dad's still at it.

So are thousands of other fun lovers all over America. You never tire of Puzzle Peg. It's the most fascinating, fun provoking game ever invented.

Puzzle-Peg



Get a set at your dealer's today. Sold at druggists, newsdealers, department stores, in fact wherever good games are sold. If you have trouble in getting your set, send 50 cents and we will mail you one postpaid, together with booklet showing 30 problems. Send today.

Lubbers & Bell 725 Second Avenue
CLINTON, IOWA

Remarkable Invention



H·A·R·K
H·A·R·K
H·A·R·K

H·A·R·K (Happer Automatic Record Kleener), an ingenious little device, quickly attached, prolongs the life and improves the tone of phonograph records.

Thrilling arias, dance-band favorites, captivating symphonics, need sound "scratchy" no longer. A soft, specially prepared felt lightly rests atop the revolving tone-grooves and continuously absorbs all dirt, dust, grit and microscopic needle-shavings. Nobody need neglect his records any longer since it costs only a dollar to protect them. So, for a complete H·A·R·K, merely mail a one dollar bill, your name and address, to Hark Sales Co., 139 No. Clark Street, Chicago.

Very Attractive Proposition to Agents

Be the head H·A·R·K distributor in your community. Every phonograph owner a prospect. Clean, pleasant, profitable business. Every sale makes another.

Write for free prospectus. Better than \$450 a month to those who act now.

\$1.00

Be A Floor Surfacing Contractor



New uncrowded field. Contractors prefer to rubst floor surfacing to American Universal Contractors. Machine does work of 6 men. Works quickly, easily. We set you up in business of your own, furnish office forms, advertising, etc.

Make \$5,000 to \$15,000 or More—Yearly

Prepare for big building boom. Make new floors perfect old floors like new. Every floor a prospect. Big money in old floors. So town too small. Beginners often pay for machines first month with profit besides. Get full information.

THE AMERICAN FLOOR SURFACING MACHINE CO.
523 So. St. Clair St. Toledo, O., U. S. A.

Swing 4 in., 11 in. between centers, 17 in. total length. Shipping weight 13 lbs. Bed of lathe is machined. Workmanship first-class. Equipped with wood turning chuck. Can be fitted with 3 in. face plate and drill chuck as special equipment. Order one today.



Price \$6.00 cash with order
Made also in larger sizes.
SYEPHER MFG. CO.
Dept. D, TOLEDO, OHIO



GIVEN AWAY!

Boys, earn this wonderful moving picture machine complete, fitted with film. Given away for selling 30 bottles of our Select Perfume at 15c each. When sold, return \$4.50 to us and moving picture machine is yours. We send you the Perfume without any charge. Send your name and address.

NEW ENGLAND NOVELTY CO., Dept. 4-D, Brockton, Mass.

Blank Cartridge Pistol FREE

REVOLVER STYLE

Well made and effective, modeled on the latest type. Revolver does not shoot real bullets, but the appearance alone is enough to scare a burglar. When loaded it may prove just as effective as a real revolver without danger to life. Does not shoot real bullets, but takes the standard .22 Calibre Blank Cartridges obtainable everywhere. A Great Protection Against Burglars, Tramps and Dogs. You can have it lying about without the danger attached to other revolvers. Advertised extensively by leading firms for a dollar.



For a limited time only we are giving these Pistols to secure new subscribers to the **RACINE BULLETIN**, a large monthly illustrated magazine. Every issue crammed full of exciting stories, interesting items from all over the world, articles on popular science, mystery, magic and tricks, money-making recipes relating to every trade and manufacture, health hints, tried and tested recipes, gossip about well known persons. Thousands of dollars given away in prizes, not to mention a free \$1,000 Insurance Policy in every issue to each subscriber—all this and lots more combine to make it one of the most interesting magazines published in America. Send ONLY \$1.00 for a three years' subscription to the **Racine Bulletin** and we will send you the Pistol free, and the magazine for three years.

Dept. 784 **THE RACINE BULLETIN** Racine, Wis.

Your Old "Bike" and The SHAW Motor

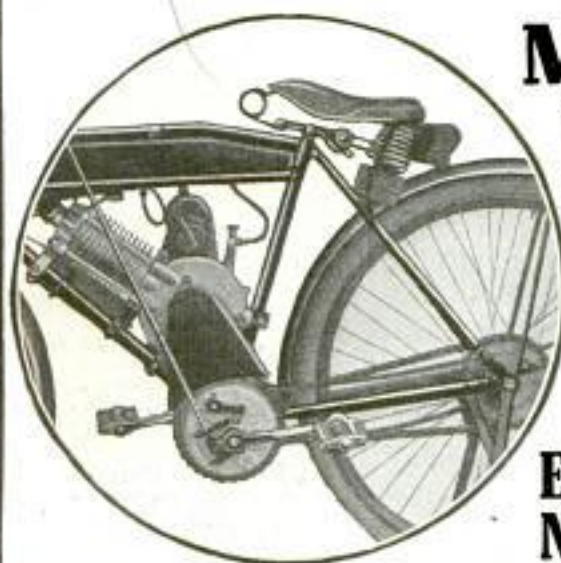

Makes A Complete Motorbicycle

Gives speed of 4 to 40 Miles an Hour!
90 to 125 Miles per Gallon of Gasoline!
1,200 to 1,800 Miles per Gallon of Lubricating Oil!

Easy to Ride—Easy to Control—Dependable

Easy to Attach—No Special Tools! No Mechanical Skill Required!

Shaw Specifications

Power Plant— $2\frac{1}{2}$ H-P SHAW Super Motor, 4-cycle type; Bore $2\frac{1}{4}$ inches; Stroke 3 inches.
Transmission—Two roller chains with countershaft clutch on crank hanger shaft, giving free engine.
Ignition—American magneto; water and oil proof.
Carburetor—Celebrated Kingston float feed type.
Lubrication—Sight feed; automatic.
Control—Grip control.
Fuel Tank—Two compartments; one for oil and one for gasoline; round tank for single bar frame, or flat tank for double bar frame, is furnished without extra cost.

Shaw Motors!

SHAW Motors are in daily use by thousands in all parts of the country and are known everywhere for their high quality and dependability. Every SHAW Motor leaves our factory with an IRON-CLAD GUARANTEE. The name "SHAW" is assurance of full satisfaction.

The Complete Shaw Motorbicycle

The SHAW Motorbicycle is a light-weight, powerful motorbicycle, complete in every detail. All latest improvements. $2\frac{1}{2}$ H-P 4-cycle motor of highest efficiency. Special Low Price now.



You don't have to do any filing, fitting or boring to make your old "foot-power" bike a dependable motorbicycle with the SHAW Attachment. A monkey wrench and a screw driver are the only tools you need. You can clamp the SHAW Attachment to your bike in 30 minutes time. Just follow the simple directions that come with it.

Fits Any Make Bicycle

The SHAW fits any standard bicycle frame. No cutting or making over. Nothing at all complicated.

Prices Reduced Now

We have made tremendous price reductions—effective **at once!** You can now get the SHAW Motor Attachment at a lower price than ever before. Take advantage—ACT!

Write Today—

For Complete Descriptive Literature and New Low Prices on SHAW Motor Attachments and Motorbicycle. Use the Coupon below. Fill out and mail it **NOW!**

SHAW MFG. CO., Department 37,
GALESBURG, KAN.

Send This Coupon for New Low Prices

SHAW MFG. CO.,
Dept. 37 Galesburg, Kansas.

Please send me New Low Prices and Full Particulars on the SHAW Motor Attachment and Complete Motorbicycle, all without obligating me.

Name

Address

R. F. D. State

Buy This Mechanically Perfect and Accurate CARTER OIL GAUGE for Your Ford or Chevrolet (490 and F. A.)

Guessing at your oil supply costs real money. You either waste money buying too much oil or you run the risk of burning out bearings when you let your oil supply run too low. You may intend to "crawl under" and open the petcocks but you neglect it.

Install the Carter Oil Gauge and your engine will work better. In addition, you will save money on your oil and upkeep costs.

Attach the highly polished, nickel-plated Carter Oil Gauge to dash or instrument board, thread the connecting tube through any hole in dash and attach to lower petcock with an elbow as shown in illustration.

Liquid in gauge glass is actuated by flow of air in connecting tube, i. e. as oil in crankcase rises, air in connecting tube is forced up, causing liquid in gauge glass to rise, and vice versa. When liquid in gauge is at "A" (see cut) the oil in crankcase is at upper petcock level; at "B," it is at lower petcock level.

No plungers, corks, or other moving parts to get out of order. Operates in all kinds of weather and outlasts life of car.

Each gauge is packed in attractive carton with instruction sheet and guarantee of satisfaction or money refunded. Retail price—\$2.00 (inc. war tax). If your dealer can not supply you, use this coupon and order. Be sure to mention name of your supply dealer.

JOBBER AND DEALERS
—Write for Discounts and Sales Helps.

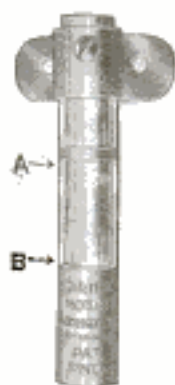

CARTER MOTOR ACCESSORIES INC.

CUT OFF COUPON HERE

CARTER MOTOR ACCESSORIES, INC.,
388 Pearl St., Buffalo, N. Y.

Gentlemen:—

Enclosed find (Check) (P. O. or Exp. Money Order) for \$.....
Ship via parcel post or express prepaid

.....(number or dozen) Carter Oil Gauge (Ford Type)

.....(number or dozen) Carter Oil Gauge (Chevrolet Type)

Dealer's Name.....

Address.....

From Popular Mechanics.....

Name.....

Street No.....

Town and State.....

(If this coupon is used by Dealer we will send shipment C. O. D., including a supply of advertising literature; also a demonstrating display outfit with order for one dozen or more.)

Quality Fiction

100% entertainment will be found in every one of the 170 pages in the April issue of

Wayside Tales

Look over the following partial list of stories:

"The Cupboard"
by Jeffrey Farnol

"With Lynn Heron"
by Winona Godfrey

"The Selling Talker"
by Newton Fuessle

"Gift of the Desert"
by Randall Parrish

"You Can't Beat Fate"
by Harold de Polo

"The Taming"
by Ted Dickson, Jr.

"Onions in Spain"
by Barker Shelton

"Perfume of the Night"
by Katharine M. Roof

"Otto Gultner"
by Frederick Sleath

"Unifawms—Rank"
by Edgar Valentine Smith

"The Red Shell"
by Edwin Baird

In addition to this superior fiction, we offer a department of original humor never before published—jokes, anecdotes, light verse, and humorous drawings.

Ask your newsdealer, or send 25 cents for a sample copy, using the coupon

WAYSIDE TALES

CHICAGO

Gentlemen: For the enclosed 25 cents, please send me the April issue of your magazine.

Name

Street

Town and State.....

Be your own Boss

Make \$25 to \$100 a week

Let me put you in a pleasant, profitable, independent business of your own.

If you are making less than \$25 a week, I can show you the way to a bigger income at once. By my plan you can build up in a few weeks a profitable business, paying a growing income, in which you'll be your own boss. You can use spare time or all your time, just as you like.

I have put hundreds of men and women on the road to financial success and independence. In all parts of the country you will find my representatives utilizing their spare time to add to their earnings, or, in full time, making more money than they ever did before.

I can do the same thing for you—you don't need any experience. If you've got grit and confidence in yourself, you can make \$25 to \$100 a week in as pleasant an occupation as anybody could wish.

Read below what a few of my representatives are doing:

C. A. Shelton, Missouri, made sales of \$280 last month working two hours a day.

D. F. Shugrue, Mass., sells \$300 worth of goods a month in part time.

Rosenburger, Ill., averages \$370 a month sales in a community of 500 families.

Frank Schoak, New Jersey, writes he sold \$250 worth of Ho-Ro-Co goods in two weeks.

Mrs. Rouse, Georgia, quit school-teaching to sell our products. In two months her sales were over \$600.

Pawling, Massachusetts, writes. "I make \$50 a week and am my own boss."

I will show letters from these representatives to anybody desiring to see them.

With the backing I give you, and the wonderful quality of Ho-Ro-Co Products, all you need is grit and confidence. Repeat orders come easy because our goods satisfy users, every time. H. B. Tenneman of Illinois, says "People call me up—stop me on the street—even write me to bring more goods."

The Quick Selling Ho-Ro-Co Line

includes household specialties, toilet articles, soaps, remedies, and other necessities required by every family. Our agents make thousands of dollars on our two leaders alone. Ho-Ro-Co Tonic and Ho-Ro-Co Skin and Scalp Soap. You can do the same. Why not start now?



Mail this coupon at once—make your start to success,

M. G. ROTH, Pres.

Ho-Ro-Co Mfg. Co.

Established in 1908

155 Locust St.,

St. Louis, Mo.

Hundreds of men and women make from \$25 to \$100 a week without previous experience in selling.

Experience is not necessary. Very few of my most successful representatives had previous experience. Ho-Ro-Co products are so good, so well-known, that it's no task to sell them. Furthermore, I give you the benefit of my years of experience—I show you how to go about this easy, pleasant work with full confidence in your ability to make money.

Get Free Sample Case

Let me tell you how to get a big, well-filled sample case absolutely free—how to show Ho-Ro-Co products to your friends and acquaintances. Then you'll realize how easily you can double or treble your present income.

If you'll send me the coupon below, I'll give you full particulars.

Write your name and address clearly in ink on the coupon.

Mail coupon at once!

M. G. Roth, President,

Ho-Ro-Co Mfg. Co. 155 Locust St. St. Louis Mo.

Send me without obligation, full particulars of your Ho-Ro-Co representative's plan whereby I can increase my income.

Name

St. & No. or R. F. D.

City

State



Jiminy crickets! that little Favorite sure does shoot!

ME? I'm goin' shootin'. Yes, sir-ee bob, me and my pal here. Sure, it's my pal—my old Stevens Favorite. The best chum I ever had.

Does it shoot straight? Does it—say, listen, old top, can a duck swim? You bet your boots it shoots straight. Slings a bullet straight and fast as a streak of greased lightning.

Man, I wouldn't take a barrel of money for my Stevens Favorite. It's a bear.

Take a squint through the barrel

Pretty, pretty smooth, eh? You betcha! And you can just store this in the old bean: every Stevens barrel is scraped smooth to less than 1-1000 of an inch. Just jot that down.

Takes a mighty long time to make a rifle that accurate. But Stevens has the habit. They're used to turning out a gun you can brag about.

Shoot us in a postcard. Simply say, "Send me your catalog."

Address:

J. STEVENS ARMS COMPANY

Dept. J-253, Chicopee Falls, Mass.

Owned and operated by the Savage Arms Corporation
Executive and Export Offices: 50 Church Street, New York



RETAIL PRICE, inc. tax, \$15.00
Stevens "Firible Loading," .22 Cal. Repeater.



RETAIL PRICE, inc. tax, \$9.85
Stevens "Favorite," 24-in. take-down.

Stevens



A Friend in Need!

Last tube punctured—patches won't stick—you're ready to start home on the rim. Then along comes a helpful friend and shows you how to vulcanize that puncture for good in five minutes. He'll tell you that he wouldn't take ten dollars for the feeling of security his Shaler Vulcanizer gives him and advise you to get one at the next garage or accessory store you pass. You'll do it, and next time the emergency comes you'll thank your lucky star that you were prepared.

Costs Only \$1.50

Slightly higher west of Denver and in Canada

Vulcanizes boots, rubbers, gloves, coats, etc. No gasoline. Each Patch-&-Heat Unit contains its own fuel. A match is all you need.

C. A. SHALER CO.

2015 Fourth Street [Waupun, Wis., U. S. A.]



Save Time and Money

Prices \$20 to \$400 Less

Eventually you will want some kind of power you can depend on. Perhaps you could use a 16, 22 or 30 H-P. — or you might want a 2, 3, 4, 6, 8 or 12. Whatever your needs—Kerosene or Gasoline—why not

Get a

WITTE
FIRST

Stationary or Portable

Sizes—
2 to 30
H-P.

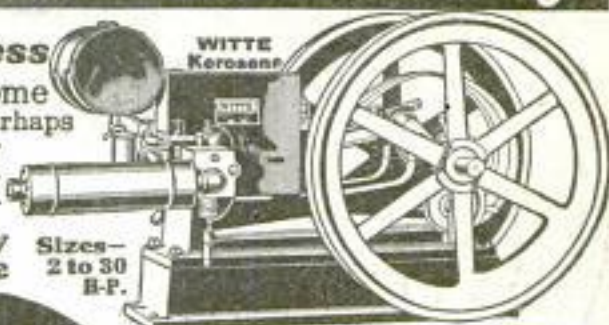

Made
By the Man
Who Sells
'em

Direct From Factory

When you buy a WITTE, you come direct to the man who makes your engine or other power outfit. You get your rig all complete ready to install and start using. You pay only the factory price from Kansas City, plus my one small profit—carload freight added from Pittsburgh. Whatever you select, I give you a straight

Lifetime Guarantee

This guarantee covers any and all defects of material or workmanship on any WITTE Engine or outfit you get for the entire life of the rig. 90-Day Test proves Quality and Service. My prices are now \$20 to \$400 less than a year ago, according to size, and style. Tell me what kind of power outfit you need, and I'll send you catalog and lowest price for immediate shipment.—ED. H. WITTE, President.

WITTE ENGINE WORKS,

1749 Oakland Avenue, KANSAS CITY, MISSOURI.
1749 Empire Building, PITTSBURGH, PENNSYLVANIA.



You can have a

Stationary Engine up to 30 Horse; a Portable Engine, 2 to 16 Horse; a Portable Sawing Outfit to operate on kerosene or gasoline, 4 to 12 Horse; a Combined Log and Tree Saw; a Stationary Buzz Saw Outfit, 2, 3 or 4 H-P.; or the new WITTE Portable One-Man Stump Borer used in preparing stumps for burning and blasting. Anything you want at a money-saving price—

Cash or Easy Payments

Built
in
Sizes
2 to 30
H-P.

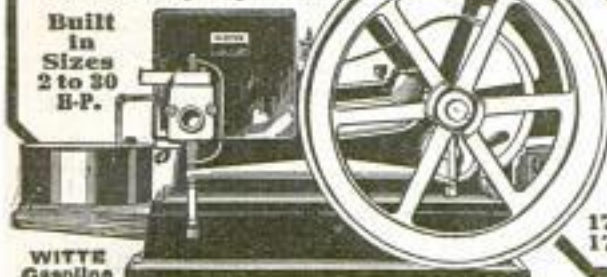

WITTE
Gasoline

WITTE

Arm Swing

LOG SAW

Cuts $\frac{1}{3}$
Faster Than
Former Rigs



Make
Money—
Save Hard Work

Now \$65⁰⁰
only **65** F.O.B.
K.C.

From Pittsburgh \$70

Tree Saw Equipment at
Small Cost Additional,
Giving You Two Rigs
in One, Operated
by Same Engine

Just The Log-Saw Outfit You Have Been Looking For—Latest Log Saw Improvements. Surplus power engine, with two fly-wheels for belt work. Friction Clutch, Lever Controlled, for starting, stopping or slowing down saw. Reversible wheels. Rugged construction. Natural feed when sawing logs makes saw cut fast. Adjustable force feed when sawing trees.

Special Points of Merit Saw finishes cut parallel with ground. No sawing dirt or rocks, no jacking up logs. Only interchangeable Log and Tree Outfit of the kind sold direct. Tree Saw parts make Log Saw a complete Tree Saw. Rig anchors to stump below saw—cuts tree clear down. Saws uphill or downhill, anywhere. Log Saw Outfit sold on our regular

90-Day Test—Lifetime Guarantee

Buy for cash, or, on easy payments, as you wish. Separate Branch Saw Outfit, only \$19.99. Write for the Log and Tree Catalog. It tells all about sawing. We also build stationary engines, all sizes, up to 30 H-P. If interested, ask for Stationary Engine Catalog, and state size. Sent Free on request.

WITTE ENGINE WORKS,

1742 Oakland Avenue, Kansas City, Mo.
1742 Empire Building, Pittsburgh, Pa.

Quick
Change
From Log
To Tree
Saw

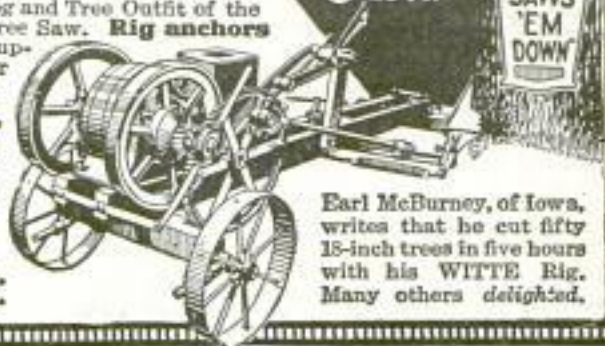

Earl McBurney, of Iowa, writes that he cut fifty 18-inch trees in five hours with his WITTE Rig. Many others delighted.



\$6,000.00 YEAR WITH THIS MACHINE

WHAT others have done, YOU CAN DO! \$6,000.00 year is low estimate. Many make more. This new machine and Haywood's Tire Surgery does the trick. Starts you in paying business quickly. No experience needed.

Many Men Making Money

Are you drifting back to lower wages? Protect yourself! Be among these money makers! Hargan, of Ill., did \$20,000.00 last year. Fotzer Bros., Pa., made profit of \$3,500.00 first year. Spring City Tire Co., Wis., did about \$50,000.00 last year. Ramsay, S. D., working alone, cleared \$441.58 in one month. Wende, Ind., approximates \$500.00 month. Tucker, Ill., high as \$137.00 weekly single handed. Mitchell, Ill., says "Record day was \$300.00." And so on!

Get My Big Proposition

Start like others have done. Get the facts. There's nothing to stop you. I'll help you to the limit. My proposition is highly interesting. Send coupon or postal to me, personally. Write me tonight.

Mr. M. Haywood, Pres.,
Haywood Tire & Equipment Co.,
1351 Capitol Ave., Indianapolis, Ind.

Dear Sir:—I am interested in Tire Surgery. Please tell me all about this profitable business and your modern equipment.

Name.....

Address.....

Our BUREAU OF INFORMATION will answer all questions regarding articles appearing in this magazine. Address Bureau of Information, Popular Mechanics Magazine, Chicago.



Buy Direct from Headquarters

BY BUYING direct from us, you save from 25% to 40% on new Columbia motors and as high as 50% on Fuerst-Friedman rebuilt motors. In addition, you get motors which are fully guaranteed for one year.

We can supply you with new or rebuilt motors of most standard makes such as Westinghouse, G. E., Wagner, Robbins-Myers, etc., for every class of work and in all sizes from tiny buffing motors to heavy duty factory motors—and you save real money on each transaction. The new, as well as rebuilt motors, include nearly all known standard makes.

Electrical Machinery Rebuilt

For twenty years we have specialized in repairing electrical machinery of all kinds. If you need repair work done, consult us, or if you want to exchange your equipment, phone or write us. Our experience insures your satisfaction.

Ask for Book 100—the price regulator on new and rebuilt motors. This book quotes prices which will prove attractive even to buyers of motors who regularly secure trade discounts. Send for your copy today.

THE FUERST-FRIEDMAN COMPANY

"Reliability Built In"

CLEVELAND

OHIO

COLUMBIA MOTORS

Aladdin Homes Save \$200 to \$800

Aladdin Homes will save a substantial amount for you through eliminating dealers' profits, saving over 18% waste in lumber and lowering labor costs in building. Aladdin Homes come to you direct, thereby reducing freight charges, and are cut to fit, saving waste of lumber and hundreds of hours of carpenter labor. Send stamps for the Aladdin catalog at once.

Bungalows, Dwellings, Summer Cottages

Aladdin prices include all the timbered framework, millwork, the siding, outside finish, porch, shingles, windows, doors, interior woodwork, lath, glass, nails, hardware, lock sets, paints, stains and varnish.

Send Stamps To day for Catalog No. 1570

THE ALADDIN CO., BAY CITY, MICHIGAN

Branches; Offices and Mills: Portland, Oregon;
Wilmington, North Carolina; Hattiesburg, Miss.
Canadian Offices and Mills: Toronto, Vancouver, Winnipeg, St. John

Have a Business of Your Own



Complete instruction in building and repairing Storage Batteries.

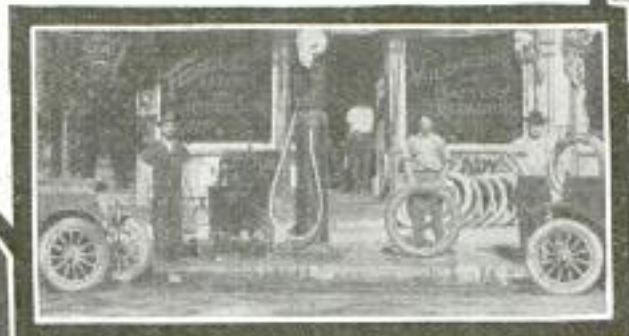

Otto Fisher, an M. S. A. S. graduate, is making good with this nice shop in Royal Oak, Michigan. He gives service on batteries and tires. This is a line that you can start with little or no capital when you know your business.



Students get practical training in all classes of tire repairing.

Why be idle or out of a job indefinitely when you can get into a good paying business of your own on a very small investment? Don't you know that there are over 10,500,000 automobiles in use right now? Each one has a battery and five tires that need repairing, and people will have to have them repaired more than ever this year. They can't afford new ones. Can you imagine a better business to get into than the Tire and Battery Repair business? You can learn this business properly in a few weeks at the factory-endorsed school.

Learn Tire Repairing and Battery Business In the Heart of the Auto Industry

Tires and Batteries are a great combination. Business in one line leads directly into the other. A motorist gets his service in one shop. That pleases and builds trade. You will be surprised, how easy it is to learn the business when you have the proper instruction, under capable directors and with the latest equipment. The courses of the Michigan State Automobile School are for instruction only—not to sell you any particular kind of equipment. This kind of training gives you the right foundation for real money-making success. When you finish the course, you know the business thoroughly—both the tire business and batteries. There is no question about making good if you do your part, as we guarantee to do ours.

No Previous Experience Necessary

The Battery and Tire Repair Courses take you through the training from the beginning—all you need is just a liking for the work. You couldn't succeed in anything if you didn't have that. You learn on several types of

equipment—each one thoroughly—so you can step into a good job in any shop if you wish to work for someone else before going into this business for yourself.

Start With Small Capital

Every city, large or small, has its opening for Tire Repairing and Battery business. It takes only little capital to start. You can begin small and build big out of your profits. Equipment is inexpensive. Takes only a little of it to turn out enough work to pay you big salary. F. J. Carney, a M. S. A. S. graduate, writes that in 3 months he built a business that pays him \$250 a month profit and it's getting better every day. A. R. Perrella borrowed money to start and in less than a year built a \$6,000 business. Carl C. Eichenburg did a \$12,000 business in less than eight months. These records are not exceptional at all. You can do as well and perhaps better. Decide now to make this step to success.



Write Today for FREE Illustrated Catalog

Get all the facts about this opportunity. Let us send you the names of M. S. A. S. graduates now in successful businesses from coast to coast. The evidence that we can do as much for you is undeniable. Our big, illustrated catalog explains the M. S. A. S. guaranteed factory-endorsed method—thoroughly. If interested in a better job, mail the coupon, or postcard—now.

Colored Students Not Solicited

MICHIGAN STATE AUTOMOBILE SCHOOL

A. G. ZELLER, President

1764 Auto Bldg., 3729 Woodward Ave., Detroit, Mich.

Mail Coupon To Day

Michigan State Automobile School,
1764 Auto Bldg., Detroit, Mich.

Gentlemen:
Send FREE without obligation, your big illustrated catalog giving complete information of your guaranteed training for the Tire Repairing and Battery Business.

Name.....

Street or R. F. D.....

City..... State.....

The Factory Endorsed School

SEE OUR PAGE ADVERTISEMENT ON PAGES 53, 75, 157

No Delivering
Commissions
Same Day You
Take Orders

Dependable
Practical
Simple—

Every
Home
Needs
It

\$5



Earn \$60 Weekly

FOR ONLY FOUR ORDERS A DAY

EARNING \$60.00 a week is easy when you sell the Fugo Automatic Fire Extinguisher. Most agents earn more. You can understand how easy it is to sell when you realize that the Fugo sells for \$5.00 while most extinguishers sell for \$15.00 or \$20.00 and are no more efficient or dependable than the Fugo. The Fugo is approved by many of America's most prominent Fire Chiefs. Millions of people want a handy, reliable fire extinguisher for their homes, office, factories, and garages. Agents take orders on every call. Some orders are for 3, 4, or 5 Fugos. There's nothing equal to it as a seller. A 5-minute demonstration and you pocket the order.—No talking. No price argument. No competition. Field unlimited. Customers easily pleased. Sales multiply fast.

Read What New Agents Say

S. B. Kurtz, of Hartesville, Ohio, writes: "I sold eight FUGOS in my first evening's work."
Henry Terp, of Green Bay, Wis., writes: "The FUGO is a superior extinguisher and by far the best seller."
Walter S. Nye, of Oneonta, N. Y., writes: "Ship twenty-four FUGOS immediately. Check enclosed. Have fifty additional orders for later delivery."
Wm. Pierson, of Norfolk, Nebraska, writes: "This is greatest agent's proposition we have ever handled. Wonderful money maker. At rate going now my sales organization will have no trouble selling 25,000 FUGOS the first year."

No Experience Needed

Our proved instructions guide you—you cannot go wrong.—A five minute demonstration and it's sold. Your neighborhood fire department will recommend it. Boost it—push it.

Exclusive Territory

Become our licensed agent, control your own exclusive territory and employ sub-agents. You take no risk—you don't invest a penny. We deliver—you receive commission same day you take orders.

Experienced agents are fast dropping other lines to take up the Fugo proposition. Write now for full particulars of the real possibilities that you have with the FUGO. Sample FUGO automatic free to every active agent.

The Ohio Instrument Co., 9414 St. Catherine Ave., Cleveland, Ohio

FUGO AUTOMATIC

FIRE EXTINGUISHER

LUMINOUS PAINT

Make Your Watches, Clocks, Etc.,
Visible by Night

The very latest discovery in the scientific world. Hitherto, practically unobtainable except at an exorbitant price, we have at last succeeded in producing this remarkable LUMINOUS PAINT, which applied to the surface of any article, emits rays of white light, rendering it perfectly visible in the dark. **THE DARKER THE NIGHT, THE MORE BRILLIANT IT SHINES.** Quite simple to use. Anyone—you can do it. A little applied to the dial of your watch or clock will enable you to tell the time by night. You can coat the push buttons or switch plates of your electric lights, watch boxes, and innumerable other articles; make your own Luminous Crosses, Luminous Remotes, etc. Small bottle, price 25c. Larger sizes, 50c and \$1.00 postpaid. **Johnson Smith & Co., 3214 N. Halsted St., Dept. 715, Chicago**

Our BUREAU OF INFORMATION will answer all questions regarding articles appearing in this magazine. Address Bureau of Information, Popular Mechanics Magazine, Chicago.

SPRINGFIELD CARBINE

\$3.50

45 Calibre



Made by U. S. Gov't
Breech Loading

First Class Condition. 41 inches long, weight 7 lbs., \$3.50. Then for \$3 more, you may have a smooth bore barrel to shoot shot. This makes a wonderful combination. The smooth barrel can be interchanged by anyone in 5 minutes. Millions of Bird or Ball Shot cartridges, 3 cents each. Send for Catalog.

W. STOKES KIRK, 1627 N. 10th STREET
Dept. P. M., Philadelphia, Pa.

The Visible Tire Tester

Make Full Time Money Selling
a 100% Auto Necessity—Not
Just a Rich Man's Accessory.

Every car owner is a "sold" prospect because he realizes his need for an accurate, easy, clean way to save his tires by knowing that they have just exactly enough air.

You can take his order for this guaranteed money back VISIBLE TIRE TESTER by a simple demonstration. Sample \$2.00. Write today for our attractive selling plan.

CHICAGO AUTO SPECIALTY CO.
1349 Bascom St., Chicago, Ill.



Sells for
\$3.00
—a fair
price

JOINT WIPING AND LEAD WORK

A modern treatise on the preparation of lead pipe and connections and the wiping of joints in various positions on lead, copper and brass pipes.

80 Pages. 115 illus. Cloth, 75 cents, postpaid.
Popular Mechanics Book Dept., 6 N. Michigan Ave., Chicago.

JUST OUT

SHOP NOTES FOR 1922

VOLUME XVIII
224 PAGES — 655 ARTICLES
465 ILLUSTRATIONS

Six-Inch Bench Lathe—Electric Soldering Outfit—Contractors' Jib Crane—Pump Troubles—Farm or Road Roller—Small Bench Grinder—Small Bench Miller are among the many useful articles in this volume.

PRICE 50 CENTS, POSTPAID

POPULAR MECHANICS BOOK DEPARTMENT
6 N. MICHIGAN AVE. CHICAGO

"JIFFY CAP"

Make Full Time Money Selling
a 100% Ford Necessity—Not Just
an Accessory!

Every Ford owner is a "sold" prospect because he avoids the disagreeable five minutes of empty, greasy struggling with gritty or crossed threads that he spends in filling his gas tank.

The Jiffy Cap brings smiles to his face as you demonstrate it, and his hand is in his pocket before you finish talking. This article sells for \$1.25.

Write today for our attractive selling plan. A sample will cost you 65c.
CHICAGO AUTO SPECIALTY CO.
1349 Bascom St., Chicago, Ill.



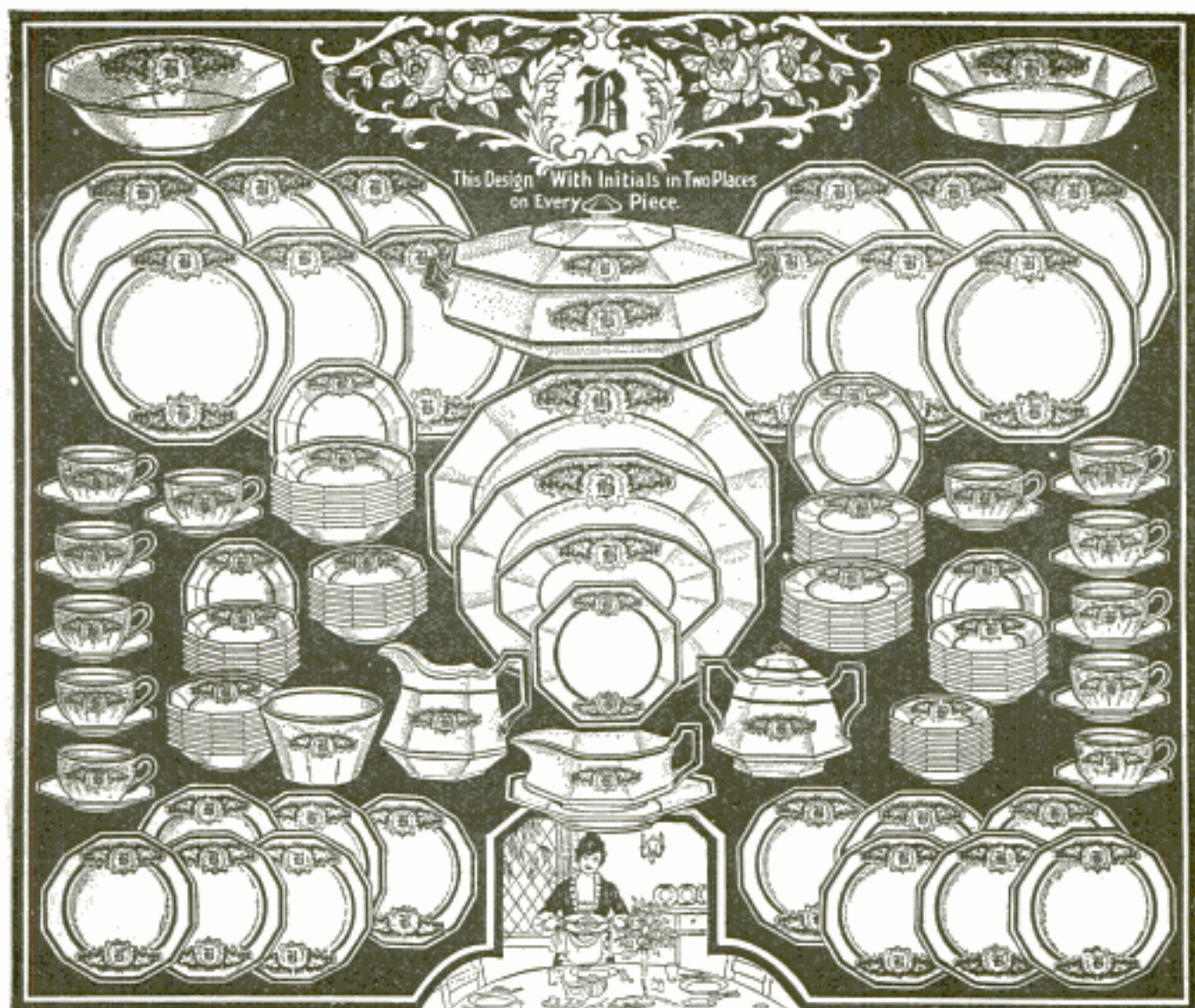

This Superb 110-piece Set, with initial in 2 places in wreath with 5-color decorations on every piece and gold covered handles, consists of:
 12 Dinner Plates, 9 inches
 12 Breakfast Plates, 7 inches
 12 Cups
 12 Saucers

12 Soup Plates, 7 1/2 inches
 12 Cereal Dishes, 6 inches
 12 Fruit Dishes, 6 1/2 inches
 12 Individual Bread and Butter Plates, 6 1/2 inches
 1 Platter, 11 3/4 inches

1 Platter, 11 3/4 inches
 1 Celery Dish, 8 1/2 inches
 1 Sauce Boat Tray, 7 1/2 inches
 1 Butter Plate, 6 inches
 1 Vegetable Dish, 10 1/2 inches, with lid (2 pieces)

1 Deep Bowl, 8 1/2 inches
 1 Oval Baker, 9 inches
 1 Small Deep Bowl, 5 inches
 1 Gravy Boat, 7 1/4 inches
 1 Creamer
 1 Sugar Bowl with cover (2 pieces)

368-Page Book Free

Brings 110-Piece Gold Decorated Martha Washington Dinner Set

Send only \$1 and we ship the full set—110 pieces. Use it 30 days. Then if not satisfied, return them and we refund your \$1 and pay transportation charges both ways. If you keep them, take nearly a year to pay on easy terms.

Your Initial in 2 Places on Every Piece—5-Color Floral Decorations and Gold

Wonderful artistic effect is given by the wreath and rich design surrounding the initial. Your initial appears in 2 places on every piece.

All Handles Covered with Gold
 Every handle is covered with polished gold. Shipping weight about 90 lbs.



Important!

Hartman guarantees that every piece in this set is absolutely first quality—no seconds. This is a standard or "open" pattern. Replacement pieces may be had of us for three years. Each piece wrapped in tissue paper. Extra care packing to prevent breakage. Shipped without delay.

Order No. 324DMA13. Bargain price, \$32.85. Pay \$1 now, \$3 monthly.

HARTMAN Furniture & Carpet Co.

Dept 4291 Copyright, 1922, by Hartman's, Chicago Chicago, Ill.

A B C D E F G H I J K L M N O P Q R S T U V W X Y Z

FREE HARTMAN FURNITURE & CARPET CO. DEPT. 4291 CHICAGO, ILL.

Bargain Catalog
 368 pages of bargains in furniture, rugs, stoves, silverware, washing machines, kitchen ware, gas engines and cream separators, etc.—all on our easy terms—30 days FREE trial. Post card or letter brings it FREE.

“Let Hartman Feather Your Nest”
 I enclose \$1.00. Send 110-piece Golden Martha Washington Dinner Set No. 324DMA13. I am to have 30 days' free trial. If not satisfied, will ship it back and you will refund my \$1.00 and pay transportation charges both ways. If I keep it I will pay \$1.00 per month until full price, \$32.85, is paid. Title remains with you until final payment is made.

Name.....
 Street Address.....
 R. F. D. Box No.
 Town..... State.....
 State your Occupation..... Color.....
 Give Initial Wanted (Any One Letter).....



No Wonder Salesmen Make Fortunes With This Amazing Invention



When a real idea comes along that does an important job and does it well depend upon it that every salesman or agent who ties up to it will clean up big. And this is one of them—a wonderful new device that saves housewives labor, muss, and drudgery. No wonder salesmen are making fortunes with this amazing invention that saves housewives from a roasting kitchen in the Summer, yet gives them three times more heat in Winter when they need it—and ready heat for changeable Spring and Fall. Just a turn of a valve instantly gives them as much or as little heat as they need. That's why the Oliver Improved Oil-Gas Burner is sweeping the country like wild-fire!

How It Frees Housewives From Summer Drudgery

IF YOU were a housewife and had to sweat and fume and fuss over a mussy coal and wood stove in a roasting kitchen in July, you'd understand why housewives all over the country are clamoring for this amazing new invention! And knowing what such a nation-wide demand means to salesmen or agents you know at once why the men and women who represent the Oliver

Oil-Gas Burner are making fortunes. It isn't hard to sell a thing that everybody wants! You don't have to be a star salesman. You don't have to talk people into a sale. A short, clear-cut demonstration—and the sale is made.

Big Money in Every Season

Salesmen make big profits with the Oliver because it is not only timely, in these days of labor-saving devices and high priced coal and wood, but it is timely every season of the year. That's why agents clean up all year round. The Oliver dispenses entirely with coal and wood. It burns 95% air and 5% oil, the cheapest fuel there is. It saves a woman work now in times when she is looking for just such things. It makes an immediate hit with her because through just a turn of a valve in winter it gives her three times the heat of any other method, just when she needs lots of heat. And in the summer when she just needs a little heat for cooking purposes a few times a day she has it right there at the turn of her wrist—and does not have to have a hot roasting kitchen in those days which are certainly hot enough for her as it is.

Now that you know these things you can understand why agents make profits as shown in their actual letters on this page. There are hundreds of others. W. H. Drew

of Michigan made \$85 in one day. L. Zucher of Ohio made \$21.50 in three hours. R. Berger of Ontario earned in one week \$258.50. Big money can easily be made just in spare time. N. Browne of Washington made \$43 in one evening.

Quick Sales—Big Profits

These men know a good thing when they see it and they know that the time is ripe for this new Oliver Improved Oil-Gas Burner. They know that this age of high-priced coal and wood makes it necessary for some substitute. They see ships and locomotives being run by oil, and big buildings being heated by it. And they know that an invention that makes effective use of this cheap fuel for every home is the thing they want to tie up to. You too can use this secret of big money. You do not need to be a high-powered salesman. The Oliver's amazing features sell it for you. When people see it they know at once that it is the thing they want. You will realize that this is a proposition that will pay you as big money as it does others. We have a definite number of open territories which we are ready to dispose of to those who act quickly. Every territory allotted is filled with big-money opportunities. And this big money comes easily. Because not only does this invention practically sell itself on sight but when you have sold one this one will sell several others as soon as your customer's friends and neighbors see it. And thru our special plan you get credit and commissions for every sale in your territory.

Coupon Brings Full Offer

Mail this coupon now for our offer. We are not making any extravagant claims about this. We do not have so. We believe that your common sense will indicate a good proposition to you when you know about it. We want to give you the facts. Won't you write us? And by doing so quickly you will be allotted an exclusive territory with private selling rights.

The coupon will bring you the facts and will save you writing a letter. But mail the coupon at once.

OLIVER OIL-GAS BURNER AND MACHINE CO.
2014-P Pine Street
St. Louis, Mo.



\$215 in One Day

"Ye gods—some seller! I made \$215 today!"

F. W. Bentley,
of Philadelphia.

\$660 a Month

"Have averaged \$660 profit a month for last six months."

A. M. Russel, Conn.

\$1000 in 4 Weeks

"Am making \$1000 per month. I have made big money before, but did not expect so much. Your Burner is just the thing."

J. Carnegiey, S. D.

Oliver Oil-Gas Burner and Machine Co., 2014-P Pine Street, St. Louis, Mo.

Please send me full facts about how I can make big money representing you in my territory. Also your plan if I wish to make big money in my spare time.

Name.....

Address.....

NOW! Camp Funston's Equipment at Tremendous Bargains!



Brand New Outfit \$65.00



17¹/₂ Sq. Ft.



SHOWER
BATH
\$2.50



CAST IRON \$2.50

Last of Big Army Camp Under the Hammer
—Final Break-Up Releases More Than
\$1,000,000 of Supplies—Your Last Chance at
These Government-Bought Goods at Sacrifice Prices.

EVERYBODY—Home Owners, Builders, Contractors, Plumbers, Purchasing Agents, etc.—now can take advantage of the Government's great sacrifice sale of Camp Funston Equipment. Our spot cash bid bought more than a Million Dollars worth at a small fraction of its original cost. Our bargain is yours. Take advantage at once! Make a tremendous saving on equipment and supplies of highest quality. Original costs have been forgotten. The buyers' strike is broken!

Everything Goes Regardless of Cost!

We can supply you with anything from a bolt to a boiler, one or a trainload! At unheard of Bargain Prices! 150 H-P. Kewanee Boilers for \$850; Hot Water Boilers, Toilets, Bath Room Outfits, Urinals, Sinks, Pipe, Valves, Fittings, Wagons—hundreds of other supplies at way less than wholesale! A complete shoe factory! Buy it all or in pieces! All these goods are of the very best quality, new and slightly used. We guarantee satisfaction. Right Now—while these bargains last—is the time to build, remodel and modernize your home. Don't buy a penny's worth of equipment anywhere until you get our Very Low Prices.

Get This Price List FREE!

Get the best that money can buy at actually Less Than Cost to Manufacture! Hundreds of bargains in this Big Illustrated Price List. Use the Coupon attached. Get yours Now!

GOLDBERG WRECKING CO.

Building 1
Camp
Funston,
Kansas

**Act
Today**

NAME

ADDRESS

Big
Illustrated
Price
List!

MAIL COUPON NOW

GOLDBERG WRECKING CO.,
Building 1, Camp Funston, Kas.
Please send me your Big Illustrated Price List, FREE.

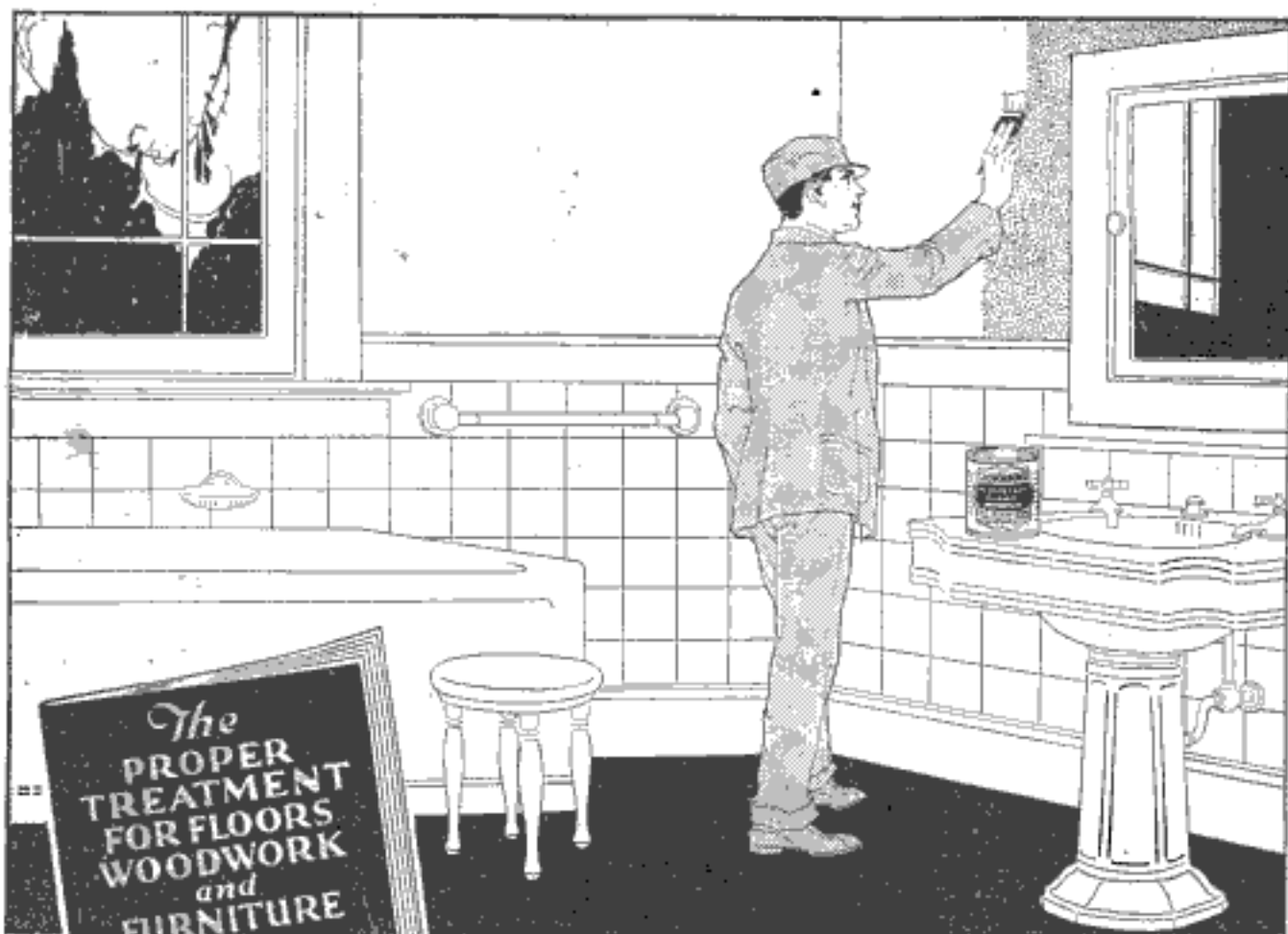

This Beautiful Book on Wood Finishing FREE

GIVES complete instructions for finishing all wood—hard or soft, old or new. Explains just what materials to use and how to apply them. Tells how inexpensive soft woods may be finished so they are as beautiful and artistic as hard wood. This book is the work of experts—illustrated in color. Gives covering capacities, includes color charts, etc.

JOHNSON'S ENAMEL

Johnson's Perfectone Undercoat and Enamel is the ideal finish for wood, plaster and metal. It will not chip, check, crack, peel or change its color. Gives a beautiful, germ-proof, porcelain-like finish which is impervious to hot soapy water, iodine, ammonia, etc.

S. C. JOHNSON & SON, Dept. PA4, Racine, Wis.
Please send me, free and postpaid, your Instruction
Book on Wood Finishing. The best dealer in paints

here is.....

My Name.....

My Address.....

City and State.....

Fill out and mail coupon for a free copy of
"The Proper Treatment for Floors, Wood-
work and Furniture."

S. C. JOHNSON & SON

"The Wood Finishing Authorities"
Dept. PA4, Racine, Wis.
Canadian Factory—Brantford

SIX AMAZING FACTS

About the Oliver Typewriter Offer

Now Priced at \$49.50

The Oliver would still be selling at \$100, as it is a standard \$100 typewriter in every way, were it not for our new selling method and the resulting increase in production.

We subtract \$50.50 from the usual price because we have found it unnecessary to spend that amount per machine to maintain an enormous force of salesmen and agents, costly branch houses in over 50 cities and other extravagances.

We now deal direct with the buyer, saving you the selling cost. You get the identical \$100 Oliver, our finest and latest model, brand new, and you become your own salesman. This simple way saves you \$50.50.



Over 900,000 Oliviers Sold

\$100 typewriter. Note its simplicity, fine work and speed.

If you agree that it is the finest typewriter regardless of price and desire to buy it, send us \$49.50 cash. Or if you wish to buy on easy installments, the price is \$55, payable as follows: \$3 after trial, then \$4 per month.

If the Oliver does not sell itself, ship it back at our expense. We even refund the outgoing transportation charges, so that the FREE TRIAL does not cost you a penny.

This is the most liberal typewriter offer ever made—and all due to co-operation between maker and buyer. Over 900,000 Oliviers have been sold.

Direct From the Factory

Here is our plan. We ship the Oliver direct from the factory to you, for Free Trial. Use it 5 days as if it were your own. Compare it with any standard

Save \$50.50

There's no need now to pay \$100 for a new typewriter when you can get the Oliver for half. Nor no need to buy any second-hand machine, costing even more than a new Oliver.

Our offer is being accepted by thousands. The very liberality of the offer proves the ability of the Oliver to sell itself. Were it not such a superior typewriter this offer would be impossible.

The coupon brings you EITHER a Free Trial Oliver or Further Information. Neither obligates you in the slightest. Check the coupon now and take advantage of this remarkable saving.

Canadian Price, \$79

The OLIVER Typewriter Company
1094 Oliver Typewriter Bldg., Chicago, Ill.

1
Half Price

2
\$100
Value

3
Free Trial

4
No Money
in
Advance

5
Easy
Terms

6
Brand
New

THE OLIVER TYPEWRITER COMPANY.

1094 Oliver Typewriter Bldg., Chicago, Ill.

Ship me a new Oliver No. 9 Typewriter for five days' free inspection. If I keep it I will pay \$65 as follows: \$3 at the end of trial period and then at the rate of \$4 per month. The title to remain in you until fully paid for. If I make cash settlement at end of trial period I am to deduct ten per cent and remit to you \$49.50.

If I decide not to keep it, I will ship it back at your expense at the end of five days.

My shipping point is.....

Do not send a machine until I order it. Mail me your book—"The High Cost of Typewriters—The Reason and the Remedy," your deluxe catalog and further information.

Name.....

Street Address.....

City.....

State.....

Occupation or Business.....

Actual photo
of one of
our rebuilt
Underwood
Typewriters.



\$3
DOWN

And It's Yours

Standard Underwood

Rebuilt like new. Every typewriter is factory rebuilt by typewriter experts. New enamel - new nickeling - new lettering - new platen - new key rings - new parts wherever needed - making it impossible for you to tell it from a brand new Underwood. An up-to-date machine with two color ribbon, back spacer, stencil device, automatic ribbon reverse, tabulator, etc. In addition, we furnish FREE, waterproof cover and a special Touch Typewriter Instruction Book. You can learn to operate the Underwood in one day.

From factory to you

Yes, only \$3 brings you this genuine Rebuilt Standard Visible Writing Underwood direct from our factory, and then only small monthly payments while you are using it makes it yours; or, if convenient pay cash. Either way, there is a big, very much worth-while saving, too. Genuine new Under-

wood parts wherever the wear comes - genuine standard four row, single shift keyboard - thoroughly tested - guaranteed for 5 years.

\$3 Puts It in Your Home

You don't even have to scrimp and save to pay cash. Instead, you pay only a little each month in amounts so conveniently small that you will hardly

notice them, while all the time you are paying, you will be enjoying the use of and the profits from the machine.

10 Days' Free Trial

Remember, you don't even have to buy the machine until you get it and have used it on 10 days' free trial so that you can see for yourself how new it is and how well it writes. You must be satisfied or else the entire transaction will not cost you a single penny.

FREE TRIAL COUPON

Typewriter Emporium Shipman-Ward Mfg. Co.

2124 Shipman Bldg., Montrose and Ravenswood Aves., Chicago, Ill.
Send by return mail Bargain Offer No. 2123 of a Standard Visible Writing Underwood. This is not an order and does not obligate me to buy.

Name.....

Street or
R. F. D. No.....

City..... State.....

Use Coupon

Now is the time when every dollar saved counts. Let us save you many dollars. Don't delay. Get this wonderful easy payment bargain offer now, so you can send for and be sure of getting your Underwood at a big saving—and our easy terms or for cash.

Act Now—
Send Coupon Today!

**Typewriter Emporium
Shipman-Ward Mfg. Co.**
2124 Shipman Bldg., Montrose and
Ravenswood Aves., Chicago, Ill.



All shipments made direct to you from our big modern factory (shown above) - the largest typewriter repairing plant in the world.