

November  
15 Cents

NOTICE TO READER: When you finish reading this magazine place a 1-cent stamp on this notice, hand same to any postal employe and it will be placed in the hands of our soldiers or sailors at the front. NO WRAPPING—NO ADDRESS. A. S. Burleson, Postmaster General

# POPULAR MECHANICS MAGAZINE

WRITTEN SO YOU CAN UNDERSTAND IT

REG. U.S. PAT. OFF.



See Page 675

Copyrighted material

# HARRIS HOMES



**When You Build The Harris Way**— you build to the *utmost possible* in Quality, Economy and Service. Why? Simply because you profit directly— *immediately*— by our 24 years experience. You get the benefit of our practical knowledge as the *originators* of the "Direct to You" Home Building Industry. We were the *first* to sell Lumber and Material direct to Home Builders at one small profit. We were the *first* to reduce vitally important industry to a *perfect system* and extend the benefits uniformly to the people of the nation. *The splendid Harris Home below has 6 rooms, bath, pantry, large living room, etc. The size is 30x26 ft. A thoroughly modern American Home in every respect.*

**"The Harris Way"** has exclusive merits—special advantages for the shrewd and careful Home Builder, possessed by no other plan or method. It is the best, safest and most sensible way to build your ideal home *right* without sacrifice of quality, or *the waste of a single penny!* Thousands have built "THE HARRIS WAY" with profit and satisfaction.

**Advance in Prices** Our prices are so low that it will be impossible to maintain same for any length of time. They are bound to advance. If you are needing a house, either for investment purposes or for a home, write now. Do not delay another moment if you wish to make a saving.

**The Material** used in building all Harris Homes is prepared by us complete for your use in a way that is instantly and easily understood. It is sensibly cut-to-fit with *absolute accuracy and positive elimination of all waste.* You pay for nothing you do not get—you pay our bed rock low, one-small profit bargain price *only* for what is needed to do the work *right* "THE HARRIS WAY."

**\$10,000,000**

**Capital Stock and Surplus—stands back of our guarantee to every Harris Home Buyer—you cannot lose.**

**Free Book of Plans** Be sure to mail coupon for the latest edition of the famous \$10,000 HARRIS HOME PLAN BOOK (Sent free in U. S. To foreign countries on receipt of 25c). A golden guide to Quality, Service and Economy in building. Explains fully everything about building economy, and how to save \$50.00 to \$250.00 on plans and material.

**\$1089** Buys The Material To Build This Beautiful Home No. 161 — Best Quality Material Throughout—Best Construction—Sensibly Cut-To-Fit.

**CUT OUT AND MAIL**

Harris Bros. Co., Dept. FL7  
Chicago

Please send me free—without obligation—the following books checked. Sent free in U. S. To foreign countries on receipt of 25c.

- Book of Plans
- Paints
- Presto-Up Ready Made Sectional Houses & Garages

Name .....

Address .....



**HARRIS BROTHERS CO. CHICAGO** Dept. FL7, 35th and Iron Sts.



CARUSO

GLUCK

McCORMACK

## Everybody naturally wants to hear the best music

If you had your choice of attending two concerts—the greatest artists in all the world appearing at one, some little-known artists at the other—which would you choose? You would quickly decide to hear the renowned artists who are famous for their superb interpretations. And this is exactly the reason why the Victrola is the instrument for your home. The world's greatest artists make records for the Victor exclusively:

Caruso, Alda, Braslau, Calvé, Culp, de Gogorza, De Luca, Destinn, Elman, Farrar, Gadske, Galli-Curci, Garrison, Gluck, Hempel, Homer, Journet, Kreisler, Martinelli, McCormack, Melba, Paderewski, Powell, Ruffo, Schumann-Heink, Scotti, Sembrich, Tetrassini, Whitehill, Williams, Witherspoon, Zimbalist.

There are Victors and Victrolas in great variety of styles from \$10 to \$400, and there are Victor dealers everywhere who will gladly demonstrate them and play your favorite music for you. Ask to hear the Saenger Voice Culture Records.

**Victor Talking Machine Co., Camden, N. J., U. S. A.**

*Berliner Gramophone Co., Montreal, Canadian Distributors*

New Victor Records demonstrated at all dealers on the 1st of each month

# Victor Supremacy

"Victrola" is the Registered Trade-mark of the Victor Talking Machine Company designating the products of this Company only.

**Warning:** The use of the word **Victrola** upon or in the promotion or sale of any other Talking Machine or Phonograph products is misleading and illegal.

**Important Notice.** Victor Records and Victor Machines are scientifically coordinated and synchronized by our special processes of manufacture, and their use, one with the other, is absolutely essential to a perfect Victor reproduction.

To insure Victor quality, always look for the famous trademark, "His Master's Voice." It is on all genuine products of the Victor Talking Machine Company.



Victrola XVII, \$250  
Victrola XVII electric, \$300  
Mahogany or oak

Please Mention Popular Mechanics

## WHEN HE WAS A BOY (BOY-LIKE) HE WROTE THIS:

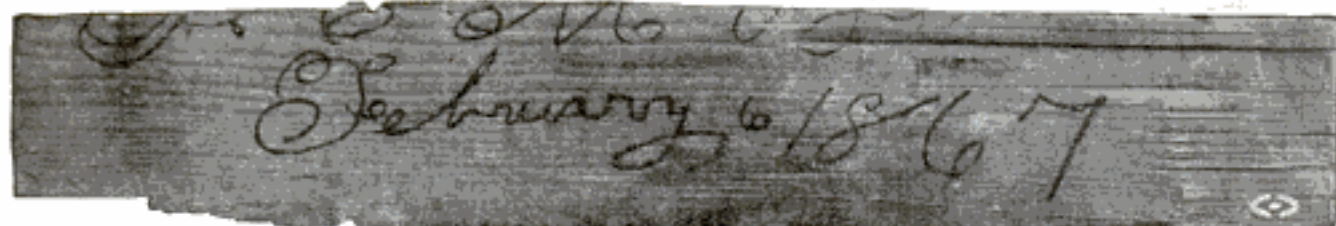

This was when they were shingling their new home, in February, 1867.

## 46 YEARS LATER, WHEN HE WAS A MAN, HE WROTE THIS:

Southern Cypress Mfrs.' Assn., New Orleans, La.

Cotton Plant, Ark., March 5, 1913.

Gents: I send you by this mail a sample of shingles placed upon my old homestead by my father in 1867. The pencil writing on same was done by me at the time the workmen put them on. They have done service from that day to the 2nd day of April, 1912, when they were removed for new building.

I can swear to the above. I was then 11 years old.

Truly yours, A. F. MABERRY.

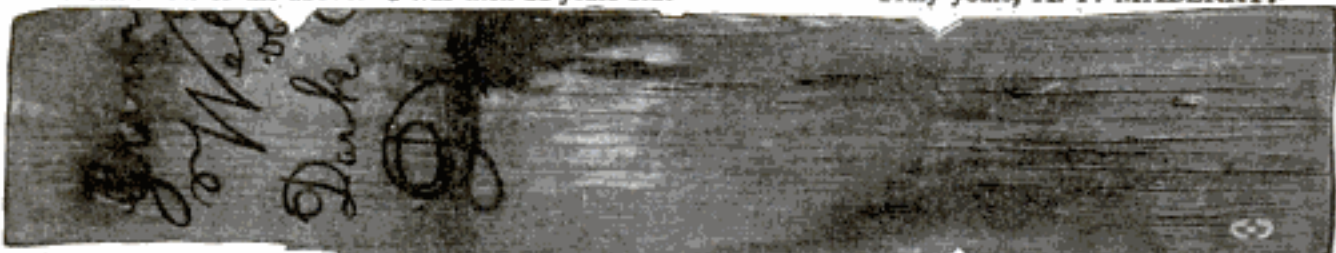

(Pretty Good Record?—with the Cypress Shingles Today as Sound as New.)

**45 years "on the job"—and still sound as a dollar.**

Here is the original of the above letter:

Cotton Plant, Ark., March 5<sup>th</sup> 1913

Southern Cypress Mfrs. Assn.  
New Orleans La

Gents: I send you by this mail a sample of shingles placed upon my old homestead by my father in 1867. The pencil writing on same was done by me at the time the workmen put them on. They have done service from that day to the 2nd day of April 1912 when they were removed for new building. I can swear to the above. I was then 11 years old.

Truly Yours  
A. F. Maberry

**"SOME" RECORD. "SOME" INVESTMENT VALUE. SOME REASON FOR 'CYPRESS' PRESTIGE.** How about writing for Volume 7, the SHINGLE BOOK of the Cypress Pocket Library? Also Volume 36, "Short Cuts to Good Carpentry"—a book for Boys and Fathers.

Let our "ALL-ROUND HELPS DEPARTMENT" help YOU. Our entire resources are at your service with Reliable Counsel.  
**SOUTHERN CYPRESS MANUFACTURERS' ASSOCIATION**  
1219 Hibernia Bank Building, New Orleans, La., or 1219 Heard National Bank Building, Jacksonville, Fla.

INSIST ON TRADE-MARKED CYPRESS AT YOUR LOCAL LUMBER DEALER'S. IF HE HASN'T IT, LET US KNOW.

Please Mention Popular Mechanics

# Popular Mechanics Magazine

6 N. Michigan Avenue, Chicago, U. S. A.

EDITED BY H. H. WINDSOR

England: The International News Co.  
5 Breems Bldg., Chancery Lane, London, E. C.

Australia:  
The Australasian News Co.

ISSUED MONTHLY

SUBSCRIPTION:

SINGLE COPY, 15 CENTS

In United States, and its possessions, Cuba and Mexico, per year, postpaid . . . . . \$1.50  
To Canada . . . . . 1.75  
To all other countries in the Postal Union . . . . . 2.50

All subscriptions are discontinued at expiration. Please examine the date printed on your wrapper.

Entered as Second Class Matter Sept. 15, 1903, at the Post Office at Chicago, Illinois, under Act of March 3rd, 1879.

Entered as Second Class Matter at the Post Office Department, Canada.

Published monthly by POPULAR MECHANICS CO.

Copyright, 1917, by H. H. WINDSOR.

Copyright, in France.

## Contents for November, 1917

Accident in Car Causes Panic and Plot Rumors . . . . .	697
Act, Arrow Shooting, How Filmed . . . . .	664
"Adams, Kate," Ship, Left Far from Water . . . . .	748
Airmen, Here and Abroad, New Equipment for . . . . .	689
America Prepares for War: Cost of Equipping Each Infantryman . . . . .	752
Student Officers Practice with Cold Steel . . . . .	694
To Knit Over a Million Articles for Tars . . . . .	659
American Builds Powerful Aeronautical Motor . . . . .	702
Analysis, Voice, Is Made with New Apparatus . . . . .	653
Answering Railroad Questions by Machinery . . . . .	673
Appliance, Gas, Novel Demonstration Made of . . . . .	753
Armor, Putting Back in the Discard, by E. C. Crossman . . . . .	737
Asylum, New, Considered Escape Proof . . . . .	710
Automobiles, Traffic Law Enforced by Impound- ing . . . . .	730
Automobiles, Two, Lone Motorist Transports . . . . .	714
Awning Shields Radiator from Desert Sun . . . . .	748
Balloonists, Training for War, by R. P. Crawford . . . . .	723
Bible, Big Manuscript, Thousands Help to Make . . . . .	715
Boats, Concrete, France Builds to Save Timber . . . . .	712
Body, Human, Device Records Outlines of . . . . .	646
Borings, Fine Metal, Separated by New Method . . . . .	728
Boy, Armless, Pulls Child from Lake with Teeth . . . . .	660
Boys and Girls, Activities and Interests of . . . . .	760
Bridge Is Painted White as Safety Measure . . . . .	736
Broom, Suction, Sweeps without Raising Dust . . . . .	706
Building, Model Factory, Is Light and Airy . . . . .	662
Burner, Weed, Is Attached to Old Locomotive . . . . .	727
Buttons, Millions of, Required for Liberty Loan . . . . .	700
Cables, Prevent Short Circuiting in Odd Way . . . . .	652
Cableway, Many Uses for in Building Bridge . . . . .	717
Café, Hotel Roof, Has Atmosphere of Steamer . . . . .	735
Camera Device Determines Proper Shutter Speeds . . . . .	655
Camera, Making Motorcycle Serve as Support for . . . . .	721
Car, Crude Horse, Serves Ocean Resort's Needs . . . . .	719
Carrier on Incline Used to Advantage by Builder . . . . .	671
Cars, Huge Sight Seeing, Look Like Dachs- hunds . . . . .	645
Cars, Refrigerator, Icing in California Desert . . . . .	744
"Casco," Stevenson's Boat, War Brings to Light . . . . .	647
Case, New Tennis Racquet, Serves as Press . . . . .	720
Casket, Buffalo Bill's Incased in Concrete . . . . .	701
Chair Can Be Converted into a Crib . . . . .	718
Chair, Hospital, Hinged Back a Feature of . . . . .	758
Chimes, Tower, Tubes Instead of Bells for . . . . .	753
Chimney, Builders' Lights on, Produce Queer Effect . . . . .	698
Civic Features Promote Comfort . . . . .	746

Columns Tested by Underwriters' Apparatus . . . . .	728
Comment and Review, by H. H. Windsor . . . . .	678
Computing, Rapid, Hinged Plumb and Level for . . . . .	672
Concrete, Reinforced, Lay at Reduced Cost . . . . .	714
Conveyor, Cinder, Clears Engine Ash Pit . . . . .	669
Costume, Startling, Taxi Driver's Substitute Has . . . . .	749
Creepers, or Mud Hooks, for Motor Cars . . . . .	753
Cribs, Massive Concrete, Installed by Derrick . . . . .	721
Customhouse, Old, Reveals Early Building Meth- ods . . . . .	665
Derricks, Fifty, Employed in Building Big Dam . . . . .	676
Developer, Chest, Tells Capacity of Lungs . . . . .	756
Dial Shows When Battery Needs Water . . . . .	759
Disaster, San Salvador Recovering from . . . . .	727
Dogs, Estimating the Cost of Feeding . . . . .	654
Drier, Photograph Print, Works Efficiently . . . . .	713
Eggs Canned Like Corn for Table Use . . . . .	733
Engine, Steam, Pulls Train of Log Sleds . . . . .	674
Fender Picks Up Person Hit by Auto . . . . .	712
Field, Athletic, Artistically Arranged . . . . .	800
Films, Romance of Ocean Bottom Portrayed in . . . . .	651
Firemen, Seasoned, Protect New Army Camp . . . . .	701
Flag, Italy's, Romantic Story Added to Lore of . . . . .	668
Flood, Artificial, Used to Move Coal Barges . . . . .	671
Floor, Concrete, Proves Almost Unbreakable . . . . .	658
Flowerpot, New, Serves as Fertilizer . . . . .	716
Flushers, Street, Utilized in Cleaning Sidewalks . . . . .	741
Food, Improved Methods for Drying . . . . .	750
Footboards, Electric, Made for Traffic Police . . . . .	722
Footbridge, Long, to Country Club . . . . .	705
Fountain, Serviceable, for Man and Beast . . . . .	648
Gallantry, Two Navy Men Win Praise for . . . . .	644
Game, New, Prussian Soldier Gets Knocks in . . . . .	759
Gas, Motorcycle Runs on Instead of Gasoline . . . . .	641
Gifts, Christmas, How to Send to Soldiers . . . . .	682
Goggles with Three Ply Lenses for Airmen . . . . .	653
Headlights, Auto, Simple Testing Outfit for . . . . .	736
Heater, Oil, Makes Cement Mixing Safe in Win- ter . . . . .	720
Hogs Solve the Garbage Problem for Denver . . . . .	707
Index, Phone, and Memo Holder Combined . . . . .	759
Inkwell, Tilting, Saves Writing Fluid . . . . .	752
Italy Wins World Honors in Aeroplane Building . . . . .	720
Jackscrew Designed on New Lines . . . . .	742
Kerensky, Russia's Many Sided Leader . . . . .	683
Lake, Japanese, Produces Musical Sounds . . . . .	733
Lathe, Tool Room, Good Features Combined in . . . . .	655
Lathe, Turning, for Aeroplane Propellers . . . . .	646
Light, Nonflare Auto, with Solid Beam . . . . .	756
Lightning Strikes Church and Strips Tower . . . . .	752

(Continued on Page 6)

Popular Mechanics offers no premiums; does not join in "clubbing offers," and employs no solicitors to secure subscriptions. It is for sale by nearly every newsdealer in the United States and Canada.

This One



J9LB-8X3-WKQ5

## [Contents—Continued]

Lights Lend New Beauty to Recreation Spots . . .	661
Lunch Counter, Patrons of, Sit in Street . . .	649
Machine, Branding, Sears Name on Oranges . . .	734
Machine, Stone Gathering, Devised for Farm Use	762
Magazine Feeds Needle to Phonograph . . . . .	758
Magazine Supplies Pipe with Smoking Tobacco . .	711
Meat, World's Supply of, Seriously Depleted . . .	686
Meter, Current, for Use in Harbor Waters . . . . .	757
Mill Exchanges Sawdust for Electricity . . . . .	699
Monument Marks State's First Rural Mail Route	654
Motorcycle Scales Wall by Climbing Wire . . . . .	656
Novelties for the Home and Its Members . . . . .	754
Oilcan, New, Has Two Compartments . . . . .	671
Outfit, Dining, for Autos, New Features in . . . . .	672
Paintings Executed Under the Waves, by R. H. Moulton . . . . .	664
Phone Outfit, for Flier and His Pilot . . . . .	682
Pipe Supplied Tobacco by Magazine . . . . .	711
Poisoners, Outpoisoning the, by E. T. Brondson .	657
Potash Works, War Made, Guarded Constantly	734
Prisoners, Famished, Red Cross to Send Food to	722
Pump, Automobile Tire, with Double Action . . . .	683
Pump, Gasoline, Protection against Short Measure . . . . .	702
Railway Car, Smoking Car in Center of . . . . .	705
Razor, Electric, Operates Like Tiny Clippers . .	716
Reforestation Undertaken in French Mountains .	709
Regulator, Draft, and Weather Vane Combined .	716
Rescue Helpless Colony Abandoned in Pacific .	704
Rescue, Heroic—Armless Boy Pulls Child from Lake . . . . .	660
Reserve, Public Service, for Patriots at Home . .	682
Reservoir, Leaky, Relined with Concrete . . . . .	749
Rugs Extracted from a File by Device . . . . .	733
Ruler, Scale, to Measure Typewriting . . . . .	762
Safe for Home Use Set in Mahogany Cabinet . . .	722
Sand, Contractor Saves Money by Dredging for . .	744
Scenes, Egyptian, Filmed Despite Obstacles . . .	751
Seat, Special, for Two Passenger Cycle . . . . .	718
Sewer, Simple Way of Building in Wet Sand . . .	719
Sharks, Fishermen Profit in Catching . . . . .	687
Ship, Long Stranded on Tropic Sands, Floated .	742
Shoe Shining Outfit, Service and Convenience in	675
Shop, Motor Car Specialty, Operated in Open Air	733
Shops Lighted by Merchants to Make White Way	718
Sign, Changeable, Teaches Safety First . . . . .	731
Sign, "Talking" Electric, of Simple Construction	642
Signal, Ornamental Auto, Has Electric Control . .	729
Signals, Electric Street, for Traffic Officers . . .	706
Signs, Police, Warn Londoners of Air Raids . . .	662
Sled, Powerful Aero, Is Alaskan Winter Car . . .	712
Soldiers, Going "Over the Top" Made Easier for	686
Sounding Outfit Reveals Depth of Railway Fill . .	713
Specialist, Grass Cutting, Has Elaborate Outfit .	742
Springs, Auto Truck, Test with Seismograph . . .	698
Stand for Wrapping Potted Plants . . . . .	759
Station, Ornamental, for Small City . . . . .	749
Steamers, Atlantic, Fitted with Mine Protectors .	740
Submarine, Model, Directed by Wireless . . . . .	715
Submarines, Chilean, Ready for Final Tests . .	678
Submersible, Baby, as Submarine's Lifeboat . . .	757
Swing, Whirling Sea, Bathers Get New Thrills in	670
Telegraphy, Girls Study, Aided by Tiny Trains . .	689
Terminal, Thousands Use During Its Alteration	740
Tire, Trouble Ameliorated by Odd Plan . . . . .	722
Tool, Shipbuilding, Bends Heavy Steel Members	756
Toothbrush, Special, Has Two Sets of Bristles . .	730
Torch, Odd, Infected Area in Hawaii Seared with . . . . .	657
Tractor, Mowing Machine, Is Converted Roadster	660
Tractor, Small Farm, Has Rotary Engine . . . . .	745
Tractor, Small Industrial, Has Double End Control . . . . .	758
Trap, Improved, with Key for Catch Basins . . .	667
Trees Frozen Scientifically with Outfit . . . . .	711
Trophies of Airman Tell Grim Story . . . . .	704
Truck Converts a Rocker into a Wheel Chair . . .	666
Truck Makes Any Auto a Farm Tractor . . . . .	697
Tubes Instead of Bells for Tower Chimes . . . .	753
Turntable, Fuel Station for Autos Has . . . . .	742
Turntable, Motor Driven, in Spraying Booth . . .	712
Vases, Tilted Flower, Held in Wire Frames . . .	653
Vault, Outdoor Safety, for Movie Films . . . . .	731
Vegetables, Canada Puts Restriction on . . . . .	656
Vessel, Passenger, Shoots Columbia River Rapids	729
Visions in the Sky at Przemysl . . . . .	642
War, World:	
By-Products of War for Neutrals and Foes . . . .	696
Fortified Field Posts Abandoned by Germans in France . . . . .	686
France Patrols Sahara with Aeroplanes . . . . .	732
Friendly Thousands Cheer Sammies Abroad . . .	673
Germans Paint Air Craft in Bewildering Colors	736
Huge War Painting Begun by French Artists	685
Impressive Prayer Service Marks Anniversary	692
Italians Employ Unusual Means to Keep War Secrets from Austrian Prisoners . . . . .	690
Movies Sent to Russia to Help Win War . . . . .	674
Naval Photos from Submarine Zone . . . . .	682
Soldiers Kneel at Snow Altar High in Alps . . . .	685
Venice Masks Art Treasures to Save Them . . . .	695
Wheel, Lost, Fails to Stop Sidecar Tour . . . . .	678
Women at New Tasks in World's Work . . . . .	703
Wood Lots, Farm, Great Value of Shown . . . . .	743
X-Ray Pictures Shown in Relief on Screen . . . . .	657

## SHOP NOTES

Blowtorch, Homemade, from Strong Can . . . . .	779
Blueprints, Proper Method of Folding . . . . .	777
Brackets, Angle Shaft Bearing, Fitting to Machine . . . . .	768
Can, Sanitary Shop Refuse, with Pedal Control Lid . . . . .	722
Case, Metal, with External Control for Knife Switch . . . . .	777
Caster, Pivoted Rear, Improves Barrow Truck . .	781
Cellar, Round Storage, for Farm . . . . .	775
Counterbore Ground Quickly from Round Stock .	776
Coupling, Shaft, Quickly Made . . . . .	769
Damper, Stove, Device for Opening Handily . . .	766
Deflector for Bottom of Rock or Gravel Chute .	781
Devices That Add Comfort to Winter Touring . .	767
Display Wheel, Novel, for Show Window . . . .	769
Doors, Cellar, Combined Hinge and Stop for . . .	770
Doors, Small, Quick Method of Making . . . . .	774
Doorstop and Coat Hook, Combination . . . . .	780
Farm, Fertilizing and Irrigating with Muck from Lake Bed . . . . .	763
Flag, Novel Illuminated, Made of Christmas Tree Ornaments . . . . .	779
Grooves, Chipped, Drain Rainwater from Walk Depressions . . . . .	767
Hacksaw, Power, Channel Bars Mitered in . . . .	768
Heater, Hot Air, Protects Water Pipes from Cold	780
Hook for Removing Cap Rings from Piling or Posts . . . . .	770
Lamp, Window, with Revolving Shade Attracts Attention . . . . .	766
Letter Printing Machine, Proof on Made with Carbon Sheet . . . . .	770
Linens, Concrete, Overcome Wear at Turns in Flumes or Troughs . . . . .	782
Machine, Spot Welding, The Electric . . . . .	771
Magnet, Small, Useful, in Woodshop . . . . .	781
Nut, Broken Motorcycle, Repaired on Road . . . .	770
Perforator for Loose Leaf Book Fillers . . . . .	774
Pipe, Small or Thin, Cutting Threads Accurately on . . . . .	764
Platens, Typewriter, Surfacing with Sandpaper . .	770
Plug, Fire, Thawing Out Quickly . . . . .	769
Pockets, Wall, for Storing Rivets and Small Hardware . . . . .	769
Press, A Homemade Paper Baling . . . . .	778
Repair, Cement Bandage on Large Pipes or Cylinders . . . . .	775
Rubber, Hard Sheet, Cutting with Scissors . . . .	766
Salt Shaker, Aluminum, Made into Lens Holder	777
Saws, Old, Provide Good Stock for Tools . . . . .	777
Scratchbrush, Small Wire, Handy in Soldering . .	765
Shaft Hangings and Fittings for the Small Shop .	765
Shingles Set by Gauge on Shingling Hatchet . . .	774
Sign, Variable "Will Be Back," Quickly Made . .	767
Spring, Strong Coil, Replacing . . . . .	769
Springs, Automobile, Simple Device for Lubricating . . . . .	776
Stand, Adjustable Koller, for Pipes, Bars, and Rods . . . . .	776

[Contents Continued on Page 8]

# A Lightning Edge on Safety Blades



A keener edge than you ever felt. An edge that will flash through the stiffest, wiriest hair. Only a few strokes works marvels on any safety blade. You can't fail to get a lightning edge. You can't misuse a Stag Sharpener. A child can sharpen blades on a Stag as well as an expert. Makes old blades better than new. Makes new blades better.

Complete, including unbreakable Trench Mirror, \$1 postpaid to you on this special offer.

**Stag Sharpener**

with barber's hone and strop and Trench Mirror complete, on our money back guarantee

**\$1**

## Protect Yourself

A dull razor is dangerous to health and life itself. The Stag Sharpener is a health protection as well as a positive luxury in shaving. The truest, simplest, quickest, easiest safety blade sharpener on earth.

## Sharpen Any Blade

Positively gives new blades a better shaving edge. Puts the oldest, dullest blades in lightning edge condition. You can never know the delights of shaving with a positively perfect razor edge, until you sharpen your own blades with the Stag Sharpener. The quickest, truest, surest, safest, easiest. The wheels of the sharpener guide the angle. Nothing to adjust. Nothing to get out of order. Practically lasts a lifetime. Our new patented feature makes the Stag more desirable than ever. Stag Sharpeners are used around the world. Complete outfit includes heavily nicked sharpener, barber's hone, strop and Trench Mirror in neat box, suitable for traveler's kit. Complete, postpaid to you only \$1. Send now.



## Trench Mirror FREE

With every Stag Sharpener we will send you a Trench Mirror positively free. Can't break. The Stag Sharpener is the ideal outfit for every soldier and sailor. We have therefore decided to give a Trench Mirror free for a limited time with every Stag Sharpener. If you want the Trench Mirror alone enclose only 35c. It will be sent to you postpaid for only 35c. Send only \$2 for the Stag Sharpener outfit complete with Trench Mirror or for the Trench Mirror only 35c.

## Sent on FREE TRIAL

Try a Stag Sharpener at our risk and at our expense. Use it ten days free. Use it at our risk and at our expense. Then if you are not delighted, send it back and get your money back in full. We gladly assume the risk and welcome your order on this liberal, free trial, money back guarantee. **Send only \$1 today.**

**Hone and Strop Free** With every Stag Sharpener we send a barber's hone and strop

### Dealers

Write to us for special terms to dealers. The Stag is the quickest and best seller on earth. Get the benefit of this advertising and our Dealer Service.

free. It is a part of the Stag outfit. The new patented, simplified improvements in the perfected Stag Sharpener and a new broad-width barber's hone and strop in attractive kit-box, all complete only \$1. Two minutes after you open the box, you can enjoy the first soft, smooth, silent shave with a lightning Stag edge. You will wonder how you ever got along without a Stag. It is the most suitable and welcome Christmas gift for any man. Send only \$1 today.

### Send Today

Enclose only \$1, money order, draft, dollar bill, or check. Send today and make a comfortable shave for yourself. You need a Stag Sharpener. Clip coupon, put in \$1 and get it by return mail.

## The Stag Company

329 Plymouth Ct., Dept. 5243, Chicago

### Special \$1 Coupon

Hone, Strop and Trench Mirror Free

THE STAG COMPANY

329 Plymouth Ct., Dept. 5243, Chicago

GENTLEMEN: Wishing to take advantage of your 10 days' free trial and money-back guarantee, you may send a Stag Sharpener, hone, strop and Trench Mirror complete. I am sending herewith \$1.

Name .....

Address .....

For Trench Mirror alone send only 35c

Don't Delay  
Write Today  
Now!

## LEARN THE AUTO- MOBILE TRADE

at home—spare times

WITH

**Dyke's Working Models  
and Simplified Instructions**

On these models you see the actual operation and learn more than you could from the auto itself—it's easy and quick. An Auto Repairman is not a machinist—his work consists of adjustments and refitting worn parts; "knowing the principle," that's the thing.

IF we PROVE to you that we've actually given instructions by mail and then assisted our students in getting into the automobile repair business—you must admit we can do the same for you.

**WRITE NOW For Dyke's FREE  
32-Page Booklet**

It is interesting and instructive in itself. Learn how you can get all this training for only \$15. The knowledge gained will be worth a hundred times its cost. Fill out below or write a postal—but do it now.

**Dyke's Correspondence School of Motoring  
Box 198, Granite Bldg., St. Louis, Mo.**

Send me your free 32-page booklet about your New Idea Working Model Course and testimonials and proofs. It is understood I am under no obligations in sending for this.

HOW  
TO  
GET INTO  
THE  
AUTO  
BUSINESS  
AND ITS  
OPPORTUNITIES

Name..... (WRITE PLAIN)

Town.....

Street..... State.....

This school is a department of the firm A. L. Dyke, Publisher and Importer. Dyke's system is endorsed by leading motor authorities of the world. SPECIAL INSTRUCTION on Six, Eight, Twelve Cylinder Engines. Electric Starting and Generating Systems Simplified.

## Ridpath's History of the World At a Bargain



Nine  
Big  
Vols.

4000 Pages  
2000 Pictures

We will name our special low price and easy terms only in direct letters to those mailing us the Coupon below. Tear off Coupon, write name and address plainly, and mail now before you forget it. The 32 Free Sample Pages will give you some idea of the splendid illustrations and wonderfully beautiful style in which the work is written. Thousands have already availed themselves of our offer and every purchaser is more than satisfied. Mail Coupon Now.

**FREE COUPON**

WESTERN NEWSPAPER ASSOCIATION (21-17)  
140 So. Dearborn St., Chicago, Ill.

Please mail your 32-page free sample booklet of Ridpath's History of the World, containing photographs of Napoleon, Socrates, Caesar and other great characters in history, and write me full particulars of your special offer to Popular Mechanics readers.

NAME.....

ADDRESS.....

### (Contents—Continued from Page 6)

Stand, Portable, for Janitor's Cleaning Equipment	764
Tackle for Hoisting Heavy Barrels	780
Tool for Grasping Small Machine Parts	764
Washers, Leather Angle, Stop Oil Leakage in Crank Case	775
Winding a Roll of Several Layers at Once	781
Wrench, Adaptable Socket	782

### AMATEUR MECHANICS

Aeroplanes, Model, Egg Beater Made into Winder for	787
Angle Door Stop and Lock at Threshold	798
Armchair, Enamelled, Made of Wooden Strips	780
Automobile, Child's Motorless	783
Automobile, Simple Means of Locking against Theft	794
Baskets, Old Vegetable, Made into Waste-baskets	798
Bottle Caps as Furniture Casters	784
Bracket, Adjustable Bench Light, Made of Pipe	798
Burns, Stove Lighter with Feeding Wick Guards against	787
Camera Shutter, Simple Arrangement for Releasing from Distance	786
Door Check, Pneumatic, Made of Bicycle Pump	795
Door, Screen and Storm, for All Year Use	793
Drawer, Convenient Tool, under Chair Seat	795
Film, Old Photo, Made into Label Holders	798
Flash Light Egg Candling Device	786
Glasses, Wedged Drinking, Parting	794
Grinder, Coffee, Repaired with Rubber Faucet Ring	789
Gun, Crossbow Magazine	786
Heater, Curling Iron	790
Hod, Coal, Made from Iron Pipe	789
Holder, Kitchen Knife and Utensil, Made of Cheese Box	793
Holders, Wire, Keep Cabinet Doors Open	785
Hose, Leaky Gas, Repairing	794
Illumination, Reflected Light, with Homemade Arrangement	788
Incubator Chicks, Stepmother for	790
Jacks, Auto, Rigged Up as Cider Press	792
Laces, Frayed Shoe, Repaired with Pitch or Wax	789
Lamp, Inexpensive Table, Made of Electrical Fixture Parts	785
Latch Hook, Locking Device for, on Gate or Door	785
Lights, Front and Rear, Fitted on Baby Cab	792
Lock, Simple Sash, for Open Windows	799
Monoplane, Model Paper, That Can be Steered	796
Pad, Cardboard Writing and Drawing	790
Pad, Rubber, Aids in Guiding Ruler	792
Paper, Writing, Handy Arrangement of in Box	797
Parting Wedged Drinking Glasses	794
Pennants, Framing Preserves Them as Souvenirs	794
Pens, Writing and Lettering, Grinding	795
Rope, Novel Signs and Numerals Made of	799
Sandpaper Trough for Beveling Instrument Bases	793
Scale, Homemade Beam Balance for Photographic Work	784
Scraper, Snow, Substantial Homemade	799
Shotgun Bead, Shield for, Improves Sighting	790
Skates, Homemade, for Use on Hard Snow	797
Spools, Roll Film, Useful in Economizing Pencils	796
Stand of Shelves Made of Old Disk Records	797
Sulky, Ice, A Motor Driven	791
"Switchboard" Protects Milker from Cow's Tail	788
Trick, Vanishing Cuff, Parlor	785
Tubes, Mailing, Handy Kink in Addressing	786
Ventilation, Thorough, Bedroom Shade and Curtains Arranged for	788
Windows, Red, in Daylight Photographic Work-room	795

## ELECTRICITY TAUGHT

Under Practical Working Conditions

14-day regular instruction in complete equipped laboratories and class rooms. 14-day employment in electrical concerns who are glad to employ our students. No matter what your education, we prepare you for responsible high-salaried positions.

1-year course in Practical Electricity  
2-year course in Commercial Engineering  
3-year course in Electrical Engineering

Write for free illustrated booklet. Mention age, education and course interested in. Fall term just opened. Enter any time.  
School of Engineering of Milwaukee 349 South Building MILWAUKEE, WIS.

Earn  
while you  
learn





# Our 21 Jewel SMASHES PRICES



## Look!

- ☞ 21 Ruby and Sapphire Jewels—
- ☞ Adjusted to the second—
- ☞ Adjusted to temperature—
- ☞ Adjusted to isochronism—
- ☞ Adjusted to positions—
- ☞ 25-year gold strata case—
- ☞ Genuine Montgomery Railroad Dial—
- ☞ New Ideas in Thin Cases.

# Only \$2.50 A Month

And all of this for \$2.50—only \$2.50 per month—a great reduction in watch prices—direct to you—positively the exact prices the wholesale dealer would have to pay. Think of the high-grade, guaranteed watch we offer here at such a remarkable price. And, if you wish, you may pay this price at the rate of \$2.50 a month. Indeed, the days of exorbitant watch prices have passed.

## See It First

You don't pay a cent to anybody until you see the watch. You don't buy a Burlington Watch without seeing it. Look at the splendid beauty of the watch itself. Thin model, handsomely shaped—aristocratic in every line. Then look at the work! There you will see the masterpiece of the watch makers' skill. A perfect timepiece adjusted to positions, temperature and isochronism.

Every fighting vessel in the U. S. Navy has the Burlington Watch aboard. Many have over 100 Burlingtons—a few over 200. This includes every torpedo boat—every submarine as well as the big Dreadnaughts.

## Send Your Name on This Free Coupon

Get the Burlington Watch Book by sending this coupon now. You will know a lot more about watch buying when you read it. You will be able to "steer clear" of the over-priced watches which are no better. Send the coupon today for the watch book and our offer.

### Burlington Watch Co.

19th St. & Marshall Blvd., Dept. 9198, Chicago, Ill.

### Burlington Watch Co.

19th Street and Marshall Blvd.  
Dept. 9198 Chicago, Ill.

Please send me (without obligation and prepaid) your free book on watches with full explanation of your cash or \$2.50 a month offer on the Burlington Watch.

Name.....

Address.....

Please Mention Popular Mechanics

# Every Electrical Man Wants These Books and we ship them for your inspection **FREE**



**10**  
Volumes —  
**3500**  
Pages —  
**4700**  
Pictures —  
**\$1** Per  
Volume —  
**\$1** Per  
Month

**Flexible**  
Covers —  
**Handy**  
Pocket-  
Size  
Volumes

**Just what you need to know to succeed in ELECTRICITY**

Please Mention Popular Mechanics

**E**VERY electrician, every engineer, every mechanic should know about these wonderfully helpful instructive books, which give in plain words a complete working knowledge of electrical engineering in all its phases.

You run into some new electrical

problem almost every day. It may be some trouble that you can't locate, or some electrical principle that you don't know just how to apply. It's up to you to find the right way out. There's no need to spend hours trying to "dope it out," no need to ask somebody else, or do a makeshift job.

The information you need to help you in your every day work is in

# HAWKINS ELECTRICAL GUIDES

These books place electricity at your finger ends. They cover every imaginable subject, principle, theory, problem, trouble, and way of doing things electrically. Every subject is indexed so that you can turn right to it. They are a study course and a reference guide in one, written in plain every day language—no wasted words—only what you need to know—check full of up-to-the-minute electrical knowledge. The guides are a complete course in electrical engineering. They will help you in every detail of the day's electrical work. You can't ask an electrical question that Hawkins Guides can't answer.

## Pocket-Size Flexible Covers

The books are small enough to slip into your coat pocket—handsome bound in flexible black covers. You can carry each volume with you until you have mastered its contents. 3,500 pages of actual information and 4,700 illustrations. Once you see these books and put them into actual use you will never again want to be without them. Try it at our expense.

## SEND NO MONEY

It will cost you nothing to receive these books—to look them over—ask them all the questions you can think of—use them in your work—study them—pick up some information that will increase your earning ability. We will ship you the entire set of 10 volumes **entirely FREE**. This is a sign of our confidence in the guides. Pure gold does not object to being tested. Keep them for seven days and if you do not decide that you can't get along without them, return them to us and owe us nothing. When you decide to keep them you only have to pay \$1.00 down and remit the balance of \$9.00 on the easy payment of \$1.00 a month till paid for.

Use this coupon to get the books. It will pay you many times over.

**THEO. AUDEL & CO.**  
New York, N. Y.  
72 Fifth Ave.



## What Electrical Men Say About—

### Helped Him Make Good

"It is only right for me to recommend highly the Hawkins Guides, for they have been of the greatest assistance to me in placing me in my present position as Superintendent of Construction Department of one of Ohio's largest Electrical Companies. I would like to see every man have a set of Hawkins Guides." Geo. Kuebel, Columbus, Ohio.

### The Trouble With Them

"The only trouble I find with the Hawkins Guides is that everybody is always borrowing them. My set was even borrowed by a high school instructor for reference work in a physics class.

### First Aid

"Number 10 Guide arrived all O. K. and complete the set, which I am very proud of. I don't think it would be possible to find a better set for either the beginner or the professional electrician." Elmer A. Stevens, Fortmasser, N. Y.

### In the Naval Electrical Dept.

"The Hawkins Guides are great help to me in the Naval Electrical Department, which they cover very thoroughly." U. S. Receiving Ship, Brooklyn, N. Y.

### Handy to Carry

"The great beauty of them is that you can carry them in your pocket. That suits me, for I never want to be without them." F. S. Collins, Richardson Engineering Co., Hartford, Conn.

### Saved Him Money

"Hawkins Guides saved me just \$1.50 the first time I looked through No. 10 Book. I had a spark coil played out, and that book showed me how to rewind it; and I made it as good as new. Hawkins Guides are the best ever." H. F. Ramey, Piedmont, Mo.

### Superintendent

"I am now superintendent of the Dunnyville Hydro-Electric System, and Hawkins Guides were a great help to me in holding down a responsible position." W. E. Swartz, Dunnyville, Ontario.

### Even in College

"I am attending Cornell University, but I use the Hawkins Guides every day for general information which I cannot get in recitation work or in laboratory experiments. I'll always speak a good word for the every-ready Guides." J. Winfield Kurta, Joanna, Berke Co., Pa.

### Wireless Operators

"I have worked wireless for ten years—but I wish I had these books years ago, as they have saved me a great deal of trouble." H. Marshall, Steamer M & B No. 2, Walkersville, Ont.

## Read This Partial List of Contents

**No. 1** Contains 348 pages, 388 illustrations. Electrical signs and symbols—static and current electricity—primary cells—conductors and insulators—resistance and conductivity—magnetism—induction coils—dynamo principles—classes of dynamos—armatures—windings—commutation—brushes, etc.

**No. 2** Contains 348 pages, 394 illustrations. Motor principles—armature reaction—motor starting—calculations—brakes horsepower—selection and installation of dynamos and motors—galvanometers—standard cells—current measurement—resistance measurement—operation of meters, etc. wait both meters—operation of dynamo—resistance—watt-meters—

**No. 3** Contains 300 pages, 423 illustrations. Description of systems—wires and wire calculations—inside, outside and underground wiring—sign flashers—lighting problems—rectifiers—storage battery systems, etc.

**No. 4** Contains 270 pages, 379 illustrations. Alternating current—power factor—alternating current diagrams—power factor—alternator principles—alternator construction—windings, etc.

**No. 5** Contains 350 pages, 614 illustrations. A. C. Motors—synchronous and induction motor principles—A. C. commutator motors—induction motors, transformers—losses, construction, connections, tests—converters—rectifiers, etc.

**No. 6** Contains 298 pages, 473 illustrations. Alternating current systems—switching devices—circuit breakers—relays—lighting protector apparatus—regulating devices—synchronous condensers—indicating devices—meters—power factor indicators—wave form measurement—switch boards, etc.

**No. 7** Contains 316 pages, 379 illustrations. Alternating current, selection, location, erection, testing, running, care and repair—telephones, etc.

**No. 8** Contains 343 pages, 435 illustrations. Telegraph—satellite systems telegraphy and telephony—wireless—electric bells—electric lighting—photometry, etc.

**No. 9** Contains 322 pages, 637 illustrations. Car lighting—trolley car operation—miscellaneous applications—motion pictures—gas engine lighting—automobile self-starters and lighting systems, electric vehicles, etc.

**No. 10** Contains 513 pages, 609 illustrations. Elevators—air compressors—electric heat—log—electric welding—soldering and brazing—industrial electrolysis—electro plating—electro-therapeutics—X-rays, etc.

Also a complete 126-page ready reference index of the complete library. This index has been planned to render easily accessible all the vast information contained in the 10 electrical guides. There are over 13,500 cross references. You find what you want to know instantly.

Please submit me for examination. I will be glad to send you \$1.00 within seven days and to furnish the balance of \$9.00 in ten monthly payments of \$1.00 each. This is a cash advance. Please send me your name, address, and occupation.

Name.....  
Address.....  
Occupation.....  
Business Address.....  
Residence.....

Since we have not yet had the pleasure of business relations with you, we shall appreciate your giving us some reference on this matter.

Reference..... P. M. Nov. '17

**THEO. AUDEL & CO.**  
72 Fifth Avenue  
New York, N. Y.



## These are the Hours That Count

**M**OST of your time is mortgaged to work, meals and sleep. But the hours after supper are yours. You can fritter them away on profitless pleasure, or you can make those hours bring you position, money, power, *real success* in life. There is a big job waiting for you—in your present work or any line you choose. Get ready for it! You can do it, through the International Correspondence Schools, without losing a minute from work or a wink of sleep, without hurrying a single meal and with plenty of time left for recreation.

### Make Your Start Now

Everything has been made easy for you; one hour a day spent with the I. C. S. in the quiet of your own home will bring you a bigger income, more comforts, more pleasures, all that success means. Can you afford to let another single priceless hour of spare time go to waste? Make your start right now! This is all we ask: Without cost, without obligating yourself in any way, put it up to us to prove how we can help you—

### Just Mark and Mail This Coupon

#### INTERNATIONAL CORRESPONDENCE SCHOOLS

Box 5617 Scranton, Pa.

Explain fully about your Course in the subject marked X:

- |   |  |
|---|--|
| <input type="checkbox"/> ELECTRICAL ENGINEER      | <input type="checkbox"/> SALESMANSHIP            |
| <input type="checkbox"/> Electric Lighting        | <input type="checkbox"/> ADVERTISING             |
| <input type="checkbox"/> Electric Railways        | <input type="checkbox"/> Window Trimmer          |
| <input type="checkbox"/> Telegraph Engineer       | <input type="checkbox"/> Railroad Trainman       |
| <input type="checkbox"/> Telephone Work           | <input type="checkbox"/> Illustrating            |
| <input type="checkbox"/> MECHANICAL ENGINEER      | <input type="checkbox"/> BOOKKEEPER              |
| <input type="checkbox"/> Mechanical Draftsman     | <input type="checkbox"/> Stenographer and Typist |
| <input type="checkbox"/> Gas Engine Operating     | <input type="checkbox"/> Railway Accountant      |
| <input type="checkbox"/> CIVIL ENGINEER           | <input type="checkbox"/> TRAFFIC MANAGER         |
| <input type="checkbox"/> Surveying and Mapping    | <input type="checkbox"/> Commercial Law          |
| <input type="checkbox"/> MINE FOREMAN OR ENGINEER | <input type="checkbox"/> GOOD ENGLISH            |
| <input type="checkbox"/> STATIONARY ENGINEER      | <input type="checkbox"/> CIVIL SERVICE           |
| <input type="checkbox"/> ARCHITECT                | <input type="checkbox"/> Railway Mail Clerk      |
| <input type="checkbox"/> Contractor and Builder   | <input type="checkbox"/> AUTOMOBILE OPERATING    |
| <input type="checkbox"/> Architectural Draftsman  | <input type="checkbox"/> Auto Repairing          |
| <input type="checkbox"/> Concrete Builder         | <input type="checkbox"/> Mathematics             |
| <input type="checkbox"/> PLUMBING AND HEATING     | <input type="checkbox"/> AGRICULTURE             |
| <input type="checkbox"/> CHEMIST                  | <input type="checkbox"/> Poultry Raising         |

Name \_\_\_\_\_

Address \_\_\_\_\_

Please Mention Popular Mechanics



Here is one of those rare books  
all of us look for and  
seldom find

## LAUGH AND LIVE

This is not a book of jokes; it's a message for all

By Douglas Fairbanks

This splendid book will help you  
to succeed—physically, mentally,  
morally, financially—**GET IT NOW**

Springfield Union says: "If this great inspirational book does not develop into the finest sort of best seller, the American public is losing its taste."

All Bookstores \$1.00 Net  
Postage extra 10 cents

BRITTON PUBLISHING CO., N. Y.

## CIVIL SERVICE

positions are in all parts of the country. Good pay, steady work, life positions, congenial surroundings, promotions on merit, short hours, annual vacation and sick leave with pay. Many thousands appointed yearly. Both sexes. No political pull. Nearly 300,000 classified positions. Common school education sufficient. Full information and questions used by the Civil Service Commission free.

COLUMBIAN CORRESP. COLLEGE, WASHINGTON, D. C.

NATIONAL  
TRADE



DENTAL  
SCHOOL

506 S. Wabash Ave., CHICAGO, ILL.

### LEARN MECHANICAL DENTISTRY—DEMAND UNLIMITED

Earn \$1200 to \$4000 yearly in mechanical dentistry. A big and growing demand everywhere for mechanical dentists—like a gold mine, unexplored. Attend this school any time of the day or evening; be taught individually and learn by actual practice, without book study. Our System, the most complete in the world, is used exclusively in this school. We are constantly called upon to fill high-salaried positions. Why not qualify for one? Be fair to yourself; find out more about exceptional opportunity we offer. Visit the school or write for booklet B.

## 16 Easy Lessons

that teach you everything about automobiles. The book that tells it ALL.

### The Automobile Instructor

By Clyde H. Pratt, II, Sr., M. E., Member Nat'l Society of Auto Engineers. 256 pages, 230 illustrations, cloth bound. Shipping wt., 28 oz.

Now 1917 edition just out. The standard work for home-study, classroom and reference, for amateur and expert. A complete course for all who desire to master this profitable profession.

### LEARN AT HOME HOW TO DRIVE AND REPAIR ALL CARS

Irreplaceable pointers for every car owner, driver, garage man and repair man. Adapted by Cleveland and other Auto Schools and by Boards of Education as their standard text-book. The author will answer your auto inquiries FREE. This book is guaranteed to be just what you want or your money back. (Auto schools, write for quantity prices.)

Price, postpaid . . . . . \$1.50

Shrewsbury Publishing Co., 5525 South Boulevard, CHICAGO, U. S. A.

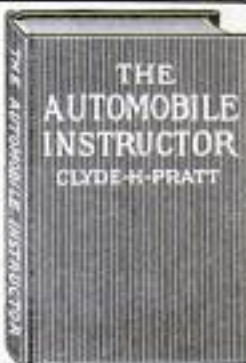

Motor Craft Encyclopedia Illustrated. Tells how to build and operate Motor Boats. Best book on boats. Price, \$1.00.

# Sign The Declaration of your Independence NOW

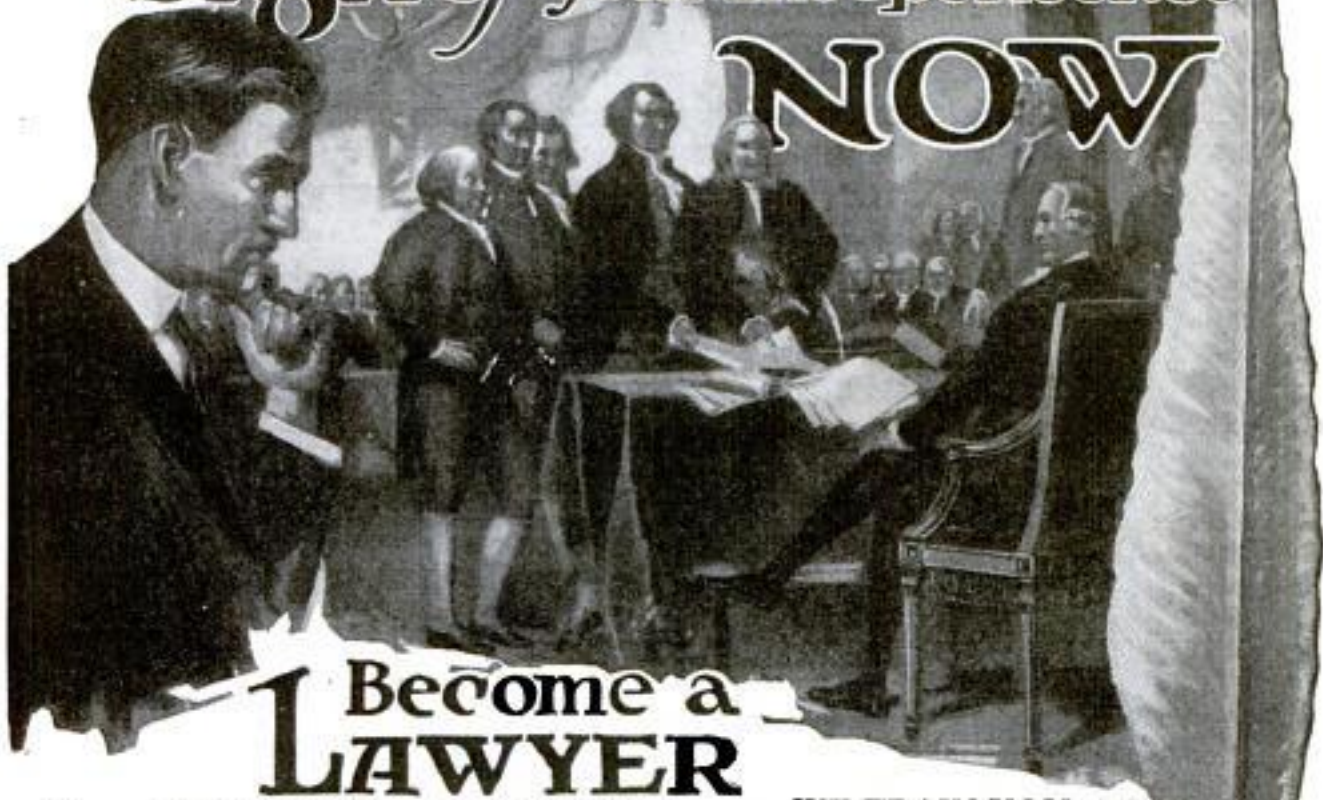

## Become a LAWYER

Law will bring You independence—personal, social and financial. Law is the greatest and grandest of all professions. Law is the greatest maker of great men. Law has raised more men to position, wealth, honor and fame than all other professions combined. Everywhere from the country village to the halls of Congress, lawyers are the leaders. The makers of the Great American Republic—our statesmen, presidents, Cabinet officers, congressmen, ambassadors, captains of industry, politicians, officials of states and cities—nearly all—have been men of legal training. The greatest men of today are—lawyers. Many of these men were born in poverty and obscurity and were raised into positions of great power by the law.

The huge growth of the American Government—the vast increase in business—the endless multiplications of firms and corporations have created new opportunities, not only for thousands of lawyers—but for tens of thousands of legally trained men in the professions and in business. Thus NOW is the time for YOU to start reading LAW.

### Excellence of La Salle Course Recognized

The Law Course of the La Salle Extension University is nationally recognized as standard for correspondence instruction. Unlike the methods of ordinary correspondence schools—you are not required to learn law slowly and laboriously from dry technical books but you are instructed and "coached" by our professors and instructors just as though you were in class taking a costly course at a resident law school. This La Salle System of "Home University Instruction" has been perfected so that you will require nothing more than clear-thinking brains and the ability to read and write English intelligently. You will meet with no difficulties—nothing beyond your capacity to learn—as our instructors and professors will take you step by step—to the day of your graduation—and with the guarantee that, if you fail to pass the Bar Examination in any state, you will be coached without cost until you do pass.

### "We Bring the University to Your Home"

In your home—by our perfected correspondence method, which has won the admiration and approval of the most noted American educators—we give you exactly the same grade of instruction and training that you would receive in class at a resident college of law. From your personal instructor you will receive close detailed supervision, and guidance step by step from one lesson assignment to another—constantly from the day you begin your studies until the day you graduate. You will never be left alone. You will be personally coached, directed, corrected. The daily "Lesson Talks" of your instructor will enable you to grasp and to thoroughly understand the legal principles taught by each lesson. You can write him as often as you wish for special help—and for explanation of points you do not understand clearly. Reply will be immediate. It will be almost like you were with him reading and studying daily.

Determine to become a lawyer—to earn from \$5,000 to \$25,000 or more—a year—you can't go wrong if you follow in the footsteps of the great Americans who have gone before—Sign your declaration of Independence NOW.

#### LA SALLE EXTENSION UNIVERSITY

Dept. 1164 F

"The World's Greatest Extension University"

Chicago, Ill.

### WE TRAIN YOU AT HOME—BY MAIL

By the system of La Salle "university" law training at home you will be enabled to hold your present position—and earn while you learn. The daily lesson assignments and "lesson talks" will make your progress easy. Success is assured. There are no "extras" to buy—we supply everything—including the La Salle Standard Library of Law entitled: "American Law and Procedure," a wonderful work by some of America's most noted lawyers, jurists, judges and professors of the leading law universities—costing over \$50,000 to produce.

### FREE—Complete Course in Public Speaking

No other Course like it. Our training—by mail—will positively teach you the art of persuasive speech. Every Lawyer—every successful man should be a forceful speaker. Our course is highly endorsed as most complete and authoritative—prepared by Frederick B. Robinson, A. B., A. M., Ph. D., Professor Public Speaking at College of City of New York. Formerly, Editor Public Speaking Review. Send coupon and learn how you can NOW secure this valuable course.

La Salle  
Extension  
University,

Dept. 1164 F

Chicago, Illinois

Send at once facts about your free offer of Complete Course in Public Speaking; also free books, "Evidence and Valuable Law Guide."

Name .....

St. and No. ....

City ..... State .....

Please Mention Popular Mechanics

Copyrighted material

# Thousands of Engineers Wanted

These New **STEAM ENGINEERS** With Standard Examination Questions and ANSWERS

Will Fit You for a Good Position All New Editions—Just Published



## Complete Examination Questions and Answers for Marine and Stationary Engineers

By Calvin F. Swingle, M. E. Giving the latest and most approved answers to all leading questions asked applicants for licenses for both Marine and Stationary Engineers. 400 pages. Fully illustrated. Pocket size. Leather, gold stamping, red edges. Price, postpaid . . . . . **\$1.50**



## Steam Boilers, Their Construction, Care and Operation WITH QUESTIONS AND ANSWERS

By Calvin F. Swingle, M. E. A complete instruction book on all types of steam boilers. Special sections on Superheated Steam and Oil Fuel for Steam Boilers. 303 pages. Fully illustrated. Pocket size. Leather, gold stamping, red edges. Price, postpaid . . . . . **\$1.50**



## Swingle's Handbook for Steam Engineers and Electricians

By Calvin F. Swingle, M. E. A practical non-technical treatise on the care and management of Steam Engines, boilers and electric machinery, also gas and oil engines, steam turbines, air compressors and elevators. With questions and answers. 1500 pages. 700 illustrations, bound in leather, gold stamping and gold edges, boxed. Price, postpaid . . . . . **\$3.00**

## Swingle's Catechism of Steam, Gas and Electrical Engineering

By Calvin F. Swingle, M. E. A new instruction book covering all important points on the care and operation of steam boilers, engines, turbines, elevators and electrical machinery, including transformers, converters, and switch boards. Indexed. 180 pages. Illustrated. Pocket size. Leather, gold stamping, red edges. Price, postpaid . . . . . **\$1.50**



FOR SALE AT ALL BOOKSTORES

Send for our large, free catalogue of books for electricians, shop men, railroad men, automobilists, carpenters, builders, sign and scene painters, card writers, etc.

Frederick J. Drake & Co., 1008 Michigan Ave., Chicago

**FREE!**

A flying model aeroplane and all materials to build your own scale model. Free with our great Home Course in the Principles of Aviation. Write at once—before this offer is withdrawn. Learn the Science of Aviation at Home—under guidance of Experts. Tremendous demand for men who know aviation. Wonderful future. Prepare now. Write us today. NATIONAL AERO INSTITUTE, Dept. 9198, Morton Bldg., CHICAGO



## 7 DAYS PARAGON SHORTHAND

In your own home, during the evenings of just one week, you can learn the famous Paragon Shorthand. Then Practice Brings the Speed. Used in Government service (also in Court Reporting). Adopted by cities for High Schools. Wonderfully easy to read. Speed capacity practically unlimited. Positive proof before you enroll. Send for it TODAY. PARAGON INSTITUTE, 522 COLISEUM PLACE, NEW ORLEANS, LA.

# What 15 cts. Will You Bring You From the Nation's Capital

Washington, the home of the Pathfinder, is the nerve-center of civilization; history is being made at this world capital. The Pathfinder's illustrated weekly review gives you a clear, impartial and correct diagnosis of public affairs during these strenuous, epoch-making days. The little matter of 15c in stamps or coin will bring you the Pathfinder 13 weeks on trial. The Pathfinder is an illustrated weekly, published at the Nation's center, for the Nation; a paper that prints all the news of the world and tells the truth and only the truth; now in its 34th year. This paper fills the bill without emptying the purse; it costs but \$1 a year. If you want to keep posted on what is going on in the world at the least expense of time or money, this is your means. If you want a paper in your home which is sincere, reliable, entertaining, wholesome, the Pathfinder is yours. If you would appreciate a paper which puts everything clearly, fairly, briefly—here it is. A dollar bill mailed at our risk will bring you the Pathfinder for a full year, or simply send 15c to show that you might like such a paper and we will send the Pathfinder on probation 13 weeks. The 15c does not repay us, but we are glad to invest in new friends. PATHFINDER, Box 8, Washington, D. C.

## Increase Your Income

Learn Show Card Writing and Lettering



A complete course (32 lesson plates) size 11x15, mailed for \$1.00. Guaranteed to suit you or money refunded if returned at once. Send for descriptive circular.

ALPHA COLOR COMPANY, Inc. 31 E. 125th Street, New York

## FREE BOOK



heads of State Conservatories. Successful 35 years. Play chords at once and complete piece in every key, within 4 lessons. Scientific yet easy to understand. Fully illustrated. For beginners or teachers, old or young. All music free. Diplomas granted. Write today for 64-page free book, "How to Study Music." M. L. Quinn Conservatory, State K X I, Social Union Bldg., Boston, Mass.

## LEARN PIANO!

This Interesting Free Book

shows how you can become a skilled player of piano or organ in your own home, at one quarter usual cost. Dr. Quinn's famous Written Method is endorsed by leading musicians and complete piece in every key, within 4 lessons. Scientific yet easy to understand. Fully illustrated. For beginners or teachers, old or young. All music free. Diplomas granted. Write today for 64-page free book, "How to Study Music." M. L. Quinn Conservatory, State K X I, Social Union Bldg., Boston, Mass.

## WEBSTER'S NEW INTERNATIONAL DICTIONARY

Whatever your question;—be it the pronunciation of a new term; the spelling of a puzzling word; the location of Nigeria, the meaning of tractor, white coal etc.—this New Creation contains a clear, accurate, final answer.

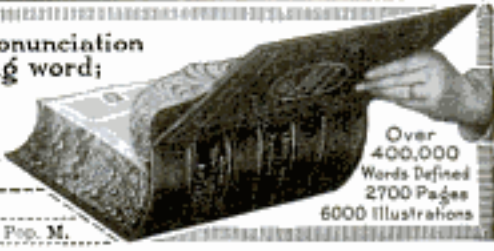

Over 400,000 Words Defined 2700 Pages 6000 Illustrations

Please send me special men pages and FREE POCKET MAPS. NAME \_\_\_\_\_ ADDRESS \_\_\_\_\_

# Short Cuts to Big Pay

## The McGraw-Hill Home Study Courses

Teach practical subjects without the aid of personal or correspondence instruction.

**Machine Shop Practice  
Metal Mining**

**Power Plant Engineering  
Coal Mining**

**Practical Electricity**

All from records of actual practice—written by specialists who are practical men. Any one library sent for 10 days' free examination on receipt of coupon below—NO MONEY DOWN. The demand for technically trained men was never so great as now—and pay envelopes never so fat. You can get your share NOW and be sure of it hereafter by equipping yourself with the information contained in any of the McGraw-Hill Study Courses. The McGraw-Hill method brings you boiled down facts compiled by experts from practical experience. There is no guesswork nor involved mathematics. Each page is clearly written and easily understood. With these books you do not need correspondence instruction. These splendid courses drawn from PRACTICE can be mastered quickly, easily and cheaply, by an hour or less of study each day for a short period. See the coupon for particulars.

### The Metal Mining Library

Study modern metal mining practice with Herbert C. Hoover and six other experts. Covers the whole field of mining from survey of property to the economics of the business itself. 9 flexible volumes splendidly bound. 3081 pages, fully illustrated. Just issued, July, 1917—now taking the mining world by storm.

\$3 per month for 8 months. \$24 complete.

### The Practical Electricity Library

The Home Study Course in Practical Electricity by Radcliffe makes it easy for a man to master electricity from the records of actual practice. No theory or complicated mathematics. No previous training necessary. Used by specialists as well as beginners. 3 volumes, containing 1400 questions fully answered.

\$1 per month for 6 months. \$6 complete.

### Coal Mining Library

The Home Study Course in coal mining will bring you more practical information on coal mining in America than one man could possibly gain in a life time of actual practice. These books make promotion sure. Eight volumes—3000 pages, illustrated. No theory—just facts.

\$2 per month for 8 months.  
\$16 complete.

**McGraw-Hill Book Co., Inc.**  
239 W. 39th St. New York

### Machine Shop Library

The Machine Shop Library supplies a working knowledge of modern machine shop practice which will enable you to qualify for the best paid shop positions in America. Free from theory. Easy to grasp. Thoroughly up-to-date. Nine volumes—3000 pages, fully illustrated.

\$2 per month for 8 months. \$16 complete.

### Power Plant Library

The duties and salaries in the power plant field are increasing daily, and here are rich opportunities for practical men with technical training. Study the whole field under experts who follow the best modern practice. 8 volumes, 3000 pages, illustrated.

\$1 per month for 12 months. \$12 complete.

## SEND NO MONEY — Just the Coupon

Simply sign and mail the coupon—the Library you are interested in will come forward immediately for 10 days' free examination. Small monthly payments. Not one cent in advance. If you want more detailed information concerning the Library you are interested in, send for free descriptive booklets, also kindly mention Popular Mechanics for November.

## FREE EXAMINATION COUPON

McGraw-Hill Book Co., Inc.,  
239 W. 39th St., New York

Gentlemen:—I am interested in the Home Study Course checked below. Please send me this Library, charges paid, for 10 days' free examination.

.....Machine Shop Library \$16

.....Metal Mining Library \$24

.....Coal Mining Library \$16

.....Power Plant Library \$12

.....Practical Electricity Library \$6

If satisfactory, I will send the first month's installment within 10 days and the remainder in equal monthly payments as stipulated above until the full price has been paid. If the books are not what I want I will write for shipping instructions.

Name.....

Home Address.....

City and State.....

Name of Employer.....

His Address.....

Your Position..... (P. M. Nov. '17)



If ever there was a need for trained mechanics in this world's history, it is *right now*. This war is one of mechanics. Mechanics will win it. Everything is dependent upon them.

### What Sweeney Service Means to the Commercial and Military World

From a military standpoint, for every soldier we put in the field, we must have 5 mechanics to back him up. Government and private military schools are crowded, turning away men that want to become officers. Thousands of men want to be aviators, to do the flying. Think a second. Who is going to do the one necessary thing—furnish the mechanics brains and ability to keep

these officers, aviators, and soldiers efficient? It is up to you. If you are subject to draft or want to serve your country, serve as a mechanic. We have millions of untrained men that will make splendid soldiers, but few mechanics.

### Men at Home

your one big opportunity is here. Think of what the taking of these thousands of mechanics from their work at home for army service means. Think of the enormous demand for mechanics, the wages they will get. If there ever was an opportunity, it is NOW. Our farms are calling for tractors and men to operate them. Our automobile factories are stripped of their mechanics and are paying any price to get trained men to take their places. Wonderful crops and greater prices than ever before in the food producing sections of the country, means more automobiles, more men needed to repair and sell them.

### Earn from \$25 to \$75

Can't you realize that your chance has come, right here now, to make big money, to get started in a business where you will be a factor in the big things doing today? Earn from \$25 to \$75 a week. There are thousands of positions open and few men to fill them. Get the training that will allow you to serve yourself and your country at the same time. Patriotism doesn't mean carrying a gun, it means giving your services where they will be of the most use.

**The Military and Commercial Life of This Country is Crying for Mechanics. Do Your Duty by Becoming One.**

### The Sweeney Automobile and Tractor School

realizes the position which this country is in, and has made tremendous preparations for training men in this work. We help our country and help the men who serve our country—you. Learn a trade under the guidance of this wonderful institution that will assure your future. Remember this, that when you get the training as a mechanic, you are giving services to your country both at the front and at home, that the untrained man cannot.

Please Mention Popular Mechanics





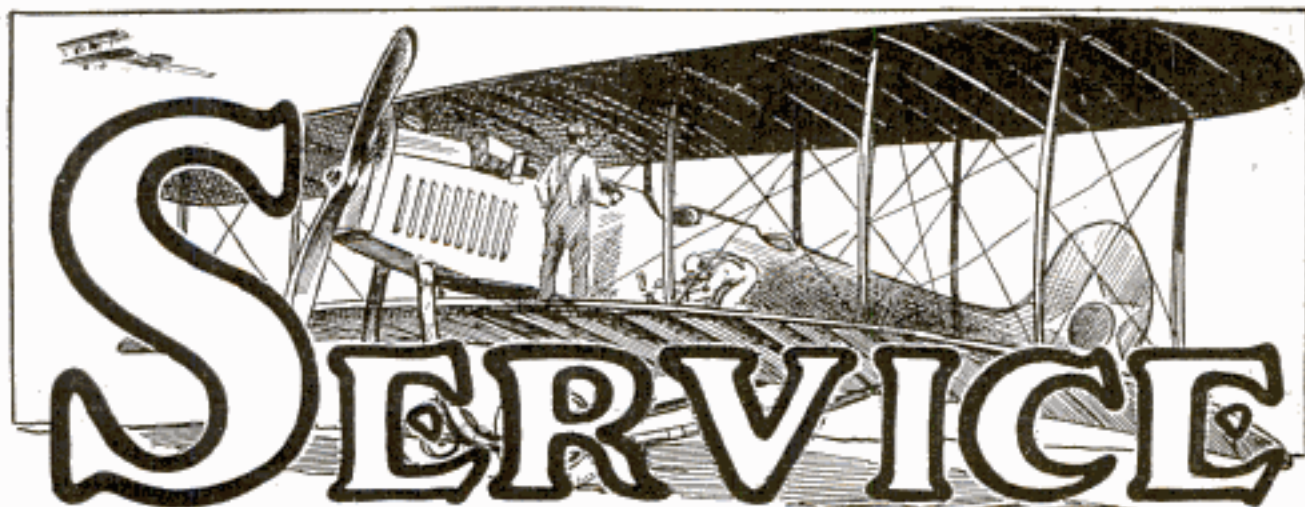

## THE SWEENEY SYSTEM

of teaching the automobile, tractor and aeroplane business, means that you learn by the practical, common sense, actual doing it method. You start in and learn every part, every repair, on the simplest machine to the most complicated. You make your own tools in the forging department, get the technical as well as the practical knowledge necessary on so-called complicated work, such as starters, batteries, and ignition systems, learn Welding, Vulcanizing, thorough machine shop training. On our tractor field we have every popular make of tractor, and you use them under identically the same conditions as will confront you on the farm. In our aeroplane department you learn EVERYTHING about an aeroplane, from the cutting and shaping of the wood used in making the body and the planes, to the covering of the planes, wrapping, testing the motors, motor construction and overhauling, in fact every part of a plane and the uses of it, with the exception of flying. Nothing is overlooked or neglected. Our course is absolutely thorough and practical. We bear the endorsement of the highest authorities in this country.

## \$1,000,000 SCHOOL

One Million Dollars invested in this school and equipment. I have absolutely every piece of equipment necessary to teach the automobile, tractor and truck business, and special work on aeroplanes and aeroplane motors, nothing overlooked. When you learn in this school, you put on a pair of overalls and forget books. You learn by doing, and in a short time become competent to repair everything, from the simplest automobile to the most complicated racing car, ambulance, truck or aeroplane.

## Greatest Demand for Men

We are having the greatest demand for men who understand automobiles, tractors, and aeroplanes, that we have ever had or ever dreamed of having, and as this draft goes into effect, the DEMAND WILL BE INCREASED. We have jobs open for EVERY MAN that is trained. Can't you realize what opportunities you are passing unless you take advantage of present conditions and get a training that will allow you to fill these positions? Get in a business where you can earn real money. Be a man, a business man.

## Write Today for My Catalogue

which describes my school, shows pictures of every department, tells you how you can succeed in this work, tells you the advantages of staying at home if you do not go to the front, shows you what positions you can fill in military life, in fact it is a complete encyclopedia of the mechanic's field of opportunity. No man will ever have an opportunity as great as this one, again. If you are mechanically inclined, you owe it to yourself, you owe it to your natural talents, you owe it to your country, to get the training that will permit you to give real service and help yourself. Learn a trade where you can grow, you can mould your own future.

Write today, because today is the day of opportunity.

E. J. SWEENEY, President

## SWEENEY AUTOMOBILE AND TRACTOR SCHOOL

The World's Greatest Trade School

1169 East 15th Street, KANSAS CITY, MO.

Please Mention Popular Mechanics

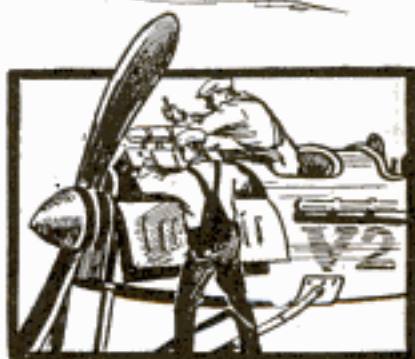

### COUPON

CUT THIS COUPON—MAIL IT TODAY

Sweeney Automobile and Tractor School

1169 East 15th Street, KANSAS CITY, MO.

Mail me your free catalogue.

Name .....

Address .....

## Learn in Spare Time to be a CIVIL ENGINEER!

Earn \$1500 to \$5000 Yearly

Here's your big chance to become a full-fledged Civil Engineer! With this set of books you can fit yourself to make big money, in greatest outdoor profession on earth! Offer fully explained in coupon. Good only within boundaries of U. S. and Canada.

Great Books Shipped FREE

50c a Week if you keep them after 7 days' FREE TRIAL.

Nine big leather-bound volumes; 4000 pages, 7x10 inches, 3000 plates, maps, diagrams, etc. Written by world's greatest civil engineers. Books tell you ALL ABOUT surveying; highway construction; railway engineering; earth work; specifications; estimating contracts; bridge engineering; masonry; reinforced concrete; water supply; sewers and drains; water power equipment; irrigation engineering—etc., etc. Written in simple language—every point made plain.

Consulting Service Free

A \$12 Consulting Membership solves your difficult problems for a whole year, FREE with the set of books.

SEND NO MONEY—JUST THE COUPON



MEASUREMENTS	CONSTRUCTION	CONSTRUCTION	CONSTRUCTION	CONSTRUCTION	CONSTRUCTION	CONSTRUCTION	CONSTRUCTION	CONSTRUCTION	CONSTRUCTION
CIVIL	CIVIL	CIVIL	CIVIL	CIVIL	CIVIL	CIVIL	CIVIL	CIVIL	CIVIL
CONSTRUCTION	CONSTRUCTION	CONSTRUCTION	CONSTRUCTION	CONSTRUCTION	CONSTRUCTION	CONSTRUCTION	CONSTRUCTION	CONSTRUCTION	CONSTRUCTION
MEASUREMENTS	CONSTRUCTION	CONSTRUCTION	CONSTRUCTION	CONSTRUCTION	CONSTRUCTION	CONSTRUCTION	CONSTRUCTION	CONSTRUCTION	CONSTRUCTION

Name.....  
Address.....  
Reference.....

American  
Technical  
Society

Dept. C 1198  
Chicago, U. S. A.

Please send Cyclopedia of Civil Engineering for seven days' examination, express prepaid. I will send \$2.00 within seven days and \$2.00 a month until I have paid \$19.80 or notify you and hold books subject to your order. Title not to pass until fully paid.

## Electrical Engineers

**WANTED** by Light and Power Plants, Railroads and Electrical Manufacturing Companies

\$1800 to \$5000 Yearly Here's your chance to fit yourself for a big job as electrical engineer. Just your name and address on the coupon, brings the books that will help you win success in the Electrical industry.

Shipped FREE This Wonderful 7-Volume LIBRARY OF **ELECTRICITY**

Covers entire electrical field. Simple, practical. 3200 pages—7x10 inches—3000 illustrations, bound in half morocco, gold stamped.

50c a WEEK only \$2.00 a month if you decide to keep them. Coupon explains special offer, good only within the boundaries of United States and Canada.

FREE CONSULTING SERVICE solves your difficult problems for entire year—free with the set—regular price \$12. Rush the coupon.

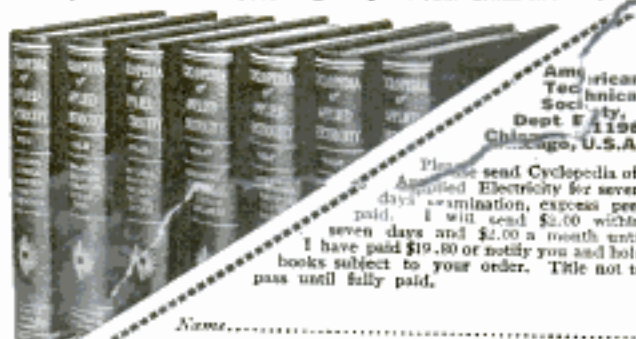

American  
Technical  
Society  
Dept. E 1198  
Chicago, U. S. A.

Please send Cyclopedia of Applied Electricity for seven days' examination, express prepaid. I will send \$2.00 within seven days and \$2.00 a month until I have paid \$19.80 or notify you and hold books subject to your order. Title not to pass until fully paid.

Name.....

Address.....

Reference.....



## Better Your Position

\$125—\$250 A MONTH

Are you under 55? War has taken the youth of the country. Railroads demand Traffic Inspectors—young men, old men, but trained men. \$125 a month and expenses to start. What is a Traffic Inspector? Briefly, he roams the continent in a Pullman to safeguard our lives and his Company's money. He is in a position to grasp opportunities. If he is efficient he is bound to gain positions of trust. Hundreds wanted now. There is no excuse for failure today. This is your chance. You can do this with proper training. F. P. S. qualifies you in 3 months' home study, and arranges for position. Write for explanatory booklet K-2.

Frontier Preparatory School  
BUFFALO, N. Y.



If you are earning less than  
**\$50.00 PER WEEK**

and like to draw — you should study

**COMMERCIAL ART**

Leading Art Managers—the men who know — recommend us and employ our students. We

will guarantee to make you successful — Learn at home in your spare time — or in our resident school — Day or evening. Write for FREE illustrated catalogue. Commercial Art School, 720, 116th St., Michigan Ave., Chicago, Ill.

## Are You Earning Less Than \$3000 Yearly?

If you are,—you're on the wrong job. You're in a rut. Why waste a lifetime working for animal wages,—when it's so easy to get into a Man's Job and earn a Man's Salary?

**Be a Traffic Manager**

Get into a new—clean—fascinating—high salaried—digested profession that assures you a place on Easy Street. Traffic Managers needed everywhere. Field can't be crowded for years to come. A POSTAL BRINGS FULL INFORMATION.

INTERSTATE TRAFFIC SCHOOL 37 TRAFFIC BLDG. FT. WAYNE, IND.

## FREE BOOK ON BANKING

Tells of the great opportunities in this wonderful profession, and how you can learn by mail. Six months' term. Diploma awarded. EDG. W. G. ALGORN Pres., AMERICAN SCHOOL OF BANKING, 490 East State St., Columbus, Ohio.

## STUDY MEDICINE, SURGERY, BACTERIOLOGY, PUBLIC HEALTH, PHARMACY

Standard Day and Night courses. Splendid faculty. Unexcelled facilities. Work-your-way-through plan. Write for catalog. Chicago Hospital College of Medicine, Box C, 3512 Madison Ave., Chicago

## Driver Agents Wanted

Five-Pass., 34" H. P., Drive and demonstrate the Bush Car. Pay for 32 x 3 1-2 Tires. It's out of your commissions on sales, my agents are making money. Shipments are prompt. Bush Cars are second of none. Write at once for my 48-page catalog and all particulars, 1918 models now ready. Address J. H. Bush, Pres., Dept. 1117, BUSH MOTOR COMPANY Bush Temple, Chicago, Ill.

I TEACH  
**Penmanship**  
BY MAIL

I won the World's First Prize for best course in Penmanship. Under my guidance you can become an expert penman. Am placing many of my students as instructors in commercial colleges at high salaries. If you wish to become a better penman, write me. I will send you Free one of my Favorite pens and a copy of the Ransom-erlin Journal. C. W. Ransom, 225 Essex Bldg., Kansas City, Mo.



# WANTED

## —More Salesmen

Never has the demand for City and Traveling Salesmen been greater. Never has the opportunity for ambitious men been better. Sales forces are now depleted owing to the "draft" and enlistments. Increased production has necessitated increased sales forces. **Business firms are calling for more Salesmen.** This is not a war-time demand only. Salesmen are always needed.

### Be a Salesman— Earn \$2,500 to \$10,000 Yearly

The Big Job in business is to sell. Without Salesmen business would be at a standstill. Their services are always the greatest in demand. Their opportunities are unlimited. The more business they secure, the greater their salaries. Let us train you to become a successful salesman—find you a good paying sales position in this uncrowded profession—help you to earn \$2,500 to \$5,000—\$10,000 yearly. Read the letters of men who have made good through N. S. T. A. Training and Service. Thousands of N. S. T. A. Members are now earning big money as salesmen.

### Earn While You Learn

You can become a successful salesman. Study in spare time. Get the necessary training and make good in a big paying sales position. Ours is the one course of practical training that links ability to opportunity and fits you to earn while you learn. It teaches you how to prepare a "Selling Talk"—how to approach the prospect—how to manage the interview—how to close the sale. Employers of salesmen everywhere are calling for N. S. T. A. men. Our Employment Department has constantly on file more requests for salesmen than we can possibly fill.

### Salesmen—Now Selling—Read This

Are you progressing fast enough in the selling field—are you in the \$5,000 to \$10,000 Class? If not, you need more training—more sales coaching—more power to persuade people to purchase your products. You may not have selected the line of goods best adapted to your particular ability—there may be any one of a hundred reasons why you are not one of the big successful men in the selling field today. Investigate our methods and learn how you can increase your income. Hundreds of salesmen having from two to twenty years' experience have used our selling plans and methods—hundreds have increased their earnings from fifty to five hundred per cent.

*We are especially well equipped to accurately and efficiently develop you into the highest type of salesman—just as we did this man.*

### Free Book—"A Knight of the Grip"

Let us send you this valuable 64-page book containing a "History of Salesmanship" and showing you how to become a successful salesman and earn from \$2,500 to \$10,000 yearly. Send the coupon and we will also send you a special list of the many lines of business in which good positions are open for salesmen. Address nearest office. Department—125.

National Salesmen's Training Ass'n. Dept. 125  
Chicago—San Francisco—New York

#### Experienced Salesman Testifies

"For several years I had been working as a salesman. Was unable to make headway. Your selling plans and methods showed me how to "approach" and "close." Am in the \$5,000 a year class. All firms should have their salesmen learn and apply your methods."—C. G. Knight, 538 W. 124th St., New York, N. Y.

#### Earns \$375 a Month

"For ten years I worked for a railroad. Was drawing \$75 a month when I left. You secured me my position. I have earned \$375 in a month. Success would have been impossible without your help."—E. C. Kisler, 2121 Andrews St., Rockford, Ill.

### MAIL THIS COUPON (Send your request to the office nearest your home)

National Salesmen's Training Ass'n. Dept. 125  
Chicago—San Francisco—New York

With no obligation on my part, please send me your illustrated book, "A Knight of the Grip," and list of lines in which positions are open.

NAME.....

ADDRESS.....



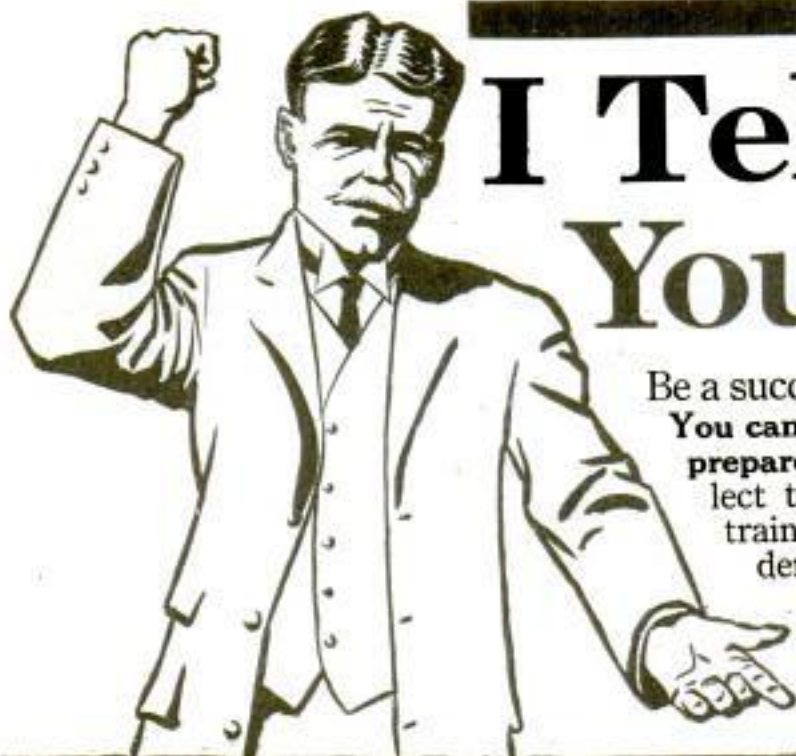

# I Tell You You Can!

Be a success and command big pay. You can easily do it if you will **only prepare yourself!** Why will men neglect to prepare themselves, when trained **Electricians** are always in demand at big pay? When employers are **searching** for \$3,000 and \$10,000 electrical men, while this country is crowded with poorly-paid men who could easily qualify for these positions!

## \$50 to \$200 a Week

As a Trained

# ELECTRICIAN

If you have a common school education you can easily qualify **at home** by my new Course in Electricity, no matter if you know nothing at all about electricity now. My Course, while complete and absolutely scientific, explains everything so clearly that any one can understand it and do the work. But this Course is designed to give you a **real** Electrical education, to help men become **bigger, better men**—men who can command big pay.

And remember, I give every student a **GUARANTEE BOND** which insures you satisfaction or every dollar of your money refunded. I can make such a guarantee because I know my Course and what it does for my students. Send for free illustrated book telling all about it. **PART OF YOUR SPARE TIME** devoted to this interesting work is all that is needed. You will find it most fascinating, and in a short time your earning power will be greatly increased.

## \$17<sup>00</sup> Electrical Outfit Free:

Every student who enrolls with me now gets a \$17.00 outfit of electrical equipment, instruments and material—**FREE**; also my Quick Money-Making Electrical Course **FREE** as soon as enrolled, so that you can earn while learning; you also get **FREE** Employment Service; **FREE** 5-year Advisory Service. And besides all this I have a pleasant and **truly valuable** surprise, for every student who answers this ad. Send in coupon now.

**You have one life to live**—and time is passing. Make the most of it. Prepare for success. Aim high; you can hit the mark if you will only **try**. **Do it! Tear off the coupon now!**

## CHIEF ENGINEER

L. L. COOKE

Chicago Engineering Works  
448 Cass Street, CHICAGO, ILL.

**CHIEF ENGINEER**  
Chicago Engineering Works  
448 Cass St.  
Chicago, Illinois  
Without obligation on my part kindly send at once, fully prepaid, particulars of your complete Practical Home Study Course in Electricity.

Name.....

Address.....

Town..... State.....

USE THIS FREE "OUTFIT" COUPON

# CLASSIFIED ADVERTISEMENTS

WORLD'S BEST WANT AD MEDIUM

We have records to prove that a classified ad in these columns will find a buyer for almost anything which can be sold. Doubtless you have some article of value to some one else which you no longer need. Why not turn it into money?

Advertisements in this section, 18 cents per word, each insertion, minimum 10 words, payable in advance. To be inserted under proper classification in the December issue, copy should be in our office October 25th.

Popular Mechanics Magazine, Chicago, Ill.

Gentlemen: We desire to express our satisfaction with the results obtained by our classified advertising in Popular Mechanics Magazine. On a small outlay of \$7.50 we received 255 inquiries, and immediate deals which totaled \$500.00, and the ad is still pulling. You surely cannot beat this record; in fact, it is the finest showing of any of our ads in any magazine. Trusting you meet with the success you deserve with your excellent advertising medium, we beg to remain Yours very truly,

BASS CAMERA COMPANY.  
Charles Bass.

## AUTOMOBILES

**AUTOMOBILE Repairs**—Automobile owners. Garages and Repairmen should subscribe for the Automobile Dealer and Repairer; 150-page illustrated monthly devoted exclusively to the care and repair of the car. The only magazine in the world devoted to the practical side of motoring. The "Trouble Department" contains five pages of numbered questions each month from car owners and repairmen which are answered by experts on gasoline engine repairs. \$1 per year; 15c per copy. Canadian subscription, \$1.55. Postals not answered. Charles D. Sherman, 50 Windsor Road, Hartford, Conn.

**PAINT your own car for \$5.** Use it next day. Nine colors. Free booklet "B" and color card tells how. Autamel Company, Rochester, N. Y.

**"LOCATING motor troubles,"** valuable information for motorists, 10 cents. John O'Leary, 1922 Harlan St., Philadelphia, Pa.

**"SELF-VULCANIZING"** Rubber 25c; luminous paint 25c (prepaid). Crown Chemical Co., Anderson, Indiana.

**INVENT Something,** your ideas may bring wealth; free book tells what to invent and how to obtain a patent, through our credit system. Talbert & Parker, 4657 Talbert Bldg., Washington, D. C.

**GET into the Automobile business,** as salesman, chauffeur, garage manager, mechanic. Automobile instruction in four weeks' residence course. Send for booklet P. M., West Side Y. M. C. A. Auto School, 318 West 57th St., New York.

**CYLINDERS** reground, new pistons and rings fitted. Restores lost power. Write for prices, giving make and model. The Evans Machine Co., Hartford, Conn.

**PATENTS** for Automobile Improvements are in great demand. We have special Automobile Department in charge of experts who are in touch with demands of trade. Write for "What To Invent and List of Patent Buyers," sent free. Victor J. Evans & Co., 158 Ninth, Washington, D. C.

## AUTOMOBILE SUPPLIES

**STOP!** That dangerous leak with Radiator Stop-Leak Compound, 3 oz. can 25c—6 oz. 46c—8 oz. 50c. Mailed post-paid on receipt of price. This compound guaranteed or money refunded. Prices to jobbers and dealers on request. Radiator Stop Leak Compound Co., 7121 So. Artesian Ave., Chicago, Ill.

**AUTOMOBILE Owners**—Garages—Make your own Automobile Polish—sell to others—90% profit—sells fast—easily made. Mail \$2.00 for formula. Rexoil Polish Co., 2602 Market St., Wilmington, Del.

**GEARS** for all purposes: transmission gears, bevel-drive gears, sprockets, axles. Special machine work. Must have old parts or drawing. Turley Gear Plant, 1505 N. 10th St., St. Louis, Mo.

**HEAVY Car Type Non-Skid Tires,** 30x 3 1/2, only \$19.45. National Cut Price Tire Co., St. Ignace, Mich.

**JUST Out**—Modern Starting, Lighting and Ignition Systems—A new book on automobile electricity without an equal. Nearly 400 Pages, 250 Engravings. Cloth. Price \$1.50 postpaid. Complete description sent on request. Popular Mechanics Book Dept., 6 N. Michigan Ave., Chicago.

**HERCULES Carbon Remover,** equals 9c gasoline. Sample 15c. G. W. Ashton Co., Clinton, Iowa.

**AUTOMOBILE Parts** for most all makes of Cars: Buicks, 16, 17, 19, 27, 29, 25, and 39. Maxwells, E. M. F., Flanders, Paige 25 and 36. Overlands 27, 38, 42 and 52. Cadillacs '09 to 1912. Parry, Regals, '09 to 1913. Oakland, Jeffery, Mitchells '07 to 1913. Empire, Elmora, Chalmers '09 to 1913. Auburn, Jackson 35. Interstate, Hudson 20 and 35. Hupp 23, Ohio, Staver, Marion, Cole, Moline, Stearns-Knight, Rambler, Howard, Thomas, Imperial, Lexington, and many others. Pistons, connecting rods, cam shafts, crank shafts, cylinders, axles, bearings and gears for most any make of car. Write us your needs. Satisfaction guaranteed. Auto Parts Company, 4116-18 Olive Street, St. Louis, Mo.

**MOTORISTS** save money and avoid profanity using "Glide" in those cold, hard-starting engines. Endorsed by engine experts as gasoline saver and carbon preventative. On sale two years. Nationally advertised. Fine Dealers proposition. One Dollar can prepaid coinless. If not sold in your locality write today. "Glide" Mfg., Galesburg, Illinois.

**A JOKE** on the Spark Plug. Pronto Spark Gaps, patented, will fire any Plug, any condition. Our wonderful new combination Plug and Gap, now ready. Convincing demonstration. Everybody welcome, write us. Pronto Manufacturing Co., Omaha, Nebraska.

**AUTO Tops** at one-half usual price. Fit any car. Prices \$8.25, \$8.30, \$11.50 without frame. One-man Tops complete \$28.00 and up. Seat covers for Fords \$8.25, \$11.50, \$12.25 up. Overlands \$9.25, \$12.00, \$18.25 up. Buicks \$8.25, \$10.50, \$18.25 up. Others similar prices. "Frost King" Asbestos Insulated Radiator and Engine Covers \$2.75, \$3.25, \$5.00 up. Repair broken light in ten minutes with "841k-tite" Window. Our local representative will give you expert advice free and save you money. Write for his address, free catalog and samples. Limited territory still open for a few more exclusive agents. Write, The Cincinnati Auto Specialty Co., Dept. MA 117, Elm St., Cincinnati, Ohio.

**DOUBLE Service Tires.** Guaranteed to give good service. Size, 30 x 3, \$5.50; 30x3 1/2, \$6.40; 33x4, \$8.80; 34x4, \$9.90; 36x4, \$9.90; 36x4 1/2, \$11.00; 36x5, \$12.10; 37x5, \$12.10. Non-skid \$1.00 extra. 10% discount on all C. O. D. orders. State if Q. D., straight side or clincher type. 5% special discount to dealers. I. Jaffess, 1319-5th Ave., New York. Branch—241 West 54th St., New York.

**\$25.00 TAKES** small front and rear axle with 28x3 wire wheels. Rear axle has sliding gear transmission. Suitable for building small car. H. M. Robinson, 1436 Wash Ave., Chicago, Ills.

**AUTO Motors**—4-cylinder, water-cooled, \$35.00 up. Buick 10-24-30 and 17. Mitchell-Everett 30—Hup 20—Flanders 20—Continental and Buda motors all sizes. Johnston, West End, Pittsburgh, Pa.

**TIRES**—At Wholesale; send at once for our price list of first quality guaranteed tires and tubes. We ship C. O. D. subject to examination without one cent deposit. Overton Tire Co., Box 5, Gelweir, Ia.

**MAGNETOS**—Bosch, all sizes and types, \$10.00 up. Remy and Spilldoerf \$3.50. Coils—Steering Wheels—Auto accessories all kinds. Write for list. Johnston, West End, Pittsburgh, Pa.

**AUTO Top Roof Covers** Save you two-thirds price of new top; tailored to fit any car; easy to apply; \$6 to \$15, parcel post paid; seat covers \$5 and up; catalog and samples free. S. & H. Top Co., 439 Hunt St., Cincinnati, O.

**INSYDE Tyres,** inner armor for Automobile tires, double mileage and prevent punctures and blowouts. Quickly applied. Cost little. Demand tremendous. Profits unlimited. Details free. American Automobile Accessories Co. Dept. P2, Cincinnati, O.

**VULCANIZE** auto tires. Make big money. Learn with our book \$1.00. Vanderpools, Springfield, Ohio.

**TRUCKS**—Double Tread Guaranteed for good service. Absolutely Puncture-Proof. Big—Strong—Extra heavy. 30x3 tire, \$5.00; 30x3 1/2, \$6.00; 33x4, \$9.00; 34x4, \$9.25; 36x4 1/2, \$12.00; 37x5, \$13.00. Big saving on other sizes and tubes also. Trade in your old tires. Discount to dealers. 10% deposit required on C. O. D. orders. Send for list now! State size and bead of tire. Max Liben & Co., 205B West 48th Street, New York.

**BIG Profits** HB Battery Charging. City current to operate. Hobarts, Troy, Ohio. Easy Payments.

**VULCANIZE** your own tires; save money; full particulars free. Superior Vulcanizer Co., 16B Fulton Ave., Rochester, N. Y.

## FORD ACCESSORIES

**STATE** representatives wanted—Ford Lighting Systems. Croft Electric Co., Toledo, Ohio.

**BRIGHTLITE** slow speed 50c. Dimmer \$1.50. Roco Engineering Co., Anderson, Ind.

**NEW 300-page** book on the Ford car for every Ford owner, dealer and repairman. Deals fully with construction, operation and repair. 160 engravings. Best and most complete Ford book published. Price, \$1.00 postpaid. Also Ford Engine Chart, 25x38 in. Location of engine troubles made easy. Price, 25 cents postpaid. Popular Mechanics Book Dept., 6 N. Michigan Ave., Chicago.

**DUBOLITE** and Dimmer, doubles both lights on Ford car also dimmer that complies with any state law. Price \$4.00. Dealers wanted. Handy Dimmer Co., 15-17 Library St., Grand Rapids, Mich.

## TO FORD OWNERS

**THE Ford** dimmer dims or brightens the headlights; most practical, convenient, easiest installed. Fully guaranteed \$1.50. Illustrated circular free. Detroit Novelty Mfg. Co., 590 Marquette Bldg., Detroit, Mich.

**SUNLIGHT System**—Fine night light at all speeds. Connected in five minutes. Complies with dimming laws. Big profits for agents. Guaranteed \$1. Sunlight System, 630 Lakeside Ave., Chicago.

**SPLENDID** up-to-date Roadster or Speed Bodies for Ford. Exceptional bargain. J. C. Edwards, Box 216, Aurora, Ill.

**I-H FORD** Gasoline Saver, \$3.50. State Distributors Wanted. No bonus asked. Lincoln Holland, Los Angeles, Cal.

**THE Ford** alarm—Horn button on gasoline control lever right under your finger. Safety and convenience, \$1.00. Circular free. Detroit Novelty Mfg. Co., 590 Marquette Bldg., Detroit, Mich.

**WONDERFUL** Ford Starter. Hand-lever, Foot-lever and spring combined; Spins the Engine. Big Success. Get State or Local Agency Quick. Three-Power Lever Starter Co., Davenport, Iowa.

BE our agent. Buy a Safety Ford Starter for \$5.00. Retail for \$15.30. Try one, write for particulars. Safety Ford Starter Corporation, Columbia Theatre Bldg., New York.

FORD Tops \$17.00 to \$24.00. Seat Covers \$4.80. Top Coverings \$5.50. Commercial Bodies \$11.40. Radiator Covers \$1.80. Write for prices. B. & S. Co., Station V., Cincinnati, Ohio.

WANTED—One responsible Ford owner or dealer for exclusive sale G. and G. Hand-Warmer. Canada patent for sale or manufacture on royalty. Lloyd Garringer, El Paso, Texas.

FORD Top Roof Cover \$6 and up. Easy to apply. You save two-thirds price of new top. Seat covers \$5 and up. Samples and catalog free. S. & H. Top Co., 429 Hunt St., Cincinnati, O.

PEUGEOT type Ford speedster, lifsize patterns, blueprints, instructions, \$5. Photographs 10c. Peugeot-Ford Speedster Pattern Co., Onarga, Ill.

LOCK your Ford securely for less than one dollar. Write for circular. Brackbill, 1307 McFerran St., Philadelphia.

SLEEP in your Ford in McMullin Auto Bed, \$8.50. Other small cars \$10. Free booklet on auto camping. Auto Bed Company, Box 9, Belingham, Wash.

#### MOTORCYCLES, BICYCLES & SUPPLIES

GET your Motorcycle or Bicycle at your price. Motorcycles \$25.00 up. Bicycles \$3.00 up (Guaranteed). Parts for all motorcycles and bicycles carried in stock; repairing. Send for big Bargain Bulletin. American Motorcycle Co., Chicago.

DON'T buy a Bicycle Motor Attachment until you get our catalogue and prices. Shaw Mfg. Co., Dept. 27, Galesburg, Kans.

MOTORCYCLES: Henderson Four Cylinder Police Machines, excellent condition, equipped, \$135.00. Indian Magneto Model \$40.00, Excelsior \$35.00, Harley-Davidson \$35.00, Emblem \$30.00, Haverford \$25.00, New Deluxe Cycloar Motors \$65.00 complete. Tires and accessories cheap. Write for latest Bargain Bulletin. Anything unsatisfactory exchanged. W. E. Waudersee Company, 1561 Woodward Avenue, Detroit, Mich.

OVERSTOCKED—100 Used Motorcycles, all makes, must be sold at once. Write for our latest catalog. Myerow Bros., 149 Berkeley St., Boston.

FOR Sale—Smith Motor Wheel—New—\$50—or next best offer. Davidson, 630 Maple, Galesburg, Ill.

35 NEW and used Indian motorcycles at a sacrifice, to close estate. Write for list. Albert Hanson, 212 Shakert Bldg., Kansas City, Missouri.

INDIAN Twin—equipped. Perfect condition. Will sacrifice. Rural 50, Webster, Mass.

MOTORCYCLES, Side Cars and Cyclecars. Their Construction, Management and Repair—The only complete work published on this subject. The dealer, mechanic and rider will find this an excellent treatise. 550 pages, cloth, 350 illus. Price, \$1.50 postpaid. Complete description sent upon request. Popular Mechanics Book Dept., 6 N. Michigan Ave., Chicago.

BARGAINS: Send today for our bargain bulletin No. 6. It describes in detail over 75 slightly used motorcycles, of all makes from \$25 up. We will also send you a rebate slip allowing you 5% on any machine bought from us this month. Now is the time to buy a slightly used motorcycle. We will hold any machine selected this month until wanted on payment of small deposit. Write now for rebate slip and bargain bulletin. Gotham Sporting Goods Co., 57 Warren Street, N. Y. City.

HARLEY-DAVIDSON \$30. The single 5 H.P. \$15. The twin \$89. De Luxe 9 H.P. \$85. Excelsior twin \$75. Indian twin \$75. Indian 2-sp. twin \$140. De Luxe twin \$30. Send for our complete list. C. H. Lang, 1704 Michigan Ave., Chicago, Ill.

1917 EAGLE Motorcycles now ready. Get circular M11 and agency proposition. Eagle Motorcycle Co., Brockton, Mass.

BARGAIN—1916 3-speed spring frame, powerplus Indian. A-1 condition. \$150. J. Werckle, 216 Gilbert St., Peoria, Ill.

MOTORCYCLES, all makes. Harley-Davidson, Indians, Excelsiors, Thors, Reading Standards, Flying Mercks, Cleveland Lightweights, all prices. Write for descriptive catalogue 8-B with pictures. Carl W. Bush Co., 518 Broad Street, Newark, New Jersey.

EASY Terms on new and rebuilt motorcycles, side cars, tandems, and lighting outfit. Motorcycle Investment Co., Brockton, Mass.

NEW Dayton Motor Bicycle—Clutch—Excellent condition—Run under 500 miles. \$89 cash. George Johnston, Langdon, North Dak.

HARLEY-DAVIDSON, three speed, electric equipped, 1916 model, absolutely guaranteed, \$225. Wm. Brand, New Hampton, Iowa.

I SAVE you half on parts and accessories for all makes. Jones, "The Parts Man," Box 491, Brockton, Mass.

BIG bargains in second-hand motorcycles, \$25 up. Indians, Harleys, Thors, Excelsiors and Mercks. Write for description. Howard A. French & Co., Baltimore, Md.

BIG bargains in good motorcycles we have taken in exchange on new ones! Send for special bargain list. Shaw Mfg. Co., Galesburg, Kansas.

BARGAINS in used motorcycles—all machines guaranteed and in A-1 condition ready for use. Write for terms and new bulletin. Photos free. Harley-Davidson Sales Company, Birmingham, Alabama.

MOTORCYCLE cylinders reground, fitted with new piston and rings, \$3.00, guaranteed. Muncie Piston Co., Muncie, Ind.

LARGE stock of rebuilt motorcycles, new parts for all makes 25% discount; second-hand parts, good as new, 50% discount. Motorcycle Parts Mfg. Co., Chicago.

WANTED: We pay cash for used motorcycles or take them in on exchange for new machines. Write with complete description, State condition of tires, frame, motor, make and model. Shaw Manufacturing Co., Dept. 157, Galesburg, Kans.

#### WELDING

DON'T Scrap Aluminum Parts. Save them with So-Luminum. New, great "3 in 1" brazing, welding and soldering compound, stronger than aluminum—perfect substitute for acetylene welding in 1/2 time and cost. Use gasoline torch or gas blower. No flux. Booklet 12. Sample bar \$1.00. Used by United States Army and Navy, endorsed by British Munitions Board. So-Luminum Manufacturing Company, 1790 Broadway, New York.

WRITE for particulars on Oxyacetylene Welding and Cutting Apparatuses and Acetylene Generators. Supplies of all kinds. Agents wanted. Hamilton Welding & Mfg. Co., Hamilton, Ohio.

WELDING—Automobile Welding with the Oxy-Acetylene Flame—Just Out—167 pages, fully illustrated. Price, \$1.00 postpaid. Explains the actual welding of all automobile parts in a manner understandable by everyone. Popular Mechanics Book Dept., 6 N. Michigan Ave., Chicago.

OXY-ACETYLENE Welding and Cutting, Electric and Thermit Welding. Brand new book of practical instruction in this process. The workman will find all necessary information for handling any kind of welding. 215 pages, fully illus. Cloth, \$1.00; Leather, \$1.50 postpaid. Popular Mechanics Book Dept., 6 N. Michigan Ave., Chicago.

SIMPLE Soldering, both hard and soft—82-page booklet telling how to join metals. Do your own repairing. 52 illustrations. 25c postpaid. Popular Mechanics Book Dept., 6 N. Michigan Ave., Chicago.

WELDING Plants \$25.00 to \$300.00. Designed for all purposes, small cash payment, balance three to six months. Every mechanic or shop should have one. Bermo Co., Omaha, U. S. A.

#### AERONAUTICS

LEARN Practical Aeronautics in genuine airplane factory. In my school students actually build Military type tractor biplanes. Pay part tuition upon enrolling and remainder when you have secured position paying \$10.00 a day. Write for this offer. Bud Morris Airplane & Motor School, 2843 Broadway, Chicago.

GET our latest Aeroplane Book containing full information about "Ideal" Model Aeroplanes, parts, plans, etc. 5c postpaid. Ideal Aeroplane Co., 82 1/2 West Broadway, N. Y.

MODEL Aeroplanes, material and supplies. Compressed Air Motors. Practical course in Aeroplane construction. Send 5c for catalogue. Wading River Mfg. Co., 550 Macon St., Brooklyn.

FLYING Boat complete, for sale; also Hydro pontoon, 80 H.P. motor. Herman Eker, Syracuse, N. Y.

BUILDING and Flying an Aeroplane—160-page handbook covering the building of small models and full-sized gliders and machines. In both biplane and monoplane models the well-known Curtiss and Bleriot types are followed. Fully illustrated with detail drawings. Price, \$1 postpaid. Popular Mechanics Book Dept., 6 N. Michigan Ave., Chicago.

BUD Morris Airplane and Motor School announces new courses in Airplane Construction. Write for special offer. This is not a correspondence course. Bud Morris Airplane & Motor School, 2843 Broadway, Chicago.

BI-PLANE Glider, full size, how to make—Our book "Amateur Mechanics No. 2" contains a complete detailed description of how to make one and also over a hundred other interesting articles. Price, 25c postpaid. Popular Mechanics Book Dept., 6 N. Michigan Ave., Chicago.

HEATH propellers for land and water produced by America's oldest aeroplane factory. Let us supply the right propeller and you will travel efficiently. Heath Aeroplane Co., 2856 Broadway, Chicago.

FOR Sale at bargain prices, Wright 4 cyl. Motor; Gyro 7 cyl. rotary; 4 cyl. Maximotor; Wright chain transmissions; Small Tractor Biplane. Northern Aircraft Co., Bay City, Mich.

LET Heath supply your aeronautical needs. Your small or large order will receive the same attention and quality we give to government. Heath Aeroplane Co., 2846 Broadway, Chicago.

MEN Learn Aviation. Government or exhibition. Pilot license guaranteed. Actual flights. Ground training device saves time—money—lives. Ideal training camp. A. C. Beech, Chief Instructor. Write Moler Aviation Instructors, Inc., 105 S. Fifth Ave., Chicago.

AVIATION Dictionary \$1. Cloth \$1.50. Languages, 143 West 47th, New York.

FOR Sale at Bargain, New 50 H. P. Roberts Motor with magneto, carburetor, radiator, gas tank, paragon propeller, new fuselage landing gear, imported shock absorbers. Price \$450. Gus Seyfried, 67 Cook St., San Francisco, Cal.

AEROPLANE mechanics wanted; thousands needed right now. Will give thorough, practical training course on modern machines for \$110. No book study, actual work only. U. S. Aero, 35 Park Row, N. Y. C.

PATENTS Wanted in Aeronautics—U. S. Government spending millions in this class for Army and Navy. Our Aeronautic Department will give full information on this subject upon inquiry. Write for "What to Invent," sent Free. Victor J. Evans & Co., 149 Ninth, Washington, D. C.

AVIATION Motors, all makes, up to 150 H.P., \$250 up. Complete aeroplanes, all types, \$500 up. State your needs. Aero Exchange, 38 Park Row, N. Y. C.

#### BOOKS AND PERIODICALS

SPEND your money efficiently by use of the "Code Unit" System. Masterpiece on the knack of handling finances and personal affairs. Circulars free. Nelson, 4129 Washington Blvd., Chicago.

ENGINEERS' questions and answers for license by Hobson, for twenty-five cents, postpaid. Send stamps. Reilly's Book Store, Philadelphia, Pa.

USED Books, Bargains, Catalog. Hiram's, A-2411 Post, San Francisco. (Books Bought.)

MAGAZINES at rock bottom prices. Send today for our free catalog "P." S. C. Hanson Magazine Agency, 4926 Kinzie, Chicago.

U. S. ARMY Infantry Drill Regulations, 58 cents. Field Service Regulations, 80 cents. Cavalry Drill Manual, 80 cents. Small Arms Firing Manual, 80 cents, cloth, postpaid. Also send for complete list of over fifty standard military and naval books. Popular Mechanics Book Dept., 6 N. Michigan Ave., Chicago.

NEW 1917 Catalog of Latest and Best Books on Mechanical, Electrical and Industrial Subjects, comprising 128 pages and adequately describing more than 400 works. Sent free upon request by Popular Mechanics Book Dept., 6 N. Michigan Ave., Chicago.

COMPLETE "Memory Course" including coupons. Value \$3; all 20c. Barry, 2409 Pac., Atlantic City.

WORLD-ROMIC Languages, Masterkey, 56c. Languages, 143 West 47th, New York.

100,000 SECOND-HAND books for sale, 25c each; costly bindings; some cost \$25.00 now; Medicine, Surgery, Agriculture; Mechanical; chemistry, philosophy, encyclopedias, law; scientific; technical; mathematics; history; fiction; religious; text; school, etc. Send 10c stamps for big catalogues (none free). "M." McCarthy, 1236 Arthur Ave., Chicago, Ill.

FIND Out for Yourself what to invent and how to procure and sell a patent for the same. My book, "Inventor's Universal Educator," covers the matter from A to Z. 143 pages, elegantly bound. Also contains 600 mechanical movements and 50 perpetual motions. Price \$1.00, postage free. F. G. Dieterich, 631 Ouray Bldg., Washington, D. C.

#### EDUCATIONAL AND INSTRUCTION

**MATHEMATICS**—including multiplication, division, proportion, geometry, trigonometry and mechanical drawing problems—easily worked by the arcoscope, the combination triangle with a brain. Postpaid, 65c cents. L. J. Leishman Co., Ogden, Utah.

BE a Finger Print Expert—\$25 to \$50 a week in this new and fascinating profession. Write—find out how you can learn at home to supply the big demand for finger print experts in banks, big factories, detective agencies, etc. Special limited offer—write while it lasts. Evans University, Finger Print Dept., Room 1198, 1772 Wilson Ave., Chicago, Ill.

**CIVIL** Engineering, one year course. Students received any time. Technical Institute, Greenfield, Ohio.

**INTERNATIONAL** Correspondence School course in "Bookkeeping and Business Forms." Will sacrifice, 311 N. E. Boulevard, Philadelphia, Pa.

**REPORTS:** Just what I've been looking for, getting along fine, wonderful success, send six more moulds. Ask Mr. Spahr about Plasterography and Pres. Wilson Medallions. P. B. Spahr, York, Pa.

**ELECTRICAL** instruction given by practical engineer. Learn this wonderful profession at home by practical instruction. By my improved method of learning you can become a Certified Electrician in a few months. Satisfaction guaranteed. Electrical outfit of instruments, tools and materials furnished free to each student. Earn money while learning. Write me for Electrical book and full particulars. Everything free if you answer now. Chief Engineer, Chicago Engineering Works, 437 Cass St., Chicago.

**A POSITION** is open for you in the Government service after we have helped you qualify. My money back offer guarantees it. Write quick for big Free book, DA-29, Earl Hopkins, Washington, D. C.

**LEARN** Electric Starting and Lighting Systems, Storage Batteries, etc., at home, by our practical, simple methods. Use a little of your spare time to become an Electric Starter Expert. We furnish complete wiring diagrams. Thousands of Electric Starter Experts are wanted at big salaries. Easy, clean and very interesting work. Free literature. Electric Starter Engineering Co., 623 No. 47th St., Omaha, Neb.

**FRENCH** Pronunciation, Masterkey, 37c. Spanish, 37c. Languages, 143 West 47th, New York.

**MECHANICAL** Drawing in ten lessons, and at a cost that will surprise you. I will make you an expert. Professor, Box 236, Annapolis, Md.

**GET a Sure Job** with big pay, steady work, short hours, regular vacations, rapid advance. Thousands of positions open with Uncle Sam. I will prepare you in a few weeks at small cost. Write immediately for big free book DU29, with special offer. Earl Hopkins, Washington, D. C.

**STENOGRAPHY** or Bookkeeping, 25c. Self-instructive Books, 100 different subjects. Marr, B285, Nashville, Tenn.

**THE Way to Get a Government Job** is through the Washington Civil Service School. We prepare you and you get a position or we guarantee to refund your money. Write to Earl Hopkins, President, Washington, D. C., for book FK29, telling about 292,295 government positions with lifetime employment, short hours, sure pay, regular vacations.

**DRAFTSMEN** and Artists succeed. Our correspondence courses in Architectural and Mechanical Drafting and Commercial Art make you efficient. Practical instruction, low tuitions, convenient terms. The Technical Institute, 4752 Cote Brillante Ave., St. Louis.

\$75.00 **BUYS** complete Moving-Picture Machine, Film and Outfit. Write for particulars. Feature Film Exchange, Dept. F, 228 Union Ave., Memphis, Tenn.

**GOVERNMENT** Positions are easy to get. My free booklet BY-29 tells how. Write today—now. Earl Hopkins, Washington, D. C.

**FOR Sale**—Powers 6 Machine, complete, and 5 reels film, \$109.00. A. M. Graham, 24 Potter Bldg., Birmingham, Ala.

**LEARN** Drafting—One of the most practical subjects, and indispensable in many occupations. Individual study at home without an instructor may be successfully carried on with the aid of our book, "A Practical Course in Mechanical Drawing," 100 pages, 157 drawings. Cloth, Price 50 cents postpaid. Popular Mechanics Book Dept., 6 N. Michigan Ave., Chicago.

**WAR Atlas**—Large 20-page (11x15 in.) Atlas of the War in Europe, containing large colored scale maps of the Battleground, showing Europe, Austria, Serbia, Germany, England, Belgium, France, Russia, Italy, Greece, the World, etc. Special data showing comparison of armies and navies involved, pictures of rulers, etc. Price 20 cents postpaid. Popular Mechanics Book Dept., 6 N. Michigan Ave., Chicago.

**WANTED**—New Ideas. Write for list of Patent Buyers and Inventions Wanted. \$1,000,000 in prizes offered for inventions. Our Four Books sent free upon request. Victor J. Evans & Co., 167 Ninth, Washington, D. C.

**MOULD** making for ornamental casting, particulars, 200 illustrations, free. Mahler, Woodhaven, N. Y.

**ARTIFICIAL** Marble, sanitary flooring, complete instructions, \$1. Ornamental casting, concrete, plaster, papiermache, decorations, garden furniture, statuary, rubber moulds, electrometallurgy. Particulars, 200 illustrations free. Mahler, D-721 Woodland Ave., Woodhaven, L. I., New York.

**ARMATURE** Rewinding—Learn at home easily by our plain simple course for Automobile Electric Starting Motor and Generator Armatures. We furnish working model, etc. Good armature winders earn big pay. Free literature. S-A Electric Works, 1096 Emmet St., Omaha, Nebraska.

#### TRADE SCHOOLS

**ELECTRICITY**, Plumbing, Bricklaying, Mechanical, Architectural and other Drafting Courses. Motion Picture Operating taught by practical work. Largest, best equipped practical trade school in America. Short time to learn. Small cost, easy payments. Write for big illustrated book; it's free. Coyne Trade and Engineering Schools, Dept. 1898, Chicago, Ill.

**HILE'S** Watchmaking and Engraving School, the largest and best equipped school in the West. 717 Market Street, San Francisco, Cal.

**PRACTICAL** Training in Paperhanging, Graining, Sign Painting, Showcard Writing. Chicago Painting School, 131 North Fifth Avenue, Chicago.

#### TELEGRAPHY

**TELEGRAPHY**—Morse and Wireless—learned at home without instructor. Instrument and instructions twelve dollars. Particulars free. Address, Acorn Self-Instructor Co. (M), Roanoke, Virginia.

**TELEGRAPHIC**—both Morse and Wireless, also Station Agency, taught quickly. Tremendous demand—much greater than supply—permanent positions secured. Big salaries—recently raised. Ideal working conditions—short hours, vacations with pay, sick and death benefits, etc., prevailing. Great opportunities for advancement. Women operators also greatly desired by Railways and Western Union. Tuition reasonable. Cheap living expenses—can be earned. Oldest and largest school—established 43 years. Endorsed by railway, Western Union, and Marconi Telegraph officials. Large illustrated catalogues free. Correspondence courses also. Write today. Enroll immediately. Dodge's Institute, 15th St., Valparaiso, Indiana.

**TELEGRAPHY**—Morse and Wireless—taught at home in half usual time and at trifling cost. Omnigraph Automatic Transmitter will send, on Sounder or Buzzer, unlimited messages, any speed, just as expert operator would. Adopted by U. S. Govt. and used by leading Universities, Colleges, Technical and Telegraph Schools throughout U. S. Catalog free. Omnigraph Mfg. Co., 41-G Cortlandt St., New York.

#### PICTURES, POSTCARDS, PENNANTS

**WOULD** you like to exchange postcards, stamps, coins (state which) with some of our 17,500 members in many countries? Membership 15c. Halcyon, Box 133-P, Erie, Pa.

**WANT** Postcards? Join our Jolly Club. Send 10c, 6 months 25c, Jolly Card Exchange, Decatur, Indiana.

25 **DETROIT** View Postal Cards. Ford plant, etc., 25c. Wm. Benke, 1187 Garland Ave., Detroit, Mich.

**CROSS-SECTIONAL** view of ocean liner "Britannic," showing interior arrangement of ship in colors, size, 14x20 inches, on heavy plate paper for framing or hanging. Very interesting. Reproduced from front cover design of July, 1914, Popular Mechanics. Will be sent postpaid to any address in the world on receipt of 4 cents in stamps to cover packing and mailing. Popular Mechanics Magazine, 6 N. Michigan Ave., Chicago.

35 **BEAUTIFUL** Post Cards Prepaid 15c. Burg, Commercial, Gary, Indiana.

10 **NICE** Postcards, Club Membership, and Catalogue 10c, Stewart Co., Providence, R. I.

**PRETTY** view cards from everywhere. Membership and 6 pretty cards, 10c. Riverside Club, Knoxville, Md.

#### OPTICAL SUPPLIES

WE duplicate broken lenses accurately. E. Pfeiffer, 509 No. Robey St., Chicago.

#### CAMERAS AND PHOTO SUPPLIES

**WRITE** for our new 1918 Camera Catalog. It will save you from 10% to 50% on new cameras—right from the factory and slightly used ones. All standard makes. Unqualified values—Look at these! No. 2 V-P Anseo, F: 7.5 Anastigmatic lens, extra speed Bionia shutter, \$15.00. New V-P Seneca Universal Focus \$3.95. New Autographic V-P Kodak \$3.00. Slightly used Icarette Model A P 6.8 lens, compound shutter \$21.00. 5x7 New Improved Seneca View \$17.50. 2 3/4x3 3/4 Eastman Folding Cartridge Premo Meniscus Achromatic lens, \$3.75. Every article guaranteed and backed by 10 days' free trial. Get your copy of catalog now and Save Money. See our display advertisement on page 180. David Stern Co. "Everything in Cameras." In business since 1885. 1118 Darrow Bldg., 1027 Madison St., Chicago.

**WANT** to save money? Then send for our free Bargain Book, which lists hundreds of slightly used and new Kodaks, Cameras, Lenses and Supplies. Save 25 to 60%. Free trial of 10 days. Money back if unsatisfactory. Consult us if you desire to trade your Camera or Lens, \$10.00 1A Autographic Kodak, R. R. type, \$9.50. No. 1 Anseo Vest Pocket Camera, R. R. Lens, \$8.00, new. Our prompt and fair dealing will please you. Central Camera Company, Dept. E-6, 124 S. Wabash Ave., Chicago, Ill.

**SAVE** camera money. Deal with specialists. Everything in photography. The greatest camera book ever issued, free for the asking. Write for it today. Every item sold under our liberal ten days' free trial offer. No camera user can afford to be without our famous Bass Book of 1901 bargains. Bass Camera Company, 109 N. Dearborn St., Dept. 58, Chicago, Ill.

**FILMS** developed free. Prints and Post Cards 25c. 8x10 enlargements 25c. Guaranteed. Emil Sprauer, Hamilton, Ohio.

**PROFESSIONAL** Motion Picture Camera complete outfit. Guaranteed in working order. \$75.00 cash for quick sale. Funda, 452 S. Warren St., Syracuse, N. Y.

**COLOR** Snapshots—Lesson Free with outfit transparent, self-blending colors 10c. E. B. Winslow Company, Tuckahoe, N. Y.

**PHOTOGRAPHS** Copied and printed on postals or cabinet size. 70c per dozen prepaid. Hingston, Whitesboro, N. Y.

**FILMS** Developed 10c roll. Six prints free. Ask for descriptive booklet. Roanoke Photo Finishing Company, 209 Bell Avenue, Roanoke, Virginia.

**DISAPPEARING** photos—transparent photos on watch crystals—two-color prints—ghost pictures; Many others. Get copyrighted book, "Foto Freaks and Helpful Hints," 50c silver. List contents for stamp. F. Van Wormer, Yamhill, Oregon.

**FILMS** developed 10c; prints, 3c to 5c. A reputable incorporated Company conducting largest existing plant. Price list and special offer. Enlargements our specialty. Chicago Photo Finishing Co., 54 W. Lake St., Dept. A, Chicago.

**AMATEURS:** Send us your vacation films for prints and enlargements. An 8x10 Sepia mailed for 35c. United Print Co., 11, Chicago, Ill.

**FREE:** Send negative for sample print. Film developed 5c per roll; print 2 1/2 x 3 1/4, 3c each; 3 1/2 x 4 1/4, 4c each; 8x10 enlargements, 25c each, from your own negative. Send for price list. M. A. Lasso, 611 9th St., Washington, D. C.

**FILMS:** Developed, any size 5c. Any size prints 3c. 8x10 enlargements 25c. Work returned same day received. Address Camera Shop, Box 69, Ann Arbor, Michigan.

**INVENTIONS:** Wanted in Motion Pictures and Photography. Special department for these classes of invention. Advice, What to Invent and List of Patent Buyers—Sent Free. Victor J. Evans & Co., 159 Ninth, Washington, D. C.

**BIG Money Saved on Photographic Lenses and Apparatus—**goods exchanged; repairing done. Ralph J. Golsen, 5123 Kenmore Ave., Chicago, Department P.

### MOTION PICTURES

**MOTION Picture Outfits** Half Price. National Equipment Co., Duluth, Minn.

**SPECIALTY** Arc Generator Produces current for half. Your engine operates. Easy Payments. Herberts, Troy, Ohio.

**MAKE Big Money** in moving-picture business. We start you and furnish guaranteed outfit on easy payment plan. Easy to accomplish. Catalog free. Monarch Film Service, 228 Union Ave., Dept. 12-A, Memphis, Tenn.

**PHOTOPLAYS** in demand. Make extra money. We show you how. Details free. Rex Publishers, Box 175 H-14, Chicago.

**HUNDREDS** of people make Big Money writing Photoplays, Stories, etc. Why don't you? Write us for free details. Bookmart Co., Dept. 12, Auburn, N. Y.

**MAKE money** writing Photo-plays; details free to beginners. No correspondence course. Producers League, 239 Wainwright, St. Louis.

**BIG Profit Nightly—**Moving Picture Business—small capital starts you, easily accomplished. Teach you—furnish everything. Ralph J. Golsen, 5123 Kenmore Ave., Chicago, Dept. M.

### BUSINESS OPPORTUNITIES

**MONEY-MAKING** Made Easy with our improved safety razor sharpener and big free advertising help. Makes dull blades keener than new at half cost. Customers everywhere—local and national; big mail-order opportunities. No experience; no canvassing; small expense; easy payments. Send postcard for Booklet. Odell Mfg. Co., Los Angeles, Cal.

**TIBBETTS** of Maine Cleared \$2,500 in six months breeding Fur-Bearing Rabbits on city lot. Breed for us; we pay \$2.00 for pairs and twenty cents pound for meat. Instructions 10 cents. General Sales Co., Cliffdale, Mass.

**TATTOOING** Outfits, \$1 up. Electric and Hand. Roberts Co., 635 West Ave., Buffalo, N. Y.

**400 MANUFACTURING** Formulas 25c. Luminous Paint (10 colors) Gas Tonic—Carbon Remover—Automobile Polish—Puncture Plugger—Non-Alcoholic Tube Flavors, 25c each. Entire collection 50c. "The Ideal," Box 543-MB, Chicago.

**HAVE a Business of Your Own.** Manufacture Name Plates, Numbers, etc. Big Illustrated Book Sent Free. E. E. Palmer, Wooster, O.

**SPECIAL Notice!! Special Offer!!!** 25-Word Advertisement in 100 Magazines Thrice, \$2. Inch Display Thrice, \$8. Page 8x11, \$133. Thrice, \$296. Try List. Bank Refs. Box 2, Atlantic City.

**CHEMICAL** Service. Let us study your requirements. Development and improvement of formulae, processes, and products; duplication; analyses; evaluation of minerals. Competent advice. Chemical manufacturing. Industrial Laboratories, New Orleans.

**BUILD a profitable business** of your own. Let us start you in the collection business. No capital needed; big field. We teach secrets of collecting money; refer business to you. Write today for Free Printers and new plan. American Collection Service, 101 State Street, Detroit, Mich.

**WE will start you** in the cleaning and dyeing business; little capital needed, big profits. Write for booklet. Ben-VonDe System, Dept. C, Charlotte, N. C.

**SLOT Machines—**Headquarters for premium machines. 1016 Germantown Ave., Philadelphia.

**NEW Way to Paint Signs—**Our patterns do the work. No experience required. Complete outfit, prepaid, \$5.00. Satisfaction Guaranteed. Ibits Advertising Co., 614 Gumbel Bldg., Kansas City, Mo.

**MAKE, Sell Carbo-Cide—**Efficient. Reliable Automobile Gasoline Intensifier. Increases Mileage, Eliminates Carbon. Results Guaranteed, 800% Profit—Unlimited demand everywhere. Formula for Tablet and Liquid Form. Exclusive territory. Latest Formula Lists and Valuable Information, Stamp. Miller, Ph. D., Tampa, Fla.

**500 FORMULAS,** including Resilvering Mirrors—Renewing Dry Batteries—Luminous Paint, 25c. "The Ideal," Box 543-L, Chicago.

**BEGINNERS' Mail Order System.** Pontleton, Box 1095, Atlantic City, N. J.

**MANUFACTURE and Sell** following goods. Big Profits. All repeats: "Self-shine Stove Polish," "Luminous Ink"—"Slimes in the dark," "Silverplating Fluid," "Dry Powder Fire Extinguisher," "Quick-death"—bedbug and cockroach powder, "Inkless Pen"—Writes with water. "Never-hone Razor Paste," "Lemonade and Orangeade Powders," "Neverwet"—Waterproofs Clothes. Formulas 20c each. All \$1.00. Michael Riensl, Cutler St., Newark, N. J.

**INVENT Something.** Your ideas may bring wealth. Free book tells what to invent and how to obtain a patent through our credit system. Talbert & Parker, 4671 Talbot Bldg., Washington, D. C.

**MAKE Money** in the Candy Business. Get into this big paying, fascinating business; retail, wholesale; start at home. It's clean, easy, big profits. Complete equipment free. Write for book, tells how to start. Otter-Swain Cor., Suite 331, 4759 Broadway, Chicago.

**BUY a business** in Florida. Why not locate where you can enjoy life while following your chosen calling? We offer selected opportunities. Clyde Burns, New Port Richey, Fla.

**START Non-Commission Realty Agency.** Experience and Capital unnecessary. Free Particulars. Non-Commission Agency, Lima, Ohio.

**Do you want to know** about conditions in any trade or business? Do you want to know how War will effect your trade or situation? Do you want to know about any college or method of obtaining an education? Have you questions to ask regarding scientific business or commercial problems? Ask us—Our experts know. Kent System, Dept. 4, Cambridge, Mass.

**FUR Farm for Sale,** located in fine hunting, fishing and trapping country; equipped with stock. Also mink, skunks, coons, ferrets, pheasants, etc., for sale. B. Tippman, La Crosse, Wis.

**ANYBODY** can make \$3 a day at home, spare time, growing mushrooms in cellars, sheds, barns, boxes. Success guaranteed. Free illustrated booklet. Hiram Barton, 324 West 48th, New York.

**PHOTOPLAYS** in demand. Make extra money. We show you how. Details free. Rex Publishers, Box 175 H-15, Chicago.

**WE start you** in business furnishing everything; men and women make handsome income weekly operating our "New System Specialty Candy Factories" home or small room anywhere; no canvassing. Opportunity lifetime; booklet free. W. Ragsdale Co., East Orange, N. J.

**ENTER a new business.** Earn \$3,000 to \$6,000 yearly in professional fees making and fitting a foot specialty, openings everywhere, with all the trade you can attend to; easily learned by anyone at home in a few weeks, at small expense; no further capital required, no goods to buy, job hunting, soliciting or agency. Address Stephenson Laboratory, 11 Back Bay, Boston, Mass.

**MANUFACTURERS, Promoters and Patent Buyers** are invited to write us stating the line of invention in which they are interested, as we can supply their wants in any class of patents. Victor J. Evans & Co., 102 Ninth St., Washington, D. C.

**INVENTORS:** We develop and perfect inventions, make models, dies, tools. Metal stamping and special manufacturing. Gerding Bros., Lion Bldg., Cincinnati, O.

**ADVERTISERS—**Mail order dealers, increase your business and profits; write for advice and book, "Successful Advertising," free. Warder Advertising Agency, 127 Warder Building, Washington, D. C.

**BE Business Broker:** Small Capital required. Large Income possible; particulars free. Miss Jack Eyrdman, 1527 Chemical Bldg., St. Louis, Mo.

**CONDUCT a profitable Candy Kitchen;** very small capital required; booklet free. Kennon School, 509 Wells St., Dept. A, Chicago.

**ADVERTISEMENTS, Mail Dealers.** Our New Rate Book lists 2,000 Principal Publications, rates, circulation. Includes 30 Mail-Order Plans, Free. Dearborn Advertising Agency, 210 Franklin Bldg., Chicago.

**START a Vacuum Clothes and Carpet Cleaning** business, \$125.00 for machinery required. Write today. General Compressed Air & Vacuum Machinery Co., St. Louis.

**SILVERING Mirrors!** My exclusive French Tartaric method opens enormously profitable business. Booklet Free. H. Barstow, 514 23rd street, Oakland, Calif.

**EXPERT Chemical Service.** Commercial Analysis, Instructions, Formulas, Processes and Trade Secrets. Manufacturing problems solved. Satisfaction guaranteed. Write for Lists and Valuable Information. W. L. Cummings, Ph. D., 127 Standard St., Syracuse, N. Y.

**PATENTABLE Ideas Wanted—**Send for 4 free books. R. B. Owen, 30 Owen Bldg., Washington, D. C.

**BIG money** in promoting inventions. Write Adam Fisher Mfg. Co., 2061D Railway Exchange, St. Louis, Mo.

**LEARN** the real estate business; our enlarged instruction book teaches listing, appraising, management, salesmanship, insurance, brokerage, advertising, renting, agency, estates, titles, rights, forms, etc.; revised edition; 240 indexed subjects; excels \$25 correspondence course; buckeye cover, \$1; silk cloth, \$1.25, postpaid. Realty Book Co., Dept. No. 29, Cleveland, Ohio.

### MAIL-ORDER SUPPLIES

**INCREASE** your sales. Place your proposition before the readers of "Cartoons Magazine." 20,000 copies guaranteed every month. Classified rate 5c per word. Mail in a trial ad today. Cartoons Classified Dept., 78 E. Madison St., Chicago.

### TO MANUFACTURERS

**I WANT** several real good articles for mail-order business. "Leony." P. O. Box 91, St. Roch., Quebec, Canada.

### FOR ADVERTISERS

**ADVERTISE!** 25 words 3 months in 120 monthlies, \$1.50; 230 magazines, \$2.75. Southwestern, 1413-1 Berendo, Los Angeles.

**SPECIAL:** 20 Words in 120 Magazines only 60c. Barry, 2409 Pae., Atlantic City.

**25 WORDS** in 50 weeklies and 100 monthlies—all \$2. Cope, St. Louis.

### ART AND ADVERTISING SERVICE

**DRAWINGS.** All kinds made by competent engineers and draughtsmen. Arthur Haar & Co., 1289 Broadway, New York City.

### BUSINESS SERVICE

**BUY—Sell—**Office and store equipment; automobiles, sporting goods, musical instruments; rubber stamp, printing, photographic outfits; electrical, experimental, scientific apparatus; machine tools; patents; 3,000 bargains; quick service. Standard Commercial Service, 516 Park Building, Worcester, Mass.

**INCORPORATE.** Our lawyers do the work, saving you time, annoyance and money in incorporating under the most liberal laws of Arizona. Laws and forms free. Southwestern Securities & Investment Co., Box D488, Phoenix, Ariz.

**TYPEWRITING** of all kinds at low rate. J. N. Manning, Madison, Wisconsin.

### SALE OR EXCHANGE

**HAVE** you anything to sell or exchange. Books, motors, dynamos, cameras, bicycles and miscellaneous objects? Advertise in "The Market for Exchange," a magazine which offers a market to everyone, everywhere. Rate 3 cents a word. Send 10 cents for sample copy to Publisher, Market for Exchange, 141 Milk Street, Boston, Mass.



## AGENTS WANTED

**SENSATIONAL** profits selling stretching cut links. Remarkable convenience. Invisible, laundry saver. Turns open and close instantly when sleeves are raised or lowered, without unbuttoning. High grade guaranteed article. Energetic District and State representatives wanted. Masier Jewellers Corporation, Sheboygan, Wisconsin.

**AGENTS Wanted**—We want 1,000 more men and women agents at once. You can easily earn \$5 to \$10 a day taking orders for our fast selling, attractive line of Soaps, Perfumes, Face Creams and Toilet preparations. Sample case free to workers. Every call a sale. We are an old established firm. Our goods well advertised and well known. You make 100% profit. Get busy—write now for our liberal proposition to agents. Crofts & Reed Co., Dept. C-211, Chicago, Ill.

**MANUFACTURER** now placing on market well tested and highly approved article for power houses, factories, public shipyards, etc. Good seller. Repeat orders excellent. Local supply houses and agents wanted. G. G., Box 2806, Boston, Mass.

**AGENTS—Salesmen—Managers**—Brand new invention just out: Elsen attachment tilts Ford steering wheels and also locks car; greatest selling Ford article on market; needed on every machine; fully guaranteed; low in price; sells like lightning. Listen! Birley, Ill., made \$394 in 5 weeks; Allen, Md., cleared \$13.86 first day. Not sold in stores; no experience necessary; we show you how; sales guaranteed; you cannot lose. Write quick for special offer. Address Elsen Instrument Co., 1206 Valentine Bldg., Toledo, O.

**RUSH** Postal for Free Sample "Spik & Span." Wonderful new washing tablet. Washes clothes spotless, without rubbing. Tremendous seller. 200% profit. Free Samples to boost sales. R. A. Newberry, 224 Peoria, Chicago.

**HELP** Uncle Sam. Save gasoline for the Army and Navy. Sell gasoline-saving tablets to auto owners and garages. Write Fosco, Box 373, Nashville, Tenn.

**AGENTS:** Biggest line, Biggest profit. Extracts, Family Remedies, Perfumes, Creams, Premiums for your customers. Western Laboratories, Inc., 1911A Van Buren St., Chicago.

**36 HOME** Articles. New, Strong Agent's line. Easy sellers. Big money-makers. Lustre Mfg. Co., 18 W. Kinzie St., Chicago.

**AGENTS.** New \$2.50 Automatic Adder. Sell every business man. Big profits. No competition. Does work of high priced machines. Bassett, 5921-Y Indiana Ave., Chicago.

**TAILORING** Agents Wanted—Big complete sample outfit and case, nearly 300 large cloth samples, 3 piece lists and everything needed for canvassing, or use in store, free to live agents. \$25.00 to \$50.00 a week; may make more. Write us today for free elegant outfit to begin, cloth samples, wholesale prices, special offer on a suit for yourself and full information—see our wonderful values, beautiful fabrics and styles. Established 28 years. Every garment made to measure—everything guaranteed and express prepaid. Just send a postal. American Woolen Mills Co., Dept. 1114, Chicago.

**\$15.00 MADE** first day by 13-year-old boy with shamescraper. Woman made \$6.00 first hour. Particulars Free. Shamescraper Mfg. Co., 4923 Montgall, Kansas City, Mo.

**\$95 To \$100** weekly manufacturing and selling Eureka Laundry Tablets through Agents, Stores and Mail. 530 labels with your name, Formulas and Plans \$1. General Sales Co., Chicoutade, Mass.

**REPEATER**—A 100 per cent labor saver. Needed every week. Particulars and sample, 10c. G. W. Ashton Co., Clinton, Iowa.

**NACMA** repeat-order household products are big money-makers. Catchy selling plan gets and holds the business. Free selling helps and samples. Exclusive territory. The Nacma Co., Dept. C-7, 20 W. Lake, Chicago.

**AGENTS,** take orders for the latest thing in a belt. Full name on buckle. Big profits. Particulars free. H. O. Specialty Co., 1912 So. Albany Ave., Chicago.

**AGENTS**—Get next to a good thing; \$10 will start you; write for particulars. Harrison Brothers, Branch 91, Poughkeepsie, N. Y.

**AGENTS:** Sell our Made-to-Measure Shirts. Over 500 patterns. Big Holiday trade. Exclusive territory. Wichita Shirt Company, Wichita, Kansas.

**SELLS** like hot cakes. New ironing wax. Perfumes clothes with lasting violet. Working outfit 5c. New offer. Perfume Gloss, 11 Water St., New York.

**INK** Pencils are quick sellers. Field untouched. Write for attractive proposition. Colonial Company, Woodhaven, N. Y.

**MARVELOUS** new winner—the Daylite Mantle Oil Light. Different from all others. Better light than electricity. Five times more efficient than common lamp. Uses common kerosene. Burns over 50 hours on 1 gallon. Guaranteed five years. Elegantly finished. To show it is to sell it. Men with rigs and autos making as high as \$325 every month. No money—no experience needed. You can start on our capital. We furnish stock of lamps on credit to reliable men. Sample lamp free. Exclusive territory. Write quick for particulars free. Daylite Company, 622 Daylite Building, Chicago, Illinois.

**AGENTS:** Brand new whirlwind seller. Sample and particulars 15c. Chas. W. Webster & Co., 2935 N. Clark St., Chicago, Ill.

**\$1,000.00 REWARD** if my High-Grade Formulas are not Money-Makers for those who Manufacture various Big Selling Specialties from them. Latest Food Products, Washing Tablets, Automobile Specialties, Tube Flavors, Dry Cleaners, Rust Soap, Luminous Paint, Polishes, No Trash. Valuable Information and latest lists—Stamp. Established 20 years. Miller, Analytical Chemist, Tampa, Florida.

**AGENTS**—Easy sales and huge profits handling our household automobile and office specialties. Let's talk business. Knights Company, Buffalo, N. Y.

**AGENTS**—We want 150 hard workers to take orders for Buckeye Raincoats. You can easily make \$75.00 a week. Wonderful raincoat for \$3.95. We deliver and collect. Sample and outfit free to you. The biggest Fall season just starting. Join our big money makers at once. Hurry! Buckeye Manufacturing Co., C-1 Union Square, New York City.

**FREE**—"Prosperity Package"—Free. Barry, 2499 Pac., Atlantic City.

**AGENTS** or Salesmen Everywhere for new line sales-clip pads; every merchant possible customer; exclusive sale and territory. Embury Sales Book Co., Hartford Bldg., Chicago, Ill.

**BEST** Raincoat Proposition Ever Offered. Easy sales. Big commissions. Agents making \$50 to \$100 per week. Sample coat and outfit free. Write quick. Tiffany Raincoat Co., 1047 P, Belden Avenue, Chicago.

**AGENTS**—Make and sell your own goods, 21 valuable manufacturing formulas and big formula catalog 10c. "The Ideal," Box 545-A, Chicago.

**125% PROFIT** selling our carbon paper and Typewriter ribbons. Samples free. Benecma Co., 5489 Woodlawn Ave., Chicago.

**POSTAL** brings positive proof of remarkable repeat order proposition; an opportunity to own your own business; tremendous profits; experience unnecessary. Equitable Corporation, 512 Ohio, Chicago.

**AGENTS** financially responsible who understand heating plants to sell Blasko Fuel Saving Devices on monthly payment plan. Every heating plant a prospect. Guaranteed to save 20%. Evaporation tests at two universities averaged 25% saving. Wolff Fuel Saver Company, 14 East Jackson, Chicago.

**AGENTS** wanted to sell Eggnet—a pure food substitute for eggs. Easy selling article—big profits—quick repeater. Stuart & Co., 10 Main St., Newark, N. Y.

**BIG** value Xmas package. Cards, booklets, tags, seals, everybody buys. Good profits. Sample 10c. Ufert, 236 W. 41st, New York.

**AGENTS:** A golden opportunity selling Yanoco "Quality Ivory" combs, brushes, mirrors and other toilet requisites. Ten to forty dollars weekly. Best season now. Ideal holiday line. Sells on sight. Yanoco Ivory Co., Leominster, Mass., Ave. P.

**"RADIO"** Luminous Paint—Quarts \$3.50, Pints \$2.00, Bottles 25c, 50c delivered. Alive With Light—Shines All Night. Outshines expensive imported. Only American Manufacturers. American Luminous Products Co., Huntington Park, Cal.

**\$61.50 WEEKLY.** Introducing and selling a new gas light burner for kerosene lamps. Beautiful light. No chimney. No mantle. Samples free. Experience not necessary. Write to-day. Luther Manufacturing Co., Dept. 320, Cincinnati, Ohio.

**POSTCARDS,** Highest grade. Snappy Comets, Soldiers, Sailor Boys, Greeting, Thanksgiving, Christmas, New Years, 100 assorted etc. Samples, price list, self-selling envelope 10c. Gross Order, 2147 Arthur Ave., New York.

**BIG** Pullers—Burglar Alarms; high grade Moth-proof Garment Bags. Utility Sales Co., Dayton, Ohio.

**STREETMEN**—Peddlers—Demonstrators. \$11.15 cents profit on every gross. Something new, sells on sight, necessity for every man; carry \$36.00 worth in your pocket; cost \$2.85 gross. Send Dime Coin for sample and particulars. Wood, 78 Virgil St., Atlanta, Georgia.

**"WE** start you in business, furnish everything; men and women; make good weekly income." Majestic Printing Co., 3044 Leeward, Los Angeles, Cal.

**MANUFACTURE** "Gas-ine." Saves one-third of the gasoline. Every motorist your customer; big profits; easy work; formula and instructions \$1. Particulars, stamp. Hile Company, Carey, Ohio.

**AGENTS** Wanted—Tolliver Guaranteed Puncture-Proof Inner Tubes sell easily—our Agents make \$5.00 to \$50.00 a day net profits—no competition. If you wish to establish a business of your own that has unlimited possibilities for profit, write us for complete details. Tolliver Tube & Tire Co., 115 Tolliver Bldg., Denver, Colo.

**AGENTS:** Even if you were deaf, dumb and blind you could sell our Aluminum Utensil Cleaner. Every housewife grabs it on sight. Steady trade and big money in protected territory. Write quick. Div. Pol. American Aluminum Mfg. Co., LeMont, Ill.

**FREE** sample with particulars. No splashing water strainers. Easy seller. Returns big. Experience unnecessary. Union Filters Co., New York.

**AGENTS**—Sell our new 5c Toilet Soap Combinations quickly for 20c, cost 6c. United Soap Works, 98 Park Place, New York.

**MEN** and women with spare time—whether employed or not employed—can make a lot of extra money with our All Profit offer. No goods to buy or sell. No deliveries. No collections. National, Dept. C-15, 18 W. Lake St., Chicago.

**AGENTS:** Biggest moneymaker ever put on the market, "Eggette" (the original egg substitute). Takes place of eggs in all kinds of baking and cooking. Sells rapidly to homes, stores, restaurants, bakers, etc. Guaranteed pure food product. Good opportunity to build permanent business with big income. No competition. Regular size package 10c equal to 12 eggs. Attractive moneymaking proposition free. Write quick. Boster Products Co., B-10 Douglas Park Station, Chicago, Ill.

**AGENTS,** \$50 a week. Will show you how. Genuine Gold Leaf Window Letters. Chicago Agency Co., 842 Altgeld St., Chicago.

**AGENTS**—Stamping names on Pocket Key Protectors; sample check with your name and address, 12c. Stamping Outfits, Emblem Checks, Check Fobs, Name Plates, Hart Mfg. Co., Desk 2, 303 Degraw St., Brooklyn, N. Y.

**AGENTS:** You can make big money taking orders for our fine made-to-measure clothes, so write quick for 60 beautiful cloth samples, 32 smart styles in rich colors, wholesale and retail price lists, lowest prices and best offer to agents. \$5.00 to \$10.00 a day easy. Big outfit, over 250 samples free to live wires. No experience needed—no capital. We furnish everything free—pay postage or express charges—back you, boost you, show you how and clearly explain everything. Costs nothing to try. Let us make you a stylish suit to measure to prove our fine quality and style. Send postal or letter today. Paragon Tailoring Co., Dept. 1114, Chicago.

**SIGN** Letter Agents and Painters: 500% Profit Gold and Silver Sign Letters for Stores and Office Windows. Anyone can put on. Big demand. Free samples. Metallico Letter Co., 404 N. Clark St., Chicago.

**HUGE** profits selling Nibco Sanitary Brushes, Auto Washers, Brown Beauty Adjustable Floor Mops, Dustless Dusters, and other specialties. Big line. Fast sellers. Write today. Silver-Chamberlin Company, Department M, Clayton, New Jersey.

**AGENTS** sell Reliable Custom-Made Raincoats and Gahardines. Big commission. Complete sample line free. Temple Raincoat Company, Templeton, Mass.

**AGENTS**—Specialty Men sell the Simplex Auto Brush, new auto and wagon washer; fits any hose; sure, quick cash sales; free samples. Francis L. Mfg. Co., Harrisburg, Pennsylvania.

**AGENTS**—Two new fast sellers. Household necessities. Demand enormous. Profits big; \$5 to \$10 a day. Live-wire men and women wanted. Write to-day for full information. H. Christensen Mfg. Company, Fort Atkinson, Wis.

**BIG PAY** and automobile furnished agents introducing wonderful new automobile fuel. Samples free. L. Ballwey, 189 Ovee Bldg., Louisville, Ky.

**\$25 DAILY** easy introducing greatest household money-saver just invented. Reduces high living cost. Saves its own first cost first 10 minutes. Sells itself in every house. Retail \$2.00. Your commission \$1.10. Samples free. Ovee Mfg. Co., 189 Ovee Bldg., Louisville, Ky.

**AGENTS**—Handle our line of Bonanza and Square Deal Sales Boards. Write for particulars. Gordon Specialty Agency (Dept. 41), 52 West Chippewa, Buffalo, N. Y.

**MEN or Women**; Introducing Soaps, Perfumes, Extracts, Toilet Preparations; 100% profit. Experience unnecessary. Costello Mfg. Co., 310 N. Ewing, St. Louis, Mo.

**SEND 25c** and get our "Keyless Burglar Lock." Something new. Agents wanted. G. W. Sautter, R. 1, Los Angeles, Cal., Box 316.

**WORLD'S Fastest Selling Auto Accessory.** County distributors wanted; good profits; write today. G. L. W. Spring Oiler Co., San Diego, California.

**AGENTS** for H & H Solder Cement; Mends Aluminum and all metals; applied cold or with heat; indispensable for household, automobiles and motorboats; neither heat nor water affect it; send 10c for sample and agents' proposition. H & H Sales Co., Orange, N. J.

**AGENTS:** We need men and women right now to take orders for World's Greatest Raincoat values. Dandy coat \$2.98. Sixty-five fabrics. Dozens of styles. Made to measure and delivered direct from our big factory to your customer. No delivering. Profit in advance. Easy to sell. Cooper making \$500 monthly. (Glover \$61.50 first four days. Neatly 22 orders in 2 days. Your average orders a day gives you \$2,540 a year profit. Full outfit and sample coat given. Write for wonderful offer. Comer Mfg. Co., Dept. U-12, Dayton, Ohio.

**AGENTS**—Snapstart Household Line on earth. Red-hot sellers, steady repeaters—100% profit. 500 light weight, fast selling, popular priced necessities. Agent's outfit free. Get busy—quick. Write today; postal will do. American Products Co., 4639 Third St., Cincinnati, O.

**AGENTS**—Make Big Money. The best line of food flavors, perfumes, soaps and toilet preparations, etc., ever offered; over 500 light-weight, popular-priced, quick-selling necessities—in big demand—well advertised—easy sellers—big repeaters. Over 100% profit. Complete outfit furnished free to workers. Just a postal today. E. M. Fellman, Mgr., 4939 3rd St., Cincinnati, O.

**AGENTS Wanted**—To advertise our goods by distributing free samples to consumer. 90 cents an hour. Write for full particulars. Thomas Mfg. Co., 562 North St., Dayton, O.

**PHOTO Pillow Tops, Portraits, Frames, Sheet Pictures, Medallions, Patriotic Pictures, Pennants, Rejects credited.** Prompt shipments; samples and catalogues free to agents; 30 days' credit. Jas. C. Bailey Co., Desk B, Chicago.

**RAINCOATS**—Direct from factory. Agent's price \$2.95 delivered. Retail price \$5.00. Agents average six coats daily. Rainy season now here. W. Lewis Raincoat Co., Cleveland, O.

**BIG Money** in phonographs; Small capital to start. For particulars, address Northwestern Phonograph Works, Dept. P., 2407 N. Clark St., Chicago.

**AUTOMOBILE Signal**, just patented; 30 sales daily; 100% profit; territory reserved. Particulars: Jordan, 1929 9th St., Washington, D. C.

**AGENTS:** Sell "Ironslide." Great new starch enamel. Wonderful success. Women delighted. Free samples. Big profit. 25 other articles. All winners. Write today. G. H. Brummund, Horicon, Wis.

**PHOTO Pillow Tops, Artists and Brocade prints.** Quick service, good work. United Print Co., 9 Chicago, Ill.

**AGENTS;** mail-order men, beginners, make and sell your own products; large formula list, three wonderful selling plans, for 10c. Harding & Co., Mattson, Ill.

**"STEAM-NO-MORE"** for eye glasses. Everyone who wears glasses buys. Live agents 200% profit. Send 10 cents for 25c sample. Gray's Sales Agency, Port Huron, Mich.

**ONE Thousand Dollars Reward** if this is not the greatest money-making household proposition. N. R. G. Laundry Tablets wash clothes in 10 minutes, without rubbing. Contains no Lime, Lye, Paraffin, Wax or other injurious chemical and cannot possibly injure the clothes or hands. Positively the wonder of the age—sells for 15c, enough for five family washings. We supply Free Samples and guarantee the sale of every package you buy. Just Leave the Free Sample with the housewife and, when you call again, she is eagerly awaiting to become your steady customer. Secure territorial rights at once, or you will regret it. A 1c postal brings sample and full particulars. Farquhar-Moon Mfg. Co., Desk M-208, 140 W. Vanburen St., Chicago, Ill.

**RELIABLE** people wanted. Place Hall's sore throat remedy in stores and appoint agents. 25c for sample. Hall Drug Co., Millinburg, Pa.

**NINETY Per Cent of Your Calls Turned into Sales!** Wonderful Enthusiasm Follows Every Demonstration! Write at Once for Full Particulars of Our Line of Eradiam (Luminous) Articles. Startling! Mysterious! Everlasting! Novel! They Shine in the dark. Crucifixes, House Numbers, Bulbs, Match Boxes, Pictures, Switch Plates. Sole Manufacturers. The Pioneer Corporation, 1259 W. 63rd, Chicago.

**KEROSENE Gas Burners** in Cook Stoves or Ranges stop use of wood or coal. Recently patented. Money-maker for Agents. The Vapor Gas Burner Co., Desk 8, Columbus, Ohio.

**AGENTS:** Sell Neverfall Iron Rust and Stain Remover. Always seasonable. Huge Profits. Big line. Credit. Sample. Sanford-Beal Co., Inc., Newark, New York, Dept. C.

**MAN Wanted** in each country community and every small town, to wear beautiful new tailored-to-order suits of clothes and be Agent in spare time among friends, relatives and neighbors. Confidential wholesale prices given, good profit on each order. No experience required, we teach you all you need to know. Write at once and get gorgeous, illustrated book of cloth samples free, and full instructions. Banner Tailoring Co., Dept. 605, Chicago.

**FAST Seller:** Improved fabric back patch for inner tubes. \$1.00 kit sent postpaid for 50c. Extra discount for large order. Every Motorist a prospect. Consumers Mfg. Supply Co., Minneapolis, Minn.

**GASOLINE Saver** for Fords: New Principle. Saves 30% Gasoline. Gives 30% more Power. No moving parts; put on with wrench in ten minutes. Price \$1.50. Guaranteed. 100% proposition to agents. The Little Cyclone Accessories Co., Dayton, Ohio.

**LUMINOUS Paint.** Shines in the dark. Make and sell your own Luminous Articles; Watches, Clocks, Switch Plates, Bulbs, Crucifixes, etc. (Everlasting.) Only 25c bottle. Luminous Paint Co., B-24, Douglas Park Station, Chicago, Ill.

**CONVEX Portraits, frames, pillow tops.** Lowest prices. Liberal Terms. Free catalog. Brewer Art Co., Sackville, Ind.

**EXQUISITE Colored Photographs** in first development from ordinary negatives. Big profits selling Instruction Books or developer to Kodakists, Photographers, Finishers. Photography knowledge unnecessary. Also get our list of labels we keep printed and sell for a dime's worth; formulas free. Just what you want, make goods, small cost, like shoe, metal and furniture polishes, washing powders, toilet articles, etc. Postal brings many new, different, bargain offers. Perfecto Printers, Drawer 968, Oklahoma City, Okla.

**NEW Luminous Crucifixes**—Headless Trouser Presses. Lowest quantity prices. Sample \$1.00. Old Paducah, Paducah, Ky.

**233% PROFIT** selling Jubilee Spark Intensi-fiers to automobile owners, garages. Sure cure for Spark Plug troubles. Sells like wildfire. Brand new. Exclusive territory. Write today. Jubilee Mfg. Co., Dept. M-2, Omaha, Nebraska.

**SELL** our Stamp, Gum, Match Vending Machines, etc. Liberal commissions. Catalogue free. Northwestern Novelty Co., Box 343, Morris, Illinois.

**BIG money** and special prizes selling a delicious ready to heat-and-eat confection. Get this at once. Particulars free. The Worcester Supply Co., Worcester, Mass.

**AGENTS Wanted.** Insurance Agents everywhere. Also traveling. Good salaries to producers who can appoint local agents. Easy selling sickness and accident policy. popular monthly payment plan. National, 514 Westover Building, Kansas City, Mo.

**AGENTS** of ability and good address to sell the best phonograph in existence. Price moderate. Our large commissions insure handsome earnings. The Orpheus Company, 571 Broad St., Newark, N. J.

**AGENTS** wanted. Economy Kerosene Burners for cooking and heating stoves. Big profits. Exclusive territory. Economy Mfg. Co., 1323 N. Dearborn St., Chicago, Ill.

**AGENTS** make 500% profit handling Auto Monograms, Patriotic Pictures, Holiday Decorations, Window Letters and Changeable Signs. Catalog free. Hinton Co., 6142 49th Court, Chicago, Ill.

**50c.** SELL Name Cards and Leatherette Cases. Wolf Cards, Philadelphia.

**AGENTS:** 30 Ping Calling Cards only 10c. P. Sheppard, Rome, N. Y.

**AGENTS,** "Eggs," the guaranteed substitute for fresh eggs, means eggs at 8 cents per doz.; enormous demand everywhere; big profits; sample free. Thomas Dougherty, 117 East 47th St., New York.

**YOU** can be your own boss with our Key Check outfit. Good for \$5 a day stamping names on pocket key checks, fobs, etc. Sample check with your name and address, 15 cents. Pease Die Works, Dept. M., Winchester, N. H.

**GOOD** income refinishing chandeliers, brass beds, automobiles by new method, producing amazing results; no capital or experience necessary; particulars free. Gunmetal Co., Ave. H, Decatur, Ill.

**CLEANING Preparations:** Dry Cleaner, Rust Remover, Laundry Tablets. Wildfire sellers. Agents coining money. Sales guaranteed. Write for offer—Hurry! Lawrence Chemical Co., Marietta, Ohio.

**1917'S GREATEST Sensation!** 11-piece toilet goods combination selling like blazes at \$1.00 with \$1.00 Carving Set Free. Everybody buys. Eagle's profit first week \$51.00. Great crew proposition. P. Pierce Co., 942 Lake St., Chicago.

**MAKE** and Sell Your Own Goods. Machinery unnecessary. Expert Chemists advice. Special attention to beginners. Formula Catalog for Stamp. Blake Mystic Company, Washington, D. C.

**WONDER** Pudding Powder makes the most delicious Chocolate, Raspberry, or Lemon pudding you ever tasted. 5 to 7 large dishes in a fifty for 10c. Sell it to stores, restaurants, hotels, families. Appoint agents. Big profits, wonderful seller. Package and particulars 10c postpaid. Morrison Company, 4414 Madison, Chicago, Ill.

**AGENTS.** Something new; Free sample. Foreign inquiries invited. Famous Products Co., Decatur, Illinois.

**EVERY** home on farm, in small town or suburb needs and will buy the wonderful Aladdin kerosene (coal-oil) Mantle Lamp. Five times as bright as electric. Tested and recommended by Government and 34 leading Universities. Awarded Gold Medal. One farmer cleared over \$500 in six weeks. Hundreds with rigs or autos earning \$100 to \$350 per month. No capital required; we furnish goods on time to reliable men. Write quick for distributor's proposition and lamp for free trial. Mantle Lamp Co., 528 Aladdin Bldg., Chicago, Ill.

**INSYDE Tyres,** inner armor for Automobile tires, double mileage and prevent punctures and blowouts. Quickly applied. Cost little. Demand tremendous. Profits unlimited. Details free. American Automobile Accessories Co., Dept. P, Cincinnati, O.

**GET** Davis' Latest Proposition. \$15.00 daily a cinch. No matter how many times you have answered my ads in last 20 years, write again. E. M. Davis, Dept. 508, 900 Lake, Chicago.

**LARGE** Manufacturer wants representatives to sell shirts, underwear, hosiery, dresses, waists, skirts, direct to homes. Write for free samples. Madison Mills, 503 Broadway, New York City.

**NEW Patriotic War Atlas** Free with my 1917 "Business Guide." Sells everywhere. Beginners clear \$7 daily. 50% commission. Outfit free. Prof. Nichols, Box P. M. 3, Nagoville, Ill.

**AGENTS**—Our gold window letter proposition beats 'em all. Stahlrite Co., Dept. P 1115 Second Ave., N. Y. Established 1905.

**DO** you want to travel at or expense? We want good men and women for traveling general agents. Must have fair education and good references. Will make contract for three months, six months or year at salary \$32.50 per week and necessary expenses. Can assign most any territory desired. For full particulars address George G. Clows Company, Philadelphia, Pa., Dept. 4-1

**BIG Textile Mills** want ambitious men and women everywhere to show latest dress fabrics, neckwear, hosiery, underwear, and sweaters. 400 styles. **Easy sales. Values** beat stores. Many making over \$50 weekly. All or spare time. Complete sample outfit starts you. Steadfast Mills, 30 Remsen St., Cohoes, N. Y.

**AGENTS—Just out, New Dollar Winner, One-Hand Speed Wrench.** Machinists, autoists, farmers, everybody buy at sight. 100% profit. Make \$30 to \$50 weekly. Toledo Speed Wrench Co., Dept. "M," Toledo, Ohio.

**\$2.50 PER day Salary Paid One Person** in each town to distribute Free circulars, and take orders for White Ribbon Concentrated Flavoring. Non-alcoholic—Big demand, steadily increasing. J. S. Ziegler Co., 7P E. Harrison St., Chicago.

**\$10 A DAY Profit—manufacture Barley Crisp;** new confection; 50 package costs you 10¢; machine, instructions complete, \$7.50 prepaid; send 10¢ for samples. Barley Crisp Company, 1267 Broadway, San Francisco.

**AGENTS—Make a dollar an hour.** Sell Mendits, a patent patch for instantly mending leaks in all utensils. Sample package free. Collette Mfg. Co., Dept. 404B Amsterdam, N. Y.

**AGENTS—Send for sample "Frotrot"—** the wash day wonder. Be convinced you can do a whirlwind business. You can clear at least \$20 to \$100 weekly, according to spare or whole time. You don't have to talk; if she doesn't buy at sight, leave sample; she will be looking for you long before you are able to make the rounds again. Samples furnished free. Premiums for your customers. Exclusive territory guaranteed to agents who can produce. Credit given. Don't call. P. M. Motter & Sons, 3213 Warren Ave., Chicago.

**AGENTS make 500 per cent profit** selling our Auto Monograms and Initials, Window Sign Letters, Changeable Signs, and Show Cards. 1,000 Varieties. Enormous Demand. Sullivan Co., 1123 Van Buren St., Chicago, Ill.

**AGENTS—Something new; patented sanitary kitchen article; whirlwind seller; big profits; write quick.** Valley Supply Co., Grafton, W. Va.

**MAN wanted** in small town or on R. F. D.; wear fine sample tailored suit, be agent, make big money; introduce us to friends, take orders for tailoring in spare time. Write for free book of cloth samples, styles, instructions. Knickerbocker Tailoring Co., Dept. 697, Chicago.

**DECALCOMANIA Transfer Initials and Flags:** You apply them on automobile while they wait. You can make \$1.38 profit on \$1.50 job; free particulars. Auto Monogram Supply Co., Dept. 1, Niagara Bldg., Newark, N. J.

**DISCOVERED! Extraordinary New Propo-** sition. Supreme Opportunity. \$200 per week Easy, demonstrating marvelous Adding Machine. Retail \$7.50. Work equals \$300 machine. Subtracts, Multiplies, Divides, automatically. Whirlwind in speed. Guaranteed Five Years. Used by U. S. Government. Sells everywhere. Amazing profits. Write quick for exclusive territory. Calculator Corp., Dept. PM, Grand Rapids, Mich.

**NEW invention, fast seller** to all classes. Popular price, many buy dozens, no competition. Big profit. Dandy mail-order proposition. The Clark Co., Clark Building, Jacksonville, Fla.

**WANTED. General Agent** to represent us in your locality. Exclusive territory. Big inducements. Chicago Agency Co., 840 Alameda St., Chicago.

**WANTED—New Ideas.** Write for list of Patent Buyers and Inventions Wanted. \$1,000,000 in prizes offered for inventions. Our Four Books sent free upon request. Victor J. Evans & Co., 163 Ninth, Washington, D. C.

**AGENTS — Ho-Ro-Co Skin Soap** and Toilet Goods plan beats everything for agents' profits. "Ho-Ro-Co," 112 Locust St., St. Louis, Mo.

**AGENTS: \$30 to \$100 a week.** Free samples. Gold sign letters for Stores and Office Windows. Anyone can do it. Liberal offer to general agents. Metallic Letter Co., 407 N. Clark, Chicago.

**CALIFORNIA Flower Bead Necklaces** beat anything for quick sales and profits. Absolutely new. Write for agent's proposition. Mission, 2819 P.M. West Pico, Los Angeles, Calif.

**AGENTS, Make Big Money; fast office** seller; particulars and samples free. One Dip Pen Co., Dept. 2, Baltimore, Md.

**AGENTS—\$5 daily** selling our Handy Tool, 12 articles in one. Lightning seller. Sample free. Thomas Mfg. Company, 762 North St., Dayton, Ohio.

**HOSIERY and Underwear Manufacturer** offers permanent position supplying regular customers at mill prices. \$50.00 to \$100.00 monthly. All or spare time. Credit. D. Parker Mills, 2733 No. 12th St., Phila., Pa.

**INVENT Something.** Your ideas may bring wealth. Free book tells what to invent and how to obtain a patent through our credit system. Talbert & Parker, 4663 Talbert Bldg., Washington, D. C.

**AGENTS — Sell rich-looking imported** 36x68 rugs, \$1 each. Carter, Tenn., sold 115 in 4 days. Profit, \$57. You can do same. Write for sample offer selling plan; exclusive territory. Sample rug by parcel post prepaid. 88c. E. H. Condon, Importer, Stonington, Maine.

**FEATHER Flowers,** the all-purpose Home flower. Business clean, attractive, profitable. Sample fifteen cents. De Witt Sisters, Route Ten, Battle Creek, Mich.

**EASY, pleasant work** for Mechanics, Shop Men, Clerks, during spare hours, will add many dollars to their salaries. Also want persons who can give full time. Big wages assured. Novelty Cutlery Co., 67 Bar St., Canton, Ohio.

**GAS Fire** in any cook stove from common coal oil. Agents coin money. Wunder Burner Company, Columbus, Ohio.

**AGENTS make \$100.00 monthly** selling our 500 Handy Household Articles; Catalogue free. Scheff Company, Desplaines, Ill.

**AGENTS—Steady Income.** Large manufacturer of Handkerchiefs and Dress Goods, etc., wishes representative in each locality. Factory to consumer. Big profits, honest goods. Whole or spare time. Credit given. Send for particulars. Freeport Mfg. Co., 59 Main St., Brooklyn, N. Y.

**GRAB Territory** on our new specialties. Full line samples and terms \$2.00. Money back if wanted. Adam Fisher Mfg. Co., 2901-G, St. Louis, Mo.

**ANY Man or Woman** can make \$35 or more weekly selling Puritan Brushes to every household. Big profits, easy work. Exclusive territory. Special method for making sales easy. Puritan Co., Dept. M, 1906 Broadway, New York.

**WANTED Reliable People—Place Engine** in stores and appoint agents. Takes place of eggs in baking and cooking at 9¢ doz. Large package and particulars 10¢ postpaid. Morrissey Company, 4403-5 Madison, Chicago.

**AGENTS, 500% Profit, Sign-Letters** for office and store fronts. Samples and particulars free. Inter-States Letter, 2424 N. Halsted St., Chicago.

**\$1,000 PER Man** per county. Strange invention startles world—agents amazed. Ten inexperienced men divide \$40,000. Korstad, a farmer, did \$2,200 in 14 days. Schleicher, a minister, \$195 in first 12 hours. \$1,200 cold cash made, paid, banked by Stoneman in 30 days; \$15,000 to date. A hot or cold running water bath equipment for any home at only \$8.50. Self-heating. No plumbing or waterworks required. Investigate. Exclusive sale. Credit given. Send no money. Write letter or postal today. Allen Mfg. Co., 311 Allen Bldg., Toledo, Ohio.

**AGENTS. We have a good proposition** for you. Write for particulars and samples. Chicago Agency Co., 838 Alameda St., Chicago.

**PORTRAIT Agents, new and old,** write us. We know what you want and need. Established 17 years. Pioneer, 1252 W. 63rd St., Chicago.

**PORTRAIT Agents: Our goods will make** you big profits. Delivery guaranteed. Refunds credited. Prompt shipments. Send for latest catalogue and prices. Adam J. Kroll & Co., 602 Blue Island Ave., Chicago, Ill.

**AGENTS: Big Hit: Our 5-Piece Alumi-** num Set is all the rage. Cheaper than Enamel Ware. Sells like wildfire. Guaranteed 20 years. Retail value \$5.00. You sell to housewives for only \$1.98. Biggest seller of the age, 9 sure sales out of every 10 shown. Others cleaning up \$10.00 to \$20.00 a day. Answer this quick to secure your territory. Div. GGS, American Aluminum Mfg. Co., Lemont, Ill.

**\$50 WEEKLY** and up selling Mexican Diamonds. Exactly resemble genuine; Same Rainbow Fire; Stand tests; sell at sight; Repeat orders. Write quick for Sample Case offer free. Mexican Diamond Importing Co., S. W. Las Cruces, New Mexico.

**"GOLDINE" Sign Letters—1,000% profit.** Particulars free. Johnston Co., Quincy, Ill.

#### AGENCIES WANTED

**AGENCY wanted** for Montreal and Province of Quebec. The Drolet Distributing Co., Room No. 24, 50 Labelle St., Montreal.

#### SALESMEN WANTED

**MASTER Salesman Wanted,** man 30 to 50, good education, college graduate preferred, of pleasing manner and strong personality, for special diplomatic personal soliciting independent business of your own, where the clientele you build up belongs to yourself. \$300 per month absolutely guaranteed for first five months' work to right man. Company well rated, established ten years. This contract is worth \$25,000 certain profit the first three years and will make one independent for life in five to ten years. Must be financially responsible and able to handle own business under own name. Territory, the South, the West, some Central. No special experience necessary, but character, personality, courage and industry essential; state age, education, past occupations and earnings in strict confidence. Address and phone number or no reply. Apply Burnham, President, 12th floor, Caxton Bldg., Chicago.

**SALESMEN calling** on Manufacturing and Factory Trade to sell High-Grade Legitimate product as a side-line. No samples to carry. Liberal commission proposition. Write North American Lined Products Co., Cleveland, Ohio.

**ACTIVE men everywhere** as Cigar Salesmen. \$20-\$40 weekly salary. Experience unimportant. Neway Sales Co., Hartford, Conn.

**STOCK Salesmen—A large, reliable, ac-** tive and progressive Corporation can use your services, if you are looking for a position that will pay you well for the amount of energy you expend. Experience unnecessary—simply ability and integrity—together with a determination to make good—are our requirements. For further information address A. M. Kathrens, 1550 McCormick Bldg., Chicago, Ill.

**TRAVELING Salesmen Wanted—Experi-** ence unnecessary. Earn what you learn. Hundreds of good positions open. Write today for large list of openings and testimonials from hundreds of members we have placed in positions paying \$100 to \$500 a month. Address nearest office. Dept. 1258, National Salesmen Training Association, Chicago, New York, San Francisco.

**BESCOHOL—New substitute** for Alcohol in Radiators. Good for 20 Below Zero. Write for territory and particulars. Sample, 25 Cents. Hearsley Specialty Laboratories, Rock Island, Ill.

**SALESMAN Wanted January 1st—Ex-** cellent line Signs and Novelties. Traveling expenses advanced. Liberal commissions. Exclusive territory. Give age, height, weight, road experience and three late business references. Stanford-Crowell Co., Ithaca, N. Y.

**SELLS on Sight—get \$2 sample,** send no money; profits \$300 to \$500 monthly; here's proof—Brant made \$17 in less than one hour; Johnson, \$12 first hour; Winston \$138 in two days; don't doubt—and be the lower; get convincing proof; wonderful fuel vaporizer quickly attached to all autos saves up to 50 per cent gasoline; increases mileage, speed and engine efficiency; eliminates carbon, engine heating; every auto owner a buyer on our proof demonstration, free-test, money-back guarantee; clinch your territory; get these big, quick profits; write immediately. M. F. Weaver, Morningdale, Sioux City, Iowa.

**TRAVELING salesmen.** Every State. Main or side line. New fast selling line of Automobile Accessories used on all cars. Samples loaned. Weekly settlements and repeat orders. Toledo Cable Co., 443 Davis Bldg., Toledo, Ohio.

**SALESMAN—\$6,000 Accidental Death,** \$30.00 Weekly Accident Benefit, \$25.00 weekly Sick Benefit, \$10.50 yearly, half amount \$5.50. \$250,000 deposited Insurance Department. Experience Unnecessary. Become independent—own your business. Guaranteed steady income from renewals. Registration. Dept. B, Newark, N. J.

**TRAVELING Salesmen Wanted**—Experience unnecessary. Earn while you learn. Hundreds of good positions open. Write today for large list of openings and testimonials from hundreds of members we have placed in positions paying \$100 to \$500 a month. Address nearest office. Dept. 1358, National Salesmen Training Association, Chicago, San Francisco, New York.

**WERE You Ever Offered a Grocery Store?** Our Proposition is Better. Let us tell you how you can handle Flour, Canned Goods, Provisions, an entire line of groceries, as well as Paints, Roofings, Stock Foods, Automobile and Machinery, Oils and Greases. No rent to pay. No investment in stock. Large orders taken from samples. Goods of guaranteed and proven quality. Selling experience not necessary. Very profitable work for "workers." Address Hitchcock Hill Co., Dept. 200, Chicago, Ill. Reference: Any bank or express company.

**SALES Manager**—For exclusive sale and distribution in restricted territory: high-caliber men, with some finances to start; good proposition to right man. Write for particulars. Gasline Co., Bridgeton, N. J.

**WANTED**—Representatives everywhere. Exclusive territory. Gold sign letters for stores and office windows. Any one can put on. Write today for free sample. Metal Letter Co., 403 N. Clark St., Chicago.

**SALESMEN**—Acquainted with grocery trade. Large demand; liberal commission; pocket sample. Wirth Salesbook Co., Dept. P., Chicago.

**AUTOMATIC** Address—\$2.50—\$3.50—\$5. Sell quickly. Wonderful sideline. Bassett, 5921-V Indiana Ave., Chicago.

**SIDE Line Men.** Do you want a real one that one order a day will pay you \$5.00. No samples to carry. Something new. Write today. Canfield Mfg. Co., 208 Sigel St., Chicago, Ill.

**EARN \$5,000 to \$20,000 yearly.** New business necessity. Details \$5 to \$200. 100-200% profit. Purchaser satisfied or money refunded. No competition. Exclusive territory. Free samples. Sayers, 408 Wainwright, St. Louis.

**SALESMEN**—Get our plan for Monogramming Automobiles and motorcycles by transfer methods. Very large profits. Motorists' Accessories Co., Mansfield, O.

#### HELP WANTED

**\$100 MONTH Paid Men—Women.** Thousands Government War Positions open. Short hours. Pleasant work. Examinations everywhere. List positions free. Write immediately. Franklin Institute, Dept. H-21, Rochester, N. Y.

**WANTED**—Men and women to qualify for government positions. Several thousand appointments to be made next few months. Full information about openings, how to prepare, etc., free. Write immediately for booklet CG25. Earl Hopkins, Washington, D. C.

**RAILWAY Mail Clerks Wanted.** Men. 18 or over. Commence \$75 month. Every second week off with pay. Education unnecessary. Sample examination questions free. Write immediately. Franklin Institute, Dept. H-21, Rochester, N. Y.

**STOP** that daily grind. Take nose off grindstone; be no man's slave, punch nobody's time clock. Own your business. I start you silvering mirrors, plating tableware home. Sure income. Plans free. Clarence Sprinkle, Dept. 28, Marion, Ind.

**CIVIL Service Examinations** lead to good government positions. Railway Mail pays up to \$1,800; Post Office Clerks—Carrier \$1,200; Customs \$2,500; Internal Revenue \$2,130; Bookkeeper \$2,500; Stenographer \$1,800; Clerk \$1,800; Technical \$1,000; Rural Carrier \$1,200; Women \$1,800; Guard \$840 up. I can coach you by mail at small cost and give bond guaranteeing success or money refunded. Particulars free to American citizens over 17. Ask for booklet QE-29, naming position wanted. Earl Hopkins, Washington, D. C.

**WANTED**—Men. Become Automobile Experts. \$35.00 week. Learn while earning. Franklin Institute, Dept. H, 802 Rochester, N. Y.

**WANTED**—Civil Service examinations open the way to good government positions. I can teach you by mail at small cost. Full particulars free to any American citizen of eighteen or over. Write today for booklet CE-29. Earl Hopkins, Washington, D. C.

**THOUSANDS** Government War Positions Open. \$100 month. Examinations everywhere. List free. Franklin Institute, Dept. H-21, Rochester, N. Y.

**LETTERHEAD** and envelope designs for any business. Price \$1.00. Sketch free. D. Freeburn, Hicksville, Ohio.

**HUNDREDS** Clerks (men and women) wanted by Government for war preparation, \$90 month. List positions free. Franklin Institute, Dept. H-21, Rochester, N. Y.

**HELP** supplied—Positions secured—Any kind—everywhere. Conway, 3 Nathan Building, Detroit, Mich.

**UNCLE Sam** has thousands of jobs open this year. I will help you get one. Write for my big free book. DX-29. Earl Hopkins, Washington, D. C.

**GOVERNMENT** wants Railway Mail Clerks, \$75 to \$150 month. Sample examination questions free. Franklin Institute, Dept. H-21, Rochester, N. Y.

**WANTED**—An Idea! Who can think of some simple thing to patent? Protect your ideas; they may bring you wealth. Write for "Needed Inventions," and "How to Get Your Patent and Your Money." Randolph & Co., Patent Attorneys, 629 F Street, Washington, D. C.

**BE a Mirror Expert.** Good income; spare time home at first; no capital; we train, start you making and silvering mirrors; French method. Free prospectus. W. P. Derr, Pres., 579 Decatur, Brooklyn, N. Y.

**FIREMEN, Brakemen, all railroads,** everywhere, \$100-\$150 monthly, experience unnecessary, positions guaranteed. Railway Association, Dept. 254, Brooklyn, N. Y.

**BE a Draftsman**—Big pay; Tremendous demand. Study at home. Complete course; drawing instruments free. Our graduates filling good positions as Draftsmen and Chief Draftsmen with Government and private concerns. We help you secure position when qualified. Write for free book. Columbia School of Drafting, 34 McLachlen Bldg., Washington, D. C.

**FOREMEN, Shopmen, and Office men** Wanted to work spare time as special representative of large well-known mail-order house, selling Watches, Diamonds and Jewelry on Credit. Liberal commissions and exclusive sales rights granted. No investment or deposit required for outfit or samples. Write at once for details. Address S. D. Miller, Dept. 14, Agency Division, Miller Bldg., Detroit, Mich.

**WANTED**—Gauge and Toolmakers, also Jig and Fixture Makers, for small interchangeable parts. Call or write to Employment Bureau, N. E. Westinghouse Co., Springfield, Mass.

**PICK** up some easy money gathering butterflies, insects. I buy 750 kinds. Some \$1-\$7. Intensely interesting. 2c stamp brings prospectus. Get posted. Sinclair, Box 245, D6, Los Angeles, Cal.

**Do you want a sure job with big pay,** easy hours and rapid advance? Write for my big free book, DW-29, which tells you how you can get a good Government position. Earl Hopkins, Washington, D. C.

**PHOTOPLAYS** in demand. Make extra money. We show you how. Details free. Rex Publishers, Box 115 H-16, Chicago.

**Do you want a position for life, with big pay,** short hours and sure advancement? Then work for Uncle Sam. My free illustrated book DK-29 tells how to get an appointment. Earl Hopkins, Washington, D. C.

**FIREMEN, Brakemen, Baggage men, 8** hours, \$140. Colored Porters wanted everywhere. Experience unnecessary. 810 Ry. Bureau, East St. Louis, Ill.

**GOVERNMENT** pays \$960 to \$1,500 yearly. Prepare for coming "exams" under former Civil Service Examiner. New Book Free. Write Patterson Civil Service School, Box 3020, Rochester, N. Y.

**FREE** Illustrated Book tells of about 300,000 protected positions in U. S. service. Thousands of vacancies every year. There is a big chance here for you, sure and generous pay, lifetime employment. Just ask for booklet CS-29. No obligation. Earl Hopkins, Washington, D. C.

**GOOD** income refinishing chandeliers, brass beds, automobiles by new method, producing amazing results; no capital or experience necessary; particulars free. Gummetal Co., Ave. G, Decatur, Ill.

**WORK** for Uncle Sam. He is the best employer. Big pay, sure work, easy hours, long vacations, rapid advance. Thousands of jobs open this year. I will help you get one. Write for my big free book, DY-29, today. Earl Hopkins, Washington, D. C.

**INVENT** Something. Your ideas may bring wealth. Free book tells what to invent and how to obtain a patent through our credit system. Talbert & Parker, 4102 Talbert Bldg., Washington, D. C.

**GOVERNMENT Examinations.** Most thorough preparation, \$5; returned if not appointed; particulars free. American Civil Service School, Washington, D. C.

**MAKE** money writing Photo-plays; details free to beginners. No correspondence course. Producers' League, 230 Wainwright, St. Louis.

#### WANTED

**WANTED** Shot Gun, Automatic Revolver. Give make, price, Pink, 4153 Wyoming, St. Louis, Mo.

#### FOR SALE

**ARMY and Navy Men, Attention!** Field, Marine, Day and Night Glasses with case, 2 1/2-mile adjustment, only \$9.50. Money back if not satisfactory. Weil's Curiosity Shop, 20 S. Second St., Philadelphia, Pa.

**UNIVERSAL** Knitting Machines. Many styles, hand or power. For Catalogue, address, Daniel Booker, Peabody, Mass.

**TYPE and Printing Material** at bargain prices. Now is the time to buy. All sizes rebuilt Job Presses very cheap. Catalogue free. Philadelphia Printers' Supply Co., 14 So. Fifth St., Philadelphia.

#### GUNS, SPORTING GOODS, ETC.

**BARGAINS.** Will trade, buy or sell Guns, Rifles, Revolvers. Send Stamp for Bargain List. Oldest, most reliable Dealer in Country. Wm. R. Burkhardt, 143 East Fourth Street, St. Paul, Minnesota.

**BUY, sell, exchange** old-time and modern Fire-arms, Antiques wanted. Stephen Van Busselaer, 895 Madison Avenue, New York.

#### BLACKSMITHS

**BLACKSMITHS, Listen!** Prepare for big wages in Navy and Arsenal with Toy's Modern Methods doing hard jobs easy. Forging and making solid welds, hardening and tempering to a standard, with colored tempering charts. All for one dollar. Samples free. W. M. Toy, Sidney, Ohio.

#### MACHINERY, TOOLS AND SUPPLIES

**FOR Sale**—1 Sprague Electric Works' 8-1, 2,000 lbs. capacity, Electric Trolley Hoist. Hoist—1 1/2 H.P. motor, single speed controller, holding speed 15 feet per minute and a maximum lift of 13 feet for operation on a 220 volt, 3 phase, 60 cycle alternating current circuit. Trolley 1.3 H.P. motor, rheostatic control operated by ropes. Speed 250 feet per minute. Carriage constructed to operate on ten inch I beam. Price and Terms on application. Wm. Wrasley Jr. Company, Chicago.

**PULLEYS, Gears, Sprockets, Shafting, Hangers.** See page 136. W. A. Jones Foundry & Machine Co., Chicago.

**"RED Devil"** Glass Cutter, improved type; cuts more glass, sample 10c. Glassiers' booklet free. Smith & Hemenway Co., 97B Colt Street, Irvington, N. J.

**WIRE**—all sizes—% to No. 16. Coppered, tinned, galvanized and plain steel wire for sale. Cooley Mfg. Co., 553 W. Monroe St., Chicago, Ill.

**MILLING** machine, back geared, Lincoln type, with arbor and vise, overhauled, \$90. Photo. Lucas & Son, Bridgeport, Conn.

#### FLOUR & FEED MILLING MACHINERY

**SPECIAL** bargains in second hand Attrition mills, burr mills, crushers, corn shellers, bran dusters, dust collectors, purifiers, reels, double, single, 2 and 3-pair high roller mills, sieve bolters, receiving separators, acourers, etc. Write for description and prices. Sprout, Waldron & Co., P. O. Box 429, Muncy, Pa.

#### ENGINES, MOTORS AND DYNAMOS

**GUARANTEED** alternating and direct current motors. Fort Wayne, Crocker-Wheeler, Wagner, Sprague, Century, Westinghouse, General Electric. All sizes. Motors repaired and exchanged. Moneyworth or Moneyback. Send for new illustrated catalog supplies and motors. Hyro Electric Co., 633 HE South Dearborn St., Chicago.

**FOR Sale**—2 K. W. 60-volt dynamo. Almost new. Cost \$75.00, sell for \$35.00. E. J. Saxton, Tiffin, Iowa.

**GENERATORS, Ball-bearing, 32 volt, 11** to 25 amperes, complete with base and pulley. Prompt shipments. Goodlite Company, Indianapolis, Ind.

**MACHINERY:** 12 H. P. Fairbanks-Morse engine with Apple starter. 1 1/2 H. P. 119 V. D. C. motor. 945 R. P. M. Cheap for quick action. H. D. Parsons, 716 Faraon St., St. Joseph, Mo.

2 H. P. GASOLINE engine Post drill. 10" Skinner lathe chuck. 831 S. 5th St., Hamilton, Ohio.

**SMALL Motors and Generators—Quantity** 1/4 H. P. A. C. Motors—110 volts—slightly used. \$14.00. Small generators—charging—lighting—moving picture Arc machines, \$10 each and up. A. C. Motors 1 and 3 phase up to 5 H. P. for immediate delivery. Write for Bankruptcy Stock sheet. Johnston, West End, Pittsburgh, Pa.

**ENGINE User Agents** Wanted to "use, demonstrate and sell" "Big Ben," wonderful new 2 1/2 H. P. gasoline engine. Free introductory offer and free details. C. Benninghofen & Sons, Dept. P, Hamilton, Ohio.

#### ENGINE CASTINGS AND BLUE PRINTS

CASTINGS for small gasoline engines, with drawings. Mustin Mfg. Co., Newport, Kentucky.

#### FOR MECHANICS

**PATENTS** Wanted. Write for list of Patent Buyers who wish to purchase patents and what to invent with List of Inventions Wanted. \$1,000,000 in prizes offered for inventions. Send sketch for free opinion as to patentability. Write for our four Guide books sent free upon request. Patents advertised Free. We assist inventors to sell their inventions. Victor J. Evans & Co., 184 N. 10th, Washington, D. C.

**TOOL Cases** For Carpenters and Machinists. Write for catalog. Keystone Case Co., 420 Lake St., Chicago.

#### ELECTRICAL

**WHOLESALE** prices. Illustrated catalog electrical motors and supplies including rosettes, lampcord, tape, plugs, sockets, wire, looms, switches, fuses, cutouts, knobs, cleats, tubes. Hyro Electric Co., 433 E. South Dearborn St., Chicago.

**PRACTICAL** Electric—Universal handy book on every-day electrical matters, alarms, batteries, bells, carbons, connections, coils, dynamos, wires, lamps, motors, telephones, etc. 135 pages, 125 illustrations. 25c postpaid. Popular Mechanics Book Dept., 6 N. Michigan Ave., Chicago.

**STORAGE** Batteries Simplified—A complete new treatise on action—maintenance—repair—use. Describes fully the Exide, Edison, Gould, Willard, U. S. I. and other forms. Only complete and up-to-date book on subject. 320 pages, fully illustrated. \$1.50 postpaid. Complete description sent upon request. Popular Mechanics Book Dept., 6 N. Michigan Ave., Chicago.

#### STAMP COLLECTING

105 CHINA, etc., stamp dictionary, list, 2c. Album (500 illustrations) 3c. Bulard, Sta. A., Boston.

PACKET of 25 stamps: no two countries alike, 500 hinges. Set of \$1 and \$2 U. S. Rev., all for 3c. Mention paper. Miami Stamp Co., Toledo, Ohio.

20 UNUSED stamps free. All different. Postage, 2c. Fisk Stamps, Toledo, Ohio.

FREE! Stamp catalogues 50c with approvals. Riedell, Schenectady, N. Y.

4 HYDERABAD Free to approval applicants enclosing reference and 2c postage. Star Stamp Company, Sandusky, Ohio.

FREE! 25 Different British Colonials to applicants for approvals. Postage, 2c. Nickles, 122 Florida Ave., Washington, D. C.

DEALERS! Wholesale bargain list free. Collections bought. Beebe Company, Yonkers, N. Y.

1,000 U. S. AND Foreign Postage Stamps, 25 Cents postpaid. C. W. Parker, 77 Kensington Heights, Meriden, Conn.

500 MIXED U. S., old and new, 12c. Weatherly, Medina, Ohio.

BIG Surprise Packet free to approval applicants. Reference. Harry P. Bridge, Clearfield, Penna.

300 DIFFERENT stamps 27c. Lutheran Club, Box 176, Terre Haute, Ind.

15 VARIETIES Japan Free; 1,000 Hinges 4c. Frank Thorp, Norwich, N. Y.

STAMPS sent on approval at 70% discount. Reference required. Emory Renoll, Hanover, Pa.

**STAMPS—500** fine foreign incl. Mex. War, Salvador, incl. officials, Guatemala, China, etc., only 10c. Best App. Sheets 60 to 80% dis. We give valuable extra Presents free! Big 120 pg. catal. free. We buy stamps. Hussman Stamp Co., St. Louis, Mo.

FREE—60 different stamps, including Newfoundland, China, Japan, Mexico, etc., to applicants for our high-grade approvals. Send 2c stamp for return postage. The Edgewood Stamp Company, Dept. H, Milford, Conn.

200 FINE varieties and buying list of U. S. stamps, 25c. Order today. Dakota Specialty Co., Watertown, So. Dak.

TRY Pauline's "Provals and improve your purchases. Premiums. Big discounts. Pauline, Townsend, Montana.

61 ALL Different Foreign Stamps, including Honduras, Mexico, China, Peru, Australia, Egypt, Japan, Chili, Russia, Argentina, Brazil, Cuba, India, Portugal, etc. Only 7 cents. Royal Stamp Company, 48 N. 51st Street, Philadelphia, Penna.

24 VARIETIES Cuban stamps, 10 cents. List of 6,000 low-priced stamps free. Chambers Stamp Co., 111 P. Nassau St., New York City.

STAMPS, 75, all different, free. Postage, 2c. Meulton paper. Quaker Stamp Co., Toledo, Ohio.

STAMPS—12 different from warring nations. 10c; 10 different foreign coins. 15c; 20 Belgian stamps. 10c. Lists free. Toledo Stamp Co., Toledo, Ohio.

ASSORTMENT Siamese stamps; satisfaction guaranteed. One Dollar, check or draft. McQuerry, Bangkok, Siam.

PACKET "A" 100 varieties foreign stamps, 20c. F. J. Pope, Charlotte, Vermont.

#### RARE COINS

\$4.25 EACH Paid for U. S. Flying Eagle Cents dated 1856. We pay cash premiums on hundreds of Old Coins. Send ten cents at once for New Illustrated Coin Value Book 4x7. It may mean your fortune. Clarke & Co., Coin Dealers, Box 15, Le Roy, N. Y.

WILL pay \$2.00 for 1904 Dollar, proof; 10c for 1912 nickels 8. Mint; \$100.00 for Dime, 1894 8. Mint. We want thousands coins and stamps. We offer up to 1,000.00 for certain dates. Send 4c now for our large descriptive Coin Circular. Numismatic Bank, Dept. H, Fort Worth, Texas.

ALL for 30c, a 25c California gold token and a 20c nickel coin of Serbia. V. Walter, New Rochelle, New York.

TWO Uncirculated Villa Copper Coins, 25c. Moore Coin Company, Commerce, Texas.

CALIFORNIA gold, quarter size 27c, 1/2 size 53c, dollar size \$1.10. Large cent before 1821, Columbian nickel coin, and catalogue, 10c. Norman Shultz, King City, Mo.

OLD Coins. Large Fall Coin Catalogue of Coins for Sale, free. Catalogue quoting prices paid for coins, ten cents. William Hasbain, 101 Tremont St., Boston, Mass.

#### GAMES AND ENTERTAINMENTS

MAGIC Tricks for pocket, parlor and stage. Largest assortment in the world. Thurston's Book of Pocket Tricks 25c. Book of Card Tricks 25c, postpaid. Send 2c stamp for catalogue. (216 page professional catalogue 10c.) A. Feisman, 115 So. State, Chicago.

MAGICAL Apparatus. Card Tricks. Mind Reading. Sensational Escapes. New Puzzles. Jokes. Amusements. Catalog free. Hooney Magic Co., Desk 99, Berlin, Wisconsin.

"THE Magical Bulletin." For magicians and entertainers only. Published monthly. Sample 10 cents. F. G. Thayer, 235 S. San Pedro, Los Angeles, Cal.

6 MECHANICAL Puzzles, Postpaid with Bargain List, 25c. Western Puzzle Works, St. Paul, Minn.

MAGIC Tricks, Novelties, Escapes, Magicians' Supplies—Illus. Catalog free. Homer Howry Co., Los Angeles, Cal.

TRICKS, Puzzles, Jokes, Magical Apparatus, Plays, Stage Supplies, Mind-reading Acts, Sensational Escapes, and Illusions. Free large illustrated 1917 catalog. Oaks Magical Co., Dept. 451, Oshkosh, Wis.

PLAYS, Vaudeville Sketches, Monologues, Dialogues, Speakers, Minstrel Material, Jokes, Recitations, Tableaux, Drills, Musical Pieces, Entertainments for all occasions. Make-up Goods. Large Catalog Free. T. S. Denison & Co., Dept. 11, Chicago.

SEND Dime for Funniest Puzzle out. Receive Free catalogue and 5 Big Joke Novelties. Catalogue 3c. Peerless, 1616 Cleveland Ave., Chicago.

FUN: Fool Mother, Six Imitation Bed Bugs 10c, Box of Rubber Tacks 10c, Free Illustrated Catalog. F & S, 1518 Spaight, Madison, Wis.

FUN, fun for Everybody. Just out. Shooting Fountain Pen with caps, 25c pre-paid. All the latest tricks, puzzles, pocket novelties. Retail and wholesale. Send 2c for illustrated catalogue. Grandfield, 1238 Theriot Ave., Bronx, New York.

TRICKS and Greenbacks. Big magic catalog, 5c. Twenty greenbacks—10c. Gilnovos, 11135 So. Irving, Chicago.

SPECIAL—Greenbacks, Sneez Powder, Stink Bombs, and Trick Cards—All 25c. Mears, No. 68, Anderson, Ind.

MAGIC—Tricks, Books and Supplies. For Amateurs as well as the Great Professionals. Any one can learn through our instructions. Feature Acts in Mind Reading, Spiritualism, Rope Ties, etc. Large illustrated Professional Catalogue, 10c. Chicago Magic Co., Dept. B, 72 West Adams St., Chicago, Illinois.

1,000 STAGE and Parlor tricks, Illustrated Catalog 10c. Small Catalog free. Second-Hand Apparatus bought or exchanged. Hornman Magic Co., Sta. 10, 470 8th Ave., New York.

#### THEATRICAL GOODS

SCENERY supplied. Anywhere. Everywhere. Moderate Rental. Amelia Grain, Philadelphia, Pa.

#### CHRISTMAS SUGGESTIONS

50 ASSORTED Christmas folders for hand coloring 50c. Self-bleeding water colors 10c. Circular free. E. B. Winslow Company, Tuckahoe, N. Y.

#### FOR BOYS

JUST Issued—Amateur Mechanics No. 8. How to make 132 different interesting things such as electric fountains, bird houses, model monoplanes, porch swing, kites of various kinds, fishing rods, camp outfit, scarecrow, shocking machine, etc. 128 pages, 234 illus. Price 25 cents, postpaid. Also all preceding numbers in the series at same price. Popular Mechanics Book Dept., 6 N. Michigan Ave., Chicago.

BIG New Book for Boys—The Boy Mechanic, Vol. II—Just Out—A sequel to, but containing nothing found in Vol. I. Tells all about 1,000 interesting things to make and do. 480 pages; 955 illus. Cloth. Price, \$2.00, postpaid. Send for descriptive circular. Popular Mechanics Book Dept., 6 N. Michigan Ave., Chicago.

#### FOR MEN

SAVE Your old "Gillette" blades. Send one dollar for a "Royal." Most durable and satisfactory sharpener on the market. Movable arm, holds both edges of blade at correct angle, against two spiral leather rollers, rotated by crank. Gives old blades a perfect edge, quickly. Satisfaction guaranteed. Royal Sales Co., Box 12, Smithboro, N. Y.

SEND us your old clothes and we will send you the money or return goods if not satisfied with our price. We buy Gentlemen's slightly worn clothing of all descriptions. David Rosenberg, 2098 South Street, Philadelphia, Pennsylvania.

MILLIONS in use! Ninth Year of Success! Burham Safety Razor outfit 25c. Perfect Shaving Qualities. Burham Agency, St. Louis.

ARE you going to France? Take me with you. I am Match Lighter and Pin Cushion. Price, 10 cents, 2 cents postage. K. B. Creel, Ft. Paso, Tex.

USEFUL Invention. Samples, 10c. Agents wanted. DeLoof, AH-247 Harmon, Detroit.

#### RAZORS AND BLADES SHARPENED

SAFETY razors sharpened; two cents each. Guaranteed. Blade box free. Electro Strapping Co., 134 Shelby St., Detroit, Mich.

#### DIAMONDS, WATCHES AND JEWELRY

21-JEWEL Watch, \$3.00. If you want a watch, any price or make, write us for confidential inside price on it. We undersell them all. Agents wanted. Rex Company, Andover, O.

## FOR THE HOME

LET Graves Adjustodraft help run your furnace this winter. See advertisement on page 124.

"EGGETTI" (the original egg substitute) takes the place of eggs in all kinds of baking and cooking. Simple to use—always fresh. Guaranteed pure food product. Makes delicious cakes, cookies, puddings, etc. 10c package equals 12 eggs. Send 10c for a package today. (Agents Wanted.) Bestever Products Co., B-11 Douglas Park Sta., Chicago, Ill.

## PHONOGRAPHS AND RECORDS

TALKING Machines and Records. Records for Victor, Columbia, Edison, disc or cylinder talking machines bought, sold. Edison Standard 9c. Blue Amberol, 25c. Victor, 15c up. Send for Record List. Weil's Curiosity Shop, 20 S. Second St., Philadelphia, Pa.

BUILD your Phonograph. Highest quality motors, tone arms, reproducers, cabinets, lowest prices. Circulars free. Central Music Exchange, Indianapolis, Indiana.

BUILD a genuine Choraleon Phonograph. Big saving and musically correct. Blue prints free. Works \$5 and up. Fine profits building and selling. Write to-day for free catalogue. Dep. A. Choraleon Co., Elkhart, Ind.

BUILD Your Own Phonograph. Any type. Big saving. Patents expired. Profits making and selling them. We furnish parts you can't make. Full instructions, dimension drawings, illustrations, parts—price-list only 25c. Circular free. Associated Phonograph Co., Dept. P, Cincinnati, O.

## MUSIC

SONG-WRITERS and Musicians: Anyone can play instantly with our Rotary Music Scale. Helps you arrange song poems to music. This musical marvel complete only \$2.00. Write Needham Music Co., D61, St. Louis, Mo.

TO introduce our catalog we will include one copy of the latest music with same for 10c. H. S. Gordon, 143 W. 56th St., New York.

FAVORITE Old Home Songs—No home in the land should be without this book of 290 of the familiar old songs everybody loves. Words and music complete in a substantial volume 3½x7 inches in size. Price 50 cents postpaid. Popular Mechanics Book Dept., 6 N. Michigan Ave., Chicago.

MUSIC-LOVERS! Catalog of latest music, all kinds, free with song-hit for dime. Roy Linwood, Box 2232, Dept. M, Boston, Mass.

## FORMULAS AND TRADE SECRETS

75 MANUFACTURING Secrets, 10c. 1,000 Formulas 25c. Luminous Paint; Dry Tonic; Mechanics Soap; Renewing Gray Batteries—Reedilvering Mirrors, 20c each. Entire collection 50c. Satisfaction guaranteed. "The Ideal," Box 343-FM, Chicago.

29,000 FORMULAS, \$1. Postpaid. Complete list 4c stamps. Edm Bromley, Waterloot, N. Y.

19,000 SELECTED scientific, chemical, technological and practical recipes and processes, including hundreds of so-called trade secrets for every business, alphabetically arranged in one large volume of 800 pages. Price \$3 prepaid. Large descriptive circular sent upon request. Popular Mechanics Book Dept., 6 N. Michigan Ave., Chicago.

## ANTIQUES AND RELICS

INDIAN curios, baskets. Engravings and autograph letters, bought and sold. Heilmuller Art Co., 1367 14th St., Washington, D. C.

COINS, notes, pistols, antiques, curios, engravings. Catalogue, 3c. Antique Shop, 33 South 18th, Philadelphia.

ANCIENT Indian arrow heads. Send for lists. A. Ruby, Middletown, Pa.

POMO Indian Star Baskets. Prices free. Gilham, Highland Springs, Cal.

## TYPEWRITERS AND SUPPLIES

NEW Rebuilt and Slightly Used Typewriters, \$8 up. Portable Machines, \$10 up. Write for our catalog 50-O. Beran Typewriter Co., 58 W. Washington St., Chicago.

STARTLING values in Typewriters, \$19 up. Factory rebuilt. All makes. Shipped on trial. Five year guarantee. Write for Special offer No. 126-K, Whitehead Typewriter Co., 186 N. La Salle St., Chicago.

WE have a number of second-hand machines traded in on the new model Victor No. 3. All overhauled and in perfect condition. Like new. Write for list and particulars. Victor Typewriter Sales & Supply Co., 60 W. Washington, Chicago.

TYPEWRITERS, all makes factory rebuilt by famous "Young Process." As good as new, look like new, wear like new, guaranteed like new. Our big business permits lowest cash prices. \$10 and up. Also, machines rented—or sold on time. No matter what your needs are we can best serve you. Write and see now. Young Typewriter Co., Dept. 327, Chicago.

UNDERWOODS, Oliviers, Remingtons, \$15 to \$45; terms to suit; or rented. Typewriter Co., 131 N. Dearborn, Chicago.

UNUSED Display Typewriters, ½ manufacturers' prices! Adopted by big corporations since 1885. Investigate Free Trial (name typewriter preferred). Co-operative Union, Covington, Kentucky.

\*LARGEST Stock of Typewriters in America. Underwoods, one-fourth to one-half manufacturers' prices; rented anywhere, applying rent on purchase price. Free trial. Installment payments if desired. Write for catalogue 70. Typewriter Emporium, estab. 1892, 34-36 W. Lake St., Chicago, Illinois.

## DUPLICATORS AND DEVICES

ROTOSPEED mimeograph, complete with supplies for duplicating typewriting. Like new, \$15.00. The Geo. W. Symes Co., Harpero, Mich.

\$300 MULTIGRAPH like new for \$100. Guaranteed. Russell Baum, Philadelphia House, Philadelphia.

"MODERN" duplicator—a Business Getter. \$1 up. 50 to 75 copies from pen, pencil, typewriter; no glue or gelatine. 35,000 firms use it. 30 days' trial. You need one. Booklet free. J. E. Durkin & Reeves Company, Pittsburgh, Pa.

## OFFICE EQUIPMENT

SAVES time, money, labor—costs less than the average mistake. The Ray adds with speed and accuracy of highest priced machines. Also directly subtracts. Used by U. S. Government, International Harvester Co., B. & O. Ry., business and professional men everywhere. Complete for \$25.00. Handsome desk stand free. Send no money, but write for 20 day free trial. Ray Company, 1432 Power Bldg., Richmond, Va.

## MAILING LISTS

2,000 BOYS and Girls' Juveniles, 100% Authentic. Compiled 1917; \$8.00; 1,000, \$5.00; 500, \$3.50; 250, \$2.00; 100, \$1.00. Allen Service Company, A202 East 90th Street, New York.

COMPLETE mail list of all auto owners in U. S. to Jan. 1, 1917. Sell best offer. N. Y. Supply Co., 1018 Randolph, Chicago, Ill.

## PRINTING, ENGRAVING AND MULTIGRAPHING

QUALITY Printing Prepaid. 500 ether envelopes, noteheads, cards, statements, \$1.35; 1,000, \$2.25; 500 linen-finished letterheads or envelopes, \$2.25; 1,000, \$3.50. Prepaid. Typewriter letters. Stamp brings samples. Model Company, Manchester, Iowa.

INCREASE your business. "How" Free! Edward Harrison, Gummed Labels, Baltimore, Md.

500 LINEN Letterheads, Envelopes or Billheads, \$1.75. Samples, complete price-list. Southern Systems, Mansura, La.

500 LETTERHEADS, Envelopes to match, \$3.00. Frank Emerson, Brooklyn, Mich.

100 PANELED Visiting Cards, leatherette case, 45c. Wolf Cards, Philadelphia.

ENVELOPES, Statements, billheads, Cards printed \$1.75 per thousand. Other printing low. Samples free. J. M. Hunt, Lambertville, N. J.

BUSINESS Cards, 100, 25c; 1,000, \$1.50. Wilson Co., 1198 Locust, Cincinnati, O.

GUMMED Labels our specialty. 1,000 Flag Labels 30c. 100 assorted samples colored flag labels 10c. Wetsel, Box 101, Madison Square, New York City.

3,000 3¼x8 ENVELOPE circulars, postpaid \$2.00. Koch Prints II, Camden, N. J.

MAIL Order Advertisers: Our perfect imitation typewritten letter will save you time, labor and money. No better advertising medium than personal letters. Samples ten cents. A. Mercado Brothers, Box "A," Tyrone, Penna.

500 R. C. CARDS assorted colors, size 2¼x4 \$1.40; 1¾x3¼ \$1.25, cash with order. One color ink. Other printing in proportion on quotation. Girard Job Shop, B2, Girard, Kans.

YOUR name on fifty "Stylogprint Cards" 35c. Card case free. Bridgen Company, Waltham, Mass.

GUMMED Labels, 3,000 60c. 50pp. catalogue 2c. MacTaggart, 1235 Arch, Philadelphia, Penna.

5,000 5¼x8½ COLORED bond circulars, \$6.25; 10,000 \$11.00; 5,000 8¼x11, \$10.75. All sizes circulars, folders, stationery. Lowest prices. Samples. Estimates free. Goods' Printery, Harrisonburg, Va.

PERFECTION Letter Company, Muncie, Indiana. Multigraphs 500 purple letters with black letter heads, \$2.15. Samples for stamp.

3,000 GUMMED Labels for \$1.00—size 1"x2". Circular free. Catalogue 2c Stamp, The Helmers Company, Hoboken, New Jersey.

PRE-USED Printing presses, Type, Supplies, cheap. List for stamp. Popular Bargains, Richland, Pa.

AT Last! Beautiful Lithography for small users. 1,000 Letterheads, 1,000 Billheads and 1,000 Statements, \$9.50. Engraving Free. Kaydee Lithographing Co., 764 Tontonia, Milwaukee.

PRINTING Outfits—Presses, type, supplies, type novelties. Send stamp for catalogue. Model Press, York, Penna.

GOOD Printing at low prices. 1,000 good letterheads, envelopes, cards, billheads, labels, circulars, \$2.50. Samples free. Catalogues, booklets and circulars our specialty. Ernest L. Fantus Co., 523 S. Dearborn St., Chicago.

WE print anything. Cuts made from photograph. Samples. Commercial Press, Batavia, Ohio.

## PATENT ATTORNEYS

PATENTS on easy payments. Send model or sketch for Free Search and certified Registration of Your Invention for Your Protection. Free Book Tells What to Invent and How to Obtain a Patent on Easy Payments. C. C. Hines & Co., 591A Loan & Trust Bldg., Washington, D. C.

FETTERSTONHAUGH & CO., 400 Victor Bldg., Washington, D. C. A 35 year old firm composed of young men for energy and push and older men for counsel—all trained patent lawyers. Free booklet.

FITZGERALD & CO., Patent Lawyers, 803 F St., Washington, D. C. Est. 1830. "The Old Reliable Firm." Free Handbook.

PATENT secured or attorney fee returned. Send pencil sketch and description for free examination of the official records and report as to whether your invention is patentable. Prompt and personal service. F. M. Stephen & Co., 15th and G Sts., Washington, D. C.

PROTECTIVE patents procured promptly. 104-page blue book on patents sent on request. Trade-marks registered. Robb & Robb, 211-215 Southern Bldg., Washington, D. C.

PATENT secured or fee returned. Hundreds of inventions sold yearly. We will help you sell yours. Send model or sketch. Books and advice free. Sues & Co., Est. 30 years, 530 7th St., Washington, D. C.

PATENT Sense—"The book the Inventor Keeps." Worth more than all other patent books combined. Free. Write R. S. & A. B. Lacey, 105 Barrister Bldg., Washington, D. C. Established 1869.

PATENTS, Trade-Marks, Copyrights, Beale & Park, Successors to J. F. Beale. Established 1899. 1422 F St., Washington, D. C.

PATENTS explained in my free books, telling what you should know—what to invent—what not to invent—how to sell your patent, etc. Write today. H. L. Woodward, 862 G St., Washington, D. C.

PATENT Your Ideas. Books, "How to Obtain a Patent," and "What to Invent," sent free. Send rough sketch for free report regarding patentability. Manufacturers constantly writing us for patents. Patents advertised for sale free. Established 20 years. Address Chandloe & Chandloe, Patent Attorneys, 455 7th St., Washington, D. C.

**PATENTS Secured or Fee Returned.** Actual search free. Send sketch or model, 1917 Edition, 90-page patent book free. My patent sales service gets full value for my clients. It should never require more than two days to return upon the patentability of your invention; nor longer than ten days to prepare your application for filing. Longer delay amounts to gross neglect and the jeopardizing of your rights. For prompt personal service write, George P. Kimmel, 212 Barrister Building, Washington, D. C.

**THE Patentome is free.** An education in obtaining patents. Established 1865. Anderson & Son, Attorneys, 797 7th St., Washington, D. C.

**PATENTS.** R. Morgan Elliott & Co., Patent Attorneys, Mechanical, Electrical and Chemical Experts, 713-721 Woodward Bldg., Washington, D. C.

**PATENTS Bring Riches; Protect Your Invention.** Attorney's Fee payable when patent allowed. Plain advice and "Patent Facts" free. Trade-marks registered. Jaynes & Jaynes, 653 Kellogg, Washington, D. C.

**PATENTS that protect and pay.** Advice and books free. Rates reasonable—highest references; best results. Watson E. Coleman, Patent Lawyer, 634 F St., N. W., Washington, D. C.

**PATENTS—Herbert Jenner,** patent attorney and mechanical expert, 646 F St., Washington, D. C. I report free of charge if a patent can be had and its exact cost. Send for circular.

**PATENTS Wanted.** Write for list of Patent Buyers who wish to purchase patents and what to invent, with list of inventions wanted. \$1,000,000 in prizes offered for inventions. Send sketch for free opinion as to patentability. Write for our four Guide books sent free upon request. Patents advertised free. We assist inventors to sell their inventions. Victor J. Evans & Co., 186 Ninth, Washington, D. C.

**"PATENTS and Patent Possibilities"** is a 72-page treatise which tells all about patents, what to invent and where to sell it. It gives honest advice to inventors and tells about the successes of some of my clients, also explaining what are frequent causes of failure. Manufacturers are constantly writing for protective patents upon all kinds of sound inventions. Can you help supply their wants? The book is free. Write for it today. H. S. Hill, 905 McLachlen Building, Washington, D. C.

**DON'T Lose Your Rights to Patent protection.** Before proceeding further send for our blank form "Evidence of Conception" to be signed and witnessed. Book, suggestions and advice free. Lancaster & Alwine, 221 Ouray Building, Washington, D. C.

**PATENT What You Invent.** It may be valuable. Write me. No attorney's fee until patent is allowed. Eatab. 1882. "Inventor's Guide" Free. Franklin H. Hough, 322 Loan & Trust Bldg., Washington, D. C.

**KEEP Up with Progress.** Promote your patent. Send \$1.00 for year's subscription to best Inventor's Magazine, "Invention and Manufacturing," United States Patent Corporation, Washington, D. C.

**PATENTS—Send sketch for free search and report.** Books on patents and book of reference letters sent free. John S. Duffie & Co., 619 F St., Washington, D. C.

**INVENTORS: Write our Patent Dept.** Adam Fisher Mfg. Co., 2961 C Railway Exchange, St. Louis, Mo.

**PATENTS obtained through D. Swift** being promptly sold to manufacturers. Write today for free books of "Inventions Needed" and surpassing references. D. Swift, 317 Seventh St., Washington, D. C.

**INVENT Something.** Your ideas may bring wealth. Free book tells what to invent and how to obtain a patent through our credit system. Talbert & Parker, 4622 Talbert Bldg., Washington, D. C.

**PATENTS without advance attorney's fees.** Send sketch for free report. Books free. Frank Fuller, Washington, D. C.

**PATENTABLE Ideas Wanted—Send for 4 free books.** R. B. Owen, 39 Owen Bldg., Washington, D. C.

#### FOR INVENTORS

**WANTED—An Ideal** Who can think of some simple thing to patent? Protect your ideas; they may bring you wealth. Write for "Needed Inventions" and "How to Get Your Patent and Your Money." Randolph & Co., Patent Attorneys, Dept. 144, Washington, D. C.

**A REAL opportunity for some inventor.** Inventors who have a patented specialty, a new labor or money saving device or an improvement on a device, system or method of construction now being used in the building field, will find it to their advantage to get in immediate touch with us. We are leading manufacturers in the building supply field, with an international sales organization, and are in a position to finance, manufacture and market another good specialty in our line. Unless you have something good, fully protected, and are in a position to talk business, don't write. We are not brokers or patent salesmen, but a big, nationally known manufacturing concern in a position to take on and develop another specialty. Address, with details, R. M., Room 908, 78 E. Madison St., Chicago.

**FOR Inventors—Better be sure than sorry.** Before patenting, advertising, or selling your invention, get bulletin by experienced inventor that saves dollars. Particulars two-cent stamp. Address, Adviser, P. O. Box 1748, Spokane, Wash.

**LET Government expert make your drawings.** Skilled designer and engineer. Valuable advice. Engineer, 3222 Park Pl., Washington, D. C.

**GREAT opportunities exist for inventors,** but a patent is not everything. My free books tell what you should know. Horace L. Woodward, 952 G, Washington.

**INVESTOR will buy patents.** Write full particulars. 621 Caswell Block, Milwaukee.

**INVENTIONS—How to protect, sell and buy them.** If you are inventive, read this book. 108 pages, 25c, postpaid. Popular Mechanics Book Dept., 6 N. Michigan Ave., Chicago.

**PATENTS on easy payments.** Send model or sketch for free search and certified registration of your invention for your protection. Free book tells what to invent and how to obtain a patent on easy payments. C. C. Hines & Co., 591A Loan & Trust Bldg., Washington, D. C.

**INVENTORS: Experimental Work** a specialty. Machines, devices, and models perfected and built. L. Darby, 189 Mulberry Street, Newark, N. J.

**PRACTICAL patents marketed.** Send copy, will investigate. No advance fees. Whitbury-North Co., Buffalo, N. Y.

**HAVE You An Idea? If so, you should protect it by a patent.** Send us a model or sketch for free opinion as to patentability. Write for our Four Books sent free to any address. Victor J. Evans & Co., 157 Ninth St., Washington, D. C.

**INVENTORS: Invest for profit.** Write for list of needed inventions. Sanders, 7 Webster Bldg., Chicago.

**PATENTS, Trade-Marks and Copyrights.** Our handbook on patents will be sent free on request. All patents secured through us are described without cost to the patentee in the Scientific American. Munn & Co., Patent Attorneys, 623 Woolworth Bldg., N. Y. Washington, D. C., office, 623 F. St.

**INVENT Something.** Your ideas may bring wealth. Free book tells what to invent and how to obtain a patent through our credit system. Talbert & Parker, 4280 Talbert Bldg., Washington, D. C.

**INVENTIONS—Patenting and Promoting.** A book containing practical advice and directions for inventors and manufacturers. Book, suggestions and advice free. Lancaster & Alwine, 221 Ouray Bldg., Washington, D. C.

**NO Attorney fees until patent allowed.** Send sketch for free report. Books free. Frank Fuller, Washington, D. C.

**INVENTORS—We specialize in manufacturing new patented articles—make models—dies—and do experimental work.** Leo J. Gerding Mfg. Co., Dept. D, Opera Place, Cincinnati, O.

**INVENTIONS commercialized on cash and royalty basis.** Patents secured. Models, experimental work and contract manufacturing. Inventors should write at once. Adam Fisher Mfg. Co., 2961A Railway Exchange, St. Louis, Mo.

**PATENTABLE Ideas Wanted—Send for 4 free books.** R. B. Owen, 39 Owen Bldg., Washington, D. C.

**MANUFACTURER of nationally known product** wants additional articles for unlimited market. Will manufacture and sell. Write The Cramer-Kraswell Co., 355 Milwaukee St., Milwaukee, Wis.

#### PATENTS FOR SALE

**FOR Sale.** Potato Harvester, fork digger and sacker. Patent pending. J. Jerome, Battle River, Minn.

**FOR Sale: Patent metal window screen** with machinery for manufacturing. Same machinery will make metal weather strip. Splendid proposition for right man. Write for details. Address, E. Starbuck, Peoria, Illinois.

**FOR Sale—U. S. patent, outright or royalty,** handy tool for electricians and auto shops. Outright preferred. For particulars write, Jos. H. Courtney, Box 152, Magdalena, N. Mex.

**FOR Sale—U. S. and Canadian Patents** on the most reliable automobile lock yet devised. Will lock an automobile so that it cannot be moved without being unlocked. You can change your lock combination as often as you choose. For particulars, write Jaul J. Cole, Eberne, B. C., Canada.

**DISHWASHING Pans—Fine agent's article.** Martin A. Smith, Cottonwood, Ala.

**PATENT on improved Article-Carrier for sale** on cash or royalty basis. Reasonable terms. For full particulars address, Joseph Fallis, Gunn, Wyoming.

**INVENTOR wants to sell Patent No. 1,217,704,** to manufacturer only. For particulars, write James Claffone, Long Island City, N. Y.

**FOR money-making inventions, call or address** Mutual Service Bureau, 55 E. MeMicken, Cincinnati, Ohio.

**PATENT for Sale.** Absolutely non-refillable bottle and cheapest manufactured. James M. Miller, 456 Hastings St., East Vancouver, Canada.

**OUTRIGHT or royalty.** Patented and others pending, self-compressing, detachable mop-wringer, or will manufacture same for agencies on contract. Jacob Schmoier, 157 Elizabeth St., E. Detroit, Mich.

**AUTOMATIC Gate** patented August 21, 1917. No. 1,237,776. Swinging type, operated from vehicle. Simplest and cheapest to manufacture. Meryl R. Fairchild, Rochester, Ill.

**COMBINED safety valve and pressure gauge** for pneumatic tires; wonderful device. Pirpo, 1068 M. Sierra Nevada, Stockton, Cal.

**PATENT to highest bidder.** Drydock men get busy. Seaport or U. S. rights. Ships listed to paint or repair without drydocking. Address, Albert McDowell, 1386 Willow St., Los Angeles, Calif.

**PATENT for Sale—Hat and Mouse Trap.** Automatically sprung and reset. Mrs. Josephine Jaesen Bell, Box 873, San Diego, Calif.

**MAKE money manufacturing some new patented device.** Write us regarding following patents for sale or lease, cash or royalty. Our number 19463, Improved Garbage Can; 10196, Clothes Pin; 10365, Shoe Plate; 10484, Block and Tackle. Get your name on our list of Patent Buyers. Talbert & Parker, 4687 Talbert Bldg., Washington, D. C.

**POSITIVE and quick control of Search Light** for enclosed Automobiles. C. E. Rice, 4941 W. Superior St., Chicago, Ill.

**IMPROVED double magazine** for automatic pistol or rifle. Box 67, Fountain, Colorado.

**CONVERTIBLE Mission Chair.** Quickly adjusted to 5 different positions. Will consider reasonable offer. M. E. Buckley, 1590 3rd., San Diego, Calif.

**\$25.00 TAKES** United States and Canadian Patents on "automatic air chuck" for air-hose. Positively only chuck that stands service and abuse without breaking. Simple, light and cheap to manufacture. Hulton, Galesburg, Ill.

**OUTRIGHT.** Recently patented device folding step for railway coach. Charles Halstead, Receiving Barracks, Jefferson Barracks, Missouri.

**COMBINED Tobacco and Match Box,** for carrying and dispensing of tobacco, matches, cigarette papers and lighting matches. For further information write J. E. Gillam, 829 Pueblo Street, Salt Lake City, Utah.

**PATENT: For Sale or Lease.** Revolving Christmas Tree Holder; electrically equipped. No experimenting. Machines completed and sold. Henry Elbe, 2024 Harman St., Brooklyn, N. Y.

**FOR Sale—Non-spilling coal hod.** Patent No. 1,217,706. Cash and royalty. Insures cleanliness and prevents waste. Will have big demand. R. L. Clark, Union, W. Va.

**PATENTED Mailing Card.** Safely carries small articles through the mail. Made of Aluminum. Will prove a big money-maker. H. M. O'Reilly, Corning, N. Y.

**SELL Patented Improvement.** An automobile gas engine. Manufacturing cost very small. Largest profits. No substitute Sale no limit. Charles Reuter, Mobile, Ala.

**PATENT** Buyers are invited to address our sales department for information on any class of Patents they wish to purchase or lease on a royalty. We have secured a number of valuable patents in all lines of invention. Mail Order, Department Store and Household Novelties a specialty. Victor J. Evans & Co., 163 Ninth St., Washington, D. C.

WE have some money-making inventions for placing on royalty; outright sale or trade. Write Adam Fisher Mfg. Co., 2061B Railway Exchange, St. Louis, Mo.

#### MANUFACTURING

**DIES, Tools, Experimental Machinery, Special Machinery, Stamping, Screw Machine Work, Manufacturing, Models, Drafting and Development of Inventions, two Shops, one Engineering Laboratory, Expert Workmen.** Our exceptional facilities, skill and experience at your command. Write today. B. G. Cline Machine Works, 318 Eighth St., St. Louis, Mo.

**PATENTED** Articles, Models, Brass Work, Machine Construction; Dies Made, Haum's Metal Specialties, Kansas City, Mo.

**WANTED** to manufacture, (not sell) small metal articles or parts. Address 16 Fulton Ave., Rochester, N. Y.

**LIGHT** Castings made from gray iron, brass or aluminum. Send sample for estimate. Gulfport Novelty Works, 1321-23-28th Ave., Gulfport, Miss.

**WIRE** Goods, all kinds, made to order. Cooley Mfg. Co., 558 W. Monroe St., Chicago.

**INVENTIONS** manufactured under contract. Write Adam Fisher Mfg. Co., 2061B Railway Exchange, St. Louis, Mo.

#### MODELS AND MODEL SUPPLIES

IF you have something to be made write us. Experience is the keynote of success. We make Models, Dies, Tools, Castings, General Manufacturing. Send rough sketch. The United Machinery Company, Station "S," Cincinnati, Ohio.

**PERFECT** models sell inventions. We make them. Write Adam Fisher Mfg. Co., 2061B Railway Exchange, St. Louis, Mo.

WE make working models for inventors; also dies and stamping of specialties, and carry a complete stock of brass gears and model supplies. Send for catalogue. The Pierce Model Works, 3405 Pierce Ave., Chicago, Ill.

**WANTED—New Ideas.** Write for list of Patent Buyers and Inventions Wanted. \$1,000,000 in prizes offered for inventions. Our Four Books sent free upon request. Victor J. Evans & Co., 163 Ninth, Washington, D. C.

#### REAL ESTATE AND FARM LANDS

A **SMALL** California Farm earns more money with less work. Raise the crops you know about—alfalfa, wheat, barley, etc.—also oranges, grapes, olives and figs. Ideal for dairying, pigs, and chickens. No cold weather; rich soil; low prices; easy terms; good roads; schools and churches. Enjoy life here. New owners welcome. Write for our San Joaquin Valley, also Dairying and Poultry Raising Illustrated folders, free. C. L. Seagraves, Industrial Commissioner, AT&SF Ry., 1933 Railway Exchange, Chicago.

**DEPUNIAC** Springs, Florida: Unique little place for \$1,200.00. Two miles north of depot on Dixie Highway. 20 acres—4 acres in pecans, nice little three-room house painted and ready to occupy. Terms— $\frac{1}{2}$  cash, balance in one and two years. We own 48,000 acres of real land; for sale at right prices; 30 acres and up. Write for booklet. The R. E. L. McCaskill Company, DePuniac Springs, Florida.

**BEST** Opportunity in Florida. Send self-addressed stamped envelope for full particulars. A. L. Collette, Milledgeville, Ga.

**BEAUTIFUL** Seashore Homesites Only \$20. Special sale lots at Alamo Beach, Texas, famous Bayshore resort. First 100 lots \$20. Terms \$1 cash, \$1 monthly. Lots 50x140 feet. Splendid investment. Write for free literature and views. Alamo Beach Company, 422 First National Bank, Houston, Texas.

**NORTHERN** Minnesota lands at \$3 and up per acre. John Crosby, 365 Palladio, Duluth, Minn.

**CALIFORNIA** little farms near Los Angeles for sale on easy payments. Write E. H. Waite, Shawnee, Oklahoma.

**TEN** acre home in California for \$300, near Corning. G. King, care P. M., New York, U. S. S. Texas.

**HILLSIDE** and Level-Land Plow combined. Patented May 22, 1917. Greatest improvement in 60 years on making plows. It's a winner. Patent for sale. Write for specifications and testimonials. F. D. Wallace, Westfield, N. Y.

**VIRGINIA**, West Virginia, North Carolina and Ohio Farms at \$15.00 per acre and up offer big values for the price. Best climate, markets, schools and transportation. Good land and neighbors. Write F. H. LaBaume, Agri. Agt. N. & W. Railway, 250 Arcade, Roanoke, Va.

**HOMESTEADS**—Best public lands left opened for settlement soon. Map and valuable information \$1.00. F. G. Thompson, Hoquiam, Wash.

**SELL** your property quickly for cash, no matter where located. Don't pay big commissions. Particulars free. Real Estate Salesmen Co., Desk B, Lincoln, Nebr.

**SEND** name, receive free offers from land owners everywhere. Mohler, Box 453, Chicago.

**OWN** your own Orange or Grapefruit grove in beautiful Fruitland Park. Let me tell you how melons, peaches, hay, your first crops, should pay for your land and grove. J. Q. Lloyd, Desk 93, Fruitland Park, Florida.

**LOCATE** in Los Indios, Isle of Pines, where "Just Naturally the Best" Grapefruit grows. Climate unsurpassed for citrus fruits and vegetables. Growers netting big returns. No hail! No frost! No sleet! No snow!! Pay for your 10, 20 or 40 acre farm with small monthly payments. Titles Guaranteed. Protect your family with this kind of life insurance. Further information cheerfully furnished. Address E. G. Allen, Room 711, 117 Wisconsin St., Milwaukee, Wis.

**MONEY-Making Farms**—15 States, \$10 an acre up; stock, tools, and crops often included to settle quickly. Write for Big Illustrated Catalogue. Strout Farm Agency, Dept. 3043, New York.

#### DOGS, BIRDS, POULTRY, PETS

**RAISE** Guinea Pigs for us. We buy all you raise. Pay better than poultry. Contract, particulars, booklet how to raise free. Cavies Distributing Co., 3102-A Grand Ave., Kansas City, Mo.

**TRAINED** beagles, rabbit hounds, foxhounds, coon, skunk dogs, ferrets, catalogue 10c. Brown's Kennels, York, Pa.

**RABBIT** hounds, foxhounds, coon, skunk dogs, setters, pointers, pet dogs, ferrets, pig-sons. List free. Violet Hill Kennel, Hanover, Pa.

**AIREDALE**, Collie and Scottish Terriers, dog, bitch and spayed bitch pups. Ground dogs. State wants. List Free. P. L. St. Charles, Ill.

**RAISE** Belgian Hares for Us, New Zealand and Flemish Giants. Profits Large! We supply stock and pay you \$3.00 each. Also Cavies, Squab Breeders, and Fur Bearing Animals. Instruction Books. Contract and prospectus for dime. None free. Outdoor Enterprise Co., Box 99, Holmes Park, Mo.

**SCOTCH** Collie Puppies; list free. Rocceito Collie Kennels, Wheatland, N. D.

**BIG** Money in Pigeons and Squabs. Free book tells you all about it. Write today. Start profitable business of your own. Demand unlimited. Investment is small. Write today for Free Book. Indiana Squab Co., Dept. 1198, Terre Haute, Ind.

**HANDSOME** Dog Collar Name Plates, Dog's Name, Your Name and Address, 25c. Sullivan, Engraver, 109 Abbott Ave., Fitchburg, Mass.

**FOR** Sale—Coon, opossum and skunk dogs. C. W. Frye, Flinger, Tenn.

**RAISE** Belgian Hares for Us. We furnish fine, pedigreed stock reasonable, and buy all you raise at \$2.00 each. Glendale Habbitry, 25-A Elm Ave., Parkland Place, Glendale, Mo.

**3** FEMALE English Setter pups, from the best of stock, and one-half breed Irish Setter and English Setter. F. L. Rhodes, Macoupin, Ill.

**SCOTCH** Collies, Eligible to registry, sable and white. Lawrence Kopriva, Bowbells, N. D.

**PEDIGREED** Greyhounds and Irish Spaniels. B. Byers, Troy, Kans.

**YOU** can make a good living in your back yard raising Belgian Hares, Particulars free. Mark Twain Stock Ass'n, 101 Hannibal, Mo.

**RAISE** skunks in city or country. Odorless method. Illustrated circular P free. Skunk Development Bureau, Chicago.

**FOX** Terrier Pups for Sale. W. Craddock, Spring Hill, Kansas.

**SQUABS** are raised in one month, they sell for fancy prices. Write at once for big free book telling how to make money breeding squabs. Plymouth Rock Squab Co., 634 Howard St., Melrose Highlands, Massachusetts.

**RAISE** Guinea Pigs, more profitable than poultry. Big demand. Thousands needed. Experience unnecessary. Send for our money-making proposition and big free illustrated book, explaining all. Laboratory Supply Co., Dept. K, 2841 Ridge Ave., Phila., Pa.

**EARN** \$20 weekly raising Belgian Hares, Particulars 10c. Anderson's Rabbitry, 2421 Ogden, Denver, Colorado.

#### PERSONAL

**STOP** using tobacco. Money back guaranteed. Send \$1 bill, A. E. May, Box 1314, Bisbee, Ariz.

**NATURAL**, guaranteed Tobacco-Cure or Nerve-Food \$1.00 Post-Paid, with Free Diet-Outline. Vegetarian Foods Co., St. Louis, Mo.

**ILL-SMELLING**, swollen and sweaty feet can be most successfully treated with "Odorgone," the powder that permanently dispels any trace of bad odor. Put up in shaker top tins. Sent anywhere for 50c coins or stamps. Money-back guarantee. The Odorgone Co., Box 523, Station "W," Seattle, Wash.

**BROTHER**—discovered nature's antidote, pleasant root, quickly overcomes tobacco habit and indigestion. Gladly send particulars. F. Stokes, Mohawk, Florida.

**TOBACCO** habit cured by harmless recipe. Sent free. Superba Co., BS, Baltimore, Md.

**WHY** be only half alive? Get well. Enjoy life. Let Prof. Ogden tell you how you can become a new being through "Energized Blood." Write for free book today. Ogden College, 414 Bell Block, Cincinnati, O.

**FREE**—Stop using tobacco. We will give free information how to conquer habit easily and permanently. Results Guaranteed. Anti-Tobacco League, Box 370, Omaha, Nebr.

#### MISCELLANEOUS

**PEARLS**, baroque, slugs, bought and sold. Designing, mounting, repairing jewelry done. "Pearls and Pearlring"—best book published \$1.00. Laverne Mapes, Indiana Harbor, Ind.

**ARCHITECT'S** level and aluminum typewriter, cheap. 1788 Brush Street, Detroit, Michigan.

**RADIUM** Ore, sample twenty-five cents. Appel, Mathews Avenue, Knoxville, Pittsburgh, Pa.

**NOXSPOTZ** best spot and stain remover made. 50c bottle postpaid for 35c. Descriptive circular Free. Deoxide Mfg. Co., Freeport, Ill.

**RUBBER** Stamps, photo type. Catalogue 15c. Pecan nuts, pound, 80c, samples 15c. Walter Karstaedt, Dayton, Ohio.

**LUMINOUS** Paint, shines in the dark. Our Luminous Paint, coated on any article, makes them visible at night. Watches, clocks, electric switch plates, crucifixes, match boxes, etc., can be coated with splendid results. (Everlasting.) Only 25c bottle. Luminous Paint Co., Douglas Park Station, B-23, Chicago, Ill.

**SELF-THREADING** Needles, package and list of time-saving articles, novelties, etc., 10c. Clarence Maugans, Anderson, Ind.

**OIL** System should save you hundreds of dollars. Adapted to any furnace for heating libraries, schools, churches, hotels or wherever heat or steam is required. Easily installed. Patented. Burner and Steam-generator \$50. Enclose stamp. No salesmen. Root Crude Oil System, 2025 C Street, Eureka, Calif.

**GRANDFATHER** Clock Works furnished to replace your worn-out ones. Price \$5 up; others with chimes—all prices. Write for our booklet. Clock Co., Nicetown, Pa.

**ADDING** Machines \$2.50—\$3.50—\$5. Bassett, 5921-W Indiana Ave., Chicago.

**FLYCK** up some easy money gathering butterflies, insects. I buy 500 kinds. Some \$1-\$7. Intensely interesting. 2c stamp brings prospectus. Get posted. Sinclair, Box 344, D-6, Los Angeles, Cal.

**CUTS** anybody can make. Simple, cheap process \$1. Specimens, particulars for stamp. M. Day, Windfall, Ind.





# WANTED *Thousands of Trained Men for the* Aeroplane Industry



**BUD MORRISS**  
Chief Instructor  
American School of  
Aviation

This well-known aviator personally guides the progress of each student. He is assisted by a distinguished Staff of Aeronautical Engineers, Aviators and Aeroplane Manufacturers. These men give you practical, right down-to-the-minute, working knowledge of the very highest merit.

If you read the newspapers you know the facts. Right now new Aeroplane factories are being built everywhere. Soon they will be ready and looking for thousands of trained men who know and understand Practical Aeronautics and the Science of Aviation. Here is your chance. *Aviation* is the young man's profession—the richest field of opportunity ever opened to "live wires." Are you one? Then write, quick, for full information. Send the coupon below.

War has given to *Aviation* only its start. The return of peace will see this amazing new industry rivaling the rapid growth of the automobile business, with *bigger* opportunities for for the pioneers, the men who get in *now* and are prepared to step into one of the thousands of big paying positions. You can do it.

## Learn in a Few Months By Mail

No matter who you are, where you live, or what your age, if you can read or write English, you can quickly and easily master this wonderful Course in Practical Aeronautics. Lessons are written in simple, non-technical easy-to-understand language, and illustrated with diagrams and blue prints. You are under the personal direction of practical aviators and aeronautical experts throughout the entire Course. Positively the most PRACTICAL, most interesting and fascinating Course of home study instruction ever prepared.

## HURRY! RUSH THIS COUPON

There's not a moment to lose. Send this coupon—or a postal today—this minute—for full particulars about this great School, its faculty of famous aviators and its remarkable training Course. We PROVE that about the wonderful SPECIAL OFFER we are now making in our effort to supply the demand for trained men. This offer will be withdrawn without notice. Act AT ONCE—today.

### Prepare Now for One of These BIG Jobs

- Aeronautical Engineer \$100 to \$300 per week.
- Aeronautical Instructor \$80 to \$150 per week.
- Aeronautical Contractor Enormous profits.
- Aeroplane Repairman \$60 to \$75 per week.
- Aeroplane Mechanic \$40 to \$60 per week.
- Aeroplane Inspector \$50 to \$75 per week.
- Aeroplane Salesman \$200 per year and up.
- Aeroplane Assembler \$40 to \$65 per week.
- Aeroplane Builder \$125 to \$200 per week.

we can quickly fit you for any branch of the Aviation Industry you wish to enter. Let us tell you about the wonderful SPECIAL OFFER we are now making in our effort to supply the demand for trained men. This offer will be withdrawn without notice. Act AT ONCE—today.

**Money Back Guarantee** You risk absolutely nothing. We give you an iron clad guarantee that we will refund every cent paid for tuition if you are not satisfied on completion of the Course. Mail coupon now while this special offer lasts.

**AMERICAN SCHOOL OF AVIATION**  
431 So. Dearborn St., Dept. 119B, Chicago, Ill.

American School of Aviation,  
431 So Dearborn St.,  
Dept. 119B Chicago, Ill.

Without any obligation on my part, please send me full particulars of your Course in Practical Aeronautics and your Special Limited Offer.

Name .....

Address .....

# Be a PLUMBER!

## They "Get the Money"

You know what big money plumbers get for even the smallest job. It's the big-pay business! With these books you can prepare for Plumber's or Master Plumber's License. Start now! Written in non-technical language. Every technical point made plain.

Complete Home Study Books

## Library of Plumbing

4 Big Volumes—1600 Pages—1000 Illustrations

Shipped FREE on 7 DAYS' TRIAL

Bound in half morocco, gold stamped—1600 7x10-inch pages—covers plumbing, lighting, heating, ventilation, steam and hot-water fitting, electric wiring—everything!

**50c a Week**

Only \$2 a month if you decide to keep them. Coupon explains offer, good only within bounds of United States and Canada.

This is a wonderful opportunity to get a valuable set of books at a bargain price and on easy terms.

### Free Consulting Service

Solves your difficult problems for entire year—(regular price \$12)—FREE with books.

**Rush the Coupon**

**AMERICAN TECHNICAL SOCIETY**  
Dept. M1198  
Chicago, U. S. A.

Please send Library of Plumbing for seven days' examination, express prepaid. I will send \$2.00 within seven days and \$2.00 a month for only six months, or notify you and hold books subject to your order. Title not to pass until fully paid.

Name.....

Address.....

Reference.....

## Let These "Shop Books" RAISE YOUR PAY

Learn at Home, in Spare Time!

Send no money—just the coupon—and get the "Pay-Raising Shop Books."

Record-breaking demand for machinists everywhere—big pay, too!

**10,000 QUESTIONS ANSWERED IN MODERN SHOP PRACTICE**

6 VOLS.—2300 PAGES—2500 ILLUSTRATIONS

Leather bound—page size 5 1/4 x 8 1/4— a vast fund of facts on shop methods, machinery, tools, etc.

**Shipped FREE ON 7 DAYS' TRIAL—JUST SEND COUPON**

Study at home. Fit yourself for a bigger job.

**50c a Week**

Only \$2 a month if you decide to keep them. Coupon explains special offer, good only within bounds of U. S. and Canada.

**Free Consulting Service**

solves your difficult problems for an entire year—(Regular Price \$12)—free with the set.

**RUSH THE COUPON**

**American Technical Society**

Dept. M1198, Chicago, U. S. A.

Please send **Modern Shop Practice** for seven days' examination, express prepaid. I will send \$2.00 within seven days and \$2.00 a month until I have paid \$17.80 or notify you and hold books subject to your order. Title not to pass until fully paid.

Name.....

Address.....

Reference.....

## Typewrite the New Way

**80 to 100 Words a Minute Guaranteed**

Totally new system. Based on *Gymnastic Finger Training!* Brings amazing speed—perfect accuracy—*BIG SALARIES*. Easy for anyone. First day shows results. Learn while working. A revelation as to speed and salary possible to typists. Write for particulars NOW. A Postal will do. Address **Tulloss School of Typewriting, 131 College Hill, Springfield, Ohio**

## ENGINEERING MECHANICAL ELECTRICAL

One Year Practical Courses. Day and Evening classes. Splendid equipment and instruction. Low tuition. For particulars address

**DETROIT TECHNICAL INSTITUTE**  
Box 308, Y. M. C. A. Building, DETROIT, MICH.

## LEARN WATCH REPAIRING



You can learn by our modern and original system of instruction every part of the Watch Repairing Trade at home as good or better than at a shop. You can earn money while learning and secure a well paying position or start in business after completing our course of instruction. Good watch repairers are always in demand and earn from \$20 to \$35 per week. For particulars apply to the **Wisconsin School of Watchmaking, Street Bldg., Milwaukee, Wis.**

STATEMENT OF THE OWNERSHIP, MANAGEMENT, CIRCULATION, ETC., REQUIRED BY THE ACT OF CONGRESS OF AUGUST 24, 1912, of Popular Mechanics Magazine, published monthly at Chicago, Ill., for October 1, 1917.

State of Illinois, County of Cook, ss.

Before me, a notary public in and for the state and county aforesaid, personally appeared H. H. Windsor, who, having been duly sworn according to law, deposes, and says that he is the editor and business manager of the Popular Mechanics Magazine and that the following is, to the best of his knowledge and belief, a true statement of the ownership, management, etc., of the aforesaid publication for the date shown in the above caption, required by the Act of August 24, 1912, embodied in section 443, Postal Laws and Regulations, printed on the reverse of this form, to wit: 1. That the names and addresses of the publisher, editor, managing editor, and business manager are: Publisher, Popular Mechanics Co., 6 No. Michigan Ave. Editor, H. H. Windsor, 6 No. Michigan Ave. Managing Editor, J. L. Peabody, 6 No. Michigan Ave. Business Manager, H. H. Windsor, 6 No. Michigan Ave. 2. That the owners are (Give names and addresses of individual owners, or, if a corporation, give its name and the names and addresses of stockholders owning or holding 1 per cent or more of the total amount of stock): H. H. Windsor, 6 No. Michigan Ave. 3. That the known bondholders, mortgagees, and other security holders owning or holding 1 per cent or more of total amount of bonds, mortgages, or other securities are (If there are none, so state): None. 4. That the two paragraphs next above, giving the names of the owners, stockholders, and security holders, if any, contain not only the list of stockholders and security holders as they appear upon the books of the company, but also, in cases where the stockholder or security holder appears upon the books of the company as trustee or in any other fiduciary relation, the name of the person or corporation for whom such trustee is acting, is given; also that the said two paragraphs contain statements embracing affiant's full knowledge and belief as to the circumstances and conditions under which stockholders and security holders who do not appear upon the books of the company as trustees, hold stock and securities in a capacity other than that of a bona fide owner; and this affiant has no reason to believe that any other person, association, or corporation has any interest direct or indirect in the said stock, bonds, or other securities than as so stated by him.

H. H. WINDSOR.

Sworn to and subscribed before me this 18th day of September, 1917.

J. GRAHAM,  
Notary Public.

(My commission expires June 17, 1920.)

# The Jobs They've Left Must be Filled by **TRAINED MEN!**

Great numbers of *trained men* have quit their jobs to join the fighting forces. *Who will take their places?*

Commerce and Industry are calling for men of *specialized training*. The nation's business must be speeded up to meet the greatest emergency in history.

If you have *natural ability* it is your patriotic duty to *train for a bigger job*. Learn in spare time!

**Thousands of Positions Vacant—  
\$1500, \$2000, \$5000, \$10,000 & Over**

In every industry, trade and profession, important positions, with attractive salaries, await men who are fitted to fill them. *The need is urgent*. Will you heed the call?

**The "American" Home Study Courses Fit You  
for Any Job You Want.**

The American School offers you a wide range of Home Study courses. These courses have helped 50,000 men to win. Choose the course that's in line with your ambitions. Start your training now. Get on the "firing line" of business at the earliest possible moment.

**You younger men—you older men**

## Here's Your Chance

There's no "age limit" in business today for the man who can fill the job.

Send your name and address on Coupon and put an X before position you want—without obligation. By return mail we will tell you how, in time that you would otherwise waste, you can fit yourself to fill it.

Complete prospectus of any course, together with a valuable book. Send the coupon this very hour. The American School of Correspondence was chartered as an educational institution in 1897.

### To Business Executives

The American School of Correspondence is co-operating with some of the country's largest corporations in the big task of training employees in minor positions to assume greater responsibilities. Details of the plan will be furnished to interested executives upon request.

## AMERICAN SCHOOL of Correspondence, Dept. G-1193, Chicago, U. S. A.

Gentlemen: Without obligation please send me booklet and tell me how I can qualify for position marked X.

Electrical Engineer.  
 Elec. Light & Power Supt.  
 Telephone Engineer.  
 Architect.  
 Architectural Draftsman.  
 Building Contractor.  
 Building Superintendent.  
 Structural Engineer.  
 Structural Draftsman.  
 Mechanical Engineer.  
 Mechanical Draftsman.  
 Civil Engineer.  
 Business Law.

Business Manager.  
 Auditor.  
 Accountant.  
 Cert'd Public Acc't.  
 Bookkeeper.  
 Fire Ins. Adjuster.  
 Sanitary Engineer.  
 Master Plumber.  
 Heat and Vent. Eng.  
 Steam Engineer.  
 Shop Foreman.  
 Shop Superintendent.  
 Sheet Metal Draftsman.

Lawyer.  
 Plumb. and Heat. Est.  
 Reclamation Engineer.  
It is also prepare for civil service examinations in all engineering subjects.

Name

Address

Age  Present Occupation

Please Mention Popular Mechanics



# Wanted— Men Who Know the Science of Aviation!

The fact that the United States government plans to send 30,000 flying men to Europe and spend possibly a billion dollars in aviation means something more than a big demand for flying men.

## It Means the Sudden Building Up of a Vast New Industry!

There will be urgent need for thousands of men who thoroughly understand the science of aviation—men who can serve as airplane designers, builders, engineers, assemblers, salesmen, repairmen, mechanics, contractors, inspectors, instructors.

# Learn at Home!

Start now to master the science of aviation. Help to meet this tremendous demand for trained men. You can learn at home, in your leisure time, without giving up your employment—and you do not need a college education.

The National Aero Institute offers you a mail course of 53 lessons in the principles of aviation. Your training will be under the supervision of aeronautical experts—men like Walter L. Brock, the famous aviator who won the great London to Paris race. While you cannot, of course, learn to fly by mail, this great home course gives you all the ground work which is so necessary to successful flying—and all the basic training needed to fit you for any of the positions mentioned above.

### This Course Gives You

all the basic training needed to fill such positions as:  
Airplane Designer;  
Builder; Salesman;  
Assembler; Con-  
tractor; Repair-  
man; Instructor; In-  
spector; Mechanic

When you have completed the course you will need only actual working experience to make you an aviation expert. Aviation experts command big salaries.

Authorities agree that after the war aviation is bound to become a vast means of transportation—passenger—freight—mail. Orville Wright says, "There is no means of transportation that is so safe." Be a pioneer in this great new industry. Pioneers have the best chance of being leaders. The sudden rise of the automobile industry turned poor men into millionaires. YOU may be the future "Henry Ford" of aviation!

# Write at Once For Special Offer

National Aero  
Institute  
Dept. 1198  
Morton Bldg., Chicago, Ill.

Gentlemen:—Please send me, free and prepaid, full particulars of your mail course in the principles of aviation, and details of your special limited offer.

Name.....

Address.....

Send for our special limited offer. Just now we are offering this Complete Mail Course in the Principles of Aviation at a greatly reduced price. We also furnish free, to every student who enrolls now, a complete flying model and all materials for a scale model. Tear out the coupon and mail it at once—before this offer is withdrawn. Do it right away—NOW.

NATIONAL  
Aero Institute  
Dept. 1198  
Morton Bldg., CHICAGO

## Gasolene is high, but THE COMING FUEL IS ALCOHOL



Wright's BOOK gives full directions for making Alcohol and De-Naturing.

Fully Illustrated. By Mail \$1.15  
283 Pages. Cloth.

SPON & CHAMBERLAIN  
120 P. M. Liberty Street NEW YORK

## ELECTRICAL ENGINEERING

men with training are always in demand. Having trained over 2600 young men in the past 23 years in the fundamentals of Applied Electricity, The Miles Electrical School, with its well-equipped shops and laboratories, is peculiarly well qualified to give a condensed course in Electrical



Including Mathematics, Steam and Gas Engines, Mechanical Drawing, Shop Work, and Theoretical and Practical Electricity, in all branches. Students actually construct dynamos, install wiring and test efficiency of electrical machinery. Courses, with diploma, complete

## IN ONE YEAR

For practical young men with limited time. 25th year opens Sept. 25th. Catalogue on request. 104 Takoma Ave., Washington, D. C.

## COPY THIS SKETCH

and let's see what you can do with it. Cartoonists and illustrators earn from \$20.00 to \$125.00 or more per week. My practical system of personal individual lessons by mail will develop your talent. Fifteen years' successful work for newspapers and magazines qualifies me to teach you. Send sketch of Uncle Sam with 6c in stamps for test lesson plate; also collection of drawings showing possibilities for YOU. State your age.

The Landon School of Illustrating  
and Cartooning  
1428 SCHOFIELD BUILDING, CLEVELAND, O.



You can be quickly cured, if you

# STAMMER

Send 10 cents coin or stamps for 70 page book on Stammering and Stuttering. "Its Cause and Cure." It tells how I cured myself after stammering and stuttering 20 years.

BENJAMIN N. BOGUE, 1114 N. Illinois St., Indianapolis, Ind.



## LEARNED BY ALMOST ANYONE AT HOME SMALL COST

Send today 2c stamp for particulars and proof.  
O. A. SMITH, Room D 156, 823 Bigelow St., PEORIA, ILL.



## WANTED—Railway Mail Clerks

Commence \$75 Month  
Increase to \$150 "

Franklin Institute  
Dept. H96, Rochester, N. Y.

Common Educa-  
tion Sufficient

Sure Pay. Life  
Job. Pull Un-  
necessary.

Send me, without charge,  
(1) sample Railway Mail Clerk  
Examination questions; (2)  
schedule showing places of exam-  
inations; (3) list of many other gov-  
ernment jobs now easily obtainable and  
(4) free book describing them.

NAME.....

ADDRESS.....



## "You Get The Job"

"We've been watching you, young man. We know you're made of the stuff that wins. The man that cares enough about his future to study an I. C. S. course in his spare time is the kind we want in this firm's responsible positions. You're getting your promotion on what you *know*, and I wish we had more like you."

The boss can't take chances. When he has a responsible job to fill, he picks a man *trained to hold it*. He's watching *you* right now, hoping you'll be ready when your opportunity comes. The thing for you to do is to start *today* and train yourself to do some one thing better than others. You can do it in spare time through the International Correspondence Schools.

No matter where you live, the I. C. S. will come to you through the mails. No matter how humble or important your present job, I. C. S. training will push you higher. No matter what your chosen work, some of the 280 practical I. C. S. home-study courses will suit your needs.

### Choose Your Career

Do you like Advertising? Salesmanship? Many of the foremost Advertising and Sales Managers in this country were I. C. S. trained. Commercial Law? Accounting? All over America bookkeepers, accountants, private secretaries, office managers, are reaping the rewards of training gained in I. C. S. spare-time study of these subjects. Engineering? Architecture? Electricity? Chemistry? Hundreds of thousands of men have climbed into big jobs in the technical professions through the I. C. S. help.

The first step these men took was to mark and mail this coupon. Make *your* start the same way — and make it right now.

### INTERNATIONAL CORRESPONDENCE SCHOOLS BOX 5615, SCRANTON, PA.

TEAR OUT HERE  
Explain, without obligating me, how I can qualify for the position, or in the subject, before which I mark X.

- |  |  |
|--|--|
| <input type="checkbox"/> ADVERTISING MAN             | <input type="checkbox"/> ELECTRICAL ENGINEER                             |
| <input type="checkbox"/> Salesmanship                | <input type="checkbox"/> Electric Lighting                               |
| <input type="checkbox"/> Commercial Law              | <input type="checkbox"/> Electric Car Running                            |
| <input type="checkbox"/> BUSINESS (Complete)         | <input type="checkbox"/> Electric Wiring                                 |
| <input type="checkbox"/> Certified Public Accountant | <input type="checkbox"/> Telegraph Expert                                |
| <input type="checkbox"/> Higher Accounting           | <input type="checkbox"/> Practical Telephony                             |
| <input type="checkbox"/> Bookkeeper                  | <input type="checkbox"/> Railroader                                      |
| <input type="checkbox"/> Stenographer and Typist     | <input type="checkbox"/> Mine Foreman or Engineer                        |
| <input type="checkbox"/> Railway Accountant          | <input type="checkbox"/> Metallurgist or Prospector                      |
| <input type="checkbox"/> WINDOW TRIMMER              | <input type="checkbox"/> ARCHITECT                                       |
| <input type="checkbox"/> Show Card Writer            | <input type="checkbox"/> Contractor and Builder                          |
| <input type="checkbox"/> Outdoor Sign Painter        | <input type="checkbox"/> Architectural Draftsman                         |
| <input type="checkbox"/> Common School Subjects      | <input type="checkbox"/> Concrete Builder                                |
| <input type="checkbox"/> Good English                | <input type="checkbox"/> Structural Engineer                             |
| <input type="checkbox"/> Teacher                     | <input type="checkbox"/> Plumbing and Heating                            |
| <input type="checkbox"/> Civil Service               | <input type="checkbox"/> Sheet Metal Worker                              |
| <input type="checkbox"/> Railway Mail Clerk          | <input type="checkbox"/> CHEMICAL ENGINEER                               |
| <input type="checkbox"/> CIVIL ENGINEER              | <input type="checkbox"/> Illustrator                                     |
| <input type="checkbox"/> Surveying and Mapping       | <input type="checkbox"/> Designer  |
| <input type="checkbox"/> MECHANICAL ENGINEER         | <input type="checkbox"/> Textile Overseer or Supt.                       |
| <input type="checkbox"/> Mechanical Draftsman        | <input type="checkbox"/> AGRICULTURE <input type="checkbox"/> Spanish    |
| <input type="checkbox"/> Machine Shop Practice       | <input type="checkbox"/> Navigator <input type="checkbox"/> German       |
| <input type="checkbox"/> Stationary Engineer         | <input type="checkbox"/> Poultry Raising <input type="checkbox"/> French |
| <input type="checkbox"/> Gas Engineer                | <input type="checkbox"/> AUTOMOBILES <input type="checkbox"/> Italian    |

Name \_\_\_\_\_  
 Present Occupation \_\_\_\_\_  
 Street \_\_\_\_\_  
 and No. \_\_\_\_\_  
 City \_\_\_\_\_ State \_\_\_\_\_

Please Mention Popular Mechanics

# LEARN AUTOS

WHERE AUTOS ARE MADE



Enlarged  
Facilities

Freely Endorsed by  
Automobile Manufacturers

Detroit is the training camp for men who make good in the automobile and allied lines. Never has the call for men skilled as mechanics, testers, inspectors, repair-men, bearing scrapers, welders, chauffeurs and salesmen been as great as it is today — and the demand is growing.

## The Y.M.C.A. Auto School

is organized to train men. A Course in this School will quickly fit the beginner to do well-paid work, and get in line for advancement in the rapidly growing automobile industry. Tuition fees go to procure the highest class of instructors and best of equipment.

### Growth Brings Added Facilities

The Y.M.C.A. Auto School is now in its New Building. Among the manufacturers who have contributed liberally toward our equipment are: Studebaker, Buick, Hupp, Chalmers, Ford, Packard, Hudson, Gray & Davis, Delco, Cutler-Hammer, Zenith, and many others. Can you ask stronger proof of the school's standing than the fact that men who know give freely of their time and money to co-operate with us.

**Tuition** includes membership in the "Y" and free service of **Employment Bureau** for one year. Our big Club House, adjoining our New Building, is at your disposal. Reading rooms, lounging rooms, gymnasium, swimming pool, billiard and pool tables, bowling alleys, with five floors of dormitories and restaurant at low rates. You are assured of not only thorough and competent instruction, but good companionship and clean living conditions with the comforts of home and club life combined. **Don't Visit Detroit Without Seeing Us.** You want to consider everything carefully before you enroll for any course of instruction. Come and look us over, whatever purpose brings you to Detroit. Get all the particulars of this school, get the records of our instructors, hear what auto factories and automobile men have to say about us, see for yourself our comfortable quarters and big equipment. We will be glad to see you and show you around whether you enroll or not. Day and night classes. Start at any time.

Write today for full particulars. Address

**EDUCATIONAL  
DIRECTOR**

Box 305, Y.M.C.A., DETROIT, MICH.

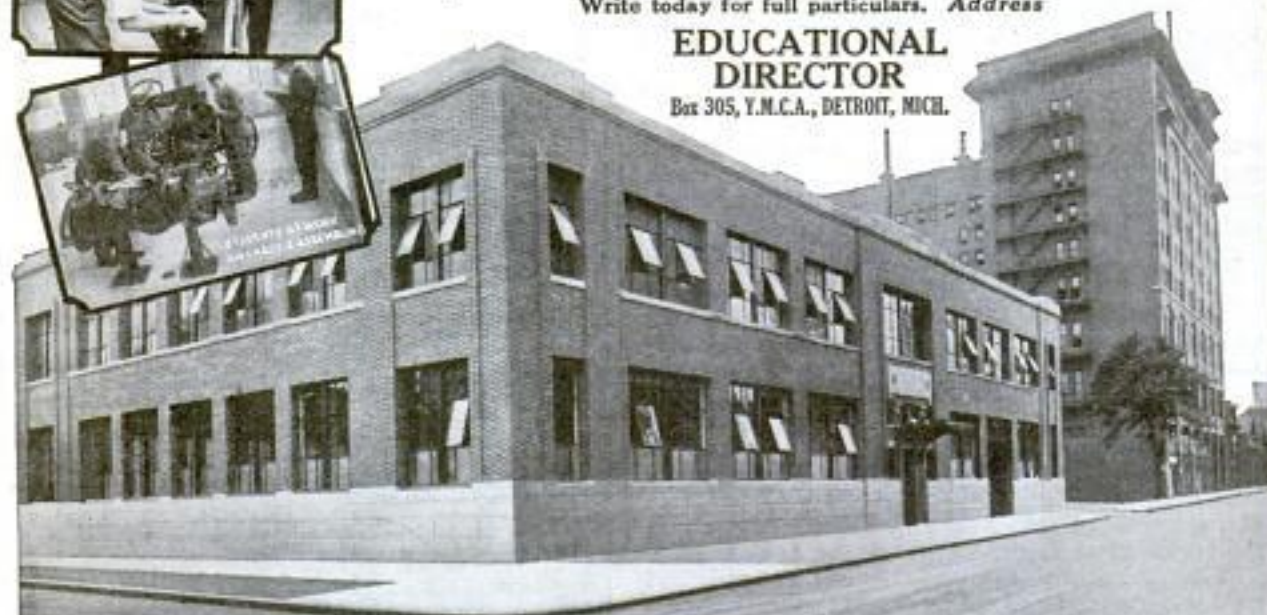

NEW HOME OF Y.M.C.A. AUTO SCHOOL

# SIGNAL ENGINEERING

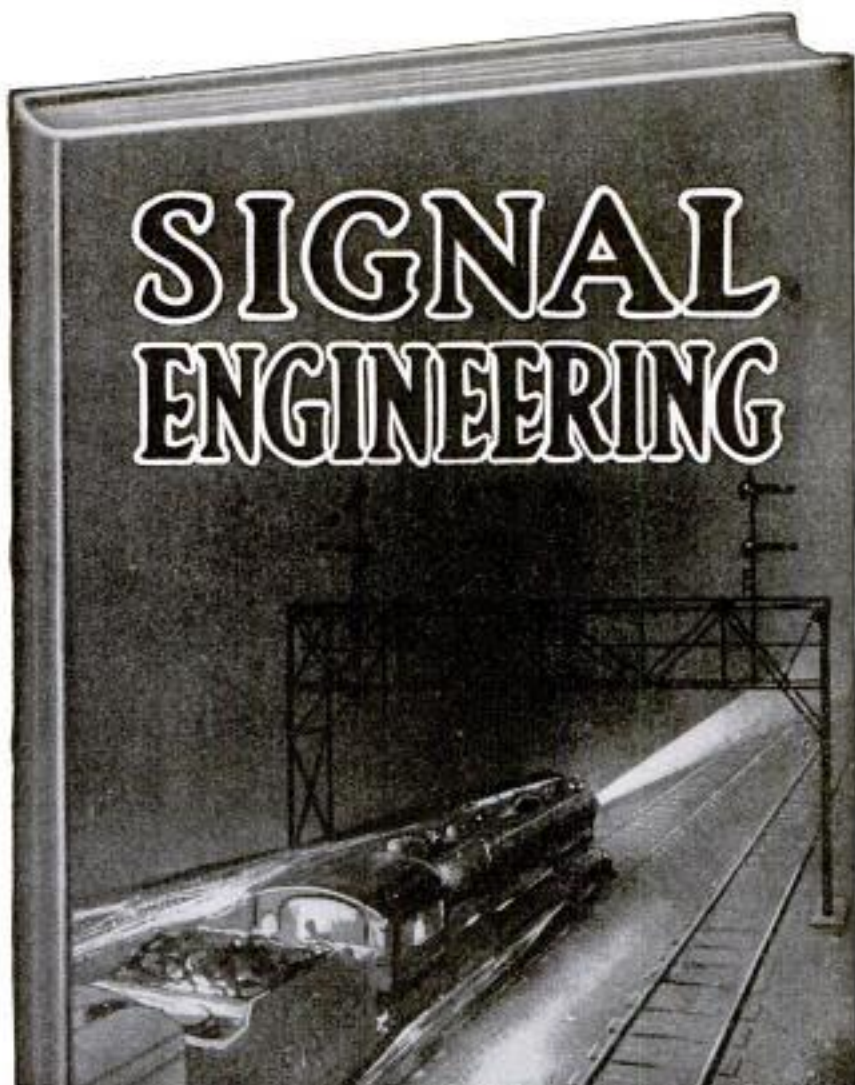

## Free Book on Signal Engineering

**T**HERE are thousands of miles of railroad that must be equipped with block signal systems. To superintend these installations and to maintain the systems now in use thousands of men are necessary. *Golden opportunities are offered.* Every ambitious man in America should write for the free book on Signal Engineering. It will be sent to you prepaid—without obligation. Send the coupon now.

### Men Are Needed to Accept High-Salaried Positions

When you stop to consider that, at the present time, less than one-fourth of the passenger lines in this country are equipped with automatic block signal systems—and when you read that the day is fast coming when the law will compel railroads to install them, you will realize what remarkable opportunities are offered to ambitious men in the profession of Signal Engineering. The work is big—broad—high salaries are paid. \$250.00 a month is an ordinary salary for a Signal Engineer.

If you join the army or navy before you have completed the course, your course of study may be resumed upon your return without any additional fees.

## Send the Coupon!

Put your name and address in the coupon, or a letter or post card now and get the free book about Signal Engineering. Too, we will tell you how you can get the training that you need in order to become a Signal Engineer. You will be under no obligation by writing for this free book. Do it now.

**Department of Signaling** Dept. 1198 — 1810 Wilson Avenue  
Ravenswood Station, Chicago, Illinois

**Department of Signaling**  
Dept. 1198 — 1810 Wilson Avenue  
Ravenswood Station, Chicago, Illinois

Gentlemen: — Please send me absolutely free and prepaid your big new book on Signal Engineering. Also full particulars about your great special free outfit offer. It is distinctly understood that I assume no obligations of any kind.

Name .....

Address .....

Age..... Occupation.....



## Music Lessons

**Book Sent FREE** Wonderful home-study music lessons under great American and European teachers given by the University Extension Method. The lessons are a marvel of simplicity and completeness, endorsed by Paderewski and other great authorities. You, too, can now quickly and easily satisfy your musical ambitions.

### Any Instrument or Voice

Write, telling us the course you are interested in, age, how long you have taken lessons if at all, etc., and we will send you our Free Book containing text and illustrations covering Lessons in PIANO (students' or teachers' courses) by the great Wm. H. Sherwood, HARMONY by Dr. Protheroe and Rosenbecker, VOICE COURSE (with aid of Phonograph) by Crampton, PUBLIC SCHOOL MUSIC by Frances E. Clark, VIOLIN, CORNET, MANDOLIN, GUITAR, BANJO, REED ORGAN, CHORAL CONDUCTING, by equally eminent teachers.

**Send NOW** for Free Book and learn how easily you can become successful. Our Free Book tells you how. Write for it today. A few Special Introductory Scholarships now being awarded by our faculty. Full particulars sent with Free Book. Investigate without cost or obligation. Write today.

### University Extension Conservatory

Proprietor Siegel-Myers School of Music

3176 Siegel-Myers Building Chicago, Ill.

Mr. A. R. Patterson, whose advertisement appears below, was for eight years a Civil Service Secretary-Examiner, and is well qualified to help YOU secure a Government Position.

## CIVIL SERVICE NEEDS MEN

Send for Free Book



Show Your Patriotism

By Working for Uncle Sam.

Men in Civil Service do as great a service as those in the field of battle. Positions pay \$75 to \$150 a month. Short hours. Easy work. No strikes, no hard times, no layoffs. No petty bosses. No politics—no pull. Ordinary education sufficient. 15 and 30 day vacations each year with full pay. Sick leave with full pay. Positions for life.

**RAILWAY MAIL CLERK, POSTAL CLERK, REVENUE OFFICER, CUSTOMS SERVICE**

and many other divisions of Government Service offer splendid opportunities for big pay and rapid advancement. If you are an American Citizen, 18 or over, send in your name for all facts about Government Positions and how to get one.

### NEW BOOK FREE!

Mr. Patterson was U. S. Civil Service Secretary-Examiner for 8 years, and has students and graduates in practically every State in the Union in all branches of Government Service. Not one cent, if you do not secure a position. Mail postal NOW for Free Book and special 30-Day Offer! Address

**PATTERSON CIVIL SERVICE SCHOOL**  
811 News Bldg., Rochester, N. Y.



H. J. RAHE,  
President.

## MEN WANTED

**\$90 to \$300 a Month**

**BE** a trained auto and tractor expert. Big demand for trained men. I have successfully trained thousands of men of no previous experience.

My graduates are found in all branches of the business making big money as Repairmen, Salesmen, Demonstrators, Garage Managers, Testers, Ignition and Self-Starting Experts, Oxy-acetylene Welders, Drivers, etc.

### Rahe Method Insures Success

You don't need previous experience or any special education. Join me here in my big school and get thorough practical training on real automobiles, trucks, tractors, gas engines, machine shop machinery, under the guidance of master mechanics as instructors. No books, printed lessons, or printed charts. Requires only a few short weeks to train you for a waiting position, paying big money from the start.

**\$50 Tractor Course Free** If you act at once I will give you a free scholarship for full course in Tractor, Gas, Stationary Engineering, Power Farming, etc. Only a few of these free scholarships. Enroll now for my regular automobile training and get this farm power course without extra cost.

**Big Free Book** Write at once for a copy of my new 80-page catalog, showing how my graduates are making good, and how they were trained for their success. H. J. RAHE, President

### RAHE'S AUTOMOBILE SCHOOL

2892 Oak Street,  
KANSAS CITY, MO.



## STUDY LAW 30 Days FREE

Let us prove to your entire satisfaction, at our expense, that the Hamilton College of Law is the only recognized resident law school in U. S., Conferring Degree of Bachelor of Laws—LL. B.—by correspondence. Only law school in U. S. conducting standard resident school and giving same instruction, by mail. Over 500 class-room lectures. Faculty of over 30 prominent lawyers. Guarantee to prepare graduates to pass bar examination. Only law school giving Complete Course in Oratory and Public Speaking. School highly endorsed and recommended by Gov. Officials, Business Men, Noted Lawyers and Students. Send today for Large Handsomely Illustrated Prospectus and Special 30-Day Free Trial.

HAMILTON COLLEGE OF LAW, 1255 Advertising Bldg., Chicago, Ill.



## BE A BANKER

Prepare by mail for this high profession, in which there are great opportunities. Six months' term. Diploma awarded. Send for free book, "How to Become a Banker." EDGAR G. ALGORN, Pres., AMERICAN SCHOOL OF BANKING, 419 East State Street, COLUMBUS, OHIO

## LEARN WATCHMAKING AND ENGRAVING



Earn while learning. Most practical watch school. Individual instructions. Graduates in great demand. Book free. Chicago School of Watchmaking, 63 E. Van Buren St., Chicago

**Stop Eating Poison!** Wrong food combinations are poisonous and destroy health—right combinations build health. Eugene Christian's 24 lessons in Correct Eating tell how to eat for health, strength and efficiency. Send for Free Trial No Money in Advance offer. Write today. Corrective Eating So., Dept. 50, 443 Fourth Ave., New York City

## Learn to PAINT SIGNS and SHOW CARDS



I teach you personally, by mail, in a short time. Oldest and largest School. Big field, work interesting. You can **EARN \$18 TO \$45 A WEEK**. Fritzer, Miss., writes: "Did job after first lesson, got \$10, profit \$7.00." Crowfoot, J. C., says: "Earned \$200.00 while taking course." Get literature, samples, guarantee—all FREE.



**DETROIT SCHOOL OF LETTERING**  
Established 1899, 211 E. S. of L. Bldg., DETROIT, MICHIGAN





# Learn Electricity

## IN FOUR MONTHS

IN THE  
GREAT  
SHOPS  
OF

# COYNE!

Practical training is the golden road to quick success. No books or theory. Here in our great shops you learn from the bottom up — under actual working conditions — as every expert must learn to completely master it. Here you handle actual equipment! Here you actually do the work that pays.

## NOW IS THE TIME TO ACT!

Now you men who have not been drafted, help your country by learning one of these big professions at once, for there will be a big scarcity of skilled men in these lines. The places made vacant by the thousands of skilled men who have answered the call of our President must be filled. Do your duty, start training now and prepare yourself for a big future.



Learn  
Drafting  
In 3  
Months  
Mechanical, Architectural, Builders' Course, Etc. — Most complete practical course in America. No mere copy work. Experts show you every step. You have the advantages of our big shops. Check coupon NOW for Free Book.

## Big Demand for Men in

**Plumbing, Bricklaying, Mov. Pic. Operating** Get into one of these professions that is not overcrowded. No previous education or experience necessary. If you haven't money come right along. We will help you earn your way. You owe it to your country and you owe it to yourself. Your opportunity is right here now, so act at once.

### FREE Employment Bureau!

Don't let anything stop you! We maintain a Free employment bureau. We help worthy — serious young men get work while studying. We also help place graduates in big jobs.

**BENNETT WELLINGTON COOKE, Director**  
**COYNE TRADE AND ENGINEERING SCHOOLS**

Dept. 1198, 39-51 E. Illinois St., CHICAGO

### MAIL COUPON FOR FREE BOOK

Get this book of Opportunity! From cover to cover it tingles with interest. Tells about our great shops! Covers many jobs open for Coyne trained men! Tells of great successes of Coyne graduates. Get this book by all means! It's free. Merely fill in the coupon, stating which trade you are interested in, and mail it now — at once!



**B. W. COOKE, Director, Coyne Trade and Engineering Schools**  
Dept. 1198, 39-51 E. Illinois St., CHICAGO  
Please send at once your big Free Book of Opportunity. I am interested in—  
 Electricity  Drafting  Plumbing  Bricklaying  Motion Picture Operating  
Name.....  
Address.....  
Town.....  
State.....

## "I'll Tell You What's Holding YOU Down, Jim"



"To be frank, you're short on headwork. You are good at packing and nailing up boxes, but many of our men can do as well. What we need right now is a Traffic Manager—a man who knows freight rates, classifications and routing of shipments. We could well afford to pay such a man a good salary. But you haven't the training to fill that job. If you had looked ahead and prepared in spare time for such work, there would be a good position open to you right now."

For 25 years the International Correspondence Schools have been a good friend to men situated like Jim. No matter where you live, what your work, how little education or spare time you have, the I. C. S. can help you get ready for advancement and better pay. Without obligating yourself, just mark and mail the coupon and find out how.

YEAR OUT HERE

INTERNATIONAL CORRESPONDENCE SCHOOLS, Box 5621, Scranton, Pa.

Explain fully about your Course in the subject marked X:

<input type="checkbox"/> TRAFFIC MANAGEMENT	<input type="checkbox"/> ADVERTISING	<input type="checkbox"/> SELLING
<input type="checkbox"/> Business Law	<input type="checkbox"/> Bookkeeping	<input type="checkbox"/> Stenography
<input type="checkbox"/> Architecture	<input type="checkbox"/> Civil Service	<input type="checkbox"/> CHEMISTRY
<input type="checkbox"/> Architectural Drafting	<input type="checkbox"/> Ry. Mail Service	<input type="checkbox"/> Illustrating
<input type="checkbox"/> Electrical Engineering	<input type="checkbox"/> Steam Engineering	<input type="checkbox"/> Farming
<input type="checkbox"/> Mechanical Engineering	<input type="checkbox"/> Civil Engineering	<input type="checkbox"/> Poultry
<input type="checkbox"/> Mechanical Drafting	<input type="checkbox"/> AUTOMOBILES	<input type="checkbox"/> Languages

Name \_\_\_\_\_

Address \_\_\_\_\_

## Stronger, Clearer Voice for You!



Weakness, huskiness and harshness banished. Your voice given a wonderful strength, a wider range, an amazing clearness. This done by the Feuchtinger Method, endorsed by leading European musicians, actors and speakers. Use it in your own home. Simple, silent exercises taken a few minutes daily impart vigor to the vocal organs and give a surpassing quality to the tones. Send for the facts and proofs.

### Do You Stammer?

If you have any voice impediment this method will help you. You need not stammer or lisp—if you will follow our instructions.

## WRITE

Send the coupon and get our free book and literature. We will tell you just what this method is, how it is used and what it will do for you. No matter how hopeless your case may seem the Feuchtinger method will improve your voice 80 per cent. No obligation on you if you ask for this information. We gladly send it free, postage prepaid. Just mail the coupon.

**Perfect Voice Institute**  
1772 Wilson Av.  
Studio 1198  
CHICAGO

Name \_\_\_\_\_

Address \_\_\_\_\_

Perfect Voice Institute  
Studio 1198 - 1772  
Wilson Ave., Chicago

Send me the book and facts about the Feuchtinger Method. Have post & opposite subject that interests me most.

Singing  Speaking  
 Stammering  Lisper

## Wonderful Camera Bargains

High grade Cameras shipped for examination and approval. You see the Camera and examine it carefully and pay only if you choose to keep it. Satisfaction guaranteed.

### Wholesale Prices

We ship direct from factory to consumer, eliminating all middlemen's profits. The Camera must serve as its own salesman. Our prices are so low that no one may be deprived of the pleasure of owning a splendid camera.

### Write for Free Catalog

We will mail our latest catalog sheets free to all who ask for them. Write at once. A postal card will do. These catalog sheets show the latest sizes and low prices on the most beautiful line of cameras ever offered Popular Mechanics readers.



H. E. Sever & Co., Dept. "3P"—140 So. Dearborn St., Chicago

## SHORTHAND IN 30 DAYS

We absolutely guarantee to teach shorthand complete in only thirty days. You can learn in spare time in your own home, no matter where you live. No need to spend months as with old systems. Boyd's Syllabic System is easy to learn—easy to write—easy to read. Simple. Practical. Speedy. Sure. No ruled lines—no positions—no shading as in other systems. No long lists of word signs to confuse. Only nine characters to learn and you have the entire English language at your absolute command. The best system for stenographers, private secretaries, newspaper reporters and railroad men. Lawyers, ministers, teachers, physicians, literary folk and business men and women may now learn shorthand for their own use. Does not take continual daily practice as with other systems. Our graduates hold high grade positions everywhere. Send today for booklets, testimonials, etc.

**Chicago Correspondence Schools**  
969 Unity Bldg., CHICAGO, ILL.

## LAW High-Grade Instruction by CORRESPONDENCE

Prepares You for the Bar—Est. 1892

Four Courses: College, Post-Graduate, Business Law and Bar Ex. Review. Classes begin each month. Approved by Beach and Bar. University Methods, Unabridged Text-Books, Cases. Course in Oratory, Public Speaking and Moot Court FREE with regular course. Graduates now practicing in every State. Write today for Catalog and Rules for Admission to the Bar. CHICAGO CORRESPONDENCE SCHOOL OF LAW, 528 Raper Block, CHICAGO



**Draw Pictures that MOVE**

The demand for animated cartoonists far exceeds supply. Get into this new, uncrowded profession now and **EARN \$25 TO \$200 A WEEK** Anyone with ordinary ability can quickly learn at home, in spare time. Write today for free book.

**HARRY PALMER STUDIOS**  
29 VANDERBILT AVE., NEW YORK CITY.

## LEARN TELEGRAPHY

Young men and women attend on credit. A practical school with railroad wires. Owned and operated by the A. T. & S. E. Ry. **EARN FROM \$55 TO \$165 PER MONTH.** Write for catalog.

**SANTA FE TELEGRAPH SCHOOL**  
515 Kansas Ave., TOPEKA, KANSAS

## STAMMERERS

Our course of private lessons will correct your impediments. **BOSTON STAMMERERS' INSTITUTE**  
Founded 1867. Samuel D. Robbins, Principal.  
246 Huntington Ave. BOSTON, MASS.

## JEWELRY ENGRAVING

We teach you, by our new and original method of instruction, this clean, fascinating and profitable business right at your home, and furnish you all tools needed absolutely free. Write for free book to the **WISCONSIN SCHOOL OF ENGRAVING, 2nd Bldg., MILWAUKEE, WIS.**

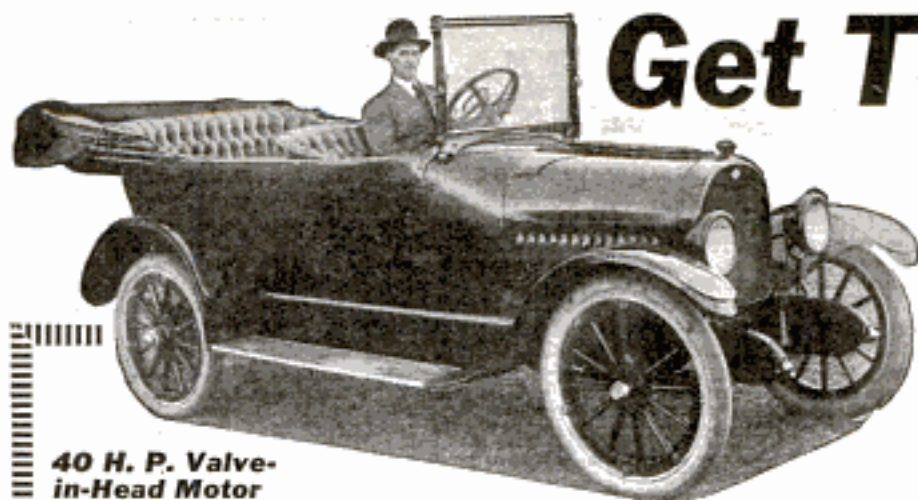

# Get This Car

and

## The Agency for Your Territory

**40 H. P. Valve-**  
**in-Head Motor**

Electric Lights and Starter—Complete Equipment

Write now for full specifications of

# BIRCH LIGHT-SIX

Find out how you can get one of these superb cars for yourself and make money selling them to others. A big opportunity is open to ambitious men who are willing to train themselves and then get out and hustle. Hundreds of cars will be sold this year in every county in the United States. Millions of dollars will be paid to automobile agents. We pay big commissions for selling Birch Cars. *Send the coupon now for full information.*

### Here Are a Few of Our Agents—

John Slingerland . . . Danforth, Ill.  
W. C. Yount . . . Pine Bluff, Ark.  
Louis H. Totterdale . . . Warren, Ohio  
Edwin Gaertner . . . Dundee, Mich.  
Lafe Burleson . . . Prescott, Ariz.  
Nell Bland . . . Statesboro, Ga.  
J. C. Linn . . . Electra, Texas  
H. M. Maloy . . . Mangum, Okla.  
W. E. Davis . . . Ashton, Kan.  
Mitchell & Mitchell, Hillsboro, Texas  
Ernest Birch . . . St. Anthony, Idaho  
R. B. Shealy . . . Leesville, S. C.  
R. G. Moore . . . Mt. Vernon, Oregon  
Warren A. Jones . . . Winchester, Ill.  
Ben Doyle . . . Carlisle, Ky.

Ask  
Them



### What New Mexico Agent Says:

"I received my car all O. K. It's the finest looking car in the county and suits me better than any car I ever saw. Lots of men have looked at the car and they said it had the finest motor they ever saw on a car. Some have asked me if the car didn't cost \$1,000 or \$1,200.

R. R. REAGAN, Boaz, N. M."

### Birch Agents Are Making Money

One of our Texas Agents sold two carloads of Birch cars within 60 days after he received his first demonstrating car. His territory is no better than others. There is no reason why you cannot do as well. Every sale means a good big commission for you and the Birch is such a wonderful car for the money that it practically sells itself to men who know automobile values.

Whether you own a car or not, get the full details of our great offer. We have a proposition worthy of the careful consideration of every man who wants to make more money. Let us hear from you as soon as possible. *Mail the coupon in the lower right hand corner right now for big free booklet and full information.*

## Be The BIRCH AGENT in Your Locality

Cash in on the demand for a strictly high-grade, light-weight, fully-equipped motor car, that exists right now in your vicinity. You have the customers. We have the cars. Let's get together. *Hurry in the coupon so we can send you all the facts about this great opportunity.*

### PREVIOUS EXPERIENCE NOT NECESSARY

We want men of character and ability and high standing in their communities to represent us. Previous experience in the automobile business is unnecessary. We require all our agents to take a brief but thorough course of training in Automobile Driving, Repairing, and Selling which will fit them to represent us in a manner creditable to us and profitable to them. We have trained hundreds of others for success in this way, and we believe this is one of the reasons for the splendid success which Birch Agents are enjoying. But of course the BIG REASON is the cars themselves and the remarkable records they are making in the hands of satisfied owners all over the United States. Eighty per cent of all Birch cars are in use by farmers and in small towns, and get the hardest kind of service. Mud, sand, rocks, hills and rough going have no terrors for these sturdy cars.

#### Send COUPON for Big FREE BOOK and Full Information

Get all the details at once. We have agents in every state in the Union now, but we want an agent in every county. You will be astonished at the liberality of our offer. Let us put all the facts before you at once. It costs you nothing to investigate, so tear off the coupon right now. Sign it and mail it to us today. RALPH BIRCHARD, Pres.

**BIRCH MOTOR CARS** Dept. 1119, 81 E. Madison St.  
**CHICAGO, ILLINOIS**

MEMBER CHICAGO ASSOCIATION OF COMMERCE

FREE  
COUPON

Ralph Birchard, Pres.  
Birch Motor Cars  
81 E. Madison St., Chicago  
Dept. 1119

Please send me your big free booklet and full particulars as to how I can get a Birch Light-Six and the agency.

Sign and  
Mail This  
Coupon

Name.....

Street No. or R. F. D.....

P. O.....

Please Write Plainly

MAIL THIS FREE COUPON NOW!



**Strongfort**  
The Perfect Man

# What Kind of a Man Are YOU?

**YOU**, young or old? In your teens or in your sixties can you face life day by day, cheerfully, with the stamina to keep going, or to rise to better things? **OR**, are you held down with the consciousness of your own physical and mental weakness? **YOUNG** or old, you will be left behind, among the incompetents, unless you have real **HEALTH**. No man ever succeeded without it. **YOU MADE MISTAKES**—so has every man. But the Real Man rises above his mistakes, makes the lesson it gave him serve him to better things. So can you. You don't have to go through life, Weak, Run-down, Nervous, Debilitated, Memory Failing, all Kinks and Pains. **YOU** can be Strong, Vigorous, Vital, Manly! The means are here. Let me tell you how.

## YOU CAN COME BACK!

I can Re-build you. Make you over again. Re-vitalize you. Fill life with the joyousness of its purpose. I, personally, am the result of the System I have perfected. I live this life, I breathe it, I radiate it to all my pupils, daily, and they become as I! I can change your whole life, for the better. I do not care what your physical ills, nor your mental worries, they yield to the Power of Strongfortism, embodying as it does the true principles of Nature's laws. No **DRUGS, OILS, PHYSICS, PILLS** or other **PIFFLE!** Just Nature, her kindly ways, under my personal guidance, and you have the safe, sure, perfect way to **HEALTH, Strength, Physical Power, the VIGOR** that makes every breath Ecstasy!

## I Can Save YOU

**IF YOU ARE INTERESTED ENOUGH IN YOURSELF** to ask me a few questions. It won't cost you anything. It will not put you under any obligations. Just because you fell, because you made that mistake, don't let it drag you down. Don't let it be a millstone about your neck. Tell me in confidence of your physical troubles, no matter what they are, and I can advise you and help you wonderfully. Yes, I will give you

### ADVICE FREE

If you knew the work—the wonderful good that I have been doing for so many years—you would not wonder why I appeal so strongly to **EVERY MAN** to come to me and let me help him.

### Let Me Re-build You

My way is exclusively my own, and I **SUCCEED** because I realize that every person is different, and each pupil must have individual, personal attention. That, too, is why each of my pupils **succeeds**. I never had a failure. It is the **SYSTEM**—it is **STRONGFORTISM**, let me tell you what it will mean to **YOU**.

There is a liberal education in his book, "INTELLIGENCE IN PHYSICAL AND HEALTH CULTURE," free for three 2-cent postage stamps to cover cost of mailing.

**LIONEL STRONGFORT** MASTER OF  
PHYSICAL CULTURE

307 Park Building, NEWARK, N. J.

Personal consultation by special appointment only

### FREE CONSULTATION COUPON

Dear Strongfort:—Please send me your book "INTELLIGENCE IN PHYSICAL AND HEALTH CULTURE," for postage of which I enclose 6 cents in stamps.

I have marked (X) before the subject in which I am interested and should like you to send me a personal talk on this subject.

- |                 |                     |                         |
|-----------------|---------------------|-------------------------|
| .. Thinness     | .. Poor Circulation | .. Alcohol              |
| .. Obesity      | .. Rheumatism       | .. Tobacco or Other     |
| .. Nervousness  | .. Heart Weakness   | .. Bad Habits and       |
| .. Insomnia     | .. Headache         | .. Weaknesses           |
| .. Indigestion  | .. Skin Disorder    | .. Despondency          |
| .. Constipation | .. Round Shoulders  | .. Poor Memory          |
| .. Short Wind   | .. Sloop Shoulders  | .. Flat Feet            |
| .. Flat Chest   | .. Deformity        | .. Increased Height     |
| .. Colds        | .. Rupture          | .. Muscular Development |
| .. Catarrh      | .. Lung Trouble     | .. Great Strength       |

Name.....[307]

Street.....

City.....State.....

**"I WANT YOU"**  
-Uncle Sam

Courtesy of Leslie's, Copyrighted

## PAY \$75 to \$150 MONTH

### U. S. GOVERNMENT WANTS

Railway Mail Clerks—City Mail Carriers—Postoffice Clerks—Clerks at Washington, D. C. War Necessitates Hundreds Immediate Appointments

Common education sufficient. Send coupon immediately. We coach candidates free.

SEND COUPON BELOW

### FRANKLIN INSTITUTE

Dept. H 103, ROCHESTER, N. Y.

This coupon, filled out as directed, entitles the sender to (1) free sample examination questions; (2) a free copy of our book,

"Government Positions and How to Get Them;" (3) free list of positions now easily obtainable; and (4) to consideration for Free Coaching for the examination here checked.

### COUPON

- |   |   |
|---|---|
| .. Railway Mail Clerk (\$900 to \$1800) | .. Customs Positions (\$800 to \$1500)                      |
| .. Postoffice Clerk (\$800 to \$1200)   | .. Internal Revenue (\$700 to \$1800)                       |
| .. Postoffice Carrier (\$800 to \$1200) | .. Stenographer (\$800 to \$1500)                           |
| .. Rural Mail Carrier (\$500 to \$1200) | .. Clerk in the Departments at Washington (\$800 to \$1500) |
| .. Bookkeeper (\$900 to \$1800)         |   |

Name.....

Address.....H 103

Use this before you lose it.

Write plainly.

Please Mention Popular Mechanics

## Learn NOW

at home in spare time by our new instruction method, Commercial Art, Cartooning, Illustrating, Designing. Delightful, fascinating work in big demand. \$50 paid for one drawing. Handsome free booklet explains everything. Write for it—now. Get our special **FREE OUTFIT OFFER** at once.

**WASHINGTON SCHOOL OF ART**  
1281 H St. N. W., Washington, D. C.

## MUSIC TAUGHT FREE

**IN YOUR OWN HOME**

You can read Music like this quickly

Piano, Organ, Violin, Mandolin, Guitar, Banjo, etc. Beginners or advanced players. One lesson weekly. Illustrations make everything plain. Only expense about 2¢ per day to cover cost of postage and music used. Write for **FREE** booklet which explains everything in full.

**AMERICAN SCHOOL OF MUSIC, 51 Lakeside Building, CHICAGO**

**Encyclopaedia Britannica**  
"HANDY VOLUME" ISSUE  
Printed on India Paper

## Voice Thrower 10c

Learn to throw your voice into a TRUNK, under the bed, out in the hall or anywhere. Lots of FUN fooling the Teacher, Janitor, Policeman, Parents, Neighbors, or Friends.

## THE VENTRILO

is a little instrument that fits into the mouth out of sight. **BOYS** or **GIRLS** can use it. **NEVER FAILS!** A 32 page book on **Ventriloquism** sent with the **VENTRILO** for **TEN CENTS**.

**Royal Novelty Co., Dept. 92, So. Norwalk, Conn.**

# Free Test Lesson in Draftsmanship



Special offer now. Pay nothing for this Test Lesson in Drafting prepared by the experts of the Chicago Technical College. Learn from a study of this lesson how well equipped you are to take up drafting as a profession. Also see from it how clearly the Chicago "Tech" Course in Draftsmanship explains every point—and how it will give you a practical training in Architectural, Electrical, Structural Steel, Machine Drafting or any other branch of Drafting in which you may be interested. No charge whatever for this lesson. We invite every ambitious man to send for it. To ask for it places you under no obligation. Get it while the offer holds good and let it show you whether or not you are a man who can study this technical calling to advantage. Just sign and mail coupon. Send no money.

## \$25<sup>00</sup> to \$100<sup>00</sup> a Week

Positions are always open to competent draftsmen and the war conditions are sure to create an extra demand. These positions pay good salaries and the well trained man always has the best opportunity for advancement. Our course gives this training in the shortest time consistent with thoroughness. Its practical value is proved by the success of our graduates. If you are in a position where the future looks doubtful, if you want to be a technical expert, if you want to be master of a calling which will make you independent, at least get the Free Lesson and the information we send upon request.

## Come to the College or Study at Home

You need not leave your present occupation to get this expert training in Draftsmanship. We will teach you by mail and you can study at home in your spare time. The work is the same as given in our Day and Evening Classes at the College here in Chicago. Your instruction will be given directly by men who are engaged in the very work they teach. They will teach you how to do just what is being done in the drafting rooms of big organizations where Chicago "Tech" graduates are always in demand at good salaries.

## Easy Payments

Pay for the course as you go along. The fee is so small the terms so easy that no matter how moderate your income may be, you can afford to get this training in Draftsmanship which will prepare you for an important paying position. Catalog and all particulars sent free with the Test Lesson.

## See For Yourself

This Free Lesson is an absolute test, pure and simple. Send for it today. In the privacy of your home study it, then you will know for yourself whether you are proper material for a successful Draftsman. Other institutions will ask for your money first. You find out later at your own expense, whether you can adapt yourself to the work and succeed in the profession.

We do not charge you one cent for the Test Lesson, either now or later. It is absolutely FREE. Nor do we obligate you in any way whatever by writing for the Free Test Lesson, so send coupon or write postal request today. If you do nothing else but secure the Free Test Lesson you will gain such valuable knowledge as will be beneficial to you through life, for the Free Lesson gives the very fundamentals of draftsmanship which are helpful to every man. Mail the coupon.

**CHICAGO TECHNICAL COLLEGE**  
1130 Chicago "Tech" Building Chicago, Ill.

## FREE Instruments

Every student of the Chicago "Tech" Course in Draftsmanship receives this set of instruments, or a cash credit in case he already has a set. We start our students at once in practical work with necessary equipment.



## Builders' Course

Men in the Building Trades whether working now as mechanics or contractors should get information about our Courses in Plan Reading and Estimating. We teach men how to make money through knowing more about their business. We want to tell carpenters, bricklayers, stone masons, and other men engaged in building work about these courses. Write for free Lesson in Plan Reading, Builders' Catalog and other instructive information.

### Chicago Technical College, 1130 Chicago "Tech" Building, Chicago

Without obligation to me, please send me your FREE Test Lesson in Draftsmanship and other interesting literature covering the subject indicated below.

Mark X opposite work in which you are specially interested.

- |   |   |
|---|---|
| <input type="checkbox"/> Architectural Drafting | <input type="checkbox"/> Builders' Course |
| <input type="checkbox"/> Machine Drafting       | <input type="checkbox"/> Plan Reading     |
| <input type="checkbox"/> Electrical Drafting    | <input type="checkbox"/> Estimating       |
| <input type="checkbox"/> Structural Drafting    | <input type="checkbox"/> Surveying        |
| <input type="checkbox"/> Sheet Metal Drafting   | <input type="checkbox"/> Map Drafting     |

Name.....

Address.....

City..... State.....

College or Home Study? State which.....

Please Mention Popular Mechanics \*

## The New York Electrical School

## Men of All Ages

Whether Sixty or Sixteen, you are assured absolute success in the future if you attend the only school devoted to teaching every angle of Electrical Industry by a method of "actual practice." All ages enter this school on the same level, are shown "how" and "why," and make rapid progress under the watchful eye of a staff of highly trained and experienced men. No preparation needed to take this course and you can start any day of any week throughout the whole year.

At this "Learn by Doing" School a man acquires the art of Electrical Drafting; the best business methods of Electrical Contracting; together with the skill to install, operate and maintain all systems for producing, transmitting and using electricity.

Write for illustrated booklet and "be shown" what the N. Y. Electrical School can do for YOU.

44 WEST 17TH STREET, NEW YORK



### Learn a Paying Profession

that assures you a good income and position for life. For twenty-four years we have successfully taught

## PHOTOGRAPHY

Photo-Engraving and Three-Color Work

Our graduates earn \$20 to \$50 a week. We assist them to secure these positions. Learn how you can become successful. Terms easy—living inexpensive. Write for catalogue—NOW!  
ILLINOIS COLLEGE OF PHOTOGRAPHY, Box P, 999 Wabash Av., Effingham, Ill.

## This Job FREE

Are you interested in the mechanical side of an automobile, its proper operation and economical maintenance?

### Owners—Garagemen—Chauffeurs

The *American Chauffeur* is a live monthly magazine featuring articles in common sense language, by "men who know," on instructive topics, which will be interesting and of great value to every auto owner, chauffeur and garageman.

### FREE OFFER

To introduce the *American Chauffeur*, we are offering this plated lacquered watch fob, with seal grain leather strap, as illustrated, ABSOLUTELY FREE, with a 3 months subscription to the *American Chauffeur* at the regular price of 25c. Your money refunded if either the magazine or fob does not come up to your expectation.

### THE AMERICAN CHAUFFEUR

91 Butler Bldg., CINCINNATI, OHIO

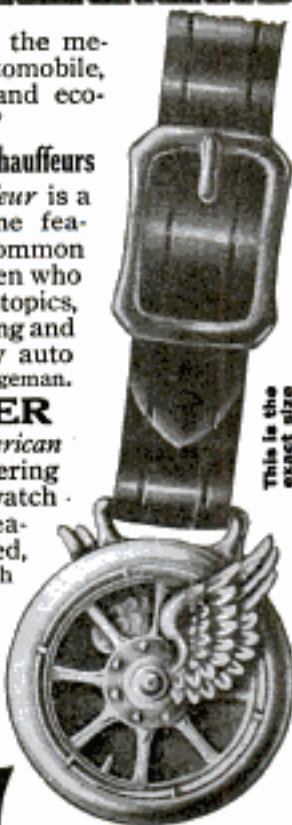

This is the exact size

Please Mention Popular Mechanics

## EARN TELEGRAPH

Morse and Wireless—R. R. Accounting (Station Agency) also taught. Tremendous Demand—much greater than supply—Permanent Positions Secured. Big Salaries—recently raised. Ideal Working Conditions—short hours, vacations with pay sick and death benefits, etc.—prevailing. Great Opportunities for Advancement. Western Operators also greatly desired by Railways and Western Union. Tuition reasonable. Cheap living expenses—can be earned. Oldest and largest school—two large school buildings, investment exceeded \$2,000,000—established 41 years. Endorsed by railway, Western Union and Marconi Telegraph officials. Large illustrated catalogue free. Correspondence courses also. Write today. Enroll immediately.

Dodge's Telegraph, Ry. & Wireless Institute  
8th Street, Valparaiso, Ind.

## The University of Chicago

HOME STUDY in addition to resident work, offers also instruction by correspondence.

For detailed information address

26th Year

U. of C. (Div. V) Chicago, Ill.



Missile Tower



## FINLAY Engineering College KANSAS CITY, MISSOURI ONLY SCHOOL OF THE KIND IN THE WEST

Specialties: Electricity, Steam, Gas. Six weeks, three months, year, and two year courses. Auto-Tractor, Armature Winding, Conduit Work, Latho Work, Oxy-Acetylene Welding, Corliss Valve Setting, Operation of Steam, Gas Electric Machinery. Anything you want, any time you want it, night or day, from a week to two years. Write for Catalog T.

## LEARN WATCH REPAIRING

Be a watchmaker—you can learn this profitable trade by correspondence in a few weeks in your own home by the DeSelms Chart System. After you complete the course you will know a watch from A to Z. You will know just what the matter is and how to repair one. When you graduate you will be a practical watchmaker and repairer and competent to fill any position. Positions for our graduates.

Ask for our Free Book. It explains our system and terms.

THE DeSELMS WATCH SCHOOL  
23 Perry Street ATTICA, INDIANA



## Do You Like to Draw? Cartoonists Are Well Paid

We will not give you any grand prize if you answer this ad. Nor will we claim to make you rich in a week. But if you are anxious to develop your talent with a successful cartoonist, so you can make money, send a copy of this picture, with \$c in stamps for portfolio of cartoons and sample lesson plate, and let us explain.

The W. L. Evans School of Cartooning  
821 Leader Bldg., Cleveland, O.

Come to Akron, Ohio  
The Tire Center  
and



## LEARN THE TIRE REPAIR BUSINESS

Big money made in this field. Tires need constant repairing. Profits large, work/eases easily. Locations everywhere.  
**EARN \$100 to \$500 MONTHLY**  
There is no limit to what you can make. Start business with small capital. We teach you everything about auto tires. School open all year. Start any day. Write for school literature, etc., Now. ALL FREE.  
Akron Tire Repair School, 71 Tires Bldg., 46-48 N. Main St., Akron, O.

# Stop Forgetting!



Prof.  
Henry  
Dickson

America's foremost Authority on Memory Training, Public Speaking, Self Expression, Lecturer and Principal of the Dickson Memory School, Hearst Building, Chicago.

## The Executive



Mr. William H. Weeks, District Attorney of Putnam County, N. Y., writes:

"After a thorough trial of your method of mental and memory training, I find it to be not only first class—simply wonderful. I can truthfully say that I would not be again without the benefits I have received from your study for \$10,000."

## The Salesman



O. G. Wehmeier, of the American Miner's Accident Association, Indianapolis, Ind., writes:

"I can honestly and truthfully say I am a new person. I have more friends than I really expected I could have. Everyone who has known me says that a wonderful change has come over me in the last six months. It is all due to the Dickson School of Memory."

## Perfect Your Memory and You Can Command What Salary You Will

Your salary—what it is today—what it will be tomorrow—depends very much on your memory. Tricky memories—wandering minds—unable to grasp detail—have thwarted thousands in their battle for success—have held them down to bare living wages—working long hours with slight prospect of advancement—subordinates for life.

## The Ability to Concentrate, to Think and Express Yourself Clearly Means Everything to Your Success

America's men of power—in business, social or public life—are uniformly men of **trained memories**. Train your memory properly and you will find yourself able to concentrate absolutely on matters at hand—to think and speak connectedly—to develop self control, to overcome self consciousness—to make your **PERSONALITY DOMINATE**. Think what this means—a better position—bigger pay—social and business success—the **EFFICIENT LIFE**.

## Give Me 10 Minutes a Day and I Will Give You a "Steel Trap" Memory

That is all I ask—just ten minutes a day for a few weeks and I will train your memory just as I have trained the memories of 50,000 others. I will make your mind an infallible classified index from which you can instantly select facts, figures, faces, arguments. No matter what your age—your education—your vocation—your place of residence—I can make you "forget proof"—can train your memory for **SUCCESS**.

## Special Offer!

"How to Speak in Public"—FREE!

For a limited period I am offering "How to Speak in Public," a de luxe edition, handsomely bound book—regularly priced at \$2.00—FREE to every student enrolling in my course. Full particulars of this unusual offer—together with a copy of my famous Memory Test and my remarkable book "How to Remember" will be sent FREE—simply for the mailing of the coupon or a postal. This is YOUR opportunity—mail it NOW.

## The Key to Success

Stop Forgetting

Prof. Henry Dickson, Prin. Dickson School of Memory  
1705 Hearst Bldg., Chicago, Ill.

Please send me free of charge and without obligation your booklet, "How to Remember"; also your remarkable copyrighted "Memory Test." Give me facts on your special offer of a free copy of "How to Speak in Public."

Name .....

Street and No. ....

City ..... State .....

## The Public Speaker



Carl F. Schaefer, one of California's biggest men, writes:

"I have been improved physically and mentally beyond my own expectations by the continued study of your course. Every business man, especially those called upon to talk at Chambers of Commerce, realty boards, advertising clubs and other meetings should take your course. I enthusiastically recommend it to my many friends."

## In Social Life



Roland Miller, of New York City, writes:

"What I have gotten from your method has advanced me both socially and financially and I feel it my duty to tell you of these excellent results."



# The Men The Navy Needs Now

**D**URING the first few weeks after the United States entered the Great War, many thousands of patriotic young Americans responded to the call of the United States Navy. So many of these fine young men offered their services who had no special qualifications for the work on board ship, that the capacities of the training stations were soon overtaxed. It shortly became necessary to restrict the enlistments of unskilled men by raising the minimum age limit of apprentice seamen, and to suspend enlistments in certain trades which were in excess, such as shipwrights, shipfitters, blacksmiths, boilermakers, plumbers, printers, painters, general electricians and yeomen (or clerks).

**The Navy still needs men, but desires to fill the remaining vacancies in its authorized complement with men who are most needed in the fleet.**

There is a demand now for competent machinists, ages 21 to 35; for cooks and bakers, 21 to 35 (or landsmen for cooks and bakers, 18 to 25); and for radio operators, 18 to 25.

Other ratings which are still open to enlistment are apprentice seamen, musicians, coppersmiths, firemen, hospital apprentices, mess attendants, and men specially qualified for machinists in the Navy Flying Corps.

An attractively illustrated booklet explaining the naval service, together with circulars describing special branches of the Navy, will be sent upon request.

## ADDRESS

**RECRUITING DIVISION**  
**NAVY DEPARTMENT**                      **WASHINGTON, D.C.**

*There is a Navy Recruiting Office in every large city*



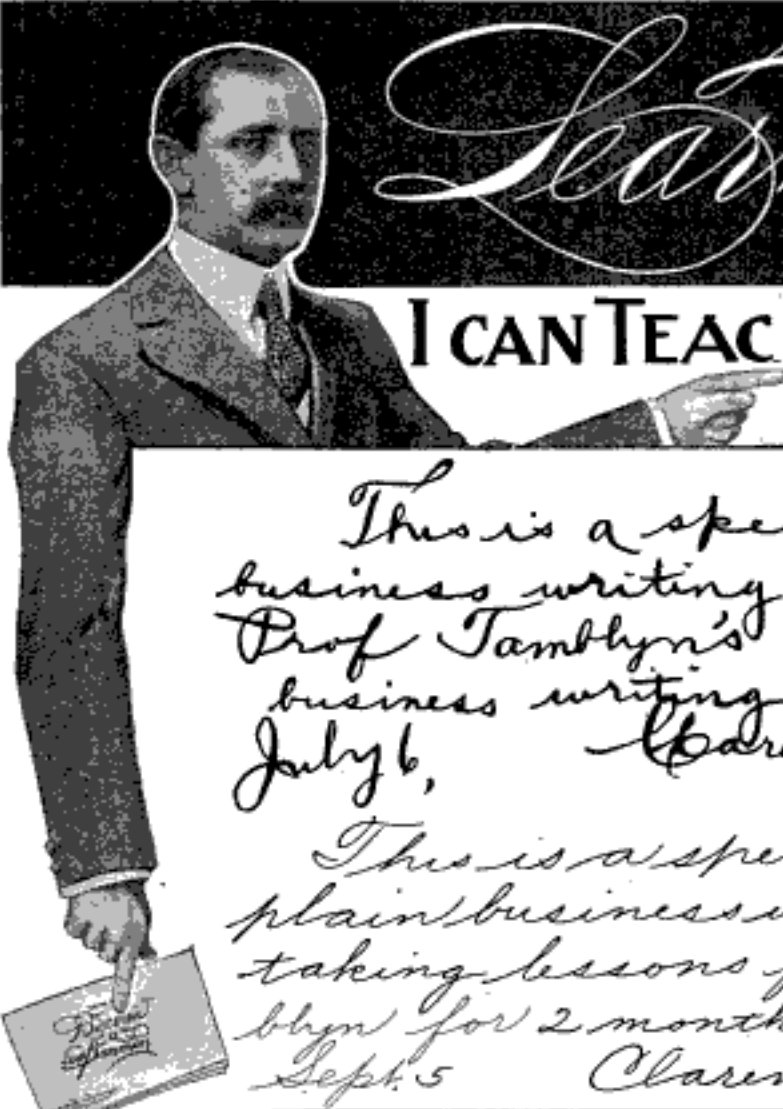

TO  
*Learn to Write*

**I CAN TEACH YOU AT HOME**  
During Spare time

*This is a specimen of my business writing before taking Prof Tamblin's course in business writing*  
July 6, Clarence P. Weber.

*This is a specimen of my plain business writing after taking lessons from F. W. Tamblin for 2 months.*  
Sept. 5 Clarence P. Weber.

**FREE BOOK**

My 32-Page book "How to Become a Good Penman" is FREE to anyone who wants to write better. Contains copies and information that will help you, and beautiful specimens that will make your eyes twinkle with delight.

**WRITE FOR IT**—use the coupon below—or a postal will do—but

**Send at Once!**

*If you enclose a stamp, I will write your name on a card with white ink, making one of the prettiest specimens of penmanship you ever saw*

**F. W. TAMBLYN**

418 Ridge Bldg., KANSAS CITY, MO., U.S.A.

**"A Wonderful Bargain"** "It is now about two months since I began your course, and while I am not quite half through with Business Writing, I am delighted with my improvement, which is quite marked as you will see by comparing my present writing with the specimen written when I began. My parents objected to my taking it up, but now see I'm getting a wonderful bargain."

—CLARENCE P. WEBER, Middletown, Del.

**Good Writing Is the Very Foundation of Business Success**

I can make a good penman of you at your own home, in your spare time, no matter where you live or how poorly you now write. Ever fail to secure a good position because of poor penmanship? Ever know of better positions you could have stepped into if you only wrote a good hand? If not, you're an exception. The advantage of good penmanship is seen all around us.

I have been teaching penmanship by mail over 20 years. I know that any ambitious person can master penmanship just as quickly and thoroughly by my system at home as if in a schoolroom under the personal instruction of the teacher.

**BEGIN NOW** to learn good handwriting and be ready for the next better position that comes your way. Learn right at home—in your own room, outside of working hours. Your spare time is all I ask.

I teach *Spelling and Letter Writing* also.

Mr. Weber's wonderful improvement shown in the specimens above was made in 2 months. Hundreds and hundreds of others in all parts of the country are doing the same.

**YOU CAN DO AS WELL**

**This Brings FREE BOOK**

F. W. TAMBLYN, 418 Ridge Bldg., KANSAS CITY, MO.

I am interested in improving my penmanship. Send me your Free Book, "How to Become a Good Penman," postpaid.

Name .....

Address .....



## Tear Off That Blindfold!

Your chance to *be somebody*, to hold a position of responsibility, to have an income that will provide every comfort of life, is within your reach.

Just one thing keeps you from finding it, grasping it: you're not *prepared*. Through the door of opportunity big jobs are waiting in every field of work. But only trained men will get them. Don't play blindman's buff with your future! Start today and train yourself to do some one thing better than others.

You can get that training in spare time through the International Correspondence Schools, just as others have done for twenty-five years—just as more than 130,000 ambitious men and boys are doing right now.

Choose your own career. The I. C. S. will train you for the position you want in the work you like best. And you need not lose a day or a dollar in your present occupation.

Tear off that blindfold! Your chance is here. The time to start is now. The way is to ask the I. C. S. to show you what they can do for you. Mark and mail this coupon—it costs nothing, but the evidence it will bring you will open your eyes.

TEAR OUT HERE

### INTERNATIONAL CORRESPONDENCE SCHOOLS Box 5620, SCRANTON, PA.

Explain, without obligating me, how I can qualify for the position, or in the subject, before which I mark X.

- |   |  |
|---|--|
| <input type="checkbox"/> ELECTRICAL ENGINEER        | <input type="checkbox"/> SALESMANSHIP                                    |
| <input type="checkbox"/> Electric Lighting          | <input type="checkbox"/> ADVERTISING MAN                                 |
| <input type="checkbox"/> Electric Car Running       | <input type="checkbox"/> Window Trimmer                                  |
| <input type="checkbox"/> Electric Wiring            | <input type="checkbox"/> Show Card Writer                                |
| <input type="checkbox"/> Telegraph Expert           | <input type="checkbox"/> Outdoor Sign Painter                            |
| <input type="checkbox"/> Practical Telephony        | <input type="checkbox"/> RAILROADER                                      |
| <input type="checkbox"/> MECHANICAL ENGINEER        | <input type="checkbox"/> ILLUSTRATOR                                     |
| <input type="checkbox"/> Mechanical Draftsman       | <input type="checkbox"/> DESIGNER  |
| <input type="checkbox"/> Machine Shop Practice      | <input type="checkbox"/> BOOKKEEPER                                      |
| <input type="checkbox"/> Gas Engineer               | <input type="checkbox"/> Stenographer and Typist                         |
| <input type="checkbox"/> CIVIL ENGINEER             | <input type="checkbox"/> Cert. Public Accountant                         |
| <input type="checkbox"/> Surveying and Mapping      | <input type="checkbox"/> Railway Accountant                              |
| <input type="checkbox"/> NINE FOREMAN OR ENGINEER   | <input type="checkbox"/> Commercial Law                                  |
| <input type="checkbox"/> Metallurgist or Prospector | <input type="checkbox"/> Traffic Management                              |
| <input type="checkbox"/> STATIONARY ENGINEER        | <input type="checkbox"/> GOOD ENGLISH                                    |
| <input type="checkbox"/> Marine Engineer            | <input type="checkbox"/> Teacher   |
| <input type="checkbox"/> ARCHITECT                  | <input type="checkbox"/> Common School Subjects                          |
| <input type="checkbox"/> Contractor and Builder     | <input type="checkbox"/> CIVIL SERVICE                                   |
| <input type="checkbox"/> Architectural Draftsman    | <input type="checkbox"/> Railway Mail Clerk                              |
| <input type="checkbox"/> Concrete Builder           | <input type="checkbox"/> Textile Overseer or Supt.                       |
| <input type="checkbox"/> Structural Engineer        | <input type="checkbox"/> Navigator <input type="checkbox"/> Spanish      |
| <input type="checkbox"/> PLUMBING AND HEATING       | <input type="checkbox"/> AGRICULTURE <input type="checkbox"/> German     |
| <input type="checkbox"/> Sheet Metal Worker         | <input type="checkbox"/> Poultry Raising <input type="checkbox"/> French |
| <input type="checkbox"/> CHEMICAL ENGINEER          | <input type="checkbox"/> AUTOMOBILES <input type="checkbox"/> Italian    |

Name \_\_\_\_\_

Occupation & Employer \_\_\_\_\_

Street and No. \_\_\_\_\_

City \_\_\_\_\_ State \_\_\_\_\_

If name of Course you want is not in this list, write it below.



## SHORTHAND IN 30 DAYS

Boyd Syllabic System. Easy to learn, based on New Principles; all difficulties of old line systems eliminated; amazing results. Prepare for a Government position paying \$900 to \$1200 a year, or for office work, court reporting or private secretaryship. Writers hold highest records. 100 to 150 words a minute in 30 days guaranteed.

### The World's Greatest System

No longer necessary to spend six months in learning shorthand. You can become an expert writer in 30 days at your own home by the Modern, Up-to-Date Boyd System. Boyd writers command highest salaries. A course in Touch Typewriting prepared by experts—winner of 13 Consecutive Championship Contests—given FREE as a part of the course. Send today for Catalog, Special Offer and Sample Lesson.

CHICAGO HOME STUDY SCHOOLS  
504 Reaper Block Chicago, Ill.



### Complete Outfit FREE

Write today for Special Offer. Let us tell you how to become an expert Letterer and Show Card Writer. Learn at home in spare time.

### EARN \$20 to \$75 A WEEK

Every dealer uses show cards. New ones needed daily. Opportunities everywhere. Earn while you learn. Free booklet explains Free Outfit offer. Write postal now.

LITHOLIA SYSTEM OF LETTERING  
Dept. 411, Flatiron Bldg., New York, N. Y.

## A GOOD POSITION

with UNCLE SAM is most desirable. Life positions, pleasant surroundings, good pay, steady work, short hours, promotions on merit. Both sexes. No political pull. Thousands of appointments yearly. Most thorough preparation \$5. Returned if not appointed. Full information and questions used by the Civil Service Commission free.

AMERICAN CIVIL SERVICE SCHOOL WASHINGTON, D. C.



## IF YOU STAMMER

attend no stammering school till you get my large FREE book and special rate. Largest and best school in the world curing by natural method. Write today.

Lee Wells Millard, Pres., North-Western School, Inc.  
2317 Grand Avenue Milwaukee, Wis.

AT HOME

## Learn TO SING

Send 2-cent Stamp for Helpful Booklet, "The Voice Made Beautiful."

HARVEY SUTHERLAND, 1832P 49th St., BROOKLYN, N. Y.

## Learn Watchwork, Jewelrywork and Engraving.

A fine trade commanding a good salary, and your services are always in demand. Address HOROLOGICAL, Dept. P, Bradley Institute, Peoria, Ill., for our latest catalog.

## Check the Job You Want!

... Railway Mail Clerk \$900 to \$1800	... Customs Positions \$ 600 to \$1500
... Postoffice Clerk \$800 to \$1200	... Internal Revenue \$ 700 to \$1800
... Postoffice Carrier \$800 to \$1200	... Stenographer \$1000 to \$1500
... Rural Mail Carrier \$600 to \$1200	... Clerk at Washington \$ 840 to \$1500

Name .....

Address .....

Sign your name and address and send us this coupon immediately. We will immediately send you (1) a full description of the position checked, (2) a list of many U. S. Gov't Jobs now easily obtainable and directions telling how to get free coaching for the position checked. Thousands War Jobs open.

Franklin Institute, Dept. H97, Rochester, N. Y.

Please Mention Popular Mechanics



## Prepare for the Opportunities in Interstate Commerce

You now have the opportunity to enter a new profession which presents practically unlimited opportunities. Fully half a million business organizations in the United States need men trained in transportation to deal with railroads and express companies and to solve the various complicated problems which arise under interstate commerce laws and rulings. The men really competent to fill the positions are yet so few that the field is wide open to those who will train for this profession now.

### La Salle Students and Graduates

can now be found employed in the executive departments of practically all the large railroads, business houses and commercial organizations in the United States. Many prominent business concerns can be named in each of which 100 to 500 or more LaSalle students or graduates from our several specialized departments are employed in responsible positions. For instance—

Pennsylvania R. R.	515
American Telephone & Telegraph Company	257
U. S. Steel Corporation	257
Baltimore & Ohio R. R.	341
Armour & Company	182
Chicago & N. W. Ry.	393
Ford Motor Company	122
Swift & Company	187
Standard Oil Company	150

Among the numerous firms and corporations employing 50 to 100 or more LaSalle students or graduates are the following:

Western Electric Company
International Harvester Co.
B. F. Goodrich Company
Wells Fargo Express Company
Goodyear Tire and Rubber Co.

and every important railroad company in the United States.

More than 125,000 men in active business life including a large number of corporation officials have been enrolled and are reaping the benefits of LaSalle training and service. Over 20,000 new students now enroll annually. The LaSalle organization consists of 800 people, including a staff of 300 business experts, professional men, text writers, special lecture writers, instructors and assistants. LaSalle students and graduates occupying responsible positions can be found throughout the entire English speaking world.

### Free Consulting Service

As a LaSalle student, you will also be entitled to the free use of our Consulting Service which gives you the privilege of calling on our staff of experts in any department at any time when you need special help or counsel. LaSalle Extension University is a clearing house of business information and through its many highly specialized departments is organized and equipped to render a practical and distinctive service which cannot be supplied by any other institution of similar character.

The man who is master of Interstate Commerce can save thousands of dollars for his employers. Not only manufacturers and wholesale houses, but railroads, municipalities, chambers of commerce and the Interstate Commerce Commission also are seeking men really qualified to act as traffic experts. The salaries paid are high. The calling itself is dignified, respected profession.

LaSalle Extension University trains men to hold the most responsible positions as Commerce Counsels, Traffic Managers and Directors of Transportation. Its corps of traffic experts and instructors is composed of men who have learned every condition and problem by actual experience with large railroads and shippers. Each is a specialist in some department of the subject.

These men, assisted by more than a hundred leading railroad and industrial officials, have put their knowledge and experience in transportation into a concrete systematized course of study which will take you step by step through every technicality concerned with Freight Rates, Classifications, Tariffs, Bills of Lading, Routing, Claims, Demurrage, Express Carriers, Ocean Trade, R. R. Organization, Regulation and Management, Laws of Carriers, Interstate Commerce Rulings, R. R. Accounting, Statistics, etc. From the day of your enrollment until you graduate you will be under the direction of skilled traffic men who will guide you in every detail of the work and give you an exhaustive training in every phase of Interstate Commerce.

### Study By Mail

All this instruction is given you in your own home. You can study in your spare time. Hold your present position while acquiring knowledge that will lead to a larger income. Make

yourself master of this new profession. At least write and get the particulars in detail. You incur no obligation by doing this. The coupon below will bring full information.

### Small Tuition—Easy Terms

No matter how small your salary may be, you can have this LaSalle Course in Interstate Commerce. The tuition is so low and the monthly

payments are so small that they will place no appreciable tax upon your income. We bring the University to you.

### Students Say—

"Raised me from freight checker to General Freight Agent."  
"Was clerk, now Traffic Manager."  
"Promoted from assistant to Traffic Mgr."

"Appointed Traffic Manager of City of Pawtucket."  
"Fifty per cent increase in salary."

## LASALLE EXTENSION UNIVERSITY

"The World's Greatest Extension University"  
Dept. 1164-C Chicago, Illinois

Please send me your books and full information on your Course and Consulting Service in Interstate Commerce and Railway Traffic. Also a copy of your valuable book for the ambitious man, "Ten Years' Promotion In One." This without obligation on my part.

Name.....

Address.....

Present Position.....



Please Mention Popular Mechanics



33,000 sq. ft. of  
Additional  
Floor  
Space

# Come to Detroit The Automobile Center and

## LEARN THE AUTOMOBILE BUSINESS

DETROIT trained men get preference and get jobs quickly. No other city can give what Detroit offers. Think what it means to learn in the Michigan State Auto School. Factories endorse our school, glad to employ our graduates or offer them territory in which to sell cars and start garages. Unlimited opportunities. 71% of Automobiles are made in Detroit. You're right in the Heart of the Auto Industry. Men are needed everywhere as testers, repairmen, chauffeurs, garage men, and salesmen. Hundreds of our graduates start in business for themselves.

## Earn \$75 to \$300 a Month

We teach you to handle any auto proposition. You graduate in from ten to twelve weeks. Our equipment is new, up-to-the-minute, and complete. No old, obsolete motors, chasses or electrical equipment used. Students actually build cars from start to finish, getting factory training in assembling, block-testing, road-testing, everything. Special complete course in Oxy-Acetylene brazing, welding and cutting, separate from regular course. Learn to time motors, rebore cylinders, adjust carburetors, magnetos, valves and bearings quickly and accurately. Six-cylinder Lozier, Chalmers "6," Detroit "6," Overland, and 8-cylinder King

are used for road instruction. Completely equipped chasses:  
Chalmers "6-30" 1917 chassis  
Detroit "6-45" 1917 chassis  
Buick Light "6" 1917 chassis  
Willys-Knight 1917 chassis  
Studebaker "6" 1917 chassis  
Hudson Super-Six 1917 chassis  
Cole "8" 1917 chassis  
King "8" 1917 chassis

We have the following completely equipped chasses:  
Metz "4" 1917 chassis  
Detroit Electric 1917 chassis  
G. M. C. 2 Ton Truck  
Saxon "6" 1917 chassis  
Maxwell 1917 chassis  
Oldsmobile "8" 1917 chassis  
Winton "6" chassis  
Packard Twin "6" 1917 chassis  
Chalmers "4" 1917 chassis

All completely equipped for students to work on. We have more than 20 motors in our block test department—2 cyl., 4 cyl., 6 cyl., 8 cyl., and 12 cyl. Our electrical department is complete, having every standard starting, lighting, and ignition system, including Delco System as used in Buick, Hudson, and Packard Twin "6."

Follow the Crowd to the Michigan State Auto School. Come to Detroit



THIS IS ONE OF THE FEBRUARY 1917 CLASSES

## Detroit Is the Place to Learn—Start Any Time

There are 44 auto factories in Detroit and vicinity and 140 accessories and parts factories. Our students have the privilege of going through any or all of them. We operate Starting, Lighting, Ignition Service Station. This has added thousands of dollars' worth of equipment and makes our electrical department unequalled. Students get actual experience in handling all kinds of electrical auto equipment and taking care of trouble. We have just installed a Sprague Electric Dynamometer for block-testing purposes for students' use. Ours is the only Auto

school having this equipment. Auto factories need Dynamometer men constantly. Factories and garages are paying big salaries to men who know how to handle electrical equipment quickly and properly. Detroit is the automobile center. You get practical instruction. School open all the year. Enter classes any time, any day. Three classes daily: morning, afternoon, evening. All instructors are members of the Society of Automobile Engineers (S.A.E.) There is a great demand for Michigan State Auto School students. Auto factories write and phone for men constantly.

### Money-Back Guarantee

We guarantee to qualify you in a short time for a position as chauffeur, repair man, tester, demonstrator, auto electrician, garage man, or automobile dealer, paying from \$75 to \$300 monthly, or refund your money. We have constantly more requests for Detroit trained men at GOOD salaries than we can supply.

**SEND THIS COUPON TODAY**

**MICHIGAN STATE AUTO SCHOOL**  
311 Auto Bldg., 687-89-91 Woodward Ave.  
DETROIT, MICHIGAN, U. S. A.

Gentlemen: Send me absolutely FREE literature on Aeroplane Motor Mechanics Course, "Auto School News" and New Catalog, or better still, you can expect

me about.....

Name.....

Street.....

Town..... State.....

### Automobile Factories Endorse Our School

The Leading Automobile factories in Detroit, as well as in other cities, endorse our school. They have been watching our school and graduates for years and are satisfied. They are putting their latest model, complete chasses in our school for students to work on. They are employing our graduates in their factories and service stations and assisting them in opening garages and salesrooms. They allow our students to go through their factories. They need trained, competent men and are asking for more of our graduates constantly. The Michigan State Auto School in Detroit, the heart of the Auto Industry, is endorsed by the Leading Auto Factories, is receiving their hearty co-operation. What better endorsement could you ask?

### Act Quickly—NOW!

Fill in the coupon; get literature on aeroplane motor mechanics, "Auto School News" and New 128-Page Illustrated Catalog. All absolutely free. Or better still, jump on the train, as hundreds have done, and come to the "Heart of the Automobile Industry," and learn right. We have no branches. Write or come direct to this school.

### MICHIGAN STATE AUTO SCHOOL

The Old Reliable School A. G. ZELLER, Pres.  
311 Auto Building, 687-89-91 Woodward Ave.  
DETROIT, MICH., U. S. A.

DETROIT  
THE HEART OF THE AUTO INDUSTRY



Please Mention Popular Mechanics

# The War Will Be Won In The Air

## Aeroplane Motor Mechanics Needed

The war will be won in the air. A course in Aeroplane Motor Mechanics is now being taught at the Michigan State Auto School. We have secured, by special permission, Curtiss Aero-nautical Motors for practice and study purposes. We have also arranged with the Curtiss Aeroplane Company for a complete Aeroplane and a great quantity of the aeroplane material. Students will be given practical instruction on the Aero-plane motor and will secure complete knowledge of the plane in general.

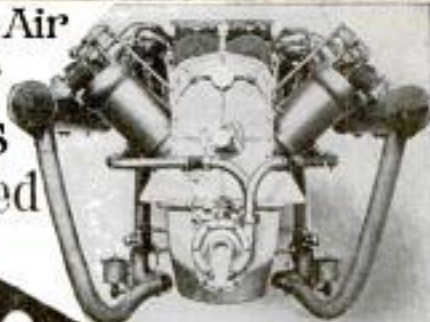

**CURTISS**  
200 Horse Power  
Aeroplane  
Motor

### Aeroplane Motor Course Started October 1st

The course is under direct supervision of a Curtiss expert who is an authority on aero-motors and aeroplanes as well as hydros and flying boats. Weeks have been spent in perfecting this course which is entirely separate from our Automobile course. Our plans are complete. A special price is made to those who enroll before November 15, 1917.



### Prepare to Serve Your Country!

### Become An Aeroplane Motor Mechanic

Aeroplanes will win the war. They are the eyes of the army. They must be in perfect running condition. Thousands of keen, well-trained men are needed by the Government to care for the aeroplanes and aeroplane motors. Men are needed in the aeroplane factories. Trained Aero-motor mechanics will get the preference.

### Get Into This New Industry Now

The men who become trained Aeroplane Motor Mechanics now will be big men in the aeroplane business. Only a short time ago the automobile business was starting, the men who got in then are now the Big Men. The Aeroplane business is in its infancy. The war will give it a big start. The men who train now will be the Big Men in the near future. The work is extremely interesting and will grow in interest as the business develops. Aeroplanes and Sea-planes will be used for every purpose. Trained Aero-motor mechanics will always be in big demand.

**THE CURTISS AEROPLANE CO.**  
AEROPLANES, HYDROAEROPLANES  
FLYING BOATS, AERONAUTICAL MOTORS  
BUFFALO, U. S. A.

September 17, 1917.

MR. A. G. ZELLER,  
Michigan State Auto School, Detroit, Mich.  
Dear Mr. Zeller:

In accordance with our conversation I have asked the Sales Department to send you a collection of motor and aeroplane parts which you can use in connection with your aeroplane mechanics' school. You will find, I think, a sufficient number of parts so that you will have no difficulty in explaining to your students the general principles of construction and operation.

These models, together with the literature which you now have will, I believe, furnish a valuable background upon which your new school work can be based. There is going to be a big demand for good aeroplane mechanics and for that reason we believe that your activity along this line is very timely and commendable.

Very truly yours,

THE CURTISS AEROPLANE CO.  
F. L. FAUROTE (Signed) F. L. FAUROTE,  
W. P. W. Advertising Manager.

### Special Price Up to November 15th

As a special inducement to those who enroll before November 15th, 1917, we will make liberal discount in the price of the Aeroplane Motor Mechanics' Course. The rate will be raised after that date.

Don't hesitate; get into this new industry now. The far-sighted, keen fellows who enter at once will reap the big benefits.

Write Now for literature and use the coupon on opposite page.

No matter whether you join the colors or stay at home, you can do your bit best as a trained man.

The Old  
Reliable School

**Michigan State Auto School**

A. G. ZELLER  
President

311 Auto Bldg., 687-89-91 Woodward Ave.

DETROIT, MICHIGAN, U. S. A.



## "I Got the Job!"

"I'm to be Manager of my Department starting Monday. The boss said he had been watching all the men. When he found I had been studying at home with the International Correspondence Schools he knew I had the right stuff in me. Now we can move over to that house on Oakland Avenue and you can have a maid and take things easy. I tell you, Nell, taking that course with the I. C. S. was the best thing I ever did."

Spare-time study with the I. C. S. is winning promotions for thousands of men and bringing happiness to thousands of homes all over the world. In offices, shops, stores, mines, mills and on railroads, I. C. S. trained men are stepping up to big jobs, over the heads of older men, past those whose only qualification is long service.

## There is a Job Ahead of YOU

Some man is going to be picked for it. The boss can't take chances. He is going to choose a trained man with sound, practical knowledge of the work.

Get busy right now and put yourself in line for that promotion. You can do it in spare time in your own home through the International Correspondence Schools, just as nearly two million men have done in the last twenty-five years, just as more than 100,000 men are doing today.

The first step these men took was to mark and mail this coupon. Make your start the same way—and make it right now.

TEAR OUT HERE

## INTERNATIONAL CORRESPONDENCE SCHOOLS BOX 5619, SCRANTON, PA.

Explain, without obligating me, how I can qualify for the position, or in the subject, before which I mark X.

<input type="checkbox"/> ELECTRICAL ENGINEER	<input type="checkbox"/> SALESMANSHIP
<input type="checkbox"/> Electric Lighting	<input type="checkbox"/> ADVERTISING
<input type="checkbox"/> Electric Railways	<input type="checkbox"/> Window Trimmer
<input type="checkbox"/> Electric Wiring	<input type="checkbox"/> Show Card Writer
<input type="checkbox"/> Telegraph Engineer	<input type="checkbox"/> Sign Painter
<input type="checkbox"/> Telephone Work	<input type="checkbox"/> Railroad Trainman
<input type="checkbox"/> MECHANICAL ENGINEER	<input type="checkbox"/> ILLUSTRATING
<input type="checkbox"/> Mechanical Draftsman	<input type="checkbox"/> Cartooning
<input type="checkbox"/> Machine Shop Practice	<input type="checkbox"/> BOOKKEEPER
<input type="checkbox"/> Gas Engine Operating	<input type="checkbox"/> Stenographer and Typist
<input type="checkbox"/> CIVIL ENGINEER	<input type="checkbox"/> Cert. Public Accountant
<input type="checkbox"/> Surveying and Mapping	<input type="checkbox"/> TRAFFIC MANAGER
<input type="checkbox"/> NINE FOREMAN OR ENGINEER	<input type="checkbox"/> Railway Accountant
<input type="checkbox"/> Metallurgist or Prospector	<input type="checkbox"/> Commercial Law
<input type="checkbox"/> STATIONARY ENGINEER	<input type="checkbox"/> GOOD ENGLISH
<input type="checkbox"/> Marine Engineer	<input type="checkbox"/> Teacher
<input type="checkbox"/> ARCHITECT	<input type="checkbox"/> Common School Subjects
<input type="checkbox"/> Contractor and Builder	<input type="checkbox"/> Mathematics
<input type="checkbox"/> Architectural Draftsman	<input type="checkbox"/> CIVIL SERVICE
<input type="checkbox"/> Concrete Builder	<input type="checkbox"/> Railway Mail Clerk
<input type="checkbox"/> Structural Engineer	<input type="checkbox"/> AUTOMOBILE OPERATING
<input type="checkbox"/> PLUMBING AND HEATING	<input type="checkbox"/> Auto Repairing
<input type="checkbox"/> Sheet Metal Worker	<input type="checkbox"/> Navigation
<input type="checkbox"/> Textile Overseer or Supt.	<input type="checkbox"/> AGRICULTURE
<input type="checkbox"/> CHEMIST	<input type="checkbox"/> Poultry Raising
	<input type="checkbox"/> Spanish
	<input type="checkbox"/> German
	<input type="checkbox"/> French
	<input type="checkbox"/> Italian

Name \_\_\_\_\_  
 Present Occupation \_\_\_\_\_  
 Street and No. \_\_\_\_\_  
 City \_\_\_\_\_ State \_\_\_\_\_

Please Mention Popular Mechanics

## How to Read a Blue Print



Secrets of the Blue Print made plain. Simple and easy. Be the master of your work. Learn quickly. New easy practical method of the School of Metal Trades. Write today for particulars and special small price.

## Earn Big Money

Be a thinker on the job. Act now. You must know the Blue Print secrets to get the best pay. Send for free booklet on the Master secrets of the Blue Print. Open the door of opportunity. Write today for Blue Print Booklet. Free.

SCHOOL OF METAL TRADES, P. O. Box 163, Chicago, Ill.

## CONSCIOUS EVOLUTION

### My New Book—Sent FREE

This book will prove to you that you are only half as alive as you must be to realize the joys and benefits of living in full. It will show you how, without drugs or medicines or dieting, without excessive exercise, without giving up any of the pleasures of life, you can revitalize, re-energize, restore every cell, tissue and organ of the body and become a **Giant** in health and mind.

### SEND FOR IT—IT'S FREE

The secret of wealth, health and happiness is fully explained in "Conscious Evolution." In it, hundreds of precise tests and this great discovery has meant to them in increased earnings, increased ability to live the well-rounded, wholly successful life. This great book will be sent free to all who are interested in greater health and mental power. Write today, now, before you forget. Alois P. Swoboda, 2069 Berkeley Bldg., New York City



Swoboda  
 Creator of  
 Conscious  
 Evolution

### Be a Taxidermy Artist



### Marvelous Book Sent FREE

You can now learn Taxidermy, the wonderful art of mounting birds, animals, taxidermy skins, etc. Learn at home, by mail. The free book tells how. Mount your own trophies. Decorate home and den. Hunters, trappers, nature lovers, you need taxidermy. Interesting, fascinating, big profits. Join our school. 65,000 students. Success guaranteed. Get our free book without delay. Send right now—today.

N. W. School of Taxidermy, 1193 Elwood Bldg., Omaha, Neb.

### 30 DAY COURSE FREE IN TIRE REPAIRING

Write Today for attractive particulars about our free course in tire repairing. Let us show you how to make \$3,000 to \$8,000 a year.  
**RELIABLE TIRE REPAIR SCHOOL** 111 Reliable Bldg. DETROIT, MICH.

### Be an Artist

### LEARN WATCHMAKING

and become independent. Good-paying positions secured. Easy to learn. Send for FREE CATALOG.  
**ST. LOUIS WATCHMAKING SCHOOL, Dept. 5, ST. LOUIS, MO.**

### Learn Electricity! 20 Lessons Free!



Let me give you 20 regular lessons in Electricity FREE. Write postal for my great book and sensational offer. Read about my new method of teaching you by mail in your own home. Earn \$2000 to \$4000 a year! **SEND POSTAL TODAY.** Let me show you what I have done for thousands of others. My guarantee covers you entire Course Free unless satisfied. Get my 20 Lessons. Write for Book and Offer NOW. Address, Albert Wood Wicks, B.S., E.E., President Wicks Electrical Institute, Dept. 4811, 81 W. Randolph Street, Chicago

# Don't Be a Wall Flower!



## Learn To Play By Note

Piano, Organ,  
Violin, Cornet,  
Mandolin, Banjo,  
Guitar, 'Cello,  
Piccolo, Trombone,  
Clarinet, Flute,  
Harp, Sight Singing

## LEARN MUSIC AT HOME

No longer need the ability to play music be shut out of your life! Now at last you can learn music — how to play any instrument — at home — yet without having a teacher at your elbow. By our wonderful home study method we have made it easy for you to play by note the Piano, Organ, Violin, Banjo, Mandolin, Guitar, Cornet, 'Cello, or learn Sight Singing.

No tiresome, "dry" exercises, no inconvenience, no trick music, no "numbers," yet simple, wonderful, easy for even a child. Now you can bring into your own life and the lives of others endless pleasure and happiness through your music. Instead of being a forsaken "wall flower" you will be the most popular person in your set. By our new plan more than 200,000 gentlemen, ladies and children in all parts of the world have learned to play successfully and skillfully.

## WONDERFUL LESSONS FREE

We want to have one pupil in each locality AT ONCE to help advertise our wonderful, easy system of teaching music. For a limited time we are therefore making a special advertising offer to give you music lessons in your own home, absolutely free. The ONLY cost is for postage and sheet music, which averages only 12½¢ weekly. We can do this because our course makes friends—pupils recommend it to others and then we make our profit. We make this offer on condition that you give them our name when they ask you.



## SEND NO MONEY MAIL COUPON TODAY

Learning music successfully by our Home Study method is a positive, proven fact. The lessons are so interesting it is more like a game than a study. Thousands who never knew one note from another before taking the lessons have developed into expert musicians. The average yearly enrollment for the past few years has been over 25,000 pupils. We grade you before you start and fit the instruction to your special needs. A beginner gets entirely different lessons than one who has had lessons. Let us send you our new 24-page book, which describes the secret principles of our wonderful New System of Music Teaching from beginning to end, and contains scores of letters from pupils who have become expert players as a result of the Course. Write to-day. Mail coupon or postal.

## FREE COUPON FOR LESSONS

U. S. School of Music, 711 Brunswick Building, New York  
Please send me your free book, "Music Lessons by Mail," explaining how I can learn to play for 12½¢ weekly. I would like to learn how to play the

instrument.....

Name.....

Address.....

**U. S. School of Music**

Dept. 711 Brunswick Bldg. New York

## Be a DRAFTSMAN Make \$25 to \$75 A WEEK!

Your name and address on the coupon brings the great Cyclopaedia of Drawing without a penny down. With these books and a cheap "school set" of drawing instruments, obtainable at any store, a man can become master of drawing and earn \$25 to \$75 weekly.

**Learn at Home** Good paying positions open everywhere. Intense activity in manufacturing, railroading, etc., calls for more draftsmen.  
**Shipped FREE on 7 Days' Trial**  
**The Cyclopaedia of Drawing**  
4 Volumes. 1650 Pages. Thousands of Illustrations.  
Bound in half red morocco. Pages 6½ x 9¼ inches. Covers all branches of Drafting; Architectural, Electrical, Structural Steel, Sheet Metal, etc. Teaches pen-and-ink rendering, lettering, free-hand, perspective, shades and shadows, working shop drawings, machine design, etc., etc.

### 50c A WEEK

Only \$2 a month if you keep the books. Coupon explains offer, good only within borders of U. S. and Canada.

### Free Consulting Service

Solves your perplexing problems for entire year—regular price \$12—free with the books.

American  
Technical  
Society  
Dept. D-1198  
Chicago, U. S. A.

Please send Cyclopaedia of Drawing for 7 days' examination, express prepaid. I will send \$2 within 7 days and \$2 a month thereafter for five months or notify you and hold books subject to your order. Title not to pass until fully paid.



Name.....

Address.....

Referent.....

## Short Story Writers Wanted!

There is a tremendous demand for short stories, photo plays, magazine and newspaper articles. 24,000 publications buy short stories, \$3,000.00 a year is a small income for a writer. You can be successful. Jack London said so. He and other great writers have endorsed our course. Learn at home during your spare time. Write Today for FREE BOOK. Our free book, "How to Write," tells you about it; also gives details of the special introductory offer that is being made for a limited time. Don't lose this opportunity. Write today. Hoosier Institute Short Story Dept., Dept. 1198, Fort Wayne, Ind.

## Automobile Machinist and Machinist Training School

Journeyman courses completed in one year. Elaborately equipped machine shops and garage. Skilled mechanics for teachers. Also twelve weeks' courses in Traction Engine and the Automobile. Trained men in all these courses in great demand at highest wages.

### Also Needed by the U. S. Government

Demand will increase as the war progresses. For years the leading Mechanical Trade School in the country. Enter any time. Winter quarter opens December 4th. Special Winter term opens January 2d. The Garage and Traction Engine courses are also offered by correspondence. Write for catalog and full information. Address

Highland Park College  
of Mechanical Trades  
121 Euclid Ave., DES MOINES, IA.



## Building and Flying an AEROPLANE

By CHAS. B. HAYWARD



A PRACTICAL Handbook covering not only the building of small models, but of full-sized gliders and machines.

The author has followed, in both biplane and monoplane models, the well-known types of Curtiss and Bleriot, choosing each as the simplest representative of its class in matters of construction and design. Detail drawings are given, with dimensions of all parts, the methods of shaping the struts and ribs, the form of running gear, the form and size of ailerons and rudders, the stretching of the fabric, the mounting of the motor, and assembling of the complete machine. The general instructions for flying, in so far as they can be given, are carefully laid down; the method of making a start; the conditions under which flights should be undertaken;

methods of control; banking on the turn; and what to do in case of failure of any part or the stopping of the motor.

The article on Accidents and Their Lessons has been given principally with the idea that every young operator should realize the fatal results of foolhardiness, lack of experience, and poor building, and should correct these shortcomings as far as possible. It is hoped that the book may not only be of invaluable assistance to the amateur builder, but may also be the means of turning into safer and more established paths the too confident inventor who might be tempted to follow his own ideas in an untried field.

166 pages, 5½x8½, fully illustrated with detail drawings. Price \$1.00 postpaid to any address.

POPULAR MECHANICS BOOK DEPT.  
6 N. Michigan Ave., CHICAGO

Members of the Naval Militia, Naval Reserve and Motor-Boat Owners, Yachtsmen, etc., who contemplate entering the service—

The most useful book you can get hold of is

## The Elements of Navigation

in a new revised edition by

LIEUT. W. J. HENDERSON  
First Naval Battalion of New York

It is the only book published giving the whole science of practical navigation in a nutshell which is non-technical and yet absolutely authoritative. New chapters have been added to cover the motor-boat situation.

It gives a short and complete explanation of the standard methods of finding the position of a ship at sea and the course to be steered. Designed for the instruction of beginners; of especial use to owners of motor-boats and yachts. Recommended by the Navy Department for use by the naval militia.

218 Pages. Illustrated. Cloth Binding. Fits the Pocket.

Price \$1.35 Postpaid

ORDER YOUR COPY TODAY

Popular Mechanics Book Dept.  
6 N. Michigan Ave., CHICAGO



# Crying Need for \$5,000 Men To Stop Traffic Losses

*How to Qualify Easily and Quickly at Home*

**T**RANSPORTATION is the second largest and most important business in the country. More than two billion dollars annually are spent in freight rates, yet it has been estimated that 8 out of every 10 shippers are losing money because of the scarcity of trained traffic men.

Every dollar wasted in freight charges represents a dollar of wasted profit or a dollar of wasted opportunity. In business today, freight charges are a vital factor in governing prices. By accepting every existent advantage in rates, a concern, or a city, can vastly undersell its competitors who waste traffic dollars.

## A Few Reasons Why

A concern in South Chicago had been shipping about 200 cars of coke from Connellsville to their smelters. Some time ago a traffic expert succeeded in getting a rate adjustment which resulted in a saving of about \$5.00 on each car. Thus, on this one item alone a saving of over \$300,000 a year was effected.

In St. Louis, through misrouting of freight, errors in reconsigning cars and undercharges on shipments, a railroad lost over \$27,000.

A traffic expert discovered that freight rates paid by the Meeker Coal Co. were exorbitant. A ruling secured from the Interstate Commerce Commission resulted in a refund of \$122,000.

An oil shipper in Kansas was losing over \$30 every day—\$700 monthly—because he did not know of certain tariff regulations entitling him to lower rates.

These are but a few instances of what is occurring every day in the traffic industry. Tens of thousands of concerns, without realizing it, are losing fortunes every year because they do not know that there are countless classifications, special freight services and rate combinations which legally entitle them to rates that would amaze them if they but knew.

Is it any wonder that competent traffic experts are paid \$2,500 to \$10,000 and even up to \$25,000 and \$40,000 a year? Is it any wonder that firms are glad to pay a percentage of what traffic managers save? The man who can do it is in high command and instead of finding himself in the position of even asking for a raise, generally has several firms bidding for his services. Why not? It's no hardship to pay a big salary out of losses turned into profit.

## Your Life-Time Opportunity

There are about 50,000 large business corporations and about 400,000 smaller shippers which must be protected by competent traffic men. These concerns have freight expenses running from a few thousand dollars to many thousands of dollars monthly. Yet in the entire country there are only a few hundred men actually competent

to save the money now being wasted through lack of efficiency in applying the Government Freight Rate System. It is estimated that over 100,000 more traffic experts are needed at once.

Heretofore, there has been no simple way to master the details of traffic management. Realizing the crying demand for trained traffic experts, and seeking relief, the American Commerce Association—a national organization OF traffic men, FOR traffic men, BY traffic men, offers to give men the training required to make them competent to handle the problems of most economical distribution. The training is given by mail and can be studied in spare time, at home. Though the most complete and thorough training is given, the Course is remarkably easy to master.

Through its Advisory Council, every member of the American Commerce Association receives the help of such men as T. Albert Gantt, traffic manager, Corn Products Co.; Wm. Scott Cowie, freight agent, Erie R. R.; Samuel G. Lutz, general traffic manager, Chicago & Alton R. R.; Chas. E. Mayer, traffic manager Stone & Webster Engineering Corporation; T. T. Harkrader, traffic manager American Tobacco Co.; as well as nearly 200 others of equal prominence.

## Startling Book Free

The Course in Traffic Management is adjusted to beginners as well as to those already engaged in traffic work. The instruction has been endorsed by such men as Robt. H. Forbes, traffic manager Butler Bros., New York; J. F. Brown, manager transportation department Chicago Board of Trade; H. G. Wilson, traffic manager of the Toledo Board of Trade; Ira S. Bassett, traffic commissioner Pittsburg Commercial Club; W. H. DeWitt, Eastern traffic manager Western Electric Co., and hundreds of others equally prominent.

It is impossible to go into details in this limited space, but the Association has published a remarkable book for free distribution which explains the instruction in detail and tells how anyone may quickly learn the cheapest rates in existence on all kinds of shipments, the fastest methods of shipment, the best methods of protecting shipments from loss and damage, and how to organize and manage a traffic department for maximum results. The book also tells what hundreds of other men have accomplished as a result of the study.

The new profession of traffic management is in its infancy. The possibilities today—great as they are—are nothing compared to what they will be a year from now. If you are at all interested in getting into this highly profitable field, paying salaries of \$2,500 to \$10,000 and more, be fair to yourself and write for the remarkable book now offered free by the Association. In writing, please state whether you are a beginner or whether you have had previous traffic experience, and give your present age and occupation. Address, American Commerce Association, Dept. 1011, 206 S. Wabash Ave., Chicago, Ill. (American Commerce Building.)

American Commerce Association, Dept. 1011, 206 S. Wabash Ave., Chicago

Please send me your book free.

Name .....

Address .....

Age..... Occupation.....

# Auto Books



## \$1.00 Down!

Only \$1.00 brings you this brand-new automobile library. It is called **Automobile Engineering**, and in it you will find everything about modern automobiles. Almost two entire volumes are devoted to the new systems of ignition, starting and lighting. Welding, vulcanizing and public garage equipment and operation are thoroughly covered. Five thick volumes, 5½ x 8 inches, flexibly bound in genuine morocco leather, gold stamped. 2,400 pages; 2,000 illustrations, tables and diagrams. Written in simple, easily-understood English, and carefully cross-indexed for quick reference.

### Only 50c a Week

Just put your name and address in the coupon, send it to us with \$1.00, and we'll ship all five volumes to you. Read them—study them—examine them carefully before you decide to buy. If you don't like them after 7 days—send them back and we'll refund your dollar. If you keep them, send only \$2.00 a month—50c a week—until \$16.80 has been paid.

### Consulting Service FREE

In addition to the books you get free of all charge a \$12.00 Consulting Membership. If any question puzzles you—write us. Our corps of auto experts will solve any auto problem. Ask all the questions you want for a whole year. This service is absolutely free.

#### Partial List of Subjects

Motors, Welding, Motor Construction and Repair, Carburetors, Valves, Cooling, Lubrication, Fly-Wheels, Clutch, Transmission, (Final) Drive, Steering, Tires, Vulcanizing, Ignition, Starting and Lighting Systems, Wiring Diagrams, Shop Kits, Commercial Garage Equipment, Electric Storage Batteries, Motorcycles, Commercial Trucks, Glossary.



## Pay-Raising Handbooks

No matter what your occupation, we have a handbook that will increase your efficiency and pave the way to a better job and bigger pay. Written in plain, understandable language, with hundreds of illustrations, diagrams and charts that make technical points as simple as A-B-C. Flexibly bound in genuine morocco leather, gold stamped.

Look over this list. Every book is fresh from the press—is literally crammed with brand-new material. If you don't see the one you want, send a postal for our 48-page catalogue.

	Pages	
Oxy-Acetylene Welding (Cloth Binding)	110	\$1.00
Auto. Ignition, Starting and Lighting	750	2.50
Auto. Troubles and Repairs	254	1.50
Plumbing	240	1.50
Gas Engines	360	2.00
Pattern Making	232	1.50
Tool Making	304	1.50
Heating and Ventilation	232	1.50
Reinforced Concrete	240	1.50
Steel Construction	372	2.00
Elements of Electricity	250	1.50
Machine Shop Work	275	1.50

### Sold at All Bookstores

Hundreds of progressive dealers stock our handbooks. If your dealer can't supply you, send us the price of the book you want and we'll send it to you postpaid. Examine it carefully—use it at your work for five full days. Then if it fails to meet with your expectations, return it and get your money back.

This offer is our best guarantee that the books are entirely as represented. Why not take advantage of it? Send in your order and remittance today—now!

AMERICAN TECHNICAL SOCIETY, CHICAGO, U.S.A.

American Technical Society, Chicago, U. S. A.

Enclosed is \$..... Please send me a copy of.....

with the understanding that if it is not entirely satisfactory I may return it within five days and get my money back.

Name.....

Street Address.....

Town.....

Pop. Mech. 11-17

American Technical Society,  
Dept. A1198, Chicago, U.S.A.

# MAIL

### This Coupon

Enclosed is \$1.00. Please send me a set of Automobile Engineering for 7 days' examination. If I decide to buy, I will send \$2.00 a month until \$16.80 has been paid, when books and Consulting Membership will be mine. Otherwise will return the books and you will refund my dollar. Title not to pass until fully paid.

C

See these books before you decide to buy. Remember—you need send only \$1.00. This offer is open to any person living within the boundaries of the U. S. and Canada.

AMERICAN  
TECHNICAL  
SOCIETY  
Dept. A1198  
CHICAGO, U.S.A.

NAME.....

ADDRESS.....

**Train Now To —**





**Make This Goal**



**Rise From a Small Position Like This**

**Put Yourself at an Executive's Desk**

## Buck the Line to Win!

Are you in the "game" or merely on the "side-line"? Are you going to be a star or a stick? You can't "get on," while "looking on." In business as well as in athletics the big stakes, the touch-downs, the goals and high scores are won by trained men. When you play, go in to win or stay out. It is easy to win when you have been trained by the best coaches in the game.

You can begin your training NOW for a high-salaried accounting position. More than 500,000 firms need expert accountants; yet there are only 2,000 Certified Public Accountants in America. You can qualify for a position in a comparatively short while. Let us show you how.

### La Salle Students and Graduates

can now be found employed in the executive departments of practically all the large commercial organizations. Many prominent business concerns can be named in each of which 100 to 900 or more LaSalle students or graduates from our several specialized departments are employed in responsible positions. For instance—

Pennsylvania R. R. . . .	215
American Telegraph & Telephone Company . . .	219
U. S. Steel Corporation . . .	220
Baltimore & Ohio R. R. . . .	224
Armour & Company . . .	162
Chicago & N. W. R. R. . . .	292
Ford Motor Company . . .	122
Swift & Company . . .	127
Standard Oil Company . . .	110

Among the numerous firms and corporations employing 50 to 100 or more LaSalle students or graduates are the following:

Western Electric Company  
International Harvester Co.  
E. F. Goodrich Company  
Wells Fargo Express Company  
Goodyear Tire and Rubber Co.  
and every important railroad company.

Over 25,000 new students enroll annually. The LaSalle organization consists of 500 people, including a staff of 300 business experts, professional men, text writers, special lecture writers, instructors and assistants.

### Free Consulting Service

As a LaSalle student, you will also be entitled to the free use of our Consulting Service which gives you the privilege of calling on our staff of experts in any department at any time when you need special help or counsel. LaSalle Extension University through its many highly specialized departments is organized to render a practical and distinctive service which cannot be supplied by any other institution of similar character.

### Learn Higher Accounting By Mail

Our staff of experts in the Science of Accounting will give you their direct personal instruction by mail, guiding you step by step until you have mastered this paying profession. You will study text books, lectures and accounting methods prepared by authorities—men who are actually employed or retained as expert advisers by leading industries. The underlying principles and the most modern methods of Business Analysis and Organization, and the Principles of Accounting, Auditing, Commercial Law and Scientific Management all made clear. You will be given special preparation for the C. P. A. examinations and made ready to command a higher salary or to enter business as a Consulting Accountant—you can get all this at home in your spare time while you hold your present position.

### Easy Terms

No large fees. No large sum to pay down. This instruction is offered on our convenient monthly payment plan. Our courses are for the ambitious man wherever he may be, no matter how small his present income.

### Mail The Coupon Today

Make the knowledge of these LaSalle experts yours. At least send for information about this course which has helped so many men to rise quickly to positions of greater profit and prestige and which you can easily master by home study.

No matter where you may be or what position you may hold, LaSalle Extension University can put you on the road to greater success. This has been proved by the record of its students and graduates. The information we will send will tell you just what knowledge you require to become proficient in Higher Accounting and how we will teach you in the shortest possible time. It will point out the possibilities that are wide open to the man who has the training demanded by large business organizations. We will also send a valuable book "Ten Years' Promotion in One." Mail coupon now.

### LASALLE EXTENSION UNIVERSITY

"The World's Greatest Extension University"  
Dept. 1164-H Chicago, Illinois

Without cost or obligation on my part, please send me particulars regarding your Home Study Course of Training in Higher Accounting and your Consulting Service. Also a copy of your valuable book for ambitious men, "Ten Years' Promotion In One."

Name.....

Address.....

Present position.....



Please Mention Popular Mechanics



## High School Course in Two Years!

Here's a thorough, complete, simplified High School Course that you can complete in **two years**. A liberal education, of incalculable value, by spare time study, at home. Course prepared by leading professors in Universities and Academies.

### Meets Entrance Requirements of Colleges and Universities

Fits you for Harvard, Yale, Princeton and other institutions of highest standing. Helps you to win in business and social life. Spend the hours you would otherwise waste, in profitable study of this fascinating course.

#### "Knowledge is POWER"

The man who **knows** is the leader. Knowledge gives you assurance, turns your **natural ability** into actual **power**. This course gives you the **key to success and power**.

#### Don't Stop Growing—

Keep on going! Train your brain! Broaden your mental vision! Make the most out of your life **before too late**. Cash in "on your natural ability."

#### High School Book Free

Send your name and address on the coupon or post card and get our new 24-page Illustrated Book. No obligations. It is absolutely free. **Write today**. The American School of Correspondence was chartered as an educational institution in 1897 and has helped 50,000 men and women to win.

#### Send No Money—Just the Coupon

### American School of Correspondence

Dept. P-1198, Chicago, Ill.

Please send free 24-page Illustrated High School Book to

Name.....

Address.....

Age.....Occupation.....



## Here's a Corking Football Story

Fellows, if you like a football story that just makes you tingle all over with excitement—a story that puts the spirit of victory into your blood and makes you feel as if you yourself were carrying the pig-skin down the gridiron for a touch-down—don't miss "Tarnation Wildcat" in the November American Boy Magazine.

That's only one of the many stories and articles you'll find in the November issue. There's an unusual Thanksgiving Day story called "The Sawmill With a Plaster." A story about a boy who never finished anything, except his dinner, until he tackled the plaster. "Only a Volunteer," another exciting story of Corporal May. "Football Strategy," an article by Walter Camp, the famous coach, which will help you make the school team. Besides these there's an adventurous sea story and a tale of the Northwest Mounted Police.

Every month The American Boy Magazine is just crammed full of such stories plus articles on Electricity, Mechanics, Aviation, Jokes, etc. This magazine is so good you just "eat it up" and long for next month's issue. Yet The American Boy Magazine is inexpensive—costs only

**\$1.50 a Year**

or 15c a copy at News-Stands



If you can't subscribe for a year, by all means get it every month. Earn the 15 cents yourself or tell Dad and Mother you want it. Most any news-stand carries it. Don't miss "Tarnation Wildcat" or "The Sawmill With a Plaster." **Go Buy it Today**. When sending subscription address

THE SPRAGUE PUBLISHING CO.  
No. 133 American Bldg., Detroit, Mich.

## THE AMERICAN BOY

"The Biggest, Brightest, Best Magazine for Boys in All the World."

Please Mention Popular Mechanics

# Pay-Raising Books at Reduced Prices!



of photographs, full-page plates, diagrams, etc., that make difficult points as simple as A-B-C. Handsomely bound in half or full morocco leather, gold stamped.

Here's your chance to get—at a bargain price—a set of books that will fit you for a better job and bigger pay. Yes, and you may pay the bargain price at the rate of only 50c a week. But you must act now! The rising cost of paper and binding materials won't permit us to continue this offer indefinitely.

No matter what your occupation, one of the sets listed below is bound to suit your needs. They are written in easily-understood language by recognized authorities, and contain thousands

## Shipped for 7 Days' Free Trial

We'll gladly send any set of books to you for seven days' free examination, shipping charges fully prepaid. Examine them carefully—use them at your work for an entire week. If, at the end of that time, you feel they aren't worth many times what we ask, send them back to us. If you keep them, pay the specially-reduced price on the easy terms explained below.

## Practical Home Study Books

	Vols.	Pages	Size of Page	Illus.	Reg. Price	Spec'l Price
Civil Engineering . . . . .	9	3900	7x10	3000	\$45.00	\$29.80
Architecture, Carpentry and Building . . . . .	10	4760	7x10	4000	50.00	24.80
Accountancy and Business . . . . .	10	8680	7x10	1987	50.00	24.80
Steam Engineering . . . . .	7	3300	7x10	2500	35.00	19.80
Applied Electricity . . . . .	7	3000	7x10	2600	35.00	19.80
Telephony and Telegraphy . . . . .	4	1728	7x10	2000	20.00	12.80
Modern Shop Practice . . . . .	6	2300	5½x8¾	2500	30.00	17.80
Heating, Plumbing and Sanitation . . . . .	4	1600	7x10	1600	20.00	14.00
Mechanical and Architectural Drawing . . . . .	4	1720	7x10	1037	20.00	12.00
Motion Picture Work . . . . .	2	600	7x10	300	12.00	6.00
Law and Practice (with Reading Course) . . . . .	13	6000	7x10	24	72.00	39.80

## Only 50c a Week

Not only can you buy these books at a rock-bottom price, but we offer them to you on the easiest of monthly payments. If, after seven days' examination, you decide to keep the set you have selected, simply send us \$2 and then \$2 a month until the present low price has been paid. Have you ever heard of a more generous offer?

Don't wait. This means money in your pocket if you act now. Remember, you take no chances whatever—it costs nothing to inspect and you are not obliged to keep the books if you do not care to buy. This offer is open to every man living within the boundaries of the U. S. and Canada. Mail the coupon now—before you turn the page!

**AMERICAN TECHNICAL SOCIETY**  
Dept. X-1198 CHICAGO, U. S. A.

### SPECIAL DISCOUNT COUPON

American Technical Society, Dept. X-1198, Chicago, U. S. A.

Please send me set of.....

for 7 DAYS' FREE examination, express prepaid. I will examine the books thoroughly and, if satisfied, will send \$2 within 7 days and \$2 each month until I have paid the special price of..... If I decide not to keep the books, I will notify you at once and hold them subject to your order. Title not to pass to me until the set is fully paid for.

NAME.....

ADDRESS.....

REFERENCE.....

Please Mention Popular Mechanics

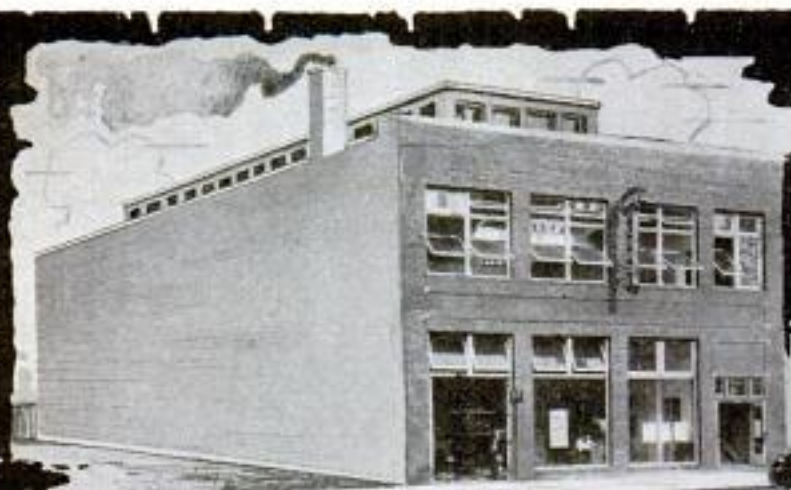

Cleveland Automobile School

# COME

## Our New School

**Specially Equipped and Built to Teach Men the Automobile Business from the Ground Up**

If you are mechanically inclined—like machinery, come to Cleveland—to this school and learn the automobile business. Here in this new modern equipped building is every facility to give you a thorough, up-to-the-minute training in this biggest of all professions. 4000 men have gone from us better equipped to battle with the trials and reverses of life. 4000 men are willing to recommend to their fellow-men that they come to Cleveland, the sixth city, and learn the profession that is demanding more men than any profession since the beginning of time.

**Earn \$75 to \$200 a Month**

**No Previous Experience Necessary**

With a few weeks' training under our capable instruction you can step right out and make \$75 to \$200 a month. We Guarantee to qualify you for a position as **Chauffeur, Tester, Garage-man, Expert Repair-man, Shop Foreman, Auto Electrician, Auto Salesman, Demonstrator, Truck Driver**, or fit you to start in this Auto business for yourself. If you desire you can take special training in **Oxy-Acetylene Welding and Cutting**, a big paying branch in up-to-date garages. You can learn **Tire Repairing**, too, on the latest and modern machines made for this purpose.

### 4000 Graduates

of the Cleveland Auto School are making good in **Factories, Garages, and in business** for themselves in all parts of the country. Geo. W. Anns, Minersville, Pa., says: "I am one of your 4000 graduates getting along wonderful in business for myself, drive my own cars and thank you for what I learned at your school." In Cleveland more accessory parts and high grade cars are made than in any city in the country. More new factories are locating here because of better shipping facilities. **The demand for our graduates is enormous, far more and greater than we can furnish.** It's your opportunity to get started right in this business—in the biggest field—where the greatest demand exists and the most money is to be made.

**Send the coupon on next page, drop a post-card or come to see us**



A Few of Our Classes

Join the Crowd  
Mail the Coupon Today

Tester

Auto Dealer  
or  
SalesmanGarage  
Owner  
or  
ManagerTire  
Repair Shop

# HERE TO LEARN The Automobile Business

**\$75,000  
Invested**

**To Train You in This Money-  
Making Business**

Everything is furnished—all tools—**nothing extra to buy.** A dozen automobiles for road service, Chassis for assembling, 4, 6, 8, and the latest 12 cylinder motors, all at your disposal. **The most modern of electric starting and lighting devices** are used in your training. You learn to take care of every trouble on any make of car, so thorough and practical is our instruction. Special Stereopticon room equipped with Motion Picture machines bringing to you inside methods employed in leading factories in the automobile industry. Reading and writing rooms are provided. **Private lockers, shower baths, etc., are at your disposal.**



**CLYDE H.  
PRATT,  
President**

## Expert Instructors

**All Members of the Leading Societies of Automotive Engineering**

You are taught to handle any kind of an automobile proposition under the personal instruction of experts, seasoned by long training in their work—men who are not afraid of grease and dirt, men who work with you every step of the way. They will put you on the right track—show you all the "short-cuts" of the business which means bigger earnings for you. **You learn by actual practice, not books.** You learn by doing. When you have finished your course to our satisfaction you are thoroughly trained, capable, and a man whom we can recommend in the highest sense to anyone in need of your services.

### Act Now! Mail Coupon. Write Today!

Get our big, *free* Catalog and complete details of this proposition. Remember, your country needs men trained in this business. They are giving them **preferred positions in the Quartermasters' Department, Signal Corps, and Aviation Service.** John J. Maxwell, a recent graduate, writes: "Joined the U. S. Medical Corps and am now in charge in Motor Squad of Ambulances. Thank you for the training you gave me." Whether you join the colors or not, investigate this opportunity. Send the coupon. Write a letter or send a post card today, or if you prefer, come to Cleveland and see us. New classes starting every few days so you can start at once.

## Cleveland Automobile School

**CLYDE H. PRATT, President**

**Dept. 11**

**1824 E. 24th St.**

**Cleveland, Ohio**



**Race  
Driver**



**Private  
Chauffeur**



**Master  
of 12-cyl.  
Motor**

*Please Mention Popular Mechanics*

### FILL OUT TODAY!

**Cleveland Automobile School  
Dept. 11, 1824 E. 24th St.  
Cleveland, Ohio**

**GENTLEMEN: Send me free  
catalog and full details of  
your Automobile Training  
School.**

**Name**.....

**Address**.....





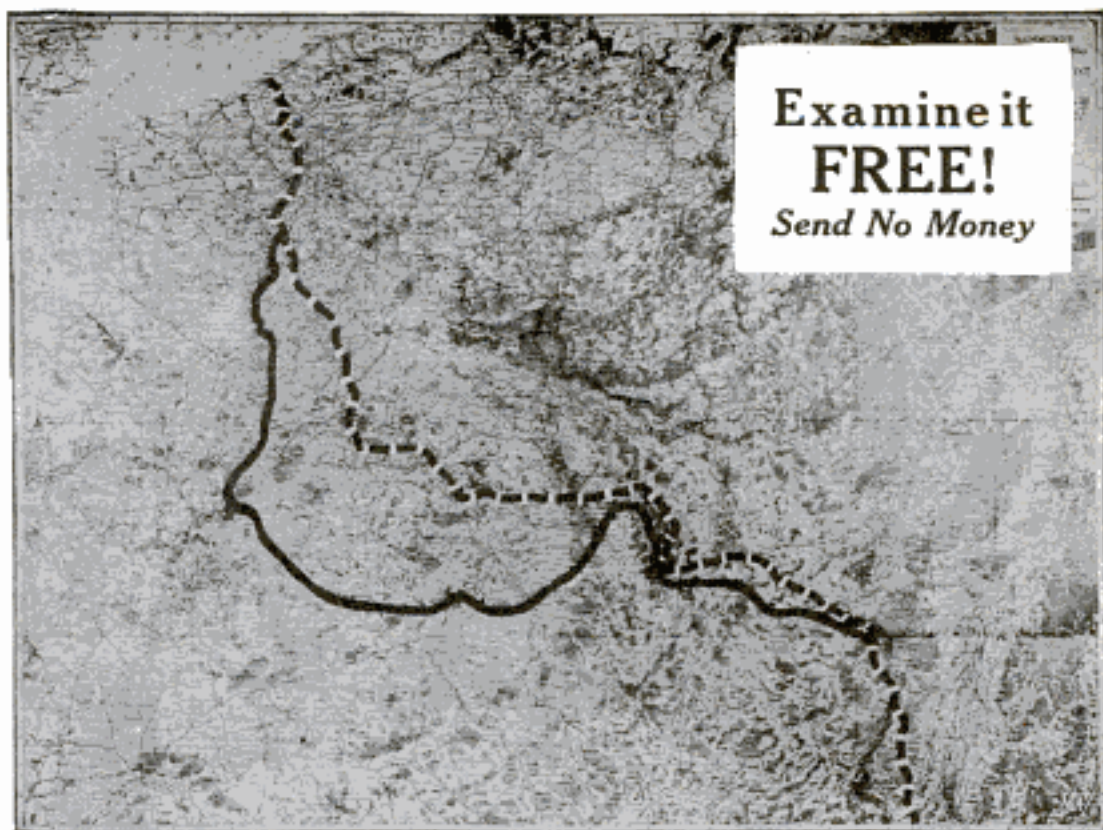

### Size 28x36 inches

This photograph is a reproduction of the most complete single map of the Western Front ever published. It is 28x36 inches in size, but folds into a convenient cover  $5\frac{3}{4} \times 7\frac{1}{2}$  inches, just right to be carried conveniently in the pocket for frequent consultation. It is printed on excellent paper, and can be had mounted on cloth if desired at slight extra cost.

# The Most Complete Single Map of the Western Front

## More than 7,000 Villages, Towns, and Hamlets

On this map there are shown more than 7,000 places. The State of Illinois contains about the same number of square miles as shown on this map and in Illinois there are less than 1,700 places of 100 or more inhabitants. In addition to this vast number of places it gives all woods, fortresses, fortified towns, naval arsenals, forts, redoubts, batteries, aircraft depots, wireless stations and railways. The forests and woods are indicated in *green*, giving the map an attractive appearance, and adding a strategical feature of importance. The scale of the map is *10 miles to the inch*. It extends west to Ashford, England; north to Antwerp, Belgium; east to Frankfort, Germany; and south to Orleans, France. It shows for comparison the *battle line of 1914*, when the Germans were *almost at the gates of Paris*. The *ground gained by the Allies* therefore, may be plainly seen. It is without exception the most satisfactory map of the Western Front which has been engraved. It has been prepared especially to throw light on movements as they occur. It may be examined with ease, for the type is bold and clean cut.

## A Complete Index Makes Locating Easy

An index of towns and villages accompanying a map of this kind has been proven an *absolute necessity*. The smaller towns are the ones usually mentioned in the news dispatches. They are not to be found on *ordinary maps*, and the locations, of

**Follow the  
American  
Troops in France**

most of them were, and still are, utterly unknown to the general public, but unless their locations are known their strategical importance cannot be grasped.

Nothing is more unsatisfactory than searching all over the map for a small place that may or may not appear upon it. However, this *loss*

*of time and patience is now at an end*, for the index which *accompanies this map*, makes it *vastly more useful and valuable*. The index contains more than 7,000 names. An idea of the importance of this statement may be gained from the fact that 90 per cent of the war maps available to-day contain less than 500 names. This index is bound in with the map and enables one to locate *instantly* any one of the 7,000 places mentioned.

## Send No Money

The great value of this map is so apparent that a copy will be sent on approval without a penny in advance. If, after examining this map, you decide to keep it, send only \$1.00 for the plain, or \$2.00 for the cloth-backed map. If not delighted with the map and index, return them and you will owe nothing. Just mail the coupon now.

## Free Examination Coupon

Nelson Doubleday, Dept. 2011, Oyster Bay, N.-Y.

Please send me the Large Scale War Map of the Western Front on approval. If it suits me, within five days I will send you \$1.00. Otherwise, I will return it.

Name .....

Address .....

If you want the map mounted on cloth, greatly increasing its durability, at the special price of \$2.00, if it suits you, write "Yes" here.....



## A World's Record in Building!

**I**N building army cantonments, naval quarters, aviation camps, supply bases, ships, boats and barges, the United States Government is shattering all precedents in emergency construction.

This stupendous war task is possible of accomplishment in such brief time only because the Government has availed itself of the services of the ablest structural designers; has assembled and utilized a mighty army of the most skillful mechanics, and has employed as the principal structural material the most serviceable, adaptable and workable of building materials—

## Southern Pine

*"The Wood of Service"*

The utilization of hundreds of millions of feet of Southern Pine lumber and timbers, in preference to all other materials, is due to something more than the fact that Southern Pine is the most available and economical of high-grade building woods—**it is a National testimonial to Southern Pine's supremacy in service qualities.**

**There is a significant lesson in this for the builder of every type of structure in which wood may be employed.**

Standard Specifications and Grading Rules for Southern Pine lumber and timbers, with a list of Southern Pine Association subscribers (manufacturers of *guaranteed* Southern Pine), will be mailed promptly on request.

**Address Department D-1**



# Southern Pine Association

NEW ORLEANS, L.A.



*Please Mention Popular Mechanics*

# Popular Mechanics Magazine

REGISTERED IN U. S. PATENT OFFICE

WRITTEN SO YOU CAN UNDERSTAND IT

5159

Vol. 28

NOVEMBER, 1917

No. 5

## Motorcycle Runs on Gas Instead of Gasoline

**T**HE use of illuminating gas for fuel, which has been undertaken as a war-time expedient for English busses and other cars, may very possibly become a permanent practice that will work revolutionary changes in the motor-vehicle field. The construction of a motorcycle that effects a great saving in fuel costs by using gas instead of gasoline, is one of the latest steps in this direction. A large gas bag, composed of fabric inclosed in a rope mesh, is supported by a steel frame above a sidecar and supplies fuel to the motorcycle engine through a tube located on the under side of the container. Tests have shown that the machine consumes only a fraction of a cent's worth of fuel for each mile of travel.

In the case of the English busses which were commented upon in Popular Mechanics Magazine for October, reports show that one company's fuel cost has been reduced from nine to three cents a mile by using illuminating gas, the price of gasoline being figured at 52 cents a gallon and gas at 60 cents per 1,000 cu. ft. These busses are equipped with 40-hp. engines and on their upper decks

are flexible gas holders with a capacity of 600 cu. ft. each. It is said that no alteration of the carburetor is necessary beyond employing a valve in the air-intake pipe to enable the driver to regulate the air supply. In Edinburgh, Scotland, gas-driven busses have also been employed with satisfactory results. Much thought is being given to providing more satisfactory gas containers. It has been predicted that if this problem can be solved, gas will come into quite general use for motor cars.

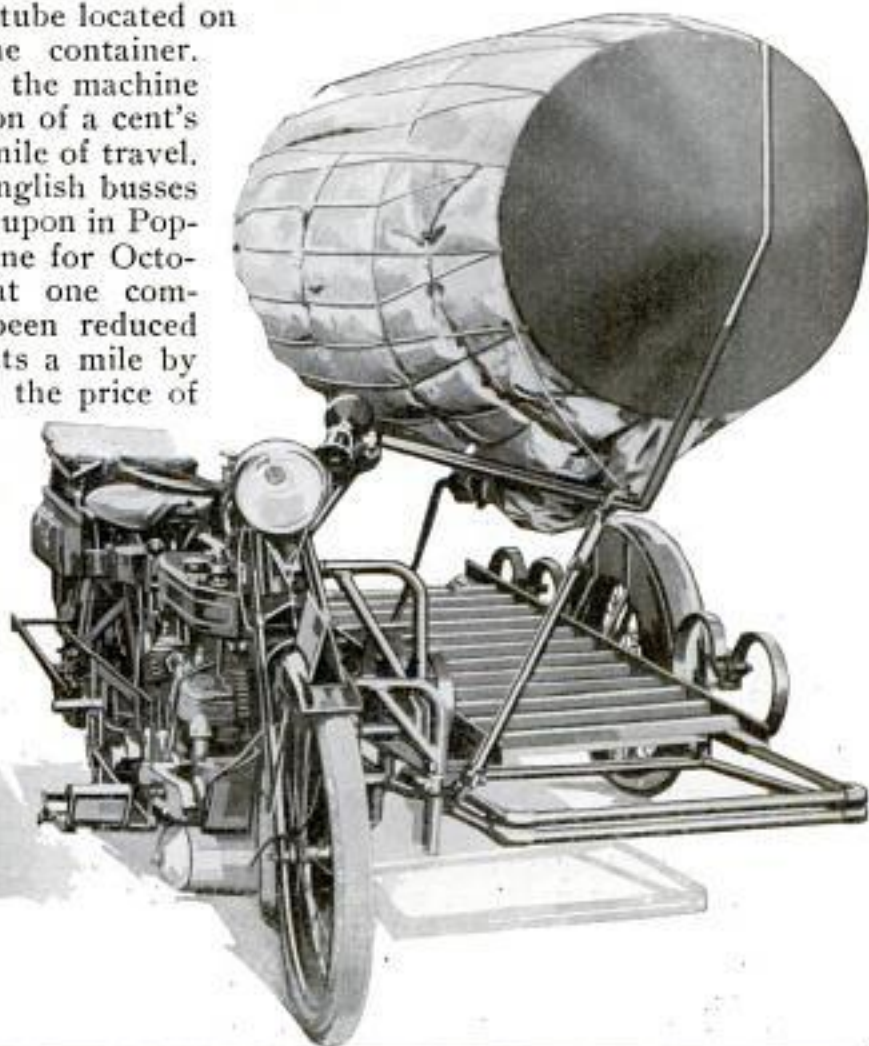

A Motorcycle That Burns Illuminating Gas Instead of Gasoline. Consuming Only a Fraction of a Cent's Worth of Fuel per Mile, According to Tests: The Conical Metal End over the Gas Container Enables the Latter to Retain Its Shape in Spite of Wind Pressure. The Sidecar is Well Suited to War-Time Ambulance Service

# VISIONS IN THE SKY AT PRZEMYSL

2982 How an Ancient Miracle, Reproduced by the Aid of  
Modern Science, Affected the Fortunes of Two Nations

By J. E. MURPHY

TALES of visions seen in the sky above Przemyśl during the series of terrific assaults that ended in the capture of that fortress city by the Russians in March, 1915, have been repeatedly told by soldiers of both armies as well as by residents of the city. So detailed and uniform are the accounts coming from widely different sources that, judged on the basis of evidence alone, the stories must be accepted as substantially true. In Przemyśl and the surrounding country there are thousands of persons, many of them claiming to be eyewitnesses, who are positive that visions of the Virgin Mary and the Christ Child repeatedly appeared in the sky above the beleaguered city, and who are convinced that these visions were of supernatural origin.

That such visions did appear can scarcely be doubted, and since it is possible for modern science to have produced them, it is unnecessary to seek for any but natural causes. There is good reason for believing that the solution of the entire mystery is to be found in the workshops of the aeroplane and stereopticon makers—that the officers in charge of the defense simply took advantage of the latest developments in flying craft and projection apparatus to spread the conviction through the ranks of both armies that the city was under divine protection. The explanation given in the following paragraphs is designed to show how the Przemyśl visions could have been produced easily by equipment that is now in everyday use.

According to reports the visions invariably appeared at night. It is a safe presumption that they appeared only when the sky was overcast with low-lying clouds, and that these were made to serve as a screen for the images projected by a stereopticon. Rain clouds are usually at a height of about half a mile above the earth. To project im-

ages so great a distance as this would be impractical. Too powerful a light would be required, and other difficulties would be introduced that might be impossible to overcome. The thing could easily be done, however, with the aid of an aeroplane, carrying an ordinary stereopticon, and flying from 700 to 1,000 ft. below the clouds.

Clear motion pictures have already been projected a distance of approximately 400 ft. By equipping a stereopticon with a searchlight instead of the usual arc light it would be entirely practical to project still pictures a distance of 1,000 ft. This would be sufficient for producing visions of an awe-inspiring nature, and with the exception of a special mirror for the searchlight, which could probably be found without any necessity for special manufacture, all the apparatus required would be such as can be obtained at any time on the market.

Essentially, a stereopticon consists of a projecting lens and a condensing lens, the latter serving to gather the scattered rays as they come from the light and turn them as a slightly converging bundle of rays into the projecting lens. The parabolic mirrors used in searchlights are made to reflect the light as a parallel bundle of rays having the same diameter as the mirror. For use with a stereopticon a special mirror would be required—one that would focus the rays into the condensing lens. To save weight, which is a vital consideration, the generator for supplying current to the searchlight could be driven by the aeroplane motor. Arranged in this way, the entire apparatus might run close to 1,000 lb. in weight, and it would probably be necessary to use a biplane, in preference to a monoplane, on account of its greater carrying power. Since there would be nothing to do in handling the apparatus but to turn the current on



"The Vision in the Sky" Which Influenced Two Armies at Przemysl in March, 1915: The Insert Shows How the "Vision" was—Probably—Projected upon the Clouds from an Aeroplane

and off, all need for a special operator could be overcome by placing the switch in convenient reach of the aeroplane pilot. Used with a biplane, the stereopticon could be carried at the side of the pilot in the position usually taken by a passenger, and to make it possible to cast the image on the clouds with the aeroplane in level flight, the stereopticon could be mounted with the line of projection pointing upward at an angle of  $45^\circ$  or  $50^\circ$  from the horizontal axis of the aeroplane.

Using the standard stereopticon slide,  $2\frac{7}{8}$  in. square, with a projecting lens having an equivalent focal distance of 16 in.—which would make a convenient apparatus for the purpose—the image cast at a distance of 100 ft. is 18 ft. 6 in. in diameter. At a distance of 1,000 ft. the image would have ten times this diameter, or 185 ft. Spreading the image over as big an area as this would result in an enormous loss in brilliancy if the ordinary arc light were used. With a searchlight this loss could be more than overcome. To produce an image of this size the airman would fly in a level line about 700 ft. below the clouds. Viewed from the ground half a mile below, the image would have the same effect as a highly luminous object 30 ft. in diameter, seen at a distance of a city block. The appearance of such an object in the sky above a city, darkened because of siege, would be a striking spectacle indeed. Soaring above the city with this simple equipment, the airman, by merely throwing an electric switch, would be able to spread hope or panic as far as his picture could be seen.

Several persons who saw the visions have said that they were "like the holy picture in the church at Czenstochowa." If the details of the undertaking are ever told, it will not be surprising if it is found that a photographic reproduction of this famous Madonna was used, for the reason that no picture in the world could have been used to better effect. The monastery of Czenstochowa is located about a hundred miles west of Przemysl and was in possession of the Austrians at the time of the siege.

The painting is familiar to the inhabitants of all that part of Europe and is so venerated that it is visited annually by an average of 400,000 pilgrims, many of whom come from East Prussia, Galicia, and west Russia, as well as from Poland. According to tradition it was painted by St. Luke and there is a belief current that it is sometimes miraculously illumined. A reproduction of this picture cast on the clouds, "surrounded by a halo of bright light," as reported—which would mean that the stereopticon slide had been made with a liberal margin of clear glass around the edges—would be readily accepted as a divine message by these people of simple and strong religious belief.

Whatever may have been the precise means used for projecting the images, there can be no doubt that they produced the effect intended. Whenever the Virgin Mary was seen hovering over the city, the Austrians, believing they were under divine protection, took fresh hope, while the Russians became panic-stricken. For hours after each appearance of the vision it was impossible to persuade or force the Russian soldiers to fire, and it is reported that because of this the capture of the city was delayed for weeks. In one typical case a Russian commander, suspecting a trick by Austrian airmen, ordered a battery to fire at the vision, hoping in this way to bring down the aeroplane that was causing such demoralization among his troops. Instead of obeying, every man in the battery fell to his knees and prayed.

### TWO NAVY MEN WIN PRAISE 5131 FOR GALLANTRY

Two men in the navy, one a seaman of the second class, and one a chief boatswain's mate, have been commended by the Secretary of the Navy for acts of gallantry. The seaman jumped overboard into the tidal basin at Washington, D. C., and rescued a small boy from drowning. He brought the lad to the surface and applied first aid in a way



This Car with Six Cross Seats Conforms More Nearly to the Ordinary Touring-Car Design. The "One-Man Top" is Not Misnamed, for One Person can Open and Fold It

that showed he had a thorough knowledge of this treatment. In the other case mentioned, the boatswain's mate rescued a coxswain from drowning after a collision between a seaplane and a flying boat. Notwithstanding the fact that the rescuer's leg was broken in the collision, he dived three times in an effort to rescue his shipmate, who was unable to swim. This heroic action enabled the endangered man to grasp a portion of the seaplane and so keep above water until rescued.

*Auto*

### 5108 HUGE SIGHT-SEEING CARS LOOK LIKE DACHSHUNDS

Two mammoth cars, which recently have been put into service in a community much frequented by tourists, illustrate the latest achievements in the construction of sight-seeing busses.

The larger of these cars, which some-

how suggest huge dachshunds, is 30 ft. 10 in. long, 8½ ft. wide, and has a wheelbase of 20 ft. 7 in. It has 10 heavily upholstered seats set crosswise, affording ample accommodations for 60 persons. Access to the seats is gained through side doors, beneath which is a folding step extending the full length of the body. This car has a maximum speed of 17 miles per hour. The design of the second machine adheres more closely to that of an ordinary touring car, having a streamline body whose shape is accentuated by a top of the regular one-man type. The car is equipped with a six-cylinder motor and an electric starter, and is capable of greater speed than the larger machine. There are six seats, the upholstery of which is comparable to that in the finest touring cars.

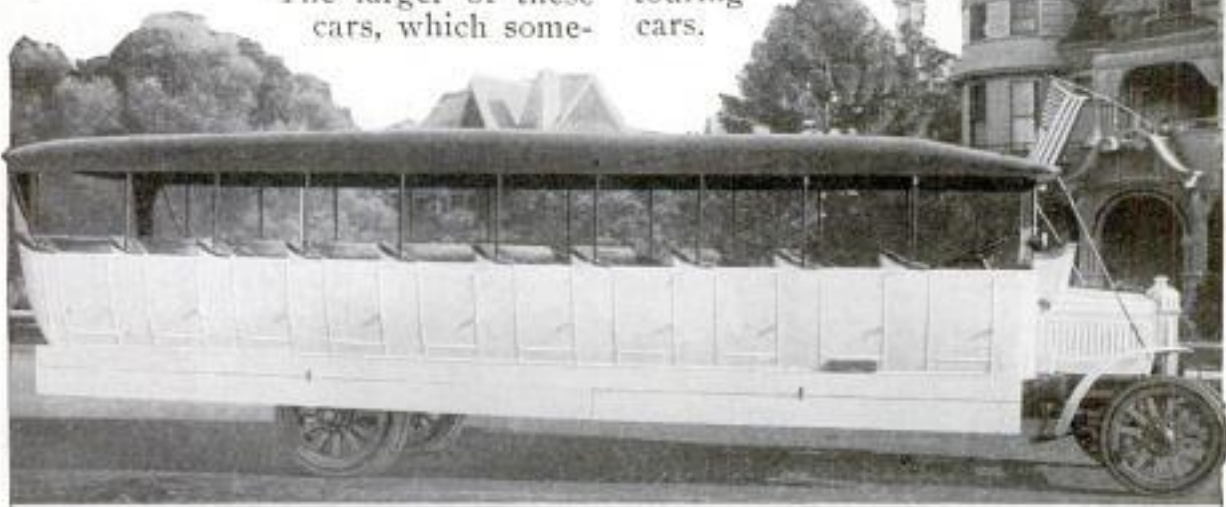

A Sight-Seeing Automobile That will Seat 60 Persons; The Frame and Upholstery of This Car Are Such That It Rides Very Easily in Spite of Its Great Length and Weight

Cont. C. H. Seiger - Box 458

721 S. Hope St. Los Angeles, Calif.

mfg. by: Kimball Motor Truck Co. Los Angeles, Calif.

## 5089 DEVICE RECORDS OUTLINES OF HUMAN BODY

In France an interesting apparatus is used for obtaining graphic outlines

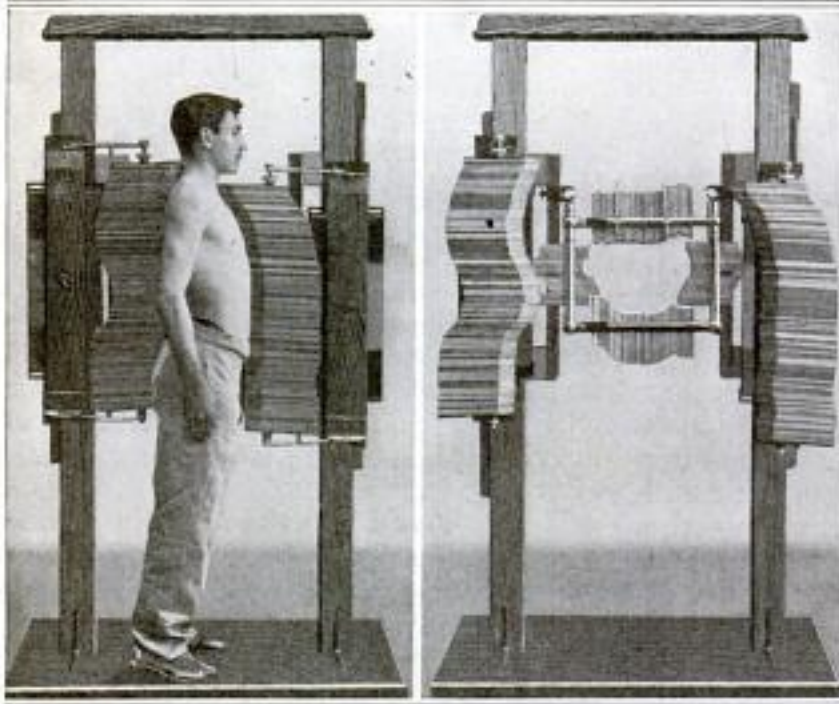

This Shows How a Vertical Cross Section of the Torso is Obtained with the Aid of the Apparatus. When the Loosely Mounted Boards are Adjusted to Conform to the Outline of a Figure, They are Locked. Right: In the Middle of the Frame is Shown the Rectangular Device That is Employed When Horizontal Outlines of the Chest are Made

of the torso when the physical fitness of a man in military or civil pursuits is to be determined. By analogous methods both vertical and horizontal cross sections of the trunk are procured

quickly and with little effort. Thin, square boards provided with central slots are arranged on two vertical rods mounted opposite each other on pivoted brackets attached to a pair of upright posts that form part of a heavy frame. When the brackets are swung so that the stacks of boards are held in close proximity to a man standing on a platform between them, the units are adjusted to conform to the outline of the subject's figure. For obtaining horizontal cross sections, similar members are provided on the four sides of a rectangular frame.

## 5069 AEROPLANE-PROPELLER TURNING LATHE

A type of lathe has recently been installed in certain air-craft factories in this country which is designed expressly for turning out propellers and

struts used on various types of aeroplanes. It will produce exact facsimiles of the models used, making both right and left-hand pieces from the

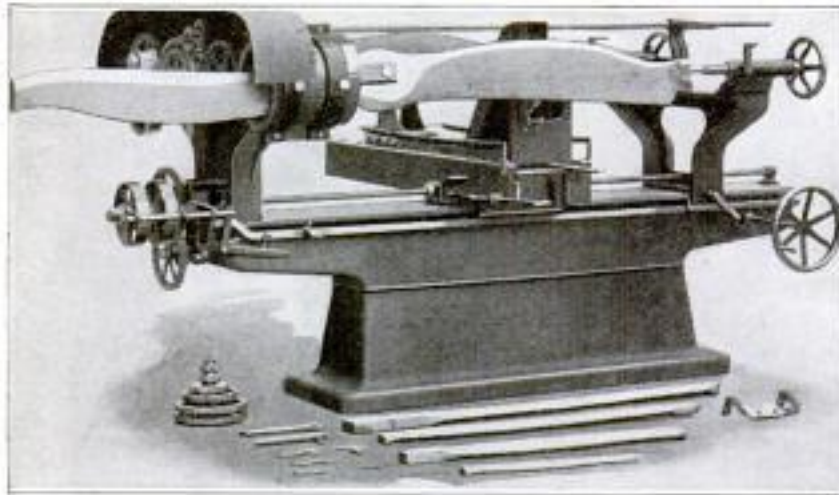

Lathe for Turning Aeroplane Propellers: It will Copy Any Model, Producing Both Right and Left-Hand Pieces, Either Larger or Smaller Than the Original

same model, and by a simple adjustment either end of the work, or the entire piece, can be made larger or smaller than the model. The cutter head is fitted with six right and six left-hand knives and will successfully turn either soft or hard wood. A hollow chuck through which the wood is inserted is used in turning propellers, as each blade is turned separately.

*Defiance Machine Works,  
Ohio*



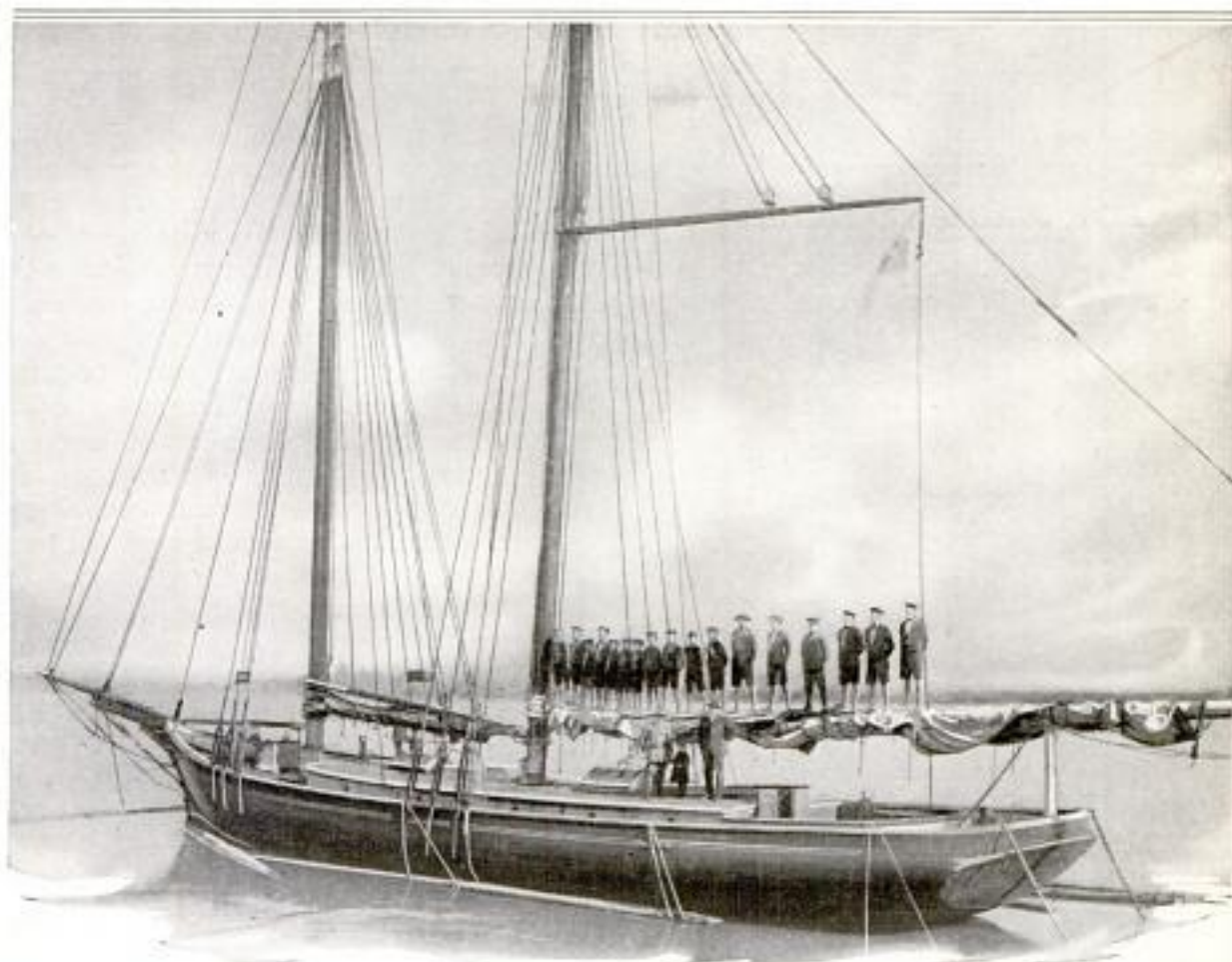

5058 The Good Ship "Casco," Once in the Service of Robert Louis Stevenson, as It Appeared a Short Time Ago When Used as a Training Ship by the Sea Scouts: Because of the Great Lack of Bottoms, Due to the War, the Yacht is being Refitted for Coastwise Trade

## WAR BRINGS STEVENSON'S BOAT "CASCO" TO LIGHT

Many of Robert Louis Stevenson's present-day admirers will be interested in knowing that the little yacht, "Casco," in which the author sailed to the South Seas from San Francisco in quest of health, nearly 30 years ago, is being rejuvenated for coastwise trading in the Pacific. The craft, which was originally built for racing in California waters, has had an eventful career. It is a topsail schooner, 95 ft. long and of 70 tons' burden. It has graceful lines, behaves well under sail, and still has life, although time and hard usage have made it a very different boat from what it was when Stevenson chartered it for his voyage to Samoa. At that time it glittered with brass and boasted a salon that was fitted luxuriously. Those who are familiar with the "Wrecker" will remember the skipper of the "Casco," Captain

Otis. The crew of "sea-lawyers," as Stevenson called them, was composed of "three Swedes and the inevitable Finn," when the author slipped out through the Golden Gate never to return. Stevenson subsequently went to Honolulu and, for a short time, engaged a house at Waikiki, where he wrote part of "The Master of Ballantrae." He then dispatched the "Casco" back to its owner at San Francisco. At a later date the boat was purchased by sealers and for a number of years engaged in that trade. At another time, according to rumor, it was used in smuggling Chinamen and opium into the United States. About a decade ago it was laid up at Victoria, B. C., and three years later was pressed into service long enough to transport a cargo of junk to Vancouver. It was then obtained as a training ship for a local

band of Sea Scouts, a juvenile nautical organization. Recently it again changed owners and is now being refitted.

### SERVICEABLE FOUNTAIN FOR MAN AND BEAST

In the city of Louisville, Ky., are several bubbling fountains of a design



Sanitary Fountain in Louisville, Kentucky, with Bowl High Enough for Checked Horses to Drink From: The Water Overflows into the Street

which makes them especially serviceable for man and beast. The fountain's standard consists merely of a vertical piece of channel iron which occupies but a small space in the sidewalk and serves as a protection for the pipe through which the water flows. The bowl stands 48 in. above the curb, well out of the way of wagon tongues, and high enough to permit checked horses to drink from it. Water bubbles continuously from a vertical pipe projecting above the bowl, thereby affording a place where human beings also may drink. No overflow pipe is provided, the water falling into the street. This tends to keep the rim clean and lessens the chance of spreading disease among animals drinking at the fountain. A faucet is provided near the base for filling pails and the like.

### "TALKING" ELECTRIC SIGN OF SIMPLE CONSTRUCTION

There is a noticeable absence of complicated wiring and expensive mechanism in a "talking" electric sign of considerable flexibility that has lately been introduced. Outstanding among its features, therefore, is its comparatively low cost of installation and maintenance. Particular advantages are that the style of type can be changed at will, without expense, and that the characters of any language can be reproduced without making changes in the wiring or mechanism. Designs of various patterns, and even animated cartoons, can likewise be executed with equal facility. As frequent changes of copy as desired are possible, and an office boy is as competent to make them as anyone. When the sign is in use, it does not require the attention of an operator.

The signboard consists merely of a bank of incandescent lamps arranged in parallel rows and connected in series with a flashing apparatus that embodies the major part of the invention. The latter has the appearance of a large table. Cut in its top surface are circular holes which in number and position correspond to the lamps on the display board. Encircling each of the apertures is a series of upright pins whose bases are connected electrically. These members serve as supports for small, round contacts that are used for "lettering in" the sign. In the center of each metal disk is a perforation which permits it to be slipped onto any one of the pins. When so placed, a part of the member extends over the margin of one of the holes in such a way as to be encountered by a vertical coil-spring contact which is mounted on a movable board beneath the table and projects through the opening. It will be understood that one of these upright springs protrudes through each of the holes. The board is supported on ball casters that rest on a base plate. Power supplied by a motor is used to give the board a circular movement. The rotation is made step by step as the upright spring contacts are carried around the inner

*Mrs Lenora H. Jones*

*2016 N. Maple St.  
Washita, Kans.*

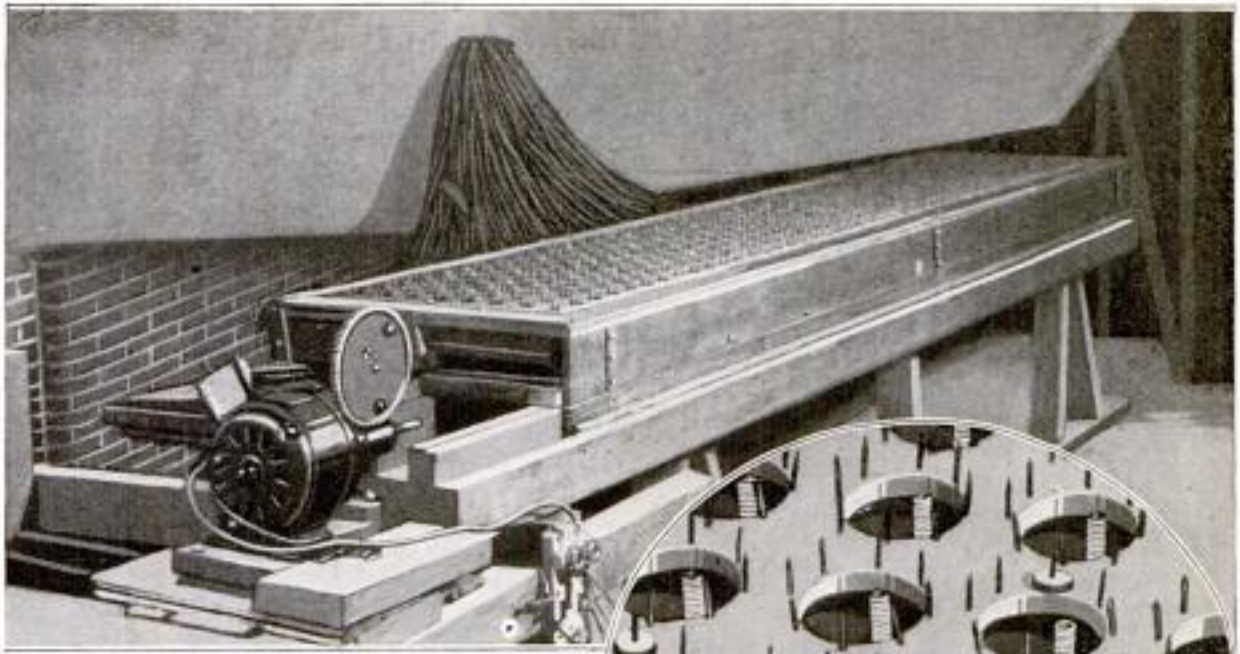

The Flasher as It Appears When Regularly Installed: At the Near End will be Seen the Motor Which Rotates the Board on Which the Upright Spring Contacts are Mounted

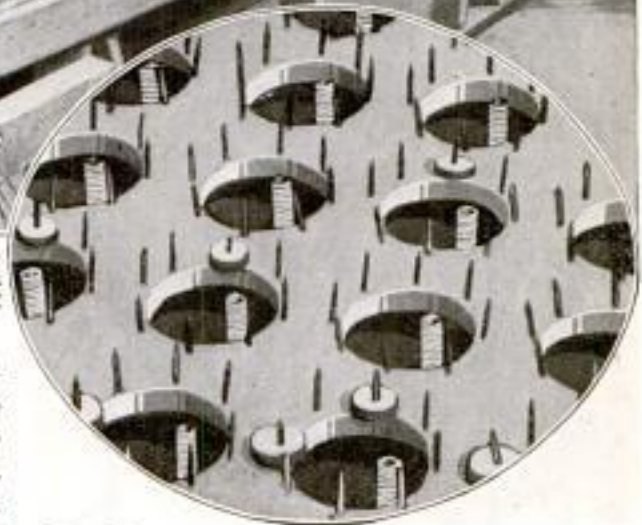

Close View of Top Surface of the Switchboard, Showing Some of the Disks in Place on the Upright Pins Encircling the Holes, Inside of Which the Coil-Spring Contacts will be Observed

circumference of the holes through which they protrude. In making this circuit they encounter the disks. This briefly explains the construction and operation of the switching mechanism.

In lettering the sign, the display board requires no attention. The words to be illuminated are spelled out on the switch table with the disk contacts. Each lamp on the sign can be used as many times as there are pins surrounding one of the holes on the flasher. By another arrangement that has been worked out, a practically unlimited number of pins can be employed. This is only needed, however, when a large number of words is to be shown. In actual use the sign displays its copy one word at a time unless two short words happen to come together. The intervals between the words is exceedingly brief so that one reads in a normal way without continual interruption.

that customers can sit at its counters without entering the building. The sides are formed by counters set on the building line, while above the



Lunch Room in V-Shaped Area with Counters So Arranged That the Patrons' Stools Project over the Sidewalk

**LUNCH COUNTER'S PATRONS SIT IN THE STREET**

A narrow V-shaped room at the end of a building erected in the acute angle of a street intersection in a Pacific coast city has been transformed into a quick-lunch establishment so arranged

counters are removable windows. Hinged stools for the patrons are fastened just outside the room and extend over the sidewalk. These can be tilted up against the side of the counter,

5099

cont. C. H. Meyer  
1319 S. Grand Ave  
Los Angeles Calif.



A Fight to the Death at the Bottom of the Ocean: In These Three Scenes from an Exceptionally Clear Movie Production the Progress of a Thrilling Hand-to-Hand Combat is Well Staged. Each Man is Armed with a Knife and is Struggling to Cut the Air Tube of His Antagonist. Eventually One of the Two Succeeds, as the Escaping Air in the View at the Left Testifies. The Grim Result of the Conflict is to be Seen in the Right-Hand View

5023 **ROMANCE OF OCEAN BOTTOM  
PORTRAYED IN FILMS**

To young and old alike, Davy Jones' locker has always held fascination. The magnificence of submarine scenery, the romance of sunken galleons and treasure chests have given the bottom of the sea an almost hypnotic charm to those of adventurous spirit. Therefore, there is little wonder that recent triumphs in underwater photography should create great popular interest among devotees of the movies. The excellence of some of the subaqueous moving-picture work now being done is well illustrated by the films of recent production shown herewith. The plots that supply the action are immaterial except in so far as they illustrate the freedom of movement that modern diving appliances afford submarine explorers. This is demonstrated in one of the pictures by a dramatic and fairly realistic battle that is staged by two divers, both armed with knives, who have discovered a treasure chest. One of them succeeds in cutting the hose that supplies the other one with air. In reel life the victim, of course, drowns, but in real life his welfare is not endangered, for he wears a suit supplied with oxygen independently of the surface pumps. The pictures have astonishing clearness and absorbing interest. In another submarine film an inverted periscope is cleverly employed. This device, which enables those on shipboard to watch and direct the diver, offers a suggestion of practical value.



An Invention with Practical Possibilities Suggested by a Movie Scene: According to the Scenario, an Inverted Periscope, Shown at the Left, Enables Persons on a Ship Above to Watch the Diver and Direct His Work

5118 **X-RAY PICTURES ARE SHOWN  
IN RELIEF ON SCREEN**

By a comparatively simple arrangement, a French scientist has provided a means of obtaining stereoscopic X-ray images that enable a surgeon to see a bullet in its true position when it is lodged in a human body. When seeing an image in relief on a screen and being able to recognize its position in relation to bones, it is possible for a surgeon to estimate accurately the distance between his instruments and the projectile, or whatever the object happens to be. Two ordinary X-ray bulbs, or a single bulb supplied with a double anticathode, are used. They are energized alternately by a commutator connected in the secondary circuit, and project two images in quick succession on the screen. The double picture makes its impression upon the retina by passing through the openings in a shutter that consists of two perforated disks revolving in opposite directions. The shutter is so arranged as to shield and reveal the screen in unison with the opening and closing of the circuit energizing the anticathodes. The work is still in an experimental stage.

5107 **INFECTED AREA IN HAWAII  
SEARED WITH ODD TORCH**

Destructive measures, almost warlike in their intensity, were taken not long ago in Hawaii to wipe out anthrax germs which threatened to devastate a large Honolulu dairy herd. Home-



Homemade Outfit in Which Distillate for the Torch was Kept under High Pressure



View Showing a Torch, Pressure Tank, and Some of the Rocky Ground being Scorched



Supplying Oil by Cableway to Workmen Who Poured It on the Carcasses to be Burned

made torches which burned distillate were employed in scorching every foot of ground in a six-acre area that had become contaminated. Also, the bodies of the animals that had died from the disease were burned and the cactus plants which covered a considerable portion of the ground were cut down, dried in a kiln, and consumed.

Each outfit included a tank, similar to the hot-water tanks installed in kitchens, which was fitted with a gauge, intake pipe, etc. It was connected by a hose with a long pipe, one end of which was fashioned into a burner by being bent into a coil and inclosed in a steel shell. The tanks were partly filled with distillate kept under high pressure by pumping air

into the containers. To start the torch it had to be preheated, but once lighted it generated its own gas and produced a flame two or three feet long, covering a square foot of ground. The estimated temperature of the torch flame was  $1,000^{\circ}$  F. and its roar could be heard a long distance. Though much of the infected area was covered with volcanic rocks, and therefore difficult to burn over, there was no spot not bearing the bluish-brown stain caused by the fearful scorching. The plague had killed about 40 out of a herd of 150 cattle, but when the authorities undertook the measures here described, the spread of the disease was completely checked. One laborer contracted the disease but recovered in 10 days.



Cheesecloth Canopies Erected over the Conduits Reduced the Temperature and Prevented Recurrence of the Short-Circuiting

## PREVENT SHORT-CIRCUITING OF CABLES IN ODD WAY

501  
During a period of hot weather in New York last summer when the temperature averaged more than  $90^{\circ}$  F. at midday, some 11,000-volt, three-phase cables carried on a New York Central viaduct became short-circuited and temporarily crippled the division, which is in the electrified area. It was discovered that the temperature inside of the conduits approximated  $140^{\circ}$  and that the trouble was primarily due to that cause. In order to reduce the heat and thereby prevent recurrence of the short-circuiting, long canopies of white

Strom & Bugleisen  
27 Warren St  
N.Y.C.

cheesecloth were erected over the conduits carrying the cables. The cloth prevented the pipes from absorbing the heat of the sun and caused a temperature reduction of from 10° to 12° in them. That sufficed to meet the problem.

a membrane. A small pendulum mounted in conjunction with this is actuated by the vibrations produced by

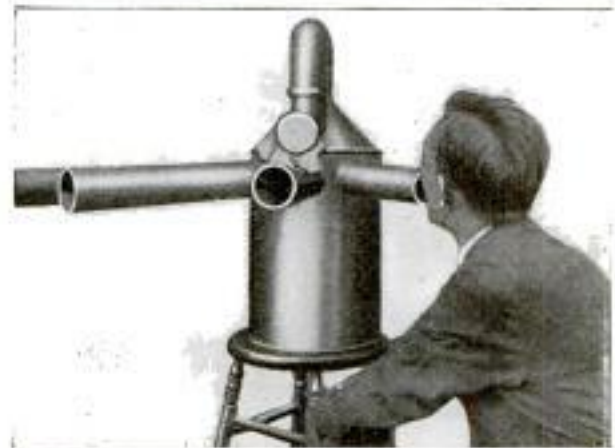

When a Pupil Sings the Vowel Sounds with His Mouth Close to One of the Tubes, the Instructor Determines the Quality of a Certain Overtone by Watching the Action of the Pendulum

sound waves. In using the device, a vocal student sings the vowel sounds with his voice pitched at middle C and his mouth close to one of the hollow tubes, each of which is tuned to a different overtone of middle C. The presence or absence of a specific overtone is indicated by the movements of the pendulum. In this way the overtones that require development and those that should be modified are ascertained.

**4965 TILTED FLOWER VASES HELD IN WIRE FRAMES**

For displaying flowers to their best advantage at horticultural exhibits, a wire rack has been devised which holds metal vases in an inclined position. In these receptacles the flowers are tipped forward toward the aisles so that they may be examined more readily by spectators. One of the big advantages offered is that when set at an angle the whole of a bouquet is brought into view.



*J. H. Fletcher*  
*Suburndale, Mass*

**5055 GOGGLES WITH THREE-PLY LENSES FOR AIRMEN**

Our government has recently placed orders for a number of airmen's goggles and gas masks in which a special three-ply glass will be used because it affords greater protection to the eyes than ordinary glass. Its two outer layers are welded under pressure and heat to a central sheet of special material like celluloid. If the glass should be cracked, the fragments will cling to the middle ply instead of flying off. The center layer also insulates the two outer layers from each other with the result that each surface of the lens



Airman's Goggles with Three-Ply Lenses Which, When Cracked, do Not Endanger the Eyes with Flying Fragments: The Diagram Shows the Make-Up of the Lenses

more readily acquires the temperature of the air next to it. Hence the glass is less apt to become clouded with mist.

**5018 VOICE ANALYSIS IS MADE WITH NEW APPARATUS**

An interesting apparatus has been lately developed by a professor of musical theory to analyze the tone qualities of the human voice and determine defects that require remedying. The instrument is built of metal and consists in part of a vertical cylinder that has a continuous series of 16 horizontal tubes of various diameters and lengths radiating from around its upper section. The top of the device is cone-shaped and fitted with a curved pipe that is covered at the outer end by

SEE CARD.

### HOW ARROW-SHOOTING ACT 4149 WAS FILMED

A motion-picture scene was produced recently which showed an actor



Acting a Movie Scene Backward: The Man on the Ladder is Pulling Out the Arrows by Jerking Invisible Threads. The Film of This Scene is Run Backward When Projected

standing against a tree while arrows were shot at him, some grazing his flesh. The hair-raising episode was produced without risk by acting it backward, so to speak. The arrows were carefully stuck in place about the actor and then, while the camera man turned his crank, an unseen assistant jerked them out one at a time, while the actor "registered" pain at the proper times. The film was then run through the projector backward and the effect produced was most startling.

### ESTIMATING THE COST 5106. OF FEEDING DOGS

A dog hater in New Hampshire, stimulated by the campaign for food conservation, sharpened his pencil, and this is what he figured:

One person in 20 keeps a dog; that's

5,000,000 dogs. It costs 10 cents a day to feed a dog, or \$36.50 a year for one, and \$182,500,000 per annum for all of them. With flour at \$15 a barrel, this sum would buy 12,166,000 bbl. of flour. If loaded 12 bbl. to each motor truck, 1,000,000 trucks would be required to load the flour at one time, and they would make a procession 2,272 miles in length.

The figures seem to be all right and unquestionably impressive, but who can estimate the heart pangs and personal loss to 5,000,000 small boys, if deprived of their dearest treasure?

### MONUMENT MARKS STATE'S 4959 FIRST RURAL MAIL ROUTE

Within the last few weeks an interesting monument has been erected at the intersection of two thoroughfares in Climax, Mich. It commemorates the establishment, 21 years ago, of rural free delivery in that state. The unveiling was conducted in the presence of the two carriers who were the first to



Monument Lately Erected at Climax, Michigan, to Commemorate the State's First Rural Free Delivery Mail Service, Which Was Among the First Established in America

take the letters to Michigan farmers. The memorial marks the place where the men left the town post office to cover their routes, which they are still traveling. Climax was one of the first





In the Upper Left-Hand Corner Are Two Views of a Camera Case Showing the Exposure Slit Open and Closed. At the Left Below Is a Spool with Tested Paper on Its End. The Insert Shows a Camera Ready to be Loaded with a Spool Having a Cap on One End



Slide Rule on the Side of the Camera Which Aids in Determining the Right Length for an Exposure

ost offices in the country to inaugurate . F. D. service. The plan was put force there on Dec. 3, 1896. According to the report of the Post Office Department for 1897, rural delivery was inaugurated for the first time on Oct. 1, 1896, out of Charlestown, W. Va. The monument contains 240 field stones gathered from each of the 240 farms on the rural mail routes radiating from Climax. It is surmounted by a cluster of electric lamps and a flagpole.

**CAMERA DEVICE DETERMINES PROPER SHUTTER SPEEDS**

To assist one in determining the proper shutter speed to employ when making a photographic exposure, an attachment has been designed for folding cameras that use roll films. The device is universal in operation and obviates the necessity of making allowances for seasons, latitudes, and local atmospheric conditions. It eliminates guesswork and helps a photographer or amateur to obtain satisfactory negatives without trouble. A circular piece of specially prepared bromide paper that prints green is attached to one end of a film spool. A revolving disk with a small round aperture is fitted in the camera case. If this is turned until a slit beneath it is uncovered, a tiny section of the test paper is exposed to light. At the same time a permanent color band is disclosed for comparison. The number of seconds required for the sensitized paper to match the permanent color, serves as a key to an instantaneous gauge. Fixed on one side

of the camera case is a graduated list of general subjects such as, "Sea with Ships," "Snow Scenes," and "Groups in Shade." Immediately beneath and similarly tabulated are the lens stops. A sliding member working next to the stationary scale carries the shutter speeds in terms of seconds ranging from  $\frac{1}{300}$  to 64. A street scene, for instance, is to be photographed and stop "U. S. 8" used. The sliding scale is moved until three, the key number obtained by use of the test paper as previously explained, is even with "Bright Street Scenes" on the first list. By then glancing opposite "U. S. 8," the shutter speed,  $\frac{1}{75}$ , the proper timing for the particular exposure, is indicated. The operation consumes only a few seconds.

**GOOD FEATURES COMBINED IN TOOL-ROOM LATHE**

A number of features have been combined in a tool-room lathe now on the market which give it accuracy, simplicity, and power. The headstock is of rigid construction, being a heavy one-piece casting; the gear guards form an integral part of the head and furnish a protective covering for the

*Inv H. L. Iddle  
To A. L. Iddle & Sons  
Springfield, Ill.*

*Davis Machine Tool Co  
Rochester, N. Y.*

*Stand*

cone, while in the top of the guard is a brake for stopping the rotation of the spindle. The back gears are placed un-

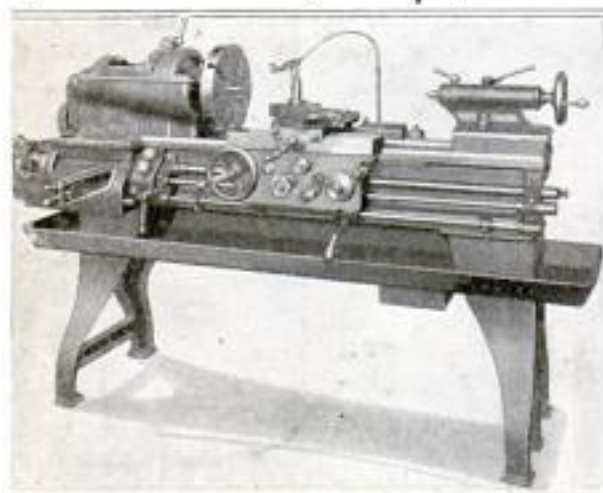

Tool-Room Lathe in Which Several Special Features have been Combined to Produce a Machine That Is Simple, Accurate, and Convenient to Operate

der the headstock, at the front end of the spindle, and are brought into mesh by a handle placed at the front of the machine, thus making it unnecessary for the operator to reach over the cone. For screw cutting, the lathe provides a range of threads from  $1\frac{1}{2}$  to 80 per inch. The motor is so geared to the spindle that four mechanical changes of speed are obtainable. To provide perfect alinement, a foot has been placed in the center of the right-hand supporting framework, thus carrying the machine on a three-point support and keeping it free from strains when it is bolted down.

### CANADA PUTS RESTRICTION ON CANNED VEGETABLES

5/33 Canned vegetables have been placed under a ban in Canada. The food controller believes that there are sufficient fresh vegetables available to more than meet present needs and that by consuming canned garden produce at this time the Dominion's winter supply will be endangered. For this reason he forbids the use of canned vegetables this fall. Just how long the ruling will remain in effect is not stated. It is thought that the new rule will benefit the market for newly grown vegetables and prevent quantities going to waste.

### MOTORCYCLE SCALES WALL 49 FT BY CLIMBING WIRE

To entertain a small group of spectators, an Oklahoma motorcyclist recently made his machine scale the side of a brick building at Alva. The feat was interesting more because of its spectacularity than anything else. One end of a strong wire was attached to the cycle's steering head and passed over a wheel suspended from a bracket projecting from a fourth-story window. The tires were removed from the machine and the other end of the wire was wrapped once around the rim of the front wheel, stretched through the valve hole in the rear one, and fastened to the spokes. The handlebars were wired to prevent movement, and a guide wire was provided so that a man on the ground could keep the motorcycle straight. Also the carburetor was turned so that it would function while the machine was in a perpendicular position. With the engine running, the rear wheel served as a reel pulling the cycle and rider up the side of the building nearly to the fourth story.



The Beginning of the Climb is Shown in the Left-Hand Picture. One End of the Wire is Fastened to the Rear Rim While the Other is Attached to the Steering Head.

The Ascent up the Wall was Accomplished by Making the Rear Wheel Serve as a Reel for the Wire



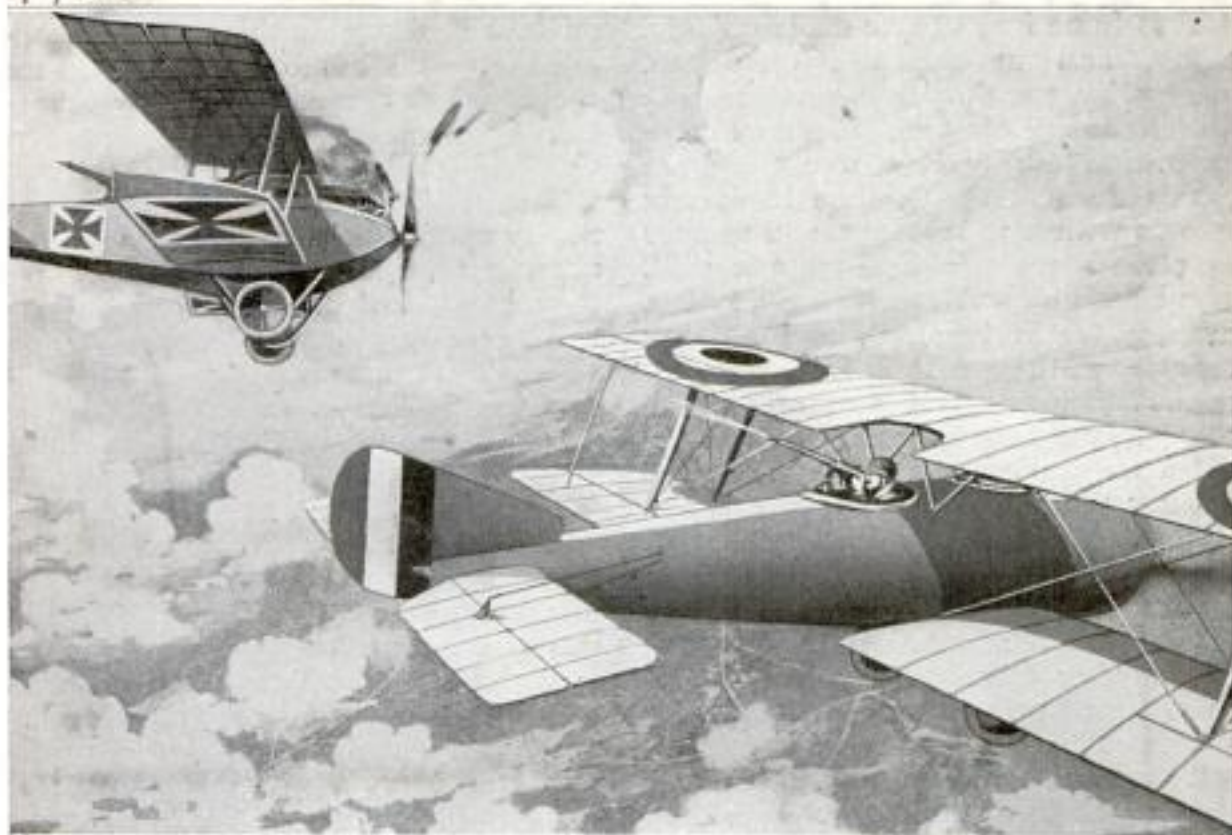

COURTESY OF THE AEROPLANE, LONDON

#### GERMAN'S ERROR GIVES BRITISH FLIER VICTORY

AN experienced airman would assert that this picture is not true to life because no trained flier would expose himself to return fire in the way the attacking German is depicted as doing. Nevertheless an actual, though very unusual, occurrence is here illustrated. During an attack by a German aeroplane on a less speedy British craft, made from behind and just below the tail of the slower machine—a position that gives the aggressor every advantage—the British gunner emptied his weapon in ineffectual fire and quickly reached for another drum of ammunition. In his haste he dropped it in the cockpit and instantly leaned down into the hole to get it. The German, not seeing him, supposed he had killed his man, and boldly rose above his enemy just at the instant the latter's head reappeared. In a flash the British gunner grasped this rare opportunity and poured such a stream of bullets into the aeroplane above him that it dived wildly and then crashed to earth.

#### 5095 OUTPOISONING THE POISONERS

By E. T. BRONSDON *Box 142 - Chgo. Ill.*

DURING the German assault upon Armentières recently, a strange and ghastly phenomenon was witnessed. Many of the shells which fell in the town were seemingly of very fragile construction. They scarcely dented the ground where they burst. They injured very few people with flying particles. They did not contain either cyanogen gas or chlorine. There was a slight incenselike odor, but this was attributed to a peculiar and impotent powder the Huns were supposed to have been forced into using. There seemed to be no reason for the shells.

Six hours later the ghastly truth began to make itself known. Soldiers, male citizens, women, and children began to collapse by the score. Many

fell in convulsions. Some went stark, raving mad. The whole community was poisoned—poisoned by some new and terrible agent that even the German archfiends had not dreamed of using before.

For nearly a week the terrible gas did its work, although the shell attacks ceased abruptly on the first day. Four thousand individuals died in agony greater than even the feared chlorine ever had caused.

The agent employed was arsine, known in the laboratory as arseniureted hydrogen, one of the deadliest of all fumes known to the chemist—beside which hydrogen cyanide and carbon monoxide may be trifled with in comparative safety.

This fume fury can be made quickly, easily, and in immense quantities, merely by treating any arsenical ore with hydrochloric acid. Made for demonstration purposes, where the pure gas is desired, the method is to mix arsenic with zinc shavings, and to pour over the receptacle hydrochloric acid. The chlorine combines with the zinc, a little water is released, and a large quantity of the arsine is formed.

The allies will feel a natural reluctance to use this weapon, just as they felt a natural reluctance to adopt the Germans' chlorine, sulphur dioxide, and "Flammenwerfer" attacks. These fall outside the pale of civilized warfare, in the same class with well-poisoning. No nation should adopt such tactics, but this war has crossed the boundaries of all civilized precept. The allies' only chance is to match the "Schrecklichkeit" of the Hun with still greater awfulness. If this can be accomplished with the Germans' own weapons, so much the better.

The arsine bomb is the most deadly weapon the world has developed. Thrown from an aeroplane, or projected from a high-caliber howitzer or rifle, the gas spreads slowly upon striking. The gas is invisible, and so heavy that no wind short of a hurricane can dispel it sufficiently to make it harmless. It is known as a "creeper"—that is, it follows the hollows of the ground, and progresses by inches. For this reason its presence is apt to be unsuspected, and it may take a week to complete its deadly work.

One whiff—and it does not have to be a lungful, by any means—is certain death. There is no remedy or antidote known to medical or chemical science. The effects are in some respects much the same as ordinary arsenic poisoning—the suffering which ensues upon accidental eating of rat poison is an example of this—but in addition, the gas attacks the big nerve centers in a totally different manner, causing aberration and convulsion, and death in a half hour or so, after the first symptoms are noticed.

The Germans made another vital

mistake in revealing this terrible weapon, the arsine bomb, to the allies, for these nations most assuredly never would have thought of using it otherwise. The mistake lies in the fact that while the Germans foisted this ghastly reality upon modern warfare, they have not the arsenic to pursue the course they have elected. They can employ this agent very seldom, making a hideous threat now and then, but not carrying it into a campaign such as they have done with the Flammenwerfer, or liquid fire.

The allies, on the other hand, have supplies of arsenic ore which are unlimited, so far as the possible needs of this conflict are concerned. They could manufacture in one year more than enough arsine bombs to kill every man, woman, and child in the whole of Germany and Austria-Hungary. An airplane can carry a sufficient number of glass-bottle bombs, filled with arsine under pressure, to make uninhabitable a town of five hundred inhabitants. This all in one trip. This is said advisedly; the inhabitants cannot protect themselves by masks or other devices as when fighting other fume enemies such as chlorine and sulphur dioxide, for there is no known substance which will absorb arsine, as lime absorbs chlorine.

With the "edge" which the coming air fleet of the United States will give to the allies, the arsine bombing of Essen-on-Ruhr, Potsdam, Zeebrügge, Wilhelmshaven, and other strongholds of Germany, should be an easy matter.

### CONCRETE FLOOR PROVES

#### 5146 ALMOST UNBREAKABLE

To the astonishment of many builders and engineers who witnessed the test, a portion of the sixth floor of a Chicago building of reinforced-concrete construction refused to give way recently under a load of over 1,000,000 lb. of pig iron. The test was undertaken in an effort to ascertain just what loads this type of construction could stand and it proved how remarkable is the supporting power of a thin

*Western Newspaper Bldg.  
Clinton & Adams Sts.  
Chicago, Ill.*

*Architect - James M. Cowen  
909 E. 4th St. Chicago, Ill.  
2007*



Left: Measuring the Stress on Steel Rods Imbedded in the Concrete. The Stress on Some of the Reinforcing Was 52,000 Pounds per Square Inch. Right: A View Showing Part of the 1,224,000 Pounds of Iron Piled on an Eight and One-Half Inch Concrete Floor in an Unsuccessful Effort to Break It

layer of reinforced concrete. The building, though less than 10 years old, is to be razed to make room for a larger one, and this fact gave an opportunity for the unusual demonstration.

The floor which bore the strain is 8½ in. thick and was built without girders, but strengthened by four-way reinforcing of round ⅝-*in.* rods of high-carbon steel. The pigs of iron were piled slowly on an area measuring 24 ft. 11 in. by 28 ft. 9 in. and supported beneath by nine pillars with caps 4½ ft. in diameter. The floor was designed for a load of 250 lb. per square foot and it was thought it would surely break under a weight of 800 lb. per square foot. But a total of 1,224,000 lb., or 910 lb. per square foot, failed to cause any serious signs of weakening, though the maximum sag was about one inch. From measurements of the stresses on the steel rods and the compression of the concrete it was estimated that 1,500 lb. per square foot would be required to break the floor.

One of the government's practical suggestions for war-time economy is that paraffin which has been used once be cleaned and saved instead of being thrown away. Sometimes the pieces can be cleaned with a brush and in other cases it is easier to strain them through cheesecloth after melting.

## TO KNIT OVER A MILLION

### 5112 ARTICLES FOR TARS

Tens of thousands of American women are wanted to help win the war by patriotic use of their knitting needles. Ten knitted articles are needed for each tar in our navy to keep him efficient and alert despite the bitterly cold blasts of the sea. The Comforts Committee of the Navy League is now engaged in getting the women of the country to fill what amounts to one of the biggest knitting orders on record. There are approximately 140,000 men on our battleships, cruisers, destroyers, etc., each of whom the committee proposes to supply with two helmets, such as is shown here, two woolen jackets, two mufflers, two pairs of socks, and two pairs of wristlets, making a total of nearly 1,500,000 knitted articles. The work is to be done by volunteers who will pay for the material which they use. Those who desire to help should write to the Navy League Comforts Committee in their respective states.



COPYRIGHT, UNDERWOOD & UNDERWOOD

### ARMLESS BOY PULLS CHILD FROM LAKE WITH TEETH

In Chicago there is a 17-year-old lad whose lack of arms is partly compensated by a game heart and a stanch back-



A Heroic Chicago Boy, Though Armless, Leaped into the Lake and Rescued a Drowning Child by Seizing the Latter's Clothing with His Teeth and Then Struggling Shoreward. Efforts to Revive the Child Proved Futile

bone. He proved his mettle a few weeks ago in a way that contributed something to the tradition of the American boy. There is inspiration in the story, and it not only deserves circulation, but is worthy of the thoughts of older fellows than John Curran, who swims with his legs only. A little youngster, eight years old, was playing with his small brother on a breakwater in Lake Michigan. When he toppled over and fell into the water, the other boy ran screaming to a near-by group of playmates. It was the armless chap, however, who faced the test. He raced to the edge of the breakwater, leaped into the lake, and swam to the place where the child appeared for the third time. Using his teeth, he grabbed the boy and struggled shoreward. Efforts to revive the little fellow proved futile and he died before an ambulance reached him. But the pluck of John Curran should live.

### MOWING-MACHINE TRACTOR IS CONVERTED ROADSTER

Four cylinders, even though they be small ones, are better than two horses when it comes to providing propulsion power for the big mowers used on golf courses. This, at least, is the verdict of the superintendent of grounds at a mid-western country club where the fairways and greens are kept in spick-and-span condition. By supplying the rear axle with a pair of broad-rimmed steel wheels and making certain modifications in the cooling system to provide proper circulation

of water when driving up and down steep inclines, the man has converted a light roadster into an efficient little tractor. It pulls a mowing machine at



For Keeping the Turf Short on a Mid-Western Golf Course, This Dressed-Up Roadster has Proved a Good Investment

an even speed, and accomplishes the work quickly and at low cost.

*Des Moines Country Club.  
Des Moines, Iowa.*

5129

## LIGHTS LEND NEW BEAUTY TO RECREATION SPOTS



New and Striking Beauty has been Given to the Famous Statue of Lincoln, Shown Above, at the South Entrance of Lincoln Park, Chicago, by Flood-Lighting It with Powerful Lamps. The Illumination Is Particularly Effective Because behind the Figure Is a Contrasting Wall of Living Green

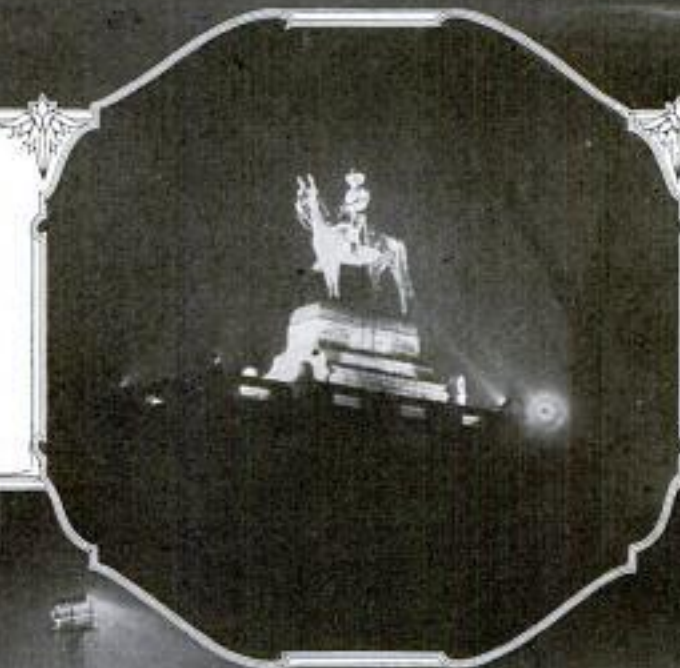

The Equestrian Statue of General Grant, Also in Lincoln Park, Chicago, has been Illuminated in an Equally Effective Manner by Concealing Lights about Its Base. Always Conspicuous on Account of Its Lofty Position beside a Popular Drive, It has Now Become Doubly so at Night



One of Two Steel Lighting Towers That have been Installed at One of Chicago's Bathing Beaches, Making This Recreation Center as Safe at Night as in the Daytime for the Thousands of Bathers Who Congregate There during Warm Weather: Each of the Towers is Equipped with Seven Parabolic Reflectors and 1,000-Watt Nitrogen Lamps Which Throw a Bright Light Far Out over the Water

### LONDONERS WARNED OF AIR RAIDS BY POLICE SIGNS

Traffic noises in London during the daytime drown the sounds of bugles



Policemen Wearing Sandwich Placards Race in London's Streets Blowing Their Whistles Loudly to Warn Pedestrians of an Approaching Air Raid

and sirens which are regularly employed at night to give warning of approaching aerial raids. Because of this, a new plan has been adopted. After a general signal, which consists of firing three bombs at intervals of 15 seconds, policemen equipped with sandwich placards bearing the legend, "Police Notice: Take Cover," hurry through the streets, some of them on bicycles, blowing their whistles loudly to attract the attention of pedestrians. In this way everyone is informed of the coming danger and given adequate chance to reach shelter before the swiftly flying raiders arrive overhead.

### PUBLIC SERVICE RESERVE FOR PATRIOTS AT HOME

One of the important official channels through which the men of the country not in the fighting forces can aid in the war is the United States Public Service Reserve which has been established under the direction of the Department of Labor. Adult males of all trades and professions are asked to enlist in this body. The purpose of the reserve is to make available for the country's good the varied abilities of the nation's men. Every member of the reserve fills out a blank which is kept on file in Washington, in which he states his occupation, his training, his fitness for various peaceful pursuits, his ability and willingness to change his location, etc. All these data are carefully classified at the capital, for as the war progresses, it seems certain that there will be much demand for variously

trained men to keep our economic forces at war strength. Every reserve member agrees to give unselfish consideration to any opportunity for patriotic service which this body may present to him. There is no compulsory feature in the organization.

### MODEL FACTORY BUILDING

#### 5094 IS LIGHT AND AIRY

To those who are intimately familiar with the sweatshops and fire traps in which thousands of city men and women are employed, a small manufacturing plant lately erected in one of the west-





The Exterior of the Factory is as Inviting as Many Residence Structures. The Well-Kept Lawn, Bright Flower Boxes, and Gay Poppy Beds Contribute Much to Its Attractiveness



Attractively Furnished Rest Room for Girl Employees Where They Often Gather for the Noon Hour: Adjoining Is a Modern Kitchen Equipped with an Electric Range

Left: Reference Books are Held in Open Portable Racks That at Night are Locked in the Vault

ern states would doubtless be a complete revelation. The building is a one-story structure of tile and concrete and is generously provided on all sides with spacious windows that flood the interior with air and sunlight. Instead of dark, forbidding walls, the exterior is finished in white. At each window there is a flower box, and spaced at intervals are trellises that in time will support green vines. The factory is surrounded by open ground and faces a well-kept lawn. Glass partitions, white walls and ceilings make all parts of the interior equally light and attractive. There is no place for dirt or papers to accumulate in the business office, which is situated at the left of the front entrance. Open racks fitted with shelves and mounted on rubber-tired wheels hold the company books that are subject to daily reference. When placed end to end, they form a counter across one part of the room during office hours, and at night are pushed into a large vault. For women employees, a rest room equipped with a

kitchenette is provided. It is furnished with plain, comfortable things and enables those who wish to do so to prepare warm drinks at luncheon time.

#### AUTOMOBILE TIRE PUMP

#### 4449 WITH DOUBLE ACTION

A tire pump just being put on the market has a single cylinder, but is double-acting, air being forced into the tire on the upstroke as well as on the downward stroke, thus saving time and labor. Air is taken into the cylinder through a small hole in the piston rod, just under the handle, and the construction prevents any of the air escaping except into the tire. No leather is used for valves or packing.



Double Action Tire Pump Co  
Lynchburg, Va



Submarine Scenes Painted under Water: The One on the Left Shows a Stately Kelp Grove Rising from Glistening White Sea Sand. The Right-Hand Canvas Shows Coral-Eating Fish of the Chaetodon Species and was Painted off Tahiti in the South Pacific

## PAINTINGS EXECUTED UNDER THE WAVES

By ROBERT H. MOULTON

**A** DISTINGUISHED American artist devotes his life to painting pictures under water. He holds that it is impossible to catch the colors and what may be called the atmosphere of submarine scenery by any method of observation from the surface. He goes down to the bottom of the ocean wearing water-tight goggles, similar to those worn by the famous pearl divers of the South Seas. These goggles are merely bits of cowhorn cut and shaped to



Mountains of Coral at the Bottom of the Sea: A Striking Painting Which Shows That the Beauties of the Deep Rival Those Found on Land

fit the eyes. They allow a small space of air between the eyes and the water, so that one can see perfectly. He uses a weight to carry him to the bottom, where he makes sketches on a specially prepared waterproof paper with waterproof crayons. The paper is first rubbed with coconut oil and stretched on a piece of glass with surgeon's tape. After several descents, each for about a minute or so, he gets his pictures outlined and then completes them in his studio.

Under the water, the artist says, there are rivers, lakes, and waterfalls, just as there are above water. The gleaming sand, swept down by the action of tides, furnishes this illusion.

The finest work of this man has been done at Tahiti, one of the Society Islands, but he has secured excellent subjects off Santa Barbara. The coloring beneath the ocean, he avers, is all in the lowest keys, merging from deep indigo and purple into the lighter, more delicate tints

of pale greens, grays, and yellows. Every point, every sharp edge, shimmers like silver in the upper regions. Rocks and cliffs in the dim light assume an appearance of inconceivable size. On land we see the foundations of every object, no matter how large or small its bulk, but when one looks down into the depths of the huge coral formations under water they seem to be resting upon deep, blue air.

Although he can work at any reasonable depth, the artist prefers about 30 feet.



The Painter of Submarine Pictures in the Costume He Wears When Making His Sketches under Water: His Water-Tight Goggles, Similar to Those Worn by South Sea Pearl Fishers, are Suspended from His Neck

## OLD CUSTOMHOUSE REVEALS

### 512 EARLY BUILDING METHODS

That a massive structure like the customhouse in New Orleans, erected on planks and logs in marshy soil, could stand for almost three-quarters of a century without a crack of any character and remain today as substantial as when it was built, has caused modern engineers to marvel. Attention was recently called to the well-preserved condition of this historic structure when certain repairs were being made. The building's foundations rest on a plank floor, 7 ft. below the sidewalk, on which is a grillage of 12-in. logs covered with a layer of concrete

1 ft. thick. The erection of the customhouse was begun in 1848 and since that time it has sunk a foot or two, with one end slightly lower than the other, and yet the building has not suffered from this settling. Another proof of the superior character of its construction is the well-preserved roof. Workmen have removed its copper covering, revealing a great layer of southern yellow-pine sheathing in almost perfect condition.

⌈The new graving dock which is nearing completion at Point Levis, Quebec, is said to be the largest in the world, being 1,150 ft. long, 120 ft. wide, and 45 ft. deep.

no Card  
666

**GOING "OVER THE TOP" MADE EASIER FOR SOLDIERS**

Features which might come under the classification "all modern improve-



COPYRIGHT, HARRIS & EWING

View of a Training Trench Dug in This Country by a Corps of Engineers and Provided with Features That Help the Occupants to Make a Quick Leap toward the Enemy

ments" are to be found in the front-line type of trenches that have been dug for soldiers in training on the campus of an American school. The features in question are notches in the trench wall and pegs, or handholds, projecting from the ridge of the parapet. These are of material assistance in giving a quick start to the charging Sammys.

**WORLD'S SUPPLY OF MEAT SERIOUSLY DEPLETED**

In a few figures issued by the food administration in Washington is to be found one of the reasons for high meat prices. In comparing present with pre-war conditions a total decrease of over 115,000,000 in the number of the world's meat-producing animals is

shown. While the increase of cattle in the United States was 7,090,000 during this period, the total world decrease was over 28,000,000. Sheep decreased 3,000,000 in the United States and 54,500,000 in the world. Hogs increased 6,275,000 in this country, but the world's supply decreased 32,000,000, approximately. For the year ended June 30, 1916, our meat exports totaled 1,339,193,000 lb., whereas the average for the three years before the war was 493,000,000 lb. These exports have gone chiefly to our allies whose stock of animals has decreased by 33,000,000 head.

**TRUCK CONVERTS A ROCKER 4889 INTO A WHEEL CHAIR**

In the household where there is a feeble or convalescent person, an improved rocking-chair truck such as is shown here may often be used to great advantage. It can be easily placed beneath a rocking chair, converting the latter into an excellent substitute for a wheel chair. The truck consists of

An Improved Rocking-Chair Truck and a View Showing How, by Means of the Truck, a Rocker can be Converted into a Substitute for a Wheel Chair



two rubber-tired wheels connected by a drop frame of steel tubing which hangs down, close to the floor.

The Northampton Co.  
Elyria, Ohio

Copyrighted material



Landing a 15-Foot Shark on the Beach at Santa Monica, California: This Creature Is Especially Valuable Because of the Oil Obtainable from It

### FISHERMEN FIND SHARKS

#### 5056 PROFITABLE CATCH

Shark fishing has evolved from a sport to an organized industry in the Pacific waters off the southwestern coast. The skin of various species of the fish when tanned forms a tough, durable leather that is in considerable demand, and the oil that is extracted from the carcass likewise has commercial value. Of late a Japanese syndicate has undertaken the exploitation of this long-neglected field and, as a result, large numbers of sharks are being captured. The mottled skins of the tiger sharks are being made into slippers, belts, gloves, and other articles, while those of the great blue and basking sharks, which are especially thick and strong, are used for purposes that demand long-lived material.

### IMPROVED TRAP WITH KEY

#### 2551 FOR CATCH BASINS

By inventing a sewer trap with a removable key for catch basins, a contractor has provided an improved feature in sewer construction that enables workmen to clean a clogged outlet



A Shark Caught in a Halibut Net: Such a Catch is Now Welcomed by the Fishermen Who No Longer Consider It Valueless

quickly without descending into the catch basin or tearing away any part of it. Extending inward from the side of the sewage reservoir just above the outlet is a wall, or shelf, whose inner edge rests on a vertical wall that extends downward a short distance below the water level and rests on a cross-bar set in the curved basin wall. The

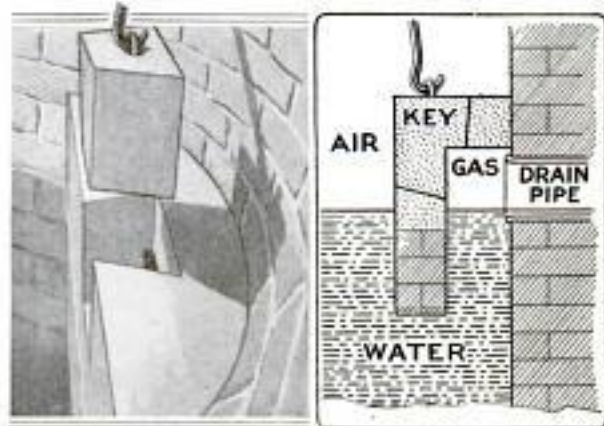

Catch Basin with Patented Trap, Showing the Cement Key That can be Removed to Give Access to the Outlet Pipe

*J. Schulerberg-*

*106 Oak ave. River Forest, Ill.*

trap so formed for the discharge pipe is provided with a removable cement block, or key, that fits in a key seat directly opposite the opening. Projecting from it is an eyelet, and whenever the outlet becomes clogged, a workman can get at the pipe by inserting a hooked pole into the basin and withdrawing the key. Then, with the aid of a hollow guide, he can force a sewer rod into the pipe and remove the obstruction. On completing the task the key is replaced. In this way the practice of breaking away the trap wall is made unnecessary.

5109 **ROMANTIC STORY IS ADDED  
TO LORE OF ITALY'S FLAG**

When the Italian forces made their superb attack upon the Austrian positions and triumphantly captured Monte Santo last August, a picturesque scene was enacted that contributes a romantic story to the history of the national emblem. Three columns, operating

from different points, combined in carrying out the remarkable assault. Before the actual advance was begun, an Italian flag—which consists of three broad vertical stripes of green, white, and red—was cut into three pieces and one of the colors given to the leader of each column. When the forces, after a bitter, terrible struggle, met at the summit of the mountain from which they had routed the enemy, the three parts of the tricolor were sewed together and the standard unfurled above the ruins of an Austrian church. This announced the Italian victory to troops occupying Monte Sabotino and surrounding heights. When the restored flag was sighted, the cheering of the soldiers echoed for miles through the mountains.

CA certain factory has succeeded in deadening the noise made by trucks running over a cement floor by covering it with heavy tar paper, laid with cement paint.



It Was above the Standing Wall, at the Right, That Italy's Mended Standard was Unfurled to Announce the Triumphant Capture of Monte Santo. The Picture Shows the Ruins of the Austrian Church That Was the Scene of the Flag Romance

**GIRLS STUDY TELEGRAPHY AIDED BY TINY TRAINS**



Demonstrating to Women Telegraph Students the Operation of a Railway Signal



A Pupil Engaged in the Equivalent of Actual Railway Work on a Two-Track Line



Girls Engaged in Preparatory Work Which Consists in Learning the Morse Code and in Acquiring Facility in Sending and Receiving Messages

4988  
 Tiny electric-railway trains, running on tracks provided with switches and block signals that duplicate actual railroad equipment, are among the first features to attract attention in the Pennsylvania Railroad System's school of telegraphy which it has recently transferred to Philadelphia. A course has been opened for women and girls, as well as men, and already there is a large number of

applicants. After the pupils have learned the Morse code and attained some proficiency with a telegraph key and sounder, they are given practical experience as block operators on the miniature railway, receiving orders from a dispatcher just as if they were in actual service. On completing the training, which occupies six to eight months, the pupil is assured of a position with the road.

**CINDER CONVEYOR CLEARS ENGINE ASH PIT**

444  
 Several railroads have adopted a new method of clearing out the pits into which firemen dump the ashes of locomotives after a run. The scheme is simple and economical. A strong metal frame, about 20 feet high, is erected near by, along a track on which an ordinary dump car may run. A three-track incline runs from the top of the frame down into the ash pit, and a small car attached to a pulley, with a counterweight, is run down the incline into the pit, where it receives the ashes as

they are raked down by the fireman. It is then pulled up the incline over the dump car, and the middle rail, ending abruptly, opens a door in the bottom of the pulley car, permitting its load to drop.



The Small Car on the Incline Runs Down into the Ash Pit beneath the Railroad Track at the Left, and There Receives the Ashes from a Locomotive, Hoists and Dumps Them into the Waiting Gondola

Owned by Venice Calif. Abbott-Finney Co. Venice Calif

670

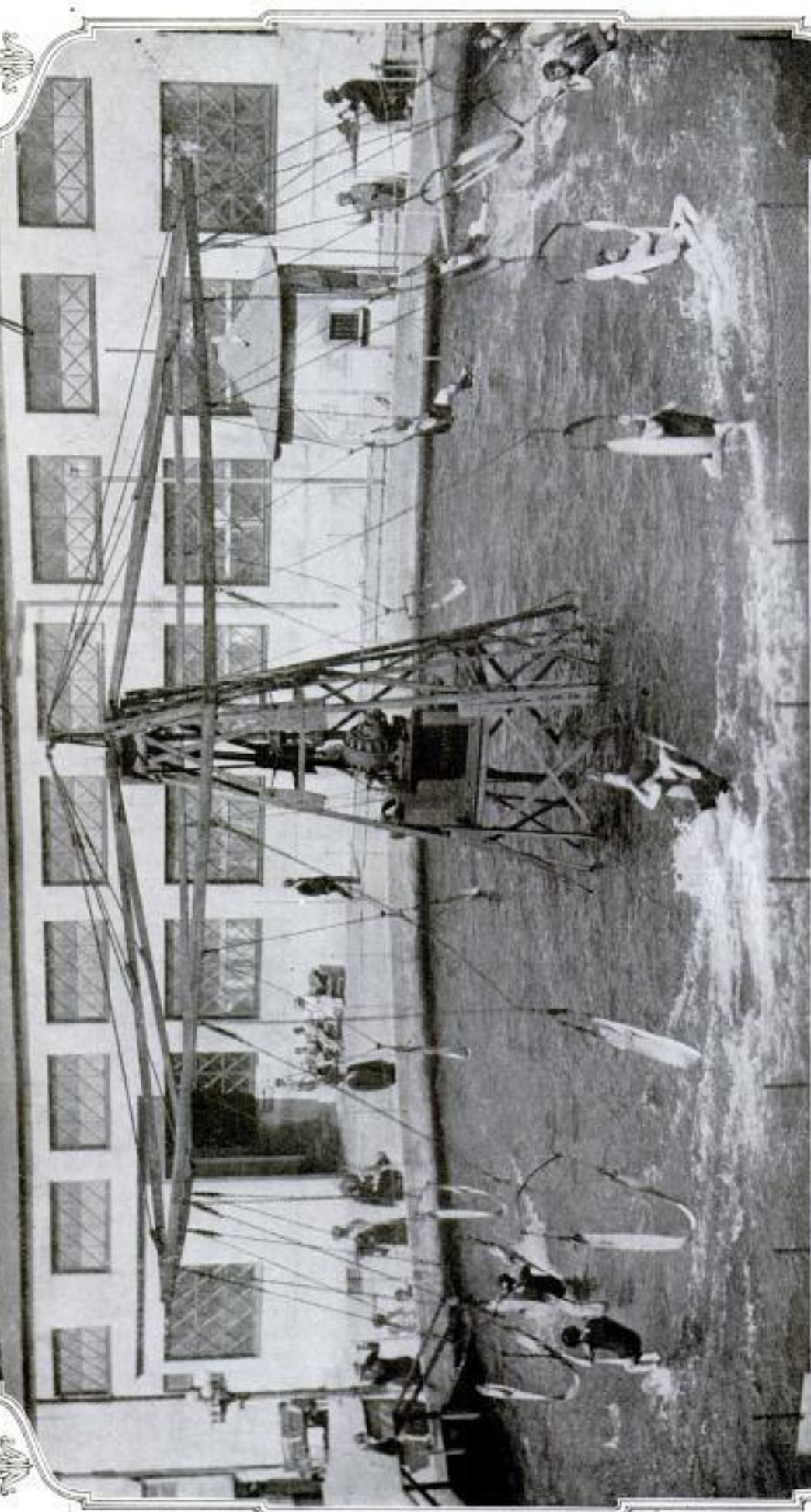

**BATHERS GET NEW THRILLS IN WHIRLING SEA SWING**  
IT is a far cry from the "old swimming hole" to this modern bathing pool with its mechanical means of entertainment. The rough spring board has given place to a motor-driven sea swing, in this instance. As the big wheel begins to move, the occupants of the swings attached to its circumference are splashed from head to foot, but presently they are swung far out to one side, above the water. The next instant, perhaps, they are plunged again into the pool by the slackening of the wheel's speed.



5155 **ARTIFICIAL FLOOD USED  
TO MOVE COAL BARGES**

Twelve thousand tons of coal were brought down the Ohio River last summer by a fleet of barges which were floated on the crest of an "artificial flood." Never before in August had such an event taken place on the Ohio, and it happened only because one man stepped in to aid nature in the undertaking. The Ohio River is always at extremely low water around the month of August, and boats drawing much more than a couple of feet of water normally are tied up.

But the United States Army Engineering Corps, wishing to demonstrate the supreme value of the river as an artery of traffic in war time, stepped in with an illuminating demonstration of what can be done even in the weeks of scant flow. Dams holding back pools along the Big Sandy, the Kanawha, and the upper Ohio rivers were opened a few weeks ago and surplus water was allowed to run out. An artificial crest of from three to six feet was formed, and on the crest, snub-nosed argosies carried the fuel so urgently needed. Without the presence of the dams which the government has already completed, this movement could not have been made.

5039 **NEW OILCAN HAS TWO  
COMPARTMENTS**

A dual compartment in which a lubricant and gasoline, or other liquids, may be contained separately, is provided in a disk-shaped oilcan that has lately been invented. A pair of spouts, or one spout and a plug that may be used interchangeably, is supplied. It is conceivable that

the device would prove a convenience to many workmen.

4267 **CARRIER ON INCLINE USED  
TO ADVANTAGE BY BUILDER**

A contractor effected a considerable saving of labor in handling building material for a large structure, by employing a simply devised carrier that operated on an incline of about 25°. The car was made by

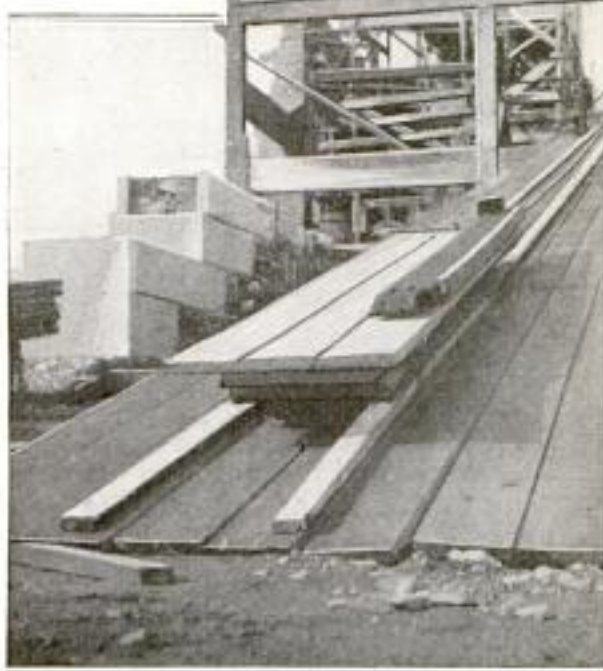

Simple Carrier Made by Mounting a Platform on Two Dollies: It was Operated by a Hoisting Engine and Elevated Three Wheelbarrow Loads of Mortar at a Time, as Well as Heavy Steel Girders

mounting a plank platform on two dollies and was drawn up the incline by the same engine that operated the brick hoist. It descended by its own weight. Two-by-fours were spiked down on the inclines to serve as a guide for the car. Roof trusses weighing 3,000 lb. were easily carried up by this means, and later in the course of construction, the carrier was used to take up three wheelbarrow loads of mortar at a time.

As a part of the special uniform for American sailors on submarines, submarine chasers, and other craft where the men will be much exposed, the Navy Department has purchased 200,000 wind-proof shirts, costing \$2.52 each.

H. J. Dunn,  
47 Kingsbury Road  
Erdington, Birmingham England.

Sw: A. E. Ornd  
1721 Newitt Ave - Everett, Wash.

672

## POPULAR MECHANICS

### NEW FEATURES IN DINING

### 5016 OUTFIT FOR AUTOS

A combined dining and kitchen outfit has been built to be carried on the



A View Showing Two Combination Dining and Kitchen Outfits: One is in Place on the Running Board While the Other is Opened Up Showing the Complete Equipment

running board of an automobile and in several respects is different from other devices of similar purpose now

on the market. When packed, it measures 12 by 24 by 28 in. It consists of a cabinet of enameled metal inclosed in a wooden case. The sides of the latter are hinged at the top, and on being drawn into a horizontal position form a table measuring 2 by 5 ft. The case is divided into numerous compartments, the lowest of which contains a collapsible stove, a coffeepot, a skillet, and a pan in which the table dishes are packed. Above this space are partitions for containing four jars, two bottles, and provisions. In addition, there is a tin food box, 9 by 9 by 12 in., and, at the top, space for five folding camp chairs. The entire outfit weighs but

40 lb., and when packed is so arranged that there is no rattling. Only a moment is required to set it up.

### 4907 HINGED PLUMB AND LEVEL FOR RAPID COMPUTING

An instrument with which a variety of trigonometrical calculations can be made is a combined plumb and level, the principal parts of which are two 24-in. stocks hinged together and having scales on adjoining edges. If the two stocks are separated somewhat, as shown in the illustration, the instrument

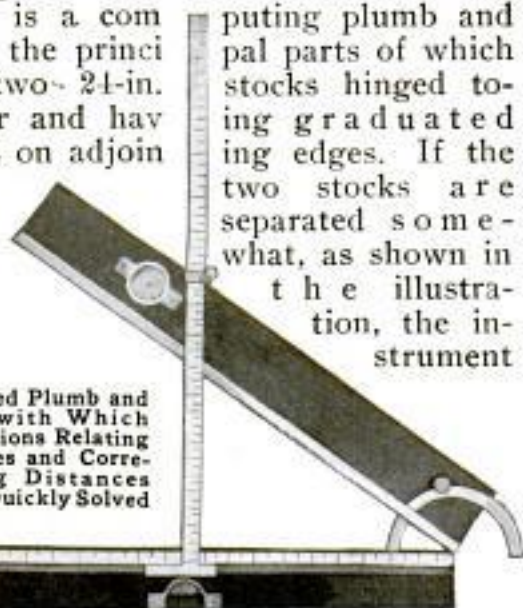

Combined Plumb and Level with Which Calculations Relating to Angles and Corresponding Distances can be Quickly Solved

may be described as resembling a letter "A" lying on its side. The upper leg is the plumb stock and the lower one the level stock. Corresponding to the cross arm of the "A" is a 24-in. rule that stands at 90° to the level stock and can be slid back and forth on it. It passes through a sliding attachment on the plumb stock. Attached to the hinged end of the level is a graduated metal semicircle which passes through a slot in the other arm. In each stock is a gravitating plumb, that in the upper arm registering from horizontal to 90°, and that in the lower arm, or level, registering from level to 10°. By referring to the various graduations a variety of problems relating to angles and corresponding distances can be quickly solved. The instrument is particularly convenient for builders because it can be folded up and packed in small space.

Sw: E. J. Jones  
Baton Rouge, La.



A Battery of Adding Machines Which Automatically Handle a Railroad's Record Cards, Making It Possible to Ascertain in Very Brief Time Such Items as the Total Weight of Certain Commodities Shipped between Two Given Points

5079

## ANSWERING RAILROAD QUESTIONS BY MACHINERY

TO many persons it may be a source of wonder how a railroad company is able to answer isolated questions such as the amount of freight shipped in a year's time from one town on the line to some other town miles away or tell the individual amounts of scores of commodities handled in a specified period. The growth of the powers of the Interstate Commerce Commission and the creation of railway commissions in the several states have resulted in demand upon the railroads for answers to all sorts of inquiries. Because of the complexity of railroad affairs the information no longer can be carefully pieced together out of station reports as was the case

years ago. The Union Pacific Railroad maintains for this purpose a system whereby almost any question arising in the auditor's office can be satisfied in a very short time without access to books or the detailed statements sent in by the freight agents along the route. The work is done by machinery and the answers are found practically automatically.

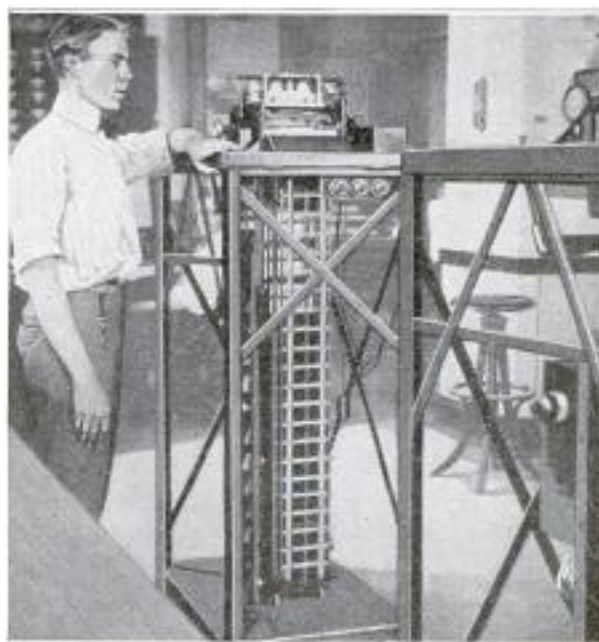

Sorting Machine Which Separates the Perforated Record Cards According to Any One of Numerous Classifications

When the daily statements arrive at headquarters from the various stations every item represented on the report is transferred to a card by means of punched holes. The cards are covered with hundreds of numbers in columns. Each station on the line has a number, and so, by punching out

certain figures, the station from which the goods were shipped, as well as the station to which they are consigned, may be represented. Punching out fig-

One of the Cards Which Form Permanent Records of Every Item of Freight Shipment

ures in other columns indicates the kind of commodity, weight, revenue, day of month and year, class of traffic, or other information.

From thousands of cards of this sort any information may be obtained. For instance, it is desired to know the amount of freight shipped from one station to another in a certain length of time. Apparently it would be an endless task, but in reality it is simple. The cards are run through a sorting machine which automatically picks out all the cards representing freight shipped to the first station. The sorting machine is set to operate in a particular column and distributes the cards in pockets according to the position of the punched holes. Then the cards are again sorted to separate those representing the freight coming from the second station. Either part of the work may be done first. In practical use the operations are carried out on a much larger scale and the individual station cards all sorted out at one time.

The next step simply consists in putting the assorted cards through an adding machine which, according to the way the figures are punched out on other parts of the cards, adds the total weight and revenue derived from business between the two stations. By similar methods the cards may be sorted out to represent any day, month,

or kind of commodity—in fact, any detailed question relating to the handling of freight for any period. The desired information may thus be obtained in a short time, whereas under the old plan it would be almost an endless task.

## MOVIES SENT TO RUSSIA TO 5218 HELP WIN THE WAR

Motion pictures are to be used on a vast scale in Russia in a campaign which, it is believed, will greatly aid the allies' cause. Because filmed drama can be understood by people of all languages it is being used to carry a message of inspiration and reassurance from this country to Russia's millions, many of whom are illiterate. A scenario has been prepared and produced and 50 copies of the picture, with all captions in Russian, have been dispatched to Russia. The film aims to show the Muscovites that they have been misled in so far as they feel that the United States is not in earnest in this war. The scenes depict the experiences of a typical Russian peasant who comes to this country to see for himself its resources and to ascertain its purposes. Ivan, as he is called, visits Pittsburgh steel mills and Detroit aeroplane factories, he watches Secretary McAdoo sign a warrant for a loan of \$100,000,000 to Russia, and he has a glimpse of the \$7,000,000,000 in gold bullion in the subtreasury in New York, awaiting war use. Motion-picture theaters are scattered all through Russia, many of them in small villages and at the front. It is proposed to show these pictures in every amusement center within the next few months.

## STEAM ENGINE PULLS TRAIN 4053 OF LOG SLEDS OVER SNOW

Those who are familiar with the history of the steam engine will recall that the first locomotive was operated on an ordinary highway. In this connection it is interesting to note that an engine is being used in a Wisconsin lumber camp during the winter months to

*J. H. Keckley Lbr. & Mfg. Co.*

*Antigo, Wisconsin*



With Creeper Treads and Forward Runners, This Steam Locomotive Makes Six or Seven Miles an Hour While Pulling 15 Heavily Loaded Sleds over Snow-Packed Roads

haul a train of logging sleds over snow and ice. The forward truck of this tractor consists of a pair of steel-clad runners. The driving is accomplished through a creeper tread. When pulling a string of 15 loaded sleds, the engine maintains a speed of six or seven miles an hour. In service it has proved economical. A crew of four men, consisting of a steersman, engineer, fireman, and brakeman, is adequate for its operation. The scarcity of timber in the district is continually increasing the length of hauls and lessening the practicability of constructing tracks for logging trains. Reduction of transportation costs is therefore necessary for the profitable exploitation of the remaining timber. The "steam sled" outfit is doing this satisfactorily during the three or four months the snow-covered roads permit heavy traffic.

#### SERVICE AND CONVENIENCE IN SHOE-SHINING OUTFIT

New equipment for the bootblack is being introduced which is manifestly superior, from the patron's viewpoint at least, to paraphernalia in common use. The stand is supplied with adjustable chairs and foot rests that eliminate the gymnastics usually required when one climbs to and from the seats.

The foot rests are out of the way and the chair lowered to a natural height when a customer steps on a nine-inch platform and seats himself. The operator elevates the chair the desired degree by actuating a lever, and adjusts the pedals to a convenient position. Revolving brushes driven through flexible shafts by an electric motor replace rags and manual brushes. For polish-



Adjustable Chairs, Disappearing Foot Rests, and Electric-Driven Brushes Are Outstanding Features of This Shoe-Shining Outfit

H. & H. Mfg. Co.

Edgen. Ill.

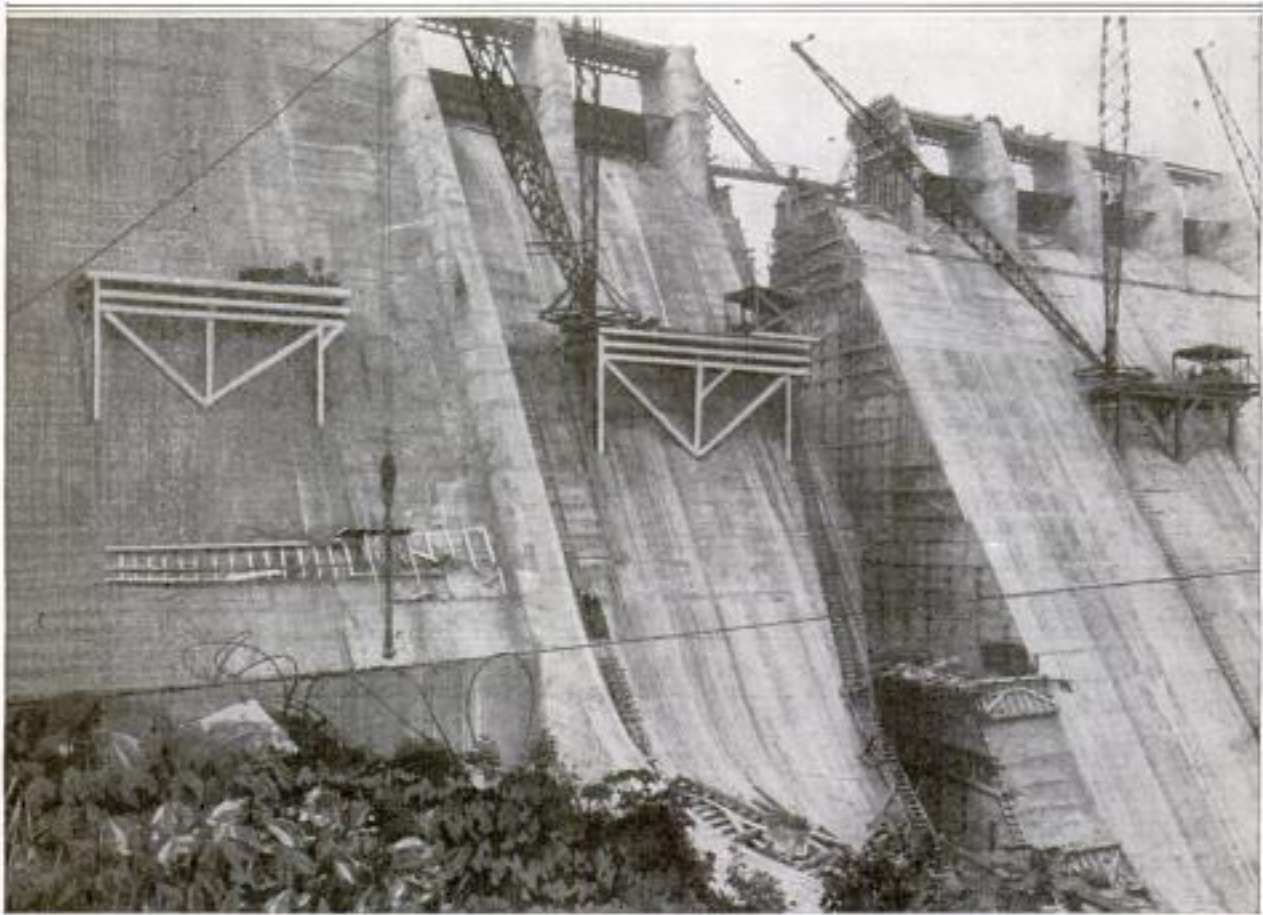

Close View of the Hydroelectric Power Dam on the Yadkin River near Whitney, North Carolina: Its of Which are Shown Here. Building Material was Brought within Reach of the Derricks on Flat Cars

ing, a special yarn brush is employed. In this way all parts of a shoe, instead of merely those easy of access, are polished evenly. The brushes remove dirt from the crevices in the leather, instead of rubbing it in, and leave the

shoes perfectly dry. Their effect on the feet is not unlike that of an electric vibrator and the operation is therefore a restful, pleasing one even to those who have corns that occasionally cause them to avoid bootblacks.

## FIFTY DERRICKS EMPLOYED IN BUILDING BIG DAM

515 For several reasons widespread interest attaches to the big dam which is now nearing completion on the Yadkin River just below Whitney, N. C. Many who have studied the fuel resources of the Southeast believe that the building of this immense structure, together with a hydroelectric plant, points to the day when the fuel problem, at least in this region, will be solved by similarly utilizing other waterways. The plant will generate an average of 45,000 kilowatts, or about 60,000 horsepower.

The methods of construction employed by the engineers greatly ex-

pedited the work. No less than 50 derricks, each with a lifting capacity of 25 tons, were utilized all at one time in hoisting material from a network of railroad tracks laid as close as the available space would permit. The derricks were at first stationed at the base of the dam and then lifted to higher ledges as the work progressed. Material was brought within their reach on flat cars of 100,000-lb. capacity. The massive curved wall is 1,300 ft. long, 220 ft. high, 160 ft. thick at the base, and 20 ft. thick at the crest. When the reservoir is filled, the water will cover 5,000 acres. The cost of

*Yadkin Dam, Whitney, N.C.*

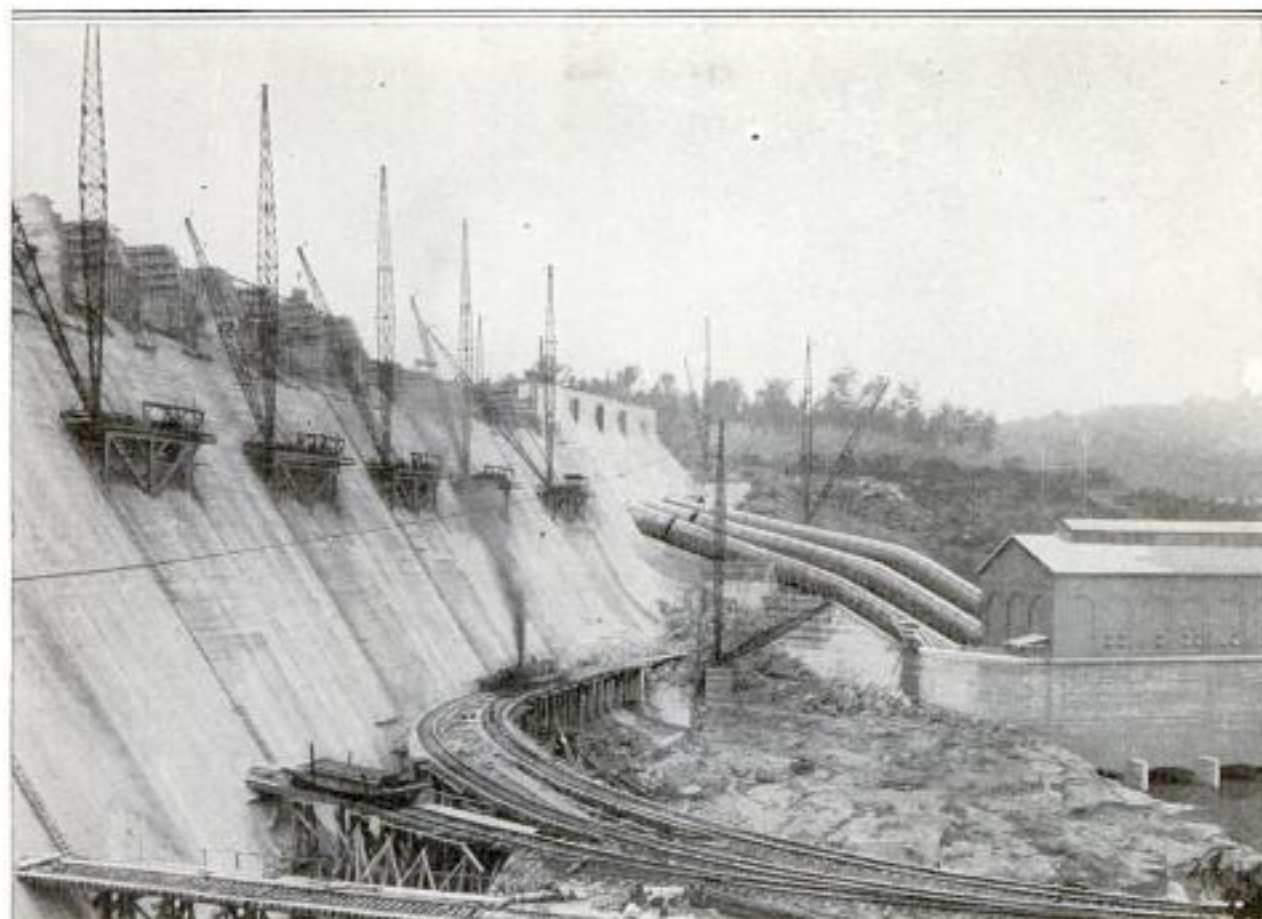

Construction was Greatly Expedited by the Use of 50 Derricks of 25-Tons' Lifting Capacity Each, Some Capable of Carrying 100,000 Pounds Each. The Power Plant will Generate an Average of 45,000 Kilowatts

the structure, including that of the electrical installation, will be \$10,000,000. The order for the cement used in the dam was one of the largest on record, it is said. The dam is of Cyclopean concrete, rocks ranging up to sizes

weighing 15 tons being imbedded in the great broad-based wall which stretches across the valley at a point where it is comparatively narrow. Four years have been required in building it.

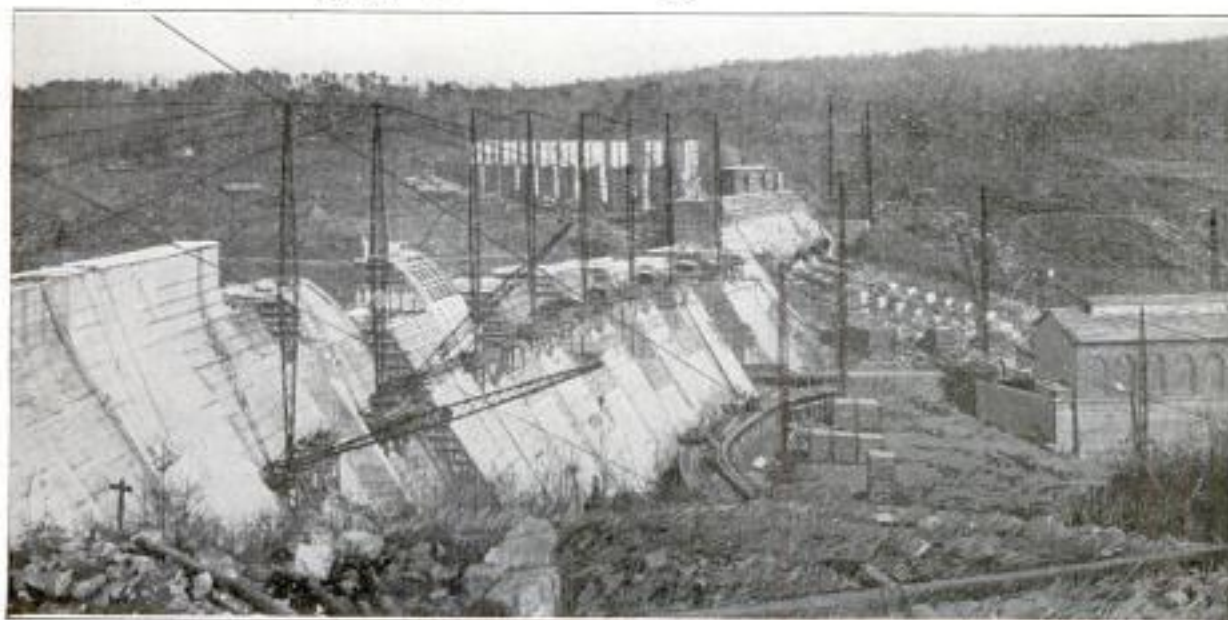

General View of the Dam Which Is 1,300 Feet Long and Has a Maximum Height of 220 Feet: When Filled, the Reservoir Which It Creates will Cover 5,000 Acres

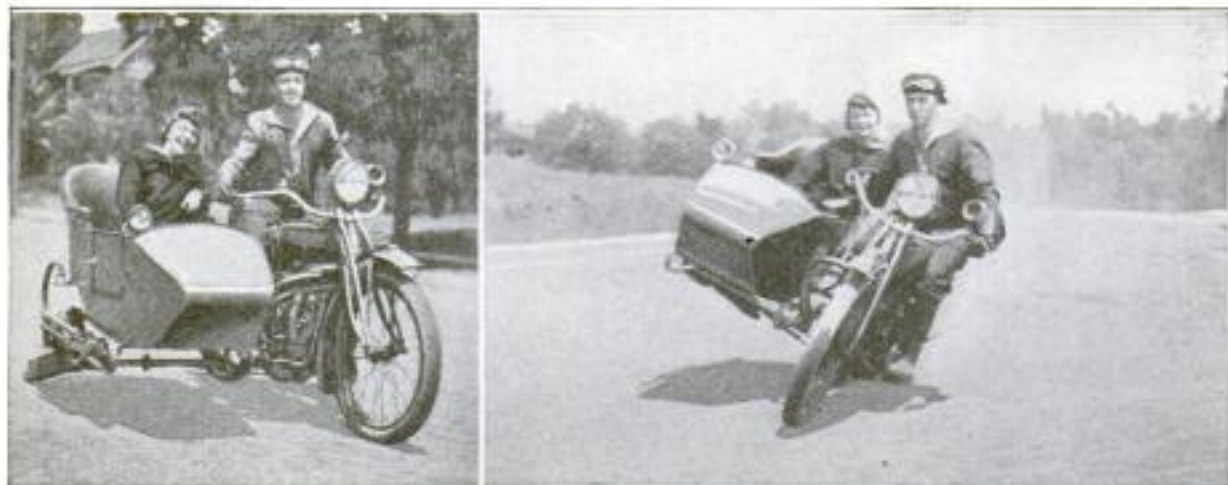

At the Left the Drag is Shown in Place and the Sidecar Supported at Its Normal Height. This Enabled a Quick Start. The Other Picture Explains How the 25-Mile Trip was Made with the Vehicle Balanced

### CHILEAN SUBMARINES READY

#### 5233 FOR FINAL TESTS

Submarines that have been under construction at the Charlestown, Mass., Navy Yard for the Chilean government are now completed and ready to make the journey to their home ports. A few weeks ago the vessels passed through the Cape Cod Canal en route to New London, Conn., where they were to be given their final tests.



COPYRIGHT, INTERNATIONAL FILM SERVICE

One of the Submarines Lately Constructed in This Country for the Chilean Navy. Passing through Cape Cod Canal before Undergoing Its Final Tests

### LOST WHEEL FAILS TO STOP

#### 5163 SIDECAR TOUR

When a motor truck skidded and smashed the wheel of a passing sidecar, the cyclist and his passenger, some 25 miles from their destination, did not abandon the tour. The broken wheel was removed and a drag constructed. With it in place, the sidecar was supported so that a start could be made. It is an easy matter to throw a motorcycle and sidecar into an inclined position by attaining a fair rate of speed and turning the front wheel quickly to the right so that centrifugal force tilts the machine in the opposite direction. Then by aligning the wheel, it is possible to travel straight ahead with the vehicle balanced and the sidecar wheel raised a foot or so above the road. The motorcyclist employed this scheme and elevated the sidecar until the drag was free from the ground. Maintaining a speed of from 25 to 30 miles an hour, he completed the trip, even negotiating curves with the outfit balanced. The distance was covered in schedule time without difficulty.

It is reported that submarines are now being built without periscopes, a system of two lenses, one on either side of the vessel, being used instead. While such a device is more difficult to discern from a distance, it requires the submerged craft to travel nearer to the surface of the water.



# COMMENT AND REVIEW

**O**UR feeling of abhorrence toward a nation which has cast aside all the traditions of civilized warfare, that puts arsenic in wells, that places ground glass in food, that hurls broadcast disease germs for man and beast, that hands out poisoned candy to trusting children, that intentionally bombs hospitals filled with sick and dying, that tortures its prisoners of war, that marches its school children with waving flags on a special national holiday when a "Lusitania" filled with helpless women and children goes down—this feeling does not apply to those who themselves, or whose parents, though born in Germany, are loyal, true Americans.

## No Middle Road

Special honor to all those who have already volunteered to fight under the Stars and Stripes to rebuke such wrong, or who have taken a pronounced stand against such iniquity! It remains, however, for many others who call themselves German-Americans, to come out squarely and unmistakably, and thus render impossible any suspicion of disloyalty. The resident here of whatever foreign descent owes it to the country of which he is voluntarily a citizen, and to himself, to do this. If he cannot do this, he should either return to that other country whose citizenship he places above ours, or expect here the same treatment which his preferred foreign country is accustomed to administer in such cases.



**L**IKE the mighty giant that it is, the United States is awakening from its long slumber and rousing itself to action, although in some respects it may be said to be just rubbing its eyes. The past 40 days have visualized more of what is being accomplished than the previous five months. Vast camps, each with a soldier population of large cities, have sprung into being like magic, and have been populated almost between sunrise and sunset. Officers and men in uniform are seen on every street, trains loaded with troops are moving with precision and promptness; nearly a million men are busy with intense training. While a modern soldier cannot be made in a day, it may be said in all modesty, because true, that the transformation worked in men with only three weeks' training, is remarkable. This is because the young American puts his whole soul into his work. In the officers' training camps, men who 20 days ago sat in comfortable office chairs or lounged in fashionable clubs, are making their practice hike of 20 and even 30 miles a day and returning at dusk to put in two or three hours hard study before bed.

## Making an Army

As I write, the stirring notes of a large marine band are heard as hundreds of naval recruits in white uniforms drill on their lake-front camp grounds, across the street. An hour ago, a full thousand of militia—not long back from the Mexican border—passed in heavy marching order, going—somewhere; but that somewhere will find every man ready, resourceful, and intrepid. Such is the material out of which the American army is being formed. An army which can be depended on to give a good account of itself—an army of which we are all proud.



**I**T is fitting that we should cheer the boys as they go forth to camp and front, but there is a no less important work for all of us who remain. The very spirit of freedom of personal belief and action which brought this nation into being, and preserved it through more than a century, has had the inevitable result of making us too easy-going and tolerant of many things. What if the man who fled his own country, or came here to secure for himself and family the advantages his fatherland denied them, did speak with disrespect and even contempt of this free land of his choice? His was only one voice in a multitude, and so, what did it matter? The melting pot would eventually refine him and

## The Test of Loyalty

eliminate the dross. That attitude, though wholly wrong in ordinary times, becomes criminal in days like these. Moreover, the giant is beginning to rub his eyes and discover that the voice comes not from unrefined metal, but from pure dross, and when organized by years of skillful propaganda, and fostered by foreign gold, creates a condition which as yet is not realized. It seems repugnant to question the sincerity and motives of those living in the same block, with whom we ride to and from our daily work, who have been even respected citizens in our own community. The Belgians and French and English in whose homes and schools and offices German spies by thousands had been living and serving acceptably for years, once indignantly repudiated any thought of insincerity. They have since learned their bitter lesson, and are we also to learn our lesson by the same costly method, or shall we profit by their experience?

Is it conceivable that the hundreds of incendiary fires and bombs in factories and harbors; the inspired strikes in all parts of the land; the concealed and open hostility to all efforts properly to equip and defend ourselves during the past three years, were all due to special agents sent over here for the express purpose? Or was it part of the same insidious world-wide spy system which in a time of peace honeycombed the departments of national government in every land, reaching in its audacity and insolence even to the spending of money in the attempt to bribe our own Congress?

There can be but one answer; and there should be but one treatment of the evil.

We will have to awaken to the danger which lurketh in darkness, and in self-protection nerve ourselves to the extreme, drastic punishment which all nations, in all times, have meted out to the traitor and spy—death. Are we prepared as individuals and communities to do this; is public sentiment strong enough to commend and uphold the government when it shall take your next-door neighbor red-handed in assistance to the enemy, and a court-martial having unquestionably established his guilt, sentence him to the firing squad; what will be your position in such a case? Is your love of your country, whom the convicted one has tried to destroy and done his bit to deliver into the hands of the enemy, strong enough for you to say "Amen," or will you weaken and plead immunity "in this one case"?

Thousands who read these words have, with sad yet glad hearts, parted with sons and brothers and relatives who have begun their journey to the front. There they will face bullets and shells and poison gases. Shall you and I, at home, be any less brave in exacting the extreme penalty on those who are fighting our boys, not face to face as soldiers, but through the most cowardly and insidious methods behind their backs?

There is no danger of misjudging anyone, for there is now no middle ground—either you are an American to your last drop of blood or you are not.

The giant is rubbing his eyes; you can by your own pronounced expression do your bit to fully open those eyes.



**E**VENTS have already given several severe shocks to our fancied security, but we are still, many of us, reassuring ourselves with the thought that it was the ambitions of the kaiser and the power lust of Prussian officers, who

*Do the  
Germans  
Want  
Democracy?*

dragged the German people and the world into the present hell on earth. As a result of hasty or careless thinking, or lack of thinking in the past, we have already had our confidence in many German ideals shaken and shattered. The intrigues with Russia; the attempts to involve us with friendly nations—Japan and Mexico—will suggest others. Are we sure, or does the belief merely express a hope, that the German people have no heart in this war and the scheme of world domination? In short, do the Germans really want democracy, or is it only that we want it for them? A good deal is made of the ambitions of the socialist party in Germany, but what of their strength? So far, reports chiefly have to deal with socialists being pushed out on the firing line as fast as recognized.

The scratch made in the sapling becomes a great scar in the tree of four decades; the grooves cut in rock by the slowly moving glacier withstand the sun and frost and rain of centuries; a child steps on the newly laid cement and the imprint remains for years. What then of the effect upon an entire nation, where the school and pulpit and controlled press teach but one thing, and that continuously from the cradle to the grave, "Germany over all," and that other "Might makes right"? As we are by nature quick of eye and limb and speech, so too are we liable to be hasty in thought, and with a wish of only good to all the world, we may easily ascribe to a foreign nation a conscience which it does not know.

It matters not who the offender may be—the man who for a price becomes the incendiary of munition works, or the man who by public speech or in public print, becomes an incendiary of patriotism, loyalty, and national morals; who incites insurrection, high or low; whatever his position or degree, he who by word or deed would betray the country becomes a traitor, and should die the traitor's death.



**W**HY does Germany want peace? Is it because she is starving? Though short on some foods, and many luxuries, there is no sound basis to expect she will fail through famine.

*No Peace  
until  
Lasting  
Peace*

Is it for want of materials with which to fashion ammunition? The stores of ammunition piled up during many years in preparation for this war have been exhausted, but in the meantime vast ammunition works have been developed with the well-known German efficiency.

Is it on account of men? Germany has yet millions of her own subjects, and can conscript millions more in Austria, Turkey, Roumania, Serbia, and the other small countries.

Germany adroitly sets in motion peace terms which are sent to her and the allies, because Germany has now possession of, and administration over, a territory amounting to nine-tenths of the territory which she determined in 1905 should be her prize in this war. That territory stretches unbroken from Hamburg to the Persian Gulf. The other one-tenth is not worth fighting for—now. With this vast territory in control, German officers in command of all their armies, German officers in their offices of state, peace only is required to weld the whole mass into a greater Germany. A few years of peace, of systematizing the subject countries, of cannon foundries and munition works piling up engines of war, of building air fleets and submarines, and intensive farming such as Germans know so well, and the menace to the world will be many fold greater than it was even in 1914. If this is a dream, it is no idle dream, but the carefully worked out plan which has been taught in German kindergartens for a generation.

H. H. WINDSOR.

September Twenty-fifth.



*Wm. Johnston, Builder  
Vesper, Oregon*

## PRIVATE CHURCH IS BUILT FOR LARGE FAMILY

5138 In a quiet, timbered spot easy of access, a man of devout tendencies has recently constructed a simple, attrac-



In This Little Chapel, Situated in a Clump of Trees on a Knoll Where Two Roads Meet, a Family of 33 Members Worships in Private

tive little church where, with his sons, daughters, and grandchildren he listens to the words of a clergyman of his own choosing and worships in the privacy of his own family. The chapel was built during the past summer and the deed to the property turned over to the bishop who presided at the dedication services. The three generations embrace 33 individuals, 19 of whom are grandchildren. When the weather is enjoyable, the family gathers at the morning service and then joins in a picnic on the grounds until it is time for the evening meeting.

## HOW TO SEND CHRISTMAS GIFTS TO SOLDIERS

5267 As the holiday season approaches hundreds of thousands of Americans are planning to send gifts to the soldiers away from home and it is very important that the postal regulations and suggestions, especially regarding mail to our forces in Europe, be observed. Packages for members of our forces in England or France should be mailed six weeks before Christmas, if possible. They may not weigh over

20 lb. and are sent at the eighth-zone rate, which is 12 cents per pound. The contents are not subject to duty.

Special instructions are given about addressing mail to our soldiers in Europe. The first line of the address should contain the name and military rank of the person to whom the package is sent, the second line should state the military unit of which he is a member, adding the branch of the service, as, infantry, cavalry, or artillery. The third line should state "American Expeditionary Force in Europe," rather than the name of any city or station. Mail sent to men in the national-army cantonments or national-guard mobilization camps in this country should bear an address as indicated above, except that in place of the last line, the name of the camp and the state in which it is located should be given. The sender's name and address should always be written on the outside of every package.

Certain department stores in this country have instructed their European representatives to make up special packets of dainties, tobacco, camp utensils, etc., which persons in America may order sent direct to their soldier friends at the front. Orders of this sort are placed with the store here which forwards it to London, or wherever its representative is located. On the arrival of the order abroad, a special packet of the character designated is dispatched to the soldier's address. While the Red Cross does not accept or forward gifts for individually designated soldiers it is glad to receive donations suitable for Christmas and will see that all such are wisely distributed. Persons desiring to send gifts to soldiers in foreign armies should first consult their local postmaster to ascertain the special regulations provided for such cases.

—  
 ¶An average of all the weather forecasts made by the Weather Bureau in all parts of the country for all seasons shows, it is said, that our "weather men" were correct in approximately 85 per cent of their predictions.

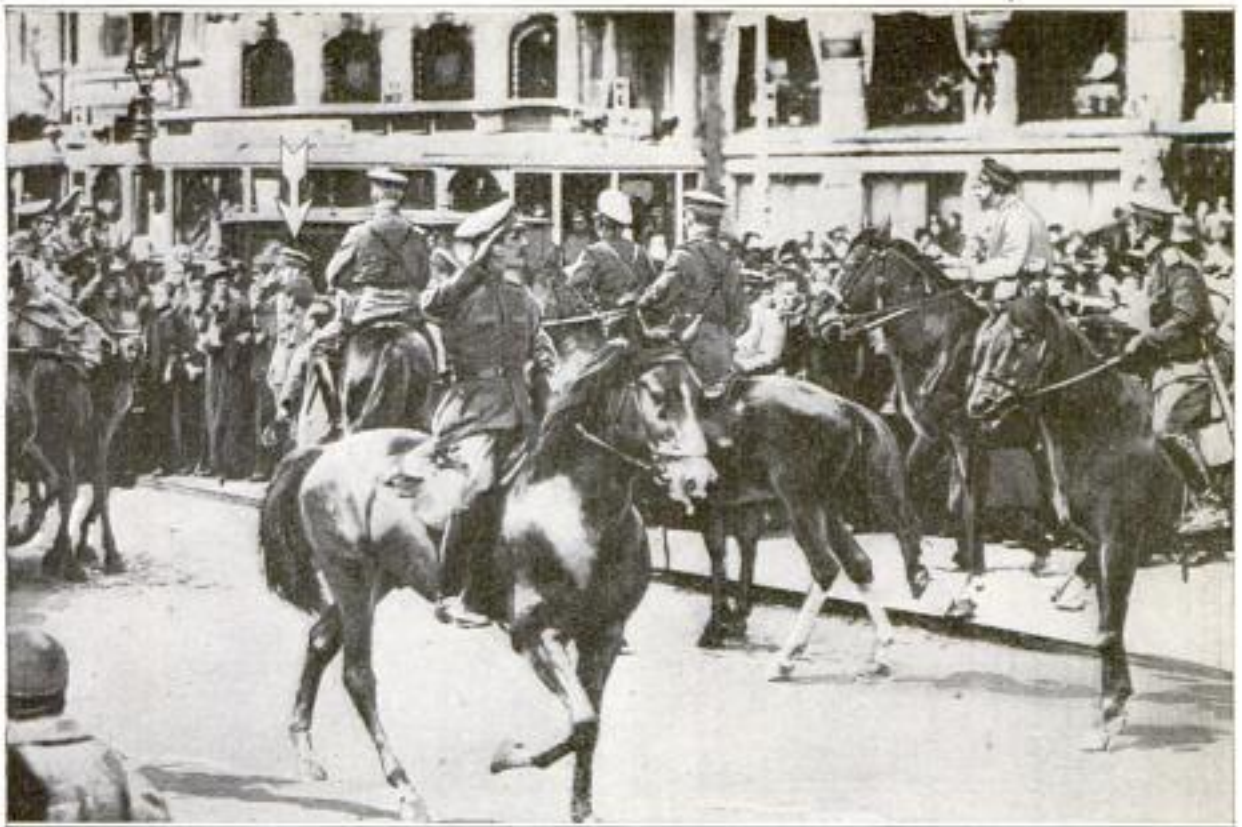

COPYRIGHT, INTERNATIONAL FILM SERVICE

Like a True Democrat, Premier Kerensky Mingles with the People. The Arrow Indicates the Russian Leader in Uniform Answering the Salute of Cossacks. The Latter are Keeping Back Crowds Assembled to Witness the Public Funeral of Comrades Recently Killed in Defending the New Government

## 5710 KERENSKY, RUSSIA'S MANY-SIDED LEADER

No figure in the great war has aroused more intense interest among the American people than that of Premier Kerensky upon whom, more than on anyone else, the fate of Russian democracy has rested. Enemies at home and abroad have plotted his downfall and his own generals have openly revolted against him but again and again this frail, intensely eloquent popular leader has emerged from crises with new power. One day he is at the front checking the defeat of the disorganized army, the next he is at his desk decid-

ing momentous affairs of state. Later he may be seen mingling with the people who throng the streets as a parade or funeral passes. All in all he is a man of extraordinary strength and peculiar weaknesses. No one can foretell his destiny but if he survives the present terrible struggle he will surely rank as one of the greatest men of Russia.

It has been repeatedly reported that the premier's health has been at the point of giving way under the months of terrible mental and physical strain and that he keeps at his task by sheer will power.



Kerensky at His Desk: This Likeness of the Heavily Burdened Premier Reveals Much of His Remarkable Personality

## HUGE WAR PAINTING BEGUN BY FRENCH ARTISTS



ON an enormous circular canvas that has been stretched on the walls of a war shrine known as "Le Pantheon de la Guerre," and situated on the grounds of the military school near Paris, a group of famous French artists have undertaken the execution of a remarkable panorama. The great painting will show the whole of the western front from Belfort to Calais, and will include immortal Verdun and the cathedral at Rheims. In front of a magnificent temple appears the winged figure of Victory and on the stairs of the massive structure are portraits of distinguished military and civilian personalities of the war.

## SOLDIERS KNEEL AT SNOW ALTAR HIGH IN ALPS

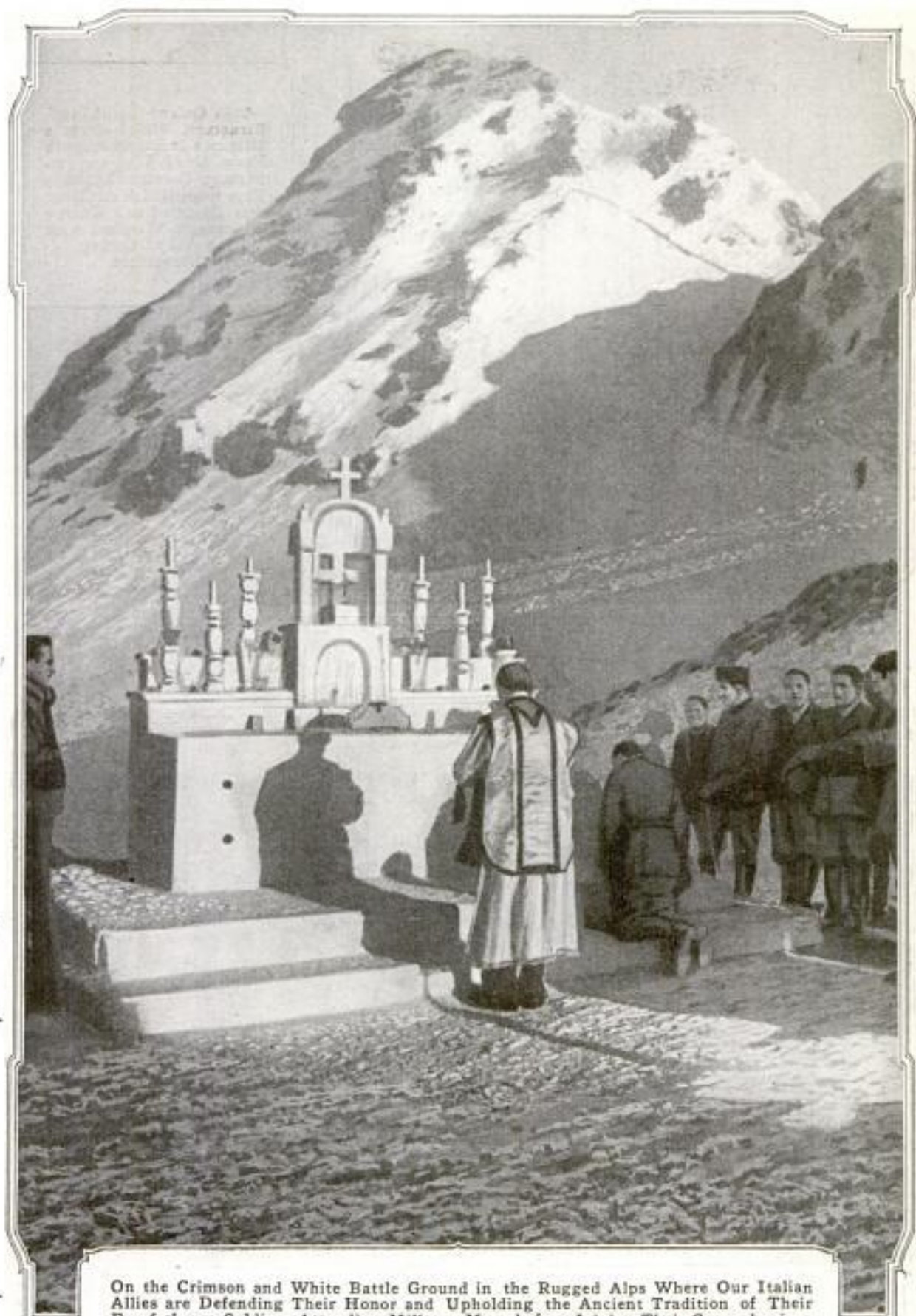

On the Crimson and White Battle Ground in the Rugged Alps Where Our Italian Allies are Defending Their Honor and Upholding the Ancient Tradition of Their Forefathers: Soldiers Attending Military Mass before Joining Their Comrades in a Concerted Assault against the Austrian Positions. The Altar, before Which the Priest is Standing, is Built of Snow and Ice

## FORTIFIED FIELD POSTS AND UNDERGROUND



This Queer-Looking Structure, Which from a Distance Is Nondescript in Form, Once Was an Important German Lookout Post from Which Artillery was Directed and Enemy Movements Watched with the Aid of Strong Binoculars



Amid the Ruins of a French Village Which was Occupied by the German Invaders for Many Months Before They were Finally Dislodged by the Allies: Heavy Stone Walls Shield the Entrances to Underground Works Which had been Projected under Most of the Town. The Picture Is Typical of Conditions in Scores of French Villages



## WORKS ABANDONED BY GERMANS IN FRANCE



Heavy Timbers and Reinforced Concrete were Used Here in Fortifying the Roof of a Subterranean Post Occupied by the Germans in a Forest on the Western Front. It is an Excellent Example of This Type of Military Construction

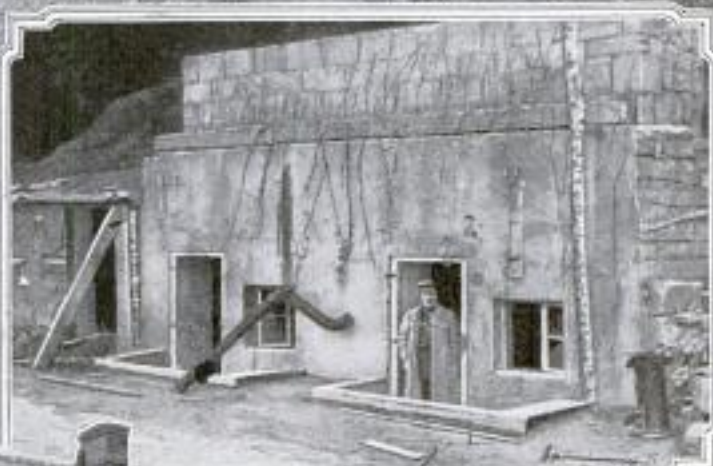

On the Aisne Front: A Post Formerly Tenanted by a Teutonic Commander and His Staff. It will be Observed That Heavy Masonry was Used to Make the Roof Proof against Bombs



An Old Farmhouse That was Made into a Veritable Fort by the Germans Who Armored It with Timber Walls of Great Thickness: It does Not Appear, However, That Much was Done to the Roof

## STRIKING NAVAL PHOTOS FROM SUBMARINE ZONE

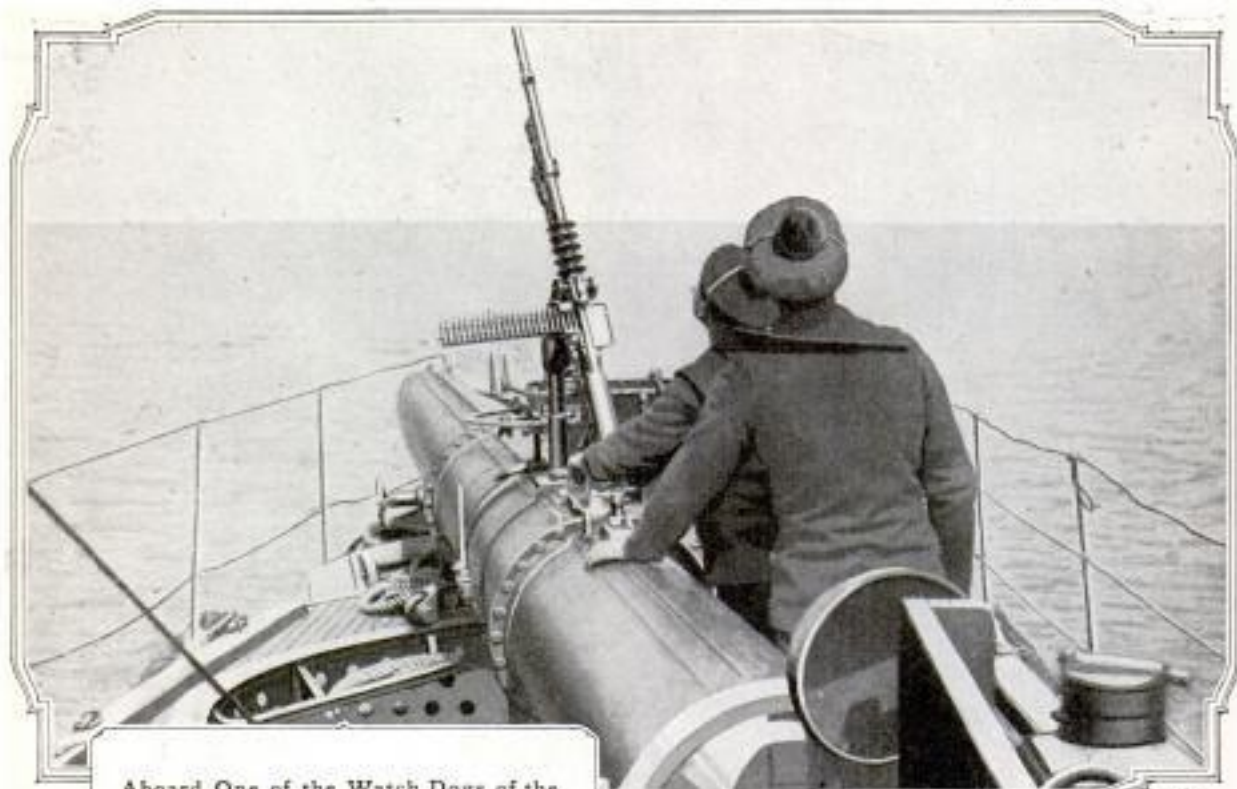

Aboard One of the Watch Dogs of the Sea: A French Torpedo Boat Ready for Action in the War Zone. The Picture Shows a Machine Gun Mounted on Top of a Torpedo Tube and Manned by Marksmen Who Maintain a Continual Vigil for Enemy Air Craft

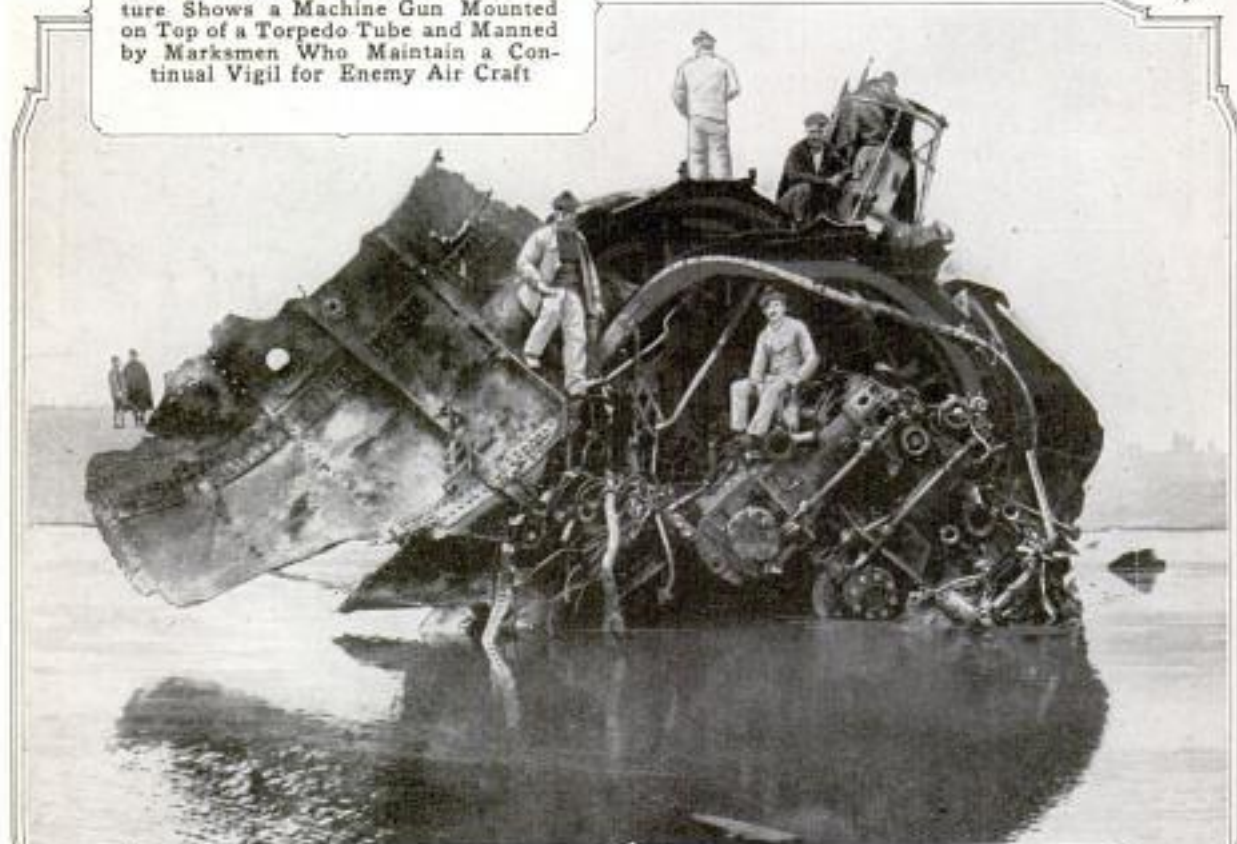

Remains of a German Submarine on the Sands near Calais: The Sea Raider became Stranded on the Beach and had to be Abandoned by Its Crew. Before Leaving It to Its Fate, the Vessel was Blown Up, with a Result That Is Apparent. In the Illustration Several French Marines may be Seen Examining the Wreck

# NEW EQUIPMENT FOR AIRMEN HERE AND ABROAD

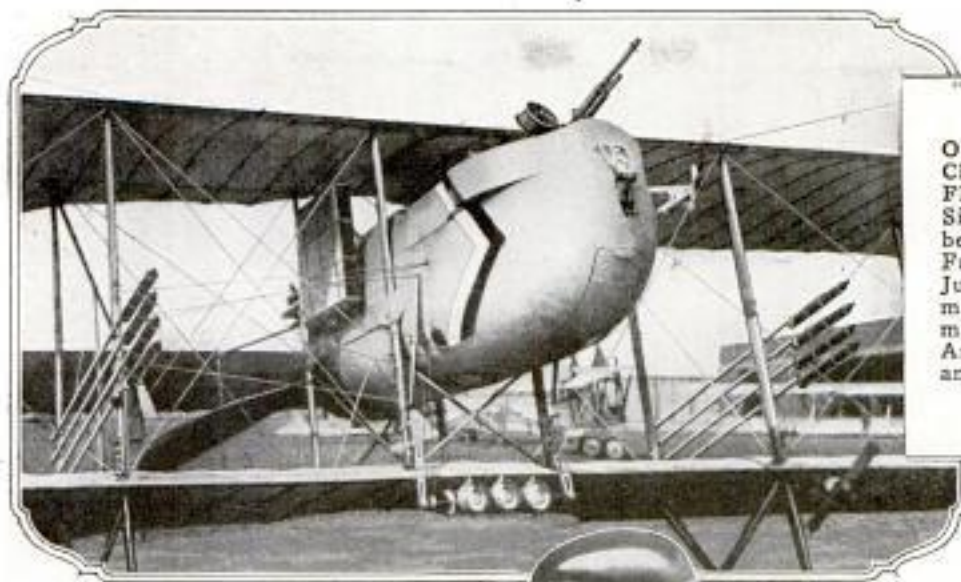

One of the Latest Zeppelin Chasers in the French Air Fleet: A Rapid-Fire Gun, Similar to the One Shown below, is Mounted on the Front of the Car. While Just beneath It is the Airman's Figurehead, or Talisman. Between the Planes Are Sets of Signal Rockets and under the Lower Plane Are Searchlights

A New Rapid-Fire Gun for British Battleplanes: That the Methods of Arming Aeroplanes have Undergone Swift Evolution during the War is Shown by the Picture on the Right. This Newly Designed Weapon for British Fighting Air Craft Is Capable of a Fire Whose Rapidity and Force Is Terrific

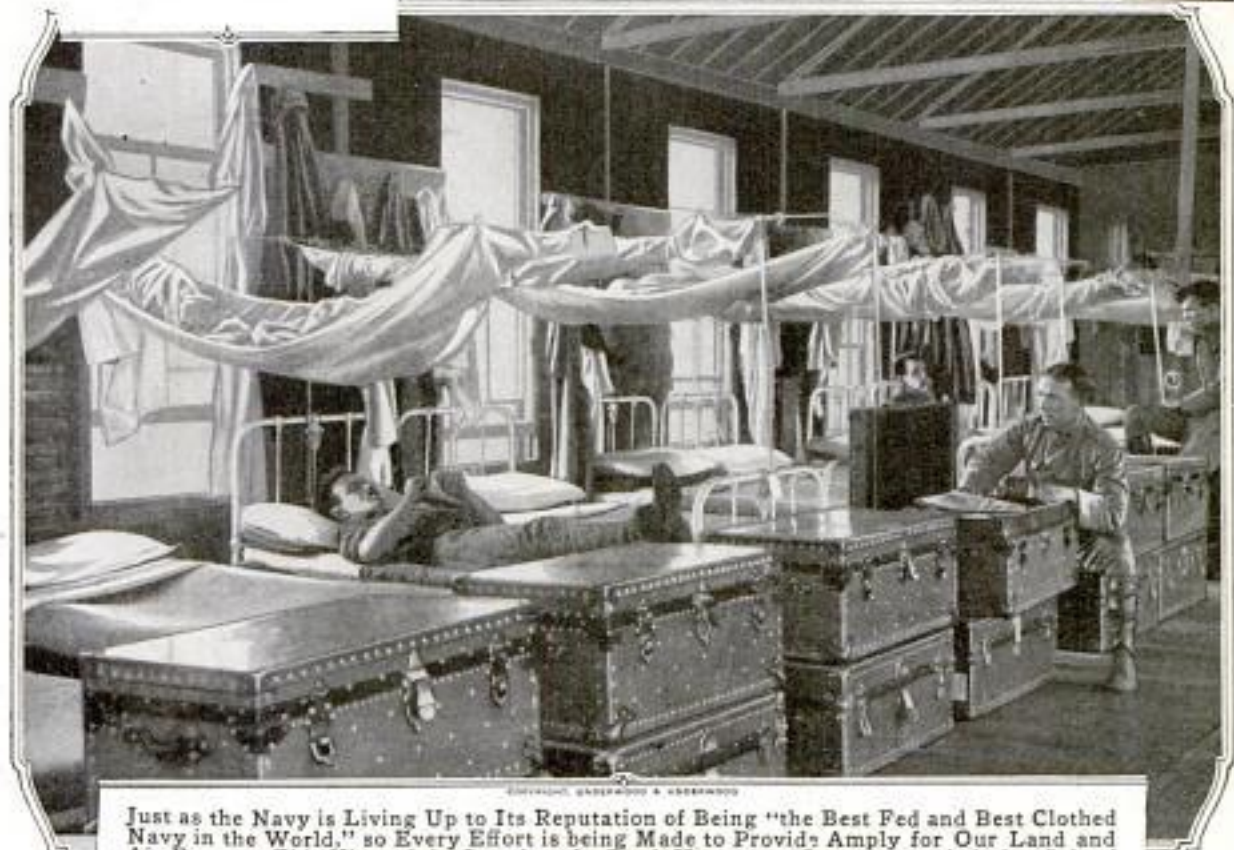

Just as the Navy is Living Up to Its Reputation of Being "the Best Fed and Best Clothed Navy in the World," so Every Effort is being Made to Provide Ample for Our Land and Air Forces. This View of the Interior of a Bunk House at a Government Aviation School Shows the Excellent Quarters of the Men Who are Training to Be the Army's "Eyes." The Comfortable Beds, Each with Plenty of Blankets and a White Pillow, and Also the Army Trunks, would Doubtless be Much Envied by European Airmen

## ITALIANS EMPLOY UNUSUAL MEANS TO KEEP



What Strange Forebodings may have Passed through the Minds of This Group of Austrian Soldiers When They were Blindfolded by Their Italian Captors before Leaving the Vessel in Which They were Detained, One can Only Conjecture. At All Events the Long Line of Ill-Clad Officers and Men Marching the Deck in Chain Formation and Stumbling down the Gangway Gave an Appearance of Going to Their Execution. However, These Blindfolded Men, Pawns in the Game of War, are Not being Led to Their Death, but for Some Reason, Best Known to the Italian Officers in Command, It was Decided That They should See Nothing of Their Surroundings on

## WAR SECRETS FROM AUSTRIAN PRISONERS



being transferred from the ship, through the town, to a railway station. The first-aid bandage that each soldier carries proved just the thing with which to bind prisoners' eyes. The precautions taken in this instance reveal a thoroughness which doubtless has helped make possible some of the big Italian gains that have been recorded near the Adriatic in recent months. The eyewitness whose sketch is here reproduced describes the men as covered with rags, showing that Austria's resources, at least in the matter of equipment, are sorely depleted. Two British officers are standing at the left witnessing the strange scene





#### IMPRESSIVE PRAYER SERVICE MARKS WAR'S ANNIVERSARY

IT was in accord with British tradition, and likewise a fitting expression of the character of the cause in which the allies are fighting, that these British troops should mark the beginning of the fourth year of the war by assembling for prayer. That gathering of the kingdom's men was one of the most impressive ceremonies in its centuries of history. As the leaders gazed upon the men that supported the forest of bayonets it was inevitable that some, at least, should contrast the force of which these thousands were a part with the handful of soldiers that Great Britain possessed at the outset of the war. Shielded by the heroic soldiers of France, the British undertook the Herculean task of transforming a whole nonmilitary nation into a trained army. This gathering was striking proof of how successfully that task has been performed.

## FRIENDLY THOUSANDS CHEER SAMMIES ABROAD



FRENCH OFFICIAL PHOTOGRAPH  
**Examining Each Other's "Shooting Irons":** This Intimate Glimpse, Reproduced from a French Official Photograph, Shows a Sammy and a Poilu Each Curiously Studying the Other's Rifle

Thousands of Britishers Packed London's Streets to View Our Khaki-Clad Soldiers. The Route Followed by These Newly Arrived American Troops Led Past Buckingham Palace Where King George Showed His Appreciation of This Country's Entry into the War by Reviewing Them. The Throng Shown Here Is at the Entrance to Whitehall



It Is Not Discounting the Genuine Friendship Which has Long Existed between This Country and Great Britain to Say That a Few Years Ago It would have Been a Courageous Prophet Who would have Predicted That an Army, Marching under the Stars and Stripes, could Arouse the Whole of London to Wild Enthusiasm. Only an Extraordinary Occasion will Make Britishers so Demonstrative. Without Question They Regarded the Arrival of Our Men in England as Worth the Finest Sort of a Demonstration

## STUDENT OFFICERS PRACTICE WITH COLD STEEL



In the Hands of a Fearless Fighter the Bayonet Is Deadly. The Accompanying Pictures Illustrate Some of the Training Given Our Boys in Its Use. The Fellows Above are Coming "Over the Top"



Plunging through Barbed-Wire Entanglements in the Journey across "No Man's Land," Where the Attacking Force is Saved from Annihilation by the Barrage Fire of the Artillery

Below: Meeting the "Enemy" in a Hand-to-Hand Encounter, a Bloody Job That Demands Extreme Dexterity. The Boche has Lost Many a Trench Because of His Inherent Fear of Cold Steel

The Bundles of Brush Are "Enemy Snipers" That Occasionally Conceal Themselves in Shell Pits

Below: At the Objective Point on the Parapet of the German Trench: In the Bottom of the Excavation Are Sandbags Representing the Germans That are to be Dealt with Summarily





## VENICE MASKS ART TREASURES TO SAVE THEM

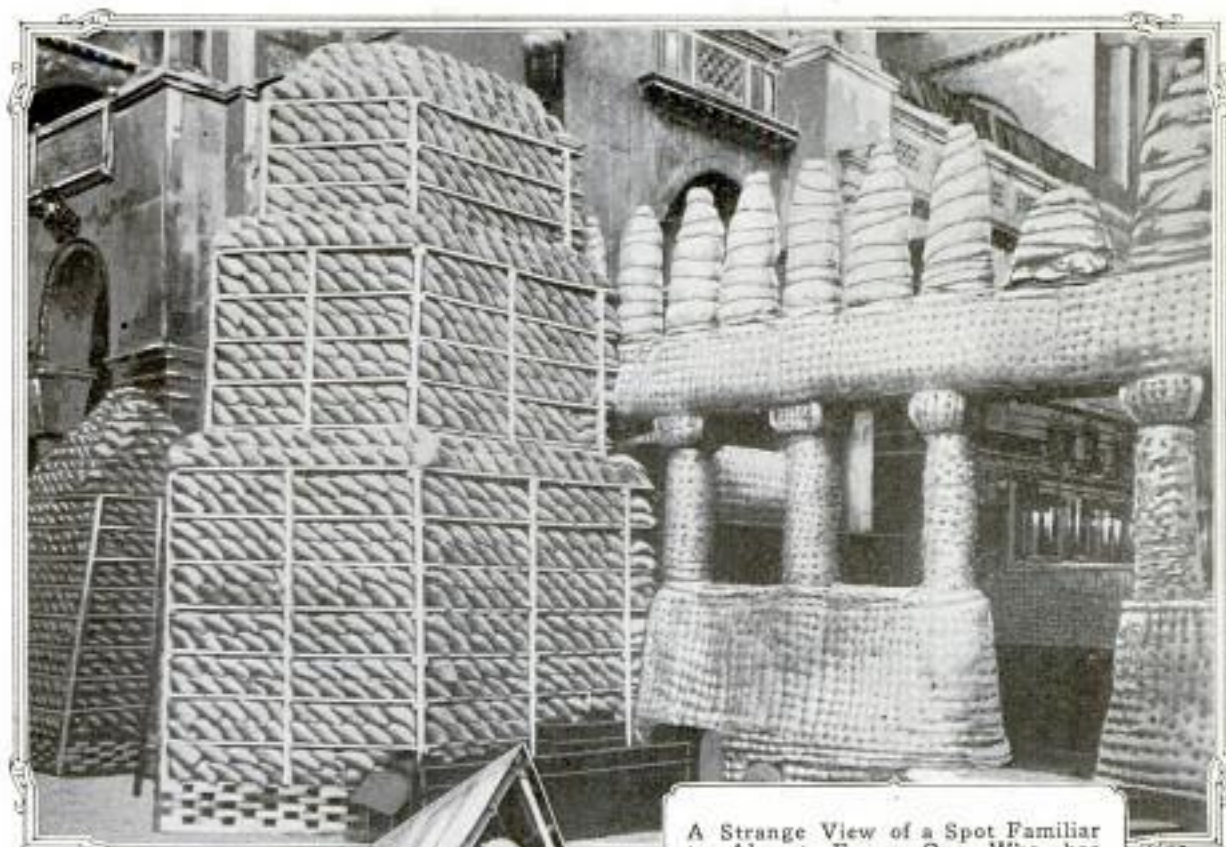

A Strange View of a Spot Familiar to Almost Every One Who has Traveled in Europe—the Altar and Sanctuary of St. Mark's Cathedral, Venice: The Venetians Consider This the Best Possible Form of Protection for the Revered Interior against the Air Raids of an Enemy Who Holds Nothing Sacred. These Coverings are Composed of Small Sandbags and Heavily Padded Quilting



While Many of the Towns and Cities of Italy have been Forced to Guard Their Treasured Specimens of Art and Architecture by Special Means, Venice, Close to the Enemy's Territory, has been Especially Subject to Attack from the Air. The Destruction Wrought in Some of Its Finest Churches has Produced Irreparable Loss. This View Shows One of the Principal Venetian Monuments Protected by Padding and Sandbags

# BY-PRODUCTS OF WAR FOR NEUTRALS AND FOES



Soldiers Guarding the Royal Residence in Amsterdam against Hungry Rioters: The Food Shortage in Holland has been so serious that there have been many disturbances in that country's principal city. Because Amsterdam soldiers refused to suppress the people, troops from elsewhere were called in. Some of whom formed a heavy guard about the palace.



Conducting Ruthless Warfare on a Business Basis: Above is a receipt given the Captain of an American sailing vessel by a U-boat commander, in exchange for the former's vessel which the German sank.

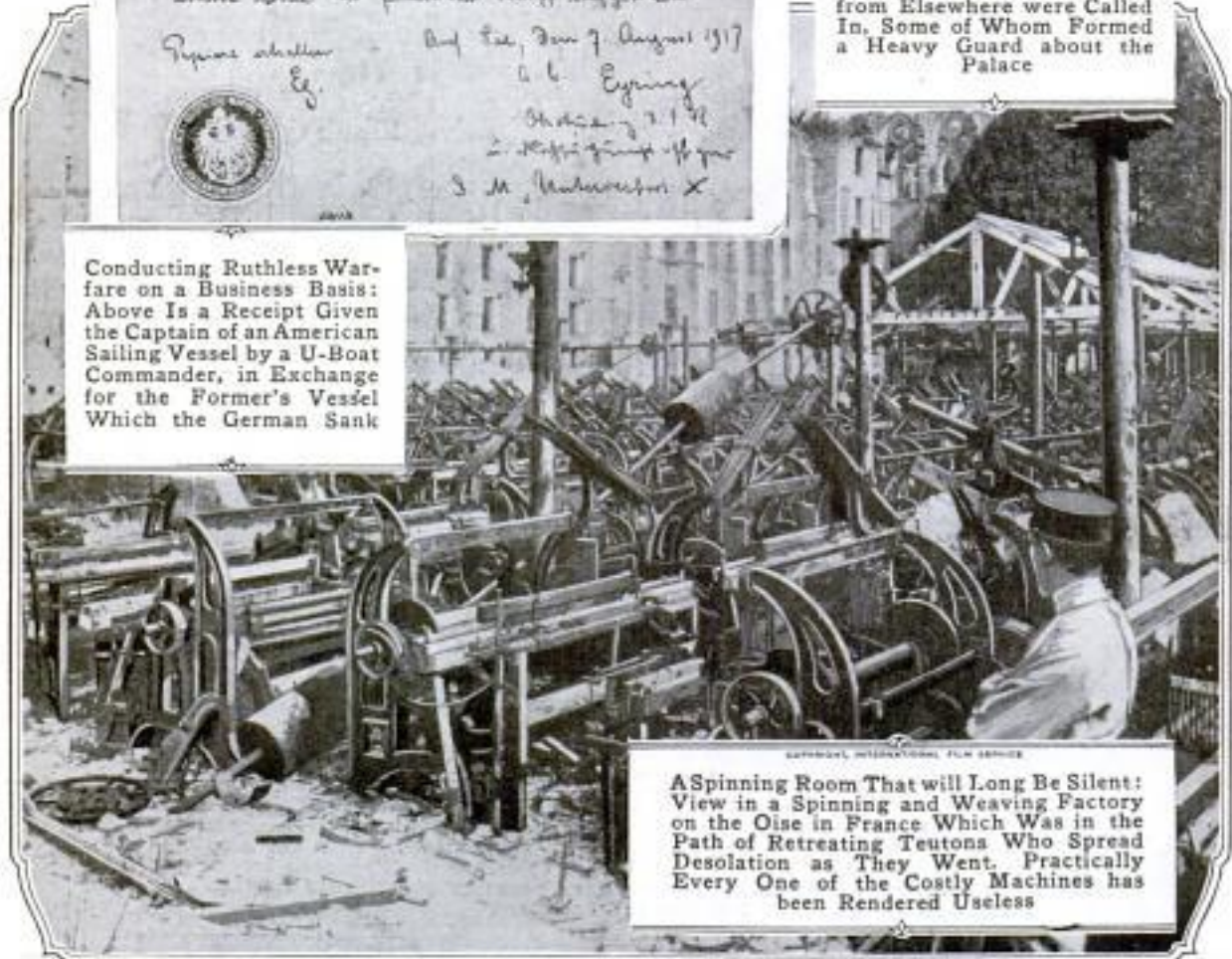

A Spinning Room that will long be silent: View in a spinning and weaving factory on the Oise in France which was in the path of retreating Teutons who spread desolation as they went. Practically every one of the costly machines has been rendered useless.

## ACCIDENT IN CAR CAUSES PANIC AND PLOT RUMORS

With the nerves of almost everybody more or less on edge because of persistent though generally unfounded rumors concerning anarchists and pro-German fanatics, it was inevitable that panic should follow an accident that occurred recently on a train bound for one of the country's large training stations. Because of some carelessness in packing or handling, a bag carried by one of the passengers burst open and from it several objects, having every appearance of being bombs, rolled down onto the floor. In an instant the car was in an uproar and people were scrambling for safety. As a matter of fact, the objects were bombs, but they did not belong to an evil plotter as was

rumored in towns along the line. Instead, they were being rushed to a training camp in response to an order.



Panic Followed the Bursting of a Bomb-Filled Package Carried by a Passenger on a Railway Train and Rumors of Anarchistic Plots were Spread

### TRUCK MAKES ANY AUTO

### 5144 A FARM TRACTOR

A new steel truck which permits the use of any automobile for tractor pur-



Steel Truck on Which Any Automobile can be Quickly Mounted and Used as a Farm Tractor: The Machine's Speed Is from Three to Five Miles per Hour

poses is of special interest because it requires no alteration in the car and leaves the latter available for ordinary driving at any time. The truck has

four broad-tired wheels and supports two grooved tracks on which the automobile is driven with the aid of two grooved skids. The only extra parts needed for the car are small sprockets fastened to the flanges of the rear hubs and two castings attached to the rear axle. These need not be removed for ordinary driving. Chains connecting the sprockets with the truck gearing are quickly put in place, after which the car is raised up and rigidly held in position by two jacks provided beneath the rear axle. The truck's steering gear is mounted at one side, the steering wheel being fastened to an arm in front of the driver.

Schofield Lab. Co.

318 Southwest Blvd. Kansas City

*Smokestack at  
40th & Morgan Sts. Chgo*

*5181*

**CHIMNEY BUILDERS' LIGHTS  
PRODUCE QUEER EFFECT**

In one of Chicago's industrial sections what at a distance resembled a

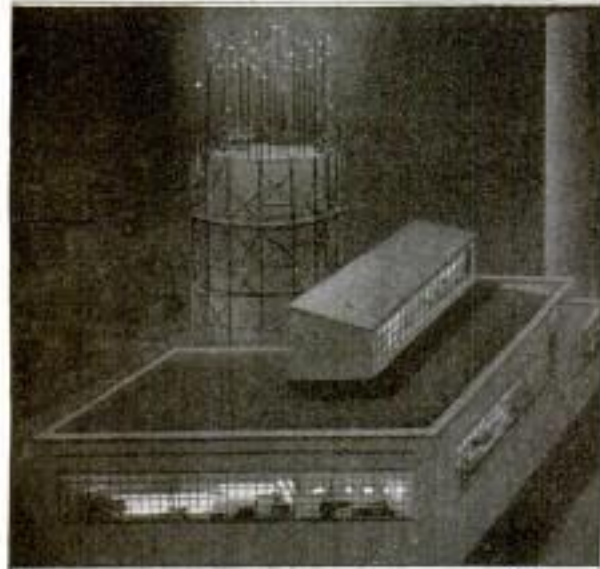

Scores of Lights Hung above a Factory Chimney, Which Was in Process of Rapid Construction, Gave the Appearance of an Illuminated Christmas Tree

huge, illuminated Christmas tree could be seen recently, rising high above the

surrounding roofs. A closer view revealed the fact that these lights were located above a concrete smokestack which was in process of construction. Because of the necessity of completing it in the shortest possible time, men were engaged on the chimney day and night, hence the unusual number of lamps which produced an effect suggestive of the holidays.

**TEST AUTO-TRUCK SPRINGS**

*505* WITH A SEISMOGRAPH.

Records which showed in minute detail the extent to which springs of varying composition, but of the same size, would take up the vibrations of an auto truck, were recently made with a device constructed like a seismograph, the instrument used to record earthquake tremors. The apparatus was mounted in a framework attached to the back of the driver's seat. A drum, 12 in. in diameter, was connected with the right front wheel by a flexible shaft so that it revolved at a rate corresponding to the vehicle's speed. Paper was supplied from a spool. The line recording the truck's vibrations

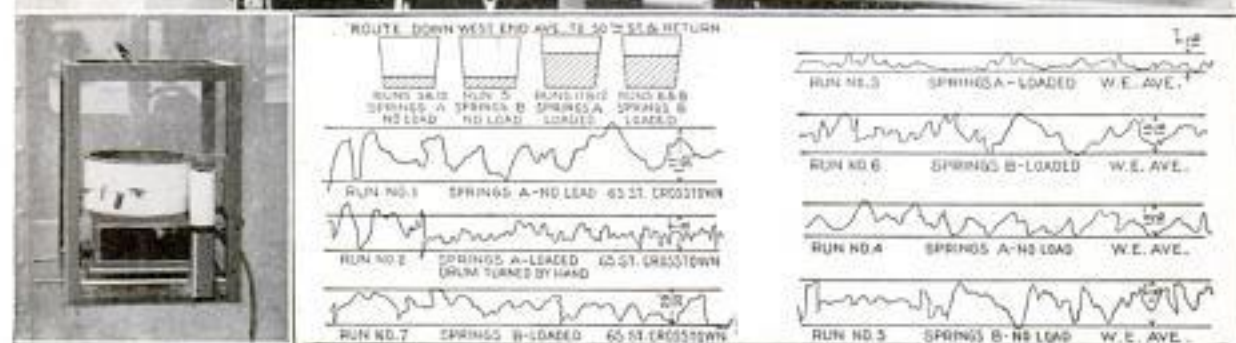
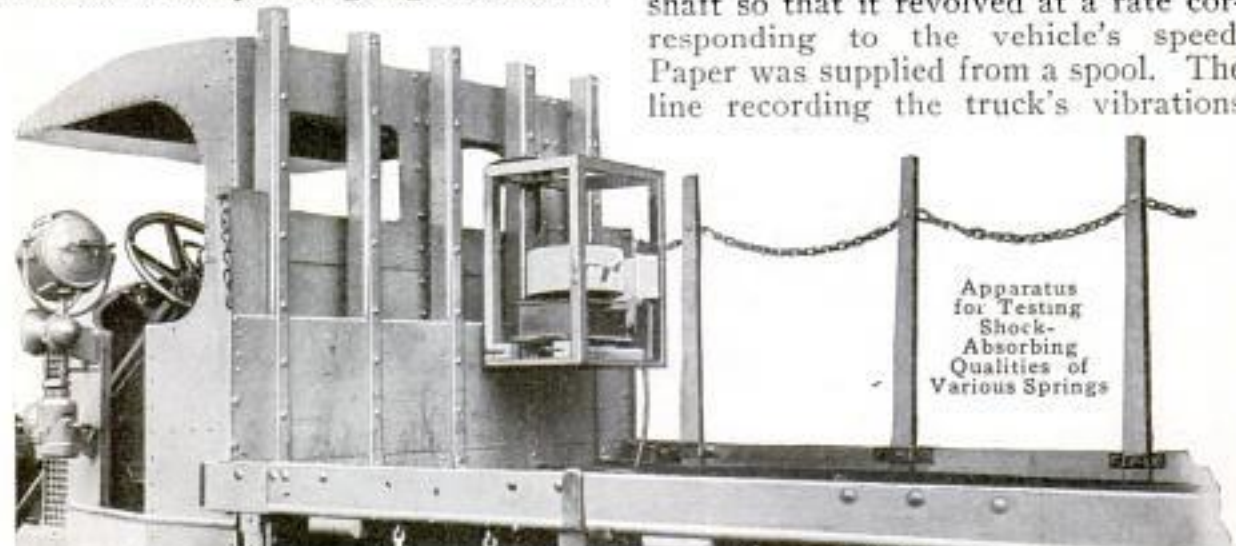

Left: Close View of the Seismographic Device, Showing Recording Pencil Held by Weighted Spring. Right: Records of Various Trips Made over the Same Route with Different Springs

*Test made by  
The International Motors Co.  
64th St & West End Ave, New York City*

In the Foreground Is One of the Largest of the Many Motors Employed in Operating This Sawmill Which Obtains Its Current from an Adjoining Power Plant in Exchange for Sawdust

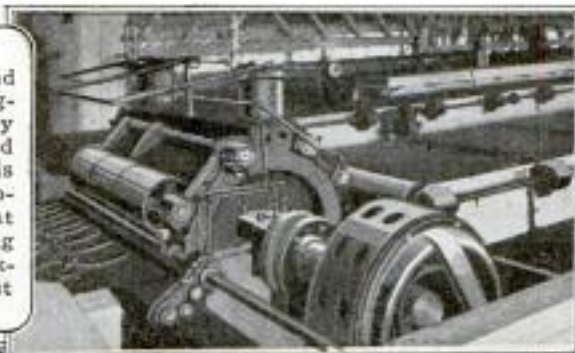

One of the Largest Saws in a Mill Operated Entirely by Electricity except for a Few Steam-Driven Machines: This Saw Is 69 Feet Long and is Driven by a 350-Horsepower Electric Motor



A Loading Crane in the Mill's Lumber Yard, Operated by Electricity: Where Power cannot be Delivered over a Wire, as in the Case of Trucks, Storage Batteries are Employed

was made on the paper, as it wound about the drum, by a pencil attached to the end of a weighted spring.

Seven test runs were made over the same route and at a constant speed of 15 miles per hour. Asphalt, cobblestones, and granite blocks were traversed, four of the trips being made with loads and three with the truck empty. The seismograph records showed a considerable difference in the shock-absorbing qualities of the various springs tested, indicating that, though a driver might not notice a difference, some types of springs cause much more wear than others.

#### MILL EXCHANGES SAWDUST 489 FOR ELECTRICITY

What is pronounced an almost ideal arrangement in respect to fuel and power for two industrial plants is to be found in a large logging region in which a big sawmill is operated entirely by power derived from an adjoining electric plant, while the latter purchases its fuel in the form of sawdust

and planer chips from the sawmill. The fuel is paid for on the basis of the amount of energy actually delivered from the switchboard, rather than the volume of combustible material received. This arrangement permits a considerable saving in operating certain of the generators. Fuel for the electric plant is stored in a huge stock house which holds the equivalent of 600 cords of wood. The generating capacity of the plant is 2,000 hp. The sawmill which receives electric power under this reciprocal arrangement has nearly 200 electric motors, ranging from a  $\frac{1}{4}$ -hp. motor that runs the planer-knife sharpeners, to the 350-hp. motor for the main saws. Monorail lumber carriers, timber loaders, and all saws are driven by motors, while in operating the log carriage, log turners, and in furnishing heat for the dry kilns, steam is used, which is also obtained from the electric plant. Storage-battery trucks are employed for hauling. The electric plant is one which serves over a dozen cities and towns, and has one line that is 40 miles long.

*Roath-Kelly Mill, Springfield Oregon*

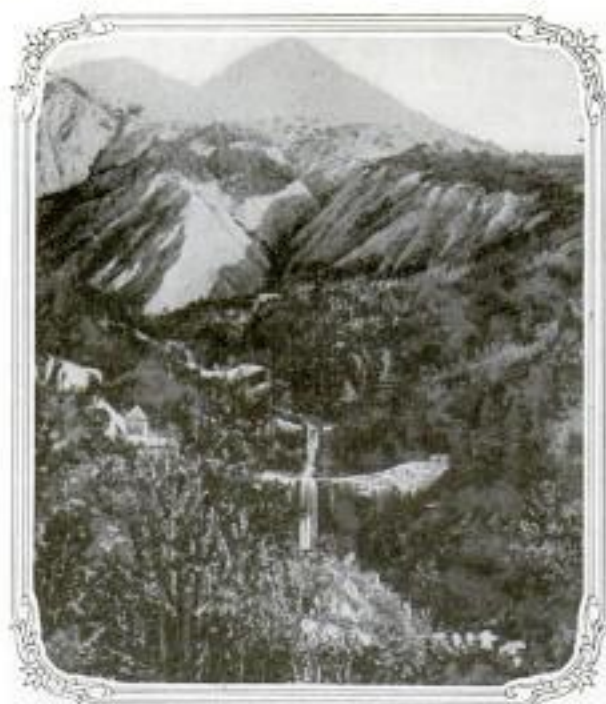

These Photographs, Showing a Point at the Headwaters of a Small Stream in the Lower Alps, Present an Example of Reforestation. The Picture at the Left was Taken in 1887 and That at the Right 20 Years Later

## REFORESTATION UNDERTAKEN IN FRENCH MOUNTAINS

In connection with flood-control agitation, more or less attention is being drawn to the subject of reforestation. While this plan, according to some of our most authoritative engineers, is manifestly impracticable so far as its application to large streams like the Mississippi or Missouri rivers is concerned, in some cases it undoubtedly does have a certain value. In the mountain regions of France and Germany the scheme has been employed, and an interesting example is afforded near the headwaters of the Ubaye River in the Lower Alps. The work was commenced in 1887 when the mountain sides were entirely bare. Masonry barrages were constructed at frequent intervals to catch silt and check serious erosion. The mountains were then retimbered. Today, instead of being a bleak, barren waste as in former times, this district is covered with trees. Since the land in this instance has little agricultural value, the chief objection to reforestation cannot be raised. In all, according to the latest figures obtainable, France has retimbered 629,488 acres. But to re-

duce the height of flood waters at Memphis, Tenn., merely from the stage reached in 1912 to that of the next highest record, the reforestation of 566,000 square miles of the upper valley's most fertile land would be required, according to the president of the Mississippi River Commission.

## MILLIONS OF BUTTONS FOR 5179 LIBERTY LOAN

A large manufacturing concern in the East has had a force of about 500 hands working day and night making liberty-loan buttons for the government. The last order was for 3,000,000 of the little celluloid buttons which one receives when he buys a liberty bond. The contract recently made with this company by the Secretary of the Treasury calls for the delivery of 100,000 buttons a day for 30 days. At the time of the first issue of bonds this company made an enormous supply of these buttons, which, however, now is exhausted so that the new order must be filled at once.

**NEW ARMY CAMP PROTECTED  
BY SEASONED FIREMEN**

5111

In the big national-army camps provision is made for offensive and defensive fighting against the destructive forces of nature as well as against the enemy, fire stations being an important part of camp equipment. In Camp Custer at Battle Creek, Mich., the headquarters for the fire-fighting apparatus is a substantial wooden structure in which a telephone and suitable alarms have been installed, together with an up-to-date automobile fire engine. Very appropriately, the drafted men who have had pre-

vious service as firemen are the ones who are manning this station. The machine carrying the apparatus is a light, powerful touring car transformed into a chain-driven truck.



COPYRIGHT, INTERNATIONAL FILM SERVICE

**Fire Station and Up-to-Date Fire Truck at Camp Custer, Battle Creek, Michigan. Manned by Drafted Soldiers Who have Had Previous Experience as Fire Fighters**

4905 **BUFFALO BILL'S CASKET INCASED IN CONCRETE**

Just as the spectacular and unusual marked the long, adventurous life of William F. Cody, better known as "Buffalo Bill," so they also characterize the place and manner of his burial. His grave was blasted from solid rock on Lookout Mountain, near Denver, Colo., at a point

which commands a wonderful view of the surrounding country. The body lies in a casket of bronze which in turn is sealed in a burglar-proof case. These two, on being set in place, were inclosed in concrete, the roof of this protection being formed with arched sheets of corrugated iron which were imbedded in the structure as the material was poured. It is over this lofty grave that a monument, depicted in a recent issue of this magazine, is to be erected to the great western scout and showman. It is believed that no one will attempt to molest the remains so exceptionally well protected by masonry and metal.

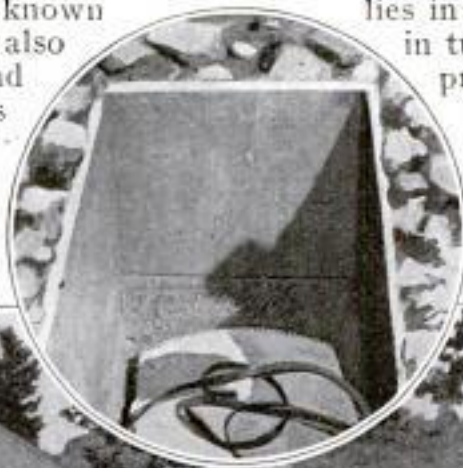

**Buffalo Bill's Grave Blasted Out of Solid Rock: The Arched Sheets of Corrugated Iron Helped Form the Roof over the Burglar-Proof Case Which was Inclosed in Concrete**

*Located at  
Lookout Mountain, Colo.*

*Dr. Jackson Fleckenstein, 1610 Jackson Bldg. Chicago*  
*Address inquired to*  
*5165* **POPULAR MECHANICS**

*702*  
*5165* **GASOLINE PUMP PROTECTION  
AGAINST SHORT MEASURE**

For installation at public garages and service stations, a gasoline pump has

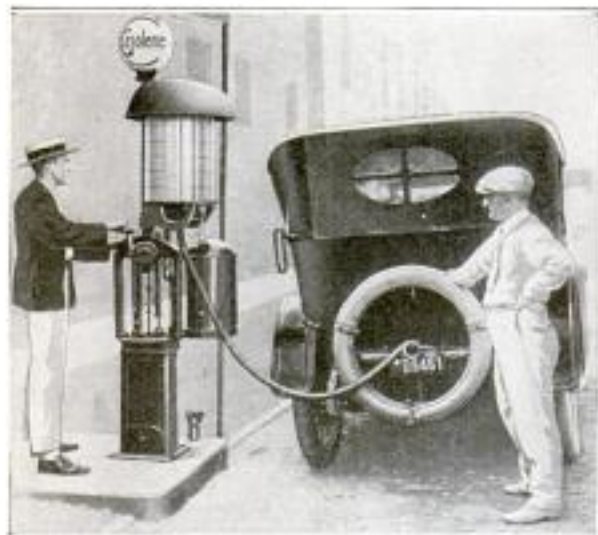

Gasoline is Measured in the Graduated Glass Containers Before It is Discharged into the Fuel Tank of a Motor Car

been developed which assures a motorist honest measure when he is purchasing fuel. Two 5-gal. glass containers that are air-tight and graduated, are supported at the top of the standard. The receptacles are supposed to be sealed by a local inspector of weights and measures. One of them discharges while the other is being filled, and a single lever controls both operations. A tube connecting the two cylinders equalizes the air pressure within them. If a patron takes the trouble of looking at the cylinders and determining their contents before any of the liquid has been allowed to flow to the car, he protects himself against dishonesty and the dealer against suspicion.

*5252* **AMERICAN BUILDS POWERFUL  
AERONAUTICAL MOTOR**

According to an official announcement made at Washington, American engineers, with the cooperation of the War Department, Bureau of Standards, and the aircraft production board, have developed an aerial motor that is equal to any that has been produced. It is now the main reliance of the United States in the quick construction of

large fleets of battleplanes and speed scouts for service overseas.

In a highly dramatic account of the achievement, the secretary of war characterized the motor as a triumph of colossal importance. Since details of its design and performance are withheld for military reasons, the enthusiasm of Secretary Baker is the most tangible indication of the engine's merits that is available. In a signed statement he asserted, "In power, speed, serviceability, and minimum weight the new engine invites comparison with the best that the European war has produced. . . . Probably the war has produced no greater single achievement. The new engine amounts practically to an international model. It embodies the best there is in American engineering and the best features of European models so far as it has been possible to adapt the latter to American manufacturing methods." These remarks were made, no doubt, with full cognizance of the remarkable strides made of late by Italian engineers which have given to Italy, it is declared, present mastery of the air.

Two engineers of international reputation were locked in a suite of rooms in a Washington hotel where they worked day and night until drawings were completed for the new motor. In this connection Secretary Baker says: "A remarkable American engine was actually produced three weeks before any model could have been brought from Europe." Since then it has been constructed and put through a series of severe tests which have proved its superiority to the complete satisfaction of its builders and the government.

The outstanding feature of the motor is its standardization. Every part of the unit has been standardized so that rapid and economical production by a great many factories is feasible. This also makes it possible to build the engine in four different models ranging from four to 12 cylinders, each using identical parts. Repairs at the front, therefore, can be made readily and new engines even assembled from parts of wrecked ones.



# WOMEN AT NEW TASKS IN WORLD'S WORK



COPYRIGHT MASTHEAD & UNDERWOOD  
 A Splendid Physique and Expertness as a Swimmer have Brought Miss Dora June Wheeler, Aged 19, of Hollis, Long Island, Unusual Distinction, for She has been Appointed Instructor in Swimming in the Federal Life-Saving Corps. She Won Special Praise Some Time Ago by Rescuing a Drowning Man. The Young Woman Is Shown in Her Surf Boat.



The Picture on the Left Is of Miss Edna Flynn of Seattle, Who was "Discovered" by a High Railroad Official in a Small Town and Made an Expert in Selling Railroad Tickets to Women. Now She is Engaged in Training a Large Staff of Young Women to do Similar Work for the Southern Pacific System.



COPYRIGHT INTERNATIONAL FILM SERVICE  
 This Young Lady Is the Bodyguard of a Woman Investigator Who Aroused Bitter Personal Enmity by Her Exposure of New York's Vice Conditions. The Fair Protector Wears the Women's Defense League Uniform.



Dangling Six Stories above Fifth Avenue, New York, on an Unsteady Painter's Scaffold Is Not a Comfortable Sensation, but Miss Lucile Patterson, a Young Artist, Endured It Recently to Paint a Patriotic Poster on a 20-Foot Billboard for the National League for Woman's Service.

### TROPHIES OF AIRMAN TELL GRIM STORY

5166

Through the almost impenetrable barrier which the war has raised between the central powers and the rest



COURTESY THE AEROPLANE, LONDON

View of the Sitting Room of the German Flier, Captain von Richthofen, Showing Several Number Plates on the Walls from Aeroplanes He has Brought Down. This Airman Won Fame as the Leader of the So-Called "Flying Circus"

of the world there filters now and then a photograph which gives an intimate glimpse of the life or personal surroundings of the enemy. Such is the unusual picture reproduced herewith, showing the sitting room of the famous German airman, Captain von Richthofen, at the headquarters maintained by him and his comrades. This group of men, because of their extraordinary daring and spectacular maneuvering in Gotha aeroplanes, has been nicknamed "the circus." On the walls of the room are to be seen several aeroplane number plates, presumably from machines which the captain brought down. Hanging from the ceiling is a chandelier made from a Gnome engine. According to recent reports Captain von Richthofen has been killed.

### RESCUE HELPLESS COLONY ABANDONED IN PACIFIC

5122

To the usually prosaic reports on file in the Navy Department has been added a dramatic account that rivals "Robinson Crusoe" and "Swiss Family Robinson." It is written by the commander of an American warship which recently visited Clipperton Island, a desolate speck of land some 600 miles southwest of southern Mexico. Here our sailors rescued 11 persons—a refined young Mexican woman, her four children ranging in age from two to eight, the woman's servant, another mother and child, and three children whose parents had perished. This forlorn group had been cut off from the world since 1914 and were all that remained of a colony of over 30 Mexicans. The men in the colony had been representatives of the Mexican government or employes of a company that had shipped guano from the island. The mother of the four came to this forsaken spot as a bride in 1908. Until 1914 the group had occasional communication with the mainland, but what proved to be the last supply ship visited the island early in that year.

Shortly after, an American schooner was wrecked on the shore and in June, 1914, the U. S. S. "Cleveland" came and took away the surviving members of the schooner's crew. At that time there was no apprehension of disaster. But no more supply boats came and provisions grew less and less until, in 1915, the man who had brought his bride to the island set out in an open boat with three companions to obtain help. They were never heard from again. Scurvy increased alarmingly and steadily lessened the size of the colony until it was so small that the supply of coconuts—averaging about one a week for the entire group—was sufficient to check the disease. Flesh and eggs of birds, a few chickens and fish, constituted the other food.

No words can describe the scenes upon the arrival of the rescue party nor the return, some time later, of the poor women and children to Mexico.

3840 LONG FOOTBRIDGE TO A COUNTRY CLUB

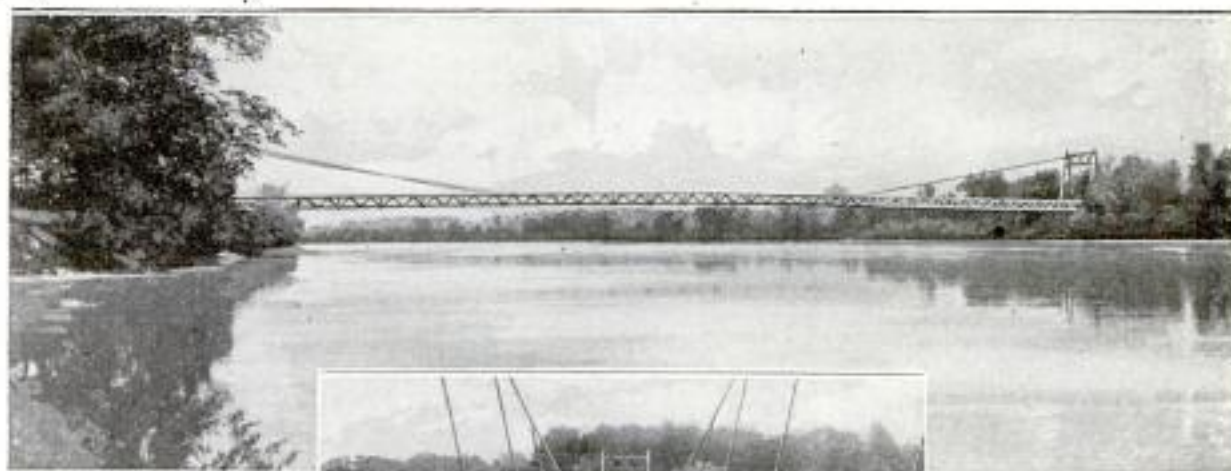

A suspension footbridge, said to be the longest bridge of its width in the world, connects a country club on Tyngs Island, in the Merrimac River, about  $7\frac{1}{2}$  miles from Lowell, Mass., with the mainland. It is 550 ft. long and  $4\frac{1}{2}$  ft. wide, and is supported by heavy

Suspension Bridge, 550 Feet Long and Four and One-Half Feet Wide, Leading to Tyngs Island in the Merrimac River: Access is Gained to It by Passing through a Coin-Operated Turnstile

wire cables anchored to a trestle at each end. The floor of the bridge is smoothly planked crosswise and there are substantial handrails on either side. Entrance to the bridge from the mainland is gained through an automatic turnstile, which opens to permit passengers to pass through upon the dropping of a nickel in a slot.

5065 SMOKING ROOM IN CENTER OF NEW RAILWAY CAR

A departure from the conventional type of coach is found in a steel passenger car built for the Erie Railroad, which has the smoking compartment in the center instead of at one end of the conveyance. This room is furnished

with 10 stationary seats and two wicker chairs, all upholstered in leather. An aisle running at one side of the smokers' inclosure connects the main sections each of which has a seating capacity for 32 passengers.

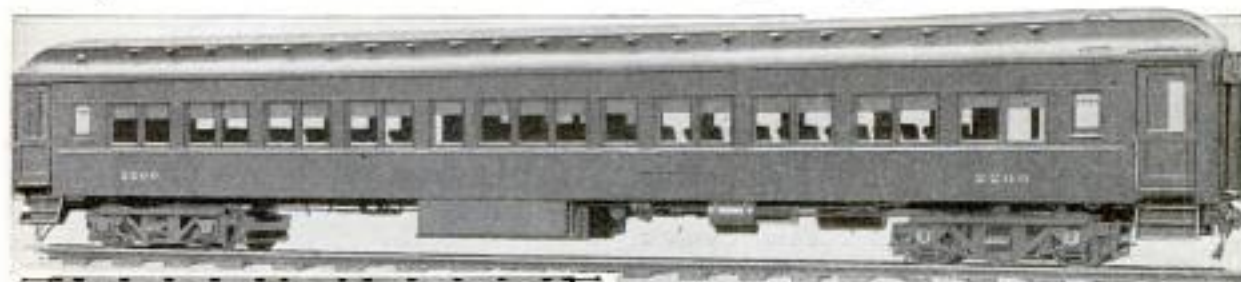

New Railway Coach with Smoking Compartment Located in the Center: The Arrangement of 12 Seats for the Smokers and Seats for 64 in the Remainder of the Car is Shown in the Diagram



No Corner Semaphores are Used with This Signal, Which is Operated by Turning an Electric Switch



A Central Traffic Signal Which is Supplemented by Semaphores at the Street Corners



The Seated Officer Controls the Signal and Arrow Shown and Also a Signal over the Center of the Street

## NEW SUCTION BROOM SWEEPS

### WITHOUT RAISING DUST

By adapting the principles of three familiar household implements—the common broom, the carpet sweeper, and the vacuum cleaner—a new dirt-collecting contrivance, a suction brush, has been devised as a labor saver. The apparatus is used in much the same manner as an ordinary broom. It is provided with a long, flexible handle which operates strong bellows that produce an effective suction force. A small flat brush at the “nozzle” end

combs the nap of a rug and loosens dust, a revolving brush picks up thread and surface litter, and the intruding air carries the dust into a bag. Its operation is purely manual; electric current is not employed. With this device floors may be swept satisfactorily without filling a room with dust. The device weighs three and a half pounds and is carried on silent rubber wheels.



## ELECTRIC STREET SIGNALS

### FOR TRAFFIC OFFICERS

It is now being generally recognized that efficient traffic regulation effects a great financial saving to the business interests of a city, and for this reason, the authorities in one of the country's growing municipalities have installed at certain street crossings especially designed electric signals. Over these intersections are hung cube-shaped signals in the sides of which are dials whose faces can be changed to read “Go” or “Stop” by operating a switch at one of the corners. With each change of the signal a bell rings and red and white lights show at the proper sides. Supplementing this central signal, and operated in conjunction with it by the policeman in charge, are signals at each corner. These consist of semaphores reading “Go” and “Stop,” together with an arrow that points in the direction traffic is permitted to travel. A red or white light is displayed in accordance with the signal given and a bell is rung when the change is made. At less congested crossings there are only central electric signals in which the words “Go” and “Stop” are alternated.

Mandel Broc.  
Chgo — Price 5.85

Seattle, Wash.  
Copyrighted material

*No Data. Card Missing - 4782.*  
*The Denver Hog Ranch Co. P.O. Box 1221 Denver Colo.*

## HOGS SOLVE THE GARBAGE PROBLEM FOR DENVER

UTILIZATION of waste food has become a problem of first importance now that America is depended upon to feed her allies' armies. For this reason the system of garbage disposal successfully followed in Denver for the last ten years is of timely interest, for there the garbage is converted into marketable pork without public expense.

The prevailing system of garbage disposal in American cities is that of incineration. This puts a burden upon the taxpayer or home owner, according to the system of cost distribution, and at the same time results in an economic waste. The reports of health departments in a majority of American cities prove that garbage disposal is regarded as an unsolved problem. In such cities, garbage is a nuisance, while in Denver it is the basis of a new public-utility corporation.

The city of Denver, with its 250,000 inhabitants, has paid nothing for the collection and disposal of its garbage for ten years, neither as a municipality, nor as individual citizens. The garbage question there is the least troublesome of all the health-department problems. The hog-ranch company, which takes the garbage, even handles complaints.

The contract between the city and the hog-ranch corporation runs in four-



A Denver Garbage Can and Ash Pit

year periods. For a consideration, \$1, the Denver hog ranch is given the privilege of hauling away the city's garbage. The company's equipment for this work consists of 35 steel tank wagons, each of 600-gal. capacity. Daily collections are made in the business district, twice a week in the residence districts in winter and every other day in summer.

Complaints received at the city hall are turned over to an employe of the hog ranch. He answers them immediately, using an automobile on the rear end of which a garbage can is carried



Ingenuous Nonfreezing Water Container and Pigs Just Starting on Their Journey through the Fattening Pens

to take care of emergency cases. City ordinances require every home owner to provide a covered, galvanized-iron garbage can; to keep this can clean, to throw into it only edible garbage. A garbage collector who finds paper, glass, or other foreign substances in the cans reports the matter to city authorities and the resident is compelled to dispose of this garbage himself.

In addition to regular government inspection at the packing houses, the state veterinarian inspects the ranch and its stock about once a week. The hog-ranch corporation is a highly specialized organization. Stables, farrowing shed, breeding pens, fattening pens, water devices, are all supervised by one man. The average number of hogs maintained is 5,000. The farrowing shed, with its 500 pens, is the center of the system. Each pen, and its outdoor yard, is floored with 2-in. planks to promote cleanliness. Alleyways on either side of the shed separate the farrowing yards from the fattening yards. A third yard system is occupied by the sows with weanling pigs. The only period in the hog's life spent upon concrete is in the weaning yards, as hard floors annoy the animals.

As soon as they will eat, the young pigs have garbage fed them, and this continues to be the basis of their diet

every other day. The ranch has 1,300 acres of alfalfa field under lease, from which an ample supply is derived.



Immunizing a 10-Weeks-Old Pig with a Double Injection of Virus and Serum: The Veterinarian Is Very Careful Never to Touch the Animals He is Treating

until they reach the market size. When introduced in the weaning yards, where they remain until eight or ten weeks old, the young pigs have alfalfa added to their diet, for a straight garbage diet does not produce as valuable pork as does a balanced ration. Two and one-half tons of alfalfa, fed green in summer, is thrown in the racks

When weaned the young pigs are immunized for life from hog cholera. A veterinarian injects cholera virus and cholera serum at the same time. Following this treatment the pigs go into the fattening pens, being graded and regraded once or twice a month, and promoted according to weight. Shoats, upon reaching a weight of 150 lb., are sent to the finishing pens, where corn is added to their diet. Attendants select brood stock at this time, and these animals never receive corn, as they must be kept thin.

A number of specially adapted feeding devices are used on the ranch. Slatted alfalfa racks prevent waste of this food. Corn is fed whole in self-regulated hoppers, an adjustable baseboard at the foot controlling the flow of grain into the trough. In the fattening yards garbage is fed on a concrete slab, 8 ft. wide and 6 in. above the ground. The slab is fenced on either side and divided by gates into sections the width

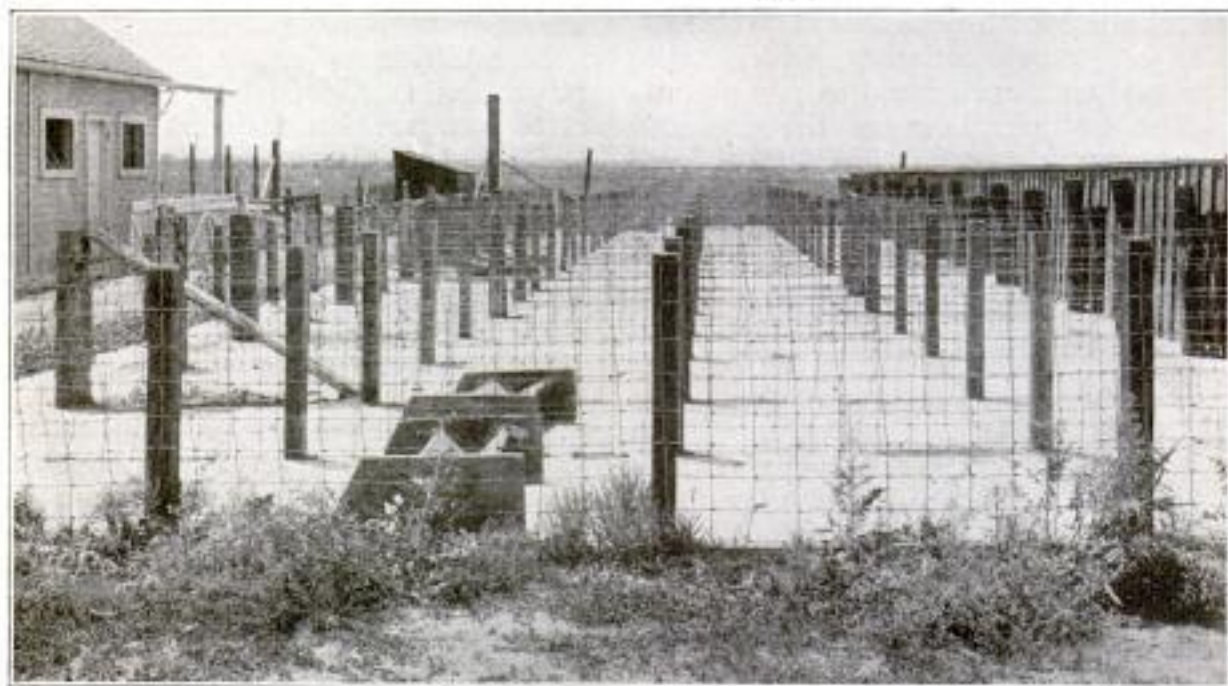

Weaning Yards Ready for Sows and Litters: The Area is Paved with Concrete to Promote Cleanliness among the Young Pigs. In the Sheds Wooden Floors are Preferred, as Concrete Makes the Animals Restless



Fat Hogs Ready for Market, Eating Corn from One of the Self-Feeding Hoppers: At This Stage the Animals Receive Garbage at a Certain Hour Daily, and Alfalfa and Corn as They Wish It

of the yards. The garbage wagon, as it comes from the city, is driven down the alleys and the garbage is shoveled upon the slabs, or floors, of the farrowing or weaning yards, as the case may be. Gates from the fattening yards admit the hogs to the slab. A hog being fattened will not clean up all garbage given him. This service is performed by a special herd of lean scavenger hogs that receive only the food they pick up from the slabs and alleyways. Men with shovels follow the scavengers, and the slabs are washed at regular intervals.

The most ingenious device upon the ranch is the water tank. It consists of a concrete base having a 2-ft. well in the center. Above this rises a galvanized-iron hood with conical top. Two 10-in. recesses permit hogs to insert their snouts, but prevent fouling of the water. Water rises from below through a pipe, the flow being regulated by a ball cock. A slide on one side of the hood may be raised, giving entrance to the lamp chamber below ground. Freezing in winter is prevented by the lamp.

In response to popular agitation two years ago, the hog-ranch company installed a complete sterilization plant at a cost of \$15,000. Its use has been abandoned on the ground that the acetic acid formed by cooking stimulates the hog's stomach for the first two months, and then attacks and ruins his digestive organs.

Until the present year, when the antiwaste campaign instigated by the world war resulted in a 33-per-cent reduction in garbage supply, the average



The Farrowing Shed Containing 500 Pens: The Tablet Attached to the Front of Each Inclosure Bears Data Concerning the Size and Age of the Litter Within

annual yield was 22,000 tons. The ranch pays drivers \$40 a month, and

estimates their board and room at \$20 per month each, making a total collection cost of about \$25,000 a year,



A Typical Litter in One of the Farrowing Pens Which is Floored with Plank: The Percentage of Survivals in Each Litter Is Large

exclusive of horse feed and interest on the investment in collection equipment. Seventy-five horses are used.

The company started six years ago

to immunize all its hogs, and this resulted in the development of a side line that is now one of the most profitable elements of the business. A laboratory of 20 rooms, with pens for 500 hogs, has been built, where cholera virus and serum are manufactured for commercial use. Half a dozen veterinarians are employed here and the product sold generally throughout the West and Middle West. Immunized brood stock, guaranteed for life, also is sold, while the company has acquired and stocked from the mother ranch, two ranches in northern Colorado, where alfalfa is the basic food. About 150 tons of fertilizer, made from the bones found in the garbage or taken from hogs that have been used in the manufacture of virus and serum, are sold every year.

## NEW ASYLUM CONSIDERED

### 1931 ESCAPE-PROOF

The most advanced ideas in the construction of detention buildings are to be found in a recently completed state hospital for the criminally insane which is believed to be escape-proof. The structure is of brick, reinforced concrete, and steel, and is built in the form of a "U," the main portion being three stories high and the wings two stories. A high wall connects the two wings so that the courtyard is entirely inclosed. There are but two entrances to the building, both locking from the

inside. The windows are guarded with flat steel bars. Long hallways run past the individual cells, each of which has a large glass door protected by steel bars permitting a passing guard to inspect the interior. A second door leads to the courtyard where the patients exercise. The building cost \$160,000 approximately.

ⓄThe woman's committee of the Council of National Defense has organized a news-collection bureau which will engage in gathering material of heroic, romantic, and economic nature concerning women in war.



Recently Completed State Institution for the Criminally Insane Which will Accommodate 200 Patients and Which by Reason of Its Special Construction is Considered Escape-Proof

*New Jersey State Hospital for Insane  
Trenton, N. J.*



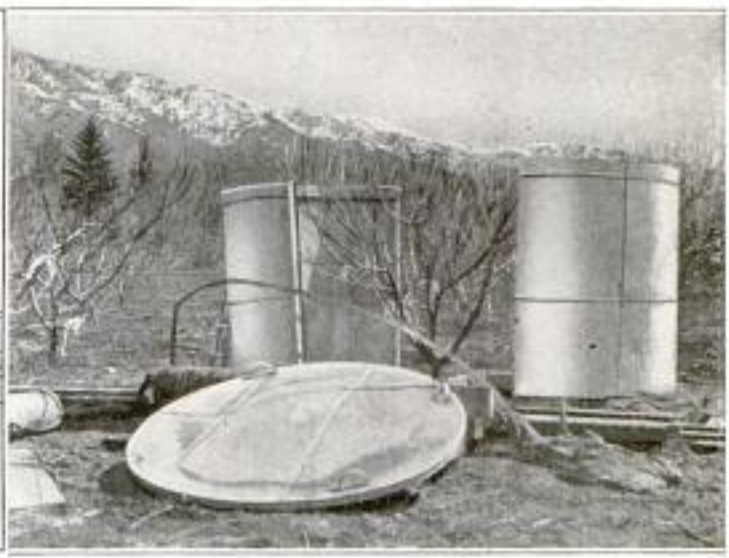
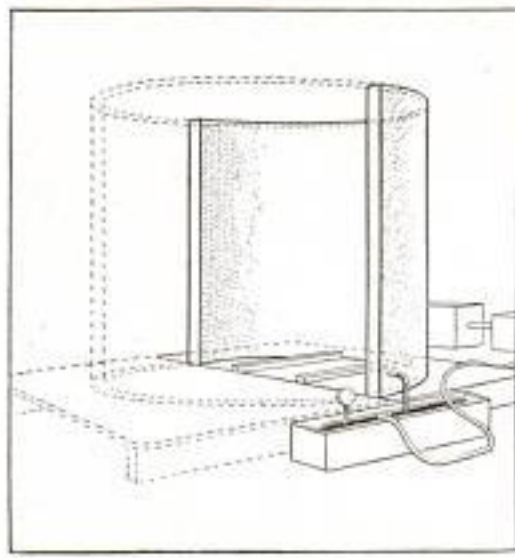

Apparatus for Freezing Whole Fruit Trees to Determine the Damage Which Various Temperatures Produce: The Two Halves of the Cylinder are Set Close about the Tree and Then Cold Air is Forced into the Inclosure

**OUTFIT FREEZES TREES SCIENTIFICALLY**

4817

Investigators at the Utah Agricultural Experiment Station have devised means for freezing fruit trees scientifically to ascertain the amount of injury to fruit which may be caused by frost and a range of critical temperatures. The principal part of the outfit built for this purpose is a double-walled cylinder of galvanized iron, 6 ft. in diameter and 6 ft. high. It is made in two parts, each mounted on a platform so that it can be moved about and fitted around a tree. In the 4-in. space between the outer and inner wall and on top of a cover, ice and salt are placed, after which the whole is covered with canvas. By means of a pump connected with an inlet in the cylinder's side, cold air is forced into the inclosure from a tank surrounded by salt and ice. An electric fan in the cylinder keeps the air in circulation. Projecting thermometers indicate the approximate temperatures of the air within. Hanging from the tree at various heights are registering thermometers which show the lowest point to which the mercury drops, while a thermograph traces the temperature changes.

With this apparatus a temperature as low as 12° F. has been obtained. The cost of operating is about \$10 per 10,000 buds. Valuable data for fruit

growers have been obtained by counting the damaged buds and later noting damaged fruit on trees that had been frozen. This process, while for a different purpose, suggests the practice of packing ice about tree roots to retard budding, as described in Popular Mechanics Magazine for April of last year.

**MAGAZINE SUPPLIES PIPE WITH SMOKING TOBACCO**

To obviate the need of continually refilling his pipe, a smoker has designed a tobacco magazine that feeds the bowl as the content of the latter is consumed. It consists of a metal cylinder supplied with a coil spring and is mounted horizontally above the stem. One end is fitted into a hole bored through the bowl. When continuous



A Spring Inside of the Cylinder Forces Tobacco into the Bowl of the Pipe

feeding is not desired, the spring can be locked and the supply of tobacco in the magazine held in reserve.

## FENDER PICKS UP PERSON

50 70 HIT BY AUTO

Recognizing the fact that the injuries of many persons hit by automobiles are made more serious by rea-



Automobile with Fender Designed to Pick Up a Person Who has been Accidentally Struck, Thereby Preventing His being Run Over

son of the fact that the cars which hit them pass over their bodies, an inventor has recently patented a fender that cushions the blow which a car may give to a pedestrian and at the same time picks him up and carries him along until the vehicle can be stopped. The fender consists of a horizontal platform of meshed wire located in front of the radiator between the mud guards. The latter extend

straight downward a short distance after curving above the wheels and thus permit the fender to be hung quite close to the ground. The wire-mesh platform is not attached directly to the mud guards, however, but to a buffer which is bolted to them. Between the buffer and the fender are several coil springs which help to cushion any blow the car may give.

## FRANCE BUILDS CONCRETE

4912 BOATS TO SAVE TIMBER

Regarding the use of concrete in the construction of vessels, much has been said and a little accomplished in this country during the past few years. It is interesting, therefore, to observe that in France considerable progress is being made in this direction. In order to reduce the consumption and importation of timber, large barges and canal boats are being built of reinforced concrete. Although it is not known how generally the practice has been adopted, the venture is not merely an experimental one. The merits of such vessels are known. They are fire-proof, can be constructed quickly by unskilled laborers, have low maintenance cost, will withstand hard usage, will not rust or rot, and are as easily towed and handled as wooden craft. Reinforced-concrete construction is supposed to have first been employed in the building of small boats. A Frenchman in 1849 built and patented a concrete rowboat.



Stern View of One of the Big Concrete Barges after the Partial Removal of the Outside Forms; Right: The Interior of a Boat Nearing Completion with Forms in Place

COPYRIGHT, M. BRANGER



A Testing Hole between Two Rows of Cars: One Advantage of This Outfit Was That It could be Used in a Switchyard Where Cars were being Moved Frequently



Ascertaining the Depth of a Railroad-Yard Fill: The Weight of the Two Men Gradually Forces the Casing Down into the Hole Made by the Sand Bucket. The Auger Lying on the Rails is Used to Penetrate Clay

4834 **SOUNDING OUTFIT REVEALS DEPTH OF RAILWAY FILL**

Accurate estimates of the depth of railway fills are among the important items which the government's employes are required to obtain in the enormous task of making a physical valuation of the country's railroads. The problem is not as easy as it might appear at first, for in the course of years the weight of a fill in many cases has caused it to settle down into the soil, and as a result calculations based on surrounding natural levels are unreliable. To meet the demands of the situation, a simple outfit has been employed by certain of the engineers, consisting of a sand bucket which is inserted into a casing composed of 4-ft. lengths of 4-in. pipe, screwed together as needed. Two blocks are bolted about the upper end of this casing, which serve as supports on which two men stand after the lower end has been inserted in the soil. By operating the sand bucket inside the pipe the men's weight gradually forces the casing down into the earth until the material brought up shows that the bottom of the fill has been reached.

4595 **PHOTOGRAPH-PRINT DRIER WORKS EFFICIENTLY**

For drying large numbers of prints, a commercial photographer has devised an apparatus that operates very satisfactorily. A wooden frame mounts a big galvanized-iron drum and a number of small rollers, about which two continuous canvas belts are so

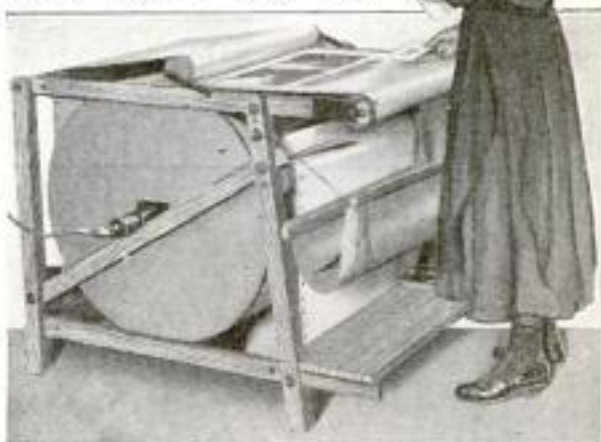

While the Prints are Carried around the Cylinder between the Two Canvas Belts, They are Subjected to the Heat and Dried

stretched that they are held tightly in contact. The cylinder is motor-driven and makes one revolution in three min-

*Inventor: Carl G. Johnson*  
*Law: Claire Mac*  
*not on market*

utes. The prints are placed between the canvas strips at the top and discharged into a hopper at the front of the machine as they complete the circuit. Inside of the drum is a gas burner. The heat keeps the fabric dry and warm.

### LONE MOTORIST TAKES 5084 TWO CARS ON TRIP

A motorist whose duty it was to drive a well-loaded motor truck a distance of 40 miles recently was some-



By Tying the Front Wheels of the Racing Car on the End Gate of the Loaded Truck This Motorist Was Able, Single-Handed, to Transport Both Machines a Distance of 40 Miles

what puzzled as to how he should carry a racing car which he had to take with him on the same trip. There was no room to load it on the larger car, and towing it in the ordinary fashion was out of the question, as there was no one to steer the smaller machine. The problem was overcome by raising up the front end and tying it to the end gate of the truck.

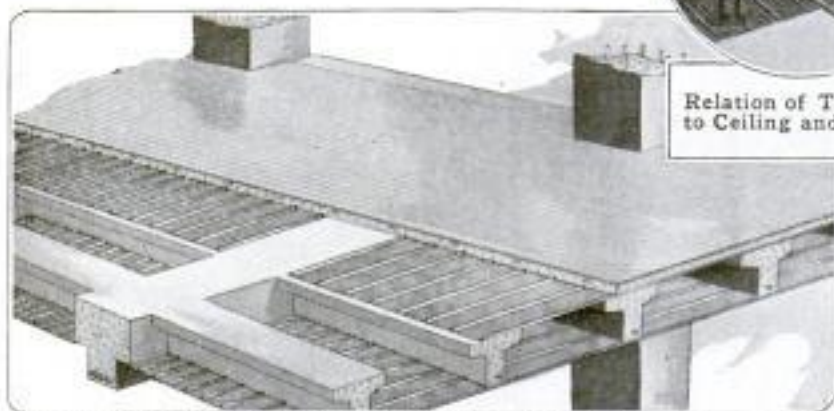

Left: Section of Partly Completed Floor. The Metal Lath are Imbedded in Under Face of T-Beams.  
Right: General View of 12-Story Concrete Office Building in Process of Construction. The T-Beams in the Floors can be Seen in Several Places

### LAY REINFORCED CONCRETE 4842 AT REDUCED COST

In erecting the new 12-story office building for the Federal Trade Commission in Washington, D. C., methods were employed which resulted in a great saving of both material and time, the contractors being able to pour a floor once in every five working days. The supporting woodwork was put up in the usual manner and all the metal lath for a ceiling was laid directly on the wooden forms and tied. Above the lath the reinforcing bars for T-shaped beams were placed so that the beams' centers would be 28 in. apart. Special metal molds for these beams were next installed. When the concrete was poured in them the metal lath below was imbedded in it and so held permanently in place. The steel forms were then removed upward, obviating the usual necessity of delaying the work until the beams had set sufficiently to support their weight and that of the men. After pipes, wires, etc., were installed, sheets of metal lath were laid immediately above the beams. These were covered with a 3-in. cinder-and-concrete floor. This form of construction results in a great saving of dead floor weight and saves much material.



Relation of T-Beams to Ceiling and Floor



Architects:  
Hewitt Halls - I-Beam Engineering Co.  
Washington, D.C.

## 4961 WIRELESS DIRECTS MODEL SUBMARINE

Because of its timeliness and good behavior, a radio-controlled submarine of recent development is commanding attention. The principle of governing vessels from land or air by means of wireless apparatus has evoked widespread comment during late years and

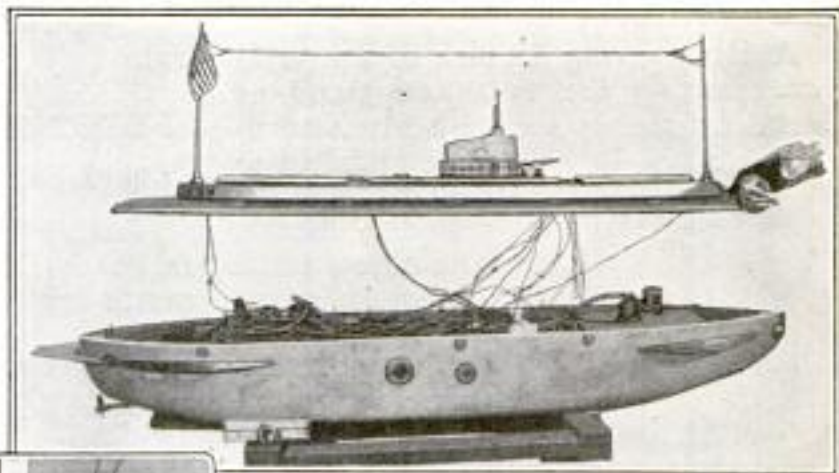

Showing the Mechanism Installed inside the Submersible, the Character of the Fins and the Elevator: The Hand Holds the Tiny Torpedo That is Fired



Eight-Hundred-Pound Model Submarine Navigating under Radio Control: The Vessel Responds Instantly to the Whims of Its Inventor

its application to fighting machines is, of course, its most important and at this time, most interesting phase. Some weeks ago an 800-lb. model submersible was launched in a large tank of water and navigated before an attentive

crowd of spectators. It performed to the satisfaction of its inventor, who regulated its movements by operating controlling keys that caused radio waves to be sent out, which in turn were picked up by antennae carried by the small craft. The vessel responded promptly at the touch of a key, proceeding forward, turning, reversing, submerging, or firing a torpedo, at the will of the inventor. Its builder suggests that a few 50-ft. submarines of this type, loaded with explosives so as to serve as enormous navigable mines, might prove effective weapons for dislodging the German navy from its place of safety in the Kiel Canal.

## THOUSANDS HELP TO MAKE

### 5062 BIG MANUSCRIPT BIBLE

A massive Bible, in the making of which 12,000 persons shared, has recently been completed as a feature of a great Bible campaign that has been instituted in England. The volume is in manuscript form and the thousands of workers who helped make it did so by writing out various passages. The tome measures 6 ft. 2 in. long and 3 ft. 10 in. wide, and when opened is 7 ft. 10 in. across. Seven goat skins were used in fashioning the heavy cover which is richly embellished with coats of arms.

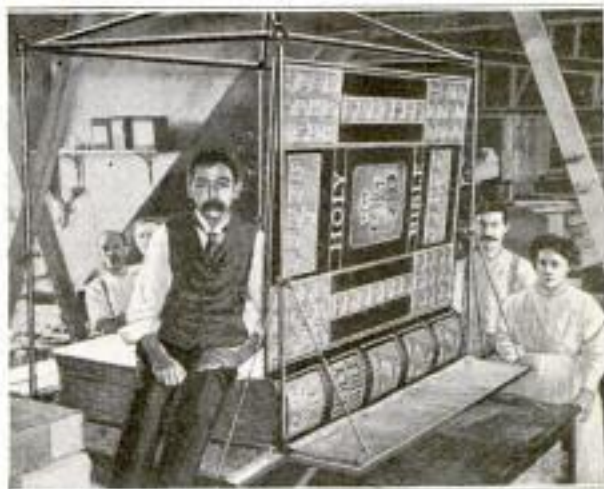

Bible Recently Completed in England Which Is in Manuscript Form and was Written by 12,000 Persons

DeVilbiss Mfg. Co.  
Toledo, Ohio

Adams Campbell Co  
Los Angeles, Calif

**MOTOR-DRIVEN TURNTABLE  
IN SPRAYING BOOTH**

4843

A labor-saving feature of an outfit for spraying the finish on wood or metal articles is a motor-driven turntable installed in the bottom of the spraying booth.



The object to be varnished, having been set on this support, revolves so that all sides can be coated alike. The turntable is driven by a 1/8-hp. motor and its speed can be regulated by means of a friction wheel and disk. A hand lever controls the raising and lowering of the table through a range of 10 in., and it can be stopped with either a hand lever or a pedal, without stopping the motor.

regulated by means of a friction wheel and disk. A hand lever controls the raising and lowering of the table through a range of 10 in., and it can be stopped with either a hand lever or a pedal, without stopping the motor.

**NEW FLOWERPOT SERVES**

5053 AS FERTILIZER

A type of flowerpot, which disintegrates and fertilizes the plants contained in it when the latter are placed in a garden, has been patented recently.



These new containers are made of clay reinforced with straw or jute, the clay being mixed with some suitable fertilizer. This material is molded under pressure and then sun or kiln-dried, but not burned. The pots are filled with earth and used in the ordinary way until the plants they contain are ready to be set out. Then, instead of removing the small plants from their container, they are set in the ground, pot and all. Within a short time the holder disintegrates, fertilizing the roots which gradually

material is molded under pressure and then sun or kiln-dried, but not burned. The pots are filled with earth and used in the ordinary way until the plants they contain are ready to be set out. Then, instead of removing the small plants from their container, they are set in the ground, pot and all. Within a short time the holder disintegrates, fertilizing the roots which gradually

Chas. H. Clifford  
Laenton, N. J.

penetrate it. Such a method of transplanting obviates disturbing the roots of the flowers or vegetables being set out.

**ELECTRIC RAZOR OPERATES  
LIKE TINY CLIPPERS**

5061

Shaving by electric power has been made possible by the invention of a motor-driven razor which operates somewhat like a pair of clippers. The instrument is provided with two blades mounted side by side which resemble safety-razor blades except that each is edged with very fine teeth. In the handle is a tiny



motor which revolves a shaft at high speed, while on the end of the shaft is a cam that causes one of the blades to oscillate rapidly. The shearing motion produced in this way cuts the hair off close to the skin with little effort on the part of the user of the razor.

motor which revolves a shaft at high speed, while on the end of the shaft is a cam that causes one of the blades to oscillate rapidly. The shearing motion produced in this way cuts the hair off close to the skin with little effort on the part of the user of the razor.

**COMBINED WEATHER VANE  
AND DRAFT REGULATOR**

4997

The ornamental metal crow which stands on top of the chimney shown in the accompanying illustration serves both as a weather vane and as a draft regulator. It is mounted on a pivoted base and swings about, keeping its back to the wind. A piece of sheet metal which extends downward from the chimney cover and swings with it, is so situated with reference to the bird that it is always



in the accompanying illustration serves both as a weather vane and as a draft regulator. It is mounted on a pivoted base and swings about, keeping its back to the wind. A piece of sheet metal which extends downward from the chimney cover and swings with it, is so situated with reference to the bird that it is always

on the windward side, thereby sheltering the flue from down drafts.

Home of H. L. Saunders,  
2221 E. 1st St. Los Angeles, Calif

Advised by W. C. Co. that razor was made by them for practice. Since then from that day most razor makers put on this 4/4/18

4070

Aerial

## MANY USES FOR CABLEWAY IN BUILDING BRIDGE



One of the Half-Dozen Uses to Which the Aerial Tramway was Put in the Construction of a Reinforced-Concrete Bridge: Carrying the Forms for the Concrete to the Bridge Carpenters, as Shown Here: This Arrangement Permitted the Men to Do a Large Part of the Carpenter Work on the Ground



Another Use for the Overhead Cable: This View Shows One of the Hoppers, Together with Its Frame Supports, being Transferred to a New Site. These Hoppers were Used in Filling Foundation Holes with Suitable Material



The Picture Above Shows a Frame being Raised into Position. In Some Cases After Frames have been Completed in a Horizontal Position Many Men are Required to Set Them Up, but Here the Work was Quickly Done by Utilizing the Aerial Tramway



General View of the Bridge Site Showing the Cableway Which Spanned the River and Three Railway Tracks: One of the Two 100-Foot Supporting Towers can be Seen in the Distance. In the Fore-ground Are Partly Completed Forms for the Bridge Arches



Excavating for the Foundations: Much Labor was Saved in Transferring the Dirt from the Excavations to Various Fills by Using an Orange-Peel Bucket Which was Suspended from the Aerial Cableway

Westfield Mfg. Co.  
Publicity Dept. Westfield, Mass.

718 5068

### POPULAR MECHANICS

#### SPECIAL SEAT IS DESIGNED FOR TWO-PASSENGER CYCLE

Two workmen who use the same motorcycle in going to and from their



The Broad Seat Allows the Men to Sit Side by Side While Riding to and from Their Work

place of employment have constructed a double seat that permits them to sit side by side while riding. Obviously this is a pleasant aid to conversation and therefore more enjoyable than the usual tandem arrangement. The seat is built with a steel frame, is fitted with springs, and is inclined just enough for comfort.

#### MERCHANTS LIGHT SHOPS TO MAKE WHITE WAY

5116

Quite an interesting system of electric illumination is being employed by merchants of a medium-sized town in the Southwest. Beneath the awnings in the entrances of many stores, 100-watt opal lamps have been installed. In addition to lighting the fronts of the shops and the sidewalks, the lamps assist in illuminating the display windows. In order to insure uniformity, the system was not installed in a block until every merchant on both sides of the street agreed to have one of the lights in his store entrance. So far about 400 lamps have been mounted.

#### POWERFUL AERO SNOW SLED IS ALASKAN WINTER CAR

4567

Motor sledding across Alaskan snow fields became a reality last winter when

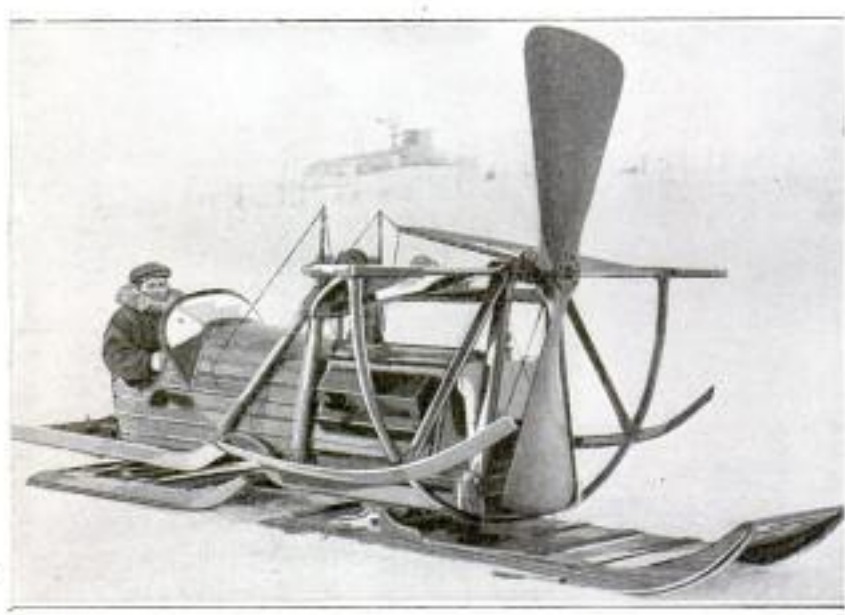

With Its 60 Horsepower, the Motor Gives the Squatty Snow Car Splendid Speed

a northern sportsman and dog racer completed the construction of a high-powered machine designed for practical transportation purposes. It is of businesslike proportions and mounts a 60-hp. motor that drives an aerial propeller of the tractor type. A speed of about 35 miles an hour is easily attained under normal conditions. The driver's seat is in a snug cockpit protected by an inclined shield. The body is carried on two low sleds. Steering is accomplished through the rear one of these, which is considerably shorter than the front member. At the top of a semicircular frame that supports a pair of skids, ailerons are attached. These are em-

Inv. H. H. Allen  
Alaska.



1. - Saw. Kellie M. S. Leavitt  
Mountainview, N. H.

ployed to hold the machine down and also to give it balance when curves are negotiated or strong cross currents of wind encountered. Iron claws, pivoted at the sides of the forward sled, serve adequately as brakes.

5054 **CHAIR CAN BE CONVERTED INTO A CRIB**

In designing a mission chair which can be converted into a baby's crib, a woman inventor has produced a substantial article of furniture possessing double utility. The chair is of generous dimensions, with sides and back of the same height. The bottom, the front crosspiece, and the back are each made in two parts attached to their respective sides and reinforced with wooden strips which slide in grooves so that the sides can be drawn apart several inches. In this way the chair is transformed into a crib. The front cross-

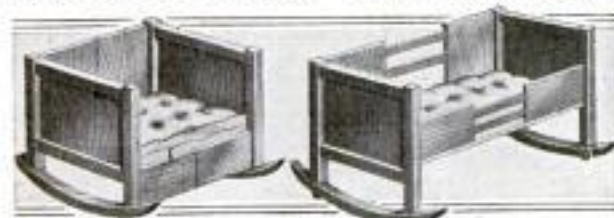

Chair Which can be Converted into a Crib by Drawing the Sides Apart and Turning Up the Front Crosspiece, Which is Hinged to the Seat

piece is hinged to the front edge of the seat and can be turned up to serve as one side of the crib.

4910 **SIMPLE WAY OF BUILDING SEWER IN WET SAND**

By means of sand points—that is, pipes with pointed, perforated ends—which were connected through long suction pipes with a set of powerful pumps, a contractor building a brick sewer was able to keep water entirely out of what otherwise would have been a very wet trench. This arrangement also enabled him to leave just enough water in the sand in the bottom of the trench to make unnecessary the use of a form for the under side of the sewer. A skilled workman, by using a shovel and occasionally a template, was able to fashion the bottom of the trench so

that brick could be laid in it. At 4-ft. intervals on the main suction pipes, laid on either side of the ditch, were

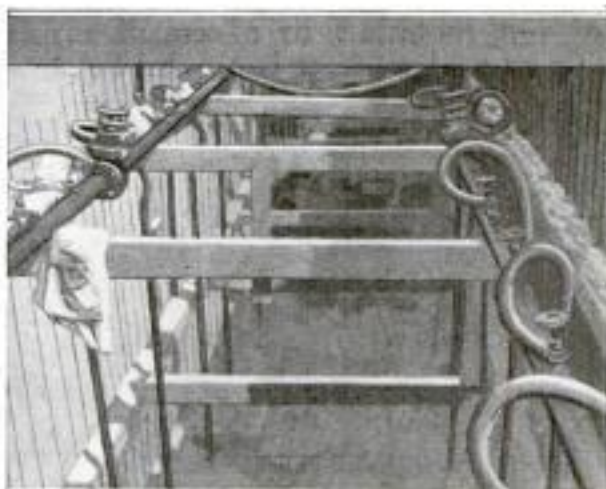

Water was Kept Out of This Sandy Wet Trench by Use of Sand Points: The Moist Sand was Molded to Hold the Brick for the Bottom of the Sewer so That No Forms were Required for That Part of the Work

hand valves by which the sand points could be turned off and on. In this way just the right amount of water was retained in the sand. Four pumps connected to 15-hp. motors were used.

5049 **CRUDE HORSE CAR SERVES OCEAN RESORT'S NEEDS**

The transportation needs of North Beach, Florida, an ocean resort, are filled, in a measure at least, by a horse car that is of the simplest construction. The vehicle is long and narrow, with two rough benches extending its full length facing each other. Each end is open, provided with a step, and



Roughly Built Horse Car Which Carries Ocean-Resort Patrons to and from the Bath Houses

used as an entrance. At the sides are uprights which support a wooden canopy.

Made by  
 Hauck Mfg. Co  
 140 Lexington St  
 Brooklyn, N.Y.

OIL HEATER MAKES CEMENT

5052) MIXING SAFE IN WINTER

Protection against possible freezing of wet materials in a cement mixer during cold weather is obtained at low

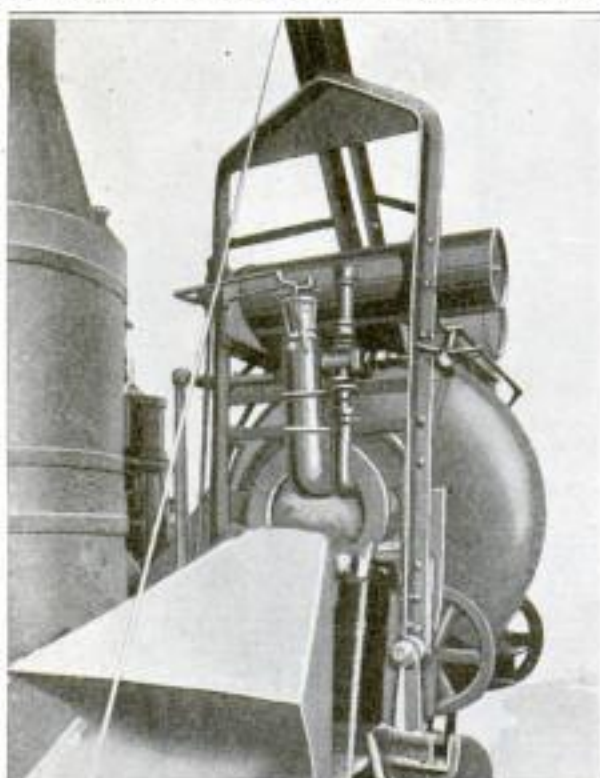

Oil Burner Which Forces a Flame into the Drum of the Cement Mixer, Thereby Preventing the Freezing of Materials in Winter

cost by using an oil-burning heater which can be attached to practically any mixing machine. Such a device unquestionably can save money for a contractor by making it safe to operate continuously when the temperature is low. The heater is provided with a 25-gal. tank which is mounted above the mixer and is connected by a pipe with a burner situated at the opening in the side of the mixing drum. Compressed air, obtained either from a hand pump or a compressor, is used to vaporize the oil and in this way a flame is forced into the interior of the drum, keeping the materials there thoroughly warm. The oil consumption is from 1½ to 2 gal. per hour. A somewhat smaller equipment is provided with a 20-gal. oil tank and operates without a compressor, the oil itself being kept under pressure by means of a hand pump.

ITALY WINS WORLD HONORS IN AEROPLANE BUILDING

While attention has been focused upon the aeronautical progress made by the British, French, and Germans, Italy seems to have forged ahead unobserved and captured the honors as the builder of the world's premier air craft. Information from apparently reliable sources indicates that the Italians now possess not only the fastest, but also the largest and best climbing aeroplanes in existence. Their success has been due to the perfection of extraordinary engines capable of producing from 500 to 700 hp. These motors are making possible the construction of planes that are larger than have heretofore been feasible. There is now being built in Italy a machine that will be driven by motors producing 3,000 hp. It is expected to carry 50 persons.

NEW TENNIS RACQUET CASE 5034 SERVES AS PRESS

Among late accessories for the tennis player is a combination racquet case and press that is durably made of sole leather and insulated with felt. The back is constructed of wood veneer and forms a solid, flat surface, against which the frame of the racquet is firmly held by four steel arms. These constitute the press, which is fixed to the inside of the cover, and are operated from the outside by turn-

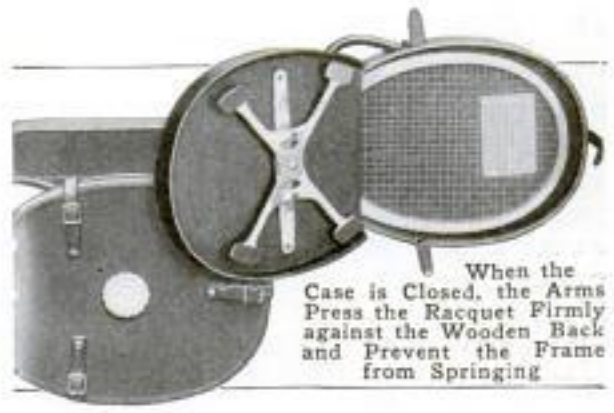

When the Case is Closed, the Arms Press the Racquet Firmly against the Wooden Back and Prevent the Frame from Springing

ing a small disk. Dampness cannot enter the case and there is no danger of the racquet frame warping or the gut being injured.

Wright & Ditson  
 16 S. La Salle St. Chicago, Ill.

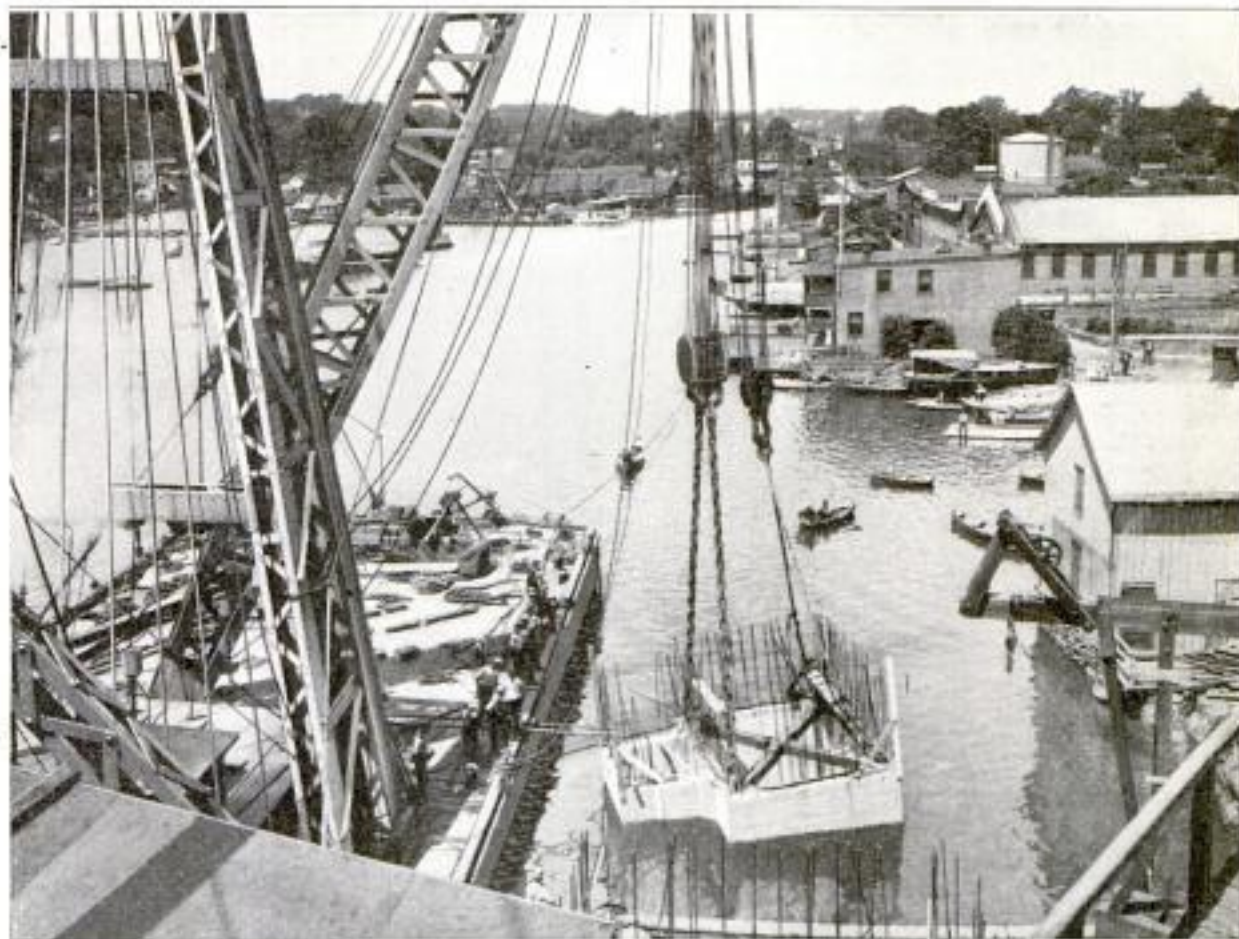

COPYRIGHT, BROWN & DAWSON  
 Showing the Powerful Derrick at Work Lowering One of the Reinforced-Concrete Intake Cribs, Weighing 150 Tons, into Place in the Harbor

*Water supply*

### 5059 MASSIVE CONCRETE CRIBS INSTALLED BY DERRICK

Two reinforced-concrete intake cribs, each weighing about 150 tons, were lowered into place in the harbor at Stamford, Conn., some weeks ago by one of the most powerful floating derricks available on the Atlantic coast. The structures were built on a platform erected adjacent to a pier, and when ready for installation were hoisted one at a time, moved a short distance to a point where excavations had been made for them in the bottom of the sound, and then dropped gradually into position. Despite their great weight they were handled without difficulty and sunk to a depth of about 25 ft. below the level of the near-by dock. Each of the structures is divided into two compartments. The screening chambers are equipped with traveling conveyors that elevate foreign matter, such as mud, leaves, drift, and fish, to

the top of the cribs where it is discharged. Centrifugal pumps driven by 100-hp. motors are mounted in the other compartments and supply water to the condensers in a local gas and electric plant.

*Unusual Use*

### 5083 MAKING MOTORCYCLE SERVE AS FIRM-CAMERA SUPPORT

By fitting a small attachment to one of the handlebars of his machine, a



Two Views Showing Motor cycle Handlebars Fitted with Tripod Head to Support a Camera

motorcyclist can advantageously eliminate a tripod from his photographic equipment. This has been done successfully by a press photographer who makes many exterior exposures and uses a cycle for transportation. A tripod head is mounted on a universal joint which in turn is held in place by a clamp. This arrangement permits a camera to be focused at any angle without difficulty. When a machine is stationary and supported by its stand, it is vibrationless even in a strong wind.

### 5074 **ELECTRIC FOOTBOARDS MADE FOR TRAFFIC POLICE**

In an attempt to lessen the exposure to which traffic policemen in northern cities are usually subjected during winter months when they must stand on icy pavements many hours each day, an inventor has devised an electric footboard. It is a small rectangular contrivance supplied with heating element and arranged to be connected to a lighting circuit. When it is placed near a curb, adjacent to



a lamp-post or an electric-light pole, current is readily obtained. Not only does the device provide a warm, dry place for a policeman's feet, but it can be made to radiate enough heat to aid materially in keeping the lower part of his body warm during frigid weather.

### 5125 **RED CROSS TO SEND FOOD TO FAMISHED PRISONERS**

In connection with a definite statement by the Red Cross to the effect that the Germans are giving totally inadequate food supplies to their prisoners, that organization announces the formation of a prisoners' relief committee in Berne, Switzerland, which will endeavor to look after our soldiers

who may be captured. At present there are about 100 Americans held by the kaiser's forces. Most of these are civilians taken from American merchantmen, while some of them are from gun crews.

The deplorable condition and the testimony of certain returned French soldiers who have been imprisoned, show that they suffered terribly from insanitary surroundings as well as from malnutrition. British, Canadian, and Australian prisoners are now dependent exclusively on food shipped from London, our Red Cross asserts. Already the Berne committee is sending bread to our fellow countrymen in Germany and arrangements have been made for transmitting letters and money from their families and friends. Assorted-food parcels and clothing will also be sent soon. In the meantime the Central Prisoners of War Committee of London has been acting for Americans held in Germany. By arrangement with the Teutonic government the food parcels are sent to the prisoners three times a fortnight.

### 5030 **SAFE FOR HOME USE SET IN MAHOGANY CABINET**

A feature of a safe now on the market which makes it especially suited for home use is the tall mahogany cabinet in which the safe proper is set. Outwardly the article resembles a smoker's cabinet, with a drawer at the top, a wooden door, a lock on the front, and a shelf beneath. This wooden exterior gives it an appearance entirely in harmony with other household furniture. Being mounted on casters, the cabinet can be moved about easily.



*Herguson Prod. Mfg. Co.  
New York City*

# TRAINING BALLOONISTS FOR WAR

By R. P. CRAWFORD



COPYRIGHT, UNDERWOOD & UNDERWOOD

A Daring French Observer Escaped from This Burning Balloon in His Parachute and Then, as the Wind Swept Him to One Side, He Seized His Camera and Obtained This Snapshot, Thus Performing a Feat Perhaps without Parallel

To become a balloonist attached to the Signal Corps requires approximately four months. During that time the youths are put through a rigorous course, including work with both free and captive balloons, class instruction, infantry drill, and general signal-corps work. The qualifications for a balloonist are much the same as for an airman: good eyesight, hearing, and physical health. All these qualities must be

**I**N June of this year began the training of the first contingent of men who within a short time will be directing the aim of the big guns in France. This interesting part of our war preparations is being carried out at Fort Omaha, Neb., where for many years the government has owned a hydrogen plant.

The object of the balloon school is, of course, to turn out men capable of handling the big observation balloons on the French front. Ballooning is different from airplaning. The balloon's sole purpose is to enable an observer to watch the work of the guns as they batter at the enemy's trenches. If the aim is not correct he telephones to the gunners down below. On the other hand, the airplane serves for bomb dropping and spying behind the enemy's lines. The observation balloon stays put, in one place, and so is ideal for observation of any portion of the line.

present to a degree above the normal.

It is, however, only the officers of a balloon company who make the observations. A company consists of 91 men and the entire number of enlisted men is necessary to carry on the miscellaneous work in handling the balloons. The young men who aspire to be officers must, generally speaking, be college graduates or have completed three years of such a course. They do not



COPYRIGHT, UNDERWOOD & UNDERWOOD

This Photograph was Taken a Few Moments Later Than the Accompanying One, by an Eyewitness on the Ground Who could Scarcely Discern the Imperiled Balloonist Descending Less Swiftly Than the Flaming Gas Bag

go first to one of the regular training camps, but are assigned directly to the school at Omaha.

The main part of the instruction consists in actual balloon work. The student makes flights in both captive and free aircraft. The very first lessons may be taken in a sham balloon contrivance which gives the novice some of the fundamentals of the game. It consists of a basket suspended from a sphere of canvas in the shape of a balloon, which in turn is fastened to the ceiling of a hangar. The student stands in the basket while the instructor proposes certain air conditions. He handles the ropes just as if he were in a real balloon. There are two ropes in the basket, one which, in a real balloon, allows the gas to escape gradually through a valve and another which controls the "rip panel" and allows the gas to escape in a body. The latter rope, of course, is usually pulled only when a balloon is near the earth, and an accidental pull at the wrong time would spell serious consequences for the observer.

On alternate days a student is given a hand at a big obser-



Captive Balloon in Which Students Make Ascents About Once in Every Two Days

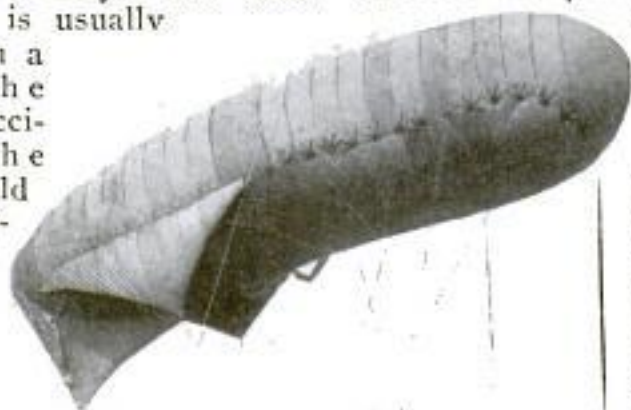

vation kite balloon. It is brought down and sent up every half hour, thus giving each pupil a chance about every other day. This balloon is firmly anchored with a 1/4-in. steel cable to an automobile truck, the engine of which furnishes the power to haul it down. There is also a telephone wire running from the balloon to the ground by means of which the observer keeps in touch with the men below.

To make the work realistic and typical of actual conditions, representations of trenches and embankments are located about four miles away in the country. There smoke bombs are set off every few minutes. The balloonist in the basket, high above the fort, judges how far these bombs, supposed to be shells fired at the enemy, are missing the trenches. He either telephones down or marks on a map divided into sectors the places where the bombs have exploded. The men out in the country also keep track of the actual locations of the bombs. In the evening the two sets of records may be compared and it can be determined how proficient the students are becoming in judging distances. Flights in



A Side View of the Same Type of Balloon as Pictured Above: It is in These Craft That the Students Get Their Training in Observation under Conditions Closely Resembling Actual Warfare. The Portable Hangar is Also Shown



On the Left Is the Hangar and Hydrogen Plant at Fort Omaha Where Men are Now being Trained to Handle Big Observation Balloons on the Front in France. Gas Stored in the Tank is Used to Inflate Both Free and Captive Craft Used by the Students

Drilling the Automobile-Truck Drivers: The Picture on the Right Shows Some of the Motor Cars Which Carry Hydrogen Tanks for Inflating the Big Gas Bags. Drill of the Character Illustrated Here is a Part of the Students' Daily Program Which Certainly Has Much of Variety in It



Inflating What is Called a "Nurse" Balloon. Used under Certain Conditions to Supply Limited Quantities of Hydrogen to Big Balloons

Instead of the Anchor being Raised and Lowered from the Ship, in Ballooning the "Ship" is Raised and Lowered from the "Anchor," Which, in This Case, is a Truck with a Powered Windlass on Which the Steel Cable is Wound

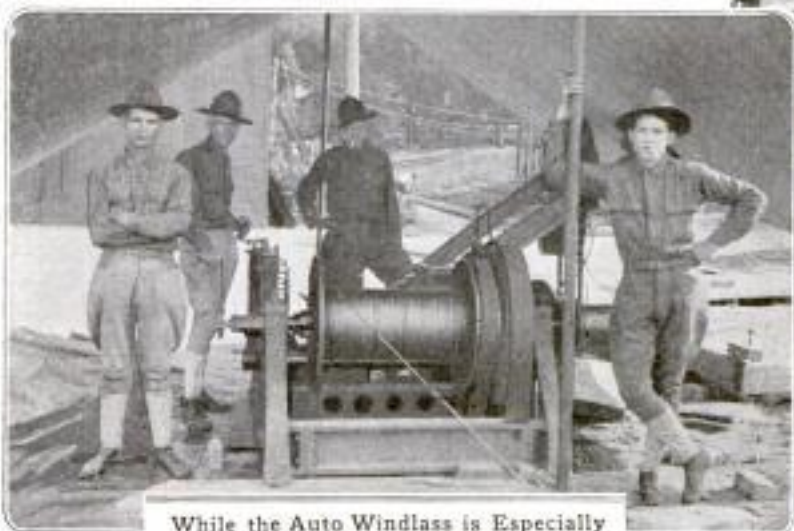

While the Auto Windlass is Especially Adapted to Field Work, Such Means is Supplemented at the School by This Electric Windlass



The Portable Telephone with Which Reports are Received from the Observer Stationed High above the Field: On the Accuracy of the Data Coming over This Wire Depends the Effectiveness of Large Fighting Forces. The Telephone Cable is Wound on a Reel by Hand



To Loiter Is to Court Death When Handling an Observation Balloon Close to the Firing Line, for Enemy Aeroplanes Are Ever on the Alert to Drop Fire Bombs on Such Conspicuous Targets. This Is One Reason Why Haste is Required in Such Preparatory Movements as are Shown in This View of Student Balloonists at Fort Omaha, Nebraska. For Them the Spreading Out of the Canvas Is Only a Matter of a Few Seconds

free balloons also form an important part of the instruction. Of course in actual warfare it is not expected that free balloons will be used. There is danger, however, that a captive balloon may break away at any time, and for that reason an observer must have experience in bringing the craft safely to the ground. Seven free flights in spherical balloons are made altogether, each one of which must be more than an hour long. One of these flights must be at night, one in which the pupil is alone, and one in which the student does all of the work in the presence of an instructor.

Field work is also taken up. The balloon and sufficient hydrogen tanks are loaded on automobile trucks and taken into the country where work is carried on under war conditions. A portable hangar, consisting of a large tent, is provided when it is desired to keep the inflated balloon out overnight.

The student also receives some instruc-

tion in the general work of the Signal Corps, such as telegraphy and signaling. For the regular enlisted men there is balloon drill every morning. This consists in spreading canvas and making ready to inflate a balloon in the field. As speedy work is required here as on the battle front. The enlisted men also care for the automobile trucks and hold down the balloons while they are being inflated and removed from the hangar. Parachute work is also part of the instruction for the observers. In

actual work on the battle front hostile airplanes may at any minute drop fire bombs on the balloon. In such a case the only safety for the observer lies in the prompt use of the parachute. Besides receiving a first lieutenantcy in the Signal Officers' Reserve Corps at the end of the course, the student is licensed as a balloon pilot by the Aero Club of America. Also, he is in line for the most adventurous type of service which the war has to offer.



An Instructor and a Student About to Make an Ascent in a Kite Balloon



## WEED BURNER IS ATTACHED TO OLD LOCOMOTIVE

To eliminate growing vegetation from the tracks of the Spokane, Portland, and Seattle Railway during the past summer, an old oil-burning locomotive was equipped with an incinerator and dispatched over the line. The apparatus was designed by the mechanical department of the road and performed efficiently when placed in operation. Fuel oil and steam to atomize it is carried through pipes to a series of six burners mounted a few inches above the rails and just ahead of the leading pony truck. They are arranged in a sheet-iron box that is filled with crushed firebrick and are similar to large blowtorches. To deflect the heat

against the roadbed, a large shield, supplied with a water pan, is attached with stay rods to the front of the locomotive and supported close to the track. Back of the pony trucks there is a sprinkler that is used as a protection for the ties.

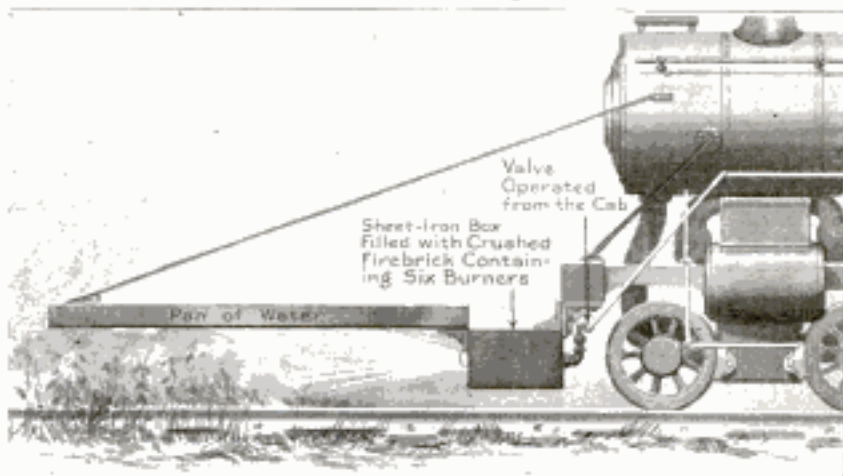

Carrying an Auxiliary Supply of Fuel Oil in a Tank Car, the Engine Averages from 15 to 20 Miles a Day While Freeing the Roadbed of Growing Weeds

The engine carries a supply of fuel oil and can cover from 15 to 20 miles a day depending on the density of the vegetation.



COURTESY OF THE AMERICAN MUSEUM OF NATURAL HISTORY

### SAN SALVADOR RECOVERING FROM DISASTER

THE stricken people in and about the city of San Salvador, the capital of the little republic of Salvador in Central America, are slowly recovering from the sudden and fearful destruction which was wrought in their midst by the recent earthquake and volcanic eruptions. To the wreckage produced by the seismic disturbances was added damage caused by fires and torrential rains. The latter filled the debris-strewn streets with mud, as the accompanying illustration shows, and greatly hindered the work of reconstruction. Fortunately the disaster, though great, was not as overwhelming as early dispatches indicated.

Designers: Underwriters Laboratories  
 B. E. Blanchard, Asst. Secy. 207 E. Ohio St  
 Chgo. Ill.

4974 **COLUMN-TESTING APPARATUS  
 USED BY UNDERWRITERS**

For testing structural columns of different sizes and types, elaborate appa-

to break, are all questions of importance that the apparatus answers definitely for the benefit of engineers, architects, and others. Two of the heavy brick walls of the furnace are movable and all of them are equipped with gas blast burners. Above the furnace is a ram capable of exerting a downward pressure of 256 tons. Under test a column is subjected to a temperature of 1,500° F. at the outset. This is increased step by step until 2,300° is reached. Mica windows in the furnace walls permit the action of heat and pressure to be watched and records made every five minutes.

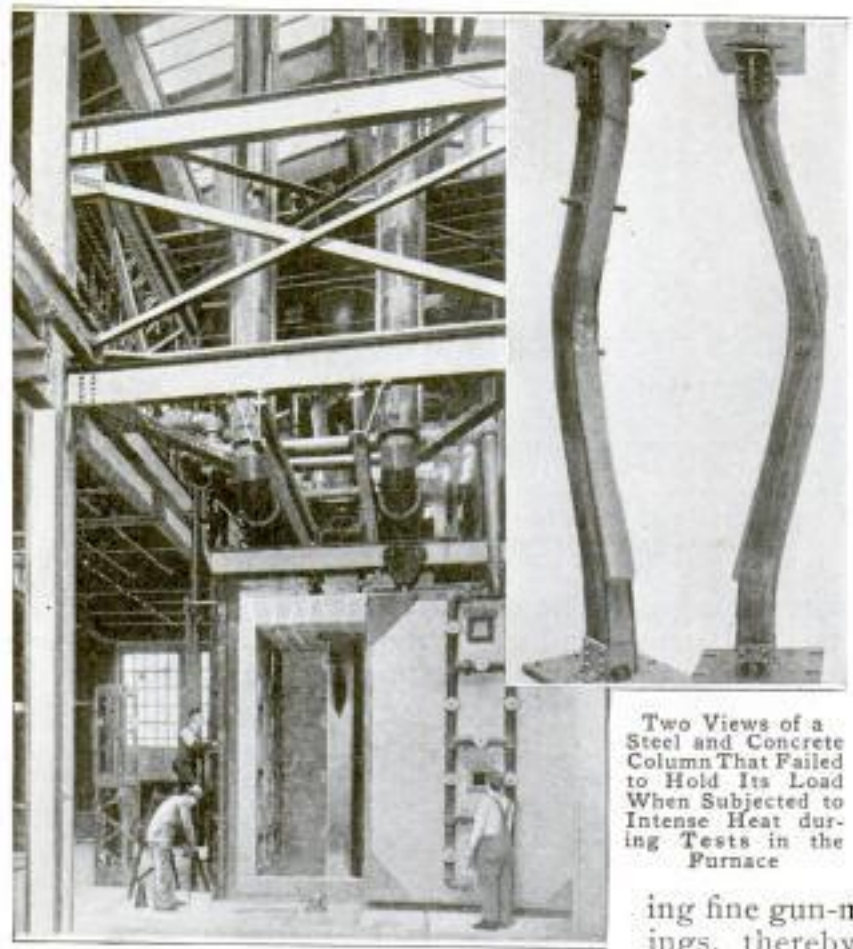

Two Views of a Steel and Concrete Column That Failed to Hold Its Load When Subjected to Intense Heat during Tests in the Furnace

One of the Movable Furnace Walls Opened to Show a Large Building Column in Position for Test: The Ram is Supported by the Steelwork Above, While the Pipes are Flues for Discharging Fumes. Mica Windows are Provided for Observation

ratus has been provided in one of the large physical laboratories of the National Board of Fire Underwriters. It is claimed to be the only equipment of the kind ever constructed for such a purpose and is now being used for the first time. Essentially, it consists of a large gas furnace in which a pillar can be subjected to great pressure along with high temperatures and the effect of each studied. Whether a specific column could carry its load in the presence of intense heat, in what way the materials would withstand flames, what would result if a stream of water were played upon the member during a fire, and how much weight would cause it

**FINE METAL BORINGS SEPARATED BY NEW METHOD**

The chief chemist of a foreign railway has perfected a method of automatically separating fine gun-metal and white-metal borings, thereby supplementing the old method of separation which was satisfactory for coarse borings only. After being transferred to bins and graded as to size by suitable means, the borings eventually are discharged into special furnaces in which the separation of the two metals takes place. Each furnace is made of tubes, one fitted inside the other. In the space between the walls of the furnace is a coil of pipe with suitable perforations for heating the inner tube with gas. The smaller tube revolves and as it turns the hot borings and the white metal which has become liquid, pass from it into revolving screens of very small mesh. The white metal escapes through the screens into a heated container whence it is run off into molds. The clean gun-metal borings are passed along and dealt with separately.

Chief Chemist  
 New South Wales R.M. Dept

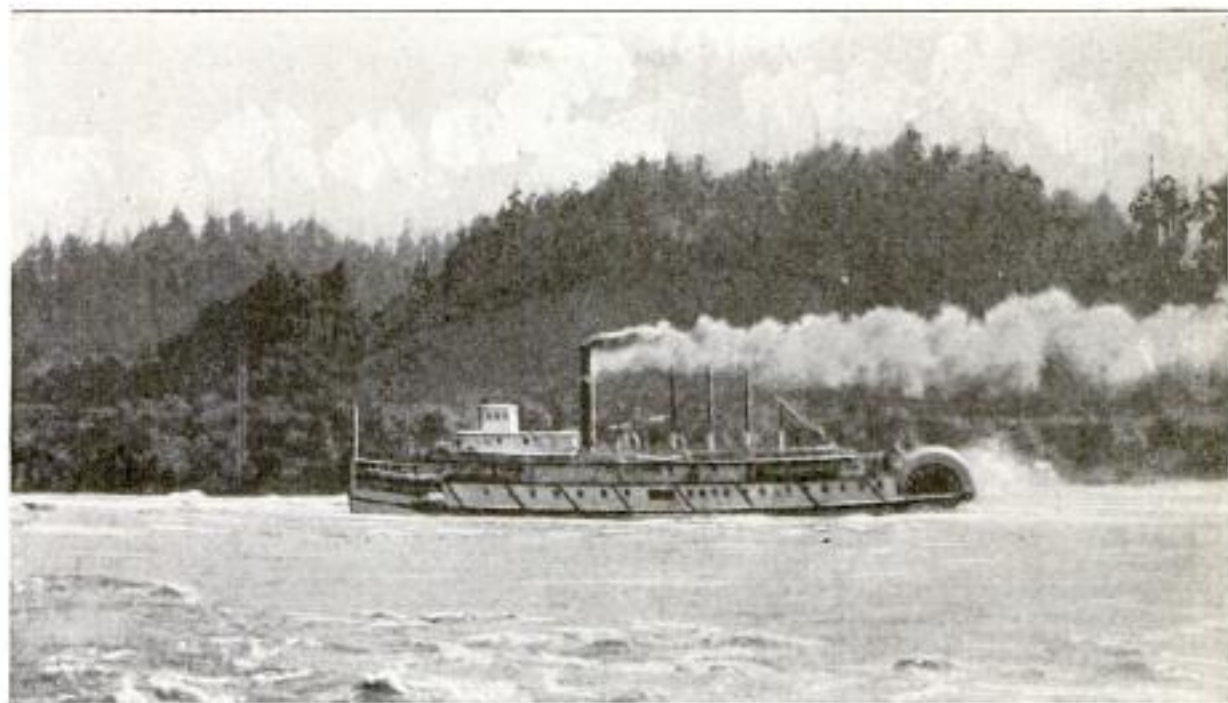

At Express-Train Speed the "Bailey Gatzert," with 125 Passengers Aboard, Shot the Treacherous Rapids in the Columbia River without Disaster

### 5080 PASSENGER VESSEL SHOOTS COLUMBIA RIVER RAPIDS

With 125 passengers aboard, the stern-wheel steamer "Bailey Gatzert" negotiated the roaring Cascades of the Columbia River at express-train speed some weeks ago. So far as is known this is the first time a passenger vessel has attempted the dangerous trip through the rapids. Owing to high water the boat on its upstream voyage was barely able to pass the locks at the Cascades. On the return trip, later in the day, the water had risen to such a stage that the locks had been closed. The captain faced the alternative of tying up the steamer or running the rapids. He chose the latter course, piloted the ship to the middle of the river and plunged downstream, braving dangerous rocks, cross currents, and whirlpools at a startling speed. The feat was accomplished without a mishap. Twenty-four years ago the steamer "D. S. Baker," towing a barge, shot the Cascades successfully. It is said that previous to that time four freight vessels had also made the trip. The "Bailey Gatzert," however, was the first passenger boat to take the chance.

### 4979 ORNAMENTAL AUTO SIGNAL HAS ELECTRIC CONTROL

A new auto signal of ornamental design consists of an electric motor that operates a white translucent hand bearing the word "Turn," and a semaphore set at right angles to the hand. There are two of these signals in each outfit, one for the rear and one for a front fender. They are controlled by a switch mounted on the steering wheel and can be set with the hand pointing to the front, rear, right, or left. The sides of each semaphore bear the words "Go" and "Stop" respectively, and are displayed according to the position of the hand. At night the signal is illuminated by a light within the hand.

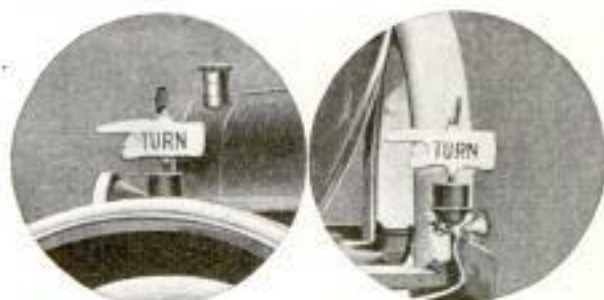

The Signals at the Front and Rear are Controlled by a Switch Mounted on the Steering Wheel. Current can be Taken from the Storage Battery or from Dry Cells

Mfg. The L. L. Britton Co.  
1107-2nd Nat. Bk. Bldg.  
Toledo, Ohio

1-*Jan!*: Gladie Pohrbough  
3016 Mason St. Omaha,  
nebr.



Preparing to Haul a Car to the Pound in Detroit: A New City Ordinance Requires That Automobiles Left at the Curb in Violation of Certain Rules shall be Kept by the Police Until a Fine is Paid

### SPECIAL TOOTHBRUSH HAS TWO SETS OF BRISTLES

5010 A special toothbrush, the bristle-holding end of which is bent to form a right angle, has been invented to use on the teeth which form a part of a bridge of gold or other materials. The bristles on the outer end of this brush vary in length, with the longest ones at the tip, and are set at an angle, thereby forming a diagonal brushing surface

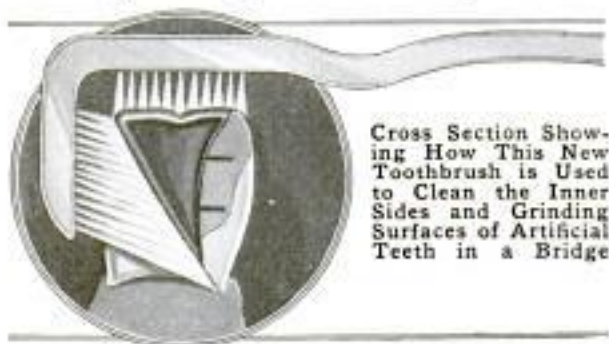

that corresponds to the surface on the inner side of the false teeth. This surface is difficult to clean with an ordinary brush.

¶The X-ray has been employed recently in determining whether certain New York troops have tuberculosis. Of the first 600 men examined by this means, 22 were found to be so infected as to disqualify them for military service.

### ENFORCE NEW TRAFFIC LAW BY IMPOUNDING AUTOS

4901 Motorists in Detroit, Mich., where there are a large number of car owners, have facetiously remarked that "nowadays the automobile leads a dog's life." The occasion for this complaint is the enforcement of a new city ordinance which resembles the provisions for dog pounds by requiring that automobiles left at the curb in violation of regulations shall be impounded. Since the passage of this regulation, last February, more than 5,000 cars have been hauled away to the pound, which is a roped-off area in one of the downtown squares. A fee of \$3 must be paid before a car is released.

This penalty is imposed for double-row parking, for parking in a safety zone, for parking within 70 ft. of an intersecting cross walk, or within 15 ft. of a fire hydrant, for parking an hour anywhere in certain congested districts, and for allowing a car to stand in front of a theater, church, office building, or other structure where large numbers congregate. This is only a part of the list of prohibitions which have been deemed necessary to relieve congestion in this city. Special police, nicknamed "dog catchers," mark cars so as to know when they have stood at the curb over an hour.

4445 **OUTDOOR SAFETY VAULT FOR  
MOVIE FILMS**

An outdoor vault of solid concrete has been constructed on the grounds of a California movie studio, for the safekeeping of negative picture films, which are often of great value, while the material is extremely inflammable. The building is rectangular and provided with double steel doors on two sides, each entrance being further protected by galvanized-iron outer doors of special fireproof construction, operating automatically on roller tracks which incline inward. An iron railing surrounds the building and strict rules govern its use.

A tank containing water maintained at a depth of 18 in. occupies the full

extent of the roof, and the pipes of a sprinkler system run along the top of the outside walls, so that complete curtains of running water protect the building in case of fire near by. These precautions are fully justified by the



Safety Vault for Picture Film at a Movie Studio: The Building Is of Solid Concrete and Its Roof Is a Water Tank. At Times It Holds \$500,000 Worth of Film

fact that half a million dollars' worth of film is sometimes stored in the vault.

4490 **CHANGEABLE SIGN TEACHES SAFETY FIRST**

A large sign which is almost sure to attract attention from day to day because its legend is changed frequently

has been erected near the entrance of a big mining company's works as a feature of a safety-first campaign among its employees. The board is divided into eight horizontal panels so constructed that they will each hold a row of 6-in. enameled letters. With these letters new safety maxims are spelled out daily, hence the legends never become so old as to be ignored by the men. Some space is usually devoted to the accident record of the previous day. The sign is surmounted by a clock and at night is illuminated by flood lights.



Changeable Safety-First Sign near Entrance to Mining Company's Works: New Legends are Placed on It Daily so That the Men Get in the Habit of Looking at the Board as They Pass

Used by Anaconda Copper Mining Co.  
Butte, Montana.  
Copyrighted material

4947

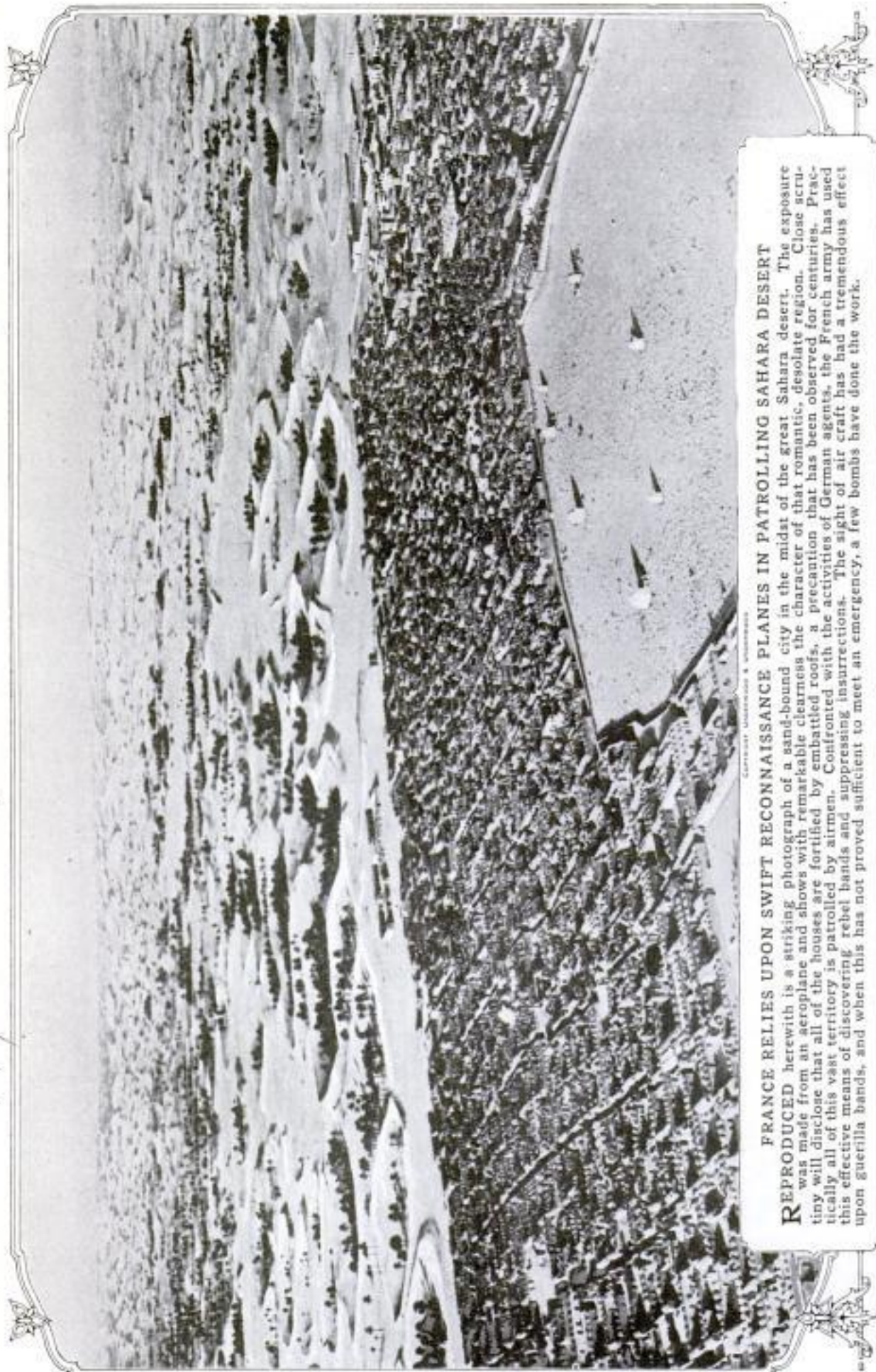

CAPITAIN UNDERWOOD'S CAMERA

**FRANCE RELIES UPON SWIFT RECONNAISSANCE PLANES IN PATROLLING SAHARA DESERT**

**R**EPRODUCED herewith is a striking photograph of a sand-bound city in the midst of the great Sahara desert. The exposure was made from an aeroplane and shows with remarkable clearness the character of that romantic, desolate region. Close scrutiny will disclose that all of the houses are fortified by embattled roofs, a precaution that has been observed for centuries. Practically all of this vast territory is patrolled by airmen. Confronted with the activities of German agents, the French army has used this effective means of discovering rebel bands and suppressing insurrections. The sight of air craft has had a tremendous effect upon guerilla bands, and when this has not proved sufficient to meet an emergency, a few bombs have done the work.

Stanley Wyckoff,  
Indianapolis Poultry Co.

Preserving  
In. POPULAR MECHANICS  
4553

EGGS CANNED LIKE CORN  
4644 FOR TABLE USE

Experiments in canning eggs have been conducted by a large poultry dealer with such success that it is now proposed to develop the process commercially. Six fresh eggs are broken into a can, which is then sealed and placed in steam where the contents are cooked in the same manner as canned corn or peas. It is said the process keeps the eggs fresh and fit indefinitely, and on being opened the coagulated mass can be sliced and served like meat roll.

A proposed variation of this method is to place each egg in the can in a parchment wrapping so that it can be removed separately when the container is opened.

### JAPANESE LAKE PRODUCES

5043 MUSICAL SOUNDS

A natural phenomenon which occurs at Lake Haruna, Japan, during the winter months has made that beautiful body of water known to natives and foreign travelers as "the musical lake." It seems that when the water is in the process of freezing, strange sounds resembling the firing of muskets or small cannon can be heard on the surface of the lake, particularly at night. This apparently is produced by the straining and cracking of the ice, but for some reason the sounds occur in a sort of rhythmical cadence and are said to possess a remarkable musical quality not found in other instances. Doubtless the unusual and picturesque setting of the body of water serves to accentuate the rather weird impression produced. At times as many as 60 reports a minute may be heard resounding across the surface of the unusual lake.

To the list of unusual specialty shops has been added an open-air, carbon-



At This Outdoor Automobile Station, One Attendant Is Able to Remove Carbon from the Cylinders of a Dozen Cars Simultaneously

removing station for motor cars. The method and equipment employed enable one attendant to care for as many as 12 cars simultaneously. Carbon remover is stored in an elevated tank that supplies a 1-in. pipe to which a dozen rubber tubes are connected. The latter convey the preparation to the cylinders.

### DEVICE FOR EXTRACTING 4867 RUGS FROM A PILE

The tedious task of displaying rugs to purchasers is lightened by a new roller with which any rug may be with-



Rug Extractor Which Makes Easier the Task of Fully Displaying Any Rug in a Pile

drawn from its pile so that the whole of it may be viewed. A long tubelike member, fastened to the edge of the rug, is provided with a ratchet and lever by means of which the rug may be quickly rolled up and then removed from the pile.

Marietta Rug Extractor Co.  
Marietta, Ohio.

Copyrighted material



Extensive Potash Works at San Diego, California, Which Sprang Up in Response to Demands Created by is Protected by an Armed

5 3/4  
11

**ODD PLAN OF AMELIORATING MOTOR-CAR TIRE TROUBLE**

To safeguard motor-car tires against blow-outs, an inventor proposes the novel scheme of installing small reservoirs in, or on, the wheels of a machine and connecting them with the tires for the purpose of cooling the air and thereby preventing the excessive pressures that are occasionally produced by expansion resulting from heat. The reservoir would serve as a radiator through which the air of a tire would be circulated and cooled.

**BRANDING MACHINE SEARS NAME ON ORANGES**

41 56

Not satisfied with marking its oranges with stickers or wrappers, a

fruit growers' association is now branding its trade name on its fruit with electrically heated dies. The branding machine has a revolving wheel carrying 18 radiating plungers, on the end of which the trade name is embossed. The temperature of the letters is governed by a thermostatic apparatus. In revolving, the markers pass beneath an inking device and then strike the oranges one after another as they are fed beneath the wheel on an endless belt composed of cup-like units. The heated letters sear the skin so that the ink, which is indelible, penetrates it and cannot be removed. This machine's capacity is 360 oranges per minute. Others of similar design are made for pears and apples. In some cases the letters are seared on without using ink.

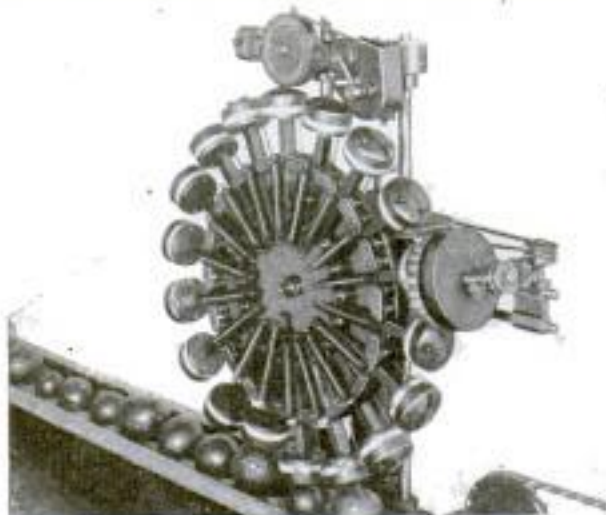

Each of the 18 Plungers Carries the Trade Name Embossed on an Electrically Heated Plate

**WAR-MADE POTASH WORKS GUARDED CONSTANTLY**

50 18

The war-time shortage of potash that has resulted because Germany has heretofore been the principal source of supply for that product, has given a great stimulus on the Pacific coast to the production of potash from kelp, which is to be found in vast beds in the ocean. On the water front of San Diego is an extensive potash plant which is only two years old and is engaged in turning out large quantities of several different products. The uninterrupted operation of the

Saw, H. Shilburg, Long Beach, Calif.  
used by Calif. Fruit Growers Exchange  
by Claremont, Calif. (Chunkei)

Plant of Hercules Potash Works  
San Diego, Calif.



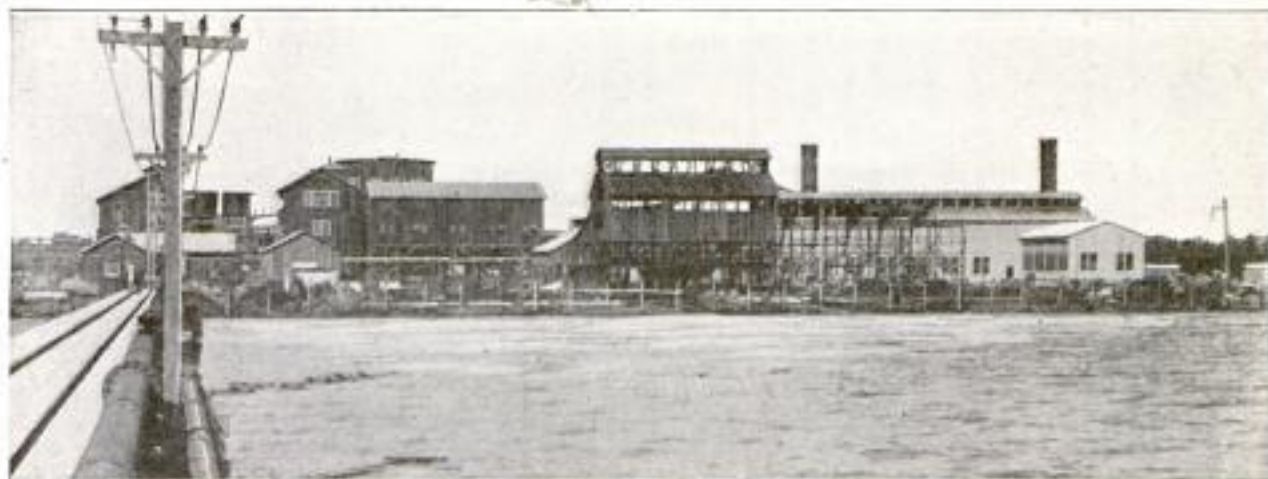

the War: In Order That the Output of Various Valuable Products may Not be Interfered with, the Plant Guard Day and Night

works is of such vital importance at this time that an armed guard, equipped with machine guns and powerful searchlights, is on duty day and

night, while patrol boats ply the water front. The employes are subjected to the most rigid examination before entering upon their tasks.

## 2998 HOTEL ROOF CAFE HAS ATMOSPHERE OF STEAMER

One of the latest innovations in the restaurant line is a marine café that has lately been established on the top of a Brooklyn, N. Y., hotel building. Masts have been erected, searchlights installed, life preservers hung in conspicuous places, and nautical trappings employed from "stem to stern" wherever possible, to give the place the atmosphere and appearance of an ocean liner. Tables and chairs are arranged about the edge of the roof on what might be termed a "promenade deck," while the central portion of the can-

oped space is elevated several feet above the surrounding part and connected with frequent flights of steps. Because of its novelty, the café is one



Situated on the Roof of a Brooklyn Hotel, This Marine Café has been Made to Resemble the Deck of an Ocean Liner



From Their Tables the Diners Obtain a Broad Panoramic View of the City with the Water Front in the Distance

of the local show places and attracts New Yorkers as well as the out-of-town visitors who form the backbone of café life in most big cities.

### BRIDGE IS PAINTED WHITE

#### 105 AS SAFETY MEASURE

For the purpose of increasing its visibility at night, a highway bridge spanning a stream in one of the mid-



Under the Glare of Motor-Car Headlights the White Bridge Stands Out Conspicuously at Night

western states was painted white some time ago. The result was so satisfactory that the commissioners decided that all bridges in the county should be similarly finished as rapidly as their repainting became necessary. For a distance of four feet above the floor, however, the steelwork, with the exception of the portal, was painted black. This, of course, was done because mud splattered by passing vehicles would soon make the lower part of the framework unsightly if it were white.

### GERMANS PAINT AIR CRAFT

#### 5120 IN BEWILDERING COLORS

According to recent reports from the western front, the Germans are camouflaging their air craft by painting them in the most vivid hues obtainable. The effect in many instances is supremely grotesque and dazzling. They are indulging in a riotous orgy of color and devising combinations that exceed the most fantastic kaleidoscopic effects

ever attained by savages. An Albatross or Aviatik, for instance, may have a green nose and a red body striped with brilliantly variegated bands. One wing may be blue on top and yellow underneath, while another is white on its upper surface and green on the underside. Some machines have green bodies, yellow noses, and red wings. Others may be red with green wings. Clashing primary colors are tiring to the eyes and many of the combinations have fairly bewildered allied pilots. It is assumed that the Boche is conducting an elaborate experiment to ascertain whether such camouflage will make it difficult for enemy airmen to determine the range of German planes.

### 5020 SIMPLE TESTING OUTFIT FOR AUTO HEADLIGHTS

A simple outfit for testing automobile headlights, devised by a police department, consists of a large screen of white oilcloth and a 5 by 5-in. piece of green glass set in a frame having a long handle. Across the screen, 42 in. above the ground, is a horizontal black line. Headlights to be tested are placed 75 ft. from the screen and their rays turned full upon it. If, on holding the piece of glass against the oilcloth above the black line, it appears green, it shows that the rays of the lamps are not properly confined. If the glass appears to be black instead of green it is evidence that the lamps are correctly focused.



Oilcloth Screen and Green Glass with Which Police Test Automobile Headlights

Installed at  
 Solington Md. Police Station  
 Copy righted material

# PUTTING ARMOR BACK IN THE DISCARD

By EDWARD C. CROSSMAN

4983  
**A** SMALL matter of five hundred and sixty-odd years ago that tried and true knight, Launcelot de Montmorency, thought he saw a bully chance to harpoon a half dozen or so low-born English churls in the front line of the English battle front near the village of Crécy. Wherefore Launcelot dropped his lance to rest, and, an armored whirlwind that clanked and rattled as it moved, he and his steed charged down on the invaders' line.

At the range of 100 yd. there spurted a jet of blue smoke from the threatened line, and there rose over the yells, the shrieks, and the clatter of steel on steel a most unfamiliar bang. The French knight rolled off his surprised steed with a loud crash and clatter of steel plates. Forsooth there was naught but a little round hole in his corselet, and yet he was dead.

That one shot put the kibosh for five hundred years on the fashion of wearing cast-iron clothes when expecting trouble with the chap across the way. Armor hung on stubbornly, but little by little the fighters abandoned armor belts in favor of higher speed. Some branches of cavalry clung to armor as late as the war of 1871, the cuirassiers, for instance. A pathetic example of the futility of such armor is in the Springfield museum. There is the helmet of a French cavalryman, and his cuirass, picked up on a stricken field of the first war with Germany in 1871.

Through the front and back of the cuirass there is a little round hole. The poor Frenchman's body was between these holes, you'll understand. Through the helmet there runs the frightful slash of a saber, swung by a husky German arm. The spectator may guess whether bullet or saber cut came first: either was fatal.

Military men laughed heartily at the mention of protective armor for land fighters. They pointed out the range, the penetration of the military rifle, and the tactics adopted by all modern armies of depending on distance, concealment, and some digging in to nullify the frightful power of this modern rifle.

Then came the Great War.

Now, with it just over three years

old, we have the spectacle of the infantrymen of all armies wearing steel helmets sufficient to turn shrapnel and shell splinters, rifle bullets at long range — and possibly rifle bullets at close range, judging by one test made in this country of a helmet that turned the

bullet of our army rifle at 50 yd. French and British officers go in wearing the old cuirass again, only this sort is built up of steel and canvas layers or else woven of chain mail.

A man in Dover, Del., stood the other day in an armor coat of his invention and let a soldier fire our army rifle at him at 25-yd. range with perfect safety.

The German infantryman is given a supplementary steel front for his

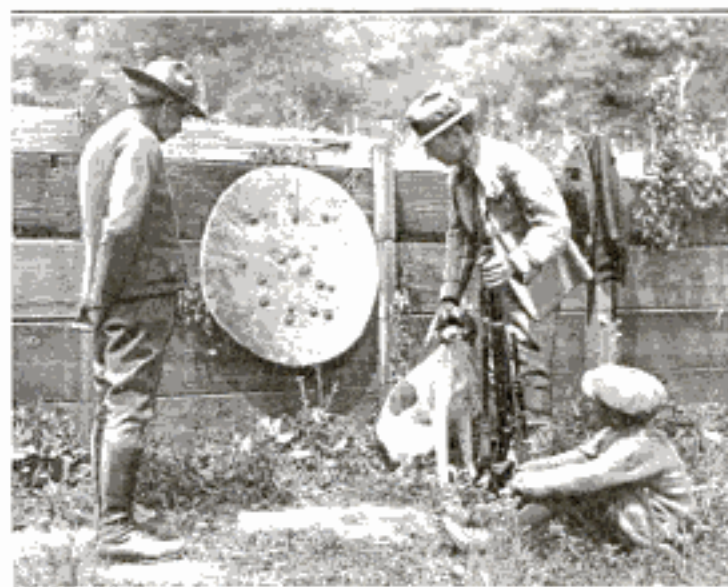

Viewing a Piece of Steel Which Marksmen Were Able to Penetrate at 700 Yards with a New Bullet That Promises to Make Light Armor Useless

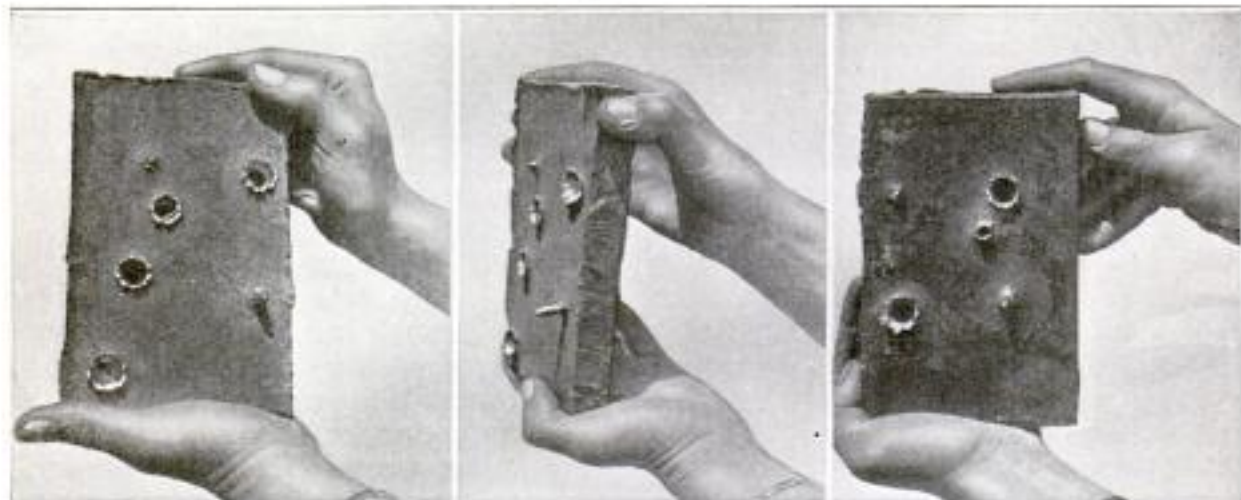

The Center and Left-Hand Views Show a Piece of One-Inch Tough Steel Penetrated by the New Bullets. Two Cores are Shown with Their Noses Through. The Dent near the Bottom was Made by a Service Bullet. That the New Missile Makes Funnel-Shaped Holes is Shown by the Right-Hand Plate Which was Shot at from Both Sides

helmet that will stop at close range the bullet from the French or British rifle.

Aeroplanes carry more and more armor, armor for the gas tank, for the passengers, and for the machine gun.

Tanks waddle serenely through blizzards of bullets that crackle and clang on their steel sides like hail on a tin roof, only this sort of hail hits—each pellet of it—with the energy of more than a ton.

Motor cars dash into the middle of threatened infantry lines and turn chattering machine guns into the advancing ranks without suffering from the return fire. The government is building many such cars.

Still the military rifle has its terrific punch and range. Still it sails through a half inch of mild steel at the muzzle. It has lost none of its potency that made armor for land fighting nearly unthinkable before this war.

Steel has been improved, but greatest of all reasons for the increasing adoption of armor for man and his motor car and airplane is the astonishing change in tactics that restricts fighting to short range and makes movements of troops correspondingly small.

But, just as the big gun shell kept pace with every improvement in armor for fighting ships, now comes an improvement in military-rifle bullets to put a temporary end, at least, to the rage for wearing clothes made in the rolling mill. While the race between big gun and ship armor has no end, because the ship can carry almost any weight, the land version of the same contest must quickly end because the weight-carrying capacity of man, motor car, and aeroplane is very limited.

Captain Clay of the ordnance department of our army designed, and had made, some months ago the first armor-piercing bullet turned out in this country. Already it has sufficiently worried the makers of steel defense for cars and planes to make them hurriedly seek alloys and heat treatments in the endeavor to keep out the new missile.

Modern military-rifle bullets are made of lead cores, with a tough jacket of sheet steel or a mixture of copper and nickel much like German silver, to make the bullet hold to the lands

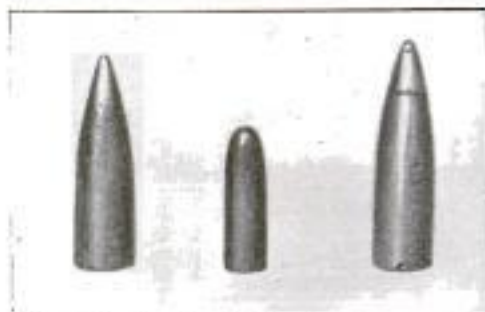

A Regular Service Bullet is Shown on the Left, a Steel Core in the Center, and a Finished Armor Piercer, with a Soft Nose, on the Right

of the rifling under the tremendous thrust of the powder gases. Just what happens when one of them hits steel we don't know, but we do know that

they invariably blast a hole much larger than themselves. The limit for the bullet from our army rifle is roughly a half inch of mild steel at 50 ft. A quarter inch or less of chilled, or treated, steel used for armoring field guns and shields keeps the bullet on the right side—considered from the standpoint of the men behind.

The Clay armor-piercer bullet consists primarily of a secondary bullet of hardened steel inside of the main missile. In the case of the bullets turned out for our army rifle and sent out to the writer for trial, this hard steel slug is .22 in. in diameter, or, the diameter of a .22-caliber lead bullet of the familiar shooting-gallery sort, and it is  $\frac{3}{4}$  in. long. The point is shaped roughly like an ordinary bullet.

This steel slug is placed inside the core of the main .30-caliber army bullet, with the base resting practically on the base of the jacket of the regular bullet. Around it, of course, is the lead core of the bullet, and around that in turn is the cupronickel jacket, so the rifling can press inward against merely tough jacket and leaden core as with the ordinary bullet.

A second improvement is the use of a soft nose—that is, with the jacket partly cut away at the extreme point of the bullet, exposing the soft lead core. This makes the bullet "bite," or "take," on the glass-hard surface of treated steel armor at a slight angle to the course of the bullet, whereas the bullet with the full jacket would glance off and go on harmlessly as the makers of the sloping-surface armor intended

it should. Getting direct right-angle hits on modern armor, whether it be on motor car, helmet, or tank, is difficult, and penetration is impossible when the bullet glances blithely off.

The sloping shoulders of the ordinary sharp-point bullet, cased in a tough jacket; merely slide off inclined surfaces, but the soft lead core, exposed at the point, even though of the same form as the full-jacket missile, flattens out on impact, giving a grip on the steel, and adding greatly to the disposition of the bullet to enter armor set at a slight angle to the course of the bullet.

The steel slug continues right through the most unreasonable amount of mild steel and gives just as surprising results in treated armor steel, compared with the penetration of the service bullet. While the jacket and the core of the bullet disappear after the bullet gets a certain distance, the steel core keeps on going. The hole made in steel is

thus of a peculiar funnel shape,  $\frac{3}{4}$  in. wide where it enters the steel, and tapering down to .22 in. where the slug emerges.

Our own trials, made with the early form of the bullet, which has now been improved by Captain Clay, developed that it gave more than a hundred per cent increase in mild steel at the muzzle, and that the proportion grew in favor of the Clay bullet as the range was extended. Taking steel of the same tensile strength and character, the service bullet just got through a half inch. The Clay bullet went through an inch of mild steel at the muzzle.



Plate of Half-Inch Steel Punctured at 300 Yards with the New Bullet: The Topmost Mark, a Dent, was Made with a Service Bullet at the Same Distance

Then we turned to a sheet of rather tough, but not treated, steel of unknown ancestry and history obtained from a scrap pile at an iron works. This sheet is 3 ft. across and .27 in. thick. Through it the service bullet went at 300 yd., but failed at greater range. The new steel-core bullet went through at 700 yd., the longest range at which the plate could be seen against its background.

Against treated, tough, armor steel the work of the bullet is still more remarkable. It more than doubles the penetrative range of the service bullet against the light, tough armor of the aeroplane. It makes the famous tanks vulnerable to rifle fire, and it strips off the armor of the motor car and puts the crew out into the blasts of lead

of the stricken field, by its ability to get through the armor that has so far been considered adequate.

At 300 yd. it clanged merrily through a 1/2-in. piece of mild steel which the service bullet penetrated at the muzzle but no farther, so you can imagine what it would have done to the famous "tin-clads" of Admiral Eads which fought some of the fresh-water battles of our Civil War.

Once more a Yankee invention bids fair to overturn some of the customs of the game of war. A few machine-gun belts full of cartridges loaded with the new bullet will serve to put armor on the scrap heap, save as used—like the shrapnel helmet—not to turn bullets, but overhead shrapnel, which is just a lot of leaden balls at low velocity.

5086  
Surface

### ATLANTIC STEAMERS FITTED WITH MINE PROTECTORS

Some of the Atlantic liners that are running the submarine gantlet have



Bow of Steamship "Lapland" Showing at Least Part of the Mounting for One of the Mine Protectors: The Large Net That is Supposed to Extend Ahead of the Stem has been Removed

been equipped with a new type of mine-protecting device that is reported to have proved meritorious. For obvious

reasons it has not been considered advisable to give general circulation to the details of the apparatus. It is permissible, however, to mention that it is understood to consist, in part, of a large net that, when attached at the bow of a vessel, extends about 50 ft. forward and several yards on either side of the stem. It is apparently a large fender that picks up contact mines, or tosses them aside, when they are encountered in the immediate path of a ship.

4347

### THOUSANDS USE TERMINAL DURING ITS ALTERATION

So carefully did contractors plan their work in making recent alterations in a Los Angeles railway terminal that the thousands who daily use the building were put to little or no inconvenience, and some scarcely knew what was going on. The principal change was the substitution of ramps for six slippery stairways which had caused many accidents and costly damage suits. An elevator was installed near the center of the building, a hole having been cut through the reinforced-concrete floor for the purpose, thereby giving access to the garage that occupies the lower level. All new material

Pacific Electric Traction Co  
Los Angeles, Calif.

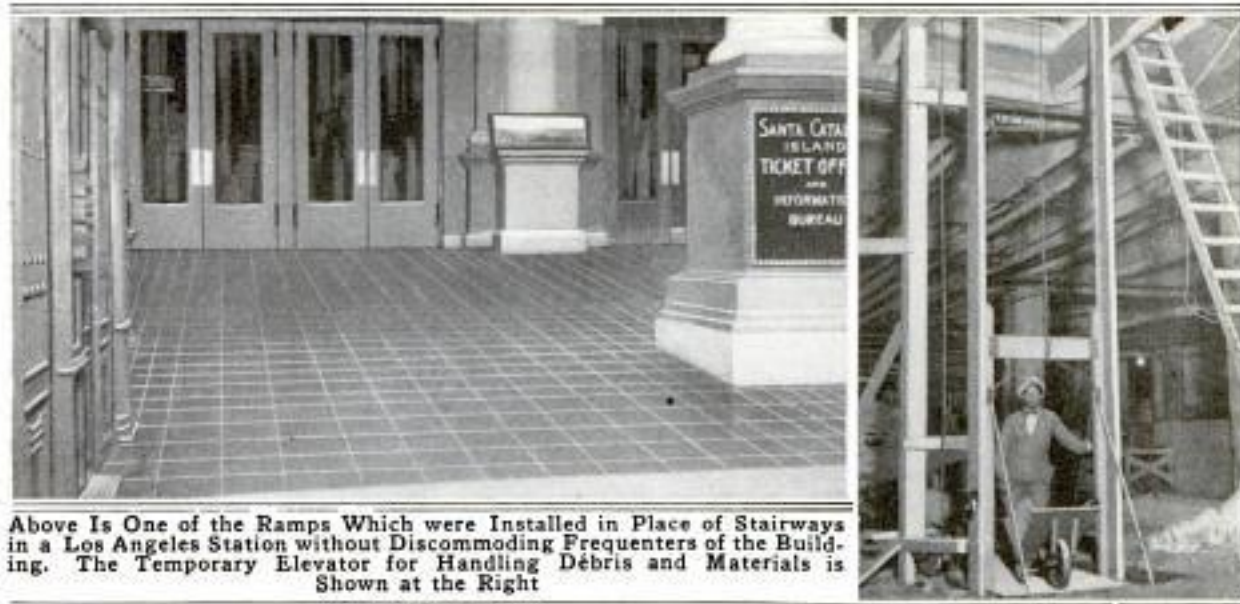

Above Is One of the Ramps Which were Installed in Place of Stairways in a Los Angeles Station without Discommoding Frequenters of the Building. The Temporary Elevator for Handling Débris and Materials is Shown at the Right

and débris were handled by way of this elevator, auto trucks carrying it in loads to and from the garage. Half of each stairway was removed in turn, an incline built in its place, and then opened to the public. Temporary partitions of cloth screened off the public passageways and kept out the dirt. The changes cost between \$25,000 and \$30,000.

5072

### UTILIZE STREET FLUSHERS IN CLEANING SIDEWALKS

To enable the sidewalks in the business section of a large city to be readily cleaned at night, an attachment has been devised for street-flushing ma-

chines. It consists of a braced extension pipe supported at a height that permits it to clear the tops of motor cars and other vehicles that invariably line the curbs in the vicinity of hotels, clubs, and theaters. The pipe is of proper length to span a car and reach the edge of a sidewalk. Coupled to its outer end is a hose that carries a fan-shaped nozzle. This is handled by a street cleaner who flushes the walk as the tank car proceeds along the pavement. When the attachment is not in use, the hose is disconnected and the extension pipe swung against one side of the machine and locked, so that it will not interfere with flushing the remainder of the street.

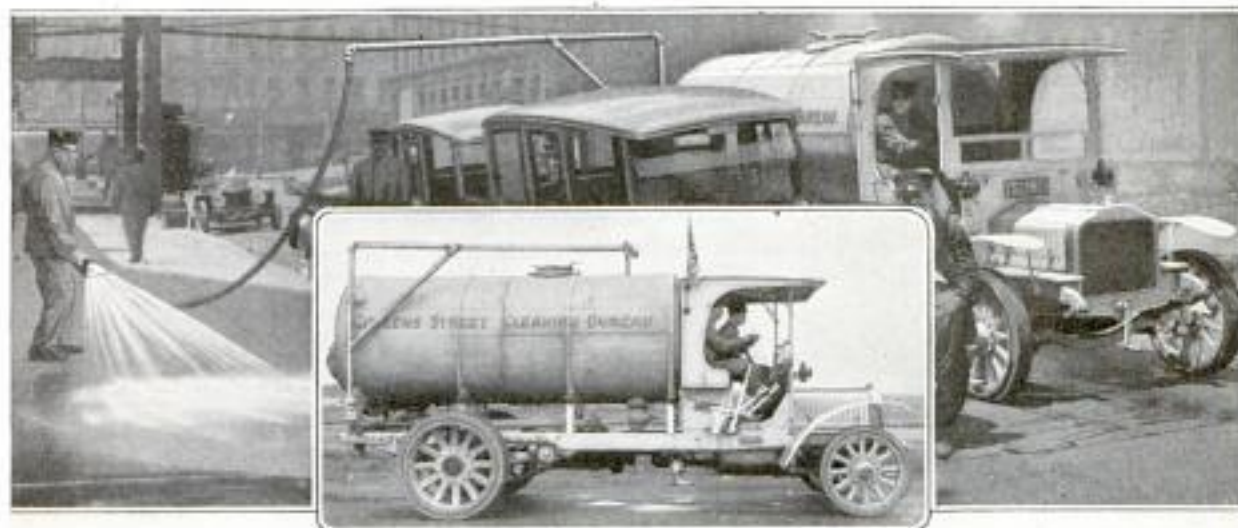

Cleaning a Dusty Sidewalk While Motor Cars Stand at the Curb Line: The Insert Shows How the Extension Pipe is Swung against One Side of the Tank and Locked When Not in Use

*Used in Chicago.*

*7-11-29*

### FUEL STATION FOR AUTOS 4109 HAS TURNTABLE

Because a gasoline station for automobiles is situated in a small area in



In the Foreground Is an Electrically Operated Turntable Located in a Confined Area Adjoining a Gasoline Station and Used to Turn Patrons' Cars Around

which it is difficult for cars to turn around, the proprietor has installed a turntable for the convenience of patrons. An electric switch, operated by an attendant, sets the motor-driven platform revolving when cars are driven on it.

*5098*

### GRASS-CUTTING SPECIALIST HAS ELABORATE OUTFIT

In a city where the climatic conditions enable him to pursue his trade the year around there is an itinerant caretaker of lawns who transports his tools in a pushcart especially designed for the purpose. The vehicle is small and its load compactly arranged, so that trips from one job to another are made easily. It is interesting to observe the variety of equipment used

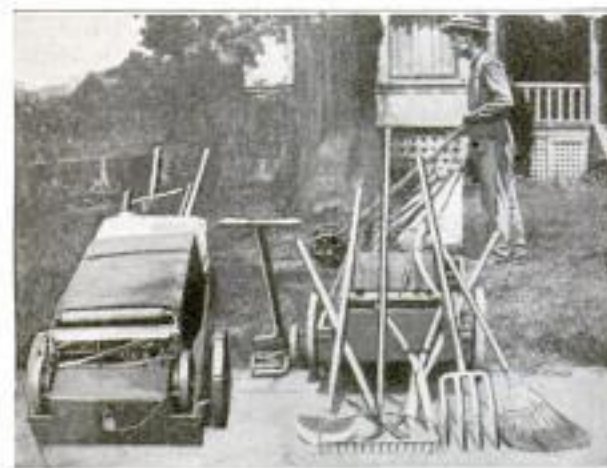

Elaborate Collection of Lawn-Trimming Implements Used by an Itinerant Grass Cutter

*3-7-29 for Jan. 29. 29  
H. Leat Rodden  
The Chamber of Commerce  
Middletown, N.Y.*

by this grass-cutting specialist. In addition to a lawn mower and trimming machine, he carries a sod cutter, spading fork, rake, a saw for trimming trees, a chisel and scraper for smoothing their bark, a sickle, hedge shears, pruning shears, grass shears, pliers, screwdrivers, files, an oilcan, and tools for adjusting the mowing machines.

### JACKSCREW DESIGNED 5025 ON NEW LINES

Greater durability and ease of operation are features claimed for a new type of jackscrew which is made by a concern in Middletown, N. Y. The ram of this tool is subject to less wear than those of ordinary jacks because it has a solid head and does not turn in its base. Raising and lowering of the ram is accomplished by turning a nut situated at the top of



the standard. The nut is of case-hardened steel and its outer surface is cogged so that it can be turned by a special lever having a hooked end. This method of operation permits the use of the jack in a space where only a twentieth of a turn can be made with the lever. Other advantages are that the lever does not rise with the ram as the latter is unscrewed, nor can the ram be accidentally screwed out of the base.

*Salvage*

### FLOAT SHIP LONG STRANDED 4569 ON TROPIC SANDS

After nearly ten years' captivity on the hot sands of the Guatemalan coast at Ocos, where it had been tossed during a typhoon, the German steamship "Sesostris" has been floated and taken to Seattle for overhauling. As the "Frances L. Skinner," it will henceforth be an American merchantman and an active memorial of a difficult,



if not extraordinary, salvaging feat. An unsuccessful attempt or two had previously been made to release the ship, but about a year ago the shortage of bottoms so increased its potential value that the task was again undertaken and carried, this time, to profitable conclusion. The boat is 380 ft. in length and has a cargo capacity of 7,000 tons dead weight. Its place on the beach at Ocos was some 300 yards from the ocean. There it served for a time as an electric-light plant and later as a summer hotel. When the final attempt at salvaging was undertaken, the sand was pumped from about the vessel and a small artificial lagoon formed. The bow was pointed seaward and a canal cut to deep water. Because of a heavy surf that kept the sand constantly in motion, it was necessary to construct a breakwater to protect the slip. Earthquakes contributed further trouble. Reliance had to be placed upon the tides, and on only three days of the month were they suitable. Thus it became necessary, after making some headway toward deep water, to hold the boat in the position gained for a whole month until the tides again offered their assistance. Examination at Seattle showed the vessel to be in splendid condition.

5046  
TAXI DRIVER'S SUBSTITUTE  
HAS STARTLING COSTUME

In the city of Durban, Natal, South Africa, the rickshaws, which to a certain extent take the place of taxicabs,



The Primitive and the Modern Contrasted in Durban, South Africa: Europeans being Drawn in a Rickshaw by a Costumed Native

are given a picturesqueness which no motor vehicles could ever possess, by reason of the costume worn by the



With a Tug Alongside, the Long-Stranded "Sesostris" being Towed through the Narrow Canal to Deep Water



By Dredging the Sand from around It, an Artificial Lake of Sufficient Depth to Float the Vessel was Established on the Beach

natives who draw the two-wheeled carts. The rickshaws themselves are of quite modern construction, with wire wheels and rubber tires, but the native attendants are decked out in a garb which is a strange combination of festooned shirt, ornamented jacket, and headgear that is truly startling. The latter consists of two large horns projecting from either side of the head, together with feathers that protrude in front and long plumes that hang down the back.

2645

### ICING REFRIGERATOR CARS IN CALIFORNIA DESERT

During the melon season in southern California, for a period of several weeks, approximately 150 refrigerator cars are iced daily at Brawley, a small station in the reclaimed desert region. This is one of the hottest points in North

loaded onto a conveyor belt which carries the large cakes to a working platform elevated slightly higher than the tops of the refrigerator cars. Runways extend from the edge of the platform to the bunker openings at each end of the cars. As the cakes reach these planks they are pushed off the conveyor and slid to men stationed on the cars, who halve them with a single stroke of a sharp fork. They are then shoved into the holes through which they drop to the ice compartments below. Usually a car is given about 11,000 lb. of ice before being loaded. When ready for shipment it is re-iced.

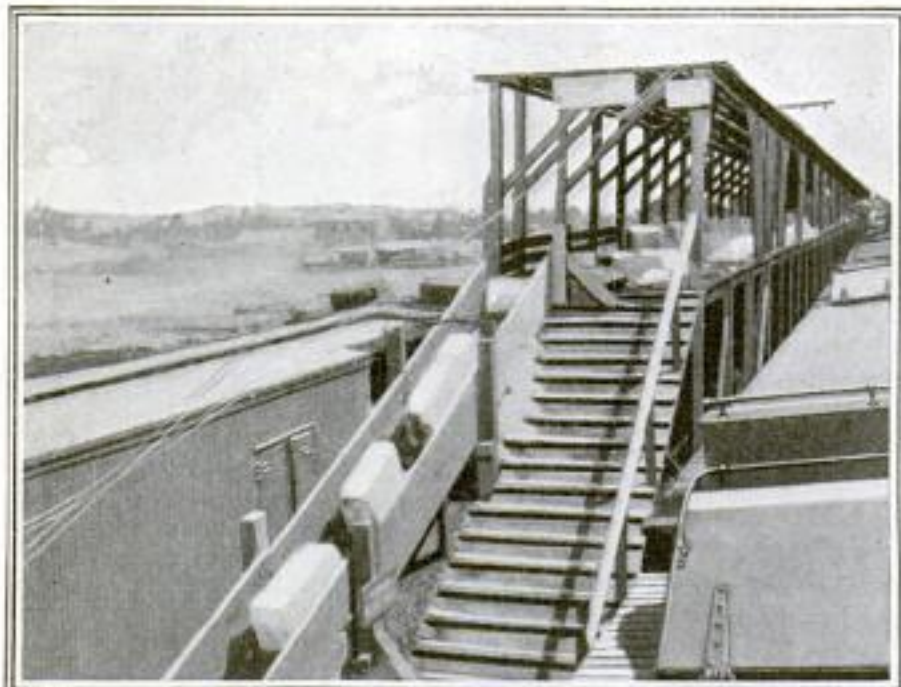

Some 150 Refrigerator Cars are Iced Daily during the Shipping Season at This Station. The Ice Is Unloaded on the Conveyor and Carried to the Platform above the Fruit Cars

America and every facility for icing the cars expeditiously so as to minimize the shrinkage as much as possible is employed. The ice is shipped from Colton, 150 miles distant, and un-



As the Conveyor Shoots the Big Cakes of Ice Along, Men with Long Spears Shove Them onto Runways Leading to the Icing Holes at Opposite Ends of the Cars through Which They are Dropped to the Bunkers. During a Normal Melon Season about 20,000 Tons of Ice are Used at This One Station

### 5019 CONTRACTOR SAVES MONEY BY DREDGING FOR SAND

For a number of years contractors in and near Boston, have obtained sand of a very fine quality for mason work from an island located at the mouth of the Merrimac River, paying for it a stated price and hiring men to

carry it in wheelbarrows aboard sand schooners stationed close by. Recently, however, a skipper greatly lessened the cost of securing the material for his firm by anchoring his vessel close to the island and dredging up sand of the same quality just off shore. In this way he was able to load overnight, whereas, in the past, loading had been

*Work done on*  
*Merrimac River*  
*Newburyport, Mass*



Getting Sand at Low Cost: Dredger Entering River to Load Up with Sand from the River Bottom, Which Formerly was Purchased on a Near-By Island and Carried Aboard in Wheelbarrows

a matter of days. Incidentally the quicker and less expensive method helps keep clear a channel which has been more or less menaced by sand bars.

### SMALL FARM TRACTOR HAS 3 260 ROTARY ENGINE

A farm tractor having a single wide drive wheel, within which is a rotary engine that develops 12 hp., has lately been patented. The drive wheel is made of two cast-iron wheels, set some distance apart and connected by a series of channel irons bolted to their rims. This enables the machine to travel over soft ground. The aim of the inventor has been to produce an inexpensive tractor having few and simple parts. The engine has three cylinders set radially around the axle, which is hollow and stationary. To the single crank in the axle all of the piston rods are attached. The combustion chambers are sit-

uated at the outer ends of the cylinders and the inner end of each cylinder constitutes a compression chamber. Gas passes from the carburetor, at the end of the axle, into the air-tight crank case, and thence into a compression chamber. The operation of valves and the piston adjoining the filled chamber forces the gas, at low pressure, into the combustion chamber of the adjoining cylinder. The engine makes 300 to 400 revolutions per minute.

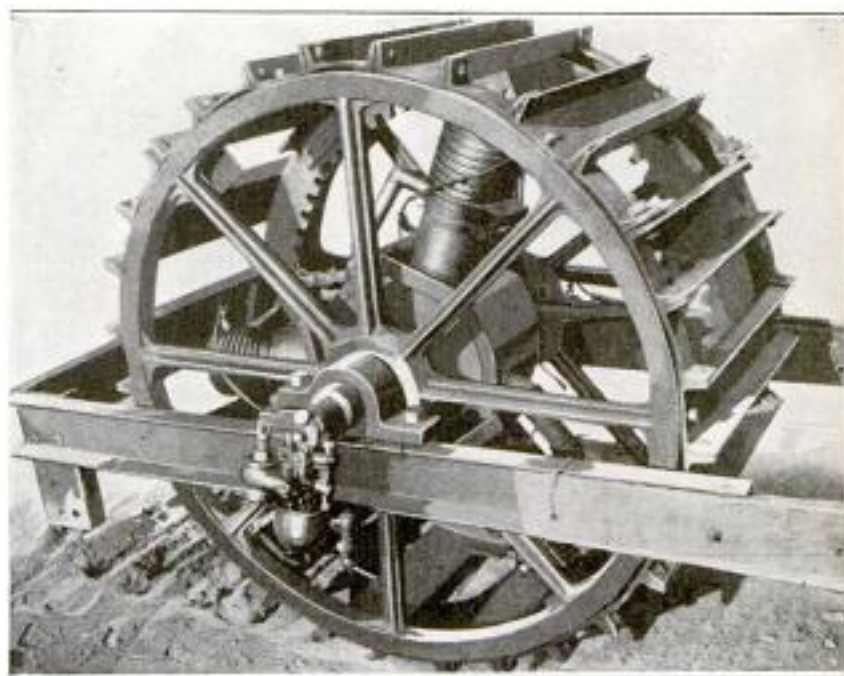

Novel 12-Horsepower Farm Tractor Driven by a Rotary Engine and Designed for Use on Small Farms

Inventor: F. O. Fredlund  
854 Cypress Ave. Pasadena Calif.

5090

## CIVIC FEATURES THAT PROMOTE THE COMFORT

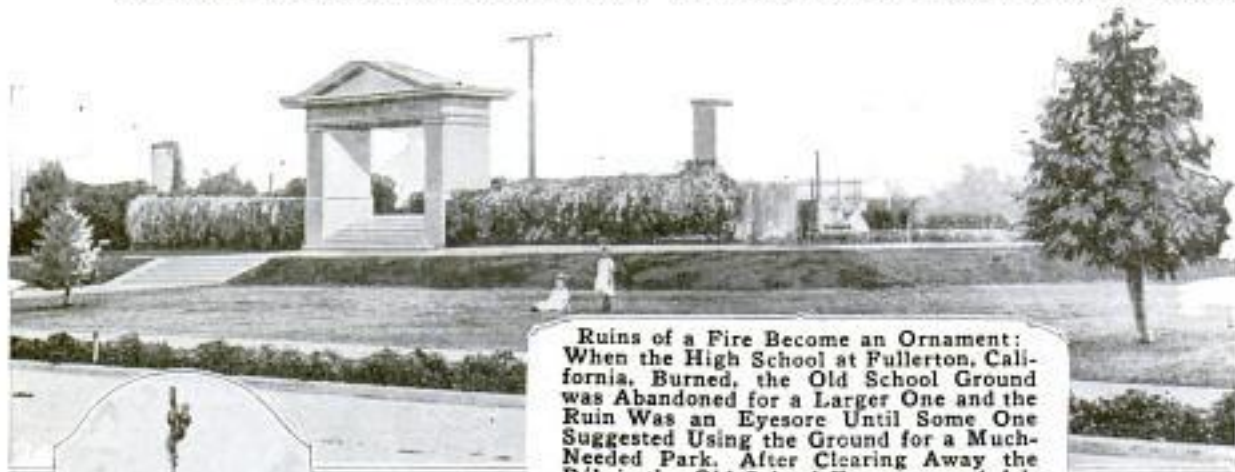

**Ruins of a Fire Become an Ornament:** When the High School at Fullerton, California, Burned, the Old School Ground was Abandoned for a Larger One and the Ruin Was an Eyesore Until Some One Suggested Using the Ground for a Much-Needed Park. After Clearing Away the Débris the Old School Entrance and Adjoining Foundation, Which was Left Standing, Became an Architectural Adornment



**When Ashland, Oregon, Set Up This Powerful Fire Whistle in Place of a Fire Bell, Reliable Pressure was Secured for the Whistle by Connecting It with a Near-By Natural-Gas Well**

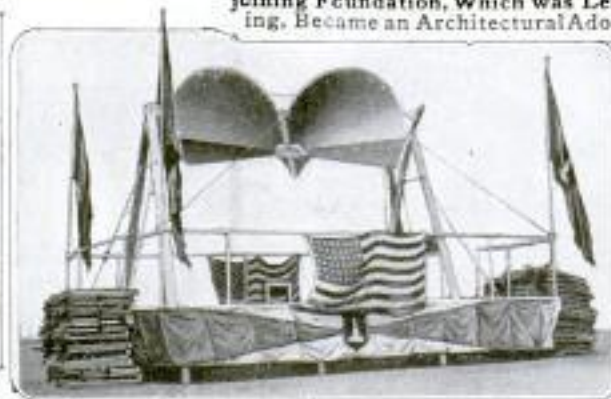

**A Portable Band Stand Used for Public Concerts by the City of Baltimore:** This Platform is Mounted on a Truck and Folds Up so That it can be Easily Moved About. A Special Feature is the Folding Sounding Board Composed of Several Shell-Like Sections That can be Packed into Small Space



**Depositing a Cent in One Side of a New Los Angeles Fountain to Obtain a Drink of Ice Water: The Other Side Supplies City Water Free**

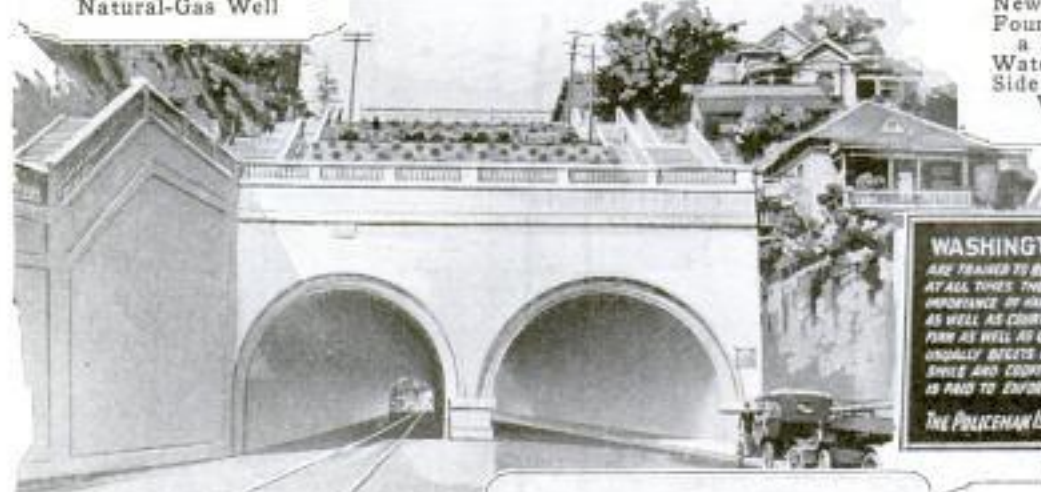

### WASHINGTON POLICE

ARE TRAINED TO BE COURTEOUS TO ALL PEOPLE AT ALL TIMES THEY HOWEVER KNOW THE IMPORTANCE OF HANDLING PAID AND UNPAID AS WELL AS COURTESY THEY MUST BE FAIR AS WELL AS GOOD NATURED COURTESY UNUSUALLY BRINGS COURTESY OR YOUR PAID SINCE AND COURTESY WITH THE MAN WHO IS PAID TO ENFORCE THE LAW

*The Policeman is Your Best Friend.*

**City Authorities Work a Striking Transformation:** The Scarred Unightly Hillside above the Mouth of Hill Street Tunnel, Los Angeles, under the Direction of the Park Commission has been Changed into This Beautiful Terraced Garden, Bordered by Artistic Flights of Steps and Balustrades



**IF YOU SEE A CRIME COMMITTED OR OBSERVE A SUSPICIOUS PERSON - STOP! NOTIFY THE POLICE AT ONCE**  
THE MORE YOU COOPERATE WITH THE POLICE, THE MORE THE POLICE CAN ACCOMPLISH FOR YOU

**In the City of Washington the Police are Acting on the Principle That in a Democracy It is Every Citizen's Duty Not Only to be Orderly Himself but Also to Aid the Officers of the Law When He Can. Hence the Unusual Signs, Two of Which are Shown, have been Erected at Many Points**

## AND ENJOYMENT OF RESIDENTS AND VISITORS



These Massive Columns of Rough Stone, 30 Feet High and 12 Feet Thick, Form an Impressive Gateway for Denver's Mountain Parks. They are Situated at the Foot of Lookout Mountain and Bear Bronze Plates Stating That They were Given to the City in 1917 by a Local Business Man



When San Jose, California, Prepared for Home-Coming Week, Folks Say It Required This Big Mail Box to Hold All the Invitations That Went "Back East." At Any Rate It Was a Successful "Ad"



In Providing These Sheltered Fireplaces—of Which There Are Four, with Their Flues in the One Chimney—Pueblo, Colorado, Safeguards Beautiful Fairmont Park against Forest Fires and Makes the Preparation of Meals Easy for Motorists. Each Fireplace Has a Removable Sheet-Iron Cover and Also a Grate. Pine Fuel is Furnished Free



A New and Artistic Use for a Tractor Bull Wheel: With Its Spokes Removed It Serves as a Border for a Flower Bed at a Street Intersection in Glenwood, Minnesota. A Red Warning Light Surmounts the Center Post



This Landmark, Known as Eagle Gate, at the Entrance of What Was Once Brigham Young's Private Grounds in Salt Lake City, has been Taken Over by That Municipality and will be Kept Up by It. The Bronze Eagle Rests on a Beehive, the State's Emblem. The Original Sandstone Pillars have been Replaced by Concrete

### AWNING SHIELDS RADIATOR FROM DESERT SUN

4881 An awning stretched over the engine hood was the unusual device employed



Prepared to Cross the Desert: An Awning Stretched above the Engine Hood to Shield the Radiator from the Direct Rays of the Sun and so Lessen Evaporation

by a motorist to protect the radiator of his car from the sun's hot rays while driving across a desert, and so in a measure conserve the water in the radiator. The shelter was made of material that reflected most of the heat, and therefore prevented the metal beneath from absorbing it.

### GOOD SHIP "KATE ADAMS" LEFT FAR FROM WATER

4971 One of the best known of the Mississippi River steamers is stranded high and dry at Helena, Ark. The vessel, the "Kate Adams," put into port late in July while the level of the swollen river was falling at a rate of an inch and a half an hour. It was made fast close to the shore,

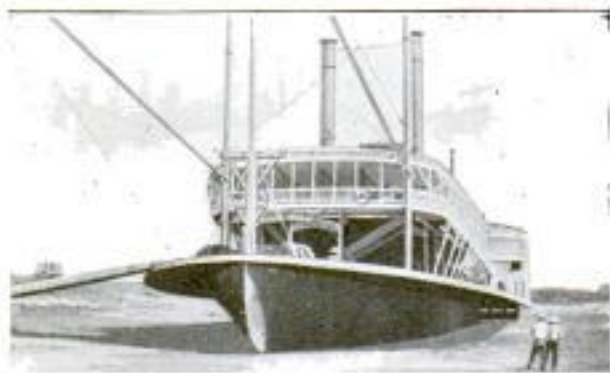

The "Kate Adams," One of the Well-Known Mississippi River Steamers, Stranded Far from Water in Arkansas

which slopes gently, and part of its cargo unloaded. After about three hours when all was ready to weigh

anchor, it was found that the ship was fast in the mud. As the waters continued to recede, the fate of the "Kate Adams" was sealed. The steamer is now 175 ft. from the water's edge.

### GREAT VALUE OF FARM

#### 5123 WOOD LOTS SHOWN

Community ownership of woodlands is suggested by the Forest Service as one means of insuring annual supplies of timber for local consumption. In pointing out the various uses of the farmer's wood lot, the statement is made that some 60 cities in this country already own wooded land, while in Europe many communities find their publicly owned forests a profitable investment. Zurich, Switzerland, derives about \$20,000 per year from a wood lot of 2,500 acres, it is stated.

But for the individual farmer, also, a timbered tract is more serviceable and profitable than many suppose. In 1909, the farmers of the eastern states received from the sale of their wood-lot products an average of \$81 for each reporting farm, or nearly \$170,000,000 in all. In that year there were over 143,000,000 acres of farm woodland in the eastern and central states. Because it is a convenient source of firewood and other material, the chief direct value of the wood lot is to the local community. Much of the material that is sold is consumed in the neighborhood, and many small veneer, cooperage, and other plants obtain their entire supply from local sources. In view of the facts which the Forest Service has brought out, it is evident that well-settled rural communities should seek to develop wood lots and so protect themselves from future timber scarcity and correspondingly high prices.

CA A simple and exceptionally efficient high-vacuum pump, recently developed by the Bureau of Standards, can be built entirely of glass by a fairly skillful glass blower. It requires for its operation only a Bunsen burner and a water aspirator.

**ORNAMENTAL STATION**

4509 **FOR SMALL CITY**

A fine example of a truly ornamental railway station is that recently completed by a western electric line for a small city which it serves. This structure is tile-roofed and is finished in light stucco with embellished doorways and windows that are slightly arched. The main part of the building contains what is designated as indoor and outdoor waiting rooms, the latter having three wide openings, for which no

means of closing is provided. At the rear is a wing for express, baggage, and for handling equipment.



Handsome Station Recently Built by an Electric Line: The Wide Doorways Lead to One of Two Waiting Rooms, Which Is Really a Partly Inclosed Porch

3998

**LEAKY RESERVOIR RELINED WITH CONCRETE**

When the city engineers of Omaha, Neb., discovered recently that a big double reservoir at Walnut Hill was leaking badly, the city decided to reline both basins with an additional 4-in. covering of reinforced concrete. Although no trace of

any water outlet could be found, there was danger that an embankment pro-

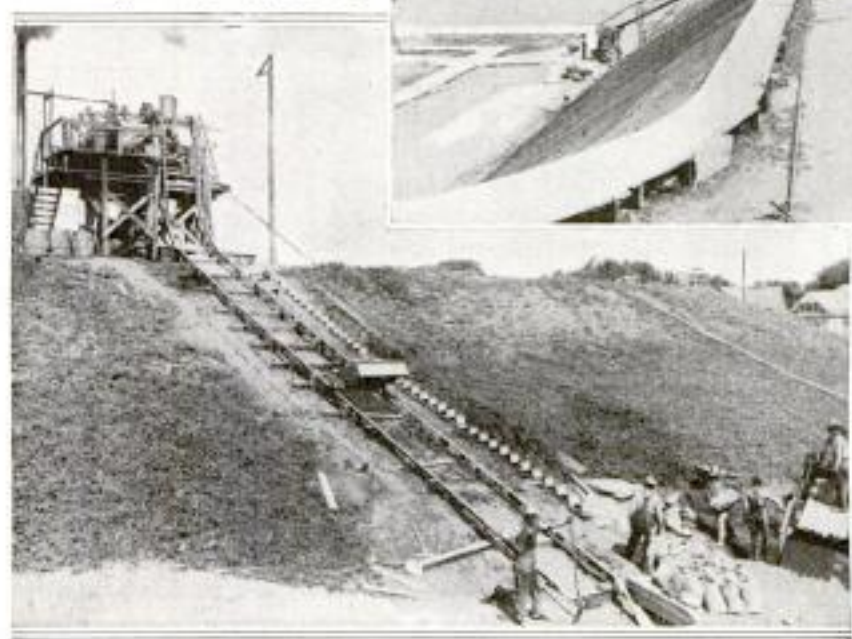

Making a Leaky Reservoir Water-Tight by Relineing with Concrete: The Inclined Track and Skip to Convey Materials to the Mixer Above are Shown at the Left, While the Method of Distributing the Concrete Inside the Basin is Seen Above

tecting a residence section might give way and cause much damage. When the water was let out of the first basin, it was found that the old concrete had cracked in several places, so the relining was timely. The problem of laying the new concrete on steel rods across the huge floor and sloping side walls of

Built by J. L. Smith & Co.  
Milwaukee, Wis.

the large basin was solved by a local engineer, who devised a plan and apparatus whereby a mixing machine was installed on top of the embankment, with a feeding track and chute into the basin at one side, while the materials were assembled at the other side of the embankment and carried up to the mixer by means of skips on

an inclined track. When mixed, the concrete was delivered through the chute to men with wheelbarrows at the bottom of the inside slope, who distributed it over the wide spaces to be relined, where the reinforcing steel rods were previously placed. In this way both the reservoir basins were once more made water-tight.

## 4190 IMPROVED DRYING METHODS FOR FOOD SAVERS

Extra-large fruit and vegetable crops in these war times, coupled with a serious shortage of cans, have brought out many improved devices for drying

Steam from the boiling water heats the tray so that the food spread out on it rapidly loses its moisture and at the same time there is no danger of burning it. Evaporators are built on the same principle which have three or four trays heated by steam from a single tank.

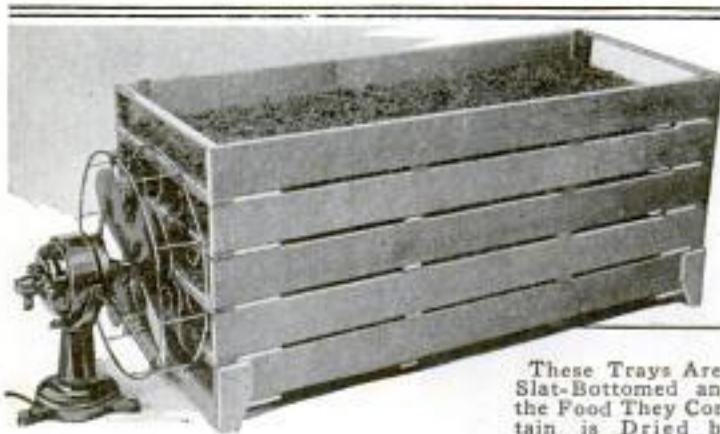

These Trays Are Slat-Bottomed and the Food They Contain is Dried by the Draft From the Fan

foods. One of the simple and serviceable outfits consists of several trays, open at the ends and provided with slatted bottoms, which when filled with properly prepared food are piled one above the other. The contents of the trays are dried rapidly by placing an electric fan at one end and forcing air among them. This is one of the methods recommended by the government for town and city people especially. Another consists in drying on the traylike top of a galvanized-iron container filled with water, which is set above a blaze.

A machine especially adapted for large-scale operation, removes the moisture from fruit, vegetables, meat, or fish by forcing gases from burning oil over the food. The heat derived from this method also assists in the drying. The machine is provided with an electric fan which blows the gases given off from burning oil through a blast pipe over a set of trays. The theory on which

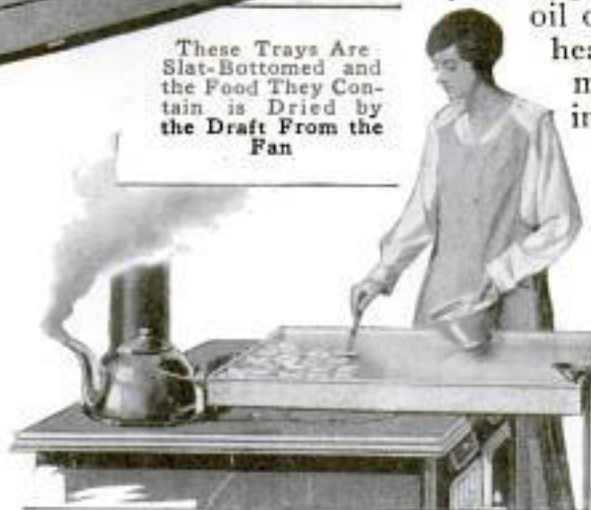

A Drying Tray Kept Hot by Boiling Water Contained in the Chamber Beneath



An Evaporator Which Removes Moisture from Food by Forcing Gases from Burning Oil over It

the outfit is constructed is that certain elements in these gases attract the moisture in the food and so effect quick, thorough drying without imparting any foreign flavor to the food.

*Grange Assn. Lafayette Bldg.  
Philadelphia, Pa.*



4984

## EGYPTIAN SCENES FILMED DESPITE OBSTACLES

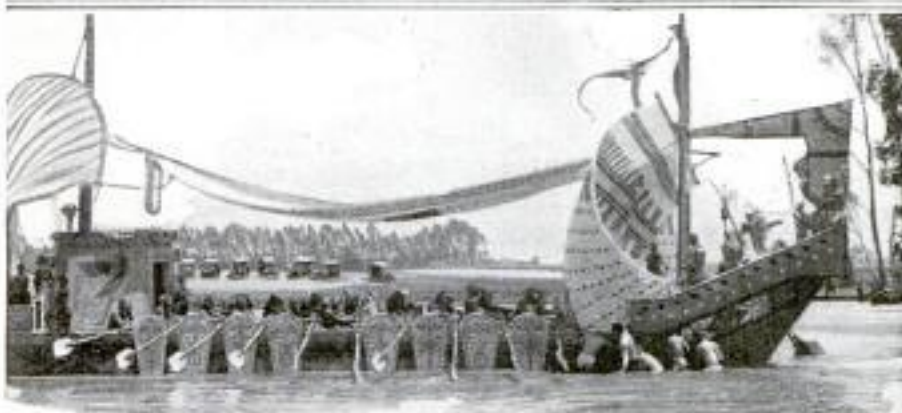
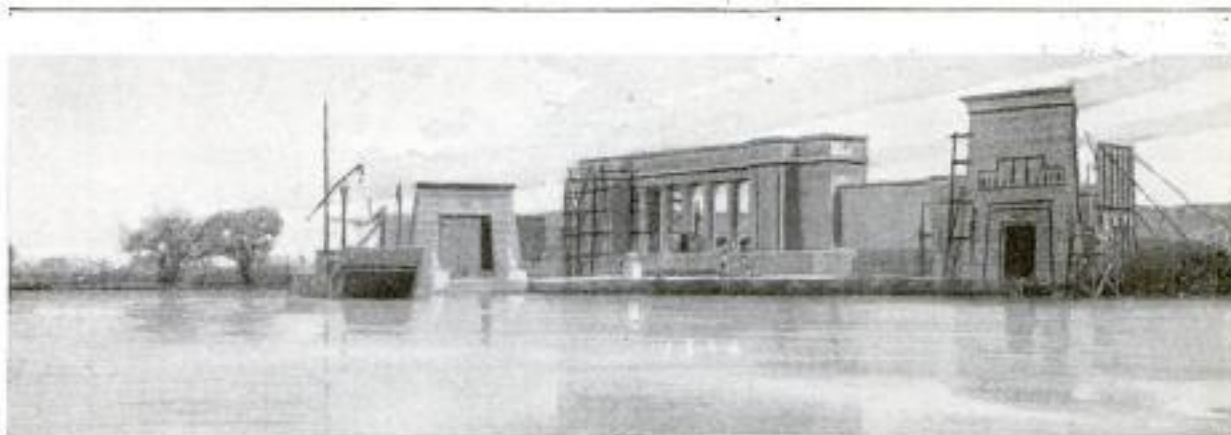

Above: The Barge at the Dock in "Alexandria". This View Gives Some Idea of the Extent of the Settings That had to be Built

Below: Pumping Water to Float Cleopatra's Barge; the End of the Slough Whose Level was Raised by Artificial Means

Back-Side View of the Barge, Showing the Men in the Water Who were Needed to Aid in Controlling the Boat, Which Proved Almost Unmanageable

The story of how the splendor of ancient Egypt and of Cleopatra's court were reproduced for a new motion-picture film illustrates the fact that many difficulties which movie producers encounter can only be overcome by ingenuity and lavish expenditure. For the purpose of showing the queen's famous voyage from Alexandria to Tarsus, a large slough was selected as a setting and dammed with a bank of earth. Water was pumped into it day and night to maintain the desired level. On the shore, false fronts were erected which reproduced with remarkable detail the architecture and appearance of the Egyptian port. After pictures had been taken of the queen's departure in her royal barge, the setting was completely altered to show her arrival at Tarsus. Two weeks were consumed in making these changes.

Peculiar difficulties were also encountered in handling the huge barge.



While outwardly resembling the ancient craft, it was, in reality, supported in the water on barrels and, because of its large, gorgeous sails and draperies, proved almost unmanageable in the wind. To supplement the oarsmen a large crew was stationed beside the boat to push it along, wading waist-deep in the water. In every view they had to be stationed out of sight, on the side away from the camera. Fortunately a great variety of types were available for the extra parts, which are said to have numbered 20,000. Powerful Negroes posed as slaves, Mexicans as Egyptians, and fair-haired Americans as Romans—all attired in costumes that were historically correct.

### LIGHTNING STRIKES CHURCH AND STRIPS TOWER

4954 When lightning struck a church in a small town some time ago, it shaved practically every shingle from the steeple and peeled most of the brick veneer from the tower without materially damaging the wooden framework beneath. At the same time some 200 window panes within a radius of about 1,000 ft. of the meeting house were forced out of

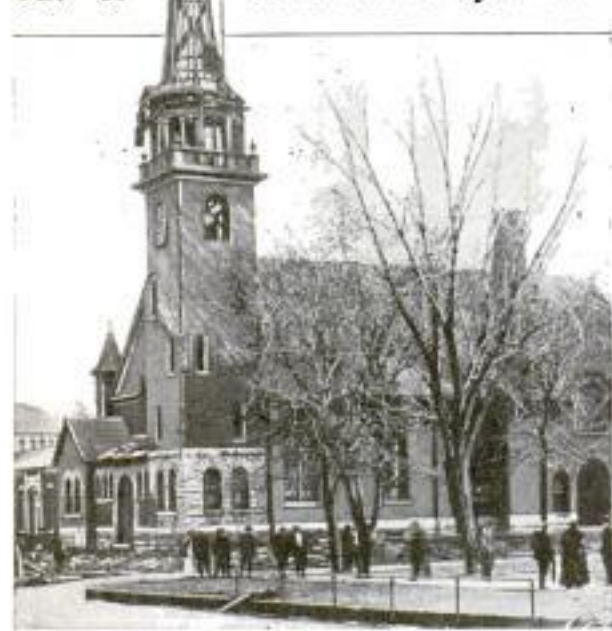

A Stroke of Lightning Divested the Spire of This Church of Its Shingles and Most of the Brick Veneer of the Tower Walls without Hurting the Framework

disturbance created. Most of these were of double-strength glass, and some were heavy plate, indicating that the stroke which produced this freakish result was one of unusual violence.

### WHAT IT COSTS TO EQUIP EACH INFANTRYMAN

5124 A detail which throws interesting light on the war's colossal cost is found in the statement that our government spends approximately \$156 in equipping every infantryman for service in France. A little calculation will show what it will cost to prepare a million or a million and a half men for the front. The equipment expenditures for the

foot soldier are classified under three heads: clothing, eating utensils, and fighting equipment. Under the latter group the rifle, the cost of which is figured at \$19.50, is the most expensive item. This amount varies from time to time. The gas mask, which also varies in price somewhat, is estimated at \$12, and 100 cartridges at \$5. The total cost of the clothing is slightly over \$100, the biggest items being \$18.75 for three wool blankets, \$14.92 for one overcoat, \$15.20 for two wool service coats, and \$10.20 for two pairs of shoes. In all, there are 23 different kinds of articles listed under clothing. In the eating-utensil group are included food to be carried in the haversack during field service, a canteen and canteen cover, cup, knife, fork, spoon, meat can, haversack, first-aid kit, and a pouch, costing approximately \$7.70.

### TILTING INKWELL SAVES WRITING FLUID

2234 Waste in writing fluid is reduced to a minimum by using a new type of inkwell, provided with a container wholly inclosed, except for a funnel-shaped opening at one end, in which the pen is inserted. This form of reservoir largely prevents evaporation. The ink tank fits into a wide, low stand and is held in place by means of two pivots situated one at each side so that the well can be tilted to make available the last drop of ink. A screw at the rear end regulates the angle at which the tank can be tipped.



It has been decided that Red Cross nurses with base hospitals and other military hospitals in France shall wear gray instead of white uniforms, on account of the limited laundry facilities in that country. An appropriation of \$14,000 has been made for the purpose.

3 - Mfg:  
Harold Chesson & Son  
West Brookfield, Mass.

*Hemp Mfg. Co.*  
 405-15 E. Oliver St.  
 Baltimore Md.

4355 **NOVEL DEMONSTRATION  
 MADE OF GAS APPLIANCE**

Quite an interesting laboratory test is employed to illustrate the merits of an apparatus that mixes air and gas in an exact ratio. For carrying out the demonstration, a glass bottle supplied with an asbestos washer, is clamped, neck down, to a channel iron. A burner is screwed to a gas-tight nipple that projects through a metal member. A mixture of air and fuel is supplied to



the burner through a rubber tube, while a second and smaller one, fitted to a connection opening into the flask at one side of the first, is provided to carry the products of combustion into a vessel of water. When ignited, the gas burns for an indefinite period in the virtually closed chamber.

This is possible only because the fuel is a self-sustaining mixture and the products of its combustion are discharged. Economy of gas and high temperature are the results of the combustion system, it is claimed, and therefore it is adapted to metal-working operations.

4491 **TUBES INSTEAD OF BELLS  
 FOR TOWER CHIMES**

A modern substitute for the time-honored but cumbersome bell chimes consists of sets of accurately tuned tubes or pipes, which can be easily installed in any belfry and occupy small space. Electric hammers, mounted at the upper end of the pipes, strike them with quick, sharp blows through the operation of projecting and recoiling magnets. The magnets are controlled by a simple keyboard which can be installed in any part of the building

desired and which can be played by any person having a rudimentary knowl-

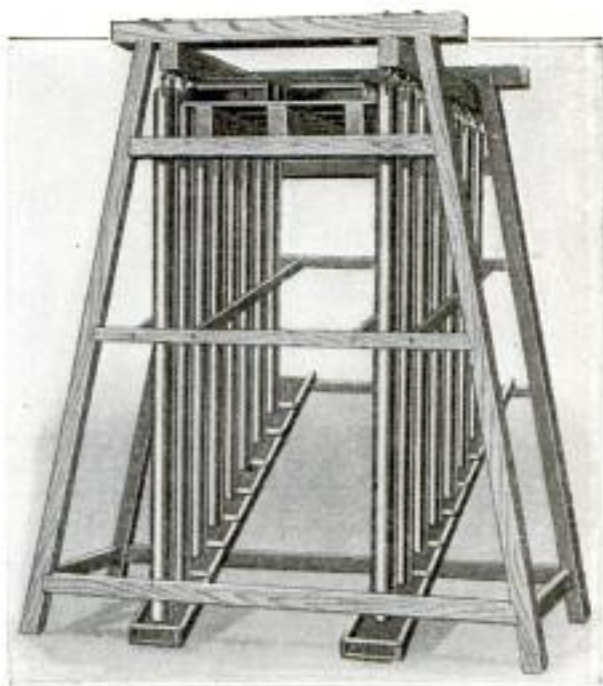

**Tower Chimes Composed of Accurately Toned Pipes Which are Played by Means of a Keyboard with Which They are Electrically Connected**

edge of the piano. Chimes of this sort require so little current to operate them that it is scarcely recorded by the meter.

3686 **MUD HOOKS, OR CREEPERS,  
 FOR MOTOR CARS**

When a motor car is stalled in mud or traveling on heavy dirt or snow roads, a set of mud hooks, or creepers, recently brought out will, it is claimed, greatly assist progress. The creeper consists of a wide strap of heavy woven belting, carrying a cleated plate of malleable iron with three staggered calks, and riveted straps with buckles for attachment to the rear tires of a car. Each creeper is shaped to fit over a tire and is securely buckled to a spoke. The set recommended for a car consists of three for each rear tire.

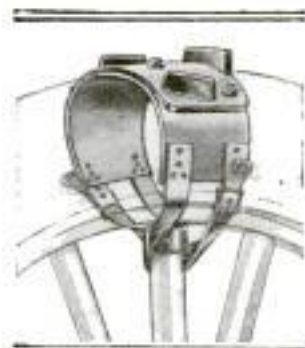

*Mfg. J. C. Deegan Musical Bells, Inc. Dept. E. Ravenswood & Bertone Ave. Chgo.*

*Mfg. Lakewood Fabric Belting Co. Lakewood Ohio*

## SOME NOVEL AND LITTLE-KNOWN ACCESSORIES



Smooth-Fitting Inside Belting for Waists, Suits, and Dresses: It Hugs Tightly without Wrinkling and Eliminates the Necessity of Making Darts. Close View is Shown at Top of Page. Price 15 to 25 Cents a Yard



Electric Milk Warmer for the Nursery: The Bottle Fits Inside of the Heater Ring, Shown in the Middle, and the Two are Placed in the Water Vessel



Light Sulky of Attractive Design with Reclining Back and Adjustable Top: A Metal Rest Supports the Front of the Vehicle When the Tongue is Lowered



Combination Double Boiler and Teakettle Intended Both as a Fuel and Space Conservator: It is Made of Aluminum of Capacities Ranging from Two to Six Quarts. Prices \$2.25 to \$3.75



A Spring and Fall Convenience: A Detachable Screen-Door Hinge That Eliminates Considerable Work for the Householder. The Hinge is Released by Turning the Thumb-screw



Sanitary Spoon for Soda Fountains and Ice-Cream Shops Consisting of a Detachable Waxed-Paper Bowl and a Metal Handle: After Once being Used the Bowl is Destroyed



About 50 Unmounted Kodak Prints can be Carried without Injury in the Leather Case Illustrated at the Left. It is Provided in Several Sizes at Prices Ranging from \$1.50 to \$2.00



With Flaring Legs That Prevent It from Tipping, and a Center Strap That Keeps a Youngster from Sliding Out, This is an Accident-Proof High Chair with a Sanitary Porcelain Food Tray



INTENDED FOR THE HOME AND ITS MEMBERS



To Protect Foods Delivered during One's Absence from Home, This Receptacle has been Designed. It is Installed in a Partly Open Window and Serves Adequately as an Iceless Refrigerator during Cold Months



Particularly Convenient for Christmas Packages and Letters: A Roll of Printed, Perforated, and Gummed Stamps Bearing One's Name and Address to be Used as "Return Stamps." Price \$2.25



Especially Suited for the Back Porch of a City Apartment Is This Waste-Paper Bag Which is Supported by a Steel Frame Attached to the Wall and Fitted with a Metal Cover. Price \$5



A Spring Foot Rest for the Motorist Facilitates Use of the Accelerator, Prevents Unintentional Acceleration, and Relieves Muscular Fatigue. The Price Is 75 Cents

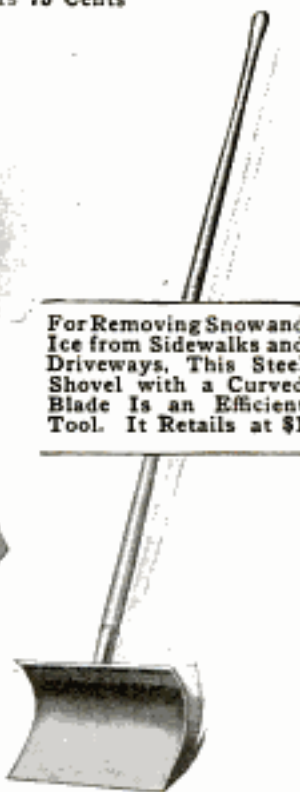

For Removing Snow and Ice from Sidewalks and Driveways, This Steel Shovel with a Curved Blade Is an Efficient Tool. It Retail at \$1



Showing Interior Construction of Compact Gas Furnace Intended Especially for Residences Situated in Regions Where Moderate Temperatures Prevail the Year Around: It will Warm a Chilly or Damp House in a Few Minutes and is Easily Regulated. Small Size. About \$100



For the Woman Who Occasionally Uses a Hammer, Sometimes with Disastrous Results, This Nail Holder has been Devised



Convenient for Milking Is This Pail, Which is Fitted with Curved Supports That Rest across One's Legs and Hold the Receptacle in Position

Mfgg: The S. J. Bass Mfg. Corp  
Yerkesmer, N. Y.

**CHEST DEVELOPER TELLS  
CAPACITY OF LUNGS**

5014

Excellent chest development, and incidentally much entertainment, can be obtained by using a simple lung exer-



Simple Lung Exerciser: As This Bag is Inflated the Indicator Attached to the Side Slides toward the End of the Graduated Ribbon. By This Means One's Lung Capacity is Accurately Measured

ciser consisting of a rubber bag fitted with a device to measure its inflation. Special benefit is derived by trying to make the bag as large as possible with a single breath. Attached to the side of the valve through which one blows is a ribbon having graduated markings. This measure passes through a slotted guide fastened to the side of the bag, and as the latter expands, the guide slides farther and farther toward the ribbon's end. The reading indicated by the position of the guide shows the number of cubic inches of air in the bag.

*Access*

**NONGLARE AUTO LIGHT  
WITH SOLID-BEAM**

2615

An improved form of reflector for automobile and other spot lights, recently patented, is claimed to produce a nonglare beam without any dark center and effective at all required distances. The new

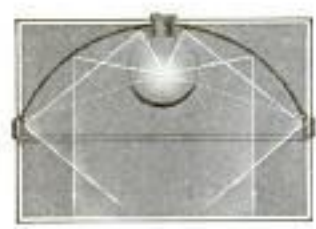

light has a 6-in. reflecting surface, and is provided with a 21-cp. nitrogen bulb.

Patent Granted to Willoughby  
Electric Specialties Co.  
Pittsburgh, Pa.

A cap deflects the direct light of the bulb to the reflecting surfaces in such a way that most of the light is thrown out directly in a parallel beam and the rest is reflected into it. The resulting beam is said to conform fully to all city ordinances and state laws, since only reflected rays are projected and no direct light from the bulb can enter the eyes of approaching drivers or pedestrians.

4791 — Machine  
**SHIPBUILDING TOOL BENDS**

**HEAVY STEEL MEMBERS**

For shaping heavy steel used in shipbuilding, a compact and comparatively light machine has been developed which is claimed to bend long members to template with minimum labor and without requiring the material to be reheated. It consists essentially of a cylinder, a double-acting ram, and an operating mechanism

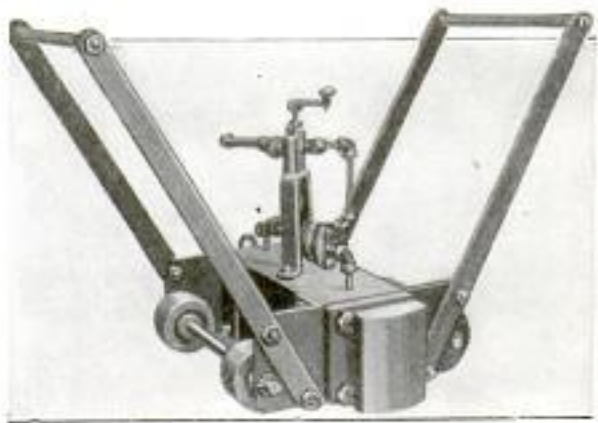

Powerful Shipbuilding Tool That Minimizes Labor of Bending Steel for Frames and Deck Beams: It Develops a Working Pressure of 20 Tons

so mounted on broad rollers that it may be rolled by pushing or pulling on handles provided at either end. A loose pin fits in holes in the bending slabs and serves as an abutment for the apparatus. Power may be supplied by pump or accumulator service. At a pressure of 1,750 lb. to the square inch, the machine with a 10-in. stroke develops a working power of 20 tons. Although it is powerful, the machine is fairly compact and not excessively heavy. In operation it is easily handled by ordinary workmen.

Mfgg: Halson Stillman  
Co. Alden, N. Y.

4847 BABY SUBMERSIBLE AS SUBMARINE'S LIFEBOAT

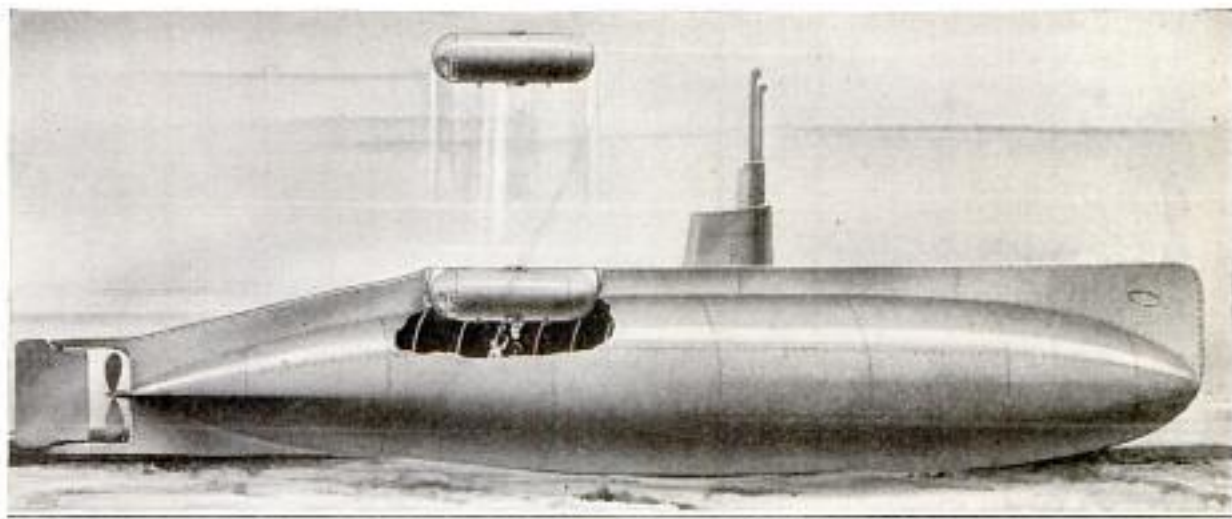

The Method of Carrying the Auxiliary Submersible and the Way It Leaves the Mother Craft are Shown in the Drawing Above. The Small Vessel is Self-Propelled and Accommodates 30 Persons

For a long time attempts have been made to evolve some sensible scheme for permitting a crew to escape when a submarine sinks, gets ensnared in a net, or for some reason becomes unmanageable while under water. In line with this work is an invention that has lately been protected by patents. It is a lifeboat and, in reality, a small auxiliary submarine that normally is held in a concave seat constructed in the top part of the large craft. Water-tight hatchways are provided in each of the vessels so that access from one to the other of them is possible. As

designed, the small craft is 26 ft. in length and 6 ft. in diameter. It is intended to offer a safe retreat for some 30 persons. Electric and gasoline motors would propel it and give it a radius of action estimated at about 500 miles. In the event of accident, members of the crew would enter the lifeboat, close the hatchways, free the small craft by unscrewing two large bolts that anchor it to the larger one, and rise to the surface. The inventor claims that existing submersibles could be equipped with the device, but in new ones it would be an integral part of the vessel.

CURRENT METER FOR USE

4112 IN HARBOR WATERS

A Cornell professor has invented an efficient current meter for securing data regarding the flow of water beneath the surface in harbors, and other localities where such information is valuable to mariners and chart makers. It was used recently in charting the currents set up by the mingling of fresh and salt water at the sea-level end of the Miraflores locks, Panama Canal; also by the hydrographic division of the navy in tracing the Gulf Stream around Florida, and in charting currents in New York harbor and at

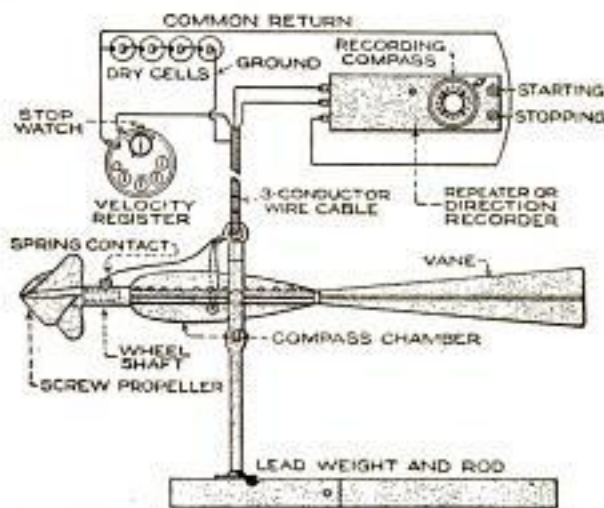

Diagram of New Current Meter Used from a Boat to Secure Data for Charts of Harbor and Coast Waters

Invt. Prof. C. E. Haskell, Cornell University  
Ithaca, New York

points on the Great Lakes. The meter determines both the velocity and direction of running water below the surface, and indicates each electrically on registers. In use, part of the apparatus is suspended by an insulated and wired cable from an anchored boat in which the batteries and registers are placed.

The meter box contains a compass in oil, to indicate direction of the flow at any depth to which it is lowered, and has a turbine tail vane, or wheel, whose turns indicate the velocity of the current, these data being duly registered on dials in the boat where the controlling switches are also located.

4957

**SMALL INDUSTRIAL TRACTOR HAS DOUBLE-END CONTROL**

For use in warehouses, railway terminals, and similar places, an electric



Two Pedals and Handles Control the Machine and may be Manipulated from Either Seat. The Arrangement Eliminates Much Needless Turning

truck with dual control which permits operation in either direction has been introduced. The object of the arrangement is to obviate the awkward maneuvering that is often necessary when a tractor is being used in narrow aisles and passageways. Instead of turning the machine around, the driver in this case has only to change his seat, for either end serves as the front end. Two battery boxes are mounted on the truck, and the tops of these serve as seats. The large compartment contains three trays of six cells each, while the small one holds an additional set, making in all 24 fifteen-plate batteries of 220 ampere-hours' capacity. With a 20,000-lb. load the tractor will push or pull its trailer trucks at a maximum speed of seven miles an hour.

**MAGAZINE FEEDS NEEDLES**

**3694 TO PHONOGRAPH**

A magazine with a capacity for a number of talking-machine needles has been patented, which attaches to the sound box of a phonograph and is so made that the steel points can be fed into position one after another as needed, with a minimum of inconvenience. The chamber consists of a slender tube, at the lower end of which is a chuck, by means of which the needle projecting from the end is held in position for use. The other needles are kept from pressing down against the bottom one by a spring that projects through the side of the magazine and can be withdrawn when the operator wants a new needle dropped into place.



**HINGED BACK A FEATURE**

**4889 OF HOSPITAL CHAIR**

A chair for convalescents or invalids, which will doubtless find much service



Two Views of Hinged Back of Chair for Convalescents or Invalids: The Occupant's Hair can be Dressed or Head Bandages Adjusted Much More Easily with the Hinged Section Let Down

in army hospitals, and elsewhere, is provided with a high back, the upper portion of which is a hinged section that can be let down when desired.

Mfg. by: The Northington Co.  
Clyde, Ohio.



Mfg. Nathan M. Stone Co  
1731 N. 22 St. Chgo.

Mfg. J. S. Pease Elec.  
Garage, 102 S. Perry St.

This permits the occupant to move his head more freely, and in case the hair is to be dressed or bandages are to be adjusted, it is then, also, a special convenience.

**PRUSSIAN SOLDIER GETS  
KNOCKS IN NEW GAME**

One of the new games which has been brought out since this country entered



The Figure of the Soldier Stands 24 Inches High and is Provided with a Regular Steel Helmet. When a Ball Strikes the Head It Wobbles Amusingly, and a Hit on the Helmet Causes a Loud Bang



Mfg. Victor Machine Co.  
Chicago, Ill.

the war is a suggestive variation of the familiar "hit the doll baby" game. In the place of a carefully balanced doll is a 24-in. figure of a Prussian soldier with a life-sized head on which is a regular steel helmet. Balls are thrown at the figure and those which strike the head cause it to wobble amusingly.

**COMBINED MEMO HOLDER  
AND PHONE INDEX**

5017

A very convenient attachment for a desk telephone consists of a combined memorandum-pad holder and an index which is attached by a clamp to the instrument post. A spring-held clip keeps loose leaves or a pad in place, on the metal surface of the holder. The latter can be turned out of the way when desired, giving access to the index beneath. Entries can be made on both sides of the index leaves, giving it a capacity for 456 names.



**STAND FOR WRAPPING  
POTTED PLANTS**

A new invention which will prove a special convenience for florists is a small circular-topped stand for use in wrapping potted plants. About this support are nested a number of paper wrappings, cylindrical in form. After a plant to be prepared for delivery has been placed on the stand, one of the wrappings is drawn up about it and tied at the top, and also at the bottom if desired. Interchangeable tops of various sizes, with wrappings to correspond, can be provided. The framework of the stand is of ornamental iron. The upper section can be locked in an upright position.

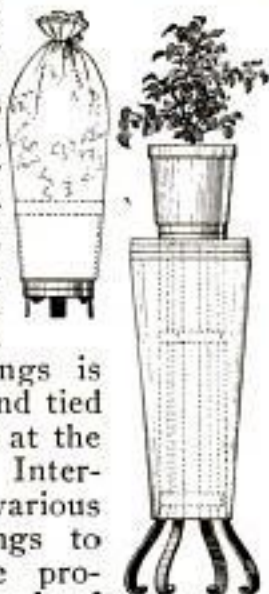

**DIAL SHOWS WHEN BATTERY  
NEEDS WATER**

An instrument recently invented by a garageman indicates by its dial on the dashboard when the storage battery of an automobile needs water through evaporation or leakage of the electrolyte in any of its cells. The dial is that of a voltmeter installed on the dash and connected to the battery by wires forming a closed circuit. When the fluid in the battery reaches a dangerously low level, the warning signal appears behind the glass of the dial.



Inv. H. Hayashi,  
2311-73rd Avenue  
Elmhurst, Calif.

A. S. Pease Electric Garage  
102 S. Perry St.  
Chicago, Ill.

## ACTIVITIES AND INTERESTS OF BOYS AND GIRLS



COPYRIGHT, NEWMAN TRAVELTALKS  
AND BROAD & DAWSON  
No Soft Blows in This  
Sport: These Japanese  
Schoolboys are Armed  
for a Fencing Game  
Rougher Than Football  
and as Popular



At 14, Theodore Coleman of Mt. Carmel, Illinois, Is a Movie-Theater Manager! This Is Part of One of His Audiences, Which Are Almost Always Overflowing



Just to Show That Royal Children Are Quite Human, Here Is Princess Juliana of Holland, Who Is Eager to "Try Out" the Ice—if She Has Something to Cling To



FRENCH OFFICIAL WAR PHOTO

Now and Then There Are Days When Joy and Gratitude Drive Away Sadness in War-Worn France. This Picture was Taken on Such a Day While Kind Women were Presenting the Children of Noyon with Toys Sent from America

SHOWN IN VIEWS FROM WIDELY SCATTERED LANDS



This Is "Baldy," a Famous and Heroic Alaskan Racing Dog, Now Living in the West on a "Pension" Supplied by His Master. The Smaller Picture Shows Two Gold Collar Plates Given Him by Admirers

Ordinary Coasting did Not Satisfy Joseph H. Lucci, Aged 15, of Alaska, and So He Made This Novel Motor Sled That can Travel 16 Miles an Hour



The Coming of Wintry Days Delights Barbara Livermore of New Hampshire for, Though Only Three, She Is Adept at Snowshoeing



It Seems Unbelievable, but Nevertheless Many Little Boys, Some Only Eight Years Old, Belong to the Crew of the Mexican Gunboat "Guerrero" That Visited San Diego, California, Recently. Several in This Picture have Shared in Bloody Battles

### STONE-GATHERING MACHINE

#### 2090 DEVISED FOR FARM USE

To eliminate the tedious work connected with the removal of loose stones

from farm lands, an operation that is ordinarily done by hand labor, a Wisconsin man has invented a machine for accomplishing the work. It is of sim-

ple construction and easily handled by a strong team. When in use the apparatus is attached to the rear of a wagon, into which it loads the stones as they are gathered. It is obvious that no mechanical device could differentiate between stones and hard clods, so provision has been made for crushing the latter and allowing the dirt to fall to the ground. The outfit consists in part of a framework that supports a conveyor, onto which the stones are delivered by parallel rows of rake bars, carried on endless chains. The device is supported on a pair of large wheels from which power for operating the mechanism is

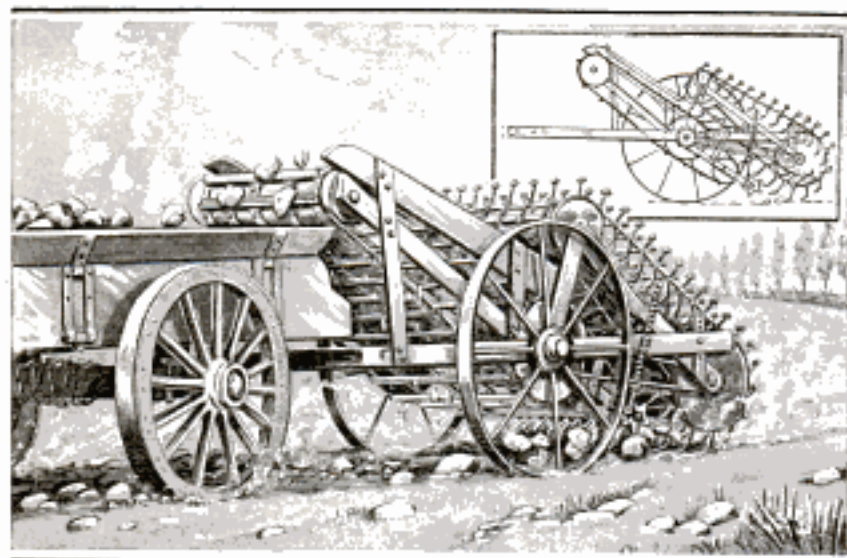

The Rows of Rake Bars Gather the Stones and Place Them on the Conveyor Which Discharges into the Wagon. Hard Clods are Crushed and Thus Separated from Stones

from farm lands, an operation that is ordinarily done by hand labor, a Wisconsin man has invented a machine for accomplishing the work. It is of sim-

obtained. The value of such a machine will be apparent to all who are familiar with the difficulties encountered in cultivating stony land.

### 3360 SCALE RULER TO MEASURE TYPEWRITING

With a scale ruler lately placed on the market by a Los Angeles firm, typewritten work may be accurately measured as to lines, letters and spaces may be counted, columns placed, and margins located, even by those who find it difficult to use the ordinary mechanical adjustments of a typewriter. The ruler reproduces the typewriter scale and is 13 in. long, the length of legal paper. The scale reproduction is 8 1/2 in. long, the width of typewriter paper.

Either of the margin ends added to the typewriter scale makes 11 in., the length of letter paper or letterheads. The ruler is used principally for planning work to fit the paper; also to find how much matter will go on a postcard and similar areas, and to place work on a stencil. In tabulation work it can be used to determine where tabular stops are to be placed on the typewriter. It is also convenient in checking legal copy, bids, reports, and the like.

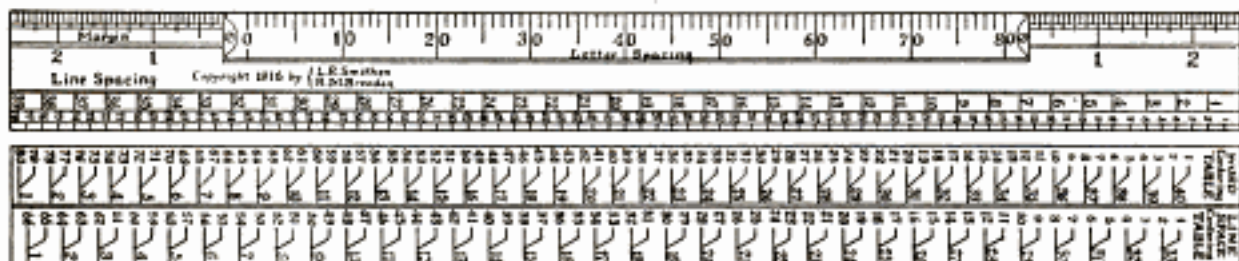

New Typewriter Scale Ruler with Which an Operator can Measure Work to be Copied, Count Lines or Letters, Center Headings, or Tabulate

Los Angeles Stationery Co.  
848 So. Hill St. Los Angeles, Calif.



## Fertilizing and Irrigating a Farm with Muck from Lake Bed

By E. R. McINTYRE

**A**N original and successful scheme for using lake water and its muck deposits for irrigating and fertilizing an adjoining farm was used by a Minnesota farmer. There being no complete outfits on the market for such projects, he worked out his own methods which have a wide application for similar projects. The pumping outfit transfers 90 tons of muck-laden water an hour from a small lake to the farm land. Of this solution nine tons an hour is muck. The lake has about 5 ft. of water at its deepest point. The muck is from 8 to 35 ft. deep, of loose formation, and easily pumped.

sionally with a long-handled rake, to stir up the muck.

Engine and pump are fastened to a small barge, as shown in the lower photograph. Connecting with the pump are two lines of pipe. One draws the muck and water into the pump, and



General Plan of the Muck-Pumping System, and a View of the Discharge Pipes at the Main Irrigation Ditch



The Barge is Anchored near the Shore and Carries the Pump and Engine

The equipment consists of one 7-hp. kerosene engine, a 3½-in. centrifugal pump, intake pipe, and a pipe used to carry the water from the pump to the highest point of land whence the distribution is through open ditches and furrows. While the pump is in operation, a man in a boat about 100 ft. off shore agitates the lake bottom occa-

tionally with a long-handled rake, to stir up the muck. The intake pipe of wood is kept at the bottom of the lake by means of weights. A 6-in. pipe is fastened to the wooden pipe and may be swung in various directions. With added pipe the supply of muck is readily extended.

To keep out stones and sand a special device is used. A box, measuring 3 by 3 by 5 ft., is placed between the pump and the intake pipe. This catches the extra large particles and keeps them out of the pump. The water and muck are taken to the highest point on the

farm, 650 ft. distant, with a rise of 17 ft., by two lines of 4-in. pipe. These are fastened to the exhaust openings of the pump on the barge. Old boiler flues are used for these pipes. Instead of piping outward from the highest point on the farm, ditches were dug, and the strawberry beds and orchard irrigated in this way. On kerosene, the cost of operation is about 10 cents an hour, the muck thus being deposited on the land at a cost of 10 cents a ton, exclusive of labor and repairs to machinery and the initial cost of \$250 for the equipment.

### Cutting Threads Accurately on Small or Thin Pipe

In cutting threads on thin or small pipe it is often troublesome, especially on short pieces, to get the threads square with the length of the pipe. There is also trouble in getting a suitable grip on the pipe so as not to bruise or scratch it if plated. A good method is to put the die holder in a bench vise, and reverse the dies, that is, turn them upside down. This will make a piece of pipe thread in the direction of the arrow. Select a piece of steel rod of a size to just slide through the pipe. Run this down between the dies into a block so fastened as to make the rod vertical. Slide the pipe down over the rod and it will be threaded straight and true. The best grip I have found is shown in the smaller sketch. Select a piece of hard wood,  $1\frac{1}{8}$  in. thick and 15 in. long. Shape it as shown, and bore a series of holes along a center line, of sizes to take the outside diameters of the pipes. Then bore two  $\frac{1}{4}$ -in. holes for bolts. With a thin saw, cut along between the pieces. When clamped on the pipe, this device will not slip or bruise it.—L. M. Drake, Daytona, Fla.

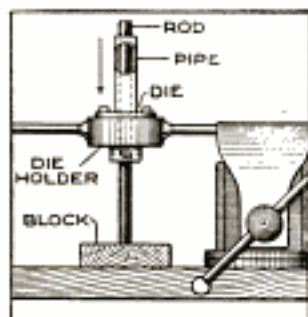

### Portable Stand for Janitor's Cleaning Equipment

A stand, on casters, and built to accommodate the various articles that a janitor uses in cleaning rooms and

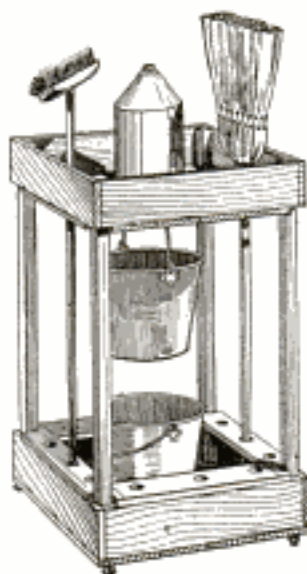

halls in large buildings, is a time and labor saver. It is made to fit a hall closet, and can be kept out of sight easily when not in use. Painting it with white enamel gives a neat appearance. When needed, the janitor rolls the stand to the room he intends to clean, leaving

the stand just outside. The casters should be of the pivoted roller type, and for use on highly finished floors larger, rubber-covered caster wheels are desirable.—Thomas O'Dea, New Haven, Conn.

### Tool for Grasping Small Machine Parts

Four pieces of steel wire and a file handle are all that is needed for the construction of a handy tool useful for setting bolts,

nuts, screws, etc., in places difficult of access. It is also convenient for recovering coins, rings, washers, etc., from plumbing fittings. The tool is made by driving into the

file handle three steel wires, in prong fashion. A wire is made ring-shaped, to slide over the prongs and compress them about the piece to be handled. The length of the prongs will vary to suit the needs of the individual user.



### Shaft Hangers and Fittings for the Small Shop

When it was found too expensive to buy hangers for a shaft in a small shop, they were improvised, and proved so serviceable that they were left in place as permanent equipment. Six of these hangers carry a 1-in. line shaft, 34 ft. long. The method of construction is simple, and the parts used can be obtained in most small shops.

Cold-rolled steel is used for the shaft. The bearings are made of short sections of gas pipe, into which babbitt is poured. The bearings require a 1 $\frac{1}{4}$ -in. pipe, cut from 4 to 6 in. long, depending on the load to be carried.

After the pipe is cut with a hacksaw to give a square end against which collars can be fitted, the sections are bored with three holes, as shown in the sketch. Two of the holes are oil holes, and the center one is for the pouring of the babbitt.

The pouring of the babbitt is accomplished by means of two wooden supports, bored, as shown, to fit the shaft, and shouldered for the pipe. The arrangement is set up as indicated, the oil holes being plugged, and the babbitt is poured into the bearings. The bearings are smoothed and cleaned in the usual manner. If the shaft and pipe are warmed slightly, a better job will result.

The method of hanging the bearings can be arranged to suit conditions. In this instance the shaft is run along the wall, and the hangers are made of wood, strongly braced, and set into the wall, as shown. The bearing is clamped into a V-groove by means of a metal plate.

The wood pulleys to transmit the power from the shaft are made by building them up of alternate layers of  $\frac{7}{8}$ -in. wood, which are cross-banded,

and fastened with glue and bolts. The pulleys can be turned true by mounting them on the shaft, and rigging up a suitable rest for the turning chisels. Collars for holding the pulleys and other fittings on the shaft, can be made up of short sections of pipe, drilled and

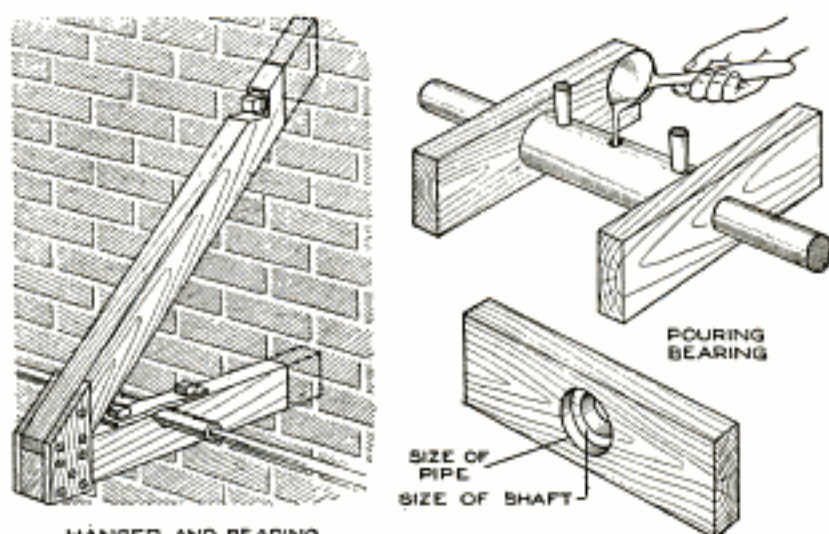

**HANGER AND BEARING**  
Equipment for Power Transmission in the Small Workshop can be Made Cheaply by Using Babbitted Pipe Bearings and Hangers Built Up of Wood

tapped for setscrews. To guard the setscrews, they should be short, and the threaded collar covered with a second collar, bored so that the head of the setscrew is recessed in a socket, and the covering collar cut to form a split ring. Suitable setscrews may be made by cutting off the threaded end of a bolt, and slotting the upper end to engage a heavy screwdriver.—Ray F. Kuns, Cincinnati, Ohio.

### Small Wire Scratchbrush Handy in Soldering

In soldering teakettles, pans, etc., it is often difficult to clean the surface to be soldered, especially on the inside of the vessel. This trouble can be overcome by using a file cleaner with long steel-wire bristles. If the cleaner is too large, cut some fine steel wires, form them around a small brass rod, bind them securely with a piece of brass or copper wire, and then sweat a little solder in around them. Such a scratchbrush will give good service for cleaning small areas.—A. Gemmell, Ansonia, Conn.

### Window Lamp with Revolving Shade Attracts Attention

The animated window display described is automatic and requires no driving mechanism. To make the re-

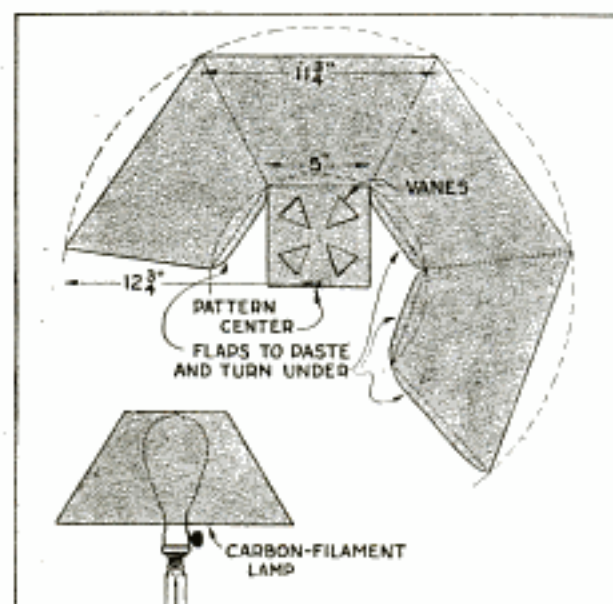

The Heat Generated by the Lamp Turns the Shade, Which is Pivoted on the Tip of the Globe

volving shade, cut from light, strong cardboard, a form, as shown. The sides may be cut with stenciled letters or designs, backed with translucent paper, or may be left solid. Four triangles are cut in the top, and the resulting vanes are bent downward at right angles. A small paper disk is then pasted in the exact center of the under side of the top, and a small hole centered in it. Mount a large carbon-filament lamp on a suitable pedestal, pivot the shade on the tip of the lamp, and turn on the current. The heat generated will flow up between the vanes and slowly turn the shade as long as the current is turned on.—B. L. Dobbins, Boston, Mass.

### Cutting Hard Sheet Rubber with Scissors

Hard sheet rubber is difficult to cut, and the average experimenter has few facilities for doing such work. An easy way to cut this material, up to  $\frac{3}{16}$  in. thick, is as follows: Mark the outline to be cut on the rubber with

a scribe. Plunge the sheet into hot water; take it out and cut on the outline with a pair of heavy scissors. The rubber will become soft like leather and will cut easily. As it becomes cooler, it will cut harder. If any more cutting is to be done, plunge it into hot water again, and continue until the cutting is finished. The sheet will probably be somewhat out of flat. To remedy this, dip the rubber in hot water, place it on a sheet of plate glass, or metal, and put another sheet of glass over the rubber, with a weight on it. Permit it to cool, and it will be flattened.—W. S. Standiford, Youngstown, Ohio.

### Device for Opening Stove Damper Handily

It is often inconvenient to get near enough to a damper in a stove or furnace to open and close it. To overcome this difficulty I arranged a simple device, as shown in the sketch. I first made four pieces of wood,  $\frac{7}{8}$  by  $\frac{1}{2}$  by 6 in., and two of them were halved together in the form of a "T," as detailed. On the ends of the cross-bar I inserted screw eyes. The other two pieces I fastened on the handle of the damper with two screws, and also put screw eyes in the ends of one of these pieces. To the floor joist I nailed a brace long enough to be within easy reach of a person standing in front of the furnace. On this brace I pivoted

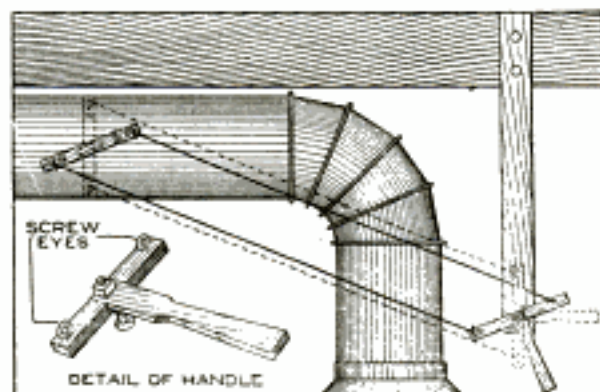

This Arrangement Made in Half an Hour Is a Great Convenience at the Furnace

the T-shaped piece, as shown. Parallel wires connected to the eyes, as



indicated, completed the arrangement. By means of the T-shaped piece I can move the damper readily from the front of the furnace.—Walter S. Jennings, Buffalo, N. Y.

### Chipped Grooves Drain Rainwater from Walk Depressions

After several years, stone and various composition walks begin to wear away on the surface. Depressions form near the center of each square of walk, and after a rain pools of water settle in these depressions. A remedy is to chip a small groove from the low spot to the side of the walk, to afford drainage for the water.

### Variable "Will Be Back" Sign Quickly Made

To save time in answering telephone calls for men who are out of the office, a clerk in a large organization devised an inexpensive device to tell when each man expects to be back at his desk. Across the top of a 3 by 5-in. filing card is lettered "Will Be Back at 2 P.M. John J. Smith".

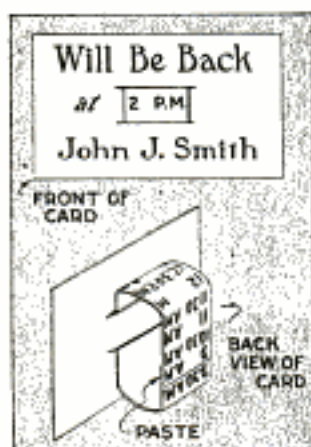

Two horizontal slits, 1½ in. long, are cut in the middle of the card about ½ in. apart, as shown. A fairly stiff piece of paper about 8 in. long is slid through these slits. On this strip the office hours, divided into half-hour periods, are indicated. The ends of the strip are pasted together forming a support for the sign. When John Smith intends to leave his desk at 10:00 a. m. for an hour, he simply slides the stiff paper through the two slits until "11:00 a. m." appears on the face of the card. This device makes it unnecessary to bother several people to ascertain when he will be back.

### Devices That Add Comfort to Winter Touring

Winter automobile touring or driving, without special preparation, subjects the tires of the car and its occu-

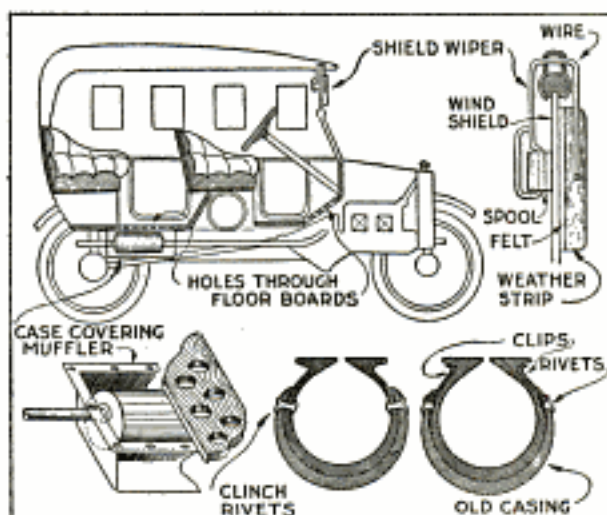

These Homemade Devices and Features Are Practical for Winter Touring or Driving. The Car is Warmed, the Tires Protected, and the Windshield Kept Clean.

pants to unusual severities. With comparatively slight labor, protection may be provided that will also decrease expenditures for tires. Excess heat, usually lost in radiation, can be diverted to portions of the car to the comfort of the occupants. The method shown in the sketch is effective. Construct a boxlike case for the muffler, and fasten this to the under side of the floor. The casing may be of sheet metal or wood. Through the floor, directly above the deflector, a number of holes should be bored, which will not materially weaken it, yet will permit the heat from around the muffler to escape into the car. The floor boards in the front compartment may be drilled in a similar manner for the heat from the radiator and engine.

Tires should be protected from the frozen roadbeds. Discarded casings will render efficient service as covers, taking most of the punishment of the winter roads, and also increasing the tire diameter and bearing surface, thus making progress through the snow less difficult. The heads of the casings are removed. Coppered clinch rivets hold the casings securely in place, as detailed.

Another convenience, when driving through snow, rain, or mist, is a home-made windshield wiper. One made of a piece of felt-edged weather stripping, mounted on a bent rod of spring wire, as shown, is practical. The clip is made of sheet metal, fastened by means of a small bolt, and, on the other end of the wire, a spool, with flanges removed, is mounted. If the felt edge is occasionally saturated in equal parts of glycerin and alcohol, it will coat the glass with an oily film, which tends to shed water and makes necessary only occasional use of the cleaner.—G. A. Luers, Washington, D. C.

### Fitting Angle-Shaft Bearing Brackets to a Machine

A shaft to be placed at an angle on a machine in bearing brackets, as shown, requires considerable fitting to get the brackets in line, so that the shaft does not bind. To avoid this trouble, the bearing brackets should be bored out  $\frac{1}{2}$  in. larger than the diameter of the shaft.

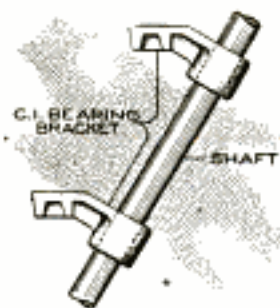

The brackets are secured to the machine; small collars,  $\frac{1}{8}$  in. wide, are provided to slip over the shaft, their outside diameter being the same as the bore in the bearing brackets. These collars are placed in position to enter the holes in the bracket, centering the shaft. Babbitt is poured through a hole drilled in the hubs of the bearing brackets. The babbitt will run around the shaft, locating it easily. It is only necessary, after removing the shaft, to scrape the inside of the bearings and drill an oil hole.—Jos. Limbrunner, Shelton, Conn.

☐ In clamping smooth work on machine-shop machines, the slipping of the metal on the surface of the machines can be overcome by inserting a sheet of paper between the work and the machine bed.

### Replacing a Strong Coil Spring

Great difficulty is often encountered in replacing the clutch spring on an automobile, or other strong coil springs, which must be compressed.

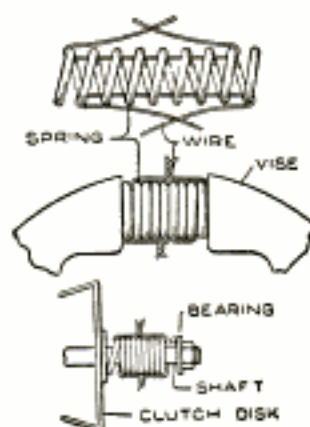

The operation is frequently dangerous, especially for one man. By binding the spring with wire, as shown in the sketch, and clamping it in a vise, one man can replace the spring quickly and safely. Two pieces of wire are inserted in the spring, which is then clamped in the vise. The wires are twisted and drawn up tightly. Then the spring is set into place, and, when the wires are cut, springs to its proper position.—Ralph M. Brown, Ithaca, N. Y.

### Channel Bars Mitered in Power Hacksaw

In making a large frame out of channel iron, the ends had to be cut at an angle. The rigging, shown in the diagram, was made to line up the channel irons for cutting.

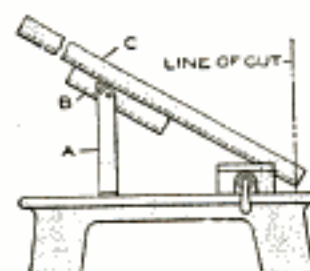

The upright A is fastened to the bed of the hacksaw, its lower end being bent at a right angle. The strip B is fastened to the upright A at such an angle that, when the channel iron rests against it, the end will be cut off at the required angle. The channel iron C is held against the strip B with a wooden clamp. The rigging should be in line with the vise so that the lower end of the work may be clamped in the vise. This method saved much time as against doing the work by hand.—C. Anderson, Worcester, Mass.

### A Quickly Made Shaft Coupling

Two old gears from the shop scrap box were used to make a shaft coupling, which proved quite satisfactory. It was used to connect an electric motor to a small water pump for experimental work. The gears were pinned to the shafts by means of standard taper pins, as shown, after which a series of round steel pins were placed in the spaces between the teeth. These pins were of such diameter as to allow them to fit in the spaces snugly. A clamping collar, made in two sections as detailed, was slipped over the pins, holding the latter firmly in place. The coupling has proved efficient, and also has the advantage of being readily disassembled.—A. L. Snell, Minneapolis, Minn.

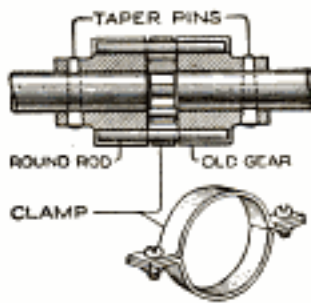

### Wall Pockets for Storing Rivets and Small Hardware

A method of storing rivets, used by a tinsmith, has many practical adaptations for the home workshop, as well as for the shop or hardware store. The tinsmith made a series of sheet-metal pockets, as shown in the sketch, 6 in. wide and 8 in. long, with an eye at one end to be hung on a nail, or shoulder hook, set in a large board or in the wall. On the front of each pocket, he soldered a rivet, or sample of whatever small article was contained in the particular pocket. When used on a workbench, the pockets are laid flat, exposing the contents.

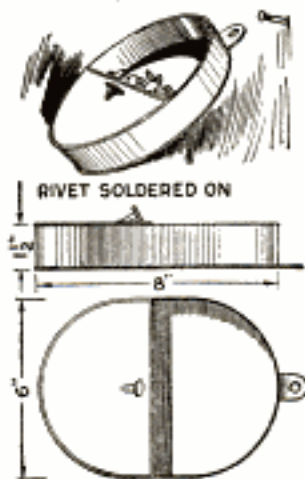

### Thawing Out a Fire Plug Quickly

When the fire department was called out one night to a serious fire, the street fire plug was frozen, and ordinary remedies failed to open it promptly. While some of the firemen attacked the blaze with chemicals and what water was available, others poured gasoline, from the tank of the fire truck, over the frozen plug and set fire to it. The plug was soon thawed out, and the fire brought under control.

### Novel Display Wheel for Show Window

A window advertising novelty which attracted considerable attention, was homemade of inexpensive materials, and driven by a small motor, the whole arrangement being compactly inclosed, as shown in the illustration. A good size for the case is 15 in. high, 3½ in. deep, and 12 in. wide, with a disk about 10 in. in diameter made of two ¼-in. boards. The smaller disk is used as a pulley, and is belted to the motor by small round belts, or cords. Cartoons, or similar devices, with advertisements between them, are mounted on the face of the disk, which can be covered with velvet or other attractive material. The wheel is driven around making the onlooker curious to see the various figures that appear in the opening. Two narrow shelves may be set into the front of the box, as shown, for displaying rings or other small articles. The front of the case is hinged as indicated, so that the disk can be re-covered as desired.

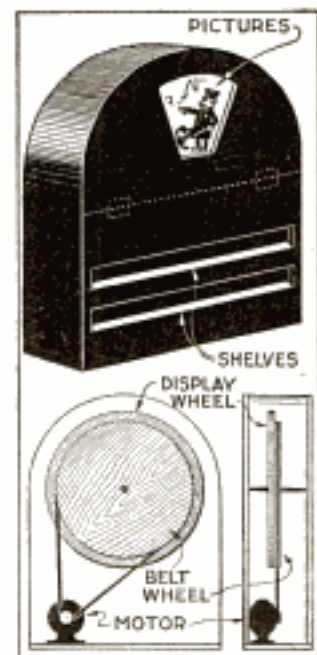

### Combined Hinge and Stop for Cellar Doors

Strips of flat iron,  $\frac{1}{4}$  by 1 in. wide, were used to make serviceable hinges

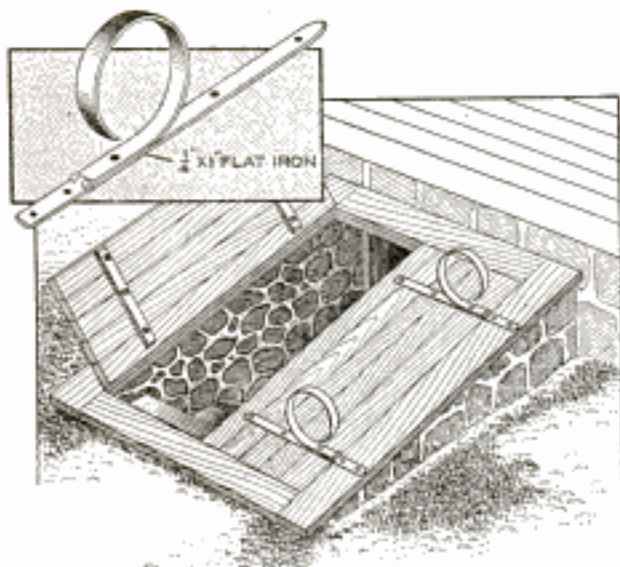

These Combined Hinges and Spring Doorstops Strengthen the Doors, and Keep Persons from Walking on Them

for cellar doors, and a strip was attached to each hinge, curled in the form of a spring, as shown, providing also a practical stop. The usual difficulty with such doors is that the hinges are soon torn loose and the doors racked to pieces. These hinges act as braces across the doors as well as stops.—M. E. Duggan, Kenosha, Wis.

### Proof on Letter-Printing Machine Made with Carbon Sheet

A simple way to obtain a proof sheet of a letter that has been set up for running on a letter-printing machine, without going to the trouble of attaching and detaching the ribbon and getting the fingers full of ink, is to lay a piece of carbon paper on top of the letterhead with the carbon face in contact with the letter, and then feed the two sheets through the machine together. The result will be a legible carbon copy in which all errors are readily found. On account of the extra thickness of paper, the lever regulating the impression should be properly adjusted.—Alfred J. Miller, Albuquerque, N. M.

### Broken Motorcycle Nut Repaired on Road

While on a motorcycle trip, far from a repair shop, one of the main nuts on the rear axle of my machine broke in two. It was an odd size, and I could not get another. Finally I clipped a loose end of heavy wire from a near-by fence, filed a V-groove around the edge of the nut on the six corners, and twisted the wire tightly around the nut in the groove. When screwed into place on the axle, the nut held satisfactorily until I arrived home.—W. H. Thies, Washington, District of Columbia.

### Hook for Removing Cap Rings from Piling or Posts

In driving posts or piling, a steel ring is usually set over the top to prevent damage to the post from the blows of the hammer, or pile-driver head. Where a number of stakes are driven, it is also convenient to use a ring which may be removed and used repeatedly. The device shown in the sketch can be made in various sizes for removing these rings quickly. On large jobs, power may be applied to the drawbar, and on smaller posts a lever may be hooked to the chain, or the bar may be made long enough to give good leverage.

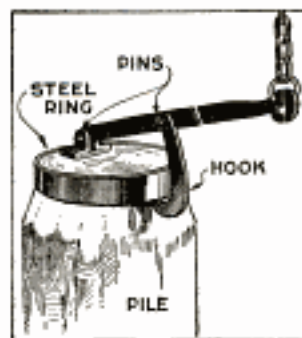

### Surfacing Typewriter Platens with Sandpaper

When rubber typewriter platens become hard and uneven they can be made soft and smooth by truing them with coarse sandpaper, and then smoothing them with fine emery cloth. They will then be almost like new, thus avoiding the poor writing caused by hard and uneven platens.

# An Electric Spot-Welding Machine

By K. M. COGGESHALL

**E**LECTRIC spot welding is rapidly replacing riveting as a means of permanently holding together two or more sheets of metal for many kinds of work. The electric weld is more quickly made than the riveted joint; it will not loosen, and is nearly as strong and durable as the material itself, if properly made. For this work a special machine is necessary. The sheets to be welded together are placed between two copper electrodes, as shown in the heading illustration and detailed in the assembly sketch and working drawings. A large current, at low voltage, is then made to flow from one electrode to the other, passing through the intervening metal sheets. As these sheets, which are generally of iron, have a much higher electrical resistance than the copper electrodes, they instantly become hot at the points where the electrodes touch them. The hotter



the metal becomes, the greater is the resistance. Finally, the iron sheets are brought to a welding temperature, and a very slight pressure forces the molten metal together, forming a perfect weld at the point of application of the pressure.

The constructional features of a modern spot-welding machine for high-speed factory work are quite complicated, but a simple, homemade machine may be built for the small shop at slight expense and without the use of special tools. A machine of this type is shown in Fig. 1. There is no danger of getting an electric shock in operating this machine, the pressure being only three volts, or little more than that of a dry battery. The transformer will stand an instantaneous overload of 400 or 500 amperes on the secondary, which is plenty for small work.

A heavy table, or workbench, serves as the support for the welding apparatus. Near the edge of the table is fastened a wooden block, about 6 in. high and 4 in. square. This forms the support for the bottom electrode, which is held in position by an iron holder fastened to the block by screws, as shown in Fig. 2. The flat bar A is only  $\frac{1}{4}$  in. in thickness, and cannot provide sufficient holding surface for the electrode B. Accordingly an iron block, C,  $\frac{1}{2}$  by 2 by 3 in. long, is bolted to A, the electrode being set through it and held by means of a setscrew.

The upper electrode is adjustable up

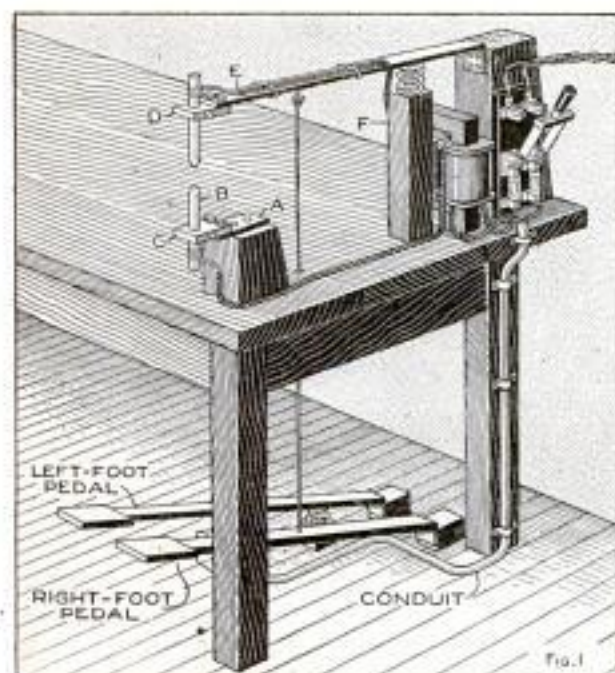

A Large Range of Spot-Welding Work can be Done with This Homemade Outfit, the Current for Which is Taken from the Ordinary 110-Volt Lighting Circuit

and down only, with no lateral movement. This is accomplished by bolting the electrode holder D to a flat iron bar, E, as shown. The electrodes must never be permitted to come together while the machine is operating, and as a safeguard a block, F, is provided with a coil spring inserted between it and the bar E. This spring holds the electrodes 4 in. apart.

For the mechanical control of the machine, a right-foot pedal is used. This pedal is connected to the bar E by a wire controlling the position of the upper electrode. The construction of the transformer is next undertaken. A direct-current supply is seldom used for welding, and the alternating current used requires a suitable transformer. It is assumed that the lighting-circuit supply is 110 volts and the frequency 60 cycles, which is the form of current in general use. The transformer consists of two windings on an iron core, as detailed in Fig. 4.

The first winding, connected to the supply circuit, is called the primary, while the other winding, which in this instance is connected to the electrodes, is the secondary. Current flowing in the primary winding will induce a voltage in the secondary directly proportional to the number of turns of wire in each winding. For the making of the core several thin sheets of iron are cut into strips,  $7\frac{1}{2}$  in. long and  $1\frac{1}{2}$  in. wide, as shown. A sufficient number should be prepared to give two piles, each  $1\frac{1}{2}$  in. high. Cut the same quantity of  $1\frac{1}{2}$ -in. strips,  $3\frac{1}{2}$  in. long. These strips are then annealed. Using the longer strips, proceed to build up the pile. The second strip is laid on the first so that it overlaps it at one end by  $1\frac{1}{2}$  in. The third strip is then placed on the second, directly over the first one, as shown. The fourth strip laps the third, lying directly over the second, and so on, to complete the pile. It is then bound temporarily with tape. Two such piles are required. The same procedure is carried out with the  $3\frac{1}{2}$ -in. strips.

From thin fiber or strong wood, cut four end pieces, 3 in. square, with holes

through the centers,  $1\frac{1}{2}$  in. square, as shown. Slip two of these end pieces on each of the long piles of strips, and secure them in position. Between these ends several layers of linen, or friction tape, are wound on the core for insulating purposes. A coat of shellac is then applied. When the shellac is dry, neatly wind on each of these two bobbins two layers of 63 turns each No. 14 gauge, double cotton-covered wire. This forms the primary winding. After giving the primary winding several coats of shellac, wind on three layers of tape, taking care that the work is neatly done as this insulation must be perfect. Again apply shellac.

Upon this insulation is wound the secondary, for which heavy wire is used. On each bobbin wind two coils of seven turns each of No. 6 gauge, double cotton-covered wire. An outside covering of tape is put on to give the coils a finished appearance. With the two wound bobbins lying side by side, sandwich the other two packs of laminated strips into the ends of their cores, so that a continuous core in the shape of a hollow square is formed.

In making connections great care must be exercised. Reference to the winding and wiring diagrams, Figs. 5 and 6, should be made, noting that the two coils on the primary are connected in series, while all four secondary coils are in parallel. The outside connections are quite simple. Two heavy cables carry the current from the secondary to the electrodes to which they are soldered, as shown in Fig. 2. The primary winding connects, through a pedal-control switch, to the 110-volt lighting circuit. A knife switch and fuses may also be inserted in this circuit if desired.

The pedal-control switch arrangement, shown in Fig. 3, is similar to the mechanical control pedal, except that, when the pedal is depressed, electrical connection is made in a quick make-and-break switch with snap action. The switch is inclosed in a metal case and set in a wooden block fixed to the floor. A heavy coil spring raises the hinged pedal when it is not held down

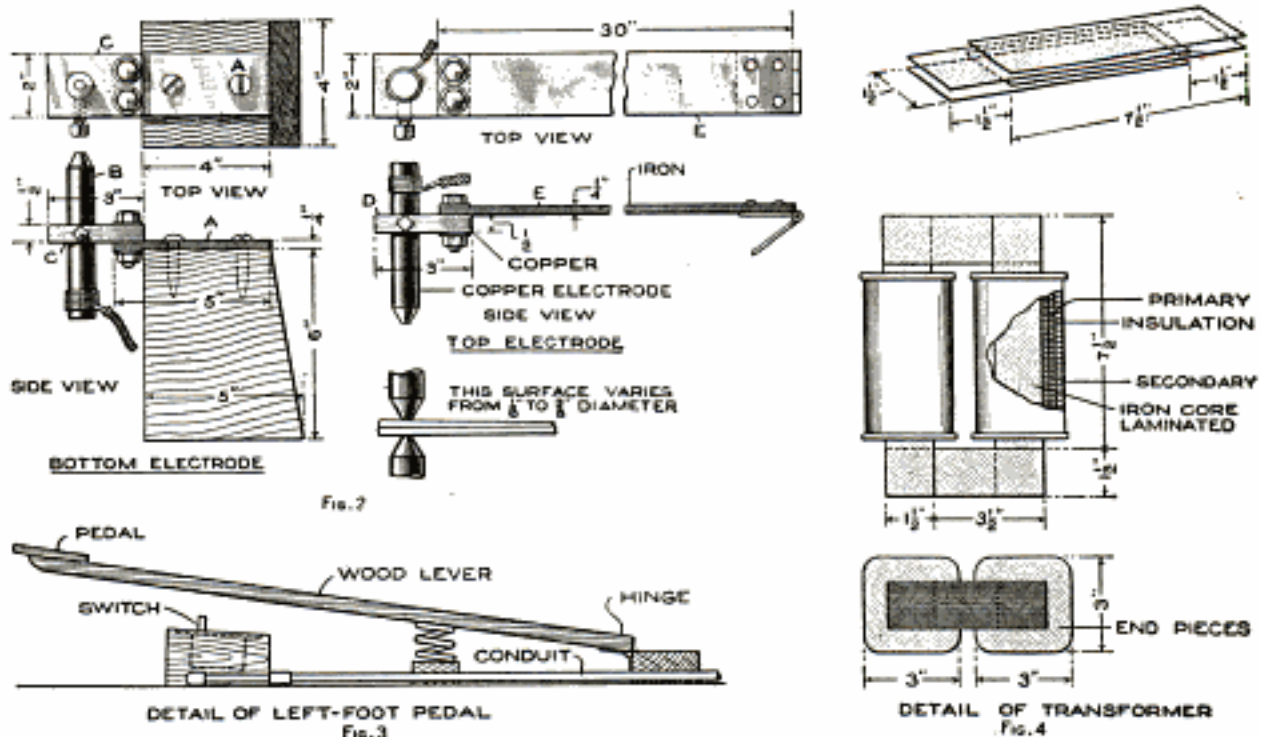

Details of Construction: Fig. 2 Shows the Details of the Electrodes and Their Fittings; Fig. 3, the Arrangement of the Pedal Control of the Switch, and Fig. 4, the Details of the Transformer

by the foot. Copper rods are used for electrodes, their diameter being about  $\frac{5}{8}$  in. The welding end is tapered to a surface varying from  $\frac{1}{8}$  in. to  $\frac{3}{8}$  in. in diameter, depending on the work to be done.

Several trials are necessary before successful results are obtained in the use of the machine. The operator should sit down to work the machine so that both feet may be used to control the pedals. After fitting the two sheets together in the exact position desired, they are placed between the electrodes. With the right-foot pedal depressed, the electrodes are brought in contact with the material, and a slight pressure applied. The left-foot

pedal is then depressed, allowing the current to flow for several seconds. The localized current heats the metal sheets to a welding temperature, and with a further pressure on the right pedal, the sheets are forced into close contact and the weld is made.

In conclusion, several kinds of metal can be satisfactorily spot-welded. Copper and aluminum are exceedingly difficult to weld, as they offer low resistance to the flow of an electric current. Galvanized iron may be welded satisfactorily, although the zinc will be burned off at the point of the weld. Tin can be welded to tin, or to sheet iron, as may also brass. Sheet iron to sheet iron gives the best weld.

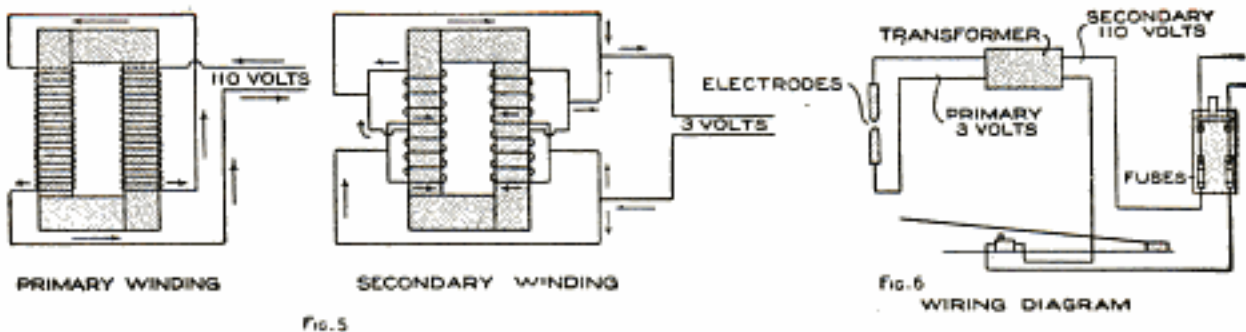

The Winding and Wiring Diagrams should be Studied Carefully, so That No Mistake is Made in the Making of the Transformer and the Hooking-Up of the Wiring Connections

### Quick Method of Making Small Doors

Small doors made of several pieces of board, extending vertically, usually require cleats on the back to keep them from warping. A panel door for the purpose is often too expensive, or too troublesome, to make. An attractive

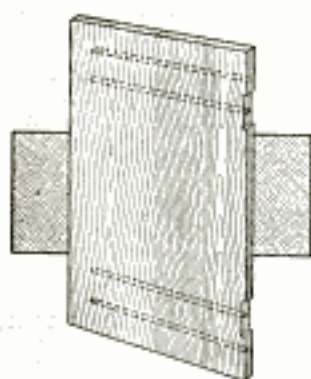

and substantial small door can be made by taking two, three, or more pieces and stringing them on dowels, seated in holes bored through the several pieces, as shown. This method is practical in making

doors up to 18 in. wide. Match the boards together and nail strips on, to keep them straight. Put the rough door in the vise, mark the places where the hinges will go, and with a long  $\frac{3}{8}$  or  $\frac{1}{2}$ -in. bit, bore through the pieces successively, to within 1 in. of the edge of the end piece. Cover the dowels with glue, and drive them home. The bit must be sharp, and the grain must be observed in order to avoid boring through the side.—Henry Simon, Laguna Beach, Calif.

### A Perforator for Loose-Leaf Book Fillers

Having a set of loose-leaf books, I made the perforator shown, instead of punching the holes with a plier-type hand punch. It perforates 10 sheets of

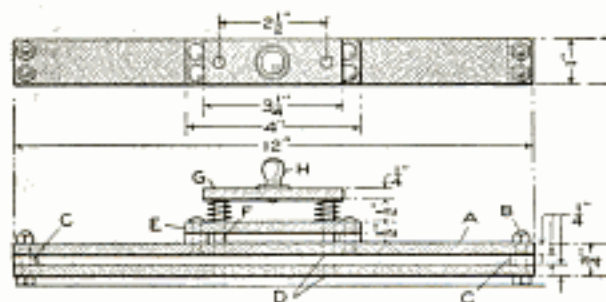

A Homemade Perforating Punch of This Type can be Made Easily, and Is Useful Especially for Loose-Leaf Sheets

ordinary paper at one time. To make the device, cut two pieces of  $\frac{1}{4}$  by 1-in. strap iron, A, and drill  $\frac{3}{16}$ -in. holes, B, in them. Drill holes, D, suitably spaced, for the punch rods F. Bolt pieces, A, together, as shown, with  $\frac{1}{4}$ -in. strips, C, between them, at the ends. Make the piece E as detailed, and drill holes to match those at D and also holes for the bolts at the end. Fit strips under the ends of the piece E. Thread the steel pins F at one end. Cut and drill the strip G as shown. Thread holes in strip G, and set the threaded pins in place. Fit a wood or metal handle, H, to the piece G. Assemble the parts as shown, and fit open coil springs,  $\frac{1}{2}$  in. long, between the plates G and E. Grind off the lower ends of the pins F, so they just come through the top plate A, grinding them at a slight angle to give a shearing effect. The sheets of paper are placed between the plates A, and a sharp blow with the hand on the handle H drives the pins through, cutting neat holes.—Bert Waychoff, Fort Collins, Colo.

### Shingles Set by Gauge on Shingling Hatchet

It is desirable when working on a roof, or other similar place, that as few tools as possible be required for the work. In shingling, this is especially necessary, in order to make speed. A kink that will save much time is the fitting of a small gauge on the front edge of the shingling hatchet, as shown in the sketch, to measure the weather exposure of the shingles. The gauge is a small U-shaped strip of iron, with a setscrew in one side of it, by means of which it is clamped at various positions on the hatchet.—C. J. Shields, Indianapolis, Ind.

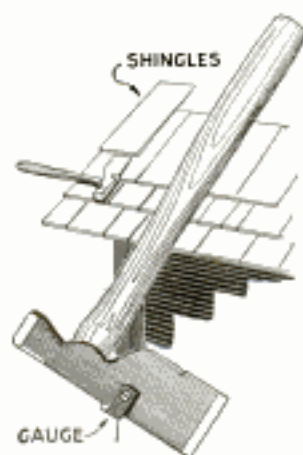



### A Round Storage Cellar for the Farm

A round storage cellar has attractive features as to practicability, inexpensive construction, and the securing of maximum storage space. That shown was built of brick, but various kinds of masonry materials, or concrete, could also be used. The inside diameter is 12 ft., and the height from the floor to the ceiling line is 10 ft., giving a good-sized cellar for the average farm. The cellar is built largely underground, and the area surrounding it is graded up, after the wall is completed. The floor, the wall foundations, and the steps are of concrete, made of a mixture of one part cement, three of sand, and five of gravel. The footing is heavy, and the floor is 4 in. thick, with a 2-in. bed of cinders or fine gravel. The walls are 12 in. thick, and can be made satis-

factorily of 8-in. hollow clay tile, faced with common brick. This gives a desirable double air space in the walls. The door should be 3 ft. wide and 7 ft. high, made in double thickness of matched lumber, with heavy roofing felt between the boards to provide in-

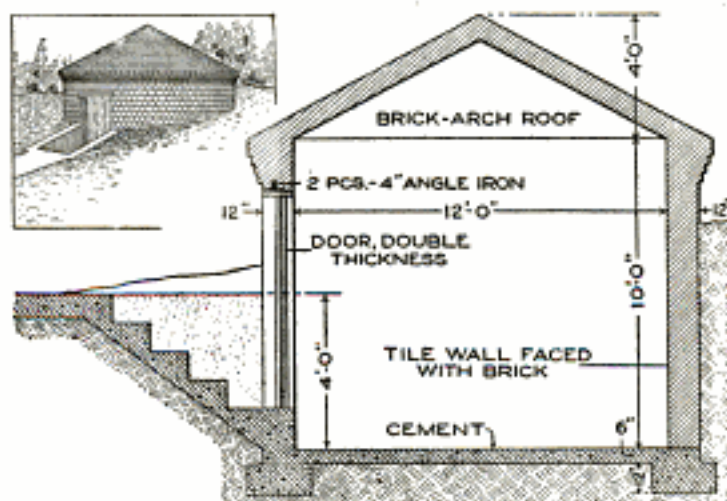

A Good Storage Cellar Is a Worth-While Investment for the Farmer, or Even for the Home Gardener and Fruit Grower

sulation against heat and cold.—W. E. Frudden, Charles City, Iowa.

### Cement-Bandage Repair on Large Pipes or Cylinders

For mending leaks in irrigating pipes, cracked pumps or cylinders, steam-heating pipes, etc., a bandage of cement and cloth makes a good job. Mix Portland cement and water to a paste; next take a long strip of loose-woven cloth, burlap, or cheesecloth, 3 in. wide, and roll it into a roll like a surgeon's bandage. Work the loose end full of the mortar, and wind it around the leak, taking a handful of the cement mortar and working it well into the cloth, at each round. Continue until the bandage is 1 in. thick; then finish over the surface with the mortar, and let it stand for 48 hours, well protected from wind and sun. It will then be ready for use. If there is a heavy pressure in the pipes, wrap wire mesh around to reinforce it. I have mended leaks in 8-in. irrigating pipe with a 20-ft. pressure, both wooden and iron, by this method.—D. H. Snowberger, Payette, Ida.

### Leather Angle Washers Stop Oil Leakage in Crank Case

It frequently happens that the oil in the crank case of a gasoline engine leaks out through the ends. This was the case on the engine of my automobile, and I eliminated the trouble in the following manner: I took a piece of  $\frac{1}{8}$ -in. leather and made a tube of it, the inside diameter being equal to that of the bearings and its length  $\frac{7}{8}$  in. It was then placed on an arbor, swedged back to the shape shown in the illustration, and cut into halves. Both halves were placed into position, as shown, and two small semicircular segments of a flat ring were screwed on, holding the leather in position.—A. K. Rudolph, New York, N. Y.

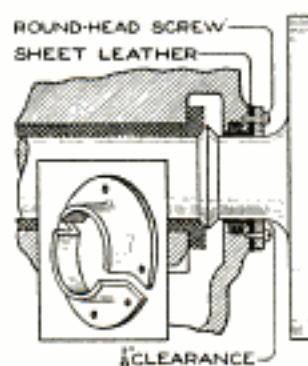

### Counterbore Ground Quickly from Round Stock

Often the mechanic in the machine shop requires a special size of counterbore and does not find it in his stock of



A Counterbore of This Type can be Ground Quickly from a Piece of Tool Steel, Which is Then Properly Tempered

tools. A quick method of supplying such a bore is to take a piece of tool steel and turn it to a shoulder pivot, as shown in the sketch, and then grind it to the proper cutting edges. The grinding can be done readily on an ordinary emery wheel, and care should be taken to provide the necessary relief at the cutting edges. The pivot, of course, must be made of the proper size for the center hole, and the lower cutting edges of the counterbore should also be given a relief toward the back.

### Simple Devices for Lubricating Automobile Springs

A simple method of supplying oil to the transverse, or cross, springs on automobiles, is employed by an expert mechanic. On both the front and rear springs, where these are fastened to the

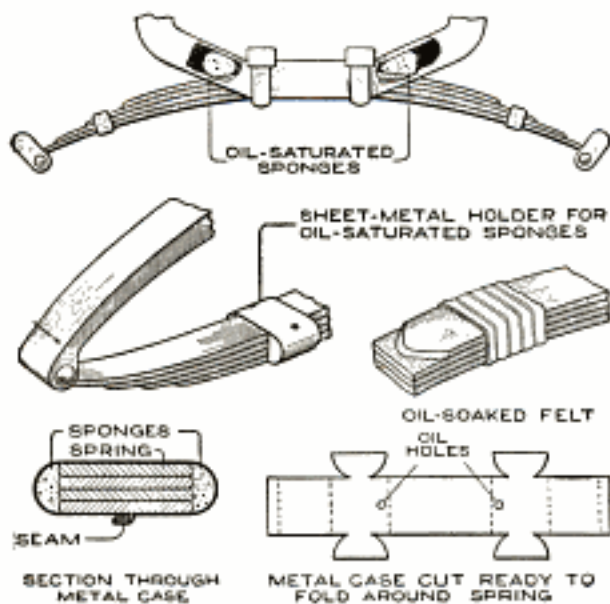

These Devices for Lubricating Automobile Springs can be Easily Installed and Give Good Service

channel frame, forming pockets, he placed small sponges soaked with oil, as shown. When the springs are deflected, the oil flows onto the springs, keeping them lubricated and free from rust. Occasionally the sponges are removed and the oil supply replenished.

Another good method for elliptical, or semielliptical springs, is to use strips of felt, or other porous material, binding this neatly around the spring with twine, and pouring oil over it. The felt is covered with waterproofed cloth or leather. A lubricator, as shown, can also be made, of tin or sheet brass, for inclosing small sponges, which are held to the edges of the blades, on springs of these types. This attachment, as detailed in the pattern, can be either folded over at the under side, into a seam, or flanges may be left to fasten with a screw and nut.—G. A. L., Washington, D. C.

### Adjustable Roller Stand for Pipes, Bars, and Rods

In handling long pipes, bars, rods, and similar pieces, a stand, having a roller at the top, is a great convenience, both in the saving of time and of heavy labor. Several of these can be arranged in a row where workmen are shunting the pieces a considerable distance. The stand shown in the sketch is of cheap and simple construction, yet quite substantial. A section of pipe is mounted on iron plates and into the top of it is fitted a screw arrangement. This may be a vise screw and nut, as shown, or a large bolt. The roller is set in a bracket, which is bolted to the vertical adjusting screw.—R. B. Sands, Detroit, Michigan.

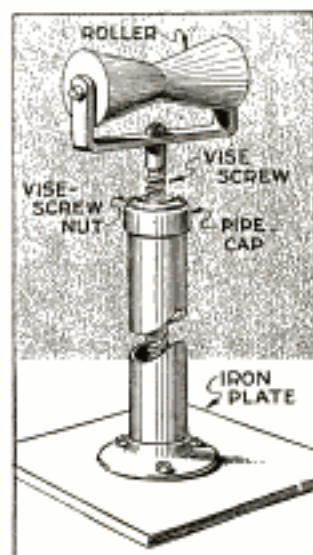

### Aluminum Salt Shaker Made into Lens Holder

When the hard-rubber holder of an eyeglass lens, used considerably on fine shop work, was broken, it became



necessary to replace it promptly. A novel method of replacing the parts was used, the upper end of an aluminum salt shaker being cut and shaped for the purpose. The

end was cut as indicated, after the salt shaker had been mounted in a lathe chuck, and the upper end was spun out to fit the lens. The larger end was also spun out to give the proper curve to the holder. The blunt-nose spinning tools used were ground from steel rods and mounted in the tool post.—Ben Frantzreb, Indianapolis, Ind.

### Proper Method of Folding Blueprints

When folding large blueprints for mailing, filing, or other purposes, they should be folded with the blue, or printed, side out, and with the title, or description, in the lower right-hand corner of the folded print. This facilitates handling and filing, and saves the useless unfolding of the print, which wears it unnecessarily.

### Old Saws Provide Good Stock for Tools

Various kinds of tools made of flat pieces of steel can be cut from old saw blades, ordinary handsaws being used for the thinner stock, and heavier circular saws for heavier material. The steel must be annealed to make it easily workable, and the tools may be hardened if desired. Some of the tools that can be made in this way are squares, calipers, gauges, and various types of measuring and marking tools, shaped from flat steel.

### Metal Case with External Control for Knife Switch

It is dangerous to have an unprotected knife switch so placed that it may be unwarily touched by some one with the bare hand. A good plan is to inclose the switch in a homemade metal case, so that the electric arcs made on opening and closing the switch are properly guarded. A V-shaped box several inches longer than the switch should be constructed from sheet iron, as detailed in the layout. Screw the box to the switch panel, as shown, and make a suitable cover, hinged at the top. The box and cover can be painted black, or the cover painted red to locate the switch box easily. To make a control operated from the outside of the box, as detailed, bore two  $\frac{1}{4}$ -in. holes through the front of the box. A staple is driven into the panel near the switch

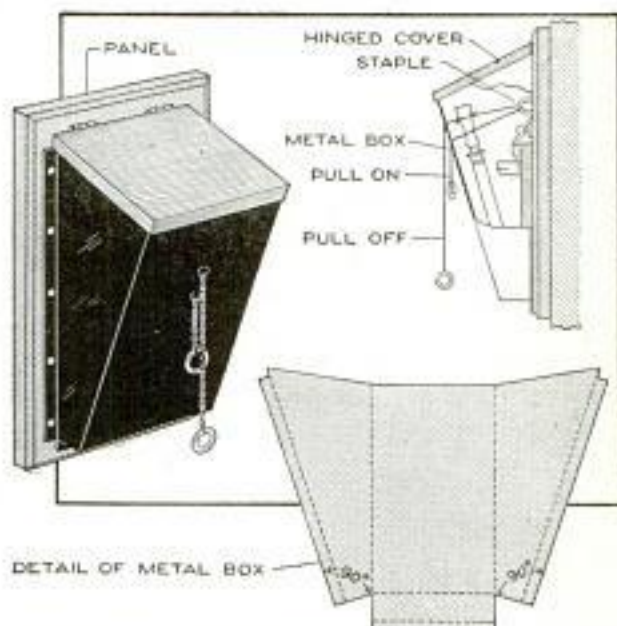

The Switch is Properly Guarded, and can be Opened or Closed Handily by Means of the Chains

handle. A small chain or cord is passed through the holes and thence through the staple, and to it is fastened the switch handle. Rings are attached to the ends of the chain, and by pulling the correct end the switch will open or close, as desired.—C. M. Hall, St. Louis, Mo.

CA small boat being towed may be steadied by dragging a bucket behind it.

## A Homemade Paper-Baling Press

By CLIFFORD A. BUTTERWORTH

HOME mechanics fairly handy with tools can make this baling press at a comparatively small cost, depending on whether or not old material is used. It will soon pay for itself through the sale of scrap paper that would not be accepted in loose form. To operate the press, push the lever D back to the position shown by the dotted lines, lift the ram as far as it will go, and put in the paper. Then lift the lever J about 2 ft., pull the lever D forward so the bolt K will slip into one of the notches, and pull down. Repeat until the paper is well compressed. To make a good bale, a piece of heavy cardboard should be placed on the top and at the bottom. Iron wire of No. 18 gauge is used for tying. When sufficient paper has been used to make a good-sized bale, take three 6-ft. lengths of wire and without removing the pressure insert them in the slots. Run the ends through spaces between the strips, at the top and bottom of the bale, and bring them together in front, fastening them tightly by twisting. Then release the ram and take out the bale. The press should be screwed to the floor with heavy angle irons.

First construct the box of matched  $\frac{7}{8}$ -in. boards. Fasten them together with cleats long enough to project  $\frac{7}{8}$  in. on each side, and  $1\frac{1}{2}$ -in. screws. Make the sides 15 in. by 36 in., and the back  $21\frac{3}{4}$  in. by 36 in. In making the back, do not put a cleat at the lower edge. Before screwing on the cleat A, cut the three slots shown in the side section, making them  $\frac{3}{4}$  in. wide. Fasten the sides to the back with angle irons, and then screw in the bottom, which is 15 in. by 20 in. long. Nail the eight 15-in. strips across it, spacing them about  $\frac{1}{2}$  in. apart.

Make the frame next, as detailed in the working drawings. In the plan above the end view, the lever arrangement is omitted, to show the frame construction clearly. The lock must also be put in place. Fasten a piece of sheet metal over the beveled end to keep the bolts from wearing the wood, as shown in the lock detail. Lining the slot with metal will make the lock slide easier. A heavy spring, B, is attached to pull the lock forward, so it will engage the notches as the ram goes down, and keep it from springing up. A lever, C, 14 in. long,

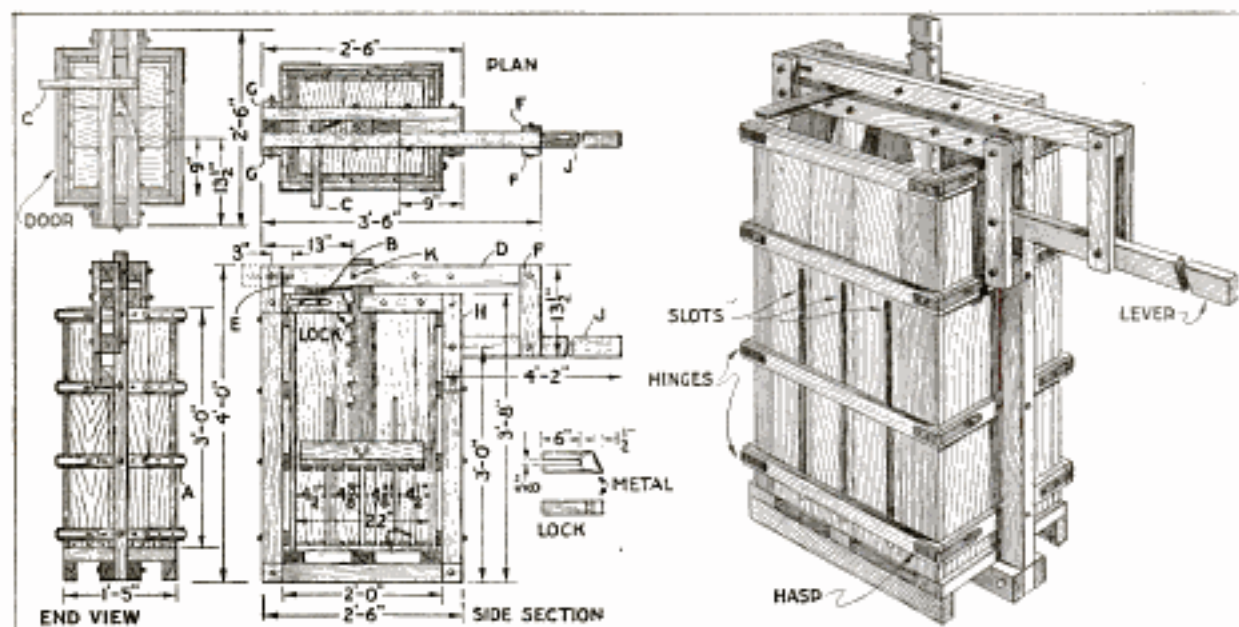

A Substantial Paper-Baling Press can be Made at Small Cost of Used Lumber, and will Soon Repay the Labor and Expense from the Sale of the Baled Paper Not Otherwise Salable

is arranged to force back the lock when it is desired to release the ram.

The main lever D is built up as detailed. Cut a slot, E, in the two main upper pieces of lever D, making it  $\frac{5}{8}$  in. wide. The two  $13\frac{1}{2}$ -in. pieces F connect the levers as shown. These, as well as the pieces G and H, should be of ash, or other hard wood. The piece H is 15 by 3 by 1 in., bolted at the upper end with an 8-in. bolt, which also holds the frame together.

To make the ram, take a 2-ft. 6-in. piece, and beginning 9 in. from the end, bore seven  $\frac{1}{2}$ -in. holes, 3 in. apart, from center to center, and insert 4-in. bolts. Then, just above each bolt and as close to it as possible, cut a notch, shaped as shown,  $1\frac{1}{2}$  in. wide and 1 in. deep. The other details can be easily observed from the working drawings and the perspective sketch.

#### Novel Illuminated Flag Made of Christmas-Tree Ornaments

The owner of a drug store wanted to display our national emblem in a novel way, and asked me to help him make up a flag, about 12 by 18 in. in size, of small electric lights, for his window. After figuring the cost, I made up a flag that answered the purpose of electric lights at night, and which has the advantage of being plainly visible in the daytime. It was made as follows: A picture frame was procured, and painted a dead black. A piece of black velvet was stretched and tacked over the back of it. An equal number of small red and silver glass balls,  $\frac{3}{4}$  in. in diameter, used for Christmas-tree decorating, were obtained, and also some blue ones,  $\frac{1}{2}$  in. in diameter, for the blue field, and  $\frac{1}{2}$ -in. silver balls for the stars. The stem of each ball was dipped in thick glue, and the balls set in position on the velvet, to make the stripes, the blue field, and the stars. When dry, the framed flag was hung in the show window, and an electric light, inclosed in a reflector, was directed upon it from in front. The colored balls each reflected the electric-light bulb in miniature, giving

the appearance of the glowing filament in small electric lamps, and the flag proved very attractive.—G. H. Niederrhoff, St. Louis, Mo.

#### Blowtorch Homemade from Strong Can

A blowtorch is easily made of an old maple-sirup can of heavy tinned

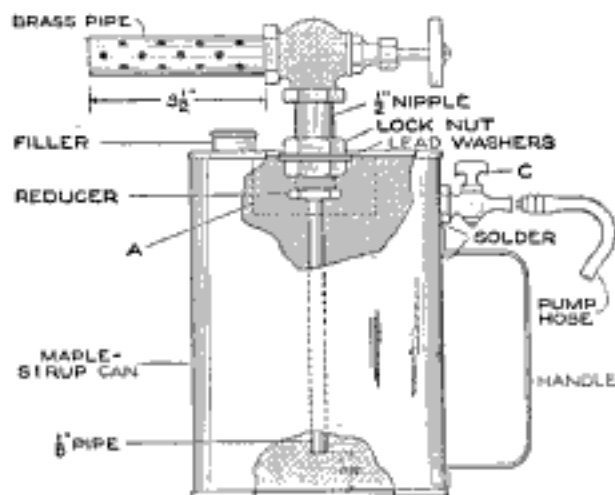

This Homemade Blowtorch Is Inexpensive and Has a Wide Range of Use for the Mechanic and in the Home Workshop

sheet iron, as shown. A  $\frac{1}{2}$ -in. brass nipple is soldered to the can, and an old globe valve fitted on. Into this is screwed a  $3\frac{1}{2}$ -in. piece of thin brass pipe with holes bored in it,  $\frac{3}{8}$  in. apart and staggered. An old bicycle pump, with a ball check valve is provided. A small brass cock supplements the ball check valve, which is opened to force air into the tank. On one side of the can, solder a handle. Remove the cork insert in the filler cap, and in its place put an asbestos washer. Fill the can half full of gasoline and pump in air.

To start the torch in operation, after the proper pressure is obtained, fill a baking-powder can cover half full of gasoline, set it under the torch pipe, and light the gasoline, which heats the valve and nipple. When it is hot, open the valve slightly by the handwheel, and by igniting the spray, a hot flame is produced, which is intensified by the increase of the air pressure.—P. P. Avery, Garfield, N. J.

### Tackle for Hoisting Heavy Barrels

Instead of using grabhooks or improvised rope slings for handling heavy barrels on a derrick or with other hoisting apparatus, the shop blacksmith was

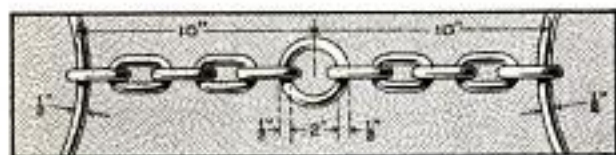

Heavy Barrels were Handled Quickly and Safely on



Hoisting Tackle by Means of This Special Rigging

ordered to make a set of rings with suitable chains to fit the barrels so that they could be hoisted quickly and safely. The rings were made of  $\frac{1}{2}$ -in. round steel rods, welded. They should be of a size to fit the barrels snugly and to cramp in the positions shown in the illustration.—C. C. Spreen, Flint, Michigan.

### Combination Doorstop and Coat Hook

A homemade device which is used as a combined doorstop and coat hook, singly or in series, is practical where space is limited and the walls behind doors are available for the hanging up of clothes in shops or similar places. It consists of a  $\frac{1}{2}$ -in. pipe nipple, about 4 in. long, one end screwed into a coupling, in which a rubber stopper is pressed, acting as a buffer, so as not to

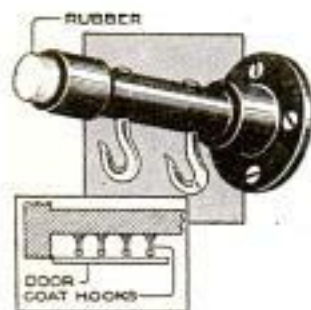

injure the wall. The other end is screwed into a flange which is fastened to the wall. The hooks are riveted in the pipe. The device is inexpensive, and if bronzed, nickel-plated, or painted, makes a neat fitting.

—Ernest Schwartz, Brooklyn, N. Y.

injure the wall. The other end is screwed into a flange which is fastened to the wall. The hooks are riveted in the pipe. The device is inexpensive, and if bronzed, nickel-plated, or painted, makes a neat fitting.

### Hot-Air Heater Protects Water Pipes from Cold

In many buildings that have more or less exposed water pipes, considerable trouble is met with in thawing out pipes during a cold wave. This is a tedious, tiresome job, especially where the pipes are hard to get at. This was the case in an oblong three-story building with a large light court running up the center. The water pipes run up along the wall of the light court and are inclosed in a box. The owner avoided frequently frozen pipes by rigging up a stove to heat the pipes in winter, the box carrying the pipes acting as a chimney for heat. There was a natural-gas jet close to the pipe box. A shelf was put on the wall, and an old stove was connected up as shown. The top was made solid so that most of the heat is carried up into a larger pipe with closed top. To avoid danger of fire, the larger pipe has V-shaped

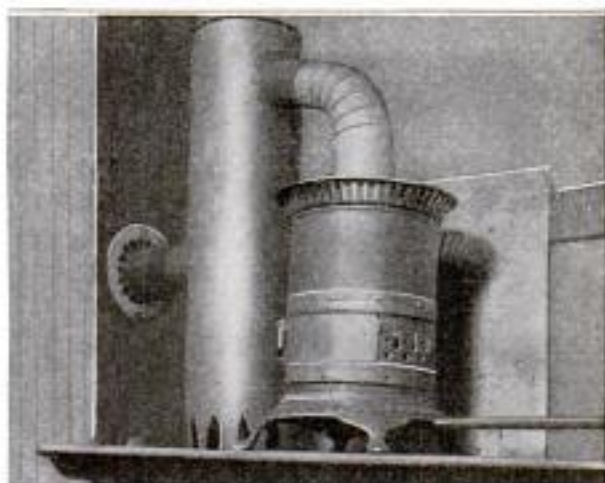

This Heating Arrangement Overcame Troublesome Freezing of Water Pipes in Cold Weather, and was Cheaply Installed

openings cut around the bottom edge to take in air, and the pipe conducting the heat into the box has a large galvanized-iron ventilating collar so as not to scorch the wood. A gas flame,  $\frac{1}{2}$  in. high, does the work and uses about 1,000 ft. a month.—Arthur L. Burgess, Columbus, Ohio.

Shellac is suitable for varnishing carburetor floats used with gasoline, but is not satisfactory if alcohol is used.

### Winding a Roll of Several Layers at Once

To wind a stock roll of several layers of paper, tin foil, etc., in one operation, first have as many small boxes as strips to roll, each one a little lower than the one back of it, arranging them in a row as shown. Cut pieces of  $\frac{1}{2}$ -in. dowel rod a little shorter than the width of the boxes, and make a roller of each dowel piece. Have the roller just above the front of the box. The rollers are necessary to protect the paper. Have the strips wound, placing them in their proper order in the suc-

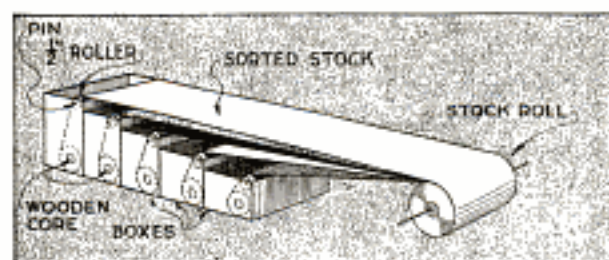

A Stock Roll of Several Layers can be Made Easily with an Arrangement of Bobbins

cessive boxes. Bringing out their ends, roll or fold them together as desired. Strips 100 ft. long can be nicely handled in this manner. This method can be used for many purposes, where long strips of different materials are to be rolled together, and kept free from air currents and dirt.—L. M. Drake, Daytona, Fla.

### Small Magnet Useful in Woodshop

An ordinary magnet is a great help in picking out small tools, nails, and other iron objects, from shavings and sawdust. By running it through the shavings collected on top of a workbench, it will collect every small iron article and save many a loss. It can also be employed in locating the position of covered nails before sawing through old work. The magnet should be hung up with a "keeper" across its ends when not in use. An electromagnet, used similarly, will prove still more useful than a common magnet for the purposes mentioned.—Henry Simon, Laguna Beach, Calif.

### Deflector for Bottom of Rock or Gravel Chute

The sketch shows a method of building a crushed rock or gravel drop, or catch, box to be placed at the lower end of an inclined chute.

The continued action of rock or gravel falling from a chute on a bare wooden deflector, or even a deflector lined with sheet iron, soon wears it out, and it must be replaced. By the method shown, the gravel forms its own wearing surface, and the wooden box does not require frequent renewal. This method can be applied to a large variety of work where building materials, coal, etc., are handled in wooden troughs, or in various gravity conveyors.—Roy H. Poston, Flat River, Mo.

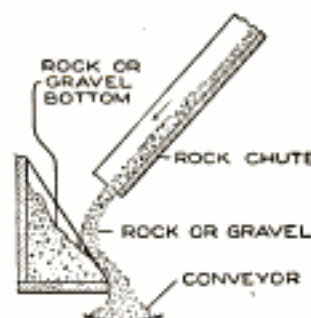

### Pivoted Rear Caster Improves Barrow Truck

Many hand trucks for carrying heavy loads have only two casters or wheels, and when a considerable weight is being moved the workman finds it hard to handle the outfit. In a large shop it was found that the work was made much easier by fitting the trucks with an extra double-roller caster pivoted under the rear support of the truck, as shown in the sketch. This enables the

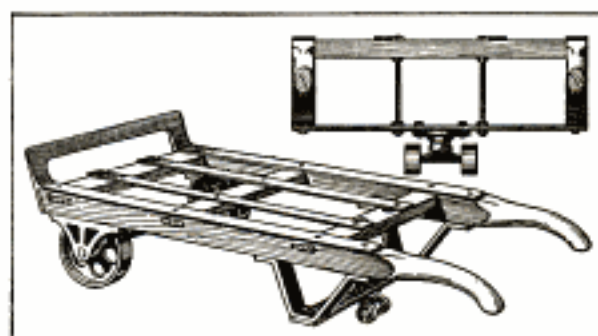

The Pivoted Rear Caster Makes It Possible to Handle Heavy Loads without Lifting Them Clear in Transit

workman to rest the load and shift it along the floor on its bearings.

### Sanitary Shop-Refuse Can with Pedal-Control Lid

To promote sanitation, and the keeping down of possible contagion from

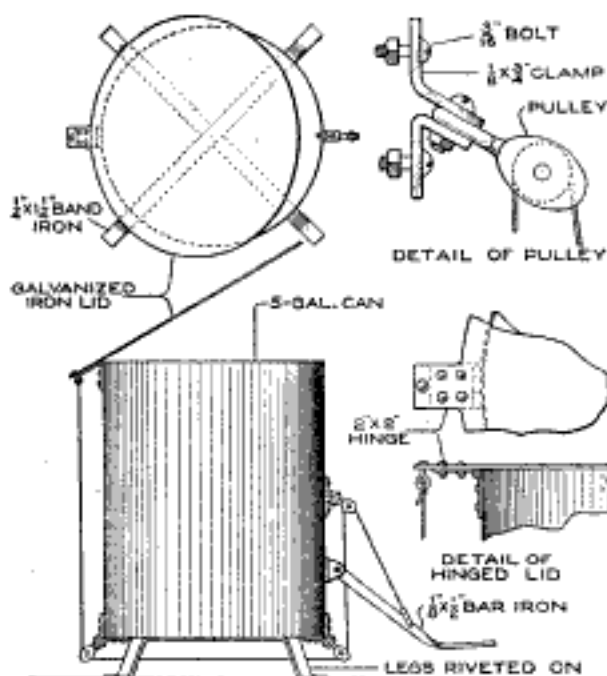

Sanitation was Promoted in a Large Shop by Providing a Strong Pedal-Control Covered Receptacle for Refuse

flies and other pests, a strong and practical refuse can was designed as the standard for a large plant, and the various shops were fitted out with these receptacles. Five-gallon cans were used for the containers, and the lids, of heavy galvanized iron, were fitted to them by means of a hinge, as shown in detail. The legs, of band iron, were arranged to support the bottom, and the cover was controlled by a pedal, rigged with a heavy cord and suitable pulley. A detail of the upper pulley is shown in the sketch. The interior of the can was suitably painted, with a black asphaltum paint, and the exterior painted with a lead paint.—A. P. Midland, New York, N. Y.

### Concrete Liners Overcome Wear at Turns in Flumes or Troughs

In wooden flumes used for transporting material in water, such as cinders, gravel, and other materials that have a tendency to cut out the sides

of the flume, especially at bends, repairs or renewals are often needed, causing a great deal of annoyance and expense. Concrete liners, fitted into the flumes, or troughs, at the points of wear, greatly increase the durability of the flumes, especially at the bends. Nails are driven in the side of the flume before the concrete is set to hold the liner in position.—H. P. Roy, Omaha, Neb.

### An Adaptable Socket Wrench

A design for a strong, light-weight, adaptable socket wrench, especially useful for the motorist's tool kit, is shown in the sketch. It is for use on nuts up to  $\frac{5}{8}$  in. across flats, and its best feature is that new inserts can be quickly and cheaply made for it to fit various sizes or shapes of nuts within its range. These interchangeable inserts are driven by a key in the end of the shank, at the bottom of the socket. The insert is retained in the socket by a spring snap which engages a nick on one side of the insert, as detailed. The inserts are made of tool steel, hardened. Machine steel, casehardened, can also be used. The shank is made of steel tubing. The sleeve is also a piece of steel tubing, and is brazed or pinned in place. The spring snap is made by cutting two saw kerfs, about  $\frac{3}{8}$  in. apart, as shown, and upsetting the end of the

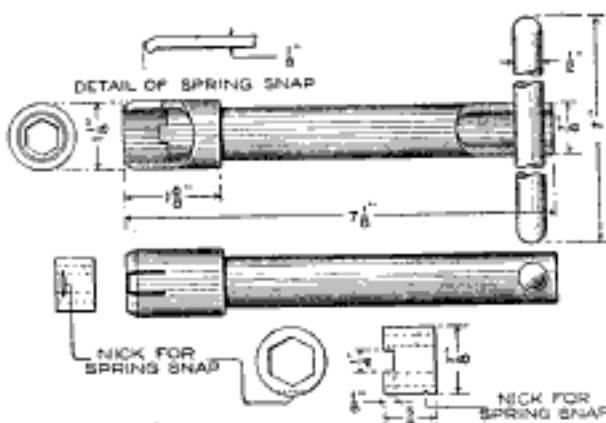

An Adaptable Socket Wrench with a Set of Inserts to Fit Various Nuts Is a Handy Tool for the Motorist or General Mechanic

metal between them so as to engage the nick in the socket.—W. B. Burr, Bridgeport, Conn.





## A Child's Motorless Automobile

By H. SIBLEY

**A** BOY who has a little skill in the use of tools can make his own motor car at about the cost of one circus ticket, and keep it up at considerably less expense. It will be a car that cannot blow up, back-fire, or turn turtle, and its driver will never be hauled into the speeders' court, yet he can, and probably will, have more real sport out of it than his father gets out of a shiny new seven-passenger car.

The machine shown in the photograph, and detailed in the working drawings, was made out of pick-up parts and materials which most boys can get. First, make a rectangular frame, 5 ft. 6 in. long and 15 in. wide, of wood, 1½ in. thick and 3 in. wide. The crosspieces at the ends are fitted between the sidepieces and nailed with spikes, or fastened with screws. Five inches from the front end of the frame, fasten into place another crosspiece against which the front end of the hood is nailed. The back end of the hood is nailed between the sidepieces, as shown in the sketches. These frames for the hood are 16 in. high and 15 in. wide. The rear set of wheels is held in place by clamping down the axle on the frame by means of two strong pipe clamps, made of strips of iron and fastened with screws or bolts. The front axle is mounted under a piece of wood, 2 in. thick, 2½ in. wide, and

17 in. long. A hole is bored vertically through this piece and through the front end piece of the main frame, and a bolt put through these holes as a king-pin.

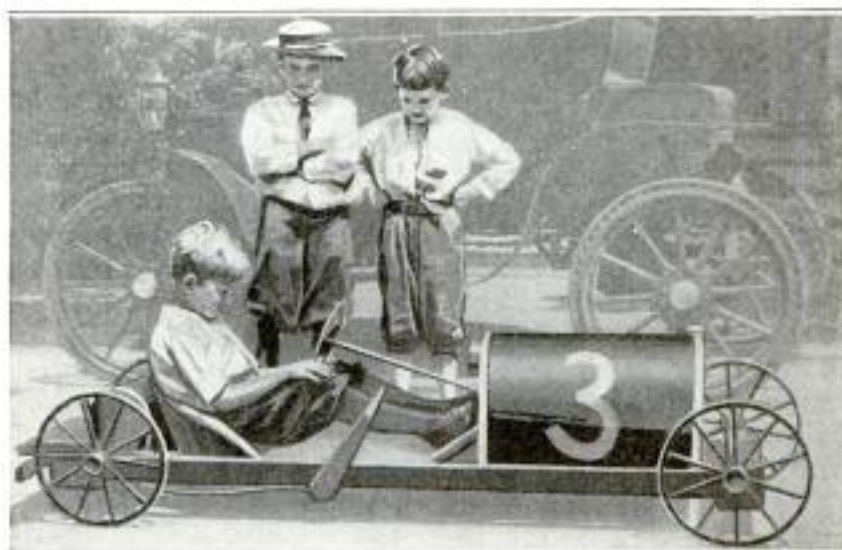

This Elegant Motorless Automobile was Made by the Young Owner and Driver, Who Is Prouder of It Than His Father Is of His New Seven-Passenger Car.

The front wheels are steered by means of two heavy cords, attached to the ends of the 17-in. piece, passing through the front of the hood, through screw eyes, as shown, and winding on a windlass set on a wooden rod or iron pipe. The steering wheel is fastened on the end of this rod. The lower end of the rod is fastened at the bottom of the front end of the hood. The latter is covered with tin from an old wash boiler, and nailed along the end pieces of the hood.

A brake beam, to stop the car and to control its speed on inclines, was fitted at the back of the main frame. It was made of a 2 by 2 by 24-in. piece of wood, with contact pads of wood nailed

at the ends, as shown. The brake beam is carried on two spikes driven into the frame, and a coil spring is provided on each spike between the beam and the end of the frame. The beam is drawn against the wheels by means of a wire attached to its middle, and con-

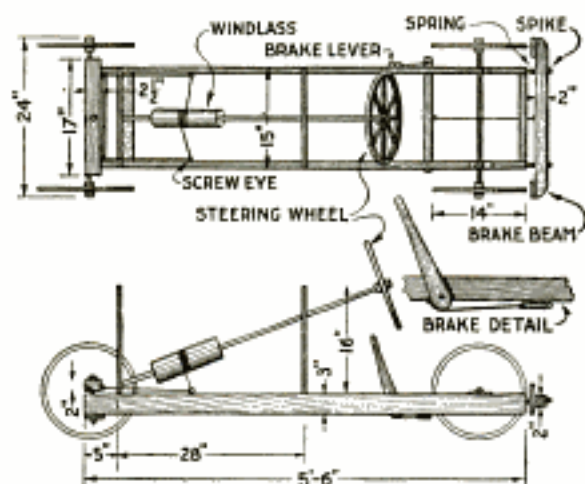

The Construction Is Simple, and the Necessary Materials can be Readily Gathered by a Wide-Awake Boy

nected to a crossbar at the brake lever. This crossbar is 1 by 1½ by 16 in. long, and is pivoted at the end opposite the brake lever by means of a screw. The brake lever is made as shown in the brake detail. It is pivoted at the side of the frame, and connected to the brake crossbar by a wire.

The seat was made of an old coal hod, and the gasoline tank behind it, of an old tin pail. All the parts are suitably painted, and other small details found on large automobiles can be fitted into place to suit the pleasure of the owner. The car is propelled by a passenger sitting behind the driver or by the latter himself, kneeling beside the seat. In coasting, both driver and passenger can, of course, ride without effort.

### Bottle Caps as Furniture Casters

Crimped bottle caps make good noiseless sliding casters for tables, benches, etc., if a three-cornered file is used to sharpen the crimps, and a piece of wood is placed on the cap to hammer on, so as not to dent the cap in driving the edge into the wood.—A. H. Hale, Brooklyn, N. Y.

### A Homemade Beam-Balance Scale for Photographic Work

My photographic scales had become injured in transportation, and, for immediate use, I built a substitute that proved of more than temporary value. It was made from box boards, tin-can covers, a couple of washers, and a large wire nail. The details of construction are shown in the illustration. The beam is 12 in. long, with a small piece nailed to the flat edge, in the center. Then a large wire nail was driven through the center of the small piece, the head cut off, and each end filed to a knife-edge as detailed. Two uprights were nailed to the baseboard, permitting the beam to swing freely. A slot was sawed along the top edge of each upright, and half a washer driven into these slots, and held in place with sealing wax. The tops of the washers were filed to receive the knife-edges.

Two tin-can covers were then tacked carefully to the ends of the beam, and the whole placed in position. The balance was adjusted by driving the required number of tacks on the under side of the lightest end of the beam.

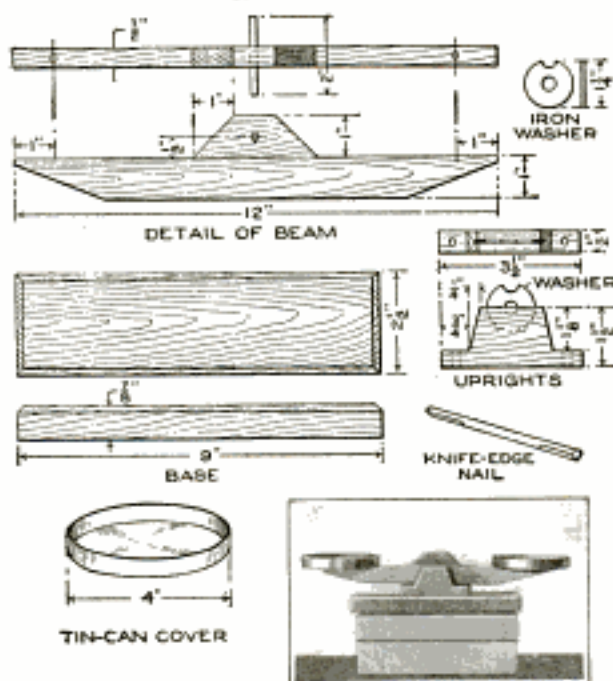

Made of Pick-Up Materials for Emergency Use. This Balance Proved Quite Substantial and Accurate

Weights can be made of lead.—L. B. Robbins, Harwich, Mass.

### Locking Device for Latch Hook on Gate or Door

The troublesome opening of a latch hook on a gate or door, permitting intruders to enter or possibly injuring the door in the wind, can be easily overcome by fitting a small catch over the hook, as indicated in the sketch. The U-shaped locking device is cut from a piece of tin, and fastened on the screw over which the hook is set. When locked, it is pushed back over the head of the hook, and cannot be easily jarred out of place.

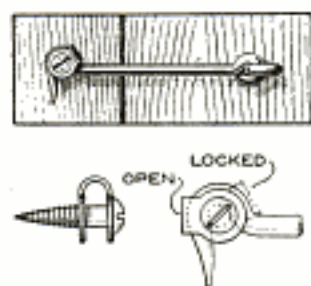

### A Vanishing-Cuff Parlor Trick

A trick which is interesting and amusing for the entertainment of the home audience, is performed with a derby hat and a gentleman's cuff. The effect is produced as follows: The performer takes the derby from his head and shows that it is empty. He removes one of his cuffs and drops it into the hat. He tips the hat over so that the spectators can see the inside, and the hat appears empty. He then shakes his arm, and the white cuff reappears, whereupon he places the hat back on his head. The explanation is simple: The white cuff, dropped into the hat, contains a false cuff link, and the inside of the cuff is painted black. A thread holds the cuff in shape until the latter is dropped into the hat, when the thread is broken without the spectators being aware of it. The cuff just fits into the hat, and its ends are deftly snapped beneath the hatband, the hat thus appearing empty. The duplicate cuff is kept on the forearm of the performer, and with a shake, slides into place.—Merritt Hale, Hartford, Conn.

CA little fresh developer added occasionally to old developing solutions will bring them up in speed and intensity.

### Inexpensive Table Lamp Made of Electrical-Fixture Parts

A small table lamp that is light and easily portable, can be made at a cost of less than \$1 from electrical-fixture parts, either old or purchased at a supply store for the job. The base is a bracket, with its brass canopy inverted, as shown. The upright is a 1/8-in. brass pipe, and it is fitted to a standard socket. The shade holder can be made complete from a strip of tin and two wires; or adapted from a commercial shade holder used for candlesticks. Various types of shades, homemade if desired, can be used.

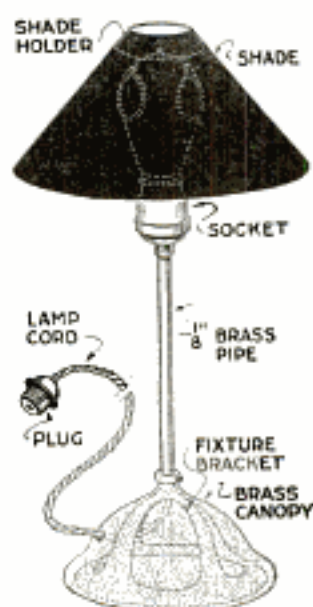

### Wire Holders Keep Cabinet Doors Open

Doors of cabinets often have an annoying tendency to swing shut when articles are being removed from the shelves. To overcome this trouble with a kitchen cabinet, I fitted brackets of No. 9 gauge wire into the sides of the cabinet, the wire being bent to the shape shown in the sketch. When the doors are to be held open, the wires are slid forward from their original position, as indicated by the dotted lines, and set in front of the doors. Before the doors are closed, the wires are quickly snapped back into place.—A. S. Thomas, Amherstburg, Ont., Canada.

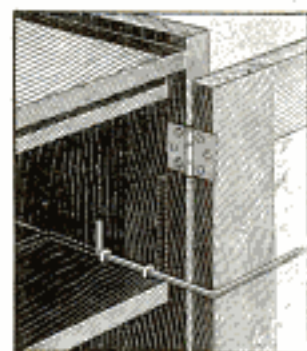

### Handy Kink in Addressing Mailing Tubes

The job of addressing a large number of mailing tubes is an awkward one, unless the tube is set so that its upper edge is on a level with the hand.

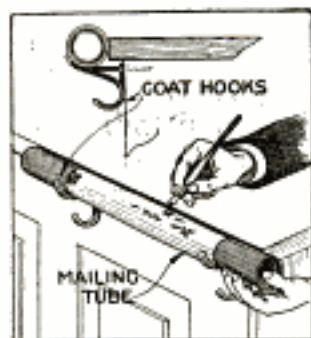

A convenient method of doing this, and a kink which is permanently useful where mailing tubes are to be addressed from time to time, is to arrange ordinary coat hooks at the side of the desk near the front corner, as shown. The tube is placed on the hooks, its upper edge even with the top of the desk, making the writing of the address as handy as in writing ordinarily.

ordinary coat hooks at the side of the desk near the front corner, as shown. The tube is placed on the hooks, its upper edge even with the top of the desk, making the writing of the address as handy as in writing ordinarily.

### A Flash-Light Egg-Candling Device

A pocket electric flash light can be easily used for testing eggs if equipped in the following manner: Take an ordinary tin funnel and cut off the spout so the small end will fit snugly over the lens of the flash light. Prepare the larger end of the funnel to accommodate a tin-can cover, so the cover will fit tight. Cut out the face of

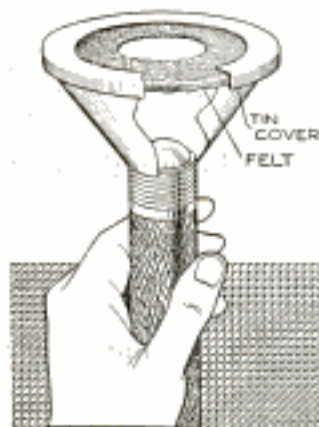

the cover, leaving a  $\frac{1}{2}$ -in. rim all around, and file the edge. Then cut a 1-in. hole in a piece of felt, place it over the large end of the funnel, and force the cover over it. This may be quickly slipped on and off the flash light and carried in the pocket. The egg to be tested is placed on the felt, over the opening, and the lamp held vertically, the operator looking down on the egg.

### Simple Arrangement for Releasing Camera Shutter from Distance

It is usually disappointing to the amateur photographer, when taking pictures of groups of which he is a member, not to be able to be in the pictures. However, most amateurs can construct a release arrangement, in a few minutes, that operates with satisfaction. A clothespin of the clip type is used. The spring should be weakened by bending it from the wood, so that it has just enough tension to bring the jaws of the clothespin together without a snap. Whittle the inner sides of the handles, as shown, so that the jaws accommodate the plunger of the shutter. Then saw a slot in the handles,  $\frac{1}{4}$  in. deep and  $\frac{1}{8}$  in. wide. Drill a  $\frac{3}{16}$ -in. hole in the whittled depression of one of the jaws, and cut a  $\frac{1}{8}$ -in. slot to it, as shown.

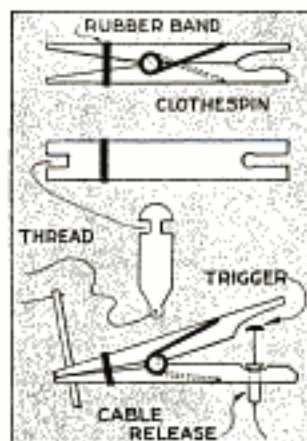

The small trigger piece is cut of hard wood. It should fit its slot snugly, at the other end of the pin.

The release device is operated as follows: Slip the plunger tube, with the shutter release cable, into its slot.

Keeping the jaws wide open, place the trigger in the slots of the two compressed handles. It is only necessary to jerk a thread attached to the trigger to free the two handles, which in turn snap the plunger. If the tension on the jaws is too strong, put a rubber band around the handles to act as a check.—Werner W. Baumeister, Walla Walla, Wash.

### A Crossbow Magazine Gun

A new type of bow gun that a boy can make, and which will give him plenty of good sport, is one of the repeating or magazine variety. To make the gun, cut a soft pine board, 40 in.

long and 5 in. wide. With a saw and knife, cut the gun form as shown. Cut a groove along the top of the barrel, where the arrow will lie ready to be shot out when the hickory bow is released. The magazine holding the five arrows is made of thin boards, 24 in. long, and is held in place by four small strips. The magazine is 3 in. deep, thus permitting the five arrows to lie evenly in it without crowding. The bow is of seasoned hickory and is set

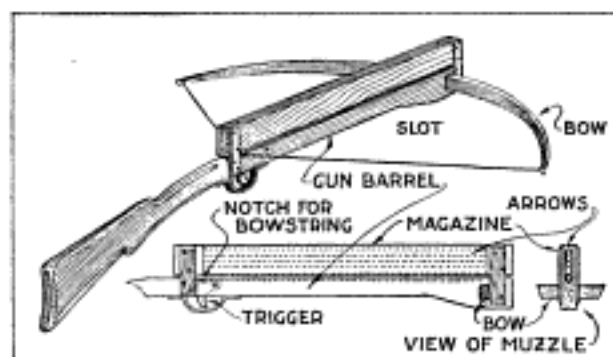

The Arrows are Stacked in the Magazine and Fired in Succession by the Bowstring Released at the Trigger

into the end of the barrel. The notch in which the bowstring catches, should be cut just under the rear end of the magazine. The trigger is an L-shaped, pivoted piece, and pushes the cord off the notch when ready to fire. As soon as the first arrow leaves the gun the one just above it drops down into the groove when the bowstring is again pulled back into place behind the notch. Pressure on the trigger shoots this arrow, another takes its place, and the cord is pulled back once more. The arrows should be of light pine, 22 in. long and  $\frac{1}{2}$  in. square, the rear end notched and the front pointed. To make the arrow shoot in a straight course, and to give it proper weight, the head end should be bored with a  $\frac{3}{16}$ -in. bit, 3 in. deep, and melted lead run into the hole.—E. F. Dalton, Cincinnati, Ohio.

✍ Ruling pens often work improperly, or have a tendency to cut the paper because of tiny feather edges at the points. These should be carefully honed and stropped off.

### Egg Beater Made into Winder for Model Aeroplanes

One of the features which take the joy out of flying elastic-driven model aeroplanes is the time taken to wind them up. For 10 cents and very little work a fast winder can be made out of an ordinary geared egg beater. Remove the outer small pinion and the revolving beater attached to it. Then cut the other beater off at A, as shown in the sketch, and the spindle at B. A few turns of tinned wire soldered to the spindle will keep the pinion from sliding off. Another piece of the same wire may be soldered to the two arms at C, to strengthen them. In use, the hub of the propeller is inserted between the two arms, as indicated and the rubber wound.—Morris G. Miller, New Rochelle, N. Y.

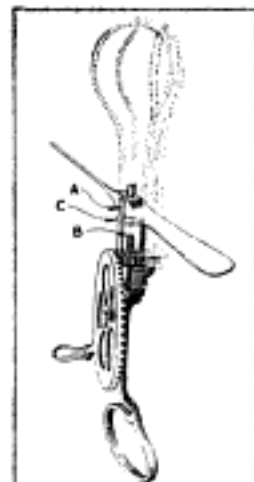

### Stove Lighter with Feeding Wick Guards against Burns

A stove lighter for gasoline or similar stoves can be made quickly. Cut a piece of tin, 7 in. long and 1 in. wide. Place a lamp wick on the tin so that a part of it projects from the end of the tin. Fold the tin so that the wick is held, but so that it can be drawn out when needed. Saturate the wick in kerosene, or other thicker oil. When wishing to light one or more burners of the stove, light the wick and apply it to the burners. The stove can be lighted with less danger of burning the hands than when a match is used directly.—Lee M. Delzell, Maroa, Ill.

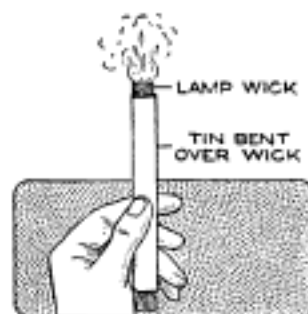

### "Switchboard" Protects Milker from Cow's Tail

A simple and effective device for guarding a person milking a cow from being hit in the face by the cow's tail



The Legend Put On the "Switchboard" by the Boys Shows How They Value It

is made of a board, about 10 in. wide and 5 ft. long. This is hung by two wire hooks from a long wire running lengthwise of the stable just over the front edge of the gutter. It is moved along with the milker and effectually protects his face while milking. The device was made by a Wisconsin farmer after nearly losing the sight of an eye in being hit by a cow's tail. He tried tying the tails of the cows while milking them, but found by actual test that some cows dropped down as much as 25 per cent in milk production when their tails were tied. The "switchboard" gives the cows the necessary freedom.—D. S. B., Wisconsin Live Stock Breeders' Association.

### Reflected-Light Illumination with Homemade Arrangement

"Friend wife" does not complain any longer because of poor light over the kitchen stove. The windows in the kitchen were so disposed that the light

was partly shut off from the stove by the person standing before it. I solved the difficulty in this way: A small window was cut directly back of the stove, in a partition between the kitchen and an adjoining storeroom, locating it just a few inches above the top of the stove. A mirror was placed, after some experimenting, so that the light from an outside window in the storeroom was reflected through the small window in the partition and onto the top of the stove. Plenty of light was thus afforded. Various adaptations of this arrangement may be worked out.—F. E. Brimmer, Dalton, N. Y.

### Bedroom Shade and Curtains Arranged for Thorough Ventilation

Curtains, shades, and similar fixtures, often interfere with the proper ventilation of sleeping rooms. By arranging these features as shown in the sketch, the ventilation is not interfered with, and the shades and curtains give the same service as with the usual arrangement. The curtains are hung singly on hinged bars, which may be homemade or those used as towel bars. Details of the supports, at A and B, are shown in the sketch. Two pairs of fixtures are provided for the shade, permitting it to be lowered at night, with free circulation of the air at the top and bottom. The shade is quickly raised, and the

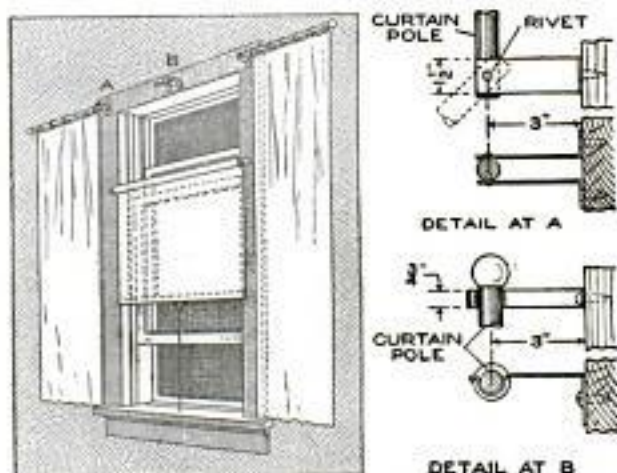

This Arrangement of Curtains and Shade Permits Thorough Ventilation in the Sleeping Room

curtains swung into their closed position.—J. E. McCoy, Philadelphia, Pa.

### Coffee Grinder Repaired with Rubber Faucet Plug

A rubber piece that held the glass container on a wall coffee grinder wore out, so that the glass would not stay in, putting the grinder out of commission. The piece worn out was a thick rubber washer, tapered at one end to form a hollow in the other, when in place. I cut a section from the thick end of a standard rubber faucet plug, and shaped it to the form of the desired washer. By removing the old rivet carefully, I was able to use it in fixing the new washer into place, and the mill was soon grinding merrily, as of old.—M. T. C., Chicago, Ill.

### Coal Hod Made from Iron Pipe

When my coal hod became worn out, I made one of a length of 8-in. galvanized-iron pipe, and found it to be handier and stronger than the kind I had used. I fitted the pipe with an iron handle and with a bail of strong wire, set in metal eyes riveted to the pipe. The upper end was cut to the curved shape shown, and the lower end square, and holes were punched along the edge for fastening it with nails to the double bottom of wood. Three wooden pads were set under the bottom, so that the hod stands easily on a spot that is not quite level.—T. E. Roberts, Toronto, Canada.

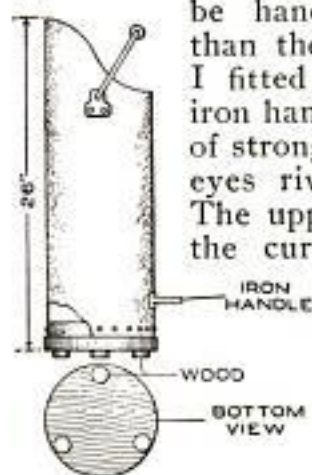

### An Enameled Armchair Made of Wooden Strips

An armchair suitable for a dressing table was made by a handy woman from pine strips. The photograph

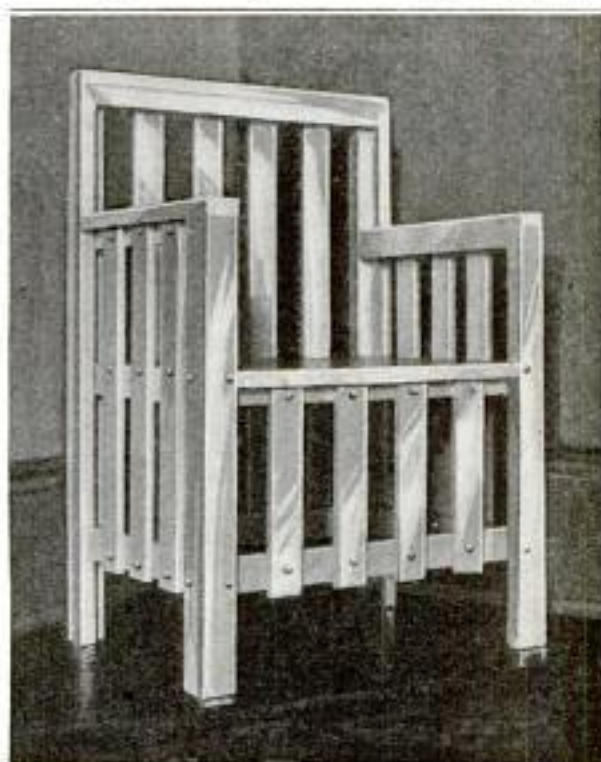

The Simple Construction of This Neat Armchair Makes It an Attractive Job for the Amateur Craftsman

shows the simple and pleasing lines of the construction. Aside from the board seat, only three sizes of wood are used, 2 by 2 in., 1 by 2 in., and 1/2 by 2 in. The pieces are fastened with screws, round-head brass ones being used at exposed points. The seat is wider from side to side than from front to back. Two coats of white paint and one of white enamel give a good finish.

The dimensions may be varied to suit individual needs. Sizes suggested are: back, 32 in. high and 24 in. wide; side, 26 in. to top of arm and 19 in. wide; seat, 17 in. from floor, 18 in. from front to back, and 20 in. wide between the front supports. The stock is all planed up square to dimensions, and sandpapered smooth. The ends should be cut squarely in a miter box, with a fine-toothed saw, and then sandpapered smooth, taking care not to round the ends.—A. May Holaday, Chico, Calif.

### Frayed Shoe Laces Repaired with Pitch or Wax

When the tag or end fastening comes off of a shoe lace, take a little black sealing wax, and press it carefully around the end of the lace and shape it to a point. This will last a long time, and does away with the annoyance of frayed lace ends.

### A Curling-Iron Heater

Heating of curling irons is a not uncommon source of fires, and to minimize this danger, an electrical heating

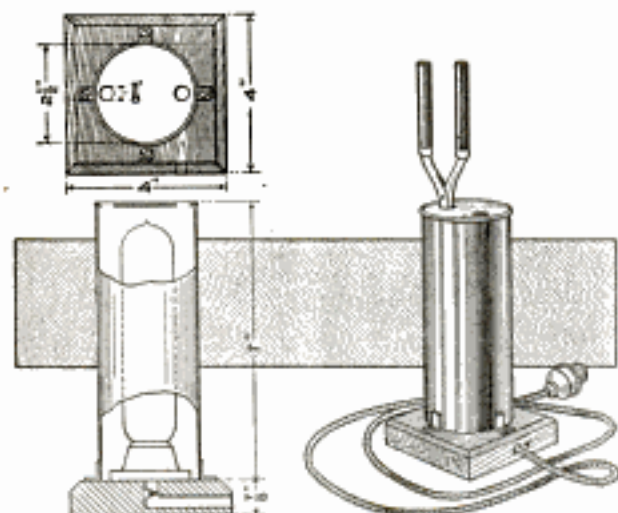

This Efficient Electric Heater for Curling Irons can be Made Quickly and Is Safer to Use than an Open Flame

device is valuable. In the arrangement shown, a long candle-shaped incandescent lamp is mounted in a suitable can, or metal tube, to form the body of the heater. This should be bright, both inside and out, and preferably nicked. Two irons can be heated by setting them in the holes in the top. Four small brackets, soldered, as shown, around the edge of the can, hold it to the base. A porcelain lamp receptacle is used, mounted on a base block. Stain, fill, and finish the wood as desired. In assembling the parts, screw the receptacle to the base, and connect the flexible cord through a suitable hole. Screw in the lamp, and fasten down the body.—John D. Adams, Phoenix, Arizona.

### A Stepmother for Incubator Chicks

The best imitation mother hen for incubator chicks that we have found, is built by attaching rag strings to the bottom of an inverted cracker, or similar, box, which accommodates 2 doz. chicks. The rag pieces are torn 1 in. wide, from coarse cloth or gunny sacking, and their loose ends just touch the floor. They are placed close together.

An inlet to the mother box is cut in the edge of it. The chicks huddle in among the string rags, keeping safe and warm, whereas without such an arrangement, they may crowd together too closely, and some of them be smothered.—J. Cecil Alter, Salt Lake City, Utah.

### A Cardboard Writing and Drawing Pad

Where neatness is desired in the writing of themes, manuscripts, etc., especially if sketches are set into the copy, a homemade writing and drawing pad is useful. The one shown in the sketch can be made easily, and is a handy device for school children as well as older persons. The paper is placed under the guide strips, as shown, and is moved along under the sliding straightedge as desired. Drawing instruments can be used handily along the straightedge, as indicated. The pad is built up as detailed in the sectional views. The general dimensions can be varied. The bottom piece is  $\frac{1}{8}$ -in. cloth board. The second layer is  $\frac{1}{32}$  in. thick and of cardboard; the next is  $\frac{1}{16}$ -in. cardboard, and the upper layer is  $\frac{1}{8}$ -in. cloth board, similar to the straightedge. The latter rests on the projecting guides for the paper, and

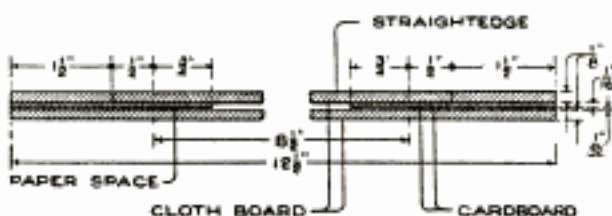
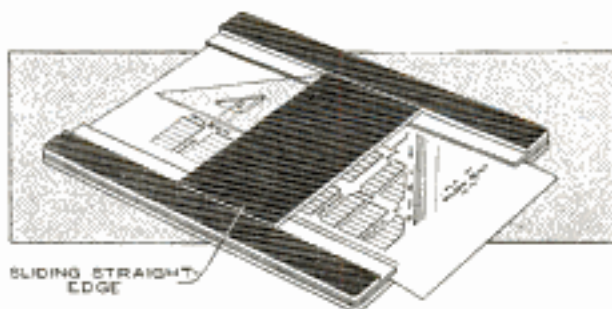

Manuscripts with Drawings may be Prepared Neatly and Quickly by the Use of This Homemade Writing Pad

is set between the shaded sidepieces.—R. S. Edwards, Walla Walla, Wash.



# A MOTOR-DRIVEN ICE SULKY

by Edward R. Smith



**N**UMEROUS types of small motors are available for the driving of bicycles and other light vehicles, and a novel installation for motors of this type is as a forward drive for an ice sulky. This power-driven sled is really pulled along, as will be seen from the heading illustration of this article and the detail drawings. It is controlled by the driver, who is seated behind the steering wheel. The size of the sulky

The crosspiece A is braced with a piece about 3 ft. long, fastened on top of it with screws. The runners B are of 1-in. stock, shaped as shown in the side view at the stern, and shod with semi-oval-section band iron. The pieces C

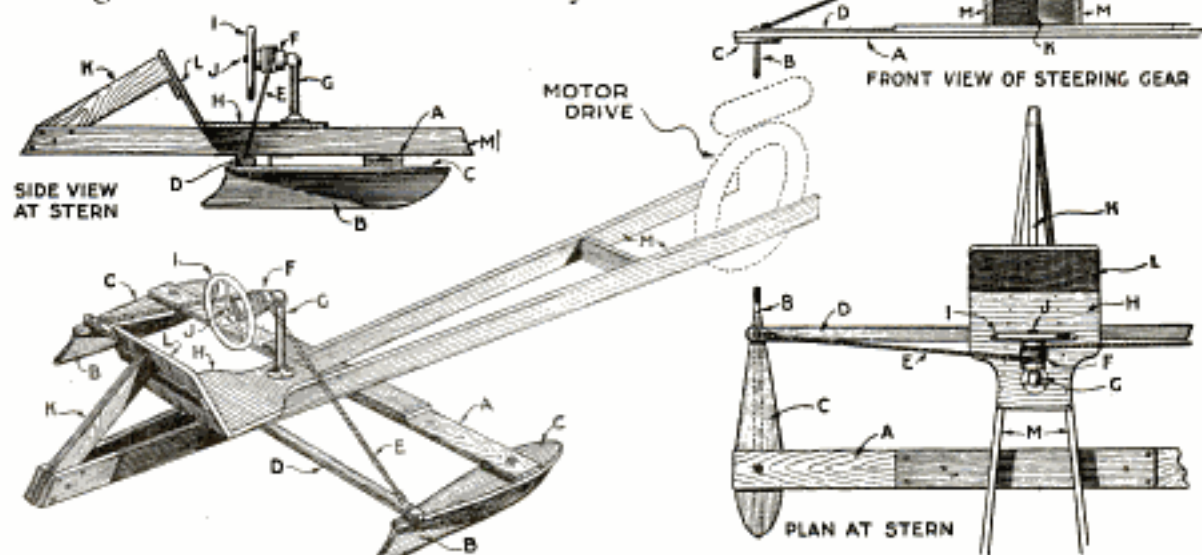

The Construction of This Motor-Driven Ice Sulky Is Interesting, the Power Plant being Located at the Forward End of the Frame, and the Weight of the Seat and Driver being so Distributed as to Give the Proper Balance and Traction

will depend more or less upon the size and power of the motor used. The motor is supported in iron brackets at the front end of the main framework, which is carried on a cross frame, A, in turn supported on two pivoted runners, B. A suitable size for the sled is about 6 ft. wide and 11 ft. long.

The long pieces for the main frame M are made of 1 by 5-in. pieces. The crosspiece A is 1 in. thick, 6 in. wide, and 6 ft. long. The stock should be fully 1 in. thick, and preferably  $1\frac{1}{8}$  in., rather than the common  $\frac{7}{8}$ -in. material.

are fastened on top of the runners with flat-head screws, and provide a suitable bearing for the pivot at the ends of the crosspiece A. The runners pivot on  $\frac{3}{8}$ -in. bolts fitted with washers and jam nuts. At the back end of the runners is a cross strip, D,  $1\frac{1}{8}$  by 2 in., pivoted at the runners. The control cord E is attached to the ends of this strip by means of screw eyes, and is wound on the drum F like the rudder cord of a motorboat. The craft is steered by the shifting of the runners at the rope control.

The construction of the control arrangement is shown clearly in the various views. It consists of a support, G, of 1-in. pipe, mounted on the front of the seat H with a flange. At its upper end is a short section of pipe joined with an elbow. The wooden drum F is carried on this section of pipe, and the wheel I is held in place, firmly fixed to the drum F, and locked by a pipe cap, J. The back rest L is a  $\frac{7}{8}$ -in. board, supported by a cleat, and braced between the two pieces of the main frame by the 1-in. piece K. Screws should be used throughout the construction in preference to nails, and they should be flat-head, and countersunk flush with the surface.

The crosspiece A also serves as a foot rest, and can be braced by four strands

of No. 18 gauge wire, twisted double and fastened about 10 in. from the ends of the piece A, and about 3 ft. to the front and rear of the crosspiece, on the main frame M. When the motor fittings are in place, the engine controls are wired at the seat within easy reach of the driver. Proper balance of the sulky can be obtained only by experimenting with the position of the seat, because of the variance in the weight and type of the motor. The fastenings for the seat and crosspiece A should be made temporarily so that they can be shifted along the main frame. The wooden parts should be oiled with linseed oil, to protect them from the weather, and the metal parts properly painted or otherwise protected against corrosion.

### Auto Jacks Rigged Up as Cider Press

With two automobile jacks, a strong linen sack, a sheet-metal tray, two ropes, and some boards, a cider press was improvised that crushed a large quantity of fruit easily. The arrangement was set up as shown. One jack, or even a jackscrew, might be used. The boards were cut and nailed up to form the platforms. The lower platform was fitted with a shallow pan, at one end of which a spout was soldered, draining the liquid into a pail. A more permanent wooden frame might easily

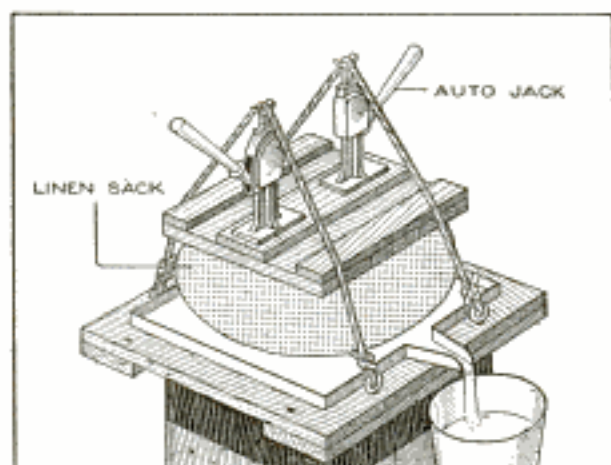

A Considerable Quantity of Fruit was Crushed and the Resulting Liquid Drained Off with This Improvised Arrangement

be devised to support the jacks.—F. Ball Pinkus.

### Rubber Pad Aids in Guiding Ruler

Artists, especially those doing photographic retouching, use a ruler and brush for making straight lines. It is necessary to have the ruler elevated, or set at an angle so the ruling edge is raised high enough to clear the hairs of the brush. A good method is to glue a piece of soft rubber tubing to the back edge of the ruler. The ruler is gripped at one end with the fingers underneath, the rubber hose resting on the surface worked upon. By moving the fingers backward and forward, the ruler is raised, and the rubber keeps it from slipping, especially on delicate air-brush surfaces.—Samuel H. Avery, Chicago, Ill.

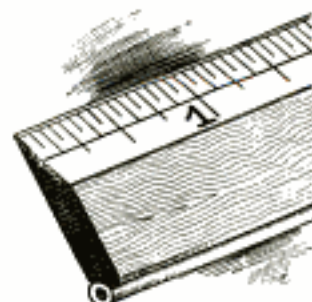

### Front and Rear Electric Lights Fitted on Baby Cab

Piloting a baby carriage after dark on heavily shaded walks often presented difficulties at the curbing, the jolt resulting in a "solo" at the rude awakening. I remedied the trouble by

placing two lights on the front and one on the rear of the cab. The cells were connected in parallel. The wiring was fastened by japanned-tin clamps. The wires were concealed, and fastened to the under side of the framework. A



In Evening Airings, Baby was Spared Many Rude Jolts at Street Crossings When the Dark Curbing was Lighted by the Head and Tail Lights on the Cab

small homemade knife switch controls the circuit from the handle of the buggy,  $1\frac{1}{2}$ -volt lamps being used and the current derived from two dry cells, fastened to the under side of the seat and inclosed in a box. The lights are convenient also in lighting a stairway when the cab is being taken up or down.—Dr. C. L. DeCou, Los Angeles, California.

### Sandpaper Trough for Beveling Instrument Bases

It is sometimes difficult for the amateur to get perfect bevels on the bases of homemade instruments. A simple and effective device for this purpose is made as follows: Two pieces of wood,  $\frac{1}{2}$  by 4 by 12 in. long, are fastened together by end pieces to form a trough, the sides of which are at an angle of  $45^\circ$ . After beveling the base with a plane, it is laid against one side

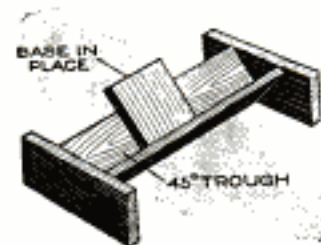

of the trough with a piece of sandpaper laid on the other side. By rubbing the base over the sandpaper, a perfect bevel is obtained.—Thomas W. Benson, Philadelphia, Pa.

### Kitchen Knife and Utensil Holder Made of Cheese Box

The best feature of this revolving knife and utensil holder is that it protects the knives. Kitchen knives should not be put into a box with other knives, forks, spoons, etc., because the edges are soon injured. The revolving holder was made from a cheese box mounted on a base by means of a rod, as shown in the sketch. The top was provided with slots, as convenient. The knife slots are around the outer edge, and the knives hang where their edges do not hit each other or utensils. The sharp edges should always be put outward. The spoons, forks, meat maul, etc., all have proper slots toward the center. Utensils, hung like this, are very convenient to get at, and are also protected from dust. Small hooks at the lower edge are handy for hanging up the egg beater, strainer, and other much used articles which cannot be set readily into the slot in the top.

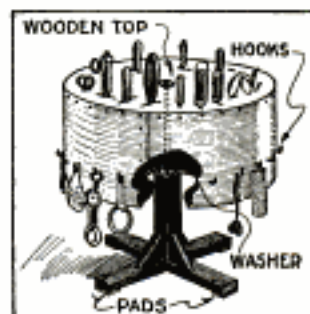

### Screen and Storm Door for All-Year Use

If a strong frame is provided for a screen door, it can be easily fitted up to be used as a storm door in winter, and then again quickly changed for use as a screen door by the method of construction shown in the illustration. The door frame is built of  $1\frac{3}{8}$ -in. stuff, with a wide rail at the bottom, which provides a foot plate where otherwise the wire mesh might be quickly broken. For summer use, the panels are fitted with screen frames, as de-

tailed, the frames being fitted between moldings fastened with round-head screws. In the fall, the screens are removed, and panels built up of matched

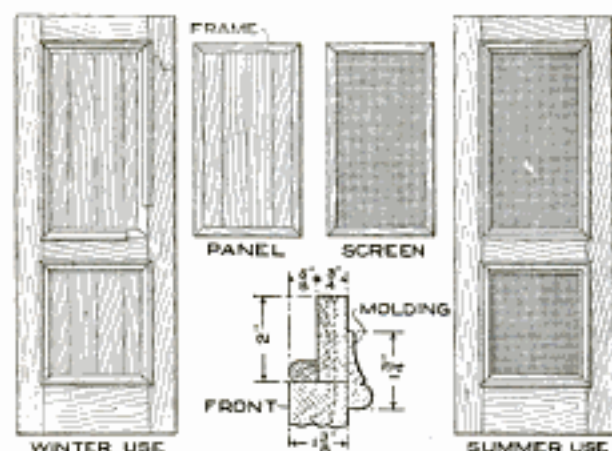

A Substantial Door can be Easily Fitted with Screen Frames and Wooden Panels. Used Interchangeably, Summer and Winter

siding,  $\frac{3}{4}$  in. thick, are set in the frame. While the first cost of such a door is greater than a single door, it can be made by the home carpenter more cheaply than can two doors, one for each season. Besides, a door of this kind, if well made, will not detract from the appearance of a well-kept home structure.—John R. Preston, New Glasgow, N. S., Canada.

### Simple Means of Locking Automobile against Theft

Locking the front wheel of an automobile in a cramped position by means



of a heavy welded chain and a good padlock is effective, as it is then impossible to move the wheels, or steer the car, since it will not even be in condition to be towed. The method has several advantages: impossibility to tow the car; secure locking of the wheel; assurance of safety owing to the inability of a thief to steer, as the car could only go in a circle.—A. P. Marsh, Chicago, Ill.

### Parting Wedged Drinking Glasses

Drinking glasses and similar articles often become wedged together so firmly that it is difficult to part them without damage. A simple method of parting glasses is to pour cold water into the inner glass and set the wedged glasses upright in a dish of warm water, which should then be gradually heated by pouring hot water into it. The contraction of the inner glass and expansion of the outer one will release the two.—L. J. L. Pouliot, Ottawa, Ont., Canada.

### Framing Pennants Preserves Them as Souvenirs

Because nailing into the wall was forbidden in the lease, a new method of hanging pennants was devised by some "rah-rah" boys in college.



Frames of narrow molding were made for the pennants, and hung from the picture molding. The walls could thus be cleaned easily and no "island" was left when one of the pennants was removed. Not the least important is the fact that the pennants are kept clean, and can be taken away from college as souvenirs, whereas the average pennant, unprotected, is soon dirty, an unpleasant reminder of pleasant associations.—William P. Langreich, New York, New York.

### Repairing a Leaky Gas Hose

A cloth-bound rubber gas hose, which sprung a leak, was easily repaired with glue by applying a goodly drop over the leak, bending the hose so the leaky part would be distended, holding a finger over one end of the hose, and drawing the breath through the other. In this way the glue was sucked into the fracture. Straightening the hose, and permitting it to dry, completed the job.

### Grinding Writing and Lettering Pens

A fine or coarse writing or lettering pen can be produced quickly by means of an oilstone. By rubbing it at the sides of the nibs, the pen is made finer, and grinding across the ends makes it coarser. By grasping the penholder in the normal writing position, and writing lightly on the surface of the stone, the pen may be ground to the style of the user, making it write more smoothly. If the pen scratches, a slight touching up on the stone, which should be a fine hone, will remedy the difficulty.

### Pneumatic Door Check Made of Bicycle Pump

A door was provided with a heavy coiled spring that caused it to slam shut, and in order to overcome this nuisance, a check was made from an old bicycle pump. The fittings being worked out neatly, did not mar the appearance of the woodwork. Band iron,  $\frac{1}{8}$  by  $1\frac{1}{2}$  in., was used for the fittings. A clamp, as detailed, was made to hold the end of the pump cylinder. A bracket,  $5\frac{1}{2}$  in. long, of

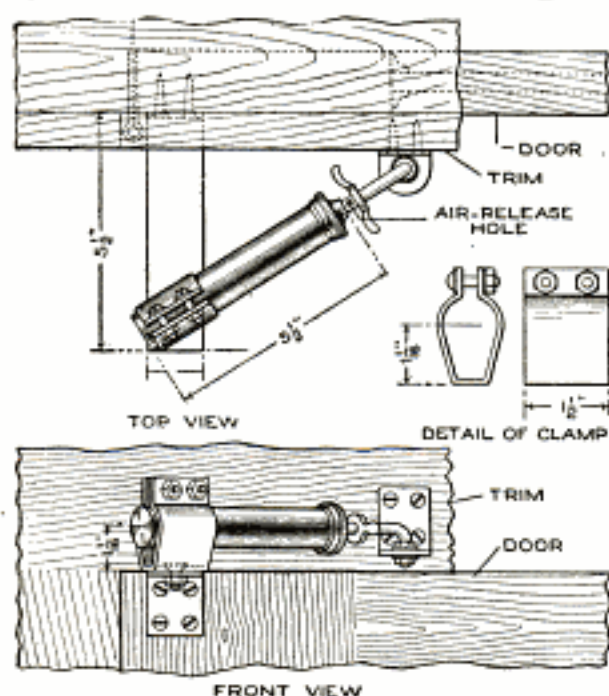

FRONT VIEW  
This Neat and Effective Door Check was Made of an Old Bicycle Pump and a Strip of Iron, Shaped and Polished

similar iron was fastened to the door, as shown, with screws, and the clamp

bolted to it. The end of the plunger was extended and bent at a right angle, so as to pivot in a small angle bracket attached to the trim, as shown in the front view. An air-release hole was provided, as indicated, so that the air was freed from the cylinder gradually as the door closed, thus preventing slamming.—P. P. Avery, Garfield, New Jersey.

### Convenient Tool Drawer under Chair Seat

For the householder who does small repairing occasionally at home, a sliding drawer under his working chair will be found a convenience. The tools are always handy when he sits down to his work, and he can put them away again without arising from the chair. This arrangement is also useful in small shops where a chair or stool is used for tinkering and light bench work.—James M. Kane, Doylestown, Pa.

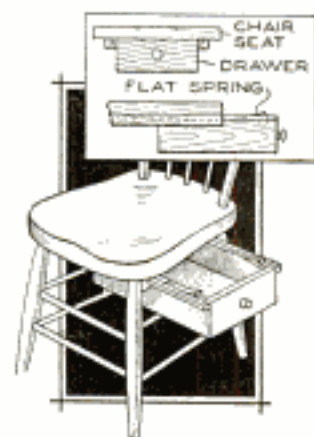

### Red Windows in Daylight Photographic Workroom

Instead of the customary dark room, with the expense of red incandescent lamps or the evil-smelling oil lamp, the photographer who works during the day should have a red room, obtained by means of a window with panes of red glass. The amateur can cover the windows with red cloth, through which will penetrate a diffuse red light of the desired quality. This is far superior to the common practice of providing an opaque screen, blocking up the windows, etc., and the screen can be made of red cloth instead of black cloth, just as handily. Proper ventilation should, of course, be provided.—Alfred J. Miller, Albuquerque, N. M.

### A Model Paper Monoplane That can be Steered

An interesting bit of paper construction is a small monoplane made from a 7-in. square of paper, folded as indi-

as shown at A and B in Fig. 3. Fold the corners C and D upward to the position C and D in Fig. 4. Fold corners G and H to the corresponding letters in Fig. 5. Fold points J and K to the corresponding letters in Fig. 6.

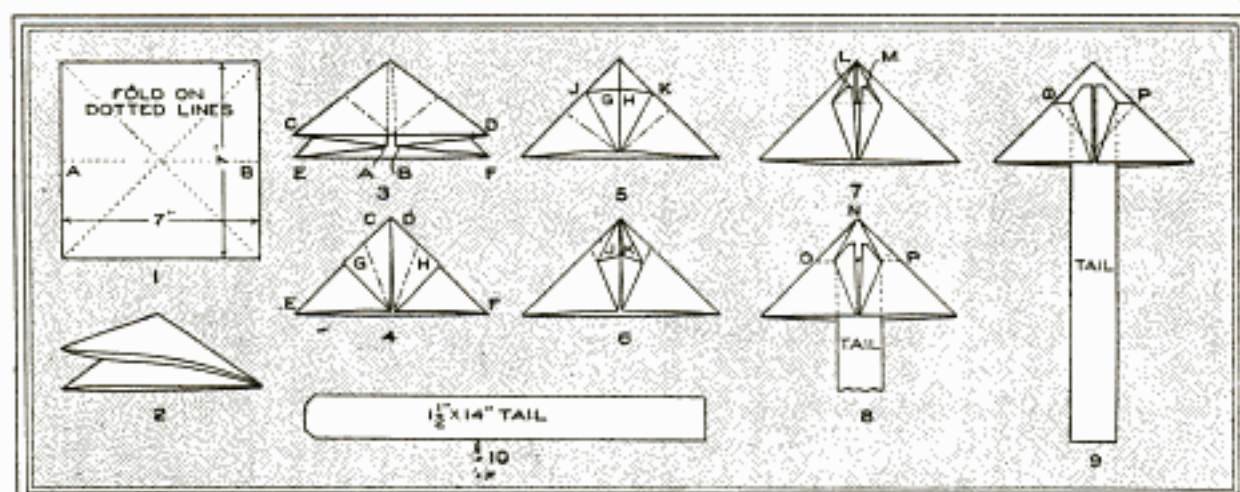

The Method of Folding the Paper is Indicated Clearly in the Diagrams, Which are to be Followed in the Order of Their Numbering, the Tail being Inserted Separately

cated in the diagram and provided with a paper tail. This little monoplane can be steered by adjusting the tail, and even made to loop the loop in the varying air currents. For the boy who enjoys experimenting with such a model this little construction offers much instruction and entertainment, and the grown-up who still has an interest in such things will also find it a worth-while job.

To make this model, fold a square of medium-weight paper on the dotted lines, as indicated in Fig. 1 in the dia-

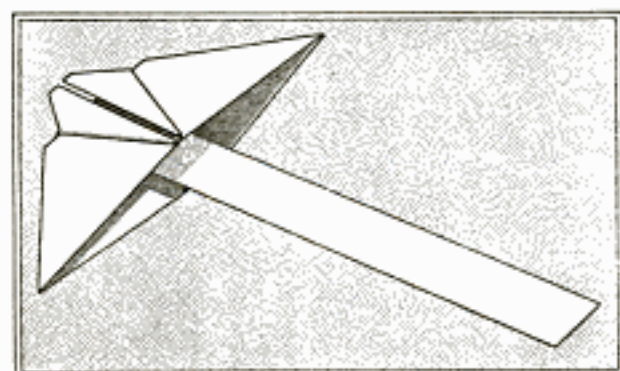

This Model Monoplane is Made of a Sheet of Paper, Seven Inches Square, and can be Steered by Bending or Twisting the Tail

gram. Then unfold the sheet and re-fold it as in Fig. 2. Then bring the folded corners A and B into position,

Raise the points J and K, Fig. 6, and fold them in so that the corners which were below them in Fig. 6 now come above them, as at L and M in Fig. 7. Fold the corner N back along the line OP, Fig. 8, so that the shape of the main portion of the model is as shown in Fig. 9, at OP. Make the tail 1½ by 14 in. long, as shown in Fig. 10, and paste it into position. This completes the model, which can be steered by bending or twisting the tail.—George H. Stipp.

### Roll-Film Spools Useful in Economizing Pencils

Now that everyone should economize, short lead pencils should receive attention. A convenient lengthener is easily made by removing the metal ends from used film-camera spools, the 3¼-in. length being the best size to use. The pencil is cut to fit the unslotted end of the spindle tightly. An eraser may be fitted in the slotted end. In a school quite a saving was made by collecting the short pencils of the pupils and having them thus fitted up in the workshop.—A. T. Moss, Napa, Calif.

### Homemade Skates for Use on Hard Snow

A pair of snow skates that a boy can make, will give him much fun and winter sport long before the ice is strong enough to make it safe for skating. The skate is made with a wooden runner, 16 in. long, 3 in. high, and  $\frac{3}{4}$  in. thick, shaped as shown in the sketch. It is fastened to the shoe with two straps. Slots for the straps are cut through the runner, as shown. After the runner is shaped, it is shod with a strip of flat band iron, fastened at the ends with countersunk screws. The rests for the heel and the front of the shoe are made of wood, shaped as shown in the top view. Crosspieces, A, support the rests and are notched into the top edge of the runner and fastened securely. The edges of the

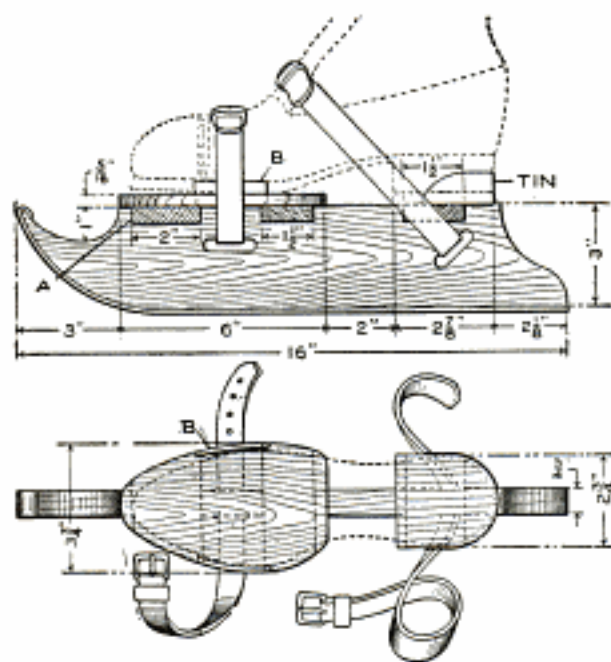

Snow Skates can be Used for Skating on Hard Snow or Ice on Streets and Sidewalks, Long Before the Usual Skating Places are Frozen Thickly

sole and the heel are kept from slipping off by guards made of tin, as shown at B and at the heel. The skates should be well oiled with linseed oil, to protect them from the snow and water.—Charles Kvasnicka, Chicago, Ill.

☞The temperature of photographic baths should be uniform, 65 to 70° F., to give the best results.

### Stand of Shelves Made of Old Disk Records

A useful stand, or series of circular shelves, may be made from discarded disk phonograph records by supporting them at suitable intervals along a small iron rod. The rod is supported in an upright position, being fastened to a suitable base, as shown. The shelves are separated and held properly spaced by empty thread spools, slipped over the rod. This makes a convenient stand for displaying small articles in shop windows, etc., as well as for use in the home.—Roy H. Poston, Flat River, Mo.



### Handy Arrangement of Writing Paper in Box

To simplify getting an envelope and a sheet of writing paper from the ordinary writing-paper box, the sheets being in the bottom and the envelopes on top, the following method will be found useful: Remove all the envelopes and paper from the box, and arrange the envelopes, each to hook over the end of a sheet of writing paper. Then stack these sets, so that an even pile is formed with a row of envelopes at each end. Set the pile in the box, and the writing materials may then be removed handily, an envelope being taken with each sheet of paper. Several extra sheets of paper and envelopes may be kept on the top of the pile keeping it intact when second sheets are used.—Everette Alan Browne, Riverhead, N. Y.



### Adjustable Bench-Light Bracket Made of Pipe

Schemes for holding an electric light over a workbench are nearly as nu-

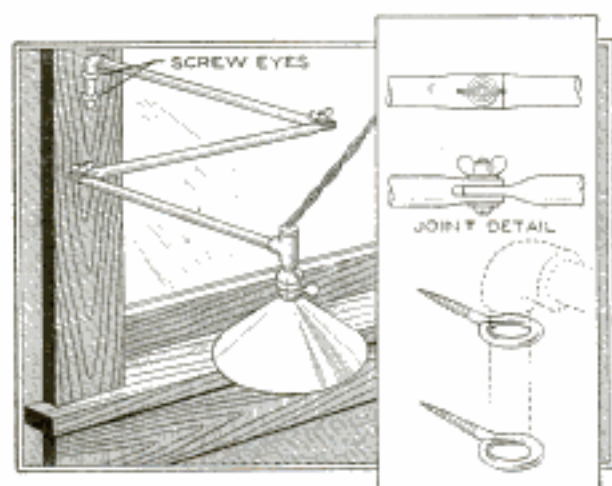

A Strong and Practical Bracket for a Bench Light was Made of  $\frac{1}{2}$ -In. Gas Pipe

merous as mechanics, but here is an arrangement that is simple, and which can be made quickly in the home shop. Several lengths of  $\frac{1}{2}$ -in. gas pipe are slitted at the ends, flattened and drilled for screws with wing nuts, as shown in the sketch. The wall end of the bracket is supported in two screw eyes, and the other fittings are made from standard parts. An insulator is fitted into the vertical end of the pipe tee, as shown, to protect the light cord.—C. C. Spreen, Flint, Mich.

### Old Photo Films Made into Label Holders

By using pieces of old photo films from which the emulsion has been cleaned off, and folding them around a cardboard label of the desired size, one end open as shown, serviceable label holders were cheaply made. The holders can be made in sets, so as to be uniform, and can then be tacked in place by means



of small tacks set along the edges. The open end permits withdrawal of the label for convenient changing of the titles as required.

### Old Vegetable Baskets Made into Wastebaskets

Several large baskets of the kind used by produce dealers for packing vegetables, were on hand, and no special use was found for them because of their large size. By cutting off the upper section, just above the middle band, and strengthening the edge by tacking on loose



staves, useful baskets were provided for waste paper and other articles. By trimming these baskets suitably, a small hotel made use of them in each of the rooms.—M. T. C., Chicago, Ill.

### Angle Door Stop and Lock at Threshold

A convenient door stop and lock was made of strap iron, bent as shown at A. The stop is fastened to the floor by means of a screw, so that the upturned end clears the vertical edge of the door about  $\frac{1}{4}$  in. It is used as a lock by placing a block between the door and the stop, as shown at B. The door can also be left ajar, the stop checking it. The length of the stop should be such that the edge of the door, when standing ajar, covers the screw, making it difficult to loosen the latter. A small catch locks the stop, as indicated at C.—W. B. Long, Washington, D. C.

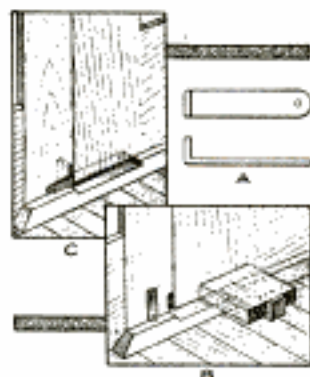



### Novel Signs and Numerals Made of Rope

Pieces of clothesline, or other rope, can be fashioned easily into novel and practical numerals and figures for signs, especially on boats and marine structures. An interesting manner of using rope is for the making of house numbers, the strips of rope being neatly tacked into place with small brass straps. The ease with which the rope can be shaped makes it possible to form quite intricate designs with it.—O. Tryon, Boston, Mass.

### Shield for Shotgun Bead Improves Sighting

Even experienced riflemen find difficulty in sighting a shotgun unless they are familiar with this sporting arm, and a shield like that shown in the sketch is a great help in sighting the gun properly. A band of spring brass,  $\frac{1}{4}$  in. wide, is shaped to clamp around the end of the gun barrels. A small shield of similar material, made as shown in the detail, is soldered to the top of the band. The latter can be easily slipped into place or removed. The shield gives a sharp contrast between the bead and the opening around it, making it easy to sight.—Herman F. Zimmermann, Los Angeles, Calif.

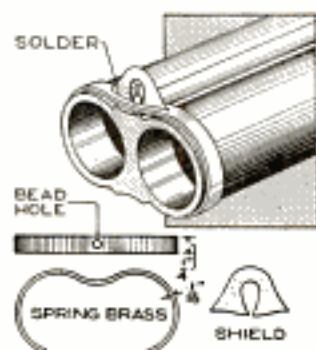

### A Substantial Homemade Snow Scraper

The ordinary fall of snow can best be removed from walks by means of scrapers. A simple but strong construction is the following: Use one board, 1 in. thick, 6 in. wide, and 24 in. long, for the scraper part. To this is rigidly fastened another board of approximately equal length and width, notched in the center for the handle,

which can be made of a suitable pole, about 5 ft. long. One end of the pole should be beveled off at  $45^\circ$ , and fastened near the bottom of the vertical board of the scraper. It is also fas-

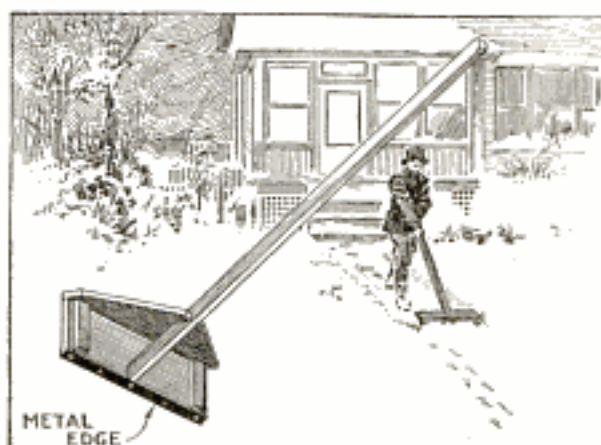

For Removing Ordinary Falls of Snow, a Homemade Scraper of This Type Is Practical

tened in the notched board. To reinforce the scraper piece, several strips of wood are nailed to it vertically. The scraping edge is shod with a fairly sharp strip of sheet iron or steel.—F. W. Buerstatte, Pullman, Wash.

### A Simple Sash Lock for Open Windows

A window lock for sashes, opened partly, can be made from two pieces of No. 14 gauge steel, 1 by  $1\frac{1}{2}$  in. long, as shown. The bottom piece has a flat-head  $\frac{1}{4}$ -in. bolt riveted in the center, and two screw and two rivet holes in it. The top piece, of spring steel, is  $\frac{3}{8}$  in. longer than the bottom piece and is riveted on one end to the bottom piece and bent upward. A slot is drilled through the center for the bolt. A wing nut on the bolt forces the top piece against the sash. The lock is set on the side stiles of the sash. The window can be left open as desired, and when the lock is tightened, it holds the sash firmly.

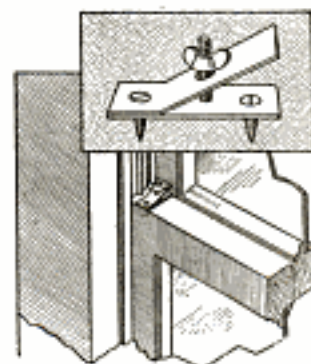

3127

## ATHLETIC FIELD ARTISTICALLY INCLOSED

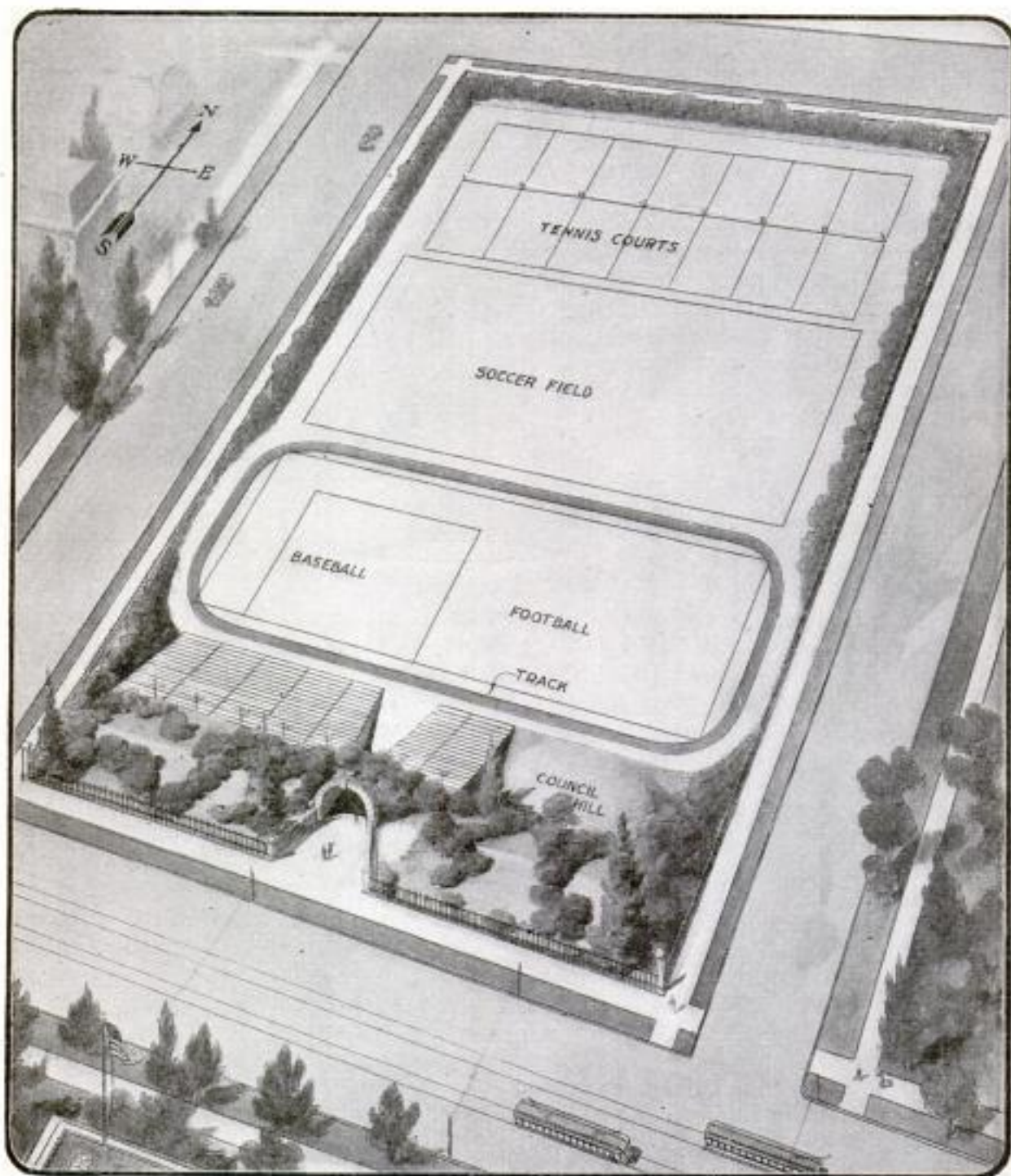

**T**HE use of unsightly board fences or cement walls have been entirely avoided as a means of inclosing high-school athletic grounds, situated in the midst of a fine residence district in Oak Park, Ill., by substituting therefor walls of artistic shrubbery, some of which cover a high earth embankment. The latter extends across the end of the grounds adjacent to the area devoted to baseball, track work, and football. Besides shutting off the view of passers-by at this end, it supports seats on its inner slope that take the place of the customary unattractive bleachers. Access to these is gained through an artistic archway adjoining which are ticket booths. Parts of the grounds are occupied by a soccer field and tennis courts. An ornamental fence supplements the shrubs as a barrier against intruders. Drinking fountains have been installed at various points.

**I**N accordance with the editorial policy of this magazine never to accept compensation in any form for what appears in our reading pages, and also to avoid all appearance of doing so, we are obliged to omit the name of the maker or the seller of any article described. This information, however, is kept on file and will be furnished free, by addressing Bureau of Information, Popular Mechanics Magazine, Chicago. [Editor.]

# \$ 545 for this 5-Room ALADDIN



## Your Own Home—Build It This Year

**H**ERE is your opportunity to own a home and dodge high building prices. You can do it even though building prices are going up! THE ALADDIN READI-CUT SYSTEM of building stands between you and present high prices. It offers you this ideal home or one hundred other attractive homes at substantial savings in price. Think of the home pictured above containing large living room and dining room, large kitchen, two large bedrooms and porch for \$545 for complete material, readi-cut. This is only one of a hundred homes with prices from \$200 to \$8000 shown in the handsome book. Let us send you a copy of this book entitled "Aladdin Homes." Send stamps today for your copy.

### Why Pay \$900 for a Home That You Can Buy for \$600?

Why hand over three hundred dollars of your savings to a contractor when you can keep that money by having any carpenter put up your Aladdin Read-Cut Home? Your staunch, beautiful Aladdin Home comes at ready for building—complete to the last lock screw in the front door. It saves you money because the lumber is cut by machinery—the materials bought at wholesale. The daily capacity of our mills is 40 Aladdin Homes—we get 18% more out of our lumber than any builder. This great saving becomes YOURS.

**What You Get** Aladdin price includes all lumber, millwork, flooring, outside and inside finish, doors, windows, shingles, lath and plaster, hardware, locks, nails, paint, varnishes. Your home is shipped in a sealed box car, complete, Read-Cut, ready to erect. Safe arrival of the complete material in perfect condition is guaranteed. Floor plan arrangement and complete description of the house shown above will be found in the Aladdin Book of Homes. Send stamps today for the book, "Aladdin Homes," No. 180.

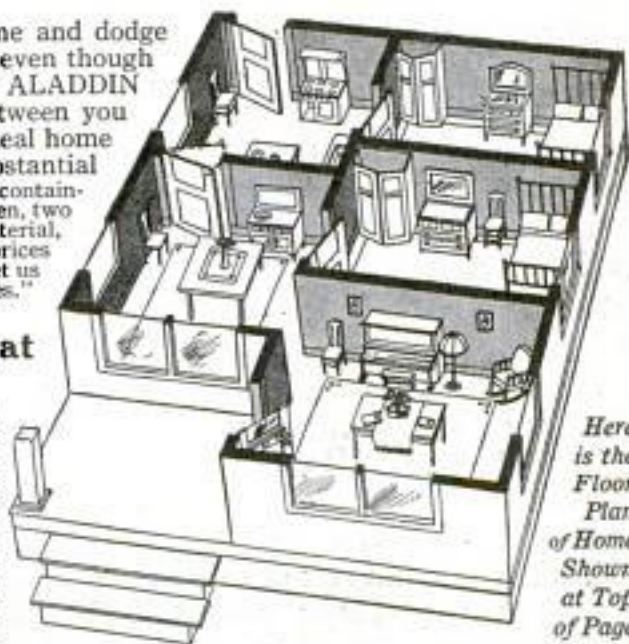

Here is the Floor Plan of Home Shown at Top of Page

# The Aladdin Company

Homebuilders to the Nation  
Canadian Branch, C. P. R. Bldg., TORONTO, ONT.

1467 Aladdin Ave., Bay City, Mich.



# How I Increased My Earnings From \$2 to \$200 a Day!

*The Remarkable Story of a Young Man's Experience  
After Reading a Wonderful Book, as Told by Himself*

SOME people say it takes money to make money—others complain that they never made money because they never had any luck. When one is up against the stern reality of making both ends meet, it is natural to feel that if they only had a little money, or a little luck, they wouldn't have to worry about their bread and butter, and rent, and clothes.

A short time ago I, too, felt that way. I was a bill clerk earning only \$12 a week, and I used to worry myself sick about my future.

To-day—it seems like a dream—all my financial troubles are over—my weekly income instead is about \$1,000—more than I know how to spend. I own two automobiles and have a chauffeur to drive me around. My children go to private schools. I have just purchased, for cash, a \$25,000 home. I go hunting, fishing, motoring, traveling, whenever I care to. I live in a new kind of world.

Let me say in all sincerity that what I have done, I believe any one can do. I am only an average man—not "brilliant"—have never gone to college—my education is limited. I know at least a hundred men who know more than I, who are better educated and better informed—yet not one of them has made as much money as I have, their earnings probably averaging less than \$50 weekly, while my income is over \$1,000 weekly. I mention this to show that earning capacity is not governed by the extent of a man's education—to encourage those who have not had the advantage of a comprehensive education.

What, then, is the secret of my success? Let me tell you how it came about.

One day, about three years ago, something happened that woke me up to what was wrong with me. It was necessary for me to make a decision on a matter which was of little consequence. I knew in my heart what was the right thing to do, but something held me back. I said one thing, then another; I decided one way, then another. I couldn't for the life of me make the decision I knew was right.

I lay awake most of that night thinking about the matter—not because it was of any great importance in itself, but because I was beginning to discover *what was wrong with me*. Along towards dawn I resolved to make an experiment. I decided to cultivate my will power, believing that if I did this I would not hesitate about making decisions—that when I had an idea I would have sufficient confidence in myself to "put it over"—that I would not be afraid of myself, of things or of others. I felt that if I could smash my ideas across I would soon make my presence felt. I knew that heretofore I had always begged for success—had always stood, hat in hand, depending on others to give me the things I desired. In short, I was controlled by the will of others. Henceforth, I determined to have a strong will of my own—to demand and command *what I wanted*.

With this new purpose in mind I applied myself to finding out something more about will power. The results at first were discouraging. While a good deal had been written about the memory and other facul-

ties of the brain, I could find nothing that offered any help to me in acquiring the new power that I had hoped might be mine.

But finally I encountered the works of Professor Frank Channing Haddock. To my amazement and delight I discovered that this eminent scientist, whose name ranks with James, Bergson and Royce, had just completed the most thorough and constructive study of will power ever made. I was astonished to read his statement. "The will is just as susceptible of development as the muscles of the body!" My question was answered! Eagerly I read further—how Dr. Haddock had devoted twenty years to this study—how he had so completely mastered it that he was actually able to set down the very exercises by which any one could develop the will, making it a bigger, stronger force each day, simply through an easy, progressive course of training.

It is almost needless to say that I at once began to practise the exercises formulated by Dr. Haddock, and I need not recount the extraordinary results that I obtained almost from the first day. I have already indicated the success that my developed power of will has made for me.

But it may be thought that my case is exceptional. Let me again assure you that I am but an average man, with no super-developed powers, save that of my own will. And to further prove my contention, let me say that since Prof. Haddock's lessons, rules and exercises have been published, I have come across hundreds of other cases where strengthened will power has brought success and fortune to people who were failures, has enabled thousands to overcome drink and other vices almost overnight—has helped overcome sickness and

nervousness, has transformed unhappy, envious, discontented people into dominating personalities filled with the joy of living.

I have been authorized by the publishers of Prof. Haddock's methods to say that any reader who cares to examine his startling book on will power may do so without sending any money in advance. In other words, if after a week's reading you do not feel that "Power of Will" is worth \$3, the sum asked, return it and you will owe nothing. When you receive your copy for examination you will be interested in the studies on The law of great thinking; How to develop analytical power; How to guard against errors in thought; How to drive from the mind unwholesome thoughts; How to develop fearlessness; How to use the mind in sickness; How to acquire a dominating personality, and hundreds of other similar personal power studies.

It is interesting to note that among the 200,000 owners of "Power of Will" are such prominent men as Judge Ben B. Lindsey; Supreme Court Justice Parker; Wu Ting Fang, ex-U. S. Chinese Ambassador; Senator T. B. Calron; Lieut.-Gov. McKelvie of Nebraska; Assistant Postmaster-General Britt; General Manager Christenson, of Wells Fargo Express Co.; E. St. Elmo Lewis; Governor Arthur Capper of Kansas, and thousands of others.

As a first step in will training, I would suggest immediate action in this matter before you. It is not even necessary to write a letter. Use the blank form below, if you prefer, addressing it to the Pelton Publishing Company, 13-T Wilcox Block, Meriden, Conn., and the book will come by return mail. This one act may mean the turning point of your life, as it has meant to me and to so many others.

---

PELTON PUBLISHING COMPANY, 13-T Wilcox Block, Meriden, Conn.

I will examine a copy of "Power of Will" at your risk. I agree to remit \$3 or return the book in 5 days.

Name.....

Address.....

*Please Mention Popular Mechanics*

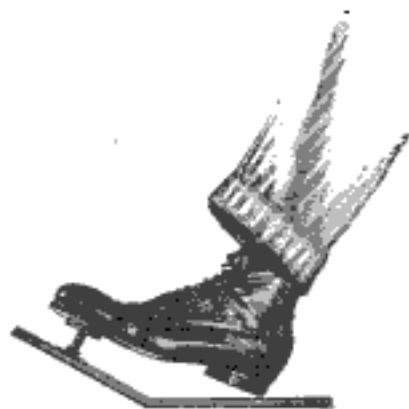

Wh-r-r!



Whr-r-r!



Whr-r-r-r-r-r-r!

## Spare your batteries

*How winter starting is often made easier  
by a lower-cold-test oil*

**Y**OU press on your starter button in summer. Whr-r-r! The engine is under way.

But winter comes. Whr-r-r!  
Whr-r-r-r-r! Whr-r-r-r-r-r—.  
Now starting is difficult.

Why?

True, the engine *is* colder. And gasoline vaporizes less readily. Starting is helped if you prime the cylinders, flood the carburetor or heat the intake manifold.

But there is one factor in overcoming this trouble that many car owners overlook. This is—correct

lubrication. The lubricating requirements of your car may demand a different grade of oil in winter.

Winter lubrication requires special study. There are many factors to reckon with. The type of feed system is one. The size of the oil drillings is another. Exposed oil piping is a possible third. Other factors also enter in.

All these factors are carefully considered by the Vacuum Oil Company engineers in making up the Chart of Recommendations.

Of the 1917 cars, 112 require a different grade of oil to meet winter conditions.

The correct winter oil is listed for each make of car in our Complete



# Every Kind of Level

## Partial List of Goodell-Pratt Tools

Screw-Drivers	Bit Braces	Lathes
Hacksaws	Micrometers	Levels
Gages	Vises	Calipers
Punches	Drills—Grinders	Squares

There is a Goodell-Pratt Level for every possible purpose, of every size, of every price. These Levels comprise the Stratton and Richardson lines, with a few additions, but are now all made in the Goodell-Pratt factory. The same high standard of materials and workmanship that distinguished the Stratton Level and that has always been a feature of Goodell-Pratt tools has been maintained in making these levels.

This very complete line gives an opportunity to select exactly the size and type of level best suited to the work. For carpenters no finer instrument can be found than the built-up, brass-bound, double plumb, rosewood level No. 4024 shown in the lower circle. The sectional construction practically insures it against climatic changes. The vials are ground to a true curve from end to end, and set solid in the stock, with the simple Stratton movable bar adjustment. The brass binding is dove-tailed its entire length and doweled to heavy brass end plates. There are four lengths in this style—24 to 30 inches.

No. 1518 is one of the narrow series running from 8 to 30 inches in length,

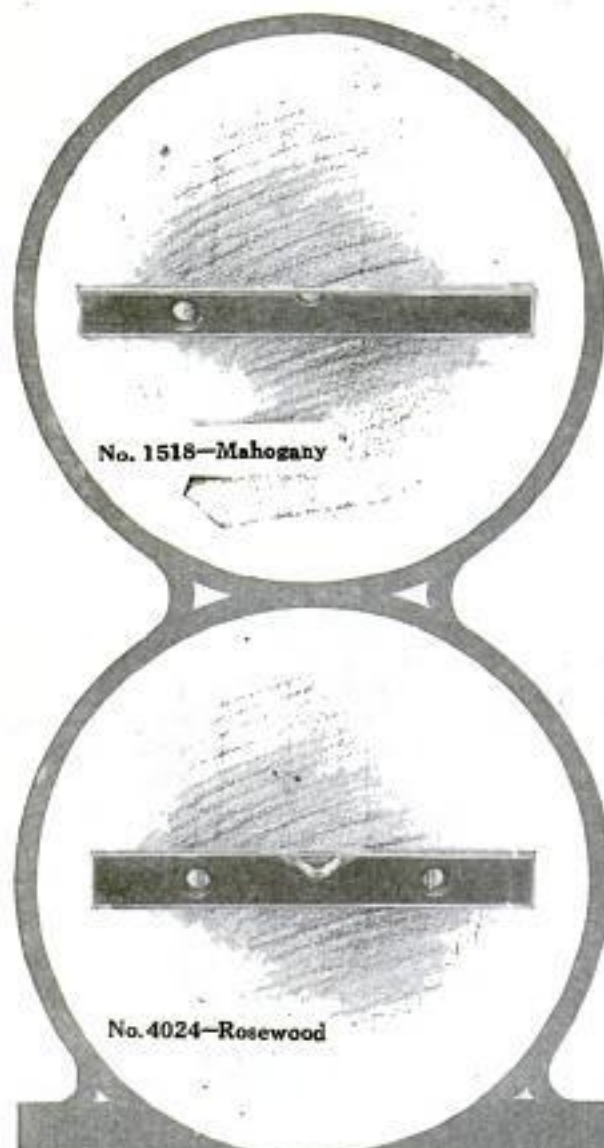

No. 1518—Mahogany

No. 4024—Rosewood

# GOODSELL

## 1 5 0 0



# For Every Kind of Job

made of a solid stick of selected mahogany, fully brass bound. The vials are sensitive and accurate, set solid, and have the regular movable bar adjustment. This level is specially designed for machinists, and is sold at a very attractive price.

There is a wide variety of other wooden levels, of rosewood, mahogany and imitation mahogany, suitable for every trade and every pocket.

The aluminum level, No. 924, is a new member of the family, put out in response to popular demand. It is very light—made completely of aluminum—has double plumb and is 24 inches long.

No. 509, at the right, is an iron level 18 inches long, double plumb, milled face and ends, sold at a popular price. It is only one of many types and sizes of iron levels for machinists and engineers, low-priced, but accurate and strong.

The name Goodell-Pratt on a tool always means a good tool, the best possible at the price.

**GODELL-PRATT COMPANY**  
*Toolsmiths* Greenfield, Mass., U.S.A.

*Send for the Complete Catalog, showing all the levels, and the other Goodell-Pratt Good Tools.*



No. 924—Aluminum

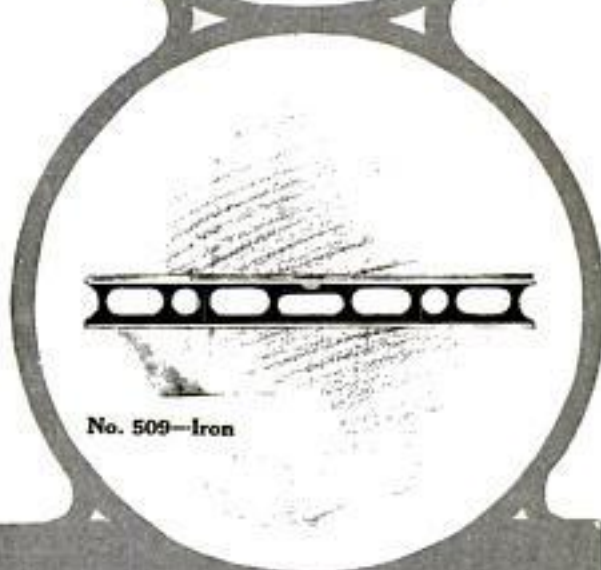

No. 509—Iron

# PRATT

## GOOD TOOLS



**Paul R. Fredericks and His Haywood Tire and Repair Shop and Accessory Store.**

He started with one machine and in one year built a business of his own which averages \$400 to \$450 a week.

**You, too,  
Can Make  
Big Money  
Read This  
Advertisement**

# \$400 a Week

## Here Is Your Opportunity!

We need immediately more men like Paul R. Fredericks to manage Haywood Tire Repair stations. "Just a year in the business and now doing \$400 to \$450 a week at a good round profit," tells the story of this ambitious young man's rapid rise to fortune. Scores of men like Fredericks have found their independence in the Tire Repair Business, have opened Haywood shops and are making big money. **The coupon on the next page or a post card with your name and address will tell you how to start. Send today.**



*Classes  
of the  
Haywood Tire  
Repairing Laboratories*

## Tire Repairing Revolutionized!!

### Motorists to Save Millions in Tire Expense

The Haywood Method of Tire Repairing is different—Scientific. It strikes a new chord in tire economy. It is efficient—Saves Tires—Increases Mileage—Lasts. It has required years of experience to develop it. Practical tests have proven it. Its superiority is acknowledged—accepted, by those who know, as a Triumph.

### Write to Haywood at Once!



*Please Mention Popular Mechanics*

# Make Big Money IN THE Tire Repair Business

## 30 Million Tires to Repair

The demand for **Tire Repairing** is now so great that more **Haywood Stations** must be established at once throughout the country. We want capable, energetic, ambitious men in charge of each—men who are dependable, competent. You can have this opportunity—share in the **Haywood success**—become a link in a mammoth chain of a country-wide, thoroughly efficient **Tire Repair Service**.

**Make \$3,000 a Year or Better!**  
**You Own Your Own Business! Keep Your Own Profits!**

Haywood equipment is sold outright. We teach you Haywood Scientific Tire Repairing in our Laboratory especially equipped for this purpose. Here you learn all about tires—the inner mechanism of construction—how to repair scientifically every tire injury. **This training is thorough—practical and equips you to give Haywood Service of the standard we advertise nationally and are so careful to maintain—the Service that saves motorists millions of dollars in tire up-keep.**



### A Wonderful Opportunity

The coupon—your name and address, brings full particulars. How to start. How to tie up with the Haywood Service. We'll give inside facts and figures about costs and profits. Explain in detail our **Co-operative Business Building Plans**. Write today without fail. Learn how you can start at once.

**Haywood Tire & Equipment Co.**  
1172 N. Capitol Avenue, Indianapolis, Ind.

**Sign and Mail This Coupon Today  
No Obligation**

**Haywood Tire & Equipment Co.,**  
1172 N. Capitol Avenue, Indianapolis, Ind.

Gentlemen: Please send full particulars of your Scientific Tire Repair Service and details of your **Co-operative Business Building Plans**.

Name.....

Address.....

*Please Mention Popular Mechanics*

# EVEREADY DAYLO



The light that says  
*"There it is!"*

**R**UNNING in from an advanced post, at night, Longshaw R. Pointt, of the American Ambulance Field Service, with two wounded men in his car, traveled a road that was less than a kilometer distant and in full view of the enemy lines.

Suddenly the engine stopped dead. To light a match would have revealed his position, with the result that at any instant a shell might sweep across the road and wipe the car and its two wounded occupants off the map!

But he had his Daylo with him and, using his hand as a shade, was able to throw light all over the engine without illuminating the scenery. In half a minute he located the trouble; in three minutes more was on his way to the hospital—SAFE! For every emergency of the night—Daylo is *always* dependable.

77 different styles at prices from 75 cents up. (In Canada 85 cents and up.) Sold by the better electrical, hardware, drug, sporting goods, stationery and jewelry stores everywhere.

Don't let your soldier boy go to camp without an Eveready Daylo—"the light that may save his life."

**AMERICAN EVER READY WORKS**  
of National Carbon Co., Inc.  
LONG ISLAND CITY NEW YORK  
Chicago Atlanta San Francisco  
Canadian National Carbon Co., Ltd.  
Toronto, Ontario



*when* all other lights fail  
*when* the motor stalls and the trouble must be located instantly  
*when* you're looking for something in that dark corner of the attic  
*when* a fuse blows and all the lights go out  
*when* you can't see to read a sign post or house number  
*whenever* you need instant, portable light, indoors or out, you need an Eveready Daylo.

Don't ask for a "flashlight"—get an Eveready DAYLO

Please Mention Popular Mechanics

Copyrighted material

**Elastic Shoulder**  
Holds shape perfectly and allows lots of room without binding. Improved Lap Seams that "give" with every motion.

**The Improved Cuffs**  
hug the wrist and won't flare out. Special stitching prevents ripping where they join the garment.

**Tailored Collarette**  
that snuggles up around the neck. Every button is good pearl sewn securely on.

**Comfortable Closed Crotch**  
that stays closed. A mighty big feature in an underwear that's just chock-full of big features.

**GUARANTEE**  
We guarantee Hanes Underwear absolutely—every thread, stitch and button. We guarantee to return your money or give you a new garment if any seam breaks.

**The Improved Ankle Cuff**  
Keeps Hanes snug around the ankles; holds the shape and makes this bang-up suit feel tailor-made. Easy to put on socks, too. Won't flare, tear or rip.

**Why Not Save That Extra on Underwear?**

With prices racing sky-high on 'most everything, it's a mighty good feeling to know you can get the finest sort of wear, warmth and comfort in winter weight underwear and at such popular prices.

It's really a startling eye-opener to see just what amazing value you can get. Read about the extra features over there in the illustration. Add 'em all up—then get this:

*Hanes Winter Weight Underwear is made of fine, long-fibre cotton, snug-fitting, slightly and strongly made. Every seam is guaranteed unbreakable where the wear is greatest. It is springy and comfortable, warm and cozy. Bull strong—washing can't faze it.*

Greatest Winter Underwear **HANES** Sold at Popular Prices

**ELASTIC KNIT UNDERWEAR**

Where can you get anything to touch that for downright value? Don't pay a high price just because you're used to paying it. Hanes is good enough for any man.

If you're paying less, add a little and get extra wear, feel and value. You'll be mighty glad of it when you warm up to this splendid underwear.

**Here's the Big Specialty for 1917**

*A boy's union suit, superbly made with an unusual silky finish. A real high-class boys' underwear that combines the best features of the men's suits with a downy softness and cozy warmth just right for youngsters. Its value can't be duplicated anywhere.*

Ask the Hanes dealer to let you see these two big underwear values. If you don't know him, write us. Don't let this chance slip by, but stock up against the cold weather by buying a half dozen suits before your dealer is sold out.

**P. H. HANES KNITTING CO.**  
Winston-Salem, N. C.

Warning to the Trade—Any garment offered as Hanes is a substitute unless it bears the "Hanes" label

This Label on Every Garment **HANES** Buy Hanes Without It

Please Mention Popular Mechanics

# AT LAST!

## An Aeroplane for Everybody!

### FLIES WITH MOTORCYCLE ENGINE

Think of flying with an ordinary twin cylinder motorcycle engine! This is the only aeroplane that will do it. It is the smallest and most efficient of all aircraft. No longer is flying the sport of acrobats and millionaires. Every man and boy in the world can build one of these remarkable aeroplanes with ordinary tools in a few weeks and learn to fly at home with safety. No shop is needed. If you can use a hammer, saw and a pair of pliers and have a shed, barn, a basement or a back yard you can build one of these remarkable flyers for a few dollars and in spare time if necessary. Costs less than 1/50 the cost of the average aeroplane and can be built for less than a fifth the cost of going to a flying school. It is the smallest, simplest, safest and most successful aeroplane in the world. The wonderful

# WHITE MONOPLANE

**A  
Proved  
Success**

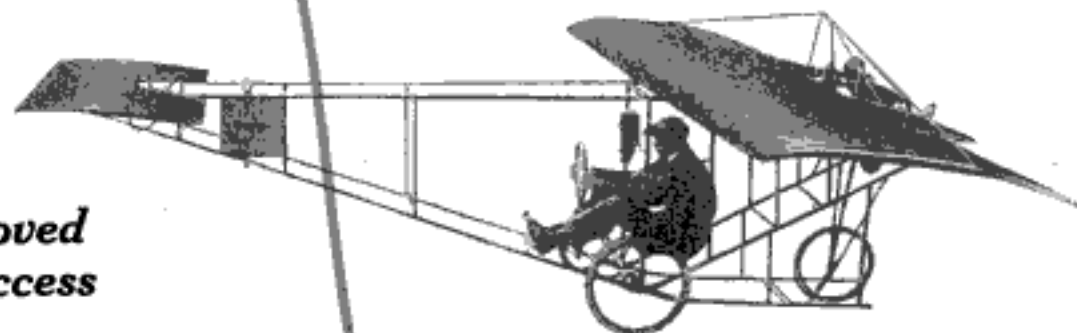

## YOU CAN BUILD IT

Remember, this is not a toy or an experiment, but a thoroughly perfected man-carrying aeroplane with 18 foot spread and a speed of 30-60 m. p. h. Lifts 190-pound man with twin cylinder motorcycle engine. Hundreds are already in use in the United States, Canada, Mexico, South America, England, Australia and the Philippine Islands. Hundreds of amateurs are building and flying these aeroplanes, men and boys who knew absolutely nothing about aeroplanes and flying before. It is the simplest and safest flyer in the world. Any make of motorcycle engine can be used.

#### WHAT OTHERS SAY:

*POPULAR MECHANICS* says:

"Undoubtedly the smallest successful monoplane in the world."

*AERIAL AGE* says:

"One of the most interesting machines yet to be developed."

*SCIENTIFIC AMERICAN* says:

"A unique type of monoplane."

*L. A. EVENING HERALD* says:

"Has solved the problem of producing small machines at a cheap price for universal service."

#### Working Drawings \$2

Send \$2 at once for a complete set of working drawings of this wonderful monoplane showing all details and dimensions in a simple manner so you can easily understand everything. Here is your chance to get into the greatest of all industries. Thousands of experienced flyers and builders are needed.

**Don't Miss This Chance! Send \$2 Now!**

### GEORGE D. WHITE

DESIGNER AND OWNER OF SOLE RIGHTS

3832 South Main Street, LOS ANGELES, CALIF.

# 1918 HARLEY-DAVIDSON

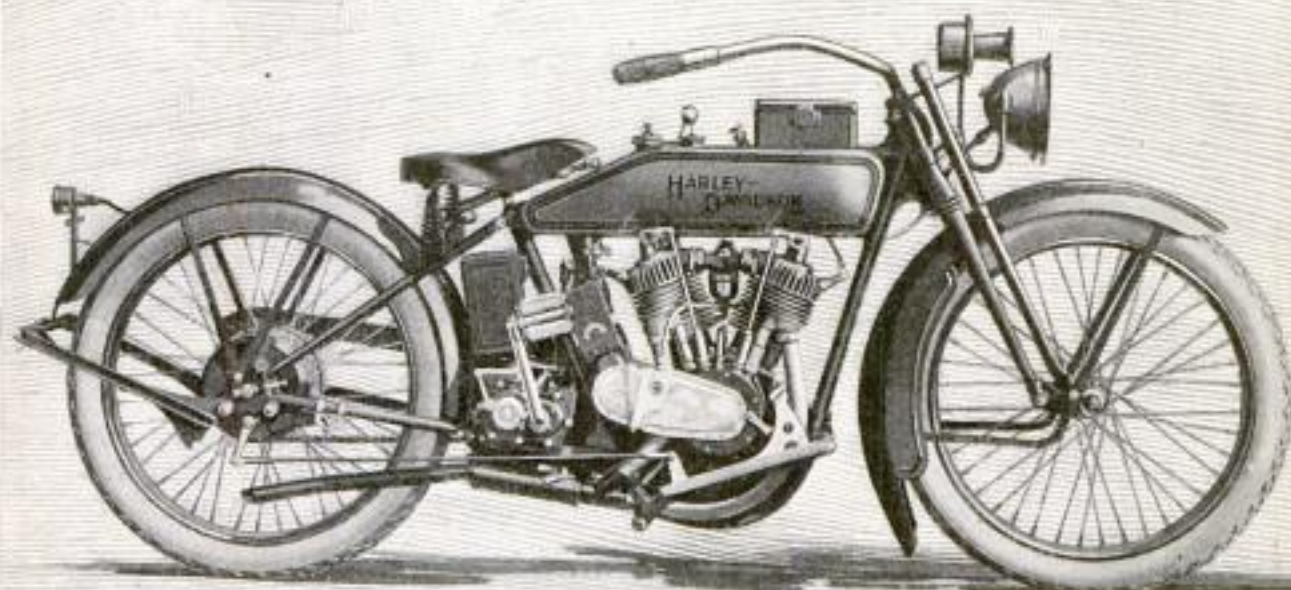

50 to 75 miles per gallon of gasoline  
600 to 1200 miles per gallon of oil  
5000 to 8000 miles per set of tires

In every successful industry there is a striving toward an ideal which shall embody perfection. The

## Harley-Davidson Motorcycle

For 16 Years The Master Mount

has been so constantly approaching the ideal that in the 1918 model there has been no fundamental change from the successful 1917 type.

We believe that seeming "trifles make perfection and perfection is no trifle." In numerous seeming "trifles"—too many to give space to here—the 1918 Harley-Davidson is one step nearer the ideal. More than ever before the buyer of a Harley-Davidson Motorcycle may rest assured that his mount will not be out of date at the end of one season. The Master Mount is built to endure.

### The 1918 Harley-Davidson Bicycles Are Out

For every member in the family there is a Master Bike, built to the Harley-Davidson standard—made to be the sturdy companion of the most exacting riders.

**HARLEY-DAVIDSON MOTOR CO.**

514 B Street  
MILWAUKEE, WIS.

# Oxy-Acetylene Welding and Cutting

## Saves You Time and Money on Speedy Repair Jobs

**F**OR repairing operating machinery quickly—when a breakdown threatens a shutdown—oxy-acetylene welding is saving time, money and eliminating the necessity of purchasing expensive replacement parts.

The Prest-O-Lite outfit is portable—enables you to effect permanent metal repairs *anywhere in the plant*, at relatively low cost.

In thousands of machine shops, factories, foundries, repair shops, garages, etc., the Prest-O-Lite Process is making big savings in repair work alone—reclaiming thousands of dollar's worth of valuable metal parts and castings from scrap heaps.

In metal manufacturing—from locomotives down to dental appliances—oxy-acetylene welding gives neater, stronger joints—simplifies construction—cut costs—*minimizes material waste*.

Wherever you have a metal joining problem—in manufacturing metal products—in laying pipe lines—or in repairing broken machinery, tools, castings, etc., remember this process saves time, money and material.

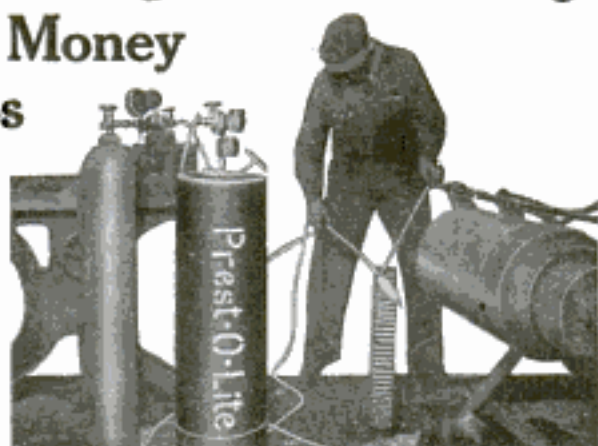

*The damaged teeth on this gear wheel were built up quickly, at very small cost by the Prest-O-Lite Welding Process*

# Prest-O-Lite

## PROCESS

Employs both gases (acetylene and oxygen) in portable cylinders. Prest-O-Lite Dissolved Acetylene is backed by Prest-O-Lite Service, which insures prompt exchange of full cylinders for empty ones. Provides dry, purified gas, insuring better welds, quicker work, and lower cost; also avoids large initial investment and depreciation.

Necessary equipment is not expensive. We furnish high-grade welding apparatus for \$75 (Canada \$100); acetylene service at additional cost. Adaptable for oxy-acetylene cutting by the addition of special cutting blow-pipe. Thorough instructions are furnished free to every user of Prest-O-Lite Dissolved Acetylene—any average workman who understands metals can learn the process quickly and easily.

Hundreds of savings made by welding in many lines of industry are described in our illustrated

literature. These savings you can realize in **your** business. Write for this **TODAY**.

### Big Profits For You in Job Welding

Garages and repair shops are making big, extra profits doing job welding. It's a money-maker—saves time and money for customers—**attracts new trade**.

**You** can make these profits. Necessary welding equipment is not costly. Big, growing demand for job welding makes profits **sure** from the start. Write us—**NOW**.

The Prest-O-Lite Co., Inc.

U. S. Main Offices and Factory  
816 SPEEDWAY, INDIANAPOLIS  
Canadian General Office  
Dept. U TORONTO, ONT.

59 Branches and Charging Plants



# World's Largest Makers of Dissolved Acetylene



# A MASTER WATCH

## The New 21 Jewel BURLINGTON



# Just Out!

The New Burlington is ready—just out—and distributed for the first time—on an astounding offer. The superb new model far surpassing everything of the past. 21 jewels, adjusted to positions, temperature and isochronism. New thin model—and all the newest ideas in gold strata cases to choose from.

And—we will send you this master watch without a cent down. If you decide to buy it—pay *only* the rock-bottom price—the same price that even wholesale jewelers must pay.

## \$250 a Month!

Just think of it! \$2.50 a month—for the New 21-Jewel Burlington—the master watch. This perfect time-piece will be sent direct to you without a cent deposit so that you can see and examine it for yourself. When you hold it in your hand you will realize what a *superb* value it is.



Here is  
One of  
Our New  
Monogram  
Designs

## Send for New Watch Book

Write today for our new catalog and the introductory offer. Read about this gigantic watch value. Read what makes a watch movement perfect—and how the Burlington is adjusted to the very second. The watch book is free. Write for it today and get posted on watches and watch values. Send the coupon now.

**Burlington Watch Co.** Dept. 1198, 19th Street and  
Marshall Blvd., Chicago, Ill.

Burlington Watch Co.  
19th St. and Marshall Blvd.  
Dept. 1198 Chicago, Ill.

Please send me, without obligation (and prepaid), your free book on watches, with full explanation of your cash or \$2.50 a month offer on the Burlington Watch.

Name .....

Address .....

# Look, Boys!

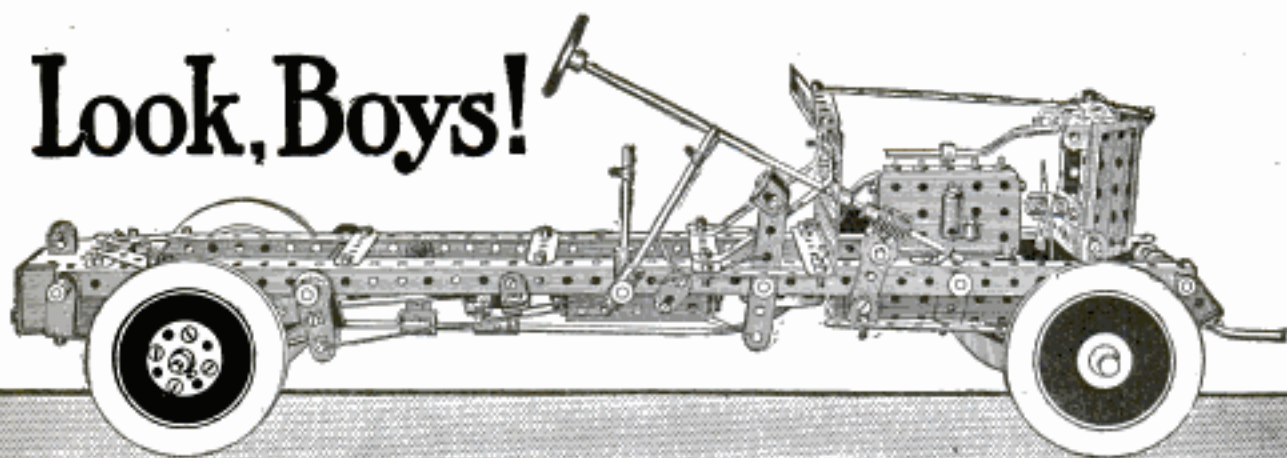

## You Can Build This Dandy AUTO with MECCANO

It is all built from regular MECCANO parts. It is just like the chassis of a real automobile, with clutch, worm steering gear, speeds, transmission, universal joint, differential, brakes, springs and all other working parts of a big car.

Just think of an engineering toy that will build models like that! You couldn't build this auto with anything but MECCANO, because it is made up of special patented parts that come only with MECCANO.

And this is only one of the scores of fascinating models you can make with this world-famous engineering toy. The Meccano Manual, which is contained in all sets from No. 1 up, pictures *hundreds* of other wonderful models. Or you can build some model of your own—something you have seen and would like to make.

And then, the next day you can have just as much fun building something *entirely different* with the same parts. And think of this: MECCANO builds *real working models*—high towers with electric elevators, derricks that hoist heavy loads, cranes that swing around, bridges that open and close, steam shovels that you can dig with!

Nothing else you could own would give you as much real sport as a set of MECCANO—it's just like a Magic Box of fun!



### MECCANO Wonder Book Free to Boys

Lots of fine models. Send your own name and address and the names of three of your boy friends and we will mail it to you along with trial

Free Subscription to "Meccano Engineer" and

details of Meccano \$1000.00 Prize Contest!

Write right now for this wonder-book.

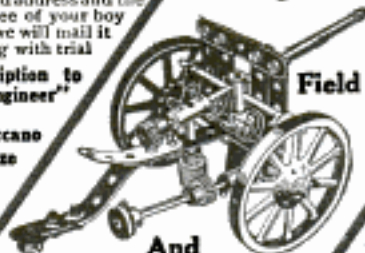

or a bully Field Gun

And hundreds of other Wonderful Models  
You can make a new model every day with MECCANO if you want to. You never get tired of MECCANO, and it never wears out.

Be Sure the Name "MECCANO" is on the Box



or a dandy Crane that lifts



or a real Steam Shovel that digs



A regular Army Aeroplane

Your Fun has only Begun

when you have built one model. For with MECCANO you can take the same parts and build—

Tell Your Folks **WHY** You Want **MECCANO**

**True Engineering Parts.** MECCANO sets are made up of accurate, standardized parts just like real engineers use, only smaller. You can use them over and over again and build all sorts of models.

**Fun Right Away.** With MECCANO you can begin building models and having fun *right away*, the minute you open the box. You don't have to study; MECCANO Manual shows you just how to go ahead.

**Models That Run Like Real Machinery.** MECCANO parts are so accurately made that you can build models that will run *just like a piece of regular machinery*. Think of building such things as Clocks that *keep time*; Looms that actually *weave*; Motor cars and Engines that run; Machines that draw beautiful designs.

**Each MECCANO Set Complete,** whether it costs \$1 or \$40. You don't have to keep buying parts.

**Build Almost Anything with MECCANO.** You won't get tired of MECCANO like you would of any ordinary building toy because MECCANO sets are so complete and the parts are so made that you can build not only the models in the Manual but also dozens of models of your own. *That's the fun of MECCANO—you can build almost anything!*

**Cash Prizes.** There are always MECCANO competitions and cash prizes for the best, most original models. Perhaps you can win one of the prizes.

### BE SURE YOU GET MECCANO

Now you can see why you want to be *sure* to get MECCANO. There isn't anything else just as good or just the same. So say the name over to yourself—MECCANO—MECCANO—MECCANO. Then tell Mother and Dad about MECCANO, and tell them *why* nothing else will give you as much fun as MECCANO will.

### Prices of MECCANO Sets

MECCANO sets include various sizes of dandy girders, plates, and perforated strips; also nuts, bolts, wheels, gears and scores of other parts—all cut from shining steel and brass, as accurately as the works of a clock. Each regular outfit, from No. 1 to No. 6, is complete with tools and full instructions. Nothing more to buy. Sets numbered 1X, 2X, 3X contain the powerful MECCANO Electric Motor. Any set sent postpaid upon receipt of price, if not at your dealer's.

No. 00.....	\$2.00
No. 0.....	1.50
No. 1.....	3.00
No. 1X.....	4.50
No. 2.....	6.00
No. 2X.....	7.50
No. 3.....	9.00
No. 3X.....	13.00
No. 4.....	15.00
And up to \$40.00	

**MECCANO COMPANY, Inc.**  
Building 10H, Bush Terminal, Brooklyn, N.Y.

Please Mention Popular Mechanics



## Accurate

Are your precision tools your best friends or your worst enemies? If you are never sure of the reading or if they wear easily and rapidly, you have to guess, and guessing produces seconds and makes pay envelopes thin.

If you use

## Starrett Tools

you can be *sure* all the time. If a Starrett Micrometer reads .808 you know that the piece is exactly that diameter or thickness.

You can place the same confidence in every one of the 2100 styles and sizes of the Starrett line. They are recognized for their enduring accuracy. They help to put speed in your work and bonuses in your pocket.

Ask for  
Catalog No. 21 AP



### The L. S. Starrett Company

*The World's Greatest Toolmakers*

Athol, Mass.

NEW YORK

LONDON

CHICAGO



42-731

Please Mention Popular Mechanics

LOOK ON THE TOP WAD FOR "INFALLIBLE" OR "E. C."

# HERCULES

## Smokeless Shotgun

# POWDERS

**Peters**

HIGH GUN  
IDEAL  
PREMIER  
TARGET

**Remington**  
**UMC**

ARROW  
NITRO CLUB

**SELBY LOADS**

CHALLENGE  
SUPERIOR

**US BLACK SHELLS**

AJAX  
CLIMAX

**Western**

FIELD  
RECORD

**WINCHESTER**

REPEATER  
LEADER

When you buy loaded shotgun shells you buy by name. You ask for your favorite make and see to it that you get it.

But if this is all you do you omit an important detail. You overlook the matter of powder.

It is just as easy to obtain a powder with which you are familiar, a powder in which you have full confidence, as it is to obtain your favorite make of shell. You ask for the powder by name just as you ask for the shell.

Hercules Smokeless Shotgun Powders, Infallible and "E. C.", may be obtained in the standard makes of shells given at the left. The shell you shoot is among them. You can obtain a Hercules powder in that shell by asking for it when you buy.

On the top wad of every shell, and on the side of the box in which the shells are sold, is printed the name of the powder with which the shell is loaded. Look for the name when buying. See that it is either Infallible or "E. C."

These powders are of high quality and uniform quality. They give light recoil, even patterns, and high velocity. Write for a free booklet which describes them fully.



**HERCULES POWDER CO.**

1025 Market Street

Wilmington

Delaware

Please Mention Popular Mechanics

The standing position. Stand at right angles to the firing line, pointing across the body to the left.



The kneeling position. Point your right knee directly to the right, along the firing line.



The prone shooting position. Lie flat at an angle of 45 degrees to the firing line.



Winchester Medals for skill with the rifle

The Gold-Plated "Sharpshooter" Medal goes to the boy or girl under 18 who makes the first grade score with a Winchester .22 rifle and Winchester ammunition.

The Silver-Plated "Marksman" Medal goes to the boy or girl who makes the second grade score.

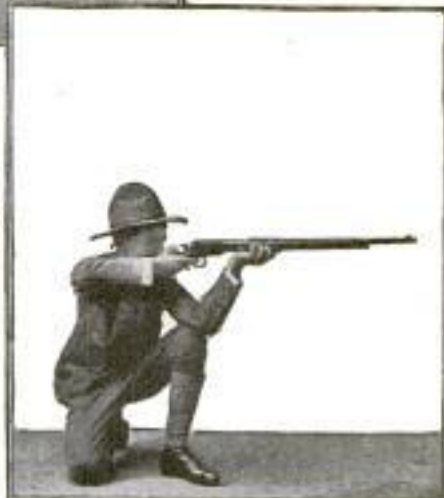

## Three correct positions for earning the "Sharpshooter" Medal

Every real boy wants a Winchester rifle. He wants it for its own sake and because it will give him a chance to compete for the famous silver-plated "Marksman" and gold-plated "Sharpshooter" medals offered by the Winchester Junior Rifle Corps.

Your boy is no exception. He wants a Winchester and he wants it now. He is fairly aching to get in on the "Marksman" and "Sharpshooter" medal contests because he sees many of his friends sporting the handsome medals themselves.

He doesn't want to be outdone. You can't blame him.

### A competition for real boys

The Winchester Junior Rifle Corps is an organization with an honorary membership among boys

who have earned their "Marksman" and "Sharpshooter" medals. Every one of the members has a diploma signed by the President of the Winchester Repeating Arms Company certifying his standing in the organization.

### The fun you can have with a Winchester .22

You want your boy in the Winchester Junior Rifle Corps. His "Sharpshooter" medal will be a source of as much pride to you as to him. It will stamp him as a boy of character and ability, a good citizen of the future. Both you and he can have a lot of fun with the beautiful Winchester .22 while you are teaching him how to hold and fire it in the three correct positions.

There is a place near you, either in the open or at a club, where you

can shoot. If you do not know where to shoot, write to us, and we will tell you where you can, or we will help you to organize a club.

### Let the boy have it now

Chances are your boy has already picked out the Winchester he wants at your dealer's store. Take him there today and get it for him. You will be surprised to find what a fine gun you can get for a low price. The dealer will explain all the rules of the Winchester Junior Rifle Corps Contest, furnish the targets and see that the boy gets the medals and diplomas when he has made the winning scores.

WINCHESTER REPEATING ARMS CO.

Dept. 144

New Haven, Conn.



MODEL 08. Take-down Repeating .22 caliber rifle, 26-inch round barrel. Shoots three sizes ammunition. The most popular .22 caliber repeater ever placed on the market.



Take-down .22 caliber single shot rifle. A low priced, light weight gun made in two sizes.

**WINCHESTER**  
World Standard Guns and Ammunition

Please Mention Popular Mechanics



## The Instant Summons

*"Instant, through copse and heath, arose  
Bonnets and spears and bended bows;*

\* \* \* \* \*

*As if the yawning hill to heaven  
A subterranean host had given."*

The whistled summons of Roderick Dhu, the hero of Scott's "Lady of the Lake," caused his Highland warriors literally to spring from the earth. Ere the echo died away, from behind bush and rock emerged the loyal and ready clansmen. In armed silence they awaited their chieftain's bidding and typified his might.

Today the Commander-in-Chief of our nation's armed forces and the resources behind them, can, by lifting the telephone receiver, instantane-

ously set in motion all the vast machinery of warfare, munitions, transportation and food conservation.

Like the Scottish mountaineers, the American people must stand in loyal readiness to perform any service in furtherance of the nation's high aim. Such a spirit of co-operation and sacrificing of individual interests can alone make certain the accomplishment of the great task to which our country is committed.



AMERICAN TELEPHONE AND TELEGRAPH COMPANY  
AND ASSOCIATED COMPANIES

**One Policy**

**One System**

**Universal Service**

*Please Mention Popular Mechanics*

## The Best Proof of Witte Quality

"I have run gas, gasoline and kerosene engines for several years, but I have never found an engine that equals the WITTE Engine for power, reliability and saving of fuel."  
—W. W. Demorest, Lamar, Ark.

"I find the engine is complete in every way, very still running and powerful. It is very sensitive to the governor and runs with even motion. If I was to buy another engine it would be a WITTE sure."  
—H. I. Sporr, Breadloaf, Vt.

"I know it would be a pleasure for Mr. Lackey to recommend the WITTE Engine, as ours is doing such excellent work and giving such splendid service. He had such a time with engines and spent so much on them before he got a WITTE, that it is truly a pleasure to have one so satisfactory."  
—Mrs. H. R. Lackey, Chautauqua, Kans.

"I have never had a bit of trouble with my WITTE Engine. All I have to do to start it is just turn the wheel and she is off."  
—W. M. Land, Lardo, Idaho.

"My 4 H. P. WITTE certainly worked fine, doing the work of a 6 H. P. It has as much power as any 6 horse engine I ever saw."  
—Richard Hoffman, Arlington, Ill.

"If you will allow me to say a few words for your engine: I call it the WITTE Common Sense Engine, for any man with common sense can run one, and it has all the power you claim, and about one-third more."  
—W. L. Hawk, Barton, Ala.



ED. H. WITTE

# I Can Make You The Best PRICE

## On a Kerosene Engine

Sell You a Better Engine—Save You \$15 to \$200

Not an experiment! Hundreds in Use! Better and more powerful than ever! Starts as easily as a gasoline engine! Will use any fuel that can be used in a Kerosene engine! You get three times as much power for the money at present fuel prices! Your own terms! Cash, Deposit, Payments, or No Money Down! If you are in the market, write me today! I CAN MAKE YOU THE BEST PRICE—Sell You a BETTER Engine—Ship At Once! Any Style—Stationary or Portable.

## WITTE ENGINES

Kerosene and Gasoline—2 to 22 H.P.

are made in the largest exclusive direct selling engine factory in the world. I make nothing but engines. Over 30 years success proves quality—immediate shipment proves superior factory equipment and business methods—just as my engines are superior. You can see the high quality in every line and curve. Look at the long solid base affording absolutely solid footing. See how cleanly-built—no cumbersome overweight of metal—no cylinder hanging out behind—no interior packing—vertical valves and many other special features that make WITTE Engines high-grade, better, and more desirable. 90-Day Trial will fully convince you of superior quality. Write for latest prices and free book, or come to factory and see them—You are welcome, Ed. H. Witte,

FREE



## WITTE ENGINE WORKS

1746 Oakland Ave., Kansas City, Mo.

1746 Empire Bldg.,  
Pittsburgh,  
Pa.

Write for this Beautiful 3 Color Illustrated FREE BOOK Today! Yours for a Post Card—by Return Mail.

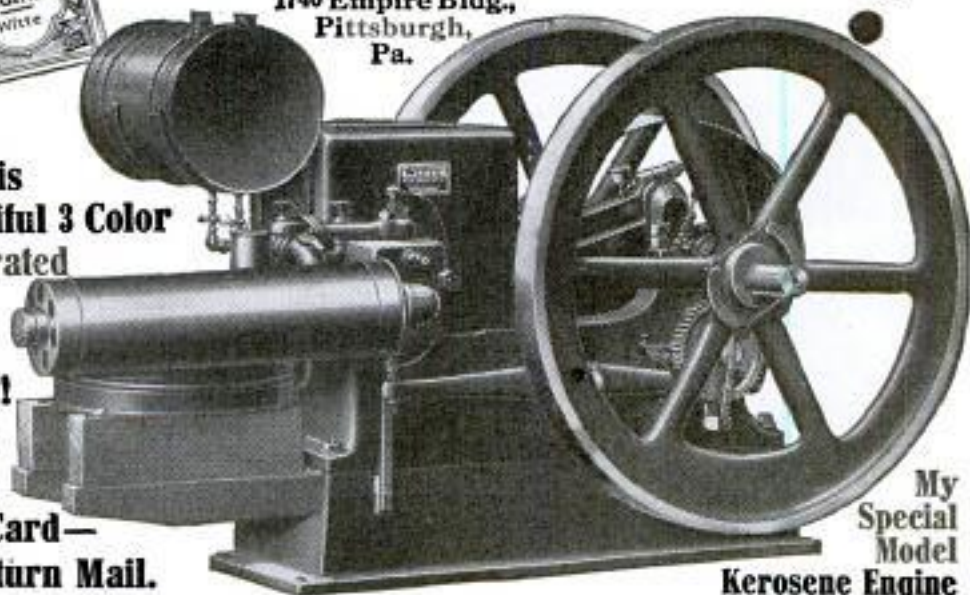

My Special Model Kerosene Engine

**OR MAIL THIS SLIP**

With Name and Address and I will send postage paid "How to Judge Engines" and "How to Make Money."

NAME.....

TOWN..... STATE.....

DU PONT AMERICAN INDUSTRIES



*Uncle Sam Knows the Real Answer:*  
**NOT ENOUGH!**  
**SAVE LEATHER**  
**For Soldiers**

TO make America's hide supply go as far as possible, hides are being split into five or more thin sheets; but, even this saving scheme fails to meet the requirements for soldiers' shoes, harness, equipment, ship upholstery, factory needs, etc., chiefly because too much hide leather is used by the public in places where high grade leather substitutes will serve as well or better.

**Uncle Sam Has Set the Pace**

The new U. S. motor trucks and ambulances will be upholstered in leather substitutes. For several years the standard for book binding in the Government Printery has been Du Pont Fabrikoid.

The upholstery specifications for the new Merchant Marine call for



For Automobile  
Tops and  
Upholstery



For Boat  
Cushions and  
Upholstery



For Furniture  
Upholstery



For Bags,  
Trunks and  
Suit Cases



For Book  
Binding



For Home Decorations,  
Novelties, Belts, etc.



REG. U. S. PAT. OFF.

*Craftsman Quality*

What Uncle Sam has found by experience and tests good enough for the Government's severe requirements should be good enough for every loyal American.

**How You Can Help**

If you are a manufacturer using leather probably part or all of your requirements can be met by some grade of Fabrikoid. While not feasible for every use of leather, the illustrations herewith show its wide range of utility.

If you use leather in your home for any purpose, try the proper grade of Fabrikoid instead.

When buying an automobile, boat or piece of furniture prefer Fabrikoid upholstery. Help the manufacturer conserve leather by patronizing those who use good leather substitutes like Fabrikoid.

Every hide displaced by a good substitute helps supply our armies with shoes, our farms with harness and our factories with belting — it helps win the war.

Manufacturers! write us your requirements and let us co-operate with you.

Americans everywhere! write for samples and names of manufacturers, of the article you want, who use Fabrikoid and of stores near you selling it by the yard.

**Du Pont Fabrikoid Company, Wilmington, Delaware**

*World's Largest Manufacturers of Leather Substitutes*

Factories at Newburgh, N. Y., Elizabeth, N. J., Fairfield, Conn., Toronto, Ont.

**DU PONT**

Please Mention Popular Mechanics





## A Little Saw of Big Saw Quality

Disston makes small circular and hand-saws of just the size and type you want in your shop. Every saw bearing the Disston name, no matter how small, is of the same quality as the great saws that cut the giant trees of every timber-producing section of the world.

You can count on a Disston, whether it be the smallest box-making or type-metal cutting saw, the sixty-five foot band-saw of the Pacific Redwood country or the big metal-cutting saws of the Pittsburgh steel plants.

# DISSTON

## SAWS AND TOOLS

If you make things of wood or metal or stone, you probably can use a Disston power saw to advantage. Write us, telling us the kind of work you do and we will tell you frankly whether a power saw will save you time and money or not, and what kind is best suited to your needs.

Disston circular and hand-saws, Disston hand-saws, Disston trowels, files, screw-drivers, levels, squares, gauges and all other Disston tools are of the same Disston quality.

**HENRY DISSTON & SONS, Inc., Philadelphia, U. S. A.**  
 CHICAGO CINCINNATI BOSTON SAN FRANCISCO NEW ORLEANS  
 MEMPHIS SEATTLE BANGOR PORTLAND, ORE. VANCOUVER, B. C.  
 SYDNEY, AUSTRALIA

Canadian Works

**DISSTON**

Toronto, Canada



Please Mention Popular Mechanics

# Heat Your Home through One Register



Enjoy furnace comfort at lowest cost this winter. Get a Kalamazoo Pipeless Furnace and be able to burn any kind of fuel. Feed but one fire—heat your entire home.

## Write for Our New Catalog

and learn what you can save in fuel bills this winter. See how easily this simple and powerful heating outfit can be installed in *your* home. Read what owners say about it. Kalamazoo Pipeless Furnace outfits where desired, heating plans FREE.

### QUICK SHIPMENT, NO WAITING

Our big stocks insure immediate filling of your order. We pay the freight and guarantee safe delivery. Cash or easy payments. Write today.

Ask for Catalog No. 936

**Kalamazoo Stove Company, Mrs.**  
KALAMAZOO, MICH.

We manufacture Stoves, Ranges, Gas Ranges, Furnaces, Kitchen Cabinets and Tables.



**A Kalamazoo**  
Trade Mark Registered  
Direct to You

## Make Coal Cost Less

by Using the Arnold Automatic Damper



This simple device placed in your Stove Pipe or Furnace Pipe immediately gives your house 25% to 33% more heat from the same quantity of fuel—no matter what type of stove or furnace you use. A Proved Success! You can easily attach it yourself—simple directions on box. Automatic in operation—Requires no attention after fire is started. Keeps your house at even temperature—no overheating with waste of fuel—no underheating with dangers to health.

**Saves Its Cost on First Ton of Coal**

Thousands already in use. Every owner a booster. Price \$1. No stamps. Order today, stating whether for Stove or Furnace and give size of pipe. Agents Wanted.

**GOSHEN EYELET CO., Goshen, Ind.**

## THIS BUNGALOW \$900 CAN BE BUILT FOR

This and many others in my new book, Building Plans for Modern Homes, will save you hundreds of dollars. One of the most complete and comprehensive books of plans ever published by any architect. Fifth edition just off the press. Two hundred and fifty floor plans and photographs of bungalows, etc., costing from \$200 up; gives sizes and cost to build. Sent postpaid for \$1.00



**FREDERICK H. GOWING**  
ARCHITECT

18 Tremont St., BOSTON, MASS.

## A WARM HOUSE \$4

EARLY in the morning is possible with THE GRAVES ADJUSTODRAFT



Model F  
The Graves Co., 3rd 1/2, 600 Hill St., Dubuque, Iowa

Automatically opens furnace-drafts at any desired hour. Eliminates bother of early rising. Saves fuel. A real necessity. Satisfaction guaranteed. Order today—winter will soon be here. Also special model for stove.

complete  
Express paid in U. S.  
Install it yourself

## FURNACE TROUBLE BANISHED LESS FUEL—MORE HEAT

**PILLEY'S CLINKER TONGS**  
Remove clinkers from furnace while fire is alight. PILLEY'S CLINKER TONGS are flexible and retain a firm and steady grip on the clinker. Handle guards protect your hands from the heat.



### PILLEY'S CLINKER TONGS

Will save their cost regularly. Less coal required when clinkers are removed. They are made of steel and iron and will last a life-time. SEND \$1.50. We prepay expressage RIGHT TO YOUR HOME. AGENTS WANTED.

**PILLEY MFG. CO., 611 3rd. St. St. Louis, Mo.**



Made by Makers of Good Goods Only

## Replace Your Heating Plant with a ROUND OAK Moistair Heating System

Only Heating System that Automatically Ventilates and HUMIDIFIES.—Keeps air moist, free from disease germs. Durable, dependable, easy to operate, a big fuel-saver. Send for FREE Book explaining all.

The Beckwith Co., Round Oak Folio—Established 1871  
300 Front St., DOWAGIAC, MICH.

## How to Cut Coal Bills 1/2 to 2/3

Free Book "From Overfed to UNDERFEED" tells how—guaranteed. Tells how to burn cheaper grades of coal cleanly and effectively. No clinkers. No partly burned coal. Ashes few, clean and white. No sifting. A boy can tend the Williamson UNDERFEED Furnace or Boiler with expert results. Coal fed from below. Hot, clean fire always on top. Write for free book today.

**THE WILLIAMSON HEATER COMPANY**  
65 Fifth Avenue Cincinnati, Ohio

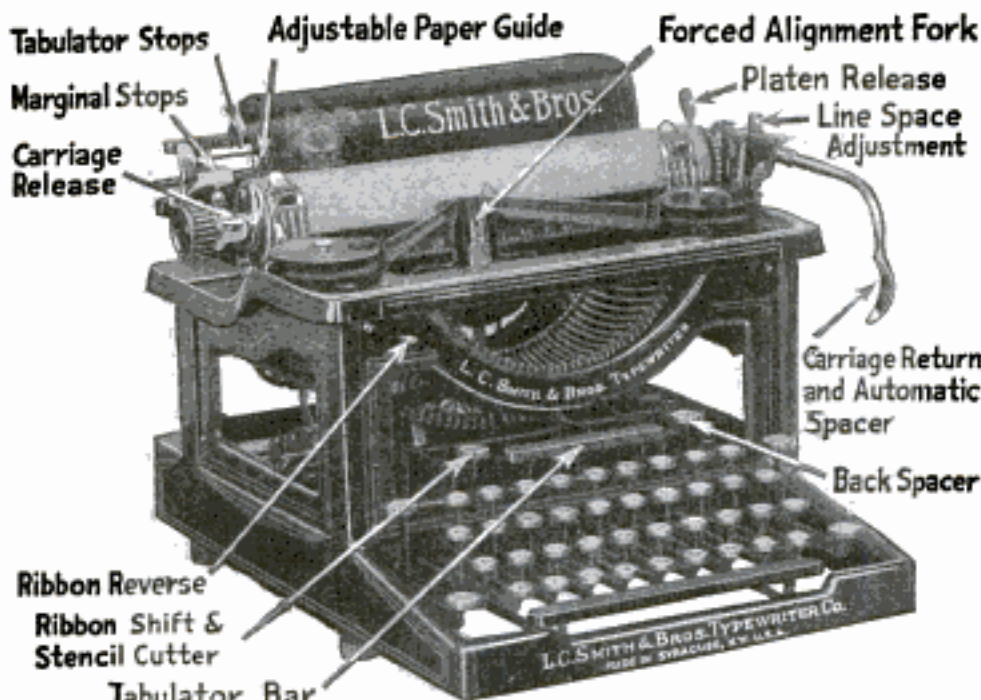

I want, through this advertisement, to establish as friendly business relations with you as I possibly can. I want you to realize also, that it is my earnest effort and intention to give you full honest value for every dollar that you spend with me. This is the only way I can succeed. My advertisement has appeared in this magazine continuously for more than four years.

I am building up my business on the foundation of good value and square dealings. I am saving thousands of satisfied customers thousands of dollars, by supplying, perfect—late style—visible writing—typewriters, at remarkably low prices.

All my transactions are handled throughout by personal correspondence. I assure you every courtesy and consideration, in your dealings with me. Your order will have my prompt, careful, personal attention. I will be glad to do business with you.

*Harry A. Smith*

Tabulator Bar  
**ALL LATEST IMPROVEMENTS**

# TYPEWRITER SENSATION

## Free TRIAL—Use As You Pay

Send me only \$2.50 a month until the low total price of \$48.80 is paid, and the machine is yours

This is absolutely the most generous typewriter offer ever made. Do not rent a machine when you can pay \$2.50 a month and own one. Think of it—Buying a \$100.00 machine for \$48.80. Cash price, \$45.45. Never before has anything like this been attempted.

# STANDARD L. C. SMITH VISIBLE

Perfect machines, standard size, keyboard of standard universal arrangement—universally used in teaching the touch system. The entire line of writing completely visible at all times, has the inbuilt tabulator with billing devices, the two color ribbon—with automatic reverse and key controlled shift, automatic flexible paper feed—automatic paper fingers, the back spacer—ball bearing carriage action—ball bearing shift action—ball bearing type bars—in fact, every late style feature and modern operating convenience. Comes to you with everything complete, tools, cover, operating book and instructions, ribbon, practice paper—nothing extra to buy. You cannot imagine the perfection of this beautiful reconstructed typewriter until you have seen it. I have sold several thousand of these perfect latest style L. C. Smith machines at this bargain price, and every one of these thousands of satisfied customers had this beautiful, strictly up-to-date machine on five days' free trial before deciding to buy it. I will send it to you F. O. B. Chicago for five days' free trial. It will sell itself, but if you are not satisfied that this is the greatest typewriter you ever saw, you can return it at my expense. You won't want to return it after you try it—you cannot equal this wonderful value anywhere.

## You Take No Risk—Put In Your Order Now

When the typewriter arrives deposit with the express agent \$8.80 and take the machine for five days' trial. If you are convinced that it is the best typewriter you ever saw, keep it and send me \$2.50 a month until my bargain price of \$48.80 is paid. If you don't want it, return it to the express agent, receive your \$8.80 and return the machine to me. I will pay the return express charges. This machine is guaranteed just as if you paid \$100.00 for it. It is standard. Over one hundred thousand people own and use these typewriters and think them the best ever manufactured.

The supply at this price is very limited, the price will probably be raised when my next advertisement appears, so don't delay. Fill in the coupon today—mail to me—the typewriter will be shipped promptly. There is no red tape. I employ no solicitors—no collectors—no chattel mortgage. It is simply understood that I retain title to the machine until the full \$48.80 is paid. You cannot lose. It is the greatest typewriter opportunity you will ever have. Do not send me one cent. Get the coupon in the mails today—sure.

**HARRY A. SMITH, 510-231 N. Fifth Ave., Chicago**

**H. A. SMITH**  
Room 510-231 N. Fifth Ave.  
CHICAGO, ILL.

Ship me the L. C. Smith F. O. B. Chicago, as described in this advertisement. I will pay you the \$40.00 balance of the SPECIAL \$48.80 purchase price, at the rate of \$2.50 per month. The title to remain in you until fully paid for. It is understood that I have five days in which to examine and try the typewriter. If I choose not to keep it I will carefully repack it and return it to the express agent. It is understood that you give the standard guarantee for one year.

Name .....

Address .....

Pop. Mech. Nov.

Please Mention Popular Mechanics

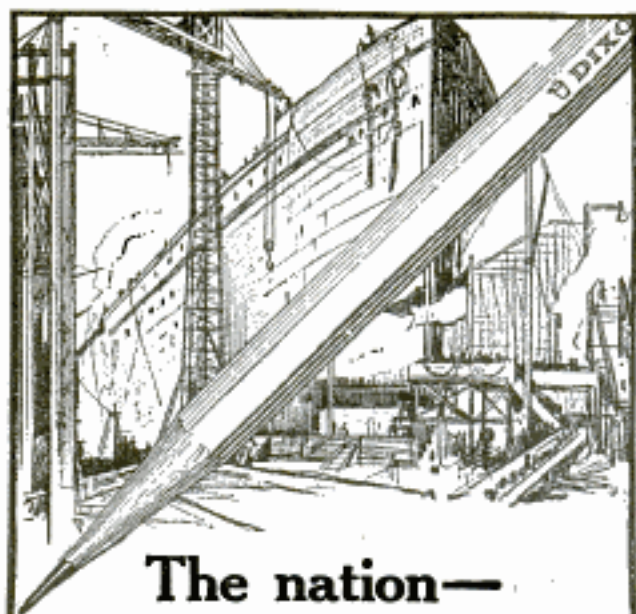

## The nation— the vessel— the pencil

The very existence of the nation depends upon its vessels—warships and merchant marines.

The efficiency of those vessels depends first of all upon the drafted plan—the pencil.

# DIXON'S ELDORADO

*"the master drawing pencil"*

is the pencil of big things. The leads hold their points longer and stand unusual pressure without breaking. They are smooth, gritless—true to grade in each of the 17 degrees.

Send 16c in stamps for full-length samples worth double the money.

**JOSEPH DIXON CRUCIBLE CO.**  
Dept. 10-J, Jersey City, N. J.

**DIXON'S BEST WHITE N°352**  
*writes white on blueprints*



Please Mention Popular Mechanics

## Builds More for Less Money

Makes 3 times as many real working models for the same money. Can be used many times. Start with 50c or \$1.00 outfit. Add to your construction material as you learn to build—only 50c per 100 feet.

## FLEXO-BUILD

Varied colored patented thick, strong strips of flexible fibre. Can be bent two ways, cut in any number of equal lengths. Practical, inexpensive, serviceable. Taken down and set up without special tools. Makes permanent, useful ornamental things: baskets, lamp shades, doll houses, etc., or mechanical models and toy bridges, engines, hoists, etc., which can be taken down.

Send for Free Catalog or Send \$1

Get the free Flexo-Build book showing many models or send \$1.00 for complete outfit (sent prepaid). Money back if you are not delighted when you see this Flexo-Build outfit.



Gaylord Bros.

510  
Clinton  
Street,  
Syracuse  
N. Y.

## Red or Black "Vulcan" Ink Pencils

The ONLY perfect, non-leakable ink pencils at moderate prices.

Two  
Sizes—

4¼ and 5¼ inches.

Extra Size—8 inches

(black only) \$1.25.

Your name in gold inlay 35c.

FREE—liberal supply of ink with

retail orders. Agents Wanted. Big Profits.

J. C. ULLRICH & CO., 27 Thames St., New York

Order  
today \$1

## Rider Agents Wanted

in each town to ride and show a new 1918 model

"RANGER" bicycle. Write for our liberal terms.

DELIVERED FREE on approval and 30 days' trial.

Send for big free catalog and particulars of most

wonderful offer ever made on a bicycle. You will be

astonished at our low prices and remarkable terms.

FACTORY CLEARING SALE—a limited number of

old models of various makes, 20 to \$15. A few good

second-hand wheels 25 to \$5. Write if you want a bargain.

Tires, lamps, wheels, sundries and repair parts for all makes

of bicycles, at half usual prices. Write us before buying.

MEAD CYCLE CO., DEPT. H108, CHICAGO

## GROW MUSHROOMS!

Start right, have good paying business month

in and month out, right at home. Costs little

to start, grow fast. Mushrooms in big de-

mand everywhere. Men, women and children

can grow them, in sheds, cellars, boxes, etc.,

in spare time. Learn expert facts about suc-

cessful growing, right spaw, etc., from

America's great authority. Send for free il-

lustr. publication, "TRUTH ABOUT MUSHROOMS," today.

BUREAU OF MUSHROOM INDUSTRY

Dept. 437 1342 N. Clark St., CHICAGO

## TYPEWRITERS SAVE FROM \$25 to \$75

Up-to-date machines of standard

makes—Remingtons, etc., thoroughly

rebuilt, trademarked and guaranteed

the same as new. We operate the

largest rebuilt typewriter factories in the world.

Efficient service through Branch Stores in leading

cities insures satisfaction. Send for catalogue.

American Writing Machine Co., Inc., 333 Broadway, N. Y.



## Would a good engineer allow his boiler tubes to clog up?

Nujol takes the place of boiler compound in the human system.

Just as the boiler compound keeps the tubes continually clean; Nujol keeps the human system continually clean.

If boiler tubes are allowed to clog up the whole plant may be very seriously affected. This is even more true of the human system.

Functioning at the same time every day is the healthiest habit in the world.

Nujol will give you this habit, which you will keep although you may discontinue the regular use of Nujol.

Take Nujol and get the "regular as clockwork" habit.

### Nujol for constipation

Guaranteed by  
STANDARD OIL COMPANY  
(New Jersey)  
Bayonne New Jersey

In packages bearing  
the Nujol trade-mark  
— never in bulk.



*"Regular as Clockwork."*

Send 75c and we will ship to soldiers or sailors anywhere.



## Sole Distributors For This Typewriter

Little over a year has passed since we first announced this big Typewriter value. Many readers of this magazine have profited and have proved the great value of this genuine, factory-rebuilt Model 5 Visible L. C. Smith Typewriter. At this time the one way to get this Model 5 is to buy it under the money-saving Larkin Factory-to-Family Plan. The manufacturers of this Typewriter rebuild Model 5s only for Larkin customers. We now take their entire output. Every Model 5 has therefore behind it two great institutions. First, our own Company, the distributors, who have been the recognized Factory-to-Family pioneers for 42 years; Second, the Model 5s own makers who in over 31 years have made more than 1,250,000 Typewriters. Where else will you find such a typewriter offered to you under like advantageous conditions? These

## Model 5 L. C. Smith TYPEWRITERS

### 10c a Day Pays Us

The new Model 5, made to the number of over 100 a day, would cost you \$45 more than this factory-rebuilt Model 5 and the terms would be \$5 to \$10 monthly. New 5s are hard to get. The manufacturer is thousands of such machines behind on orders. Besides, why pay more than our price when we guarantee this Typewriter, equal in looks, in construction, in service that it will give you, to a much more expensive Typewriter? We make it very easy for you to own this Typewriter.

#### Only a Limited Number to Sell

This manufacturer rebuilds only a certain number of Model 5s a month. We take all of them. The number is limited. While we have supplied all who have so far wanted this Typewriter, yet at times we have been pretty close run. Increasing demand may soon mean some will have to do without. It's first come first served. Suppose you get our offer and the complete Typewriter Catalog now.

**Larkin Co. Desk TPM-1117, Buffalo, N. Y.**

Send no money for the Model 5 L. C. Smith Typewriter, also complete FREE Catalog.

Name .....

Address .....

are the accepted standard for scores of America's greatest business institutions. They have made tests more severe than you would ever make. They play no favorites in the strenuous game of business. Guess occupies no place in their decisions. What they demanded of this Model 5 before adopting it was a typewriter capable because of its construction and modern equipment of meeting every need of present day intensive correspondence. A typewriter which would stand up day after day and year in and year out under the most severe use to which it could be put. We ourselves made such tests years ago before equipping our own offices with the 500 Model 5s with which we wrote last year, 1,590,000 letters to our two million customers. Previously we used other makes. For years we have used the L. C. Smith exclusively. What more convincing evidence do you demand than that we have submitted to prove that here is the Typewriter you ought to own?

#### They Have Made Over a Million—They Know How

Think of the conditions of business thirty-one years ago when the manufacturers of this Model 5 began to build Typewriters. Think of their record of making more than 1,250,000 Typewriters in that time. It means that they kept pace with the changing needs of business and that then, as now, their product was always in the forefront, a Typewriter that acknowledged no superior. That experience makes sure the quality of this Model 5. It costs out all risk. Don't chance it with a less dependable typewriter, one unknown, when the time-tested Model 5 can be gotten on the most convenient terms.

**Send This Coupon Today—Save \$43**

## Best Hand Lantern



A powerful portable lamp, giving a 300 candle power pure white light. Just what the farmer, dairyman, stockman, etc., needs. Safe—Reliable—Economical—Absolutely Rain, Storm and Bug proof. Burns either gasoline or kerosene. Light in weight. Agents wanted. Big Profits. Write for Catalog.

The Best Light Co., 324 E. 5th St., Canton, O.

## 50c TRIAL ORDER for 10c BEST KODAK FINISHING

Any size roll developed 10c; six prints free with first roll. Or send six negatives, any size, and 10c for 6 prints. Beautiful 8x10 mounted enlargements, 35c.

ROANOKE PHOTO FINISHING CO., 208 BELL AVENUE, Roanoke, Va.

## Wonderful New Kerosene Light FREE

Beats Electric or Gasoline

We want one person in each neighborhood to whom we can refer customers. Takes very little time and no investment. The new Aladdin kerosene mantle light

**Burns 50 Hours on One Gallon**



TWICE THE LIGHT ON HALF THE OIL

common kerosene. No odor, smoke or noise, simple no pumping up, no pressure, won't explode. Tests by U. S. Government and thirty-five leading universities show the Aladdin gives three times as much light as best round wick flame lamps. Won Gold Medal at Panama Exposition. Over three million people already enjoying this powerful, white, steady light, nearest to sunlight. Guaranteed. And think of it—you can get it without paying out a cent. All charges prepaid. Ask for our 10-day Free Trial Offer and learn how to get one Free.

**AGENTS WANTED**

MANTLE LAMP CO., 412 Aladdin Building, CHICAGO, ILL. Largest Kerosene 'Coal Oil' Mantle Lamp House in the World

## RECIPE FOR GRAY HAIR

To half pint of water add 1 oz. Bay Rum, a small box of Barbo Compound, and ¼ oz. of glycerine. Any druggist can put this up or you can mix it at home at very little cost. Full directions for making and use come in each box of Barbo Compound. It will gradually darken streaked, faded gray hair, and make it soft and glossy. It will not color the scalp, is not sticky or greasy, and does not rub off. Adv.



## PRINT MY OWN

Cards, circulars, menus, book, paper, etc. From \$5. Larger \$18. Rotary \$90. Save money. Print for others, big profit. All easy, rules sent. Write factory today for illustrated catalog presses, TYPE, cards, samples. THE PRESS CO. D-37. MERIDEN, CONNECTICUT.

## FIBRE LEGS ARMS



### 4-LB. FIBRE LEGS—ON EASY TERMS

Orthopedic braces for all deformities. Send for booklet. MINNEAPOLIS ARTIFICIAL LIMB CO., 636 Dean Bldg., MINNEAPOLIS, MINN.

## NO MORE BALD HEADS



WHEN our VACUUM CAP is used a few minutes daily. We accept no pay until you have tried the Cap 60 days and are satisfied. The Vacuum Cap is an appliance that draws the blood to the Hair roots and starts a new healthy crop of hair. It stops Dandruff, stops the hair from falling out.

Bought by Doctors and men who know that it is the only reasonable HAIR GROWER known to science. No Drugs Used. Write for application blank, testimonials, and booklet on "HAIR," sent sealed in plain envelope, FREE.

## THE MODERN VACUUM CAP CO.

V. 559 BARCLAY, DENVER, COLO.

# Send Only

Any article shown here, sent direct to your home, for only \$1.00 now. Use it for 30 days, then if, for any reason whatever, you want to return it to us, we will pay the freight both ways and refund your money. If you decide to keep it, pay the balance on our easy terms. Order more than one article if you wish, on the same terms direct from this ad or from our catalog.

That is the offer from the House of Hartman which gives you an opportunity to share in the benefits of our great buying power and of our charge account system which means getting the utmost in value and the easiest terms. That "the customer is always right" is the foundation of the policy on which we have built success from a little store to a \$12,000,000 concern with hundreds of thousands of customers. Send to us for anything you want. Order direct from this advertisement, or get our 454-page book, make your selection from it, and your charge account will be opened. Send the coupon below.

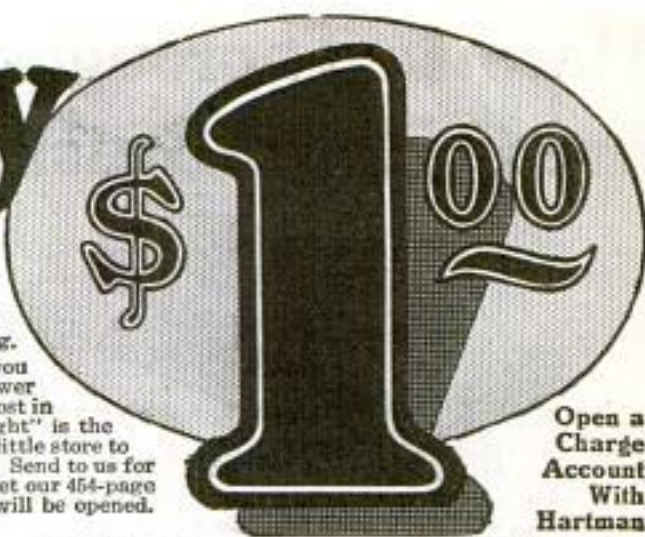

Open a  
Charge  
Account  
With  
Hartman



## \$1 Brings This Rocker

Frame made entirely of kiln dried hardwood. Arms and front posts are genuine quarter sawed oak, other exposed parts being fine seasoned oak in handsome golden oak finish. Seat has four springs and back has six springs all supported on elastic steel bands. Filling is wood fibre and cotton felt. Handsomely upholstered in imitation Spanish brown leather. Height of seat from floor 17 in. Height of back from seat 25 1/4 in. Seat is 19x19 in. Width of chair over all 30 1/2 in. Shipping weight about 40 lbs. Sent from Chicago Warehouse or Factory in Western New York State.

Order by No. 79MA7. Price \$3.45. Send \$1.00 now. Balance in payments of 75c monthly.

## \$1 Brings This Dresser

Send only \$1.00 and we will ship this Dresser. Try it 30 days. If not satisfied, return it and we will refund the \$1.00 and pay freight both ways. If you keep it pay on our easy terms. Made in Colonial design of seasoned hardwood finish in imitation of quarter-sawed oak. Rich golden oak finish. French bevel plate mirror 24x16 inches. Base top is 40x19 inches. Two overhanging drawers and two full length drawers below. Shipping weight about 110 lbs. Shipped from factory in Central Indiana.

Order by No. 185MA11. Price \$9.95. Send only \$1.00 now. Balance in payments of \$1.00 monthly.



## \$1 Brings This Beautiful Colonial Dining Room Set

Here is another Hartman offering that will add beauty and utility to your home. A value that seems unbelievable, but we contracted for such a large number of these elegant Dining Room Sets that we secured them at the lowest factory prices. Now we offer them while they last at a price which gives you an unparalleled bargain. And before you decide to keep the set you have the opportunity to actually use it in your own home. Send only \$1.00 and we will ship it on 30 days' free trial.



5 pieces in the popular Colonial style. Built of solid and quarter-sawed oak. Table has large 45 in. top. Supported by massive 7 inch pedestal resting on a well designed Colonial base. Chairs have genuine quarter-sawed oak back panels and top slat. Are full box seat construction and upholstered in durable imitation Spanish brown leather. Furnished in Golden Oak or Fumed Oak. Shipped direct from our Chicago Warehouse.

Order Golden Oak by No. 241MA11. Price \$19.80. Order Fumed Oak by No. 241MA12. Price \$19.95. Send \$1.00 now. Balance \$2.00 monthly.

# HARTMAN'S 454 Page Book of Bargains FREE

This book shows amazing values in Furniture, Stoves, Silverware, Jewelry, Lamps, Baby Carriages, Phonographs, Kitchen Cabinets, Ice Boxes, Dishes, Curtains, Sewing Machines, Carpets, Rugs, Aluminum Ware, Vacuum Cleaners, Paints, Roofing, Gasoline Engines, Cream Separators and hundreds of other articles. If you do not see what you want in this ad send for the great bargain catalog and select from it. Mark coupon to order direct or send post card or coupon for the catalog. We will mail it free.

**HARTMAN FURNITURE AND CARPET CO.**

3945 Wentworth Ave., Dept. 1071 Chicago

## Hartman Furniture & Carpet Co.

3945 Wentworth Ave., Dept. 1071 Chicago

Send me the merchandise marked X, it being understood that I am to have the use of it for 30 days and if for any reason I do not want to keep it I may return it at the end of that time and you will pay freight both ways and refund my payment. If I keep it I am to pay balance on your easy terms.

Rocker No. 79MA7  Dining Set, Golden Oak No. 241MA11  Dining Set, Fumed Oak No. 241MA12  Dresser No. 185MA11

Name.....

Address.....

If Catalog only is wanted, write name and address above or send post card.

Please Mention Popular Mechanics

## Here is a "Thoroughbred" Hand-Brush



Just as there are thoroughbreds among the millions of other horses, prize dogs amongst the mongrels, real men amongst men, so there's a thoroughbred in any line of goods—even hand-brushes.

You can buy a "skate" for \$50, but to get a real race-horse the elastic must come off the bankroll.

The Pro-phy-lac-tic Hand-Brush costs one dollar; most of the other hand-brushes sell for 10 to 25 cents.

This brush is built to last—no matter how hard you use it. The picture above is of one that has been in daily use in an office for six years. The bristles are thickly set, elastic, yet stand up. They are selected from the choicest boar hair that can be bought in the world's market, are set in an aluminum plate which is riveted to the hard wood back with eight rivets. The brush is not coarse, nor hard to the feel—you can scrub hard as you please—it won't irritate your fingers or knuckles. Hard water, soft water, cheap soap, fancy soap, and long soaking do not harm this brush in the slightest. And don't forget it's a good-looking hand-brush—nothing fancy about it, but looks what it is—staunch quality, with the good taste to be severely plain. It will never become soft with use, nor will the bristles "slop over" or come out.

Don't you think it's worth at least a dollar to have a thoroughbred Pro-phy-lac-tic hand-brush?

Ask for it at a store, but if you can't get it there, send us a dollar and we will mail your brush to you, nicely packed in a box.

If, when you get your brush, you don't believe your dollar was well spent, let us know. We'll gladly send you back the dollar.

**FLORENCE MANUFACTURING COMPANY**  
253 Pine Street, FLORENCE, MASS.  
We make the Pro-phy-lac-tic Tooth Brush

## Roofing Book FREE



Get Our  
**Freight Paid Roofing Prices**

Don't buy roofing of any kind until you get our big Free Roofing Book, describing full line of Edwards Famous "Tightcote" Galvanized Roofings, Sillings and Ceilings, and our lowest freight-paid prices. Then see for yourself how much we save you by selling direct and saving you all in-between dealers' profits.

### EDWARDS "REO" Metal Shingles

Absolutely rust proof. By our patented "Tightcote" process, edges as well as sides of metal sheets are heavily coated with zinc—not a space the size of a pin point exposed to weather. Fire and lightning proof. Outlasts three ordinary roofs. Forever wind and weather proof. Need no repairs—and all roofing expense. Patent INTERLOCKING DEVICE makes water tight seams—all nail heads covered—no chance for rust or leaks.



#### EDWARDS Galvanizing Test

Edwards "Tightcote" Galvanized Roofing can be bent, twisted or struck by lightning, and the galvanizing will not crack or flake. Bend it or hammer it—you can't loosen or scale the galvanizing. No other galvanized roofing can withstand this test.

Garage \$69.50 Wide variety of  
Use styles, all

size of Portable Fireproof, Metal Garages, \$29.50 and up.  
Lowest prices ever made. Postal prices for Garages  
Catalog free.

Write Today for free samples and proof that we  
can save you a lot of money on any  
kind of roofing siding or ceiling you may need. Ask  
for Roofing Book No. 1150.

**THE EDWARDS MFG. CO.,**  
1100 - 1150 Pike St., Cincinnati, O.

**FREE**  
Samples &  
Roofing Book

ARE you reading the double-page  
Westinghouse more-than-advertisements in The Saturday Evening Post, Literary Digest, Collier's, Leslie's, National Geographic, Popular Mechanics and other publications?

## TRAPPERS WE BUY FOR CASH



Highest prices paid for all Furs, Hides and Ginseng. Best facilities in America. No Commissions. Send for our prices and FREE valuable information before shipping elsewhere.

**ROGERS FUR COMPANY**  
DEPT. 254 ST. LOUIS, MO.

## SWALLOWS RIFLE NOISE

"Wonderful," you say. "Where does that ear-splitting report go?" Just equip your rifle and enjoy every minute while on your hunting trip, at the training quarters, or on your own premises. A

## Maxim Silencer

MAKES YOUR AIM SURE

prevents nervous tension; allows girls and boys to practice as marksmen without disturbance. Our free Booklet has a fund of good stories worth your reading.

Write for it now.

The Maxim Silencer Company  
93 Homestead Ave., Hartford, Conn.



FREE  
This  
Book





**GILBERT**  
**MYSTO MAGIC**

**Have Fun—Give Shows—Earn Money**

Here's a great Gilbert Toy, boys—Mysto Magic Sets with which you can perform wonderful feats of magic just as they are done on the stage. You can earn money giving shows in your home, or at parties, socials, churches and theatres.

**Famous Tricks of the Greatest Magicians**

Gilbert Mysto Magic Set 2004 contains scores of the best tricks of famous magicians, with apparatus; Magician's Wand; large poster; and big Manual of Magic Knowledge, the greatest book on magic ever written; tells how to do a number of fine tricks not requiring special apparatus, like the Multiplying Dollar Bill, Disappearing Tumblers, etc. Price of No. 2004 Set \$5 (in Canada, \$7.50). Other Sets \$1 to \$10.00. (Canada \$1.50 to \$15.00).

**Big Magic Catalog FREE**

Send for it today. Save money and buy one of the sets it describes, or ask for one for Xmas. Sold at all toy dealers and department stores.

The A. C. Gilbert Co., 306 Blatchley Ave., New Haven, Conn.

Canadian Representatives: Menzies & Co. Limited, Toronto, Ontario



**MONEY IN MUSHROOMS**

**NOW TIME TO START**  
To Take Care of Food Shortage This Winter

An uncrowded occupation. Exceptional opportunities for live men and women. Raised at home. Only small space needed. Small expenditure will start you in a practical money-making enterprise. Big Profits. Booklet telling all free. Write, Nat'l Spaw Co., Dept. 17, Boston, Mass.

**FREE** **BOOK TELLS HOW TO MAKE \$150 TO \$1000 PER MONTH**

Making celebrated **Flavo** Nature-Flavored Flour in rural communities or small towns with **AMERICAN MARVEL Flour Mill** (Self-Contained)

You can quickly become a member of Community Marvel Millers. We start you. Help you. 30 days' free trial. Investment and terms easy to handle. Write for fully illustrated book. **ANGLO-AMERICAN MILL CO., Inc.** 135-141 Trust Bldg. Owensboro, Ky.

**FORD AUTO GIVEN TO AGENTS**

HERE'S an opportunity to earn big money—\$6 to \$12 a day, with easy work, all your time or spare time and obtain a Ford Automobile free besides. A straight out from the shoulder business proposition. No voting or guessing contest. We want wide-awake men and women to introduce into every home our famous ZANOL Pure Food Products, Non-Alcoholic Food Flavors in tubes, Toilet Preparations, Perfumes and Soaps; 250 other light weight household necessities.

**Make \$50 a Week Easy**

No experience necessary—we teach you how, give you the right start and help you make a success. Absolutely no limit to your earning power. We can use only a certain number of General Agents, so get in touch with us at once. We furnish our representatives with a free automobile. Just send postal for particulars and money making offer.

**AMERICAN PRODUCTS CO.**  
2939 Third St., Cincinnati, O.



**DIAMONDS WATCHES ON CREDIT**



**MAKE THIS A DIAMOND, WATCH AND JEWELRY CHRISTMAS**

Our Diamonds are distinctive in beauty and brilliancy. A Genuine Diamond is the best investment into which you can put your money. It constantly increases in value and lasts forever.

**Christmas Gifts** The easiest, most convenient way to make handsome, "worth-while" presents is to send for our Catalog, make your selections in the quiet of your own home, and have everything charged in one account. By this plan you can make very little ready money supply all your gifts.

**Send for Free Catalog**

There are over 2,000 photographic illustrations of Diamond Rings, Diamond La Vallieres, Diamond Ear Screws, Diamond Scarf Pins, Diamond Studs, Signet and Emblem Rings, Watches, Wrist Watches, Bracelets, Cuff Links, Brooches, Lockets, Chains, Charms, Silverware, Clocks, Toilet Sets, etc.

Whatever you select will be sent, all shipping charges prepaid. You see and examine the article right in your own hands. If satisfied, pay one-fifth of purchase price and keep it; balance divided into eight equal amounts, payable monthly.

**Men's Favorite Diamond Ring**

Extra heavy 14 karat solid gold six-prong Tooth mountings. Faultlessly made. Specially selected fine diamonds, perfectly cut and very brilliant. The deep groove and graceful lines make this a very popular mounting. See our Catalog and select just the ring you wish. Each ring is cased in a handsome box.



**WATCH PRICES "DOWN TO BED ROCK"**

**21 Jewel Watches** That Will Pass Railroad Inspection **\$2.50 a Month**

Send for Catalog and get posted about Watches before you purchase. Our Catalog illustrates and describes all the new models—15, 17, 19, 21, 23 Jewels, adjusted to temperature, isochronism and positions. Our watches are guaranteed by the factory and further guaranteed by us. We make all necessary repairs, barring accident, free of charge, for a period of three years from date of purchase.

**LOFTIS SOLITAIRE DIAMOND CLUSTER RINGS**

The Diamonds are Mounted So as to Look Like a Large Single Stone

- 92-\$50 Looks like a \$150 single stone. \$10 Down, \$5 a Month.
- 94-\$75 Looks like \$250 single stone. \$15 Down, \$7.50 a Month.
- 96-\$100 Looks like a \$300 single stone. \$20 Down, \$10 a Month.
- 98-\$125 Looks like a \$350 single stone. \$25 Down, \$12.50 a Month.

The Loftis Seven-Diamond Cluster was designed for those who desire a large show ring for the least money, as it has the exact appearance of a Solitaire that would cost three or four times as much. The secret of the rare beauty of this ring lies in the perfectly matched stones, all of the Diamonds, set in platinum, being uniform in size, quality and brilliancy; mounting is 14 karat solid gold. A gift that is sure to please.

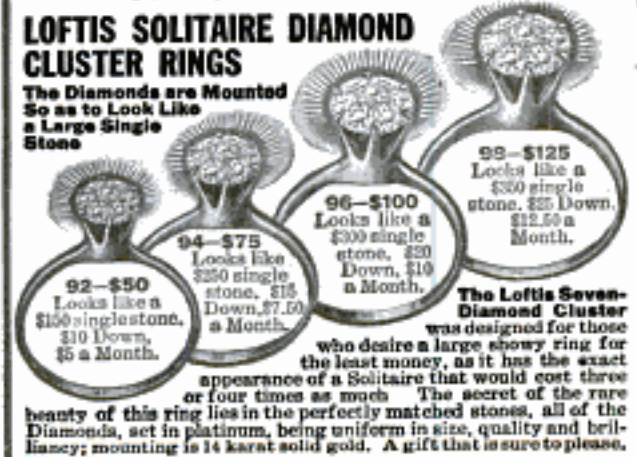

**Suggestions for Christmas Presents**

A few of the many desirable articles shown in our large, handsome Catalog, selected for their popularity and exceptional value. Prices range as shown, up to any price you wish to pay. We can fill any requirement.

- |   |      |                                    |        |
|---|------|------------------------------------|--------|
| Diamond Rings, Solitaire                | \$10 | Diamond Cuff Links                 | \$5    |
| Diamond Rings, Loftis 7-Diamond Cluster | \$50 | Diamond Scarf Pins                 | \$5    |
| Diamond La Vallieres                    | \$10 | Pearl Necklaces, Diamond-set Clasp | \$8.50 |
| Diamond-set Cameo La Vallieres          | \$12 | Wrist Watches                      | \$15   |
| Diamond Brooches                        | \$7  | Watches                            | \$12   |
| Diamond Ear Screws                      | \$10 | Bracelets, solid gold              | \$10   |
| Diamond Studs                           | \$10 | Cameo Rings, Diamond-set           | \$10   |
|   |      | Vest Chains, solid gold            | \$8.50 |

Send for Free Catalog today, before you forget it.

**LOFTIS** The National Credit Jewelers  
DEPT. F894 108 N. STATE STREET CHICAGO, ILL.  
BROS & CO. ESTD 1853  
Stores in Leading Cities

Please Mention Popular Mechanics

## What \$10 Buys of Larkin Co.



### Make Your Own Comparisons

You owe it to yourself to investigate the great savings you can make by Larkin Factory-to-Family Dealing. Send for Catalog and learn how with a \$10 purchase of household supplies you can get this \$10 Rocker or your choice of 1000 other Premiums as the saving you make by dealing direct with the Great Larkin Factories. Send at once for this big book of Christmas Economies. It's free.

Mail Coupon Today

Larkin Co. Buffalo Peoria Chicago

Please send me your Fall Catalog No. 148.

Name .....

Address .....

G. P. 359 .....

A Baseball Jersey



### Be the First in Your Club

School, City or Town, to wear this pure, all wool sweater, double collar and cuffs. Your choice in colors. This jersey was selected by 10,000 of my customers for last season. Your chum will recommend it. Send for my big illustrated catalogue. Write me and learn my offer for your club's order. Popular Prices. Best Grade Sporting Goods—Baseball, Basketball, Tennis, Golf, Football, etc. WRITE ME NOW.

JACK SHANNON CO., Dept. 46, 54 E. Monroe St., Chicago

## On Four Weeks' Trial—

Piano or Player Piano

Yes, we will ship you on 4 weeks' free trial, a genuine highest grade Wing Piano or Player Piano DIRECT from our own factory, all freight prepaid by us. Your choice of 33 new art styles in any shade of mahogany, walnut or oak on four full weeks' Free Trial in your own home. At the end of 4 weeks, if you wish, return it at our expense.



No Money Down — Freight Prepaid

No money down—no deposit—no freight to pay. You'll be amazed at our direct-from-the-factory price on the famous Wing, guaranteed for 40 years. Easy monthly payments or cash if you prefer. But first, four weeks' absolutely free trial in your own home.

## The Wing Piano

is renowned everywhere for its exquisite purity of tone and superior construction. Since 1868—for 40 years—we have been building Wing Pianos. More than 45,000 are now in use.

Valuable Book

Free "The Book of Complete Information About Pianos"

Tells all about the secrets of piano making and selling. Its 140 pages show how to judge piano quality and prices. Sent free and prepaid. Also our catalog of newest art styles in Wing Pianos and our free establishment offer.

Wing & Son (Est. 1868)

Wing Building, Dept. 1220 New York  
9th Avenue and 13th Street



# DEAF?

## Make This Test In Your Own Home

The Acousticon will surely make you hear because it has succeeded with over 500,000 delighted patrons of ours who were so troubled.

You do not know this, however, and we are confident enough to want everyone to know before he spends a cent. Everyone knows that deafness is progressive—and unless the ears are stirred to activity they grow steadily worse; thousands write us the Acousticon enables them to hear perfectly and has permanently improved their hearing.

Therefore we ask that you write us, saying: "I am hard of hearing and will try the Acousticon"—That's all. We will send you, delivery charges paid, the

## Acousticon For Ten Days' FREE TRIAL No Deposit—No Expense

All we ask is that you give it a fair trial in your own home and among familiar surroundings. Then there can be no doubt of whether it improves your hearing.

If it does not do so, we want it back without a cent of expense to you for the trial, because we know it is good business policy to have none but satisfied and enthusiastic customers—That's the only kind we now have. Write for your FREE TRIAL today.

GENERAL ACOUSTIC CO., 1307 Candler Building, N. Y.  
Canadian Address, 621 New Birks Bldg., Montreal

## AGENTS \$60 WEEKLY



Robinson Folding Bath Tub, Big Seller. Costs little, no plumbing, little water. Weight 15 pounds, folds into small roll. Full length bath, far better than tin tubs. Guaranteed 10 years. \$10 a day easily made. Write for free tub offer.

ROBINSON CABINET MFG. CO. 4748 Factory Bldg., Toledo, Ohio

## ASBESTOS

We are miners and shippers of Crude Asbestos in any quantity. We produce all grades at our world-famous Bell Asbestos Mines, in Canada. We also card fibres, spin yarns, weave cloths, and make all sorts of Asbestos products.

For anything you want in Asbestos, turn to

**KEASBEY & MATTISON COMPANY**

Dept. S-3, AMBLER, PENNA., U.S.A.

Owners of the world's largest Asbestos Mines

## Masters of Mileage

Pent up in every tire that bears the name Vitalic, are thousands of miles of enduring, uninterrupted service.

The makers of Vitalic bicycle tires have followed the structural principles of the automobile tire itself. Hence the tremendous strength of the cut- and bruise-resisting Vitalic treads. Hence the resilience and resistance of the carcass, which is made of layers of tough, highly frictioned fabric.

For smooth, spry going, maximum pleasure and minimum repair bills, ride on Vitalics.

# VITALIC Bicycle Tires

*Tougher Than Elephant Hide*

Four great tires in the Vitalic line. Each of astonishing toughness, elasticity and long life.

**Vitalic De Luxe** is made of the choice of the world's best rubber throughout its extra-thick tread and tube. Its two-ply motorcycle tire fabric is built of strongest cotton thread, triply-twisted. Highest quality friction. V-shaped suction non-skid tread. All white. Retail Price, \$4.50 each.

**Vitalic Enduro** — Egyptian fabric, 2-ply. Very high-grade inner tube and friction. Carefully selected rubber throughout. White side walls and black block tread. Built for real service. Retail Price, \$3.00 each.

**Vitalic Brigadier** is a rugged, enduring performer. Tough, four-ply Egyptian fabric. A great favorite with riders who demand long service at a moderate price. Black, heavy, studded tread. Extra-heavy inner tube. White sides. Retail Price, \$4.00 each.

**Vitalic De Luxe**  
\$4.50  
Each



**Vitalic Cord Racer** — The perfect racing tire. Retail Price, \$4.25

### Send Today

for FREE Vitalic testing section and booklet, "Tougher Than Elephant Hide." Please give name and address of your bicycle tire dealer.

**Vitalic Brigadier**  
\$4.00 Each



CONTINENTAL RUBBER WORKS, 1964 Liberty Street, Erie, Pa.



## Deafness Is Misery

I know because I was Deaf and had Head Noises for over 30 years. My invisible Anti-septic Ear Drums restored my hearing and stopped Head Noises, and will do it for you. They are Tiny Megaphones. Cannot be seen when worn. Easy to put in, easy to take out. Are "Unseen Comforts." Inexpensive. Write for Booklet and my sworn statement of how I recovered my hearing.

A. O. Leonard, Suite 226, 150 5th Ave., N. Y. City

## Rémoh Gems



Look and wear like diamonds. Brilliance guaranteed forever. Stand like, acid and fire like diamonds. Have no paste, foil or backing. Set only in 14 karat solid gold mountings. About 1/2 the price of diamonds. A marvelous synthetic gem—will cut glass. Guaranteed not an imitation, and to contain no glass. Sent C.O.D. subject to examination. Write today for our illustrated catalogue. It's free.

Rémoh Jewelry Co., 559 Washington Ave., St. Louis, Mo.

## Eat Tyler's Macerated Wheat

Whole Wheat, Nuts, Raisins, Etc.  
Greatest of all Health Foods.

RIGHTLY used is a sure and quick cure for constipation and indigestion, obviates headaches and makes you weigh just what you should. Lowers blood pressure, lessens hardening of the arteries, puts iron and other mineral salts in the blood, so essential in the maintenance of the chemical equation of the body—key to health and efficiency. A boon to old men, nervous women and sickly, puny babies. Insures thrifty growth and sound teeth in children.

Send ten cents for a big sample can, and Tyler's Raw Food Book and Health Guide, or better still send \$1.00 for a 3-lb. can postpaid everywhere. Absolutely guaranteed or money back. Testimonials without number. Write today for convincing proofs.

BYRON TYLER, (Estab. 1899)  
60 Gibraltar Bldg., Kansas City, Mo., U. S. A.



Please Mention Popular Mechanics

# DIAMONDS WATCHES & JEWELRY

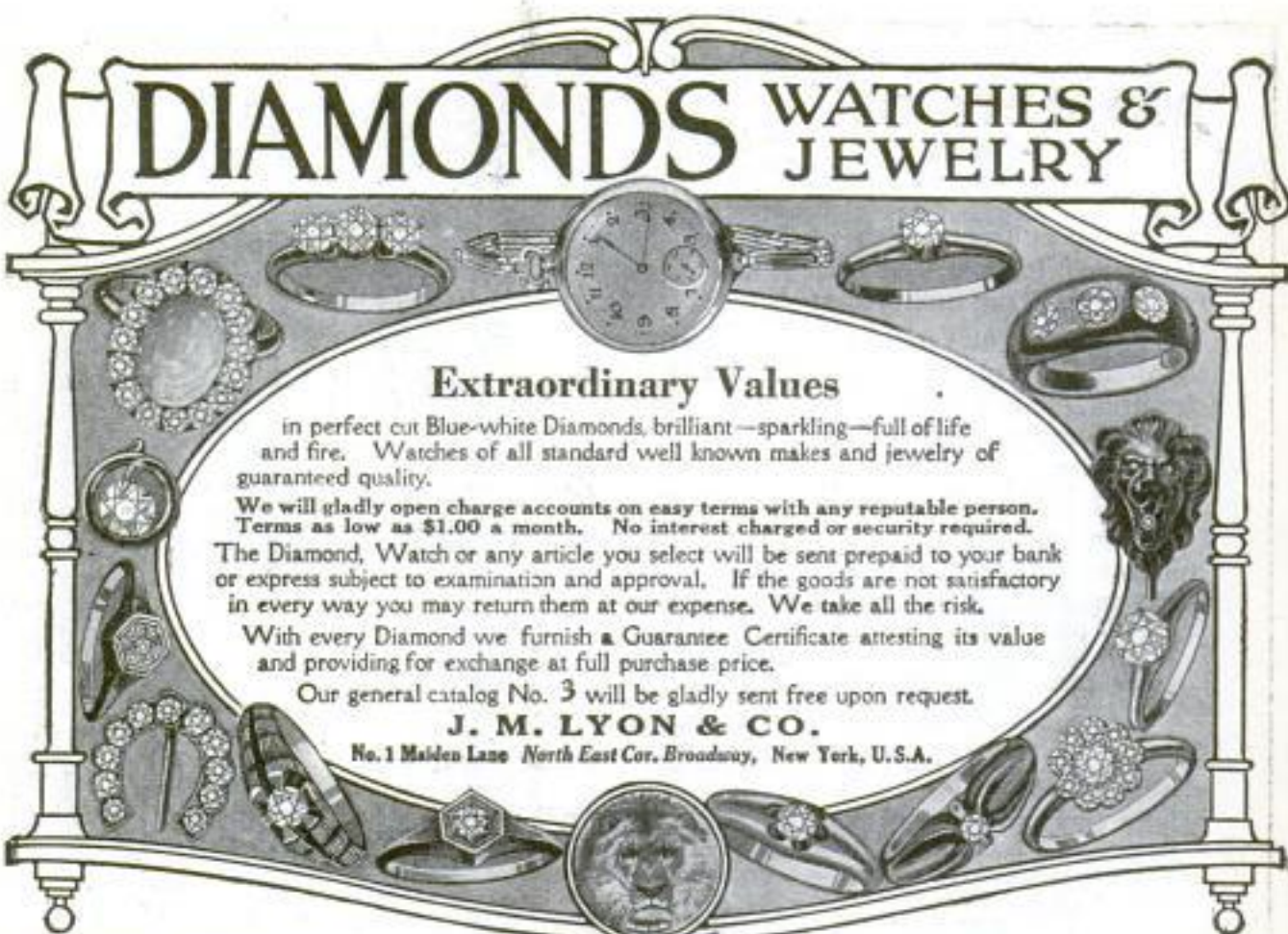

**Extraordinary Values**

in perfect cut Blue-white Diamonds, brilliant—sparkling—full of life and fire. Watches of all standard well known makes and jewelry of guaranteed quality.

We will gladly open charge accounts on easy terms with any reputable person. Terms as low as \$1.00 a month. No interest charged or security required.

The Diamond, Watch or any article you select will be sent prepaid to your bank or express subject to examination and approval. If the goods are not satisfactory in every way you may return them at our expense. We take all the risk.

With every Diamond we furnish a Guarantee Certificate attesting its value and providing for exchange at full purchase price.

Our general catalog No. 3 will be gladly sent free upon request.

**J. M. LYON & CO.**  
No. 1 Maiden Lane North East Cor. Broadway, New York, U.S.A.

**Boys Like a Pretty Room**  
Your boy will beautifully decorate his room if you give him some

**MOORE PUSH-PINS**  
Glass Heads, Steel Points

Moore Push-less Hangers, the Hanger with a Twist, for framed pictures, mirrors, etc.

At Stationery, Hardware, Drug and Photo Supply stores. In Canada 15c. Sample and Booklet Free. Write Dept. 36.

**10c**

**MOORE PUSH-PIN CO., Philadelphia, Pa.**

**\$5 TO \$10 A DAY**

**AGENTS—BIG HIT**  
**5-Piece Aluminum Set**

Cheaper than enamel ware. Guaranteed 20 years. Retail value \$5.00. You sell to housewives for only **\$1.98**. Sure sale wherever shown. Answer quick for your territory.

**American Aluminum Mfg. Co.**  
Div. L X 5 Lemont, Illinois

**Don't Wear a Truss**

**Brooks' Appliance**, the modern scientific invention, the wonderful new discovery that relieves rupture will be sent on trial. No obnoxious springs or pads.

**Brooks' Rupture Appliance**

Has automatic Air Cushions. Binds and draws the broken parts together as you would a broken limb. No salves. No lies. Durable. cheap. Sent on trial to prove it. Protected by U. S. patents. Catalogue and measure blanks mailed free. Send name and address today.

**C. E. BROOKS, 126 State St., Marshall, Mich.**

## BIG CHANCE FOR AGENTS



**You can earn BIG MONEY**

selling the most complete line of guaranteed transparent handle Knives and Razors with Photo, Name and Lodge Emblem—also full line of cutlery. Write today for catalogue and terms.

**Golden Rule Cutlery Co., 212 N. Sheldon St., Dept. 363, Chicago, Ill.**

**MEN WOMEN**

**Raise Mushrooms**  
**Profits Astonishing**

Easy to grow in spare time at home, in cellars, basins, sheds, boxes, etc. I furnish market. Success guaranteed. Free illustrated booklet. Read how a beginner took \$132.50 from cellar bed. Write today.

**HIRAM BARTON**  
Desk 2, 329 W. 48th St., New York

## SPECIALY PRICED TO INTRODUCE OUR XMAS GIFT CATALOG

FORTUNATE purchase before leather advanced in price enables us to offer 28,000 of our PRACTICAL BILLFOLD at what the leather alone is worth today.

THIS INVALUABLE combination currency-card case, a distinctive *Leather Gift*, in genuine Sealgrain Leather, yours at this low price of 50c (\$5.40 Doz.) prepaid while they last. This model design with photo frame, transparent identification card, 1918 calendar and loose leaf MEMO PAD.

SIZE closed 3x3 1/2; open 6x7 1/2 inches. Packed in handsome gift box, with engraved card. SAME in fine Morocco Leather, only \$1.00 (\$10 Doz.) prepaid. Order some of each at once. Order SHIPPED DAY RECEIVED. Illustrated catalog FREE. SEND DRAFT, MONEY ORDER or STAMPS TODAY. Money cheerfully refunded.

**A. LANDA & SONS CO., Mfrs. Dept. F-2 CHICAGO**

**50c Postpaid**

Name Engraved FREE in 23-kt. Gold

For Ladies and Gentlemen



# PATENTS

**IF YOU HAVE AN INVENTION** which you wish to patent you can write fully and freely to Munn & Co. for advice in regard to the best way of obtaining protection. Please send sketches or a model of your invention and a description of the device, explaining its operation.

All communications are strictly confidential. Our vast practice, extending over a period of seventy years, enables us in many cases to advise in regard to patentability without any expense to the client. Our Hand-Book on Patents is sent free on request. This explains our methods, terms, etc., in regard to *Patents, Trade Marks, Foreign Patents, etc.*

All patents secured through us are described without cost to the patentee in the *SCIENTIFIC AMERICAN*.

## MUNN & CO.

SOLICITORS OF PATENTS

672 WOOLWORTH BLDG., NEW YORK  
and 625 F STREET, WASHINGTON, D. C.



### Be Your Own Boss

Work for yourself. Learn how to make big profits with a **Kingery Peanut Roaster and Corn Popper**. 50 styles. Easy terms.

Write for Catalogue P. M. telling what others have done.

302 E. Pearl St. CINCINNATI, O.

**Kingery Mfg. Co.**



Erickson Artificial Limb Co., 38 Wash. Av. N., Minneapolis, Minn.

Do Not Chafe, Overheat or Draw End of Stump

Write For Catalog

PATENTED

We are Under Govt. Bond

## Relief to Ruptured People

Any appliance is a truss. Ruptured people must wear a support. Our New Sponge Rubber Pad (pat'd) is velvety, soft to the skin, pliable, cannot slip, extremely comfortable, adapts itself to ruptured parts with less pressure, is sanitary, long lived. Massages and strengthens muscles, allows blood circulation and produces many cures.

**Scrotal Pad Needs No Leg Strap**  
Our New Akron Sponge Rubber Scrotal Pad (pat'd) holds 8 out of 10 cases of scrotal hernia perfectly without strap between the legs.

**Cures Man of 86**  
The Akron Truss Co. Gentlemen: I am 86 years and 6 months old and have had a rupture for 27 years. I am an active man, tend to a large garage, own and split the wood and do the household chores. I bought an Akron Truss and wore it one year and am as sound as a dollar.  
Respectfully yours, S. W. Glass, Illinois.

**Cured Double Hernia**  
The Akron Truss Co. Gentlemen: I have worn one of your trusses for some time. All this time have carried two heavy sumps case; notwithstanding this handicap, your truss has cured me of a double hernia.  
Yours truly, O. E. Jones, Indiana.

**Girl Baby Cured**  
The Akron Truss Co. Gentlemen: The infant's truss was a perfect success. The child wore it about one year, and the rupture healed so that a person cannot see she was ruptured. Yours truly, J. Haynes, Illinois.

**Free Sample Pad** A Sample Akron Sponge Rubber Truss Pad will be sent absolutely FREE upon request, also booklet "Relief to Truss Bearer." It's full of help. Ask your dealer, or write us.  
**THE AKRON TRUSS CO.** 71 TRUSS BLDG. Akron, Ohio

# 10¢ a Day

now buys this superb  
**Farny Violin**



**AN** exquisite instrument—perfect in tone and superbly finished. Made by the great French violin maker, Henri Farny, and now offered to you at the rock-bottom price. You may pay this rock-bottom price at the rate of only 10 cents a day. 10 days' free trial. Write for special circular—send coupon at once.

### Your Choice of Instruments

This Farny violin is only one of the bargains we have to offer. Write today for our new Violin

catalog. There you will find illustrated products of the leading violin makers of the world—Farny, Bader, Giler, Heberlein, Fiedler, Wurlitzer and many others. Violins of the highest grade, as well as those of moderate prices—all special values. Priced from \$2.75 to \$50.00, and from \$80.00 to \$250.00. Write now.

#### Rare Old Violins

Our collection of rare old violins is one of the largest in America. Write today for Special Art Catalog.

## WURLITZER

200 years of instrument making

Get the benefit of our mammoth facilities for buying in large quantities. The house that supplies the United States Government now makes a startling money-saving offer direct to you. Write for circular.

### One Week Free Trial

You cannot judge a violin by seeing it in the store or by playing upon it once. Play on one of these instruments in your own home, in your own way, for one full week. Then you will be able to decide.

If you are not satisfied send it back at our expense. If you wish to buy, pay only the rock-bottom price—at the rate of only a few cents a day.



### 10c a Day

now buys this superb Lyric Cornet. Exquisite triple-valve padded long model Lyric Cornet direct to you on a startling offer. One week free trial before you decide to buy. Liberal allowance for old instruments. Write today for 194-page Catalog—showing 2561 instruments that you have to choose from.

### Send the Coupon

Put your name and address on the coupon now and indicate catalog matter you wish us to send you. Absolutely no obligation in sending the coupon. Do it now. Find out about the startling money-saving offer we are making. Write today—send **Coupon** or a **Letter or a Post-card**.

**The Rudolph Wurlitzer Co.**

Dept. 4728  
East 4th Street,  
Cincinnati, O.  
S. Wabash  
Avenue,  
Chicago

**The Rudolph Wurlitzer Co.**

Dept. 4728  
S. Wabash Ave., Chicago, Ill.  
4th Street, Cincinnati, Ohio

Gentlemen:—Please send me without obligation, free and prepaid the catalog matter checked below:

- The special violin circular.  
 Special low priced violins under \$15.00  
 Your 225 page illustrated catalog of musical instruments.  
 Catalog of music stands, cases and other structured instrument accessories.  
 Art catalog of rare old violins.

Name.....

Address.....

## Automatic Feeding For Large and Small Drills



"Yankee"  
Tools  
Make  
Better  
Mechanics

### This "Yankee" Bench Drill

automatically exerts just the right pressure to do the work in quickest time without smashing drill points.

You can use the largest drill the chuck will hold, or the smallest, and do the work without paying any attention to feed. Set drill on Friction Feed and bring drill point in contact with job, then shift lever and Ratchet Feed automatically maintains an even, uniform cutting pressure until the job is completed.

Can't jam gears or smash teeth. Table is adjusted by hand screw and bracket, or removable. A big range in size of work is possible, making this "Yankee" Bench Drill exceedingly useful to garage and repair men.

### "Yankee" Bench Drill

No. 1003—One Speed—18 3/4 inches high, holds round shanks to 1/4 inch diameter.

No. 1005—Two Speeds—28 inches high, holds round shanks to 3/8 inch diameter. Three-jaw hardened tool or steel chuck. Price at Factory.

No. 1003 . . \$10.00 No. 1005 . . \$16.50

### "Yankee" Vise No. 990

Convenient for holding irregularly shaped work on table of Bench Drill. Machined at right angle on bottom, sides and end.

Price, \$2.20

Your dealer can supply you

Write for "YANKEE" Tool Book showing "YANKEE" Metal and Wood Boring and Screw-driving Tools.

NORTH BROS. MFG. CO., Philadelphia

# "YANKEE" TOOLS

Make Better Mechanics

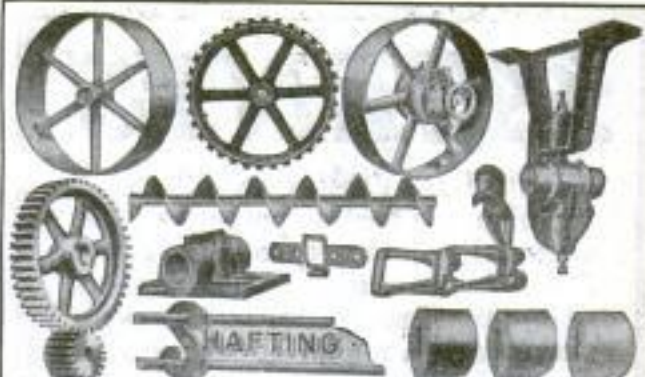

A complete line of appliances for the transmission of Power. Anything from a bolt to a complete mill or factory outfit. Send for catalogue. Largest Manufacturers of Pulleys in the country.  
440 W. 12th Street  
**W.A. Jones Foundry & Machine Co. CHICAGO**

## SEBASTIAN



The Standard Medium Priced Tool for over 30 years is offered in either Geared Head Motor Drive, Cone Head, Quick Change

or Plain Change Gear. As a Money Saving Tool you should investigate its merits before purchasing a lathe. CATALOG?

**The Sebastian Lathe Co. 107 Culvert Street. Cincinnati, O., U.S.A.**

THE MOST IMPRESSIVE PART OF THE BRITISH ARMY—M. Paul Birault, editor of the Bulletin des Armées de la République, who recently returned to Paris from a visit to the British front, is a man of discernment, says the Christian Science Monitor. The day after he had witnessed a battle, seeing it all, "from the artillery preparation up to the wave of assault," he was asked what had impressed him most. He promptly

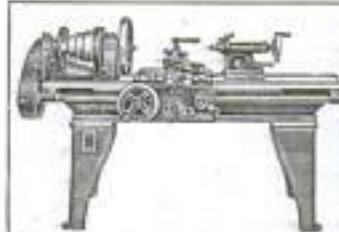

### South Bend Lathes

For the Machine and Repair Shop

**How to Run a Lathe**  
A 50 cent book for 10 cents.  
Postpaid, stamps accepted.

Straight or Gap Beds. Send for free color catalog listing prices on entire line.  
**SOUTH BEND LATHE WORKS**  
423 Madison St., South Bend, Ind.

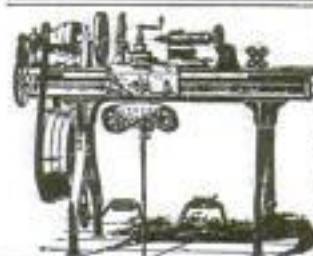

## LATHES

9 to 18-inch Swing

List price \$75 and up according to size. When ready to buy send for Lathe Catalog and prices.

**W. F. & John Barnes Co.**  
100 Ruby Street, ROCKFORD, ILL.

### Drilling Wells is a Year Round Business

Drilling Water Wells is a profitable, healthful, year-round business. There are wells all around you to be drilled. Don't you want to get into a money-making business for yourself? Write for particulars.

**STAR DRILLING MACHINE CO.**  
664 Washington St. AKRON, OHIO

Please Mention Popular Mechanics

## Russian Bristles Stiffest and Best Quality in WHITING-ADAMS Hair Brushes and Well Set in the Back

### WOW! WHITING-ADAMS HAIR BRUSHES

are made of best quality Russian bristles with perfect elastic spring. They are mounted in beautiful tropical hard woods, and adorned with a highly polished surface.

These handles will not rot or disintegrate

John L. Whiting - J. J. Adams Co., Boston, U. S. A., Dept. C

Brush Manufacturers for Over 100 Years

Whiting-Adams Brushes awarded Gold Medal and Official Blue Ribbon, the Highest Award at Panama-Pacific Exposition, 1915



### CRESCENT WOOD WORKING MACHINERY

will help make more profits for your shop during the winter months. Send today for our catalog of hand saws, jointers, saw tables, planers, planers and matchers, disk grinders, swing cut off saws, shapers, variety wood workers, Universal wood workers, borers, hollow chisel mortisers.

THE CRESCENT MACHINE CO.  
93 Columbia St., Leontonia, Ohio



### Tool Cases for Toolmakers and Machinists

Keep your tools orderly arranged in a Gerstner Portable Tool Case. There's a place for every tool in one of the felt lined drawers. Every up-to-date mechanic needs one and you'll find our Cases the best built, neatest and most practical on the market. We guarantee to please or refund all money. Write for a free booklet.

*Gerstner & Sons*

Mfrs. of Mechanics' High Grade Tool Cases  
808 Columbia St., DAYTON, OHIO

replied: "The kitchens of the Royal Dublin Fusiliers." "Amongst all those soldiers," he added, "who rivaled each other in courage, those who seemed to me the finest were the cooks, who, unarmed, under the shell fire, polished up their pots and pans as if their kitchen on wheels were appearing in a review." Anyone might have noticed it, of course; but then most people, in all probability, would not.

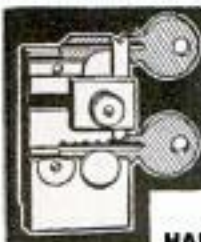

### Duplicate Keys

for all Yale and similar Locks made in one minute with Harrison M.I.P. Key Filing Machine. No misfits. Thousands in use. \$3.50 net. Special diamond-shaped files for angular cut keys, 40c each. Harrison C.K. Key Clamp duplicates all common keys without a caliper. Price, \$1.10. Parcel post prepaid.

Money returned if not satisfactory.

HARRISON & CO., 81 New St., New York



300-A  
3/4"  
-2"  
Pipe

## THREADING

PIPE NIPPLES BOLTS and requiring only a few square feet of floor space in an unused corner of your shop, one of the 4 sizes (belt or motor driven) of

## OSTER COMBINATION MACHINES

will pay you big dividends in money saved over hand-threading. 3 days' work a month pays a profit. Catalog free—ask for List 30.

THE OSTER MFG. CO.

2100 E. 61st St., Cleveland, Ohio, U. S. A.

## Every Builder and Contractor Needs this Level

### 10 Days' Free Trial

We have been makers of transits and levels since 1863 and our instruments are the standard of the world. Prove the superior quality of the Aloe Convertible Level by giving it a 10 days free trial. Use it on your every-day work laying out buildings, leveling up foundations, walls and floors, aligning, shafting walls, piers, etc., for getting angles or levels anywhere.

### Easy Monthly Payments

If you decide to keep it, the instrument will earn its way while you make monthly payments so small that you hardly feel them. Costs no more than to pay all cash. No red tape about it, no embarrassing questions, everything confidential.

### Aloe Convertible Level

is the finest instrument ever offered at anywhere near its price. Permits taking of sights both above and below the horizontal. For taking vertical sights it is provided with a special convertible bracket rigidly and permanently attached to the cross bar. The telescope is fitted with permanent axis which rests in bracket bearings and is held by clasp easily and quickly released.

Aside from being a level, it is a modified transit that permits a much wider range of work than is possible with the ordinary architect's level. With it the man without technical training can obtain the same absolutely accurate results as the expert. Write today for descriptive circular.

A. S. ALOE CO.,  
620 OLIVE ST., ST. LOUIS, MO.



DO  
IT NOW

Please send  
List 30 to

Name .....

Address .....

City .....

State .....

Occupation ..... (2100)

**B.S.**  
TRADE MARK



He Wants  
to be  
**SURE**

so he uses a Brown & Sharpe Tool.

He's a good mechanic — a careful workman always. He's the kind of a man who is picked for promotion. He has a keen appreciation for the value of accuracy in modern machine shop practice. He's a good workman and he owns a kit of good tools which makes a combination that's bound to win.

Stamped on each tool in his kit is the positive proof of machinists' tool quality—Brown & Sharpe.

Whether you are an apprentice, toolmaker, machinist, mechanical engineer or experimenter

## Brown & Sharpe Machinists' Tools

will help you in a way that will gain your lasting appreciation.

Send for Catalog 27 listing this entire line, together with matter of instructive value to you in your work.

You'll find it a valuable book to have in your kit

**Brown & Sharpe Mfg. Co.**  
PROVIDENCE, R. I., U. S. A.



### The Edge is Rusty

Invisible surface rust dulls a razor. You can't wipe a razor blade dry enough to prevent rust because the cutting edge isn't as smooth as it looks. It has tiny irregular "hills and valleys" like a miniature saw. A powerful magnifying glass shows this. Rust caused by moisture forms between these saw-like teeth—*unless prevented!*



### 3-in-One Oil

prevents rust—keeps the cutting edge clean and keen—makes shaving easier. Moisten your thumb and forefinger with a drop of 3-in-One. Draw the razor blade gently between them. Do this before and after shaving.

Rub a little 3-in-One well into your strop to bring out the grain of the leather and make the blade adhere to the strop. For sale at all good stores in 50c, 25c and 15c bottles; also in 25c Handy Oil Cans.

**FREE** Liberal sample of 3-in-One Oil and "Razor Saver" Circular sent free.

**Three-in-One Oil Co.**  
165 CNR. Bdw., N.Y.



**OLD BUILDING MATERIAL SELLS ABOVE ORIGINAL COST**—The building material in the former city hall at Cleveland, which was recently demolished to make room for a new public library, was sold at much higher prices than the original cost. Oak lumber, which in 1876—the year of the building of the city hall—had been bought for \$15 a thousand feet, now brought \$45 for the same quantity, and old brick, which cost the city \$4 a thousand 40 years ago, sold for eleven dollars.



### TOOL CASES

For Up-to-Date TOOLMAKERS and MACHINISTS

We carry the finest and most complete line of mechanics' toolcases and tools in the country. We guarantee to please you or refund money. Write for free catalogue.

**J. M. WATERSTON**  
75 Woodward Ave., DETROIT, MICH.



### "RED DEVIL" Fence Tool No. 1900

## 11 Tools in One

Contains 2 staple pullers, 2 hammers, 2 wire cutters, wrench, wire stretcher, tyer, pincher, and pipe grip. Made of steel, 10 inches long. For farmers, householders, gardeners, ranchmen, etc. Sample tool sent for \$1.25, if not obtained from dealers. CIRCULARS FREE.

**SMITH & HEMENWAY CO., INC.**  
97 Coit Street IRVINGTON, N. J.

Please Mention Popular Mechanics





**Stanley  
Tools**

## Stanley Adjustable Try and Mitre Square No. 21

One of the handiest tools in a Carpenter's Kit. Especially useful for doing short work about windows, doors, etc., or in putting on butts or locks.

The *Blade* is adjustable and as it can be reversed, provides any size of try or mitre square within the capacity of the tool. In reversing, it is not necessary to remove the blade from the handle, consequently the tool is always assembled and ready for use.

The locking device is such as to insure the blade being firmly and accurately secured at any point desired. The edges of the *Blade* are machined, graduated in 8ths, 16ths and 32nds of inches, and the tool is square inside and out.

It is also an excellent depth and marking gauge. Both *Handle* and *Blade* are nickel plated. Made in three sizes.

—Special Circular Upon Request.—

**STANLEY RULE & LEVEL CO.**  
NEW BRITAIN, CONN. U.S.A.

**UNITED STATES GREATEST SILK-MANUFACTURING COUNTRY**—France is usually considered the greatest silk producer in the world, but the United States has for some time stood in the first place, and practically all the best of the silks used here are also made here. For three years before the war the mills of the United States used about the same amount of raw silk as France, Germany, Switzerland, and Italy combined, and twice as much as France alone. At present, war makes the silk-manufacturing industry in this country more important than ever.

## THE AWL YOU WANT

See That Reel



Is the World's Greatest Pocket Sewing Device. Makes Lock Stitches; sews anything heavy or light. Just the thing for mending shoes, canvas, tents, awnings. Should be one of the Army's equipments. \$1.00 Postpaid.  
**C. A. MYERS COMPANY, 6339 University Ave., Chicago, Ill.**

## Portable Cases

For Tool Makers and Machinists



Twelve styles, felt lined drawers, solid brass trimmings, best of material, beautiful finish, low prices, satisfaction guaranteed. Ask for booklet of cases built for service.

**THE PILLIOD LUMBER CO.**  
SWANTON, OHIO

**LEPAGE'S**  
**GLUE** HANDY BOTTLES  
SAVES YOU DOLLARS 10¢



# SIMONDS

## Particular Jobs

require tools that are made with that minute attention to details which gives the perfect result. That is why

## SIMONDS SAWS

are popular with men who are particular about their work.

Ask your dealer about  
*Simonds Saws.*

**The Simonds Manufacturing  
Company**

The Saw Makers Fitchburg, Mass.

Established 1832

5 Factories 11 Branches

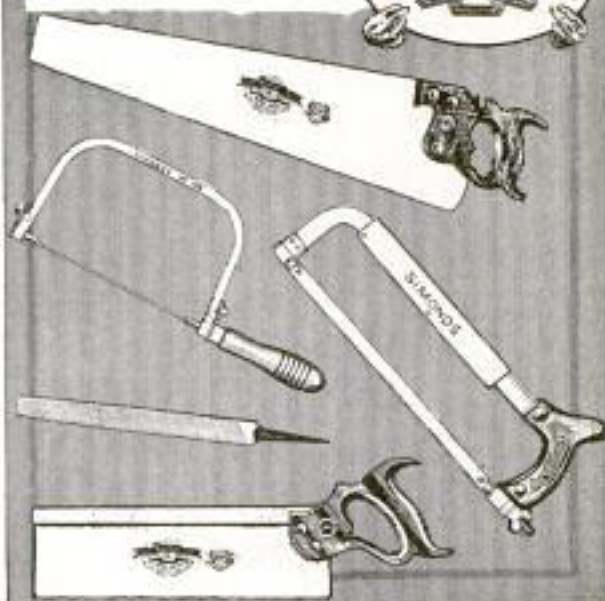

Please Mention Popular Mechanics

# SARGENT



## For Every Bench Use There's a Sargent Automatic Set Plane

And every user feels it's a different plane by the way it takes hold of *any* wood.

Here's why: Thin cutter with quicker grinding advantage, Rigidity for sure work, Quick and Easy Adjustment for coarse or fine cuts, Adjustable Knob, and Automatic Set, by which the clamp, when replaced after removal, will always return to its original position until reset.

Ask your dealer to show you the Planes that do work not possible with other planes, or send for catalogue describing these and other Sargent Planes.

**SARGENT & COMPANY**  
49 Water St., New Haven, Conn.

## DROP-FORGED Snips \$2 to \$4.60 FOR HIS XMAS

Made for hardest service. Highly tempered crucible steel, drop forged. Cuts keen. Holds the edge. Cuts 18-gauge metal at point easily—cutting power three times that of ordinary straight snip. For sale by dealers or sent postpaid in United States at these prices:

7-inch, stamped, \$1.30
8-inch . . . . . 2.00
10-inch . . . . . 3.00
12-inch . . . . . 4.00
14-inch . . . . . 4.60



CIRCULAR ON REQUEST

BARTLETT MFG. CO., 20 E. Lafayette Ave., Detroit, Mich.

## Pattern Maker's Tool Chest

Style J—

**Patternmakers' Special**  
Leatherette covered. Solid mahogany fronts. Extension drawer slides. Felt lined throughout. A real tool chest to meet your particular requirements. Guaranteed.

Eighteen other styles and sizes—quartered and plain oak and leatherette covered. Perfectly designed. Guaranteed.

## Buy This "UNION" TOOL CHEST

and stop the nuisance of lost tools. Has a place for every tool to keep it safe, clean, free from knocks and moisture—you know immediately if one is mislaid or borrowed. Write for our Catalog and Prices. If we have no dealer near you, get our special offer.

**UNION TOOL CHEST WORKS** 99 Railroad St. Rochester, N.Y.

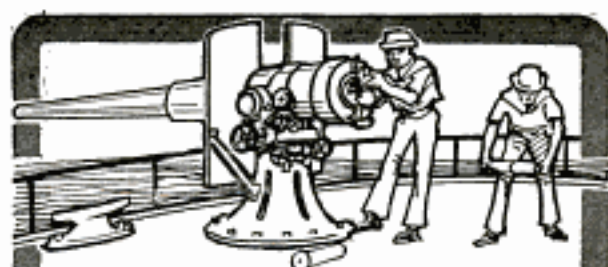

## WITH UNCLE SAM AT SEA

Every piece of machinery on shipboard must be kept in topnotch order for the call to "Clear for Action." The Crescent Wrench in the hands of our navy's mechanics is doing more than a bit in meeting the demand for absolute efficiency at sea. Crescent preference is based on Crescent construction—extraordinary convenience in handling the most difficult work—and on the long life which the Crescent standard insures.

## CRESCENT TOOL CO.

Jamestown, N. Y.



**SUN NEVER SETS ON UNITED STATES TERRITORY**—With the acquisition by the United States of the Danish West Indies this country is in the same position that Great Britain has long maintained, of being a country upon which the sun never sets. The distance between St. Croix, one of the former Danish West Indies islands, to Balabac, the westernmost of the Philippines, is just over 180° of longitude. Just as the sun sets on Balabac it rises on St. Croix.

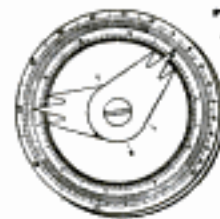

## The Midget Slide Rule

will add, subtract, multiply, divide, solve problems involving even and uneven roots and powers. Also gives the Logarithms of numbers and the Sines, Tangents, Cosines and Cotangents of all angles. Its operation is very simple; quickly solves any mathematical problem. Made of wood and metal. Adapted for shop and office use. Fits the pocket, 3 1/4" in diameter. **75c**  
Price, with instructions.

Your money back if you are not satisfied

GILSON SLIDE RULE CO., NILES, MICH.



## WHITE VALLEY GEMS

**Look and Wear Like Diamonds**  
Brilliance guaranteed 25 years. Will cut glass. Stand acid and fire tests and scratch a file. Any style 14-K solid gold ring, pin or stud, (regular diamond mounting) sent for Free Examination. No Money in Advance. Write today for special prices and free catalog.

**WHITE VALLEY GEM CO., Mfg. Jewelers**  
827 Wulsin Building Indianapolis, Indiana

## Water Pumps Water

with a Rife Ram. Plenty of it for every purpose about your farm and country home—day and night, winter and summer, without fuel, labor, freezing or repairs. The

## RIFE RAM

is operated by any small stream having a fall of three feet or more and a supply of three or more gallons per minute. Fills high elevated tanks or operates air pressure system. Easy to install. First cost the only cost. Always on the job; over 11,000 in daily use. Tell us your water supply conditions. Ask for free estimate and catalog. Now is the time to install. Write today.

**RIFE ENGINE CO., Dept. F. 90 West St., NEW YORK**

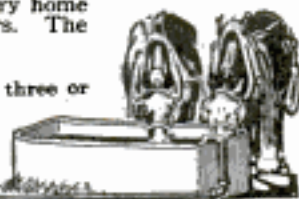

# SUGAR 5c Lb.

One of our leaders. We save you money on Groceries—catalogue free with trial order. The requests for catalogues are enormous and hundreds of thousands of dollars are lost annually by mail order concerns in sending out catalogues to places where no benefit is ever derived. To avoid all this unnecessary expense and be in a position to sell our goods at the lowest possible price, we have decided on the following plan: We will only send Bargain Grocery Catalogue to such people who can prove to us that they are really interested in saving money on groceries. We quote herewith a few of the bargains listed and which are sold in different parts of our catalogue:

**FLOUR - \$10.36** Per Barrel  
(One of Our Leaders)

Our Best Flour.....\$10.36 per barrel  
Our Best Flour..... 5.18 per half barrel  
Our Best Flour..... 2.59 per 49-pound sack  
Our Best Flour..... 1.30 per 24½-pound sack

## HERE IS OUR PLAN

Send us \$1.99 for the following Trial Order and we will then know that you mean business, and we will include with your order our Bargain Grocery Catalogue, in which you will find big grocery bargains:

### TRIAL ORDER A.O.

	(Estimated) Retail Price	per Pylee
5 pounds Our Best Granulated Sugar.....	50 cents	25 cents
1 large size package Quaker Oats.....	10 cents	7 cents
1 pound Guaranteed Baking Powder.....	50 cents	39 cents
¼-pound Black Pepper (Ground).....	25 cents	15 cents
¼-pound Cinnamon (Ground).....	25 cents	15 cents
¼-pound Ginger (Ground).....	25 cents	15 cents
¼-pound Mustard (Ground).....	25 cents	15 cents
2 bars Kirk's White Flake Soap.....	16 cents	9 cents
2 packages Uneeda Biscuits.....	16 cents	8 cents
1 bar Fels Naphtha Soap.....	5 cents	3 cents
1 pound Breakfast Cocoa.....	60 cents	39 cents
3 packages Washing Powder.....	15 cents	9 cents
1 Catalogue Free	Retail Price \$3.22	Our Price \$1.99

**YOU SAVE \$1.23**

OUR GUARANTEE: Your money returned in full if you are not more than pleased  
**COLE-CONRAD CO.** Dept. A.O., 2214 Ogden Ave., Chicago, Ill.

**SUGAR - \$5.00** Per 100 Lbs.  
(One of Our Leaders)

Our Best Granulated Sugar.....\$5.00 per 100 lbs.  
Our Best Granulated Sugar..... 2.50 per 50 lbs.  
Our Best Granulated Sugar..... 1.25 per 25 lbs.  
Our Best Granulated Sugar..... .50 per 10 lbs.

## Other Big Bargains in our Catalogue

Uneeda Biscuits, 12 packages.....40 cents  
Quaker Oats, 6 large packages.....36 cents

### AND OTHER BIG BARGAINS.

**Remember** We send no catalogue unless we receive your trial order. We sell the trial order complete only and no part of same. Nor do we sell any article mentioned in this advertisement separately. Rush your trial order at once, and get our catalogue and commence saving big money on all your groceries.

### ORDER BLANK

COLE-CONRAD CO., Dept. A.O., 2214 Ogden Ave., CHICAGO, ILL.

Gentlemen:—Enclosed please find \$1.99, for which send me Bargain Grocery Order No. A.O., and include free your catalogue showing your Big Grocery Bargains, it being understood and agreed if I am not perfectly satisfied that I can return the goods and you will at once return my money.

Name.....

Address.....

City.....State.....

Express Office.....

## Comfort Indoor Closet

### Odorless Sanitary Germ-Proof

Every home without sewerage needs one. Most convenient, meritorious home necessity in a century. A boon to sick people. Can be placed anywhere in the house.

### Abolish Outdoor Closet

Put a warm Comfort Toilet in your home, a guarantee of healthy, sanitary conditions. Germ-life killed by chemicals in retort. Emptied once a month—no trouble. Needs no other attention. Boards of Health endorse it. Write now for literature, prices, etc. Agents wanted—exclusive territory.

Comfort Chemical Closet Co.,  
391 Factories Bldg., Toledo, O.



Get an Free Trial  
30 days

## Acetylene Blow Torch

# Prest-O-Torch

Quicker and cheaper than a gasoline blow-torch for brazing and soldering

For factories, repair shops, linemen, dentists, jewelers, the Prest-O-Torch saves time and money. Used with Prest-O-Lite Tanks—ready-made gas. Intense, concentrated flame instantly lighted. No depreciation, safe and convenient. Style A, price, \$1.25 (Canada, \$1.35) will braze up to 3/8 inch round rod. Style "C" for heavier work, \$2.75 (Canada, \$2.85). Special styles for dentists. Write for literature or send order now. Money refunded if not satisfied.

The Prest-O-Lite Co., Inc. 835 Speedway  
Indianapolis, Ind.  
Canadian General Office, Dept. A4, Toronto, Ont.



No. 102

1/4 to 1 1/4"

**OSTER**  
**BULLDOG**  
**DIE-STOCKS**

Send for Catalog

## 6 sizes in one tool—

HERE'S a tool that is a wide-range pipe-threading outfit in itself because it threads all sizes of pipe from 1/4 to 1 1/4 inches. It's one of the famous Bulldog Die-Stocks. You don't need to be an expert to operate a Bulldog—self-locking dies, self-locking guides, no re-threading, and no loose parts make it the easiest tool to handle.

Our free booklet "The Bulldog Tale" tells the whole story in simple, straightforward language.

BETTER USE THE COUPON NOW

**The Oster Mfg. Co.** 2100 East 61st St., Cleveland, Ohio

Name.....  
Business.....  
Address.....  
City.....State.....  
(250)

# An Easy Way to Make Money

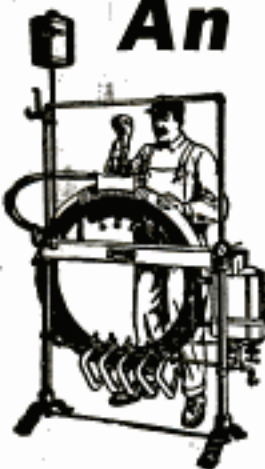

Don't be content to plod along on a small salary. Be independent. Go in the tire repairing business and make \$60 or more a week. One man made \$45 the first day he received his outfit. Others are making \$25 a day and hundreds of wide-awake men are making \$200 to \$500 a month.

No experience needed. We teach you how. Very little capital required. But slight risk, as every car owner in your town is a possible customer. Jobs are plentiful because tires blow out and puncture every day.

## SHALER Tire Repair Outfit, \$65

will do as much and as perfect work as the big \$250 to \$500 vulcanizing outfits. A boy can vulcanize perfectly with this simple machine. It's the only vulcanizer that has **Automatic Heat Control**. It must vulcanize just right. It can't undercure or overcure a tire. Requires no watching or regulating. You can learn to do expert tire vulcanizing in half an hour with the Shaler.

**WRITE FOR FREE BOOK** "HOW TO OPEN A TIRE REPAIR SHOP" and complete Catalog, which gives full information.

WRITE QUICK BEFORE SOME HUSTLER GETS AHEAD OF YOU.

C. A. SHALER CO., 2010 Fourth Street, WAUPUN, WIS.

## MAKE YOUR BIKE A MOTORCYCLE

at a small cost, by using our attachable outfit. Fits any Bicycle. Easily attached. No special tools required.

### "Used His Four Years"

Harry A. Hyatt, of Boreas River, New York, writes: "About four years ago I received my motor attachment, and wish to say that I am satisfied with it in every way, for it has certainly given me good service. Anyone wanting a motorcycle or attachment, I would recommend them to the Shaw Manufacturing Co."

**FREE BOOK** Write today for bargain list and free booklet, fully describing the SHAW Bicycle Motor Attachment. Motorcycles all makes, new and second-hand, \$35.00 up.

**SHAW MANUFACTURING CO.**  
Dept. 6 GALESBURG, KANSAS



## 35 MILES PER HOUR IS RECORD OF THIS CAR

Built by a boy from Junior parts furnished by us. Parts very cheap. Send 26 cents for blue prints and price list of parts, showing how to build this speedy little car.

Any boy can build this car

SYPHER MANUFACTURING CO., 146 Warren St., Toledo, O.

## IVER JOHNSON

REVOLVERS SHOTGUNS BICYCLES MOTORCYCLES

Send for free books, "A"—Arms, "B"—Bicycles, "C"—Motorcycles.

Iver Johnson's Arms & Cycle Works  
307 River Street FITCHBURG, MASS.

## Champion Toledo

Dependable Spark Plugs

Champion Spark Plug Co., Toledo, Ohio

## STANWELD Cold Drawn Seamless Steel TUBING

Lightest, smoothest, strongest Steel Tubing made. World's largest manufacturers of bicycles, motorcycles and automobiles use it exclusively. Send for Folder "A."

**THE STANDARD WELDING COMPANY**  
Main Office and Factory CLEVELAND, OHIO



## Convert Your Bicycle into a Motor-Cycle

Motor fits any wheel. BEST, MOST RELIABLE. Best hill climber. More STEFFEYS in use than all others. Stamp for circulars. STEFFEY MFG. CO., 5007 Brown Street, PHILA., PA.

Attractive *Columbia* Bicycles  
Catalog Free  
**WESTFIELD MFG. CO.** Department 15  
WESTFIELD, MASS.

## Amesbilt PLEASURE AND COMMERCIAL BODIES FOR FORDS

Also Ames-ton Worm Drive Truck Unit and Commercial Unit.  
WRITE FOR LITERATURE  
**The F. A. AMES CO., Inc., 1308 Third St., Owensboro, Ky.**



## Send for Literature About the AUTO-WHEEL Convertible Roadster

The most wonderful boy's wagon in the world. Turn up the sides and it's a real Coaster. Turn them back and it's a regular Roadster. It's two wagons in one. Made by the manufacturers of the famous Auto-Wheel Coaster. Don't take a substitute. Send for Booklet today. Mention name of three Coaster Wagon Dealers in your town and we will also send you FREE a handsome FELT PENNANT. Address.

**BUFFALO SLED CO., 137 Schenck St., No. Tonawanda, N. Y.**  
In Canada: Preston, Ont.



Rider Agents Wanted

## Delivered TO YOU FREE

Your choice of 44 styles, colors and sizes in the famous line of "RANGER" bicycles, shown in full color in the big new Free Catalog. We pay all the freight charges from Chicago to your town.

**30 Days Free Trial** allowed on the bicycle you select, actual riding test in your own town for a full month. Do not buy until you get our great new trial offer and low Factory-Direct-To-Rider terms and prices.

**TIRES LAMPS, HORNS, pedals, single wheels and repair parts for all makes of bicycles at half usual prices. No one else can offer you such values and such terms.**

**SEND NO MONEY** but write today for the big new Catalog. It's free.  
**MEAD CYCLE COMPANY**  
Dept. H108 Chicago

Please Mention Popular Mechanics

## Stop that Squeak!

In the springs of your car with

# HOMOL

TRADE MARK

It polishes the metal, the glass and the body. It prevents rust.

Made for sportsmen by sportsmen, Homol is the "best-ever" oil for reels, guns—for everything in kit and camp. Also for all office and household needs.

If your dealer hasn't Homol yet, send us his name and a quarter and we'll send you this big five-ounce can, carriage prepaid.

William Peterman, Inc., 200 Fifth Ave., New York City



Unscrew the cap and out springs the spout ready for use. Screw on the cap and in goes the spout, away from dust and dirt.

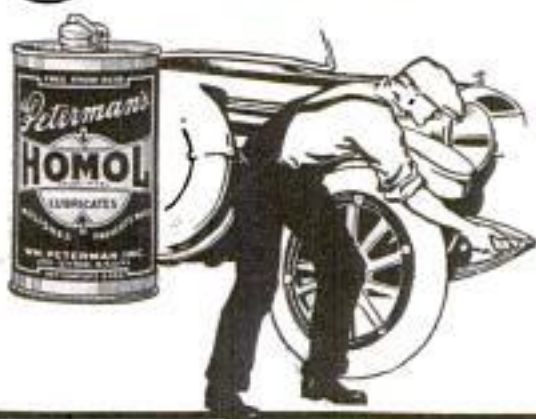

**THE CORBIN DUPLEX COASTER BRAKE**  
is the standard brake equipment assuring absolute control. Equip it now. Send for catalog.  
**THE CORBIN SCREW CORP.** The American Hardware Corporation, Successor  
NEW BRITAIN, CONN. BRANCHES: New York, Chicago, Philadelphia

**MIAMI-MADE BICYCLES**  
Stand at the top of the bicycle world.  
**RACYCLE, HUDSON, MIAMI, FLYING MERKEL**  
Write for our catalog.  
**THE MIAMI CYCLE & MFG. CO., MIDDLETOWN, OHIO**

## DODGE BROTHERS MOTOR CAR

### BIG PROFITS with this BATTERY CHARGER

Hundreds of garage owners are clearing \$20 to \$60 profit every month with this 500-Watt H-B quick-charging equipment. Recharges one to seven batteries at a time, at cost of about 15¢ per battery. Autoist pays 75¢ to \$1.50. At least \$4.50 profit each capacity run.

#### \$15 Puts This Money-Maker in Your Garage

Balance in eight monthly payments of \$20 each. Earnings will quickly pay for machine. Every outfit fully guaranteed. Tear out this ad and send with name for full particulars.

**HOBART BROS. CO., Box 511, Troy, Ohio**



## America's Tested Tires

# GOODRICH

**BLACK SAFETY TREADS**

**THE B.F. GOODRICH COMPANY, Akron, Ohio**



## Net

Prices Direct to You

**A**BSOLUTELY net terms on any diamond you choose. You can now buy direct. No jobbers, no retailers to pay. Write for our net price list and Diamond Book showing an exquisite collection of splendid, blue-white

## Diamonds

Rings in all styles, Tiffany, Belcher, etc., La Vallieres, brooches and other diamond jewelry. Every diamond a superb gem. Selected by a famous expert. Perfectly cut to give maximum brilliancy. Richly mounted in solid gold and platinum settings.

**Free Examination** Not a cent down—you see the diamond before you accept it. We want you to compare these diamonds with others at twice their price.

**\$2<sup>50</sup> Monthly** Only \$2.50 a month will make you the wearer of a

beautiful diamond ring. Other terms, \$3.50 \$4.50 and up—and middle-men's profits cut out.

## Write

### For Net Price List and Diamond Book

Shows the different gems, styles of mountings and gives our best net prices with terms of payment. Do it now—today.

**BURLINGTON WATCH CO.**  
Dept. 1198  
Chicago, Ill.

**Burlington Watch Co.**  
Dept. 1198  
Chicago, Ill.

Without obligations send me your net price offer on diamonds; also send Diamond Book

Name.....

Address.....

Take Pictures with—

## The EXPO WATCH CAMERA



A camera that closely resembles a watch in size and appearance—takes pictures  $\frac{1}{2} \times \frac{1}{2}$  inches as shown on margin. Easy to operate. It's a camera for both amateur and professional.

## Surprise Your Friends

Take their picture in the act of doing some funny stunt. Next time you see them produce the print. You will have a lot of fun over their bewilderment and catching people in queer and awkward positions. Carry the EXPO about in your pocket—easily concealed in the palm of the hand—picture can be taken unobserved. Produces clear, sharp negatives, indoors or outdoors equal to any camera on the market.

## One Cent a Picture

The EXPO loads in daylight with a 25 exposure film costing 25c. A whole day's outing picture taking can be had for the small sum of 1c a picture. Films are also made in 10 exposures for 15c. Photos may be enlarged to any size. We have Automatic Enlargers specially made for the purpose, that may be had any time.

## Quick as a Flash

The EXPO takes pictures through the stem, where the rapid fire lens is located. Equipped with a time and instantaneous shutter. Weighs but three ounces and is highly nickel-plated. Endorsed and in constant use by the police, newspaper reporters, detectives and general public. Important evidence can be secured with a camera of this kind. Sold under a positive guarantee. Delivered to any address in the world.

**\$2.50**

For EXPO WATCH CAMERA, postage 10c extra. Films, 25 Exposures, 25c—10 Exposures 15c. Leather Pocket Carrying Case 35c. Adjustable View Finder for Watch Camera 50c. **JOHNSON SMITH & CO., Dept. 52, 54 West Lake St., CHICAGO**

Johnson  
Smith & Co.Dept. 52  
54 W. Lake St.  
CHICAGO, ILL.Please send me one EXPO  
WATCH CAMERA for which  
I enclose \$2.50 and 10c to  
cover postage.

Name \_\_\_\_\_

Street Address \_\_\_\_\_

City \_\_\_\_\_



## STOP USING A TRUSS

Do Away With Steel And Rubber Bands



Inner surface is made adhesive to secure the FLAPAO-PAD firmly to the body, keeping the FLAPAO continual-ly applied and the pad from slipping. No straps, buckles or springs attached. Soft as velvet—easy to apply.

It's the Non-Slip- ping, yet Non-Rigid Pad and What is Within It That Counts

PAT'D  
APRIL 6  
1909

## FREE to 5,000 Truss Sufferers

To the extent of 5,000 sufferers who may apply I will send, ABSOLUTELY FREE, a sufficient quantity of the Flapao to positively convince them that this is the only logical, common-sense way of treating rupture. Flapao is a highlystringent medication placed within the Flapao-Pad and being absorbed through the skin, creates a wonderful feeling of relief and at the same time tends to strengthen the weakened muscles and thus permanently close the rupture opening. The process of recovery is natural, so you'll have no use for a truss—you can throw it away forever! Old and young have testified under oath that the Flapao-Pads cured their rupture—many of them long-standing, aggravated cases—without delay from work. Patent allowed in U. S. and foreign countries. Awarded Gold Medal at Rome and Grand Prix at Paris.

**Send No Money**—for a sufficient quantity of the Flapao is sent without charge to enable you to give it a thorough test; you pay nothing for this trial now or ever. Write for it and full information today. Address Flapao Laboratories, Block 1427 St. Louis, Mo.



**CORONA** The Personal Writing Machine weighs 6 lbs. Writes all kinds of correspondence. \$50 with carrying case. Write for booklet No. 32. Corona Typewriter Co., Inc., Groton, N. Y.



## "BOW LEGS and KNOCK-KNEES" UNSIGHTLY

SEND FOR BOOKLET SHOWING PHOTOS OF MEN WITH AND WITHOUT THE PERFECT LEG FORMS  
**PERFECT SALES CO., 140 N. Mayfield Ave., Dept. 5 Chicago, Ill.**



## 1/2 PRICE—TO INTRODUCE



ONLY \$2.50

To prove to you that our blue-white **MEXICAN DIAMOND** exactly resembles the finest genuine South African Gem, with same dazzling, rainbow-hued brilliancy (GUARANTEED), we will send you this beautiful, high-grade, 12-kt. gold-filled Tiff. Ring, set with 1-kt. gem, **\$2.50** regular catalog price, \$4.98. **FOR ONE-HALF PRICE.**

Same gem in Gent's Heavy Tooth Belcher Ring, catalog price, \$6.25, for \$3.10. Wonderful, dazzling, rainbow brilliancy. **GUARANTEED 20 YEARS.** Send \$1.00 and we will ship C. O. D. for FREE EXAMINATION. Money back if not pleased. Act quick. State size. Offer limited. Only one to a customer. Catalog Free. Agents Wanted. **MEXICAN DIAMOND IMPORTING CO., Dept. ET., LAS CRUCES, NEW MEXICO** (Exclusive Controllers of the Genuine Mexican Diamond)

SUPERIOR SINCE 1904

Over 100,000 in Use

Merely sold through recommendation. For PERSONAL DESK or GENERAL OFFICE. It checks mental calculations. Buy through your Stationer. Write for 10-day trial offer.

**E. GANCHER, A. A. M. CO.**  
148 Duane Street, NEW YORK

AGENTS WANTED

**Golden Gem**  
PORTABLE  
Adding Machine \$10



Multiplies—Subtracts

# Swear Off Tobacco



Tobacco Tells on Nervous System



Tobacco Ruins Digestion



Tobacco Stunts Boy's Growth



Tobacco Robs Man of Virility



Tobacco Steals from You the Pleasures, Comforts, Luxuries of Life

## Tobacco Habit Banished In 48 to 72 Hours

### Immediate Results

Trying to quit the tobacco habit unaided is a losing fight against heavy odds, and means a serious shock to your nervous system. So don't try it! Make the tobacco habit quit you. It will quit you if you will just take **Tobacco Redeemer** according to directions.

It doesn't make a particle of difference whether you've been a user of tobacco for a single month or 50 years, or how much you use, or in what form you use it. Whether you smoke cigars, cigarettes, pipe, chew plug or fine cut or use snuff—**Tobacco Redeemer** will positively remove all craving for tobacco in any form in from 48 to 72 hours. Your tobacco craving will begin to decrease after the very first dose—there's no long waiting for results.

**Tobacco Redeemer** contains no habit-forming drugs of any kind and is the most marvelously quick, absolutely scientific and thoroughly reliable remedy for the tobacco habit.

### Not a Substitute

**Tobacco Redeemer** is in no sense a substitute for tobacco, but is a radical, efficient treatment. After finishing the treatment you have absolutely no desire to use tobacco again or to continue the use of the remedy. It quiets the nerves, and will make you feel better in every way. If you really want to quit the tobacco habit—get rid of it so completely that when you see others using it, it will not awaken the slightest desire in you—you should at once begin a course of **Tobacco Redeemer** treatment for the habit.

### Results Absolutely Guaranteed

A single trial will convince the most skeptical. Our legal, binding, money-back guarantee goes with each full treatment. If **Tobacco Redeemer** fails to banish the tobacco habit when taken according to the plain and easy directions, your money will be cheerfully refunded upon demand.

### Let Us Send You Convincing Proof

If you're a slave of the tobacco habit and want to find a sure, quick way of quitting "for keeps" you owe it to yourself and to your family to mail the coupon below or send your name and address on a postal and receive our free booklet on the deadly effect of tobacco on the human system, and positive proof that **Tobacco Redeemer** will quickly free you from the habit.

Newell Pharmacal Company  
Dept. 300 St. Louis, Mo.



### Free Book Coupon

NEWELL PHARMACAL CO.,

Dept. 300

St. Louis, Mo.

Please send, without obligating me in any way, your free booklet regarding the tobacco habit and proof that **Tobacco Redeemer** will positively free me from the tobacco habit.

Name.....

Street and No.....

Town..... State.....

Please Mention Popular Mechanics

# WANTED IDEAS



Inquiries from Manufacturers and Other Buyers of Patents  
Who Are Looking for Good Ideas

## Protected by Owen Patents

Are constantly being received. Hundreds of ideas are wanted—a market exists for them to-day. YOURS may be one of them. Send for my free books and see for yourself—read the requests for inventions protected by me. Many are simple. You can help supply this demand.

As soon as my clients' rights are protected I aid in every practicable way, **without charge**, to sell. Their applications are advertised free—their patents are called to the attention of the proper prospective buyers—every necessary thing is done. Get my booklets and see.

## THESE ARE FREE

You will incur no obligation by writing me. A simple request will bring them to you—the finest, most reliable and instructive patent books published. A postal will do.

**"Successful Patents"**—a 72 page guide book, tells how to proceed; describes my advantageous business methods; gives references, testimonials, etc.

**"Stepping Stones"**—gives hundreds of hints of inventions wanted; articles from interviews of noted authorities; tells the truth about prizes for inventions.

**"Patent Promotion"**—tells you how to sell; why some inventors fail; discusses the value of your idea; how I aid my clients; manufacturing aids furnished you; recent successful patents, etc.

**"Patent Buyers"**—Publishes letters, and abstracts of letters, from over 400 of the many manufacturers, and other patent buyers, who wish to buy, or obtain on royalty, **Owen Patents** on innumerable inventions of interest to them.

You will also be sent from time to time, as new inventions are wanted, full information concerning them. Only in this way can you keep up to date.

**WRITE FOR THESE TO-DAY**—Advice costs nothing. All communications confidential. Your work will receive my personal supervision—but my fees are no higher than others.

### Results Speak Loudest—But Here Are Some References

Columbia National Bank,  
Washington, D.C.  
National Lockfile Co.,  
Washington, D.C.  
The Carnahan Press,  
Washington, D.C.  
Lightning Gun & Cycle Works,  
Oklahoma City, Okla.

Antholene Mfg. Co., Hutchinson, Kan.  
National Hack Co.,  
61 Hanover St., Boston, Mass.  
The C. J. Loftus Co.,  
13 Spring Common, Youngstown, Ohio.  
Whitehead Hosiery Mills,  
Burlington, N. C.  
Dickinson Mfg. Co., Des Moines, Iowa.

A LARGE NUMBER OF OTHERS IN MY BOOKLETS.

**RICHARD B. OWEN** 9-303 OWEN BLDG.  
WASHINGTON, D. C.  
NEW YORK OFFICE: 22nd Floor Woolworth Building

Inventors submitting their inventions to me are protected in a tangible manner until their applications are filed.

### Nuts for You to Crack

Invent something for which a demand exists—for which there is a waiting market. Here are abstracts from a few recent requests—hundreds are published in full in my literature. Can you invent any of these? Watch this list each month.

A gentleman who is connected with one of the largest manufacturers of pianos and piano players desires to acquire patent rights to improvements in this field. Can you supply this demand?

A large Southern company wants to buy patents on an improved "Ball-Gum Vending Machine, with non-slag fraud device, or trash eliminator, as part of the coin chute or mechanism." They want a machine that can be manufactured at a reasonable price.

Can you devise a new idea in the line of advertising specialties, signs and calendars? A large company has just written for something along these lines, adding: "we manufacture goods from paper, cloth, wood, metal and leather."

Improvements in electric spot and seam welders and also patents covering novelties which may be electrically welded instead of riveted are desired by a large Western manufacturer in this field.

### SPECIAL FREE REPORT

Send sketch or model of your invention for free report on patentability, practicability, etc.



# PATENTS TRADE-MARKS AND COPYRIGHTS

LARGEST PATENT FIRM  
IN THE WORLD

## SPECIAL OFFER

### Free Opinion as to Patentability

Before sending your invention to any attorney or manufacturer or disclosing your invention, write for our free blank form **PROOF OF CONCEPTION** in order to protect your invention and secure your rights. This should be signed and witnessed and returned to us, together with a model or sketch and description of your invention, and we will give a **FREE OPINION** as to the patentability of the invention. If we report the invention patentable we will furnish a Certificate of Patentability.

**VICTOR J. EVANS**

**This Certificate of Patentability, together with our blank form Proof of Conception will protect the inventor and serve as proof of the invention until the case can be filed in the U. S. Patent Office.**

**Obtaining Assistance for Inventors**—Our certificate is of great assistance to inventors who require financial aid to obtain patents.

## OUR FIVE BOOKS MAILED FREE

(See Coupon Below)

to any address. Send for these books—the finest publications ever issued for free distribution.

### How to Obtain a Patent

Our illustrated eighty-page Guide Book is a book of reference for inventors and contains 100 mechanical movements, illustrated and described. Tells how to invent for profit.

### What to Invent

Contains a valuable list of inventions wanted and suggestions concerning profitable fields of inventions; also information regarding prizes offered for inventions amounting to **One Million Dollars**

### Millions in Trade-Marks

Shows the value of Trade-Marks and information regarding unfair competition.

### List of Patent Buyers

Contains requests from manufacturers, mail order houses and promoters for patents secured by us and suggestions as to **New Ideas** they wish to purchase. We place our clients in touch with capital free of charge. We have recently received over 300 requests from manufacturers.

### Foreign Patents

We have direct agencies in all the principal foreign countries and secure foreign patents in the shortest possible time and at the lowest cost. Write for our illustrated Guide Book on Foreign Patents, sent free to any address.

We Advertise Our Clients' Inventions Free in a list of Sunday newspapers, in manufacturers' journals and in World's Progress. Sample Copy Free. We save you time and money in securing patents. After the patent is granted we assist you to sell your patent.

## WANTED NEW IDEAS

Prepare Now to meet the Demands of Industry in All Fields for New Ideas and New Inventions. We are constantly receiving requests from manufacturers who consult us when purchasing patents for inventions in all lines. We invite manufacturers and promoters to address our Sales Department regarding the purchase or leasing of a number of meritorious patents secured by us.

VICTOR BUILDING



**FREE COUPON!**

## VICTOR J. EVANS & CO.

New York Offices: 1007 Woolworth Bldg. **PATENT ATTORNEYS** Pittsburgh Offices: 514 Empire Bldg. Philadelphia Offices: 1429 Chestnut St.  
Main Offices: 765 Ninth St., N. W., WASHINGTON, D. C.

Name..... Address.....

Please Mention Popular Mechanics

# PATENTS SECURED OR FEE RETURNED

Latest and Most Complete Patent Book Ever Published for Free Distribution  
**WRITE FOR IT**

## Compare My SERVICE and TERMS with Those of Any First Class Attorney

Send Sketch, Photograph, or Model of your invention for an ACTUAL SEARCH of the Records of the Patent Office and report as to patentability — FREE. I give every detail of every case my closest personal attention and do not entrust your interests to assistants. Impartial advice on your ideas. I help you sell your patent. Terms moderate. My 90-page book (1917 edition) tells what inventors should know before they apply for a patent.

**GEORGE P. KIMMEL**, Patent Lawyer, 200 Barrister Bldg. Washington, D. C.



"The book the Inventor KEEPS"

Worth more than all other patent books combined. FREE. Write

**R. S. & A. B. Lacey**  
116 Barrister Bldg.  
Washington, D. C.  
Established 1869



## Patent Secured or Fee Returned

Hundreds of inventions sold yearly. We help market yours without cost. Our new book is FREE. Send model or sketch for free opinion.

**A. M. BUCK & CO.**

204 2nd Nat'l Bank Bldg., Washington, D. C.

## Protective Patents

Procured Promptly. No fee refund, no guarantee certificate, no so-called prize or free search schemes used in our business. Inventors 104 page Blue Book sent on request.

**Robb & Robb**, 211-215A Southern Bldg., Washington, D. C.

## PATENTS

THAT PROTECT AND PAY

## Books and Advice Free

Send sketch or model for search. Highest References. Best Results. Promptness Assured.

**WATSON E. COLEMAN**, Patent Lawyer  
634 F Street, N. W. Washington, D. C.

## PATENTS

**C. L. PARKER**  
Formerly Member Examining Corps, U. S. Patent Office  
PATENT LAWYER  
MCGILL BLDG.  
WASHINGTON, D. C.

Patents, Trade Marks, Copyrights, Patent Litigation

Handbook for Inventors, "Protecting, Exploiting and Selling Inventions," sent free upon request.

Send for FREE BOOK { WHAT TO INVENT  
WHAT NOT TO INVENT  
HOW TO SELL YOUR PATENT  
Nearest Patents and report in each case to be filed—no charge  
**H. L. WOODWARD**, 9th and G Sts., WASHINGTON, D. C.

**PATENTS SECURED OR ALL FEES RETURNED!**  
**THAT PAY** ACTUAL FREE SEARCH of Patent-Office Record as to Patentability of your invention  
With each favorable report we issue a Contract to Return All Fees!

Send data at once by registered mail and we will promptly advise how OUR CLIENTS PROCEED TO MAKE FORTUNES. Over \$627,212.00 made by clients.

Patents Sold FREE: Read "Patent Sales Department" of our 190-page Guide Book, FREE!

Don't miss this book. Mail postal today.

**E. E. VROOMAN & CO.**, 871 F Street, WASHINGTON, D. C.



## GEARS ALL KINDS SMALL

The most accurate made and prices reasonable. We carry a complete line of gears in stock for immediate shipment. Can also quote on special gears of all kinds. Send us your inquiries.

WRITE FOR CATALOGUE

**CHICAGO STOCK GEAR WORKS**  
16 S. Fifth Av. CHICAGO



MECHANICAL SUPPLIES AND MATERIAL of all kinds.

EXPERIMENTAL AND LIGHT MACHINE WORK to order.  
132 MILK STREET. BOSTON

Models and Gears

## Experimenters—Inventors

Developing inventions and making working models our specialty. Well equipped shop and staff of experts at your service. Carry complete stock of gears. Shipments same day order received. ESTABLISHED 1882.

**UNION MODEL WORKS**, 121 S. Clark St., CHICAGO

**BEES PAY BIG PROFITS**  
Raise your own honey. We start you right. Send today for Bee Supply Catalog. Sent FREE.  
**DADANT & SONS**, HAMILTON, ILL.

## POULTRY PAPER

44-124 PAGE periodical, up-to-date; tells all you want to know about care and management of poultry for pleasure or profit. Four months for 10 cents.  
**POULTRY ADVOCATE**, Dept. 98, SYRACUSE, N. Y.



## \$500 REWARD

We will pay \$500.00 reward to anyone who can permanently dim the brilliancy of the RAJAH Im. diamond without destroying the stone.

**RAJAH Im. Diamonds**

They stand all diamond tests—fire, acid, etc., and glass cutting. Their brilliancy is eternal. Guaranteed for a lifetime. Set in solid gold, and sent to you on 30 Days' Free Trial. If you can tell it from a real diamond return it. Send today for our beautiful, FREE illustrated jewelry catalog in colors. Write now.

**KRAUTH & REED**, 159 N. State St., Dept. P-2 CHICAGO, ILL.

A YEAR TO PAY

# Can You Invent Something?

—or is there an invention tucked away in your brain?

**I**F so, now is the time to produce it. Manufacturers everywhere are demanding new articles to keep up big production. *Their wants must be supplied.*

## This is your opportunity!

Many manufacturers have written us saying just what they are looking for; we will send you this

### List of inventions wanted, free for the asking.

Hundreds of other manufacturers have written us for *anything new and useful*—kitchen utensils, household articles, automobile specialties, labor-saving devices for the office, plant or farm—anything from big machinery to small novelties—anything to save time, make work easier, or do its work better.

Thousands of new plants have been built and others have been enlarged. Many are making

articles for which there is only *temporary* sale. All will want something which they can build to sell as a steady, *permanent* business. Wise manufacturers are laying their plans **NOW**. This is why they are scouring the country for **NEW INVENTIONS**.

**IF YOU HAVE AN INVENTION** send us a sketch or model and description and we will give you a **FREE OPINION CONCERNING ITS PATENTABILITY**. If you have no idea at present, write for our list of articles called for by manufacturers. We will also send you our book "WHAT TO INVENT," giving information which everyone should have.

*Both the list of inventions wanted and the book are free*

**Chandlee & Chandlee, Patent Attorneys, 537 7th St., Washington, D. C.**

# Wanted—Ideas

**Inventors! Send for these Remarkable FREE BOOKS, Today**

## "Inventions Needed"

This book lays before you a description of the active and profitable field of invention. It tells you the inventions the world needs today, the devices manufacturers are seeking for their business, the ideas for which the public will pay big money.

## "How to Get Your Patent"

This book is a guide to the inventor. If you have invented something and desire to learn what it will cost you to get your patent and what you must do to find your market, read this book.

## "Special Bulletin of Patent Buyers"

This bulletin contains letters from men who are seeking to purchase patents. We act as intermediary without one cent of charge, between the man who invents and the man who invests.

**Send Model or Sketch and description of your invention for Free Opinion as to patentability**

*Rejected and Difficult Cases are Our Specialty*

**RANDOLPH & CO.**

600 F St., N.W., Washington, D.C.

**RANDOLPH & CO.**  
600 F St., N. W., Washington, D. C.

Gentlemen: Please send me without obligation on my part, the books indicated on margin of this coupon. (Write on margin of coupon, names of books desired.)

NAME.....  
STREET.....  
CITY.....STATE.....





## THE Bausch and Lomb BALOPTICON

Entertains through the sense of sight as the phonograph does through the ear. The Balopticon is not a toy, but a very practical instrument, designed to meet every requirement of a projection lantern. Various models for use with lantern slides or for the direct projection of opaque objects, such as photos, post cards, specimens, etc. Also combination models for both methods, with instant interchange. The new gas-filled Mazda lamp gives an illuminating equipment superior to the old style arc lamp, but using less current. The entire instrument is simple enough for a child to operate. Prices range from \$26.50 up. Write for booklets about the Balopticon—also price lists.

### Bausch & Lomb Optical Co.

576 St. Paul Street, Rochester, N. Y.

New York Washington Chicago San Francisco

Leading American Makers of High Grade Optical Products.



Pictures sharp and brilliant to the corners—not dull and hazy

Type like this—  
not like this

**Simplex Ironer** Ends ironing drudgery. Free booklet on request.  
AMERICAN IRONING MACHINE CO., Chicago

## GET THIS SUIT

made to your own measure. It won't cost you one single cent. We will give it to you so you can show it to your friends and take a few orders. It will be a big advertisement for us. You can easily make from

**\$35 to \$50 EXTRA** Every Week

and besides that be the best dressed man in your town. It's an opportunity you cannot afford to overlook. Even if you only want to order a suit for yourself, don't fail to

**Write for OUR BIG OFFER**

Don't delay a minute. Drop us a line or send us your name on a post-card, and we will send you, absolutely free, our wonderful style book, containing 64 beautiful samples to choose from. **WRITE NOW.**

The Progress Tailoring Co., Dept. 878, Chicago



**BIBLE TO BE USED IN LITERARY TEST OF IMMIGRANTS**—The Department of Labor has announced that reading matter for a literary test for aliens will be taken from the Bible, from which passages will be selected in more than 100 languages and dialects. This is simply because the Bible is the only book available in virtually every language, and not because it is to many peoples a sacred book.

## "I Would Not Part with it for \$10,000"

writes an enthusiastic, grateful customer. "Worth more than a farm," says another. So testify over 100,000 Men and Women who have worn it.

## The Natural Body Brace

Develops erect, graceful figure. Brings comfort, health, strength and pep.

## Makes You Feel Good and Look Good

Replaces and supports misplaced internal organs; reduces enlarged abdomen; straightens shoulders; relieves backache, curvatures, nervousness, ruptures, etc., in both sexes. Fine after operations. Write today for illustrated booklet, measurement blank and our very liberal free trial proposition.

**HOWARD C. RASH, President**  
Natural Body Brace Co., 223 Rash Building., Salina, Kans.



Hand Forged  
Razor Steel  
Blades, No. 57



A Genuine \$2 Knife for 88c

Direct at Factory Prices

This \$2 KNIFE 88c Postpaid  
Hand Forged Razor Steel Blades

Handy shaped blade makes this knife best for mechanics, sportsmen and farmers; light but strong; re-sharpened easily. Stag handle, German silver finish; blades file tested.

hand forged from razor steel and warranted.  
Sample 88c. 3 for \$2.12 postpaid.

Send for our 100 page List and "HOW TO USE A RAZOR" **FREE**

MAHER & GROSH CO., 106 A. St., Toledo, Ohio

This NEW ELGIN ON 30 DAYS FREE TRIAL



**Adjusted**  
**17 Jewel Elgin**

This New Thin Model 17 Jewel Elgin is absolutely supreme where Reliability is a factor. Double sunk dial—Double Roller Escapement—Double strata 25 year Goldcase. It's just the watch you've always wanted.

**Send No Money! \$1.50**  
—A—  
**MONTH**

Easy Credit Terms As Low As  
Just send your name and address for this New Elgin with our Special \$5 Gold Chain Free, and our bed-rock confidential price will surprise and delight you.

**Sent on Approval** You do not risk a cent. We send this Watch and \$5 Chain complete on your own approval — also our 160 page **FREE CATALOG**, showing all kinds of Watches, Diamonds, etc., all on smilingly easy terms. **Send your name and address today.**

The House That Sells More Elgin Watches Than Any Other Firm in the World.

**HARRIS-GOAR CO.,** Dept. 225  
KANSAS CITY, MO.  
**WE DO AS WE ADVERTISE!**

It is estimated that the annual expense for military preparedness, \$750,000,000 a year, is insurance at the rate of one-half per cent per year, about the same as for insurance against fire, says the Buffalo Medical Journal.

## Sunshine Lamp 300 Candle Power FREE!

TO TRY IN YOUR OWN HOME

Turns night into day. Gives better light than gas, electricity or 18 ordinary lamps at one tenth the cost. For Homes, Stores, Halls, Churches. A child can carry it. Makes its own light from common gasoline. Absolutely SAFE.

**COSTS 1 CENT A NIGHT**

We want one person in each locality to whom we can refer new customers. Take advantage of our SPECIAL FREE TRIAL OFFER. Agents Wanted.

**SUNSHINE SAFETY LAMP CO.**  
159 Factory Bldg., Kansas City, Mo.



WEAR

Trade Mark  
Registered

**B.V.D.**

U. S. Patent Office  
and Foreign Countries

UNDERWEAR

Be Sure It's "POROSKNIT"  
GENUINE SUMMER UNDERWEAR  
Cool, elastic, comfortable—GUARANTEED  
Chalmers Knitting Co., 78 Washington St., Amsterdam, N. Y.

## When You Build

please bear in mind that there is still plenty of

**WHITE PINE**

Send for our free booklet, "WHITE PINE IN HOME-BUILDING"

**WHITE PINE BUREAU**

1626 Merchants' Bank Bldg. ST. PAUL, MINN.

# 10 Cents a Day

HERE you can get any known instrument sent to you for a free trial of one week in your own home.

And every article is offered at the rock-bottom price. You will be astonished at these values. And then—this rock-bottom price may be paid at the rate of only a few cents a day. Ten cents a day buys an exquisite triple silver-plated Lyric Cornet. But first write for our new catalog.

## WURLITZER

200 years of instrument making

The name "Wurlitzer" stamped on musical instruments has stood for the highest quality for nearly two centuries. We are manufacturers or importers of every known musical instrument and every one is sold direct to you at the rock-bottom, direct-from-the-manufacturers price. We supply the U. S. Government.

## One Week's Trial

Try out the instrument of your choice in your own way before you decide to buy. Compare it with other instruments. Test it. Use it just as if it were your own. Then after one week's trial—either pay a little each month or send it back.

## Take Your Choice

On this great special offer you have over 2000 instruments to choose from. Any one of these will be shipped to you for one week's free trial in your own home. The Cornet, Viola and Saxophone illustrated here are but three out of the thousands of remarkable offers that we make.

## Send the Coupon

But first put your name and address on the coupon now and get our big, new catalog absolutely free. Just state what instrument you are interested in and we'll send you the big 194-page book free and prepaid.

The Rudolph  
Wurlitzer Co.

Dept. 1198

East 4th Street,  
Cincinnati, Ohio  
S. Wabash Av.  
Chicago, Ill.

The Rudolph  
Wurlitzer Co.

Dept. 1198

East 4th Street,  
Cincinnati, Ohio  
South Wabash Ave.,  
Chicago, Illinois

Gentlemen:—Please send me your 194-page catalog absolutely free. Also tell me about your special offer direct from the manufacturer.

Name.....

Address.....

I am interested in.....  
(Name of instrument here)

Please Mention Popular Mechanics



## Big Fun— Little Cost!

If you have never played Billiards or Pool you can hardly realize the intense fascination of these fine, clean, interesting games. Just think what it would mean if you could control the balls, make the carom, combination and pocket shots, put the "English" on the ball, and make "follow" and "draw" shots!

It's practice, home practice, that makes the expert Billiard and Pool player. Begin now! Don't you want to "hold your end up" with your friends?

Afford it? Of course you can afford it! Why, it costs only a few cents a day (payable monthly) to purchase a

# BURROWES

## Billiard and Pool Table

These world-famous Tables are magnificently built. The most delicate shots, calling for skill of the highest order, can be executed with the utmost accuracy. In the finest homes in this land, including those of some of the famous experts, Burrowes Tables are used for home practice. Sizes of Tables range up to 4½x9 feet (standard) to fit any size room. No special room is needed—you can put up or take down your Burrowes Table in a moment.

## \$1 DOWN

Prices of Burrowes Tables range from \$15 up, on easy terms of \$1 or more down and a small amount monthly. Cues, balls, and full playing equipment are free with each Table.

### Here's Your Chance—Free Trial

On receipt of first installment we will ship the Table. Play on it one week. If unsatisfactory return it, and on its receipt we will refund your deposit. This insures you a free trial. Write for illustrated catalog, giving prices, terms of payment and full information.

Burrowes Tables are now on sale in many cities and towns, so you can inspect them before ordering if you wish. Write to us and we will tell you all about it.

## THE E. T. BURROWES CO.

166 Spring St., Portland, Me.  
San Francisco and Los Angeles Offices.

## TORREY Razors

make  
smooth  
shaving  
a daily  
delight

With a Torrey you always shave clean and smooth, because it has the perfect shaving edge. Adjusted to glide over the face at the right angle. Cuts close, without pulling, without roughing the skin.

### A Real Man's Razor—

this beautiful razor is one of the finest examples of Torrey skill in razor making. It guarantees comfortable shaving.

If your dealer hasn't Torrey Razors, write to us; we'll tell you where to get them, and send you FREE booklet, "How to Shave."

The Torrey Honing Strop has no equal.

The J. R. Torrey Razor Company  
Dept. P, Worcester, Mass.

IF IT ISN'T  
**AN EASTMAN**  
IT ISN'T A KODAK

## A Birthday Present

If you are racking your brains to think of a suitable birthday present—stop. Go to any dealer and ask to see Ingersoll watches. There are eleven kinds from a \$1 to \$3.

## Used Pianos

All standard makes; Steinway, Chickering, Emerson, Kimball, etc., \$55 to \$175. Used player-pianos \$195 to \$325. Easiest payments. No money down. 50 free music lessons. 30 days' free trial.

**BIG PIANO BOOK FREE**  
Beautifully illustrated, full of piano information, showing celebrated Starck pianos and player-pianos. Send today for book and latest bargain list.  
P. A. STARCK PIANO CO.,  
99 Starck Bldg., Chicago.

## SAVE MONEY ON SHOES

National Aluminum Shoes on wear several pairs of all-leather, rubber or wood sole boots or shoes, for work on farm, creamery, railroad, in mine or factory. GUARANTEED—break-proof bottoms. Waterproof—rust-proof. Noiseless, fit fine, easy walking. Keep feet dry, warm, comfortable. Removable cushion felt insoles. Best leather uppers. Removable friction taps take up wear, prevent slipping—easy to replace at small cost. Thousands of satisfied users. Money back if not satisfied after seeing and trying on. Write for free catalog giving prices, styles and how to order.

**NATIONAL ALUMINUM SHOE CO.**  
Box 35  
RACINE, WIS.

Please Mention Popular Mechanics

# HERMAN'S U.S. ARMY SHOES

Munson Last

This last was adopted by government experts after four years of severest tests in all phases of actual army life as the most perfectly constructed to meet the soldier's needs. It is comfortable. It protects the feet on the roughest marches. It will stand wear and tear and still look fit. Conforming to the natural shape of the foot it prevents foot troubles.

The shoe that will stand the strain of army life will meet the test of civilian needs in camp, machine shop or office—wherever work or recreation takes you.

Write for the name of a Herman dealer near you. Or you can buy from us by mail—fit and satisfaction guaranteed. Munson's, black or tan, \$7. Look for the shield trade mark.

Catalog of All Styles

FREE—Write for it

Jos. M. Herman Shoe Co.  
Army Contractors  
801 Albany Bldg.  
Boston, Mass.



# 5 MONTHS TO PAY

Tailor-Made-to-Order



Have your clothes made to order from finest, stylish fabrics by our expert tailors and take 5 months to pay.

Look into this offer—get the facts (all explained in our Style Book.) Try on the suit we make for you and if not an amazing value return it at our expense. Otherwise pay on our easy terms.

As \$1.00 Down  
As Little As

You can order by sending us little as a dollar down—and that back if you want to return the suit. Fit, workmanship and quality guaranteed.



Send Coupon For This FREE Book

STANLEY-ROGERS CO.  
Makers of Fine Made-To-Order Clothes  
CHICAGO, U.S.A.

### \$1000 Reward

Given in gold to anyone who can prove that we do not actually operate our own great tailoring shops and make to order from customer's measure every man's garment ordered from us.

### Save \$15 to \$25

See for yourself. Compare our fabrics with any elsewhere and see what our quantity buying and direct selling to customers saves you on high class tailor made-to-order garments.

This Big Style Book shows pictures in actual colors of garments made by us. You see exactly how you will look. Choose from the remarkable 70 cloth samples of the very pick and cream from leading mills. All prices and terms given too. Get this book even if you are not ready to order now. Get posted on the styles and the prices. The Style Book is free. Send coupon or a postal and get it now.

### STANLEY-ROGERS COMPANY

1015 Jackson Blvd. Dept. 1136 Chicago, Illinois

Please send me FREE your new Fall Style Book showing latest Metropolitan Styles, also 70 Cloth Samples and full particulars of your great \$1.00 down with 5-Months-To-Pay Offer.

Name .....

Address .....

Please Mention Popular Mechanics

# JOHNS-MANVILLE Asbestos

POP-CORN CRISPETTES MAKE BIG MONEY



\$1,500 Made One Month

Perrin, Cal., took in \$380 in one day. Almost the enormous profit of 400 per cent. \$1 cash returned you for every 25c spent. Not theory! Not guess work! But actual bonafide proven records of profits. Send for book.

1351 HIGH ST. W. Z. LONG CO. SPRINGFIELD OHIO



Plays All Disc Records

Victor, Columbia, Edison, Pathe, Emerson, Little Wonder Big and similar instruments selling for \$50. Our price much less. Sent anywhere for 30 days' trial. Get the Beautifully Illustrated Symphonola Catalog. Shows this and other beautiful styles.

### A Dime a Day Pays for This Symphonola

With it you'll enjoy the best Popular, Patriotic, Dance, Classical, Operatic, Sacred, Band records made by the world's greatest musicians. Write for offer today.

Larkin Co. Desk SPM-1117, Buffalo, N. Y.

**THIS  
MEANS  
YOU!**

# LEARN ELECTRICITY

No matter what your age is, you and every one of us can help our country, and the best way to help is as a trained man. Electricity is one of the most important lines of work both in civil life and in government service.

If you have a common school education you can easily qualify at home by my new Course in Electricity, no matter if you know nothing at all about electricity now. My Course, while quite complete and absolutely scientific, explains everything so clearly that anyone can understand it and do the work. This course is designed to help men become *bigger, better men*—men who can command big pay. Part of your spare time is all that is needed.

**CHIEF ENGINEER COOKE, Chicago Engineering Works, 449 Cass St., Chicago, Ill.**

# Uncle Sam Needs Trained Men

*Your Country Needs You*



## \$17 Electrical Outfit FREE

Every student who enrolls with me now gets a \$17.00 outfit of electrical equipment, instruments and material—FREE; also my Quick Money-Making Electrical Course FREE as soon as enrolled, so you can earn while learning; you also get FREE Employment Service. I am Chief Engineer of the Chicago Engineering Works and will give you my personal instruction and help. Write for Free Electrical Book.

### Motor Perfection

is what you get in Watkins Class "B" all iron motors. Especially fine for canoes and light boats. Constant and efficient.

3 H. P. single cylinder . . .	45 lbs.
6 H. P. double cylinder . . .	85 lbs.
12 H. P. four cylinder . . .	155 lbs.

Are light, at the same time strong, accomplished by using semi-steel castings, high carbon steel shaft, bronze bearings, high class workmanship.

**THE WATKINS MOTOR CO.**  
837-839 W. 6th Street Cincinnati, Ohio

### Universal MARINE MOTOR

9-12 H. P. 4 Cycle 4-Cylinder. Speed range 300 to 1800 R.P.M. Adapted to boats from 14 to 30 feet. Write to

**UNIVERSAL MOTOR CO.**  
OSHKOSH, WIS. Dept. P

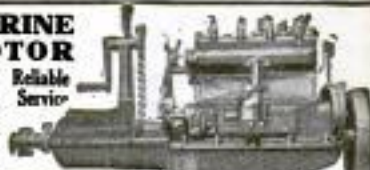

For Bulletin No. 25 giving full description

### EVINRUDE

Detachable rowboat and canoe motors. Magneto—Built-In Fly-Wheel Type. Silencer and Automatic Reverse. CATALOG FREE USED BY 25 GOV'TS. OVER 80,000 SOLD

**EVINRUDE MOTOR COMPANY**  
563 Evinrude Block Milwaukee, Wis.

### Mullins Steel Boats Can't Sink

When you think of buying a boat, whether it be a 16-foot Runabout, a big 26-foot Auto Boat, or something in between—remember that Mullins Steel Boats are guaranteed for life. They cannot sink, leak, water-log, dry out or open at the

seams—never require caulking. Designed by America's foremost naval architects—built in the largest boat factory in the world. More than 65,000 in use. Big catalog of steel or wooden motor boats, rowboats or canoes, on request.

**THE W. H. MULLINS CO., 52 Franklin Street, SALEM, OHIO**

GET THIS CATALOG FULL OF VALUABLE INFORMATION TO EVERY BOAT OWNER ON

### RACING PROPELLER WHEELS, REVERSE GEARS AND MARINE ACCESSORIES

LARGE CATALOG FREE. SEND TODAY

**MICHIGAN WHEEL CO.**  
1129 MONROE AVE., GRAND RAPIDS, MICH.

### Get this LA Engine Book



—it gives valuable information about motor boat engines. It also describes the full line of L-A motors and tells of the 30 days' free trial plan. Write for your copy today.

**LOCKWOOD-ASH MOTOR CO.**  
1430 Horton Ave. Jackson, Mich.

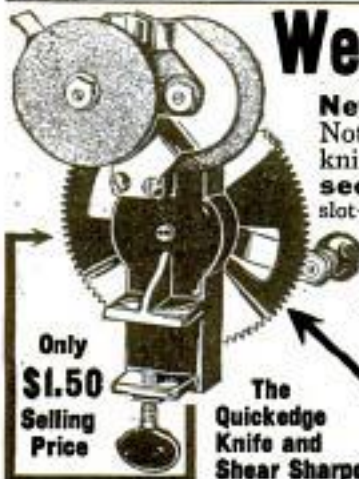

## We Want Agents at \$30 to \$75 a Week

**New Invention**—Just out. Needed in every home every day. Patented. Nothing else like it. Low priced—**Sells on sight.** Sharpens any kitchen knife, paring knife, carving knife, bread knife, or shears and scissors in **ten seconds.** Mechanical masterpiece. A child can use it. Just put knife in slot—turn crank—sharpens both sides at once automatically. **We want representatives at once**—men and women hustlers. Get this position where **profits start first day.**

### No Experience Necessary — 200% Profit

Make as much money next week as these men are making now. J. C. Lewis, of Kansas, says: "I have sold one hundred sharpeners in four days." Hobart Kerr, of Md., writes: "The women can hardly wait till they get them." Herbert Cain, of Ky., sold nine after supper. At the end of the first day, J. W. Gordon, of Pa., writes: "I sold two dozen and I sold to every one I saw." Wm. G. Hall, of N. J., says: "I think it is great. I sold six in about one-half hour. The machine is a mighty fine proposition. I am a mechanic and I know what I am talking about." You can make this money. **WRITE TODAY. TERRITORY FREE. GET BUSY AT ONCE.**

**QUICKEDGE SHARPENER CO., 692 Sharpener Bldg., CHICAGO, ILL.**





## Distinctive Homes at Guaranteed Costs!

GORDON-Van Tine Homes have an air of quality that separates them from ordinary "plan houses." Many adapted from work of America's best architects—inexpensive simplifications of town and country homes. All at Guaranteed Costs—the same everywhere. Our wholesale prices save you big money.

Full of home comfort ideas and built-in conveniences. Over 100,000 customers. Built in every State

# Gordon-Van Tine Co.

## Satisfaction Guaranteed or Money Back

—all climates. Shipped Ready-cut to fit—or not Ready-cut, as you prefer. Former method saves time, material, reduces cost. Shipped promptly anywhere.

Write for our new Book—200 plans—FREE! Just out —"Gordon-Van Tine Homes"—shows photos, plans and Guaranteed "Mill-to-Owner" prices on over 200 houses. Get it before you build. Use Coupon.

Use Coupon.

6513 Case Street

Established Half a Century

Davenport, Iowa



**GORDON-VAN TINE COMPANY**  
6513 Case Street, Davenport, Iowa  
Please send me FREE the books checked below:

Gordon-Van Tine Home Plans	Garages
Green-houses and Hothead Sash for the Home Grower	Summer Cottages

Name .....

Street and No. ....

City..... State.....

**\$5 TO \$10 A DAY** easily earned taking orders for our high grade Soaps and Toilet Preparations. Our goods well known — nationally advertised. Ladies and men make 100% profit. No experience necessary. Write for sample case offer.  
**CROFTS & REED CO., Dept. C-174, Chicago, Ill.**

**B&B Blue-jay Corn Plasters** Stop Pain Instantly End Corns Completely  
25c Packages at Druggists

**WRITE FOR FREE BOAT BOOK**

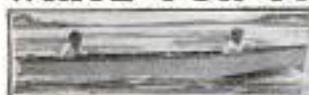

Build your own boat — From \$3 up for full-sized patterns — \$33 buys complete frame, 12-pas. 23-ft. Motor Boat. Write today.  
**BROOKS MFG. CO., 8211 Res. Av., Saginaw, Mich.**

**Engine User-Agents Wanted**  
Men wanted in every county to sell, demonstrate and sell "BIG BEN"—wonderful new gasoline engine for every work. Big demand. Liberal profits. Free details and introductory offer.  
G. Besenbald & Sons, Department 611, Hamilton, Ohio.

**WEBER Throttle-Governed VALVE-IN-HEAD KEROSENE ENGINES**

WILL SAVE YOU HALF IN FUEL COST. All 1917 Weber Engines are equipped with that great engine improvement, the "Weberator." Makes Kerosene as convenient to use as Gasoline. Saves 1/2 the cost. Write today for full details and 60 day trial offer. Hold direct to user at factory prices.  
**WEBER ENGINE CO., Dept. 1778 KANSAS CITY, MO.**



**OTTAWA KEROSENE ENGINES**

Latest design. Durable. Powerful. Reliable. Massive. Built to do hard, heavy work—to give lasting service. Uses Cheapest Fuel. Pulls 25 to 50% more H.P. than rated. Shipped as free month's trial. Easy terms. Sizes 1 1/2 to 22 H.P. 10-Year Guarantee. Book free — postal gets it.



Ottawa Mfg. Co. 535 King St. Ottawa, Kans.

FREE BOOK

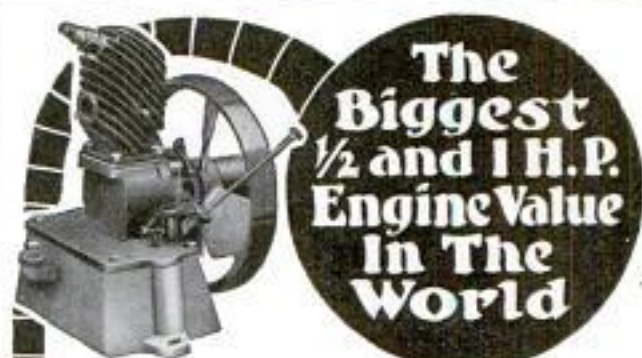

**The Biggest 1/2 and 1 H.P. Engine Value In The World**

Here is a chance to get a real engine at low cost. A small, light and powerful engine to run your grindstone, emery wheel, lathe, drill, wash machine, cream separator or any other light machine. The

**Maytag Multi-Motor**

solves the power problem for the home or farm workshop. Simple, easy and economical to run. Equipped to run with gas or gasoline. No cams, gears or valves to get out of order or cause expense. Two sizes—1/2 h. p. 35 lbs.; 1 h. p. 65 lbs. Use it anywhere. Easy to carry. Guaranteed for life. Write today for full descriptive circular and low factory-to-you price.

**THE MAYTAG CO.**  
Dept. 229  
NEWTON,  
IOWA

The Maytag Company

Please send me Multi-Motor folder and special low factory price.

**USE THIS COUPON**

Name .....

Address .....

Town.....

Please Mention Popular Mechanics

# New KEROSENE LIGHT BEATS ELECTRIC OR GASOLINE

10 Days FREE—Send No Money

Men With  
Rigs or Autos  
Make

**\$100 to \$300  
Per Month**

Our trial delivery plan makes it easy. No previous experience necessary. Practically every farm home and small town home will say after trying. One farmer who had never sold anything in his life before writes: "I sold \$1 the first seven days." Christensen, Wis., says: "Have never seen an article that sells so easily." Norring, Iowa, says: "92 per cent of homes visited bought." Phillips, Ohio, says: "Every customer becomes a friend and booster." Scamming, Minn., says: "No heavy talk necessary. Sells itself." Thousands who are coming money endorse the Aladdin just as strongly.

**No Money Required.**

We furnish stock to get started. Sample sent prepaid for 10 days' free trial and given absolutely without cost when you become a distributor. Ask for our distributor's plan. State occupation, age, whether you have rig or auto; whether you can work spare time or steady; when can start; townships most convenient for you to work in.



BURNS  
94%  
A.F.R.

**TWICE THE LIGHT  
ON HALF THE OIL**

We don't ask you to pay us a cent until you have used this wonderful modern white light in your own home ten days, then you may return it at our expense if not perfectly satisfied. We want to prove to you that it makes an ordinary oil lamp look like a candle; beats electric, gasoline or acetylene. Fussed by Insurance Underwriters. Children handle easily. Tests by U. S. Government and 35 leading Universities show that the new ALADDIN

**Burns 50 Hours on One Gallon** common kerosene (coal oil), no odor, smoke or noise, simple, clean, won't explode. Over three million people already enjoying this powerful, white, steady light, nearest to sunlight. **Won Gold Medal at Panama Exposition.** Greatest invention of the age. Guaranteed.

**\$1000 Reward** will be given to the person who shows Aladdin in every way (details of offer given in our circular). We want one user in each locality to whom we can refer customers. To that person we have a special introductory offer to make, under which one lamp is given free. Write quick for our 10-Day Free Trial Offer and leave **Yours FREE** how to get one free, all charges prepaid. **Yours FREE**

**MANTLE LAMP CO., 312 Aladdin Building, CHICAGO, ILL.**  
Largest Kerosene (Coal Oil) Mantle Lamp House in the World

**Get One FREE**



## Powerlight

Again awarded Gold Medal Int. Exp. Only Portable Lamp approved by Underwriters. Highest endorsement—Used by U. S. Army. Burns Common Kerosene or Gasoline. Equal Safety. 335 C.P. 20 Hrs. 1 qt.

**LOW COST—  
BIG PROFITS**

No Wick.  
No Chimney.  
No Torch. No Danger.  
No Odor.

Positive guarantee—Sells on sight—No experience necessary. 20 Styles—AGENTS WANTED. Exclusive territory.

**POWERLIGHT CO., 543-A Broadway, NEW YORK**



## Beacon Lamp FREE

**Lights Your Home Like Day!**  
100 Candle Power Incandescent pure white light from (kerosene) coal oil. Beats either gas or electricity. **Costs Only 1 Cent for 6 Hours**

We want one person in each locality to whom we can refer new customers. Take advantage of our Special Offer to secure a Beacon Lamp FREE. WRITE TODAY. AGENTS WANTED.

**HOME SUPPLY CO., 111 Home Bldg., KANSAS CITY, MO.**

**RECTIFIERS** for garages. All sizes. Charge from alternating current 1 to 8 batteries. \$12.00 upwards.  
**AMERICAN BATTERY CO., 1137 Fulton St., Chicago. (Estab. 1888)**

## Earn \$27.50 A Day Easily



Work all or spare time. Own a business of your own. Akron Lighting Systems wanted in homes, stores, churches, public buildings. Best and cheapest light known. Uses common gasoline. Absolutely safe. Permitted by insurance companies.

**SELL AKRON LIGHTING SYSTEMS**  
Simple, dependable, durable. Has latest patented improvements. Gives abundance of bright, clear, soft, steady light which is restful to the eyes. Complete line portable lamps, lanterns. Fully guaranteed. Exclusive territory to Agents. Offer Free. Write NOW for Catalog, agents proposition, all FREE.

**AKRON GAS LAMP CO., 111 Gas Bldg., Akron, Ohio**

## For Light That Never Fails Use the "Storm King" Lantern 350 C.P.

Burns Kerosene or Gasoline—Gives Powerful, Bright, Sure, Satisfying Light. Learn how easily and cheap you can obtain the "Storm King" and other Lamps and Lighting Systems. Write now.

**BIG PROFITS FOR AGENTS**  
**NATIONAL STAMPING & ELECTRIC WORKS**  
Dept. 4 410-424 S. Clinton St. CHICAGO



## 300 Candle Power of Light at a Cost of 1-8c Per Hour Burns Kerosene or Gasoline

This lamp generates and burns its own gas from ordinary kerosene. "QUICKLIT" gasoline lamps can be lit with an ordinary match like city gas.

Write today for illustrated catalog of our complete line of kerosene and gasoline lamps, lanterns, Agents Wanted and lighting systems.

**The Nagel-Chase Mfg. Co.**  
176 East Erie St., Chicago



## WHITE FLAME

**BURNERS** make your old kerosene lamps and lanterns give a brilliant white light better than electricity or gas. Doubles your light. Saves oil. **NO MANTLE TO BREAK.** Guaranteed Safe and Reliable. Delights every eye. Send now for complete sample postpaid 25 cents, stamps or coin. 3 for \$1. **MONEY BACK IF NOT SATISFACTORY.** Live Representatives Wanted. Exclusive Territory.  
**WHITE FLAME LIGHT CO., 68 Clark Bldg., Grand Rapids, Mich.**



## The "BEST" LIGHT



Positively the cheapest and strongest light on earth. Used in every country on the globe. Makes and burns its own gas. Casts no shadows. Clean and odorless. Absolutely safe. Over 200 styles. 100 to 2000 Candle Power. Fully Guaranteed. Write for catalog. AGENTS WANTED EVERYWHERE.

**THE BEST LIGHT CO., 324 E. 5th St., CANTON, O.**

## GREEN AUTOMATIC MACHINE



**Let This Machine Grind Out Money for You**

**THE GREEN AUTOMATIC MACHINE \$10 A DAY AND UP**

Sharpens, Honors and Strops all kinds of safety razor blades in one operation, from four to six blades in one minute. For both quality and quantity this machine is in a class by itself. There is nothing like it on the market. Let us send you our free booklet explaining everything, including the "AMERICAN" Key Cutter—cuts square, angular or round slots. Liberal proposition to State Agents.

**AMERICAN SHARPENING MACHINE CO. (Inc.), 184 W. Washington St., Dept. 11, CHICAGO**

## "AMERICAN" Key Cutter





**LISTERINE**  
The Safe Antiseptic

**A SUPERIOR** antiseptic to be used immediately as a dressing to prevent infection of any cut, small wound or abrasion.



### SMALL ENGINES

Perfected Gasoline Engines— $\frac{1}{2}$ , 1 and 1 $\frac{1}{2}$  h. p.—for Farm and Shop use. Price \$19.50 and up. Also

### WASHING MACHINES

We ship on trial. Send for Booklet and Special Offer.

SEVERKROPP ENGINE CO. RACINE, WIS.

1224 18th St.

### STARTER for FORD CARS

## Health? Take Turkish Bath at Home—Only 2 Cents



Physicians are abandoning drugs for this new treatment. If your mind or body is tired, open your pores and feel the rapid change in your condition, at cost of 2c a bath. The Robinson Bath Cabinet is the only scientifically constructed bath cabinet ever made for the home. Great \$2 Book Sent Free—"The Philosophy of Health and Beauty." Write today. Agents Wanted. **ROBINSON MFG. CO.** 915 No. 12th St. TOLEDO, O.

# Deafness



Perfect hearing is now being restored in every condition of deafness or defective hearing from causes such as

Relaxed or Sunken Drums, Roaring or Hissing Sounds, Perforated, Partially Destroyed Drums, etc.

### Wilson Common-Sense Ear Drums

"Little Wireless Phones for the Ears"—

require no medicine but effectively replace what is lacking or defective in the natural drums. They are simple devices, which the wearer easily fits into the ears where they are invisible. Soft, safe and comfortable to wear at all times.

Write today for our 168 page FREE book on DEAFNESS, giving you full particulars and plenty of testimonials.

**WILSON EAR DRUM CO., Incorporated**  
1023 Inter-Southern Building LOUISVILLE, KY.

# Why Pay Full Prices for Diamonds

Christmas Offerings Ready

## HERE you can get diamonds at

wonderful savings, proved by customers' letters. Diamonds which originally sold at full prices. The exact qualities for which full prices are paid today. Any new mounting you prefer. Encased in a handsome gift box. And you can try to match it at full sixty per cent more.

## Diamond Banking

A house over 60 years, and rated over a million dollars in the business of diamond banking—lending money on high grade diamonds, watches, and other jewelry. When the money we lend is not repaid, we must sell the diamonds.

### Look These Over

$\frac{1}{2}$ — $\frac{3}{32}$  kt. exact weight of fine blue-white, perfectly cut, genuine diamonds. A magnificently brilliant gem set in white gold ten-stone ring. You can try to match at fully sixty per cent more. Guaranteed Cash Loan \$45. Unpaid Loan Price \$55

A distinctly new cluster of large unpaid loan diamonds set to give effect of solitaire of glittering brilliancy. New effect with platinum like top. Try to match at sixty per cent more. Unpaid Loan \$43.50 Price \$55

1— $\frac{1}{8}$ ,  $\frac{3}{64}$  kt. actual weight but larger in appearance on account of dramatic spread make and well balanced proportion. A perfectly cut, blue-white fine quality stone in gentleman's 14 karat solid gold ring. Try to match at \$460.00. Guaranteed Cash Loan \$200. Unpaid Loan Price \$279

Many wonderful watch bargains are shown in our bulletin. Here's a 21-jeweled double roller, full-size Hamilton in a serviceable case. Guaranteed good as new and to pass railroad inspection. Try to match at \$37.00. Unpaid Loan Price \$17.95

## Sent on Approval!

We will be glad to send you, prepaid, on approval, and without obligations, any of our bargains for FREE EXAMINATION. See them for yourself—examine them before you decide to buy. Liberty Bonds accepted as cash.

## To Make Quick Sales We Offer Astonishing Bargains

Savings of 60 per cent on our prices. Hundreds of customers' letters testify that they have made this saving. Write for our bulletin today.

## Guaranteed Cash Loans

Diamonds bought here are like insurance policies. You know what you can borrow before you buy—see our Cash Back Guarantees.

## Send the Coupon!

Hundreds of special bargains listed in this new bulletin. Write for it today. Not just one quality of diamonds, but all qualities are shown in this remarkable bulletin. Your name and address on the coupon is enough, but write NOW.

**Jos. DeRoy & Sons**  
- Only Exp. Post Office  
1932 DeRoy Building  
Pittsburgh, Pa.

Reference by permission:  
Farmers' Deposit  
Nat. Bk.,  
Marine Nat.  
Bk., and  
Pittsburgh  
Daily News-  
paper.

Name \_\_\_\_\_

Address \_\_\_\_\_

Jos.  
**DeRoy & Sons**  
1932 DeRoy Bldg.,  
Pittsburgh, Pa.

Gentlemen:—Please send me, absolutely free and prepaid, your new Bargain Bulletin of diamonds, watches and other jewelry. It is distinctly understood that I assume no obligation of any kind.

# Oh! Here's What You Want for

## a Real Lionel Train!

Zingo! How it speeds away the instant you touch the switch. But why not? It's a real, electric train patterned after the big ones — run by a powerful high-speed electric motor. For a million of thrills, get a Lionel Train! Made of heavy gauge steel, beautifully enameled, unbreakable; good for years of fun. Operates at low cost on batteries, or on house circuit with Lionel Multivolt transformer. Absolutely safe.



Send for My Big Free Xmas Catalog — showing complete line of freight and passenger sets; over a hundred fascinating pictures. Pick out your gift and, if not at your dealer's, I'll ship prepaid on receipt of price.

J. Lionel Cowen, Pres. The Lionel Mfg. Co., 48-G, E. 21st St., New York City

# LIONEL ELECTRIC TOY TRAINS

& Multivolt Transformers

### LOOK! A Dandy New Lionel Transformer

Attaches to your house current. Runs all electric trains and electric toys and small apparatus, 2 to 30 volts. At your dealer's or shipped prepaid on receipt of \$5.40. Others up to \$8.00.

**\$3.40**  
Cheaper Than Batteries

Blades so high quality as to cut nails or hairs

**AGENTS WANTED SPARE TIME**

**EARN \$75 TO \$250 A MONTH** KNIVES AND RAZORS made of Car-Van (Old Damascus) steel, Scientifically Tempered, Photographically Handled. Entirely new. Sell on sight. Write for Special Agency Proposition. Send 5c stamps for Easy Money Booklet. \$1.00 for Sample Knife, your name, address and any emblem to handle.

**THE CANTON CUTLERY CO., Dept. 59, CANTON, O.**

### Thordarson Improved

## TOY Transformer



An ideal Christmas gift for a live boy. Runs a dozen toys at once. Connects direct to light circuit, doing away with heavy, expensive batteries. Large capacity—11 different voltages; absolutely safe. Economical. Lasts forever. **PRICE, \$3.00.**

Write Today for Description  
**THORDARSON ELECTRIC MFG. CO.**  
501 S. Jefferson Street CHICAGO

### Super-Sensitive Microphone Only \$7.50

This instrument is offered at an extremely low price. It is excellent for building your own amplifier. Can also be used in many experiments where a sensitive microphone is required.

### Detectograph, \$15

This detecting instrument of marvelous sensitivity can be used for detecting secret conversations. Outfit consists of Sensitive Transmitter, 25-ft. Black Cord, Receiver, Headband, Case and Battery.

Send for One Today and Convince Yourself.

Detectograph, \$15

### THE \$15 MICROPHO DEAF-PHONE

is a super-sensitive instrument which has been developed to meet the demands for a practical and efficient hearing device at an extremely low price. It is equal to any \$35 instrument made and superior to most of them. The outfit consists of One Super-Sensitive Transmitter with cord connector; One Super-Sensitive Ear Piece with small black cord; One Black Single Headband; Black Case and Two Batteries. Write today for free booklet.

**MICROPHO-DETECTOR COMPANY**

Gaston Boissonnault, President

**25 DEY STREET NEW YORK**

Makers of Super-Sensitive Microphone Apparatus

## DIAMONDS AND WATCHES ON CREDIT

### SENSATIONAL WATCH SALE

ELGIN, HOWARD, WALTHAM or any Watch you want

Easy Payments and Free Trial.

Free 90-page Catalog. Send for it.

### GREAT DIAMOND SALE

SPECIAL \$39.50 GENUINE DIAMOND RING

A Wonderful Value, \$4.50 per month

30 DAYS' TRIAL

The most astounding sale of perfect cut Diamonds ever offered.

TERMS LOW AS \$1.50 PER MONTH

No Money Down. FREE TRIAL

ALFRED WARE CO., St. Louis, Mo., Dept. 782

**Free Catalog**



# All Metal-White Enamel

## Get Kalamazoo Quality

SEND for our new catalog and learn how little it costs to own this wonder of a cabinet—white enameled—all metal porcelain enamel sliding top—nickel trimmings. Glass rolling pin, patented bread board and 8-piece crystal spice set included free.

**Write Today**—Get our "direct-to-you" price—cash or easy payments. We pay freight—quick shipment—30 days' trial, 300,000 customers boosting for Kalamazoo products. Write today.

Ask for Catalog  
No. 15

Kalamazoo Stove  
Company  
Manufacturers  
Kalamazoo, Mich.

Stoves, Ranges,  
Gas Ranges,  
Furnaces, White  
Enameled, All-  
Metal Kitchen  
Cabinets, Tables.

A Kalamazoo  
Direct to You



## Lift Corns out with Fingers



A few drops of Freezone applied directly upon a tender, aching corn stops the soreness at once and soon the entire corn or callus loosens and can be lifted off with the fingers without even a twinge of pain.

## Freezone

Removes hard corns, soft corns, also corns between the toes and hardened calluses. Does not irritate or inflame the surrounding skin or tissue. You feel no pain when applying it or afterward.

Women! Keep a small bottle of Freezone on your dresser and never let a corn ache twice.

Small bottles can be had at any drug store in the U. S. or Canada

THE EDWARD WESLEY CO. CINCINNATI, OHIO  
Please Mention Popular Mechanics



## Here's Health

—vim, vigor, vitality! The keen, vivid relish of youth for work and pleasure! **Snap, ginger, punch in every thought and action!** The joy of glorious health, strength, power, life—yours through vibration.

Wake up that sluggish circulation! Send the rich, red blood leaping along through every vein and artery! Tune up those jangled nerves! Stir up those sluggish organs! Flood your whole body with health! Don't be satisfied with mere existence! **Begin to live!**

## Arnold Vibrator

Try this wonderful machine yourself. Test it on your own body. Notice the difference after the very first treatment. See how pleasant and easy it is to use—how marvelous the results. And don't forget that these results are permanent because vibration gets right at the cause of things—goes to the very root of the trouble. Aches and pains vanish like magic. You don't need to take anybody's word for these things—you can find out for yourself.

## 10 Days' Trial Free

Get the facts about our generous free trial offer. Learn how you may get these things yourself **at our risk**, and if you are familiar with the prices asked for ordinary vibrators you will be amazed to find how much less it costs to own the genuine guaranteed Arnold Vibrator. When there is so much at stake why risk buying an imitation unknown machine? Insist on the Arnold. Ask for it by name.



## 80-Page Book Free

Your name and address on the coupon or a postal or letter brings you valuable 80-page book on Vibration free and full particulars of our special offer.

ARNOLD ELECTRIC CO., 1488 W. 12th St., Racine, Wis.

## Mail Coupon For FREE Book

ARNOLD ELECTRIC CO., 1488 W. 12th St., Racine, Wis.

Please send me your big illustrated Book and 10 days' TRIAL REDUCED PRICE OFFER, all free.

Name .....

Street .....

City..... State.....



## STRUCTO

Boys' Engineering Outfits

**Greatest Toy Ever Invented  
For Real Boys**

Structo is a miniature of the mechanical world for boys. The famous Structo Girder is the only girder from which all types of beams can be made.

Structo enables you to make regular working models, engines, battleships, bridges, sky-scrapers, pile drivers, clocks, steam shovels, elevators and hundreds of other things—just like famous engineers and inventors make. Then you connect your motor and they work just like the real machines do.

The Structo book shows you how to make hundreds of working models. You can design many other models yourself.

### Power Electric Motor

goes free with outfits Nos. 4, 5, 6 and accessory outfit No. 3-A.



**Structo Gears** are wonder gears—deep cut—sure to work.



### STRUCTO AUTO BUILDER

A Toy That Includes All the Mechanical Principles of a Real Automobile



Has a triple unit motor, a real steering apparatus—transmission with three speeds—first, second, reverse and brake. Also a differential gear that is a duplicate of the gears used in present-day auto construction. The body is of a roadster type. You build it yourself—you make a real working automobile.

**Structo Manufacturing Co.**  
FREEPORT, ILL.

Write Today For Full Particulars.

Do <sup>YOUR OWN</sup> Plumbing or Heating  
Our New **EASY WAY**  
Buy From Us Direct—Save 1/2



### Send for Our Big Valuable "Handy-Man" Book

Shows over 10,000 different fixtures and supplies in plumbing and heating goods at Wholesale, with our new easy adjustable installing features.

OUR HANDY-MAN BOOK shows and tells you how to properly install our new cut-to-fit STEAM, HOT WATER, or HOT AIR HEATING PLANTS, or plumbing outfits, and how to make any plumbing or heating repairs. Any handy man with a few ordinary tools, and the help of our free planning service, can properly do the work himself.

### "Our New Hardin Easy Way"

To avoid sending this large 236 page, well bound, valuable book broadcast, we ask a temporary deposit of 25c, which will be refunded on first order. Or if you are not satisfied, return book, and we will refund your money at once.

Every home owner, contractor, farmer, institution, etc. needs this BIG HANDY-MAN BOOK. WRITE TODAY.

**HARDIN LAVIN CO.**

40 Years at

4540-50 Cottage Grove Avenue  
Dept. E CHICAGO, ILL.

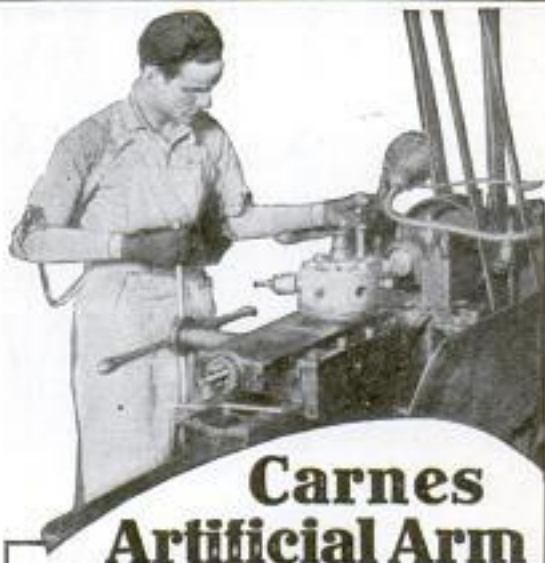

## Carnes Artificial Arm

has put Louis Rondeau back on the payroll as a wage-earner. He now is employed in a big Kansas City factory operating a machine. Both of his arms have been amputated and he wears two Carnes Artificial Arms. His salary and efficiency have not been lessened.

Endorsed by surgeons everywhere, the Carnes Arm has been declared to be the best substitute ever invented for a natural arm. Is the only arm with full finger motion, hand turning and bending wrist and bending elbow.

**Awarded Gold Medal at San Francisco,  
San Diego and London.**

Write in today for big illustrated Catalog B.25 containing pictures and testimonials from wearers of Carnes Arms.

**CARNES ARTIFICIAL LIMB CO.**

31 Carnes Bldg.,  
904 East 12th St. Kansas City, Mo.

# VENUS 10¢ PENCIL

**T**HIS is the famous drawing pencil chosen by the most prominent engineers, architects, artists and draftsmen. *Unequaled for smoothness!* 17 perfect black degrees from 6B to 9H hardest and hard and medium (indelible) copying. Use it for your work!



## FREE!

This trial box with five *VENUS* Drawing Pencils, Holder, and Venus Eraser sent free! Write for it.

**American Lead Pencil Co.**  
249 Fifth Ave., NEW YORK  
and Clapton, London, Eng.

The government has recently issued a pamphlet giving the best methods of saving coal used for domestic heating purposes. The pamphlet, known as "Technical Paper 97," may be had by making application to the Bureau of Mines.



Cash with order buys this small  
**\$3 BENCH LATHE**  
Swing 3 in. 8 in. C. to C. Shipping Wt. 10 lbs.  
**PETER AUSTIN, 810 W. First P.M., MUNCIE, IND.**



**B-E-T-T-E-R MUSIC**  
**Williams' Sounding Board**  
Placed under record on any disc phonograph.  
SEND \$1.50 TO  
**O. B. WILLIAMS CO., Seattle, Wash.**  
U. S. A.  
Manufacturers Sash and Doors.

## AGENTS — KEROSENE (COAL OIL) BURNER

**MAKES ANY STOVE A GAS STOVE**

**FREE Sample to Workers**

Makes its own gas from Kerosene (coal oil). Gives every home a gas stove. Absolutely safe. Cheapest fuel known.



**Cooks a Meal for 2 Cents** Agents just coinng money. Women wild about it. No more overheated kitchens. No more danger from gasoline.

**Safe, Clean, Odorless, Cheap** Every home a prospect. Low price makes quick sales. Easy to carry and demonstrate. Big profits. Your territory is open. Write today.

**THOMAS BURNER CO., 2648 Gay St., Dayton, Ohio**

Please Mention Popular Mechanics

## ANY WATCH YOU WANT on CREDIT



### 1917 Models

**WALTHAM  
HAMILTON  
ELGIN, MILLER  
Illinois, Howard**

Sent on **30 Days Free Trial**

## No Money Down

**Express Prepaid in Advance by Me**

You take no chances with me. I am "Square Deal" Miller and I trust the people. That is why I am doing the greatest Credit Watch, Diamond and Jewelry business in the country. Suppose you want any one of the country's best makes of watches? Name any one, I have it for you. No money Down, Express Prepaid. A full month to carry it in your pocket and the easiest of Long Time Payments. That's the best that tells. All these watches **GUARANTEED 25 YEARS**

## I Smash the Terms

**No References Demanded**

My terms are made to suit you. You get unlimited credit, with no red tape, notes or collectors. All unnecessary detail left out.

**An "Open Charge" Account**

the same kind of credit you get from your grocer. No matter where you live or what your income is, you can now own the finest watch, a beautiful diamond or any rare jewelry and never miss the money.

## Costly Catalog FREE

Send me your name and address so I can mail you, Free and postpaid, the most beautiful catalog of its kind ever printed. I want you to have this book. It's a gem. It illustrates all makes of valuable Watches, Elegant Genuine Diamonds, and a vast assortment of Beautiful Jewelry, all on the easiest and most liberal terms

**Square Deal MILLER**  
PRES.

934 Miller Bldg., Detroit, Mich.



**BE THRIFTY  
BUY A DIAMOND  
PAY MONTHLY**

**MONEY REFUNDED  
IF YOU CAN BUY  
CHEAPER FOR CASH.**



**Fine Diamonds**

Our diamonds are all perfect cut beautiful stones, white in color and lots of fire.

**SQUARE DEAL  
MILLER  
PRES.**

**Fine Diamonds**

You cannot buy by mail better diamonds at any price than we are selling on credit.

**FREE CATALOG COUPON**

**SQUARE DEAL MILLER, Pres.**  
934 Miller Bldg., Detroit, Mich.

Please send me your 1917 Catalog and explain fully your 30 Day Trial Plan and Easy Terms

Name.....  
Address.....

**Identify Kwik-lite by These Features**

The Telescopic Joint near the center of Kwiklite, the Quality Flashlight, permits easy access to battery for inspection or renewal. The Self-Locking Switch allows constant or intermittent light. Protect yourself against substitution by looking for these points of perfection. Illustration shows 3-Cell Metal Tubular Kwiklite No. 6343. Beautifully nickled. Complete with Seamless Battery and Mazda Bulb, only \$1.75. If your dealer can't supply you send direct. Booklet 37, describing the entire line of 88 different models, sent free. Renew any flashlight with Kwiklite Seamless Batteries. 25% longer service guaranteed.

THE USONA MANUFACTURING CO., New York Toledo San Francisco

## SAVE 25% to 60% ON GRAFLEX-KODAKS

AnSCO, Rexo and Premo Cameras

10-Day Free Trial Guarantee

If unsatisfactory, money will be refunded in full.



Complete Line of  
Motion-Picture Cameras  
Write at Once For Our Free  
Bargain Book  
and Catalog

listing hundreds of  
slightly used and new  
cameras, also supplies  
of every description.

No matter what camera you want, we can save you money. Compare our prices with others on slightly used and new cameras and we know you will be another one of our satisfied customers. Our prompt and fair dealing will please you. Established in the Photographic Business over 18 years. (5)

**CENTRAL CAMERA CO.**

Dept. 1308, 124 S. Wabash Ave., Chicago, Ill.

Give HIM  
This  
Wonderful  
Gift!

Give the "lucky man" a fishing rod and reel outfit. Write for Illus. "Bristol" and Meek Catalogues and study for yourself all the fine points of these prize winners.

For Bait Casting, "Bristol" De Luxe, \$25, and Meek No. 3, \$33; or "Bristol" No. 33, \$12, and Meek Blue Grass Reel No. 25, \$12. For Fly Casting, "Bristol" De Luxe, \$25.00 and Meek Reel No. 2, \$32, or "Bristol" No. 8, \$4.50 to \$6.25 and Meek Blue Grass Reel No. 33, \$7.50. The All Purpose Rod— "Bristol" No. 11, \$4.50 to \$6.25 and Meek Blue Grass Reel No. 5, \$15.00— or any combination made up of our offering of over 60 different "Bristol" Rods and Meek and Blue Grass Reels. If your dealer cannot supply you, we will fill your order at catalogue prices.

The Horton Mfg. Co. 196 Horton St. BRISTOL, CONN.

The U. S. War Department is in need of inspectors of ordnance equipment and an examination for such positions has been announced by the Civil Service Commission. Those interested should write to the Equipment Division, Inspection Section, 1330 F St., N. W., Washington, D. C., or to any office of the U. S. Civil Service Commission, for full information.

## A Marvel of Modern Science THE ILLUMINAL GAS LIGHTER

No carbon, flint or alcohol, or parts to get out of order. Just hold over open gas jet and it lights immediately. Works on coal and water illuminating gas.

Wonderful agents' proposition— send for particulars, or 25c for sample.

The Illuminal Corporation  
64 Murray St. New York



## WE ARE READY TO PROVE THE EXCELLENCE OF OUR BREECHLOADER

Our Claim That It IS THE FIRST and ONLY Positively DRY "JUICELESS", "HEELLESS", "CLOGLESS", SWEET, SANITARY, OPEN SAFETY Smoking Pipe Ever Devised IS Backed By Our BONA FIDE GUARANTEE To Make Good Or REFUND The Purchaser's Money UPON DEMAND. Such A Proposition Precludes Further Parley. The Practical Man Cannot Fail To See Genuine and Feasibility In This NEW SIMPLE Method. HOW DOES IT LOOK TO YOU? Surely GOOD ENOUGH To Try With ALL CHANCE ELIMINATED.



## THE BREECHLOADER

Is EXTREMELY SIMPLE, Most Substantial and Practical; Neat and Unique in Design; A Very Desirable Size; 5 1/2 in. long With Graceful Curves; A Little on the "Chubby" order, Half Bent; Considerably Lighter, Holding about one-fourth more Tobacco than the ordinary pipe of the same size. The bowl and breech Plug are made of FIRST QUALITY, GENUINE FRENCH BRIAR; Given a Rich, Natural, Friction Finish; Solid Rubber Stem; Sterling Silver Mounted With Aluminum Clog Eliminating Shield. Price Including Nickel Plated Pipe Companion \$1.00 Postpaid. Or Write For Free Booklet.

THE BREECHLOADER PIPE COMPANY, Inc.  
SUITE 6 B, 335 BROADWAY, NEW YORK, N. Y.



# Prest-O-Lite

For  
Motorcycles

## The Best Light for Your Motorcycle

To every motorcycle rider—bent on business or pleasure—clear, brilliant, dependable light is of vital importance.

Prest-O-Lite is the ideal light for motorcycles. It is easy to install, requires practically no attention and costs less to buy and operate than any other efficient lighting system.

The flame of Prest-O-Lite is always steady and powerful, flooding the road ahead with a clear, white light that penetrates rain, fog, dust or smoke.

### Practical, Safe and Inexpensive

Because of its simplicity, economy and safety Prest-O-Lite is the light for constant service—it is sturdy, practical and trouble-proof.

Bumps and jolts to your machine do not affect it—it stands all kinds of hard usage in night rides over rough roads, without injury.

Get Prest-O-Lite on your motorcycle and prove to yourself its many advantages and economies. Your dealer can fit you out with the necessary equipment. See him today.

Write today for literature explaining the simplicity of a Prest-O-Lite installation.

**The Prest-O-Lite Co., Inc.**

U.S. Main Office & Factory, 265 Speedway, Indianapolis, Ind.  
Canadian General Office, Dept. N-8, Toronto, Canada.

*The World's Largest Makers of Dissolved Acetylene*

**Prest-O-Lite Exchange  
Agencies Everywhere**



## Unparalleled Suit Offer!

We will tailor a suit to *your own measure* and send it to you on approval.

**\$5<sup>00</sup>** And we will send you any suit. Take your pick from our fine big style book. Then pay the balance in small monthly amounts. If the suit sent you is not the best fit and the best value you ever had, send it back. We refund every cent you paid—you are not out a single penny.

But send the coupon now for our new Fall Style Book—and get the benefit of our new low prices. The men who write now—immediately are the men who get the lowest prices. We cannot guarantee that the low prices in our Fall Style Book will last long.

### Guaranteed ALL-WOOL

On account of the high price of wool, more cotton and wool mixtures are being used now than ever before. Don't buy any suit without an "All-Wool" label, guaranteeing all-wool fabrics. The government gives you this protection. Use it! In every Babson suit you'll find the all-wool guaranty.

### Send the Coupon For Style Book!

The Fall Style Book is ready. It is handsomely printed in full colors and shows the newest New York Styles. With book comes 40 large samples of the all-wool fabrics from which you're to choose. Write,

**Babson Bros. Dept. 1198  
W. 19th St., Chicago, Ill.**

**Babson Bros.**  
Dept. 1198 19th St.  
Chicago - Illinois

Gentlemen: Please send me your free colored Style Book and 40 cloth samples of the real goods for suits and overcoats. Also explain your easy credit terms and put me on your preferred list.

Name .....

Address .....

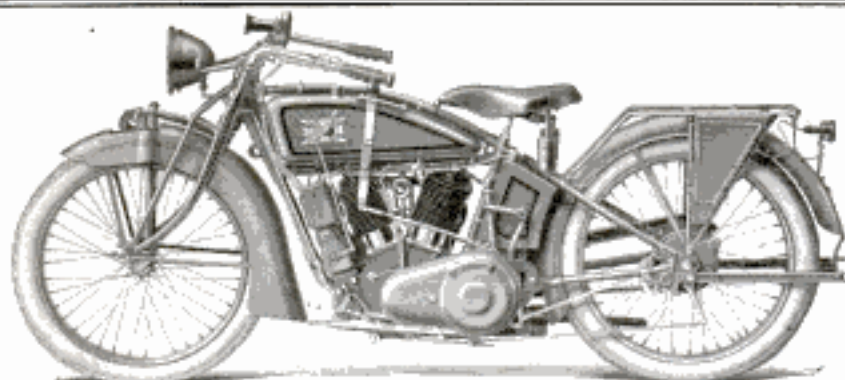

An Achievement  
of Science

## The Master Motorcycle

Series 19  
Military Model

# EXCELSIOR

We announce with pride the appearance of the Excelsior, Series 19, Military Model Motorcycle.

Like all of the Excelsiors of the past ten years the new Excelsior leads the field in excellence of workmanship, and in the strength and goodness of materials, and like all its predecessors is possessed of many features of superiority which, many of them Exclusively Excelsior, tend to make the Excelsior Series 19, the Master Motorcycle of the year.

### A Few of the Features

Extra Large, roller bearing, multiple disc clutch, with removable bearing faces.

Double Truss, Military Type Front Fork, the strongest fork ever put in a motorcycle.

Excelsior Kusion sprocket equalizes the pull and conserves every ounce of power delivered by the motor.

Removable Center Bar permits quick and easy access to the motor and removal of cylinders without interference with any other part of the power plant.

Inclosed clutch and motor drive chain, protects these important parts from dirt and road grit.

Foot starter and Automatic Compression Control, assure a quick and easy start always — in any kind of weather.

Tubular steel luggage carrier with steel tool box.

Rustproof, Military Olive Drab Finish, including hubs, spokes, etc.

The Finest Motorcycle on the Market.

**EXCELSIOR MOTOR MFG. & SUPPLY CO., 3702 Cortland Street, CHICAGO, ILL.**

## SEND for CATALOG P28

It will be pocket size, 8x4½ and will contain 248 pages with over 1,100 illustrations, describing in plain, clear language all about Bells, Push Buttons, Batteries, Telephone and Telegraph Material, Electric Toys, Burglar and Fire Alarm Contrivances, Electric Call Bells, Electric Alarm Clocks, Medical Batteries, Motor Boat Horns, Electrically Heated Apparatus, Battery Connectors, Switches, Battery Gauges, Wireless Telegraph Instruments, Ignition Supplies, etc.

Send for a copy now.

**Manhattan Electrical Supply Company, Inc.**

New York, 17 Park Place St. Louis, 1106 Pine St.  
Chicago, 114 So. 5th Ave. San Francisco, 604 Mission St.



## Wilmo Manifold

Gives More Miles From Any Gasoline

A. A. A. tests show 42% to 54% greater mileage.  
Price \$7.50 to \$15, according to make of car.

**THE WHITTIER COMPANY**  
First National Bank Bldg. Dept. 8011 Chicago, Ill.

## Buy an Akron-Williams

**Tire Repair Outfit.** Get into this profitable business with the same equipment that is used and endorsed by 90 per cent of the big tire manufacturers and successful repair shops. Write for book giving full details.  
**The Williams Foundry & Machine Co.**  
50 Cherry Street AKRON, OHIO



## Pulls you out of trouble

Carry this little Pull-U-Out in your tool box and you will be independent of road conditions. With it a boy can, unaided, pull a 5000 lb. car out of ditch or mud. Pays for itself on its first job. Besides pulling autos out of trouble it will do all kinds of lifting and pulling in the factory, garage, on the farm or construction job, etc.

Consists of a winding drum, lever crank, 40 feet of steel cable, two 7 ft. chains and 3 stakes. Weighs only 28 lbs. and goes in space 4x8x14 inches.

A pressure of only 30 lbs.  
on the handle will lift a ton



Cheaper and better than a chain block.  
Does jobs no other machine can do.

**WRITE FOR BOOKLET—VERY INTERESTING**  
Tells how and why this marvelous little Pull-U-Out works.

**Pull-U-Out Sales Co., 935 Olive St., St. Louis, Mo.**



## Do You Like to Draw?

Whether your ambition is to become a second Bud Fisher or whether you draw merely for your own amusement—you will find lots of inspiration in

## CARTOONS MAGAZINE

It contains each month the cream of caricature, and cartoon art the world over. The foremost American cartoonists are represented, together with the most famous of the Parisian artists and cartoonists of Berlin, London, Petrograd, and Rome.

Either as an art student or a student of current events you will enjoy seeing how cartoonists are portraying world history in the making. "Cartoons" is a monthly review, but doesn't take itself too seriously.

There are pictures by Ethel Plummer, stories by Helena Smith-Dayton, comics by King, Webster, and others, and Parisian sketches by the artists of Fantasio and La Baionnette. It also tells what the big fellows in the cartoon world are doing.

A two-bit piece together with the following blank filled out, will bring you post haste a sample copy.

CARTOONS MAGAZINE,  
6 North Michigan Avenue, CHICAGO

Enclosed find 25 cents for which send me a sample copy of your magazine.

Name.....

Street and No. ....

City..... State.....



## "I Can Succeed!"

"What other men have accomplished through I. C. S. help, I can. If the I. C. S. have raised the salaries of other men, they can raise mine. If their positions have been bettered, mine can be. To me, I. C. S. means 'I CAN SUCCEED.'"

Get the "I Can Succeed" spirit, for the International Correspondence Schools *can* raise your salary—whether you're a dollar-a-day man or a dollar-an-hour man, a long-hour man or a short-hour man, young or old.

No matter where you live, what you now do, or how little time or money you may have, the I. C. S. have a Course of Training to fit *your* needs.

Hundreds of thousands of ambitious men have achieved success through I. C. S. help in the past 25 years—over 130,000 are *now* studying, getting ready for the big jobs ahead. Join them and make your life something to be proud of—you *can* do it.

Mark and mail the coupon TODAY and find out *how*; it won't obligate you in the least.

### INTERNATIONAL CORRESPONDENCE SCHOOLS BOX 5618, SCRANTON, PA.

Explains, without obligating me, how I can qualify for the position, or in the subject, before which I mark X.

- |   |  |
|---|--|
| <input type="checkbox"/> ELECTRICAL ENGINEER        | <input type="checkbox"/> SALESMANSHIP            |
| <input type="checkbox"/> Electric Lighting          | <input type="checkbox"/> ADVERTISING             |
| <input type="checkbox"/> Electric Railways          | <input type="checkbox"/> Window Trimmer          |
| <input type="checkbox"/> Electric Wiring            | <input type="checkbox"/> Show Card Writer        |
| <input type="checkbox"/> Telegraph Engineer         | <input type="checkbox"/> Sign Painter            |
| <input type="checkbox"/> Telephone Work             | <input type="checkbox"/> Railroad Trainman       |
| <input type="checkbox"/> MECHANICAL ENGINEER        | <input type="checkbox"/> ILLUSTRATING            |
| <input type="checkbox"/> Mechanical Draftsman       | <input type="checkbox"/> Cartooning              |
| <input type="checkbox"/> Machine Shop Practice      | <input type="checkbox"/> BOOKKEEPER              |
| <input type="checkbox"/> Gas Engine Operating       | <input type="checkbox"/> Stenographer and Typist |
| <input type="checkbox"/> CIVIL ENGINEER             | <input type="checkbox"/> Cert. Public Accountant |
| <input type="checkbox"/> Surveying and Mapping      | <input type="checkbox"/> TRAFFIC MANAGER         |
| <input type="checkbox"/> RISE FOREMAN OR ENGINEER   | <input type="checkbox"/> Railway Accountant      |
| <input type="checkbox"/> Metallurgist or Prospector | <input type="checkbox"/> Commercial Law          |
| <input type="checkbox"/> STATIONARY ENGINEER        | <input type="checkbox"/> GOOD ENGLISH            |
| <input type="checkbox"/> Marine Engineer            | <input type="checkbox"/> Teacher                 |
| <input type="checkbox"/> ARCHITECT                  | <input type="checkbox"/> Common School Subjects  |
| <input type="checkbox"/> Contractor and Builder     | <input type="checkbox"/> Mathematics             |
| <input type="checkbox"/> Architectural Draftsman    | <input type="checkbox"/> CIVIL SERVICE           |
| <input type="checkbox"/> Concrete Builder           | <input type="checkbox"/> Railway Mail Clerk      |
| <input type="checkbox"/> Structural Engineer        | <input type="checkbox"/> AUTOMOBILE OPERATING    |
| <input type="checkbox"/> PLUMBING AND HEATING       | <input type="checkbox"/> Auto Repairing          |
| <input type="checkbox"/> Sheet Metal Worker         | <input type="checkbox"/> Navigation              |
| <input type="checkbox"/> Textile Overseer or Supt.  | <input type="checkbox"/> AGRICULTURE             |
| <input type="checkbox"/> CHEMIST                    | <input type="checkbox"/> Poultry Raising         |
|   | <input type="checkbox"/> Spanish                 |
|   | <input type="checkbox"/> German                  |
|   | <input type="checkbox"/> French                  |
|   | <input type="checkbox"/> Italian                 |

Name.....

Present Occupation.....

Street and No.....

City..... State.....

Please Mention Popular Mechanics



## 1000 Interesting Things For Boys to Make and Do

are described in this great book

### The Boy Mechanic, Vol. II

(A sequel to, but containing nothing found in Vol. I).

480 Pages. Size 6 $\frac{3}{4}$  x 9 $\frac{3}{4}$  x 1 $\frac{3}{4}$  in. 995 Illus.

Cloth Binding. Price \$2.00 Postpaid.

## Boys! Build Things!

This Big Book Tells You How to Make

Aerial Gliders	Merry-Go-Round
Aeroplane Kite	Mile-O-View Camera
Art Craft Work	Model Aeroplane
Bicycle Horn	Model Boat
Blowgun	Monorail Sled
Boats	Motion-Picture Camera
Boat Landing	Muskrat Trip
Bobbeds	Paddle-Wheel Boat
Camps	Pea-Shooting Gun
Camp Furnishings	Photographic Appliances
Cartridge Belt	Pushmobile
Catamaran	Pushmobile for Ice
Cyclemobile	Reed Furniture
Disk Pistol	Roller Coaster
Dog Exerciser	Sail for Wagon
Electric Fishing Signal	Scarecrow
Electric Fountain	Skates of Wood
Electric Horn	Skiff
Electric Motor	Skis
Ferris Wheel	Snowball Thrower
Fish Attractor	Snowshoes
Fishing Tackle	Spot-Light Lantern
Flymobile	Springboard
Footboats	Steam Turbine Boat
Games on Ice	Steam Turbine Engine
Grape Arbor	Steering Sled
Houses of Poles	Stilts
Hurdle	Sunlight Flasher
Ice Boats	Surfing
Ice Gliders	Swimming Raft
Indoor Games	Tricks
Kites	Vaulting Pole
Lawn Tennis Marker	Water Wheel
Live Bait Pail	Windmill

### And 932 Others

Sent postpaid to any address upon receipt of price by the publishers.

**POPULAR MECHANICS BOOK DEPT.**  
6 N. Michigan Ave. CHICAGO

# Are You Mechanically Inclined?

If so, this list of Practical, Up-to-Date Electrical and Mechanical BOOKS at **25c each, postpaid** WILL INTEREST YOU

Each one is a complete, dependable treatise and worth the price several times over

	Pages	Illustrations
Practical Electrics . . . . .	135	126
Study of Electricity for Beginners . . . . .	88	54
Dry Batteries, Their Construction . . . . .	59	30
Modern Primary Batteries . . . . .	105	55
Electric Gas Igniting Apparatus . . . . .	101	57
Alternating Currents . . . . .	90	33
Electrical Circuits and Diagrams—Part I . . . . .	72	217
Electrical Circuits and Diagrams—Part II . . . . .	80	78
Magnets and Magnetism . . . . .	94	49
Small Electrical Measuring Instruments . . . . .	90	59
Woodwork Joints . . . . .	101	178
How to Build a Bi-Plane Glider . . . . .	60	31
Model Vaudeville Theatres . . . . .	90	34
Windmills and Wind Motors . . . . .	83	76
A. B. C. of the Steam Engine . . . . .	30	6
Steam Engine Design . . . . .	102	34
Inventions, How to Protect, Sell and Buy Them . . . . .	108	1
Simple Soldering, Both Hard and Soft . . . . .	82	52
Induction Coils, How to Make and Use Them . . . . .	75	35
Experimenting With Induction Coils . . . . .	73	26
Wimshurst Machine, How to Make and Use It . . . . .	112	30
Simple Experiments in Static Electricity . . . . .	72	51
Making Wireless Outfits . . . . .	61	27
Wireless Telephone Construction . . . . .	74	43
Telegraphy for Beginners . . . . .	63	19
Small Accumulators, How to Make and Use . . . . .	80	40
Wiring Houses for Electric Light . . . . .	93	42
Low Voltage Electric Lighting . . . . .	92	23
Electric Bells, Annunciators and Alarms . . . . .	95	70
Magneto Telephone . . . . .	86	23

A uniform series, size 5x7 inches. Paper cover. You will be surprised at how much good reliable information 25 cents will buy.

Any of the above books sent postpaid to any address upon receipt of price by

**Popular Mechanics Book Dept.**  
6 N. Michigan Ave., CHICAGO

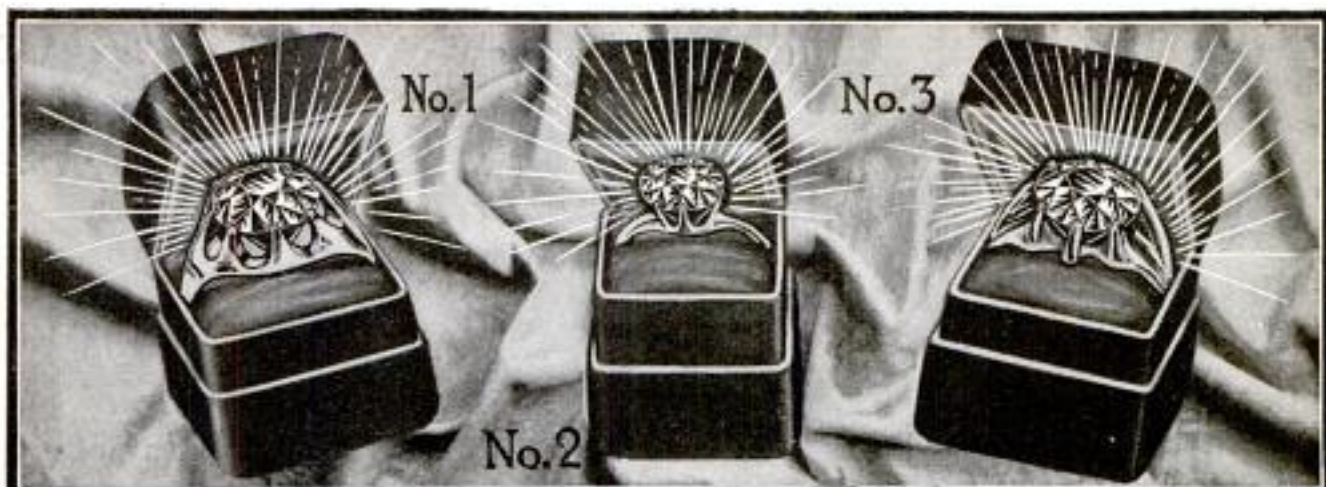

## YOUR CHOICE FREE FOR 10 DAYS' WEAR



No. 4

Every  
Piece  
Beautifully  
Set In  
Solid Gold  
Mountings

No. 5

### In Ordering Rings

To get the right size Ring, cut a strip of heavy paper so that the ends exactly meet when drawn tightly around the second joint of finger on which you want to wear the ring. Be careful that the measuring paper fits snugly without overlapping, and measure at the second joint. Send the strip of paper to us with order coupon.

## Compare It With a Diamond

Here is the most amazingly liberal offer ever made on precious gems. To quickly introduce into every locality our beautiful TIFNITE GEMS—which in appearance and by every test are so much like a diamond that even an expert can hardly tell the difference—we will absolutely and positively send them out FREE and on trial for 10 days' wear. But only 10,000 will be shipped on this plan. To take advantage of it, you must act quickly.

Send the Coupon NOW! Send no money. Tell us which item you prefer—Ring, Pin or La Valliere. We'll send your selection at once. After you see the beautiful, dazzling gem and the handsome solid gold mounting—after you have carefully made an examination and decided that you like it, if you believe you have a wonderful bargain and want to keep it, you may pay for same in small easy payments as described in this advertisement. Then the Ring, Pin or La Valliere is yours to give away, sell, or wear just as you prefer. If, however, you can tell a TIFNITE GEM from a genuine diamond, or for any reason you do not wish it, send it back at our expense.

## TIFNITE GEMS

### Solid Gold Mountings

are recognized as the closest thing to a diamond ever discovered. In fact, it requires an expert to distinguish between them. In appearance a Tifnite and a diamond are as alike as two peas. TIFNITE GEMS have the wonderful pure white color of diamonds of the first water, the dazzling fire and brilliancy, cut and polish. They stand every diamond test—fire, acid and diamond file. The mountings are exquisitely fashioned in latest designs—and guaranteed solid gold.

## Send No Money— Send No References

Just send coupon. You do not obligate yourself in any way. The coupon—only the coupon—brings you any of the exquisitely beautiful pieces shown and described here. If you want ring, state whether ladies' or gentlemen's, and be sure to enclose slip of paper showing exact finger measurement as explained below.

Send coupon now and get a TIFNITE GEM on this liberal offer. Wear it for 10 days on trial. They have no artificial backing—absolutely guaranteed not to be made of glass. All set in latest style mountings of pure solid gold. Each is a wonderful bargain. Just send the coupon. Then decide whether you want to keep the TIFNITE on our amazingly liberal offer. Send for yours now—today—sure.

The Tifnite Gem Co.  
Rand McNally Bldg.  
Dept. 275, Chicago, Ill.

### Flat Belcher Ring

No. 1. Solid gold mounting. Eight claw design with flat wide band. Almost a carat, guaranteed genuine Tifnite Gem. Price \$12.50; only \$3.50 upon arrival, balance \$3 per month. Can be returned at our expense within 10 days.

### Ladies' Ring

No. 2. Solid gold Tiffany mounting. 1 as a guaranteed genuine Tifnite Gem almost a carat in size. Price \$12.50; only \$3.50 upon arrival, balance \$3 per month. Can be returned at our expense within 10 days.

### Tooth Belcher Ring

No. 3. Solid gold, six-prong tooth mounting. Guaranteed genuine Tifnite Gem almost a carat in size. Price \$12.50; only \$3.50 upon arrival, balance \$3.00 per month. Can be returned at our expense within 10 days.

### Ladies' La Valliere

No. 4. Solid gold throughout. Chain 18 inches long. One-half carat guaranteed genuine Tifnite Gem artistically mounted in genuine latest style black enamel circle. Price \$15.00; only \$3.50 upon arrival, balance \$3 per month. Can be returned at our expense within 10 days.

### Scarf Pin

No. 5. Solid gold throughout. A beautiful open circle mounting. Half carat guaranteed Tifnite Gem. Price \$12.50; only \$3.50 upon arrival, balance \$3 per month. Can be returned at our expense within 10 days.

## FREE Trial Coupon

THE TIFNITE GEM CO.,  
Rand McNally Bldg., Dept. 275, Chicago, Ill.

Send me.....No.....on 10 days' approval.  
(Ring, Pin or La Valliere)

If satisfactory, I agree to pay \$3.50 upon arrival and balance at rate of \$3.00 per month. If not satisfactory, I will return same within 10 days.

Name.....  
Address.....

Please Mention Popular Mechanics



## ATTENTION!

Every soldier, every individual in a Home Defense League, every member of a semi-military organization, and in fact every citizen of the United States will need one or more of the following standard officially prescribed military books, all of which have text corrections right up to date.

**Infantry Drill Regulations. U. S. Army.**

*Price, 50 cents*

**Cavalry Drill Regulations. U. S. Army.**

*Price, 75 cents*

**Small Arms Firing Manual.**

*Price, 75 cents*

**Field Service Regulations. U. S. Army.**

*Price, 75 cents*

**Artillery Drill Regulations.**

*Price, \$1.25*

**Manual of Interior Guard Duty.**

*Price, 50 cents*

**Engineers' Field Manual.**

*Price, \$1.25*

**Manual for Non-Commissioned Officers and Privates.**

*Price, 50 cents*

**Manual for Army Cooks.**

*Price, 75 cents*

**Blue Jackets' Manual. U. S. Navy.**

*Price, \$1.00*

**Boat and Deck Book. U. S. Navy.**

*Price, 60 cents*

**Manual of Courts Martial.**

*Price, \$1.20*

**Manual for the Medical Dept. U. S. Army.**

*Price, \$1.10*

**Army Horse in Accident and Disease.**

*Price, 85 cents*

**Drill Regulations for Machine Gun Companies.**

*Price, 70 cents*

**Drill Regulations for Sanitary Troops.**

*Price, 75 cents*

**Signal Book. U. S. Army.**

*Price, 35 cents*

**Manual of Physical Training.**

*Price, 75 cents*

Any of the above books will be sent post-paid to any address upon receipt of price.

**Popular Mechanics Book Dept.  
6 N. Michigan Ave., Chicago**



## NOW YOU NEED A GOOD ATLAS

Never before in the World's History has an atlas been so constantly necessary to an intelligent understanding of the World's News.

**Here is the IDEAL ATLAS**

Hammond's Comprehensive Atlas is a compact octavo volume, bound in flexible leather. It solves the problem of

**Large Scale Maps in a Book of Handy Size**

Contains 512 pages, 256 pages of large scale maps of all States, Canadian Provinces, Countries of the World, etc., also 256 pages of text, index, compilations, gazetteer, statistics of population, etc.

**Self-Revising After the War**

Each copy contains a certificate entitling the purchaser to a supplement of maps showing the new boundaries after the war is over, making this atlas self-revising.

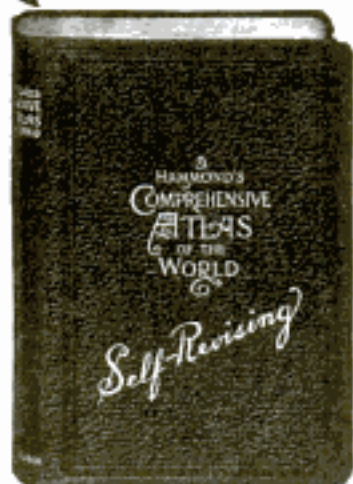

Size 9 1/2 x 6 3/4 x 1 1/4 Inches

**Special New Maps Show the Several War Zones**

Get your atlas now. Use it during the great war when you need it most and rest assured it will be up-to-date after the war is over. Price, Leather \$2.50, Cloth, \$1.65 Postpaid

**Return Privilege** Any purchaser who is not more than satisfied with this atlas may return same and have his money promptly refunded.

**POPULAR MECHANICS BOOK DEPT.  
6 N. Michigan Ave., CHICAGO**

## TO FRANCE

*Every Man Who Goes to France Will Want This Book*

**OXFORD**

## English and French

*Conversation Book for Army and Navy Men*

OXFORD  
ENGLISH AND FRENCH  
CONVERSATION BOOK  
FOR  
ARMY AND NAVY MEN

Compiled by R. Sherman Kidd, assisted by Capitaine A. Du Pont, Military Expert, sent by the Government of France to instruct Reserve Officers' Training Corps at Harvard.

**Aviation Section**

Compiled by  
**LIEUTENANT C. L. CABOT**  
U. S. N. R. F.

This book was compiled by military men for military men. It is a handbook of military, naval, aeronautical, and other words, terms and phrases in both English and French, arranged for easy pronunciation. A simple, accurate method that enables anyone to converse in French on all subjects. It is compact, practical, and inexpensive. Size to fit soldier's pocket.

*Handsome Keratol binding, stamped in gold  
Price, 50c Postpaid*

**Popular Mechanics Book Dept.  
6 North Michigan Ave., CHICAGO**



## Real Fortresses of Stone

With these wonderful fortress sets of Anchor Blocks, made of real stone, boys can build modern forts like the one above, equip them with guns and play at actual war. There's no finer or more interesting construction toy, no better Xmas gift.

### RICHTER'S ANCHOR BLOCKS

F. Ad. Richter & Co.

Dept. 201, 74 Washington St., New York

Send me your booklet giving full particulars about Anchor Blocks.

Name.....

Address.....

City.....State.....

WITH other sets of Anchor Blocks—made of red, blue and buff colored stone—any boy or girl can erect real stone buildings, bridges, castles, towers, battlements and arches. The blocks last forever. They teach architecture and engineering.

Sets 50c to \$5.00

Just fill in and mail the coupon on the right for illustrated catalog.

**F. AD. RICHTER & CO.**  
Dept. 201, 74 Washington St., New York

BABY BRANDED WITH FAMILY CREST—A baby recently born in San Francisco to a foreign family had its wrist marked in indelible ink with the family's coat of arms, in order to avoid any possibility of a mix-up.

## TYPEWRITERS



We have hundreds of practically new typewriters in this special sale. All in A-1 condition. In this lot are Underwoods, L. C. Smiths, Monarchs, Remingtons, Oliverts, Foxes and many other well-known makes, positively as good as new. To be sold at 20% discount this month only. Write to us for typewriter catalog and we will tell you how you can save money on your typewriter.

**American Typewriter Exchange**  
12-14 W. Washington St. CHICAGO

## Dependable Small Power

Not a miniature engine, but a small gasoline or gas motor designed for the use of inexperienced persons on work up to ½ horsepower. It is ideal for the washing machine and cream separator. It is equipped with a combination foot starter and counter shaft. Lubrication, speed regulation and cooling are automatic. All moving parts are enclosed. It is safe, simple, silent and sure.

Send for Our Booklet A.  
**Elgin Gas Motor Company**  
ELGIN, ILL.



## THERE IS BIG MONEY IN CARD PRINTING

of all kinds if done with an **Automatic Press**

Send for our Free Booklet No. 6

**S. B. FEUERSTEIN & CO.**

Manufacturers  
542 Jackson Blvd., Chicago



## Entirely New Signal Positive—Pleasing—Penetrating

Wonderful improvement in warning devices. Safer. Safer. Most economical. So superior to other styles—new standard equipment on many leading cars. Operated directly by explosion through priming cup—opening in cylinder. Not an exhaust whistle. Vastly better. Easily installed. Never fails. Clear, sweet-toned warning note cuts through noisiest traffic confusion. Guaranteed for life. Sold on Trial. Low first cost only cost. Write quick for circular. Big money-making proposition for agents and dealers—ask for it.

**THE BUELL CO.** 1610 Michigan Ave. CHICAGO

We Send Prepaid,  
No Money Down,  
10 Nights' Free Trial

See it, try it, test it in any way you want in your own home, alongside any other light. Then if you feel like parting with it send it back at our expense. The trial costs you nothing. We take all the risk.

**U. S. GOVERNMENT** report shows mantle oil light more than 3 times as efficient as ordinary lamp. The Daylite is whiter and brighter than gas or electric, at ¼ the cost. Pays for itself in a few months in oil saved. No smoke, no dirt, no odor. Uses common wick and is lighted same as ordinary lamp. Simple and safe, cannot explode. Only oil light guaranteed for 5 years. Only mantle light with telescoping tube; full details in complete illustrated catalog—It's FREE.

**AGENTS WANTED.** No money—no experience—needed. Five out of six buy the Daylite the minute they see it. Wanted in every home. No talking necessary. Sells itself. No capital required. We supply stock, all necessary equipment, and protected territory. Men with rigs or autos are making \$6 to \$15 every day, month after month.

**WRITE NOW FOR LAMP—FREE** for ten nights' trial. Tell us if you have a rig or auto, whether you can work spare time or steady, your age, occupation, what territory you want and when you can start.

**DAYLITE COMPANY, 311 DAYLITE BUILDING, CHICAGO, ILLINOIS**

**BURNS KEROSENE**



Copyrighted material



## ACHIEVEMENT

Twenty-five years ago the General Electric Company was founded. Since then electricity has sent its thrill through the whole structure of life.

Eager to turn wheels, to lift and carry, to banish dark, to gather heat, to hurl voices and thoughts across space, to give the world new tools for its work—electricity has bent to man's will.

Throughout this period the General Electric Company has held the great responsibilities and high ideals of leadership.

It has set free the spirit of research. It has given tangible form to invention, in apparatus of infinite precision and gigantic power.

And it has gone forth, co-operating with every industry, to command this unseen force and fetch it far to serve all people.

By the achievements which this company has already recorded may best be judged the greater ends its future shall attain, the deeper mysteries it yet shall solve in electrifying more and more of the world's work.

7317

# GENERAL ELECTRIC COMPANY



# DIAMONDS ON EASY PAYMENTS ONLY

## LOOK \$2.50 A MONTH

**\$75 DIAMOND ONLY \$50**

### New Distribution Plan

means a saving of one-third of your money. Write today, make your Christmas selections now.

**Here Is the Opportunity of a Lifetime**

### Startling Offer

—explained when you receive the **New Diamond Book** just off the press. Shows many sizes of diamonds, designs of rings and other beautiful pieces of Diamond jewelry. Any Diamond you want to see will be sent without one penny down. We trust you absolutely. Examine the diamond all you want to. Wear it **30 Days Free**. Send it back at our expense if you do not want it.

**Don't Pay Three or Four Dealers' Profits**

We sell "Direct" from diamond cutter to you at practically European prices. Save one-third to one-half of your money.—and our **Great Distribution Offer** means a still greater saving to you.

### WEAR THE DIAMOND

all the time. Right from the time you receive it, and our splendid plan makes you the owner and you scarcely miss the money.

Select your diamond from these shown here if you want to

Write for **Free Diamond Book** today. See all the dazzling beauties.

**Santa Fe Watch Co.**  
Dept. N-83 Topeka, Kans.



№155-D. \$50



№151-D. \$50



№135-D. \$25



№137-D. \$35



№136-D. \$50



№138-D. \$75



№139-D. \$100

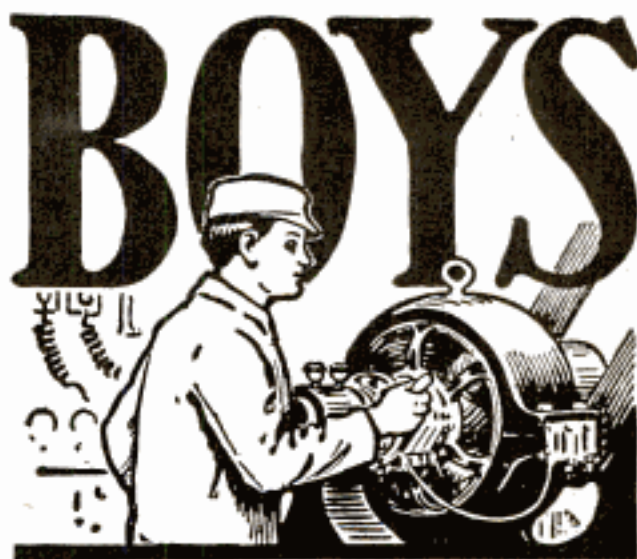

## Big Money in Electricity

The Electrical industries offer wonderful opportunities to boys with a liking for Electricity. The salaries paid to trained men are large, promotion comes rapidly and, best of all, the work is fascinating.

The discovery and development of new lines (such as wireless telegraphy and telephony), from time to time, promise attractive and paying fields to those who wish to specialize. The *will to do* and *Special Training* will bring success to you.

The International Correspondence Schools can help you to become an expert in electrical work, no matter what branch you like best. Thousands of young men have already won success through I. C. S. help. You can do as well as anybody, if you try. Everything is made so clear that you can learn in your spare time, regardless of where you live or what your work. No books to buy.

There's big money in Electricity. Get after it by marking and mailing the Coupon today. *Finding out costs you nothing.*

### INTERNATIONAL CORRESPONDENCE SCHOOLS

Box 5616, SCRANTON, PA.

Explain, without obligating me, how I can train for the position before which I mark X.

- |  |  |
|--|--|
| <input type="checkbox"/> ELECTRICAL ENGINEER       | <input type="checkbox"/> ARCHITECT               |
| <input type="checkbox"/> Electrician               | <input type="checkbox"/> Architectural Draftsman |
| <input type="checkbox"/> Electric Wiring           | <input type="checkbox"/> Mine Foreman or Supt.   |
| <input type="checkbox"/> Electric Lighting         | <input type="checkbox"/> Business (Complete)     |
| <input type="checkbox"/> Electric Car Running      | <input type="checkbox"/> Bookkeeper              |
| <input type="checkbox"/> Electric Machine Designer | <input type="checkbox"/> Stenographer            |
| <input type="checkbox"/> Telegraph Engineer        | <input type="checkbox"/> Advertising Man         |
| <input type="checkbox"/> MECHANICAL ENGINEER       | <input type="checkbox"/> Salesmanship            |
| <input type="checkbox"/> Mechanical Draftsman      | <input type="checkbox"/> Window Trimmer          |
| <input type="checkbox"/> STEAM ENGINEER            | <input type="checkbox"/> Civil Service           |
| <input type="checkbox"/> GAS ENGINEER              | <input type="checkbox"/> AGRICULTURE             |
| <input type="checkbox"/> CIVIL ENGINEER            | <input type="checkbox"/> Poultry Raising         |
| <input type="checkbox"/> Structural Engineer       | <input type="checkbox"/> AUTOMOBILES             |
| <input type="checkbox"/> CHEMICAL ENGINEER         | <input type="checkbox"/> Auto Repairing          |

Name \_\_\_\_\_

Present Occupation and Employer \_\_\_\_\_

Street and No. \_\_\_\_\_

City \_\_\_\_\_ State \_\_\_\_\_

If name of Course you want is not in this list, write it below.

## INDOOR CLOSET

### More Comfortable, Healthful and Convenient than the Out-Door Closet

Eliminates the out-door closet and open vault. They are breeding places for germs. Have a warm, sanitary, odorless toilet right in your house. No going out in cold weather. A boon to invalids. Endorsed by State Boards of Health.

W. M. Davis writes: "Your indoor closet is giving absolute satisfaction. It is certainly the thing for a home without sewerage."

### Absolutely Odorless Put It Anywhere in the House

The germs are killed by a chemical process in water in the container, which you empty once a month. **Absolutely no odor.** No more trouble to empty than dishwater. Closet absolutely guaranteed. Write for full descriptions and price.

**Agents Wanted — Big Profits** Wonderful opportunities in every town, village and in the country. Best season just at hand. Every home is a good prospect. Sell eight out of every ten you call on. Ernest Kidwell writes, "Have ten orders." G. A. Dismen says: "Ship at once twenty closets and fifteen washstands. Sold them all in one community." Sell itself. Everybody hates the outdoor closet. Everybody wants a **Ro-San Indoor Closet**. Write quick for territory and full particulars. We are prepared to ship promptly any quantity of closets — no waiting.

**ROWE SANITARY MFG. CO., 12811 Rowe Bldg., Detroit, Mich.**  
Ask about the **Ro-San Washstand** — Hot and Cold Running Water Without Plumbing



## You can't saw wood with your hands tied



K 88-26"



You wouldn't think of *trying* to do it because of the waste of time and effort. But that's just what you *are* doing when you try to do first-class work with an ordinary saw.

KEEN KUTTER Saws are made from specially tempered highest grade crucible steel. Their teeth are perfectly set and carefully filed. The blades are taper-ground from handle to tip and from the cutting edge to the back. This prevents binding in the cut even when used in green or partly cured lumber.

And each KEEN KUTTER Saw must pass a rigid examination and test of these distinctive features before it reaches your hands.

Test a KEEN KUTTER now—your own way. Try it once and you'll never again use any but the saw that unties your hands for better and easier work.

The name KEEN KUTTER—not on saws alone, but on *all* tools—means the highest quality possible to produce.

### SIMMONS HARDWARE COMPANY

Manufacturers and Distributors

St. Louis      New York      Philadelphia  
Toledo      Minneapolis      Sioux City      Wichita

"The recollection of *QUALITY* remains long after the *PRICE* is forgotten."—E. C. Simmons  
Trade Mark Registered

Please Mention Popular Mechanics

**"When I buy my diamond, what security is given me?"**

THE ANSWER

THIS BOOK FREE



We sell diamonds of the finest quality at attractive prices. Buying diamonds direct and with less "overhead" than large, showy, expensive offices, we offer better value for the same money. To insure your confidence in our claims and in the genuineness of our offer to refund full purchase price if you are dissatisfied, MASS. BONDING CO., a \$1,500,000 corporation, bonds every diamond we sell. By this arrangement, in addition to our own certificate of guarantee, we give with each diamond purchase Mass. Bonding Co.'s certificate that the diamond is bonded by them, and that if you are dissatisfied and return it within 30 days they guarantee **Your Money Back.**

We are the first and only diamond merchant offering **THIS DOUBLE-BARRELED SECURITY.** Goods sent for inspection to your nearest bank or express office—without cost to you. Order safely by MAIL Today.

Ask for Catalog No. 32

**FRANK N. NATHAN CO.**  
373 Washington St., Boston, Mass.  
Diamond Merchants over 27 years

Write Today

Tells how to order diamonds and jewelry by mail without risk. No money in advance. Free examination of goods—no obligation. Write for free catalog No. 32 with latest supplement, which describe articles of distinctiveness and good taste in personal adornment.

Distinctive Gentleman's Ring



Large, brilliant diamond of splendid color. Hand-some 14 Kt. Solid Gold mounting. Diamond set in Solid Platinum, Only \$95.

**ORDER BOOKS BEFORE ADVANCE IN PRICE**

**SEND TODAY—SAVE \$5.00**

The present low price on this great work will be withdrawn when the few sets left are sold. Quick action saves \$5.

**10-VOLUME LIBRARY OF ARCHITECTURE Carpentry and Building**

4760 Pages 7 x 10—4000 Plates and Diagrams

These books answer 10,000 questions on building. Written by 25 architects, contractors and engineers.

**50c. a week**

**Shipped FREE on 7 Days' Trial**

Only \$2 a month if you decide to keep them. Coupon explains special offer, good only within bounds of U. S. and Canada.

**Consulting Service Free**  
Solves your difficult problems for entire year—(regular price \$12)—free with the set. Rush the coupon.

**American Technical Society**  
Dept. R1198, Chicago, U. S. A.

Please send Architecture, Carpentry and Building for seven days' examination, express prepaid. I will send \$2.00 within seven days and \$2.00 a month until I have paid \$24.80 or notify you and hold books subject to your order. Title not to pass until fully paid.

Name.....  
Address.....  
Reference.....

**MAKE EASY MONEY TRAPPING**

Herbert Wassenburg made \$60.65 in 60 days, trapping in spare time and shipping the furs to **Biggs at Kansas City.** You can do as well. Advance information on fur market now ready. Write.

**TRAPS, GUNS, Ammunition, Animal Baits,** everything a trapper needs at rock-bottom prices. Send for Catalog of Trappers' Supplies FREE.

**FREE**—Send your name for Free Subscription to *The Trapper's Exchange*, greatest trappers' magazine published. Nearly a million subscribers. Head trapping secrets used by thousands of other trappers.



**E.W. BIGGS & CO.**  
587 Biggs Bldg. KANSAS CITY, MO.

**Ten-Pinnet**  
The New Bowling Sensation!

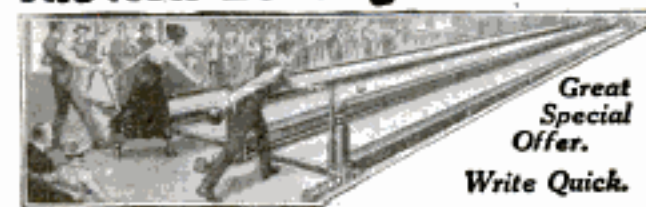

Great Special Offer. Write Quick.

**GET** into business of your own with this great new automatic bowling gun. Has taken the country by storm. Great chance! Big money, quick profits! Cash rolls in every day. No operating expense. Find out quick about this great opportunity. Send for our big FREE book.

**\$25.00 to \$75.00 a Week**

That's what you can earn with Ten-Pinnet. Get the big money. You can! **Free Book** Write today for free book and special offer. Learn how to start with little money—pay for others out of profits.

**TEN-PINNET CO.,** Dept. 1198, Indianapolis, Ind.

**Be a CHIEF ENGINEER!**

**Make \$125. to \$250. Monthly**

**LEARN at HOME** Books Free on 7 Days' Trial

Do you realize that mills, factories and railroads of the entire nation are calling for competent engineers? Here's a chance to fit yourself for "the big job" by spare time study of this great

**7 Volume Library of Steam Engineering**

Seven big leather bound books—3300 pages, 7x10 inches, 2500 illustrations. Every fact on stationary, marine and locomotive engineering at your finger tips—all for 50c a week!

**Consulting Service Free** With the set of books we give you a \$12 Consulting Membership which solves your perplexing problems, free for a full year. Coupon explains easy payment plan. Sign and mail today. This offer good only within bounds of United States and Canada.



**COUPON Brings Books Free**

**American Technical Society, Dept. S1198, Chicago, U. S. A.**

Please send Library of Steam Engineering for seven days' examination, express prepaid. I will send \$2.00 within seven days and \$2.00 a month until I have paid \$19.80 or notify you and hold books subject to your order. Title not to pass until fully paid.

Name.....  
Address.....  
Reference.....



**FINCK'S**  
"DETROIT-SPECIAL"  
**OVERALLS**  
and  
**COMBINATION SUITS**  
"They Wear Like a Pig's Nose"

**"Good Enough for Me!"**  
**Says Uncle Sam**

The United States Government, after thorough investigation, has just placed an extensive order for Finck's "Detroit-Special" garments.

Only the best is good enough for the boys in khaki; and this endorsement simply echoes that of two million satisfied users.

Wherever hard service is required, you'll find Finck's "Detroit-Special" overalls and work-garments in demand.

We say so; Uncle Sam says so; you'll say so, too, once you've tried them.

**Overalls, \$1.75 and \$2.00    Jackets, \$1.75 and \$2.00**  
**Combination Suits, \$3.00**

**W. M. Finck & Company** 1154 Gratiot Ave.  
DETROIT, MICH.

BRANCHES:

St. Louis, Missouri; Seattle, Washington; San Francisco, California; Dallas, Texas

**The Electrical  
Experimenter**



**BOYS!**

Here is **THE** electrical magazine for you. For the Dabbler and the "How-to-make-it" fiend. Chuck full of experiments and the latest electrical doings. Non-technical—in plain English. One of the foremost authorities on **WIRELESS** in the U. S.

200 Illustrations, 90 big pages, over 100 articles.

**One Copy Will Convince You.**  
**At All News Stands, 15c.**

\$1.50 a year (Foreign \$2.00). Send 25c for 3 numbers.

**The Electrical Experimenter**  
234 Fulton St., NEW YORK

**WONDERFUL LIGHTS**

For Every Purpose. Write for Catalogue. Agents Wanted.

**WONDER MANUFACTURING CO.**  
100 South Fifth Street, TERRE HAUTE, IND.



**RAISE BELGIAN HARES For**

**U.S.**  
**HUGE PROFITS** easily and pleasantly made. We furnish stock and pay you \$6.00 a pair and express charges for all you raise. Contract and book "Profits in Hares," 10c. Nothing free.  
**NATIONAL FOOD & FUR ASSOCIATION**  
Dept. 10, 557 12th St., MILWAUKEE, WISC

Bangkok, the capital of Siam, is situated on 26 islands.

**Folding DOUBLE X-RAY**



With this **Double X-RAY** you can apparently see through **cloth** or wood, see **bones** in the body. Makes the **flesh** look transparent. An optical illusion. By mail **10 cts.**, three for **25 cts.** Postpaid.  
**ARDEE COMPANY, Box #13, STAMFORD, CONN.**

Does Red Meat Cause

**RHEUMATISM?**

Send now for **FREE** copy of Dr. R. L. Alaker's article published in The Independent September 10th. Frank E. Morrison, Publisher, 806 St. James Bldg., New York.

**Taxidermy  
Book  
FREE.**



**Stuff Beautiful  
Birds.** Learn by mail to stuff and mount

all kinds of birds, animals, fish and game heads, make rugs, tax skins. Mount your own specimens and make money preserving for others. Men, women and boys learn easily and quickly. Success guaranteed of no tuition. Write today for our wonderful **FREE** book "How to Learn to Mount Birds and Animals. N.W. School of Taxidermy, 9108 Elwood Bldg., Omaha, Neb.

Write Today.

**\$1** **FOR THIS GUARANTEED FOUNTAIN PEN** An extraordinary offer to introduce the Big Basch Diamond catalog. Diamonds listed as low as \$97.50 per carat. Pen is a safety lever self-filler, simplest and most practical fountain pen ever made. Barrel and cap of first quality Para rubber. **Your name in gold free.** Pen is 14K solid gold, iridium tipped and hand tempered. Full size, 8 1/4 inches long. Free repair for two years guaranteed. Send \$1.00 for pen today. Money returned if not satisfied, or ask for free diamond book anyway. Free examination on everything. **L. BASCH & CO., Dist. 63479 State & Quincy St., CHICAGO**

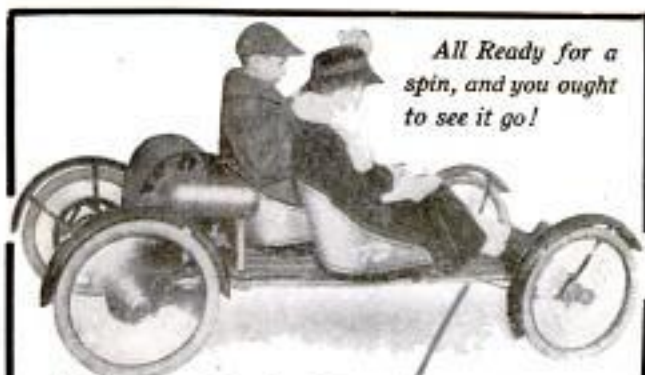

All Ready for a spin, and you ought to see it go!

## Here It Is! A Small Automobile with Speed and Power AMERICAN FLYER NO. 2

The cheapest and best motor propelled vehicle of its kind ever produced. Can be handled by any fifteen year old boy or girl, but it is large enough to carry two adults of ordinary size and weight.

Climbs hill like the big fellows—has a speed up to forty miles per hour, makes from forty to fifty miles per gallon of gasoline.

Two cylinder, four cycle opposed type engine with magneto and carburetor. The slickest thing you ever saw. Simple in construction—easily started from the seat—oiled by splash system—develops maximum power on minimum amount of gasoline. Four horse power, brake test, ample to propel car with two passengers over any ordinary road. For pleasure or business. For children or adults. Write for free catalogue. This is the car you've been waiting for.

**\$200.00 F. O. B. LaFayette**

**American Motor Vehicle Company  
LAFAYETTE, INDIANA**

## Ready! Aim! FIRE!



### American Boys Attention!

Get at the breech of a Big Dick. Exciting fun; no danger.

Shoots thirty-six (36) wooden bullets as fast as you can turn the firing-crank. Shoots true as your aim.

Big Dick is modeled after the machine guns in use on the European battle fronts and for indoor war play has no equal.

24 inches long  
9 inches high  
36 shots a minute

**Price, \$3.00**

Sold by most good toy dealers or direct from us on receipt of price.

**MILTON BRADLEY CO.**

Dept. B, SPRINGFIELD, MASS.

Makers of the World's Best Games

**RADIO BLINKER SIGNAL SET**  
Pat. Sept. 4, '17

For individual instruction and practice in sending or receiving messages by means of sound (radio) or light (blinker) signals. Officially adopted by U. S. Navy, Massachusetts Institute of Technology and Boy Scouts of America. Used by U. S. Army and U. S. Marine Corps.

**Price \$5.00** Net Weight 1 lb. 6 oz.

Manufactured solely by Frank B. Perry & Sons, Newton Center, Mass.

**Be a Caille Owner Agent**

No selling experience necessary. No office or shop necessary. Anyone can easily operate the Caille Gasped! Outboard Row Boat Motor. 2 speeds forward, stand still, 2 speeds reverse without stopping motor. Salt water fitting.

**Special Owner Agent's Offer**  
Our best advertisement is a Caille in operation. Owner Agents sell from one to twelve a year. We sell you one at a big discount. Here's a chance to earn a Caille five times while you play.

**FREE**—Catalog—Owner Agent's Offer—Book on Marine Motors—All Free.

Caille Perfection Motor Co., 31 Caille Bldg., Detroit, Mich.

**Learn How to WRESTLE**

In Your Own Home  
By Mail

Yes, learn to become an expert wrestler right in your own home, by mail, from the greatest wrestlers the world has ever known. Be an athlete, be strong, be healthy. Learn how to throw and handle big men with ease. Learn to defend yourself. All taught in our course of lessons, and illustrated with hundreds of charts and actual photographs by

**Farmer Burns and Frank Gotch**

Farmer Burns, "the grand old man of the mat," taught Frank Gotch, the present World's Champion, all he knows about wrestling, so Gotch says. He will now teach you Scientific Wrestling—Physical Culture—Jiu-Jitsu—Self Defense. Every man and boy in America, no difference what age, needs this wonderful course of lessons. Write today—your name, age and address on a postcard or letter brings you our fine book absolutely free—no obligations of any kind. A splendid book on wrestling and physical culture. Write today stating your age.

Farmer Burns School of Wrestling, 1198 Range Bldg., Omaha

This Wrestling Book FREE

## I Want to Make You a Present Of This Acorn UNI-LITE!

### I Am Organizing An Army of Money-Winners. Want to Join?

Yes—you get the Uni-Lite without paying a penny for it. But that's not all! I want to help you join my army of men and women "coining money" without doing much of anything except talk

neighbor-like to their fellow townspeople. I want you to send me your name and address on a post card so I will know where to mail complete information telling how to get Acorn Uni-Lite free.

A new and astonishing light. Gives radiance equal to 20 ordinary lanterns or lamps. Cost only 3/4 of a penny per hour. A wonderful light for in and around homes—farms—garages. Just answer this ad and I'll tell you about it. CLYDE E. PADDEN, Sales Manager.

**ACORN BRASS MFG. CO., 121 Factory Building, CHICAGO, ILLINOIS**



**GENUINE DIAMONDS \$70 PER CARAT**

FROM THE DIAMOND CUTTERS DIRECT TO YOU BY MAIL AT DIAMOND CUTTER'S PRICES



A136 14K ladies' solitaire.  $\frac{3}{8}$  carat diam. Complete **\$23.91**



A137 14K ladies' solitaire.  $\frac{3}{8}$  carat diam. Complete **\$45.40**



A138 14K ladies' solitaire. 1 carat diam. Complete **\$71.87**



A139 14K ladies' solitaire.  $1\frac{1}{4}$  carat diam. Complete **\$89.37**

**FREE Examination**

Choose any article in this ad or our catalog and we will ship it prepaid to your bank or express office for your examination and approval. It costs nothing to examine our tremendous values.

**MONEY BACK IN FULL ANY TIME WITHIN ONE YEAR**

Our ironclad guarantee gives you the right to return the diamond any time within one year, and we give you back the full price you paid, without even one cent deducted.

**1918 CATALOG FREE**

244 pages of remarkable values in Diamonds, Watches, Jewelry, etc., offering you a wealth of Christmas gift suggestions. Write for it now—**it's free.**

**FREE!** Red, White and Blue enameled American Flag Button sent with our catalog free if you mention this magazine.

**I. PRESS & SONS**  
IMPORTERS AND CUTTERS OF DIAMONDS  
WHOLESALE JEWELERS  
9018 CHESTNUT ST.  
PHILADELPHIA, PA.



**RACINE UNIVERSAL MOTOR**

**\$7.50**

**Unusual Offer**

—Here is an unusual opportunity to own a life sized, full powered, guaranteed Racine Universal Motor of 110-130 volts that will amaze you in its completeness and remarkable value.

Never before have you seen the duplicate of this A.C. and D.C. motor at the unheard of price \$7.50. Attached to any light socket it will save you many dollars in grinding, polishing or sharpening and will run a sewing machine, fan or small machinery. Always dependable. Fully guaranteed. To protect you we furnish a guarantee certificate with every motor. You must be satisfied or we don't want your money. Thousands in use. Get yours today. Take advantage of this offer now.

**FREE**—To every purchaser of a Racine we will give absolutely without cost an emery wheel, a buffer, a cord and plug. All you need do is attach it to a light socket and it is ready to save or earn money for you. All Racine Motors are guaranteed. Don't let another day pass before you order yours at this low price.

*If your dealer does not carry Racines, write us direct.*

**Racine Universal Motor Co.**  
53 W. Jackson Blvd., CHICAGO, ILL.



**You Have Natural Ability**

**Don't Let It Go To Waste!**

The world is full of "round pegs in square holes"—men and women whose *natural abilities* fit them for bigger jobs, better pay, more congenial surroundings. How about you?

**THERE IS ONE KIND OF WORK YOU CAN DO BEST**

Yes, better than any other! Your *natural ability* fits you for it. And, too, you will make *more money* in this job than in any other. To fit yourself into the right job that utilizes your natural ability is a difficult task. Some men never find the right job. But you can get help.

**A "Natural Ability" Success Laboratory**

We have helped thousands to turn their *buried talents* into the pure gold of *success*. We apply scientific methods of analysis—the results are invaluable.

**Personal Analysis Free**

We will give you the same analysis that has helped others to real success. Will tell you how to line up your natural talents with your practical experience. The analysis is free.

*Write today* for the personal examination blank. Just send your name and address. You'll be under no obligations.

**American School of Correspondence**  
Dept. G 1198, CHICAGO, U. S. A.

**Mathematics Made Easy by ROPP'S CALCULATOR AND SHORT-CUT ARITHMETIC**

Shows the Answer as Quickly as a Watch shows the Time to all Problems likely to occur in the Office, Store, Shop, Bank, Farm, or Factory.



**Over 2,000,000 Sold**

Explains and simplifies every principle in Arithmetic, Mechanics, and Mensuration.

**PRICES, POSTPAID**

Desk Size.....\$1.25

Leather, Pocket Size.....\$1.00

Leather, Vest Pocket Size.....\$0.50

Pocket Size...\$0.50

Send for 4-page description of this work

Popular Mechanics Book Dept., 6 N. Michigan Ave., Chicago

**Health, Strength, Vitality**

Use **Vi-Ray-O**  
RADIANT ENERGY



To improve physical strength, restore health and aid all vital functions. Vi-Ray-O is not a vibrator, but a scientific instrument used by thousands of physicians daily. It benefits by electricity. No shocks, no pain, no disagreeable sensations of any kind. Feeds your nerves with vitalizing energy, relieves aches and pains, develops muscles, aids beauty and purifies the blood. Effective treatment for skin and scalp diseases, headaches and chronic ailments.

**Use It for 30 Days—Free** We will send you free our treatment book (usually sells for 50c) it tells of the wonderful benefits that can be obtained by use of the Vi-Ray-O treatments. Try it in your own home 30 days free. Write today. **Dealers Wanted.**

**Western Coil & Electrical Co., Box 29, Racine, Wis.**

**Get This Book**  
BEFORE  
BUYING A  
**TYPEWRITER**  
We Save You Money

**Amazing Values-All Makes**

We can save you from 40% to 75% on any standard typewriter, according to model. Why pay one hundred dollars or thereabouts when you can get the same value for less than one-third the price. Keep the difference in your pocket. Our free book tells why we can make such low prices. Send for it.

**TEN DAY TRIAL OFFER**  
WITH IRON-CLAD GUARANTEE

Every machine is thoroughly rebuilt and sold with the privilege of TEN DAYS' TRIAL. You can thoroughly test the machine, use it as much as you wish for ten days. If not satisfied return it at our expense. If you keep it you are fully protected by an iron-clad agreement.

**Cash, Instalments or Rent**

Our prices and terms will suit you. You can buy outright for low cash, on small monthly instalments or rent by the month. Rental applies on purchase price if you decide to keep the machine.

Send for "The Truth About Typewriters" and Free Catalog.

**Young Typewriter Co., Dept. 511, Chicago**

**BALE YOUR WASTE PAPER INTO CASH**

Why bother with burning your waste paper when you can bale it so much quicker and easier and sell it for cash? Let me send you one of my new Tip-Top Balers on 10 days' trial at my risk. Just put it in your store room or basement and empty your newspapers, circulars, etc., into it. When full, bale in half the time required by other balers.



—One Chicago Bank sold more than \$7000 worth of waste paper last year.  
—One office building sold \$5000 worth.  
—One retail dealer sold \$400 worth.

**ROWE'S TIP-TOP PAPER BALERS**

are the best working, easiest operating balers on the market because they are the only ones having the patented Tip-Top self-setting screen. With this you perform two operations in one—when you press one tilting—you are automatically getting ready for another. Other

advantages of this Baler are: Top is entirely open; no arms or beams in the way; self-lifting top; non-bulging triple thick bottom; 15% greater filling capacity; baler easily removed—doesn't stick or bind at the sides; Sells at low prices and fully guaranteed. Made in four sizes for home, office, store and factory. Basic wires and list of paper buyers near you sent free. Write for Free Price and Prices Address, ROWE MFG. CO., Dept. P-11, GALESBURG, ILL.

**No Better Christmas Present for \$1.50**

than a year's subscription to

**Popular Mechanics Magazine**

containing 3600 Pictures and 3600 articles

Much of it interests Everybody

Most of it interests Anybody

All of it interests Somebody

Order through your newsdealer or address the publishers, POPULAR MECHANICS, CHICAGO

**Buy DIAMONDS Now at the Old Price**

BASCH is the house that has not raised the prices 30 to 50 per cent on genuine diamonds. But we must pay more for next importation and so must you. Buy now. You may still have full carats at \$27.50, three-quarter carats at \$12.50 and one-quarter carats at \$5.00. Don't wait until prices advance.

**\$9.75**  
Per Carat

**\$1.00—Full Size Fountain Pen**

Full size, 6½ inches long, lever, self-filler, barrel and cap are pure 14-karat gold. Your name embossed in gold free. Pen is 14k. solid gold brilliant tipped. Guaranteed free repairs for 2 years. Special Factory Price to you, \$1.00.

Write for Diamond Catalog. Write today for the Basch DeLuxe Diamond Book. It is free, Best diamond guide ever issued. Send for it today sure. L. BASCH & CO., Dept. 03472, State and Quincy Streets, Chicago, Ill.

**FLORIDA GROVES**

and Truck Farms Pay Large Profits

Choice lands suburban to Tampa—low prices, easy terms. No better land in Florida. No better climate in U.S. Write today for free booklet.

**NORTH TAMPA LAND CO., 6 N. Michigan Avenue, Chicago**

**Build Your Own PHONOGRAPH**

It's Easy With Our Help

A few hours' interesting work saves many dollars and gives you a machine exactly to suit your ideals. We furnish motors, tone arms, case material, blue prints and full instructions. Plays any record. You can make fine profit building phonographs for your friends.

Write Today for Our Free Blue Print Offer

**CHORALEON CO.**

211 Monger Bldg., Elkhart, Ind.



**SAVE OVER HALF**

**EDWARDS STEEL BUILDINGS**

Many Styles and Sizes  
Garages—Barns—Factories, Etc.

Put up or taken down in a jiffy. Save time and labor. Have a strong, permanent, fireproof building, any size, smallest to largest, for any purpose. Made of steel. Ready to erect.

**FREE** Catalogs with prices and plans for the building or buildings you need. Write for them.

**THE EDWARDS MANUFACTURING CO.**

METAL ROOFING, METAL LOCKERS, ROLLING DOORS, ETC.

320-370 EGGLESTON AVE. CINCINNATI, OHIO



# WANTED A Good Honest AGENT In Each County

## \$1800 to \$5000 This Year

We want a thousand additional agents at once—local agents for townships and counties, and general agents or district managers. **Exclusive county agency free.** A proposition of unlimited possibilities—a **cash opportunity.** Wonderful new business. **No experience required.** No competition. No risk. Sample outfit furnished. Just follow easy instructions and work honestly—for yourself. All or spare time work. **A profit for every hour.** A customer at every home. A chance that guarantees you independence. Your opportunity. **Act today.** Send your application for free county agency.

## Amazing New Home Invention The Shafer Ventilated Chemical Indoor Closet

**No plumbing—no waterworks—no cesspool. Banishes the outdoor closet. Revolutionizes living conditions in country and village homes. Solves the one humiliating and perplexing country home problem. An imperative necessity to health, comfort and convenience. Perfected for his own use after years of experimental work by a heating and ventilating engineer. Tested in over 2000 homes for three years. Now offered to the homes of the world at a nominal price. Gives positive, guaranteed satisfaction. Demanded everywhere. A sale at every home. Warranted for ten years. Absolutely odorless, sanitary, germ proof.**

**30 DAYS' FREE TRIAL** Endorsed by physicians, health authorities, schools and thousands of homes. Every day we receive letters such as the following: "I have observed many of them in highly successful operation. In my private practice I unhesitatingly and continually recommend them. **I wish these closets were in every home.**"—Dr. Thomas H. Turner (Health Officer). "I recommend The Shafer Closet in every home as a necessity and as a duty to public health."—Dr. D. B. Henry. "It is a complete success—a splendid invention of great practical use."—O. M. Misener, (Supt. of Schools). "Every home that would put one in and use it for a week would never let it get out of the house."—Arthur B. Ransom, (Farmer).

## \$112 Cash Profit in One Day

That's the record of one man (a plumber) in a single day. **The same man has never sold less than five Closets for any half day's work.** Every home a prospect. Every sale makes dollars—not pennies—of cash profit. **Liberal commission to agents.** Biggest money-making opportunity ever offered, because it is an invention that is positively needed in every home not supplied with waterworks and sewerage system. Listen: L. J. Duile, Mo., (Insurance Agent) says: "This is an easy thing to sell. **Everybody you go to and talk Closet to has another prospect for you.**" C. A. Carter, Ill., (former Grain Dealer) says: "I was out today two hours and sold three. Find enclosed check. **Ship me twelve at once.**" W. H. Bartholomew, Wash., (Farmer) says: "Closets arrived yesterday. **Sold one in 15 minutes.**" Seymour L. Vance, N. Y., (Carpenter) says: "I sold nine the first three hours." W. D. Belknap, Ohio (former Real Estate Agent) wired: "Sold ten Closets today—send twelve by express." Do you want more proof of success and profit? Send today for free illustrated book showing pictures of homes and rooms containing this wonderful device, complete description, color plates, letters of endorsement from health authorities, doctors, editors and scores of users with names and addresses. This book is **free**—send for it today—investigate.

### Send No Money—Agents' Outfit Free

**No order required to start.** Order book, business cards and prospectus with exclusive agency contract **FREE.** Co-operation, advertising, assistance. **Business supplies capital.** We teach you how to make amazing success. Permanent business—all or spare time. Secure your county under exclusive agency contract now—**free.** Don't delay. Write us a letter or postal card, giving your name, address, and the name of your county, and mail it today. **No previous experience necessary or required.** You can make this success. **Your profits will start the first day.** Make \$40 a week to \$5000 a year commencing **NOW.** Risk a stamp to get complete, proved, reliable free information. **This is your part—DO IT RIGHT NOW.**

The Shafer Mfg. Co., 487 Colton Bldg., Toledo, Ohio





# GILBERT TOYS



**Hello Boys!**  
REG. U.S. PAT. OFF.

Here's a straight tip for you. You don't have to be told about the loads of fun you can have building models of battleships, flying machines, cranes, skyscrapers, farming machinery, etc. Every regular fellow knows it. But—the important thing to keep in mind when buying a construction toy set is: Will your models look real—will the battleship that you build look like a regular member of Uncle Sam's floating flotilla, or will you have to hang a sign on it saying, "This is a battleship?" You know, making Erector what it is, has been serious to me. I guess I've never got over being a boy, myself. I know the importance of having things genuine.

Most toy-makers are satisfied to get the first impression. But I know how a boy feels—when he realizes his toy isn't true—that the steel-work in his toy skyscraper isn't like the real building he saw or that his toy engine won't work—why, he's hurt! He's done with it! Fellows! I know what I'm talking about when I tell you to be sure to get

## ERECTOR

REG. U.S. PAT. OFF.

**"The Toy Like Structural Steel"**



and there are hundreds of thousands of other fellows who will second my motion. The square four-sided Erector girder is the thing—it's in a class by itself—it's absolutely necessary if you want models of battleships that look like battleships, skyscrapers that look like skyscrapers, and hundreds of other models that look just like the things they represent. What's the use of building stuff if it doesn't look real? The answer is: Get Erector!

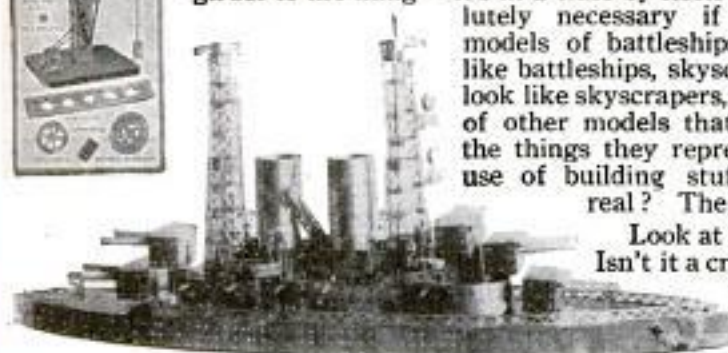

Look at the battleship shown here. Isn't it a crackerjack with its skeleton fighting turrets and gigantic guns that can be turned in any direction? Wouldn't you like to own it, wouldn't

you enjoy building it, and wouldn't you be proud to show it to your friends? There's no limit to the fine things you can build with Erector, and no limit to the size of your models because you can constantly add to your first set with new Erector parts.

Boys, tell your parents you want Erector this year for Christmas. It will give you the finest kind of fun and you'll never grow tired of it.

Learn all about the Gilbert Engineering Institute for Boys—how you can get free membership in it and win handsome Diplomas, Degrees, Gold Fraternity Pins, Gold Watches, Thirty Dollars in Salary, etc. Mail back the coupon now for a free copy of my beautiful book, "How to Become a Gilbert Master Engineer," which tells the whole interesting story, and I will also send you a free copy of my magazine for boys, "Gilbert Toy Tips." Mail back the coupon now before you forget.

*A.C. Gilbert*  
President.

**The A. C. Gilbert Company**  
101 Blatchley Ave., NEW HAVEN, CONN.



The  
A. C.  
Gilbert  
Company  
101 Blatchley  
Avenue

NEW HAVEN, CONN.

Send me a copy of "Gilbert Toy Tips" and your booklet, "How to Become a Gilbert Master Engineer."

Name .....

Street .....

City .....

State .....

**GILBERT TOYS**

ERECTOR  
ELECTRICAL SETS  
TELEGRAPH SETS  
ELECTRICAL MOTORS  
CHEMISTRY OUTFITS  
SUBMARINES  
MECHANICAL TOYS  
MACHINE GUN  
PUZZLE PARTIES  
NURSES OUTFITS  
MAGIC SETS  
KIDDIKINS  
BRIK-TOR

## The "D-D" KHAKI WATCH

For Officers, Soldiers, Aviators, and for Sportsmen  
Prestige WALTHAM MOVEMENT Accuracy



A Safety  
Test  
from  
actual  
photographs

Safe  
The "Khaki" Glass,  
Non-explosive  
and unbreakable

**Dangerous!**  
Nitro-cellulose Watch Glass

The "Khaki" Glass will not catch fire. Other unbreakable watch crystals of nitro-cellulose products are highly inflammable. Our "Khaki" Glass is non-explosive and unbreakable; a protection for both the watch and wearer. This Glass cannot drop out or become loose because held securely in place by our patented Double Clinched Bezel. Dust proof and not affected by climatic changes. (Bezel Patented, Sept. 11, 1917)



The "No Fuss"  
Strap

No Buckle, No Eyelets, Slips  
over hand as a loop. Patented.

Strike  
Again!  
It Can't  
Crack!

"Cravenette"  
Finished

Olive Drab Webbing, Moisture  
Proof, Stronger than Leather.

**RADIUM DIAL**

Sold by leading Watch Dealers  
Write us for full description

**JACQUES DEPOLLIER & SON**

Manufacturers of High Class Specialties for Waltham Watches  
15 Maiden Lane New York City, U.S.A.



"Sammy's"  
Favorite

**5¢ A DAY  
BUYS A GIBSON**

Terms as low  
as \$1.00 down and  
\$1.50 per month. Man-  
dolin or guitar sent on ap-  
proval. Liberal allowance  
on old instruments in ex-  
change for the "Gibson."  
Get our new Free Book—  
112 pages, 111 illustrations.  
Valuable for musician, for  
player and teacher. Explains  
wonderful new violin in-  
struction with curved and  
graduated Top and Back  
and Stradivarius Arching  
under treatment on "How to Practice."

Also free treatise on "How to Practice."  
**Teach and Sell the Gibson  
Make \$1800 to \$5000  
or More a Year**

Become a teacher. Splendid opportunities  
for Mandolin and Guitar teacher—either  
sex, in every locality, for private and class  
instruction and sale of "Gibsons." They  
have "made" many a teacher profession-  
ally and financially. We have permanent  
teaching and business opportunity now  
open for either sex. Other positions pen-  
ding. Write promptly, A. C. Brockmeyer,  
St. Louis, Mo., Teacher and Director,  
writes: "Will do \$10,000 business in 1917;  
did \$7,000 in 1916." Wm. Place, Jr.,  
Evansville, Ind., Star Solicitor for Victor,  
unqualifiedly endorses the "Gibson."

**Do Business On Our Capital**

Become our agent. We help sell. Agents'  
territory protected. Stock furnished. We  
pay the advertising. You make the profit.  
You pay 2 goods when sold; return  
goods not sold. Try our "Sell best,"  
which is "use improved our new \$1.00  
book "The Organization, Direction  
complete Catalog, free treatise, also  
information about the Wm. Place, Jr.,  
if teacher check here

Gibson Mandolin-Guitar Co.,  
171 Parsons St., Kalamazoo,  
Mich., U.S.A. Gentlemen: With-  
out obligation send me free book  
and complete Catalog, free treatise, also  
information about the Wm. Place, Jr.,  
if teacher check here

Mandolin Mando-cello Guitar  
Mandola Mando-bass Harp-guitar

Name.....  
Address.....  
Be sure you have checked instrument.

Orchestra," by America's most  
successful director, Wm. Place, Jr.  
Write now for Catalog, Treatise,  
How to Practice, Psycho-  
logically Explained, "Sell  
Don't wait! ACT NOW. Fill  
in the coupon.

Gibson Mandolin-Guitar Co.,  
171 Parsons St.,  
Kalamazoo, Mich., U.S.A.

## TEMCO

*Pays Its Way Every Day*  
The speedy, dependable and durable portable electric drill—taking the place of hand work in thousands of machine shops, garages, factories, ship yards, public buildings, etc. A wonderful tool enjoying a wonderful and fast increasing popularity.

**EXECUTIVES AND SUPERINTENDENTS**—investigate this money and time saving tool. **IT PAYS ITS WAY EVERY DAY.**

**MECHANICS**—ask the boss to get a TEMCO. Show them you are alive to good things. Five sizes—9 to 19 pounds. Capacities to 1/2" drilling in steel.

Also Temco Drills, Grinders, Buffers, etc., of larger capacity.

At leading Dealers and Jobbers Everywhere.  
Write for our catalog.

Drills by electricity anywhere—direct or alternating current

**The Temco Electric Motor Company**  
144 Sugar Street LEIPSIK, OHIO  
Makers also of TEMCO-Auto Shock Absorbers and TEMCO Shock Absorbers, Master Vibrators and Lock Switches for Cars.

# TEMCO

THE TOOL OF MANY USES

**PHONOGRAPH AS EGG TIMER**—A clever piece of advertising was recently done by a Montana firm dealing in phonographs. Their ad was in the form of a rule for boiling eggs, and read as follows: "Have a kettle full of boiling water. Drop eggs in water. Start a three-minute record on your talking machine and, when through, the eggs will be nicely boiled. If you have no phonograph, see us."

## FREE STEEL SHOE BOOK SAVES \$20

Tells all about my Celebrated Steel Shoes. One of the greatest inventions in footwear the world has ever known. Over a million people now wearing them. Wear as long as three to six pairs of leather shoes. Easiest, most comfortable shoes you ever had on your feet. No cold, wet feet, therefore Colds, Rheumatism, Grip, Lumbago, Lameness, and other ailments prevented. No corns, bunions or tender, tired feet. Write today for my free book.

Investigate this wonderful proposition.  
Address: RUTHSTEIN, Steel Shoe Man, Dept. 32, RACINE, WIS.

## 1/2 Carat Genuine Diamond Ring \$48.75

**Buy Diamonds Now at the Old Price**  
Right in the face of extreme rising costs in diamonds we make this announcement. Every price 25 per cent under ordinary retail prices because we import direct from diamond cutters and are satisfied with small profits on a great volume of sales. You may still have full carats at \$47.50, three quarter carats at \$72.00 and one quarter carat at \$20.00. Every stone guaranteed in writing.

\$1—Full Size Fountain Pen. Full size, 5 1/2 inches long, lever, self-filler barrel and cap are pure Para rubber. Your name indelible in gold free. Pen is 14K, solid gold fountain tipped. Guarantees free repairs for 3 years. Special Factory Price to you \$1.00.

Write for Diamond Catalog. Write today for the Beach DeLuxe Diamond Book. It is free. First diamond guide ever issued. Send for it today sure. L. Beach & Co. Dept. 3-3471 State and Quincy, Chicago, Ill.

Please Mention Popular Mechanics

# FEDERAL BICYCLE TIRES



**Built for Easy Riding**

The pleasure of bicycling is enhanced when you know you have good tires. The white "Rugged Tread" or the black "Traffik Tread" Federal Tires will always give dependable satisfaction. Be sure to ask for Federals. For sale by leading dealers. If your dealer can not supply you send us his name and address, and we will send you booklet and handsome felt pennant free.

**THE FEDERAL RUBBER COMPANY**  
 Factories: Cudahy, Wisconsin

**1917 Indian Motorcycles** With New Power-plus Motor and Cradle Spring frame. Write for catalog.  
**HENDEE MFG. CO., 710 State Street, SPRINGFIELD, MASS.**

Make a Warm Friend by Presenting a  
**CHASE Plush Motor-Car Robe**

**The RIGHT Rule "Interlox" for YOU** MASTER SLIDE RULE

Don't waste time with a folding rule that can't give you accurate inside measurements—use this up-to-date Interlocking Rule that SLIDES in and out. No other rule like it. Gives quick and correct inside and outside measurements. If not at hardware dealer's, send his name and 25c per foot (any length from 2 to 8 ft.) and we'll send one prepaid. Dealers and Agents! Write for Liberal Proposition

**DAHL MFG. CO., 51J E. 43d Street, NEW YORK**

## Violin Lovers



Please send us your name today so we can mail you copies of our two latest Violin Catalogs. One catalog is of Rare Old Violins and the other of Modern Violins. These catalogs are illustrated in colors, contain much authoritative information, and will make a valuable addition to your library. Sent free to violinists. We take used violins in exchange. WRITE TODAY.

**WYON & HEALY** 56-58 E. Jackson Blvd. **CHICAGO**  
 WORLD'S LARGEST MUSIC HOUSE

# Simply Pull

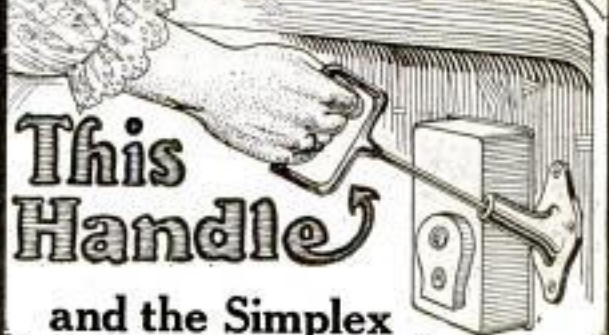

**This Handle**

and the Simplex Starter positively starts your Ford

*If it doesn't, send it back and get your money.*

No more cranking—no more broken arms—no more climbing out into rain and mud and cold. The Simplex cannot kick and you'll never have occasion to. Any woman or child can operate it. It's the only practical, simple, low priced, guaranteed Ford Starter made.

**The Simplex Ford Starter** **\$10**  
 The Guaranteed Starter (Price Advances Dec 1<sup>st</sup> to 12<sup>29</sup>)

**Thousands in Daily Use** and every one making good. Has been successfully used for three years.

Everything concealed beneath the hood except the handle, which projects through the dash. No connection with engine when not being used. Made substantially of the very best material—no rattle—no moving parts to wear out—no complicated bearings or gears on crank shaft.

### Dealers Wanted

in every community. Simplex Starters are good sellers because they're good starters. There's a liberal profit for the dealer. Every Ford owner is a prospect—and every sale made makes many more. Remember, it's guaranteed. Write for special terms to dealers.

### Order Today at Our Risk

Send draft or money order today for \$10.00 and we'll deliver Simplex to you by prepaid express. Put it on your car and use it 10 days; then, if you're not satisfied, send Simplex back at our expense and we'll refund your money. If you want it sent C.O.D., send \$1.00 to cover express charges and pay the balance (\$9.00) when Simplex arrives. If you're a dealer, send full price—we'll give you credit for dealer's discount.

**Simplex Mfg. Company**

Box 460

Anderson Indiana

Simplex Mfg. Co.  
 Box 460 Anderson, Ind.

Enclose \$10.00 for one Simplex Ford Starter, subject to your guarantee of a refund if I return same within 10 days after receipt.

Name .....

Address .....

(If a dealer send in your business letterhead with coupon.)

After December 1st, 1917, price \$12.50

Please Mention Popular Mechanics

# 586.8 MILES OVER

## Chicago's Most Congested Streets in 24 Hours On High Gear



### A Remarkable Feat Accomplished by a Stromberg-Equipped STOCK SEVEN-PASSENGER Chalmers

March 26th, noon, a Stromberg-equipped stock Chalmers seven-passenger touring car—complete with standard body, top and full equipment—carrying four passengers—was started on a 24-hour run through the heart of Chicago's busiest traffic. 586.8 miles were traversed—with a perfect score. Every mile—all stops, all starts were made on high gear, and high gear alone.

#### The Motor was in Operation Every Second of the Time

in the "thickest" of Chicago's most crowded streets—crossing the loop. Weather conditions were detrimental—cold—snowy—windy. Still the engine never faltered—never failed to respond instantly. Never was there a greater display of flexibility—of dependability. And with this splendid efficiency, there was a substantial saving of fuel—an average of 11 miles on a gallon of gasoline. Write at once for the details and money-saving facts. State name, model and year of your car.

**STROMBERG MOTOR DEVICES CO.**

Dept. 1114, 64 E. 25th St., CHICAGO

# New STROMBERG Does it! CARBURETOR

### SHINE YOUR OWN SHOES AND SAVE MONEY

IT IS VERY EASY WITH  
OUR ADJUSTABLE ALL  
METAL BRACKET

LASTS A LIFE TIME

PAYS FOR ITSELF  
FIRST MONTH

No Soiled Hands

No Bending

Holds Any Size  
Shoe



Sent prepaid for \$1.50

In Canada the price is \$2

**F. S. KAY CO.**

1733 Republic Bldg. Chicago

### Make Yourself as Healthy and Attractive As You'd Like to Be

Enjoy vigorous, glorious health. Wonderful new invention—most scientific, successful, natural way of acquiring beauty and health. Users astonished at results.

## The Violetta

most advanced design of Violet Ray instruments. Fairly marvelous system with beauty and health-giving life. Excites blood with oyster. Massages tissues with action of Violet Ray. Strengthens entire body. Brings glow of natural luster, irresistible beauty and health. A delight to use. No shocks. Remarkably speedy benefits.

No other method of Beauty or Health Culture compares with it. Wonderfully effective in treatment of skin affections and scalp diseases. The most successful means of relieving ailments of any nature. Send now for free booklet that shows how to make yourself as attractive as you'd like to be.

**BLEADON-DUNN CO.**  
Dept. C, 12 So. Dearborn St., Chicago, Ill.



38278 \$130.      36034 \$45.      Buy Today      36030 \$25.      36184 \$100.

## Eight Months to Pay

Buy "Sweet" Diamonds and Jewelry at cash prices on Credit terms. WE TRUST YOU—no security—no red tape. Each GUARANTEED for QUALITY and VALUE. We accept "Sweet" Diamonds in exchange, at full price PLUS 7½% annual increase.

### Pay Only 20% Down, 10% Monthly

Anything you select from our DeLuxe Catalog No. 6E sent AT OUR EXPENSE. You see before you buy. Over one thousand gifts. Diamonds, Rings, Pins, Lavalieres, Watches, Silverware, Cameras, Phonographs, French Ivory Toilet Ware and Cut Glass. Send for your FREE copy today.

**L. W. SWEET & COMPANY, Inc.**  
2 and 4 Maiden Lane 6-E      NEW YORK CITY

36043 \$100.

36254 \$50.

36226 \$25.

36071 \$55.

36055 \$300.

36211 \$90.

36080 \$100.

# The Cleveland Lightweight



## It Dominates —

Where elegance and refinement are essential, the Cleveland Lightweight is in marked evidence.

In its ultra-distinctiveness, it enjoys that reputation which places it wholly apart from the ordinary.

Cleveland Dealers are making money

We will gladly talk the Agency proposition with you.

**\$175 F.O.B. Cleveland, O., U.S.A.**

Cleveland Motorcycle Manufacturing Co.  
7209 Platt Avenue, Cleveland, Ohio

## \$25,000 A YEAR

is what can be made by selling a Fridge a day. We want more live wide awake dealers who can see a big proposition such as we can offer. Investigate our proposition and make big money. See our full page ad on page 7, October issue Popular Mechanics.

Fridge, The Silk Hat Ice Man, Wells St. Bridge Bldg., Chicago

## Abdominal MASSAGE

with the wonderful new **KOLON MOTOR** brings health, strength and energy. Banishes chronic constipation. Write for interesting booklet—"Colon Cleanliness"—mailed free. Send a postal.

**MARTIN'S METHOD, Inc., Dept. 80, 105 E. 30th St., NEW YORK**

## DUCK'S BIG 300-Page No. 11 Electrical and Wireless CATALOG

Mailed on receipt of 8 cents in stamps or coin, which may be deducted on first dollar purchase. Great cost of catalog and low prices prohibit distribution otherwise. Catalog contains 160 pages of wireless apparatus and 140 pages of electrical supplies. No bigger or better values are obtainable elsewhere.

**THE WILLIAM B. DUCK CO., 223-227 Superior Street, TOLEDO, OHIO**

## MAKE MORE MONEY



You Can Easily Earn  
Extra Money in Your  
Spare Time Selling the  
**WOODSTOCK**

Typewriter

The World's New Leader

The handsome, new, trouble-free machine that sells itself and always satisfies. Meets every demand. Suits every purse. Now so popular that people are asking for it in every community—Plenty of prospects.

Own One Yourself and make money besides. Hundreds of men and women, young and old, are making easy money selling the Woodstock. Here's a sample of a letter from one just starting with no experience.

E. H. Bumpstot, Westerville, Ohio, writes:  
"The machine really sells itself. I have already sold four Woodstock Typewriters and I doubt if it has taken as many hours to do it."

We have stacks of letters like this. You can do as well or better. Be the fortunate one in your town to make extra money by having this latest Great Seller. Write today for special agency terms and time payment plan.

**Woodstock Typewriter Co., Dept. N 108 Chicago**



Thomas  
A.  
Edison

## Mr. Edison's Wonderful New Phonograph

The world's greatest inventor has made the music of the phonograph life-like, at last. Success—after years of labor on his favorite invention! Read our offer on his wonderful new phonograph.



Only  
**\$1.00** and  
after trial

An astounding offer—the New Edison, Mr. Edison's great new phonograph with the new Diamond Stylus reproducer and your choice of all the brand new Diamond Amberol Records will be sent to you on **free trial without a penny down**. The finest, the best that money can buy at very, very much less than the price at which imitations of the genuine Edison are offered—a **rock-bottom offer direct from us**.

## Entertain Your Friends

Hear all the latest up-to-date song hits of the big cities. Laugh at the side-splitting minstrel shows. Entertain your family and your friends with everything from Grand Opera to Comic Vaudeville—then if you choose, send the outfit back to us at our expense.

## Rock-Bottom Direct Offer

If you wish to keep Mr. Edison's superb new instrument, send us only \$1.00 after the free trial. Pay the balance on the easiest kind of monthly payments.

Think of it—a \$1.00 payment, and a few dollars a month to get this outfit of Mr. Edison's new phonograph with the Diamond Stylus reproducer, the life-like music—the same Diamond Amberol Records—all the musical results of the highest priced outfits—yes, the greatest value for \$1.00 down, balance on **easiest monthly terms**. Convince yourself—a free trial first! No money down, no C. O. D., not one cent to pay us unless you choose to keep the instrument.

## Our New Edison Catalog Sent Free

Your name and address on a postal or a letter (or just the coupon) is enough. No obligations in asking for the catalog. Get this offer—while this offer lasts. Fill out coupon today.

**F. K. BABSON**  
Edison Phonograph Distributors  
1198 Edison Block  
Chicago, Ill.

Canadian Office:  
855 Portage Ave.  
Winnipeg,  
Manitoba.

To  
**F. K. Babson**  
Edison  
Phonograph Distributors  
1198 Edison Bk.  
Chicago, Ill.

Gentlemen: Please send me your New Edison Catalog and full particulars of your free trial offer on the new model Edison Phonograph.

Name.....

Address.....

**FREE**



**BOOK & FORM EVERY INVENTOR SHOULD USE**



# U.S. PATENTS

PATENTS AND TRADE MARKS.



**LANCASTER & ALLWINE**

REGISTERED ATTORNEYS

Lancaster & Allwine  
247  
Ourray Bldg.,  
Washington  
D. C.

## War Inventions Wanted

History will repeat itself in the present War. The greatest victories will be won, not through overpowering numbers, but through the surprises wrought by invention. Life and property will be saved for the Nations by inventions. The Government is ready to experiment with and carefully consider any inventions which will aid in winning and ending the War. The **Special War Bulletin** just off the press will give you a good idea of what is needed. We will send it to you free of charge. Located in Washington, we are in close touch with the proper Government Officials who should be approached with inventions for use in War time, and we will advise you fully how the disclosure should be sent.

Our cooperation with an inventor is, **First**, to help him establish his rights before sending a sketch, drawing or model to any attorney; **Second**, to give a frank opinion whether it will pay to patent his idea, based upon our extensive knowledge of the patent laws, manufacturers' wants and facilities; **Third**, to obtain for him on reasonable terms, a patent that absolutely protects; and, **Fourth**, advise and assist him in making the invention a source of profit by outright sale, territorial grants, obtaining royalty, or the independent manufacture of the invention.

All matters are held strictly confidential, and personal services are assured by our **Service Guarantee Contract**. **References:** 2nd National Bank, Washington, D. C.; John P. Roth Packing Co., Cincinnati, Ohio; Home Savings Bank, Washington, D. C.; Duskil Mop Co., Paducah, Ky.

Before disclosing the invention to anyone, sign, witness and deposit in our fireproof safe, the form "Evidence of Conception" and establish your rights. A completed sample form in our book shows you clearly how to protect your invention. All are free. Just ask for them on a post card or simply mail coupon.



**COUPON**

LANCASTER & ALLWINE, 247 Ourray Bldg., WASHINGTON, D. C.

Send me free book, "Inventions-Patenting and Promoting," Special War Bulletin, and blank form "Evidence of Conception."

NAME .....

ADDRESS .....

**R. MORGAN ELLIOTT & Co.**  
PATENT ATTORNEYS

MECHANICAL, ELECTRICAL & CHEMICAL EXPERTS

713-721 WOODWARD BUILDING  
WASHINGTON, D. C.

# PATENTS

Send me your ideas. Manufacturers want patents I procure. Prompt, confidential, personal service by successful patent attorney with highest references. Honest advice and "The Truth About Patents" Free.

**J. R. KELLY, 743 Woodward Bldg., WASHINGTON, D. C.**

---

**COMPETENT PATENT SERVICE**  
BY A FORMER EXAMINING OFFICIAL  
OF THE U. S. PATENT OFFICE

**NORMAN T. WHITAKER**  
LAWYER AND ENGINEER  
27 LEGAL BLDG. WASHINGTON, D. C.  
INQUIRIES INVITED



# PATENTS

**Send Sketch or Model of Your Invention for Free Opinion as to Patentability**

Our Certificate of Patentability is Evidence of Conception of your invention and may prove valuable to you. Our Credit System enables you to file your application for Patent and proceed without delay. Every case receives personal attention of one or both members of the firm. Patents we secure advertised at our expense in Popular Mechanics Magazine.

Write today for Free copy of 104-page book, "How to Obtain a Patent and What to Invent"

**Talbert & Parker, Patent Lawyers**  
4 683 Talbert Bldg. WASHINGTON, D. C.



## Patents on Easy Payments

Send sketch for free opinion as to patentability. Write today for our new book on what to invent and how to protect your invention under our **NEW EASY PAYMENT PLAN**.

**C. C. HINES & CO.**  
591a W. L. & T. Bldg., WASHINGTON, D. C.

THE DAWN PATENTS OF INVENTION

- PATENT - AND - POSSIBILITIES -

THE WAR opens a wide field for invention - Submarine Destroyers, Torpedo Carriers, Airships, etc. are needed. Help your country meet the emergency!

AFTER THE WAR, Tanks, Agricultural Machines, Railway Appliances, etc. will be needed. Patents can be made supplying these demands. Prepare now for the future.

Get the right start by reading the free book "Patents and Patent Possibilities." It tells how to obtain a patent and where to sell it. Write for it today.

B. S. HILL, 802 N. Landon Building, Washington, D. C.

Please Mention Popular Mechanics

# I Will Save You More Than 1/2 on a \$100 UNDERWOOD

E. W. S. SHIPMAN, President

EVERYONE knows the reputation of the Underwood Typewriter. I will send you on **TEN DAYS' FREE TRIAL** a High Grade No. 4 Visible Writing Underwood, with Back Spacer, Tabulator, Stencil Attachment, Two-color Ribbon, Waterproof Cover and Special Touch Typewriting Instruction Book, that will teach you to operate this simple Underwood in one day. I will give you a **written** guarantee of **FIVE YEARS' SERVICE** from date of sale and I will save you much more than one-half the manufacturer's price.

## 25 Years' Experience—Confidence of 200,000 Customers

I am the largest typewriter re-builder in the world, employing the most expert workmen in the typewriter business. I handle only Underwoods, obtaining all my machines and all new parts direct from the Underwood Company.

## How I Double the Life of An Underwood

Do not confuse me with a second-hand dealer. I put each machine through a process that I have spent 25 years perfecting. Each machine is taken apart and re-built from top to bottom.

The frame is re-enameled, the bright parts re-nickled. All parts unfit for further service are discarded and replaced by new parts purchased from the Underwood Company. Every machine is equipped with new type, new platen, new ribbon vibrator, front scale, feed roll, ribbon, space bar, key rings, key glasses, rubber feet, etc. Expert mechanics re-adjust and re-align each machine. It will stand any mechanical typewriter test.

You May  
**RENT** APPLYING RENT ON PURCHASE PRICE  
OR  
**BUY** FOR CASH OR ON EASY PAYMENTS

## My Five Year Guarantee—Ten Days Free Trial

I personally stand back of every machine that goes through my factory with a **WRITTEN FIVE YEAR GUARANTEE OF SERVICE**. I guarantee to send you a genuine Underwood, exactly as illustrated and described here-with. You don't even have to buy the machine at the time you get it. You can try it for ten days **FREE** and then, if you conclude the machine I send you does not look, work and write like new, you may return it and I will refund any deposit or charges paid by you. This guarantee affords you complete protection.

**Rent or Buy** Mail coupon or post card today for special low price and terms. You can **RENT**, applying six months' rental on purchase price, buy on easy terms or secure discount for cash.

## Our Other Plan Brings Underwood FREE

A new plan—our agency plan. You are not asked to do any canvassing or soliciting for orders. You simply co-operate with us, becoming part of our nation-wide organization. You can easily get your Underwood **FREE** in this way. Send name and address on coupon today and learn about Offer No. 52.

E. W. S. SHIPMAN, President

**Typewriter Emporium**  
CHICAGO

SEND AND MAIL COUPON TODAY  
TYPEWRITER EMPORIUM, 34-36 W. Lake Street, CHICAGO

Five  
Year  
Guarantee

Ten  
Days'  
Free Trial

Name .....  
Street or R. R. No. ....  
City .....  
State .....

Please Mention Popular Mechanics



## JAPANESE ROSE BUSHES

### The Wonder of the World

Japanese Rose Bushes bloom all the year round. Just think of it. Six weeks after planting the seed, the plants will be in full bloom. It may not seem possible, but we positively guarantee it to be so. They will bloom every ten weeks, Summer or Winter, and when three years old the bush will be a mass of roses, bearing from five hundred to a thousand roses on each bush. The flowers are in three shades—white, pink, and crimson. The plants will do well both in and out doors. We guarantee at least three bushes to grow from each packet of seed. Price, 10c packet, 3 pkts. for 25c postpaid.

### Shoo Fly Plant

A very remarkable botanical curiosity you should have. Though quite odorless, it will not remain in a room where it is grown. Bears very pretty blossoms; blooms summer and winter. Grows rapidly from seed. SEEDS 15c packet, 3 for 40c, postpaid. Johnson Smith & Co., Dept. 92, 54 W. Lake St., Chicago

### Weather Plant

NATURE'S WEATHER PROPHECY By mysterious changes that take place, this remarkable plant accurately forecasts the weather many hours in advance. Will grow anywhere all the year around. An interesting house plant. Bears large, fragrant, pink, butterfly shape flowers. SEEDS, 15c packet, 3 for 40c, postpaid Johnson Smith & Co., Dept. 92, 54 W. Lake St., Chicago

## LUMINOUS PAINT

**Make Your Watches, Clocks, Etc., Visible by Night** The very latest discovery in the scientific world. Hitherto, practically unobtainable except at an exorbitant price, it has now succeeded in producing this remarkable LUMINOUS PAINT, which, applied to the surface of any article, emits rays of white light, rendering it perfectly visible in the dark. THE DARKER THE NIGHT, THE MORE BRILLIANT IT SHINES. Quite simple to use. Anyone who can do it. A little applied to the dial of your watch or clock will enable you to tell the time by night. You can coat the push buttons or switch plates of your electric lights, switch boxes, and innumerable other articles; make your own Luminous Crochets, Luminous Rosaries, etc. Bottle containing sufficient to coat several small articles. Price 25c. Larger sizes 50c and \$1 postpaid. Johnson Smith & Co., Dept. 92, 54 W. Lake St., Chicago

### INVISIBLE INK

The most confidential messages can be written with this ink. For the writing MAKES NO MARK. Cannot be seen unless you know the secret. Invisible for many reasons. Keep your posts and other private communications away from prying eyes. Great fun for playing practical jokes. Only 15c Bottle

### VANISHING INK

Writing written with this remarkable ink vanishes entirely in a few weeks (sooner if desired), leaving the paper QUITE BLANK. 15c post. LUMINOUS INK writing can be READ ONLY IN A DARK ROOM; writing shines like fire. Quite invisible at daytime. Very remarkable. 15c

### AMERICAN FLAG Gum Stickers

Use these Flags on your envelopes, post cards, stationery, packages, and every piece of mail you send out, and show your patriotism. Let everyone know you are an American. Flags are gummed on the reverse side, and about the same size as postage stamps. Price 10c per package of 90 Flags.

### Sneezing Powder

Place a very small amount of this powder on the back of your hand and blow it into the air, and everyone in the room or car will begin to sneeze without knowing the reason why. It is most amusing to see their reactions, as they never suspect the real source, but think they have caught it on from the other. Between the laughing and sneezing you yourself will be having the time of your life. For parties, political meetings, car rides, or any place at all where there is a gathering of people, it is the greatest joke out. Price 12 cents, or Three Packages for 30 cents.

### STAGE MONEY

With a bunch of these bills, it is easy for each person of limited means to appear prosperous. By flashing a roll of these bills at the proper time and peeling off a genuine bill or two from the outside of the roll, the effect created will be found to be all that can be desired. Prices, postpaid: 15 Bills 40c, 50 Bills 25c, 125 for 90c, or \$3.50 postpaid.

### TRUMPET KAZOO

With the Trumpet Kazoo you can, without previous practice whatsoever, play any tune right off, imitate any bird or animal, harp, snare drum, Punch and Judy, etc. No holes to finger. It is simplicity itself. Produces excellent music. You do not blow into it, but sing, speak, laugh or make any desired imitation. Used with astonishing results at society meetings, home, club or church entertainments, dances, serenades, picnics, outings, excursions. Just the thing for charades and shows, bicycle and marching clubs, etc. Excellent for vocal or instrumental accompaniments, either with or without other musical instruments. Price 15c

### MAGIC FLUTE

Wonderfully Sweet Toned and Musical A marvelous musical instrument. No other instrument produces sweeter music, whether outside of the roll, the effect created is the perfect notes of a quick-step or the solemn strains of a church hymn—in fact, any class of music can be played upon the Harmonica without practice, so it is almost a self-playing instrument. When played with a piano accompaniment or any other musical instrument, the effect is charming. Full printed instructions for playing with each instrument. Price 15 cents.

## All the Latest Surprising and Joke Novelties

- |  |     |   |           |
|--|-----|---|-----------|
| Pharo's Serpents Eggs, box             | 10c | Mummified Penny (defies the law of gravitation) | 20c       |
| Miniature Water Pistol                 | 10c | Mysterious Tumbler and Vanishing Coin Trick     | 25c       |
| Spectra's Snake (very life-like)       | 15c | Enchanting Bottle (won't lay down)              | 25c       |
| False Mustache (fool your friends)     | 10c | Magic Plate Lifter                              | 25c       |
| Ford Agito Puzzle (Latest)             | 15c | Imitation Gold Teeth                            | 3 for 10c |
| Magic Plate (anyone can play it)       | 15c | Great Ringler Puzzle                            | 10c       |
| Rubber Razor (very formidable)         | 25c | Wire Puzzles, 10c 25 different                  | \$1.25    |
| Rubber Dagger (sensational)            | 25c | Esac-Trick (Push Button)                        | 10c       |
| Wireless Smeasner (great joke)         | 25c | Inkless Pen (writes with water)                 | 10c       |
| Pocket Detective (see behind your ear) | 25c | Imitation Bed Bugs                              | 10c       |
| Great Mind Reading Mystery Cds.        | 10c | Squirt Ring                                     | 10c       |
| Thurston's Mysterious Trick Cds.       | 10c | Trick Bill Book                                 | 10c       |
| Fighting Roosters, pair                | 14c | Glass Revolver                                  | 25c       |
| Cover the Spot Trick, a scene, nov.    | 19c |   |           |
| K Ray Novelty                          | 19c |   |           |

Johnson Smith & Co., Dept. 92, 54 W. Lake St., Chicago

## Automatic Repeating Rifle

Fires 20 Shots in One Loading



This is a regular size automatic revolver. Shoots B. B. shots obtainable anywhere, same as other rifles and guns. Repeats 20 times with one loading. Very handsomely finished. Only 25c Postpd

No caps or load necessary, as it works with a spring and shoots with rapidity and accuracy. Simply load with 20 B. B. shot, then press the trigger. Nothing to explode—absolutely harmless and safe. Remember, it is not a mere toy, but the same size and shape as a REGULAR AUTOMATIC. Sent complete with a round of shot for ONLY 25c postpaid. Johnson Smith & Co.

## GREATEST TOY SENSATION OF THE DAY! FIGHTING DREADNAUGHT

SENSATIONALLY REALISTIC!!!

Here is a model of Uncle Sam's fighting monsters. Eight big guns, each of which flashes, at correct intervals, from twelve to twenty times. Extra ammunition always obtainable. Absolutely harmless. Can be operated indoors or out. Now boys! Here's your chance to see a battleship in action, and the best of it is you can OWN the ship and command the firing yourself! By having two or more Battleships, you can arrange EXCITING NAVAL BATTLES in your own home. Price of Warship and Ammunition, 15c, three for 40c, or a fleet of 12 ships for \$1.50 postpaid. Extra Ammunition, 5 cents per pkg.



## SONOPHONE CORNET

You can play it if you can talk. No knowledge of music needed. The simplest and most successful musical instrument ever brought out. Any man, woman or child that is able to talk or hum a tune can play it right from the very start without any previous practice whatsoever. Simply place the mouth-piece of the Cornet to your lips, hum through it any tune that you are familiar with, leaving out the words, and you'll have success straight off, and you will be overjoyed with the marvelous results. By a wonderful acoustic effect it is quite easy in very close reproduction on the Sonophone the tone of a trumpet or flared horn, and with some practice you can imitate a cello or tenor trombone in a surprisingly brilliant manner. Harmonizes well with piano or any other musical instrument. Failure is absolutely impossible. Well made of brass, highly polished, 7 1/2 inches long, 5 1/2 inch bell. The outfit includes 1 Sonophone Cornet, 1 Extra package Diagrams, and one book of nearly 100 New and Old Time Favorite Songs, words and music. Price only 50c. The complete outfit mailed postpaid anywhere.



## New Vamping Card

NO TEACHER NEEDED—SURPRISINGLY SIMPLE SYSTEM. Persons having neglected their Musical Education need not despair, for with the aid of our new VAMPING CARD (placing the card upright over the piano keys), you can at once Vamp away to thousands of songs, ballads, waltzes, Rag Time, etc., etc., equal to a Professional Musician. No knowledge of music is required. After using it a few times, you will be able to dispense with the aid of the Vamping Card entirely. The price of this very clever invention is only 15 cts. postpaid.

## NEW AUTOMATIC LIQUID PISTOL

This New Improved Automatic Liquid Pistol is the very latest design in Water Guns, and would readily be taken for one of the real Automatic Pistols. It is made from steel, with black finish. Very simple to load and discharge. No rubber bulb to get out of order. Great sport for boys and girls, so it throws a fine stream of water a distance of 25 feet. When diluted ammonia is used, it makes a very effective weapon against vicious men and animals. Measures about 6 inches in length. Price 25 cents, postpaid.

Johnson Smith & Co. Dept. 92, 54 W. Lake St., Chicago Only Concern of Its Kind in America



# WANTED! WE WANT 300 AGENTS AT \$35 TO \$70 A WEEK

**NEW INVENTION** —just out. Needed in every home every day. Patent just applied for. Nothing else like it. Supplies what every housewife has wished for for years. Perfected after long experimental work by mechanical experts. Low priced—anyone can use it—**sells on sight**. We want three hundred representatives at once—men or women hustlers—to advertise, accept orders and manage deliveries for our new **Quickedge Knife and Shear Sharpener**. Sharpens any kitchen knife, paring knife, carving knife, bread knife or shears and scissors in **ten seconds**. Agents are taking orders at every house—**wiring for rush shipments**. Write today for this opportunity to make \$10 to \$20 every day.

## MAKE \$300 NEXT MONTH

This little machine is a mechanical masterpiece. A child can use it. Just put knife in slot—turn crank—**grinds automatically**—draws blade to keen, sharp, perfect, lasting edge at **absolutely correct bevel for daily use**. Nothing to adjust—nothing to change, nothing to get out of order—**absolutely guaranteed**—will last for years. Once they see it and use it, women will not do without it for several times its cost. One agent wrote: "It was easier for me to learn to sell the **Quickedge** than it was to learn to tear open my pay-envelope in my former dollar-a-day job." Get out of the dollar-a-day class. Get this position, where profits start the first day.

## No Experience Required

Just take one of the machines to any house and show it—give a ten-second demonstration upon the dullest knife in the house; **the order is yours right on the spot; instantly**. No talking necessary. No argument. The machine simply sells itself, **and stays sold**. Every customer becomes your friend. They tell others, your profits double and multiply. I gave one hundred on trial over night. Collect the cash for every one of them next day. **The machine will do its own talking**; it is so easy to operate, no explanations or instructions are necessary. Secure your county now; **free**. Get started right now and

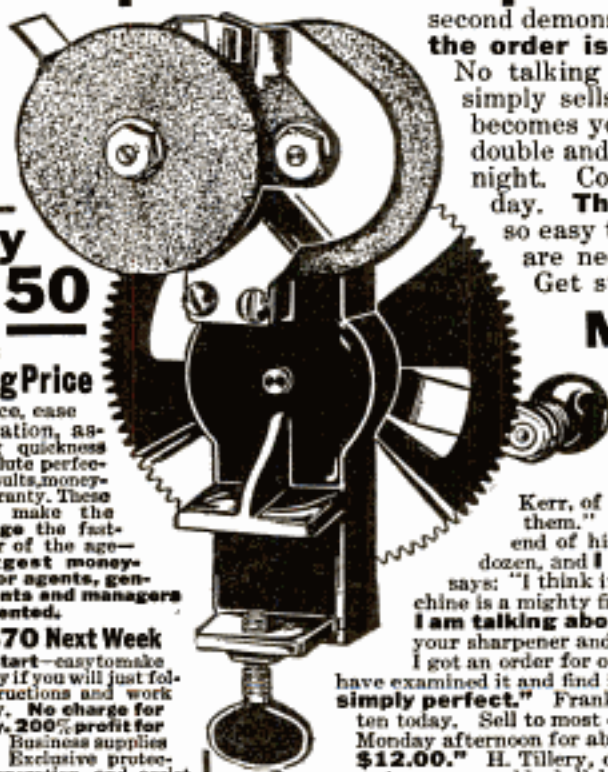

Only  
**\$1.50**  
Selling Price

Low price, ease of operation, astonishing quickness and absolute perfection of results, money-back guaranty. These things make the **Quickedge** the fastest seller of the age—the **biggest money-maker for agents, general agents and managers ever invented**.

### Make \$70 Next Week

**Easy to start**—easy to make big money if you will just follow instructions and work faithfully. **No charge for territory. 200% profit for agents.** Business supplies capital. Exclusive protection, co-operation and assistance. Failure impossible. Nothing to risk. Success assured.

**Easy to demonstrate**—and every woman is anxious to see it work—then she would not do without it. No talking necessary. Just show the machine and take the order—**one dollar profit on every call you make**.

Send for application blank and complete information today—**free**. Investigate. **Get the proof**. Don't delay. Write a postal card or letter right now. **Territory is being assigned very fast**. Get your county now—**free**. Write today.

The  
**Quick-  
edge  
Knife  
and Shear  
Sharpener**

Grinds any Kitchen Knife  
or Shears in 10 Seconds

Absolutely Guaranteed

## Make as Much Money Next Week as These Men are Making Now

J. C. Lewis, of Kansas, says: "**I have sold one hundred Sharpeners in four days**." Hobart Kerr, of Md., writes: "The women can hardly wait till they get them." Herbert Cain, of Ky., sold nine after supper. At the end of his first day, J. W. Gordon, of Pa., writes: "I sold two dozen, and **I sold to every one I saw**." Wm. G. Hall, of N. J., says: "I think it is great. I sold six in about one-half hour. The machine is a mighty fine proposition. **I am a mechanic and I know what I am talking about**." Peter Courland, of Mich., writes: "I received your sharpener and opened it in a barber shop. I ground his shears and I got an order for one right on the spot." H. A. Henkel, of Va., says: "I have examined it and find it a wonderful little machine. **The workmanship is simply perfect**." Frank King, Colo., says: "Sample received Saturday. Sold ten today. Sell to most every house." Forest Webb, of Pa., says: "Went out Monday afternoon for about three hours and received one dozen orders. **Profit \$12.00**." H. Tilery, of Tenn., wrote: "I took three orders first hour. When you sharpen an old, dull knife, dull as a hoe, in less than a minute, **they sit up and look**." Ray Carter, of Mass., writes: "I went out two days and have orders for thirty sharpeners." **Profit \$30.00 for first two days**. John Durr, of Wis., also says: "**I have sold thirty in two days**."

You can make this money. **Send now. Territory free.**

**GET BUSY. WRITE TODAY.**

**The Quickedge Sharpener Company**

No. 692 Sharpener Building  
215 N. Desplaines St., Chicago, Ill.

# Camera Economy

## Linked!

Send for this 1918  
Camera Catalog To-  
day and save from  
10% to 50% on all  
Cameras and supplies.

**David Stern Company**  
"Everything in Cameras"

Quality Developing and Printing,  
Complete line of High Grade Photo  
Accessories and Supplies, Motion  
Picture Cameras.

1110 Davsco Building  
1027-29 Madison St.  
Chicago, Illinois  
In Business Since 1885

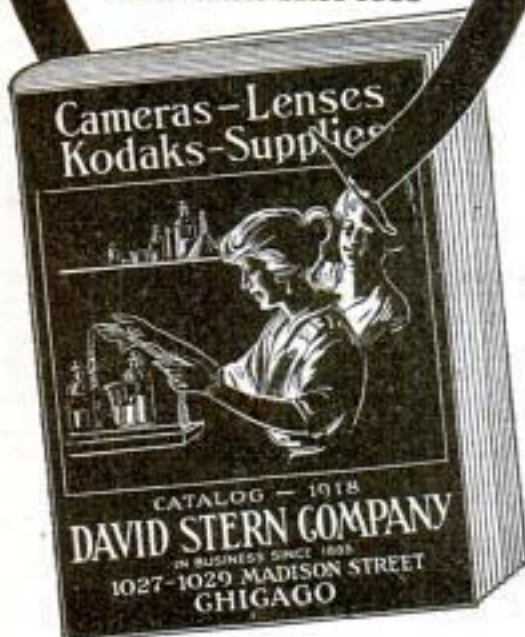

Please Mention Popular Mechanics



## Anyone can play this Symphonic Player Piano

Without the necessity of taking a long tiresome course of music lessons. Young and old, pianists and all others quickly learn how to play the most entertaining music with this Symphonic. Think of the delightful times you and your family will have with such an instrument. You'll be able to play the best Popular, Patriotic, Classical, Dance, Sacred, Operatic pieces. You'll always be ready to entertain anyone at a moment's notice. This Player Piano with other beautiful styles of Symphonic Pianos and GRAND Pianos all shown in actual colors in our Piano Catalog.

### Ask Today for Your Piano Book

Sent FREE on request. Give our liberal offers. Easy payments and over four years' time to pay while enjoying your instrument. Write for your copy today.

Please state whether interested in the Player Piano, in the Piano or in the GRAND Piano.

**Larkin Co. Desk P. M. 1117, BUFFALO, N. Y.**

## Club Feet

Little Robert Taylor was born with deformed feet. Plaster paris casts were used without success—so he was brought to the McLain Sanitarium. His parents' letter tells the story:

"We are more than thankful for what you did in straightening Robert's feet. Of course his feet are terribly scarred from the plaster casts, but there are no scars from your work on him. His feet are so straight; and he runs, jumps and does anything any other boy can do." Mr. & Mrs. John W. Taylor,  
1516 So. Flower St., Los Angeles, Calif.

This is not a selected case—neither is the result unusual. In correcting this deformity no plaster paris or general anaesthesia was used.

### Crippled Children

The McLain Sanitarium is a thoroughly equipped private Institution devoted exclusively to the treatment of children and young adults afflicted with Club Feet, Infantile Paralysis, Spinal Diseases and Curvature, Hip Disease, Wry Neck, etc. Our book, "Deformities and Paralysis"; also "Book of References", free on request. Write for them.

The McLain Orthopedic Sanitarium  
902 Aubert Ave., St. Louis



TWIN 2 FIRE

Distinct Sparks

## The Spark Plug With An Extra "Punch"

Twin Fire Spark Plugs fire two independent sparks simultaneously. This adds vigor to the gas explosions, makes combustion complete and economizes fuel; reduces carbon, banishes trouble, insuring a constant fire.

### Price, Only \$1

Twin Fire is the only plug that fires a two series spark. If one point clogs, the other still fires and the hot explosions clean the foul one. No other multi-point plug will fire when even one point clogs. Adds pleasure to your driving as you never have to think about your spark plugs. Go to your dealer or write us direct.

Twin Fire Spark Plug Co.  
660 Woodward Ave., DETROIT, MICH.

Dealers: Thousands of motorists buy Rex for our attractive offer. It means quick turn-overs and liberal profits.



## Mammoth Jubilee Book Free

Picturing 5152 Home Things  
Make your own Credit Terms—1 to 3 years' time,  
SPIEGEL, MAY, STERN CO., 800 W. 35th St., Chicago

## \$4.50 Offer



Only \$4.50 down brings you the brand new Rex (with 10 years' guarantee) built because world's greatest merchandise house wanted a better machine than any on market. Sent on trial. Typewriter prices smashed! Write today for our big free book and our starting offer. Our big illustrated book is an education in typewriters. Write for it now!  
Rex Typewriter Co., Dept. 1198, LeMoine Bldg., Chicago



**Boy Electrician** with 75 illustrations for making graph apparatus, Telephone, Lights, Bells, Alarms, Coils, Batteries, Current Reverser, Electric Engine, Etc. By Electrical Experts so that anyone can understand it. With Cat. All 10c Postpaid.



**Boys' Own Toy Maker**

Tells how to make a Talking Machine, Camera, Electrical Motor, Bicycle Bell, Canoe, Boomerang, Bobbed, Wind Mill, Microscope, Water Wheel and Motor, Siltie, Toboggan, Snow Coaster and Sail Boat, Telephone, Electric Bell, Railroad, Wind Mobile, Paddle Raft, Traps, Etc., etc. All 10c, postpaid.

## Instructive & Entertaining Popular Books

Chemical Wonders	Fun, Magic & Amusements	10c	How to Play Piano	25c
Secrets & Mysteries	How to Dance (New and old)	25c	" " " " " " " " " " " "	25c
Money-Making Secrets	Vest Pocket Dictionary, Enlarged	25c	" " " " " " " " " " " "	25c
Amateur Electrician	150 Recipes on Latest Songs	10c	Astrology Made Easy	10c
Cosmic Radiation	Clog Dancing Made Easy	10c	Birthday Readings	25c
Yeasting	Hunters' and Trappers' Guide	50c	Collection of 10 National Songs with Music	10c
Bumorous Dialogues	How to become American Citizens	10c	Ready Made Speeches and Toasts	25c
Bumorous Recitations	Egyptian Wish Dream Book	10c	Rare Coin Guide	10c
Complete Letter Writer	Jolly Joker's Joke Book	10c	Book of Great Secrets	25c
Vanderville Joke Book	Minutal Show (Heart to Heart)	10c	Swatler Gardener's Scrap Speeches	25c
Song and Joke Book	Favorite Telling by Cards	25c	How to Play Checkers, Chess and Dominoes	25c
Irish Song & Joke Book	Old Songs and New Discoveries	10c	New Guide to Beauty	25c
Star Toy Maker	Rabbits; How to Breed	10c	How to Play Checkers, Chess and Dominoes	25c
Star Riddle Book	Comic Songs and Recitations	25c		
300 Popular Toasts	Complete Guide to Boxing	25c		
Hoyle's Card Games	Etiquette and Politeness	25c		
Lighting Calculator & Sheet-Cut Arithmetic	Old Dr. Brown's Great Book of Secrets, Tricks, Formulas, etc. (Over 1000 pages)	\$1.00		
Tricks with Colas				

All 10 cent Books 3 for 25c; All 25 cent Books 5 for \$1.00  
J. C. DORN Dept. 17, 707 South Dearborn Street CHICAGO, ILL.

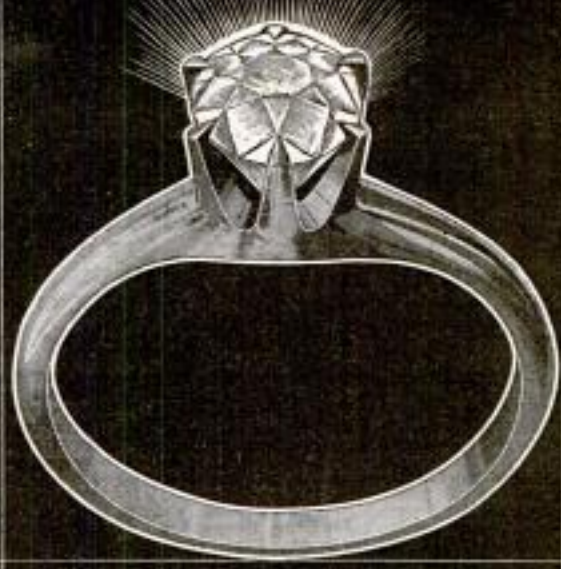

## Compare It With a Diamond

If You Can Tell the Difference  
—Send it Back at Our Expense

THESE new, man-made gems will be a revelation to you. After centuries of research, science has at last produced a gem of dazzling brilliance that so closely resembles the diamond that you'll not be able to distinguish it. You may see it for yourself—without charge. We will send you any of the Lachnite Gems that you may select for a ten days' free trial. We want you to put it to every diamond test. Make it cut glass—stand the diamond file, fire, acid—use every diamond test that you ever heard about. Then, if you can distinguish it from a diamond, send it back at our expense. Write for our new, free jewelry book.

## Pay As You Wish

If you wish to keep the remarkable new gem, you may pay the rock-bottom price at the rate of only a few cents a day. Terms as low as 8 1/2 cents a day without interest. No notes, mortgages or red tape. You pay only the direct, rock-bottom price—a mere fraction of what a diamond costs.

## Set in Solid Gold

Lachnite Gems are never set in anything but solid gold. In our new jewelry book you will see scores of beautiful rings, La Vallieres, necklaces, stick pins, cuff links, etc., etc. from which you have to choose.

## Send Coupon For New Jewelry Book

Put your name and address in the coupon or on a letter or post card now and get our new jewelry book absolutely free. You will be under no obligations to buy anything—or to pay for anything. The jewelry book is free. Send your name and address now.

Harold Lachman Co.  
12 N. Michigan Ave.  
Dept. 1198  
Chicago, Illinois

Harold Lachman Co.  
12 N. Michigan Av.  
Dept. 1198, Chicago

Gentlemen: Please send me absolutely free and prepaid your new jewelry book and full particulars of your free trial, easy payment plan. I assume no obligations of any kind.

Name.....  
Address.....



## A Startling Offer

We will send you this National long model Cornet for a week's free trial. Try it out in your own way, then if you are not perfectly satisfied with it, send it back at our expense.

### You Try It Before You Buy It

After trial if you decide you wish to buy it, and you are convinced it is the greatest value in the world, you can pay the rock-bottom, competition defying price at only a few cents a day. This is the first time in history that this remarkable Cornet or any National Instrument has been offered at rock-bottom factory prices. Send no money, just the coupon at once before this unusual offer expires. We are not dealers or agents — we are manufacturers, and you deal direct with us at the factory-to-you price. The National Cornet is used and endorsed by America's leading Cornetists. Our 33 years' experience plus our 10 year guarantee insures your complete satisfaction. Send the coupon or post card today and you will be astonished at the wonderful offer we are making. Send for our free trial and special circular: you incur no obligations. That's our plan, we rely on your judgment.

**William Frank Company, Manufacturers**  
Dept. S-1, 229-235 W. Austin Ave., CHICAGO, ILL.

#### COUPON

Government: Please send me special circular containing your special "factory-to-you" prices on National Cornets and Trombones absolutely free.

NAME.....

TOWN.....STATE.....

R. F. D.....



**WIFIE WON'T KNOW THE OLD BUS  
IF YOU PAINT IT UP WITH**

## Effecto AUTO FINISHES

Your wife will be proud to ride in your little old last year's car if you give it a coat or two of Effecto. Not a wax or polish, but a durable, quick-drying, high-luster auto enamel, made in seven colors.

Sold by paint, hardware and auto accessory dealers. Send for Color Card. Pratt & Lambert-Inc., 153 Tonawanda Street, Buffalo, N. Y. In Canada, 99 Courtwright Street, Bridgeburg, Ontario.

**MADE BY THE MAKERS OF  
PRATT & LAMBERT VARNISHES**

## DIAMONDS - WATCHES ON CREDIT

EXAMINE OUR GOODS THOROUGHLY BEFORE DECIDING TO PURCHASE. WE PAY ALL SHIPPING CHARGES. IF SATISFACTORY IN EVERY WAY, PAY 20% DOWN, 10% MONTHLY. SEND FOR FREE CATALOG NO. 25. TO-DAY 160 PAGES, 4000 PHOTOS, DIAMONDS, WATCHES, JEWELRY, ETC. IT TELLS ABOUT OUR LOW PRICES, CONFIDENTIAL RELATIONS AND BINDING GUARANTEE. 10% OFF FOR CASH.

1506 \$37.25      3237 \$100      7070 \$25      7078 \$45      9738 \$85      9734 \$50

**JAMES BERGMAN** ESTD 1896      37-39 MAIDEN LANE      NEW YORK CITY

## Mechanics, Engineers and Firemen



Wanted to manufacture Straight-line Metallic Packing for Steam, Air, Gas, Water and Ammonia. Learn an art that will not interfere with your present position, which will help you earn money on the side. This is an entirely new field and is not only a money-maker but a great chance to secure a better position. Write J. G. Streck, Drawer "F," E. Liberty Sta., Pittsburgh, Pa.

## Russel Internal Gear Drive Axle



The most serviceable and economical motor truck axle made. Write for convincing reasons why your truck should be equipped with the Russel Axle.

**RUSSEL MOTOR AXLE COMPANY, Central Ave., North Detroit**

## "DON'T SHAVE YOURSELF"

Until you have tried a "BALIHONE," writes an enthusiastic user. He continues: "Two years ago, after years of torture from imperfectly sharpened razors, a friend brought me a "BALIHONE," and asked me to try it. I knew no more about sharpening razors than a farmer would about cutting out a suit of clothes. My attempts at sharpening were successful from the first and shaving has been a pleasure ever since. I have not been shaved by a barber during this period; I have saved at least \$15.00 in money on sharpening and several times that amount in time and temper. I know that now I am master of the situation; I can have a perfectly satisfactory shave when I want it and no man living has or can have a sharper razor than I. I have used but one razor since getting the BALIHONE. — This is the true testimony of one and we can furnish others of a like character. Prove it yourself.

**Hone and Strip It Yourself!** Regular or safety. New idea. New principle in the Balihone. Makes your old razor as good as new. Makes your safety blade better than new. Produces a marvelous edge every time. You can't fail with it. Send for one today and make your shaving a joy. The Balihone is a hone and a strip all in one. It will make your poor razor shave beautifully. Size of Balihone 6 1/2 in., weight 3 oz.

**Very Popular with Army and Navy Men**

PRICE, \$1.00 — With Holder for Safety Blades, \$1.25. AGENTS WANTED  
**BALIHONE COMPANY, 1403 Conway Building, CHICAGO, ILL.**



USING ORDINARY RAZOR

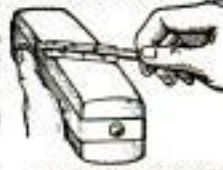

USING SAFETY RAZOR

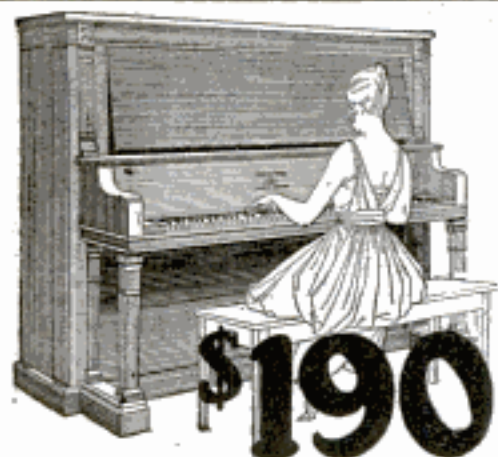

**\$190**

**Three Years to Pay**  
for the beautiful

## MEISTER PIANO

and a guaranteed saving of  
**\$100 to \$150**

Eight exquisite styles to choose from and  
the one you select will be sent to you on

**30 DAYS' FREE TRIAL—  
ALL FREIGHT PREPAID**

If you like the piano we will sell it on  
**Small Monthly Payments**

To suit your convenience  
**AS LOW AS \$1.00 PER WEEK**

No cash deposit asked. No interest  
on payments. No extras of  
any kind. Stool and scarf FREE.

Write today for our 100-page catalog illustrated in  
the natural colors of the wood. It's FREE.

**ROTHSCHILD & COMPANY, Dept. J-16, CHICAGO, ILL.**

## Has The Motor Boat Bug Got You?



Health and happiness are assured with one  
of the new popular priced Gray motors in  
your boat. Select your boat from our 1917  
Boat Builders Catalog showing products of  
200 leading boat builders. Select your  
engine from our new complete Engine  
Catalog. Both books FREE. Send today.  
**GRAY MOTOR COMPANY**  
1146 Oakland Ave., DETROIT, MICH.



## Thief Proof

Put your valuables in this **SAFETY ALARM BOX**.  
Leave it anywhere. It can't be stolen. It can't be opened  
or tampered with. Absolute safety. You can carry it  
around. A thief can't. Write for special introductory  
price on this marvelous new safety invention.

### PROTECT YOUR VALUABLES

At a trifling cost now you can protect jewelry, money and  
valuable papers. Safety Alarm Box pays for itself over again  
every year. Made of metal in handsome design, mahogany  
finish. Lasts forever. Write for special low introductory  
price and all particulars. Write today.

**Agents Wanted.**

**DRIVER-DORSETT COMPANY**  
140 S. Dearborn Street CHICAGO, ILLINOIS

# Here's Health and Power— Vim and Vigor



Do you want them?

Strength that is more than

mere muscular strength. The  
strength of better health, abun-  
dant nerve force. The strength of  
keen relish. Write and find out  
what vibration will do for you.  
Nine out of ten people are only  
half alive. How about yourself?  
Do you feel just right? If you  
haven't that vigorous "go ahead"  
feeling all the time, don't fail to  
send the free coupon today for our  
big new book that will tell you all about

## THE WHITE CROSS ELECTRIC VIBRATOR



Our Combination

Outfits give you three  
of the greatest curative

agents—Vibration, Faradic  
and Galvanic electricity.

We will send this wonder-  
ful machine to you  
on free trial. See it—try  
it—feel its health-giving  
vibrations for yourself.  
White Cross Electric Vi-  
brators can be connected  
up as easily as electric  
lamps, or, if your home is  
not wired for electricity,  
they will operate on their  
own dry cells.

## Vibration Is Life

In vibration there exists  
many of the secrets of life. The  
safest, surest and quickest way to  
recover normal health is by scienti-  
fic manipulation of the organs  
affected and in this way stimulat-  
ing them to perform their duties,  
whether it be those of digestion, res-  
piration, circulation, or the nervous  
system. The rich, red blood will be  
sent coursing through every vein and artery.  
Write today—now—for our free book.



### Send the Free Coupon

Just your name and address on  
the free coupon or a letter or a post-  
card is enough. We will send you  
absolutely free and prepaid, our new  
book, "Health and Beauty." It's  
free. No obligations of any kind.  
Write today—at once.

**Lindstrom, Smith Company**  
1100-1110 South Wabash Avenue  
Dept. 1198 Chicago, Illinois

We also manufacture White  
Cross Electric Stoves, Irons,  
Hair Dryers, Electric Lan-  
terns, Electric Fans, Elec-  
tric Automobile Horns,  
Electric Curling Irons,  
Heating Pads, Small  
Motors, etc., etc.  
Dealers write.

**Lindstrom,  
Smith Co.**

1100 S. Wabash Ave.  
Dept. 1198 Chicago

Please send me, abso-  
lutely free and prepaid,  
your new book, "Health  
and Beauty" and full particu-  
lars about the White Cross  
Electric Vibrator. I assume no  
obligation of any kind.

Name.....

Address.....

My Electrical Dealer's Name is.....

Please Mention Popular Mechanics

<p>999</p>  <p>2 VOLTS 10 AMP</p>	<p>Electrical Cyclopedia</p>  <p>FREE</p>	<p>9204</p> 	<p>103</p> 	<p>2904</p> 
<p>Chloro Plunge Battery for students. Wt. 1 lb. \$0.50</p>	<p>FREE. 228 page cyclopedia, 400 illus. See below</p>	<p>Airtel House phone, with bell. Wt. 3 lbs. \$2.50</p>	<p>Exper. Elect. Course in 20 lessons, 168 pages. Prep'd \$0.55</p>	<p>2 real telegraph instruments, codes, wire, etc. Learn telegraphy in 30 days. Wt. 2 lbs. Set \$1.25</p>
<p>310</p>  <p>8 VOLTS 10 AMP</p>	<p>1800</p>  <p>E. I. Co. N. Y.</p>	<p>5000</p> 	<p>1024</p> 	<p>1355</p> 
<p>8 Volt 10 Amp. Dynamo. Battery charging and lighting, wt. 20 lbs. \$11.00</p>	<p>Silent High Frequency Test Buzzer. Wt. 1 lb. \$0.90</p>	<p>Rheostat Regulator, Porcelain base. Wt. 1 lb. \$0.90</p>	<p>Real Telephone Receiver. Wt. 1 lb. \$0.50</p>	<p>Boutaniere Bag light. Works on any flashlight. Wt. 4 oz. \$0.60</p>

# BOYS

When ordering any of the above include postage, else goods go by express collect. Ship'g wts. are given. Goods shown here are only a fraction of our wonderful assortment illustrated and described in our famous 228-page Cyclopedia Catalog containing 400 illustrations, Treatise on Wireless Telegraphy, Code Chart and 20 coupons for Free Wireless Course. Cyclopedia sent free for 4c to cover postage only. Send for your copy today.

THE ELECTRO IMPORTING COMPANY, 245 Fulton Street, NEW YORK CITY, N. Y.

## MARVELOUS CAMERA! VALUE!



### Latest Vest Pocket Rexo

Selected Universal Focus  
Meniscus Achromatic Lens

**\$6<sup>66</sup>** Here is the New Baby Wonder of the camera world. Remarkably light. Weighs only 8 oz. Takes pictures 1 5/8" x 2 1/2" on any standard roll film. Eight exposures, 18c. No Focusing. Speeded shutter. Anyone can get good results with this

"Every Click a Picture" camera. The Ideal Camera for the Soldier—for everybody. Carry it conveniently in your pocket all the time.

### America's Camera Headquarters

We have everything you need in the photographic line—at Bargain Prices. Save Money on all "Good Things" in the camera line. Write today for our famous book of 1001 Bass Bargains. A copy Free to you on request.

**BASS CAMERA CO.**  
107-J Dearborn St.  
CHICAGO, ILL.



**Ives Toys**  
Make Happy Boys

### Here You Are Boys!

Throw open the throttle of that big, powerful Ives locomotive, with its long, low, streamline body—the very latest type. Watch the big driving wheels spin. She's off! See her pull that train along. Now work that switch! She's crossing over! Press it again! She's slowing up! Now she's stopping at the station.

Get an Ives Train and track. Ask your folks for one for Christmas. Passenger cars, freight cars, coal cars, cabooses—just like real. Electric and mechanical locomotives—bridges and signals that you can build yourself with Ives Struktiron. Write for FREE FOLDER today, and name of Ives dealer near you.

The Ives Manufacturing Corporation  
202 Holland Ave., Bridgeport, Conn.

### Boys! Get This Book

A really gorgeous book, with big pictures of trains in real colors and colored designs used in the cars. Tells about electricity and history of Ives Trains. Send five 2c stamps for it to pay postage, packing, etc.



## WATCHES — WATCHES — WATCHES

The lowest price and best terms for standard makes, including the famous 19-jewel Illinois Rockland. SEND FOR ACTUAL PHOTOGRAPH—SHOWS CASE AND MOVEMENT.

**LENOX JEWELRY CO.** 373 Washington St., BOSTON, MASS.

Our prices on easy payment plan are lower than others charge for cash.

# SUGAR—4c



## Gold Medal Flour \$8.50 PER BBL. MONEY BACK IF NOT MORE THAN PLEASED

Read every word of this advertisement. It shows you how to SAVE MONEY on groceries. Our Grocery Bargain Catalogue is included free with your first order. Economy is the national watchword. We serve you better, save you money. We eliminate waste by sending our catalogue only to those who can prove to us that they are interested in saving money on their grocery purchases.

## Our Enormous Business      Our Price-Saving Plan

in Groceries, buying as we do for more than a hundred thousand families, enables us to maintain our high standard of quality, and at the same time quote prices so low that we have no competition.

Why continue to pay big prices and unnecessary profits to dealers when you can buy better goods from us at nearly half the prices you pay elsewhere?

**Don't Forget!** We do not send our Bargain Catalogue until we receive your trial order, nor do we sell a part of the order nor any one article mentioned in the list separately. The Ford plan of selling automobiles is our plan in selling groceries. We serve all well by serving all alike.

Rush your trial order by return mail. It will put you on our permanent list of careful grocery buyers. It will bring you our catalogue and our bargain bulletins. Strike the first blow today in the battle against increasing grocery costs.

## GUARANTEE

### When You Receive These Groceries

call in your friends to examine them, and if you do not all agree the groceries are entirely satisfactory in every way, and just what you expected to get, and at much lower prices than you can get elsewhere; if you do not find you have saved money, simply return the entire shipment to us and we will immediately refund your money.

We reserve the right to return any money tendered us in payment of goods contrary to our selling plan. REFERENCES: Independence State Bank of Chicago, Dun, Bradstreet.

## MONEYWORTH WHOLESALE GROCERS

DEPT. E-38

Cor. 14th and Ashland, CHICAGO, ILL.

Send us \$2.99 for the following Trial Order and we will then know that you mean business, and we will include with your order our Bargain Grocery Catalogue and Monthly Bargain Bulletins, in which you will find big grocery bargains and save many dollars.

## \$2.99 Grocery Assortment E-38

Approximate Retail Price	Approximate Weight, 16 lbs.	Our Wholesale Price to You
\$0.50	5 lbs. Pure Cane Granulated Sugar	\$0.20
.12	1 Large Size Package Quaker Oats	.06
.08	1 Package Uneeda Biscuits	.02
.08	1 Bar Ivory Toilet Soap	.03
.15	1 Can Campbell's Tomato Soup	.08
.07	1 Bar Kirk's Flake White Laundry Soap	.02
.07	1 Bar American Family Soap	.02
.25	1 Can Sardines, La Paris Brand, French Style, smoked and spiced, fried in best oil. Very appetizing	.14
.90	2 lbs. Moneyworth Brand Coffee	.70
.80	1 lb. Tea, highest grade, uncolored, Japan	.57
.50	1 lb. Guaranteed Baking Powder	.39
.39	1 Bottle Family Concentrated Bluing, 4 ounce bottle, equal to one gallon ordinary bluing	.23
.60	1 lb. Pure High-Grade Breakfast Cocoa	.33
.50	1/2 lb. Pure Ground Cinnamon	.20
\$5.01	Our Special Catalog Free!	\$2.99
	Our Wholesale Price to You	\$2.99
	Approximate Saving to You of \$2.02	

### MONEYWORTH WHOLESALE GROCERS,

Dept. E-38, Ashland and 14th St., Chicago, Ill.

Gentlemen:—For the enclosed \$2.99 you may send me your special Trial Bargain Assortment, Catalogue of grocery bargains and future Bargain Bulletins as issued. This order is given with the understanding that if I am not perfectly satisfied, the entire order may promptly be returned to you and you will at once refund my money plus all transportation charges and postage. State whether you want order by express or freight.

Name .....

Address .....

City..... County.....

State..... R. F. D.....

Express..... What Railroad?.....

NOTE—The above firm is thoroughly reliable and will do exactly as they advertise. You are perfectly safe in ordering from them.—Independence State Bank of Chicago



Ignatius Barnard, Pres't.



**\$88**  
PER  
CARAT

# DIAMONDS

Direct from **Barnard & Co.**  
**Diamond Headquarters**

at **World's Lowest Prices**

Here are the secrets of my money-saving prices on diamonds: With my world-wide business of tremendous volume, I can buy direct from the cutters of Europe, then resell direct to you at the smallest margin of profit. I have eliminated all middlemen—all waste—in the selling of diamonds and guarantee that you cannot match my prices anywhere, wholesale or retail. If you don't see a saving of 35% in the diamond I send you for free examination, send it back.

## Send No Money!

Merely send for my beautiful Diamond Book—select the diamond and mounting of your choice, and I'll ship it for your inspection—at my expense and without obligating you to buy. As we get all our business in this way our success proves our prices lowest by comparison.

## Bankable Money Back Guarantee

The only bankable Money Back Guarantee in the diamond business. You can take it to any bank and cash in on your diamond investment if you want to. The only guarantee without red tape, delays or evasions. It is also a legal certificate of carat weight, quality and value of the diamond. Allows you to exchange it at full value at any time.

## 1918 De Luxe Book **FREE** of DIAMONDS

Profusely illustrated in colors. Shows thousands of the greatest bargains in diamonds. Tells you all about diamond qualities, colors, imperfections. Shows every fashionable and popular style of mounting in 14K solid gold and platinum at actual factory cost. Also all sizes of diamonds in 7 different qualities at import prices. Free for the asking.

Ignatius Barnard, Pres.

## Barnard & Co. Diamond Headquarters

N. W. Cor. State and Monroe Sts.  
Dept. 3388C  
Chicago, U. S. A.

Please Mention Popular Mechanics

**\$88**  
Per Carat.  
Blue White, perfect cutting, good brilliancy. Worth \$250 per carat.  
1-4 C \$15.95  
1-2 C 40.25  
3-4 C 64.25

**\$133**  
Per Carat.  
Extra Blue White, perfect cutting, extra brilliancy. Worth \$350 per carat.  
1-4 C \$25.00  
1-2 C 60.00  
3-4 C 90.00

**\$177**  
Per Carat.  
Wassillon Steel Blue White, perfect cutting. Slight perfect.  
1-4 C \$27.00  
1-2 C 71.00  
3-4 C 115.00

**\$233**  
Per Carat.  
Roberts Victor Steel Blue, perfect cutting, first quality eye perfect.  
1-4 C \$30.00  
1-2 C 75.00  
3-4 C 105.00

**\$288**  
Per Carat.  
Rare Jaeger-Johnson Violet Blue, absolutely perfect and better than first quality.  
1-4 C \$42.00  
1-2 C 110.00  
3-4 C 200.00

14K Solid Gold 1-4C Steel Blue White \$30.00	14K Solid Gold 1-2C Wessillon Blue White \$79.50
14K Solid Gold 1-2C Extra Blue White \$41.50	14K Solid Gold 1-2C Jaeger Blue Perfect \$121.50
14K Solid Gold 1-2C Rare Steel Blue \$62.50	14K Solid Gold 1-2C Extra Blue White \$80.00
7 fine quality Best Blue White Diamonds, platinum cluster, 14K ring \$70 size \$44.88	7 Diamond cluster, finest Blue White Diamonds, platinum, 14K ring \$110 size \$67.13
14K curved rose finish ring, 1-2C Blue White Diamond \$35.88	14K Solid Gold Ring, 1-2C Steel Blue Diamond \$109.88
14K Solid Gold Ring, 1-2C Steel Blue Diamond \$59.88	14K Solid Gold Ring, 1-2C Rare Steel Blue Diamond \$172.50

**FREE** DIAMOND BOOK COUPON  
BARNARD & CO., Dept. 3388C  
N. W. Cor. State & Monroe Sts., Chicago  
Without expense to me or the slightest obligation please mail 1918 De Luxe Book of Diamonds to

NAME.....  
ADDRESS.....  
CITY..... STATE.....





## One Father Writes of **BILLIARDS** "We've a Full House All the Time!"

Put a Brunswick Carom or Pocket Billiard Table in your home and watch how quickly it surrounds your boys and girls with good companions.

Young people idolize Home Billiards. And these princely contests act as a tonic on older folks.

Carom and Pocket Billiards are never twice alike, but ever enlivened by friendly jest and laughter. Among life's most enduring memories are the happy hours and comradeship of billiards.

### **BRUNSWICK** **HOME BILLIARD TABLES**

Even the cottage or small apartment has room for a genuine Brunswick. And it gives you *scientific* Carom and Pocket Billiards—life, speed and accuracy!

The "Baby Grand" is a home-size regulation table for spare rooms, attics, basements and private billiard rooms.

The "Quick Demountable" can be set up anywhere and easily folded away when not in play.

See these tables in handsome color reproductions, get our low prices, easy terms and home trial offer. All contained in our new billiard book. Send your address at once for free copy.

### **THE BRUNSWICK-BALKE-COLLENDER CO.**

Dept. 56C, 623-633 S. Wabash Ave., Chicago

DEALERS: Write at once for attractive agency proposition.

#### **Low Prices, Easy Terms Balls, Cues, Etc., Given**

Brunswick prices today are extremely low for tables of such masterly construction and beauty.

Our Popular Purchase Plan lets you play while you pay.

With every table we give a high-class Playing Outfit Free—Balls, Cues, Rack, Markers and Expert Book of 33 Games, etc.

#### **Send for Billiard Book Free**

#### **THE BRUNSWICK-BALKE-COLLENDER CO.**

Dept. 56C, 623-633 S. Wabash Ave., Chicago

You may send me free copy of your color book—

#### **"Billiards—The Home Magnet"**

and tell about your home trial offer.

Name .....

Address .....

Please Mention Popular Mechanics



## HARNESSING *the* MOUNTAIN to Conquer the Mountain

THE mountains, for years almost impassable barriers to transportation, have been made to yield their limitless store of energy to the service of man.

The tremendous forces of mountain torrents have been fitted to the yoke of achievement and now furnish the power that hauls the great all-steel trains of the "*St. Paul Road*" across the backbone of the continent—440 miles through the Belt, Rocky and Bitter Root Mountains. An additional 211 miles is being electrified through the Cascade Mountains in Washington.

When next you journey to the cities of the Pacific Northwest travel electrically on either of those famous trains "*The Olympian*" or "*The Columbian*."

Mountain travel without cinders—without jar or grinding brakes. Snow-clad vistas unobscured by trailing smoke, via the

## Chicago, Milwaukee & St. Paul Railway

*Electrification literature giving full particulars of this momentous achievement sent on request to*

F. A. MILLER  
Passenger Traffic Manager  
CHICAGO



*Please Mention Popular Mechanics*

# The Oliver Typewriter

**WAS  
\$100**

**A \$2,000,000  
GUARANTEE**

**NOW  
\$49**

## That This \$49 Typewriter was \$100 The Sales Policy Alone Is Changed. Not the Machine

The Oliver Nine—the latest and best model—will be sent direct from the factory to you upon approval. Five days' free trial. No money down—no C.O.D. No salesmen to influence you. Be your own salesman and save \$51. Over a year to pay. Mail the coupon now.

On March 1st we announced the Oliver Typewriter Company's revolutionary plans. On that date we discontinued an expensive sales force of 15,000 salesmen and agents. We gave up costly offices in 50 cities.

### Prices Cut in Two

By eliminating these terrific and mounting expenses, we reduced the price of the Oliver Nine from the standard level of \$100 to \$49. This means that you save \$51 per machine. This is not philanthropy on our part. While our plan saves you much, it also saves for us.

### The Identical Model

The Oliver Typewriter Company gives this guarantee: The Oliver Nine we now sell direct is the exact machine—our latest and best model—which until March 1st was \$100.

This Oliver Nine is a twenty-year development. It is the finest, the costliest, the most successful model that we have ever built.

More than that, it is the best typewriter, in fifty ways, that anybody ever turned out. If any typewriter in the world is worth \$100, it is this Oliver Nine.

Over 600,000 have been sold. This is the same commercial machine used by the U. S. Steel Corporation, the National City Bank of N. Y., Montgomery Ward & Co., Morris & Co., Packers, the Pennsylvania Railroad and a host of others.

### Simplified Selling

Our new plan is extremely simple. It makes it possible for the consumer to deal direct with the producer.

You may order from this advertisement by using the coupon below. We don't ask a penny down on deposit—no C. O. D.

When the typewriter arrives, put it to every test—use it as you would your own. If you decide to keep it, you have more than a year to pay for it. Our terms are \$3.00 per month. You are under no obligation to keep it. We will even refund transportation charges if you return it.

Or if you wish additional information, mail coupon for our proposition in detail.

### Don't Pay \$100

Why now pay the extra tax of \$51 when you may obtain a brand new Oliver Nine—a world favorite—for \$49? Cut out the wasteful methods and order direct from this advertisement. Or send for our remarkable book entitled, "The High Cost of Typewriters—The Reason and the Remedy." You will not be placed under the slightest obligation.



### The Oliver Typewriter Company 1098 Oliver Typewriter Building, Chicago, Ill.

NOTE CAREFULLY—This coupon will bring you either the Oliver Nine for free trial or further information. Check carefully which you wish.

**MAIL  
TO-DAY**

#### THE OLIVER TYPEWRITER CO. 1098 Oliver Typewriter Bldg., CHICAGO, ILL.

Ship me a new Oliver Nine for five days' free inspection. If I keep it, I will pay \$49 at the rate of \$3 per month. The title to remain in your name until fully paid for.

My shipping point is.....  
This does not place me under any obligation to buy. If I choose to return the Oliver, I will ship it back at my expense at the end of 5 days.

Do not send a machine until I order it. Mail me your book—"The High Cost of Typewriters—The Reason and the Remedy," your de luxe catalog and further information.

Name.....

Street Address.....

City.....State.....

**This Coupon Is Worth \$51**

The *New* Shaving Stick

# COLGATE'S "HANDY GRIP"

COLGATE'S "Handy Grip" combines economy, convenience, speed, and comfort better than any other shaving preparation. We couldn't improve the soap, so in each detail of economy and convenience we improved the box to make it worthy of its contents.

The central illustration shows a cylindrical metal container for the shaving stick. The text on the container reads "COLGATE & CO. HANDY GRIP SHAVING STICK".

Four instructional panels are arranged around the container, each with a title "HANDY GRIP" and a diagram of a hand using the product:

- Top Left Panel:** Shows a hand unscrewing the cap. Text: "Unscrew the last of the stick—no waste".
- Top Right Panel:** Shows a hand inserting a stick into the container. Text: "Stick it on the new stick — and save 20%".
- Bottom Left Panel:** Shows a hand holding a small container. Text: "'Refills' can be bought for less than the complete Grip".
- Bottom Right Panel:** Shows a hand turning the cap. Text: "One turn of the Grip locks it securely".

**The Last Word in Shaving  
Convenience & Economy**  
A "Handy Grip" should be in every soldier's kit